

Wireless World

RADIO AND ELECTRONICS

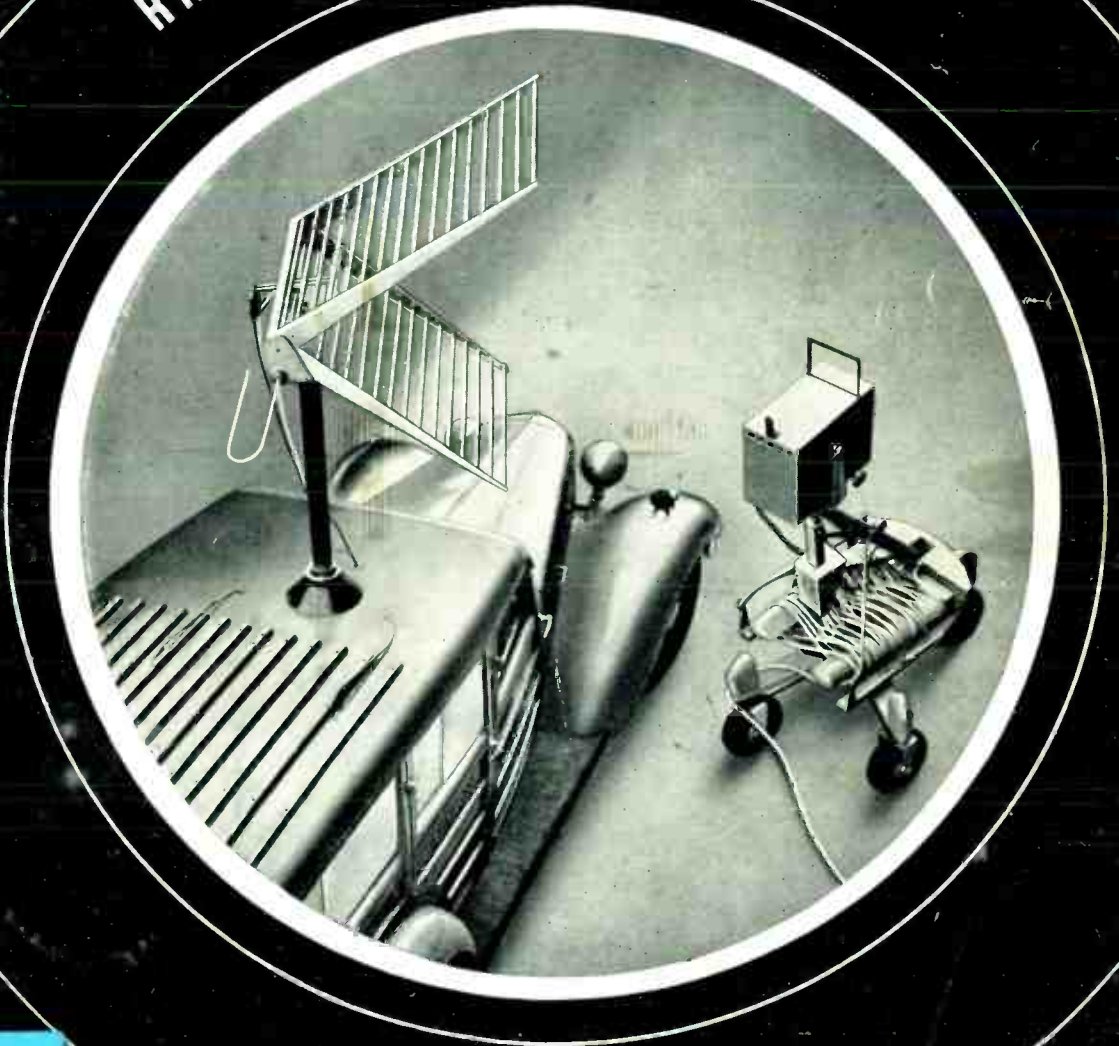

JULY 1947

1/6

Vol. LIII. No. 7

IN THIS
ISSUE :

WIRELESS FOR TRUNK COMMUNICATIONS

NATIONAL SALES SERVICE

B.I. Callender's

BRITISH INSULATED CALLENDER'S CABLES LIMITED
 NORFOLK HOUSE, NORFOLK STREET, LONDON W.C.2

B. I. Callender's National Sales Service covers the British Isles. There is an office in your district fully staffed and equipped to meet the special needs of the radio industry in the area.

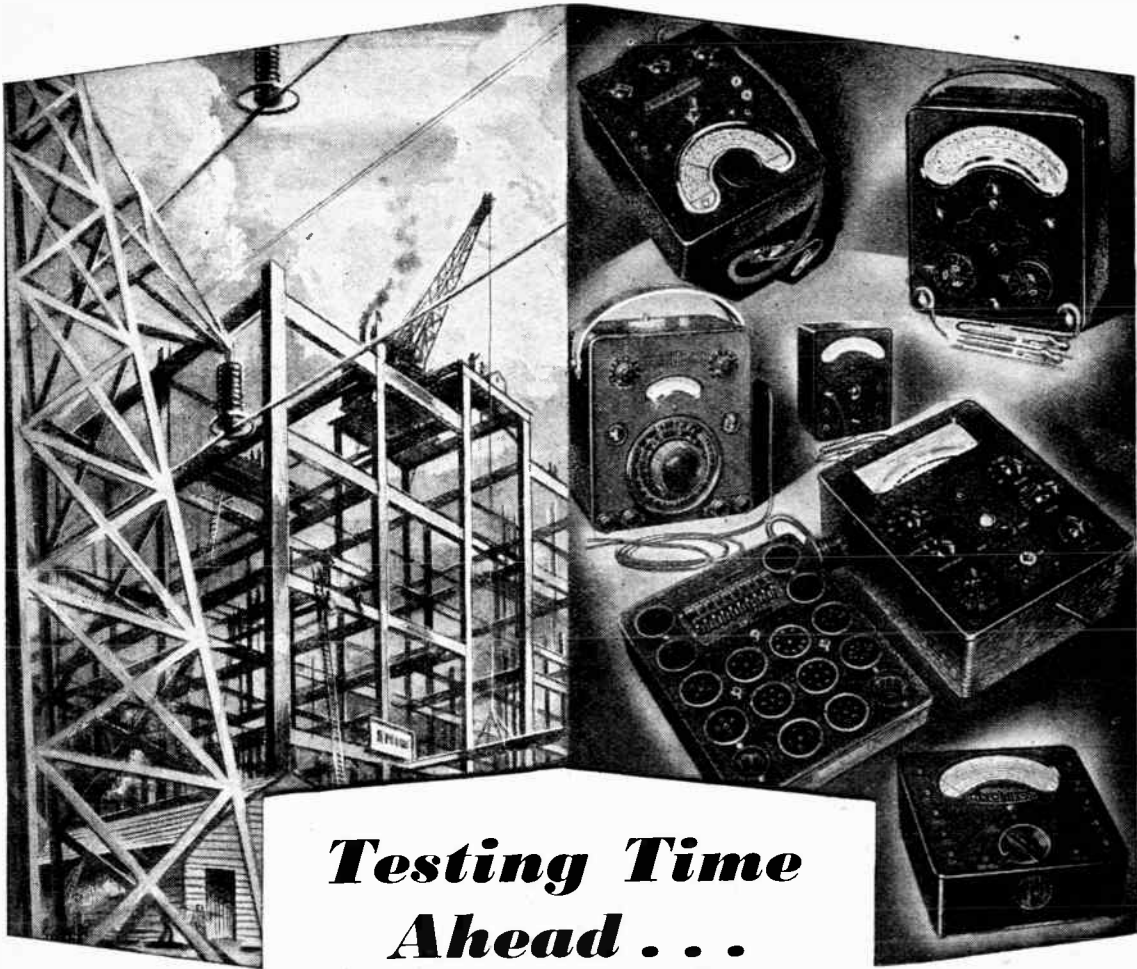

Testing Time Ahead . . .

RECONSTRUCTION, as we now know too well, means something other than enjoyment of the non-existent fruits of victory. The amenities of a world at well-earned peace are not for us until we have replaced the ravages of war with the necessities of life and the realities of universal peaceful intent for victors, victims and vanquished alike. That is speaking collectively . . . For ourselves, we learned much and progressed far in the six years of ceaseless toil, urged on by dire necessity and peril. We are not resting now. We are still pressing on, pressing into the service of those engaged in rebuilding the body and soul of a whole world the knowledge gained, the advancements perfected, the skill and craftsmanship that outmatched the efforts of our enemies.



Regd. Trade Mark

PRECISION ELECTRICAL MEASURING INSTRUMENTS

Sole Proprietors and Manufacturers:

THE AUTOMATIC COIL WINDER & ELECTRICAL EQUIPMENT CO. LTD., Winder House, Douglas Street, London, S.W.1.

Phone: VICTORIA 3404/9

"Avo" Electrical Testing Instruments set a standard by which other instruments are judged.

- THE UNIVERSAL AVOMETER
- THE "AVO" ALL-WAVE OSCILLATOR
- THE "AVO" VALVE TESTER
- THE "AVO" TEST BRIDGE
- THE UNIVERSAL AVOMINOR
- THE D.C. AVOMINOR
- THE "AVO" LIGHT METER
- THE "AVO" EXPOSURE METER
- Etc., Etc.

Catalogues on application.



Opening of the new world of adventure

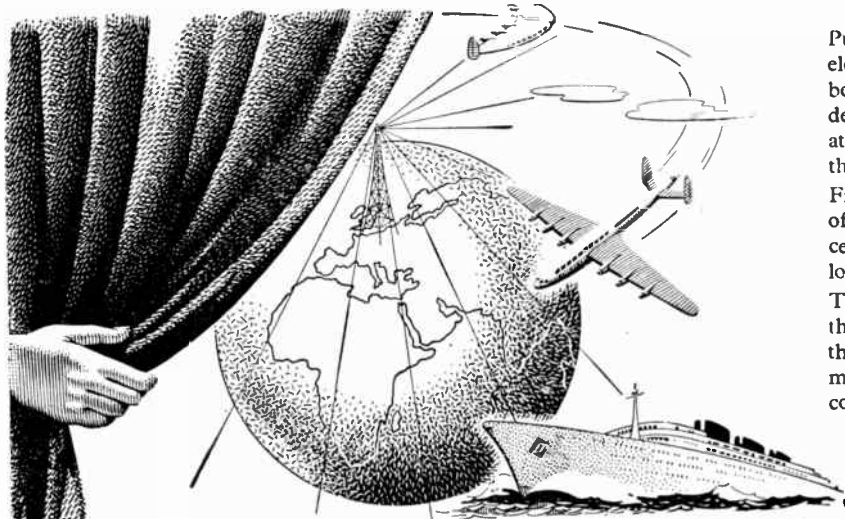

Pull back the curtain on the age of electronics—the era of industry that began with the end of the war. The development of new services on land, at sea and in the air are all part of the Marconi post-war plan.

From the first great adventure of wireless communication half a century ago Marconi's have never looked back.

Today they are looking *forward*—to the reconstitution of old services and the introduction of new achievements in the world of wireless communications.

MARCONI

THE GREATEST NAME IN WIRELESS



MARCONI'S WIRELESS TELEGRAPH CO., LTD.

THE MARCONI INTERNATIONAL MARINE COMMUNICATION CO., LTD.

MARCONI HOUSE, CHELMSFORD, ESSEX



The PIFCO ALL-IN-ONE RADIOMETER

tests everything electrical
**RADIO, HOUSEHOLD APPLIANCES
& MOTOR CAR LIGHTING ETC!**

25/-

Ask your local Factor to show you one of these remarkable instruments and to put your name down on his waiting list.

The new S.P. Catalogue

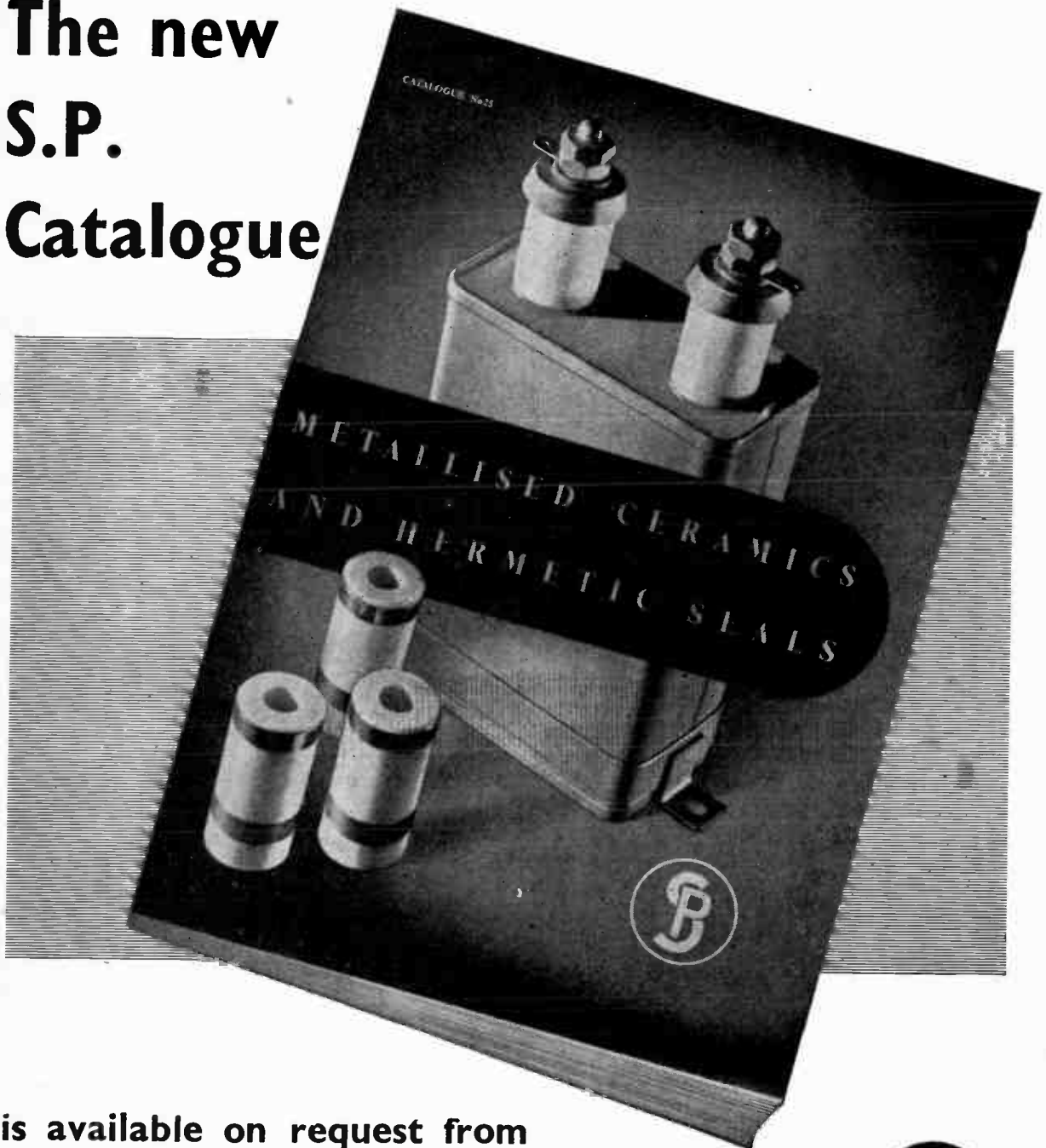

is available on request from

STEATITE & PORCELAIN PRODUCTS LTD.

Stourport on Severn, Worcs. Telephone: Stourport III. Telegrams: Steatoin, Stourport.



S.P.48



*If your radio set
has been letting
you down*

'HAVE-A-GO'
with

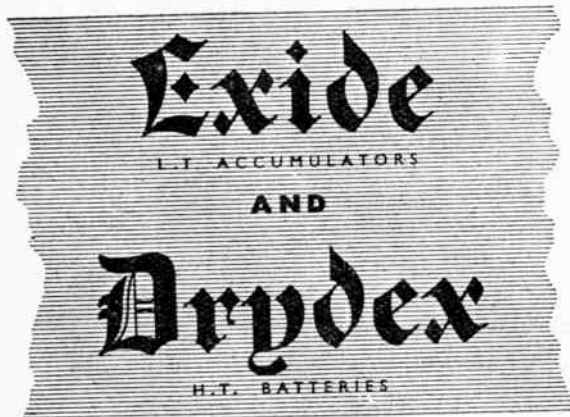

PRODUCTS OF
THE CHLORIDE ELECTRICAL STORAGE COMPANY LTD
EDx8A

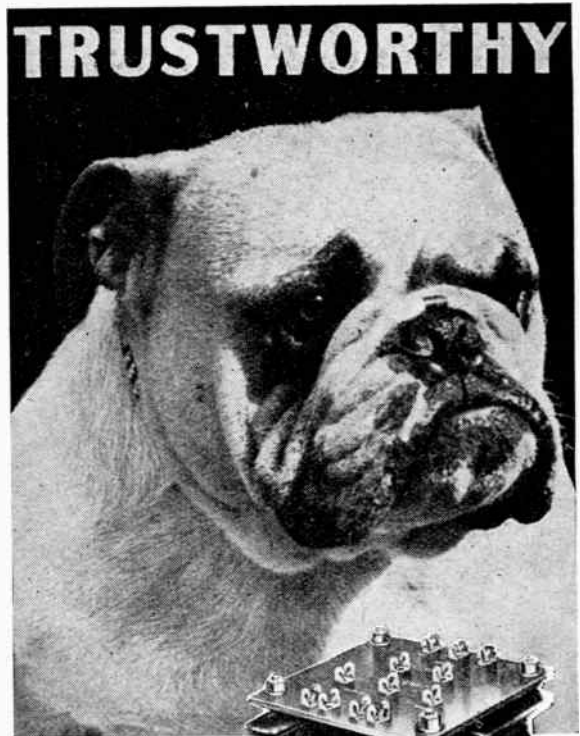

British to the backbone, and thoroughly dependable under all circumstances—no wonder Gardners Somerford mains Transformers and Chokes are specified in installations where reliability is imperative.

The range comprises 45 mains Transformers and 27 Chokes, covering all normal needs and available for IMMEDIATE DELIVERY.

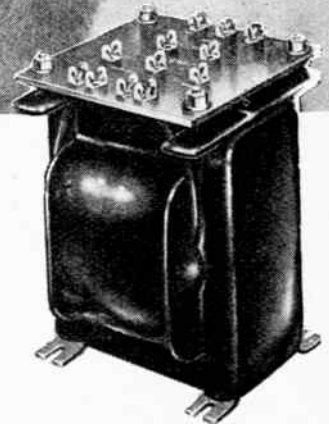

GARDNERS
"Somerford" MAINS
TRANSFORMERS
AND CHOKES

COUPON

Please send leaflets describing Somerford Transformers and Chokes

NAME

ADDRESS

GARDNERS RADID LTD., SOMERFORD, CHRISTCHURCH, HANTS.

FOR RADIO • INDUSTRY • LABORATORY

POINTERS FOR DESIGNERS

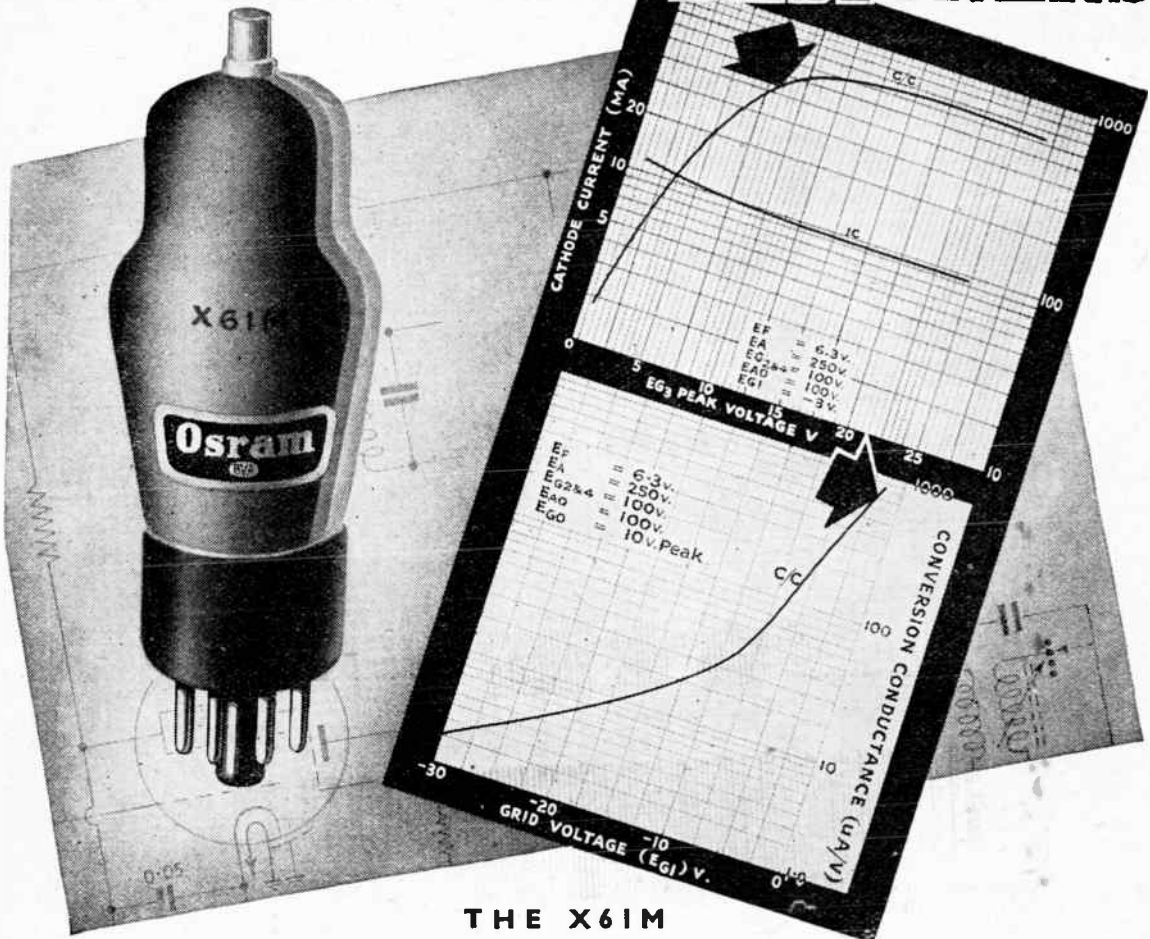

THE X61M

An indirectly heated 6.3v. frequency changer of the Triode-Hexode type, the OSRAM X61M is suitable for operation up to 60 megacycles per sec. (5 metres). Outstanding features include:—

- High conversion conductance for comparatively low cathode current, improving signal to noise ratio.
- Signal handling capacity is such that negligible distortion is apparent up to 5 volts R.M.S. on the signal grid.
- Negligible "pulling" when tuned anode oscillator is used, making ganging of tuned circuits easy.
- Control characteristic is designed to work in combination with KTW61 as IF amplifier, giving maximum control on both valves with negligible distortion.

A detailed technical data sheet is available on request.

Osram
PHOTO CELLS

G.E.C.
CATHODE RAY TUBES

Osram
VALVES

Adv. of The General Electric Co. Ltd., Magnet House, Kingsway, London, W.C.2

THE PROBLEM OF THE LABORATORY BATTERY

solve it simply and easily by installing a

WESTAT

FULLY AUTOMATIC RECTIFIER EQUIPMENT

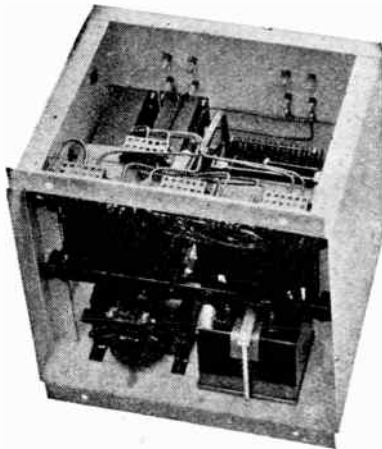

250-watt* equipment with cover removed to show internal construction. No gas discharge tubes, barreters, D.C. saturated chokes or relays.

- Battery automatically maintained in a charged and healthy condition despite erratic loads.
- Battery cannot be overcharged even if left unattended for very long periods. Maximum cell voltage is accurately controlled.
- Battery cannot gas and, therefore, will not give off corrosive spray. "Topping-up" is seldom required.
- Battery cannot be overdischarged — the "Westat" automatically provides a heavy charge when battery voltage is low.
- Battery life prolonged without any added attention.
- Fully compensated for mains voltage variation.

* Made in a range of sizes with outputs from 40 to 1800 watts

Write for descriptive pamphlet No. 11L to Dept. W.W.

WESTINGHOUSE BRAKE & SIGNAL CO. LTD.
82, YORK WAY, KING'S CROSS, LONDON, N.1

Radio in every room with these
NEW & BETTER
Extension Speakers

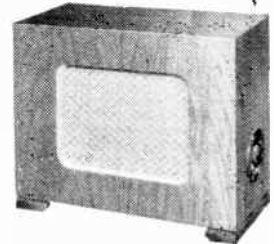

Have you joined that ever increasing number of listeners who enjoy the pleasure and convenience of "radio in every room" with the NEW and BETTER Stentorian Extension Speakers?

Though moderately priced, the Senior and Junior models with their handsome walnut veneered cabinets offer you a marked improvement in reproduction and are an acquisition to any furniture scheme.

ASK your local dealer to demonstrate — you will be convinced of the outstanding quality of these new Stentorian speakers.

SENIOR MODEL
Type SC. - £5 15 6
Type SX. - £5 2 6
Speaker, 9" diameter, handling capacity 7 watts.
Magnet, flux density 12,000 lines/sq. cm.
JUNIOR MODEL
Type JC. - £5 0 0
Type JX. - £4 10 6
Speaker, 8" diameter, handling capacity 6 watts.
Magnet, flux density 10,000 lines/sq. cm.
"X" models minus transformer



Stentorian

THE FINEST EXTRA SPEAKER FOR ANY SET
WHITELEY ELECTRICAL RADIO CO., LTD., Mansfield, Notts.



5 mmf/ft

NEW LOW LEVELS in capacity and attenuation of CO-AX Cables mean new possibilities in electronic equipment design both for the war effort and for the post-war electronic age.

Write for characteristics

BASICALLY BETTER AIR-SPACED

CO-AX LOW LOSS CABLES

TRANSRADIO LTD. 16 THE HIGHWAY BEACONSFIELD 4 BUCKS

DUBILIER PRECISION WIRE WOUND RESISTORS

The remarkable accuracy of the DUBILIER PRECISION WIRE WOUND RESISTOR is due to its scientific construction. A slotted high insulation ceramic former is wound with enamelled resistance wire of not less than 0.0014" diameter. During winding the wire is subjected to tests to eliminate accidentally shorted turns and to ensure the essential high standard of insulation between turns. Contact between resistance element and terminals is by the exclusive DUBILIER moulded metal method which removes the possibility of weak, non positive or noisy connections. All units are suitable for use up to 50 Kc/s. Full technical details on request.

DUBILIER CONDENSER CO. (1925) LTD · DUCON WORKS · VICTORIA ROAD · N. ACTON · LONDON · W.3
 Telephones: ACOrn 2241 (5 lines) Telegrams: Hivoltcon, Phone, London. Cables: Hivoltcon, London. Marconi International Code
 D.10

MORE THAN
1,500 DIFFERENT TYPES
**machine
tools**

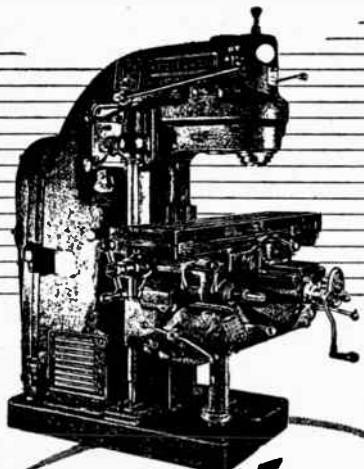

**AVAILABLE
NOW!**

Government Surplus machine tools available NOW at attractive prices. YOUR opportunity to get better equipment and increase production.

DISPOSAL CENTRES, where records of all machines available may be inspected, are open to the public for enquiries from 10 a.m. to 4 p.m. Monday to Friday inclusive:—

BIRMINGHAM C.M.L. Buildings, Great Charles Street

BRISTOL 8/9 Elmdale Road, Bristol 8.

CARDIFF Imperial Buildings, Mount Stuart Square.

GLASGOW 21 Glassford Street.

LEEDS 10 Bank Street, off Boar Lane.

LONDON Room 0088, Ground Floor, Thames House North, Millbank, S.W.1.

MANCHESTER Britannia House, Fountain Street.

ISSUED BY THE MINISTRY OF SUPPLY

R&A
BRITAIN'S FOREMOST
REPRODUCERS

Reproducers and Amplifiers Ltd.,
WOLVERHAMPTON,
ENGLAND.

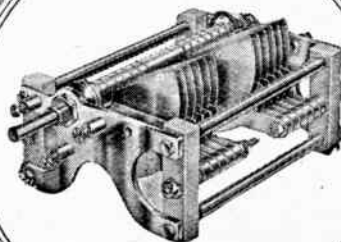

TYPE SSTR — SQUARE LAW.

"Cyldox"
TRANSMITTING *Capacitors*

SYDNEY S. BIRD & SONS, LTD.
CAMBRIDGE ARTERIAL ROAD, ENFIELD, MIDDX.
'Phone : Enfield 2071/2. 'Grams : "Capacity, Enfield."



*Modern
Miniatures*

by

Mazda



A completely new range of high efficiency Miniature Valves has been introduced by MAZDA to meet the requirements of the Electronic Engineer.

THE EDISON SWAN ELECTRIC CO. LTD., 155, CHARING CROSS ROAD, LONDON, W.C.2.

B



Model P84. An 18" diameter Speaker with a peak power handling capacity of 40 Watts; suitable for public address purposes.

Model P₂VO. A 2½" diameter Speaker, weighing only 3½ ozs., designed for small personal radios.

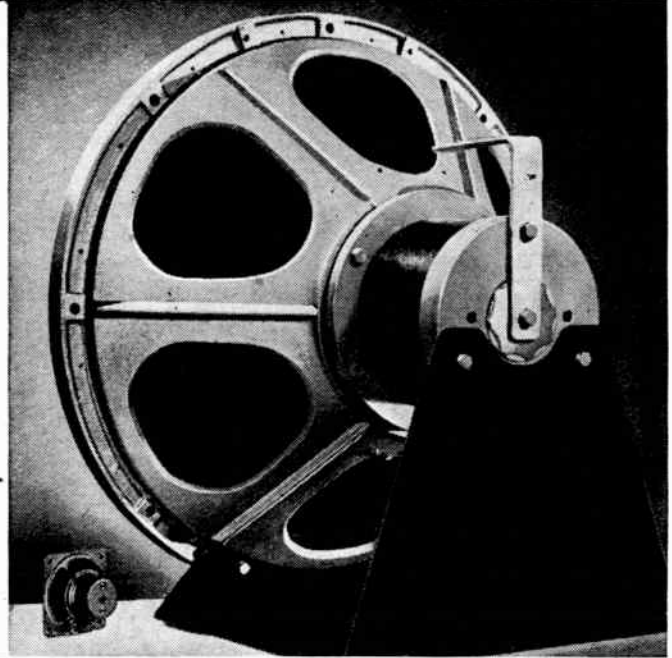

CELESTION LTD KINGSTON-ON-THAMES, SURREY
 TELEPHONE: KINGSTON 5656-7-8-9

NEW!!

"Q-MAX" V.H.F. CONVERTOR

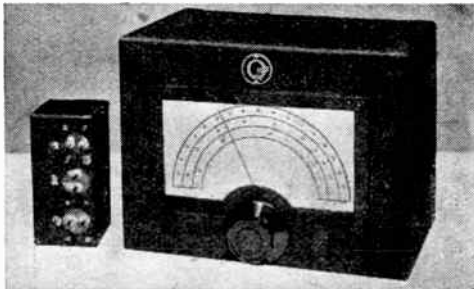

Embodying circuit refinements not found in any other make plus advantages of **MONO-UNIT COILS**. Full Vision Calibrated Scale. One knob tuning and Extra Top Coil Range.
PRICE (With 30Mc/s or 56Mc/s Coil Unit) ... 19 Gns.
 (Extra Coil Units, 30/- each)

**RELEASE DATE JULY 21
 THE "Q-MAX"
 'FOUR BAND FORTY'
 TRANSMITTER**

*If you have had our catalogue,
 send Stamped Addressed
 Envelope for latest additions.
 If not, send 6d. stamps for both.*

Obtainable from your local "Q-MAX" Dealer or direct from

BERRY'S
 (SHORT WAVE) LTD

25, HIGH HOLBORN, LONDON, W.C.1
 (Opposite Chancery Lane) Telephone: HOLborn 6231

**Double Efficiency
 from these
 transformers.**

Each SAVAGE transformer is efficient in two ways. First, because it is built by specialists in transformer construction who know how to keep losses to an absolute minimum. Secondly, because each transformer is designed to satisfy the user's exact requirements and built to do the job he wants it to do.

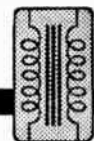
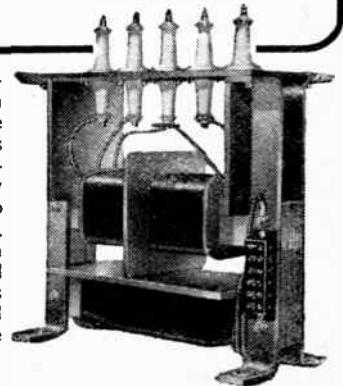

**"PURPOSE-BUILT"
 Savage
 TRANSFORMERS LTD.**

51 NORTHGATE STREET DEVIZES. Phone 536

U.I.C.

Silvered Mica & Ceramic CAPACITORS

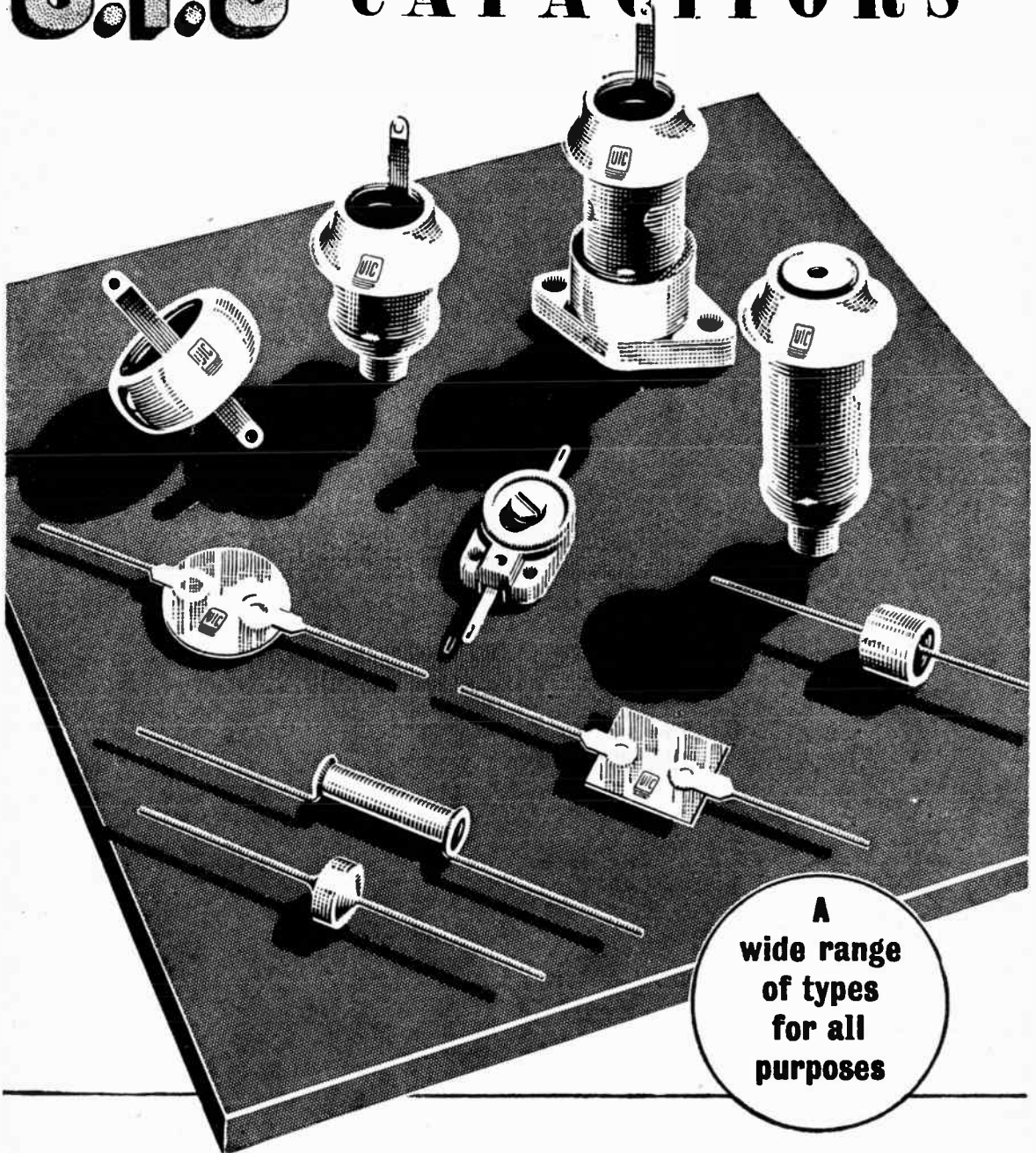

**A
wide range
of types
for all
purposes**

UNITED INSULATOR CO. LTD., OAKCROFT ROAD., TOLWORTH, SURBITON, SURREY

Telephone : Elmbridge 5241 (6 lines)

Telegrams : Calanel, Surbiton

Unsurpassed In Ceramics

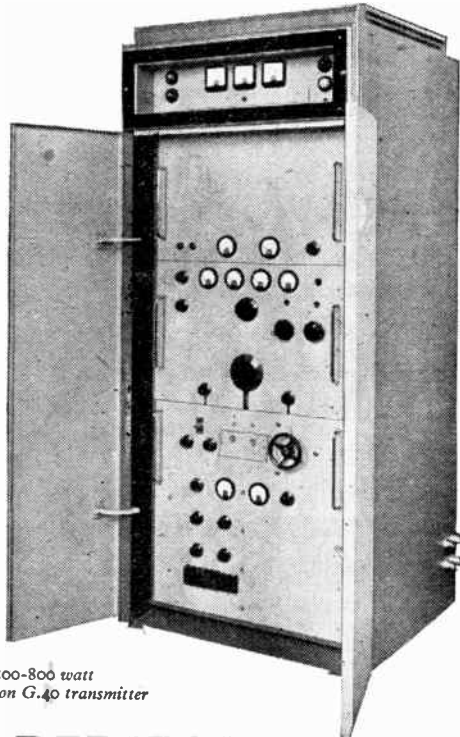

The 500-800 watt Redifon G.40 transmitter

REDIFON G.40

A new transmitter of exceptional adaptability

THE Redifon G.40 transmitter is a post-war design available with alternative R.F. and Modulator units, enabling the user to select exactly those services which fit each individual requirement. Maximum output power is over 800 watts on C.W., or 500 watts for Telephony or M.C.W.

In its simplest form, the Redifon G.40 is a C.W. transmitter for medium or shortwave communication. A frequency range of 137 Kc/s to 25 Mc/s is covered by 4 alternative R.F. units, any two of which can be fitted into one set, operating simultaneously or on instantaneous switch-over.

As a telephony station, the G.40 can be fitted with one R.F. unit and a Modulator to give 500 watts for broadcast or communication purposes.

The G.40 is ideal for medium-sized airports, where an M.F., C.W. beacon is required for navigation, and S.W. telephony for ground-to-plane communication. For this role a special model is available with a 500-watt telegraphy channel and an independent 250-watt telephony service.

For full details of the Redifon G.40 write to our Communications Sales Division.

Rediffusion Ltd.

Designers and Manufacturers of Radio Communication and Industrial Electronic Equipment

BROOMHILL ROAD, LONDON, S.W.18



BIRMINGHAM SOUND REPRODUCERS LTD

CLAREMONT WORKS, OLD HILL, STAFFS. TEL: CRADLEY HEATH 6212/3

LONDON OFFICE: 115 GOWER STREET, W.G.1. TEL: EUSTON 7515

W-W 82

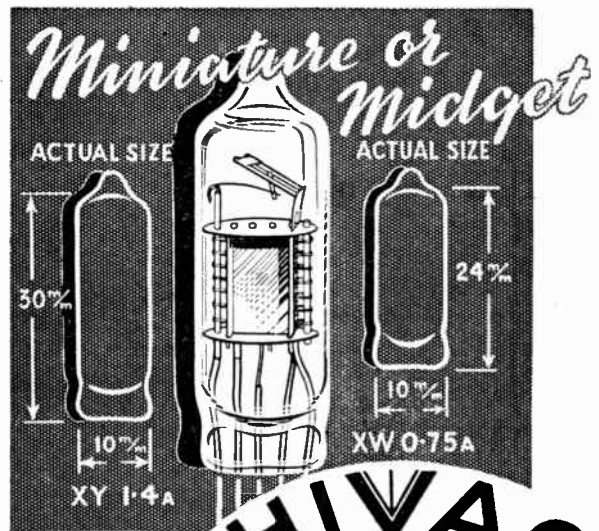

NEW TYPES FOR
MIDGET RECEIVERS
HEARING AIDS
METEOROLOGICAL
INSTRUMENTS
ETC.

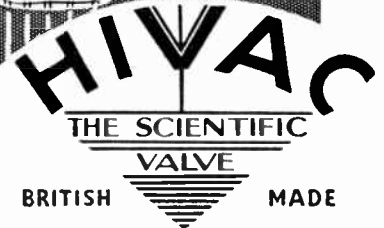

HIVAC LIMITED Greenhill Crescent. Phone HARROW Harrow on the Hill, Middx. 0895



announce NEWS of
EDDYSTONE
 COMMUNICATION RECEIVERS



THE NEW "640"
 for Short Waves only
31 to 1.7 Mc/s

Model "640" is designed for high-efficiency on short-waves (note broadcast band is omitted) and has electrical band-spread available throughout tuning range. Particularly applicable for both commercial and amateur communication use.

PRICE . . . £42 . 0 . 0 (PLUS PURCHASE TAX £9.0.7)

The "640" has outstanding signal/noise ratio and extremely good image rejection. Provision for external connection of "S" meter.

A SPECIMEN MODEL may be seen at Webb's and we are now taking orders for rotational supply in August/September. Write for details of our Registration Scheme.

- ★ Eight valves (plus rectifier).
- ★ One R.F. and two I.F. stages.
- ★ Three bands 9.7 to 176.5 metres.
- ★ Band-set control has amateur bands calibrated. Band-spread control with fly-wheel for smooth and positive tuning.
- ★ B.F.O.
- ★ Crystal filter.

MODEL "504"

Continuous Coverage
30,000 to 600 Kc/s.

The Communication Receiver for general purpose use, continuous coverage 30,000 to 600 Kc/s. One dial tuning with precision gearing, effective scale length is 36 inches per band.

PRICE . . . £48 . 10 . 0 (PLUS PURCHASE TAX £10 . 8 . 7).

A limited number of "504" receivers are available ex stock at Webb's.

- ★ Nine valves (plus rectifier).
- ★ Two R.F. and two I.F. stages.
- ★ Crystal Filter.
- ★ Noise Limiter.
- ★ B.F.O.
- ★ Five switched bands.
- ★ Continuous coverage 30,000 to 600 Kc/s.
- ★ Sensitivity better than 2 microvolts.
- ★ "S" meter.



WEBB'S RADIO, 14 SOHO STREET, OXFORD STREET, LONDON, W.1 Phone : GERrard 2089

Hours of Business : 9 a.m.—5.30 p.m. Sats. : 9 a.m.—1 p.m.

*The better they are made
the more outstanding the results*

MADE IN THREE PRINCIPAL MATERIALS.

FREQUELEX. An insulating material of low Dielectric Loss, for Coil Formers, Aerial Insulators, Valve Holders, etc.

PERMALEX. A High Permittivity Material. For the construction of Condensers of the smallest possible dimensions.

TEMPLEX. A Condenser material of medium permittivity. For the construction of Condensers having a constant capacity at all temperatures.

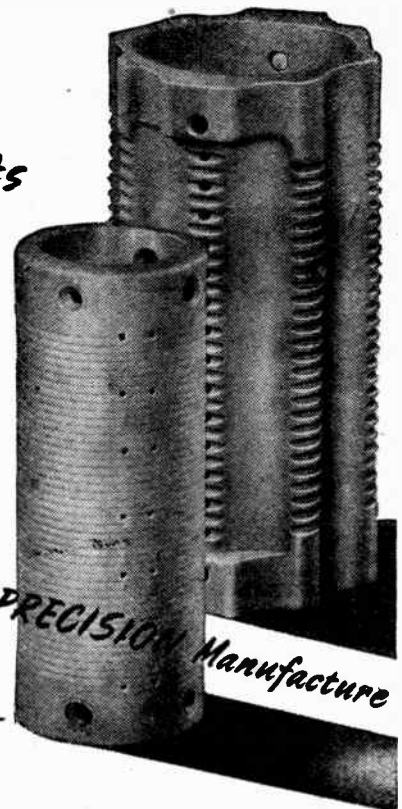

Bullers

Specialize in PRECISION Manufacture



BULLERS LOW LOSS CERAMICS

BULLERS LTD., 6, Laurence Pountney Hill, London, E.C.4. Phone: Mansion House 9971 (3 lines)
Telegrams: "Bullers, Cannon, London."



*Products of
Quality & Reliability*

**MAINS TRANSFORMERS
A. F. TRANSFORMERS
SMOOTHING CHOKES
THERMAL
DELAY SWITCHES
POWER RESISTANCES**

Made by

OLIVER PELL CONTROL LTD

Telephone - WOOLWICH 1422
CAMBRIDGE ROW · WOOLWICH S.E.18



FOR THE RADIO SERVICEMAN DEALER AND OWNER

The man who enrolls for an I.C.S. Radio Course learns radio thoroughly, completely, practically. When he earns his Diploma, he will KNOW radio. We are not content merely to teach the principles of radio, we want to show our students how to apply that training in practical, every-day radio service work. We train them to be successful!

Write to the I.C.S. Advisory Dept. stating your requirements. Our advice is free and places you under no obligation.

-----You may use this coupon-----

INTERNATIONAL CORRESPONDENCE SCHOOLS Ltd.

DEPT. 38, INTERNATIONAL BUILDINGS, KINGSWAY, LONDON, W.6.2

Please explain fully about your instruction in the subject marked X

Complete Radio Engineering Radio Service Engineering
Elementary Radio

And the following Radio Examinations:--

British Institution of Radio Engineers
P.M.G. Certificates for Wireless Operators
City and Guilds Telecommunications
Wireless Operators and Wireless Mechanics, R.A.F.

Name..... Age.....

Address.....

*Something new —
Something better...*

**AVAILABLE
NOW →**

AVAILABLE SHORTLY

The new "REYNOLDS" 10-valve de-luxe Radio Gramophone. Outstanding reproduction. **115 guineas**, plus tax.

The new "REYNOLDS" "ALL-INDIA EIGHT" Table Radio Receiver, fully tropicalised. Price on request. Model T12 AMPLIFIER, in streamlined case, for AC, DC mains. **18 guineas**, nett.

See next issue for illustration of these outstanding lines.

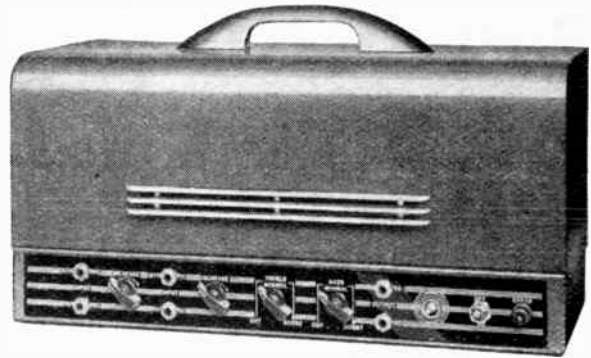

MODEL T.40 DE LUXE AMPLIFIER

For outdoor meetings, large halls, factories etc. Superior in appearance, design and performance. 40 watts undistorted output, 4 separate matched inputs. Separate volume controls, electronic mixing, unique treble or bass tone control system.

Overall dimensions 18½ in. long, 11 in. high, 8½ in. wide.

Guaranteed for 12 months, valves for 3 months

PRICE COMPLETE, ready to operate **27 GNS.**

TRADE ENQUIRIES INVITED

OBTAINABLE FROM YOUR LOCAL DEALER OR IN CASE OF DIFFICULTIES WRITE DIRECT TO US.

REYNOLDS UNIVERSAL MANUFACTURING COMPANY LTD.

410, DUDLEY ROAD, EDGBASTON, BIRMINGHAM, 16.

Telephone : SMEthwick 0201

Introducing!
the MICOVAC

**SELF-CONTAINED BATTERY OPERATED
UNIVERSAL ELECTRONIC TEST METER**

D.C.		A.C.		OHMS
Volts	mA	Volts		
0 - 5	0 - 0.15	0 - 5	} 25C/s to 10Mc/s	0 - 10 Meg
0 - 15	0 - 1.5	0 - 15		0 - 100 Meg
0 - 50	0 - 15	0 - 50		INPUT Resistance
0 - 150	0 - 150	0 - 150		On A.C. 10 Meg
0 - 500	0 - 1500	0 - 500 (AF only)		On D.C. 5 - 50 Meg

Voltage multiplier 0-5000 v. D.C. and VHF probe available

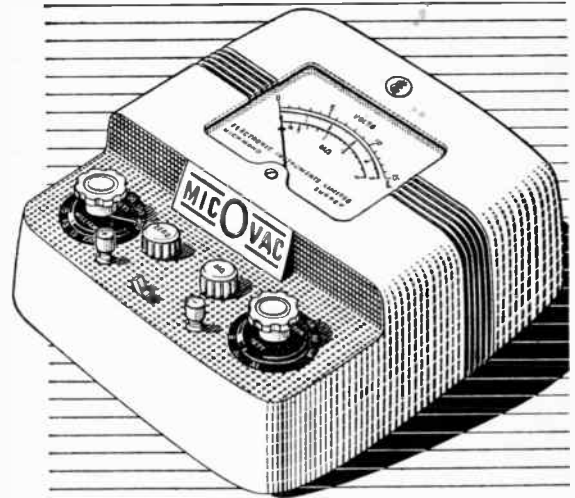

AN E-I-L PRODUCT



Price £24.10s.

ELECTRONIC INSTRUMENTS LIMITED

17 PARADISE ROAD · RICHMOND · SURREY

Telephone: Richmond 4917

PERTRIX REDRESSED FOR PEACE

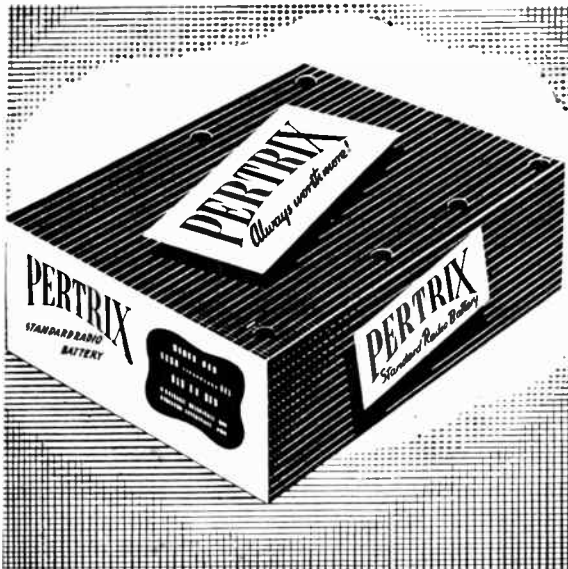

PERTRIX BATTERIES have emerged from the testing ground of war as more reliable, more efficient than ever before. You will soon see them in the smart new post-war pack shown above. It denotes the finest battery for radio use yet made.



HOLSUN BATTERIES LIMITED

137 Victoria Street, London, S.W.1.

P.I.A.

Wharfedale

TYNY EXTENSION SPEAKER

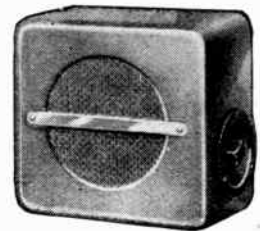

7½" x 7" x 3½"

Fitted with "TRUQUAL" Volume Control and sensitive 5" Unit.

Finished in Cream and Chromium. Ideal for Kitchen or Bedroom.

The little speaker with the big voice

PRICE 50/- (Without Transformer)

Supplies are being sent to usual Factors as available.

Made and Guaranteed by
WHARFEDALE WIRELESS WORKS

BRADFORD ROAD, IDLE, BRADFORD

Telephone: IDLE 461. Telegrams: Wharfedel, Idle, Bradford

SPECIAL OFFERS!

U.H.F. RECEIVERS.
RESISTORS. METERS.

TYPE R1481 U.H.F. RECEIVER. 66-86 mc/s. Brand new and unused.

Rack mounting, finished in grey, tuning meter, etc. Easily converts to "5" by compressing coils and re-trimming.

Valve line up: R.F., Mixer, Osc. (Voltage stabilised), 3 I.F. Amplifiers, 2nd Det. and A.V.C., A.F. Amp., Output and B.F.O., 11 Valves in all. SP61's, P61, EF39's, EF32, 6H6, and 6J5. Only require 6.3 v. and 250 v. for immediate use. This is a beautiful Rx and worth at least £60-£70. **£15 0 0**

Our price complete in transit case ...
Except for frequency range this set is the same as the R1132.

RESISTORS (Vitreous)

10 Watt, 500 ohm, 4,700 ohm, 5,000 ohm, 10,000 ohm, 20,000 ohm, 22,000 ohm, 25,000 ohm	2/6
25 Watt, 5,000 ohm, 7,000 ohm	2/6
5,000 ohm, Tapped at 2,000 and 1,500 ohm	3/6
50 Watt, 3,000 ohm, 7,000 ohm	3/6
75 Watt, 12,000 ohm, 2,000 ohm	4/6
100 Watt, 4,700 ohm, 50,000 ohm, 20,000 ohm	5/6

METERS. Thermo Ammeters. Brand new, 2in. square cased .5 amps, 10/6. 2in. round cased, flush 350 m/A, 10/6. 2in. round cased 2.5 amps, 15/-.

0-20 m/A Moving Coil, round flush mounting 2½in. scale, 3½ o/dia. flange. Brand new and in maker's cartons 17/6
0-500 m/A Moving Coil, 4in. dia. scale, panel mounting 2½in. deep. A beautiful job. Brand new and in maker's cartons 20/-
500 Microamp (.5 m/A) Meters 1½in. dia. scale, flush mounting. Graduations (0-10) and pointer luminous. Fully Sealed against moisture and are ideal for use in a field strength meter, etc. 1½in. dia. single hole fixing by screwed locking ring. Die-cast one piece case 25/-
3in. 0-1 m/A Meters scaled 0-10 Volts. At present connected for A.C. (with internal rectifier). In polished wood case with recessed lid. Case 5in. x 6½in. x 5in. Ideal for making into test sets. £2. 10. 0

RADIOMART

SEND FOR LATEST LIST 'W.W.'

Telephone: Midland 3254

48 HOLLOWAY HEAD, BIRMINGHAM, 1

EDDYSTONE AND THE AMATEUR

- Covers all Amateur Bands from 31 to 1.7 Mc/s.
- Separate Electrical Band-spread.
- Really good Signal-to-Noise Ratio.



- High Image Ratio.
- Vacuum mounted Crystal Filter.
- Adaptor for Battery operation.

THE NEW EDDYSTONE '640'

AN AMATEUR BANDS COMMUNICATIONS RECEIVER OF FIRST-CLASS DESIGN

The Eddystone "640" Receiver has been specifically designed to fulfil the amateur enthusiast's needs for a really first-class Communications Receiver. It is a nine-valve Superheterodyne with electrical bandspread over the whole tuning range, the amateur bands being distinctively marked. Tuning range is from 31 Mc/s to 1.7 Mc/s. The circuit includes 1 R.F. and 2 I.F. stages. Sensitivity is better than 2 microvolts. Very efficient 1.6 Mc/s. Crystal Filter vacuum mounted. All essential requirements incorporated—B.F.O., Noise Limiter, Standby switch, etc. Provision for "S" Meter. Cabinet measures 16½ in. x 10 in. x 8½ in., and is handsomely finished a fine ripple black.

PRICE: £42. Purchase Tax £9 0s. 7d. (Release date August.)
A matching Loudspeaker unit "652" can be supplied at £3 7s. 6d.

Please order from your Registered "EDDYSTONE" Retailer, as we do not supply direct.

STRATTON & Co., LTD

EDDYSTONE WORKS

WEST HEATH

BIRMINGHAM 31



In phase with every musical mood

POLYPHONIC RADIO

BY THE PIONEERS OF
WIDE RANGE REPRODUCTION

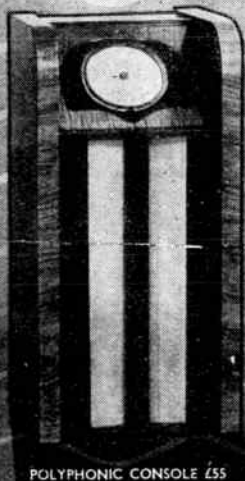

POLYPHONIC CONSOLE £55



POLYPHONIC RADIOGRAM £67. 10. 0



PHASE INVERTOR
SPEAKER £12. 10. 0

SOUND SALES LIMITED

57, ST. MARTIN'S LANE, LONDON, W.C.2

Phone: TEMPLE BAR 4284

WORKS: WEST STREET, FARNHAM, SURREY

AGENTS

ANDOVER: Thomas Lynn & Sons.

ISLE OF WIGHT: C. C. Clark & Sons.

LEEDS: Vallance & Dav-son Ltd. (and branches).

NEWQUAY: C. C. Gerry.

NORWICH: Panks' Radio.

SHEFFIELD: Needham Engineering Co., Ltd.

SOUTHSEA: Seals of Southsea, Ltd.

TCC

PAPER DIELECTRIC *Tropical* TUBULAR CAPACITORS



"METALMITE"



"METALPACK"

It is important that the condenser C₁ should have a high insulation resistance if the reading is not to be affected by D.C. potentials in the circuit to which

"METALMITE" (Miniature) TUBULAR PAPER CAPACITORS

Capacitance mFds.	Working Voltage D.C.		Dimensions Inches		Type No.	List Price Each
	at 71°C.	at 100°C.	Lgth.	Dia.		
.001	500	350	1	.2	CP30S	1/9d.
.002	500	350	1	.2	CP30S	1/9d.
.005	500	350	1	.25	CP32S	1/10d.
.01	500	350	1	.34	CP33S	1/10d.
.02	500	350	1	.34	CP34S	1/10d.
.05	500	350	1	.34	CP36S	2/1d.
.005	350	200	1	.22	CP31N	1/8d.
.01	350	200	1	.25	CP32N	1/8d.
.02	350	200	1	.34	CP33N	1/9d.
.05	350	200	1	.34	CP35N	2/-
.1	350	200	1	.34	CP37N	2/3d.
.05	200	120	1	.34	CP34H	1/11d.
.1	200	120	1	.34	CP36H	2/2d.

"METALPACK" TUBULAR PAPER CAPACITORS

Capacitance mFds.	Working Voltage D.C.		Dimensions Inches		Type No.	List Price Each
	at 71°C.	at 100°C.	Lgth.	Dia.		
.001	1000	750	1 1/2	1/8	CP49W	1/10d.
.002	1000	750	1 1/2	1/8	CP49W	1/10d.
.005	1000	750	1 1/2	1/8	CP45W	1/10d.
.01	1000	750	1 1/2	1/8	CP45W	1/10d.
.02	750	500	1 1/2	1/8	CP45U	1/10d.
.05	500	350	1 1/2	1/8	CP45S	2/1d.
.1	350	200	1 1/2	1/8	CP45N	2/1d.
.1	500	350	2 1/2	1/8	CP46S	2/2d.
.1	1000	750	2 1/2	1/8	CP47W	2/6d.
.25	350	200	2 1/2	1/8	CP48N	2/8d.
.25	500	350	2 1/2	1/8	CP47S	2/10d.
.5	350	200	2 1/2	1/8	CP47N	3/-
.5	500	350	2 1/2	1/8	CP91S	3/10d.
1	350	200	2 1/2	1/8	CP91N	4/-

FOR the ever-increasing applications where the maintenance of a high value of insulation resistance is of paramount importance, the T.C.C. "METALPACK" Tropical and "METALMITE" Miniature Tropical types are indispensable. By virtue of the aluminium tube, hermetically sealed construction, the initial insulation is maintained, even under the most arduous climatic conditions.

THE TELEGRAPH CONDENSER CO., LTD.

RADIO DIVISION

NORTH ACTON · LONDON · W.3

Telephone. ACORN 0061

Wireless World

Radio and Electronics

37th YEAR OF PUBLICATION

JULY 1947

Proprietors:
ILIFFE & SONS LTD.

Managing Editor:
HUGH S. POCOCK,
M.I.E.E.

Editor:
H. F. SMITH

Editorial, Advertising
and Publishing Offices:
DORSET HOUSE,
STAMFORD STREET,
LONDON, S.E.1.

Telephone:
Waterloo 3333 (50 lines).

Telegrams:
"Ethaworld, Sedist, London."

△
PUBLISHED
MONTHLY

Price: 1/6

(Publication date 26th
of preceding month)

Subscription Rate:
Home and Abroad
20/- per annum.

MONTHLY COMMENTARY	235
WIRE OR WIRELESS? By Thomas Roddam ..	236
MICROPHONE PRE-AMPLIFIER By R. Selby ..	239
TELEVISION O. B. VEHICLE	241
TUNED A. F. FILTERS By H. E. Styles ..	242
DESIGN DATA (14): Resonant R. F. Chokes ..	246
WORLD OF WIRELESS	247
TELEVISION RECEIVER CONSTRUCTION—5 ..	251
LETTERS TO THE EDITOR	258
POSITIVE AND NEGATIVE By A. B. Vaughan	260
CHANNELS OF COMMUNICATION—2 By	
"Cathode Ray"	261
SHORT-WAVE CONDITIONS By T. W. Benning-	
ton	264
RANDOM RADIATIONS By "Diallist" ..	266
UNBIASED By Free Grid	268
MINIATURE V.H.F. TRANSMITTER-RECEIVER	269
SENSITIVE PHOTO-ELECTRIC RELAY ..	270
RECENT INVENTIONS	272

Branch Offices:

COVENTRY:
8-10, Corporation Street.
Telephone: Coventry 5210.

Telegrams:
"Autocar, Coventry."

BIRMINGHAM:
King Edward House,
New Street, 2.

Telephone:
Midland 7191 (7 lines).

Telegrams:
"Autopress, Birmingham."

MANCHESTER:
260, Deansgate, 3.

Telephone:
Blackfriars 4412 (4 lines).

Telegrams:
"Iliffe, Manchester."

GLASGOW:
26B, Renfield Street, C.2.

Telephone: Central 4857.
Telegrams: "Iliffe, Glasgow."

△

As many of the circuits and
apparatus described in these
pages are covered by patents,
readers are advised, before
making use of them, to satisfy
themselves that they would
not be infringing patents.



REPLACEMENT VIBRATORS FOR CAR RADIO

Send new life coursing through your car
radio. Put a STRATOSIL Vibrator into circuit
... it defies all climatic conditions
and operates efficiently—anywhere.
Your dealer can supply—in case of difficulty
write direct to us

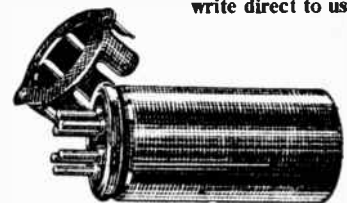



VALVES AND THEIR APPLICATIONS

By M. G. SCROGGIE, B.Sc., M.I.E.E.

No. 7: Mullard TWIN TRIODE ECC32

THERE are quite a number of special circuits, such as multivibrators and push-pull drivers, that use a pair of similar triodes; for these purposes twin triodes usually save cost and space.

Each triode in the ECC32 is a normal type with a μ of 32 and r_a of 14,000 Ω . Used with a 0.1 M Ω coupling, the voltage gain is nearly 30, and varies little with the supply voltage, which chiefly affects the signal output obtainable. For low distortion (2-3%) the output at 200 volts is 45 V peak, and at 400 V is 115 V peak. The ECC32 is not restricted to designs with common cathodes; and the capacitance between anodes is less than 1 pF. In a 2-stage amplifier, the grid pin farther from the heater pins should be used for input.

For driving push-pull amplifiers or providing symmetrical c.r.t. deflecting voltages, there are several well-known phase-inverter circuits. The gain obtainable from most of them, using a pair of similar valves, is approximately equal to that of one ordinary stage. In the cathode-coupled or Schmitt circuit it is only about half as much, and a negative voltage has to be provided; but it is a very versatile sort of circuit, and especially suitable for c.r.t. deflection.

Ideally, the signal anode currents would be equal and opposite, so would cancel out in R_c . In practice they must be sufficiently unequal for their difference to give enough voltage drop in R_c to drive V2 oppositely to V1. To minimize this inequality, R_c should be large—of the same order as R_{a1} and R_{a2} —and the voltage gain per stage also large. With the ECC32, for example, the difference in outputs need be only about 5%; and this, if not negligible, can be corrected by making $R_{a1} < R_{a2}$.

A feature of this circuit is that if one wants to mix another signal in the balanced output, without coupling the two signal sources, the grid of V2 is available for doing so.

It is obvious, too, that by coupling the anode of V2 to the grid of V1 it can be made to generate sustained oscillations, of a type depending on the couplings. If a 2-phase output is not needed, R_{a1} can be short-circuited. A very stable constant-frequency oscillator, using an untapped inductor, may be based on this arrangement, which is easily seen to be an earthed-grid triode driven by a cathode follower. Used as an amplifier, it is capable of covering a very wide frequency band.

The following are a few references to details of the foregoing schemes:

"Cathode - Coupled Push - Pull Amplifiers," O. S. Puckle; *Electronic Engineering*, July, 1943.

"The Cathode - Coupled Double-Triode Stage," Emrys Williams; *Electronic Engineering*, May, 1944.

"Cathode - Coupled Oscillators," F. Butler; *Wireless Engineer*, 1944.

"Cathode - Coupled Wide-Band Amplifiers," G. C. Sziklai and A. C. Shroeder, *Proc. I.R.E.*, Oct., 1945.

"Self-Balancing Phase Inverters," M. S. Wheeler, *Proc. I.R.E.*, Feb., 1946.

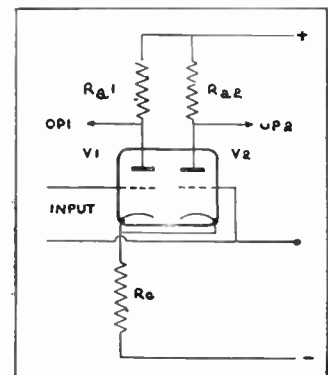

BASIC CATHODE-COUPLED CIRCUIT



This is the seventh of a series written by M. G. Scroggie, B.Sc., M.I.E.E., the well-known Consulting Radio Engineer. Reprints for schools and technical colleges may be obtained free of charge from:

THE MULLARD WIRELESS SERVICE CO. LTD.,
TECHNICAL PUBLICATIONS DEPARTMENT,
CENTURY HOUSE, SHAFESBURY AVE., W.C.2

Wireless World

Radio and Electronics

Vol. LIII. No. 7

JULY, 1947

Price 1s. 6d.

MONTHLY COMMENTARY

Radio Exhibition Plans

ARRANGEMENTS are already well advanced for the first post-war National Radio Exhibition, to be held at Olympia, London, from 1st—11th October. Naturally, at this early stage there are many details of the show to be finally settled, but it is already clear that the organizers, the Radio Industry Council, have brought in some radically new ideas.

In our opinion the Olympia shows of the years immediately before the war contributed much less than they might have done towards the growth of radio. They were essentially planned to "sell" broadcasting to the public—and that was already "sold." Although we welcome co-operation between those who conduct broadcasting and those who make the equipment with which it is received, it seems no function of the industry to act as unpaid publicity agents for the B.B.C. The shows were devoted almost exclusively to broadcasting, and dealt hardly at all with other branches. Emphasis on severely technical developments was considered as being out of keeping with the spirit of the exhibition, and no great effort to cater for those interested in such things was made. There were as a rule few exhibits of even a mildly educational nature; little, in fact, to encourage members of the public to take an intelligent interest in the technical means by which broadcasting was brought to them and little to help them to obtain the best possible results from their equipment.

There are, as we have said, signs that all this is to be changed at the 1947 show. A large number of manufacturers of non-broadcast apparatus—transmitters, electronic equipment, etc.—are expected to be represented, as will Government departments and other non-commercial users of wireless. If, as we understand, the show is to be of a more informative nature than in the 1930s, that is strictly in harmony with changes brought about by the war, when untold thousands of men and women became familiar with wireless. A large number of them attained a high technical standard

and of these a good proportion retain their interest in radio. Suitably encouraged, they will exert an important influence on public appreciation of the finer points of broadcast receiver design and performance.

It is to be hoped especially that means will be sought to instruct and inform visitors of the potentialities of modern equipment and how to use it to best advantage. Of course, bearing in mind the diverse nature of the attendance at a public exhibition, it will be all to the good if the pill of instruction can be coated with the gilt of entertainment, but we think that there is plenty of scope for serious educational exhibits.

As an example of something on which the public needs information, the broadcast receiving aerial comes to mind. This matter was forcibly brought out by a contributor to the correspondence section of our May issue. He contended that ten million-odd listeners have been encouraged for so long to use their sets with no aerial, or with a miserable apology for an aerial, that few of them realise the possibilities of the modern broadcast receiver. Here is an opportunity to devise a convincing exhibit to demonstrate the benefits conferred by a proper aerial system used with a sensitive set.

Thoughts for the Future

Wireless World does not decry the idea of a "popular" annual radio exhibition, with a wide appeal, but we hope that it will eventually become a great deal more than that. The various branches of wireless tended to drift apart as a result of the vast expansion brought about by the inception of broadcasting. Then, as an outcome of war, these branches again found common ground in many fields, and have tended to come together again. This convergence is all to the good, and we should like to see in the near future an annual radio exhibition that would be regarded as the focal point of the year in the whole world of wireless.

Wire or Wireless?

By THOMAS RODDAM

THESE is a rather snobbish feeling that line work is just an old-fashioned poor relation of radio. Even the professional radio engineer has this feeling, although he always keeps a sharp eye open, for the line engineers have been very prolific in ideas. Obvious examples of our debt to them are wave filters, negative feedback and wide-band amplifier techniques. The interchange of ideas, with the radio engineer often getting more than he gave, was always at the level of circuit methods. It was felt that the field of usefulness of

engineers thought this was an out-of-date standby for use during "Dellinger's."

This view is now in urgent need of revision: radio's future is in active competition with the cable and the overhead wire. Some readers will remember the struggles which took place in the early days of radio between the wireless organizations and the cable companies. Like the affair of the Kilkenny cats, mutual cannibalism was the final outcome. The new battle between radio and wire may never come out into the open as public competition: it

The Future of Trunk Communications

errands. Native gentlemen who are skilled at constructing bracelets from copper wire are believed to support this outlook; in America, where a more sophisticated approach is adopted, Western Union are setting up radio links to do the work now done by overhead wires.

Readers of *Alice Through the Looking Glass* will remember the train of which "the smoke is worth a thousand pounds a puff" with a guard whose "time is worth a thousand pounds a minute." The cost of the London-Birmingham coaxial cable was quoted as a thousand pounds a mile: apart from television relaying, what is this extremely expensive piece of wire used for? The answer is that with only a megacycle bandwidth in the amplifiers 240 carrier telephone channels can be superimposed on a single cable. With improved amplifiers wider bands still can be obtained, so that many hundreds of speech channels can be connected using only a single coaxial cable in each direction. This is simply an extension of a principle already in common use, in which carrier frequencies between 12 kc/s and 60 kc/s are used to convey twelve channels on a pair of overhead wires.

Later in this article we shall discuss the circuit methods adopted by the line engineers.

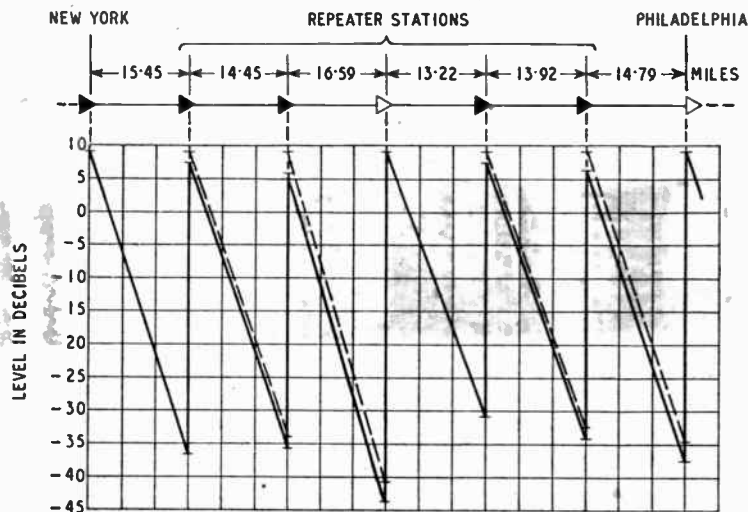

Fig. 1. Level diagram of New York-Philadelphia carrier telephone system.

radio barely overlapped that of line working, so that common techniques were used with a different fundamental aim. Radio was for broadcasting, or for very long-distance communication by telephone or telegraph, with telegraph as the normal method: lines were principally for short- and medium-distance communication, chiefly by telephony, and usually within the area of a town or county, although anywhere within a continent was possible. Of course, there was the transatlantic cable, but most radio en-

may be waged in the conference rooms of technical administrators between staffs of engineers and economists. Yet battle there is bound to be. Some people do not believe this. At a recent I.E.E. meeting, at which colonial telecommunications were discussed, some speakers expressed the view that a radio link was a rather temporary affair, to be used only until there was time to put up poles, hang wires from them and hack a path through the jungle to enable the maintenance engineer to bicycle on his fault-finding



[Courtesy: Bell System Technical Journal.]
Fig. 2. Auxiliary repeater station on New York-Philadelphia route.

Meanwhile, where does the radio engineer come in? The answer is that he, too, knows how to transmit a wide band of frequencies from one point to another. Assuming that the bandwidth corresponds to modulation frequencies of up to 2Mc/s, which we shall see later is what we want, this is just the same problem as we have in television. Even at 7 metres this bandwidth is not hard to get: at higher frequencies, around 500 Mc/s (60 cm), for example, it is difficult not to provide the required bandwidth. Highly directional aerials can be used to concentrate all the energy from the transmitter in the direction of the receiver, and to collect the energy at the receiving end, so that only small power is required for rather more than optical range. One system* installed during the war in British Columbia, worked on frequencies between 42 Mc/s and 50 Mc/s, using 250 watt transmitters. The longest circuit was from Prince Rupert to Langara Island, a distance of 108 miles, and the average input to the receiver was

Fig. 3. Amplifier, controller and testboard equipment at an auxiliary repeater station.

[Photos by courtesy Bell System Technical Journal.]

100 μ V, which was well above the receiver's requirement of 20 μ V. This circuit carried only one telephone channel, but the 98-mile path from Prince Rupert to Alliford Bay carried two telephone channels and four teleprinter channels. Other links in the British Columbia network were shorter, but distances of about 40 to 50 miles may be regarded as normal for V.H.F. radio links. We can therefore imagine a chain of receiver-transmitter re-

lays spaced 50 miles apart passing our radio signals across country.

What do the line people do? Fig. 1 shows what happens between New York and Philadelphia, and is based on information given in *Bell System Technical Journal*, Vol. XVIII, No. 4. By the time the signals on the coaxial cable have travelled 15 miles they have been attenuated about 30db. To avoid cross-talk the input level is restricted, so that it is then necessary to amplify the signals before they fall too near noise level. The sort of installation needed for this is shown

and the season, the frequency characteristic of the attenuation alters, so that the gain regulating circuits must allow not only for overall changes of attenuation,



Fig. 4. New York terminus of carrier telephone system.

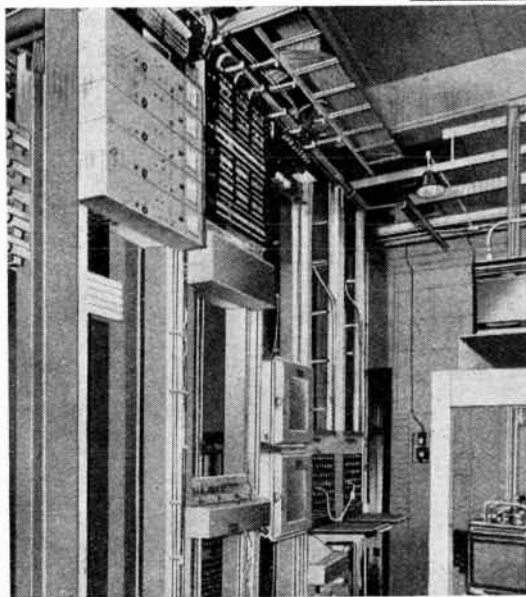

in Figs. 2 and 3, also reproduced from the above paper. Obviously quite a lot of money must be spent on these repeater stations. To make it more difficult, "twist" regulation must be provided; as the temperature of the cable changes with the weather

but also for change of attenuation at different frequencies.

Here the radio engineer is on a very good wicket. His transmission path is, at V.H.F., pretty stable, and the variations of attenuation are not frequency selective. Of course, if he gets more than one transmission path he will run into selective fading, but this can be avoided. Furthermore, if he uses frequency modulation, he can provide a link of absolutely constant overall equivalent, and, again assuming that no multipath distortion is present, the 50 miles of radio link should be a very solid and quiet transmission path. Of course, even at 500 Mc/s it is quite hard work designing a frequency modulation system to take modulation frequencies up to 2Mc/s, but before the war one experimental system at least had been set up as a means for providing television relaying, and we have had quite a lot of experience with wide bands and short wavelengths since then. It is very much easier in some ways than the radar and broadcasting prob-

* R.C.A. Review, June, 1946.

Wire or Wireless?—lems, because, unlike broadcasting, we can concentrate all the power in a narrow beam, and, unlike radar, we do not receive only a small amount which has been scattered back. The powers used in this sort of work are measured in watts, not in kilowatts and megawatts, and the valves used are almost conventional in design.

It seems very likely that we shall soon see some experimental links working on this basis. Certainly there seems to be no reason why we should not. All the techniques are known and understood: only the application is needed. What do we need at the transmitter and the receiver? Obviously, we need the basic elements of the normal transmitter and receiver, the modulator, amplifier and oscillator at the transmitter, the frequency changer, amplifiers and detector at the receiver. In addition, we must take a very close interest in the way in which our 240 telephone circuits are all connected to the same radio modulator at the transmitter end and to the output circuits at the receiver. In the New York-Philadelphia link the speech frequencies in the band 200 c/s to 3,400 c/s are used to modulate a carrier of frequency 60 kc/s to 108 kc/s. Twelve such carriers, spaced at 4 kc/s intervals, are obtained in this band. One sideband only is selected, so that the channel now occupies the band 60.2 kc/s to 63.4 kc/s, 64.2 kc/s to 67.4 kc/s, and so on up to the twelfth channel in the band 104.2 kc/s. There is a difference between British and American practice according to whether lower or upper sideband is selected, but this does not make any fundamental change in the principle of the system. The whole group of twelve channels is then shifted bodily by a second "group modulator" to the desired frequency band. Thus, by modulating the group with a carrier frequency of 912 kc/s, it can be moved to occupy the band 972-1,020 kc/s, the upper sideband being again selected. In this way the whole frequency spectrum between 60 kc/s and 1,020 kc/s is occupied by 20 groups, each made up of 12 channels. The equipment which does this is shown in Fig. 4. This is

the heart of the whole system, and, comparing it with the size of a receiver or a 50-watt transmitter, the reader will see that if the radio man insists that he is not interested in what happens before they pipe the signal into his modulator, he is in for a pretty thin time, because the engineer on the line side will take the running of the transmitter and receiver in their stride.

The urgent problem for the radio engineer has therefore two aspects. First of all, he must understand the methods and techniques which have been adopted for multichannel telephony on lines. The fact that elaborate systems have been evolved does not mean that they are necessarily final in form, although they are now so well established that it will not be easy to make any changes unless some considerable improvement can be made. Secondly, he must study the problems of wide-band radio links at very high frequencies. These are urgently needed both for telephone purposes and for television. In many countries television can only be run economically by the simultaneous broadcasting of one programme in several large towns. Radio links from the studio to the

satellite towns are essential. Furthermore, few countries are willing to start up a new television service on British pre-war standards: they have heard so much about 1,000-line stereoscopic colour television with sound on a common carrier that they will not invest their money in a system they believe to be out of date. The radio links must therefore be designed to accommodate the very wide bandwidths which the future television systems will require. The reader will appreciate that to provide a frequency modulation system handling signal frequencies up to, say, 20 Mc/s means that a deviation of ± 30 Mc/s must be used. This is still rather a nightmare for the engineers, but when bandwidths of this sort are available, and there is no doubt that they will be in a few years' time, we shall be able to be thoroughly extravagant in using them for communications purposes. Telegrams will be sent by high-speed facsimile processes, for example, and we may have 400-line television thrown in as an extra on trunk telephone calls. There is, in fact, no limit to what can be envisaged once the V.H.F. radio link comes into its own.

Books Received

Electrical Transmission in Steady State.—By Paul J. Selgin. This book is the sixth in a series on radio communication edited by Beverly Dudley. It is based on a series of lectures given in 1942/43 by the author under the American Government's War Training Programme. It aims primarily at giving a sound knowledge of fundamental theory. 427+ix pages. McGraw-Hill Publishing Co., Ltd., Aldwych House, London, W.C.2. Price 25s.

Principles of Radio for Operators.—By Ralph Atherton, M.S. The material contained in this book is used in the American Navy for the 16-week course of training for radio operators. Each of its sixteen chapters covers a week's training. A set of problems is given at the end of each chapter of the book which covers basic electrical principles and explains the function of each section of a receiver. There are also chapters on transmitters and aerials. 344+x pages. Macmillan and Co., Ltd., St. Martin's Street, London, W.C.2. Price £1.

Short-Wave Listeners' Annual, 1947.—The eight chapters of this, the first edition of the annual, include sections on commercial W/T stations as well as broadcasting and amateur stations. Lists of station addresses and slogans

are also included. Among the useful miscellaneous data are a wavelength-frequency conversion chart and a list of Standard Times. 78+vi pages. Amalgamated Short-Wave Press, Ltd., 57, Maida Vale, London, W.9. Price 25 6d.

Electronic Developments.—By K. G. Britton, D.Phil. An idea of the scope of this book, which gives "simple qualitative accounts of some of the more common electronic devices," will be gathered from the headings to some of its thirteen chapters. They include the Electron, Thermionic Valve, Cathode-ray Tube, Klystron, Positive Grid Oscillator and Magnetron, Cyclotron, Photo-electric Cells, Electron Multiplier, Electron Microscope and Application of Electron Technique to Television. 208+viii pages with 74 figures. George Newnes, Ltd., Southampton Street, Strand, London, W.C.2. Price 7s 6d.

Radio Receiver Servicing and Maintenance (Fourth Edition).—By E. J. G. Lewis, M.Brit.I.R.E. The main addition to this edition is the inclusion of a chapter on A.C./D.C. and American midget receivers. 324+x pages with 161 figures. Sir Isaac Pitman and Sons, Ltd., Parker Street, Kingsway, London, W.C.2. Price 8s 6d.

Microphone Pre-Amplifier

Cathode Follower Circuit Suitable for P.A. Work

By
R. SELBY

DURING the course of modernizing some general-purpose P.A. equipment, it was thought that the existing moving-coil microphones constituted a weak link in the chain of what was intended to be a high-fidelity amplifying system, and consideration was therefore given to the sound cell type of piezo crystal microphone.

The outstanding advantage of this type of microphone is the good frequency response, stated by the makers to extend almost level to about 10,000 c/s. Non-directional pickup, small size and weight, and absence of "blasting" when overloaded, are also useful features. On the other hand, the low voltage output (which cannot be stepped up by a transformer as in the case of moving coil microphones) and the high impedance present problems. The makers give the output as -66 db to a reference level of 1 volt-per dyne per sq cm and the impedance as being similar to a capacity of 0.005 μ F. In the absence of reliable figures for other types, it is difficult to make any

accurate comparison, but in practice it may be said that additional voltage amplification of perhaps 35 to 40 db is required as against a sensitive moving-coil microphone and transformer. The high impedance, predominantly of a capacitive nature, implies that the microphone must work into a load of the order of 5 megohms if loss of bass is to be avoided, and that the self-capacity of the lead, which must be thoroughly screened, will cause a loss of voltage.

A preliminary attempt at incorporating an additional high-gain

stage of amplification in an existing A.C. mains amplifier proved, as expected, to be unsatisfactory owing to hum and noise. Attention was therefore turned to the use of a separate pre-amplifier, using D.C. supply for valve heaters, and employing to advantage the characteristics of the cathode follower.

The main amplifying stage, V_1 , is conventional, employing an R.F. pentode (EF50). This valve is very suitable for the purpose, since it has a very steep slope and is satisfactorily non-microphonic. Strictly speaking, the use of a variable-mu valve is to be deprecated, but in view of the extremely small grid swing to be handled it is not considered that any distortion is introduced. In spite of the use of a 5 megohm grid resistor no grid current can be detected. Bias is derived from a potential divider across the heater supply.

The output stage is a cathode follower, employing another EF50. The high input impedance enables maximum gain to be obtained from V_1 without loss of high frequencies, whilst the low output

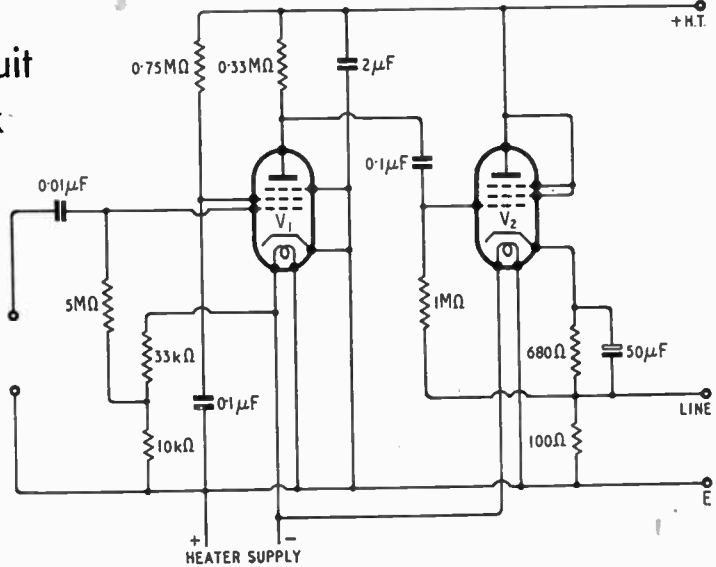

Fig. 1. Circuit diagram of amplifier. V_1 and V_2 are EF50's.

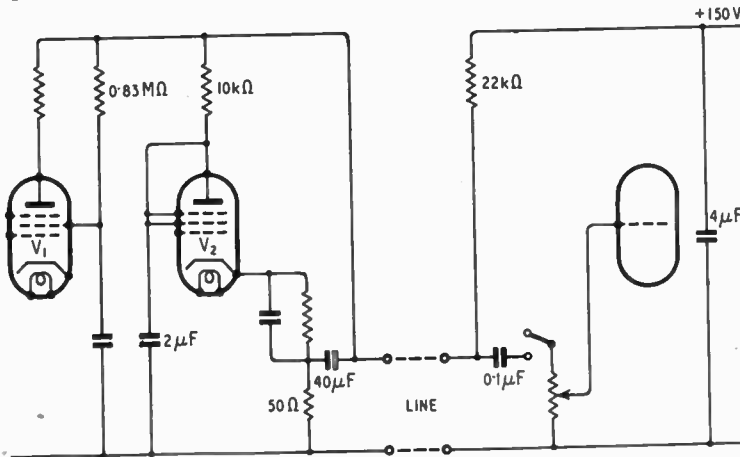

Fig. 2. Method of obtaining H.T. supply from main amplifier.

Microphone Pre-amplifier—

impedance permits operation with an unscreened line to the main amplifier. This feature was considered essential, as screened cable, apart from expense, is less durable and much more awkward to handle and joint than ordinary T.R.S. flex.

There is, of course, a considerable loss in the output stage due to the use of the very low load resistance of 100 ohms, but the overall gain of the amplifier is sufficient for all ordinary purposes. If desired, higher values can easily be substituted by a switch, so that when conditions permit the operation of a higher impedance line a higher signal level can be maintained.

H.T. consumption is approximately 2 mA at 100 volts and can, therefore, be supplied easily from a dry battery. Alternatively it may be obtained from the main amplifier, either by a separate line, or by utilizing a species of phantom circuit on the existing signal line, as shown in Fig. 2. The latter method has proved entirely satisfactory. A switch has been fitted to disconnect the circuit for occasions when the main amplifier is being used alone, otherwise its input will be shunted by the comparatively low 22k Ω resistance.

It will be noted that the anode circuits of the pre-amplifier have been rearranged slightly in order to provide the necessary filtering between A.F. and D.C. as simply as possible. This also permits the use of a slightly higher H.T. voltage with a consequent substantial increase in gain, and it becomes possible to reduce the load resistance to a figure as low as 50 ohms. The blocking condenser should be as large as possible in order to keep the line impedance low at low frequencies. The writer has used 40 μ F but a value of the order of 100 μ F would be preferable, and is not difficult to arrange since the rated working voltage need not be more than about 150 volts.

The H.T. supply must be adequately decoupled and should be taken from a potential divider in preference to a series dropper, in order to prevent excessive rise of voltage on the line and on the electrolytic blocking condenser if the heaters of V_1 and V_2 are cold.

The use of this type of pre-amplifier is not, of course, confined to the sound cell microphone. With suitable alterations to the input constants, any other type of microphone may be used, and a pickup may be fed into the grid of V_2 or the suppressor of V_1 . In fact it may easily be developed into a mixing unit of any desired

complexity. The writer has incorporated a method of remotely controlling the main amplifier. The main virtue lies in the use of a cathode follower for matching to a low-impedance line, and in the writer's opinion represents a distinct advance on the conventional output stage with step-down line transformer.

Clip-on Test Prod

Made from Easily Obtained Materials

THE test prod described here, although it is not quite as simple in construction as the plain pencil type, combines the slender-

the gripping jaws A and B at the business end are separated. Inside the handle, as shown in Fig. 1 (b), there is a spring that normally

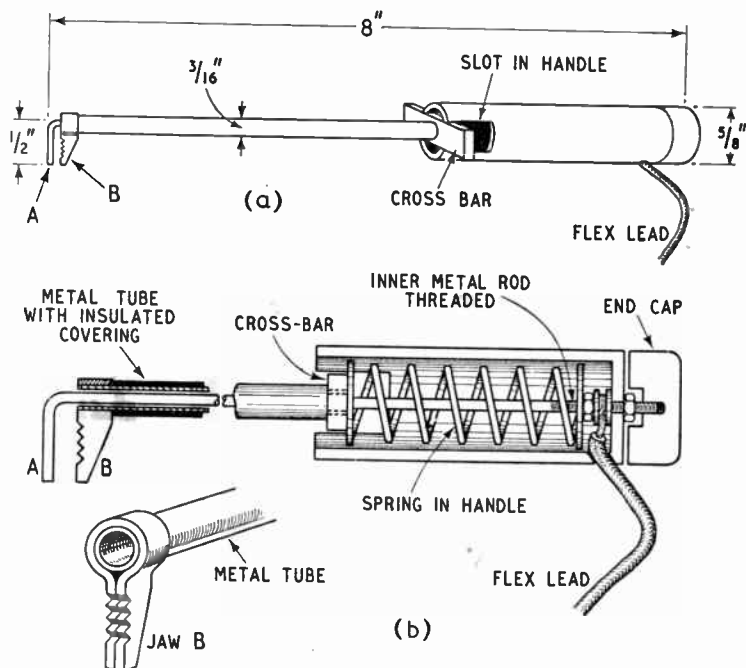

Fig. 1. Constructional details of the clip-on test prod. For general-purpose use the handle portion can be 3½ in long and the prod part 4½ in.

ness and adequate insulation of that type with a gripping device that enables it to be clipped on to a test point and left hanging there while both hands are free for work. Anybody who has once made and used one of these gadgets will wonder how he ever put up with the non-gripping type. It can be easily made in the most modest workshop.

Fig. 1 (a) shows the general appearance and dimensions. When the cross-bar in the handle is pulled back by the forefinger and thumb,

presses these jaws together, thus gripping the wire, terminal, etc., that form test points, when this cross-bar (which slides in a slot in the hollow handle) is released. The details will probably be obvious from the diagrams. The author has found it possible to construct these gripping test prods with quite simple and easily obtained materials such as a bicycle spoke for the inner rod, thin metal tubing, Terry springs, and ebonite tube for the handle part.

W. H. C.

Television O.B. Vehicle

New Pye Equipment

DESIGNED to operate in a minimum time after arrival at a site, the Pye television outside-broadcast vehicle is a complete television transmitter from camera to aerial housed in a Humber Utility vehicle. The transmitter has an output of some 50W at 660 Mc/s for a modulation level corresponding to peak white and this is fed through a balanced feeder to a horizontal dipole mounted in a reflector and carried by a telescopic mast projecting through the roof of the vehicle. The mast is motor-controlled and on arrival at a site it is necessary only to switch on the motor; it then looks after itself and switches itself off when the full height of 40ft is reached, so leaving the operators free to attend to the other apparatus. The aerial gives a beam of about $\pm 20^\circ$ and a gain of some 14 db.

Two camera units on four-wheeled dollies are carried. The wheels are coupled to the camera so that rotating it also turns the wheels and they are thus always set correctly for a direct forwards and backwards movement. A simple view finder

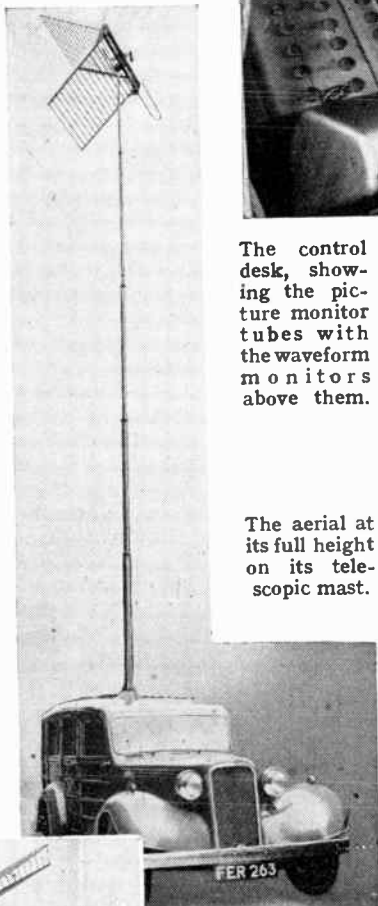

The control desk, showing the picture monitor tubes with the waveform monitors above them.

The aerial at its full height on its telescopic mast.

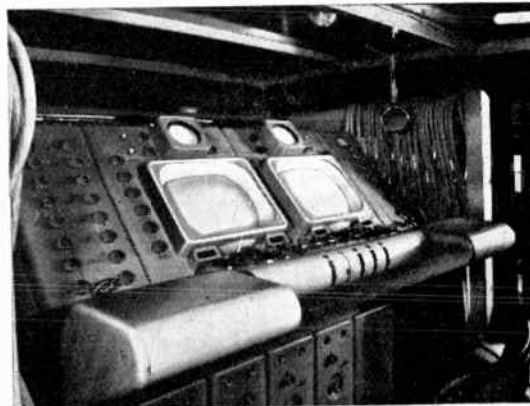

The control desk contains two picture monitor tubes and two waveform monitors. Fading and mixing facilities are provided.

The cameras have Pyton iconoscope-type tubes and contain the sound pre-amplifiers as well as the video amplifiers and scanning equipment. E.H.T. is obtained from the line fly-back and there is a safety interlock to remove the supply if the time-base fails. Each camera has 100 yards of cable containing five screened pairs and nine unscreened leads.

Pulse generating equipment in the van produces the synchronizing pulses and mixes them with the V.F. signals, diode clamps being used throughout to maintain the black level.

The Pye Videosonic¹ system is used, in which the sound channel is conveyed by width-modulated pulses inserted in the line sync pulses, thus saving a separate R.F. transmitter and receiver.

The power supply comes from a 3.5-kW generator driven from the vehicle engine, but provision is made for the use of 50 c/s mains when such a supply is available. A separate intercommunication set is provided so that the O.B. crew can work under the immediate direction of the producer at the main television station.

The complete station and vehicle weighs 2½ tons and there is room for a crew of three, including the driver. The station was shown at the British Industries Fair at Olympia.

¹ *Wireless World*, December, 1945, Vol. 51 p. 371.

only is fitted, both electrical and optical focus being controlled by the operator at the control desk in the vehicle. Optical focus is controlled through the agency of a Selsyn system.

One camera on its dolly is shown alongside the vehicle and the other folded up in its carrying position on the drop-back. The backs of the monitor and control racks can also be seen.

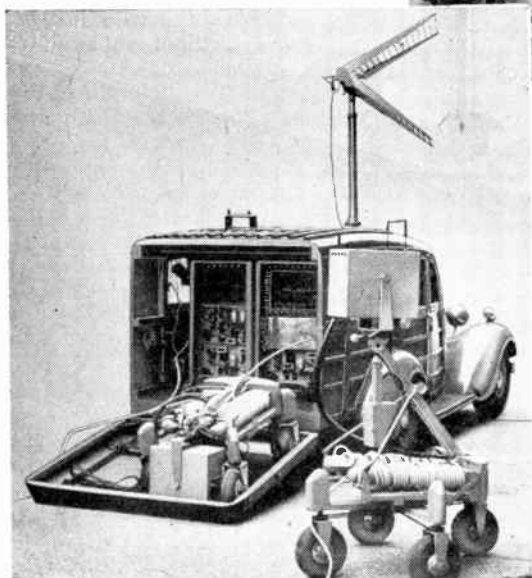

OUR COVER

In the cover picture the folded dipole of the intercommunication channel of the Pye O.B. Equipment can be seen at the side of the reflector of the vision aerial.

Tuned A.F. Filters

FOR purposes such as correction of pick-up response or elimination of heterodyne interference it is often necessary to employ filters which will attenuate a certain specified band of frequencies only. In such cases it is usual to employ either the parallel tuned rejector circuit (1) or the series tuned acceptor circuit (2).

It is a simple matter to design such circuits so as to obtain any desired maximum attenuation at the resonant frequency, but the degree of attenuation at other frequencies depends upon the magnification factor, "Q," of the tuned circuit. Calculation of "off resonance" attenuation is somewhat involved owing to the reactive component of the tuned circuit impedance at such frequencies, the difficulties being accentuated in circuit (2) by the presence of the shunt resistance R normally required for bias and volume control purposes.

It has, however, been found possible to derive a simple re-

1.—General Considerations and Design Formulae

By H. E. STYLES, B.Sc.

- C = Capacitance in farads.
- r = Resistance in series with L (including the coil resistance).
- R = Resistance across output of filter.
- S = Input series resistance in circuit (2).
- f_0 = Frequency of maximum attenuation.
- f = Frequency other than f_0 .
- F_0 = Desired maximum effective¹ attenuation factor at frequency f_0 .
- F = Desired effective attenuation factor at frequency f.
- Q = Magnification factor of the tuned circuit comprising L, C and r.

From the last equation, knowing F_0 and f_0 , the value of Q required to produce any desired attenuation F at frequency f can be determined. Usually it is desired to ensure that the attenuation shall become negligible at a given frequency and for practical purposes negligible attenuation can be taken as corresponding to $F = 0.8$ (- 2 decibels).

Table I gives the value of $Q \left(\frac{f_0}{f} - \frac{f}{f_0} \right)$ corresponding to an attenuation of 2 decibels for any maximum attenuation of from 3 to 39 decibels, the first horizontal line giving values of $Q \left(\frac{f_0}{f} - \frac{f}{f_0} \right)$ for maximum attenuations (at f_0) of from 3-9 decibels, the second line from 10-19 decibels and so on. From this table the value of $Q \left(\frac{f_0}{f} - \frac{f}{f_0} \right)$ corresponding to negligible attenuation for a given maximum attenuation can be read off and hence, knowing the values of f_0 and f, the required value of Q can be obtained.

R is normally determined by considerations other than frequency correction and knowing R, Q, F_0 and f_0 the necessary values of L, C and r can be obtained from the equations given above.

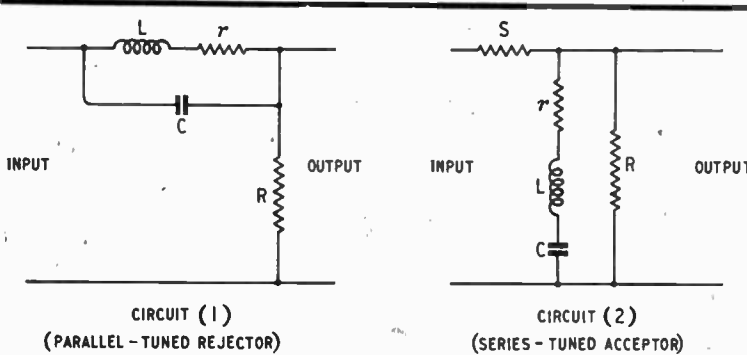

Filter circuits for which design data are given in the text.

lationship between attenuation, frequency and "Q" by means of which the required value of the latter can readily be calculated, thus enabling the circuit constants to be chosen so as to produce any desired maximum attenuation and bandwidth of affected frequencies.

The derivation of this relationship is given in the appendix, final design data being as follows: Let L = Coil inductance in henrys.

Design Data for Circuit (1).

$$L = \frac{R(1 - F_0)}{2\pi f_0 Q F_0} = \frac{Qr}{2\pi f_0}$$

$$r = \frac{R(1 - F_0)}{Q^2 F_0}$$

$$C = \frac{Q F_0}{2\pi f_0 R(1 - F_0)} = \frac{1}{2\pi f_0 Q r}$$

$$Q \left(\frac{f_0}{f} - \frac{f}{f_0} \right) = \pm \sqrt{\frac{F^2 - F_0^2}{F_0^2(1 - F^2)}}$$

¹ Effective attenuation factor is absolute attenuation factor divided by any constant attenuation which may be produced at frequencies outside the affected bandwidth. For circuit (1) absolute and effective attenuations are identical but for circuit (2) effective attenuation equals the absolute attenuation times $\left(\frac{R+S}{R} \right)$ since the circuit produces a constant attenuation of $\left(\frac{R}{R+S} \right)$ at frequencies far from resonance.

Design Data for Circuit (2).

$$L = \frac{Qr}{2\pi f_0}$$

$$C = \frac{1}{2\pi f_0 Qr}$$

$$r = \frac{SRF_0}{(R + S)(1 - F_0)}$$

$$= \frac{F_0 S}{1 - F_0} \text{ when } R \text{ is infinitely great.}$$

$$Q \left(\frac{f_0}{f} - \frac{f}{f_0} \right) = \pm \sqrt{\frac{F^2 - F_0^2}{F_0^2(1 - F^2)}}$$

as before.

Thus the value of $Q \left(\frac{f_0}{f} - \frac{f}{f_0} \right)$ can again be obtained from Table I when it is desired only to ensure a given maximum effective attenuation at f_0 with negligible effective attenuation (-2 db) at f .

Circuit (2) will of course produce a constant attenuation of $\left(\frac{R + S}{R} \right)$

at frequencies far from resonance, but this will not affect the frequency correction characteristics of the filter. This constant attenuation can be reduced by increasing the value of R which in some cases may be omitted, bias being applied by a resistance shunted across the input to the filter. Such a resistance will not affect the attenuation characteristics of the filter, although it will modify its input impedance. In such cases, since $R = \infty$, circuit (2) will theoretically produce no attenuation at frequencies far from resonance, the impedance of the tuned circuit then becoming infinitely great. In practice, however, stray capacitance across the output of the filter, together with the self-capacity of inductance L , may result in unwanted attenuation of high frequencies and consequently it is usually inadvisable to make R unduly large.

It will be observed that in the case of circuit (2) the value of r , R and S are interdependent and various combinations may be employed to yield the same value of F_0 . The absolute attenuation will however vary with variations in R and S whilst the input impedance of the filter will also depend upon the resistance values chosen. These considerations will decide the most appropriate values

for R , S and r in any given circumstances.

Input Impedance of the Alternative Filters.

Circuit (1).

The input impedance varies from a minimum value approximating to R at frequencies far from resonance, up to a maximum value of $\frac{R}{F_0}$ at the resonant frequency.

This change in impedance may be limited by shunting a resistance R' across the filter input, the attenuation characteristics of the latter being thereby unchanged. In such a case the minimum

resonance whereas circuit (2) attenuates such frequencies by a

factor $\frac{R}{R + S}$ which cannot be made unduly large by increasing R if undue loss of high frequencies is to be avoided. In some circumstances such loss may be compensated for by shunting S with a condenser of suitable value.

(b) Effect of Reactive Input Sources.

If the source feeding the input to the filter is of reactive character the behaviour of circuit (1) may be upset by unwanted resonance effects. This is less likely to occur with circuit (2) as the

TABLE I.

Values of $\pm Q \left(\frac{f_0}{f} - \frac{f}{f_0} \right)$ corresponding to an attenuation of 2 decibels at frequency f when maximum attenuation at f is as indicated.

Maximum Attenuation (db)	Units										
	Tens	0	1	2	3	4	5	6	7	8	9
0					0.83	1.3	1.6	2.0	2.4	2.8	3.3
1		3.8	4.3	4.9	5.6	6.3	7.2	8.1	9.1	10.2	11.5
2		12.9	14.6	16.4	18.4	20.6	23.2	26.0	29.1	32.8	36.8
3		41	46	52	58	65	73	82	92	104	116

impedance will approximate to $\frac{RR'}{R + R'}$ whilst the maximum impedance at resonance will be $\frac{RR'}{R + F_0 R'}$.

Circuit (2).

In this case the impedance varies from a maximum value of $R + S$ at frequencies far from resonance down to a minimum value of $\frac{Rr}{R + r} + S$ at resonance. If R be large compared with r , the minimum impedance will approximate to $S + r$, whilst if R be omitted completely the maximum impedance will tend towards infinity. The variation in impedance can therefore be controlled by choice of R .

Factors Influencing Choice of Filter Circuit.

(a) Transmission Loss.

Circuit (1) produces no attenuation at frequencies far from

series resistance S , if of large value, tends to isolate the tuned circuit of the filter from the input source. For this reason circuit (2) is often the more suitable for direct coupling to pick-ups, etc., which normally are of reactive character.

(c) Phase Change.

Both circuits may produce considerable changes in phase, particularly at frequencies corresponding to values of $Q \left(\frac{f_0}{f} - \frac{f}{f_0} \right)$ approximating to unity. Whilst such phase changes are normally unimportant, the behaviour of amplifiers employing negative feed-back may thereby be adversely affected.

(d) Component Values.

When it is necessary to ensure a specified minimum input impedance it will generally be found that one of the two alternative filter circuits will require more convenient component values than

Tuned A.F. Filters—

the other. Usually it is desirable that the value of the inductance should be as low as possible and it will be noted that for both circuits $L = \frac{Qr}{2\pi f_0}$. Thus the circuit requiring the smaller value for r will also necessitate the employment of the smallest inductance.

The minimum impedance of circuit (1) is approximately equal to R whilst, in the case of circuit (2), provided that F_0 is reasonably small and R reasonably large, the minimum impedance will not differ greatly from S .

Now for circuit (1) $r_1 = \frac{R(I - F_0)}{Q^2 F_0^2}$ and for circuit (2)

$$r_2 = \frac{S F_0}{I - F_0} \text{ approx.}$$

$$\text{Hence } \frac{r_1}{r_2} = \frac{R(I - F_0)^2}{SQ^2 F_0^2}$$

Thus, for a given minimum impedance, r_1 will be greater than r_2 if $(I - F_0)$ is greater than QF_0 .

Therefore, if Q is less than $\frac{I - F_0}{F_0}$ circuit (2) will usually require more convenient circuit components than circuit (1) and vice versa.

Example of the Use of Design Data.

Assume that it is desired to attenuate a heterodyne whistle of 9,000 c/s by 20 db whilst at the same time the attenuation at 6,000 c/s is not to exceed 2 db. Also, the input impedance must not fall below 250,000 ohms, no limit being set to the maximum input impedance.

Then from Table I we find that for a maximum attenuation of 20 db an attenuation of 2 db corresponds to a value of 12.9 for

$$Q \left(\frac{f_0}{f} - \frac{f}{f_0} \right)$$

Now $f_0 = 9,000$ and $f = 6,000$.

$$\text{Hence } \frac{f_0}{f} - \frac{f}{f_0} = 0.83.$$

Thus $Q = 15.6$.

Since $F_0 = 0.1$ (i.e. -20 db.),

$$\frac{I - F_0}{F_0} = 9$$

Hence it is evident that for the purpose in question circuit (1)

will demand the more convenient component values. We therefore have for circuit (1) :—

$$r = \frac{250,000 \times 0.9}{15.6 \times 15.6 \times 0.1} = 9,250 \Omega$$

$$L = \frac{15.6 \times 9,250}{2\pi \times 9,000} = 2.56 \text{ H.}$$

$$C = \frac{I}{2\pi \times 9,000 \times 15.6 \times 9,250} = 0.00012 \mu\text{F.}$$

**APPENDIX.
Derivation of the Design Data.**

Using the nomenclature employed previously we have :—

$$f_0 = \frac{I}{2\pi\sqrt{LC}} \text{ (to a first approximation), } Q = \frac{2\pi f_0 L}{r}$$

$$R_D = \frac{L}{Cr} \text{ for circuit (1), and } R_D = r \text{ for circuit (2).}$$

where R_D = equivalent resistance of the tuned circuit at f_0 .

If Z = impedance of the tuned circuit at f and ϕ = phase angle between current in the external circuit and the applied voltage.

Then $Z = R_D \cos \phi$ in circuit (1).

$$= \frac{r}{\cos \phi} \text{ in circuit (2), and } \tan \phi = Q \left(\frac{f_0}{f} - \frac{f}{f_0} \right).$$

For Circuit (1).

At a frequency f this circuit comprises an impedance of $R_D \cos \phi$ in series with a resistance R , the phase angle being ϕ . The resultant impedance Z_1 is given by the expression $Z_1^2 = R_D^2 \cos^2 \phi + R^2 + 2RR_D \cos^2 \phi$

$$\text{Now } F_0 = \frac{R}{R + R_D}, \text{ hence } R_D = \frac{R(I - F_0)}{F_0}$$

$$\text{Also, } F = \frac{R}{Z_1}, \text{ hence } F^2 = \frac{R^2}{Z_1^2} = \frac{R^2}{\cos^2 \phi (R_D^2 + 2RR_D) + R^2}$$

$$= \frac{I}{\cos^2 \phi \left\{ \frac{(I - F_0)^2}{F_0^2} + \frac{2(I - F_0)}{F_0} \right\} + I} = \frac{I}{\cos^2 \phi \left(\frac{I - F_0^2}{F_0^2} \right) + I}$$

$$\text{Hence } \cos^2 \phi = \frac{F_0^2 (I - F^2)}{F^2 (I - F_0^2)}, \text{ but } \cos^2 \phi = \frac{I}{\tan^2 \phi + I}$$

$$\text{Hence } \tan^2 \phi = \frac{F^2 (I - F_0^2)}{F_0^2 (I - F^2)} - I = \frac{F^2 - F_0^2}{F_0^2 (I - F^2)}$$

$$\text{Thus } Q \left(\frac{f_0}{f} - \frac{f}{f_0} \right) = \sqrt{\frac{F^2 - F_0^2}{F_0^2 (I - F^2)}}$$

For Circuit (2).

In this case let $\frac{R}{r} = A$ or $R = rA$, and $\frac{S}{r} = B$ or $S = rB$.

Considering first the circuit comprising L, C, r and R , we have, at frequency f , an impedance of $\frac{r}{\cos \phi}$ in parallel with resistance R at a phase angle of ϕ . If Z_1 be the resultant impedance

$$\frac{I}{Z_1^2} = \frac{\cos^2 \phi}{r^2} + \frac{I}{r^2 A^2} + \frac{2 \cos^2 \phi}{r^2 A} = \frac{\cos^2 \phi (A^2 + 2A) + I}{r^2 A^2}$$

The phase angle α of this resultant is given by $\cos \alpha = Z_1 \left(\frac{\cos^2 \phi}{r} + \frac{I}{rA} \right)$

Considering now the complete circuit (2), we now have an impedance Z_1 in series with a resistance S at a phase angle α . The resultant impedance Z_2 is therefore given by

$$Z_2^2 = Z_1^2 + S^2 + 2SZ_1 \cos \alpha = Z_1^2 \left\{ I + \frac{B^2 r^2}{Z_1^2} + \frac{2B}{A} (A \cos^2 \phi + I) \right\}$$

Let K = absolute attenuation factor at frequency f . Then $K = \frac{Z_1}{Z_2}$

$$\text{Hence } K^2 = \frac{Z_1^2}{Z_2^2} = \frac{I}{I + \frac{B^2 [\cos^2 \phi (A^2 + 2A) + I]}{A^2} + \frac{2B}{A^2} (A^2 \cos^2 \phi + A)}$$

$$= \frac{I}{\cos^2 \phi (A^2 B^2 + 2AB^2 + 2A^2 B) + (A + B)^2}$$

(Continued at foot of opposite page)

Broadcasting in Australia

Review of the Present Position

WITH her 130 medium-wave broadcasting stations Australia has more transmitters in proportion to her population than America. Australia's 7,000,000 people are served by 100 commercial stations and 30 Government transmitters—one station to every 56,000—whilst America has one to every 127,000. In this country there is one to every 900,000.

The radio density is 19.69 sets per 100 of the population, which means that nearly every home has a receiver, for the statistician's population figures show an average of 4.25 people in every home.

The Government transmitters, which vary in power from 1 to 10 kW, are operated by the Australian Broadcasting Commission established in 1923 on similar lines to the B.B.C. The power of commercial stations is limited to 2 kW.

In addition to the medium-wave stations there are five short-wave transmitters operated by the A.B.C. for the benefit of the more remotely situated population. Australia's 1,500,000 licensed listeners pay £1 a year. An additional licence for a second receiver costs 10s a year. There were 72,000 such licences at the end of last year.

Experimental transmissions were recently started from a 2-kW F.M. station working on 90 Mc/s in Melbourne. Some twenty receivers built by the P.M.G.'s Department, are being used for the field tests. Over 900 applications for commercial F.M. transmitting licences have been made during the past few years. In a report issued some months ago by the Parliamentary Standing Committee on Broadcasting the conclusion was reached that F.M. service tests should be made by the Post Office in each of the six capital cities and that the Australian Federation of Commercial Broadcasting Stations should be given the opportunity of making similar tests.

Commenting on the possible introduction of television in Australia the Standing Committee in its report points out that it is unfortunate that British and American television equipment is not interchangeable. This means that unless international standardization is introduced within a reasonably short time it will be necessary "to make a fundamental decision involving Empire preference as regards an Australian service." The committee recommends that tenders be

invited for the erection of experimental stations in Sydney and Melbourne.

Turning now to the overseas transmitters, it was not until the end of 1939 that the Australian Department of Information started short-wave broadcasts. The transmitters used were one of 10 kW belonging to Amalgamated Wireless, Australasia, and two 2-kW A.B.C. stations. Radio Australia, as the overseas broadcasting section is called, now operates two 100-kW transmitters (VLA and VLB) and

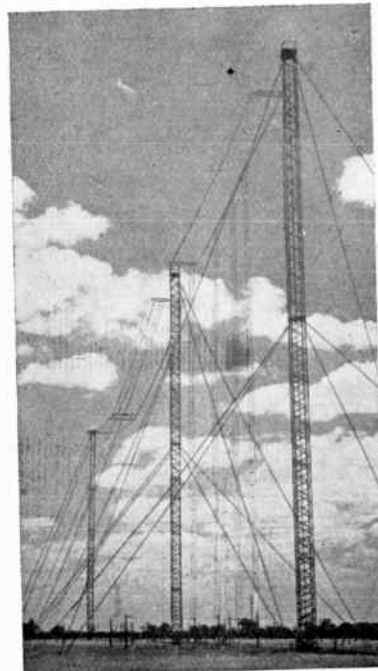

RADIO AUSTRALIA. Some of the nineteen arrays at Shepparton, Melbourne, for the overseas transmissions of the Commonwealth Department of Information. The transmitters are operated by the P.M.G.'s Department.

one 50-kW station (VLC) at Shepparton, 110 miles north of Melbourne, and a 10-kW station, VLG, at Lyndhurst, 24 miles south-east of Melbourne.

The Shepparton transmitters employ nineteen aerial arrays for operation on frequencies between 6 and 22 Mc/s.

Australia's radio industry is now operating nearly 100 factories employing twice as many people as were in the industry before the war. Of the 200,000 sets sold last year about 25 per cent were battery operated. Prices are about 25 per cent above those of 1939.

Tuned A.F. Filters—Appendix (Concluded from previous page)

Now circuit (2) produces a constant attenuation at frequencies far from resonance equal to $\frac{R}{R+S}$ or $\frac{A}{A+B}$.

Let L = absolute maximum attenuation at f_0 .

$$\text{Then } L = \frac{Rr}{Rr + Sr + S.R} = \frac{A}{A + B + AB}$$

$$\text{Hence } F_0 = \frac{(A+B)}{A} L = \frac{A+B}{A+B+AB}$$

$$\text{and } F = \frac{(A+B)}{A} K.$$

$$\text{Thus } F^2 = \frac{(A+B)^2}{A^2} \times \frac{A^2}{\cos^2 \phi (A^2 B^2 + 2AB^2 + 2A^2 B) + (A+B)^2}$$

$$\text{Hence } \cos^2 \phi = \frac{(A+B)^2 (1 - F^2)}{F^2 (A^2 B^2 + 2AB^2 + 2A^2 B)}$$

$$\text{therefore } \tan^2 \phi = \frac{F^2 (A^2 B^2 + 2AB^2 + 2A^2 B) - (A+B)^2 (1 - F^2)}{(A+B)^2 (1 - F^2)}$$

$$= \frac{F^2 \left(\frac{A+B+AB}{A+B} \right)^2 - 1}{1 - F^2} = \frac{F^2 - F_0^2}{F_0^2 (1 - F^2)}$$

$$\text{or } Q \left(\frac{f_0}{f} - \frac{f}{f_0} \right) = \sqrt{\frac{F^2 - F_0^2}{F_0^2 (1 - F^2)}} \text{ as for circuit (1).}$$

Design Data (14)

Resonant R.F. Chokes

At high radio frequencies it is a common practice to employ resonant chokes to prevent R.F. currents from straying into unwanted paths. In the detector output circuit and in the heater leads of R.F. valves the use of such chokes is not uncommon.

A resonant choke is an inductance which resonates with its own self-capacitance at the radio-frequency concerned. It thus acts as a parallel-resonant circuit at this frequency, and offers a high impedance; because of this the choking action falls off as the frequency departs from resonance. It

because the resonance tends to be too sharp in relation to the bandwidth. They could, however, be used in I.F. amplifiers, but they are rarely needed. They find most application at frequencies of 10 Mc/s and over, where it is possible to use a single-layer winding, and then the design of suitable chokes becomes amenable to simple calculation.

When the coil is wound with a large ratio of length to diameter the length of wire required is one-half wavelength. As the ratio is

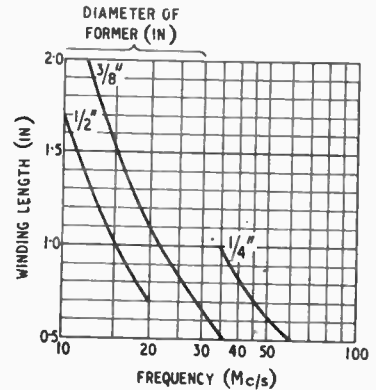

Fig. 3.

length of one turn is $\frac{3}{8} \times 3.14 = 1.18$ in., so that $109/1.18 = 92.5$ turns are needed. The turns per inch are $92.5/1.5 = 61.6$, and reference to wire tables shows that No. 28 enamelled wire can just be used with careful winding.

Figs. 2 and 3 show curves of winding length as a function of frequency for a number of different winding diameters, and for No. 36 and No. 41 gauges enamelled wire respectively. They are derived from Fig. 1, and are convenient in design, since they enable one to pick the most suitable dimensions very quickly, and it is usually sufficiently accurate to wind the coil to length without bothering about the actual number of turns.

For 13 Mc/s, for instance, with No. 36 wire one could hardly use anything less than $\frac{3}{8}$ in diameter, since anything smaller would be inconveniently long. Fig. 2 gives the winding length as 1.4 in. With No. 41 wire, however, one can well drop to $\frac{1}{2}$ in diameter and wind to 1.22 in. One might not, of course, be able to stand for the higher D.C. resistance of No. 41 wire; one certainly could not in a heater circuit and, in fact, one would try not to drop below about No. 26 gauge for this purpose. Such chokes are not usually needed below about 30 Mc/s, and the dimensions are then so reduced that larger wire is not impracticable.

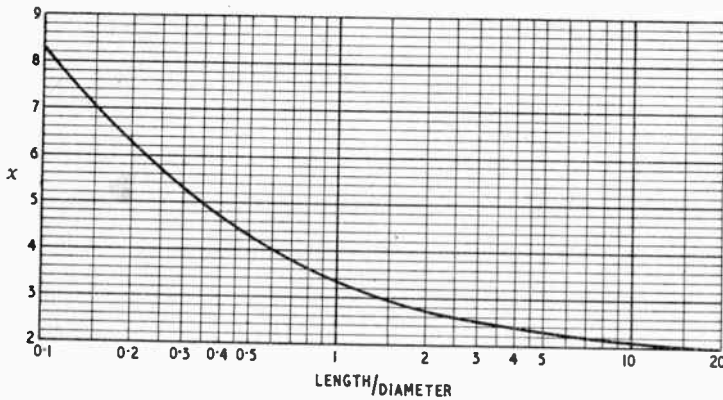

Fig. 1.

is, however, effective over a reasonably wide band, and the resonance frequency should be chosen to lie towards the middle of the band to be covered.

Chokes of this kind are not often used at the lower frequen-

duced, the length of wire needed is lessened also. This is easily understandable, for shortening a coil increases the coupling and capacitance between turns and so increases the inductance.

Fig. 1 gives a curve showing the value of x as a function of the ratio of length to diameter of the coil, where x is the number by which the wavelength must be divided to find the length of wire needed.¹

As an example, suppose that length/diameter is 4 and that the choke is to resonate at 45 Mc/s. Fig. 1 gives $x = 2.4$, and the wavelength corresponding to 45 Mc/s is 6.66 metres. The length of wire is thus $6.66/2.4 = 2.775$ m = 109 in. If the diameter of the coil is $\frac{3}{8}$ in the length is $1\frac{1}{2}$ in, and the

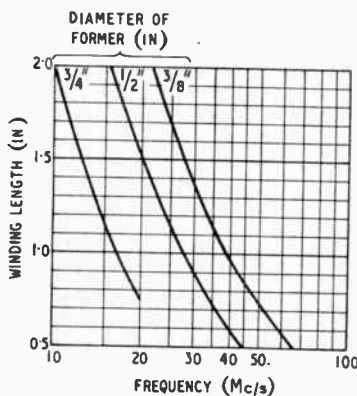

Fig. 2.

¹ "H.F. Resistance and Self-Capacitance of Single-Layer Solenoids," by R. G. Medhurst, *Wireless Engineer*, February and March, 1947, Vol. 24, pp. 35 and 80.

*50L6s — hard to get
 BRIMARIZE! it's a better bet

Substitute a 35L6GT for that hard-to-get 50L6GT. Both are Beam Tetrodes and both International Octals. Their characteristics are similar, except for a small difference in heater voltage. An increase in line cord resistance is all that is required to make this substitution.

50L6GT

PUNCH HOLES HERE

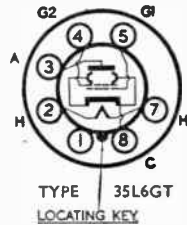

RATED CHARACTERISTICS

	50L6GT	35L6GT
Heater Volts	50V	35V
Heater Current	0.15A	0.15A
Anode Volts	110V	110V
Anode Current	49mA	41mA
Screen Volts	110V	110V
Screen Current	4mA	2.0mA
Grid Bias	-7.5V	-8V
Power Output	2.0W	1.5W

TYPE	CHANGE SOCKET		CHANGE CONNECTIONS		OTHER WORK NECESSARY	PERFORMANCE CHANGE
	FROM	TO	FROM OLD SOCKET	TO NEW SOCKET		
35L6GT		INT/OCTAL NO CHANGE		NO CHANGE	Increase line cord resistance by 100 ohms (110 volt receivers) or 80 ohms (230 volt receivers)	NEGLIGIBLE

BRIMAR
 RADIO VALVES

★ OPERATION BRIMARIZE
—a manoeuvre executed by qualified radio engineers in order to effect the widest possible use of available BRIMAR VALVES.

STANDARD TELEPHONES AND CABLES LIMITED, FOOTSCRAY, SIDCUP, KENT.

WATCH THIS SERIES FOR THE BEST ADVICE.

INSTRUCTIONS: Punch holes where indicated and cut away this portion. Cut out and file them in the order in which they appear. This column will then give you a quick reference index.



**Have you thought of Morganite
for the problem?**

Of course there are Morganite Potentiometers and Resistors for Radio, but do you know that Morganite Resistors are available in ratings up to 500 watts in sizes from 0.05 to 100 cubic inches in rods, tubes and special shapes? In addition to light electrical applications such as clocks, automobile regulators and fluorescent lamps, Morganite Resistors are doing heavy duty, for instance, in electrical power switchgear.

Surge protective Resistors obeying the law $R = KV^2$ have now been developed and are creating a revolution in the design of surge protective apparatus and interference elimination.

MORGANITE

THE MORGAN CRUCIBLE COMPANY, LIMITED, LONDON, S.W.11

World of Wireless

NEWS OF OLYMPIA

OWING to the number of applications for space in the fifteenth National Radio Exhibition, being organized by the R.I.C. for October 1st to 11th in Olympia, the layout of the stands had to be rearranged. The ballot for stands was held at the beginning of June and the latest list includes the names of 175 firms.

In the section devoted to electronics and communications twenty-three manufacturers will be exhibiting.

"Non-commercial" users of radio equipment who will be exhibiting include the B.B.C., Board of Trade (Export), Cable and Wireless, G.P.O., Scotland Yard and the Ministries of Civil Aviation and Supply.

A feature of the exhibition—the motto of which is "Britain Builds Radio for the World"—is an Export Centre where overseas visitors will find every facility.

INSTRUMENTATION

A BULLETIN of information on technical matters relating to communications, methods of measurement and electro-medical science is to be issued bi-monthly by Marconi Instruments, St. Albans, Herts, under the title "Marconi Instrumentation." It is written essentially for the industry and professionals and deals with trends of development, new applications and experiences in the use of measuring equipment rather than with descriptions of individual instruments.

The first issue contains articles as diverse as the relationship between power factor, loss angle and magnification, clinical aspects of electro-surgery, and monitoring systems for signal generators.

'EXPERIMENTAL SCIENCE'

THE above is the title of a booklet issued by the Institute of Physics to explain the purpose, scope and value of the courses leading to the award of National Certificates in Applied Physics. They are awarded by a joint committee of the Ministry of Education and the Institute.

The prescribed training, which is in applied physics rather than in electrical and mechanical engineering, provides for part-time study for three years for the Ordinary National Certificate, and for a further two years for the Higher National Certificate. A student entering for the course should have

had full-time continuous education up to the age of 16 or have completed satisfactorily a junior two-year part-time course after leaving an elementary school.

Candidates for the Higher National Certificate who succeed in reaching a sufficiently high standard in the final examination will be granted exemption from the academic requirements for membership of the Institute of Physics.

Copies of the booklet, which has been widely distributed to colleges and in the industry, may be obtained from the secretary of the Institute, 47, Belgrave Square, London, S.W.1.

TELEVISION PROGRESS

THE announcement within a day or two of each other that contracts had been placed by the G.P.O. and the B.B.C. for the erection of both the Birmingham television transmitter and the radio-relay link stations between London and Birmingham has created considerable interest. That long-term plans have been made is also evidenced by the placing of a contract with Marconi's for sound and vision equipment for a subsequent transmitting station, the site for which has not yet been decided upon.

The vision transmitter for the Birmingham station, the site for which is still uncertain, has been ordered from Electric and Musical Industries, whilst the sound equipment will be supplied by Marconi's. It will be recalled that the London station was supplied by the same companies.

Whilst the G.P.O. specification for the London-Birmingham television radio-relay link calls for duplex working, the G.E.C. link will provisionally provide reversible single-channel working in order to expedite its introduction.

Two intermediate stations will be used to relay the signals between the terminal stations which will be near London and Birmingham, respectively. It is uncertain whether the terminals will be linked to the transmitters by radio or cable. Owing to the nature of the terrain one of the paths between stations will be about 20 miles long and the other two about 40 miles each.

Each station will be equipped with an 80ft lattice steel tower on the top of which will be a 9ft square cabin containing the R.F. and signal channel equipment. The transmitting and receiving paraboloids, each

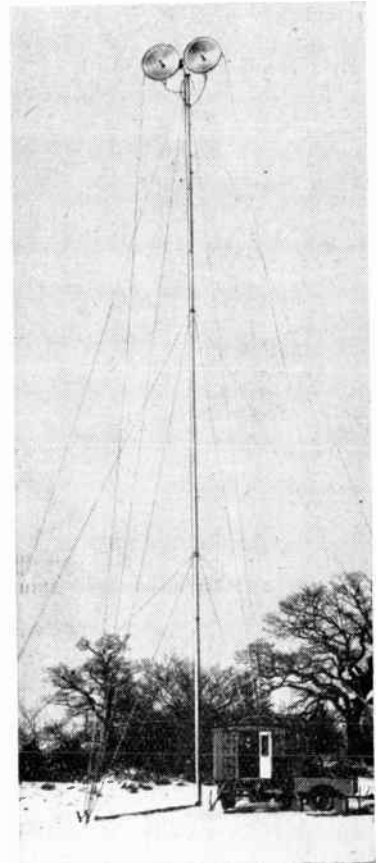

MOBILE FIELD UNIT used by the G.E.C. during the winter trials to determine the best route for the London-Birmingham television radio-relay link.

12ft in diameter, will be mounted on the cabin. They will incorporate a de-icing system. A small building at the foot of the tower will house the supervisory control equipment and the power supply units.

Four transmitter frequencies of the order of 1,000 Mc/s will be employed and these may be used over and over again if the link should be extended to other centres. It is hoped to give details in a future issue of the system of modulation used by the G.E.C. in the superhet receivers, whereby the video-frequency signals do not appear except at the terminals.

Duplicate equipment (except aerials) is provided at each station and will automatically come into operation in the event of a failure. The aerials will be automatically

World of Wireless—

switched over to the standby gear by radio-frequency contactless switches. The equipment at each station will be controlled at the terminal.

MARINE RADIO AIDS

WHILST the International Meeting on Marine Radio Aids to Navigation, which was concluded in New York on May 9th, was not plenipotentiary, many fundamental resolutions were passed which will be conveyed by the delegates to their respective countries. Thirty-two nations were represented.

It was left to the U.K. and the U.S.A. jointly to implement the recommendation that an international standing committee be set up to obtain and co-ordinate numerical data on the performance of various radio navigational aids.

The following joint resolution was submitted by the U.K. and the U.S.A. and unanimously adopted: "That Decca, provided that it continues to give operational satisfaction and that the application of lane identification proves effective, appears to provide a position fixing system of an accuracy which meets the mariner's requirements and therefore should be improved and expanded in regions where the nations concerned consider it desirable."

Lane identification has been successfully demonstrated to various authorities in this country and a brochure has been produced by Decca describing the method where-

by a ship, entering the range of a Decca chain without accurate knowledge of its position, may instantaneously determine it.

It is understood no case was made by the U.K. delegation for Gee as it is considered to be of no use as a marine aid. This is the opposite view to that taken by civil aviation. In view of this it is interesting to note that one of the recommendations calls for the co-ordination of air and marine interests in each country so that delegates to international meetings on aids for either may speak with the interests of both in mind.

Regarding long-range navigational aids it was agreed that the requirements of aviation are more pressing than those of shipping, but in determining the most appropriate aeronautical aid it is suggested that due consideration be given to the needs of both. It was agreed by the delegates that "Standard Loran gives higher accuracy within its effective coverage area than does Consol within its larger effective coverage area." It was suggested that the Loran system should be expanded wherever it can jointly serve both marine and aviation.

Whilst it is not contemplated that early action will be taken to make the fitting of radar compulsory it is recommended that as a pre-requisite "a universal performance specification of shipborne radar" should be prepared.

No recommendations were made regarding frequency allocations nor restricting shipborne radar to one frequency band.

BRIT. I.R.E. CONVENTION

THE first post-war convention of the British Institution of Radio Engineers was held in Bournemouth from May 20th to 23rd. Members and visitors were officially welcomed at an inaugural luncheon on the Tuesday and attended a convention banquet on the Thursday.

In addition to the presentation of technical papers—covering such diverse subjects as waveguides for micro-wave multi-channel communications, radio navigational aids, F.M. transmitter design, high-fidelity recording and reproduction, railway radio, H.F. and V.H.F. valves, television and broadcast aerial design—facilities were available for visits to technical establishments in the vicinity of Bournemouth. These included the B.O.A.C. Airport at Hurn, a demonstration of the Decca Navigator on board the motor yacht "Navigator" and H.M.S. "Collingwood" the Admiralty's main technical training school for radio, electrical and the various radiolocation devices.

AMATEURS AID U.N.

PLANS are being made for the enlistment of amateurs to transmit weekly bulletins on behalf of the United Nations Organization. The offer of amateur help in disseminating U.N. information was made by the president of the International Amateur Radio Union and an agreement has been signed providing for co-operation for one year.

The bulletins will be issued to two or three key operators in New York who will transmit them at scheduled times. These transmissions will in turn be re-broadcast by amateurs who will form a world-wide network.

PERSONALITIES

Sir Clifford Paterson, F.R.S., has received the James Alfred Ewing Medal for 1946 from the I.E.E. on the joint recommendation of the Royal Society and the Institute of Civil Engineers. Sir Clifford, who received the medal for specially meritorious contributions to the science of engineering in the field of research, is Director of the G.E.C. Research Laboratory.

Professor Willis Jackson, of the Imperial College of Science and Technology, London, has been appointed by the Minister of Supply to the Ministry's Advisory Council on Scientific Research and Technical Development.

O. F. Brown, assistant secretary of the Department of Scientific and Industrial Research, was appointed a C.B.E. in the Birthday Honours. He joined the D.S.I.R. as secretary of the Radio Research Board in 1918 and

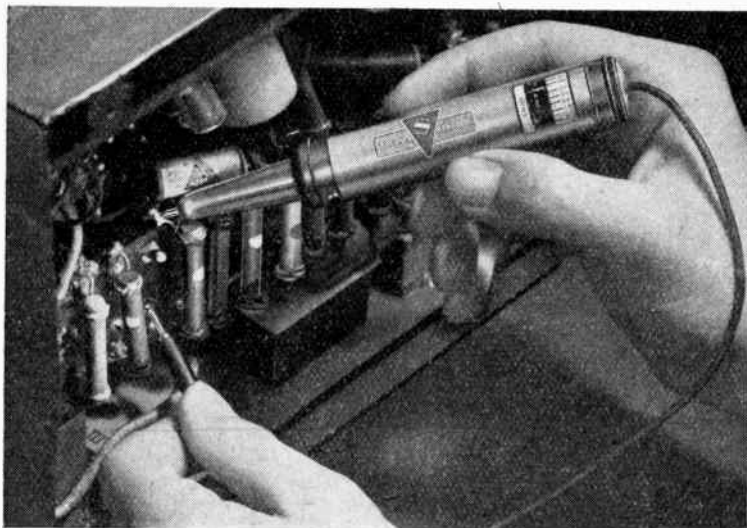

POCKET OHMMETER—This miniature testing device for radio servicemen has recently been introduced by Sylvania in America. It embodies a Weston 1.5 mA full scale meter and a "pen" drycell.

served on the first Television Advisory Committee. Early during World War II he went to the M.A.P. and in 1941 was appointed Director, Telecommunications Division. Returning to the D.S.I.R. in 1944, he took charge of the new Headquarters Information Division and was appointed to the present Television Advisory Committee. Mr. Brown was general secretary of the British Commonwealth Scientific Conference held last July and is secretary of the standing committee formed to carry on the work of the conference.

H. L. Kirke, head of the B.B.C. Research Department, was also appointed a C.B.E. Within a year of joining the B.B.C. in 1924 he was appointed to his present position. For a few years prior to joining the B.B.C. he was with



H. L. KIRKE, C.B.E.

Marconi's. A member of the I.E.E., he was chairman of the Radio Section in 1944-45. He is chairman of the Acoustics Group of the Physical Society.

Professor G. W. O. Howe, D.Sc., who retired from the James-Watt Chair of Electrical Engineering, Glasgow University, a few months ago, has been given the honorary degree of Doctor of Laws of the University. Dr. Howe is technical editor of our sister journal *Wireless Engineer*.

The American Medal for Merit was awarded to a number of British scientists a few months ago "for exceptionally meritorious conduct in the performance of outstanding services to the United Nations." The U.S. Embassy has recently given details of the citations, some of which are quoted below:—

Sir Edward Appleton "was outstanding in the effectiveness of his work for co-operation between British and American scientists, and was responsible for important phases of the early research leading to the development in England and the United States of modern radar".

Dr. Robert Cockburn, head of the Counter-measures Group of T.R.E., "was instrumental in devising new electronic techniques to counter the enemy's use of fire control methods, navigation aids and bombing devices. . . . In the field of radio and radar counter-measures, Dr. Cockburn was the British scientist who, above all

others, had the most comprehensive grasp of the scientific and operational problems involved".

Albert P. Rowe, head of T.R.E., "exercised a dominant rôle in the development of radar and counter-measures in the United Kingdom. When American scientists working in these fields proposed to establish advanced laboratories in England, he co-operated enthusiastically, opening his own establishment for their equal use".

Sir Robert Watson Watt's "years of work, in a field little frequented, largely formed the basis of the extraordinary early success of British radar when the onset of the war engulfed England in a wave of bombing. . . . The success attained in the military employment of these new scientific devices and methods inspired and stimulated the great radar programme in the United States. . . . In the development and effective combat employment of superior types of radar, radar counter-measures and communications equipment, his services were of enormous value".

IN BRIEF

Dearer Replacement Valves.—The British Radio Valve Manufacturers' Association has issued a list of price revisions for types which they regard as obsolete or obsolescent, but for which there is still a demand for the maintenance of existing sets. Nearly sixty types, and their equivalents in different makes, are affected, and price increases in the majority of cases are between 20 and 60 per cent.

On the Map.—It was agreed at the fifth International Hydrographic Conference, recently concluded at Monaco, that the symbol for radar on marine charts should be "RR" to differentiate from "R" which is used for radio. The radar symbol has been used by the Admiralty for some time.

Amateur Transmitters.—The number of licensed amateur transmitters in Great Britain and Northern Ireland on June 9th was 5,101.

British Wireless Dinner Club.—The 24th dinner of the British Wireless Dinner Club was held in London on June 6th with the president, Major-General Sir Leslie G. Phillips, in the chair. The guest of the evening was Sir Edward Appleton, F.R.S. During the evening the election of president and officers for the ensuing year took place, A. J. Gill being elected president and Vice-Admiral J. W. S. Dorling vice-president.

Licence Figures.—A further increase in the number of broadcast receiving licences in force in Great Britain and Northern Ireland was recorded at the end of April, when the total was 10,810,550 (approx.). Of this total 16,600 were television licences. The corresponding figures for March were 10,780,400 and 14,550.

Broadcasting Stations.—The second edition of the *Wireless World* booklet, giving details of frequency, wavelength and power of 1,200 broadcasting stations in the long-, medium- and short-wave bands is now available. To minimize errors entries have been checked against the frequency measurements made at the B.B.C.'s receiving station at Tatsfield. To meet the criticism that there are no details of medium-wave stations outside the European zone, the title of the booklet has been changed to "Guide to Broadcasting Stations." It is available from booksellers, price 1s, or by post from our Publisher, 1s id.

London-Kabul Radio Link.—Cable and Wireless, in co-operation with the Afghan Administration, opened a direct 3,500-mile wireless-telegraph beam service between London and Kabul on June 1st.

For "m" read "μ"!—The signal strength quoted in the caption to the illustration of the C.B.C. aerials on page 216 of the June issue should, of course, have been given in microvolts.

R.C.A. Index.—The Radio Corporation of America has issued new indices to R.C.A. technical articles and papers that have appeared in various publica-



LOUD HAILER ON THE ROAD. A Hampshire Constabulary police car, fitted with an Ardente re-entrant horn loudspeaker of a type similar to that used as a marine "loud hailer" during the war. The speaker is stated to have a reliable range of 20-25 yards for talking to fast-moving cars; for pedestrian control the range is over 100 yards.

World of Wireless—

tions. Vol. I covers 1919-1945 and Vol. II (a) is for 1946. Copies are obtainable free from R.C.A. (Laboratories Division), Princeton, N.J., U.S.A.

INDUSTRIAL NEWS

Anglo-Belgian Exhibition.—Particulars of an exhibition of British products for European markets, which is to be held in the Salle de la Madeleine, Rue Duquesnoy, Brussels, from September 4th to 9th, are obtainable from the organizers, H. & H. Trading (London), Ltd., 5, Copthall Buildings, Copthall Avenue, E.C.2.

Anglo-Danish Exhibition.—Arrangements are being made by the British Import Union of Copenhagen, in collaboration with the Federation of British Industries, to hold an All-British Exhibition in Copenhagen in September, 1948. A further announcement will be made by the Board of Trade as soon as plans are completed.

H.M.V. public address equipment has been installed in the Savoy Hotel, London. H.M.V. equipment was also used at Olympia for the recent "Ideal Home" exhibition and the B.I.F., for which 390 loudspeakers were used.

Masteradio, Ltd., has a new head office at 10-20, Fitzroy Place, London, N.W.1. (Tel.: Euston 2628.) The sales and service depot is at 319-321, Euston Road, N.W.1. A new factory at Treforest, Glamorgan, is starting production and the company's works will eventually be centred there instead of at Watford, Herts.

Chloride.—The London sales depot of the Chloride Electrical Storage Co., evacuated from Shaftesbury Avenue to Richmond early in the war, is now at 6-10, Whitfield Street, Tottenham Court Road, W.1. (Tel.: Museum 1616.)

Watson Watt.—The address of Sir Robert Watson Watt and Partners, Ltd., the recently formed company of technical consultants, is 27, Chancery Lane, London, W.C.2. (Tel.: Holborn 3721.)

Multitone Advertisement: Correction.—In the Multitone advertisement which appeared in the June issue it was stated "The amplifier incorporates volume compression circuit and two channel output; one channel provides level *modification*, the other high pass." The word in italics should, of course, read "amplification."

Relay Services Exhibition.—The latest equipment developed for wire-broadcasting relay systems was shown at an exhibition held recently in London by the Relay Services Association of Great Britain. Among the exhibits were high-power audio amplifiers and communication-type receivers made by Associated Electronic Engineers and W. Bryan Savage; small parts and accessories by Belling-Lee, British N.S.F., G. Frye (Relay) and Relay Electric; loudspeakers by C. French, Whiteley Electrical and Wharfedale cables and overhead wires by B.I. Callender's, G.E.C. and T.C.M.C.; valves, C.R.T.s and test apparatus by G.E.C. and Mullard.

English Electric Valve Co., Ltd., Queen's House, Kingsway, London, W.C.2, has been formed to manufacture radio and electrical apparatus.

Leland Instruments, Ltd., exhibited at the fifteenth International Fair at Barcelona, which was open from June 10th-25th.

CLUBS

Birmingham.—Meetings of the Birmingham and District Short-Wave Society are still held monthly, on the first Monday at 8.0 at the "Hope and Anchor," Edmund Street, but it is hoped to hold them fortnightly. Sec.: N. Shirley, 14, Manor Road, Stetchford, Birmingham, 9.

Bournemouth.—The new secretary of the Bournemouth and District Amateur Radio Club is Col. S. G. Plomer, O.B.E., 75, The Grove, Moordown, Bournemouth, Hants.

I.S.W.C.—A special programme is to be broadcast from HCJB, Quito, Ecuador, for members of the International Short-Wave Club, on June 27th at 05.30 (D.B.S.T.). Transmission will be on 12.445, 9.958 and 15.115 Mc/s (24.08, 30.12 and 19.85 metres). Reception reports should be sent to Radio Station HCJB, Casilla 691, Quito, Ecuador, S. America. I.S.W.C. Sec.: A. E. Bear, 100, Adams Gardens Estate, London, S.E.16.

West Bromwich and District Radio Society meets on Mondays at 7.30 alternately at the "Gough Arms," Jowetts Lane, and Udall Engineering, Mill Street. Practical work is done at the latter address, where the club transmitter, G3BWW, is located. Eight of the members are licensed amateurs. Sec.: R. G. Cousens (G3BCS), 38, Collins Road, Wednesbury, Staffs.

Wigan.—Reception reports of transmissions in the 40-metre band from the station of the Wigan and District Amateur Radio Club (G3BPK) will be welcome. Sec.: H. King, 2, Derby Street, Spring View, Wigan.

Worcester now has a radio society—the Worcester and District Amateur Radio Club. Meetings are held on the first Thursday in the month at the Victoria Institute. Sec.: D. Higley, 1, York Place, Worcester.

MEETINGS**Institute of Physics**

Industrial Radiology Group.—A symposium on "Methods of Crack Detection" on July 18th and 19th at the Electric Lamp Manufacturers' Association, 2, Savoy Hill, London, W.C.2. Details are obtainable from L. Mullins, Research Laboratory, Kodak, Ltd., Harrow, Middx.

Physical Society

Acoustics Group.—A symposium on sound absorption and reverberation on June 26th, at 10 a.m., at the Royal Institute of British Architects. Speakers include Prof. P. V. Bruehl, of Gothenburg University, and J. Moir, of B.T.H.

Television - Signal Generator

ALL POWER TRANSFORMERS, LTD., of 8a, Gladstone Road, Wimbledon, S.W.19, have produced a television-signal generator, Model 200, which is designed to suit the needs of research and development laboratories. It produces a 45-Mc/s modulated R.F. output, the modulation comprising the standard sync pulses and any of the following picture signals: all-black, all-white, 9 horizontal white bars, 9 vertical white bars, chess-board pattern of 64 black rectangles.

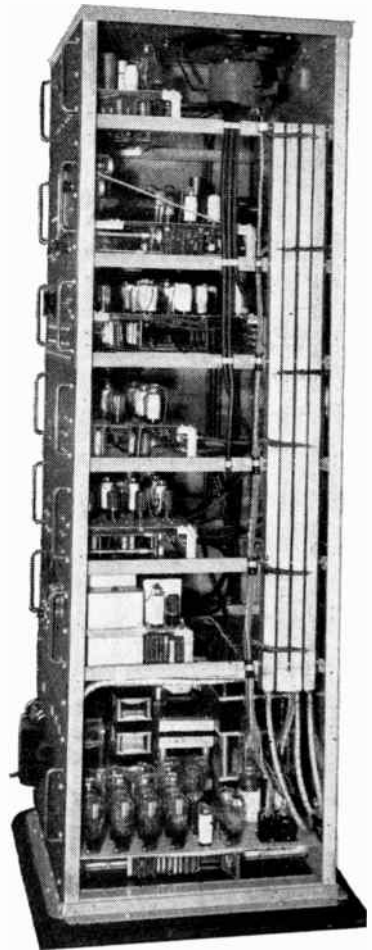

Side view with covers removed of All Power Transformers television-signal generator.

All signals are derived from a 101,250-c/s master oscillator by counting down, and stabilizing means are included to keep the phase of the signals constant with respect to the 50-c/s mains. The equipment is rack-built.

Television Receiver Construction

5.—Line Time-base and E.H.T. Supply

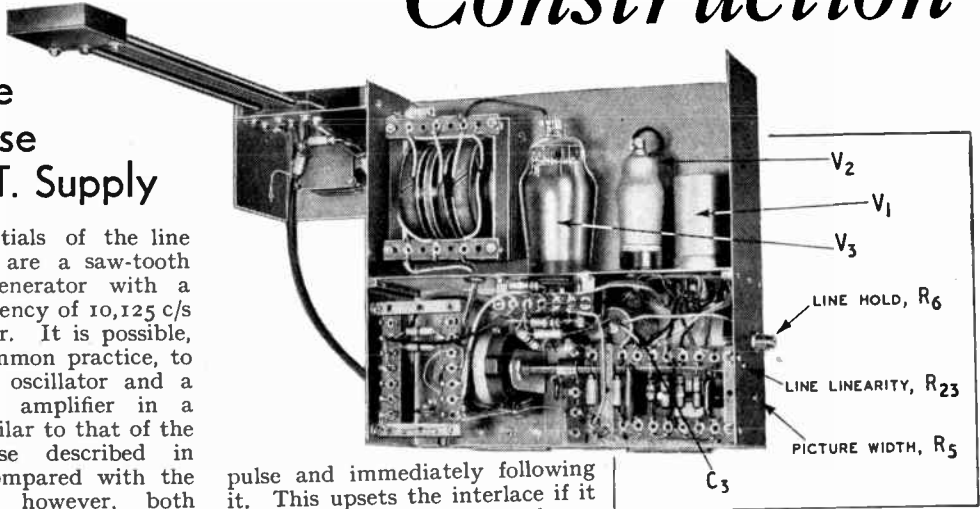

THE essentials of the line time-base are a saw-tooth voltage generator with a recurrence frequency of 10,125 c/s and an amplifier. It is possible, and in fact, common practice, to use a blocking oscillator and a pentode power amplifier in a circuit very similar to that of the frame time-base described in Part 4. As compared with the frame circuit, however, both linearity and synchronizing are less easily secured.

Linearity is more difficult because there is an additional factor involved—the oscillatory nature of the deflection circuit. Synchronizing is more difficult because the line-scan blocking oscillator transformer must have fewer turns than the frame and it becomes rather hard to develop enough synchronizing voltage across it. In addition, the blocking oscillator develops a large amplitude pulse of opposite sense to the sync

pulse and immediately following it. This upsets the interlace if it is allowed to reach the frame circuits and consequently a buffer stage between the line and frame circuits is desirable.

As an alternative the Transistron-Miller integrator saw-tooth generator has many advantages for the line scan. It requires a very small synchronizing voltage and the "back-wash" from it is small enough not to affect the interlacing even if a buffer

is not used. The saw-tooth output is remarkably linear but is negative-going.

The output pentode must be supplied with a positive-going saw-tooth. This can be obtained from a resistor in the cathode circuit of the Transistron, but it is

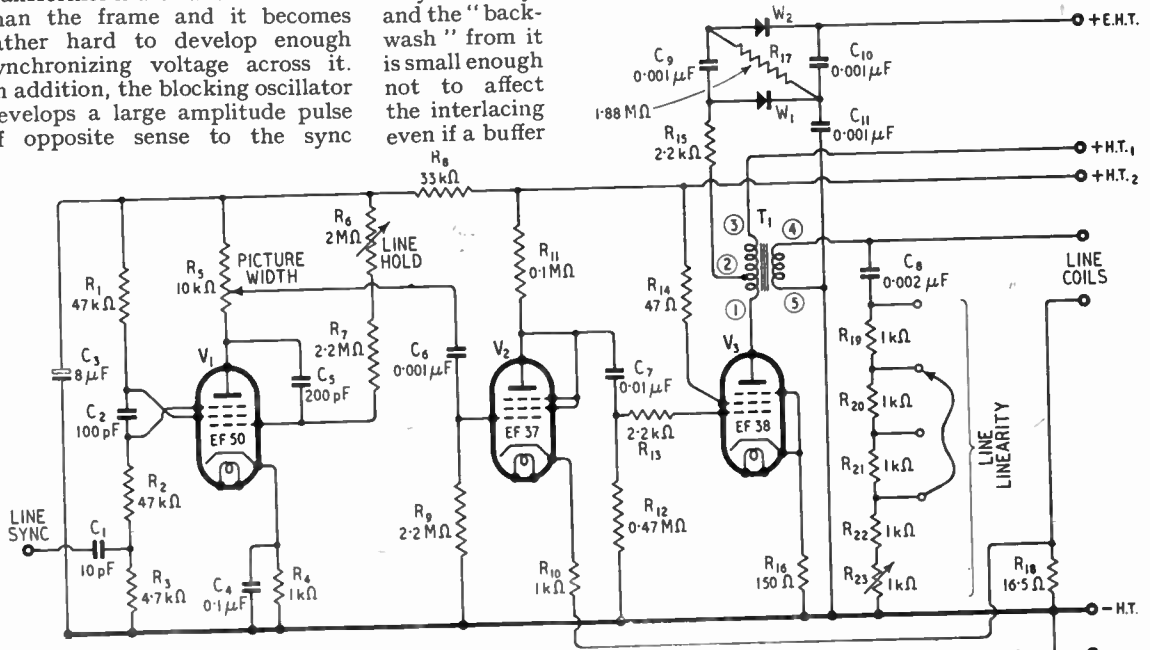

Fig. 1. The complete circuit diagram of the line time-base and E.H.T. supply. A Transistron-Miller integrator is used for the saw-tooth generator with a two-stage amplifier having heavy negative feedback.

Television Receiver Construction— more satisfactory to take the normal negative-going output and use an intermediate stage, because this permits the use of heavy negative feedback in the amplifier and this makes it extremely easy to obtain a linear deflector-coil current.

The circuit diagram of the complete line time-base unit is given in Fig. 1. The saw-tooth generator is V_1 , a valve of the

voltage across it falls and so the G_1 —cathode voltage changes in a positive direction causing both anode and screen G_2 currents to rise and the electrode potentials to fall. The rising voltage across R_5 is very nearly equal to the falling voltage across C_5 , so that the voltage across R_6 and R_7 is nearly constant. This is the condition for a linear change of voltage across C_5 and as the voltage across R_5 is changing similarly

sync pulse applied to G_3 . This reduces anode and increases G_2 current.

The above conditions hold while C_2 discharges through R_2 and during this time C_5 charges through R_5 and the grid-cathode path of the valve from H.T. It does this because with the anode current cut off, the control grid becomes positive to cathode.

When the charge on C_2 has leaked away sufficiently, G_3 becomes lower in potential and once more permits anode current to flow. This reduces the screen current and causes the screen and G_3 potentials to rise further. The action is again cumulative and there is a rapid change-over to the assumed initial conditions.

The time for which anode current is cut off is governed largely by the time constant $C_2(R_2 + R_3)$ and by the grid base of G_3 . With the EF50 rather a small time constant is required and with 100 pF for C_2 a resistance value of around 50 k Ω is suitable. The sync input needed is small and so it is applied to a tapping on the grid leak formed by using 47 k Ω for R_2 and 4.7 k Ω for R_3 . It is applied through a 10-pF capacitor which together with R_3 acts as a differentiator.

The cathode resistor R_4 and its by-pass capacitor C_4 are included to make the generator self starting. Without them, it would sometimes fail to start in the absence of sync pulses.

The saw-tooth output is taken from the slider of R_5 , which forms the "Picture Width" control, to the input of the amplifier. The first valve V_2 is an EF37 (or EF36, 6J7, 6J7G, GT, etc.) strapped as a triode and RC-coupled by R_{11} , C_7 and R_{12} to the EL38 output valve V_3 . A grid stopper R_{13} is included to inhibit parasitic oscillation and a screen stopper R_{14} is also used. The screen is fed from the + HT₂ line at about 250 V.

The value is self-biased by R_{18} and feeds the deflector coils through the transformer T_1 . A resistance R_{18} is included in series with the deflector coil and the voltage developed across it by the passage of the deflector-coil current through it is applied to the cathode of V_2 as negative

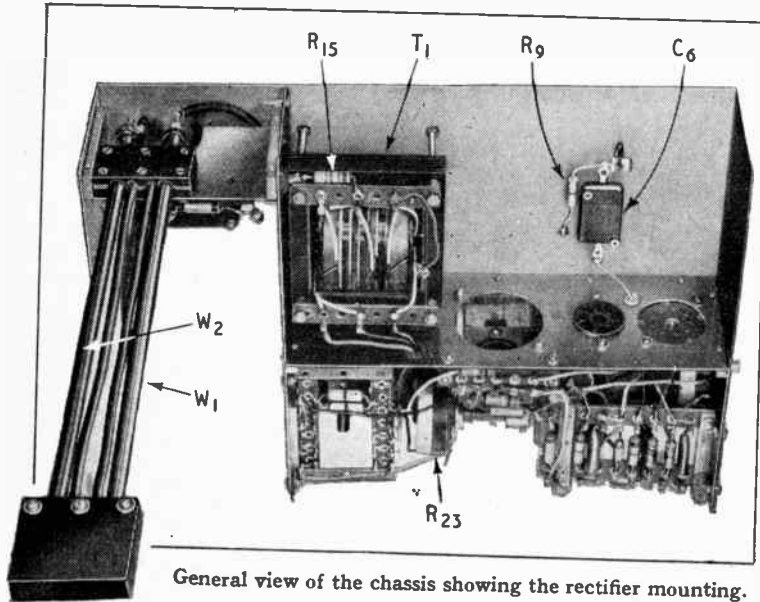

General view of the chassis showing the rectifier mounting.

EF50 type. A detailed explanation of the action of the Transistron-Miller integrator has already been given¹ and it is, therefore, sufficient to deal with it rather briefly.

Starting with C_5 charged to the full H.T. voltage which, in this instance, is the voltage across the decoupling capacitor C_3 , the conditions are that the suppressor grid G_3 is at about cathode potential and that both the screen grid G_2 and the anode are drawing current so that the potentials of these electrodes are below H.T. Because of the voltage drop across R_5 , the control grid G_1 is negative with respect to cathode by this amount, and there is no grid current.

The capacitor C_5 then discharges through R_5 , R_6 , and R_7 and the

this also is nearly linear and is the voltage used for the scan.

When the anode voltage falls beyond a certain point the field of the anode becomes insufficient to attract to itself the normal proportion of the electrons passing G_2 . As a result, the anode current drops and the screen current rises. The latter causes G_2 to change negatively in potential because of the increased drop in R_1 and the potential of G_3 also changes negatively since G_2 and G_3 are connected through C_2 . This turns still more electrons back to G_2 , further increasing the screen current. The action is cumulative and the valve is very rapidly driven to the condition of anode current cut-off, a heavy screen current, a very low screen potential and a highly negative G_3 voltage.

In normal operation the action is initiated by a negative-going

¹ "Linear Saw-Tooth Oscillator," by W. T. Cocking, *Wireless World*, June, 1946, Vol. 52, p. 176.

current feedback. With the high degree of feedback provided, the whole amplifier, from its input voltage to the deflector coil, is extremely linear and it is con-

valve V_3 is actually cut off for a short period following the fly-back. If it is cut off, negative feedback is inoperative during this period and variable damping

A voltage-doubler rectifier circuit is used and fed through the anti-parasitic oscillation resistor R_{15} from a tapping on T_1 ; this is done since rather less than the

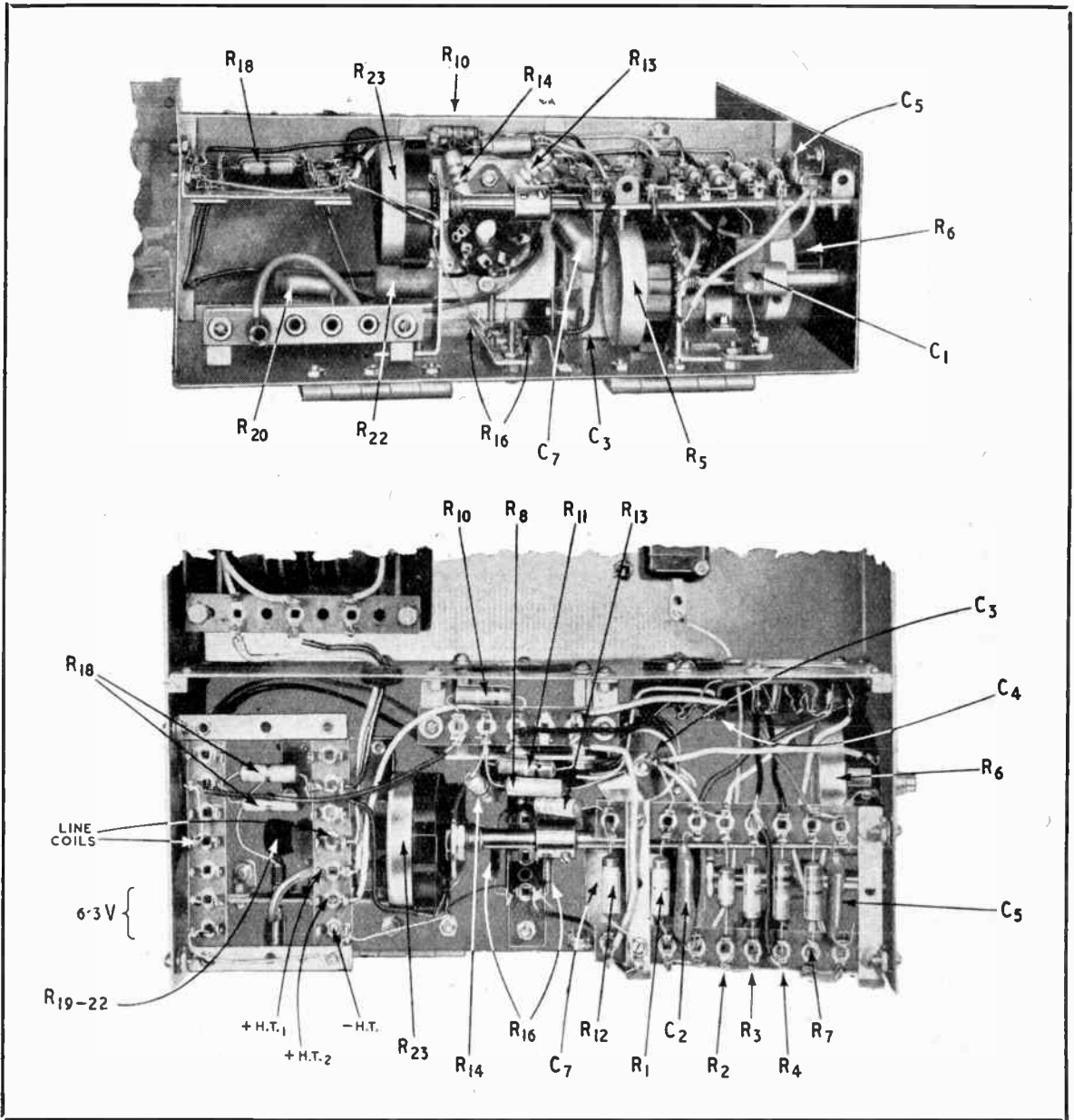

Details of the layout of components are clearly shown in these photographs of the underside of the chassis. C_1 is joined to a single insulator tag to which a lead is run from the Line Sync Output tag on the frame time-base.

sequently easy to obtain a linear scan. However, this is not sufficient to ensure a linear scan at the extreme left-hand side of the picture, for with the most economical operation the output

is accordingly provided to control the linearity at this point. It is provided by C_8 in conjunction with R_{19} , R_{20} , R_{21} , R_{22} , R_{23} . The E.H.T. supply for the tube is taken from the line fly-back.

full voltage on T_1 is needed. Three capacitors, two rectifiers W_1 and W_2 , and a resistor R_{17} , form the rectifier which provides an output of some 5 kV. The form of construction

Television Receiver Construction— adopted is clearly shown in the photographs and is similar to that of the frame time-base. The chassis measures 9½in by 9in high

end of the main chassis. A shelf mounted ½in below the top carries the rectifiers and is cut away near the rectifier terminals.

On account of their length the

protective cover to prevent accidental contact.

The power supplies at 6.3 V, 250 V and 480 V are taken by flexible leads to a tag-board on

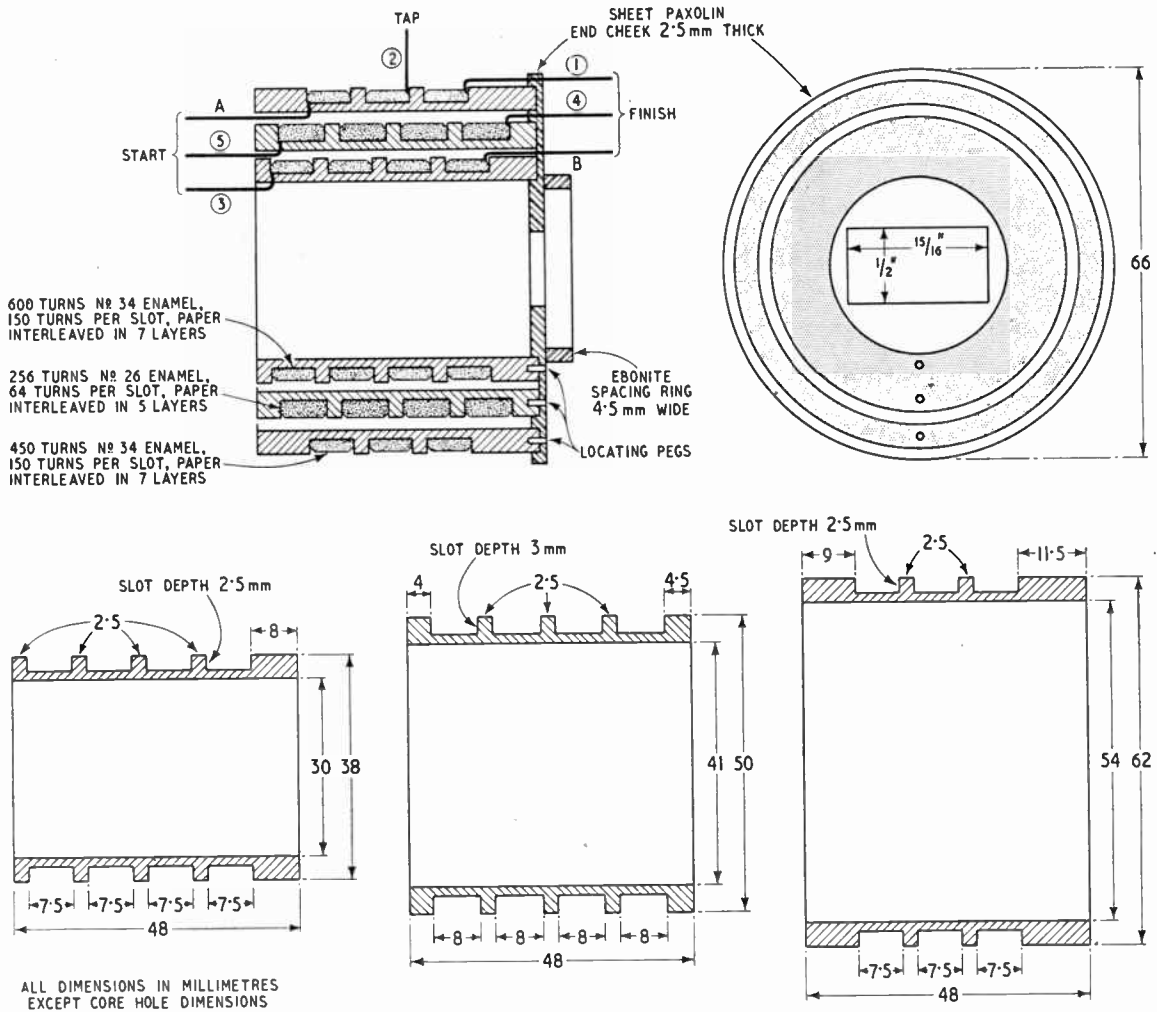

Full details of the output transformer are given here. The complete assembly of bobbins is spaced from the core by two ebonite rings to increase the leakage paths.

by 3in deep and has a shelf mounted ½in from the top to support the valveholders. The shelf is carried by strips of ¼in by ⅜in brass screwed to the chassis and which also act as stiffening members. On account of the great height of the EL38 its valveholder is carried by a small sub-panel standing 1in below the main valve shelf and secured to it by two pillars.

The E.H.T. components are carried in a sub-chassis measuring 3in x 3in x 3¼in screwed to the

rectifiers are not easy components to dispose of, particularly as they must be kept away from hot parts. They are held in place by a simple clamp and lie across the C.R. tube. As the connections are all at high voltage to earth ignition-cable is used for the leads and a protecting box cut from fibre sheet is used to cover the ends remote from the chassis. Similarly, a fibre plate is used as a cover for the sub-chassis. The fibre does not provide any normal insulation; it is used purely as a

which there are also two tags for the deflector coil leads. A single tag near the input circuit is used for the sync input and is connected by a flexible lead to the "line sync" terminal on the frame time-base unit.

The 1.88-MΩ resistor R₁₇ in the E.H.T. circuit comprises four 0.47-MΩ resistors connected in series and this arrangement is adopted to reduce the voltage existing across any individual resistor. The feedback resistor R₁₈ is two 33-Ω resistors connected

in parallel, because the required 16.5 Ω is not a standard value. Similarly, R₁₆ comprises two 300-Ω resistors in parallel.

The waveforms at various points in the circuit are shown in Fig. 2 and it is a great help in adjustment if an oscilloscope can be used and connected across R₁₈. In order to obtain the full scan the line linearity resistance R₁₉—R₂₃ must be carefully adjusted in conjunction with the picture width. Several fixed resistors, connected to sockets and a wander-plug, are used in conjunction with the vari-

able R₂₃ merely because variable resistors of sufficiently high power rating are too difficult to obtain at present for it to be practicable to use a single component.

tries to obtain too much output. Beyond a certain point a kink appears in the wave as shown in Fig. 3 (b), at first small A, and then very large B.

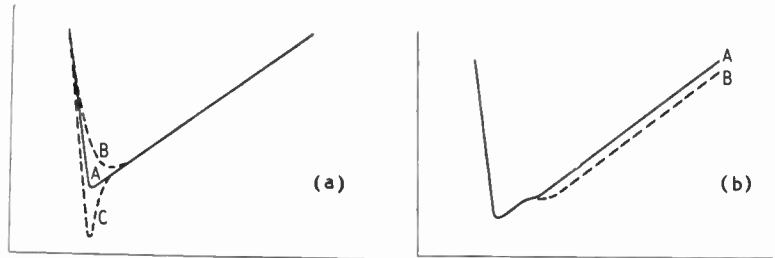

Fig. 3. The waveforms appearing across R₁₈ shown at (a) are with correct A and with incorrect damping B and C. The effect of excessive drive on V₃ is indicated by the waves of (b).

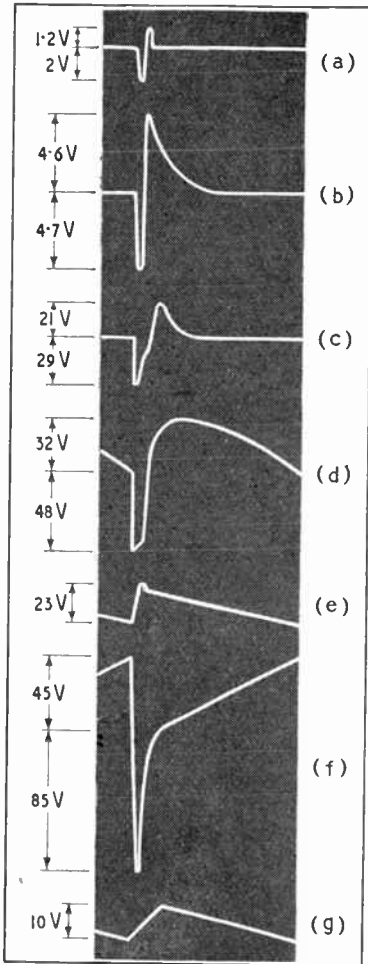

Fig. 2. The waveforms across R₃ without and with V₁ in place are shown at (a) and (b) respectively. The suppressor, screen and anode waveforms of V₁ are shown at (c), (d) and (e) and the grid voltage of V₃ at (f). The voltage across R₁₈ is shown at (g) and shows the output current wave.

Set the wander plug to include R₁₉ and R₂₀ in circuit at first and with R₆ set for a small output examine the waveform across R₁₈. It should have one of the forms sketched in Fig. 3 (a) in which A is the correct one. By adjusting R₂₃, in conjunction with the wander plug to bring in or cut out additional resistance if necessary, there should be no difficulty in bringing it to this correct form A.

Now increase the amplifier input by R₅. There will at first be little or no change of output waveform, except for its magnitude. At length, however, it will start to change to the form B. This occurs when the input is sufficient to cut off V₃ at the end of the fly-back.

As soon as this point is reached, readjust R₂₃ to bring the waveform back to A and continue the process of increasing the input and readjusting R₂₃ to keep the waveform like A. The adjustment should be carried out with the saw-tooth generator synchronized to the television signal, because there is a change of both amplitude and frequency in V₁ between the synchronized and unsynchronized conditions. If the correct sync pulse is fed to the line sync terminal, it is necessary only to adjust R₆ to synchronize the generator and the setting is not critical.

The process of adjusting R₆ and R₂₃ should, of course, cease when the correct picture width (7½ in with a 9-in tube) is obtained. There should be no difficulty in obtaining this, but it is as well to indicate what happens when one

This appears because V₃ is cut off for too long. The overshoot starts the flyback correctly but the valve does not start to drive early enough and a flat in the wave appears. On the picture the effect is a vertical bright line about one inch from the left-hand side.

If an oscilloscope is not used, the adjustments must be carried out by observing the picture and this is not so easy. Waveforms like B of Fig. 3 (a) are characterized by a bright line on the extreme left-hand edge and in an extreme case, by a folding over of the left-hand edge. Waveforms like C, however, result in an

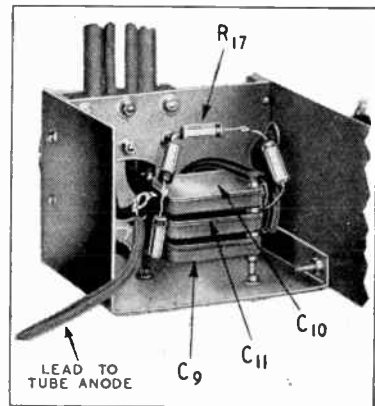

A close-up of the E.H.T. components. Great care must be taken with the insulation here.

extension of the left-hand side and if one observes an object in the picture on a panning shot it will be seen to increase in width as it comes to the left-hand side. On the test pattern the black rectangles in the border will be

Television Receiver Construction—

wider on the left than on the right.

There is a considerable difference in the current taken by the EL38 with and without drive. With 480 V for HT₁ and 250 V for HT₂, the anode and screen currents are 72 mA and 8 mA with no drive and rise to 94 mA and 14 mA with drive for normal output. The screen dissipation rises from 2 W to 3.5 W and is well within the rating of 6 W. The anode dissipation with no drive is about 34 watts, which is considerably in excess of the rating. Care must be taken not to run the valve for any lengthy period without drive. With full drive the stage draws 45 watts from the H.T. supply, but this is not anode dissipation, for the major part of it is dissipated in the load and not in the valve. The exact dissipation at the anode is not known, but is of the order of 10-15 W only.

The E.H.T. voltage can be checked roughly by inserting a meter in series with a string of resistors totalling some 40 MΩ as a minimum. The voltage is the current multiplied by the resistance. It will be lower than the actual voltage, however, because of the load of even a 40-MΩ resistance. With 40 MΩ series resistance, the voltage is 4 kV per 0.1 mA and an indication of some 4.5-5 kV should be obtained; the actual voltage without the meter will then be some 5.5-5 kV.

Although the current requirements of the output stage are

COMPONENTS

The parts in this list are the ones employed in the original model. Any components of the same electrical specification and suitable physical dimensions can be used.

Capacitors

C ₁	10 pF, 250 V working ..	T.C.C. Type CM22
C ₂	100 pF, 250 V working ..	T.C.C. Type CM23
C ₃	8 μF, 500 V working ..	Dubilier Drilitic
C ₄	0.1 μF 350 V working ..	T.C.C. Type CP41
C ₅	200 pF 250 V working ..	T.C.C. Type CM24
C ₆	0.001 μF 350 V working ..	T.C.C. Type M
C ₇	0.01 μF 1,000 V working ..	T.C.C. Type CP41
C ₈	0.002 μF 5,000 V test ..	Dubilier Type 680
C ₉ , C ₁₀ , C ₁₁ ..	0.001 μF 5,000 V test ..	Dubilier Type 680

Resistors

R ₁ , R ₂	47 kΩ ½ W	Erie
R ₃	4.7 kΩ ½ W	Erie
R ₄ , R ₁₀	1 kΩ ½ W	Erie
R ₅	10 kΩ 3 W, variable, linear law	Reliance Type TW
R ₆	2 MΩ, variable, linear law ..	Reliance Type SG
R ₇ , R ₉	2.2 MΩ ½ W	Erie
R ₈	33 kΩ ½ W	Erie
R ₁₁	100 kΩ ½ W	Erie
R ₁₂	0.47 MΩ, ½ W	Erie
R ₁₃ , R ₁₅	2.2 kΩ ½ W	Erie
R ₁₄	47 Ω ½ W	Erie
R ₁₆	2 × 300 Ω 1 W, in parallel ..	Welwyn
R ₁₇	4 × 0.47 MΩ ½ W, in series ..	Erie
R ₁₈	2 × 33 Ω ½ W, in parallel ..	Erie
R ₁₉ , R ₂₀ , R ₂₁ , R ₂₂ ..	1 kΩ 3 W	Welwyn
R ₂₃	1 kΩ 3 W, variable, linear law ..	Reliance Type TW

Valves

V ₁	EF50	Mullard
V ₂	EF37	Mullard
V ₃	EF38	Mullard

Rectifiers

W ₁ , W ₂	Output rating (based on R.M.S. input), 2 kV, 3 mA	Siemens Type H4/200
---	---	---------------------

Transformer

T₁ See text.

Note.—In Part 4, the type number of the 2-MΩ variable resistor was inadvertently given as Reliance Type TW instead of Type SG.

heavy, the early stages take very little. V₂, for instance, draws only 0.9 mA and V₁ takes 2.8 mA all told. In some cases, alternative valves are permissible. For V₂ the EF36 or any variety of the 6J7 can be used, while the American type 807 is a suitable alternative for the EL38. No changes of

component values are needed.

So far no mention has been made of the output transformer T₁. This is a very important component and details are given in drawings and photographs. The requirements are high insulation, low leakage inductance and self-capacitance, and an adequate primary inductance.

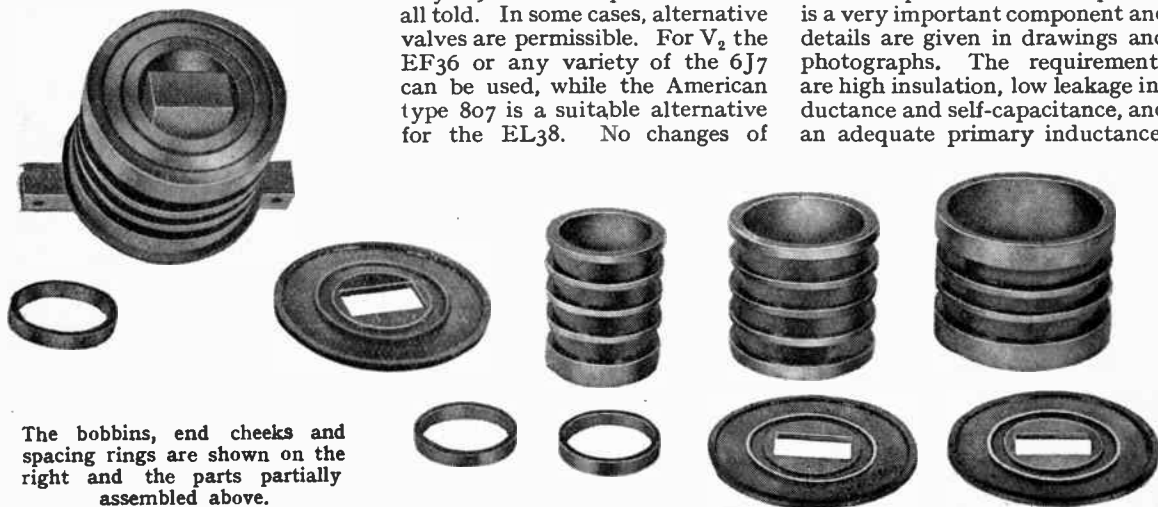

The bobbins, end cheeks and spacing rings are shown on the right and the parts partially assembled above.

Windings are carried by three concentric bobbins each having slots in which the windings are layer-wound with paper interleaving.

Experience has shown that surface leakage is the biggest trouble and so the slots are not symmetrically placed in the bobbins but are to one side to increase the leakage path at the high-voltage end. If bakelized paper or ebonite tubing of the right size is available the bobbins can be turned from this. However, such materials are not easy to obtain and the writer has successfully used ordinary gummed-paper strip.

A mandrel should be turned of the diameter of the inside of the former and wrapped with a layer of thin waxed paper to prevent the former from sticking. The strip is then wound on slowly, wetting it thoroughly as it is done and giving time for the paper to stretch. The paper should be pulled tight as it is wound and the former should be built up somewhat oversize. It should be put on one side for two days or so to dry thoroughly, and with a little care it will be found to turn on a lathe quite well if a sharp tool is used. Of course, as with any laminated material one must turn in the right direction, otherwise the tool just digs in and starts unwinding the paper.

The turned bobbin should be baked, if a dry oven is available. The oven of an electric cooker is quite suitable, but the ordinary gas cooker is hardly advisable since the combustion of gas produces quite a lot of water vapour amongst other things. When quite dry give the bobbins two or three coats of shellac varnish.

The end cheeks are cut from laminated bakelized sheet and have rectangular holes, to take the core; grooves are turned on the inner faces to centre the bobbins. As the leading-out wires from the inner and middle bobbins pass through holes in the cheeks it is necessary to prevent them from turning, since if they did, the leads would be sheared off. This is done by drilling a small hole through one end cheek and a little way into the edge of the

(Continued at foot of next column)

New Domestic Receivers

A TABLE radiogramophone Model 516TG has been introduced by Sobell Industries, Langley Park, nr. Slough, Bucks. The receiver is a superhet (4 valves + rectifier) with a 4-watt output stage and covers the usual short, medium and long waveranges. A cabinet has been designed with a roll top, giving access to the record-playing

"Sobell" Model 516 T.G. table radiogramophone.



turntable. The price is £40 19s plus £8 16s 1d purchase tax. A model with two short-wave ranges covering 12-100 metres and a medium-wave range is available for export.

The "Sobell" Model 717 is a seven-valve receiver with an 8-watt push-pull output stage covering long, medium and two short-wave ranges. The rounded top front edge of the walnut veneered cabinet contains a rotating drum scale connected to the wave-change switch and shows only one scale at a time. The

bobbin, and putting a small wooden pin through with a touch of glue.

In spite of the poor apparent qualities of the former material the writer has found it to be quite satisfactory and has had no breakdowns in any transformer built in this way even when working with voltages 50 per cent higher than those found in this equipment.

The voltage per section is quite high and it is thus necessary to put the windings on carefully in even layers with a single turn of the paper between layers. Care must be taken to prevent the end turns of the late layers from dropping down at the edges. It is well to cut the interleaving strips very slightly wider than the slots.

price of the Model 717 is £34 13s plus £7 9s purchase tax. A radiogramophone incorporating the same chassis with a 12-inch

loudspeaker, Garrard automatic record changer, costs £143 17s plus £30 18s 7d purchase tax. A tilting panel brings into view the radio receiver dial, and the record changer is housed in a drawer which is normally closed while playing.

Restoring Bass

IF the bass response of a set several years old has gradually failed, and if everything possible to restore it electrically has been done, it may be worth while to take more drastic measures.

Like most other things, loudspeakers deteriorate with age. One part most likely to suffer from old age is the cone suspension. If it is made of some composition fibre, it will slowly harden with age until it feels quite stiff when you try to move the cone by hand. If and when that happens, bass response will disappear, because the cone can no longer move freely to pump an air column.

To rectify the trouble, set the speaker down somewhere with the cone upward. Take a tin of very light machine oil, and run some oil round the two corrugated grooves in the cone suspension. Let it stand until no more oil soaks in, then remove the surplus with a piece of cotton wool. Don't let oil run down the cone, or get anywhere else but in the suspension grooves.

Results may not be immediately apparent, but within twelve hours the loudspeaker should be producing bass as robustly as in its pristine youth.—A. D.

LETTERS TO THE EDITOR

H. J. Round on the Origin of "Squegger" ♦ Causes of Night-time Ionization ♦ Amateurs Losing Frequency Band?

"Squegger"

OCCASIONALLY one still comes across the term "squegger" as a description for various forms of blocking oscillators. I have not seen any credit given to the originator of the "squegger" circuit and, incidentally, the inventor of the name.

Some time during the first World War (about 1916, I should say) Major C. E. Prince, who was then working on aircraft telephony, showed me a transmitting wave-meter which he had made. It was built on conventional lines, with a tuned anode circuit and grid reaction coil.

Some time before that date I had introduced the grid leak and condenser into transmitter circuits, giving the class C type of oscillator. Prince spotted that if the grid leak was greatly increased in value auto-

matic modulation of the transmitted signal occurred.

He roughly described the process to me as a "squeezing" operation and there and then decided to call the circuit a "squegger."

New Barnet. H. J. ROUND.

"Whistling Meteors"

THE author of this article (your April issue) omits mention of two important factors: cosmic rays and "afterglow." The latter is very strong during summer nights and can be visually recognized in semi-daylight. Would meteoric ionization account for the rise in night-time ionization during summer months?

Cosmic rays are powerfully active at all times, the only force which is capable of modulating them being a "severe" ionosphere storm. The force of cosmic rays extends to many

millions of electron volts and results in charging the atmosphere with positive, negative and neutral particles according to latitude, longitude and height. Furthermore, cosmic rays as measured at the earth's surface follow the geomagnetic contours faithfully. Indeed, there is a North-South, East-West anomaly which is so marked in the world critical frequency contours. Here, then, is some definite correlation. One other correlation is that cosmic rays, too, have a peak at the earth's leading face—a matter of about one per cent.

I am only too conscious of the ionization that must be produced by meteors to question its validity, but can we attribute the whole of the night-time ionization in the ionosphere to them?

I would suggest, therefore, that night-time ionization is due to at least four causes, namely: (1) Residual or afterglow, (2) cosmic rays, (3) meteors and (4) other causes, such as terrestrial radiations, etc.

ALBERT PARSONS.

Portsmouth.

Amateurs on E.H.F.

IN the May issue of *Wireless World* R. Naismith, of the N.P.L., discussing the reception of six-metre transatlantic signals, expressed hope for an increase in the number of people interested in 50-Mc/s work. This is heartily endorsed by the large number of British amateurs who have been taking practical steps to this end, both by transmission and reception on frequencies of this order. But these amateurs have been rudely shaken within the last few weeks by the discovery that there is a great possibility of these frequencies being taken from them. This act of ingratitude towards a loyal body of men and women is one which should not be allowed to pass without comment in your pages.

The war work performed by amateurs may not be known to the persons responsible for the proposal to withdraw from amateur use the frequencies in question. But surely there is someone who can put a brake on the wheels of officialdom and ensure that at least a portion of the band is retained for the "hams" who, to quote an official citation, "gave freely of their time and skill" during England's hour of need.

E. R. WESTLAKE, G6KR.
Shrewsbury.

Domestic Recordings

THERE is one essential point which "Diallist" in his "Random Radiations" and pre-

Thrush Capacitance-Resistance Bridge



Thrush Model 34A capacitance and resistance bridge.

THIS measuring set employs a wheatstone bridge circuit to which is applied an A.C. voltage at 50 c/s and balance is indicated by a "magic eye" valve.

A continuously variable potentiometer with a calibrated scale forms

one of the ratio arms, the other is a range selector switch with seven positions, three for resistance covering 5 Ω to 5,000 Ω, 500 Ω to 0.5 MΩ and 50 kΩ to 50 MΩ, three for capacitance covering 5 pF to 5,000 pF, 500 pF to 0.5 μF and 0.05 μF to 50 μF. The remaining position sets the circuit for matching capacitors, or resistors, to an external reference.

An accuracy of ±2 per cent is claimed for the calibration of this bridge and a few check measurements made with reference standards confirm that this order of accuracy can be attained with careful adjustment.

In addition to the functions already described provision is made for taking power factor measurements on the highest capacitance range and also for testing leakage in condensers, the "magic eye" indicator being employed for this purpose.

This bridge, which is described as the Model 34A, is enclosed in a portable case measuring 8 in × 6 1/2 in × 4 in. The price is £14 3s 6d, and the makers are Thrush Radio and Electrical Industries, 1, St. Thomas's Square, London, E.9.

vious contributors to the *Wireless World* seem to have overlooked as regards disc *versus* tape or film reproducers; that is, the simplicity of the disc method.

Practically any person from eight to eighty years of age can use them and physical disability is generally no bar. Further, 70 to 75 per cent of gramophone fans do not want long recordings; they prefer selections from their favourite operas, etc., and until the film or wire method is made as simple as the placing of a disc record on a turntable, and some simple method of autoselect, whereby a selection could be played on an auto-changer, without any complicated joining up of wires or cementing together of films, the disc method will remain.

As forecasts seem to be in vogue at present, I will add my own; disc records will remain because of their simplicity of use, but, for long recordings of symphonies, operas, etc., the tape or wire recording has a future if the manufacturers can be

persuaded to put it on the market, supplying a suitable soundhead as an accessory to the ordinary disc machine.

A. J. LITTLE.
Edinburgh.

Frequency Bands

WIRELESS WORLD rightly objects to the use of such vague terms as "very," "ultra" and "super" for defining precisely delimited frequency bands. But are you not yourselves similarly open to criticism for accepting with open arms the equally vague words "long," "medium" and "short" as designations of wavebands?

W. E. WEBBER.
London, N.W.

[Probably, but we can plead long-established usage, expediency and wide acceptance of these terms. They designate wavebands which fortunately fall roughly into natural classifications by virtue of their propagation characteristics. More fortunately still, the waveband

limits (in metres) correspond to such beautifully round numbers that they can be easily memorized. "Very," "ultra" and "super," as used officially for frequency classification, lack these advantages, and the significance arbitrarily attached to these words is not generally known. —Ed.]

"Electronics"

"CATHODE RAY" told us (in your February issue) that "electronics" is a useful word, but—" May I underline the "but," or, rather, go so far as to suggest that the term as used is a thoroughly bad one? By the usage of language it should have a vastly wider application than to "the conduction of electricity through gases or *in vacuo*." This arbitrary restriction of the meaning of the word seems to me to be unwarranted and undesirable. By analogy "electronic" should be the adjectival form of "electron." L. WAFER.

R.S.G.B. D.F. Contest

ON Sunday, May 18th, sixty-seven competitors and friends participated in a hunt for a hidden radio transmitter, the only information vouchsafed being that it was within 10 miles of High Barnet, Herts, was operating on 1,765 kc/s and using the call sign G6CT/P.

Despite showers in the afternoon enthusiasm ran high, yet only five teams actually located the transmitter within the stipulated period.

The first to reach the transmitter, which, incidentally, was cunningly

Locating a Hidden Radio Transmitter With Amateur-built Direction Finders



S. T. Smith was the second competitor to locate the transmitter. He is a member of the R.S.G.B. and Southend Radio Society.



(Above) Taking preliminary bearings at the starting point.

(Left) D.F. Superhet used by the winner, F. Holdaway.

hidden in a dense thicket just off a by-lane near Radlett, was F. Holdaway, of the Romford Radio Society. He was followed about an hour later by S. T. Smith's team and soon after R. A. Davis's party, also of the Romford Society, joined them. The winner used a miniature five-valve superhet, screened frame and a short vertical aerial for "sense" determination.



Positive and Negative

Direction of Current Flow

ELECTRONS really exist. J. J. Thomson and others showed by experiment that electrons really do "shoot off" from hot bodies. Furthermore, it has been shown that if the carbon rod of a battery is connected to a plate and the zinc to a heated cathode, both being contained in an evacuated envelope, the electrons are "encouraged" to cross the space between. Then in any circuit including a valve it is an easy matter to draw an arrow showing the direction of electron flow from cathode to anode. The direction of flow through any other component follows.

As an example consider the rectifier supply unit of Fig. 1. First draw an arrow between cathode and anode of the rectifier valve, then as many more arrows as you like round the circuit, all the same way. Thus, in the resistance shown to represent the rest of the receiver electrons must flow from A to B.

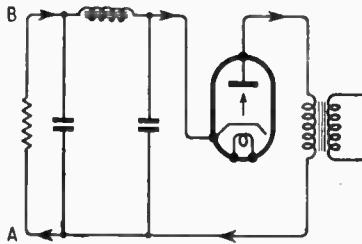

Fig. 1. The direction of electron-current flow in a half-wave rectifier.

In this way the direction of flow in any part of any circuit containing a valve can be found. If a battery is part of the circuit it must be remembered that the red end—the carbon of a dry battery—"sucks" electrons and the black end "pushes" them out. Hence it is as easy to find the direction in a circuit containing a battery as in one with a valve.

Gremlins have a language of their own. A gremlin riding round a circuit on the back of an electron calls all the joys to

By A. B. VAUGHAN, B.Sc.
(Derby Technical College)

come "positive" and all those already passed "negative." These words are borrowed from the mathematicians who use "negative" to mean the opposite way to the direction it has been agreed to call "positive," or a quantity of opposite kind to that called positive. If a plug is called "positive" in Gremlin it is certain that its socket is called "negative."

Some parts of the tour on electron-back are specially important and are to be remembered. The coil of a moving-coil meter is such a part. The terminal to which electrons go, as seen from *inside* the meter coil, is marked +. Of course, it is not + from the point of view of an electron that has already passed through it, but as it is those now in it that make the pointer move (or burn out the coil!) it is their point of view that labels the terminals. A battery's job is to cause an electronic commotion outside itself, so it gets labelled from the point of view of electrons *outside* it.

Now consider the circuit of Fig. 2. The arrows show the direction of flow; there can be no argument about that. As seen from "ground level" the cathode is labelled + because electrons are going towards it. The grid is connected to ground level, so is entitled to no label. However, the electrons just leaving the cathode find the grid is trying to push them back, so from their point of view it is negative. If the labels + and - are permanently left on the diagram it must be obvious from what point of view each one was put in.

If something makes the grid go a little negative (as seen from the earth line) fewer electrons flow to the anode, but since the suck of the battery is unchanged electrons must be drawn from the upper plate of C towards the battery. More electrons then flow to

the lower plate in an effort to fill the void. As a result there is an increase in potential difference between the plates; that is, the upper plate becomes more positive

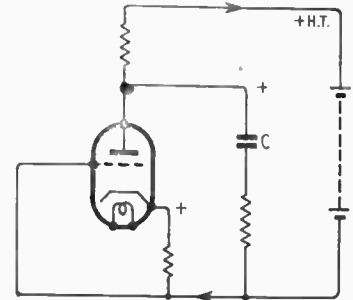

Fig. 2. The electron flow in an RC amplifier stage.

(as seen from the earth line). It is thus labelled +. Nevertheless, the upper plate of C in the diagram has become *less* negative when viewed from the point usually marked "H.T. +."

Moral: Beware of plus and minus, but the direction of electron flow cannot go wrong.

BOOK REVIEW

F.M. Radio Handbook, 1946 Edition. Edited by Milton B. Sleeper. Pp. 149. Published by F.M. Company, Great Barrington, Mass., U.S.A. Price \$2.

There are fifteen chapters devoted to the history and theory of frequency modulation. Chapter 2, Theory of Frequency Modulation, is the important one and consists of a very good elementary explanation of F.M. and of the circuits peculiar to it.

Many of the other chapters, such as those on Audio Distortion, High Fidelity, Antennas and so on, might well be considered out of place. The matters dealt with are quite independent of the form of modulation used and apply equally to A.M. They contain much useful information, but of a kind for which one would not turn to a book entitled F.M.

BELLING-LEE QUIZ (No. 13)

Answers to questions we are often asked by letter and telephone

Q.24. *If a "Skyrod" or Television Aerial is erected on a building, is there any added risk of being struck by lightning?*

A.24. Since the number of T.V. and Skyrod aerial installations has become considerable and following a period of thundery weather with lightning, the service department has been inundated with enquiries as to what users can do to protect themselves and their property against damage by lightning. These enquiries come in from members of the public, wireless dealers and wholesalers.

First of all, the nomenclature is unfortunate, in so far that a lightning conductor does not conduct or attract lightning, and a lightning arrester cannot arrest lightning.

One would expect interested people to realise that architects do not fit "lightning conductors" to chimneys, factories or other buildings to increase their chances of being struck, therefore why should those who fit a T.V. or Skyrod aerial, presumably with some visual resemblance to a "lightning conductor," expect increased danger?

Readers who have visited Switzerland (and presumably other alpine countries where isolated wooden buildings are commonplace) will have noticed two or three spikes several feet high on roofs of isolated hillside dwellings, these are not aeriels but "lightning conductors" to minimise the risk of a strike which inevitably would result in fire.

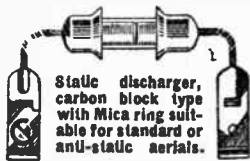

Static discharger, carbon block type with Mica ring suitable for standard or anti-static aeriels.

Manufactured by BELLING & LEE Ltd.
List No. L.350 selling at 9/6.

If a house is struck, in nine cases out of ten it is a chimney that takes it. Technically this is due to the column of ionised (slightly conductive) warmer air which—winter or summer—is rising from it and drifting away down wind, ultimately rising far above any aerial. This is happening from every house all the time, therefore when a house is struck the first solid matter encountered by the charge is the chimney, which is usually shattered. Sometimes the charge travels down the chimney shaft and damages the decorations

Questions referring to lightning and thundery weather are becoming very numerous and below we repeat questions 24 and 27, which deal with these subjects.

of the rooms en route. If the unfortunate house is on the 'phone the wires are generally fused, in spite of the proven *1 "lightning arrester" fitted by the G.P.O. *All this happens whether or not there is an aerial lashed to the chimney.*

When you take into account the many millions of houses, and the

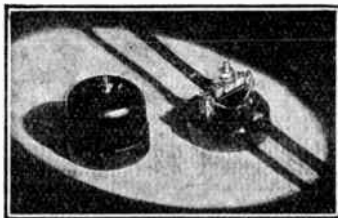

Another type of static discharger specially designed for use with Television aeriels and Belling-Lee*2 twin-feeder. List No. L.376. Price 9/6.

odd one or two that are damaged by lightning, you realise that the risk is negligible. As tangible proof of this, damage by lightning is generally included in every householder's comprehensive insurance policy, and no increased risk is recognised by the addition of an aerial, T.V., Skyrod, or horizontal.

As an additional "vote of confidence" every Belling-Lee aerial system is insured by us for a period of twelve months, up to a sum not exceeding one hundred pounds, against damage to the aerial system or radio or television receiver due to lightning. Following normal procedure, this comes into operation only in the event of there being no collateral insurance or after any existing insurance cover has been exhausted.

Q.27. *Precipitation Static—what is it?*

A.27. This is not a very good name, but it has become accepted as applying to any form of static caused by electric charges building up on an aerial quicker than they can leak away: the result is a form of corona. Aerial corona usually extends only a microscopic distance from the conductor, is usually invisible even in the dark, but is often audible near the conductor as

a faint hissing sound. The condition is not common except in certain districts. We have reports from high locations round Sheffield, in parts of Yorkshire, on cliff top locations by the sea, etc. It may occur without rain when it is generally heard as a particularly violent hissing noise in the loudspeaker. Thundery weather is not essential. It is generally accompanied by rain or hail, and is sometimes known as "rain static." This type is heard as a series of pops, the frequency of which varies, rising to a roar as the centre of the rain storm approaches. Temporarily earthing the aerial stops the noise, but it builds up again in a few seconds. The charges may be induced from clouds, or by charged raindrops. In dry locations the charge may be built up by the friction of sand or other particles being impelled upon the aerial. The trouble is serious on aircraft, and may result in the air services over vast areas being grounded while the condition persists. The condition came to the notice of some home listeners only after the advent of the more efficient Skyrod aerial. It is now becoming an occasional nuisance to television enthusiasts, who must use an efficient aerial; fortunately it is not frequent in London. So far our technical staff have only seen rain static splashes obliterating an unmodulated raster, and we anxiously await reports of the effect when a transmission is on.

We are not taking all this "sitting down." We have already done a lot of research, including the interrogation of German scientists, and of course a very thorough survey of all that has been written in other countries. The problem of the "ground aerial" is quite different from that on air-borne aeriels. We are quite hopeful of success. We would welcome co-operation from our readers. Will those of you who are troubled in this way help us by keeping us advised as to conditions when the nuisance is observed. If you will undertake to help, please write for a questionnaire. It doesn't matter whether or not you use a Belling-Lee aerial.

TO BE CONTINUED.

- *1. Static discharger is a more accurate title.
- *2. L.336 Balanced twin feeder, per yard, 7½d.



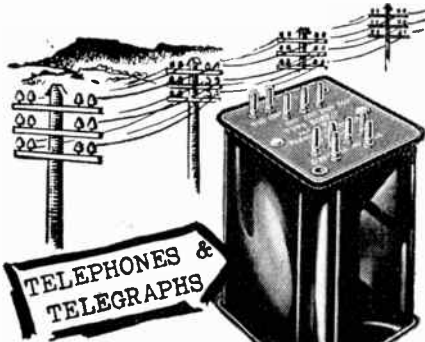

YOU SEE THEM HERE,
YOU SEE THEM THERE,
YOU SEE THEM EVERYWHERE,
THOSE DEMNED ELUSIVE PARMEKOS.

We make no excuse for the fact that some Parmeko Transformers are available only on long delivery dates . . . in fact we are rather proud that everyone who uses Transformers seem to come to us these days and are prepared to wait some time.

Consider well and we know you will be writing to us . . . we're looking forward to it . . . time we knew you anyway !



PARMEKO OF LEICESTER.
MAKERS OF TRANSFORMERS.

LONDON CENTRAL RADIO STORES

Special Offer of Ex-Govt. Receivers, etc.

Type R1147B 7-VALVE U.H.F. RECEIVER

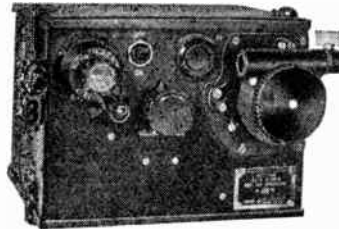

Range approx. 200 mc/s
A Real Opportunity!

Beautifully constructed and fitted with micro-condenser drive. Valve type two EF50, two EF36, one each EBC33, RL7, RL16. In black metal case 8x7x6in. Set, complete with valves **£27.6**
Carriage & Packing extra 5/-.

Type R208 6-VALVE SHORT-WAVE RECEIVER

Precision-built
Communication Type
Range 10—60 mc/s

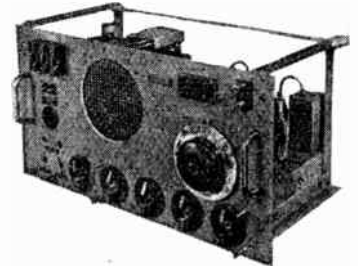

Suitable for AC 100-250 v. or 6-v. battery operation. Metal rectifiers, B.F.O., Built-in Speaker, Super Slow motion dial. Provision for phones, etc. A real super job in grey metal cabinet. Complete with Valves and Vibrator ready to use **£18.00**
Carriage & Packing extra 12/6.

Type R103 Mk. 2. 7-VALVE SHORT-WAVE RECEIVER



Range 1.7—7.5 mc/s

These receivers were originally designed for use in cars and can be converted into car radios. I.F.s 465 Kc/s. No power pack. In black metal cabinet 12x7x7in. Complete with Valves **£7.00**
Carriage & Packing extra 3/6.

Type 217. OSCILLATOR UNITS

These units contain very useful components: two EF50 Valves, three P.O. type Relays, numerous Condensers including two 25v. 25mfd. Electrolytics, Resistors, Potentiometers, etc. Bargain price **£11.26**



MOVING COIL HEADPHONES, 30 ohms. Complete with headband **17/6**
MOVING COIL HAND MICROPHONES, 30 ohms **11/6**

See June issue for other illustrated items.

Closed Thursdays 1 p.m. Open all day Saturday.

23, LISLE ST. (GER. 2969) LONDON, W.C.2

Channels of Communication

2. Are They Being Used to Capacity,

and, If Not, How Can They Be?

LAST month we noted that channels of communication, like bottles of milk were scarce, not because there were fewer of the than before, but because the demand was rising all the time. And that whether they were radio or line channels, their width (in frequency) was a measure of the rate at which information could be passed along them. Put another way, if a given quantity of information was sent in a short time, Δt , it occupied a wide frequency band, Δf , and vice versa.

Constant D.C. or A.C. (occupying no frequency width) could not convey signals until it was modulated, and the faster it was modulated the wider the spread of sidebands. Nobody had found (or was likely to) any escape from this conclusion. But in the endeavour to find more channels a possible line of attack was to see whether

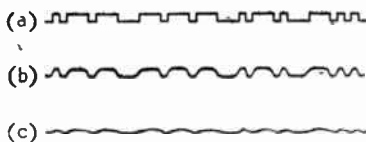

Fig. 1. The wide channel needed to send the square-cut morse (a) can be narrowed (b) without any reduction in the information. (c) is the result of attempting to send (a) through a still narrower channel; the information is lost. Is there a definite minimum channel for a given rate of information?

they were really running full, or if the information could be squeezed tighter without damaging any of it. Was there a definite minimum "quantum" of frequency band \times time, $\Delta f \Delta t$, needed to convey one unit of information?

Now read on.

One approach is Fourier analysis. This must be familiar to most readers, for example, in the well-known fact that if a sine wave is distorted, say by amplifying it by a valve, the distorted wave can be analysed into a fundamental—a

sine wave of the same frequency as the original—plus harmonics, sine waves of higher frequency. The more angular a wave-form, the more harmonics are needed to build it up. That can easily be shown by drawing the waves and adding them together. Some interesting examples—square and peaky curves—appeared in *Wireless World* Dec., 1945, p. 358.

Next, it should be fairly easy to see that the more exact and comprehensive the information to be signalled in a given time, the more angular and complex the signal must be, and therefore the wider the frequency band it covers. Fig. 1a is a word in morse, clear-cut and perfect to read. To make all the sharp corners, occurring at varying intervals, a very wide range of sine wave frequencies is needed. In Fig. 1b the corners have been rounded off by passing the signal through a channel-narrowing filter, but the morse is still readable. The a version was wasteful signalling. But if channel economy is pressed too far, as at c, so that only the lowest

this paring-down of the signal before one loses the information?)

Radar is one extreme example. In it one wants to mark a time as exactly as possible. To do so one sends a sharp pulse. For perfect accuracy in signalling the time, the front (or back) of the pulse must be quite vertical, or it must be infinitely sharp-pointed. Any of these requirements necessitates an infinite number of harmonics. So although a time or other single item of information could be signalled in an infinitely small period of time by an infinitely short pulse,

By "CATHODE RAY"

an infinitely wide channel would be needed.

This elementary signal is all width (of frequency) and no length. It is represented on a frequency/time diagram as an endless horizontal line (of time)—Fig. 2a. In practice, of course, radar has to be content with a finite (though very large) Δf , and as a result the pulse is slightly rounded off and occupies a finite (though very small) Δt . It is represented in Fig. 2a by a narrow horizontal strip.

The Decca Navigator is at the opposite extreme. It is the frequency that must be exact. Only a single frequency per station is used, but theoretically it takes an

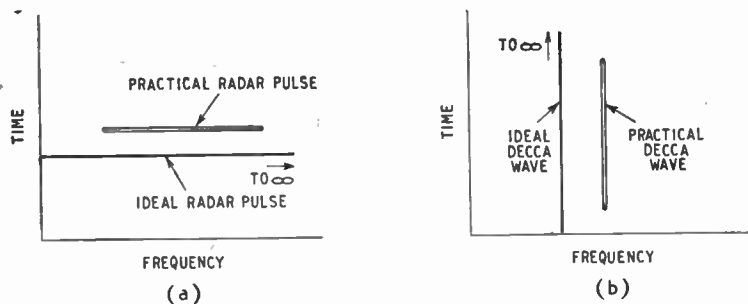

Fig. 2. A signal conveying a single item of information can be represented as a small area $\Delta f \Delta t$ on a frequency/time diagram. One theoretical extreme is the infinitely brief pulse (a); the other is the unmodulated wave train (b).

frequency sine waves are left, the morse becomes unreadable. (Again, is there a definite limit to

infinitely long time to establish it. So in Fig. 2b it appears as a vertical line. "But what nonsense!

Channels of Communication—

It doesn't take an infinitely long time, or anything like it, to get a continuous train of pure sine waves going!" Practically true; but if a succession of sine waves ever has a beginning and ending, that is modulation (admittedly it may be at a *very* low frequency, such as 1 cycle per month), and brings in sidebands accordingly. So a perfectly pure sine wave is an impossibility! Practical Decca is therefore a long narrow strip in the diagram.

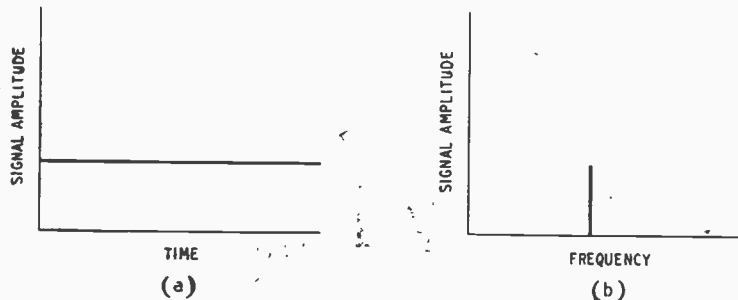

Fig. 3. Unvarying D.C. or A.C. can be represented either as at (a) or (b) (or as in Fig. 2b). If the Time and Frequency scales in (a) and (b) are interchanged, the diagrams represent an infinitely brief pulse (as does Fig. 2a).

Zero \times infinity being both mathematically indeterminate and practically impossible, what about middling values? How small can a little circular or square area, representing one elementary signal, be? At first it might seem that it could be as small as one liked, subject to the receiver being able to pick it out from the inevitable background of noise that tends to swamp signals if the amplification is increased too far. But it isn't like that at all, for the frequency/time diagram says nothing about the strength of the signal, which can be enormous even if the spot representing it is small. But if, in order to avoid spreading out the sidebands, you modulate very gradually, it takes a long time, Δt ; while if you try to shorten the time, out spreads Δf . It is not easy to see how one would set about finding the minimum value, if any, of $\Delta f \Delta t$; but Dr. Gabor has done it, and arrives at the figure $\frac{1}{2}$. That is to say, if you have a channel 500c/s wide you can send one element of signal in $1/1,000$ th of a second. Anything less than that won't register at all. This is where the analogy with quantum mechanics comes

in; a quantum of energy is the least amount that will produce any effect.

You may be wondering what shape, intermediate between an endless constant signal and an infinitely brief pulse, a unit signal has to have in order to occupy this minimum area on a frequency/time diagram. The strength-variation of any signal can, of course, be plotted either on a time base or a frequency base, as we saw last month. Thanks to Fourier, it is only

necessary to have one of these to be able to draw the other. (By the way, each of them is called a *Fourier transform* of the other.) The unending D.C. or A.C. of Fig. 2b is shown on an amplitude/time diagram by a line at a constant height, Fig. 3a, or on an amplitude/frequency diagram as a single vertical line, b. (If D.C., it stands at zero on the frequency scale.) The interesting thing is that if the frequency and time scales in Fig. 3 are interchanged, the results represent the

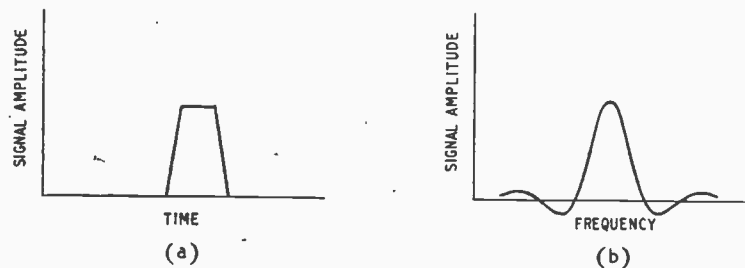

Fig. 4. The interchangeability of time and frequency scales, exemplified in Fig. 3, applies to all shapes of signals. Here is another example: a sloping-sided pulse (a) occupies the frequencies shown in (b); and a pulse shaped in time like (b) occupies a frequency band as shown by (a).

opposite extreme, an infinitely brief pulse. Does it surprise you that this interchangeability holds

good for all shapes of signals? For example, a finite pulse with sloping sides, Fig. 4a, occupies frequencies as shown in Fig. 4b. And the wavy pulse shown in Fig. 4b (if the frequency scale were altered to time) occupies frequencies shown in Fig. 4a (if the time scale were altered to frequency).

So there is a sort of poetic symmetry in Dr. Gabor's finding that the "smallest" signal (on a frequency/time diagram) has the *same* shape on both time and frequency diagrams. He names it a *logon*. It is the smooth curve shown in Fig. 5, known to mathematicians as a probability, or error, or Gaussian curve. A logon can be broad in time, and narrow in frequency, or vice versa, so long as $\Delta f \Delta t = \frac{1}{2}$ (Fig. 6): such changes of proportion are represented merely by multiplying and dividing the f and t scales in Fig. 5 without altering the shape of the curve at all.

It having been established that there is a definite minimum signal, the one remaining link in the investigation is to find out whether existing methods of signalling use the fewest possible number of logons, neatly packed together like sardines in their communication channels. This is where one leaves the relatively firm paths of mathematics and becomes involved in psychology and things like that. We have noted (Fig. 3) that methods of signalling can be extravagant. Merely for the purpose of bringing the recipient's attention to a particular word from the English dictionary, Fig. 3a is no better,

for all its larger number of logons, than Fig. 3b. But if, in addition, it is desired to entrance the

eye with the sight of square-cut morse characters, only that limited amount of rounding-off can be practised which the signaller reckons will not be noticed by the said eye.

The same thing enters into sound communication. If all that is necessary is to reproduce spoken words so that the meaning is understood, the channel can be much narrower than if it is necessary also to convey the aesthetic pleasure of hearing those words spoken almost indistinguishably from the original voice. And the recognizable outline of a tune costs less to send than a thrilling performance of it. There are also difficult questions of language and telegraph codes as vehicles of information.

These matters are still being investigated, but one thing that is quite clear is that even just-intelligible speech is a less efficient method of signalling than telegraphy. There is reason to believe that it occupies about 40 times the theoretical minimum width of channel needed to con-

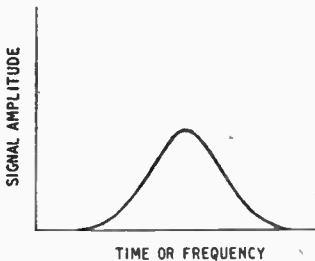

Fig. 5. This is the shape of the smallest possible signal, distinguished by the fact that it is the same on time and frequency bases.

vey the words at the same rate. Is it, then, possible to "code" the human voice for electrical communication, translating the code back into voice at the receiving end? This is rather an ambitious undertaking, because not only the mere words but also the intonation (which often indicates whether the face-value of the words, or its opposite, is to be taken as the true meaning) is included in the total information to be signalled. Yet the attempt has been remarkably successful; the essentials of speech, normally requiring a channel about 3,000 c/s wide, have been compressed

into about 300 c/s by means of what the American inventors named (for obvious reasons) the Vocoder.

The basic principle of the Vocoder is not to transmit the actual voice sounds at all, but only signals for turning the appropriate sounds on and off. To telephone such sounds as "th"

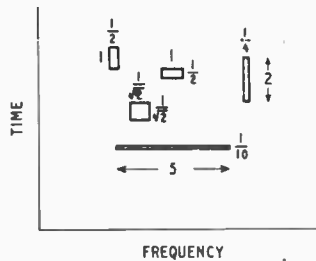

Fig. 6. All of these signals are logons, shaped as in Fig. 5. The different shapes here correspond to different ratios of time scale to frequency scale in Fig. 5.

in the ordinary way, it is necessary to have quite a wide channel—wider than the ordinary G.P.O. normally provides, anyway.* But one can install a machine at the receiving end capable of making a "th" sound, and turn it on from a distance whenever that sound occurs in the conversation, which is not frequently enough for the switching signal to need much of a side-band. Even after arrangements for making all the other voice sounds have been added, the frequency of the signals needed to switch them on whenever required is much lower than the frequencies in the sounds themselves. Each syllable needs only a few signal cycles to cause it to be uttered, though the actual sound may consist of scores or even hundreds of cycles.

Going a little more into detail, spoken sounds are of two main kinds. Whispering consists entirely of one kind, and humming entirely of the other. The former is enough to convey the words, the latter the intonation and "body." "Th" in "thin" is wholly of the first kind; "th" in "this" has the second kind

* If you don't believe me, 'phone up a friend and ask him to write down this message and let you see it—"I faw your tothograph in the newftater ve uvver hay."



SPEAKERS OF DISTINCTION

The extensive range of TANNOY Sound Equipment now available embodies the latest technical developments in design and performance.

Here are two examples of distinctive Loudspeakers. The one shown above is Type LSH/200/H a weather-proof Re-entrant Horn giving first-class quality reproduction.

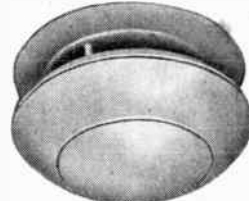

This is Type LS/CIR/5. A Bowl Loudspeaker suitable for Ceiling or wall mounting, combining the latest developments in speaker design with artistic appearance.

TANNOY

—SOUND EQUIPMENT—

GUY R. FOUNTAIN LTD.,

"THE SOUND PEOPLE"

"TANNOY" is the registered trade mark of equipment manufactured by

GUY R. FOUNTAIN LTD.,
WEST NORWOOD, S.E.27.
GIPSY HILL 1131

The largest Organisation in Great Britain specialising SOLELY in Sound Equipment.

Branches at Manchester, Belfast, Newcastle-on-Tyne, Birmingham, Bristol, Glasgow, etc.

Channels of Communication—

added, which enables it to be sung, whereas the first sort of "th" interrupts singing whenever it occurs. At the reproducing end of the Vocoder the two types are represented by two sound generators; one makes a general noise such as one gets from an over-sensitive amplifier, covering the whole audio spectrum, without definite pitch; the other is a variable-frequency oscillator. At the sending end there is an analyzer which develops a signal whose strength depends on the pitch of voiced sounds. With unvoiced sounds like "f" this signal naturally fails, and as a result only the noise-maker is effective at the receiver. But directly a voiced sound is uttered at the transmitter, the pitch signal switches in the oscillator and also controls its pitch.

There is also at the transmitter a spectrum analyzer which measures how much sound there is from moment to moment in each of ten 250-c/s frequency bands into which the whole accepted speech-frequency band is divided. The ten resulting signal amplitudes are passed along ten 25 c/s-wide channels and cause corresponding slices of the noise spectrum to be reproduced in the correct proportions.

So altogether eleven 25-c/s channels are required; total, 275 c/s. How these channels can be packed tightly side by side without wasteful "voids" is for the bright communication engineers to work out. They seem able to do anything like that.

The speech turned out at the receiving end is undeniably synthetic, but quite intelligible.

The equipment, of which I have given only a rough idea, is too elaborate to use for multiplying conversations along ordinary telephone lines, but there are particularly expensive telephone circuits—such as the transatlantic radio—where it seems the extra cost would pay for itself very quickly. And, incidentally, fox unauthorised listeners-in more thoroughly than ever.

This is not the only scheme for dehydrating speech to economize in its transport; another is to extract all but sufficient cycles to identify each sound, and then

make up the quantity at the receiver. This is done by slowing down all the frequencies without increasing the time (thus there must be fewer of every sort) and then speeding them up again in the reconstituting process at the receiving end.

Just one last point about channels. Authorities responsible for them are repeatedly emphasizing that radio ought never to be used when lines will do. And rightly so, because (except for boundaries due to limited range and directional radiation) there is only one radio medium for everybody, whereas there are millions of lines and there can be millions more, each capable of providing many channels. From the earliest days of radio it was customary to send several messages at once, by dividing the "ether" into channels on a frequency basis (frequency - division multiplex"). The slices are becoming so thin now, even up to 200 Mc/s, that the business slogan "There is always room at the top" seems to be ceasing to apply to radio

channels. In line telegraphy, before the frequency-division idea occurred, Baudot invented a system in which several senders were allowed the use of a single line for fleeting moments in strict and rapid rotation ("time-division multiplex"). But now the frequency-division method has been applied on a grand scale to line telegraphy and telephony (we like to think it was inspired by success with radio), so that a single coaxial telephone line is used to carry hundreds of conversations. And radio occasionally uses time-division, as in television (vision and sync. and perhaps even sound on one frequency channel) and in certain pulse communication systems.

Now that time and frequency are being so finely divided, the one remaining prospect of increasing the supply of channels is in the packing department. Broadcasting, in which the aesthetic aspect matters, is the most likely to be damaged by these new high-pressure packing methods, so will have to look out.

Short-wave Conditions

Expectations for July

By T. W. BENNINGTON

(Engineering Division, B.B.C.)

DURING May there was a very considerable decrease in the daytime maximum usable frequencies for these latitudes, whilst there was a considerable increase in the night-time M.U.F.s. Communication on the higher short-wave frequencies—like 26 Mc/s—was not very reliable—particularly in east/west directions, but medium frequencies were usable for very long periods, and those as high as 15 Mc/s were often usable the night through. Some medium-distance communication on very high frequencies by way of sporadic E occurred.

There was less ionosphere storminess than during the previous two months, though some storms did occur, the most disturbed periods being 1st, 14th-17th, 23rd-24th and 26th-28th. Several "Dellinger" fadeouts occurred, the most intense of these being at 1017 on 6th, 1247 on 16th and 1429 on 29th.

Forecast.—There should be very

little difference in either daytime or night-time M.U.F.s during July, as compared to those for June. Working frequencies for long-distance transmission should therefore be relatively low by day and high by night, except on transmission paths to places in the high latitudes of the Southern Hemisphere. Medium frequencies—like 17 Mc/s—should remain of use for very long periods, and 15 Mc/s may remain usable the night through on many circuits. Daytime communication on the very high frequencies will be possible only infrequently.

The E and F₁ layers will control transmission over medium distances—up to about 1,800 miles—during the daytime, and in these cases daytime as well as night-time frequencies will be relatively high.

Communication over distances up to about 1,400 miles may often be possible by way of sporadic E—which is likely to be prevalent this month—and when this happens frequencies far above the normal M.U.F.s for the distances in question may be usable.

Below are given, in terms of the

broadcast bands, the working frequencies which should be regularly usable during July for four long-distance circuits running in different directions from this country. All times given here are G.M.T. In addition a figure in brackets is given for the use of those whose primary interest is the exploitation of certain frequency bands, and this indicates the highest frequency likely to be usable for about 25 per cent of the time during the month for communication by way of the regular layers:—

Montreal :	0000	15 Mc/s	(22 Mc/s)
	0300	11 "	(19 ")
	0800	15 "	(22 ")
	1300	17 "	(24 ")
Buenos Aires :	0000	17 "	(24 ")
	0100	15 "	(22 ")
	0700	11 "	(20 ")
	0900	15 "	(23 ")
	1000	17 "	(26 ")
	1400	21 "	(29 ")
Cape Town :	0000	15 "	(22 ")
	0200	11 "	(18 ")
	0500	15 " or 17 Mc/s	(23 ")
	0700	21 "	(30 ")
	1400	26 "	(34 ")
	1700	21 "	(32 ")
	1900	17 "	(26 ")
	2100	15 "	(23 ")
Chungking :	0000	15 "	(20 ")
	0600	17 "	(23 ")
	2000	15 "	(21 ")

Ionosphere storms are not usually very troublesome during July (though last July was in fact a very disturbed month), so it is hoped that radio conditions may be relatively stable. At the time of writing it would appear that the most likely periods during which disturbances may occur are 8th-11th, 17th-18th and 20th-22nd of the month.

Footnote.—Though there is not space in this section of *Wireless World* to publish detailed predictions in the form of circuit curves, I certainly think that a curve often conveys more information than a tabular list of predicted working frequencies. Readers can, however, construct a tolerably accurate set of circuit curves from the figures given and, though they will not be quite correct, they will at least show the general diurnal variations in the fre-

Showing construction of a curve for predicted usable frequency bands are indicated.

quencies of use over various circuits. For amateur use the figures in brackets are likely to be most useful, remembering that these will give a curve whose frequency values are above the *average* predicted M.U.F. for the month. The example given will show how this may be done, the points being taken from the Cape Town table, and showing when the indicated frequency is *first* usable during the day.

R.F. Tuning Wand

This is a useful device for checking the trimming accuracy of signal and I.F. circuits in receivers having coils that are accessible. The wand is 6in long and $\frac{3}{8}$ in diameter and has a brass plug at one end and a dust iron one at the other.

Either end brought close to, or inserted in, a tuned circuit coil will affect the tuning and hence the strength of the received signals. If the presence of the wand produces louder signals the indications are that that circuit is out of trim. And the end of the wand which produced this improvement will indicate whether the circuit is tuned to a higher or to a lower frequency.

A test on a V.H.F. set at 60 Mc/s showed it to be extremely sensitive to very small amounts of mistuning so that the claim that it is effective up to 200 Mc/s seems a reasonable one.

The wand is obtainable from A. & H. White, 105-107, Talbot Road, London, W.11, and the price is 5s.

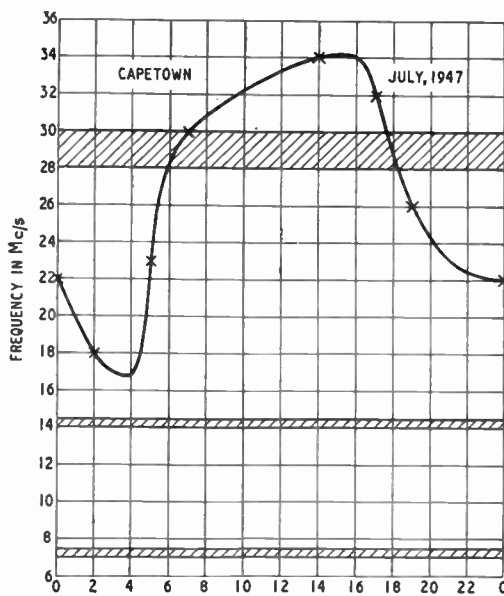

C.P.20A 15 WATT AMPLIFIER

for 12 volt battery and A.C. Mains operation. This improved version, has switch change-over from A.C. to D.C. and "stand by" positions and only consumes 5½ amperes from 12 volt battery. Fitted mu-metal shielded microphone transformer for 15 ohm microphone, and provision for crystal or moving iron pick-up with tone control for bass and top and outputs for 7.5 and 15 ohms. Complete in steel case with valves.

As illustrated. Price £28 0 0

"SUPER FIFTY WATT" AMPLIFIER

This Amplifier has a response of 30 cps. to 25,000 cps., within ½ db., under 2 per cent. distortion at 40 watts and 1 per cent. at 15 watts, including noise and distortion of pre-amplifier and microphone transformer. Electronic mixing for microphone and gramophone of either high or low impedance with top and bass controls. Output for 15/250 ohms with generous voice coil feedback to minimise speaker distortion. New style easy access steel case gives recessed controls, making transport safe and easy. Exceedingly well ventilated for long life. Amplifier complete in steel case, with built-in 15 ohm mu-metal shielded microphone transformer, tropical finish.

Price 36½ Gns.

AD/47 10-VALVE TRIODE CATHODE FOLLOWER AMPLIFIER

For this recording and play-back Amplifier we claim an overall distortion of only 0.01% as measured on a distortion factor meter at middle frequencies for a 10-watt output. The output transformer can be switched from 15 ohms to 2,000 ohms, for recording purposes, the measured damping factor being 40 times in each case. Full details upon request.

Dealers and Export Agents should write for special terms to:—

VORTEXION LTD.
257-261, THE BROADWAY,
WIMBLEDON, LONDON, S.W.19

Telephones: *Liberty 2814 and 6242/3.*
Telegrams: "VORTEXION, WIMBLE, LONDON."

RANDOM RADIATIONS

'Planes and Television

FROM letters which readers have kindly sent me I gather that the reflection of vision signals from low-flying aeroplanes is a more frequent form of nuisance in some localities than I had realized. Before the war low-flying planes—indeed planes of any kind—were uncommon in my part of the world and since the war I have not been operating a vision receiver at all regularly, on account of a bit of eye trouble. The usual complaint is flutter, due to phase differences between the direct and the reflected signal. One reader tells me that he finds the effect at its worst when the 'plane is right overhead. He does not say whether or not he uses a reflector, but I infer that he does since he is mainly troubled when the 'plane is above him or on the Alexandra Palace side of him. He suggests that there may be possibilities in an aerial so designed as to be sharply directional in both horizontal and vertical senses. Seems like another pretty little problem for Belling and Lee's anti-interference department! Another reader, who uses no reflector, says that he has the worst bother when a 'plane is flying so that his aerial is between it and A.P. A reflector should certainly help here. This reader describes one extraordinary effect which occasionally occurs: sixteen dark bars occupy the screen when reflected and direct signals are in phase. The bars are horizontal and about four times as wide as the spaces in between them. He lives close to a big aerodrome and the interference which he describes seems to be most likely to be due to some kind of radar (possibly G.C.A.) using pulse transmissions with a constant recurrence frequency. He suggests Gremlins!

□ □ □

The Good Old Times

"FREE GRID'S" photograph in last month's issue sent my memory back to the days when those of us who began our radio careers in the Early Broadcasting Age—or even in the Pre-Broadcasting Age—used to litter every part of our homes (including the drawing rooms of our long-suffering wives) with knob-studded boxes, trailing wires and acid-splashing accumulators. How we used to dread the spring (and other) cleanings which were apt to be undertaken as surprise operations the moment we

were safely out of the way! The most devastating bit of spring cleaning that ever came my way concerned a 120-volt high-tension battery; and H.T.B.s of that size cost about thirty good shillings in those far off days. As that was before we had begun to indulge in niceties such as grid bias, it hadn't wander-plug sockets; just two straightforward terminals marked 0 and +100V. Possibly I *did* leave it on top of the china cabinet. But why not? It was a beautiful battery, surely an ornament in itself.

I know that there was what was disparagingly described as "a squiggle of wire dangling down from one of those screw things." But is the connection of its negative to its positive pole with a piece of flex the proper way to tidy up a H.T.B.? And was I to blame for the damage to the china cabinet by loathsome oozings from eighty short-circuited and ruptured cells? Time, the great healer, has drawn a merciful veil over this and other painful incidents of the pioneering days of wireless. All the same, I wouldn't mind wagering that not a few of my fellow pioneers, including perhaps "Free Grid," acquired in self defence a certain proficiency in the art of french polishing.

□ □ □

Same Old Game

The wives of wireless enthusiasts had a hard time of it in the old days. In the light of a recent experience I am not sure that Tenny-

son's dictum that men must work and women must weep does not still hold good. Mrs. Diallist and I were invited the other day to the home of one of the younger Authorities in the World of Radio. He had just completed the construction of the Last Word in Radiograms; its high fidelity must be heard to be believed; would we come to tea, hear it and believe? My own experience of Last Words in both wireless sets and radiograms is that they are curiously like gardens: you always seem to turn up—even if it's by invitation—on the wrong day. "If only you could have seen the petunias (or the delphiniums, or the pæonies) last week." . . . "If only you could have come next week, you'd have seen the salvias (or the phlox, or the lupins) in their full glory." We were not, therefore, surprised (Mr. Diallist has learnt a thing or two about wireless with the passing of the years) when our host, showing a certain frowning of the brow, informed us as we entered the front door of his home, that, though it had been working perfectly on the previous evening. . . . The lady of the house—it was interesting to observe the attitude of the younger radio-addict's wife—didn't say much about the super-set, but let slip the remark that she liked her little portable because it enabled her always to be sure of getting the nine o'clock news.

□ □ □

Just Like the Old Days

We were conducted into the drawing room. Mark that, the drawing room. In one corner was a gigantic loudspeaker. Over at least an eighth of its parquet floor sprawled (Continued on opposite page)

Books issued in conjunction with "Wireless World"

	Net Price	Post-age
WIRELESS DIRECTION FINDING, by R. Keen, M.B.E., B.Eng. (Hons.), Fourth Edition, 1,042 pages	45/-	(9d.)
TELEVISION RECEIVING EQUIPMENT, by W. T. Cocking, M.I.E.E., Second Edition	12/6	(5d.)
FOUNDATIONS OF WIRELESS, Fourth revised Edition, by M. G. Scroggie, B.Sc., M.I.E.E.	7/6	(4d.)
RADIO LABORATORY HANDBOOK, by M. G. Scroggie, B.Sc., M.I.E.E., Third Edition	12/6	(4d.)
WIRELESS SERVICING MANUAL, by W. T. Cocking, M.I.E.E., Seventh Edition	10/6	(4d.)
HANDBOOK OF TECHNICAL INSTRUCTION FOR WIRELESS TELEGRAPHISTS, by H. M. Dowsett, M.I.E.E., F.Inst.P., and L. E. Q. Walker, A.R.C.S., Eighth Edition	30/-	(8d.)
BASIC MATHEMATICS FOR RADIO STUDENTS, by F. M. Colebrook, B.Sc., D.I.C., A.C.G.I.	10/6	(4d.)
LEARNING MORSE. 335th thousand	6d.	(1½d.)
RADIO WAVES AND THE IONOSPHERE, by T. W. Bennington	6/-	(3d.)

Obtainable from booksellers everywhere or direct (cash with order) from the publishers

ILIFFE & SONS LTD., Dorset House, Stamford Street, London, S.E.1.

the most marvellous diversity of wireless bits and pieces that I have seen for many a long year. There were little chassis containing one or two valves; there were medium-sized chassis with three or four; there were large chassis with five or six. Wires trailed gloriously from here to there and from there to all sort of unexpected places. Knobs sprouted like mushrooms in a lush pasture after a September rain. Performance was, of course, frankly horrible; but, knowing the skill and the erudition of the maker of the set, I am sure that it would have been fine could our visit have taken place a day earlier or a day later. Wireless, it appears, is more and more the same old game no matter how rapidly improvement follows improvement.

□ □ □

Plastics and Television

SOMETHING was said in the June W.W. about the work done by Dr. Starkie of I.C.I. and his lab. team in developing plastics for big-screen television purposes. I went to his recent lecture before the Television Society and was impressed not only by the story he unfolded but also by the well-thought-out and well-designed demonstration apparatus. The big snags in the use of a Schmidt optical system with a small C.R.T. are two. First of all, the screen end of the tube must be processed to a considerable degree of optical precision. Secondly, the half-angle now obtainable does not

exceed 45 degrees, which means that to provide an image of reasonable size on the viewing screen the "throw" from spherical mirror to screen must be so long that it would not be possible to accommodate the whole system in a cabinet of reasonable size for domestic use. Dr. Starkie told us that an inexpensive process is being worked out for processing the ends of C.R.T.s separately and later sealing them on to the bulbs. If this can be done, the process should not be a very costly one, for the required contour of the C.R.T. screen is spherical; the work can therefore be done as a repetition job by automatic machines. He said also that a considerable increase in the half-angle was being obtained by new methods and that much shorter throws should soon be practicable. One speaker in the discussion following his lecture brought out an interesting point: would it not be possible to house the C.R.T., the spherical mirror and the aspherical corrector screen inside the television cabinet, but to have the viewing screen outside it and quite separate from it? This raises an interesting possibility. If such an arrangement were feasible, the viewer could arrange the size of the image (within the limits of the illumination available) to suit himself, by using a longer or a shorter throw as might be required. One very interesting demonstration was that of a specially corrected flat viewing screen, on which images could be seen at a remarkably wide angle without undue distortion.

Direct Recording Gear

DESIGNED for fitting to existing turntables, the "Technifon" Model T.G.1 traverse gear is driven through worm gearing from a flange fitting over the turntable spindle. The standard groove pitch is 120 per inch, but separate lead screws

time scale calibrated from 78 r.p.m. to indicate the unexpired recording time.

The electromagnetic cutting head can be supplied with an impedance of 4 or 15 ohms and is stated to have a uniform frequency response, with a 3/4-inch stylus, from 50 to 6,000 c/s. The input power required is 4 watts.

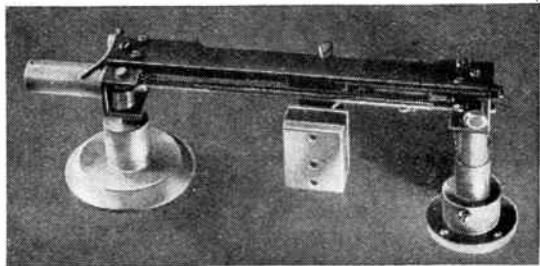

"Technifon" Model T.G.1 traverse gear.

are available for 96 and 104 grooves per inch. The standard direction of cut is from an inside start, but an outside start can be supplied. All mechanisms are provided with a

The price of the Standard model T.G.1 including cutter head is £15 15s, and the makers are Technifon, 99, Belgrave Road, London, S.W.

PREMIER RADIO CO.

MORRIS & CO. (RADIO) LTD.
ALL POST ORDERS TO 167 LOWER CLAPTON RD., LONDON, E.5

Phone: Amherst 4723
ALL CALLERS TO 169, FLEET STREET, LONDON, E.C.4.

Phone: Central 2833
Send 2½d. stamp for Terms of Business: Cash with order or C.O.D. over £1.

RADIOGRAM CABINETS

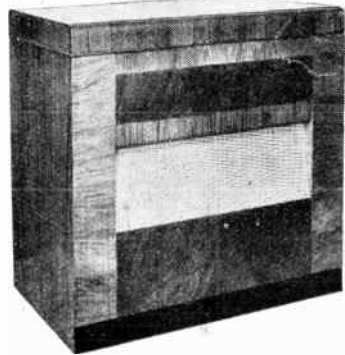

Dignified appearance and good workmanship. Size: 31in. high, 18in. deep, 33in. wide. Cabinet only £26, with motor and pick-up, £32/16/- . With record changer, £42/16/- .

ALUMINIUM CHASSIS.—Substantially made of bright aluminium with four slides, 10in. x 8in. x 2½in., 7/- ; 12in. x 8in. x 2½in., 7/9 ; 16in. x 8in. x 2½in., 8/6 ; 20in. x 8in. x 2½in., 10/6 ; 22in. x 10in. x 2½in., 13/6.

TYPE 103. Rotary Transformer. Normal rating is 19 v. D/C input. Output 300 volts 30 m/a and 6.5 volts 3 a. D/C. By applying between 20 and 250 volts D/C to the H/T output side, the two low-tension windings may be used to charge accumulators. The 19-volt side will charge a 6-volt accumulator at 2-3 amps, the 6.5 side a 2-volt accumulator at 1-2 a. With a 12-volt input to the 19-volt side, 180 v. at 30 m/a, and 4 v. at 3 a, may be obtained. With a 6-volt input to the 6.5 side, 160 v. at 30 m/a, may be obtained. By extending the spindle which is flush with the frame, and applying 200 to 250 v. D/C mains to the 300 v. side, the unit becomes a powerful high-speed electric motor, suitable for small drilling machines, etc. Similarly, it may be used with 6 or 12 v. input to the 6.5 v. or 19 v. side. It employs a powerful ring magnet and is of substantial construction coating originally over £5. A fortunate purchase enables us to offer these fine units at 10/-.

2-VALVE SHORT-WAVE BATTERY KIT. A complete kit of parts for a 2-valve receiver, covering 15-600 metres, including valves, coils, drilled chassis, H.T. and L.T. dry batteries to last approximately 6 to 12 months. A pair of double headphones and full instructions. Price £3/10/- . An extra coil can be supplied, covering 600-1,900 metres at 4/-.

500 MICROAMP METERS. Moving-coil, 2in. diameter flush mounting. Available by the following manufacturers. Met-Vick 500 ohms, Ferranti 70 ohms, Weston 116 ohms. Either type, 21/- . Special quotations for quantities. The following accessories are available to convert the above meter into a multimeter. Set five multipliers plus/minus 2 1/2% to read 10 v., 50 v., 100v., 250 v., 1,000 v., 7/6 the set. Bridge Type Meter Rectifier 10/- . Separate 0-10,000 ohms scale chart, 1,000 ohm. Preset Resistance and Fixed Resistor to convert meter into ohm-meter with 1½ v. battery, 3/6.

MIDGET RADIO KIT. Build your own Midget Radio. A complete set of parts, including valves, loudspeaker and instructions. In fact, everything except cabinet necessary to build 4-valve Medium and Long Wave T.R.F. Radio operating on 200-250 v. Mains, A/C or D/C. Valve line-up, 6K7, 6J7, 25A6, 25Y5. Wave-lengths covered 200-557 and 700-2,000. Size 10 x 6 x 6in. Completely drilled chassis. Price, including tax, £7/7/6. An attractive bakelite cabinet can be supplied at 25/- extra or wired and tested in cabinet. Price £10/18/6.

SUPERHET MIDGET RADIO KIT. A complete kit of parts for a 5-valve superhet. Covers 18-50 and 200-557 metres. AC/DC 200-250 v. 6K8, 6K7, 6J7, 25A6, 25Y5. Size: 10 x 6 x 6in. Completely drilled Chassis. Price, including tax, £8/5/- . An attractive bakelite cabinet can be supplied at 25/- extra.

Unbiased

By FREE GRID

Jumbled Jargon

WE who move in professional radio engineering circles often pride ourselves on the accuracy of our terminology, not always, I fear, with complete justification, otherwise we should not tolerate such a horrible hybrid word as "television." I wonder if any of you can tell me when and where this dreadful word was first used and why? It is every bit as bad as the American use of the hybrid "mortician" instead of the more correct "thanatologist," although in either case a man who is "skilled in death" suggests to my mind a gangster rather than a respectable member of the honourable profession followed by the sepulchral Mr. Sowerby and his young apprentice Oliver.

Personally speaking I am a great stickler for technical and terminological accuracy even to the extent of approving the use of the word "chymist," which I noticed recently on a shop in South London, instead of "chemist." Needless to say, I shall in future buy my "chymicals" there as the proprietor's efforts at accuracy in terminology suggests that he will make an equal effort not to confuse drugs which are of dangerously similar appearance, like Epsom-salt and oxalic acid crystals.

The word "television" has, I



"An atmosphere all its own."

fear, come to stay, but it is not too late to straighten out another case of what, with Mr. Churchill's permission, I will call terminological inexactitude. It had its origin a quarter of a century ago when Lisle Street was the Petticoat Lane of every wireless experimenter, and the commanding presence of a very gracious lady, long since gone to her Valhalla, lent it an atmosphere all its own. In those days we used to ask humbly for a ten- or twenty-

plate condenser and none but the boldest of us talked learnedly of microfarads, unless we wished to run the risk of being thrown out of the shop.

Nowadays, of course, a condenser is a capacitor and the particular electrical property which it possesses is no longer capacity but capacitance, and quite rightly too. Unfortunately, however, a device which possesses the property of resistance is not always a resistor as it ought to be, even in *Wireless World* (April issue, page 122). There seems also to be some confusion about the word inductance which does not always refer to the electrical property of that name but sometimes to the wire, or coil of wire, which possesses it. To call the latter thing an inductor may result in further confusion, for the term could equally well refer to a boy's horseshoe magnet which, when waggled near a wire (which, of course, possesses inductance) causes induction. The terms inductor and inductee might well be applied to the magnet and the wire. If we replace the boy's magnet by a waggling current passed through the wire and cause induction that way, then surely the current becomes the inductor the wire being at all times the inductee?

No doubt I shall either be told that I am all wrong or that these terms have been precisely defined long ago, but, if so, why not put them right or, alternatively, use them rightly, whichever cap happens to fit.

P.A. to be Mechanized

I HAVE often thought that the introduction of P.A. systems at our great railway stations was more of a drawback than otherwise. What is gained in being able to make train announcements is more than offset by the irritating reiteration of such items of information which one has to put up with if waiting long on the station, as one invariably does nowadays. Interspersed with such announcements are so-called musical items which although pleasant enough in themselves, become inextricably mixed up with the clang and clatter of porters' bar-

rows and the bawling of babies. The resultant noise, if not exactly nerve shattering, is at any rate enough to disturb the serenity of a Mark Tapley.

There is nothing amiss with the apparatus, it being the method of using it which is at fault. Music may have charms to soothe the savage breast but as we are not yet savages, in spite of the shortage of clothing coupons, I suggest that it be cut out. With regard to the announcers, I don't suppose that I could do any better myself without a few lessons in elocution and I will say no more than that I prefer the mike maulers of stations in the North of England and in Scotland as I cannot understand one word of



what they are talking about and do not, therefore, have my nerves rasped raw either by "refinement" or "refoinment" of speech.

Now that we are to have this P.A. business introduced into the sanctity of our railway carriages so that the guard can announce the stations as we approach them, it would seem to me like the proverbial last straw were it not for something of which I had news the other day.

The thing in question is an entirely new P.A. system which is to be brought into use shortly at one of our railway stations. It consists virtually of dozens of gramophone records each with its own pickup and constantly revolving turntable. Each record has on it a message relating to "the train on No. 6 platform —" and so on. Each message is being constantly repeated and anyone of them can be brought into use by a push-button, whole banks of which like a mammoth typewriter are mounted on a control desk. The only type of message requiring "live" announcing will be emergency ones. A high fee will be demanded for the privilege of breaking the artistic continuity of the recorded voice which, by the way, is that of a well-known B.B.C. announcer trying to earn an honest tax-free penny.

Miniature V.H.F. Transmitter-Receiver

Details of the Plessey Mobile Radio-Telephone

BY using miniature components wherever possible the Plessey Company has produced a complete mobile radio-telephone which measures only $9\frac{3}{4}$ in \times $7\frac{3}{4}$ in \times 8 in, including the power unit. The complete set is small enough to be mounted on the rear carrier of a motor cycle.

This V.H.F. equipment is intended for any mobile service requiring a compact radio telephone for use on a single spot frequency between 50 Mc/s and 160 Mc/s and having full facilities for remote control.

The description "transmitter receiver" usually implies that some part of the equipment is common to both the transmitter and the receiver. This Plessey set is no exception and the receiver's A.F. amplifier is used for both send and receive, being fed in the one case from the receiver and operating either headphones or a loudspeaker, and in the other serving as the modulator for the transmitter. In addition the amplifier can be employed separately as a P.A. system.

This versatility of operation is provided by appropriate switching located on the remote control unit, the amplifier itself being incorporated in the power supply unit. This is a vibrator type giving 250 volts on receive and 375 volts on transmit. It takes its primary supply from a battery and on 12 volts consumes 5 amps on receive and 10 amps on transmit; this includes all filament supplies. A 6-volt power unit is also available.

P.A. switch and a socket for the send/receive switch. Normally this is mounted on the hand microphone but it could be fitted in any position operationally more convenient if required.

The super-heterodyne receiver has a crystal controlled local oscillator, its 18th harmonic being extracted by frequency multipliers and fed to the frequency changer. One R.F. and three I.F. stages are used, the latter operating on 4.5 Mc/s and having a maximum bandwidth of 70 kc/s for A.M. or F.M. operation. This equipment can be operated on either A.M. or F.M. by fitting the appropriate types of units to the main chassis.

Crystals are also used in the transmitter, for A.M. as direct control of the frequency and on F.M. as a stabiliser in conjunction with a reactor valve. Its ninth harmonic is extracted to feed into a pair of EC52 valves in push-pull and operating as a power doubler. The R.F. output is 6 watts at 50 Mc/s, falling to 3 watts at 160 Mc/s.

In the assembly of the equipment the power unit forms the base and on to this is fitted, by means of hinges, the receiver and transmitter units. These open like the two halves of a door and expose the underside of all the chassis for servicing. Detachable hinges are fitted so that any unit can be removed

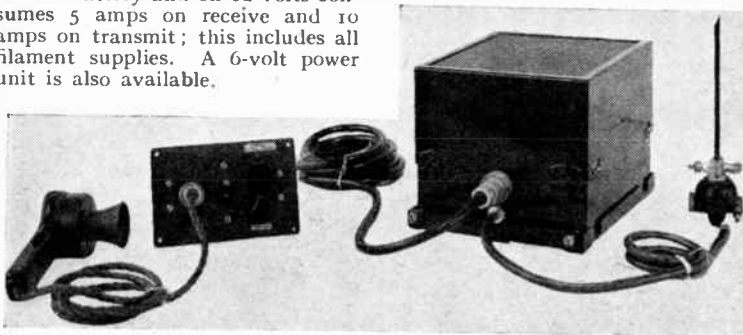

Plessey V.H.F. radio telephone comprising transmitter-receiver, control unit and hand microphone.

Once set up on the operating frequencies, which can be quite different for transmit and receive, the equipment is operated from the small remote control unit. This contains a three-position receiver volume control switch, a radio/

for repair or replacement if it develops a serious fault. The transmitter and receiver units are further protected by a snap-on cover.

The flexible aerial provided is a quarter-wavelength long, and is fed through a 40-ohm coaxial cable.

And now—

A.C./D.C.

**20-25-WATT UNIVERSAL
AMPLIFIER—U885**

Gives considerably greater power output than usually expected from A.C./D.C. equipment. Constructed on the same lines as our 30-watt A.C. model and fitted with latest control panel carrying microphone, gramophone and tone controls, mains switch and pilot lamp and special 3-position switch providing either change-over or mixer circuit for gramophone and microphone. Three-stage high-gain type having four valves in parallel push-pull in output stage, a total of 10 valves. Output for high and low impedance speaker circuits.

Full details of this and other models sent on request.

TRIX

Quality

SOUND EQUIPMENT

THE TRIX ELECTRICAL CO. LTD.

1-5 MAPLE PLACE—TOTTENHAM COURT ROAD—LONDON, W.1

TELEPHONE: MUSEUM 5817 GRAMS & CABLES: TRIXADIO, WESDO, LONDON.

Sensitive Photo-Electric Relay

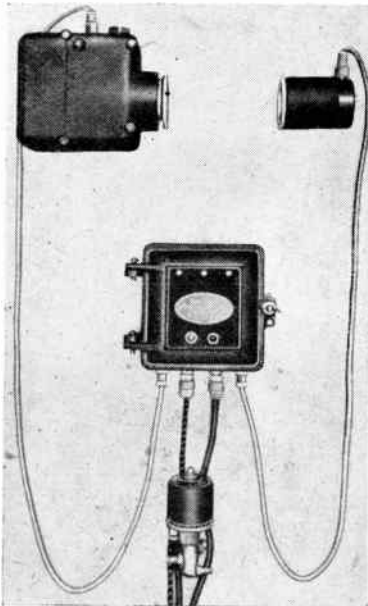

Complete relay outfit, Type "PES-II," with light source and heat filter (top left), barrier layer cell (top right), and power supply and relay unit connected to a magnetic gas control valve.

CONTACT cells of the barrier layer type, using elements such as cuprous oxide and copper, or selenium sub-oxide and gold, have been employed commercially either as rectifiers or as light-sensitive current generators in photographic exposure meters. J. A. Sargrove has investigated the effect of light on the rectifier characteristics of selenium sub-oxide/gold cells under A.C. conditions and has evolved a very simple and efficient relay, suitable for industrial process control, which dispenses with valve amplifiers and is more robust than the glass-bulb photo-emissive cells usually employed.

A family of rectifier characteristics with illumination ranging from zero to 10,000 lux (lumens per sq. metre) is given in Fig. 1. These curves relate to the "Mega-

tron" Type "N" cell used in the Type "PES-II" equipment made by Sargrove Electronics, Sir Richard's Bridge, Walton-on-Thames, and it will be seen that as the illumination is increased the forward resistance (indicated by the slope of the current-voltage curves) decreases very slightly, but that there is a much greater decrease in the reverse resistance. If an alternating (50 c/s) voltage is applied to the cell through a series resistance with sufficient amplitude to traverse the whole characteristic, the mean value of the unidirectional current component available will decrease as the illumination increases; a relay of the Post Office type connected in series will be held closed until the cell is illuminated when it will open. In a typical case the power dissipated in the relay changes by 85 mW between 10,000 lux and darkness. Using the same cell as a photo-electric generator with a comparable load the power difference for a similar change of illumination would be only 0.3 mW.

Barrier layer photocells would

be destroyed by the application of sustained voltages required to plot the characteristics by conventional methods, and the curves shown in Fig. 1 were obtained by a pulse technique designed to allow the heat generated to be dissipated in each cycle. The use of A.C. in conjunction with a series resistance achieves the same object in practical applications. The use of a simple water-cell heat filter in the beam from the light source permits a higher electrical rating for the photo cell.

Light-Modulated Rectification in Barrier Layer Cells

The high power ratio of the cell enables the relay switch to be mounted some distance away, and the small dimensions of the cell make it suitable for mounting in the confined spaces of complicated machinery for counting, sorting and similar processes.

It is claimed that with suitable time constants in the associated (Continued at the foot of next page).

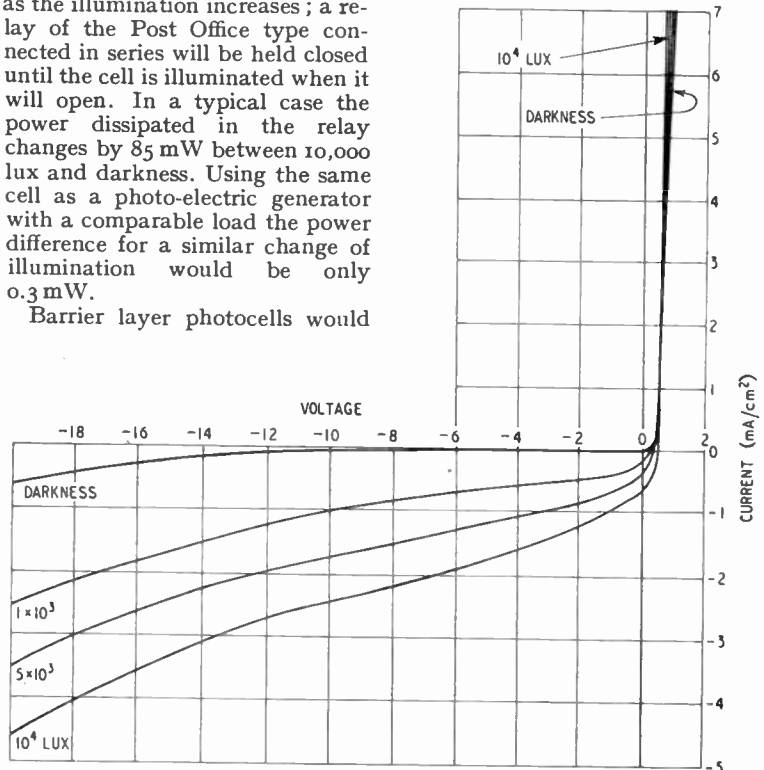

Fig. 1. Characteristics of selenium sub-oxide/gold film barrier layer cell under different degrees of illumination.

Manufacturers' Literature

FOUR illustrated brochures, describing loudspeakers, switches, variable condensers and trimmers respectively, have been issued by The Plessey Co., Ilford, Essex.

"The Hy-Meg Handbook"—a catalogue of insulating varnishes and compounds, with technical notes on choice and application, from Lewis Berger and Sons, 35, Berkeley Square, W.1.

1947-1948 catalogue of electrical components and accessories from Belling and Lee, Cambridge Arterial Road, Enfield, Middlesex. Circulation restricted to engineer-designers in the electrical and electronic industries.

Catalogue of "Wearite" components including "P" coils and packs, I.F. transformers, A.F. transformers, vibrators, etc. From Wright & Weaire, Gt. Peter House, Lord North Street, London, S.W.1.

Folder of technical information on the Type LSD.2 microsecond photographic flash tube from Mullard Wireless Service Co., Century House, Shaftesbury Avenue, London, W.C.2.

"Developments in Rubber"—a collection of technical papers on various aspects of rubber-to-metal bonding—from the Andre Rubber Co., Kingston Bypass, Surbiton, Surrey. Available to educational institutions, etc., by application on official notepaper.

Leaflet RF/D.447 describing Ferranti-Wild-Barfield dielectric heating equipments from Wild-Barfield Electric Furnaces, Watford Bypass, Watford.

"Electronics—A Factor in Industrial Efficiency." Extract from an article in *The Economist* reprinted in booklet form and issued by The Mullard Wireless Service Co., Century House, Shaftesbury Avenue, London, W.C.2.

"Lane Identification (Issue 2)," a booklet describing a method of reducing ambiguity in the Decca Navigator System, from The Decca Navigator Co., 1-3 Brixton Road, London, S.W.9.

"Introduction to Electronics"—a pamphlet for the layman—from The General Electric Co., Magnet House, Kingsway, London, W.C.2.

Sensitive Photo-Electric Relay—

circuits, the light-modulated rectifier might find application in teleprinter and photo-telegraphic services.

A paper on "A.C. Behaviour of Barrier Layer Photo Cells" by J. A. Sargrove, M.Brit.I.R.E., A.M.I.E.E., published in the *Journ. Brit. I.R.E.*, No. 2, 1947, includes a detailed hypothesis to account for the observed phenomena and also many circuits suitable for practical applications.

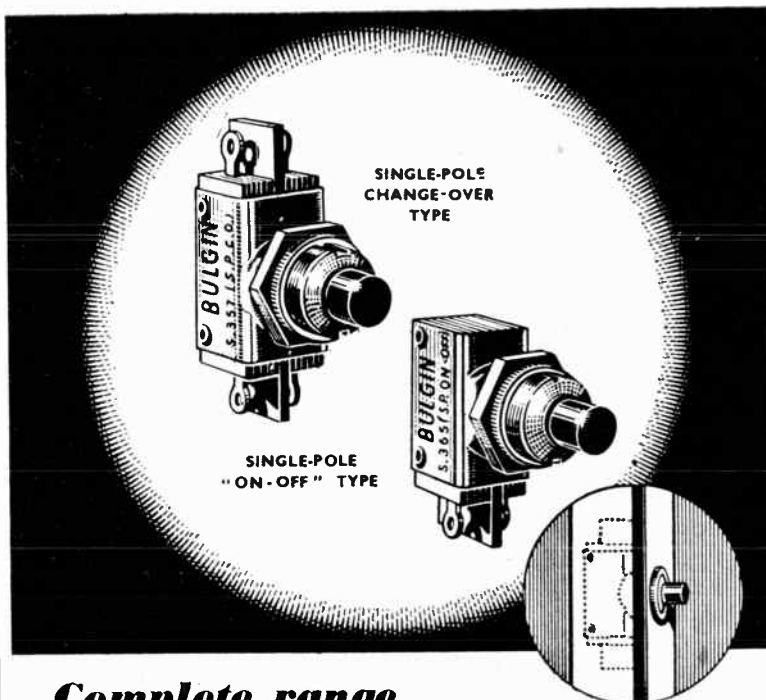

Complete range of pressure switches

High quality Bulgin switches especially suitable for refrigerators and other equipment where circuit is required on opening or closing of the apparatus. S.365 is a single-pole, 3 Amp. toggle lever switch with push-action, biased to "Off," pressure on the knob placing the switch in "On" position, circuit being maintained whilst the knob is depressed. On release of pressure the switch returns to "Off" position. Designed for 6-250 v. a.c. or d.c. circuits; max. test voltage 1000 peak. Fixing by single $15/32"$ ϕ hole for panels up to $3/16"$; solder tags for connection.

S.357 is similar but change-over, biased to one position, and rated at 2 Amp. Other types available are:—

S.358 similar to S.365 but incorporating 6.BA. terminals.

S.359 similar to S.358 but reverse action, i.e., push for "Off," returns to "On."

S.366 similar to S.359 but connection by tags.

"The choice of critics"

BULGIN

A. F. BULGIN & CO. LTD. · BYE-PASS-RD. · BARKING

Telephone: RIPPleway 3474 (5 lines).

RECENT INVENTIONS

A Selection of the More Interesting Radio Developments

AERIAL FEEDERS

A ROTARY aerial system, as used, say, for radiolocation, is coupled to a stationary S.W. generator or amplifier through a connection which includes no rubbing contact nor any inductive source of troublesome radiation.

In the diagram, A is the outer tube, and B the inner core of a coaxial feeder, which is connected at its far end to the rotating aerial. A₁ and B₁ are the corresponding parts of a coaxial line connected to the fixed or stationary equipment. The two feeders are coupled together by enlarging the end of the tube A so as to overlap the end of the tube A₁ by a quarter-wavelength, the core B₁ being recessed to admit the reduced end of the core B for a similar distance.

The spaces between the overlapping parts simulate quarter-wave lines which

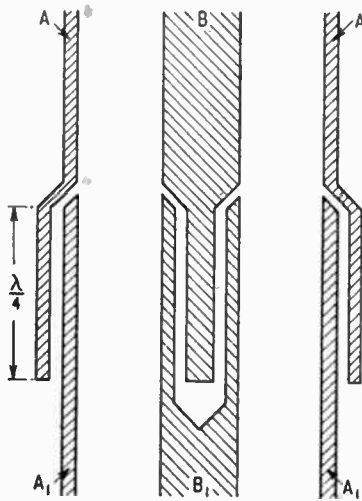

Rotary aerial coupling

are open at both ends, so that they offer no impedance to oscillations travelling in either direction. At the same time, the feeder AB can be rotated freely about the line A₁B₁. The use of open and closed quarter-wave stubs is also described for switching the aerial on and off as it passes from one section of its rotation to another.

The General Electric Co., Ltd.; and D. C. Espley. Application Date June 14th, 1940. No. 578737.

FREQUENCY MODULATION

CENTIMETRE waves are frequency modulated by the action of a vibrating member which varies the effective volume, and therefore the

tuning, of the hollow resonator of an oscillation generator of the rhumbatron type.

An aperture formed in the outer wall of the resonator, beyond the sealed-in portion, is protected by an open-ended quarter-wave stub, which prevents the escape of the internal oscillations. A plunger, driven by the moving coil of a loudspeaker, works into the stub, so that its free end projects into the resonant cavity, thus controlling the frequency of the generated oscillations. Alternatively, the aperture in the resonator may be closed by a flexible diaphragm for direct speech modulation.

The General Electric Co., Ltd., and D. O. Hawes. Application date December 18th, 1942. No. 579745.

CRYSTAL RECTIFIERS

BORON carbide in contact with a metal point is used for receiving centimetre waves, its efficiency being found to remain substantially constant wherever the metal is placed on the crystal surface. The boron carbide should be highly polished, and the metal should be a smooth round point of tungsten or of a gold-silver alloy.

The General Electric Co., Ltd., and J. W. Ryde. Application date November 23rd, 1940. No. 578952.

WAVEGUIDES

TO give a waveguide of rectangular cross section some degree of flexibility, the two broader walls are made from a pair of sheet metal plates, which are connected together along the edges by closely spaced parallel wires to form the narrower walls. This allows the guide to be flexed at right-angles to the metal plates.

By giving the plates an initial axial twist of 90 deg, the completed guide will be flexible in all directions perpendicular to, and about, the axis; whilst if the first twist is followed by a similar section of reversed twist, the guide is free to expand or contract, concertina-like, about the main axis. The metal framework is preferably protected by a rubber or other flexible covering.

C. E. Fenwick and C. S. Wright. Application date, March 28th, 1944. No. 580377.

AERIAL SYSTEM

A RECEIVING aerial is so placed and orientated, with respect to the radiation field of a nearby trans-

The British abstracts published here are prepared with the permission of the Controller of H.M. Stationery Office, from specifications obtainable at the Patent Office, 25, Southampton Buildings, London, W.C.2, price 1/- each.

mitting aerial, that signals from a distant station can be received on substantially the same frequency as the local transmission. The arrangement is particularly useful for relay systems in which incoming signals are boosted and re-radiated from point to point.

As shown, the receiving frame aerial is set at right angles to the plane of the loop formed by the feeders F which energize the transmitting aerial T from R.F. source S. Since the currents in each branch of the symmetrically-arranged feeders is equal, and in phase, the magnetic pickup will be neutralized in the receiving aerial. The electrical field is eliminated by screening the

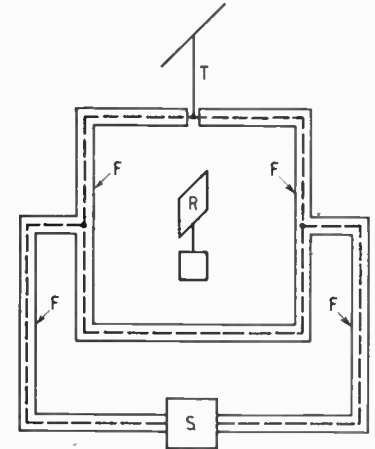

Radio relay aerial system

feeders, as shown, a gap being left at the point of junction with the open aerial T. The capacity of the latter may be increased by the provision of a top cross-wire.

J. Robinson. Application date June 1st, 1943. No. 579655.

SECRET SIGNALING

THE carrier wave is first frequency modulated by a complex masking wave formed from a coded selection of the higher harmonics of an auxiliary frequency, after which the carrier is frequency modulated by the signal proper. Before it is radiated, the resulting wave is also amplitude modulated by the auxiliary frequency, in order to provide a synchronizing signal.

In reception, the synchronizing signal is separated and applied to control an harmonic generator, pre-set to the masking code used at the transmitter. The output from this unit is applied to restore the plain signal to its original form. To prevent the masking signal from being analysed by an unauthorized listener, it is interlocked with the plain signal at the transmitter in such a way that it can never be radiated alone.

The British Thomson Houston Co., Ltd. (communicated by the General Electric Co.). Application date November 25th, 1943. No. 582798.



ERIE

Electronic Component Products

RESISTORS · CERAMICONS · Hi-K CERAMICONS
SUPPRESSORS · POTENTIOMETERS
VITREOUS ENAMELLED WIRE-WOUND RESISTORS

ERIE RESISTOR LIMITED

CARLISLE ROAD
 TELEPHONE: COLINDALE 8011-4
 FACTORIES: LONDON,

THE HYDE · LONDON ·
 TELEGRAMS: RESISTOR, PHONE, LONDON
 ENGLAND · TORONTO, CANADA

N.W.9 · ENGLAND
 CABLES: RESISTOR, LONDON
 · ERIE, PA., U.S.A.

**INSTRUMENTS
FOR
SPECIAL
PURPOSES**

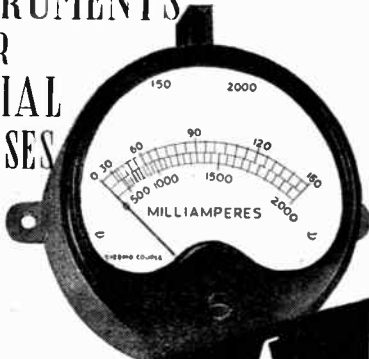

HIGH-GRADE
MODERN
DESIGN.

SIFAM

ELECTRICAL INSTRUMENT
TORQUAY COMPANY LIMITED DEVON



When
SENSITIVITY
is
VITAL!



Type "A"

Details of all types of S. G. Brown headphones priced from 25/- to 105/- are given in Brochure "W.W." Free on request.

Time and again lives have depended upon the sensitivity of a pair of Headphones.

The enthusiastic radio amateur, experimenter and serviceman using headphones of just average sensitivity should make sure that the next pair they purchase are of the utmost sensitivity as well as capable of giving true quality reproduction.

The famous S. G. Brown Type "A" Headphones give highest possible efficiency; this is attained by the Adjustable Reed Movement which replaces the usual flat diaphragm.

Your local dealer can supply
S. G. BROWN TYPE "A" HEADPHONES
Price 60/- per pair.

Phone
ACOrn
5021

S. G. Brown, Ltd.

VICTORIA ROAD, NORTH ACTON, LONDON, W.3

**THE
ROBERTS PORTABLE**



VALVE & CIRCUIT ANALYSER

- Tests Valves for Current, any Electrode, A/C & D/C. 11 Ranges 0—2.5 Amps.
- Tests Electrodes for Volts, any Electrode, A/C & D/C. 17 Ranges 0—1000 Volts.
- Checks Resistance any Electrode. Valve to Valve or Chassis. 3 Ranges 0—1 meg.
- Can be used as Universal Meter 2000 Ohms. per volt.
- Invaluable for testing A.C.—D.C Radio Receivers.

**NO NEED TO REMOVE CHASSIS
FROM CABINET FOR TESTING**

Best materials and workmanship. Guaranteed for 12 months.
Dimens.: 12x12x6 ins., weight 11 lbs. Manufactured by:—
LONDON SOUND LABORATORIES LTD.,
40, South Molton Lane, Bond Street, London, W.1.

Sole Distributors:

Kerry's
LONDON

WARTON RD., STRATFORD,
LONDON — E.15
And all Branches.

STABLE
to



Resistors produced by the cracked carbon process remain stable to $\pm 1\%$ of initial value.

★ Tolerances $\pm 1\%$
 $\pm 2\%$ $\pm 5\%$

Low temperature co-efficient.

Welwyn carbon resistor

WELWYN ELECTRICAL LABORATORIES LTD.
Welwyn Garden City, Herts. Telephone: Welwyn Garden 3816-8

**WALTER SWITCHES
ARE MADE FOR**



**WALTER
INSTRUMENTS, LTD.**

GARTH RD., LOWER MORDEN, SURREY
DERWENT 4421. Grams: WALINST, MORDEN, SURREY

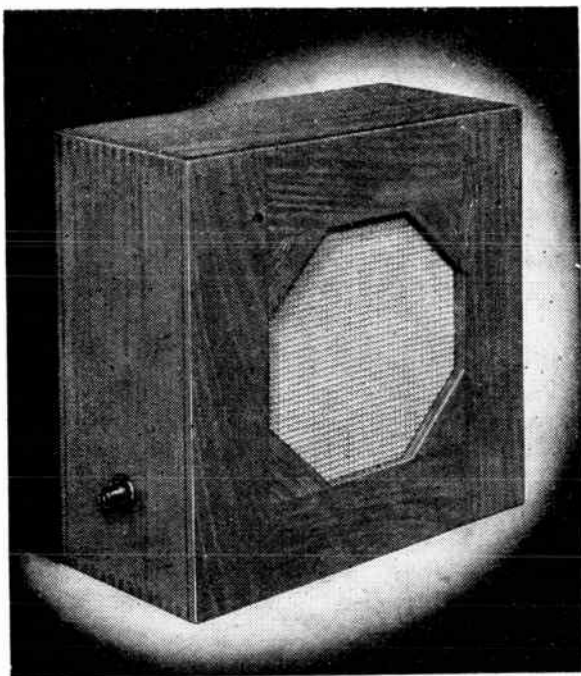

Dimensions : 17½" × 17½" × 8½". Unit : 12" P.M. Type T2/1205/15.
 Nett Weight : 23 lbs. 12 ozs. Max. Power Input : 12-watts peak A.C.

GOODMANS
Public Address
CABINET LOUDSPEAKER
 TYPE AL/S

THIS well-known unit is now available again in a strongly made cabinet of natural polished seasoned mahogany, with locked corners, for use in halls, theatres and factories, and on all indoor installations where high power and fidelity are required. Rugged construction and excellent appearance render it ideal for permanent installations and for short term hire work involving constant handling. Portability and adequate bass response are noteworthy features. Nominally of 15-ohms impedance, a suitable line transformer can be fitted internally to present any required impedance at the socket connection.

FIDELITY

 EFFICIENCY

GOODMANS
Loudspeakers

GOODMANS INDUSTRIES, LTD.,
 LANCELOT ROAD · WEMBLEY · MIDDX.

Stabilised Insulation BY MODERN IMPREGNATION METHODS

HYMEG

HIGH-SPEED PRODUCTION

Now, special methods of continuous conveyor impregnation and baking developed with the use of HYMEG have still further reduced processing times to a fraction of those previously believed necessary. Often faster than infra-red baking with none of the defects, reduced handling, absence of special jigs, with complete freedom from blistering, bubbling and porosity, are some of the advantages claimed and substantiated for HYMEG High Speed Production methods.

HYMEG Synthetic Insulating Varnishes are recognised and widely used for their mechanical rigidity, improvement of electrical properties of windings; heat, moisture, oil, acid and alkali resistance as well as for the considerably reduced stoving time necessary.

HYMEGLAS REGD.

GLASS FIBRE INSULATION SYSTEM

This integrated system of development is successful in enabling machines to be designed and operated without weak links in the chain of insulation below 200°C. Thus the fullest advantage is taken of modern glass fibre insulation by providing a degree of bonding and insulation at every point in which the uniting of Hymeg impregnation with the Hymeg as used for subsidiary insulations gives a solid homogeneous winding of equally efficient characteristics and heat resistance throughout.

After much research in our laboratories and in conjunction with many well-known specialist manufacturers, we have now evolved the Hymeglas system of Insulation which comprises modifications of Hymeg as used for coil impregnation to meet the varying conditions applying to each field of manufacture.

Hymeglas therefore virtually eliminates any risk of insulation failure and enables motors and the like to operate under abnormal conditions for long periods without risk of electrical breakdown.

Due to the excellent space factor of glass fibre as compared with the more usual asbestos and mica Class B insulations, it is often possible in redesigning with the Hymeglas system to employ larger copper sections with well-known advantages.

The Berger Technical Service—the research work of which produced "HYMEG" and "HYMEGLAS" is available to advise manufacturers on all problems of insulation. Get in touch now with—

LEWIS BERGER & SONS LTD. (Est. 1760)
 35, BERKELEY SQUARE, LONDON, W.1.

Telephone : MAYfair 9171.

MANUFACTURERS OF INSULATING VARNISHES AND ENAMELS.

M.R. SUPPLIES Ltd.

the old-established house with the reputation for value, service and despatch, offer the following high-class RADIO and ELECTRICAL material from stock. Our discriminate buying is your guarantee of satisfaction. All prices net.

RESISTANCE BOXES. Decade type. Units 0/10. Tens 0/100. With additional 100 ohms. Fitted moving coil galvo. Switching from Wheatstone Bridge and other tests. Very fine instruments in teak case 16in. by 7 1/2in. by 6in. A remarkable opportunity for laboratories, technical schools, etc. Brand new, by most prominent makers, 65/- (despatch 2/6).

INSULATION TEST INSTRUMENTS. Special offer of "Record" instruments. 500 v. gen., 0.20 megohms and inf., 29 15s. Also the Everhed "Wee-Megger," same rating, £11. Suitable portable leather cases, with sling, 12/6 (not sold separately).

SHORT-WAVE RECEIVERS, Model 3/II. Operation A.C. mains and mobile (6-volts). 4-valve superhet employing standard valves. Three bands, 3.1 to 5.4, 5.2 to 9.8, 7 to 15.5 Mc/s (approx. 19 to 100 metres—bringing in all European service transmissions) B.F.O. and fine vernier tuning. Supplied with 'phones but output ample for speaker. Receiver in metal housing, 4 1/2in. sq. by 9 1/2in. Separate Power Pack, metal housed 4in. by 5in. by 10 1/2in., metal rectified. Two vibrators (extra H.T. available from L.T.). With all leads, plugs, 'phones, etc. a really fine equipment, brand new in clip-fastener steel container 12in. by 10 1/2in. by 6in., 29 17/8 (despatch 7/6)

PUBLIC ADDRESS SPEAKERS. Exceptional offer of the very efficient Beslo Reflected Horn Projector Speakers, with 10-watt P.M. m.c.oil Unit 15 ohms imp. Flare only 12in. long and 14in. dia. On swivel bracket with wheel bolts for clamping at any angle. Completely storm-proof and ideal for all outdoor and mobile P.A. Brand new and undamaged, 25 17s. 6d. (despatch 5/-). STEEL TRIPODS to suit these and all P.A. speakers, collapsing to about 5ft. and extending to max. 12ft. Perfectly rigid in use. 55/- (despatch 3/6).

BATTERY CHARGING KITS for 4-amp. Charger. These components are far better in quality than those supplied in a commercially constructed charger and construction is quite simple. S.T.C. Metal Rectifier for charging up to 12 v. at 4 amps., 22/6. Associated Mains Transformer, prim: tapped 200/220/240 v. 50 c.; Sec: tapped for 6 and 12 v. charge, finished in die-cast brackets with terminal boards, 36/-.

Rotary Rheostat, panel mtg., with 2 1/2in. control knob, 4 ohms 4.5 amp. (or 9 ohms 3 amps.), 23/6. Panel Ammeter, 3 1/2in., 0.5 amps., 27/6. Suitable Metal Case (perforated), 7/6. The kit, 25 17s. 6d. carr. paid (or items sold separately).

SMALL ELECTRIC BLOWERS. 12 v. A.C./D.C. Motor with filtered intake and outlet at one end. Outlet aperture, 1 1/2in. sq. Total length, 5in. width, 4 1/2in. Powerful blast, 29/6.

M. COIL HEADPHONE AND MICROPHONE SETS. Remarkable offer—the inserts provide three m/coil microphone. One headset and hand microphone, lot 15/-.

EARON HEADPHONES, best makes, ex-Govt., new, 4,000 ohms, 12/6 pr.; 120 ohms, 10/- pr. Both with headgear.

"FUZIT" WIRE JOINTERS. This very useful S.T.C. product electrically welds all gauges of wire from 50 to 30 s.w.g. (copper and resistance). Operation 200/250 v. A.C. Ready for use with portable transformer and hand-tool with carbon electrodes. Leadset if required but supply limited, 78/6 complete (despatch 2/8).

"AYO" ALL-WAVE OSCILLATORS from stock. A.C. mains, 85 Kc/s to 80 Mc/s. Calibrated output—internal modulation. With two dummy serials, £18.

POTENTIOMETERS. Centre-tapped wire-wound attenuators. Res. 3,000 ohms in 40 x 75 ohm stud taps. With screening box, dia. 2 1/2in. by 2 1/2in., 18/6.

In Stock: Vent-axia Extractor Fans, Stuart Turner Electric Pumps, large selection of Amplifiers, P.A. Speakers, Microphones, Pickups.

(Please include sufficient for despatch.)

M.R. SUPPLIES LTD., 68, NewOxford Street, London, W.C.1.
Telephone: MU5EUM 2958

SENSITIVE VALVE

Voltmeter

PRINCIPAL FEATURES

VOLTAGE RANGE
1 mV to 100 volts.

FREQUENCY RANGE
50 c/s to 250 kc/s.

ACCURACY
±5% of the actual reading.

INPUT IMPEDANCE
2 megohms.

ZERO SETTING
Stable and remains set on all ranges.

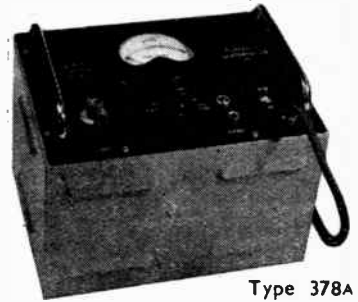

Type 378A

This instrument is now available from stock. Write for full particulars and specification. PRICE £75

FHL FURZEHILL LABORATORIES LTD
TELEPHONE BOREHAM WOOD
ELSTREE 1137 HERTS

GOOD NEWS

for the Deafened!

RAYTHEON

Hearing-Aid Valves
Now Available in Quantity

YES—good news for all who use hearing-aids, and for all who manufacture or sell them. Raytheon valves... especially designed for hearing-aids, and noted the world over for their sturdy long life and rugged construction... are available for immediate shipment.

These are the world's most widely-used valves for hearing-aids. They give maximum performance for minimum battery drain. They are proven favorites with engineers, manufacturers and users alike.

Ask for complete information. Address your inquiry to Submarine Signal Company (London) Ltd., Artillery House, Artillery Row, London S.W.1. England or to:

RAYTHEON MANUFACTURING COMPANY
International Division,
60 East 42nd Street, New York 17, N. Y., U. S. A.



Excellence in Electronics

Be Independent of Electricity Cuts

The MASTERADIO 6A. HTP Vibratorpack will supply high-tension D.C. from a 6-volt accumulator, up to 3 watts. It is suitable for operating radio receivers and any equipment where the power required does not exceed 3 watts. It is smaller in size than a normal H.T. battery. Fuller information gladly supplied on request.



Photograph of Vibratorpack Type 6A. HTP showing robust construction. Delivery can now be made within fourteen days.

Masteradio VIBRATORPACKS

MASTERADIO LTD., 319/321, EUSTON RD., LONDON, N.W.1

Rate 6/- for 2 lines or less and 3/- for every additional line or part thereof, average lines 5-6 words. Box Numbers 2 words, plus 1/- Press Day: August 1947 issue, first post To day, July 8th No responsibility accepted for errors.

WARNING

Readers are warned that Government surplus components which may be offered for sale through our columns carry no manufacturer's guarantee. Many of these components will have been designed for special purposes making them unsuitable for civilian use, or may have deteriorated as a result of the conditions under which they have been stored. We cannot undertake to deal with any complaints regarding any such components purchased.

NEW RECEIVERS AND AMPLIFIERS

UNIVERSAL ELECTRONIC PRODUCTS (G8UQ), 36, Marylebone High St., London, W.1. Tel. No. Wel. 4058.
OUR U.E.7 amplifier is designed for the connoisseur who requires the best possible reproduction together with the highest standards of workmanship and materials. 10 watts undistorted output from 8 valves (triodes) in double push pull, with independent controls for treble and bass. We invite you to hear this instrument demonstrated. 2/6d stamp for details.

A FEW hundred sets, all brand new, Canadian Mark 58 Walkie Talkies for sale for shipment, lying London.—Write Box 331. [7777]
DEGALLIER'S, Ltd., announcement.—When taken imports American receivers is permitted we shall have these; information will be in this column when available, please watch future issues. [7541]

A MPLIFIERS; new 1947 model Hi-Fi units, with triple tone controls, built to customer's specification.—Broadcast & Acoustic Equipment Co., Ltd., Broadcast House, Tombland, Norwich 26970. [6433]

1947, 2-wave receivers universal mains, complete kit with valves, speaker, cabinet, instructions, diagrams, etc.; one hour assembly; limited numbers available; £7/5; 5/- carriage; c.o.d. or c.w.o.—Radio Unlimited, 16, Carnarvon Road, Leyton. [7833]

WIRELESS WORLD Quality amplifier (page 161, May issue), built with quality parts to specification, tested and guaranteed complete with all valves; £25/10; 12in. speakers and gram. motors supplied to order.—Enquiries to R.T.S., Ltd., Laurel House, 141, Little Ealing Lane, W.5. Ealing 6962. [7691]

R.X.R.A.F. radar Identification Friend or Foe transmitter-receivers, operates between 155-185 megacycles, and easily convertible for amateur use, complete with 10 valves, 2 type RK34, 1 type EF50, 4 type 5F41, 3 type D1, and 20 watts motor generator, only 79/6 (carriage 4/-); Canadian type 58 Mk. 1 "Star" transmitter-receivers, complete with 8 valves, 2 sets of headphones and microphones, 3 aerials, Battle battery, etc., etc., and instruction books, all brand new, in original manufacturer's cartons, complete and ready to switch on, only £10/10 (carriage 5/-); illustrated leaflet available on application; also refer to our advertisement under "Test Equipment" offering ex-Army wave-meters.—U.E.I. Corp'n., 32, St. Gabriels Rd., London, N.W.2. [7373]

RECEIVERS, AMPLIFIERS—SECOND-HAND
HRO-MX, 17-30 mcs; £35.—Harden, 23, Wilnicott Rd., Leicester. [7849]

R1155 R.A.F. receivers, excellent condition, 16 to 4,000 metres; £15.
IN nearly new condition, realigned and calibrated, guaranteed working order; £17/10.
CAN be supplied with output stage/power pack and loudspeaker; £27/10.

FULLY modified, as follows, becomes an all-round super set with high quality output D.F. parts removed, new front panel, bass and treble boost with separate tone controls, R.C. coupled push-pull output (2-PX4s), gram input, other refinements, complete with loud speaker; £35.—Write for details.

R1155s already purchased, modified and serviced and power packs supplied.—R.T.S., Ltd., 8, Gladstone Rd., Wimbledon, S.W.19. Tel. Lib. 3303. [7003]

MCR1 receiver with a.c./d.c. power pack; £5/10.—Taylor, 35, Royal Cres., W.11.

R.C.A. AR77E 51-541m/cg, R1155, both perfect, complete, lot; £85.—Box 4. [7716]

A MERICAN 9-valve communication receiver, 500kc-18mc, ac model; £27/10.—Box 5.

HALLICRAFTER "Skyrider" 5-10, as new; offers.—Adcock, Market Pl., Watton Nk

15-WATT amplifier, Callaro turntable and pickup, 12in Goodman's speaker in cabinet; £25 lot.—Box 212. [7747]

R1155 receiver, accurately lined up and complete with power pack, and loudspeaker in separate cabinet; £21.—Box 8. [7725]

Partridge News

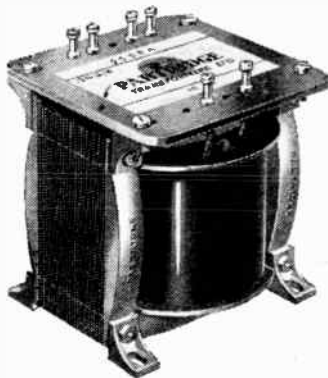

INDIVIDUAL DESIGN

PARTIDGE Precision Built TRANSFORMERS wound to suit individual requirements now incorporate:—Silver plated turret terminals giving a low potential drop and carrying up to 15 amps. Adequate room on each for easy soldering of several external circuit wires.

Firm clamping of the laminations by means of scientifically designed pressure die-castings.

Interlocked fixing feet providing alternative mounting.

Illustrated above is mounting style "DN" which can be employed if desired on all components wound to special requirements.

AVAILABLE STOCK

A comprehensive range of mains and audio components is now available from stock, and we can despatch small quantities of these per return. We would stress that before ordering you send for our list detailing these components. Our stock range now covers almost all normal requirements, and by availing yourself of this service you will save the inevitable delay in the production of a special component.

CATALOGUE

A new catalogue illustrating various mounting styles is now available. This incorporates full data on our components, including fixing dimensions, weight, method of termination, etc. You are invited to send for a copy, issued free of charge.

Telephone:



Abbey 2244

PARTRIDGE TRANSFORMERS LTD

76-8, PETTY FRANCE, LONDON, S.W.1

A.R. Co., 27, Temple Fortune Mans., N.W.11.
Spe 4352.—Communication receiver, type 1155, 5 bands, with power pack; £20. [7801]
PHILCO Walkie-Talkie, 18 valves, complete lightweight headphones, handset, telescopic aerial.—122, Windmill Av., Kettering
COMMUNICATIONS receiver, 13-valve, 5 waveband, var. b. wdth., crystal check, B.F.O., triple turret; £30.—Box 8996. [7690]
TRANSMITTING/RECEIVING set (walkie-talkie) complete, plus webbing equipment, spares and batteries; what offers?—Box 8995.
TELEVISION.—Murphy A.56v receiver, excellent cond., recently overhauled by makers; £50.—Chaundy, Banbury Rd., Bloxham.
HALLICRAFTER 821 Bv superhet, 27-68 mc, L.S., 230v ac, overhauled; best offer over £25.—GSCP, 33, Manley Rd., Sale. [7845]
HAMMARLUND super pro receiver, with matched loudspeaker, as new; £65 or nearest offer.—Write Latham, Little Hill, Much Hadham, Herts. [7753]
R.A.F. 1155 receiver, modified and fitted out put stage and power pack, thoroughly overhauled, working condition, less speaker; £22 or offer.—Box 8991. [7677]
PHILIPS' communication receiver, brand new, one R.F., two I.F., M.W., I.W. and short 5.6 to 18mc/s, separate ac mains unit; what offers?—Box 215. [7752]
VORTEXION super 50watt amplifier; only used twice; carriage free; £30.—World Radio & Electric Co., 78, Radford Boulevard, Nottingham. Tel. 77983. [7824]
RC.A. 20W amplifier, as new, multi-ratio input and outputs, p.p. 61.6s, complete with new valves, in superb streamlined case similar to AR88; £25.—Box 332. [7778]
FOR sale, a number of secondhand 65 and 85-watt amplifiers suitable for wireless relay exchanges.—For further particulars and inspection arrangements write Box 205. [7734]
HAMMARLUND Super-Pro., 100-400kc/s, 2.5-20mc/s, complete with power supply, in very fine working order, photo and parries. If not used; best offer over £50.—Box 336.
EDDYSTONE 504 communication receiver, E perfect, £36; 7-panel transmitting rack, Eddystone, undrilled, £7; 1mhof amplifier case, 4 handles, 17½ panel, undrilled.—Fairbairn, 181, High St., Ayr. [7732]
ER.R.A.F. Loran radar sets with 5in electrostatic C.R.T., with time base, 26 valves including 6SN7, 6116, 68J7, and calibrated 100kc crystal, suitable for conversion to oscillograph; £10.—Apply Box 405. [7797]
W.W.Q.A. 8 watts 2-valve tuner, gram motor, crystal p.u., in mahogany cabinet. Goodman's 12in auditorium spkr. 50in vented acoustic chamber, purchaser collects; £25.—131, Torcross Rd., Ruislip, Ruislip 6139.
WIRELESS WORLD "all-wave super-seven receiver, p.p. quality amplifier, feeder unit, B.T.H.-R.K. senior speaker, in radio cabinet, perfect condition; best offer secures.—53, Kenilworth Drive, Croxley Green, nr. Watford, Herts. [7736]
FOR sale, 5 Marconi type RP42/1 fixed receivers and 4 Marconi type RP42/2 mobile receivers, in good working order.—Offers to be sent to The Chief Constable of the East Riding of Yorkshire, County Chief Constable's Office, Beverley, E. Yorks. [7775]
RADIOGRAM ac-dc, 7 watts p.p., modern, £38; Crosley Console 110 or 230v dc, 7v perfect, £18; ac-dc amplifier and local station radio, double-spring motor, pick-up speakers, in case, £9 car. pd.—Radio Service, 131, Elgin Rd., Ilford, Essex. [7728]
VORTEXION 20-watt quality amplifier, £18; 12in Goodman's p.m. speaker, 15-ohm, £5; model 343 Cosor ganging oscillator, £37/10; Labgear electronic fault and signal tracer, £34/10; the above are all new and never been used.—H. Welsh, 382, Brockley Rd., S.E.4. [7764]
CLYDESDALE for ex-Government radio bargains: ex-U.S. Navy, aircraft receiver, CWS43AAY at 42/6, carr. 7/6; CZR43AAX, at 42/6 ea., carriage 7/6 extra; ex-R.N. R3067, at 42/6 ea., carriage 7/6 extra; ex-R.A.F. 1124, at 30/- ea., carriage 5/- extra; power unit 320 for R1124, at 12/11 ea., carriage 5/- extra; and hosts of other first-rate surplus equipments; send now for lists.—Clydesdale Supply Co., Ltd., 2, Bridge St., Glasgow, C.5.
A MERICAN Western Electric receivers, A.R.1585, ex-R.A.F.: 12-valve, 1½ metre, 6 channels, using seven 9001s, three 6AK5s, EBC33 and 12A6 valves, size overall 12inx 6inx5in, three units packed in sep. cartons, receiver, control unit with channel selector, flanging and BA, beat note and output, Off. Nav. and Voice switch and phone jack, chassis with EBC33 and fuse unit into which the receiver fits, black crackle finish, complete minus vibrapack and connecting cables; £5/5.—H. H. Vignash, The Maltings, Rayleigh Rd., Hutton, Brentwood, Essex. [7733]

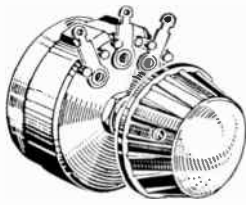

Types T.W. and S.G.

(as illustrated)

As recently specified :

"HIGH QUALITY AMPLIFIER"

- 1-25,000 ohms T.W. linear
- 2-100 ohms T.W. linear

"TELEVISION RECEIVER"

- 1-2,000 ohms T.W. linear
- 1-2 megohms S.G. linear

are now available.

For full details of all types, write to :

RELIANCE

Manufacturing Co. (Southwark) Ltd.

Sutherland Road, Higham Hill,
Walthamstow, E.17

Telephone : Larkwood 3245

CRYSTAL PICK-UP



WITH *Unbreakable* CRYSTAL

The ACOS G.P.10 combines purity of reproduction with extreme reliability. A unique flexible assembly renders the crystal virtually unbreakable, while a needle-pressure adjustment is incorporated in the base. Resonance-free response from 50-8,000 cps. Output 1.5 v. at 1,000 cps. Needle pressure 1½ ozs. (adjustable). Vibration-free arm movement. Screened lead. Price in Great Britain 44/- (including P.T.).

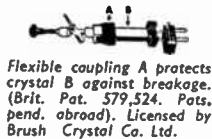

Flexible coupling A protects crystal B against breakage. (Brit. Pat. 579,524. Pats. pend. abroad). Licensed by Brush Crystal Co. Ltd.

Obtainable only from Radio Dealers

COSMOCORD LTD
ENFIELD: MIDDLESEX

TEST EQUIPMENT

H. FRANKS, 58, New Oxford St., W.C.1.
Tel. Mus. 9594.

OFFERS the following ex-Govt. equipment to callers only. Comprising the following:—AC mains driven oscillators, type 37; receiving units, type 69; C.R. units, type P1246; C.R. power units, type 526; ac mains receiving units, type 103A, less valves; performance meters, type 53874; ac mains wavemeters, type W1252; battery wavemeters, type W1095; receivers, type 1147; receivers 3132, receivers 3075; indicator modulators, auto transformers; C.R. units, type 198; receivers, type 76A; battery driven amplifiers, Venner time switches, large assortment of volt. amp and milliamp. meters, neutralizing units with R.F. meters, metal rectifiers, relays, vibrator packs, etc.

WEB Megger, 250 volts, almost new, £6/10; approval.—Box 8993. [7679]

Blutely new; 18gns.—Box 486. [7843]

MILNES H.T. unit, 120V Minor, reconditioned, complete; offers.—Box 344. [7775]

PHILLIPS resistance capacity br., G.M.4140. perf.; best offer over £8.—Box 330. [7775]

WESTON Analyzer, Type 3, Model E772, in case, good condition; £20 or nearest.—22, Heath Way, Rugby. [7688]

AVOMINOR Universal, new, £8/10; Avomator D.C., as new, £4.—Bennetts, 28, Lower Richmond Rd., Putney, S.W.15. [7765]

MEGGER C.C.T. rating ohmmeter, megger 50v, 3-0-3. 30-0-30v meter, all E. V., as new, in leather cases; offers.—Box 8998. [7775]

FOR sale, Universal Taylor meter, model 90, just overhauled, volts, amps, ohms, £10.—Deith, 14, Queen Victoria St., E.C.4. Cen. 0039.

WEE-MEGGERS, brand new, ex Govt., 250-volt, complete in leather case; list price £12, our price £8; 2nd hand ditto, £5, post free.—Auto Collections, Ltd., 126, St. Albans Av., Bedford Park, W.4. Tel. Chiswick 1601.

PYE service workshop rack comprising signal generator, output meter, and component tester, £55 or near; Avometer Model 7, £15 or near; Taylor valve tester, Model 45A, £15 or near; rack and meter barely used.—Michaelson, 77d, Compayne Gardens, London, N.W.6. [7685]

EXPERIMENTERS! Service engineers! Nuplans announce their plan No. 9, a wide range audio oscillator. Also No. 10, the Wobblulator, for rapid I.F.-R.F. alignments.—Each plan 2/6 from E. N. Bradley, "Whinnie Knowe," Escalls, Sennen, Cornwall. S.a.e. for test gear plans lists. [7769]

COMplete cathode ray tube oscilloscope in black crackled cabinet, 2 3/4 in. tube, internal or external sweep, full working instructions and connecting co-axial leads, internal power supply, ideal modulation checker, an absolute gift; complete £6; s.a.e. lists other bargains.—Amateur Radio Service G6HP, Canning St., Burnley, Lancs. [7779]

WAVEMETERS, ex-Govt., class D No. 1 Mark II ranges 1,900-4,000 kc/s, 4,000-8,000 kc/s, check frequencies at intervals of 1 mc up to 25 mc/s, oscillator crystal check, battery operated, supplied with spare vibrator, spare valve, and instruction book, brand new; £6/15, carriage paid; send for fully descriptive leaflet; also a few only less spares at 85/- (carriage 3/-).—U.E.I. Corp., 32, St. Gabriels Rd., London, N.W.2. [5910]

NEW LOUSPEAKERS

HIGH quality, precision-built speakers. Ticonal magnets, detachable diaphragms, die-cast chassis, twin cone.—Broadcast & Acoustic Equipment Co., Ltd., Broadcast House, Tombland, Norwich 26970. [6435]

REXONAX introduce an outstanding duplex reproducer consisting of low frequency and high frequency horn loaded units of specialised design incorporating separate output transformer and frequency dividing network; exceptionally smooth response from 40-12,000 c.p.s., efficiency approximately 35%; low intermodulation and harmonic distortion with high power handling capacity; even distribution of all frequencies over wide area from mouth equivalent of over 16 sq feet; adjustable "high-low" balances; compact dimensions; built to highest ideals, not down to a price, for those engaged in obtaining the most realistic reproduction of sound.—Details and demonstrations, "Rexonax," Lowther House, St. Marks Rd., Bromley, Ravensbourne 5225

LOUSPEAKERS. SECOND-HAND

HARTLEY TURNER 215, perf., £7; Part-ridge O.P. trans. for same, 30/-.—Box 406.

18IN Epoch speaker, complete with field power pack mounted in large solid cabinet; £11.—Box 7. [7724]

VALVES

HAM has 6V6GT (6), 832 (4), 807 (3), 6Q7G (2), 12Y4, 1LH4, 1R4 (1) each, 3B7 (2), 1LNS (2) at list prices.—Box 213.

UNUSED trans. valves, surplus to amateur's needs, 4RC813 at 52/6 ea., 4 RCA830B at 27/6 ea., or offer for 8 in a batch—Box 342 [7800]

LASKY'S RADIO

THIS MONTH'S SPECIALS

SPECIAL PURCHASE EX-W.D. MOVING COIL METERS. All brand new. Boxed and unused. First Grade by Ferranti, Pullin, Walsall, Everett, Dwarf, Metro-Vick, E.A.C., Weston, G.E.C., Turner etc. No. 1, 2in. 0-1.5 m/a. Price 12/8 each.

No. 2, 2 1/2in. 0-1 amps. Price 12/6 each.

No. 3, 2 1/2in. 0-20 amps. Price 12/6 each.

No. 4, 2in. 0-10 volts. Price 12/8 each.

No. 5, 2in. 0-250 volts. Price 14/- each.

No. 6, 2 1/2in. Thermo-couple. Ammeter H.F. 0-4 amps., 13/6 each.

No. 7, 2in. 0-1 m/a. Res. 500 ohms (calibrated 0-50 mod. bias). Price 13/8 each.

ELECTRO-STATIC HIGH VOLTAGE METERS.

No. 1, 0-3,500 volts, 25/- each.

No. 2, 0-750 volts, 20/- each.

SCREENED VALVE TOP CAPS. 9d. each.

I.F. TRANSFORMERS. 465 kc/s Iron cored with or without flylead High Q. 7/6 each, 14/- pair.

I.F. TRANSFORMERS. 465 kc/s Air cored high Q. Mica Trimmers, with or without flylead. 14/- pair.

MEDIUM AND LONG WAVE T.R.F. COILS, with reaction and circuit high gain, 8/6 per pair.

8 MFD. 500 V.W. ELECTROLYTIC CONDENSERS. Waxed Cardboard Tub. 3/6 each, 36/- per dozen.

8-8 MFD. 500 V.W. ELECTROLYTIC CONDENSERS Aluminium can, best quality, nickel type, 5/6 each

5in. P.M. MOVING COIL SPEAKERS, 3 ohm speech coil, 19/- each.

8in. P.M. WITH PENTODE TRANSFORMER, 3 ohm speech coil, 27/6 each.

6in. P.M. WITH PENTODE TRANSFORMER, 3 ohm speech coil, 27/6 each.

TAYLOR ALL-WAVE SIGNAL GENERATOR, £15.

AVO ALL-WAVE SIGNAL GENERATOR, £13.

Delivery immediate from stock. Carriage extra. All Types Crystal and Magnetic Pick-ups.

Over 6,000 Radio Valves at B.O.T. Prices.

We have space for only a few items of our extensive stock. Send lit. for our current lit. and bulletin.

Terms: Pro-forma, Cash with Order or C.O.D. (No C.O.D. under £1). Orders over £5 post free. All goods covered by our unconditional guarantee. It will pay you to pay us a visit.

LASKY'S RADIO

370, Harrow Road, Paddington, W.9

(Opp. Paddington Hospital.)

Telephone: CUNNINGHAM 1979

Hours: Mon.-Sat. 9 a.m. to 6 p.m. Thursday Half-day

YOU

can become
a first-class
RADIO
ENGINEER

We are specialists in Home-Study Tuition in Radio, Television and Mathematics. Post coupon now for free booklet and learn how you can qualify for well-paid employment or profitable spare-time work.

T. & C. RADIO COLLEGE
North Road, Parkstone, Dorset

(Post in unsealed envelope, 1d. stamp)

Please send me free details of your Home-Study Mathematics and Radio courses.

NAME

ADDRESS

W.W.61

ALL new valves, 3A5s, 1R5s, 185s; 10/- each.—Josling, New Mill, Penzance. [7768]
LARGEST and most comprehensive range in the country, British and U.S.A. types, at Board of Trade prices; send for lists (valves available), free, s.a.e.; valves sent c.o.d.; retailers not supplied.

RANSOM, Bond St., Brighton. [7223]
FOR sale, 106 mains and battery valves (in and boxed), surplus to requirements, many difficult to obtain, A.C., A.C./D.C., Octal, s/contact and U.S.A., to be cleared at list prices; write for list.—E. A. Porritt, 13, Westdale Rd., Forest Hill, S.E.23. [7842a]

VALVES at list price, +P.T. new, £22, X24, FH2, Pen 4DD, PM24M, PM24A, MKT4 5-pin, MX40, 50L6, FBI1, CBL1, CBL31, CL33, also many other scarce types; c.o.d. or c.w.o. list.—Renall, "Eureka," Seagrove Ave., Hayling Is., Hants. [7850]

FRITH RADIOGRAPH, Ltd., the Leicester specialists, offer from their comprehensive stocks over 5,000 receiving and transmitting valves, including many difficult types. Woden transformers ex stock include 17M 11, 12, 13, 14, 16; DTF 12, 13, 14, 16, 17, 19; DCS 13, 14, 16, 17; PGB 11, 12, 13; DT1, DT2, UM1, UM3. Special skeleton-type mains, 250.0-250.60mA, 4/2A, 6.3/3A, 19/6; ditto, 350.0-350.25/- Die cast outputs, 6,000 or 10,000CT load, sec 3-15ohms, 30watts, 39/6. Allwave S.M. dials, 7in x 4in, with glass and escutcheon, 12/6. Our latest list details many bargains for the constructor, serviceman and amateur; also many competitive lines available to the trade. Comprehensive lists are free for the asking. We also have in stock over 100,000 spares for all types of British or American radios, for which we invite your enquiries. Trade service dept. for Motor dealers.

FRITH RADIOGRAPH, Ltd., 69-71, Church Gate, Leicester. Phone 58927. [7681]
RADIOGRAPHIC, Ltd., 66, Osborne St., Glasgow, C.I. mail order specialists.—TX valves, 25T 45/-, QV04/7 25/-, 805 110/-, etc.; RX valves 128A/7 14/-, 12A6 12/10, 1R5, 18T, 154, 12/10 each, etc.; R1155 receivers, with power plug and mod. detent, £15/15; C.F. 500 K.C. plug in crystals with OSC coils, 9/6 each; 100 PF. TX. var. cond., 2/6 each; modulation indicators, type 2, 40/- each; wavemeters, W1252, 22-30mcs., W1239, 39-50mcs., new, unused, £24/2/6 each; Muirhead precision dial drives, type 1 13/6, type 2 22/- each; thermo ammeters 0.350ma, 2 1/2in, 17/6 each; potted mains trans., 200-250 input, output 250.0-250.0 75ma, 6.3v 2amps, 27/6; 8in mains energised speakers, 1,000ohm field, with O/P trans., £2/2; FCC 4md 800v teily filled condensers, 4/6 each; Labgear C.R.T. viewing units and mod. indicators, £16/16; list available; this is only a small selection of what we have available; it pays to keep in touch with Radiographic, Ltd., Glasgow. Tel. Bell 3776. [7720]

DYNAMOS, MOTORS, ETC.

VOLTAGE stabilizers, 6kva 230v 50cps+1%, input 160v to 260v ac.—C. Leatherbarrow, Ltd., 6, Stanley St., Liverpool (Central 7251).
QUANTITY alternators, 5kva 230v 50 cps, at 1,500rpm. Cont. rated, bare shaft, vent. type.—C. Leatherbarrow, Ltd., 6, Stanley St., Liverpool (Central 7251). [7738]

ROTARY converter (E.D.C.C.) 230v dc-230v ac 50 on base with filter, 39amps output, pre-war manufacture, condition almost as new; nearest offer £10.—10, Carlton Drive, Gatley, Cheshire. [7697]

TWIN rotary H.T. units, with tappings for input 12 or 24v, outputs 260v at 130ma or 260ma, or 520v at 130 ma, size approx. 6in x 9in x 5in; £5/5.—L.L.K., Ltd., 27, Wind Hill, Bishop's Cleeve, Herts. [7698]

ALL types of rotary converters, electric motors, battery chargers, petrol-electric generator sets, etc., rotary transformers, input 12v d.c., output 600v at 250ma; price £4/10 each, nett, post paid.—Ward, Lordcroft Works, Haverhill, Suffolk. Haverhill 201. [7503]

DC to ac, motor alternators, E.D.C. manufacture, 110v dc input, 220v ac output at 250 watts, screen protected, ball bearings, new and as new; price, £12/10 each, carriage paid; others up to 1,000 watts.—Johnson Engineering, 319, Kennington Rd., S.E.11. Reliance 1412X. [7705]

BRAND new, in carton, motor generator, B type J, weight 18lb, input 12v, output 6v 5a, 150v, also 300v 240milliamps, continuous rating, 4,500rpm, 8 condensers; only 12/6 plus 3/- carriage; special price for quantities; s.a.e. lists.—Amateur Radio Service G6HP, Canning St., Burnley. [7761]

EX-GOVERNMENT surplus, dc motor generators, input 12v, output 250v/0.30.065amps and 6.5v/2.5amps, £4/5; battery-operated valve testers, ex-R.A.F., £3/10; H.F. filters, 5/6; aerial filters, 5/6; relays, 5/6; cathode ray sockets, 2/-; carriage paid, cash with order.—Winco Industries, N. & P. Bank Chambers, 17, Stretford Rd., Manchester, 15

Something here for You?

TRANSFORMERS, double wound. Robust ex-W.D. model, 230 volts to 4-0-4 volts 7 1/2 amps., as new, 17/6; 230 volts to 12 volts 3 amps., 32/6; 230 volts to 20 volts 2 amps, 30/-; 2.2 kW., large size, 400 volts 50 cy. to 220 volts with nine 25-volt tappings, £9/10/-. Can be adapted for use on 220 volts A.C.

AUTO TRANSFORMERS, 230 volts to 110 volts 85 watts, 25/-; 150 watts, 35/-; 300 watts, 60/-; 900/1000 watts, £7/10/-.

CIRCUIT BREAKERS, enclosed type, 7 1/2 amp. A.C. Circuit Breakers, 21/- each.

INDUCTOR ALTERNATORS, 400 watts, beautifully made to Government specification, totally enclosed single or 3-phase 50 cycle 230 volts 4-pole, ball bearings, speed 2,800 r.p.m., need 6/8 volt separate excitation; as new, £8/10/-.

SOLENOIDS, 24 volt D.C., heavy solenoids, lift 14 lbs., 15/-.

RELEASES. We have a large stock of surplus G.P.O. relays, various contacts, high resistance, 1,000 ohms or L.R. 30 ohms, from 5/- each. Siemens 200 ohm slugged relays, 5/- each. High-speed keying relays, two 500-ohm coils, 7/6 each. Send us your enquiries.

REORDER PARTS. Precision made Recorder parts. Chart drum and clips, 5/6. Magnetic clutch 6 volt, 25/-; 9in. traverse shaft, 4in. threaded 120 to inch with bearings, 12/6. Stylus with carriage, rods and bracket, 7/6.

GALVOS. Tinsley moving coil reflecting mirror, 100 ohms resistance, £5/10/-, in polished wood case with glass door front. G.P.O. vertical galvos for circuit testing, 25/-.

TELEPHONES. G.P.O. wall type telephone constructors part, bracket mike in moulded bakelite case, Transformer and Condenser, Hand magneto Generator, magneto bell, switch, hook and contacts, walnut case, 8in x 6in x 3in., fitted terminals and G.P.O. long magnet bell receiver. Diagram for wiring, all for 35/- per pair. G.P.O. Candlestick Telephones with Receiver and Cords, 15/- Postage 1/6 extra. Hand combination Telephones, moulded bakelite type with locking switch in handle, cord and plug as new, 15/- each. Spare insets, 2/6 each.

FANS. D.C. table fans oscillating type, 110 volts, 45/- each; 220 volts, 55/- each, with blade and guard, packing and carriage extra at cost.

FAN MOTORS ONLY. 110 or 220 volt D.C. fan motors, large bulkhead type, 35/- each.

SEWING MACHINE MOTORS, new, flat construction, 230 volts AC/DC high speed 1/20 h.p. with pulley belt and bracket, £4/10/- each.

BELLS. Tangent 1/C bells, 230/50 volts A.C., 6in. gong; as new, 42/-.

ROTACEPTORS for E.H.T. at 50 cycles from 12 volts D.C., two sizes, 5,000 volts and 10,000 volts at 20 m.a., for portable neon luminous tubes or daylight colour matching lamps. Completely ironclad with small interrupter motor at top. Transformer and Condenser below. Overall size, 6in. x 4 1/2in. x 13 1/2in. high, £6/10/- each.

PREPAYMENT METERS. Ferranti 230 volt A.C. 10-amp. type, 1/- slot, calibrated 6d. per unit. £4/15/-, carriage extra.

SWITCHES. Dewar key panel type 8-pole C.O. flush fitting, 5/-; Yaxley 3-pole 3-way, 3/6; 8-pole 1-way, 3/6; D.P.C.O. toggle switch 250 v. 1 amp., flush panel, 3/3; 8-way Lucas switch box, 3/6; 6-way, 3/-.

MAGNETS. D.C. Electric magnets, weight 10 oz., lift on 2 volts, 1 1/2 lb., 4 volts 3 lb., 6 volts 4 lb., new surplus, 7/6 each. Permanent powerful flat bar magnets, 2 1/2in. x 1in. x 3/4in., drilled 2 holes each end, for any pole pieces, 2/- pair. The wonder Magnet magnets, Alni perm steel disc; 3/4in. dia., 1/8in. thick, with 3/4in. centre hole, 3/6 each. Large stock of Horseshoe magnets. Send for special Magnet Leaflet "W."

ELECTRADIX RADIO

214, QUEENSTOWN ROAD, LONDON, S.W.

Telephone: MACaulay 2159

GRAMOPHONE AND SOUND EQUIPMENT

VOIGHTH m/c pick-up, complete, as new; offers.—Box 487. [7852]
J. H. BRIERLEY, Ltd., announce a complete range of new equipment:—
RIBBON pick-up, £5/10 plus £1/7/6 tax; special Mumetal screened transformer for ribbon pick-up, £2; armature pick-up, 5gms plus £1/6/9 tax; special Mumetal screened transformer for armature pick-up, £1; combined coupling transformer and domestic tone compensation unit for armature pick-up, £1/7/6; the latest JB/12/Q amplifier for use with the above pick-ups with many special features. £48; pre-amplifier, standard type, £9; filters, JB/1/PF 1 and 2 with cut-off frequencies of 7,500 c/s and 13,000 c/s respectively, matched for a terminating impedance of 24,000 ohms, £3/10 each.

FULL details of any or all the above items will be supplied on receipt of 3d in stamps. WE have the following items, surplus to our requirements: Small quantities of 32 and 45 s.w.g. enamelled wire; laminations, 300 701 (Mumetal) insulated, 600 Rola No. 3, 17 gross Rola No. 4, 25 gross M.F.A. Silico 2 No. 29A; please state needs.—J. H. Brierley, Ltd., 46, Titebarn St., Liverpool, 2. [7226]

R.G.D. superionic 12-valve auto radio, R model 1202; offers.—Write Latham, Little Hill, Much Hadham, Herts. [7754]

GOOD quality mic. and moving-coil pick-up transformers; 4/6 each to clear, c.w.o. or c.o.d.—40, Bonsall Rd., Birmingham, 23 [7750]

FLOOR model record player, ample record space, "Collaro" unit, cabinet polished; £15.—Strange, 16, Carnarvon Rd., Leyton, E.10. [7276]

TRANSFORMERS, tone control and filter chokes for all "W.W." circuits.—R. Clark, 30, Langland Crescent, Stanmore, Middx. Woy. 5321. [7532]

HIGH fidelity diagram in oak cabinet, H mixed autochanger, 11-2,000 metres, straight superhet, push-pull 15watt triode output, 16in energised speaker; £125 or offer.—Box 8992. [7678]

RECORD players of every description, or desk, portable or floor model; amplified or otherwise; also amplifiers, speakers, pick-ups, chassis; s.a.e. list.—Radio Unlimited, 16, Carnarvon Rd., Leyton. [7830]

RADIOGRAM by F. E. Godfrey; twin Garrard 201A motors, Rothermel SH studio pick-ups, three speakers (two energised, one PM), independent treble and bass controls, class A push-pull, PX25 output, high quality local station receiver, heard by appointment; £150.—Write Box 0006. [7721]

BRITISH Sound Recording Association offers all interests of the professional and amateur recording engineer and quality reproduction enthusiast.—Details of information bureau, meetings, publications and membership application form from Hon. Secretary, BCM/BSRA London, W.C.1. [7772]

MARCONI autochange unit in portable case, £10; Western Electric amplifier and speaker in leather-cornered case, £9; Stenograph extension cabinet speaker, small low amplifier, 1/2ps for gram and microphone, £6; portable gramophone case with clockwork motor, 30/-.—Wallace Heaton, Ltd., 126/7, New Bond St., W.1. [7701]

TELEVOX playing desks incorporating high quality totally enclosed induction motor (100-240v a.c.), high fidelity magnetic pick-up, 12in turntable, automatic stop and start mechanism, speed regulator and pick-up rest, all fitted on a strong 18swg steel chassis, 14 1/2in x 12 1/2in x 3 1/2in deep, finished in black ripple, and mounted on 4 rubber feet, model No. T.P.D.1 (M); price 8 1/2gns, including purchase tax, cash with order; packing and carriage 4/6 extra; no e.o.d.; still available in limited quantities.—Televox Sound Service, 37, Albert Rd., Southsea, Hants, Tel. Portsmouth 4982. THE Televox Sound Service has pleasure in announcing the production of their model P.D.2 playing desk within the next 6-8 weeks, fitted with a belt-driven turntable and powered by a constant speed induction motor, with speed adjustment; this model will be mounted on the same chassis as our previous models, namely, with black ripple finish, size 14 1/2in x 12 1/2in x 3 1/2in deep, mounted on 4 rubber feet, with or without pick-up; full details will shortly be available together with price from the above address.

THE Televox Sound Service has pleasure in also announcing the early production of a floor model record player, incorporating the above belt-driven turntable unit, mounted in a sliding cabinet, and supported on a modern tubular steel frame with easy access record rack; the top of this player is covered with a substantial black ritelite (plastic glass) surface, specially designed to support table model radios; full details will shortly be available from the above address. [7857]



BAKERS 'Selhurst' RADIO

18" and 12" P.M. QUALITY SPEAKERS
8 and 15 WATT AMPLIFIERS

TICONAL
MAGNET



Triple
Cone

PIONEERS OF MOVING COIL SPEAKERS

Improved 1947 MODELs
CINEMA Model - - - \$8 19 6
AUDITORIUM Model - - - \$5 18 6

Send 2/6 l. stamp for illustrated list to:
BAKERS 'SELHURST' RADIO
75-77 Sussex Road, South Croydon, Surrey
Telephone: OR7yin 4225

INFINITE Baffle corner deflectors, scientifically designed acoustic chambers as reviewed in "Wireless World", June; send for catalogue.—Broadcast & Acoustic Equipment Co., Ltd., Broadcast House, Tombland, Norwich 26970. [6434

PORTABLE recording equipment: M.8.S recording machine, 20 watt amplifier, new, from stock: Blank discs, cutting needles, trailer needles, microphones, lightweight pick-ups, matching transformers, speakers, etc.; trade enquiries invited.—Sound Discs (Supplies), Ltd., 83a, Bold St., Liverpool. [6964

1947 quality record reproducers, amplifier and radio chassis, gram motors, pick-ups, speakers, micrograms, players, etc.; lowest prices in the trade; s.a.c. for detailed list; special this month, Universal amplifiers, 12 watt, 10gns.; 15 watt, £14/10.—Radio Unlimited, 16, Carnarvon Rd., Leyton, E.10. **COMPONENTS—SECOND-HAND, SURPLUS VALUE!** Matt has it.

SPECIAL offer headphones, w/lead and jack plug, 5/6 per pair (boxed 2 pairs). **SPEAKERS**, P.M. 4in 17/6, 5in 15/6, 8in 22/6, all less transformers; transformers (output) to match, 5/6 ea.

CONDENSERS, 0.1, 0.01, 9/- doz; 8 mfd (canned), 3/6; 8+8 (canned), 6/6; all 500v working 16 mfd electrolytics (chassis mounting), 7/6.

LINE cord 0.3 amp (60 ohms per ft), 2-way 1/6 per yd, 3-way 2/6 per yd. **VOLUME** controls (Centralab), various values, 1/s 3/6, w/s 4/9; Rothermel crystal pick-ups de luxe, £2/16/3 (inc. P. Tax); metal £2/12/6 (inc. P. Tax); Cosmocoord-Magnetic P/ups, 33/-, inc. P. Tax; television cable (aerial lead-in), 1/- per yd; a large assortment of B.V.A. and V.S. valves always in stock; let us have your enquiries.

MATT RADIO SERVICE (Kingston 4881), 152, Richmond Rd., Kingston-on-Thames, Surrey. [7168

ALIGNED INSTRUMENTS SERVICES, 1, Colworth Rd., Leytonstone, E.11.

40 COIL pack: A superhet coil pack with an h.f. stage, uses 9 iron cored coils in a 16-50, 200-500 and 800-2,000 metres circuit for 465kc/s, i.f., complete with circuit diagram, aligned and gain tested; this coil pack enables the amateur with no signal generator to construct a first-class all-wave receiver; price £2/10. Circuit diagram only, 2/6, post free. **30 COIL** pack series: A famous series of precision-made coil packs now too well known to need description. Superhet types: Model 30, 16-50, 200-550, 800-2,000, at 42/-; 30A, 12-30, 30-75, 75-200, at 42/-; 30B, 16-50, 200-550, at 30/-; 30C, 200-550, 800-2,000, at 30/-; 30S, 12-30, 30-75, 200-500, at 42/-. T.r.f. types: Model 30D, 16-50, 200-550, 800-2,000, at 35/-; 30E, 12-30, 30-75, 75-200, at 35/-; 30F, 16-50, 200-550, at 27/6; 30G, 200-550, 800-2,000, at 27/6. Each is complete with circuit. Circuits only, 2/6. High Q i.f. transformers: 465kc/s, iron cored, permability tuned, for use with above superhet coil packs, aligned and gain tested, price 17/6 per pair. **TUNING** condensers: 2-gang matched to all our 30 coil pack series, price 15/-; 3-gang matched to our 40 coil pack, price 17/6; these condensers ensure that correct alignment and waveband coverage is maintained; many other interesting A.I.S. products available; send stamp for new price list; terms, cash with order or c.o.d.; no c.o.d. under £2; over £5 post free. [7370

SOUND SALES Ltd.—Surplus war production, radio and amplifier chassis, etc. **SOUND SALES Ltd.**—Surplus war production, quantities of transformers and chokes, various types.

SOUND SALES Ltd.—Surplus lists, describing various types chassis, transformers, chokes, which have accumulated during war years, in preparation of samples for approval for Government Departments; majority should be of interest to amateurs and experimenters; list 3d. each from West St., Farnham. [7781

FOR sale, 80 amplifier heater transformers; 1 primary 230 volt, secondaries two 4.3 volts, 4-5 amps, and one 7.5 volts, 1.5 amps; makers G.E.C.

GEORGE COHEN, SONS & Co., Ltd., Wood Lane, W.12, and Stanningley, nr. Leeds.

I.X.-R.A.F. "Identification Friend or Foe" receiving and transmitting units with 4 straight mains H.F. pentodes, Mazda, one Mullard E.F.50, 3 television diodes and 2 double-triode mains valves by Brimar; also 20 watts motor generator, 24 volt input, 480 volt 40 m.a. output, 50/- each, plus carriage 4/-; includes a wealth of small components such as carbon and w.w. resistors, tubular and mica condensers, all good values, plus coils and condensers, magnetic relays and mechanical relays.—W Harford, 128, Greengate, Salford, 3. [7060

IMPORTANT TO ALL USERS OF G.L. AMPLIFIERS

Your A.C. Model can be operated from 6 volt car battery. Simple quick change-over for dual use, indoor or outdoor. Write for details to Dept 68.

DELIVERIES. A sore point when demand exceeds supply, we are fortunate in having worked to a "longsight" plan, our despatches are in some instances upon receipt of order.

From the modest Gramo Amp. 10 watts at 8 gns. to the De Luxe 60 watt job, between these extremes is an amplifier designed for your particular need, whether amplification is required from microphone, record, or sound film track.

Example. **AC/25** Real P.A. Portable 25 watts faders, for microphone and gram. Treble and bass controls, electronic mixing. Output 3.8.15 ohms. Price complete 18gns.

A smaller model **AC/18**, giving 15 watts—15gns. also fader on two inputs with H.G. stage.

TRANSFORMERS. The steel sheet allocation is under the guidance of the M.O.S. The Radio Industry is not included for supplies, virtually deliveries of all laminations have ceased.

Our Transformers and chokes use "GELCOR," finest electrical steel, we make our own laminations, and to a large extent are independent of market conditions. Large stocks of steel permit us to continue our range of over sixty different models, also to undertake a limited number of contracts from other manufacturers. Your enquiries are invited.

GENERAL LAMINATION PRODUCTS LTD.,

Winder House, Broadway, Bexleyheath.



Connections housed at end of handle - away from the heat!

There's no corrosion of the connections in the Solon Electric Soldering Iron. Tucked neatly away at the end of the handle, the heat can't get at them. Efficient rubber sleeve cord grip prevents sharp bending of the flexible. The heating element is INSIDE the copper bit—giving constant heat; no waste of current! Features that make Solon soldering quicker, cleaner, safer! All Solon irons are supplied with Gt. of Henley 3-core flexible. Made for the following standard voltages—200/220, 230 250.

Made in England.

Illustration shows standard 240 watt model. Other types and sizes for various special jobs. **W. T. HENLEY'S TELEGRAPH WORKS CO. LTD** Engineering Dept., 51-53, Hatton Garden, London, E.C.1

SOLON Electric

SOLDERING IRON FOR INDUSTRIAL USE

Woodwork by Lockwood

We are Specialists in the Manufacture of high-class Precision Woodwork for the Radio and Electrical Trades and we shall be pleased to receive your enquiries for the following:—

- RADIO CABINETS
- INSTRUMENT CASES
- BAFFLES · HORNS
- TRANSIT CASES
- LABORATORY FURNITURE, FITMENTS, ETC.

Timber Licence Required



& COMPANY

67, Lowlands Road, Harrow, Mdx.

Phone: BYRon 3704

SUPREME RADIO, 746b, Romford Rd., Manor Park, London, E.12. Est. 15 years. Tel. III. 1260.

THIS month, announcing Government surplus; anchoring tags, 3/- gross; Mazda valveholders, 54/- gross; stand-off insulators, 12/- gross; 4-pin American valveholders, porcelain, 12/- gross; 500 pfs, 30/- gross; filament or heater h.f. chokes for short wave receivers, 3/- doz.; short wave coils, 3/- doz; switch wafers, 2, pole, 3-way, porcelain, 4/6 doz; standard grid caps with lead, 4/- doz; standard grid cap mounted on paxalin panel, with 57 ohm low resistance, anchoring tag, nut and bolt for fixing attached, 6/- doz; paxalin panels with 8 anchoring tags wired to same, 1 500 ohm 2w resistance, 1 10,000 ohm 2w, 1 170 ohm 2w, and 2 0.1 500v tubular condensers, 2/- complete panel; paxalin panels, 4 anchoring tags, with 3 0.1 condensers attached, 1/6 per panel; paxalin panels with 3 anchoring tags attached, 1.002 condenser, 1.000v working, 1 2,000 ohm 5w resistance, nut and bolt, 1/6 panel; paxalin panels with 11 anchoring tags, 5 5,600 ohm 5w resistance attached, 3/- panel; resistances, 3,300 ohm 5w 1/6 each; conrectual plug and sockets, 1/6 complete; Phillips knobs, 1 1/4in shank, 1/2in spindle fitting, 1/6 doz; Westinghouse meter rectifiers, 5ma, 5/6 each; paxalin panels with anchoring tags, 11-way, 8, 4 and 3-way, 1d per way; earphones with head bands, 50 ohm, 4/6 pair; earphone inserts or mikes, 30 ohm, 3/6; pilot bulbs, 6, 5, 3, small head, B.T.H., 4/6 doz.

SEND 2/- stamp all enquiries and price list; 6d extra all orders under £5; no c.o.d. [7793]

UNIVERSAL ELECTRONIC PRODUCTS (198UQ), 36, Marylebone High St., London, W.1. Tel. No. Wel. 4058.

HIGH performance superhet tuning units covering 16-50, 200-500 and 1,000-2,000 metres, complete with I.F. transformers, valve holders and attractive edge lit glass dial, fully aligned and tested. Type A, for 6K8 and 6K7 valves, price (less valves), £5/8/6. Type B, as above but with addition of third valve holder (for 6Q7), together with volume control, wired, aligned and tested, price (less valves), £6/10/0. postage 2/6 extra in each case. R1155.—If you are not satisfied with the performance of your set write for details of our conversion. We now have a special department dealing with these receivers and can offer prompt service. Our works are available for the construction of specialist type receiving or transmitting equipment to specification. Prototype and development work undertaken. [7841]

MIDLAND RADIO COIL PRODUCTS.—I.F. transformers, 465 kc/s, permeability tuned, 3/8in high by 1 1/2in square, per pair 15/6, single 8/-; superhet coils, 465 kc/s, small type, air-cored, all ranges, 500 pf. tuning (IQ88), 160 pf. (IQ8), 2/6 each; B.F.O. coils, aerial filters, 2/6 each; TRF pairs, L and M, 7/6; Hystystone chokes, A.V. 3/-, S.W. 2/-; mains transformers, 350v 60ma, 4 or 6v htr., 30/-; 250v 70ma, 4 or 6v htrs., 25/-; 350v 120ma, 4, 5 and 6v htrs., 35/6; wood cabinets, green, brown or blue enamelled, 25/6; woven L.S. fabric, 12in x 14in, 2/6, any length, 14/- per yd. x 42in.

MIDLAND RADIO COILS PRODUCTS, 13a Silver St., Wellingborough, Northants. [7704]

SOUTHERN RADIO'S wireless bargains:— Portable T1333 transmitters, brand new, complete, crystal, 2 valves, aerial, hand generator, in original packing, 55/-, carriage and packing 5/6. Latest radio publications: Radio valve manual of British and American Types, 3/6; Radio Circuits, fully descriptive, receivers, power packs and transmitters, 2/-; Amplifiers, 2/-; Coil and Transformer manual, 2/-; Short wave handbook, 2/-; Direct Disc recording manual, 2/-; Test Gear construction, 1/6; Radio Pocket book, 1/-; Television constructors manual, 3/6; Radio Aerial Handbook, 2/6; Ultra Short Wave Handbook, 2/6; Radio Hints manual, 2/6; 10 hows for radio constructors, 1/-; Bulgin Radio Service manual, 2/6; Radio Constructors manual, 3/-; Radio resistors, colour code at a flick chart, 1/-; Radio Reference Handbook, cloth bound, very comprehensive, 12/6; American Service manuals, Spartan-Emerson Crosley-Belmont (parts 1, and 2); Stewart-Warner-Fada, 12/6 per volume, postage extra. Ex-Govt. motor generators, brand new, type 10K/21, input 12v, output 480v, 40ma D.C., 17/6 ea., plus 2/6 postage; type "F", 28v input, 1,280v output, 72ma D.C., 25/-, plus 2/6 postage; Yaxley type rotary switches, 2-way, 5/-; permanent crystal detectors, 2/6 ea.; aluminium panels, 16 gauge, 18x7in, 3/6; Cutler Harmer rheostats, 30 ohms and 10 ohms, 4/6; ex-service Morse keys and buzzers, 1/6 ea. (15/- per dozen), brand new; Westectors, type WX6 and W112, 1/- ea. (10/- doz.); Lufbra adjustable hole cutters, cut metal, wood or plastic.

SOUTHERN RADIO SUPPLY Co., 46, Lisle St., London, W.C.2. [7805]

ARMSTRONG

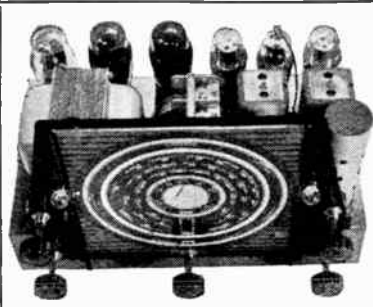

Model EXP83

ALL-WAVE 8-VALVE SUPERHET RADIOGRAM CHASSIS

incorporating wave-band expansion, e.g. the 16-50 m. band covers just over 20 inches on the large glass scale, treble boost control, gram switching, all controls work on both radio and gram. High quality push-pull output gives 10 watts audio. For 100-250 v. A.C. mains.

Price 14 gns. plus tax.

Model EXP53

ALL-WAVE 7-STAGE RADIOGRAM CHASSIS

This new radiogram chassis incorporates wave-band expansion on all bands. Volume and tone controls work on both Radio and Gram. 4 1/2 watts R.C. coupled output. Supp'd complete with full size loudspeaker. This chassis has a lively performance, good quality reproduction, and represents excellent value. For 200-250 v. A.C. mains.

Price with speaker £13 plus tax.

Model UNI-83

ALL-WAVE 8-VALVE SUPERHET CHASSIS

incorporating wave-band expansion, large glass scale, treble boost control, gram switching, all controls work on both radio and gram, high quality push-pull output giving 6 watts audio. For 200-250 v. D.C. or A.C. mains. Provisional Price 14 gns. plus tax.

Model AMP14

HIGH GRADE AMPLIFIER CHASSIS

Two inputs, bass compensating circuit, treble boost control, 14 watts push-pull output preceded by 4 triodes.

Price 13 gns.

Demonstration Sets are available for interested callers to hear and illustrated technical specifications are ready.

ARMSTRONG WIRELESS & TELEVISION CO. LTD.
WALTERS ROAD, HOLLOWAY, LONDON, N.7
Phone: NORth 3213

CHARLES BRITAIN RADIO, Ltd., offers further interesting bargains in standard and ex-service components.

SELENIUM miniature rectifiers, type H18, will replace almost any half-wave valve rectifier, 5/- ea, larger type H25 7/6; Sprague metal-cased condensers, -1 500v wkg 9/- doz, -1 350v wkg 8/6 doz, -01 1,000v wkg 5/6 doz, Midget iron-cored coils, S.W. medium and long wave individual, I.F., Ae and Osc. 3/- ea; TRF ditto, medium and long on one former, 8/6 pr; 8in speakers, less trans £1, 5in ditto 14/6 ea; superbet all-wave coil packs with colour coded leads and instructions, 21/-.

SPECIAL bargain: Brand new and crated ex-U.S. Navy indicator unit, complete with 11 new valves and 3in C.R. tube, valves include 7 6N87, 1 6X5, 1 6G6, 1 6H6, 1 2X2, and tube 3BD1, price carriage free, £5/19/6; U.H.F. receivers R1147 contain the following new valves, 2 EF36, 1 EBC33, 2 EF50, 1 EF54, 1 EC52, in strong packing case, 39/6 ea; Walkie Talkie 38 sets, brand new, complete with aerial throat mike and earphones, £4/5; indicator units in metal case with 6in electrostatic C.R. tube and time base and amplifier, easily converted into a 'scope, £3/10.

this item for callers only

SPECIAL offers: MCR1 batteries, 10/- ea or 2 for 17/6, regret no sets left; moving coil mikes, new and undamaged, 3/6 ea; telecopic receivers, size 7x5x2in, with shoulder strap for carrying with 4 Hivac Midget valves, £3; with full instruction- and extra components for converting into a personal 2-station receiver, £4/5; price made up by us and in working order, excluding batteries, £5/5.—Send for our latest list of all standard components. Charles Britain (Radio), Ltd., 2, Wilson St., London, E.C.2. Tel. BI. 2966.

EX-GOVERNMENT stock—7,500 transmitter, oscillators, power units, receivers, rotary converters, de luxe slow motion dials, 12-24v motors, amp and voltmeters, at fraction of original cost; callers only.—Alec Davis, 8, Percy St., W.1. [7225]

SINGLE and twin screened flex, volume controls, BA, screws and nuts, lamination strip, iron dust cores, coil screen tins, mains transformers, I.F. transformers, smoothing chokes; lists.—John Downton & Co., 89, High St., Epping, Tel. 2163. [7421]

LARGE selection radio components, etc., including Sound Sales 6watt amplifier, baffle, loud speakers, chokes, transformers, valve tester, tachometer, oven thermometer, tools, etc.; bargain, £30 the lot.—Write or call, 8, Holland Av., S.W.20. [7749]

SEND for details of range of 5 tuner units, L.T.R. and superhet, 5 to 2,000 metres, including a model with 4-position bandwidth switching; also ac and ac/dc power output units, triode and pentode models available, chassis complete with valveholders and cut-outs for electrolytics and with 2 octal plugs and sockets; 16g. sheet aluminium, with sloping front for Williamsons' high quality amplifier; £1/12; 16g. sheet aluminium chassis for W.W. frame time base unit, complete with valveholders and brackets, 11/-.—T. 64, St. Leonard's Rd., London, S.W.14. [7497]

COULPHONE RADIO, 58, Derby St., Ormskirk, Lancs.—All goods previously advertised still available; new goods only; c.o.d. or c.w.o.; post free over 5/-; Coulphone for kits; the most comprehensive range of complete receiver kits made by a firm who specialize solely in kits; the kits are complete in every detail, and include valves; most comprehensive construction manual supplied with every kit; construction manuals available separately, 2/8 post free; it is worth your while to send for one of these manuals before purchasing a kit elsewhere, just to make sure you are getting the best value for your money; note, all prices include purchase tax, nothing further to pay; cabinets available for those who require same.

4 VALVE P.R.F. AC/DC, 200-550 and 1,000-2,000 £9; 5-valve superhet, AC/DC, 16.5-50, 200-550, 1,000-2,000, pick-up and extension speaker sockets, tone control, £12; 5-valve superhet, AC, £12/10; tuning units, assembled and aligned, superhet, 16.5-50, 200-500, 1,000-2,000, model A3, R.F. and P.C. £6/15; model B3, R.F., FC, IF, D.D. £8/15; model Q3, FC, IF, £4/10.

WEYMOUTH coil packs, 3 WB superhet, aligned, 36/6; high Q Midget IFT's, 465 kc/s, 18/9 pair; std. size iron cored, 15/- pair; FT type coils, 12.5-2,000 metres, 2/9 ea.

OUTPUT transformers for quality amp. (Apl. and May issues "W.W."), to author's specification 67/6; mains transformers, 800-250v primaries, 4v or 6.3 and 5v L.T.s, 300ma 60ma, 23/6; 350v 100ma, 28/6; 450v 200ma, 45/-; 1,250-1,000-750-0-750-1,000-1,250v 300ma (no L.T.s), 92/6; everything from a 5pf condenser to the latest Connoisseur super pick-up at £3/18/8; send 2/- stamp for new 24-page catalogue [7792]

'Astronic'

TRADE MARK

BNN Series, single, dual or tri-alloy screened Transformers.

Hermetically sealed with soldering spills or with tag panel, both for sub-chassis wiring or with international octal base.



APPLICATION :

Line to grid, line to line, microphone, driver, intervalve, anode to line, etc.

HERMETIC SEALING :

In view of the increasing demand for hermetically sealed versions of the BNN series, an integral glass sealed base has been developed.

Literature, in course of preparation on request.

**ASSOCIATED
ELECTRONIC ENGINEERS Ltd.**
DALSTON GDNS. STANMORE MIDDIX.
Wordsworth 4474-5-6.

e.h. VV. VV.

GEE OSCILLOSCOPE

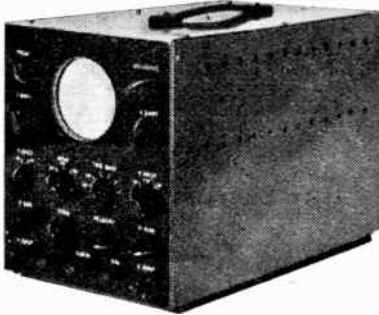

AN INSTRUMENT OF OUTSTANDING PERFORMANCE

BRIEF SPECIFICATION.

Screen : Green 3 1/2 in. diameter.

Frequency Response : From D.C. (zero frequency) to 100 kc. s. on both axes.

Sensitivity : Y axis 75 mV/cm., X axis 190 mV/cm.

Time Base : 3 to 20,000 sweeps per second with expanding control providing a sweep of 5 times screen diameter thereby increasing effective sweep speed to 100,000 per second.

Synchronizing : Internal (at work frequency) 50 c/s. and external.

Supply : 200-250 volts 50 c/s.
Size : 9 1/2 in. x 8 in. x 14 1/2 in. Weight : 22 lbs.

PRICE COMPLETE with instructions £35
Delivery in 3 months. TRADE SUPPLIED.

GEE ELECTRIC

LITTLE NEWPORT ST., LONDON, W.C.2
GER. 6794

ROTARY transformers, 12 volts d.c. input, output 275 volts 110ma and 500 volts 50-80ma simultaneously, ideal for P.A. or mobile transmitters; bargain, £2/10 each, including carriage.—Bargain Radio Stores, 72, Cape Hill, Smethwick. [7782

COPPER wires, enamelled, tinned, cotton and silk covered, all gauges; B.A. screws, nuts, washers, tags; ebonite panels and tubes, coil formers, headphones, flexes, solder, etc.; comprehensive list on request; trade supplied.—Post Radio Supplies, 33, Bourne Gdns., London, E.4. [7719

FEEDER units, 4-band, wired to detector stage, tested and performance guaranteed, best components used complete with ECH 35 or CCH35, EF39 and EBC33; or 6K8, 6SG7, 6R7, all incorporating Denco CT2, coil turrets and maxi Q I.P.T.s, Q 155, price £9/9; high fidelity amplifier, stabilized power supply, variable treble and bass boost, triode output with feedback, input 0.1 volt for 12 watts, send for full particulars; connoisseur pick-up, £2/18/9 with transformer, postage 1/-; good stocks of Q-Max (Berry's) and Denco components; Denco catalogues 7d inc. postage; Armstrong stockists.—Goodsell, Ltd., 40, Gardner St., Brighton, Sx. [7864

ALUMINIUM panels, 18in x 12in 4/6, 18in x 8in 3/-. 18 gauge. Foil, 18in x 8in, 1/3. Alm. chassis, 14in x 8in x 2in deep, undrilled, 6/6; drilled, 5-valve holes, 7/6; small chassis, 5 1/2in x 3 1/2in x 1 1/2in deep, undrilled 4/6, drilled 4-valve holes 5/5; ditto in beautiful black crackle, undrilled 6/-. drilled 6/11, all 4-sided, post 6d. extra. Speaker gauge, 6in square 1/3, 12in 2/9, 18in 4/3. Metal Grille, light bronze or cream, 9in square, 3/5 Perspex, 18in x 13 1/2in x 1/2in, 21/-; half size, 10/6. Westinghouse instrument rectifiers, 1 or 5 m/a, 10/6 each. Weymouth all-wave s/het coil pack, 36/6, or coils only, 11/6 pair. Stand-off insulators, 2in, 1/6 pair; 1/2 meg V/controls less switch, 2/9. Exceptional quality international Oct. V/holders, 9d. each. Suppressors, plug or distributor, 1/9 ea. Hivac midget valves, 1.5v, X11, XL, XD, 11/-. Magnet-type pickups, 31/7. Crystals, 53/6. Solon elec. soldering irons, 21/9. Moving coil speaker units, 2 1/2in, 3 1/2in, 5in, 6in, 8in, 10in, 12in, prices from 23/6. Filament transformers, input 200/230/250v, output 6.3v tapped 4v at 3amp, 19/3. Varnished cotton systofex, 2mm, 4-yard lengths, 1/-. All above-mentioned goods sent carriage paid. Official Eddystone stockists. Official Wearite ceramic switch stockists. Varley mains transformers, chokes etc. Avo Minor DC meter, 4gs.; ditto A.C./D.C. £9/10. Model 7 £19/10. Model 40 £17/10. Bridge £11, plus usual postage. Special offer to callers only of a limited supply of 4-valve S/het all-dry portables, complete, from 6gs. each.—Fenwick, Dept. P., Gt. Brickkiln St., and Snow Hill, Wolverhampton.

H.T. and l.t. rectifiers, battery charger kits, not surplus, all new goods with full guarantee. New small space type selenium h.t. rectifier for a.c./d.c. sets, 250v 60ma, takes place of valve rectifier and occupies no more space, 9/6, post 6d.; ditto 120v 25ma for eliminators, 7/6, post 6d., product of famous manufacturer; selenium l.t. rectifiers, with informative instruction sheet, 12v 0.75amp, 7/6; 12v 1.5amp, 10/6, post 4d.; 12v 2amp, 12/6, post 7d.; 12v 3amp, 18/6, 12v 4amp, 25/-, post 9d.; 12v 5amp, 27/6; also new heavy duty aluminium cooling finned 12v 6amp giant type, 32/6, postage 1/-; 24v 2amp rectifiers, 29/6; 24v 5amp, 39/6; many different types in stock, including types for conversion of garage chargers; eliminator kit, transformer, 2 selenium rectifiers, 2 8mfd condensers for 120v 20ma eliminator, with 2v trickle charge, 39/6, post 10d.; charger kits, 50watt mains transformer with 12v 3amp rectifier and ballast bulb for 2v to 12v charger, no rheostat and ammeter needed, foolproof, 48/6; ditto with 2.5amp rect., 44/-, post 1/-; ditto with 2amp rectifier, 38/6, post 1/-; also as above but with 6v 2amp rectifier for 2v, 6v charger, 34/-, post 10d.; heavier type 75watt transformer with 12v 4amp rectifier and ballast bulb for 2v to 12v charger, 62/-, post 1/-; 140watt transformer and 12v 5amp metal rectifier for 6v, 12v charger, £4/5, a very fine job; trickle charger rectifier, 2v 0.5amp type with transformer, makes ideal trickle charger for 2v cell, guaranteed one year, 13/6, post 7d.; for commercial charging, heavy duty transformer, selenium rectifier, ballast bulb, will run continuously for years, for 1 to 20 cells at 1amp, £4/15; for 1 to 12 cells at 2amps, £4/15; for 1 to 20 cells at 2amps, £6/15; all guaranteed one year; transformer and rectifier specially designed for these; ammeters, 0-6amp flush type, 12/6; sliding rheostats, 0.4ohm 25amp, 15/-; Lustraphone m/coil mikes, £4/10; Rothermel Bullet mikes, £2/18/6.

CHAMPION, 43, Uplands Way, London, N.21.

Our comprehensive stock of first-class components enables us to meet the most exacting requirements of the radio constructor. Please send us your enquiries and we will give these our speedy and prompt attention. Our constant aim is to give you service and satisfaction. Here is a selection from the Raymart Catalogue.

CERAMIC VALVEHOLDERS.
4-pin English, type VH4G, 1/3. 5-pin English, type VH5G, 1/3. 7-pin English, type VH7, 1/6. 8-pin English, type VH8, 1/6. 9-pin English, type VH9 for EF60, 2/-, 4-pin American, type VA4G, 1/6. 5-pin American, type VA5G, 1/6. 7-pin American, type VA7G, 1/6. 8-pin International Octal, VA8, 1/6. Acorns, VAA for 854 955, etc., 2/6.

COUPLERS.
Type EC. Extension type 1in. hole to 1 1/2in. shaft, 1/-.
STAND-OFF INSULATORS. White Glazed, 1/-.
Type SX, 3 1/2in. high, 2/-.
BEEHIVE STAND-OFF INSULATORS.
Type SG. Brown Glazed, 1/-.
AERIAL INSULATORS.
Type AG, 3 1/2in. Ribbed Pyrex Glass, 1/-. Type LG, 7in. Ribbed Pyrex Glass, 7/10.

FEED-THROUGH BUSHES.
Type FB, 4BA hole, 2 pieces, pr. 3d. Type FT1, 2BA hole, 2 pieces, pr. 4d.

LEAD-IN INSULATORS.
Type PLB, 1 1/2in. dia., Pyrex lo w lead-in bows, 1/7.
AERIAL "T" PIECES.
Type AT, 1/3.

VARIABLE CONDENSERS.—Standard.
Type SX, 3 1/2in. Type VC10X, 4-. Type VC100X, 5/6. Type VC160X, 6/6. Type VC250X, 7/9. Type VC20D, double spaced, 4/3. Type NC05, treble spaced, 4/6. Type TC40, treble spaced, 5/3.

VARIABLE CONDENSERS.—Midget.
Type MC15X, 3/9. Type MC60X, 5/-. Type MC120X 6/3. Type MC5DX, double spaced, 3/9. Type MC15DX, double spaced, 4/-.
REDUCTION DRIVE.
Type ERD, 6-1 reduction, used with 12-1 dial, give 72-1 slow motion, 3/11.

All goods well packed and despatched C.W.O. or C.O.D., whichever best suits you. When sending C.W.O. please include sufficient for packing and postage.

VALLANCE'S
144, BRIGGATE, LEEDS, 1

Phone 29428 and 29429.
Branches (for callers only) at
53, High Street, Scunthorpe, Lines, and 16 Leeming Street, Mansfield, Notts.

Start Call Signs, G2HHV, G8SX, G3ABD, G3AHV G3BDD.

WE APOLOGISE to those who have been waiting months for replies. Our post-war plans have been frustrated so far. Sorry!

VOIGT
PATENTS LTD.

Be WISE and PATIENT

Be WISE and PATIENT

Be WISE and PATIENT

Be WISE and PATIENT

Be WISE and PATIENT

Be WISE and PATIENT

Be WISE and PATIENT

Be WISE and PATIENT

Be WISE and PATIENT

Be WISE and PATIENT

Be WISE and PATIENT

Be WISE and PATIENT

Be WISE and PATIENT

Be WISE and PATIENT

Be WISE and PATIENT

Be WISE and PATIENT

Be WISE and PATIENT

Be WISE and PATIENT

Be WISE and PATIENT

Be WISE and PATIENT

Be WISE and PATIENT

Be WISE and PATIENT

In the interests of better quality...

The LABYRINTH LOUDSPEAKER

(TYPE S. L. 15)

... for Music Societies—Schools
Theatres — Quality P.A. — and
all music lovers

A partitioned cabinet to form a folded pipe—the back of the unit coupled to it in such a way that the quarter and half wave resonances are under independent 'Q' control—cabinet acoustic resonances arranged to cancel pipe anti-resonances. The result is a smooth bass response down to 35 c.p.s.

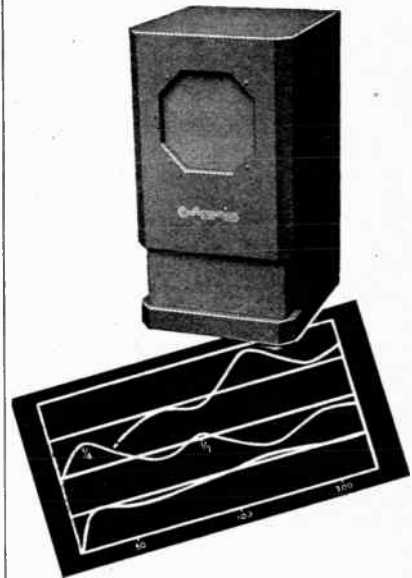

ACOUSTICAL

MANUFACTURING COMPANY LIMITED
HUNTINGDON

TELEPHONE: HUNTINGDON 361



THE "FLUXITE QUINS" AT WORK

"FLUXITE'S the stuff my old boy
That makes soldering a joy
Sets 'em up good and fast
and they're up there to last
Look out I'm just testing" yelled Ol.

See that FLUXITE is always by you—in the house—garage—workshop — wherever speedy soldering is needed Used for over 30 years in Government works and by leading engineers and manufacturers. Of all Iron-mongers—in tins, 10d, 1/6 & 3/-

TO CYCLISTS! Your wheels will NOT keep round and true unless the spokes are tied with fine wire at the crossings AND SOLDERED. This makes a much stronger wheel. It's simple—with FLUXITE—but IMPORTANT.

The FLUXITE GUN puts FLUXITE where you want it by a simple pressure Price 1/6, or filled, 2/6.



ALL MECHANICS WILL HAVE

FLUXITE

IT SIMPLIFIES ALL SOLDERING

Write for Book on the ART OF "SOFT" SOLDERING and for Leaflets on CASE-HARDENING STEEL and TEMPERING TOOLS with FLUXITE. Price 1d. each.

FLUXITE LTD.

(Dept. W.W.), Bermondsey Street, S.E.1

A PERFECT joy to build!—The 5-valve ac or ac/dc 3-wave Superhet Assembly (all main components ready mounted on chassis) forms the foundation of a powerful receiver at a price you'll like; send postage now for full details.—N. R. S., 66 Parkhill Rd., N.W.3.

KEW coil pack has outstanding features, high "Q" windings, adjustable cores, one hole fixing, size 3 1/2 in x 2 1/2 in x 1 1/4 in; will improve performance of average 5v superhet; price 33/-; trade enquiries invited.—J. Morgan, 164, Whyteleafe Rd., Caterham, Surrey.

ROTARY transformers, brand new, ex Govt. stock, suitable for car radios, mobile amplifiers, country house receivers, etc., solid frame with fixing feet; these transformers can be utilised for 6 or 12volt input, and will give with 6v input, output of 200v at 50ma for continuous operation, 150v at 80ma for periods up to 3 hours, or with 12v input, output of 480v at 40ma, continuous operation, 400v at 80ma periods up to 3 hours, size 7 1/2 in x 3 1/2 in, weight 6 1/2 lb, original price £7/7, each 25/-; midget m. wave, t.r.l. coils, high gain, 5/-; m.l. wave with reaction, circuit, 7/6; m.l. wave, iron cored, adjustable cores, circuit, 10/6; s.m.l. ear, and osc. coils, circuit, 10/6; Weymouth midget i.f.s., iron core, 465kc/s, per pr. 18/9; standard i.f.s. 465kc/s, per pr. 15/-; standard ditto, 2mc/s, each 3/6; Weymouth all-wave coil pack, 36/6; 2-gang condensers, 0.0005mfd, 12/6; ditto 0.0001mfd, 10/6; 3-gang 0.0001mfd, 12/6; 2-gang 0.00017mfd, split stator, 6/-; Tiny Tim 2-gang, fitted trimmers and perspex dust cover, 2in x 1 1/2 in x 1 1/2 in, 17/6; speakers, minus trans., p.m. 5in. 21/-; ditto p.m. 6in. 27/-; coloured ivoryine dials, s.m.l. wave, 4 x 3 1/2 in, 2/-; ditto 5 x 5 1/2 in, 2/6; celluloid m.l. wave, 5 x 5 1/2 in, 1/6; s.m.l. motion drum drive, 3/-; epicycle drive, 3/3; square plane, m.l. drive assembly, with escutcheon, drive, glass, pointer, etc., 11/6; Rothermel Senior piezo crystal pick-ups, 56/3; ditto, S.8, at 52/6; pocket voltmeters, 0.5v-0.25v, 12/6; relays, 400ohms d.p.d.t., 3/-; plywood sheets, for backs, cabinets, etc., 22 x 14 1/2 x 1/4 in, 2/6; Avo capacity bridge, £11; condensers, 8 x 8mfd 500v, 7/6; 25mfd 25v, 2/6; 50mfd 12v, 2/-; 4mfd 1,000v, 7/6; 2mfd 1,000v, 3/-; 4mfd 100v, 9d.; line cord, 3-way, 0.3amp, yd 3/-; ditto 2-way, yd 2/-; Stanelco soldering irons, 200-240v, 19/6; mains droppers, 0.3amp 800ohms, 5/6; 0.2amp 1,000ohms, 4/6; 0.3amp 600ohms, 4/-; Bernards publication stockist, Television Constructor's Manual, 3/6, etc.; transformers, chokes, trimmers, etc., etc., comprehensive lists monthly; 2 1/2 d. stamp enquiries; postage extra all orders. O. GREENLICK, Ltd., 34, Bancroft Rd., Cambridge Heath Rd., London, E.1. Tel. Stepney Green 1334. [7866]

RADIO CLEARANCE, Ltd., 27, Tottenham Court Rd., W.1. Mus. 9188.—U.H.F. receivers, ex-R.A.F., R.1481, 10 6.3 valves, range 65-86 mcs, sequence R.F. (VR65), mixer (VR65), osc. (VR66), 3 I.F.s (VR53), B.F.O. (VR53), det and A.V.C. (VR54), A.F. (VR57), output (VR67), 0-180 deg 6in S.M. dial, tuning meter, R.F. and L.F. gain controls, A.V.C./M.A.N./B.F.O. switch, jack sockets for Mon. and line, I.F. 12 mcs, size 19in x 10 1/2 in x 10 1/2 in (fits standard 19in rack), ideal for conversion to 5 metres, etc., requires power 250v and 6.3v, all brand new, supplied complete with all valves in original wooden cases with hinged lids (1ft 10in x 1ft 4in x 1ft 1in), circuit diagram with values with each set, £12/12 carriage paid; ex-Army No. 38 transceivers, 5-valve battery sets, range 7.4-9 mcs, complete with valves and junction box (used with 19 set in tanks), all brand new, unused, 50/-; 2-section rod aerials in canvas case, 7/6; 3 spare valves in metal case (1-ATP4, 2-ARP12), 10/-; mains trans., all primaries, 230v 50cs, secs. 300-0-300v, 200ma, 5v 3a, 6.3v 2.5a, 6.3v 3a, 25/-; 300-0-300v 200ma, 5v 3a, 6.3v 4.5a, 22/6; 2,000v 2ma, 2v 2a, 4v 2a, 21/-; primary 80v, 1,000c/s, suitable for rewinding as small H.T. or heater trans., etc., 3/6; I.F. chokes, 2.5h, 200ma, 1/6; 20h, 200ma, 12/6; 20h, 400ma, 18/6; I.F. chokes, cover-S. and M.W., 1/6; U.H.F., 1/-; super het. coils, M.W. A.E., M.W. osc., I.W. A.E., L.W. osc., former size 1/2 in x 1 1/2 in, 2/6 each; iron cored 465 k/cs trap, 2/9; set of 4 coils and trap, 11/6; I.F. trans., 465 k/cs, iron cored, 14/- pr.; visual indicators, ex-R.A.F., in bakelite case, inc. 2 complete Weston moving coil meter movements, 300 microamps F.S.D., 6/11; metal rectifiers, 12v 1a bridge type 4/6, 250v 60MA H.W. 4/6; moving coil meters, 0-30MA, 2 1/2 in scale, 8/6; moving coil headphones, slightly used, 10/6 pr.; lightweight high res. (4.5000) headphones, 7/11 pr.; air spaced variable cond., 30 P.F., 1/2 in spind. 1/-, 50 P.F. diff. ceramic base, 1 1/2 in sp., 2/-; switches, 1p 3w 1/9, 1p 9w 2/6, 1p 6w 2b 3/-, 2p 6w 2/6, 2p 5w 3b short spindle 2/9, 2p 5w 2b 3/6, ceramic 3p 3w 4/- [7865]

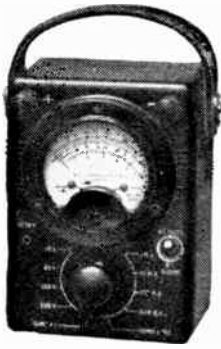

ONE OF
THE MANY
OF OUR
HIGH
GRADE
INSTRUMENTS
"MADE TO
MEASURE"

Complete range of service instruments available.

Wide range of laboratory instruments of pioneer design.

High sensitivity meters with 2½", 3½" and 5" scales

BRITISH
PHYSICAL
LABORATORIES
QUADRANT WORKS, FINCHLEY LANE,
LONDON, N.W.4

Telephone: Hendon 3682.

REWINDS

Armatures, Fields, Transformers, Pick-ups, Vacuum Cleaners, Gram. Motors, Speakers Refitted New Cones & Speech Coils.

All Guaranteed and promptly executed. New Vacuum Cleaners, most popular makes. Send stamped addressed envelope for list of Radio Spares, and C.O.D. Service.

A.D.S. Co. 261-3-5, Lichfield Road, ASTON, BIRMINGHAM, 6

HILL & CHURCHILL LTD.

BOOKSELLERS

SWANAGE, DORSET.

Available from Stock:—

Terman	"Radio Engineers Handbook"	35/-
Terman	"Radio Engineering"	30/-
Millman & Seely	"Electronics"	27/6
Glasgow	"Principles of Radio Engineering"	22/6
Bond	"Radio Direction Finders"	18/-
U.S.A.	"Radio Handbook" 10th Edition	17/6
	"A.R.R.L. Handbook" 1947	13/-
Ride	"Cathode Ray Tube at Work"	25/-
	Postage Extra.	

We have a large selection of English and American Books on RADIO and TELECOMMUNICATION

CATALOGUE ON APPLICATION

G. A. KYALL, 65, Nightingale Lane, London, S.W.12. Mail order only. No c.o.d. under £1 please. Postage extra on all orders. Please write plainly. All new goods, unused. U.S.A. make 0.1mf 500v tubular screened condensers, 5/6 dozen; resistances, assorted, ¼w, ½w, 1w, best makes, sizes from 100ohms to 2megohms, including 15 ½watt sizes, level selection given, 40 for 5/-; also 2watt 150,000, 220,000, 470,000, 820,000, 43,000, at 3/- per dozen; 33,000ohm 3watt, 3/- dozen; 1,800 wire wound, 1/- dozen; panels with screened 0.1mf and 12 resistances, 2/3 each; Yaxley type switches, single bank, 9-way, 2/3; and 2B, 3P, 3W, 2/3; 3-bank 2L, 4W, with middle screen, special type, 3/9, post 8d.; Octal plugs with metal caps and chassis type paxolin sockets, 3 2/6; with solder tags, 3 3/-; U.S.A. 4-5-6-pin chassis type paxolin valve holders, British made, 3/- doz to clear; metal boxes finished in flat black, ideal for instrument boxes, etc., complete with paxolin ¼in panel, size 8½x7½x3½ deep approx., 4 fixing lugs, 4 corner sockets for panel fixing, 6/9 each complete; R.F. amplifiers, type 25, ex-R.A.F., new, in cartons, contain 5w S.P. 3B ceramic switch with good knob, 15 H.F. type trimmers in 3 divisions, 3 SP41 metallised valves in amphenol valve holders, ceramic coils easily removable for re-winding, fixed tuning of 30-40mc, complete in metal case with res. and cond., 50/- each; new high resistance phones with sponge ear-pads, magnetic type, with microphone of good quality, 10/9 set, complete with 4w plug, type 10H/10991; power microphones of multi insert type, new, 20/-; ditto second-hand with high resistances, phones not guaranteed, 8/9; high speed relays with platinum contacts, 1,000ohms, on/off, 3/6; ditto on/off 300ohms, about 20ma. ceramic insulation, 3/6; volume controls, 10,000ohm medium spindle, 1/6; short spindle, ¼meg and 1meg, 1/6; 300ohm preset wire wound, 1/6; control boxes, small type, with fixing bracket containing toggle switch wires as SP, DT, h.f. choke section wound 25ohms and 0.0005 mica condenser, 800ohm resistance, size 3x2x1½in approx., 1/9 each; control box, metal, with Yaxley type 2b 4w 2p switch with 2½in well-finished pointer knob, on/off toggle, and DP, DT toggle, case size 6x3x3 approx.; control box, type A.M.404, with Yaxley type switch, 5w 2p 3B, well-finished knob, internal toggle switch, 3 green indication lampholders with bulbs, 1 ditto clear with neon type bulb, push switch double M. & B., 1 relay of 20,000ohms, 1B 2M with ceramic and spaced insulation, second relay of 3,000ohms, single pole M. & B., resistances, etc., case size 10x4½x3½ approx., 12/6 each, all boxes new in cartons; control box with Yaxley type switch 2B 3P 3W, red indication lampholder with bulb, resistance panel size 5x3½in with 0.1mf and res., 2 25mf 50v electric electrolytics, plugs and jacks, 2 ½rds screened cable, 6 ½rds twin rubber, etc., size case 8x6x2, 10/6 each, perfect condition.

SETS of radio receivers from £7/8; 4- and 5-valve, new materials, table models, semi-midget; our latest kit.—Wylwyn Star 1947 has connections for gramophone pick-up, extensions to loudspeaker A.V.C., 6 hours average time for constructing; full details, diagrams with each kit; c.w.o. or c.o.d.—Isher woods, Reme House, 81, Plungington Rd., Preston, Tel. 3348, Estab. 1936.

HENRY'S RADIO.—Midget A.F. units, 11 comp, 3 IT4 valves, 3 ceramic holders, Midget "Hyperloy" mike trans, 50,000ohm midget pot, 8 resistors, 9 condensers, the whole mounted on Paxolin panel, brand new, 25/- only; Midget two-gang 0.0005, with trimmers, 2½in x 1½in x 1½in, 13/9 each; Midget two-gang 0.000375, 2in x 1½in x 1½in, vanes enclosed in perspex, 14/6; Midget two-gang 0.0001 ceramic insulation, 1½in x 1½in x 1½in, 8/6; button w-holders, ceramic, 1/- each, for IT4, 1R5, etc.; electrolytics, 8mf 500vw 4-, 16mf 500vw 5/-, 8x8mf 500vw 6/-; 16x16mf 350vw med, 9/- ea.; micropack, 25mf 25v 2/6; 40mf 150vw tubular 4/-; Coils, Wearite, A. I.F. and osc., 3/- ea., med. and long wave with reaction, and circuit, 8/6 pr.; med., long and s. s.-het, with circuit, 9/6 pr.; I.F. trans, 465 k/c/s. Wearite iron-cored, 20/- pr.; Standard iron-cored, 15/- pr.; air spaced, 15/- pr.; Weymouth Midget iron-cored, 18/9 pr.; 110k/cs, 12/6 pr. Coil packs: Weymouth 3 wave, 36/6; R.F. Midget, iron-cored, 3 wave, 39/-; limited quantity only. Cathode ray indicator, comprising 3½in Mullard ECR35, C/R, electrostatic tube, 2 EF50, 2 FB34 valves, plus high voltage condensers and resistors, complete in metal case, tube guaranteed, ideal for conversion to oscilloscope, carriage paid, 90/- each. Send stamp for comprehensive list of radio components of every nature. Cash with order, or c.o.d. (over £1). Trade enquiries invited.

HENRY'S RADIO, 5, Harrow Rd., W.2. Paddington 1008-9. [7838]

Specialists in

HIGH POWER - HIGH QUALITY

PUBLIC ADDRESS
SYSTEMS

★
AMPLIFIERS

from 150 W to 1kW

W. Bryan Savage Ltd

WESTMORELAND ROAD, LONDON, N.W.9

Telephone: Colindale 7131

HARTLEY - TURNER HIGHEST FIDELITY SERVICE

The wide smooth response of the 215 speaker which manufactures neither artificial Bass nor excessive output at 3-4 kcs, P.S. demands an equally good response from the rest of the equipment. The average "high fidelity" T.R.F. receiver may not have as wide a response as its owner believes, nor does it follow that an amplifier made from a good design is necessarily free from distortion. To cope with this situation we shall introduce a sensitive T.R.F. receiving unit with the 3rd Programme very much in mind, and a 30-watt amplifier available either complete, in kit form, or as a "book of words."

Full details of these and other products will be sent to everyone on our mailing list. See that your name is included. Meanwhile the most important single item is the

SPEAKER: MODEL 215—£9

H. A. HARTLEY CO. LTD.
152 HAMMERSMITH RD., LONDON, W.6
TELEPHONE: RIVERSIDE 7387

"ENGINEERING OPPORTUNITIES"



This unique handbook shows the easy way to secure A.M.I.Mech.E., A.M.Brit.I.R.E., A.M.I.E.E. City and Guilds, etc.

WE GUARANTEE—
"NO PASS—NO FEE."

Details are given of over 150 Diploma courses in all branches of Civil, Mech., Elec., Motor, Aero., Radio, Television and Production Engineering, Training, Building, Govt. Employment, R.A.F. Maths., Matriculation, etc.

Safeguard your future; send for your copy at once—FREE.

B.I.E.T., 387, SHAKESPEARE HOUSE,
17, STRATFORD PLACE, LONDON, W.1.

1937

Record Storage



Here, to end your record storage problem once and for all, is the new lightweight portable 'IM RAK'. Holds up to 50 records, 10" and 12", yet requires little more space than a medium-sized table lamp.

Is No Longer



Every record easy to get at. Every division individually numbered. Records held firmly in position by resilient, plastic covered, sprung-steel divisions and cushioned at points of contact.

Any Problem



Finished in a wide choice of gay colours. And you can add on new racks just like a unit bookcase. Now available at most record shops, price 29/6d., plus 6/5d. tax. Optional dust-proof plastic cover 7/9d., plus 1/8½d. tax.

The new



MADE BY THE MAKERS OF THE FAMOUS IM NEEDLES

For details of your nearest supplies write to Alfred Imhof, Ltd., Dept. W3, 112, New Oxford Street, London, W.C.1. Museum 5944.

POWER packs, new, chassis 13x5x2in, trans., 2 chokes, 3-8mfd, 300v, 120ma, 6.3v 5a, 5v 2.5a; 45/-; carr. 3/6; cash with order.—4, Sussex Rd., New Malden, Surrey.
24v D.C. motor, 25/-; 2in M.C. meters, 10/-; 1ma; 50ma, 20/-; ea.; 0.5a D.C., 10/-; ex-Radar chassis, 19inx20inx3in with ft. and rear panels, 13inx19in; having ample space and power supplies, ideal for complete television sets. 3 trans., 5 rects., 2x2, 3 of 5U4G, 2 of 6X5GT, 2x, 1mfd 7,000v w, 4x4mfd 600v w, plus 25 Int. Octal v. holders, etc., input 236v, output 11.T.3, 600v, 320v, 640v, 760v, 1.T. 6.3v 20a, 6.3v 9a, 6.3v 6a; £8.—142, Rush Green Rd., Romford, Essex. [7843a WANTED, EXCHANGE, ETC.]

WANTED, 70L7, -G. T. Jamie, 15, Nelson St., Edinburgh. [7742]

WANTED "Wireless World" May 7, 1937.—Box 427. [7820]

WANTED, audio oscillator, 20-20kcs, single dial B.F.O.—Box 335. [7789]

WANTED, small wire sound recorder.—Lan dauer, Red House, Capel, Surrey. [7813]

WANTED, Voigt unit, no horn, must be new condition, 200v field.—Box 209.

WTD., Voigt L.T. twin, c. horn, bass chamber A.C. 100 gram motor.—Box 329.

WTD., Murphy radiogram A40; cash or part exch. A40 Console.—Crampin, Grimsby.

ADVERTISER requires quantity of 6 B.A. screws, steel preferred.—Gyrotone, Ltd., Coleshill, Nr. Birmingham. Coleshill 3169.

WANTED, surplus transformers, new or damaged.—Send sample and price required to Sea Rescue Equipment, Ltd., Chiltern Works, Watford. [7266]

WANTED, a number of pre-selector tuning mechanisms as fitted R.A.F. transmitter types 1154H, 1154M, 1154N; pay 10/- each if good condition.—Box 208. [7741]

WE buy for cash, new, used, radio, electrical equipment, all types, especially wanted, radios, radiograms, test equipment, motors, chargers, recording gear, etc.—If you want to sell at the maximum price call write of phone to University Radio, Ltd., 22, Lisle St., Leicester Sq., W.C.2. Ger. 4447.

REPAIRS AND SERVICE

MAINS transformers rewound, new transformers to any specification.

MOTOR rewinds and complete overhauls; first class workmanship, fully guaranteed.

F. M. ELECTRIC Co., Ltd., Potters Bldgs., Warser Gate, Nottingham. Est. 1917 Tel 3855

MAINS transformer rewound and constructed to any specification; prompt delivery.—Brown, 3, Bede Burn Rd., Jarrow. 3460

LOUDSPEAKER repairs, British, American, make; any make; moderate prices.—Sinclair Speakers, 12, Pembroke St. London, N.1. Terminus 4355. [3308]

LOUDSPEAKERS repaired; transformers, clock coils, chokes, rewound; prompt attention; prices quoted.—E. Mason, 5, Balham Grove, Balham, London, S.W. [7667]

ELECTRICAL measuring instruments skilfully repaired and recalibrated.—Electric Instrument Repair Service, 32B, Kilburn Lane, London, W.9. Tel. Lad. 4168. [6935]

COIL specialists.—Tuning and oscillator coils, C.I.F., L.F., and mains transformers, chokes, etc., rewound and wound to specification; speaker repairs.—Electronic Services (R.T.R.A. Service Section), Arwenack St., Falmouth.

LOUDSPEAKER repairs, any make, reasonable prices, prompt delivery, to the trade and quality fans; 25 years' combined experience with Rola, Magnavox, Goodmans, Celestion.—Sound Service Radio, 80, Richmond Rd., Kingston-on-Thames. Kin. 8008. [4977]

24-HOUR service, 6 months' guarantee, any transformer rewind, mains outputs and i.f.s., etc., all types of new trans., etc., supplied to specification; business heading of service card for trade prices.—Majestic Wind ing Co., 180, Windham Rd., Bournemouth.

REWINDS, mains transformers layer rewound wax impregnated, O/P trans formers, chokes, fields, clock coils, pick-ups, fractional hp motors, competitive prices, prompt delivery; guaranteed work.—W. Groves, Manufacturing Electrical Engineer, 154, Ick-nield Port Rd., Birmingham, 16. [4547]

TRANSFORMERS, chokes, etc., of every description rewound, quick service; all rewinds carefully tested on elaborate test equipment before despatch; new transformers to any spec. "Wireless World" transformers a speciality.—Radio & Transformer Services, Manchester Rd., Hollinwood, Tel. Fai. 2507.

NATIONAL RADIO SERVICE & TELEVISION CO.—Traje service engineers; immediate service any district; rewinds to all types transformers, armatures, motors, loudspeaker cones, speech coils fitted; British and American components and valves; enquiries invited for contract trade service; multiple transformer winding.—63, High St., St. John's Wool N.W.8 Primrose 6725 [6752]

GALPINS

ELECTRICAL STORES
408, HIGH STREET, LEWISHAM.
LONDON, S.E.13.
 Telephone: Lee Green 0309. Near Lewisham Hospital.
TERMS: CASH WITH ORDER.
NO C.O.D.

EX-R.A.F. R.F. UNITS TYPE 110A.

New and unused, consisting of 5 valves, including grounded grid 750 m/cy. tube, small 12 volt motor and numerous other components, would make very useful crackers, 55/- each, 5/- carriage.

EX-R.A.F. RADAR IMPULSE TRANSFORMERS (new, boxed). We have no actual data on these, but believe them to have an output of 15,000 volts at 3 kVv. for a micro second. A bargain for the experimenter at 10/6 each. P.F.

EX-G.P.O. VERTICAL TYPE GALVANO-METERS, centre zero reading 30/0/30, 7/6 each, post 1/-. Mallory 12 volt. vibrators, new and unused, 7/6 each. Electrolytic condensers, 80 m.f. 350 volt wkg., 5/6 each, post 9d.

L.T. RECTIFIERS (new), 6 volts, 1½ amp., 7/6 each, 12 v. 1½ amp. 10/6 each, 9d. post. Instrument Rectifiers, 5.H., 10 or 20 m/a. types, 4/6 each.

VOLTAGE CHANGER TRANSFORMERS, auto wound, fully guaranteed, immediate delivery, all tapped 0, 110, 200, 220, 240 volts, 250 watts, 45/-; 350 watts, 55/-; 500 watts, 70/-; 1,000 watts, 85/15/-; 2,000 watts, £8/15/-.

SHUNT WOUND D.C. 110 volt motors, 1,500 r.p.m., approx. ½ h.p. condition as new, 17/6 each, post 2/-.

EX-G.P.O. Permanent Magnet Moving Coil Speakers (makers Tannoy), suitable for extension or small P.A. work, fitted in wooden case, 9in. x 9in. x 7in., as new, 27/6 each.

MAINS TRANSFORMERS by well-known makers. Input 200/250 volts, output 700/0/700 v., 80 m/a. 4 v. 3 a. 12 v. 1 a., 30/- Ditto, 300/0/300 v., 200 m/a. 6.3 v. 20 amps. 5 v. 3 a., 45/- Ditto, 450/0/450 v., 150 m/a. 5 v. 2 a. 6.3 v. 4 a., 37/6. Ditto, 500/0/500 v. 150 m/a. 4 v. 4 a. 6.3 v. 4 a. 5 v. 2 a., 55/- Ditto, 350/0/350 v., 120 m/a. 4 v. 4 a. 5 v. 2 a. 6.3 v. 4 a., 35/-.

AUTO WOUND MAINS TRANSFORMER (Mains Booster). 1,500 watts tapped 0, 6, 10, 19, 175, 200, 220, 225, 240 and 250 volts. New, ex-Govt., £5/10/- each, carriage 5/-.

EX-R.A.F. AERIAL COUPLING UNITS, absorption type. Range from 1.2 to 5.3 m/cycles. 10/- each, post 1/-.

ELECTRIC LIGHT CHECK METERS, for 200/250 volt 50 cyc. 1 phase, ideal for subletting, etc., guaranteed electrically 2½ amp. load 12/6, 5 amp. 20/6, 15 amp. 20/-, 20 amp. 25/-, 30 amp. 30/-, 40 amp. 35/-, 50 amp. 45/-, 100 amp. 50/- each, plus 1/6 carriage extra.

EX-R.A.F. I.F.F. UNIT (Model) 3002 complete with 10 valves types 3X70E, 1EFS0, 4VR65, 2XYT61A, and rotary converter 12 volts input. 450 volts 40 m/a. output. These units are as new. Price complete, £3/10/-, carriage paid.

EX-R.A.F. CRYSTAL MONITORS TYPE 2. 3-valve Battery working, complete and ready for use less valves and xstals, operational frequency depends on xstal frequency, condition as new. Price 19/6 each, plus 1/6 carriage. Complete in carrying case, size 8½in. x 8in. x 6in.

EX-R.A.F. MICROPHONE TESTERS. These consist of a Ferranti 2½in. m/coil Octo 1 m/a. meter with Westinghouse Rectifier incorporated, calibrated at present 0 to 10 volts, microphone transformer, jacks, etc., all contained in polished teak case, size 6½in. x 5½in. Condition as new. Price 37/6 each.

EX-G.P.O. (AMERICAN) VIBRATOR PACKS. Type M222, 4 volts D.C. input, output 100/120 volts A.C. 20/30 m/a. New and unused, 27/6 each, carriage 2/6.

METERS. All first grade moving coil instruments, new, boxed, ex-Govt., 0 to 40 volts, with series resistance removed. 5 m/a, 15/- each, 0 to 10 amps. 15/-, 0 to 1 m/a, 21/- All 2in. scale and by well-known makers.

EX-NAVAL CATHODE RAY RECTIFIER UNITS. New and unused, sold for components which consist of:—2x5 mf. 2,500 v., 1x.1 5,000 v., 6x2 mf. 800 v., 2x8 mf. 800 v. approx. 15 volume controls, various values, approx. 100 small condensers and resistances, smoothing choke and 9 v. holders, including 3 EF50 and 1 tube base. All components wired and with the addition of mains transformer would make a good oscilloscope. Price 55/-, carriage paid.

THESE ARE IN STOCK

Reference Data For Radio Engineers, comp. W. L. McPherson, 5s., post 5d.
 Classified Radio Receiver Diagrams, by E. M. Squire, 10s. 6d., post 4d.
 Radio Engineers Handbook, by F. E. Terman, 35s., post 9d.
 Practical Wireless Circuits, by F. J. Camm, 6s., post 4d.
 Principles of Television Engineering, by D. G. Fink, 27s. 6d., post 8d.
 Wireless Coils, Chokes and Transformers, by F. J. Camm, 6s., post 4d.
 Radio Handbook (10th ed.), by Editors and Engineers, 15s., post 9d.
 Wireless World Valve Data, 2s., post 2d.
 Radio Tube Valve Mecum, by P. H. Brans, 12s. 6d., post 6d.
 The A.R.R.L. Antenna Book, 3s. 6d., post 4d.
 Ultra High Frequency Techniques, ed. Brainerd, 28s., post 8d.
 "Electrical Engineer" Reference Book, ed. Molloy, 42s., post 9d.

WE HAVE THE FINEST STOCK OF BRITISH AND AMERICAN RADIO BOOKS. WRITE OR CALL FOR COMPLETE LIST.

THE MODERN BOOK CO.

(Dept. W.24), 19-21, Praed St., London, W.2.

MORSE CODE TRAINING



There are Candler Morse Code Courses for BEGINNERS AND OPERATORS.

Send for this Free "BOOK OF FACTS"

It gives full details concerning all Courses.

THE CANDLER SYSTEM CO., Room 55W, 121 Kingsway, London, W.C.2
 Candler System Co., Denver, Colorado, U.S.A.

100 kcs. QUARTZ CRYSTAL UNIT
 Type Q5/100



for Secondary Frequency Standards

★ Accuracy better than 0.01%. ★ New angles of cut give a temperature coefficient of 2 parts in a million per degree Centigrade temperature change. ★ Vitreous silver electrodes fired direct on to the faces of the crystal itself, giving permanence of calibration. ★ Simple single valve circuit gives strong harmonics at 100 kcs. intervals up to 20 Mcs. ★ Octal based mount of compact dimensions. PRICE 45/- Post Free

Full details of the Q5/100, including circuit, are contained in our leaflet Q1. Send stamp-to-day for your copy

THE QUARTZ CRYSTAL CO., Ltd.
 63-71 Kingston Road,
 NEW MALDEN, SURREY
 Telephone: MALden 3034

MISCELLANEOUS

128 service sheets and 40 *Wireless Worlds*: offers over 80/-.—Box 8999. [7702]
 L I N E cord, 0.2amp 3-way, 100 ohms per ft.; 2/- yd.—2, Surbition Sq., Nottingham.
 "W.W.", Nov. '37-Oct. '38 (4R copies)—1,750 brass nuts, 4 B.A., 1 1/8 grs.—Pucker, Barnack Works, Bensham Lane, Croydon.
F R E E!—Bargain lists that will save you pounds, get copy to-day.—S.a.e. to Brown, 63, Salisbury Av., Farnham Rd., Slough, [7773]
B A. screws, bolts and nuts; large selection available in brass, plated steel and dural.—List from John Downton & Co., 89, High St., Epping, Tel. 2163. [7771]

C H A S S I S and panels in aluminium from 3/9 each; prompt delivery, any size plain or punched for valveholders, etc.—M.E.A.D., 13, Bence Lane, Darton, Barnsley. [7693]

S G. F A R N E L L, formerly of Leicester College of Technology, would be glad to hear from any former member of R.A.F. or Army groups.—Write BM/VOLTS, W.C.1. [7489]

L O U D S P E A K E R acoustic chamber cabinet, described "Electronic Engineering" April, 1941, inch solid mahogany, felt lagged, Rola G12, power pack; offers.—Box 1. [7710]

L A M I N A T I O N S, various, including 188 and 30 M and E, sizes in radio and Mu metal, large quantities for sale; state your price and quantity required.—Box 214. [7751]

5 / - only, steel cases with hinged lid and chassis, 8 1/2 x 8 1/2 x 6 1/2 in, sprayed black, radio kits from £5; s.a.e. bargain lists.—Brown, 63, Salisbury Av., Farnham Rd., Slough. [7774]

W E can supply ex stock some 7 or 8 different patterns iron dust cores; please send us your sample for our quotation.—John Downton & Co., 89, High St., Epping, Tel. 2163. [7709]

I N S T R U M E N T cases with panel, new, finished grey or black crystalline enamel, chromium handles, all sizes from 15/6.—Radio Electronic Development Co., Moretonhamstead, Devon. [7680]

C I R C U I T diagrams (individual designs) to order; radio queries answered, charge, if no diagrams involved, 2/6; chassis assembled, tested; apparatus repaired.—Write R. G. Young, 3a, Bridges Rd., Wimbledon. [7717]

P R E S S tool for modern design bakelite tension speaker cabinet, size about 8 1/2 x 5 1/2 in; sample cabinet will be sent to bona-fide enquirers upon request.—Gardners Radio, Ltd., Somerford, Christchurch, Hants. [7708]

M I D G E T radio cabinets, hand made, polished, exclusive design, 12 1/2 x 7 1/2 x 6 1/2 in, inside measurements, dialcut 4 x 3 in; 30/- each; callers or c.w.o., money back guarantee.—Burman's, 64, Reighton Rd., Upper Clapton, E.5.

T O clear! 100ft reels stranded bronze aerial wire, with clips; usual price 4/6, our price 2/3, post 8d.—Marble Arch Motor Supplies, Ltd., Head Office and Showrooms, 286, 302, Camberwell Rd., S.E.5 (Rod, 2181), and at all branches. [7485]

F O R sale, P.V.C. sheathed cables, screened copper wire braided and polythene core, conductors from 1/0.022 to 7/0.032; also lead sheathed solid polythene with single conductors and semi-air-spaced poly. spider copper wire braided and P.V.C. sheathed, large quantities, new condition.—Box 206. [7735]

WORK WANTED.

E N G R A V I N G.—Precision instrument firm in West London can undertake specialized machine engraving of knobs, dials, panels or sundry components; excellent delivery on small quantities.—Write Box 1641; c/o Charles Barker & Sons, Ltd., 31, Budge Row, E.C.4.

D R A W I N G and tracing work for radio and electrical engineering, jig and tool and light engineering, photoprinting; full sets of drawings undertaken to commercial or Ministry standards.—Drawing & Tracing, Ltd., 456a, Ewell Rd., Tolworth, Surbition Phone Elmbridge 7406. [7703]

T E L E V I S I O N aerial installations and aerial maintenance, full range of antennas supplied and/or installed by experts; removals and re-erctions arranged; our pre-war Television Service Dept. is now open.—Brochures from Wolsley Television, Ltd., 87, Brixton Hill, S.W.2. Tulse Hill 1240. [7320]

T H E name to note for all kinds of radio, electrical and metal work to specification, modern rustproof, all shapes and sizes undertaken, and for tropical use; components and sub-assemblies executed to meet recognised wiring and material standards; consultation, advice without obligation.—Write Dept. 25, Sea Rescue Equipment, Ltd., Chiltern Works, Clarendon Rd., Watford, Herts. [5977]

B U S I N E S S E S F O R S A L E O R W A N T E D R A D I O, elec., toys, cycle, suburb Bristol. U shop, 4 rooms, bathroom, garden, turnover £2,107, scope £2,300; freehold, s.a.v.—Lansley, 53, Friar St., Reading [7794]

EX-GOVERNMENT "CIRCUIT"

R116A.—Battery Communication Receiver Theoretical Practical Diagram with notes. 2/3, post free.

R109.—Short-wave car or Battery Receiver; 11 pages of circuits and useful information including fault finding, 2/3, post free.

NCR1.—Midget Battery Communications Receiver (pocket radio), 2/9, post free.

58 Walkie-Talkie Battery Transmitter-Receiver; copy of official instructions plus diagrams of set and Power Pack, 3/6, post free.

Demobbed Valves.—Commercial equivalent of Service Valves and vice versa. 2/6, post free.

Alignment Peaks give I.F. Frequencies of Domestic Receivers. 7/6, post free.

R103A.—Mains or Battery Short-Wave Communications Receiver. 1/6, post free.

1155 R.A.F. Communications Receiver. 2/3, post free.

Battery WF.38.—1/6, post free.

R107.—1/6, post free.

In addition to the circuit we can supply most of the above sets and many others. Write for our list.

V.E.8., 42-46, WINDMILL HILL, RUSHP, MIDDLESEX.

A.C.S. RADIO

SPECIALISTS IN AMATEUR AND EXPERIMENTAL SHORT-WAVE EQUIPMENT,

Communications Receivers, Television High quality Amplifiers, Speakers, Aerials, Receiving and Transmitting Valves and Meters, etc.

List "W" free on request to:—

A.C.S. RADIO, 44, Widmore Rd., BROMLEY Kent. Phone: RAV 6510

TRANSFORMERS & COILS TO SPECIFICATION.

MANUFACTURED OR REWOUND

JOHN FACTOR LTD.,

(Formerly Stanley Cattell Ltd.),

9-11 East Street, TORQUAY, Devon
 Phone: Torquay 2162.

NEW DUAL TESTOSCOPE

Ideal for high and low voltage testing; 1/30, 100/850 A.C. and D.C. Allowance made on old models

Send for interesting leaflet (R.14) on Electrical and Radio Testing, from all Dealers or direct.

RUNBAKEN-MANCHESTER-I

Radiographic can now offer the following

Transmitting VALVES:

EIMAC 35T.. 45/- RCA 813.. 110/-

RCA 805 .. 110/- RCA 866.. 27/6

Send for Lists of TX VALVES.

100TH Available Shortly.

RADIOGRAPHIC LTD.

66, OSBORNE ST., GLASGOW

The
**C. D. P.
RECORDER**

is of robust construction and is built to give years of service without the necessity of renewals.

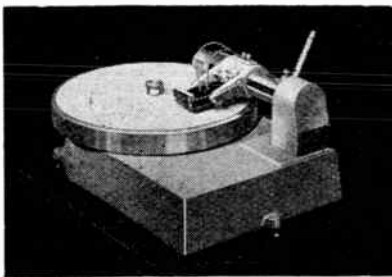

Price £30

Of the large number already in use, both at home and abroad, the majority are in recording, film and broadcast studios.

THIS SPEAKS FOR ITSELF

The addition of a new balanced armature cutting head (now fitted as standard) places this machine in the highest category for workmanship, high quality recording and reliability.

Also Recording Amplifier and Moving Coil Microphone, complete £32.

Please write for Brochure direct to manufacturers:

**BOURNE
INSTRUMENTS
BOURNE, LINCS.**

Phone 224

**Aladdin
RADIO CORES**
for all purposes
GREENFORD, MIDD. WAXLOW 2300

POST-WAR TELEVISION

The advance in Radio Technique offers unlimited opportunities of high pay and secure posts for those Radio Engineers who have had the foresight to become technically qualified. How you can do this quickly and easily in your spare time is fully explained in our unique handbook.

Full details are given of A.M.I.E.E., A.M.Brit.I.B.E. City & Guilds Exams., and particulars of up-to-date courses in Wireless Engineering, Radio Servicing, Short Waves, Television, Mathematics, etc., etc.

We Guarantee "NO PASS—NO FEE"

Prepare for to-morrow's opportunities and post-war competition by sending for your copy of this very informative 112-page guide NOW—FREE.

**BRITISH INSTITUTE OF ENGINEERING
TECHNOLOGY (Dept. 388)**
17, Stratford Place, London, W.1

RADIO, elec., main rd., Reading, rent £100, lease 21 corner premises, shop, 6 rooms, yard, trade £25, neglected; £950 s.a.v.—Lansley, 53, Friar St., Reading. [7796]

RADIO, elec., cycle, main rd., Slough dist., vendors property, lease or freehold shop and workshops, 3 rooms, trade £80 audited a/cs.; £1,850, s.a.v.—53, Friar St., Reading.

RECORDING studio, well established, popular North-West coast resort, no competition, modern office and studio accommodation in main shopping district (rent £104 p.a.), owner leaving district; £1,000 including all stock, apparatus, furnishings; business taught, prepared to re-invest £500 for sleeping partnership.—Box 493. [7862]

FINANCIAL PARTNERSHIP
SMALL relay concession wanted; advertiser willing to consider working partnership.—All replies in strict confidence to Box 8994.

SITUATIONS VACANT
THE GENERAL INFIRMARY AT LEEDS, Physics Dept.

APLICATIONS are invited for the post of electronics technician to undertake development, construction and maintenance work on electronic apparatus for medical use under the guidance of the Physicist. Applicants should have good basic knowledge of valve circuits, considerable experience of high grade constructional work. Salary in accordance with scale for Grade B technician, commencing at not less than £350 p.a.—Applications should be sent to House Governor and Secretary, The General Infirmary at Leeds, as soon as possible. [7729]

REQUIRED, test engineer with knowledge of high-power, high-frequency valve generators.—Box 6222. [6886]

RADIO draughtsman required by radio manufacturers in S.E. London area, previous experience essential.—Write, stating age, experience, etc., to Box 210. [7744]

LEADING radio component manufacturers require capable male progress clerk for their London sales office.—Write full details, age, experience, salary, etc.—Box 431. [7861]

WORKS manager required for small radio factory near Salisbury; state age, exp. and salary required.—Write in first instance to Box 1,000, Parris, 121, Kingsway, W.C.2.

SERVICEMAN-MANAGER for small Sussex shop; vacancy August to replace retiring partner; must be able to do all jobs; permanency right man; full particulars, don't be brief.—Box 428. [7826]

RADAR engineer required for planning and demonstration commercial marine instruments; will be based on London area.—Apply in writing, stating age, qualifications and salary reqd., to Box 297. [7737]

EX-R. SIGS. personnel required to fill positions of responsibility, having the same wide field of interest as that covered by their Army training.—Write Box D/5016, A.K. Advg., 212a, Shaftesbury Ave., W.C.2. [7696]

JIG and tool draughtsman required by large manufacturers of radio and electrical appliances in S.E. London area; applicants should write, stating age, exp.; permanency and prospects for right man.—Write Box 211.

CHIEF engineer required with great exp. in commercial receivers and television; first-class references necessary; excellent position offered in a known London radio factory; salary approximately £1,000 p.a.—Box 333.

EXCELLENT opportunity.—Production manager of great skill and exp. in radio assembly reqd.; first-class references must be forwarded before interview; high salary offered plus bonus for the right personality.—Box 334.

PHYSICIST for production and laboratory assistant required immediately by manufacturers of Mercury Vapour Discharge appliances; exp. in electronics an advantage; detailed application stating salary.—Box 430.

LARGE organisation in West Middlesex requires field service engineers with good television and radio knowledge, smart appearance, car an advantage but not essential.—Apply, stating details of past experience age and salary required, to Box 8616. [7556]

FOREMEN required for assembly line production of good class radio receivers; applicants must have a good knowledge of modern methods of production and have served in a similar capacity; South Birmingham area.—Write, stating age, exp., salary reqd., Box 2.

RADIO service mechanics for works installation in service department, N.W.2 district, London; normal qualifications and experience, preferably including car radio and an aptitude to clean mechanical work; wages as prevailing levels, good prospects.—Write, stating age and experience, to Box 10. [7727]

LEADING radio component manufacturers require two first-class representatives, one for Birmingham and the North, and the other for London and the South; connections with radio manufacturers and wholesalers desirable but not absolutely essential, salary plus expenses.—Write full details Box 489. [7859]

M. WILSON LTD

AMPLIFIER CHASSIS

12-WATT MODEL

5-valves including Rectifier

First valve 6C8 (double triode) is used as Tone Control and 1st LF Amplifier and detector when used following a radio unit. This valve feeds into a phase inverter (also a double-triode) of the balanced type, the output being fed into two beam tetrodes, 6V6's or 6L6's in push pull with negative feed-back. The rectifier is a 5U4G. The output transformer, is of the multi-ratio type with loads of 10,000, 4,000 and 2,500 with speech coil tappings for 3, 7.5 and 15 ohms impedance. In the above unit the beam tetrodes may be wired up as triodes if preferred, giving a better frequency response for a slight reduction of output to approximately 10 watts undistorted. Controls are: 1. Radio/gram switch. 2. Tone control. 3. On/off switch and Audio volume control. The mains transformer used gives good voltage regulation, impregnated and interleaved to ensure against breakdown. It is also fitted with three fuses, two in the mains leads and one in the rectifier circuit.

Price complete, less Speaker 17 Gns. Blue Prints of above (2 Practical, 1 Theoretical) available separately, with detailed price list 5/- per set.

6-WATT MODEL

5-valves including Rectifier

Specification as above but employing low wattage output valves with components to suit.

Price complete, less Speaker, 15 Gns. Blue Prints (2 practical and 1 theoretical) available separately with detailed price list 3/6 per set.

4-WATT PX4 MODEL

4-valves including Rectifier.

This amplifier gives 4-watt undistorted output and is assembled on a 16 swg aluminium chassis and is fitted with a separate tone control. Volume control with on/off switch, sockets for microphone, gramophone and extension loudspeaker. Hum-free, good quality reproduction. A.C. only, 200/250 v. Valves: PX4 (output), M4, MH4, U4S. Overall dimensions 8in. x 6in. x 7 1/2in. Ready to play.—Complete with valves and speaker. Price (including valves and speaker), 12 Gns. Blue Prints (two practical and one theoretical are obtainable separately, and are issued with detailed price list for all necessary components, which we can normally supply as required. Price 3/6 per set.

4-WATT AC/2 PEN MODEL

4-valves including Rectifier

Assembled on chassis fitted with separate tone control. Volume control with on/off switch, sockets for microphone, gramophone and extension speaker. Hum free, good quality reproduction. A.C. only. Input 200-250 v. Valves: A.C./HL triode, MH4 triode, AC2Pen D.D. output pentode, U4S full wave rectifier. Size overall 8 x 6 x 7 1/2in. Ready for use. With Bin. P.M. loudspeaker and output transformer.

Price, including valves and speaker, 10 Gns. Blue Prints (2 practical and 1 theoretical) available separately with detailed price list 3/6 per set.

A circuit that pleases the critical

A.C. 6-VALVE SUPERHET

3 Wavebands 16-50, 200-500, 800-2,000 m. Blue Prints (2 practical, 1 theoretical) with priced list of parts, 3/6 per set.

**307, HIGH HOLBORN,
LONDON W.C.1. Phone: HOLborn 4631**

TO

Chief Buyers
of
**INDUSTRIAL
ORGANISATIONS**



YOU can save yourself many a headache when vitally urgent Radio Electronic equipment is called for, by phoning PADDINGTON 6116.

ALREADY we supply the Services, many Government Departments, local authorities, Research and Development Organisations, Training Colleges, etc.

WE specialise in this work and carry large stocks of high-grade components which, in emergency, we can forward immediately against your phoned Official Order Number.

NO enquiry or order too small, or too large or too difficult—in fact, the more difficult it is the better we like it.

An enquiry under your letter heading will bring our 24-page illustrated catalogue by return post.

TELE-RADIO (1943) LTD.,
177 Edgware Road,
LONDON, W.2
Telephone: PADDINGTON 6116

THE COIL PICKUP

gives users High Fidelity with
Low Record Wear

Wilkins & Wright Ltd., Holyhead Road,
Birmingham 21.

LONDEX for RELAYS

AERIAL CHANGE-OVER RELAY

for Radio Frequency
Type AECO 4.

3 V.A. Coil Consumption,
especially designed for
Transmitters, High Fre-
quency Heating, Amat-
eur Stations, etc.

Ask for leaflet
112/WW



LONDEX LTD SYDNEY
MANUFACTURERS OF RELAYS 6258-9
207 ANERLEY ROAD - LONDON - S.E.20

Anodised Aluminium Dials, 3 waveband
180° sweep, engraved with station names, in
green, red and white, with switch indicator
markings. $2\frac{1}{2}$ " x $5\frac{1}{2}$ " post paid. ... 6s. 3d.

AC/DC Superhet kits, 3 wave, 5 valve,
with full wiring diagrams and instructions,
chassis valves and 8 inch speaker post paid
£13 10s. 0d.

3 wave Superhet Coil Pack with wiring
diagram, switch, padders and trimmers post
paid 37s. 6d.

Special Components Catalogue
1/- post paid.

B. T. S.
63, London Road, Brighton 1.
Sussex.

RADIO mechanics, electricians and instru-
ment mechanics with experience of air-
craft installation and maintenance, R.A.F. ex-
perience on heavy bombers an advantage.—
Application form on request to Signals Supp-
intendent, Lancashire Aircraft Corporation,
Ltd. Bovingdon Airport, Hemel Hempstead.

FOREMAN required with thorough know-
ledge of radio component part production
including coil winding; applicants must be
capable, possess good knowledge of modern pro-
duction methods and must have held a similar
position; South Birmingham area.—Write,
stating age, experience and salary reqd., Box 3.

JUNIOR assistant required for Technical
Publications Dept. for radio manu-
facturers situated in W. London; knowledge of
radio theory, measurements and experience of
compilation of technical documents preferred
—Write stating age, experience, qualifications
(if any) and salary required, to Box 423.

IMPORTANT radio manufacturing company
in London requires first-class sales tech-
nical man with previous managerial experience
if possible; must be good correspondent.—Full
particulars of age, experience, academic qual-
ifications if any, and salary required, to X.N.,
Box 9/5110, A.K. Avlg., 212a, Shaftesbury
Av., London, W.2.

REQUIRED, a lecturer in Radio Theory and
Practice; degree or diploma in electrical,
electronic or radio engineering, as well as
practical radio or radar experience essential;
salary according to Burnham Scale with allow-
ances for industrial experience.—Apply im-
mediately in writing to the Principal, Marine
School, South Shields.

FOREMAN required for works radio instal-
lation and service department, N.W.2 dis-
trict, London; additionally to first-rate tech-
nical qualifications, preferably including car
radio experience, should be an able and tactful
disciplinarian; salary as prevailing levels; pen-
sion scheme, good prospects.—Write, giving age
and experience, to Box 9.

SENIOR and junior draughtsmen required
for work on prototype equipment; in con-
nection with television transmitters; seniors
should have some experience in light electrical
engineering.—Apply by letter only, stating age,
qualifications and experience, to the Director,
Research Laboratories of the General Electric
Co., Ltd., Wembley, Middx.

ELECTRONIC engineer for large industrial
concern in North-West London; ap-
plicant must have Degree, or equivalent, in
Electrical Engineering, and sound theoretical
knowledge of electronic control circuits and
equipment, age preferably under 30; ap-
plicant should give full particulars of experi-
ence, qualifications, and salary reqd.—Box 341.

RADIO engineering company in South Lon-
don requires engineer to take charge of
test department specializing in radio naviga-
tional equipment; applicants must be able to
prove they have first class technical qualifica-
tions combined with considerable experience in
similar work; position offers good opportunities
to the right man.—Write full details to Box
7429.

DRAUGHTSMEN or designer-draughtsmen
required for engineering dept. of radio
manufacturers in Enfield district, with experi-
ence of light engineering and mechanics; ex-
tensive development and design programme
with prospects of original work; 5-day week,
first class working conditions and amenities.—
Apply Personnel Officer, Ferguson Radio Cor-
poration, Ltd., Gt. Cambridge Rd., Enfield.

LEADING radio component manufacturers
require capable correspondence clerk for
their London sales office; applications are
invited from experienced men, capable of deal-
ing quickly with voluminous correspondence,
and with some knowledge of card-records and
of the trade in general; knowledge of foreign
languages and of export formalities would be
an advantage.—Write full details, age, experi-
ence, salary, etc., Box 490.

LEADING component manufacturers require
the services of a graduate radio engineer to
carry out research and development pro-
grammes in connection with electronic com-
ponents, fuses and suppressors; good back-
ground in general physics and some inventive
ability essential; salary will be in accordance
with qualifications and experience, but will not
exceed £500 per annum; give full details of age,
education and experience.—Box 216.

EXPERIENCED wireless mechanics capable
of carrying out complete overhauls and
repairs to various types of Army and trade
pattern wireless transmitters and receivers;
wages 104/6 per week, plus up to 20/- per
week ability pay according to technical qual-
ifications and skill.—Applications should con-
tain full personal particulars of applicant and
experience and should be forwarded in writing
to Civilian Establishment Officer, Kinnegar
Workshops, R.E.M.E., Hillywood, Co. Down,

A COMPLETE SERVICE for the MODERN RECORDING ENGINEER

- Complete disc and wire recorders.
- Recording amplifiers, speaker units.
- Direct recording discs 5" to 17".
- Steel cutters, sapphire recording and reproducing styl.
- Crystal and moving coil microphones.
- Desk and pedestal stands, Electronic mixers.
- Envelopes, labels and complete accessory service.

For details, call or write to:



**RECORDER HOUSE, 48-50, GEORGE ST.,
PORTMAN SQUARE, LONDON, W.1.**

Cables: SIMSALE, LONDON.

Telegrams: SIMSALE, WESDO, LONDON.

"VIBRO-ARC" Engraving Pen



For rapid engraving any
metal—hard or soft.
Operates from 4-6v
Battery or A.C. Trans-
former giving 6-10 amps.

HOLBROW & CO.,

8, Mossley Avenue, Wallidown, Bournemouth.

Beethoven

ROTARY CONVERTORS

220 D.C. to 220 A.C.
Details from—
BEEHOVEN ELECTRIC EQUIPMENT LTD.
Beethoven Works, Chase Road London. N.W.10

MIDLAND INSTRUMENT CO.

Ex-GOV. AMPLIFIERS, triode and Q.P.F. valves,
four transformers, key switch, on-off switch, conds.,
resistances, etc. Contained in black steel cases,
7in. x 6in. x 4in. Operates from 2-volt and 120-volt
batteries. Ideal for pickup amplifier or loudspeaking
intercom, already converted for immediate use,
25/-, post 1/-. Electro-magnetic microphones for
above amplifiers, 3/6 extra. Send for our May Lists,
2d. with S.A.E. Note new address:—

MOORPOOL CIRCLE, BIRMINGHAM, 17.
Tel.: HARborne 1308.

REWINDS

Send your "Burn outs" to be
Rewound—no technical data
wanted. Post Transformer, etc.,
labelled with your name and
address marked "for Rewind."

**OUR WINDINGS ARE
LAYER WOUND & IMPREGNATED
SOUTHERN TRADE SERVICES, LTD.**
297/299 HIGH ST., CROYDON

Tel.: 4870

Manufacturers of "TELECRAFT" PRODUCTS

Planet



An AC/DC Five Valve Superhet Two Wave-Band Receiver for 220-250 volt mains . . .

Of striking appearance in attractive two-colour plastic cabinet, with unique illuminated translucent dial and novel tuning mechanism to combine slow and accurate tuning with fast band search (5 tuned circuits).

SPECIFICATION:

Specially built-in "Hemoscope" aerial . . . Manufactured for the home market in Medium Wave Band 200/550 metres and Long Wave Band 800/2,000 metres . . . Also for Export in Medium and Short Wave Bands 16/49 metres.

£13.13.0 Plus Purchase Tax **£3.3.8.**

In maroon, red, white or pastel shades of blue, pink, green, 7s. extra. Plus 1/9 P. Tax. Guaranteed.

CHAMPION ELECTRIC CORPORATION
CHAMPION WORKS, SEAFORD, SUSSEX
 Tel. No.: SEAFord 3235.

COVENTRY RADIO

COMPONENT SPECIALISTS SINCE 1925

Thermo-Coups, 15 & 100 m.a. types. . . . 5/6
 Micro Ammeters, 20-0-20 m.a. 3 1/2" scale . . . 66/-
 Rectifiers, metal L.T. 12v. 1 1/2 amp. 12/-
 " " H.T. 260v. 50 m.a. 12/-
 Send for list of new 1st grade Radio components Price 3d post paid

COVENTRY RADIO.
DUNSTABLE ROAD, LUTON.

REQUIRED in Slough district, development and design engineers experienced in the following categories of radio work: (1) H.F. high power transmitters; (2) V.H.F. low power multiple-channel F.M. transmitters; (3) V.H.F. receivers for (2); (4) Portable single-channel transmitter/receiver sets. Salary according to experience.—Write Box 590, Dorlands, 18-20, Regent St., London, S.W.1. [7731

PHILIPS Group of Companies have vacancies for senior engineers, electrical and mechanical, for work on radio and television receiver design at Mitcham; the posts are permanencies, and salary ranging from £500 to £800 per annum will be offered to suitable applicants, according to qualifications and previous experience.—Apply in writing, to Secretary, Mitcham Works, Ltd., Mitcham Junction.

NORTHERN POLYTECHNIC, Holloway, N.7.—Radio laboratory steward (male) required immediately in the department of radio and musical instrument technology. Candidates should have a thorough knowledge of radio communications, technical electricity and civilian radio servicing, preferably with industrial experience; salary £190 to £250 per annum, plus a cost of living bonus, at present £78 per annum.—Applications should be made in writing, to the Secretary, Northern Polytechnic, Holloway, N.7, giving full details of age, qualifications and experience. [7740

BRITISH BROADCASTING CORPORATION.—Applications are invited for a number of appointments of engineers (Grade D) on a salary scale, £375-£20-£475 (minimum age 21) for duty at the Corporation's transmitting, studio and recording centres. Candidates, who must be of British nationality and parentage, must possess theoretical knowledge in electrical engineering, preferably in light current subjects, up to Higher National Certificate standard, together with practical experience in radio transmission, low frequency or sound recording work. Selected candidates will be required to serve a probationary period of six months, which will include a three months' training course at the Corporation's Engineering Training School at Evesham, Worcestershire. Confirmation of appointment will be subject to passing a qualifying examination at the end of the training course. Entry to the permanent staff (contributory Pension Scheme) is subject to two years' qualifying service.

APPLICATIONS, stating age, qualifications and experience, should reach the Engineering Establishment Officer, Broadcasting House, London, W.1, within 14 days of the appearance of this advertisement. [7787

BRITISH BROADCASTING CORPORATION.—Applications are invited for the post of engineer in lines department based at Manchester after preliminary training in London. Applicants should possess a university degree in physics or electrical engineering (or equivalent qualifications). They should have had wide practical experience and have a sound theoretical knowledge of distortion correction for all types of circuits and telephone lines used for the transmission of music, as well as voice frequency and carrier telephony. The successful applicant will be responsible for lines work in North Wales and the whole of the Northern part of England. Salary on appointment will be dependent on qualifications and experience and subject to favourable report will rise thereafter by annual increments to a maximum of £945 per annum.—Applications, stating age, qualifications and experience, should reach the Engineering Establishment Officer, Broadcasting House, London, W.1, within 14 days of the appearance of this advertisement. [7700

MINISTRY OF CIVIL AVIATION.—Appointment of radio mechanics, Grade II, APPLICATIONS are invited for appointment as radio mechanics at civil aviation radio stations in the United Kingdom. Candidates must possess a knowledge of the fundamental principles of radio and radar with a general knowledge of one or more of the following radio aids for navigation: Direction finding, Loran, Gee, Radar Beacons, A.C.R. or G.C.A. They should also have practical experience in the use of tools, filing, drilling, hard and soft soldering, cabling and wiring, and be experienced in the use of electrical and radio measuring instruments including cathode ray oscilloscopes. The possession of City and Guilds Certificates in Radio Communication and Technical Electricity will be an advantage. The pay will be 115/- per week, inclusive, rising by annual increments of 3/- a week to a maximum of 130/- a week. Applications, which must be in writing, stating date of birth, full details of qualifications and experience, and quoting the reference, C.A. 10, R.M. 1, should be addressed to the Establishment Division, Ministry of Civil Aviation, 10, Fleet St., London, E.C.4. [7707

J. BULL

& SONS (ww)
 246, High St.,
 Harlesden,
 N.W.10

announcing following additions to their List of Valves, British and American, from 5/10 as given in June issue of "Wireless World," page 45. These may be added to the many hundreds of types: CBL1, CBL31, 1B725, HP4106, KT33C, U403, YR105 30, YR150/30, X41C, 1B7, 6A87/1833, 6AC7/1852, 6C4, 707, 12847. Order C.O.D. Please enquire for any valve you require, even if not listed. We may have it. Old and new types are arriving daily.

Here is a non-classified selection of new items in order of their day-by-day arrival:—
Electro Plating Home Outfit Kit enables to nickel-plate any article which is electroplatable; operates from 1.5 volt dry battery, complete, £1 9s. 6d. **Stripper for Wire and Cable**, capacity 1.044-5 036 V.I.R. and flexibles Micro blade setting (18% Tungsten H.S. cutter, quick change bed, 15s. **Erie Steel Tray Box** with swing lid, containing 16 1-watt Resistors, assured values from 12 ohms to 10 megohms; not only colour coded but actually marked. Will carry 100% overload. Same as above but 4 1/2-watt 15 ohms, 10 megohms, £1 4s. **Pocket Level**, all metal, long life, accurate, spirit filled, 5s. **Magnifying Lens**, 2in. diameter, with frame and handle, 10s. **Lexington Moving Coil Pick-up**, scientifically engineered, 25 6s. **Motor, Elec. working model kit**, operates from 4.5 torch batt., 9s. 11d. **Gas Tester-Cooker**, electric, convertible unit, £3 19s. 6d. **Mice Traps**, electric, hygienic (no wattage), 12s. 6d. **Thermostatic Soldering Irons** for fine work, 70 watts, 12 0/6s., £1 4s. **Therm Elec. Gaslighters**, con plate with battery, ready to use, 11s. 6d. **Midget Radio Kit**, "Black Rhapsoody", modern in appearance and construction, complete from cabinet, black plastic to the last screw. Perfect natural tone value 4 valves, medium and long waves A.C./D.C. assembled in 3 hours, £11 9s. 7d. **Collaro Motor and Pick-up Unit** in leatherette carrying case, £11 5s. **Pocket Radio MCH1**, for battery and mains, on all waves, £12 4s. 6d. **Multicolors Ernie 3-color Solder** in new window cartons, 16 SWG 5s. 3d. **13 SWG 4s. 10d. Taylor Valve-tester**, 47A, portable, £25. **Hunts Capacitor**, analyzer and resistance bridge, C.R.B., £18 18s. **Midget Condensers**, 25 x 25 mfd., 200 v., 7s. 6d. **Taylor 120A**, £2 10s. **Transformers**, multi ratio (12 ratio), 9r. 9d. **Bleek-thread**, insulating material for neat jobs, 1s. **Ball Drive**, smooth epicyclic friction drive, ratio 6 to 1 1/2in. shaft, 3s. 3d. **Hand Drill**, precision instrument, smooth handle action, £1 4s. **Sentinel**, the new no-mast all-copper Aerial, 8 s.w. 9, hand drawn, 6s. 6d. **Wonder Crystal Set**, complete with headphones to match, £1 2s. 6d. **All-wave Oscillator**, battery operated with 2 dummy aerials, £12. **Trimmer Tool Kit**, complete outfit for set aligning, £1 12s. 6d.; Super kit, £1 17s. 6d. **Glass Dia.** 5 x 8in., all wave multicolour stations, 3s. 6d. **Solon Penicil Bit Solder Irons**, 230-250 v., 18s. 9d. **Speaker Fabric**, modern weave, coupon free, square foot 2s. 6s. **Sunray Lamp "Collaro"**, complete with goggles, £5 15s. 10d. **Cement Tin**, 6s. **Metal Engraving Pen**, electric, 10s. 6d. **Hydrometers**, non-break model, all plastic, 7s. 6d. **Telsen Electric Immersion Heater**, 200-230 v. 400 watts, 16s. **Moving Coil Microphone and Headphone Assembly** (approx. impedance of each unit 48 ohms). Microphone has "push to talk" switch (worth 4s), complete, only 17s. 6d. **Truthful**, wood plastic, 1s. **Therm Gaslighter Elements**, 1.5 v. 9d. **Therm Gaslighter Extensions** of torch, 1s. 3d. **Milammeter**, 0-5, 2 1/2in., £2 6s. **Milammeter**, 0-1, 2 1/2in. moving coil, £2 11s. 6d. **Lead-in Wire**, 4 mm. rubber insulated, per yard, 1s. **Service Sheets**, British or American, per doz. 10s. 6d. **Midget Speakers**, zinc, wood plastic, 7s. 6d. **Mains Transformers**, Pri. 200, 230 and 250 v.; Sec.: 350-0-350 v. 75 mA, 4 v. 4s. 4 v. 2s. £1 14s. 6d.

J. BULL & SONS (WW),
 246, High Street, Harlesden, N.W.10

WARD ROTARY CONVERTERS

For Radio, Neo Signs, Television, Fluorescent Lighting, X-ray, Cinema Equipment and innumerable other applications

We also manufacture:—
 Petrol Electric Generating Plants, H.T. Generators, D.C. Motors, etc., up to 25 K.V.A.

CHAS. F. WARD
LERDSCROFT WORKS, HAVERHILL, SUFFOLK
 Telephone: Haverhill 253 & 4.

SITUATIONS WANTED

TECHNICIAN, 39, C. & G. exp R.F., A.F. comp., insts., teaching; seeks pos. lab. or dev. television pref.—Box 431. [7829]

WIRELESS mechanic, good qualifications, keen on research and development, incl. television; London district pref.—Box 217.

VARIABLE, Gold Coast, radio service engineer; 30; A.M.I.E.T., A.I.P.R.E., Brit., I.R.E., student 7 years commercial radio servicing, own test gear; good salesman all electrical goods.—Box 432. [7835]

ADVERTISER, 35, present in financial organisation, £500 year, seeks technical post in radio or allied trade, commercial qualifications, 5 years radar instructor R.A.F., 20 years' exp. radio, television, some capital available later; offers, suggestions.—Box 488.

RADIO officer, 25, ex-M.N., City and Guilds Radio Comm., Grades I and II (awaiting results Grade III), 2nd Class P.M.G., studying grad. Brit.I.R.E., wide experience communication equipment, seeks progressive post radio industry; available August.—Box 8997. [7694]

EXPORTING firms please take note! Senior engineer (British), high British and American qualifications; experience: research, production, administration, Scandinavian market conditions and regulations; 32, healthy, ambitious, versatile; full or part time; travel anywhere; free August.—Thomson, Poste Restante, Elsinore, Denmark. [7755]

TUITION

ENGINEERING careers and qualifications. BOTH Government and industry have announced and emphasised that young men with technical knowledge and qualifications must receive every chance to rise to the highest positions within their capacity, in post-war engineering and allied industry; write to-day for "The Engineer's Guide to Success"—200 courses free—which shows you now you can become A.M.I.E.E., A.M.I.A.E., A.M.I.Mech.E., A.F.R.Ae.S., etc., and covers all branches in radio, automobile, mechanical, electrical, production, aeronautical, etc. THE Technological Institute of Great Britain, 82, Temple Bar House, London, E.C.4. [4918]

A.M.I.E.E. examinations.—Qualified electrical engineer-lecturer (B.Sc. (Eng.) Hons. A.M.I.E.E.), specializes in private individual tuition, vacancies for April, 1948, or later exams; personal or correspondence.—Box 407.

MILESTONES IN "QUALITY"

Tuners and Amplifiers by Lowther

Demonstrations daily at

THE LOWTHER MANUFACTURING CO.
Lowther House, St. Mark's Road,
BROMLEY, KENT.
Rav. 5225

THE POLYTECHNIC, 309 REGENT ST., W.1
School of Engineering.

Head of School; PHILIP KEMP, M.Sc. Tech., M.I.E.E., A.I.Mech.E.

FULL-TIME DAY COURSES are available in Electrical and Telecommunication Engineering. The courses, which extend over a period of four years, prepare for the National Diploma and Professional examinations and for the B.Sc. (Eng.) London. **Session 1947-8 begins on September 16th, 1947.**

EVENING COURSES in these subjects commence on Monday, 22nd September. New students will be enrolled on 15th, 16th and 17th September, from 6 to 8 p.m. Prospectuses, giving full particulars of courses, fees, etc., may be obtained on application to the undersigned.

J. C. JONES, Director of Education.

RADIO training.—P.M.G. exams. and I.E.E. Diploma; prospectus free.—Technical College, Hull. [0611]

RADIO Engineering, Television and Wireless Telegraphy, comprehensive postal courses of instruction.—Apply British School of Telegraphy Ltd., 179, Clapham Rd., London, S.W.9 (Estd. 1906). Also instruction at school in wireless for H.M. Merchant Navy and R.A.F. [3249]

THE Institute of Practical Radio Engineers have available Home Study Courses covering elementary, theoretical, mathematical, practical and laboratory tuition in radio and television engineering; the text is suitable coaching matter for I.P.R.E. Service entry and progressive exams; tuition fees at pre-war rates—are moderate.—The Syllabus of Instructional Text may be obtained, post free, from the Secretary, 20, Fairfield Rd., Crouch End, N.8. [6722]

BOOKS, INSTRUCTIONS, ETC.

WEBB'S radio map of the world locates any station heard, size 40x30in, 4/6, post 6d.; on linen, 10/6, post free.—Webb's Radio, 14, Soho St., W.1. Gerrard 2089. [9947]

TRANSFORMERS & CHOKES
To Special requirements 14 days

High Quality Vacuum Impregnated
AUSTIN MILLS LTD.
LOWER CARRS
STOCKPORT
Telephone : STO. 3791 Established 20 years.

THIS—Does these—



ACCURATELY and QUICKLY Chassis, Brackets, Irons, Condenser and Transformer clips—**TREPPANNING** Steel or Aluminium. Five sizes—12" to 36" Full particulars from **A. A. TOOLS, (W),** 197a, WHITEFACE ROAD, ASH FOR-UNDER-LYNE

AMBASSADOR



RADIO

Extended Tuning Scale—exclusive to Ambassador—makes micrometer tuning simplicity itself.

Superior electrical and mechanical construction employing advanced technique.

Four valves plus rectifier with three wave bands. A.C. Superhet Receiver with A.V.C.

A modern cabinet in Australian walnut of pleasing, simple proportion, with Bakelite escutcheon, size 19" x 12" x 8 1/2". £17 plus purchase tax.

AMBASSADOR RADIO WORKS
HUTCHINSON LANE,
BRIGHOUSE,
YORKS.

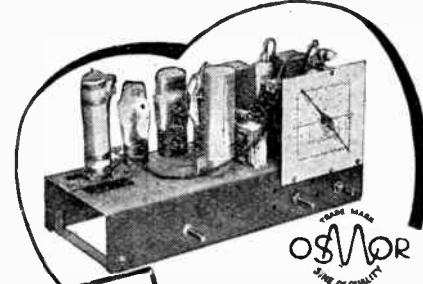

FOR THE TRADE OR AMATEUR

RADIO HEART

All the principal components of a factory-made 3 wave superhet receiver, matched and assembled, ready for wiring. Tested and proved for reliability, sensitivity and many exceptional qualities. Easy to build; saves time; no snags.

Let us send you details.

Sole Manufacturers:—
MORGAN, OSBORNE & Co., Ltd.
Southview Road, Warmingham, Surrey
Upper Warmingham 2560

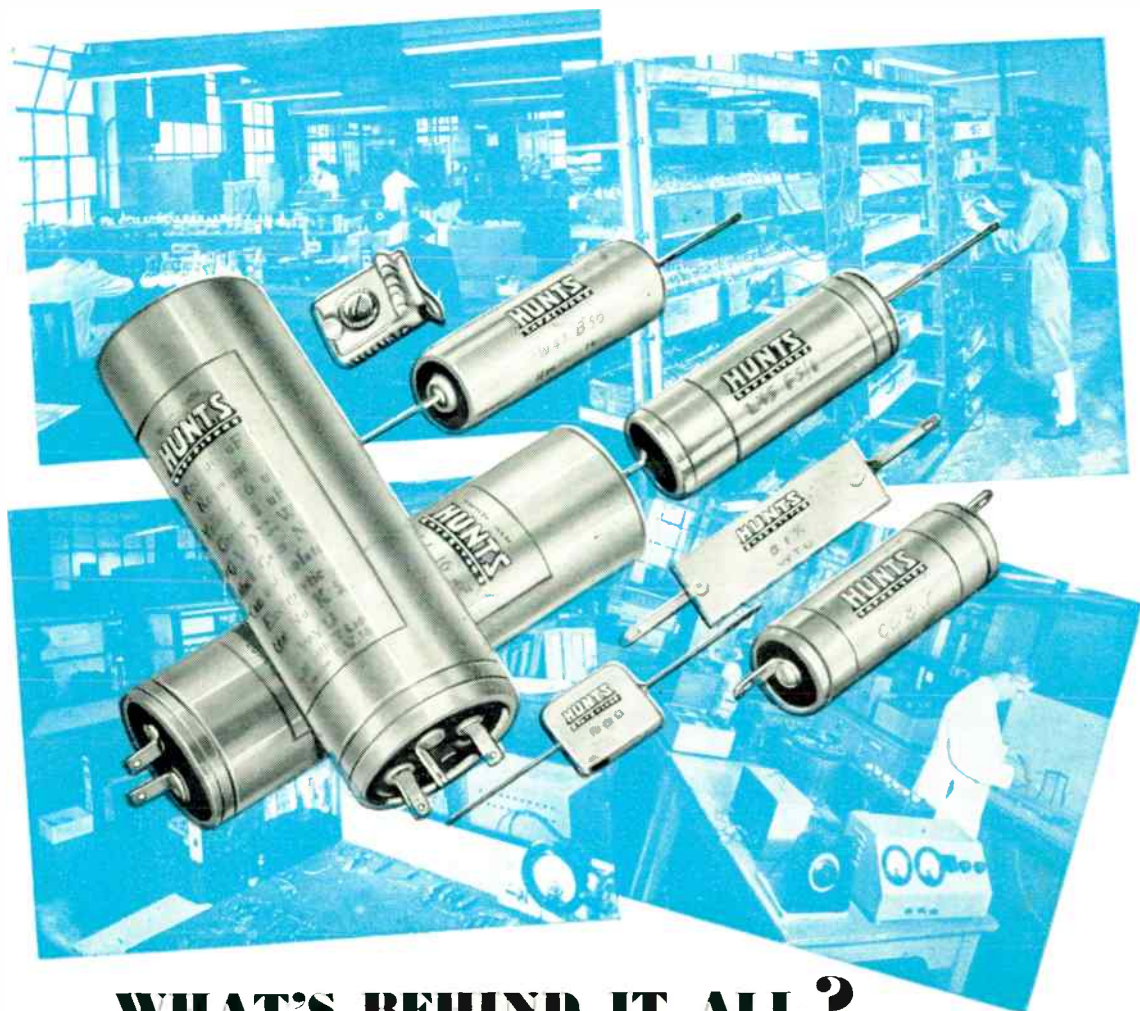

WHAT'S BEHIND IT ALL?

Extensive research laboratories, special design and development departments, wide manufacturing resources—all at your service, but not on your overheads! When you use any Hunt Capacitor, whether a normal type or as advanced as the Hunts exclusive Metallised Paper series, you are benefiting from

everything that Hunt's have achieved in many years of whole-hearted specialisation in capacitor design and manufacture. To specify Hunts as standard, to choose Hunts for replacements, to decide on Hunts for special purposes—all are the wise actions of people who demand nothing but complete reliability.



A. H. HUNT LTD · LONDON · S.W. 18
Established 1901

THE FIRST BRITISH POST-WAR RADIO SHOW

In October, Britain will display at Olympia the wonderful equipment that has given her World leadership in radio, radar and electronics. New inventions for radio in the Home, in the Fighting Forces, in Crime detection and in Industry. This pageant of British radio and television will display everything in radio to-day and a glimpse of the wonders of tomorrow.



RADIO OLYMPIA

OCT 1-11

OLYMPIA • LONDON • ENGLAND

★ This space has been donated to the Radio Industry Council by Multicore Solders Ltd., makers of Ersin Multicore Solder.