

Wireless World

RADIO AND ELECTRONICS

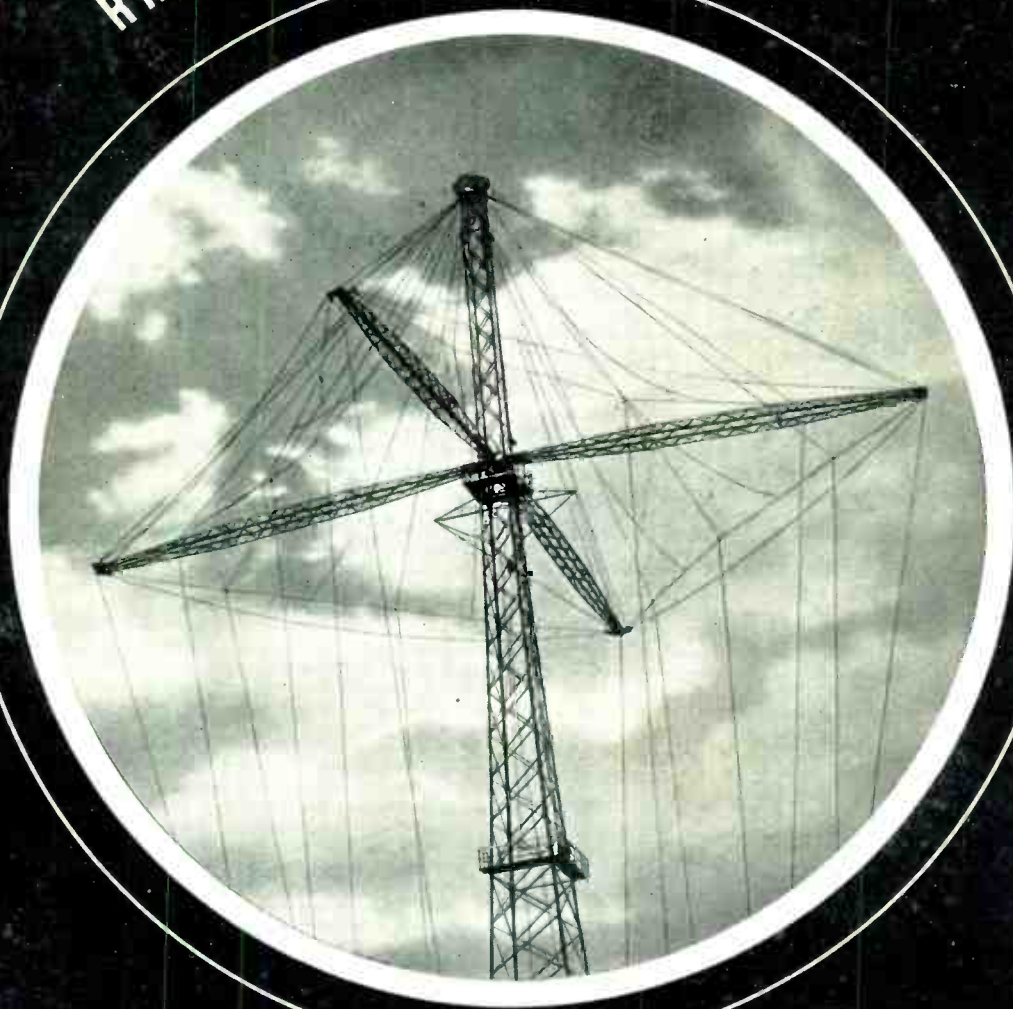

AUG. 1946

1/6

Vol. LII, No. 8

IN THIS
ISSUE :

THE OUTPUT STAGE: Effects of Mis-matching

THERE'S ALWAYS ROOM FOR ANOTHER ROLA

Rola SPEAKERS
 SELL THEMSELVES ON THEIR REPUTATION

*... and the Receivers
 in which they have
 been installed!*

BRITISH ROLA LTD. • GEORGIAN HOUSE • BURY ST. • ST. JAMES'S • LONDON, S.W.1 • ENG.

**Getting
Down
to
it!**

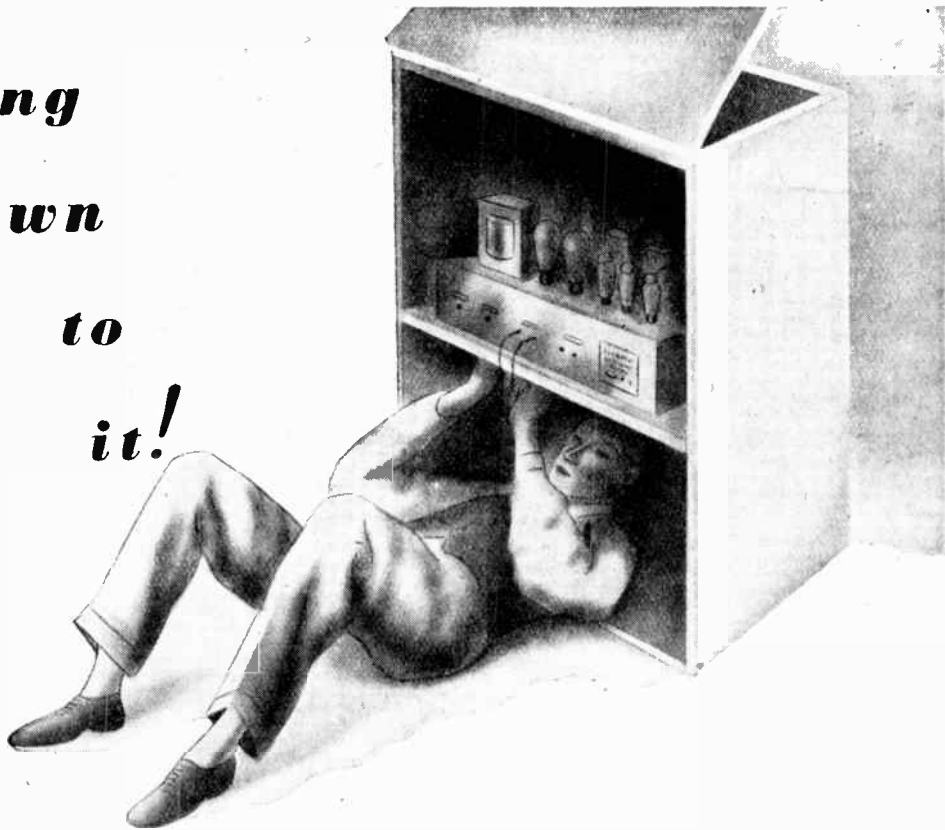

The 50-range Model 7 Universal AvoMeter is the ealder of the world-famed range of "Avo" Electrical Measuring Instruments which are appreciated for their compact portability, dependability, and a steadfast accuracy which is often used as a standard by which other instruments are judged. Fully descriptive pamphlet available on application.

OF course you don't have to take us too literally, but we assure our innumerable friends that we are pressing on with the production of all the well-known "Avo" Testing Instruments with a view to speeding up delivery dates as time goes on.

Meanwhile we have not neglected to use the advances perfected during the war years, and the several new Instruments scheduled for early production will measure up to the traditional "Avo" standards of accuracy and reliability.



(Regd. Trade Mark)

ELECTRICAL TESTING INSTRUMENTS

Sole Proprietors & Manufacturers:-
THE AUTOMATIC COIL WINDER & ELECTRICAL EQUIPMENT CO., LTD.
 WINDER HOUSE · DOUGLAS STREET · LONDON · S.W.1 TELEPHONE: VICTORIA 3404/8

THE NEW EDDYSTONE COMMUNICATIONS RECEIVER TYPE 504



The first post-war All British Communications Receiver is on the way—an "Eddystone"—with refinements that long experience in short-wave manufacture and close contact with war-time research has produced. The 504 is a 9-valve superheterodyne receiver with two R.F. stages, F.C., two I.F. stages with crystal filter, combined A.V.C. detector and first audio amplifier, noise limiter, B.F.O. and output valve plus the usual rectifier.

All valves are international octal based. Continuous tuning from 30,000 Kc/s to 600 Kc/s in five overlapping switched bands. Single tuning control with vernier indicator. Tuning mechanism is beautifully made, noiseless, free from backlash, with gearing reduction of 140:1 and effective scale length of tuning dial of 36 inches per band. I.F. 450 Kc/s B.F.O. permeability tuned and capacity controlled. Sensitivity better than 2 microvolts. Selectivity 30 db. down at 5 Kc/s off resonance. Very effective noise limiter. Output 3,000 milli-watts. External speaker. Speaker and telephone jack plugs. "S" meter, illuminated dial. Finished battleship grey with blue front panel and chromium fittings. Size 16 $\frac{3}{4}$ ins. x 10 $\frac{1}{2}$ ins. x 9 ins. For 110 volts and 200/240 volts, 40-60 cycles A.C. Consumption 65 watts.

PRICE: **£48 10s.** (Purchase Tax £10 8s. 7d.)

Supplies will be available in August through appointed "Eddystone" Agents.

EDDYSTONE

"Puts Perfection into Performance"

STRATTON & CO., LTD., EDDYSTONE WORKS, WEST HEATH, BIRMINGHAM

LONDON COUNTY COUNCIL

NORWOOD TECHNICAL INSTITUTE

Knight's Hill, West Norwood, S.E.27

GIPsy Hill 2268/9

Principal: L. N. COOMBS, B.Sc.

OPENING DATES—NEW SESSION

Day Students: MONDAY, 9th September, 1946
Evening Students: MONDAY, 23rd September, 1946

ENROLMENT

Day Students: Now until 7th September, 1946
Daily, from 9.30 a.m.—5.0 p.m.
Evening Students: 16th to 20th September, 1946
Daily from 6.0—8.30 p.m.

FULL-TIME DAY COURSES

Matriculation and Preliminary Professional
1st M.B., Intermediate Science, and Pharmacy

PART-TIME DAY COURSES

Special courses in Pure Science, Radio Engineering and Radio Servicing, for students who are released by their employers for part-time day attendance

PART-TIME DAY CLASSES

Science, Languages, Literary, Music and Women's Subjects

EVENING CLASSES

Science (to B.Sc. General)
Matriculation and Preliminary Professional
Radio and Television
Commercial
Languages, Literary and Music
Women's Subjects

PROSPECTUS ON APPLICATION TO PRINCIPAL

NEW ROMAC RADIO & ORAL COMMUNICATION COMBINED

25 Watt, Model 25/HII.

Incorporated Radio Tuning Unit,
Provision for Moving Coil or
Crystal Microphone and High
Impedance Gramophone Pick-up to
meet the demand of the present
day for High Grade Equipment.

Delivery Ex Stock

Also our Model 25/HI Amplifier for
Microphone and Gramophone input
only, also with high quality output
of 25 watts.

Delivery Ex Stock.

Gramophone Playing Desk Unit
in attractive case with lid available
with either Amplifier.

ROMAC RADIO CORPN. LTD.

THE HYDE • HENDON • LONDON, N.W.9

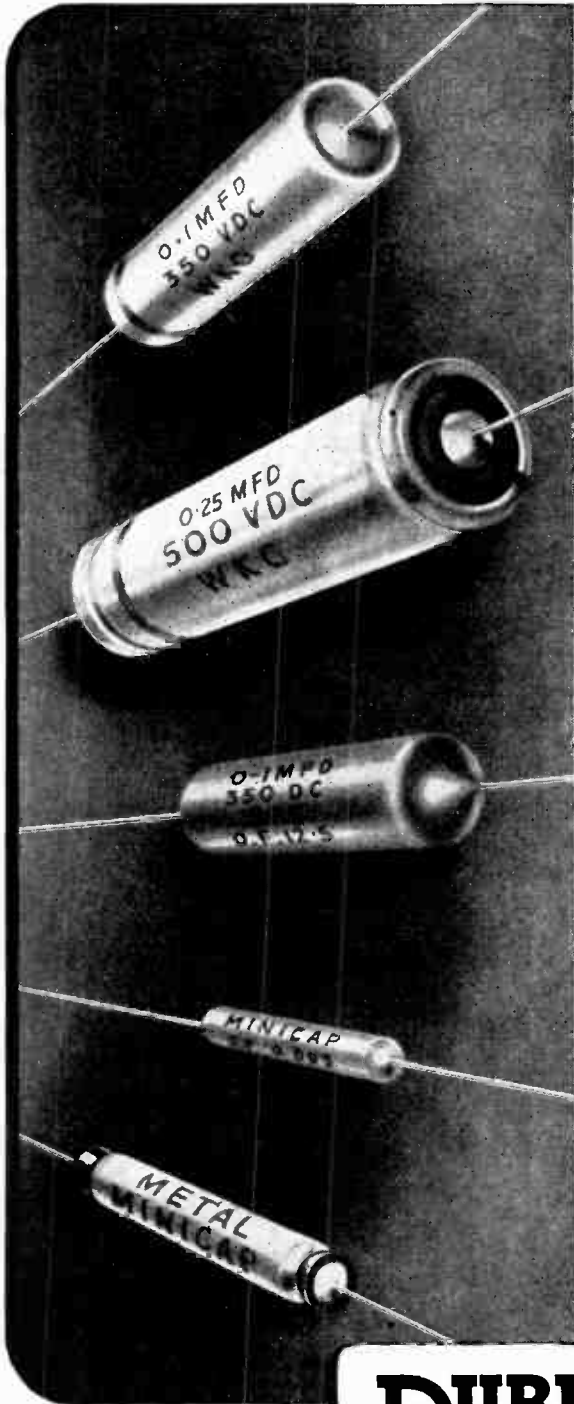

PAPER *Capacitors*

THE STANDARD OF TECHNICAL EXCELLENCE QUALITY AND RELIABILITY

The Dubilier low inductance **Tubular Paper Capacitors**, with extended foil elements, cover the wide field of general commercial requirements; their construction providing inexpensively the highest degree of excellence.

The **Metal-Cased Tubular Paper Capacitors**, specifically designed and developed for stringent tropical conditions, satisfy the most exacting requirements. Neoprene sealed and impregnated for use at high operational temperatures they effectively meet exceptional demands.

The **Metallised Paper Capacitors** are extremely compact and efficient, setting a new standard in their own class.

Where miniature capacitors are necessary and where minimum size and weight are imperative together with electrical performance and mechanical strength, the "Minicaps" are the most satisfactory selection.

The **Metal-Cased "Minicaps"** are Neoprene sealed and capable of withstanding the most severe conditions of tropical temperatures and humidity and fully justify inclusion in all designs.

MAKERS OF THE
WORLD'S FINEST CAPACITORS

DUBILIER

CONDENSER CO. (1925) LTD.

D4

DUBILIER CONDENSER CO. (1925) LTD., DUCON WORKS, VICTORIA ROAD, NORTH ACTON, W.3

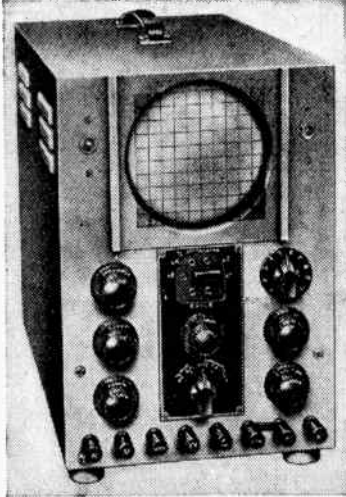

STATIC TWO-DIMENSIONAL
visual delineation of any recurrent law.

RELATIVE TIMING OF EVENTS
and other comparative measurements with extreme accuracy.

PHOTOGRAPHIC RECORDING
of transient phenomena.

SIMULTANEOUS INDICATION
of two variables on a common time axis.

INDUSTRIAL INDICATING and TESTING afford increasing scope for the Cathode Ray Tube as the only device with the above inherent features of which the last is unique in the Cossor DOUBLE BEAM Tube.

The Model 339 Cossor Oscillograph thus equipped is invaluable on all problems of research, production or operational testing, when the effect examined is applied as a voltage. When recurrent the traces are studied visually and when transient are recorded photographically, using Model 427 camera.

A. C. COSSOR LTD.,
INSTRUMENT DEPT.

Cossor House, London, N.5

Phone: CANonbury 1234 (33 lines).
Grams: Amplifiers Phone London.

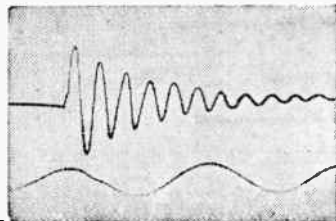

M.R. SUPPLIES Ltd.

offer the following brand new and reliable Radio and Electrical Material. Prompt despatch. All prices net.

ROTARY TRANSFORMERS, very remarkable offer of a limited number (ex-Govt.). Input 12/20 v. D.C. Outputs: 300 v. 30 m.a. and 6.5 v. 3.2 amp. P.M. field—can be run from any of the three coms. Suitable for charger from D.C. mains, cine motor, etc., only 21/- each (despatch 1/6).

ROTHERMEL PIEZO-CRYSTAL PICK-UPS, new low prices:—Senior, in black bakelite, 57/6. Also 8.8, with channel steel arm, 54/-. **ROTHERMEL Sapphire Gramophone Needles**, permanent, fine reproduction, 12/6. **STROBOSCOPES** (card-board) showing 78, 79 and 80 r.p.m. on 50 c. viewing, 1/-.

METAL RECTIFIERS by 8TC (Selenium). All for charging up to 12 volts at 1.5 amp., 12/6; 3 amp., 22/6; 6 amp., 39/6; 10 amp., 49/6. These are all full-wave, bridge connected. Suitable **TRANSFORMERS**, all with tapped primary, 200/250 v. Sec.—7, 11 and 15 v. at 2 amps., 20/-. Sec.—8 and 14 v. at 3 amps., 32/6. Sec.—5, 12 and 17 v. at 6 amps., 49/6 (desp. 2/-). These can be sold separately.

POWER TRANSFORMERS:—With tapped primary, 200/250 v. All layer wound, interleaved and constantly rated. Sec.—350/0/350 v. 120 m.a., 4 v. 5 a., 4 v. 2 a., 39/6 (desp. 1/6). Sec.—450/0/450 v. 150 m.a., 8.3 v. 4 a., 6.3 v. 2 a., 5 v. 3 a., 49/6 (desp. 2/-). We do not offer any "Cut-rated" transformers.

SIGNAL GENERATORS. We confidently recommend the new BPL Instrument and have already supplied many of the large firms' laboratories. Operation 200/250 v. A.C. Frequencies:—100/250, 250/650, 650/1,600 Kc/s. 1.6/4.5, 4.5/12, 12/30 Mc/s. Accuracy 1 per cent. 1 volt in 10 ohms. All ranges modulated to depth of 30 per cent. by internal 400 c. oscillator (off switch provided). 6 in., illuminated scale. 400 c. brought out separately. Double screening, 221 net (desp. 2/6). Ex stock.

MEGGERS. The "Wee-Megger" by Eveready again in stock. Pressure 500 volts. Range 0/20 megohms and inf. Supplied with pocket and log books, 29/10s. **VENT-AXIA EXTRACTOR FANS**. A few of the very efficient "Silent 6" at the pre-increase price. 220/250 v. A.C. Fitted weatherproof cowling. Easy to instal, consumption only 24-watt, 25 8s. 8d.

WILLIAMSTERS by Taylor. High-grade moving coil, 2 1/2 in. flush mtg. Deflection 0/500 milliamps (can be despatched for lower reading), 29/6.

VARIABLE RESISTANCES. Cressall wire-wound potentiometers (or rheostats), 10 ohms, 1 amp., with knob, 5/6. **SLIDING RESISTANCES**, fully enclosed, 100 watt range:—4 ohms 5 amps, 10 ohms 3 amps, 50 ohms, 1.4 amp., 100 ohms 1 amp., 200 ohms 0.7 amp. or 400 ohms 0.5 amp., any one, 27/6. Also 6 ohms 10 amps (600 watt) 59/6 (desp. 3/-).

INSTRUMENT KNOBS, 1 1/4 in. with 2 1/2 in. skirt, brass bushed with 1/4 in. bore, with 2 set screws, 1/8 each, 11/9 dozen.

POINTERS knobs, brass-bushed, 1/4 in., 8d. each, 6/6 doz.

LOUDSPEAKERS. We only offer the superior types. Vitavox High-fidelity P.M. models, with high-flux ticonal magnets, 12 in. die-cast chassis, 15 ohms coils, the K12/10 (10 watt), 27. K12/20 (20 watt), 21/1 (desp. either 5/-). The new Gramplan 7 watt, 9 in. P.M. Speaker with either 2 or 15 ohms coil, 38/- (desp. 1/6). The ideal unit for horn-loading. **PROJECTOR SPEAKERS**, large range in stock for immediate delivery:—Vitavox 10 watt P.M. Unit (15 ohms) with 4 1/2 in. all-metal round Horn, 210 10s. (desp. 7/6). With 30 in. all-metal square Horn, 28 17s. 6d. (desp. 5/-). Units only:—Vitavox 10 watt, 28. G.E.C. 12 watt (with line transf.), 27 10s. Reslo and Gramplan 10 watt, 27 5s.

Please include sufficient for despatch where not stated.

M.R. SUPPLIES Ltd., 68, New Oxford Street, London, W.C.1

Telephone: MUSeum 2958

★ ADASTRA ★
GALVANISED SECTIONAL STEEL
RADIO MASTS
Send for Catalogue *WQ/330*
POLES LTD TYBURN RD. EDINGTON
BIRMINGHAM 24

Difficult Problems?

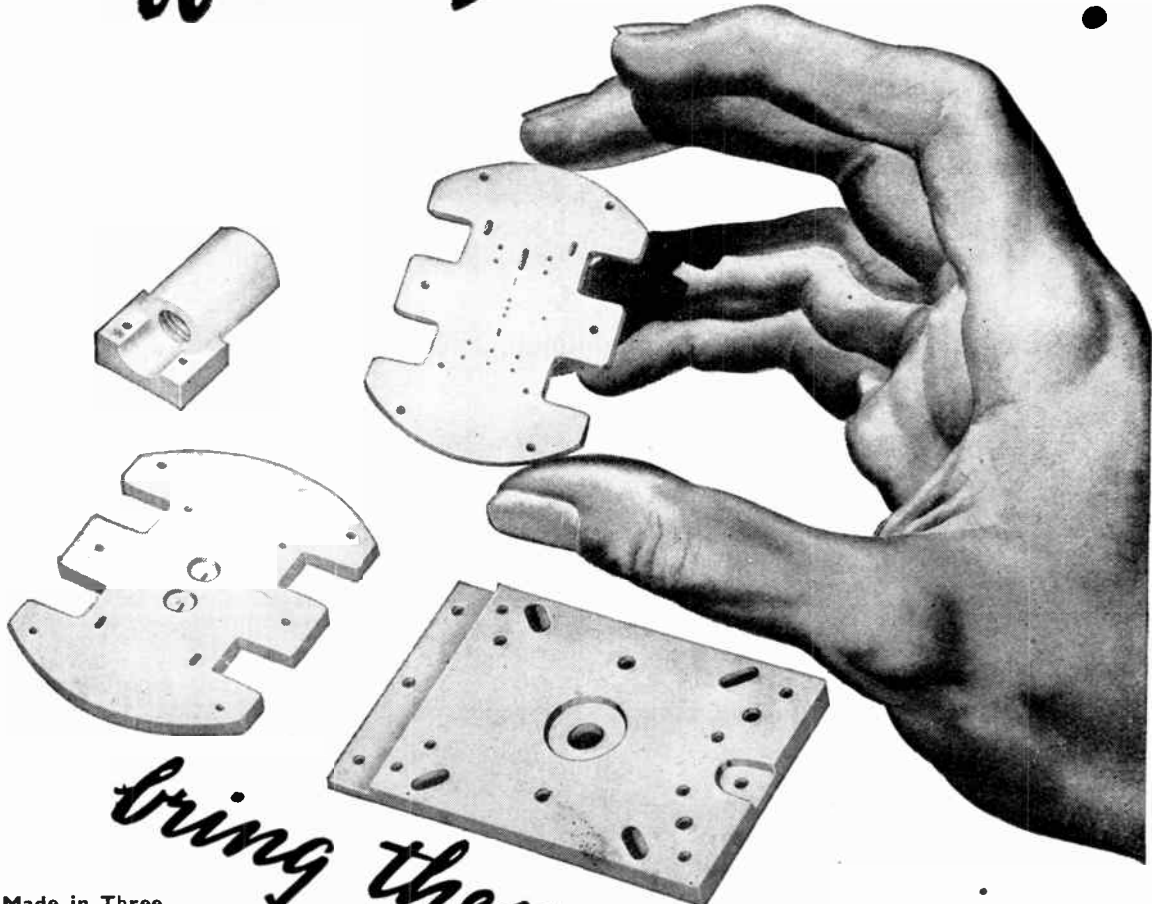

Bring them to ...

Bullers

Made in Three
Principal Materials

FREQUELEX

An insulating material of Low Dielectric Loss, for Coil Formers, Aerial Insulators, Valve Holders, etc.

PERMALEX

A High Permittivity Material. For the construction of Condensers of the smallest possible dimensions.

TEMPLEX

A Condenser material of medium permittivity. For the construction of Condensers having a constant capacity at all temperatures.



BULLERS LOW LOSS CERAMICS

BULLERS LTD., 6, LAURENCE POUNTNEY HILL, LONDON, E.C.4

Telephone: Mansion House 9971 (3 lines) Telegrams: "Bullers, Cannon, London" Manchester Office: 196, Deansgate, Manchester

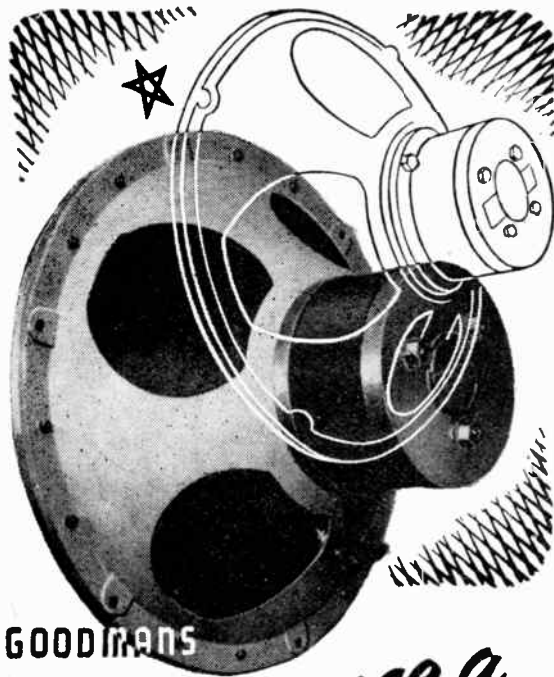

GOODMANS

Announce a
15 in
LOUDSPEAKER

The illustration shows the comparative sizes of a Goodman's 15 in. and 12 in. Loudspeaker. You already know the performance of the famous 12 in. Now consider the technical data of the new 15 in. model.

Overall Diam. 15 in.—
Overall Depth 8 in.
Fundamental Resonance—55 c.p.s.
Voice Coil Diam—2 in.
Voice Coil Imped.—4 ohms at 400 c.p.s.
Flux Density—14,500 gauss.
Max. Power Capacity—25 W. peak A.C.
Net Weight—26lb. 8oz.

With an excellent response up to 6,000 c.p.s., and an unusually high power handling capacity, this instrument sets a new standard in Loudspeakers for the Dance Hall, Rink, Cinema and Heavy Duty P.A. installations.

PRICE £18.10s. (subject)

The **GOODMANS** T10/1501/3·5
Loudspeaker

GOODMANS INDUSTRIES LTD., LANCELOT RD., WEMBLEY, MIDDX.
Telephone : Wembley 4001 (8 lines).

We are
STILL TRYING

to meet the great demand for our products and to improve on the delivery period

Catalogue 6d.
DENCO (CLACTON) LTD.
OLD ROAD, CLACTON, ESSEX
Telephones : CLACTON 151 & 807



FOR THE RADIO SERVICEMAN DEALER AND OWNER

The man who enrolls for an I.C.S. Radio Course learns radio thoroughly, completely, practically. When he earns his Diploma, he will KNOW radio. We are not content merely to teach the principles of radio, we want to show our students how to apply that training in practical, every-day radio service work. We train them to be successful!

Write to the I.C.S. Advisory Dept. stating your requirements. Our advice is free and places you under no obligation.

.....You may use this Coupon.....

INTERNATIONAL CORRESPONDENCE SCHOOLS Ltd.
DEPT. 38, INTERNATIONAL BUILDINGS, KINGSWAY, LONDON, W.C.2.

Please explain fully about your instruction in the subject marked X
Complete Radio Engineering Radio Service Engineering
Elementary Radio

And the following Radio Examinations:—
British Institution of Radio Engineers.
P.M.G. Certificates for Wireless Operators.
City and Guilds Telecommunications.
Wireless Operator and Wireless Mechanic, R.A.F.

Name..... Age.....

Address.....

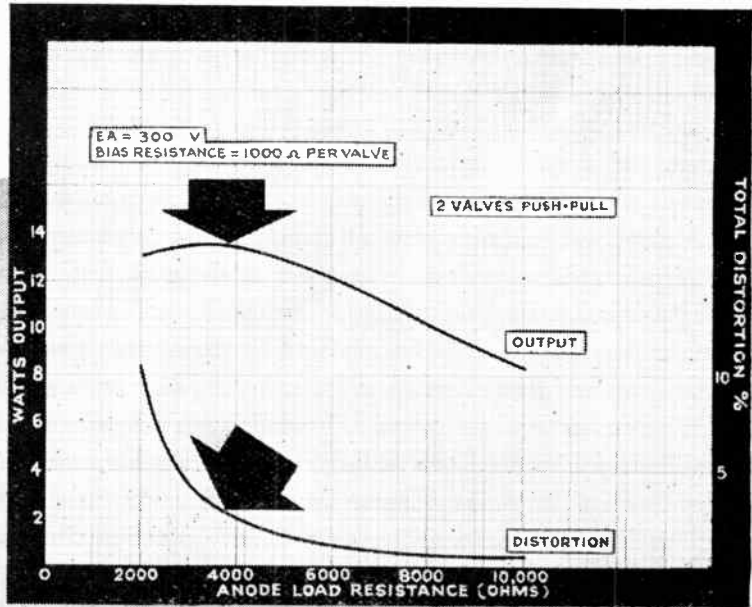

POINTERS FOR DESIGNERS

THE P X 4

A low impedance power triode, the OSRAM PX4 has achieved an almost unique popularity as an output valve (usually in push-pull pairs) for high quality Audio Frequency amplifiers at moderate power. Its outstanding features include :—

- Large undistorted power output — ample for all domestic purposes — up to 13.5 watts per push-pull pair.
- Very low harmonic content — only 2% distortion in push-pull at full output.
- Long life at a continuous anode dissipation up to 15 watts per valve.

A detailed technical data sheet is availz'b'e on request.

Osram
PHOTO CELLS

G.E.C.
CATHODE RAY TUBES

Osram
VALVES

Advt. of The General Electric Co. Ltd., Magnet House, Kingsway, London, W.C.2.

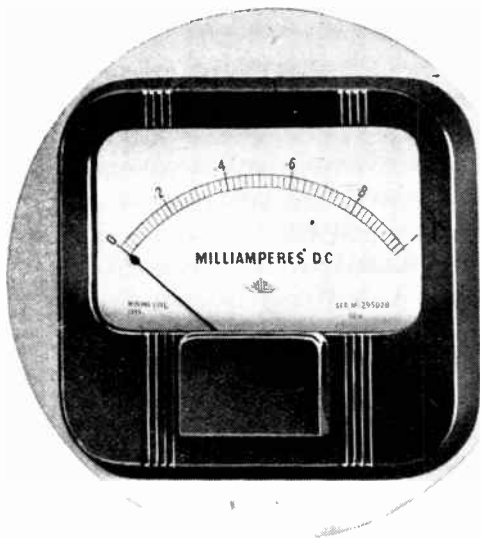

PULLIN

SERIES 35
ILLUMINATED DIAL
RECTANGULAR
INSTRUMENTS

THE Pullin illuminated dial fitment gives even illumination over the whole scale. Being external it cannot cause heating of the movement. It is housed in a metal box on the front cover and can be easily inspected or replaced without the use of tools. The box acts as a reflector and its design and position enhances the appearance of the instrument. The lamp is a 6 V. 3 watt tubular festoon type. The terminals are at the back of the instrument case.

These instruments are available in a wide range of moving coil types to meet every requirement. Full details upon application.



Please address all correspondence to: Dept. J., Phoenix Works
Great West Road, Brentford, Middlesex. Ealing 0011

BALL DRIVE

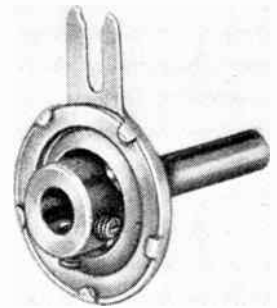

- SMOOTH, RELIABLE & VERY POWERFUL
- Epicyclic friction drive, ratio 6 : 1
- May be used to increase ratios on other drives or attached direct to component spindle (1/4" shaft).

PRICE 3/3 RETAIL



JACKSON

BROS (LONDON) LIMITED
KINGSWAY · WADDON · SURREY
TELEPHONE: CROYDON 2754-5 TELEGRAMS: WALFILCO, PHONE, LONDON

— Wharfedale —



Public Address

**LOUD
SPEAKER**

W.12

Now fitted with

13,000 LINES
FLUX DENSITY

PRICE
135/-

TICONAL MAGNET

Die Cast Non-resonant Chassis with accurate rear suspension. Impedance 15 ohms. Diameter 12". Weight, 11½ lbs. Peak input, 15 watts.

WHARFEDALE WIRELESS WORKS

NEW ADDRESS :

BRADFORD ROAD, IDLE, BRADFORD

Telephone : Idle 461.

Grams : Wharfedel, Idle, Bradford.

METALLISED CERAMICS

for

Hermetic Seals and Soldered Assemblies

FREQUENTITE BUSHES



Photographs (above) actual size.
- Drawings not to scale.

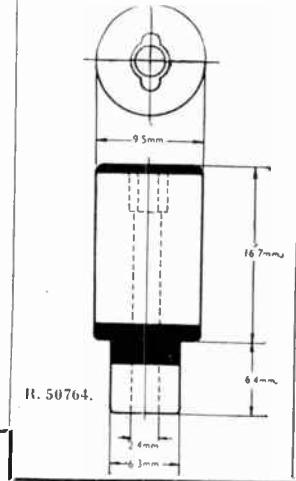
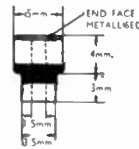
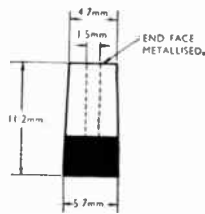
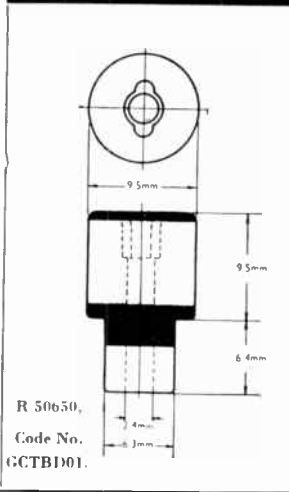

Code nos. are those used in I.S.C.Tech.C.
Specification No. R.C.L./330.11.

PORCELAIN BUSHES

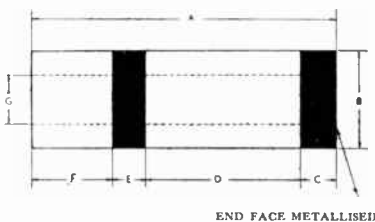
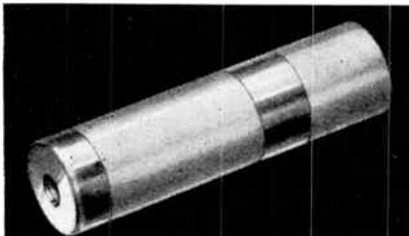

TYPE	CODE	A mms.	B mms.	C mms.	D mms.	E mms.	F mms.	G mms.
R. 50734	GCTBC01	20.3	7.6	3.8	6.4	4.6	5.5	3.0
R. 50768	GCTBC02	20.3	12.7	3.8	6.4	4.6	5.5	5.1
R. 50769	GCTBC03	20.3	15.2	3.8	6.4	4.6	5.5	6.4
R. 50770	GCTBC04	38.1	10.2	5.1	15.7	6.4	10.9	4.1
Q. 2092	GCTBC05	55.9	12.7	6.4	25.4	8.9	15.2	5.1
Q. 1982	GCTBC06	78.7	15.2	6.4	38.1	8.9	25.3	5.1

For full information and prices please write to:

STEATITE & PORCELAIN PRODUCTS LTD.

STOURPORT-ON-SEVERN, WORCS. T'phone: Stourport III. T'grams: Steatoin, Stourport.



LINAGLOW LIMITED

R.A.F. PORTABLE TRANSMITTERS

—USED but COMPLETE—

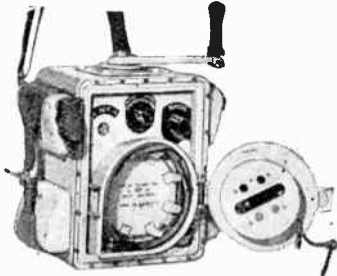

Complete Transmitter

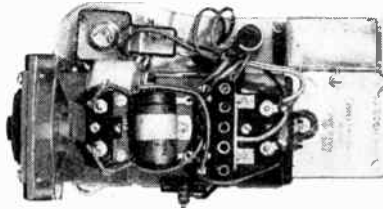

Power Pack
With Hand Generator giving 6 volts & 350 volts.

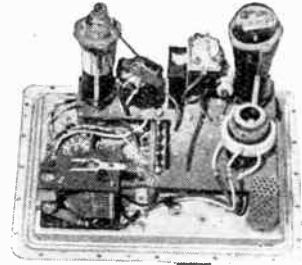

Top Panel of Transmitter

Containing a wealth of valuable components, useful for the amateur or can easily be converted for use on amateur bands. Circuit diagrams and Parts Lists supplied with each instrument. Each transmitter is complete with valves, crystal, Litz wound coils, morse key, variable condenser, relays, portable aerial, resistors, chokes, condenser, etc.

(Approximate cost to Manufacture £39.)

PRICE

35/-

Carriage and packing 2/6 extra.

Please note NEW ADDRESS: Dept. M.O.68, 34, OSNABURGH ST., EUSTON RD., N.W1.

(Nr. Gt. Portland St. Station)

Telephone No. EUsTon 8406 (5 lines.)



At last you CAN do something

WHERE NOISE LEVEL IS HIGH

TYPE P.V.H. NOW AVAILABLE

The Gramplan Type PVH—a velocity loudspeaker—has been in short supply and you haven't been able to deal with "high noise level" workshops. Now the supply situation has eased—type PVH is available for general installation. Go over your P.A. systems and get rid of those irritating "blind spots" which exist where noise level is high or awkward partitioning is interfering.

GRAMPIAN SPEAKER
Projector Type PVH. 10 watts. 15 ohms. Impedance. PRICE

£13.5

GRAMPIAN MICROPHONE
Type M.C.S. Pressure operated. 70-8000 cycles. Impedance 20 ohms. PRICE

£7.5

GRAMPIAN
LOUDSPEAKERS

All orders dealt with in strict rotation.

Phone: GRAMPIAN REPRODUCERS Ltd. FELTHAM 2057. Hampton Rd., Hanworth, Middx.

Scientific G.L.S.

LABGEAR

• FOR MODERN SERVICE •

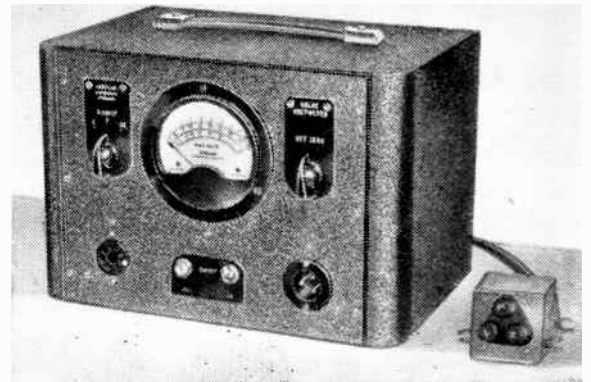

NOW ANOTHER RADIO ENGINEER'S FRIEND
LABGEAR VALVE VOLTMETER

3 Ranges. Input Capacity 5.4 uuf. (av.)

BUILT TO LABORATORY STANDARDS.
ENQUIRIES TO:

PRICED TO SUIT ALL.
WILLOW PLACE,
CAMBRIDGE.

Labgear

Tel.: 2494 (2 lines).

MANUFACTURERS OF FIRST CLASS TEST EQUIPMENT.

Radio Towers



These three 600-foot fully insulated steel radio towers, built for the G.P.O., support a complicated aerial system. The erection of such towers and masts demands a high degree of specialized knowledge and a vast experience. B. I. Callender's have built some of the tallest radio towers in existence and are prepared to undertake further work in any part of the world. Further information is available on request.

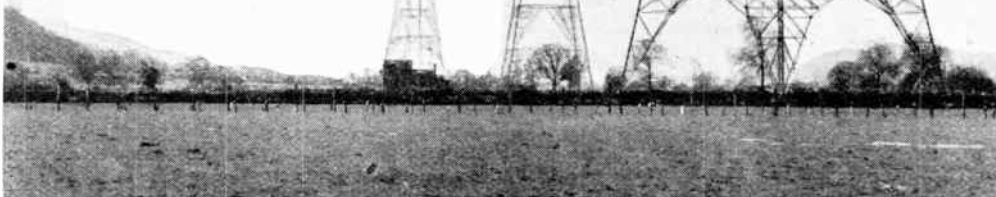

BRITISH INSULATED CALLENDER'S CABLES LIMITED
NORFOLK HOUSE, NORFOLK STREET, LONDON W.C.2

EQUIPPING A LABORATORY ?

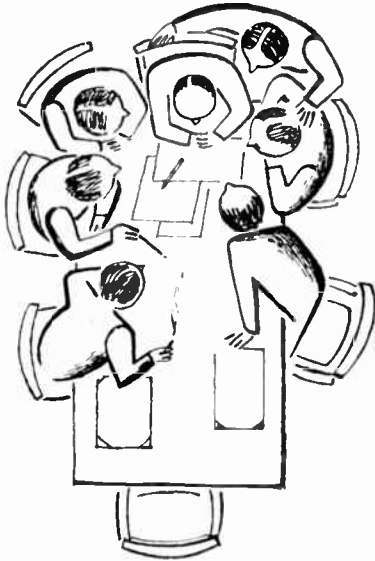

Let's get our heads together

Time and time again experience has shown that a considerable saving of time and money could have been made if Marconi Instruments had been called in at the very earliest stages of equipping or re-equipping a scientific laboratory. All too often it is found that vital instruments have to be installed almost as an afterthought when it is too late to site them in the most logical and convenient place. All too often it is found after several measuring instruments have been installed that a single piece of Marconi apparatus could have done the work of them all.

Consult Marconi Instruments from the start—it costs nothing and may save a great deal of time and money.

MARCONI INSTRUMENTS LTD.

ST. ALBANS, HERTS. Telephone : ST. ALBANS 4323/6. Northern Office : 30, ALBION ST., HULL. Telephone : HULL 16144
Western Office : 10 PORTVIEW ROAD, AVONMOUTH, BRISTOL. Telephone : AVONMOUTH 438

ARE YOU A ONE ROOM RADIO LISTENER?

Now that Stentorian Extension Speakers are coming back to the shops the pleasure of listening again becomes complete. Just plug in one of these superb permanent magnet speakers to your set and you can enjoy its clear, pure tone anywhere in the house: sitting-room, kitchen, bedroom, wherever you happen to be. Supplies are still short, but a Stentorian is worth looking for. Ask your local dealer about them.



PRICES

- Minor Type MX (for Low Impedance Extension) - 29/6
- Minor Type MC (with Universal Transformer) - 35/6
- Baby Type BX (for Low Impedance Extension) - 43/6
- Baby Type BC (with Universal Transformer) - 49/6



Stentorian

THE PERFECT EXTRA SPEAKER FOR ANY SET

WHITELEY ELECTRICAL RADIO CO. LTD., MANSFIELD, NOTTS.

IF YOU USE WAX

We Are At Your Service

THE WIDE RANGE OF OKERIN DI-ELECTRICS

created in our own laboratories fulfils almost every need of the Electrical Industries. Grades have been designed for the most severe and varied conditions. Most are resistant to mould and fungus growth, whilst special types are evolved whenever new applications arise.

We invite technical discussion on difficult problems.

ASTOR BOISSELIER & LAWRENCE LTD.

(Sales Dept.), Norfolk House, Norfolk Street, Strand, W.C.2
Telephone : Temple Bar 5927.

PINCH EFFECT

and its relation to record wear

A maximum of .0004" vertical movement is necessary to overcome the "pinch effect" which has been carefully dealt with in the design of

The LEXINGTON MOVING COIL PICK-UP

SCIENTIFICALLY ENGINEERED

This is made possible by our patented principles and the introduction of precision watch making mechanics in its construction.

Price £5 plus 25/- P.T.



The new features are :

- Robust design. Accidental dropping on record will not damage Pick-up.
- Extremely low moment of inertia (80 milligrams total weight of movement).
- Pure sine wave with n^o harmonic distortion.
- Response curve flat from 30 c/s to 12 Kc/s.
- Automatic needle or sapphire changing opens new fidelity field to the amateur.
- Can be used with normal record changer without fear of damage.

PRE-AMPLIFIERS are also available. Compact design for screwing in cabinet. With or without bass recording characteristic correction. Suitable for use with standard amplifiers.

POWER AMPLIFIERS, 8, 15, and 30 watts undistorted output.

Obtainable from your Local Dealer.

Send stamp for illustrated brochure giving full technical details and prices. DEMONSTRATIONS DAILY, MONDAY TO FRIDAY, 10 - 5 p.m. Trade enquiries invited.

COOPER MANUFACTURING CO.
134, Wardour Street, London, W.1. GERard 7950

consult us on your

PLASTIC PROBLEMS

COSMOCORD LTD · ENFIELD

BARGAINS

METAL RECTIFIERS most famous make. Deliver 250 volts, 120 m/A.

2 will give 500 v 120 m/A.
4 1000 v 120 m/A.

and never need replacement. This will solve your H.T. problems. Brand new, tropical finish. Our price 2/11d. each.

MOUNTED 1000 Kc CRYSTALS in holders, with stainless steel ground electrodes by Britain's finest maker. Make up a frequency meter to comply with G.P.O. requirements, or allow you to recalibrate a receiver with highest accuracy. Also cheap enough to regrind to 1.7 or 3.5 Mc. Complete with holder, brand new, worth £4 each. Our price 7/6d.

CANADIAN NO. 65 TRANSMITTER-RECEIVERS. 8 valve superhet and transmitter complete with power supply, 3 aeriels, 2 pairs headphones, 2 crystal differential microphones, and all instructions. Brand new in maker's cases. Cost £100. Our price 13 Gns.

R.A.F. 1154 TRANSMITTERS. Complete with valves but require a power pack, covers the Ham bands. Secondhand but good condition. Price 6 Gns.

Coming Shortly — a super dipole aerial with polythene concentric feeder. National type dials as fitted. H.R.O. receiver.

Get our full Bargain List by sending stamped addressed envelope to :—

RADIOMART
G.S.M. (GRAM) LTD.

48 HOLLOWAY HEAD, BIRMINGHAM 1

5 mmf/ft

NEW LOW LEVELS in capacity and attenuation of CO-AX Cables mean new possibilities in electronic equipment design both for the war effort and for the post-war electronic age.

Write for characteristics

**BASICALLY BETTER
AIR-SPACED**

CO-AX LOW LOSS CABLES

TRANSRADIO LTD. 16 THE HIGHWAY BEACONSFIELD 4-BUCKS.

Symbols of accuracy



Model 400
moving coil instrument

Now available as low as 5 microamps full scale

Send enquiries to your usual factor or direct to

Taylor Electrical Instruments Ltd.
419-424 MONTROSE AVENUE, SLOUGH, BUCKINGHAMSHIRE
Tel: Slough 21381 (4 lines) Grams: "Taylins" Slough

ERSIN MULTICORE

Multicore Solder contains 3 cores of extra active non-corrosive Ersin Flux. No extra flux is required and joints can be readily made on oxidised surfaces. The three cores of Ersin Multicore ensure rapid melting and flux continuity, thus speeding up soldering operations and eliminating waste.

NOMINAL 1-lb. REELS HIGH TIN CONTENT PRE-WAR QUALITY.

Catalogue Reference No.	Alloy Tin,Lead	S.W.G.	Approx. Length per nominal 1-lb. reel.	Price per nominal 1-lb. reel (subject).
16014	60/40	14	64 feet	6 -
16018	60/40	18	178 feet	6/9

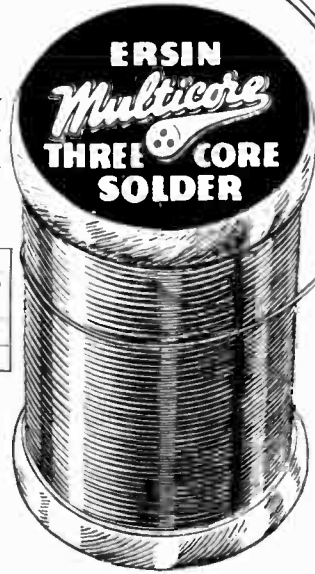
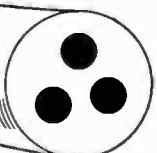

Purest tin and lead are used in Multicore Solder.



High Precision standard of soldered joints obtained.



Multicore being made in gauges between 10 & 22 S.W.G.

MULTICORE SOLDERS LTD., MELLIER HOUSE, ALBEMARLE STREET, LONDON, W.1
Tel. REgent 1411 (P.B.X. 4 lines)

ROTHERMEL

HIGH FIDELITY PIEZO-ELECTRIC PRODUCTS
available from stock.

- PICKUPS
- MICROPHONES
- HEADPHONES
- THE HUSHATONE
- DEAF AID MICROPHONES
- CONTACT MICROPHONES
- A.C. AMPLIFIERS

Also the new ROTHERMEL GENUINE SAPPHIRE High-Fidelity Gramophone Needle—over 2,000 playings.

Send for Informative Literature on all ROTHERMEL Products.

★ TWO NEW AMPLIFIERS

For many years R. A. ROTHERMEL has made intensive research in Amplifier design and we present with confidence two new A.C. Amplifiers, the VR/2 4½-watt and the HG/308 8-watt, which have been specially designed for use in connection with all types of Crystal Microphones and Crystal Pickups. They are compact, robust, and represent the ultimate in design, workmanship, material, and quality of reproduction.

Write for Bulletin.

R. A. ROTHERMEL LTD.,
ROTHERMEL HOUSE, CANTERBURY ROAD, KILBURN, N.W.6.
Telephone: MAIDA VALE 6066 (6 lines).



MODEL 44
*Precision
multi-range
Measuring
Instrument*



Some noteworthy features :

- A six inch mirror scale with knife edge pointer.
- A patented moving coil cutout operating on forward, reverse or gradual overloads.
- Immediate delivery.

ELECTRONIC INSTRUMENTS LTD.
17, PARADISE ROAD, RICHMOND, SURREY

**FLOATING
ROTOR**

**DOUBLE
CONTACT**

*Only in
the famous*

**OAK
SWITCH**



Other British N.F.S. Products Include : PAPER CAPACITORS, SILVERED MICA CAPACITORS, WIRE WOUND RESISTORS AND VOLUME CONTROLS—Write for full details.

Manufactured by
BRITISH N.S.F. CO. LTD.
KEIGHLEY, YORKS.

London Offices : 25, Manchester Square, W.1. Tele. : Welbeck 7941/6
Sole Licensees : OAK MANUFACTURING CO., Chicago.

Constant Voltage

TRANSFORMERS
LINE VOLTAGE VARIATIONS OF
 $\pm 15\%$ REDUCED TO $\pm 1\%$
TYPICAL SPECIFICATION
Input Voltage ... 190-260 v. 50 c/s.
Output Voltage ... 250 v. $\pm 1\%$
Max. load ... 150 watts.
Input power factor over 90%
Prices on application. Write for details.

ADVANCE COMPONENTS LTD.
BACK RD. SHERNHALL ST. WALTHAMSTOW. E17. PHONE: BARKSWOOD 4366



CERAMIC *Pot* CAPACITORS

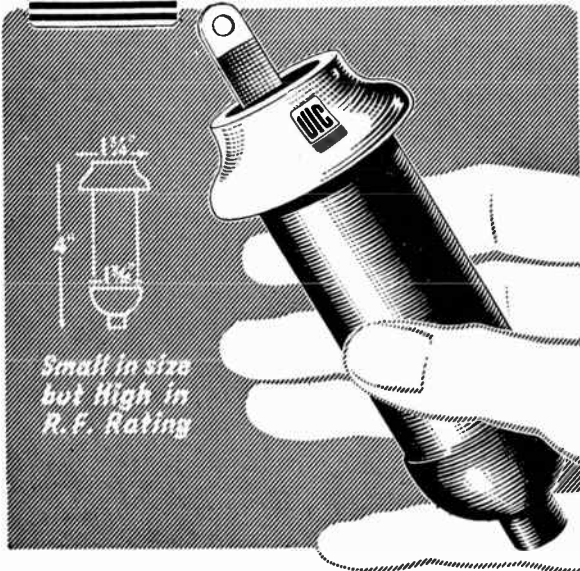

*Small in size
but High in
R.F. Rating*

THE U.I.C. Fixed Ceramic Pot Capacitor—KO 2944—illustrated above, has been primarily developed for use in transmitter circuits. Made only from the highest grade raw materials and subjected to the most rigorous tests, its rating for its size is unsurpassed.

Capacitance Range : 120—250 pF. RF Load : 26 kVA with 14 amps. Working Voltage : 5 kV R.M.S. Further details on application.

**DISC
TYPE
H.V.D.**



Specially suitable for
PULSE WORKING
Capacitance Range
3 pF - 50 pF
Working Voltage
2 kV R.M.S.
RF. Load
Up to 10 pF 2 kVA
with 2 amps.
Up to 50 pF 0.8 kVA
with 1.5 amps.

UNITED INSULATOR CO. LTD
Oakcroft Rd., Tolworth, Surbiton, Surrey
Telephone : Elmbridge 5241 Telegrams : Calanel, Surbiton

Unsurpassed In Ceramics

WEBB'S *Radio*

COMPONENTS FOR HIGH FIDELITY REPRODUCTION

OUTPUT TRANSFORMERS for use with push-pull PX4's, 6V6's, 6L6's, etc. Available in four different primary impedances, all have tapped secondaries, 2½, 7½ and 15 ohms.

Type PPHF4 (4,000 P to P) ; PPHF8 (8,000 P to P)
.. PPHF6 (6,000 P to P) ; PPHF10 (10,000 P to P) each £1 : 7 : 6

LOUDSPEAKERS. Goodmans Permanent Magnet 12in. type. Can be recommended for use with "Quality" amplifiers and our PPHF output transformers £6 : 15 : 0

MOVING COIL PICK-UP. The Wilkins & Wright type "N" moving-coil pick-up marks a tremendous step forward in gramophone reproduction. Confidently recommended by Webb's for those wanting genuine high fidelity. Uses normal easily inter-changeable needles, and supplied with equalizing input transformer. Price (including £1:5:7 Tax) £7 : 0 : 7

MICROPHONES. Meico moving - coil chrome-plated stand mounting. A first-class microphone, impedance 25 ohms £5 : 5 : 0
Matching transformer £1 : 1 : 0
Rothermel Crystal D104, world renowned as the best general-purpose crystal microphone..... £5 : 5 : 0
Handle type £6 : 0 : 0

ALL COMPONENTS CARRY
WEBB'S UNCONDITIONAL
GUARANTEE OF SATISFACTION

TUNING COILS AND PACKS

"U.C.L." Kit for the construction of a modern 3-waveband superhet, comprising the essential components :—

- (1) 3-waveband coil pack, assembled with coils, switch, padders and trimmers mounted on sub-chassis, wired and tested for assembly into the receiver chassis. Wave-range 16.8 to 51, 200 to 550 and 800 to 2,000 metres.
- (2) A pair of 465 Kc/s I.F. transformers.
- (3) Two-gang tuning condenser.
- (4) A glass tuning scale with correct calibrations for three bands.

Boxed complete with circuit diagram of complete receiver. Price (including tax) £4 : 17 : 6

AERIAL RELAYS. Stocks now available of new double-pole Aerial change-over relay. Approximate size, 3in. x 2½in. x 1½in. high, low-loss construction. Contacts take 4 amps. R.F. Coil operation 4 to 6 volts A.C..... £2 : 17 : 6

HIGH VOLTAGE CONDENSERS. Unrepeatable at price, U.S.A. "Aerovox" metal can type with mounting clips.

8 m.f.d. 600 v. size, 3½in. x 1½in. x 3½in. high 5 : 0
4 m.f.d. 1,000 v. size, 2½in. x 1½in. x 4½in. high 7 : 6

Write, 'phone or call—

WEBB'S RADIO

14, Soho Street, Oxford Street,
London, W.1

Telephone - - - GERrard 2089

Please note our **SHOP HOURS** — 9 a.m. to 5 p.m.
(Saturdays 9 a.m. to 1 p.m.)

Coil winding MACHINES

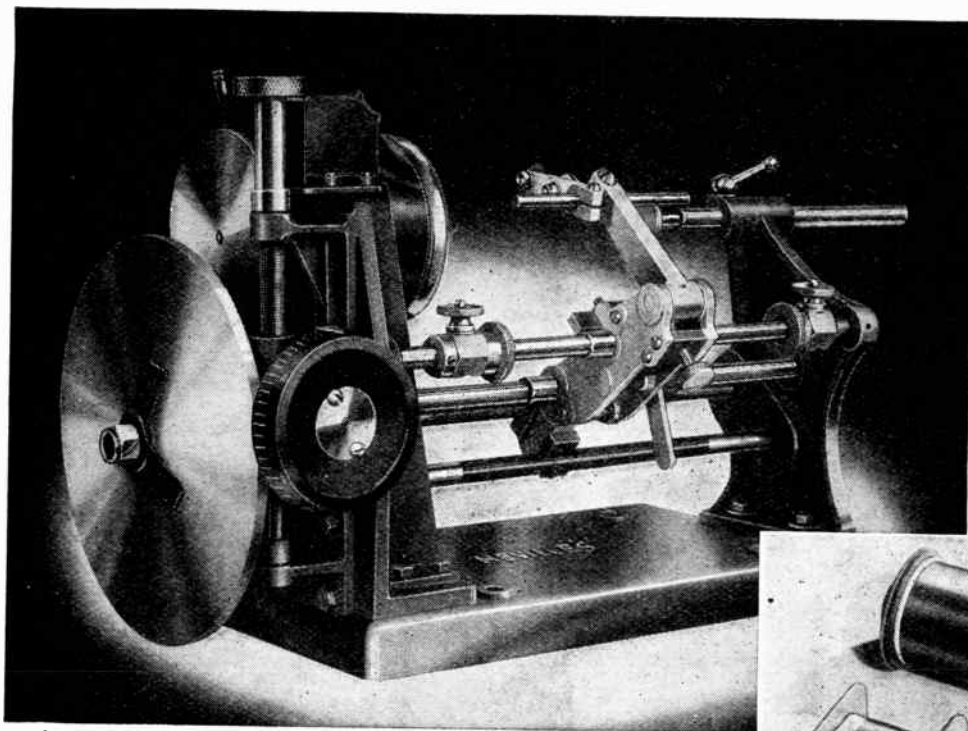

A typical selection of coils wound on the Neville's Pretoria Coil Winding Machine.

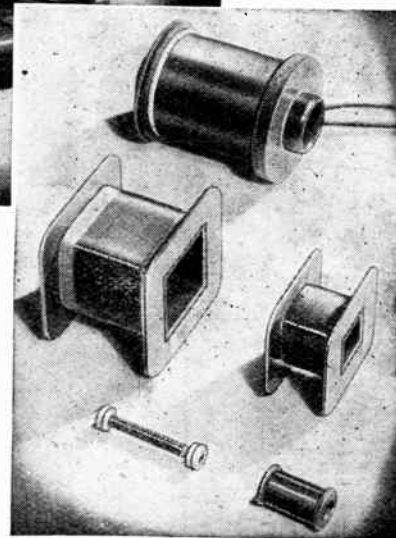

THE NEVILLE'S PRETORIA MODEL

For winding solenoid, transformer, choke and stator coils.

A bench-mounting universal automatic coil winder embodying many refinements hitherto only obtainable on expensive machines. A special foot-operated clutch gives smooth control of the winding spindle and it is possible to wind up to four coils simultaneously.

CAPACITY : Coils from 3/16" to 6" in length. Gauges of wire 22—48 S.W.G.

DIMENSIONS : The machine is 23½" long, 10" wide and 12" high.

DRIVE : 1/4 H.P., 1425 R.P.M. Electric Motor.

SPINDLE SPEEDS : 400, 530, 800, 1250, 3000, R.P.M.

Write to department WD for full particulars. An experienced staff are available to give individual attention to any coil winding problems. Your enquiries are invited.

NEVILLE'S (LIVERPOOL) LTD

THE SIMMONDS TOWER · GREAT WEST ROAD · LONDON
A COMPANY OF THE SIMMONDS GROUP

Wireless World

Radio and Electronics

36th YEAR OF PUBLICATION

AUGUST 1946

Proprietors:
ILIFFE & SONS LTD.

Managing Editor:
HUGH S. POCOCK,
M.I.E.E.

Editor:
H. F. SMITH

Editorial, Advertising
and Publishing Offices:

DORSET HOUSE,
STAMFORD STREET,
LONDON, S.E.1.

Telephone:
Waterloo 3333 (50 lines).

Telegrams:
"Ethaworld, Sedist, London."



PUBLISHED
MONTHLY

Price: 1/6

(Publication date 26th
of preceding month)

Subscription Rate:
Home and Abroad
20/- per annum.

MONTHLY COMMENTARY	245
SHORT-WAVE FORECASTING. By T. W. Bennington	246
MORE ABOUT AERIALS. By "Cathode Ray"	251
MARINE LOUDSPEAKING GEAR. By P. Hickson	254
THE OUTPUT STAGE By A. W. Stanley	256
DECCA NAVIGATOR STATIONS. By M. G. Scroggie	260
MEASURING INSULATION RESISTANCE. By J. Piggott	263
TELEVISION V.F. STAGE. By W. T. Cocking	265
MERCANTILE MARINE RADAR	269
WORLD OF WIRELESS	270
SHORT-WAVE CONDITIONS	273
RANDOM RADIATIONS. By "Diallist"	274
UNBIASED. By Free Grid	276
LETTERS TO THE EDITOR	278
RECENT INVENTIONS	280

Branch Offices:

COVENTRY:
8-10, Corporation Street.
Telephone: Coventry 5210.
Telegrams:
"Autocar, Coventry."

BIRMINGHAM:
King Edward House,
New Street.
Telephone:
Midland 7191 (7 lines).
Telegrams:
"Autopress, Birmingham."

MANCHESTER:
260, Deansgate, 3.
Telephone:
Blackfriars 4412 (4 lines).
Telegrams:
"Iliffe, Manchester."

GLASGOW:
26B, Renfield Street, C.2.
Telephone: Central 4857.
Telegrams: "Iliffe, Glasgow."



As many of the circuits and apparatus described in these pages are covered by patents, readers are advised, before making use of them, to satisfy themselves that they would not be infringing patents.



... but ~~WEARITE~~ Stratosil Sealed VIBRATORS OPERATE EFFICIENTLY UNDER ALL CLIMATIC CONDITIONS

Come rain, come shine, or any other climatic condition, Wearite 'Stratosil Sealed' Vibrators will continue to operate without trouble. Why? Oh! We designed and built them with just that end in view, and after tests, specified the following as essentials . . .



- All steel construction—even the rivets—uniform expansion under temperature extremes ensured.
- Vibrator acoustically and electrically shielded by Metal Can, sponge rubber lined.
- Precious metal driving contacts—non-tarnishable—ensure starting under the lightest pressures and voltages.
- Contacts ground almost to optical limits.
- Stack assembly—mica and steel only used.
- Base sealed by the WEARITE Stratosil process.
- Always keep going . . .

STRATOSIL Sealed VIBRATORS

SEND TODAY FOR FURTHER DETAILS, AND REMEMBER, WE ALSO MAKE SOME OF THE BEST TRANSFORMERS, COILS AND SWITCHES.

WRIGHT and WEAIRE LIMITED

HIGH ROAD · TOTTENHAM · LONDON · N.17 · TELEPHONE: TOTTENHAM 3847-9

STRENGTH and PRECISION

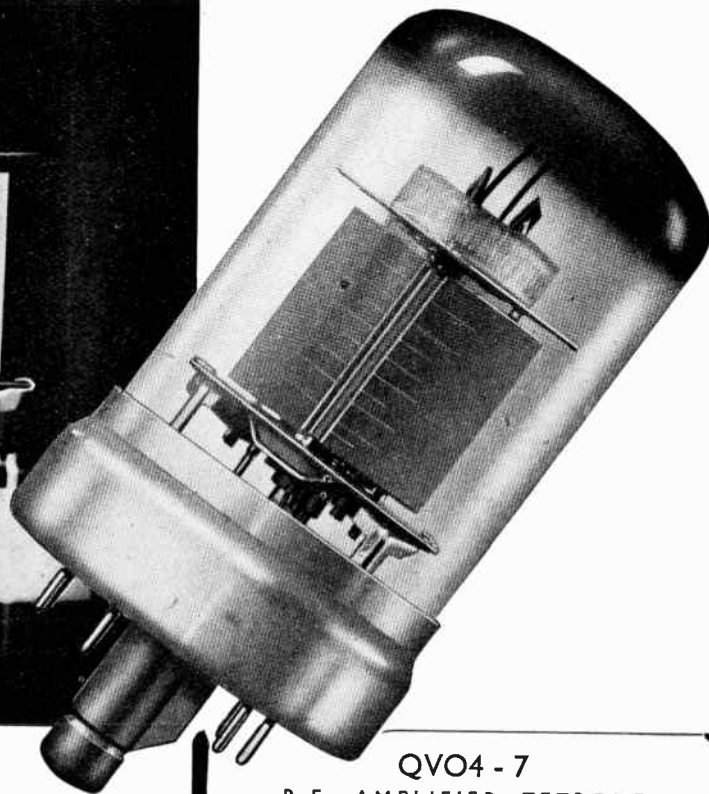
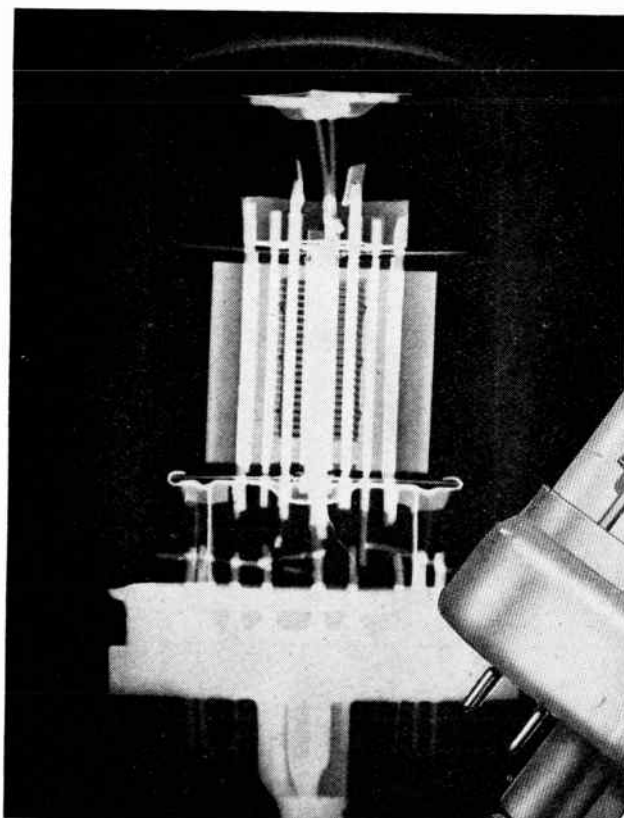

At Mullard, manufacturing methods and processes keep pace with development. Designers who choose Mullard Master Valves know they are as reliable in service as they are advanced in technique.

This X-ray and photograph of the Mullard QVO4-7 illustrate its mechanical strength and precision. As far as performance is concerned, examine the abridged data on the right. A valve destined to be popular with communications engineers for R.F. Amplifiers and Frequency Multipliers.

For further developments watch

QVO4 - 7 R.F. AMPLIFIER TETRODE

As Class C
Amplifier.

V_a 300 V.

I_a 42.5 mA.

W_{out} 6.0 W.

Frequency
150 mc/s.

V_f 6.3 V.

I_f 0.6 A.

Max. overall
length 78 mm.

Max. diameter
38 mm.

Mullard

Mullard

THE MASTER VALVE

Technical data and advice, on the applications of the QVO4-7 and other transmitting and industrial valves, can be obtained from THE MULLARD WIRELESS SERVICE CO. LTD., TRANSMITTING & INDUSTRIAL DIVISION (TECHNICAL SERVICE DEPT.), CENTURY HOUSE, SHAFTESBURY AVENUE, LONDON, W.C.2.

Wireless World

Radio and Electronics

Vol. LII. No. 8

AUGUST, 1946

Price 1s. 6d.

Monthly Commentary

Broadcasting Policy

RESPONSIBLE critics of broadcasting have often played on the theme that the real weakness of the B.B.C. is timidity; that it must always play for safety; that the fear of giving offence over-rides the desire to please. Criticism in similar terms might now be directed against the recently issued White Paper* which sets forth the Government's attitude towards broadcasting in general and towards the renewal of the B.B.C. Charter in particular. It is a disappointing document, written with disarming *naïveté*, which contains nothing to arouse wrath and little to merit praise; certainly there is nothing in it that promises alleviation of the admitted weaknesses of British broadcasting. As shown in our summary, published elsewhere in this issue, the new Charter will maintain the *status quo* for five years, with trivial and in some cases obviously necessary changes in matters of detail.

Why No Enquiry?

We have seldom read less convincing arguments than those put forward in an attempt to explain why a public enquiry has not been held before renewal of the Charter. *Wireless World* does not press for any fundamental change in the basic constitution of British broadcasting, but we have long contended that the possibility of bringing about changes that are certainly not trivial should be fully examined. None of the Government statements explains why we must now wait for five years before anything can be done.

Perhaps the most disappointing section of the White Paper is that dealing with Regional "devolution." Here it would seem that the Government has swallowed hook, line and sinker the propaganda assiduously circulated by B.B.C. spokesmen for several years: that a measure of regional autonomy inside the Corporation will *ipso facto* infuse into broadcasting that highly desirable spirit of competition that is now lacking. We have already expressed the view—and no one has

contradicted us—that it will do nothing of the kind. Indeed, the average listener will not know that competition exists; for technical reasons alone, he is unlikely to hear anything but the National and his own Regional programmes. He will never exert pressure to have his local programme brought up to the level of those in some other region that are more to his taste. Means of infusing real competitiveness into our system of broadcasting have been put forward in this journal and elsewhere; they should have been publicly discussed before perpetuating the hoary fallacy that regional autonomy will be effective.

The Wrong Medium

On the whole Regional question, and quite apart from the question of competition, the Government seems to have been sadly misled. Regional broadcasting is not, and never has been, a highly significant part of our system of distribution. But the B.B.C. likes it, because it provides means for appeasing those noisy minorities and "pressure groups" whose activities are always so embarrassing to the Corporation. The words "regional" and "broadcasting" are in themselves almost contradictions in terms; radio broadcasting (except on V.H.F.) is essentially a matter to be considered on the widest national—if not international—lines. It is not a medium for distributing trivialities to a local audience.

On the question of Government control, the White Paper is more reassuring. It reaffirms the view that the B.B.C. "should not be subject to continuous Ministerial guidance," and expresses the belief that the policy endorsed by successive former Governments is "best calculated to ensure freedom of expression." But we think that more positive measures should be taken to disassociate the B.B.C. from direct Government control. As things are, the foreigner will still firmly believe that every B.B.C. statement is inspired or at least approved by the British Government. That has long been one of the reasons for excessive cautiousness.

c

* "Broadcasting Policy," Cmd. 6852, H.M.S.O., 6d.

SHORT-WAVE FORECASTING

Wartime Advances : Contour Charts of the Ionosphere

WHEN war broke out in 1939 knowledge of the ionosphere had advanced a very long way from the point where it stood at the end of 1925, the year during which the principal layers were first located and their characteristics measured. Regular records of all the principal ionospheric values, showing

By T. W. BENNINGTON

(Engineering Division, B.B.C.)

the curving layers of ionised gas upon a passing radio wave were already well understood. The causes and nature of the disturbances to which the ionosphere had been found to be susceptible had also, to some extent, been ex-

But when it came to applying the ionospheric data to practical short-wave transmission there remained many things which were inexplicable. Often the scientific information did not fit in with observed short-wave results; worse still from the practical point of view, a wrong result was often produced when the information

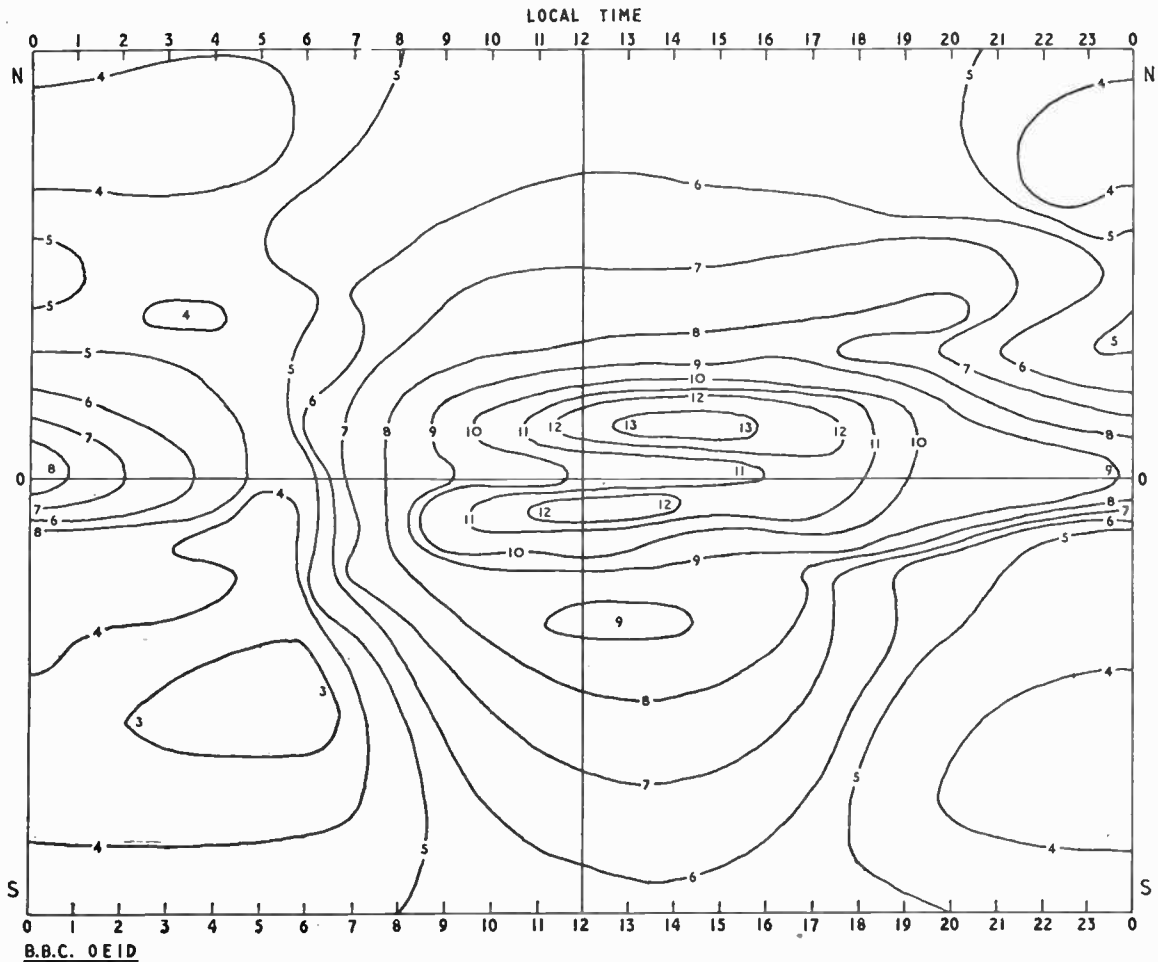

Fig. 1. Contour chart showing predicted critical frequencies. This chart and that of Fig. 2 relate to the "I" zone (see text) and to the month of May, 1946.

how they varied with time of day, season of the year and epoch of the sunspot cycle, had in fact been obtained over many years; and the details of the effects of

plained, and thus the failures of short-wave communication—partial or complete—which from time to time occurred, could be accounted for.

was used in the process of forecasting short-wave conditions for some time ahead.

There was nothing, as a matter of fact, at all wrong with the iono-

sphere data in itself. It was simply deficient in two important respects; i.e., it was only applicable to a very few discrete geographical points, and for these particular points it was not sufficiently detailed. The principal point of deficiency, however, was the first. Knowledge of the structure of the ionosphere on a worldwide basis was very imperfect for the simple reason that so few observing stations then existed at which measurements were regularly made. Measurements made at one or two points on the earth's

latitude and longitude could be made from them, there was no guarantee that these assumptions, however logical they seemed to be, were in any way correct.

Pre-war Position. — In 1939 there were, in fact, only four ionosphere observing stations from which measurements were regularly available on a 24-hour-a-day basis, though others existed which published results of measurements made at infrequent intervals, and yet others which, because of the nature of the times, regarded the information as secret material and

Standards at Washington, and those of the Carnegie Institution at Huancayo, Peru and at Watheroo, Western Australia.

So far as the B.B.C. was concerned, the utmost use was made of this meagre information, and it did, at least, prove helpful, particularly in the planning of services to parts of the world to which short-wave coverage had not previously been given.

After 1939, however, the information soon proved inadequate for the prosecution, from the radio point of view, of a "global"

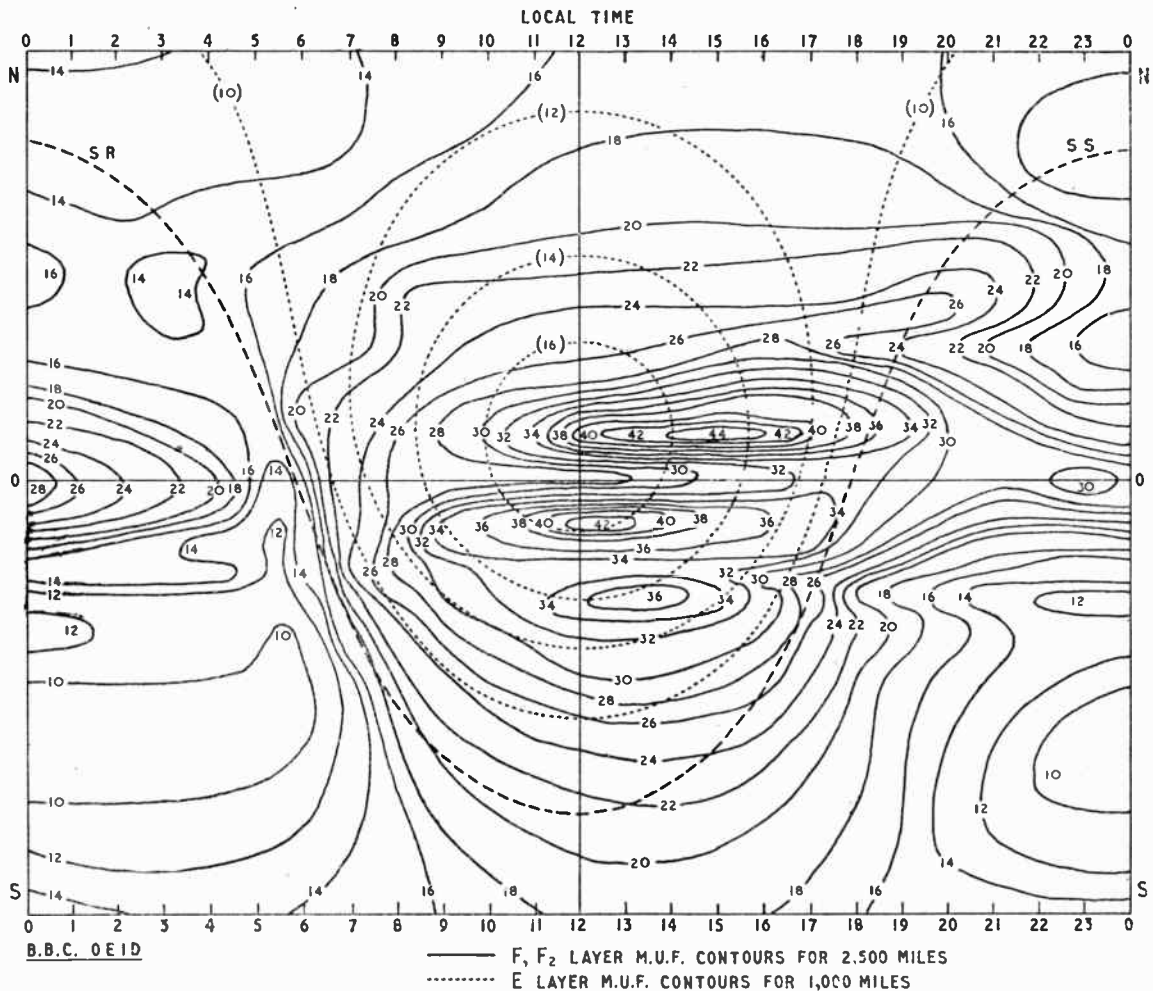

Fig. 2. Specimen contour chart of maximum usable frequencies.

surface did not give much information as to the state of the ionosphere at other points, and although assumptions as to the distribution of ionisation with

so did not publish it at all. The four stations upon which one had to rely were that of the National Physical Laboratory at Slough, that of the National Bureau of

war, and steps were taken to remedy the deficiency by the establishment in various parts of the world of more ionosphere observatories. During the course

Short-wave Forecasting—

of the war, and especially after the entry of the U.S.A. into it, the number of such observatories was continuously increased, and at the present time there are some 52 of them operating in British, Dominion and foreign countries throughout the world. Whilst the war lasted the data they supplied, as well as the techniques which had been developed for applying the data to practical short-wave problems had, of course, to be kept secret, but now some idea of these techniques, and of the progress made in them during the war, may at last be given. That will be the purpose of the remainder of this article.

Ionosphere Contour Charts.—

Let us first of all be clear in our minds why it is so desirable in short-wave communication to have a knowledge of ionosphere conditions at many different geographical points. In long-distance transmission the wave travels upwards obliquely and so will first enter the ionosphere at a point up to about 1,250 miles distant from the transmitter. No matter in what direction we are transmitting, therefore, we are from the very beginning interested not so much in ionosphere conditions above this country, but in those prevailing elsewhere. As the wave proceeds on its journey it will travel back and forth between earth and ionosphere and this may take it as far as, or even farther than, the Antipodes, where opposite seasons and times of day prevail. We must not imagine the wave to consist of just a "ray" of radio energy impinging on the ionosphere at certain separate geographical points, but as a large number of rays travelling side by side and so traversing a large number of different paths. We are, generally speaking, concerned with conditions over the whole region of the ionosphere on the Great Circle path—and perhaps to each side of it—between the points where the main body of radiated energy first strikes the ionosphere and leaves it for the last time before coming down to the receiving point.

Origin of Ionospheric Charts.—

The most convenient way in which the conditions obtaining

over a large area of the ionosphere may be depicted is by means of ionospheric contour charts, constructed so as to present the conditions in terms convenient to the short-wave technician on geographical charts. It is believed that such charts were first produced by K. W. Tremellen of Marconi's Wireless Telegraph Company. They were, in fact, a logical development of the old Eckersley-Tremellen shadow charts, evolved many years before the war, which aimed at indicating short-wave conditions on a world-wide basis by reference to the distribution of daylight and darkness over the world's surface. These were later changed so as to present short-wave reception data in terms of wavelength contours instead of in different grades of daylight or darkness. About 1942 ionosphere data coming in from various stations was embodied in the charts being prepared by Mr. Tremellen, and later the preparation of charts more or less entirely on the basis of ionosphere data was undertaken by him and by various other organizations in this country and abroad.

So far as the B.B.C. is concerned the ionosphere data was, from the time it first began to be regularly obtained, made use of in a somewhat different way to that about to be described. But when sufficient data became available it was decided that Mr. Tremellen's method supplied the most easily workable solution to the problem, and ionospheric charts have, for several years, been regularly constructed. Very briefly the principles of their construction and methods of use are as follows:

Preparation of Contour Charts.—

The most important quantities measured by ionosphere observing stations are the critical frequencies and virtual heights of the various layers for a wave sent vertically upwards; in their most useful form the observations appear as a monthly summary of the results obtained for each hour of day. The "critical" frequency of a layer, it will be remembered, is the highest frequency returned by the layer when the wave is sent vertically upwards, whilst the virtual height is the height above ground from which the

wave is returned. Measurements are on the assumption that the wave travels up and down with the velocity of light. These measurements are transmitted to the national research bodies of the countries concerned, who distribute them to the various "users" within their countries, among whom the B.B.C. is one. A steady stream of this material is thus coming in, to be used when appropriate in the construction of the charts.

Let it be assumed for the moment that the same values of critical frequency and virtual height as are obtained at any one observing station would be obtained at all other points on the earth's surface lying in the same latitude at the same instant of local time. This seems a quite logical assumption at first sight; namely, that in any one latitude the diurnal variation in the values measured is exactly the same as the world rotates upon its geographical axis. If, therefore, we take a Mercator projection (without the usual geographical features of the world upon it), and along the parallel of latitude appropriate to each observing station enter in the monthly mean of the critical frequencies obtained at that station, equally spacing the 24 hourly measurements so as to cover the entire width of the projection, then we may assume that we have recorded conditions for that latitude for the 24 hours. We may enter the hours of local time along the top of the projection (as in Fig. 1), and when we have entered the measurements of every one of the observing stations in its appropriate latitude, we may assume that we have recorded the monthly average critical frequency on a world-wide basis. Now if we join up all points of equal critical frequency we produce a critical frequency contour chart (similar to Fig. 1), which depicts the world-wide variation in critical frequency. If we draw the chart upon transparent cloth we can, by laying it over a Mercator map of the world and by sliding it along to represent the diurnal rotation of the earth, see the monthly mean critical frequency at any place at any value of local time.

Forecasts.—If, instead of the

values obtained for any month, we wish to see the critical frequency conditions for a month not yet reached, we can, from an examination of the sunspot cycle trend, calculate what change in critical frequency should occur at every time of day and at every station from the values, for example, for a similar month for which we have the measured data. By applying a correction to the measured values for the month which we decide to use, therefore, we may plot on the chart the *predicted* values for the month ahead for which we intend to draw the chart. The chart is then a world

cal frequency. It will be remembered that, as the obliquity of the wave path increases, i.e., as the distance increases, so does the Maximum Usable Frequency continually increase above the critical frequency. Thus, when the critical frequency is, for example, 6 Mc/s, the M.U.F. for 1,000 miles might well be 14 Mc/s, for 1,500 miles 18 Mc/s and for 2,500 miles 21 Mc/s. There is thus a different M.U.F. for every distance outward from the transmitter, which continues to increase up to the maximum distance which can be covered in one hop, i.e., some 2,500 miles.

lines through the points of equal value we produce a contour chart of *predicted M.U.F.* for 2,500 miles transmission, such a chart being shown in Fig. 2.

Longitude Effect.— Now we must refer to a complication which the measurement of critical frequency at an increasing number of geographical points soon brought to light. It was found that the assumption that the critical frequency would be the same at all geographical points of the same latitude at the same instant of local time was an incorrect one, for stations lying in almost the same latitude but in

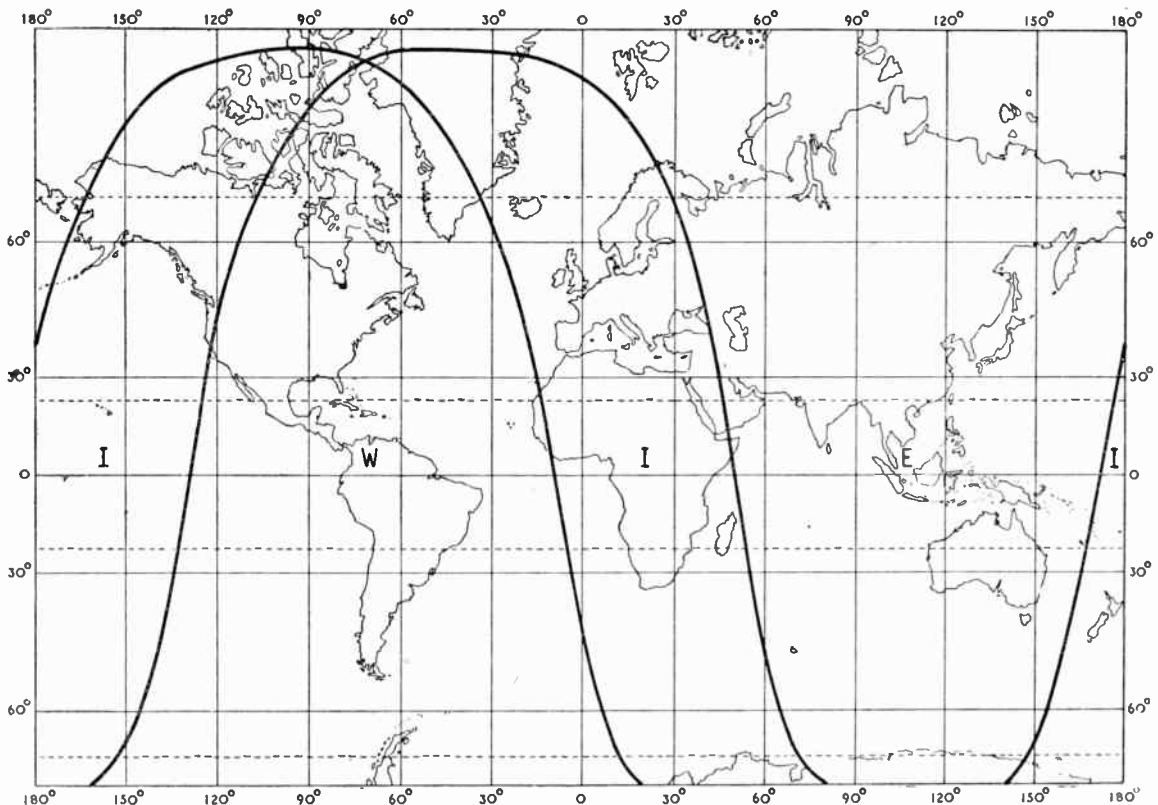

Fig. 3. Zones covered by a series of three contour charts.

contour of predicted critical frequency. (See Fig 1.)

Now, although a contour chart of critical frequency is extremely useful, it really shows the conditions for a wave sent vertically upwards, and in practice we shall be sending our waves obliquely upwards. In these circumstances, we shall need to use frequencies considerably higher than the criti-

cal frequency. It is most convenient in practice to draw the contour charts in terms of the M.U.F. for 2,500 miles (the maximum distance for one hop), so instead of entering the predicted critical frequencies upon the chart we multiply them by the appropriate M.U.F. factors for various times of day and latitudes and enter the results upon the chart. Then by drawing

different longitudes obtained diurnal characteristics of critical frequency differing quite considerably in value. It was found, in fact, that the ionisation of the layers depended not only upon the geographic, but upon the geomagnetic, latitude and longitude of the observing station. In order to overcome this difficulty it was found necessary to divide

Short-wave Forecasting—the world into three "zones," the boundaries of which were determined by certain geomagnetic meridians, and to plot separate M.U.F. contour charts for each zone. These zones are the "East" zone centred on geographic longitude 110° E., the "West" zone centred on longitude 70° W., and the "Intermediate" zones cover-

ing the areas lying between the East and West zones. These zones are shown in the map of Fig. 3, and the proper contour chart to use for any particular transmission path is determined by its location with respect to these zones. Fig. 2, for example, is applicable only to the I (intermediate) zone.

(To be concluded)

NEW MOVING-COIL PICK-UP

Constructional Details of the "Lexington"

TO ensure faithful translation of the lateral deviations of a record groove into rotary motion in a moving-coil pick-up it is essential amongst other things that the movement should have only one principal degree of freedom. This is achieved in the "Lexington" pick-up by mounting the moving coil between end bearings with "watchmaking" clearances. Damping is applied by a rubber pad at the needle holder, which plays no part in the suspension of the coil.

The moving coil is housed in a light plastic tube which has just enough resilience to allow the small vertical movement required

by "pinch effect." Deflection of the centre of the coil in this manner is limited by a ring of increased diameter formed round the centre of the tube; this acts as a stop if the pick-

Mechanism for the insertion and removal of the tapered needles is incorporated in the tone-arm rest of the "Lexington" pick-up.

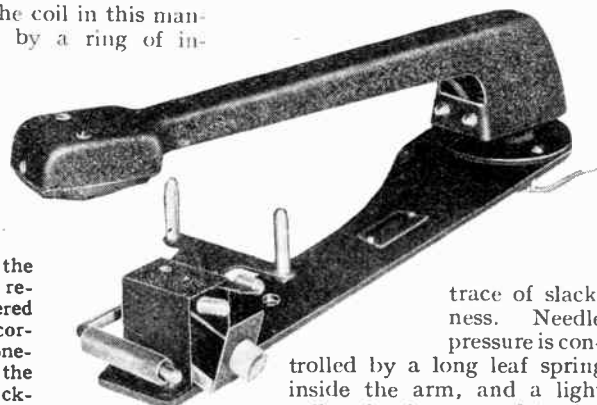

trace of slackness. Needle pressure is controlled by a long leaf spring inside the arm, and a light coil spring is arranged to give the tone arm a lateral bias towards the centre of the record. This is stated to result in a reduction of surface noise. The weight at the needle point is of the order of $\frac{1}{2}$ oz.

The average output is about 1mV and the frequency response is stated to be flat from 30c/s to 12kc/s. A coupling transformer giving an output of 50mV is available and also a heavy gauge Mumetal screening box. External bass compensation is necessary and a twin triode pre-amplifier incorporating the necessary tone correction circuits is obtainable from the makers, the Cooper Manufacturing Co., 134, Wardour Street, London, W.1. The price of the "Lexington" pick-up is £5 plus £1 5s purchase tax. The output transformer costs 16s and the Mumetal screening box 14s 2d. Sapphire needles with 0.0015-inch tip radius are available at 15s 3d each.

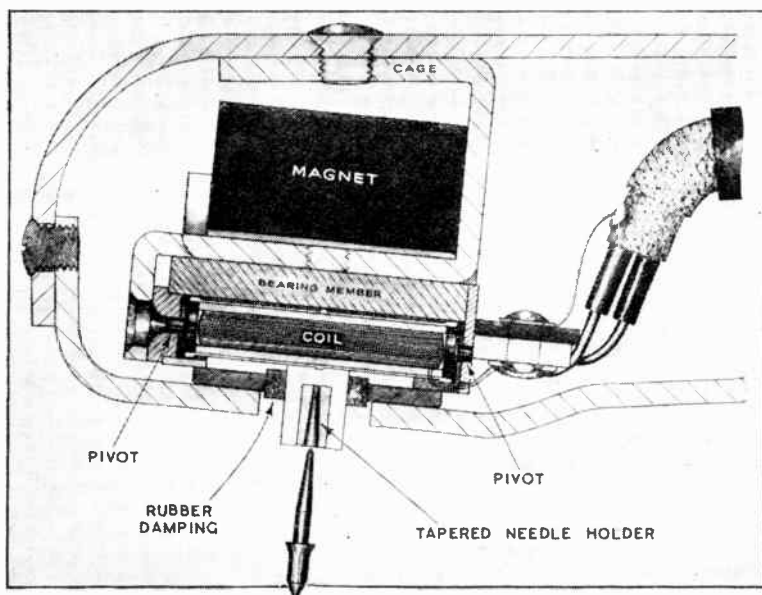

Sectional diagram of the "Lexington" moving-coil pick-up head.

MORE ABOUT AERIALS

Polarization : Gain : Reflectors

By "CATHODE RAY"

BEFORE going on, I should like to thank a reader for objecting, quite rightly, to my statement last month "The direction of the electric field is parallel to δl ." Radiation fields may be queer things, but they cannot be at right angles to the direction of motion *and* parallel to δl except where the direction of motion is at right angles to δl . At P in Fig. 2 it is not, so the quoted sentence is misleading. The electric field at P is, of course, parallel to the bit of wire marked " $\delta l \sin \theta$ " in Fig. 2.

This is a good point at which to deal with *polarization*. It is quite easy. It is the direction of the field. But which field? Around a vertical aerial (in directions at right angles to it!) the electric lines of force are vertical too, and the magnetic lines are horizontal, in the form of expanding rings. When electromagnetic waves are said to be vertically polarized, what is meant is that the *electric* field is vertical. It is a good thing it was agreed to name the polarization after the electric field rather than the magnetic, because it helps the memory—"vertical polarization, vertical aerial." If

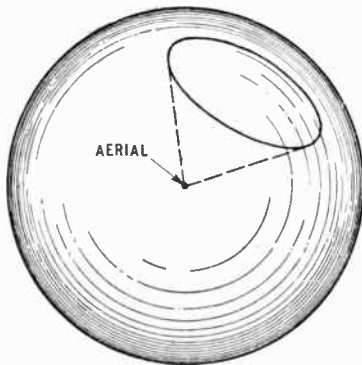

Fig. 5. If radiation is confined into a cone instead of spreading out along every radius of a whole sphere, the "gain" is proportional to the reduction in spread.

the receiving aerial is horizontal it will receive nothing from a vertically polarized wave. This may

seem contrary to experience; if so, it is because (a) practical aerials are hardly ever perfectly and entirely horizontal (or any other particular direction), and (b) polarization is apt to get twisted about a bit on the way from sender to receiver. Most aerials except dipoles are partly vertical and partly horizontal, and if the radiations from these are in phase, the resultant will be inclined at some angle. If not in phase, the direction of field will turn around like a corkscrew, and a receiving aerial at any angle will receive some of it.

If you take a dipole with well-screened connections and receiver, and listen on it to the television signal, you will find you get nothing when the dipole is pointing directly towards the transmitter; that is because of the receiving polar diagram, see Fig. 3 (last month). You will also get little or nothing when the dipole is broadside to the transmitter, if it is horizontal, even though that is a maximum of the polar diagram; that is because the B.B.C. television is vertically polarized. It is important not to mix up these two reasons for lack of reception.

Another fundamental idea is *gain*. Unlike an amplifier, an aerial cannot multiply the signal power supplied to it, any more than a megaphone can increase vocal power. But both can multiply the power delivered to particular receivers, by concentrating on them instead of spreading it out all around.

For a given total power radiated, the least concentrated distribution is, of course, perfectly uniform in all directions; so that the 3-dimensional polar diagram is a sphere with the aerial as centre. If the aerial being considered were to concentrate the whole of its radiation into one-tenth of the surrounding space, so that its polar diagram was a cone (Fig. 5), receivers in the direction of the cone would receive as much

as from a uniform aerial giving ten times as much total radiation. The directional aerial would be said to have a gain of 10. As no simple practical aerial does have

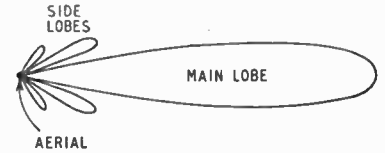

Fig. 6. Typical polar diagram of a directional aerial.

a spherical polar diagram, gain is generally reckoned with reference to a simple component aerial such as a dipole (which by itself has a small gain with reference to the theoretical spherical aerial).

Any aerial has just the same gain for receiving as for transmitting. It is a particularly useful sort of gain, because it not only increases signal strength but at the same time it reduces noise coming from other directions. In fact, it makes reliable long-distance communication possible.

Practical aerials don't give a sharply defined polar diagram as in Fig. 5, with uniform radiation in the cone and nothing at all anywhere else. A typical polar diagram for a highly directional aerial is more like Fig. 6. The radiation falls off gradually around

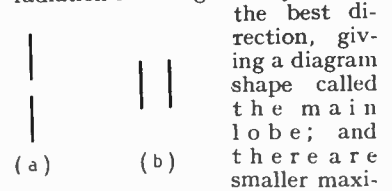

Fig. 7. (a) Collinear and (b) collateral arrangements of dipoles.

the best direction, giving a diagram shape called the main lobe; and there are smaller maximum directions. The gain is reckoned as the number of times the power input would have to be multiplied to produce the same field strength as in the main lobe maximum direction, if the directional aerial were replaced by a simple dipole or other comparison type.

More About Aerials—

Anything that makes an aerial more directional increases its gain. How, then, is it made more directional? The principal technique

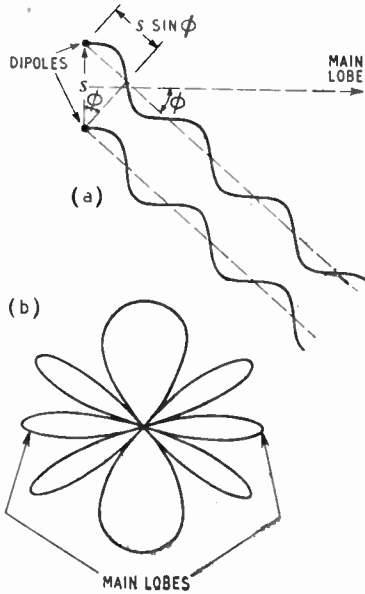

Fig. 8. Illustrating the principle of directional aerials. At the particular angle ϕ shown in (a), the radiations from two dipoles spaced by the distance s arrive completely out of phase. Comparing phases at all angles, the polar diagram can be traced out. The one shown at (b) is obtained when $s = 2$ wavelengths.

is to arrange the δ s—the tiny bits of aerial—so that their radiations are all in phase in the desired direction and as much out of phase as possible in all others. So many δ s are needed to make an aerial that the problem can only be tackled this way by the calculus; but one can dodge this and yet get nearly the right answer for dipole arrays by working in units of one dipole, which, although so much larger than δ , has a similar polar diagram. The assumption is that a real dipole with R.F. current I at the centre (tapering off towards the ends) can for purposes of calculation be replaced by an imaginary dipole with I at full strength throughout, compensated by making it 36 per cent shorter.

A very simple aerial array consists of two dipoles, with the total available power divided equally

between them. They can be arranged as in Fig. 7(a) (collinearly) or Fig. 7(b) (collaterally). In either case, you, looking at them equidistantly and broadside on, are receiving the maximum from both; so if there is any gain, you ought to be getting it. But, you say, each is fed with only half the power, so how can there be any gain? $2 \times \frac{1}{2} = 1$, surely?

This equation, though undoubtedly true, misses the point. If the power is divided equally, the current in each is 70.7 per cent ($1/\sqrt{2}$) of what it would be if all put into one dipole (power is proportional to current squared!), so the gain is $2 \times 1/\sqrt{2}$, or $\sqrt{2}$, or 1.414. The gain of n dipoles, all in phase and all with the same polarization and all equidistant from the receiver, is \sqrt{n} .

The clue to what happens in other directions is given in Fig. 8(a). Waves start off in phase from the dipoles, but in directions in which they have unequal journeys, such as that shown, at an angle ϕ to the main lobe, they arrive out of phase. If $s \sin \phi$ happens to be half a wavelength, as shown, the result in that direc-

spondingly narrow. Unfortunately, at some greater angle there will be a difference in journey of a whole wavelength, making the separate radiations come into step again and giving a side lobe as intense as the main one. The greater s is, the narrower and more numerous are the lobes (Fig. 8(b)). The details of these lobes are calculated quite simply by trigonometry, or more laboriously by going through the above phase comparison for every few degrees. Obviously the whole polar diagram alters if the wavelength is changed. Fig. 8(a) shows collateral dipoles. If they are made collinear, the side lobes are progressively reduced by the factor $\sin \theta$ as in Fig. 2, which helps a bit. But the most effective way of concentrating radiation into one main lobe is to fill in the distance s with more dipoles, until there is only one direction—at right angles to s —in which the radiation from all the dipoles is in phase. Or, to be more correct, two directions— forwards and backwards.

As it is highly unlikely that both of these directions will be wanted at the same time, one of them is just a waste of energy. The cure is a reflector to turn it back and make it reinforce the desired lobe. Fig. 9(a) represents the instantaneous amplitude of waves radiating both ways from a dipole o , caught at the moment

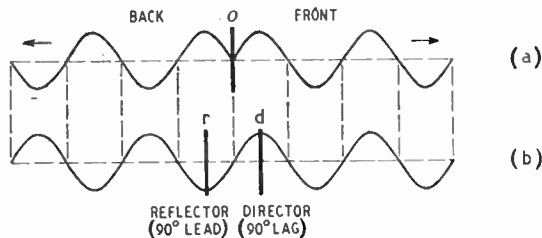

Fig. 9. Method of finding out how to reflect radiation. (a) represents the original waves coming from the aerial, and (b) those necessary to combine with them to produce the desired result.

tion is nil, because the two dipoles cancel one another out. Obviously, if the dipoles are placed far apart, the angle ϕ at which the radiation is reduced to zero is (for a given wavelength) small, and the main lobe is corre-

when the field at the aerial itself is zero and just starting on a negative half-cycle. Below, at (b) is drawn the wave that

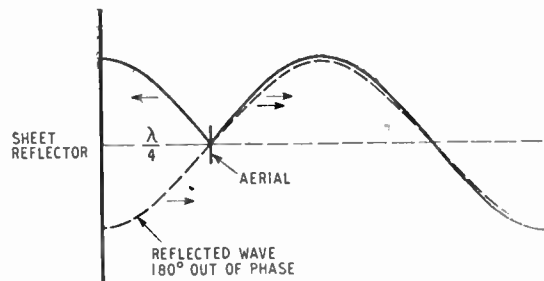

Fig. 10. Showing why the spacing of a perfect sheet reflector should be quarter of a wavelength.

would have to be superimposed on (a) to cancel out backward radiation and double forward radiation. There are only a few possible points for originating such a wave. The position of the dipole o , or any other zero point, is no good, because dipoles can't be made to send a negative half-cycle one way at the same time as they are sending a positive half in the opposite direction. Either position r or d , a quarter wavelength from o , will do, however, provided that r radiates quarter of

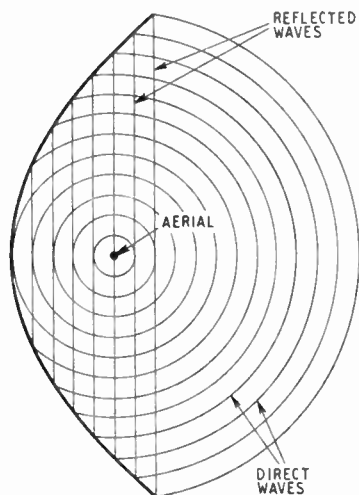

Fig. 11. Parabolic mirror for pencil-beaming centimetre waves.

a cycle (90°) ahead of o , or d 90° behind.

The easier one to manage is r , because it radiates in approximately the right phase by induced current from o , if it is tuned to it, and need not be fed from any outside source.

Now there are simple explanations of how this happens, but I'm not going to repeat them, because the situation is really quite complicated, and it is misleading to pretend otherwise. For one thing, r and d (called *parasitic* aerials) are subject to both radiation and induction fields, which are not in phase with one another; for another thing, r and d react on o . But it is fairly obvious, and quite true, to say that the phase of the parasitic radiation depends on the spacing, and can also be adjusted by off-tuning the parasitic aerial, making it longer or shorter than o . In general, r (the

reflector) should be longer than o , and d (called a director) should be shorter; and the best spacing for most purposes is rather less than quarter of a wavelength.

In an array of dipoles, a reflecting dipole can be placed behind each; but if there are very many this may be rather tedious, and it is easier (especially with very short waves) to put up a continuous sheet of metal or some close-mesh wire netting. In either case the action is the same: the reflector has currents induced in it that cause radiation, which combines with the original radiation. Taking the ideal case of a perfectly conducting sheet, if Nature is to avoid the anomaly of a p.d. between two points that are perfectly short-circuited, she must arrange matters so that the primary field is cancelled out at the conducting surface by the secondary field, which must therefore be 180° out of phase with the primary. To bring both these fields into phase in the radiating direction, the surface should be quarter of a wavelength behind the aerial (Fig. 10). As no surface is a perfect conductor, the best practical spacing may be slightly closer. And it is not difficult to see that the phase relationships are unchanged if one or more extra half-wavelengths are slipped in.

An example of a nearly perfect reflector is the sea, and a rather less perfect one is the land. These are not, of course, generally utilized to reflect a beam vertically upwards, as might be suggested from the foregoing argument. Sea and land do at least help in preventing waste of radiation downwards, and as they are there anyway whether we like it or not, it is generally arranged that the aerial sticks up out of them, or is placed at such a height above them that their reflections tilt up at the desired angle. The behaviour is calculated in the same general way as for spaced aerials, by combining the two radiations (direct and reflected in this case) with regard to relative phase.

You will have gathered that if a narrow pencil-shaped beam is wanted, without side lobes to speak of, it is necessary to use a very elaborate array of dipoles in

two dimensions, as well as a reflector behind. An alternative is to use quite a simple aerial, perhaps only a single dipole, and develop the reflector so that it not

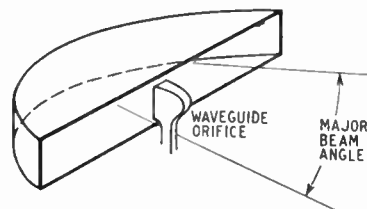

Fig. 12. Cheese aerial for fan-shaped beam.

only deals with the radiation directly behind but also with that going in nearly all directions. To do this the reflecting surface must extend around the source to catch as much of it as possible, which means that it must be much bigger than the source and therefore at least several wavelengths in diameter. So it wouldn't be wise to attempt it on wavelengths of many metres. In fact, this technique is confined mainly to centimetre waves. The surface must also be everywhere at the correct angle to form the beam, and to make the radiation in the beam everywhere in phase. The answer is the well-known parabolic mirror, as shown in Fig. 11 (which gives a clue to the geometrical construction). Nearly all the direct radiation from the aerial on the side away from the mirror is *not* in the beam and would spoil the plan if it were not prevented by a reflector dipole or other means of making all the aerial output go into the mirror.

For many radar purposes a fan is more useful than a pencil. Fig. 11 is all right as the narrow cross-section of a fan, but in the plane at right angles to this the radiation is required to spread out more. So instead of extending the reflector into a bowl, it is more or less just a bent strip. To give some degree of beaming, the top and bottom of this parabolic strip are closed in by flat plates, giving the "cheese" aerial (Fig. 12). A typical cheese gives a beam width of nearly 40° deg in the vertical plane and only 2° deg in the horizontal. It is usually fed from a waveguide; but the working of the cheese is, I fear, another story.

MARINE LOUDSPEAKING GEAR

Some Details of the Ardente "Loud Hailer"

By P. HICKSON (Ardente Acoustic Laboratories)

DURING the latter part of 1938 and the beginning of 1939 the Admiralty were considering the use of loudspeaking equipment for inter-ship communication, and a considerable amount of development and experimental work was undertaken, culminating in the production of a robust, long-range compact loudspeaking set for marine use, which underwent Admiralty trials towards the end of 1939.

It was necessary for the amplifier to be independent of ship's mains, so that voice commands could still be given when the ship's power supply had failed due to enemy action or other causes. The amplifier was, therefore, designed to operate entirely from a 12-V accumulator, which could be kept charged from the ship's A.C. or D.C. mains, by means of a simple charging unit.

Owing to the high electro-acoustic efficiency of the loud-speaker system used, the audio

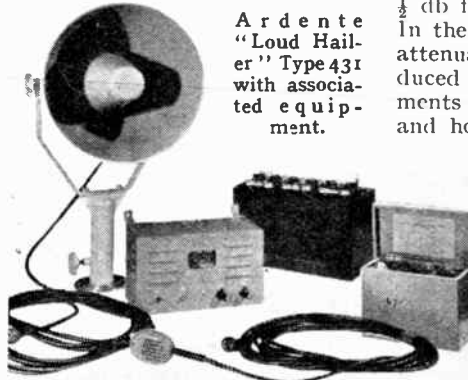

Ardente "Loud Hailer" Type 431 with associated equipment.

output of the amplifier required did not exceed 15 watts, and it was therefore possible to keep the physical dimensions of the amplifier—an important consideration in small vessels—down to the minimum, the size of the amplifier being 13½ in × 6 in × 8½ in, while the weight is 23 lb.

similar to the standard U.S. types 6N7G and 6L6G. The high-tension supply is provided by a small motor generator giving an output of 320 V.

A circuit diagram of the amplifier is shown in Fig. 1. The frequency response is flat within

½ db from 300 to 10,000 cycles. In the lower end of the response attenuation was purposely introduced so as to match the requirements of the loudspeaker unit and horn characteristics, to provide maximum intelligibility at speech frequencies over long distances. The attenuation in the bass is minus 3 db at 100 cycles, and minus 8 db at 50 cycles. Only two types of valves are used, known by their naval numbers of NR73 and NR77, which are very

It will be seen from the circuit diagram that part of the high voltage supply is filtered through a resistance and condenser circuit to the primary of the microphone transformer. This provides the energising current for the trans

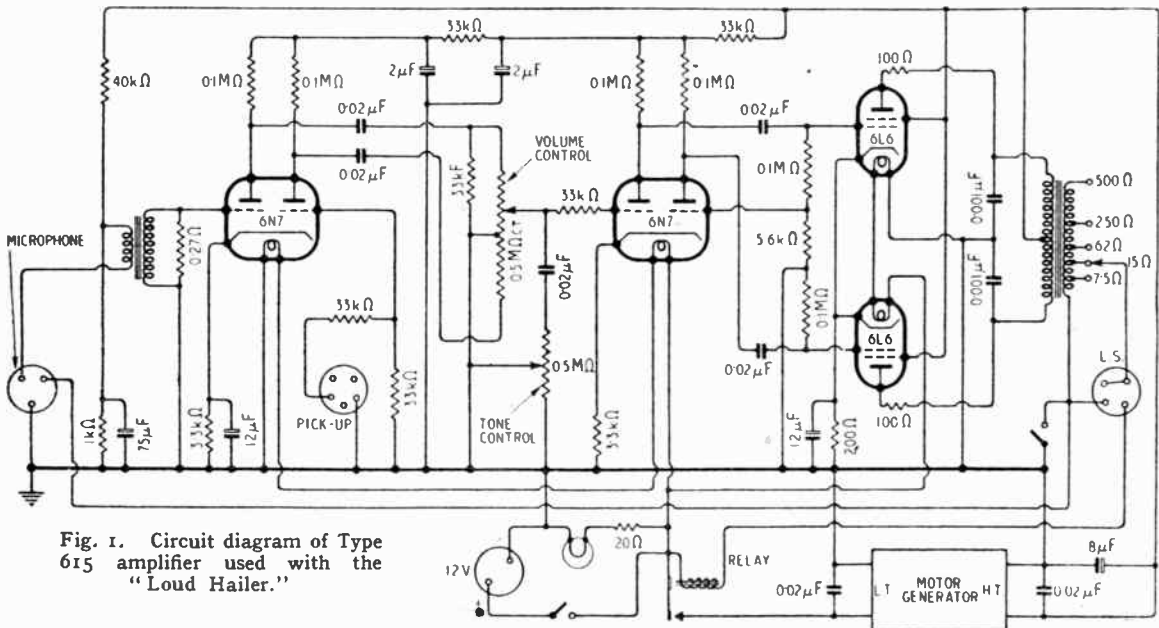

Fig. 1. Circuit diagram of Type 615 amplifier used with the "Loud Hailer."

verse current carbon microphone. A microphone of this type was chosen in preference to a ribbon, moving coil or crystal type, on account of its robustness, absence of magnetic parts that might be liable to affect the ship's compasses and by virtue of its design, waterproof even to the extent of continuous immersion. This type of microphone also enabled the physical dimensions of the outer case to be made so that the microphone could be comfortably held in a gloved hand. A thumb-operated remote control switch on the microphone case controls the relay on the amplifier, which starts up the high voltage

distance, with the response peaking at 3,000 cycles. A further small peak occurs at 300 cycles.

The electro-acoustic efficiency is approximately 40 per cent., so that a good proportion of the amplifier power of 15 watts is converted into acoustic power. The speech beam is such that a sighting device was necessary, in order to ensure reliable reception by the ship being spoken to, and

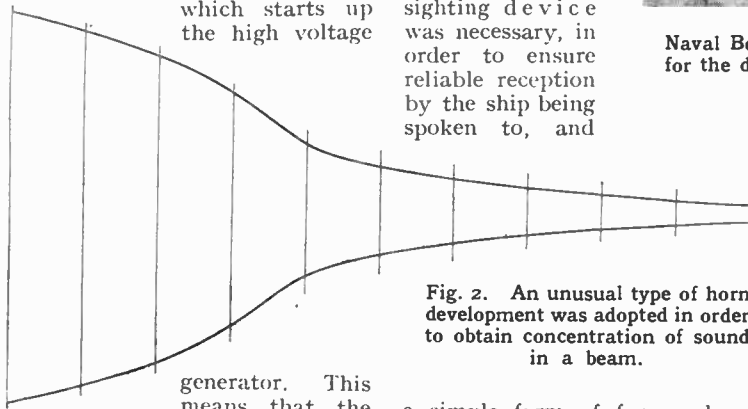

Fig. 2. An unusual type of horn development was adopted in order to obtain concentration of sound in a beam.

generator. This means that the current drawn from the accumulator is only that required by the heaters of the tubes, except while actually speaking.

The loudspeaker, being the item of the equipment having the largest physical dimensions and the one most likely to be exposed to the weather for prolonged periods, received the most important design considerations. A re-entrant folded horn was considered essential for the loudspeaker, because the windage on an ordinary trumpet-type projector would have been excessive, and the space taken up by a long horn could not be afforded. In order to concentrate as much of the available power output as possible into a narrow beam, so as to get the maximum range, a horn development of abnormal characteristics was required, the actual development of the horn being shown in Fig. 2. This shape, together with the loudspeaker unit fitted, provides an intense speech beam, approximately 100 yards wide at $\frac{3}{4}$ mile



Naval Beach Party operating the "Loud Hailer" for the direction of beach traffic during the North African campaign.

of loudspeaker a tube sight is fitted instead. The loudspeaker horn is mounted on a bracket and mounting sleeve, which enables the speaker to be mounted on the fitting normally provided for a searchlight projector on the bridge. Hand wheels allow for directional and elevational adjustment. The equipment is completed with the necessary accumulator, box of spare parts and instruction booklet.

The loudspeaker unit is of the permanent magnet type, using "Alnico" or "Ticonal" high flux-density magnets. The original type of diaphragm was of pulp-acetate construction with an aluminium speech coil, but the mortality rate of this was rather high in view of the hygroscopic qualities of the diaphragm and the behaviour of the aluminium speech coil under extremes of temperature. A later type of diaphragm of "Dural" construction, with a copper speech coil, reduced the frequency of diaphragm replacements.

Much of the work on the development of the loudspeaker horn was done by Wm. H. Bebbly and the design of the loudspeaker unit was undertaken by L. W. Murkham, of Reslo.

During the war years, from 1939 to 1945, over twenty thousand Ardente "Loud Hailers" have seen service in all theatres of war, and in practically every imaginable application.

a simple form of fore and rear sight is fitted to the top of the loudspeaker horn, the rear sight folding out of the way when not required. On a more recent form



R.N. Commandos using the Ardente equipment. The ordinary megaphone is, of course, used for short-range work.

THE OUTPUT STAGE

Effect of Matching on Frequency Response

By A. W. STANLEY

THIS article has been written in an attempt to clarify the mechanism of operation of moving-coil loudspeakers and the effects of mismatching on frequency response. The audible difference in quality of reproduction of a loudspeaker when driven by correctly-matched triode and pentode valves is well known and is quantitatively investigated. It is also well known that the acoustic power given by a loudspeaker is dependent on the turns ratio of the matching transformer. It will be shown here that the frequency response, too, depends to an extent on the impedance of the driving source—and consequently on the turns ratio of the output transformer. Experimental confirmation of this point is provided by a set of loudspeaker response curves, taken for different values of generator impedance,

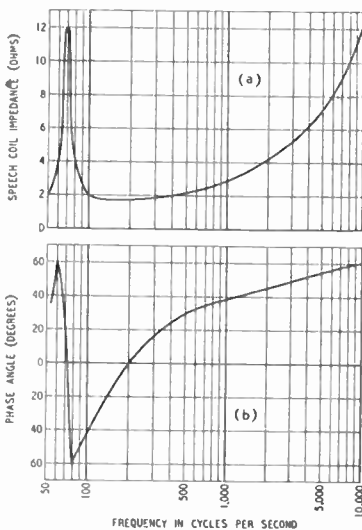

Fig. 1. Variation with frequency of moving-coil impedance (a) and phase angle (b).

kindly supplied by Messrs. Goodmans Industries, Ltd.

A moving-coil loudspeaker is not a purely resistive device at all frequencies although it is a better approximation to that ideal

than other types: the exact nature of the impedance of a typical moving-coil loudspeaker of 2 ohms nominal impedance is illustrated in the curves of Fig. 1 (a) and 1(b), reproduced from a previous article.* These curves show the variation with frequency of the impedance, Z , and the phase angle, θ , between applied voltage and current. It will be more convenient in this

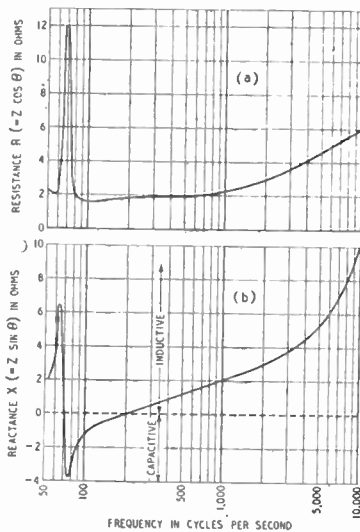

Fig. 2. Variation of resistance (a) and reactance (b) of a moving-coil loudspeaker of 2 ohms nominal impedance.

article to know how the reactance, X , and the resistance, R , of this particular loudspeaker vary with frequency. It is a simple matter to calculate these from the formulae $X = Z \sin \theta$ and $R = Z \cos \theta$ and the results are given in Figs. 2 (a) and 2 (b). These curves are interesting: notice the considerable increase in resistance at the bass resonant frequency (70 c/s for this speaker) and also the fact that the impedance is capacitive between 70 c/s and 400 c/s.

Let us now consider the equivalent circuit of the output stage of an A.F. amplifier given in

* "Negative Feedback and the Loudspeaker": *Wireless World*, Dec., 1944.

Fig. 3. Here the output transformer has been omitted (this is equivalent to assuming that it is perfect) and the anode A.C. resistance and equivalent generator voltage of the output valve

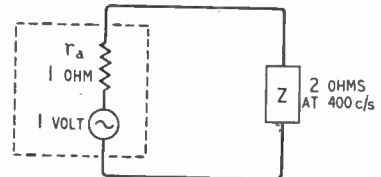

Fig. 3. Equivalent circuit of loudspeaker and output stage. The output transformer has been omitted.

have been given the values they have effectively at the secondary of the output transformer. First we shall assume that the transferred A.C. resistance r_a (i.e., R_a divided by the square of the turns ratio of the output transformer) is 1 ohm, half the impedance of the loudspeaker at 400 c/s, this being the usual triode matching condition. For convenience of calculation let the generator have a voltage of 1 volt. Then at any frequency the current in the circuit is given by:—

$$I = \frac{1}{(r_a + R) + jX} = \frac{1}{(r_a + Z \cos \theta) + jZ \sin \theta}$$

As shown in Figs. 2 (a) and 2 (b) both X and R equal 3 ohms at 2,000 c/s, so that the current in the circuit of Fig. 3, at this frequency, is given by:—

$$I = \frac{1}{4 + j3} = \frac{1}{5} = 0.2 \text{ amp.}$$

The total power dissipated in the loudspeaker at this frequency is then

$$I^2 R = 0.2^2 \times 3 = 0.12 \text{ watt.}$$

The power delivered to the loudspeaker by the output valve can similarly be calculated at other frequencies and the results of so doing are given in curve (a) in Fig. 4. The power varies considerably with frequency, the greatest change being from 0.245 watt at 150 c/s to 0.04 watt at 10,000 c/s.

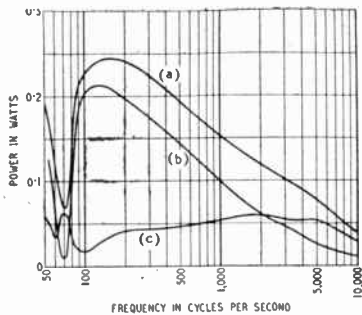

Fig. 4. Curve (a) shows the variation of power with frequency where $Z_{400} = 2r_a$. The heat loss is shown at (b), and (c) gives difference between (a) and (b).

It is instructive to calculate how much of this power is lost in the form of heat in the speech coil. In order to calculate this we need to know the D.C. resistance of the speech coil. We shall not be far wrong if we assume this to be 1.5 ohms in the case of the loudspeaker, the characteristics of which were given in Fig. 1. We know that the current in the circuit of Fig. 3 is 0.2 amp at 2,000 c/s so that the power wasted in the speech coil at this frequency in the form of heat is given by:—

$$I^2 R_{DC} = 0.2^2 \times 1.5 = 0.06 \text{ watt.}$$

Curve (b) in Fig. 4 shows how this power varies over the audio-frequency range. By subtracting the ordinates of curve (b) from those of curve (a) we obtain the curve (c) which represents the power which is converted by the loudspeaker into useful sound output, together with that which is used up in overcoming the various frictional resistances which are called into play the moment the diaphragm moves. This curve is remarkably level. Unfortunately we cannot deduce from this that the radiated sound power of this loudspeaker is therefore approximately constant and independent of frequency, since we do not know what fraction of this power disappears in overcoming friction. In some poor loudspeakers most of the power supplied by the output valve disappears in this way at the very high audio-frequencies, with the result that such loudspeakers are very deficient in "top." Indeed, if we did know exactly what fraction of the power supplied was

useful, it would be a simple matter to deduce the response curve of the loudspeaker from curve (c)*. Curves (a), (b) and (c) were calculated on the assumption that the output transformer is perfect. A poor component will give a loss in "top" due to the presence of leakage inductance and also a loss in bass response if the primary inductance is inadequate.

One of the fortunate features in the operation of loudspeakers driven from low-impedance sources, apart from the better damping they provide compared with high impedance sources, is that at the bass resonant frequency and at high audio frequencies where the increasing impedance of the loudspeaker tends to cause a fall in current and hence in the power supplied to the loudspeaker, the loss in the form of heat also

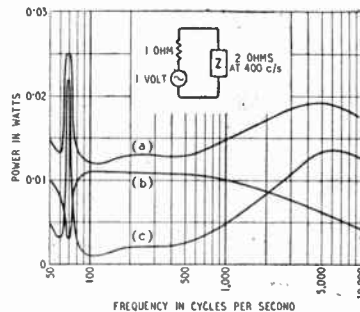

Fig. 5. Repeat of Fig. 4 using the pentode matching condition, i.e.,

$$Z_{400} = \frac{r_a}{5}$$

decreases and so tends to keep the sound output of the loudspeaker approximately constant.

A repeat of the above calculations for a pentode output valve, without negative feedback, gives the curves of Fig. 5, which correspond with those of Fig. 4. The circuit used in the calculations is also given in Fig. 5. The effective internal resistance of the valve was assumed to be five times the impedance of the loudspeaker at 400 c/s, a typical output pentode matching condition. Although we have specified that Fig. 4 applies to the triode case and Fig. 5 to the pentode case, it should be realised that it

* The directivity of the loudspeaker, i.e., the fact that it focuses high notes into an axial beam, would introduce complications into the calculation, of course.

is only the ratio of valve internal resistance to speaker impedance which is different. Fig. 4 will also apply to a pentode if $Z_{400} = 2r_a$ and Fig. 5 to a triode if $Z_{400} = \frac{r_a}{5}$. Although we shall refer, in the subsequent text, to triode and pentode matching conditions we mean by these phrases the conditions where $Z_{400} = 2r_a$ and $Z_{400} = \frac{r_a}{5}$ respectively. Comparison of Figs. 4 and 5 shows very convincingly the pronounced increase in output power at the bass resonant frequency and at high audio-frequencies given by a pentode valve in comparison with a triode. With a high effective driving source impedance the current in the circuit does not fall to anything like the same extent at the bass resonant frequency and at the high audio frequencies as for low-impedance sources. Hence the increased power at these frequencies.

Examination of Figs. 4 and 5 will show that in each case the ordinates of curve (c) are the same fraction of the corresponding ordinates of curve (a). At 70 c/s, for example, this fraction is approximately 0.9. The value of this fraction is clearly some indication of the efficiency of the loudspeaker. It is, in fact, equal to power used in overcoming frictional resistance to motion plus power radiated as sound divided by total power supplied to loudspeaker. That is total power supplied minus power dissipated as heat in speech coil

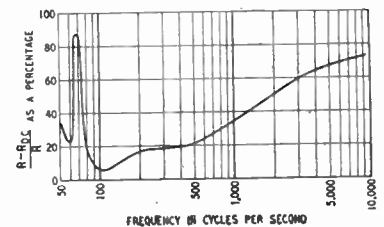

Fig. 6. Curve showing dependence of $\frac{R - R_{DC}}{R}$ (representing maximum possible efficiency) on frequency for the loudspeaker of Fig. 1.

divided by total power supplied

$$= \frac{I^2 R - I^2 R_{DC}}{I^2 R}$$

where I is the R.M.S. value of

alternating current in the circuit of Fig. 3.

$$= \frac{R - R_{DC}}{R}$$

The value of this expression for the particular loudspeaker we have been considering throughout has been plotted as a percentage against frequency in Fig. 6. In this R_{DC} was assumed to be 1.5 ohms. The values of the ordinates in Fig. 6 may be regarded as indications of the maximum possible efficiency (i.e., the maximum value of

$$\frac{100 \times \text{acoustic output}}{\text{Electrical input}}$$

for the loudspeaker in question). It is interesting to note that at the

The same result is obtained if one considers the curves labelled (c) instead of those labelled (a) at these same two frequencies. The bass emphasis given by the pentode at the bass resonant frequency can also be estimated in this way. Considering the power at 70 c/s and 400 c/s from curve (c) in Figs. 4 and 5, we can see that the pentode gives

$$10 \log_{10} \frac{0.022}{0.002} \times \frac{0.042}{0.062} = 8 \text{ db.}$$

more output than the triode at 70 c/s than at 400 c/s. Hence the ratio of the response at 10,000 c/s and 70 c/s to that at 400 c/s depends on the value of the impedance of the driving source,

of internal impedance equal to the impedance of the loudspeaker at 400 c/s. The "top lift" given by the constant-current generator compared with the constant-voltage generator is seen to be about 14 db at 10,000 c/s and the bass lift is about 20 db at 90 c/s. These results, as one would expect, are somewhat greater than those deduced earlier for the triode and pentode cases.

From what has been said it is clear that the response curve of a loudspeaker has no very great meaning unless the effective value of the impedance of the driving source is stated. If a manufacturer takes the response curves

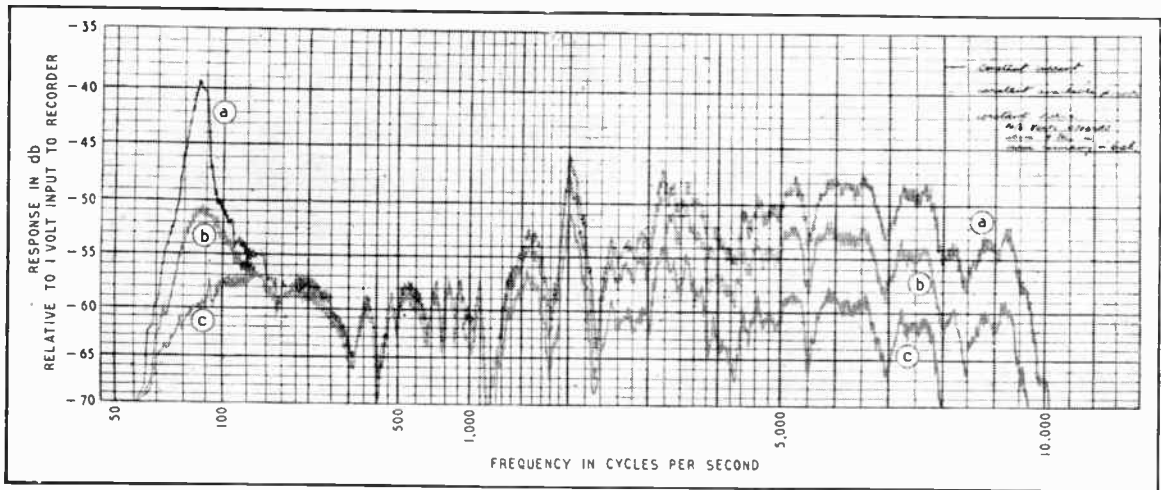

Fig. 7. Response curves for the same loudspeaker; (a) under constant-current conditions, (b) when $Z_{400} = r_s$ and (c) for constant-voltage output. (By courtesy of Messrs. Goodmans Industries, Ltd.)

bass resonant frequency the efficiency can be as much as 90 per cent whereas at 400 c/s it cannot exceed 20 per cent. At 100 c/s it cannot exceed about 6 per cent.

From the curves of Fig. 4 we can see that the total power delivered to the loudspeaker in the triode case is 0.208 watt at 400 c/s falling to 0.04 watt at 10,000 c/s. In the pentode case, however (see Fig. 5) the total power is 0.013 watt at 400 c/s and 0.017 watt at 10,000 c/s. This gives the acoustic superiority of the pentode as regards "top" compared with a triode as being

$$10 \log_{10} \frac{0.017}{0.013} \times \frac{0.208}{0.04} = 8.3 \text{ db.}$$

(i.e. the power at 10,000 c/s compared with that at 400 c/s).

being greater for high impedance sources than for low ones. The greatest difference possible, therefore, is between the response given by a source of zero impedance, i.e., a constant-voltage generator and one of infinite impedance, i.e., a constant-current generator.

To illustrate this the curves of Fig. 7 have been prepared by Messrs. Goodmans Industries, Ltd., by whose permission they are reproduced here. The author would like to express his thanks to this firm for their help in this matter. They show three response curves of the same loudspeaker, all made level at 400 c/s, one taken under constant-current conditions, a second for constant-voltage output and the third with the loudspeaker fed from a source

of a certain loudspeaker under constant-current conditions, a purchaser driving the loudspeaker from a low-impedance output triode or from a pentode with considerable negative voltage-feedback will probably lose at least 10 db, and probably more, of the extreme "top" indicated by the curve.

The same remark applies to the sound output at the bass resonant frequency. It may, of course, be argued that the acoustics of the room in which the loudspeaker is placed may make a bigger aural effect than this, but it is as well to know precisely what the loudspeaker is doing. In order to realize in practice the exact response curve published by the manufacturers, one must use the

same driving source impedance as they did in taking the curve—or alternatively one could use a different output impedance and some sort of tone control system.

To show the effect of output impedance on the response of a loudspeaker, Fig. 8 has been prepared. It shows the "lift" at 10,000 c/s and 70 c/s (compared with the output at 400 c/s) relative

Fig. 8. Curves showing the output at 70 c/s and 10,000 c/s in terms of that at 400 c/s of the loudspeaker of Fig. 1 over that given by a constant-voltage generator, as a function of the ratio of r_a to Z_{400} .

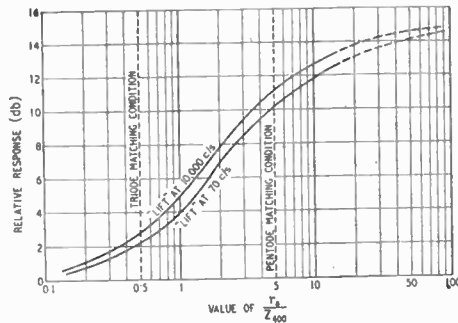

to the response given by a constant-voltage generator for the loudspeaker of Fig. 1 as a function of $\frac{r_a}{Z_{400}}$. The pentode and triode matching conditions are indicated here and it is seen that the difference between them is 8 db, as deduced earlier. The greatest deviation is 15 db which agrees well with Fig. 7 even though the two figures apply to different loudspeakers. Most of the curves in this article may be applied to any conventional moving-coil loudspeaker with little error, for their impedance-frequency curves, from which this work was deduced, are of much the same shape. It should not be forgotten, however, that we have assumed throughout this article that the output trans-

former used is perfect, and therefore has no leakage inductance. In practice the existence of leakage inductance may modify the shape of some of the curves which have been deduced. Normally leakage inductance causes a loss of high

notes but if a capacitance is connected across the primary winding of the transformer it may resonate with this and give "top lift." In Fig. 9, Fig. 8 has been modified to illustrate the effect of altering the turns ratio of an output transformer on the frequency response of a loudspeaker. The curve illustrates the deviation from the response given by the triode matching condition. By doubling the turns ratio we lose 2 db (practically undetectable by ear) at 70 c/s and 10,000 c/s. By halving the turns ratio, equivalent to quadrupling the impedance of the driving source, we gain 5 db at 70 c/s and 10,000 c/s.

TRANSMITTER RELAYS

THE judicious use of relays can make a profound difference in the ease of operating an amateur transmitting station. With the introduction by Londex of an aerial change-over relay, designed especially for V.H.F. work, one of the most difficult functions can now be attempted without fear of loss in efficiency.

The model most suitable for amateur use is the AECO4, which will handle up to 4 amps of R.F., and has its contacts mounted on polystyrene insulation.

No measurable loss in output could be determined when one of these relays was fitted to a five-metre transmitter, which hitherto fed into a separate aerial. By the inclusion of the relay one aerial can be made to serve for both transmission and reception; moreover,

switching can be effected at any convenient distance from the operating position.

The AECO4 relay has heavy contacts of pure silver, those for the transmitter switching being larger than for the receiver, which is as it should be. It operates with 3 watts, nominal, input and can be obtained for either A.C. or D.C. supplies at any voltage. The model tested was wound for 12 volts D.C. and consumed just over 120 mA. The contact carrier arm is so mounted that perfectly even pressure is applied to both pairs of contacts.

Mounted on a bakelite baseplate, the AECO4 relay measures 3in x 3in x 1 1/2in overall and costs £2 17s 6d.

A small keying relay, the Type ML, tested on the same transmitter, gave an equally satisfactory performance, making clear-cut morse characters without the slightest signs of chatter. In unmounted

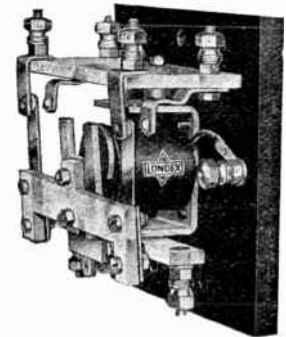

Londex type AECO4 aerial change-over relay.

form it measures 2in x 1 1/2in x 1 1/2in, and with one pair of contacts costs 18s.

The makers are Londex, Ltd., 207, Anerley Road, London, S.E.20.

MANUFACTURERS' LITERATURE

HANDBOOK of photo-electric cells and multipliers, with technical information on their use. Cinema Television, Ltd., Worsley Bridge Road, Lower Sydenham, London, S.E.26.

Pamphlets giving technical details of the electronic voltmeter, cathode-ray oscillograph and quartz frequency standard made by Radio-Aid, Ltd., 29, Market Street, Watford, Herts.

List of television aerial downloads from Aerialite, Ltd., Castle Works, Stalybridge, Cheshire.

O'Neil-Irwin Mfg. Co., Minneapolis 15, Minnesota, U.S.A.—Booklet describing a system of die-less duplicating of mechanical parts by means of "Diacro" benders, shears, etc.

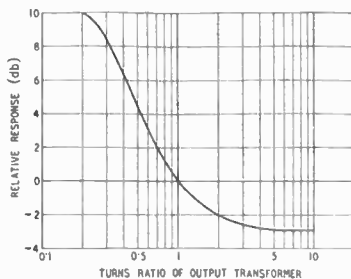

Fig. 9. Curve showing output at 70 c/s and 10,000 c/s in terms of that at 400 c/s of the loudspeaker of Fig. 1 as a function of the output transformer ratio. Unity turns ratio corresponds to the triode matching condition, in which $Z_{400} = 2r_a$.

DECCA NAVIGATOR STATIONS

Details of the Transmitter Chain

By M. G. SCROGGIE, B.Sc., A.M.I.E.E.

THE operation of Decca Navigators at sea and in the air, described in the March, 1946, issue, depends upon a constant service from a "chain" of fixed transmitters. Their duty is to maintain, over the whole surrounding service area, a phase pattern that is stationary and permanent. Failure in either of these respects might have serious results for any craft relying on the Navigator for guidance. After examining the details of the system, however, only an extreme sceptic could find any ground for misgivings.

First as regards fixity of the phase pattern. Two trains of continuous waves cannot, of course, maintain a fixed phase relationship with one another unless they are of exactly the same frequency. And if they are of the same frequency they cannot be separately received by radio for purposes of phase comparison. This

phase comparison frequency, which is reconstituted from them in the Navigator receivers by extracting the appropriate harmonics. If the phase difference between them is constant and correct at any one geographical position it must (apart from irregularities in wave propagation) be constant and correct everywhere else. All that is needed, then, is to install a Decca Navigator receiver or its equivalent at some fixed point and arrange that its phase discriminator output voltage controls the phase of one of the two transmissions, pulling it back if it tends to stray, in essen-

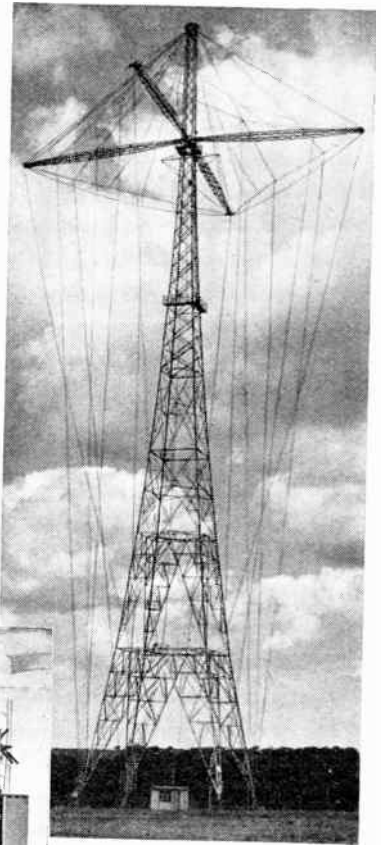
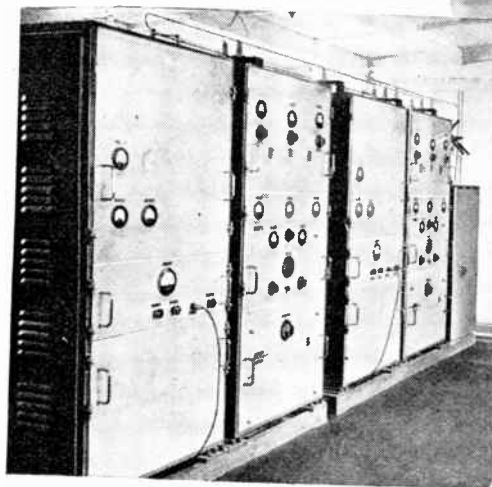
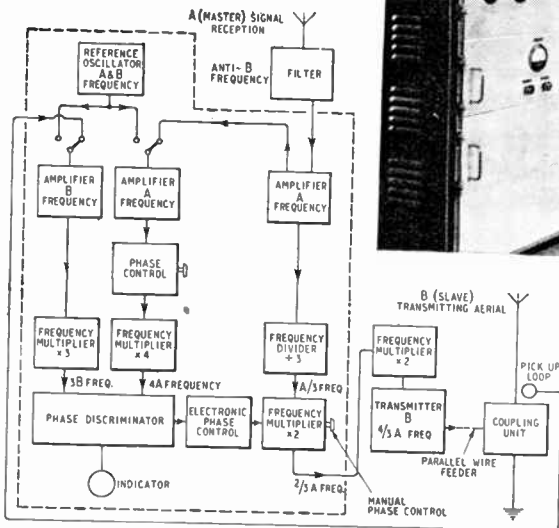

Fig. 2. Aerial, consisting of self-supporting 325-ft tower insulated from the ground. The efficiency of the tower as a radiator is improved by aerial wires strung from the horizontal booms. The hut at the foot of the tower contains the coupling transformer.



(Left) Fig. 3. Two of the three transmitters at the Decca Slave Station near Lewes.



tially the same manner as automatic frequency correction.

To relieve the automatic

Fig. 1. Block diagram of Slave Station equipment.

dilemma, it may be remembered, is overcome by transmitting on two exact submultiples, say one-third and one-quarter of the

phase corrector of any responsibility for keeping the transmitter frequency in step, thus enabling it to concentrate on

holding the phase within the extremely narrow limit of 1/200th part of a cycle (only 0.015 μ sec!), the drive for one transmitter in each pair (the Slave) is obtained from the other (the Master) by frequency multiplication and division. The Master, station A, is crystal controlled, and in the British chain radiates at 85 kc/s. Its signal is picked up at the Slave station on

a small vertical aerial and fed, via a filter to reject the relatively very strong Slave signal, into an amplifier (see Fig. 1), the frequency of whose output is divided by three and then doubled twice to give a 113.3-kc/s drive for the Slave transmitter.

Although the correct frequency ratio is thereby automatically ensured, the phase relationship of the Slave's third harmonic to the Master's fourth harmonic (both 340 kc/s) would be quite random and liable to fluctuate unless it were controlled. The dotted line in Fig. 1 encloses the phase lock unit, the left-hand portion of which is similar to a two-channel section of a Navigator receiver. To one amplifier is fed the 85-kc/s Master signal, and to the other the 113.3-kc/s Slave signal picked up by a small loop close to the transmitting aerial lead. The 340-kc/s harmonics are extracted from both and passed into the phase discriminator, the D.C. output from which actuates not only the usual "Decometer" indicator, but also an electronic phase control in the drive frequency multiplier chain.

The phase of the A amplifier output is adjusted so that when the space phase pattern is correct and in agreement with the Decca charts the discriminator output is zero. The amplifiers themselves are periodically checked for relative phase shift by means of a reference oscillator having harmonics on both A and B frequencies, in the same way as in the Navigator receivers. A manual transmitter phase control is pro-

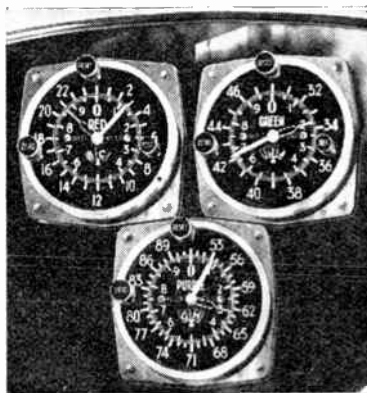
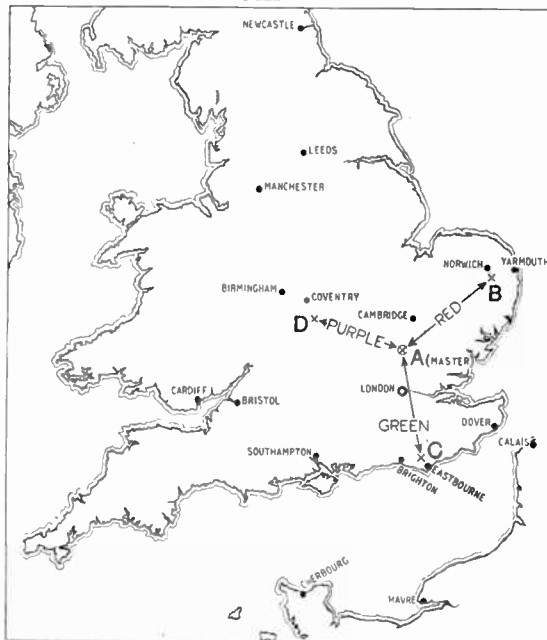
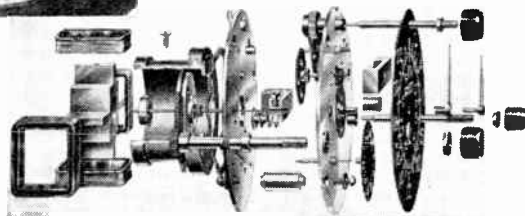

Fig. 5. "Decometer" indicators of Decca Navigator for use with 4-station chain. On the right is an exploded view of the Decometer.



remote monitor receiver is sited roughly midway between the two stations. An error in the indicator reading shown there is notified to the Slave station. At present it is done verbally, but the intention is to make this remote control fully automatic.

The other essential of the service is con-

Fig. 6. Situations of the four stations forming the Decca South England chain.

vided for initially setting the automatic phase control at the centre of its working range, where the phase error is nil and the locking most effective. It is readjusted if ever there is any long-term phase drift in either direction, indicated by a reading on the discriminator output voltmeter. The phase-lock unit, installed in duplicate in a screened cabin, is in Fig. 4.

As a further check on the correctness of the phase pattern, a

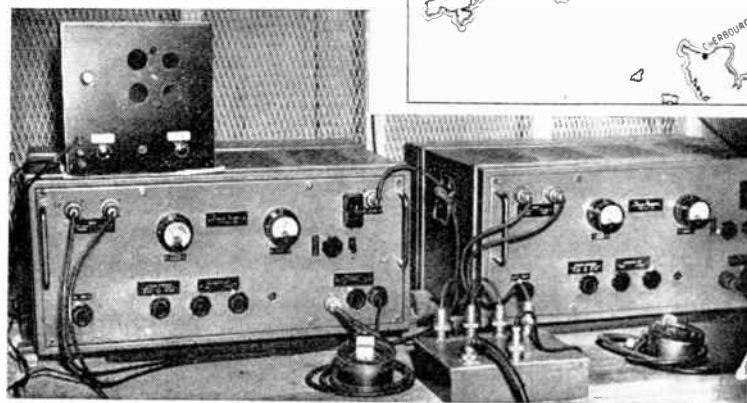

Fig. 4. Phase-lock units in duplicate.

tinuity. Fortunately literal continuity is not needed, as the characteristics of the Navigator are such that breaks of the order of one second can be tolerated. It is this feature that renders the system so remarkably immune from relatively strong "noise" and other impulsive types of interference. At each station there are three complete transmitters (Fig. 3). One is in action, another has its filaments

Decca Navigator Stations—

lit and all ready for immediate change-over, while the third can be shut down for maintenance. If the working set fails, relays switch over to the ready transmitter, and the service is restored within 1 to $1\frac{1}{2}$ seconds of the breakdown. The new wave comes up from the start in correct phase, so there is no possibility of Navigators slipping a whole cycle and indicating the wrong "lane."

Power supply is safeguarded by having available the public mains, two diesel-driven generators (one running in readiness), and one petrol-electric.

Owing to the relatively low radiation resistance of aerials at

OUR COVER

This month's cover shows mast-head details of the aerial at one of the Decca transmitting stations.

frequencies of the order of 100 kc/s, it is a problem to counteract the tendency for loss resistances to predominate, wasting most of the R.F. power supplied by the transmitter. The radiators at the Decca stations are of a new design (Fig. 2), which, according to field strength measurements, are stated to have the remarkably high radiation efficiency of 45 per cent. The transmitter output being 2 kW, actual radiation is therefore 900 watts. As the successful results over a radius of hundreds of miles during the war were achieved with a radiation of about 15 watts, the service now being established provides a substantial margin for unfavourable reception conditions.

To obtain a fix, at least two pairs of stations are needed, of which one station (the Master) can be common to both pairs, making a three-station chain. The second Slave (station C) is similar to the first except that its frequency is $\frac{3}{2}$ that of the Master, giving a common comparison frequency of 255-kc/s.

A two-pair chain has certain ambiguities and ineffective zones, so the Decca chain now being

completed in England is composed of four stations: a central Master and three Slaves spaced 120° around it, as shown in Fig. 6, enabling three position lines to be determined on triple-indicator Navigators (Fig. 5). Besides giving greater accuracy, this arrangement provides a further margin against breakdown. Other chains are under construction in France and Scandinavia.

NATIONAL PHYSICAL LABORATORY

THE work of the N.P.L. was necessarily kept secret during the war, but this ban has now been lifted, and demonstrations of work in progress have recently been given to this journal. In the Radio Division much work has been done on the measurement of the effect of the moisture content of the atmosphere on the propagation of centimetre waves. The dielectric properties of water are measured, as well as the reflection and transmission coefficients of thin layers of water, with the aid of miniature transmitters and receivers.

At wavelengths below some 3

DYNATRON RADIO-GRAMPHONE

A RADIOGRAM version of the "Merlin" receiver described in our June issue has been produced by Dynatron Radio, Ray Lea Road, Maidenhead. It incorporates automatic record changer with a sapphire needle armature pick-up. The walnut cabinet is plastic bonded and has independent lids for the radio and gramophone sections. The price is 150 guineas plus £38 1s. 3d. purchase tax.

cm, the absorption of a humid atmosphere can be quite high, but under normal conditions in this country it seems unlikely to be serious until the wavelength is under 1 cm.

Research of considerable ultimate importance is being carried on into atmospheric noise. Daily observations of noise level are made at a large number of stations distributed over the world and the N.P.L. carries out the tabulation and analysis of the records. The object is to obtain sufficient information for the prediction of the noise level at any time and place.

The location and determination of the paths of thunderstorms is of meteorological value and was important during the war on account of the vulnerability of balloon barges to lightning. Cathode-ray D.F. equipment with crossed-loop aerials is employed for this, with the usual D.F. technique of simultaneous observation at two widely spaced receiving stations.

A considerable amount of centimetre-wave apparatus was shown, including a low-power transmitter and receiver for 1.2 cm. A klystron valve is used and feeds a rectangular waveguide with a horn radiator. Wavemeters and cable-measuring apparatus were important items of the display.

Radio-frequency heating was used during the war for drying cabbage, since dehydration could be effected in about one hour with dielectric heating as compared with eight hours in a normal oven. The apparatus demonstrated had an output of some $7\frac{1}{2}$ kW at 5 Mc/s.

An interesting exhibit in the acoustics section was a lorry fitted out as a travelling laboratory. It is intended for noise and acoustic measurements in factories and in connection with housing schemes.

The high-voltage section demonstrated an oscilloscope of the continuously evacuated type operating at 55 kV. High-voltage cable measurements at 600 Mc/s were also shown. The method of voltage measurement used is closely akin in principle to that used at power frequencies, but the modern high-frequency crystals are used as rectifiers; they are fed from a minute probe in the wall of a section of the cable.

MEASURING INSULATION RESISTANCE

An Unusual Experience with an Avometer

By J. PIGGOTT, B.Sc. (Eng.) A.M.I.E.E.

(Post Office Engineering Dept.)

WHILE the author was conducting some experiments on a single-pair overhead line about 5 miles long, near London, its characteristics at carrier frequencies were not up to expectations. The insulation resistance of the line was suspected and, in the absence of a 500-volt "Megger," a "Model 40" Avometer was used to measure the insulation resistance. The results were as follows:

electro-chemical effects, or from earth potentials, were considered and the meter switched to "D.C. volts," with the following results:

frequency attenuation readings which must be the result of some other fault. Returning to the Avometer results and to prove

Meter switch position	Wire-to-wire	Each wire to earth
0.12V. range	No deflection	0.01V.—0.02V. varying
1.2V. range	No deflection	0.08V.—0.1V., varying.

These readings appeared more hopeful. As it was thought probable that the source im-

pedance was high, the charge in impedance of the meter (lower for the lower range of voltage) would account for the discrepancy in voltage readings between the two ranges. It was also feasible that both wires could be at the same D.C. potential relative to earth; this could account for the zero deflection wire-to-wire, but

Meter switch position	Wire-to-Wire	Each wire to earth
D.C. resistance	No deflection	No deflection
1,000-ohm range	(>1,000 ohms)	(>1,000 ohms)
D.C. resistance	No deflection	3,000 to 4,500 ohms, varying.
10,000-ohm range	(>10,000 ohms)	

These results appeared contradictory. How could the wire-to-wire insulation resistance be greater than 10,000 ohms (no deflection on 10,000-ohms range), when each of the wires showed between 3,000 and 4,500 ohms to earth? Further, a 3,000-ohm resistance does produce some slight deflection on the 1,000-

pedance was high, the charge in impedance of the meter (lower for the lower range of voltage) would account for the discrepancy in voltage readings between the two ranges. It was also feasible that both wires could be at the same D.C. potential relative to earth; this could account for the zero deflection wire-to-wire, but

Resonant Frequency

The Avometer makes use of a current limiting rectifier and tests with a high-frequency oscillator indicated that the inductance of the moving coil in the meter resonated with the shunt capacitance of the protecting rectifier at about 450 kc/s with rectification taking place. This effect was found on other ranges of "D.C. ohms" and "D.C. volts," but to a much reduced extent, due to series resistance damping. The variations in the deflection obtained with the overhead-line tests were entirely due to reception of several radio transmissions. The "AVO" was behaving as a radio receiver, and the overhead line had been acting as an effective receiving aerial. The insulation resistance of the line later proved to be entirely satisfactory and the original "fault" to be something quite simple in the carrier-frequency measuring equipment.

Laboratory tests on a sample Model 40 Avometer which demonstrate the reasons for the deflections described above are recorded on Figs. 1, 2 and 3. Fig. 1 shows the effect of carrier frequencies on the deflection, with the meter switched to the D.C. 0.12-volt range. The meter is energised from a relatively

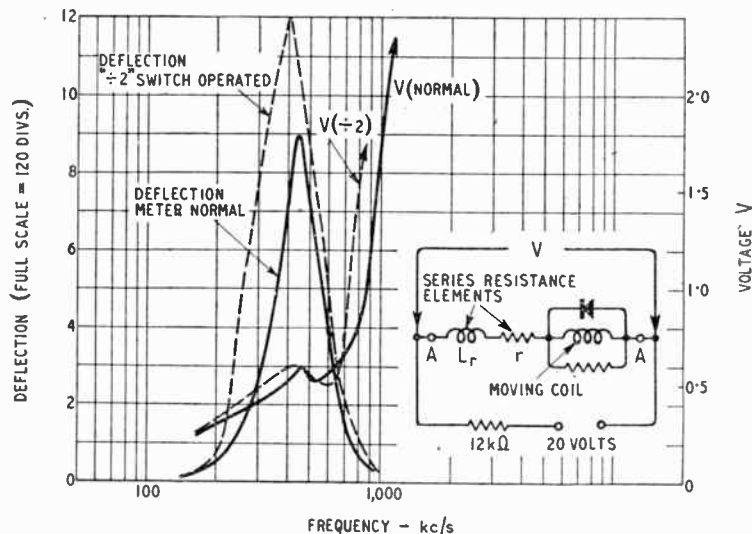

Fig. 1. Variation of deflection with frequency on D.C. 0.12-volt range. Meter terminals AA.

ohm range, whereas this definitely did not occur with the meter thus connected between wire and earth. The usual difficulties from

why should the wire-to-earth readings vary continuously? D.C. potentials could not account, however, for the original carrier-

high impedance constant voltage source. The full-line curves give the deflection and corresponding voltage across the instrument terminals. A resonance is seen to occur at about 450 kc/s. The corresponding curves for the

"Avo" range will have a very sensitive cut-out device and a protective rectifier will not be necessary to ensure operation, and abnormal effects due to H.F. currents will not occur.

It is thought that all that is

A.R.R.L.

Handbook for 1946

THE twenty-third edition of the American Radio Relay League's annual publication, the A.R.R.L. Handbook, marks a return to peacetime amateur radio. Its issue was delayed this year in order that the space latterly devoted to the War Emergency Radio Service could be more usefully employed in expanding the chapters devoted to the latest V.H.F. equipment. No changes have been thought necessary this year in the designs given for transmitters and receivers for use on the lower amateur frequencies as these fully satisfy current needs.

Every aspect of amateur radio is covered by this handbook, which opens with a brief history of amateur radio, explains fundamental principles, provides designs for transmitters and receivers, explains how to make and use modern test apparatus, discusses aerial design and erection and after devoting some 40 pages to tabulated valve data gives sound advice on the operation of an amateur transmitting station. Its 468 pages of text are a mine of valuable information and these are well supported by 1,250

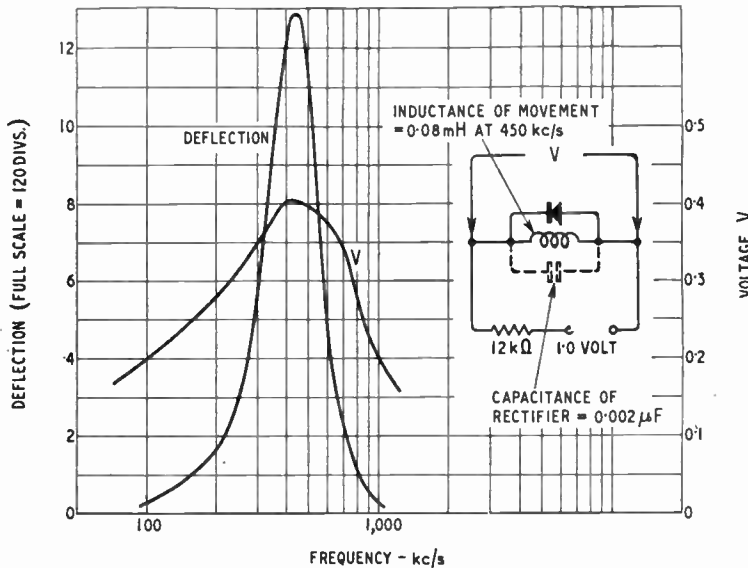

Fig. 2 (Above) Resonance of moving coil and shunt rectifier only.

Fig. 3 (Right) Effect of external filter. A.C. voltage and frequency required to produce a deflection of 2 divisions (full scale 120 divs.).

"÷ 2 in." switch operated, are shown dotted.

Fig. 2 shows the shunt resonance of the rectifier and moving coil. The measured values of capacitance and inductance checking with the resonant frequency.

Fig. 3 indicates the improvement which can be obtained by the addition of a filter to the instrument externally. This is not considered a practical solution except in very unusual applications of the meter.

Several "Model 40" and "Model 7" meters which were checked for this effect, all exhibited a resonant frequency of about 450 kc/s. These meters are fitted with automatic cut-outs which require a protective rectifier. Older "Universal" meters fitted with a fuse do not behave in this manner, as no protective rectifier is connected. It is understood that a future model in the

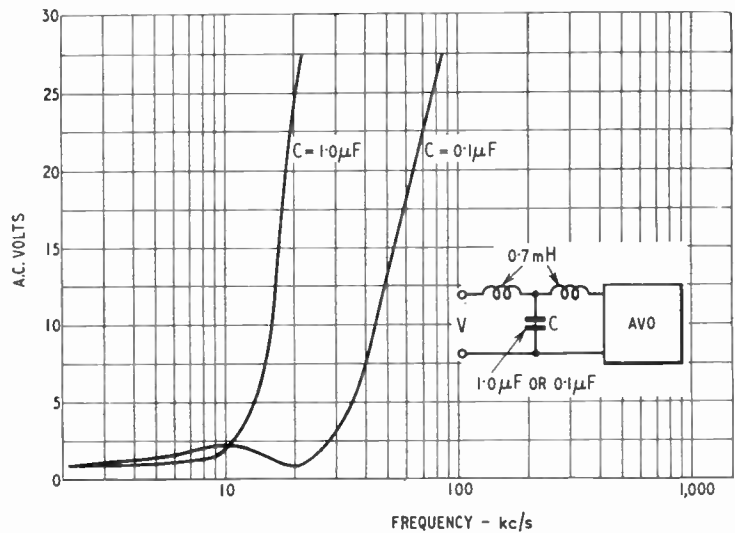

necessary is for users of Model 40 or Model 7 Avometers to be aware of the effects discussed in this article. For instance, when checking the H.T. potentials or currents in valve circuits, if unexpected values are obtained, it may be that the circuit is oscillating, or that H.F. currents in the range 300 to 700 kc/s are circulating.

illustrations and 114 charts and tables.

The Handbook is obtainable direct from A. F. Bird, 66, Chandos Place, London, W.C.2, the price being 10s 6d., plus 7d postage. Alternatively orders can be placed with the Radio Society of Great Britain, New Ruskin House, Little Russell Street, London, W.C.1, for delivery from America, the price being the same.

E.M.I.

AND THE RADIO AMATEUR



Recognising the achievements of the radio amateur in peace and war, it is the intention of E.M.I. to make available from time to time items of specialised equipment of particular value to the radio amateur at home and overseas. Detailed information will appear in due course in the *Wireless World* and other amateur periodicals.

ELECTRIC & MUSICAL INDUSTRIES LTD.

HAYES, MIDDLESEX

VORTEXION

"SUPER FIFTY WATT"

AMPLIFIER

This **AMPLIFIER** has a response of 30 cps. to 15,000 cps., within $\frac{1}{2}$ db., under 2 per cent. distortion at 40 watts and 1 per cent. at 15 watts, including noise and distortion of pre-amplifier and microphone transformer. Electronic mixing for microphone and gramophone of either high or low impedance with top and bass controls. Output for 15/250 ohms with generous voice coil feedback to minimise speaker distortion. New style easy access steel case gives recessed controls, making transport safe and easy. Exceedingly well ventilated for long life. Amplifier complete in steel case, with built-in 15 ohm mu-metal shielded microphone transformer, tropical finish. As illustrated. Price 29½ Gns.

A.C.20 AMPLIFIER CHASSIS.—This well-known model has been retained, and has a response 30—15,000 cps., mixing arranged for crystal pick-up and microphone, large output transformer for 4—7.5 and 15 ohms to deliver 15 watts at less than 5 per cent. total harmonic distortion to the speakers. Metal Cabinet for above, if required, £3. Price £15 15 0

RECORD REPRODUCER CHASSIS.—This is a development of the A.C.20 amplifier with special attention to low noise level, good response (30—18,000 cps.) and low harmonic distortion (1 per cent. at 10 watts). Suitable for any type of pick-up with switch for record compensation, double negative feedback circuit to minimise distortion generated by speaker. Has fitted plug to supply 6.3 v. 3 amp. L.T. and 300 v. 30 mA. H.T. to a mixer or feeder unit ... Price £18 0 0 Metal Cabinet for above, if required, £3.



C.P.20A 15-WATT AMPLIFIER for 12 volt Battery and A.C. Mains operation. This improved version of the old C.P.20 has switch change-over from A.C. to D.C. and "stand by" positions and only consumes 5½ amperes from 12 volt battery. Fitted mu-metal shielded microphone transformer for 15 ohm microphone, and provision for crystal or moving iron pick-up with tone control for bass and top and outputs for 7.5 and 15 ohms. Complete in steel case with valves. Price £22 10 0

We very much regret that owing to increased costs we are reluctantly compelled to advance all the above prices by 10 per cent. on orders placed after July 1st.

DEALERS AND EXPORT AGENTS should write for special terms to:—

VORTEXION LTD.

257-261 THE BROADWAY,
WIMBLEDON, S.W.19.

Telephones: LBerty 2814 and 6128

Telegrams: VORTEXION, WIMBL., LONDON.

QUARTZ CRYSTAL UNITS



For your **FREQUENCY STANDARD**

TYPE JCF/200 LOW TEMPERATURE COEFFICIENT BAR

Frequency . . . 100 Kc/s
Accuracy . . . ± .01 %
Price £2 - 15 - 0

Vacuum mounted for optimum stability
A high precision unit of extreme stability,
the crystal being nodally mounted on fine
wires soldered to the bar.

DELIVERY FROM STOCK



For your **TRANSMITTER**

TYPE 2 LOW TEMPERATURE COEFFICIENT PLATES

3-50/3-75 Mc/s or 7-00/7-50 Mc/s for the
30 Mc/s band.
3-66/3-75 Mc/s or 7-32/7-50 Mc/s for the
60 Mc/s band.

PRICES:—

Random frequency in either band . . . £1 - 10 - 0
Specified frequency in either band . . . £1 - 16 - 0

AVAILABLE FOR IMMEDIATE DELIVERY

SALFORD ELECTRICAL INSTRUMENTS LTD.

PEEL WORKS, SALFORD 3

Telephones: BLAckfriars 6688 (6 lines).

Telegrams and Cables: "SPARKLESS, MANCHESTER"

Proprietors: THE GENERAL ELECTRIC Co. Ltd., of England

TELEVISION V.F. STAGE

Direct Coupling Between Tube and Amplifier

By W. T. COCKING,

M.I.E.E.

THE usual method of feeding a cathode-ray tube is to apply the picture signal to its grid in such a way that positive-going voltages represent changes in the white direction. Now it is desirable to feed the sync separator from a point of large signal amplitude, and as there is rarely any point of larger signal amplitude than the tube input, it is convenient to feed both from the same point. However, sync separation is much more easily effected from a negative-going signal than from a positive and there is considerable difficulty in obtaining good results with economy of material when the separator is fed in parallel with the tube grid.

It is not always realized, however, that it is possible to apply the picture signal to the cathode of the C.R. tube instead of to the grid. When this is done the tube requires a negative-going input and, as the sync separator also best likes this polarity of input, most of the difficulties disappear. In addition, direct coupling to the tube is permissible with safety and neither for sync separation nor for the picture channel are D.C. restoring diodes needed. D.C. restoration in the sync channel is required, but owing to the polarity of the signal it can be obtained from the sync separator without an additional valve.

The basic circuit of this form of stage is shown in Fig. 1 where V_1 is the video amplifier and V_2 the sync separator. The complete composite picture and sync signal is applied to V_1 as shown. Usually it will be provided by a diode detector with direct coupling so that the bottoms of the sync pulses are substantially at earth potential and the rest of the signal is positive with respect to earth. Consequently, V_1 must have sufficient grid bias to avoid grid current on a peak-white signal. This is about 1.5 volts

more than the peak-to-peak signal amplitude.

The anode current of the valve is a minimum at the bottom of the sync pulses and a maximum on peak white. The voltage drops across R_1 are also respectively a minimum and a maximum, so that with respect to earth the anode voltage is most positive at the bottom of the sync pulses and least positive on peak white. The

anode waveform is thus an amplified inverted copy of the input, as can be seen from the inset waveform diagram in Fig. 1; it is negative-going on the picture signal. It may be remarked that the inductance L is included to correct for the shunting effect of the circuit capacitance. As we are not concerned with the high-frequency response at the moment we can ignore it for the present.

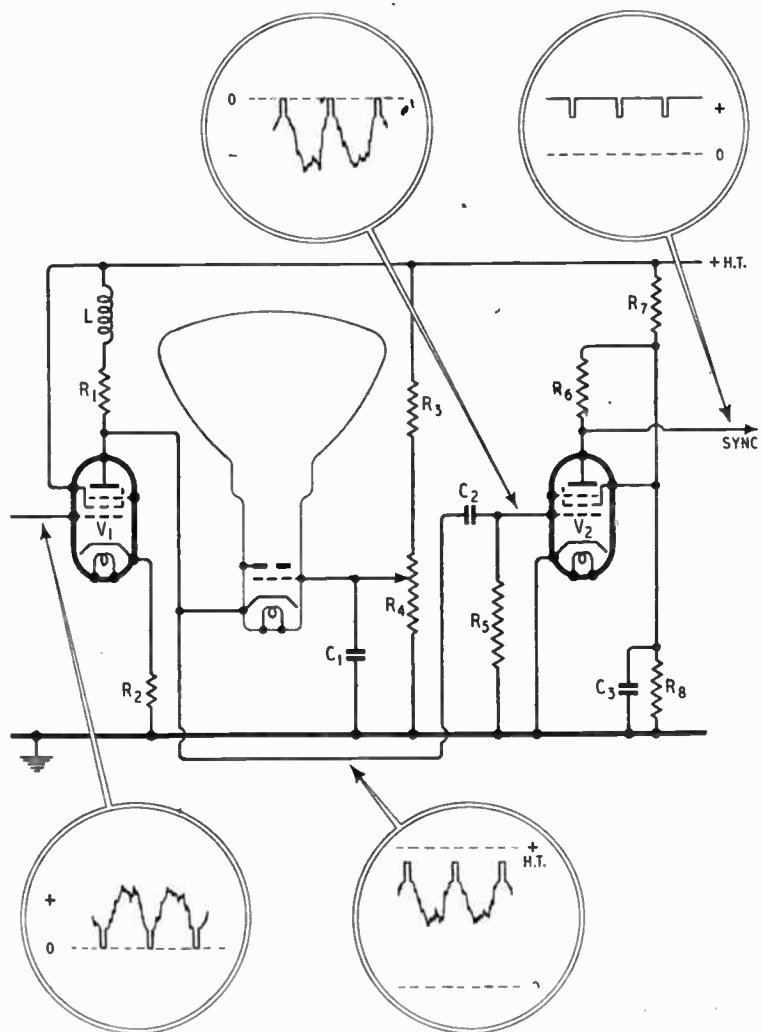

Fig. 1. The basic circuit of a V.F. stage directly coupled to the cathode of a C.R. tube is shown here together with the waveforms existing at various parts of the circuit. The sync separator is also included.

Television V.F. Stage—

The V.F. output of V_1 is applied to the C.R. tube by direct connection to its cathode. Tube bias is obtained by taking its grid to a potential divider R_3 , R_4 across the H.T. supply. A typical tube needs about 21 volts change of grid-cathode potential between black and white. This must be provided by the picture part of the signal and, as this is 70 per cent of the total amplitude in a normal case, the input to the tube consists of a 30-volt p-p signal of which 9 volts is sync pulse and 21 volts is picture signal.

As an example of the order of magnitude of the circuit elements, it will be assumed that V_1 has a mutual conductance of 6 mA/V, that its minimum anode current is 5 mA and that its screen current is 10 per cent of the anode. The value of R_1 might well be 2.5 k Ω . For a total output of 30 V p-p, the change of anode current must be $30/2.5 = 12$ mA, so that the anode current varies between the limits of 5 mA and 17 mA. With an H.T. supply of 250 volts the anode voltage varies between $250 - (2.5 \times 5) = 237.5$ V and $250 - (2.5 \times 17) = 207.5$ V. Black level corresponds to the threshold between the sync pulses and the picture signals and is represented by an anode voltage of $237.5 - 9 = 228.5$ volts.

The tube bias for black depends on the tube design and its anode voltage; it might well be a grid-cathode potential of -40 V. Therefore, when the cathode is at $+228.5$ volts, the grid must be at $228.5 - 40 = +188.5$ volts and this is obtained by the adjustment of the slider of R_4 for the required brilliance.

Turning back to the V.F. stage itself, since the mutual conductance is 6 mA/V and R_1 is 2.5 k Ω the amplification, defined as the ratio of the output voltage change to the grid-cathode voltage change, is $6 \times 2.5 = 15$ times, so that for 30 V p-p output the grid-cathode voltage is 2 V p-p.

The input to the stage is developed between grid and earth, however, and it is necessary to take into account the feedback from the bias resistance R_2 and also to determine the bias resistance. With maximum signal

the grid-cathode potential must be -1.5 V to avoid grid current, and with a signal of 2V the no-signal bias must be -3.5 V. The anode current is 5 mA and the screen current 0.5 mA with no signal, so that the cathode current is 5.5 mA, and the value needed for R_2 is $3.5/5.5 = 0.635$ k Ω .

So far as the feedback is concerned the valve functions as a triode, for both screen and anode currents flow through R_2 . As the screen current is 10 per cent of the anode current, the effective mutual conductance for feedback purposes is about 10 per cent higher than that between grid and anode only. Feedback thus reduces the gain by the factor

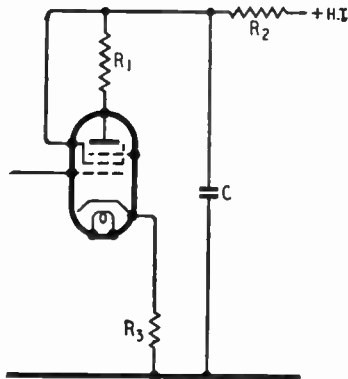

Fig. 2. The impedance of the power supply, represented by R_2 and C , affects the D.C. amplification.

$1 + 6.6 \times 0.635 = 5.2$, and the true amplification of the stage between input and output becomes $15/5.2 = 2.88$ times. For an output of 30 volts p-p, the input needed is thus some 10.4 volts p-p. This is a suitable value of detector output, and can usually be obtained without difficulty.

Turning now to the sync separator, this is a pentode with its grid fed through C_2 with the full V.F. stage output. No grid bias is provided and the positive-going sync pulses drive it into grid current and provide D.C. restoration. The effect of the coupling is substantially only to remove the anode voltage of the V.F. stage. The tips of the sync pulses are at about earth potential and the whole signal is negative with respect to earth, as shown in

the waveform diagram. The values for C_2 and R_5 are not critical; the requirement is that R_5 be very large compared with the grid-cathode resistance of V_2 when grid current is flowing and that C_2 be large enough not to charge to an appreciable voltage during the time of one line. These requirements are well met by values of 1 M Ω and 0.1 μ F.

Sync Separator

The screen voltage of V_2 is chosen so that anode current cut-off occurs for a grid voltage less than black level. This is some 9 volts so that a screen voltage giving cut-off at -8 volts would suppress the picture signal completely. However, a factor of safety is required, and in addition the full 21 volts of picture signal may not always be wanted on the tube. It is, therefore, a good plan to design the sync separator for an input of one-half of the normal and to allow a factor of safety on top of this. This means that cut-off should occur at a grid-cathode potential of less than -4.5 volts, and to obtain a reasonable factor of safety one would place the actual figure at about -3 volts. As grid current flows up to about -1.3 volts, the tips of the sync pulses will rest at about -1 to -1.3 volt, and the effective grid-cathode voltage change on the sync pulses will be of the order of 2 volts.

It is advantageous to make R_6 of high value, since this gives a limiting action on the positive part of the input signal and reduces the effect of noise during the sync pulses. However, stray capacitances limit the value which can be used while retaining the pulse shape. It cannot often exceed 20 k Ω and must sometimes be less.

With a high- g_m type of valve for V_2 cut-off at -3 volts grid potential occurs for a screen voltage of the order of 40–60 volts and the amplitude of sync pulse output is around 20–40 volts. The screen voltage is, of course, obtained from the potential-divider R_7 , R_8 .

In spite of the direct connection of the tube cathode to the anode of the V.F. stage, the D.C. component of the signal is not retained

perfectly. Because of the resistance of the H.T. supply, it may be excessive. It is sometimes necessary, therefore, to modify the circuit in such a way that this accentuation of the D.C. component is avoided.

The effective circuit of the V.F. stage is shown in Fig. 2 in which R_2 represents the total D.C. resistance of the power supply and C is the output capacitance. Down to at least the line-recurrence frequency, C can be regarded virtually as a short-circuit and for all rapid changes in the signal the resistance R_2 plays no part and the amplification is as calculated earlier. However, it is not a short-circuit to direct current and the amplification is then dependent on the value of R_2 as well as R_1 .

The effect of the D.C. component is illustrated in Fig. 3. At (a) is shown a series of pulses representing two black lines followed by six white lines, minor variations in the signal such as the black level steps being omitted for simplicity. When the D.C. component is removed the waveform is modified to (b). The tops and bottoms of the pulses

are no longer horizontal but decay exponentially. As a result the tips of the narrow pulses do not rest on the zero base line, but pass over it by an amount which depends on the total amplitude of the pulse.

When the input pulse amplitude changes, there is a gradual change in the output. In Fig. 3 (b), this gradual change is shown as extending over six cycles, but in practice it may take several hundred cycles to reach the final condition. The curved tops and bottoms to the pulses are then almost horizontal straight lines, and the first and last pulses appear as sketched in Fig. 4 (a).

When the D.C. component has excessive amplification, the effect is just the reverse. The output rises during the horizontal parts of the pulses and the output waveform varies in the manner sketched in Fig. 3 (c). Just as in the case of a lack of the D.C. component, the effect in practice is more gradual and is effected over many more cycles than are shown here. The first and last cycles of many thus have nearly horizontal tops as in Fig. 4 (b).

The mechanism is not difficult

to understand. In Fig. 2, assume that the grid potential is changed suddenly in the positive direction so that the anode and screen

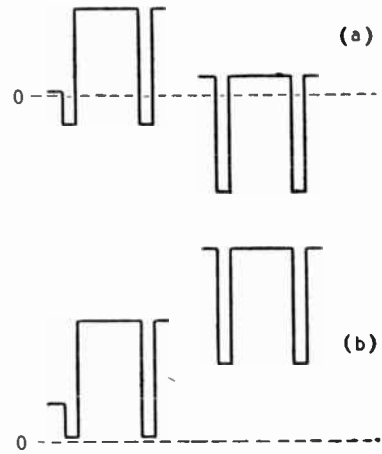

Fig. 4. With large time-constants the effects shown in Fig. 3 take very many cycles to complete and the tops and bottoms of the pulses are then almost horizontal. The first and last pulses of a long series then take the forms shown at (a) and (b) for inadequate and excessive D.C. components.

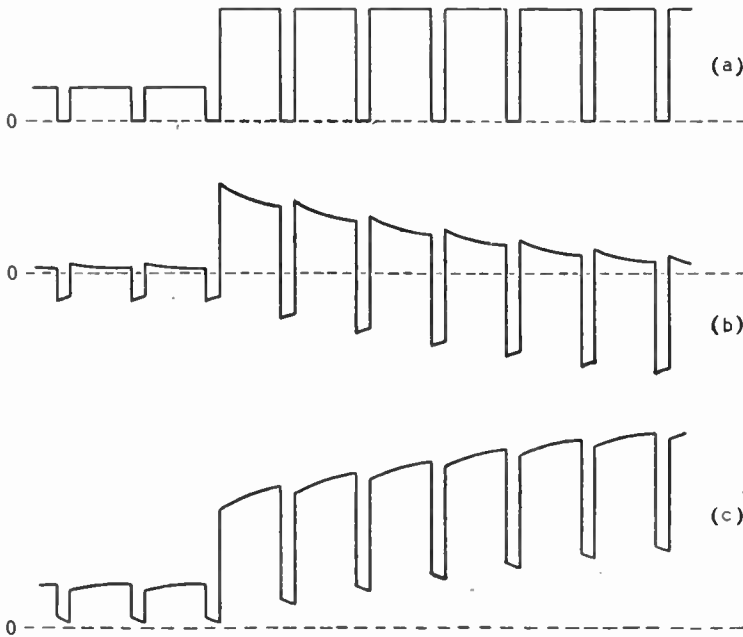

Fig. 3. The effect of incorrect amplification of the D.C. component of the signal is shown here. The proper result appears at (a), inadequate and excessive D.C. components give the effect shown at (b) and (c) respectively.

currents change by Δi_a and Δi_{sp} respectively. The voltage across C cannot change instantaneously so that the voltage drop across R_2 is unchanged and C supplies the increase of current. The anode voltage then changes by $\Delta i_a R_1$ in the negative direction.

After a time, however, the voltage across C falls because the current which it supplies to the valve reduces the charge on it. As the voltage falls, the voltage drop across R_2 , and the current through this resistance, increase and after a time a new equilibrium condition is reached in which the current through R_2 has increased by $\Delta i_a + \Delta i_{sp}$. The anode voltage has then changed by $\Delta i_a R_1 + (\Delta i_a + \Delta i_{sp}) R_2$.

If we call g_m the normal mutual conductance of the valve between grid and anode and g_c the mutual conductance with screen and anode strapped then the amplification to sudden changes of input is $A_1 = g_m R_1 / (1 + g_c R_2)$ whereas to a maintained change after a period of time it is $A_2 = (g_m R_1 + g_c R_2) / (1 + g_c R_2)$, assuming that R_3 is

Television V.F. Stage—

small compared with the screen A.C. resistance of the valve.

The ratio is $A_2/A_1 = 1 + \frac{g_c R_2}{g_m R_1}$. In a typical case we might

have $g_m = 6 \text{ mA/V}$; $g_c = 6.6 \text{ mA/V}$; $R_1 = 2.5 \text{ k}\Omega$; and $R_2 = 0.5 \text{ k}\Omega$. Then $A_2/A_1 = 1.22$ and the amplification of the D.C. component is 22 per cent too great.

This is not serious in many cases, but suppose that R_2 must

The ratio is thus

$$\begin{aligned} \frac{A_2}{A_1} &= \frac{g_m R_1 + g_c R_2}{g_m R_1} \cdot \frac{R_5}{R_4 + R_5} \\ &= 1 + \frac{g_c R_2}{g_m R_1} \\ &\quad \frac{1}{1 + R_4/R_5} \end{aligned}$$

For equality of amplification we must clearly have

$$\frac{R_4}{R_5} = \frac{g_c R_2}{g_m R_1}$$

In the example given above

tion is not necessarily constant at all frequencies, but it is constant above the line-recurrence frequency of 10 kc/s and it is the same at D.C., and this is usually all that matters.

By relating C_1 and C_2 properly, however, the amplification can be made constant at all frequencies. This relation is, approximately, $C_1 R_2 = C_2 R_4$. The approximation comes about through assuming that the A.C. resistance of the screen-cathode path of the valve is very large compared with the impedance of R_2 and C_1 in parallel.

In the example above we had $R_2 = 5 \text{ k}\Omega$; $R_4 = 100 \text{ k}\Omega$; $R_5 = 45 \text{ k}\Omega$; and $C_1 = 8 \mu\text{F}$. Therefore, $C_2 = 8 \times 5/100 = 0.4 \mu\text{F}$. When R_2 is smaller, less compensation is needed. Thus, suppose $R_2 = 0.5 \text{ k}\Omega$, with $g_m = 6 \text{ mA/V}$; $R_1 = 2.5 \text{ k}\Omega$ and $C_1 = 16 \mu\text{F}$; then $R_4/R_5 = (6.6 \times 0.5)/(6 \times 2.5) = 0.22$. If $R_5 = 50 \text{ k}\Omega$, $R_4 = 50 \times 0.22 = 11 \text{ k}\Omega$ and $C_2 = 16 \times 0.5/11 = 0.728 \mu\text{F}$. In practice one would use about $1 \mu\text{F}$.

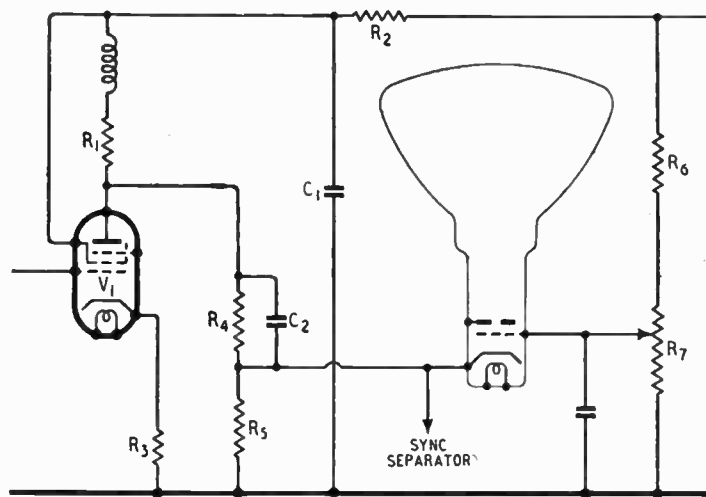

Fig. 5. Excessive amplification of the D.C. component can be avoided by this circuit in which C_2 , R_4 and R_5 introduce a loss equal to the excess provided by R_1 , R_2 and C_1 .

be higher—perhaps, for decoupling, voltage dropping or smoothing. It might then be $5 \text{ k}\Omega$, and A_2/A_1 would be 3.2 and the D.C. component would be amplified over three times too much.

The effect can be avoided by using the circuit of Fig. 5. For rapid changes both C_1 and C_2 can be regarded effectively as short-circuits so that the amplification is

$$A_1 = \frac{g_m R_1}{1 + g_c R_2}$$

For a maintained grid potential the amplification is

$$A_2 = \frac{g_m R_1 + g_c R_2}{1 + g_c R_2} \cdot \frac{R_5}{R_4 + R_5}$$

when $R_5 \gg R_1$ and $R_4 + R_5 \gg R_1 + R_2$.

A_2/A_1 was 3.2, so that $g_c R_2/g_m R_1 = 2.2$. Hence we must have $R_4/R_5 = 2.2$ for compensation.

The actual values used are not critical, but in general R_4 and R_5 in parallel should not exceed some $50 \text{ k}\Omega$. If we arbitrarily make $R_4 = 100 \text{ k}\Omega$, we have $R_5 = 45 \text{ k}\Omega$. The two in parallel are $31 \text{ k}\Omega$ which is reasonably low. R_1 at $2.5 \text{ k}\Omega$ is very small compared with R_5 at $45 \text{ k}\Omega$ and $R_1 + R_2$ at $7.5 \text{ k}\Omega$ is also small compared with $R_4 + R_5$ at $145 \text{ k}\Omega$, so that the conditions above are satisfied.

It is not in general necessary to be fussy about the values of C_1 and C_2 . The former will usually be fixed by decoupling or smoothing requirements and may well be $8 \mu\text{F}$. Usually the same value is suitable for C_2 . The amplifica-

NEW TEST EQUIPMENT

AMONG the equipment now being produced by The Wayne Kerr Laboratories Ltd., of Sycamore Grove, New Malden, Surrey, is a radio-frequency bridge for the measurement of capacitance, resistance and inductance to an accuracy of ± 1 per cent. Measurements can be made at any frequency from 10 kc/s to 5 Mc/s; there are five capacitance ranges covering 0.01 pF to $0.02 \mu\text{F}$ and six resistance ranges—from 10Ω to $10 \text{ M}\Omega$. The inductance determination is carried out by a resonance method and the range available is limited only by the need for resonating it with a capacitance within the above limits at a frequency between 10 kc/s and 5 Mc/s.

The bridge is direct reading and intended for use with external source and detector. It costs 85 guineas.

This firm also makes a component bridge, Type Bro1, which covers capacitance up to $500 \mu\text{F}$, resistance up to $500 \text{ M}\Omega$, and inductance up to $5,000 \text{ H}$ —the lowest ranges being 0.15 pF , 0.15Ω , and 0.15 H respectively. It is direct reading with an accuracy of ± 2 per cent, and A.C. operated. It costs 19 guineas.



FIRST in post-war design The **UNIT SYSTEM** of RADIO

This system gives a good theoretically correct application to practical radio, as each stage is completely screened from the others, making possible reproduction of the very highest quality.

- UNIT No. 1 :** A/C. Complete H.F. and I.F. stages, 3-waveband coil unit (16-50, 185-550, 800-2,000 m.).
- UNIT No. 2 :** A/C. Complete L.F. Output and Power stages. Volume tone radiogram mains on/off switches.
- UNIT No. 4 :** A second I.F. stage 460 kc/s.
- UNIT No. 5 :** Second detector A.V.C. and 1st L.F. Phase inverter, 2 output tetrodes in push-pull, 12 watts output. Volume tone radiogram mains on/off switches.
- UNIT No. 6 :** Power Pack for AC, AC/DC, or as required.

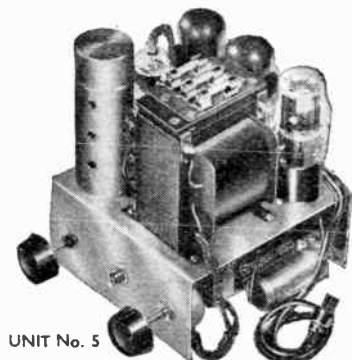

UNIT No. 5

UNIT No. 3 — Specification:

A High Frequency Unit covering 5—2,000 m. in 6 wavebands. Only gap between 540 and 800 m.

All coils are midgeet Iron-cored high Q. Aerial feeds into first stage which employs a Mullard EF50 short-wave H.F. pentode mounted in a 9-pin ceramic valveholder, the plate section feeds into an H.F. transformer coil and the grid section into the F.C., a Mullard ECH35 (ceramic octal valveholder) of which the oscillator section is tuned grid.

The switch is a 3-bank, 2-pole, 6-way, fitted with shorling plates. Anode of H.F. pentode F.C. is coupled to an I.F. transformer of 460 kc/s, iron cored, which feeds into a Mullard EF39 (H.P. pentode—Amphenol oct. valveholder) feeding the second I.F. transformer (similar to I.F. No. 1). Output of H.F. Unit is taken to a socket mounted on chassis.

Tuning Condenser: Standard .0005 mfd., ceramic insulated, rubber mounted, fitted with epicyclic S/M drive, ratio approx. 15:1. 6-waveband Dials calibrated on all W/L in metres, kilocycles and megacycles, station names not being shown. Controls: R.F. gain, 6-waveband switching, I.F. gain, tuning. Aerial Socket: designed for dipole, standard or earth. A.V.C. on all wavebands except the two shortest. Unit fitted with visual tuning indicator (Magic Eye). Colour-codes, service sheets and technical data on Selectivity, etc., supplied with the Unit.

UNIT No. 7 : High Fidelity Output and Power Stages —two L.F. valves feeding two PX 4 valves in push-pull (triodes). Volume tone radiogram mains on/off switches.

● All units are mounted on heavy gauge aluminium chassis, components and valves carefully screened where necessary. Mullard or equivalent B.V.A. Valves are supplied.

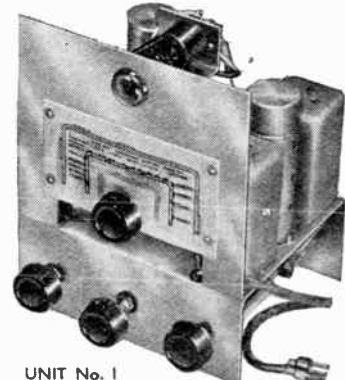

UNIT No. 1

Specially made to our design by Standard Radio Ltd.

Prices and Delivery Date on application.

307, HIGH HOLBORN, LONDON, W.C.1

Telephone: HOLborn 4631

ACOUSTICAL RESEARCH

THE TANNOY LABORATORY can provide a skilled and specialised service in the investigation of all problems connected with vibration and sound. This covers most aspects of acoustical research and is available to industry and Government Departments engaged on priority projects.

TANNOY
RESEARCH LABORATORY
GUY R. FOUNTAIN, LTD.
"THE SOUND PEOPLE"



"TANNOY" is the registered Trade Mark of Equipment manufactured by **GUY R. FOUNTAIN, LTD.** "THE SOUND PEOPLE" WEST NORWOOD, S.E.27 and Branches. 'Phone - - Gipsy Hill 1131



We've been 'away' for 7 YEARS

... and no "vacation" either; it was pure vocation the whole time, turning out equipment for the Services. But all this "time" we were designing, planning, and thinking of the day when this pressure would ease and we could start making even better Public Address Equipment for you, and our production plans include a completely new range of Sound Equipment and Components. Be amongst the first to know about our new products—ask us to place your name on our Mailing List.

MICROPHONES

LOUDSPEAKERS



AMPLIFIERS

PORTABLE EQUIPMENT

R. S. AMPLIFIERS LIMITED

REYNOLDS RD., ACTON LANE, LONDON, W.4. Phone: CHISWICK 1011-3



MULTIMATCH MODULATION TRANSFORMERS



Woden engineers have developed a special range of Multimatch modulation transformers for Amateur Transmitting use, details of which are given below. The transformers are vacuum impregnated and fitted in compound-filled steel pots giving reliable and silent working.

Primary impedances, 2,000/18,000 ohms. Secondary impedances, 200/20,000 ohms.

Suitable for 30 watts Audio.	TYPE U.M.1.	Max. Sec. current, 120 m/a	35/-
Suitable for 60 watts Audio.	TYPE U.M.2.	Max. Sec. current, 200 m/a	46/9
Suitable for 125 watts Audio.	TYPE U.M.3.	Max. Sec. current, 250 m/a	67/-
Larger sizes to order.			

Obtainable from Messrs. Webbs Radio, Soho Street, London, W.1, or direct from

WODEN TRANSFORMER CO., LTD., Bilston, Staffs.
Phone: Bilston 41959

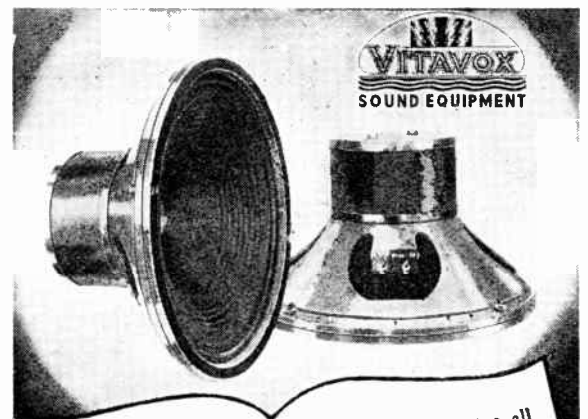

It is a fact that although VITAVOX K12/10 and K12/20 P.M. Speakers are not available in unlimited quantities, their quality is such that they are well worth waiting for.

It is a fact too that all specification figures are actual and not nominal.

VITAVOX LIMITED,
WESTMORELAND
RD., LONDON, N.W.9.
Phone Colindale 8671/3

MERCANTILE MARINE RADAR

Details of Metrovick Type MRI Equipment

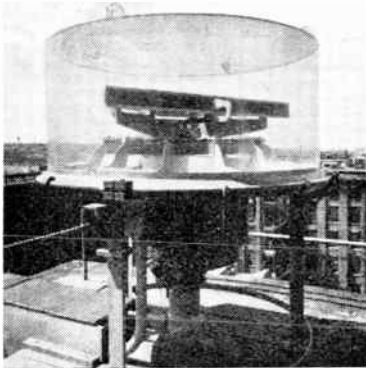

signal generator and "strobe" range indicator, control unit with safety switches and monitoring meter, power supply unit, and at the bottom the modulator for the transmitter. Independent ventilation is provided for each unit and any unit can be pulled out after releasing catches which are combined with safety switches.

Aerial scanner unit on test on the roof of the Woolwich Works of Siemens Bros. & Co. The air inside the Perspex dome is dried and the temperature thermostatically controlled.

THE navigational radar sets so far described in this journal have been prototypes built for demonstration purposes. We are now able to give some details of the Metropolitan-Vickers marine radar which is in production and is being supplied to shipping companies. Hire-maintenance and servicing contracts are being handled by Siemens Bros. and Co., Woolwich, who have contracts with shipping interests in all parts of the world.

The performance conforms with the specification laid down by the Ministry of Transport and gives returns on obstructions as near as fifty yards. A control is provided for expanding the centre of the display when nearby objects are indicated on a circle about an inch in diameter and their bearings can be accurately taken by an illuminated radial cursor. The P.P.I. display is relative to ships head and an annular bearing scale is provided. If compass repeater signals are available the display can be locked to north.

Unit construction has been adopted and the main console which would normally be installed in the wheelhouse is 6ft 7in high and occupies 2ft square of floor space. It contains the following units starting from the top: main I.F. amplifier, display unit, time base and marker

The transmitter is housed in a substantial weatherproof cast metal box on anti-vibration mountings and can be installed on deck near to the aerial. The unit is sealed and provided with a differential air valve to keep the pressure constant with changes of temperature. Any air drawn in from outside is dried by passing through a silica gel dessicator.

General view of the Metrovick Type MRI radar equipment. The small audible warning unit is shown on the left of the transmitter and would normally be installed with the console in the wheelhouse.

The aerial scanner is a parabolic "cheese" feed from a horn coupled to the waveguide. It revolves at 20 r.p.m. inside a sealed Perspex dome which is air-conditioned in the same way as the transmitter; thus the whole of the waveguide system is supplied with dry air. A bank of

thermostatically controlled heaters is provided to minimize icing of the surface of the dome.

A peak power of 50 kW is supplied in the $\frac{1}{4}$ sec pulse which has a repetition rate of 1,000 per sec. The nominal operating frequency is 9,500 Mc/s (3 cm band).

An ingenious automatic warning device has been developed for use with this equipment. Once in each revolution of the scanner a test sector is selected and the feeble "sea returns" are used to check the overall efficiency of the equipment. If everything is up to standard a faint "pip" is heard in a loudspeaker. A commutator is arranged to select a different sector for each test and the search precesses through 360 degrees in about ten revolutions of the scanner. The warning device can also be set to give a loud "pip" on any object within three miles; thus the officer of the watch is relieved from the duty

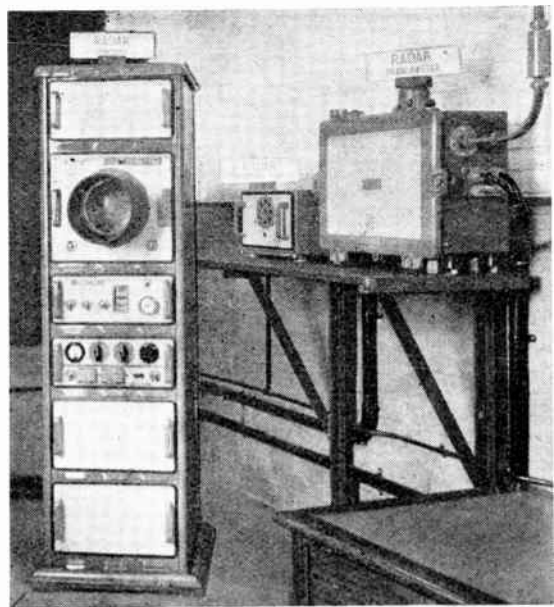

of constantly watching the screen.

It is understood that the price of the equipment will be in the region of £2,600-£3,000, depending on the accessories required.

World of Wireless

B.B.C. CHARTER

HAVING decided that an enquiry by an independent body appointed to advise them on the organization of British broadcasting "would not be appropriate in present circumstances," the Government have renewed for a further five years the B.B.C.'s ten-year Charter, which expires on December 31st.

The White Paper on Broadcasting Policy presented by the Lord President of the Council and the Postmaster-General to Parliament sets out the Government's intentions.

The reasons given for not holding an enquiry include: (1) That the existing licence has run for only 2½ years under normal conditions; (2) that it is too early to foresee the effect of the wartime technical advances on peacetime broadcasting; and (3) that the international reallocation of wavelengths will affect any future plan. The Government's views on the B.B.C. monopoly of broadcasting in this country are summarized by this quotation from the White Paper: "The Government are, however, satisfied that the present system is best suited to the circumstances of the United Kingdom."

In dealing with the technical side it is stressed that great importance is attached to improving the technical quality of the service and that approval has been given to the B.B.C.'s intention "to press ahead with the development of F.M. . . . as a solution to some of the reception difficulties." The hope is expressed that "the radio industry

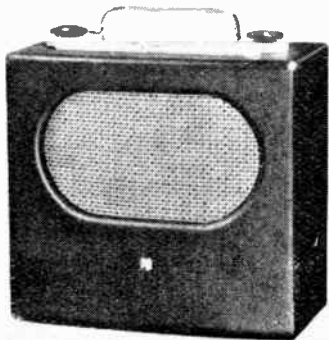

NEW PORTABLE. Quite a number of broadcast sets besides the "standard" £15 mains models are now becoming available. This photo shows the new Pye "Baby Q" (Model 75B), a self-contained "all-dry," battery-fed superhet.

will realize the importance of producing F.M. sets."

The reorganization of the regions and the introduction of the "third programme," probably on October 1st, is dealt with at some length. The third programme will be radiated by one Droitwich transmitter on 514.6 metres and by a number of the "H" stations, 60 of which were erected as a wartime measure in all important centres of population, on 203.5 metres. It is considered essential that two of the B.B.C.'s M.F.s should be set aside for the European service.

The Government do not consider there is a case for any change in the present policy of prohibition of commercial programmes.

In an appendix dealing with wired broadcasting it is stated that a "decision on the question of public ownership and operation of wire broadcasting services" has been deferred "pending a further review nearer the date (December 31st, 1949) on which the licences held by the relay proprietors are terminable."

THE U.I.R.

AS a result of a meeting in March, convened by the Belgian National Institute of Broadcasting (I.N.R.), of representatives of seventeen member countries of the International Broadcasting Union (U.I.R.) and three non-members, a committee was set up to investigate the activities of the U.I.R. Six countries were represented on the committee—Belgium, Czechoslovakia, France, Great Britain, Holland and the U.S.S.R. (not a member of the U.I.R.). Six meetings of this committee were held in Brussels during May as a result of which it was proposed to form a new organization to be known as the International Broadcasting Organization (O.I.R.), with headquarters at Brussels, and to dissolve the present U.I.R., formed in 1925.

Sir Noel Ashbridge, representing the B.B.C., abstained from voting as he did not consider the present time is a suitable one for dissolving the U.I.R.

A meeting of all European broadcasting organizations eligible to take part, opened in Brussels on June 24th, when it was agreed that the O.I.R. should be formed. At a subsequent meeting of the U.I.R. it was decided that it should not be dissolved, so that there are now two international broadcasting organizations each having a different membership. At the moment Great Britain belongs to neither.

LONG-DISTANCE TELEVISION

AMONG the claims for long-distance reception—other than occasional freaks—must be added that of Derek Swaine, a research engineer at Pye, Ltd., who, using a new Pye B16T set, is receiving the Alexandra Palace transmissions at Torquay, South Devon, a distance of approximately 170 miles.

Photographs of the pictures received in Bournemouth, Hants—approximately 100 miles from Alexandra Palace, sent to us by K. A. Y. Russell, a reader, indicate how consistently good the reception is at that distance. He is using a modified version of the *Wireless World* Magnetic Television Receiver using three R.F. stages instead of the original one.

It is interesting to recall that another reader, F. T. Bennett, was regularly receiving the A.P. transmissions at St. Peter Port, Guernsey, C.I.—approximately 180 miles—in 1939. We have not had reports from him since the restarting of the service.

"THE TRANSMITTING LICENCE"

THE first of a series of booklets dealing with specific aspects of amateur radio to be published by the Radio Society of Great Britain has appeared with the above title. It is not a technical publication, but aims at presenting in a convenient form the information regarding licensing required by a prospective amateur transmitter.

Obtainable from the R.S.G.B., New Ruskin House, Little Russell Street, London, W.C.1, price 9d., this 24-pp. booklet gives, *inter alia*, specimen questions from, and syllabus for, the Radio Amateur's Examination, a list of officer and other ranks in the three fighting services whose qualifications will give exemption from the morse and technical examinations, and a summary of the conditions governing the issue of a licence.

RADIO LUXEMBOURG

IN the section of the White Paper "Broadcasting Policy" dealing with sponsored programmes, it states: "The Government intend to take all steps within their power, and to use their influence with the authorities concerned, to prevent the direction of commercial broadcasts to this country from abroad."

A few days before the White Paper was published the Luxembourg station announced that the re-introduction of sponsored programmes, scheduled for July 1st,

had been unavoidably delayed. It is learned from Paris that a joint Anglo-French offer to lease the station for relaying B.B.C. and French Government programmes has been turned down by the Radio Luxembourg Board on the grounds that their charter from the Luxembourg Government does not permit them to "lease time to foreign governments." It would appear, however, that the discussions have not yet ended.

TELEVISION TEST GENERATOR

DESIGNED primarily for use in research and development laboratories, All Power Transformers, Ltd., of 8a, Gladstone Road, Wimbledon, S.W.19, are producing a television test signal generator, which includes pulse outputs at 10,125 c/s, 50 c/s and 25 c/s, and a 45-Mc/s R.F. output modulated by various "picture" signals. These include horizontal or vertical bars, a pattern of 64 rectangles and an actual picture. This last is derived from a photographic transparency.

A television display system is included and its time-bases can provide outputs for other purposes. There is also a single-sweep oscilloscope. The apparatus is rack built and priced at £1,300.

AMATEUR BANDS

TWO additional bands became available for use by British amateurs on June 30th. They are the 7.15-7.30 and 14.1-14.3 Mc/s bands. The power limitations are 25 watts for Class "A" amateurs, who are permitted to use W/T only, and 150 watts for Class "B" —W/T and R/T.

The bands now available for British amateurs are:—

1.8-2.0 Mc/s	} C.W., M.C.W., R/T
7.15-7.30	
14.1-14.3	
28.0-30.0	
58.5-60.0	

It is understood that the G.P.O. is negotiating with the Admiralty for the release of the 1.715-1.800 Mc/s band on a shared basis.

The R.S.G.B. reports that the G.P.O. has agreed to issue 150-watt licences as soon as the 3.5, 7 and 14 Mc/s bands become available.

It has been suggested by the American Radio Relay League that 'phone stations should be allocated a definite section of the 7- and 14-Mc/s bands and the question is under discussion by the R.S.G.B. who have been in communication with the A.R.R.L. on the subject.

For the purpose of comparison we publish below a summary of the bands (Mc/s) at present open to U.S. amateurs. The types of transmission permitted—A ϕ , un-

modulated carrier; A₁, C.W. telegraphy; A₂, M.C.W.; A₃, A.M. R/T; A₄, facsimile; A₅, television; F.M., frequency modulated R/T and W/T—are also given.

3.5-4.0 A ₁ .	} A ϕ , A ₁ , A ₂ , A ₃ , A ₄ , A ₅ , F.M., Pulse.
3.9-4.0 A ₃ .	
27.185-27.455 A ϕ , A ₁ , A ₂ , A ₃ , A ₄ , F.M.	
28.0-29.7 A ₁ .	
28.1-29.7 A ₃ .	
29.0-29.7 F.M.	
50.0-54.0 A ₁ , A ₂ , A ₃ , A ₄ .	
52.5-54.0 F.M.	
140-148 A ₁ , A ₂ , A ₃ , A ₄ , F.M.	
235-240 A ₁ , A ₂ , A ₃ , A ₄ , F.M.	
420-430 A ₁ , A ₂ , A ₃ , A ₄ , A ₅ , F.M.	
1715-1295	
2300-2450	
5250-5650	
10000-10500	
21000-22000	
Above 30000	

WHAT THEY SAY

AN OBLIGATION.—The technical periodicals, through which advances in basic research and technical application to engineering and industry are disseminated, constitute the circulatory system upon which the great body of scientists depends for stimulus and integration . . . The obligation of the scientist and the engineer to society is not discharged until a record of his technical achievements is published and made a part of that common knowledge from which he has himself drawn in making his contribution.—G. P. Harnwell, Editor of "Review of Scientific Instruments," writing in the "Proceedings of the I.R.E."

RATIONALIZATION.—The changes required to bring British Broadcasting into line with British democracy are few and simple, and need not cost extra money. Transmitters are there. Studios and other equipment are there. The Post Office is already responsible for many of the technical services which broadcasting depends on. The most efficient plan, as well as the easiest, would be for the Post Office to take over transmitters and heavy equipment, operating them technically and leasing them to various independent bodies for programme output.—Sir Frederick Ogilvie, former Director-General of the B.B.C., writing in "Picture Post."

PERSONALITIES

Among those in the world of wireless who received decorations in the second of the Birthday Honours lists are the following, who become Officers of the Order of the British Empire (O.B.E.):—W. A. S. Butement, assistant director of scientific research, Ministry of Supply; J. F. Coales, Admiralty Signal Establishment (A.S.E.); F. M. Dimmock, B.B.C. engineering division; W. G. Edmunds, Cable and Wireless; H. Larnder, for services as assistant director of communications development, M.A.P.; F. W. A. Frost, Cable and Wireless; A. C. B. Lovell, Tele-

NOW IN PRODUCTION

New IMPROVED

1946 Model

30-WATT AMPLIFIER T.633B

Three stage, high gain type. Push-pull output circuit with inverse feed back. Embodying all the features responsible for the success and efficiency of the original T.633, with up-to-date refinements of design and finish. The new circuit provides facilities for speech/music switching or mixing to suit all conditions of operation.

Other Models available 5-500 watts and full range of accessories.



TRIX

Quality SOUND EQUIPMENT

THE TRIX ELECTRICAL CO. LTD.
 1-3 MAPLE PLACE-TOTTENHAM COURT ROAD-LONDON, W.1
 TELEPHONE: MUSEUM 5817 GRAMS & CABLES: TRIXADIO, WESDO, LONDON.

communications Research Establishment (T.R.E.); N. Pemberton, A.S.E.; A. H. Reeves, T.R.E.; N. Shuttleworth, M.Sc., A.S.E.

The following become M.B.E.s:—A. F. Bulgin, Sqn. Ldr., R.A.F.V.R.; J. W. Findlay, directorate of communications development, M.A.P.; T. C. Finimore, A.S.E.; J. E. Giles, flight radio officer, British Overseas Airways Corp.; W. Hannah, engineer-in-charge, B.B.C. recording unit; E. S. C. Heathcote, Allen West and Co., Brighton; J. E. Rhys-Jones, chief engineer, communication receiver development laboratory, Plessey Co.; K. E. Latimer, Ph. D., head of line development laboratory, Mullard Radio Valve Co.; A. W. Martin, chief engineer, E. K. Cole, Ltd.; J. W. S. Pringle, T.R.E.; J. W. Snowdon, A.S.E.; A. F. Thomson, wireless superintendent, Post Office Radio Station; C. H. Webb, A.S.E.; G. Wickenhauser, general manager and chief engineer, Scophony, Ltd.

The following were awarded the British Empire Medal:—Miss F. Attridge, Marconi's W.T. Co.; C. W. Brenchley, G.E.C.; H. Brogden, T.R.E.; C. Darton, Murphy Radio; A. T. Goble, wireless operator, Admiralty Station, Goonhavern; J. H. Groombridge, Radar Research Development Establishment, Ministry of Supply; A. R. Lewis, wireless operator, Admiralty; W. W. Marsh, valve laboratory, Standard Telephones and Cables; D. H. Moseley, T.R.E.; S. Y. Myers, Radar Research and Development Establishment, Ministry of Supply; B. J. P. O'Connell, A. C. Cossor, Ltd.; Miss R. W. Padain, Reliance Manufacturing Co.; W. H. Rangecroft, wireless operator, Admiralty; D. Robb, E. K. Cole, Ltd.; D. T. Satchell, T.R.E.; E. West, Peto Scott, Ltd.

F. B. Duncan, who recently resigned from the Boards of the Gramophone Co. and the Columbia Graphophone Co., has been appointed deputy managing director of Murphy Radio. He was first chairman of the Radio Industry Council, from which he resigned in April.

Leslie Gamage, joint managing director of the G.E.C., has been elected chairman of the British Export Trade Research Organization.

Professor Willis Jackson, who was recently appointed head of the Electrical Engineering Department of the Imperial College of Science and Technology in succession to Prof. C. L. Fortescue, has been nominated chairman of the Radio Section of the I.E.E. He was a member of the I.E.E. Council from 1939-42 and was re-elected last year. Prof. Jackson is also a member of the Radio Research Board. Since 1938 he has occupied the chair of electrotechnics at Manchester University.

Dr. M. Reed, M.Sc., has been appointed general manager of the Radio Division of R.F. Equipment, Ltd., manufacturers of Sobell receivers, and will be in charge of production and engineering. Dr. Reed was previously with Siemens Bros.

G. Darnley Smith, managing director of Bush Radio, has been elected chairman of the Radio Industry Council.

H. Warren, M.Sc., managing director of the B.T.H. Company, and former director of the company's research and engineering, has received the honorary degree of Doctor of Science at Birmingham University.

IN BRIEF

Communication Convention.—A "Radio-Communication Convention" is to be held by the Institution of Electrical Engineers from March 25th to 29th, 1947. Papers to be read will refer particularly to wartime developments and their peacetime applications.

E.M.I. Institutes, Ltd., is the name given to a new organization created by E.M.I., Ltd., to "provide training over the whole sphere of electronic sciences." Its headquarters will be at the London Radio College and it will be under the direction of Prof. H. F. Trewman, who will be managing director and principal.

Radio Apparatus (except H.T. batteries) is not in the list of token imports now allowed into this country from the United States at the rate of 20 per cent per annum by value of the American manufacturers' pre-war trade.

Servicing Examination.—Of the 68 entrants for the Radio Servicing Certificate Examination, held in May under the auspices of the Radio Trade's Examination Board, 44 passed the entire examination, six passed the written section and nine passed the practical tests.

I.E.E. Premiums.—Among those who have been selected by the Council of the I.E.E. as recipients of Premiums for papers read, or accepted for publication, during the 1945-46 Session are the following members of the Radio Section: Institution Premium, Dr. F. C. Williams, O.B.E.; John Hopkinson Premium, J. F. Coales, J. C. Calpine and D. S. Watson; Fahie Premium, F. C. McLean and F. D. Bolt; Duddell Premium, Dr. H. G. Booker; Ambrose Fleming Premium, E. C. Cherry; Extra Premiums, C. F. Booth, F. J. M. Laver, R. J. Clayton, Dr. J. E. Houldin, Dr. H. R. L. Lamont, W. E. Willshaw, Dr. R. A. Smith, E. C. S. Megaw, M.B.E., O. I. Ratsay, R. J. Dippy, Dr. N. R. Campbell, and V. J. Francis.

INDUSTRIAL NEWS

Frame-Aerial Mains Sets.—In referring last month to post-war mains-driven broadcast sets with built-in frame aerials, we overlooked the existence of the Rees Mace "Cameo" receiver, which was introduced last year. It is a 4-valve all-wave A.C./D.C. superhet, including the self-contained frame-aerial feature.

Layer-built Battery.—A 67½-volt H.T. battery for miniature portables is being made by Vidor, Ltd., West Street, Erith, Kent. It measures only 2.7×3.7×1.3in and has a life of 85 hours at 8 mA. The price is 15s 6d, including purchase tax.

Batteries into Battle is the title of an illustrated brochure issued by the Chloride Electrical Storage Company telling the story of Exide achievements during the war.

Cossor Service.—A new depot attached to the Cossor factory near Oldham is to be used as a servicing centre for the Northern area. The new address is A. C. Cossor, Ltd., Northern Service Depot, Wren Mill, Chadderton, Oldham, Lancs. Tel.: Main (Oldham) 3266. With the opening of this depot, where Cossor and other receivers will be handled, the depot at 8, Neville Street, Leeds, has been closed.

Pye 45A Receiver.—This is the universal mains counterpart of the Model 15A receiver for A.C. mains which was reviewed in the January issue. The power output is 1.75 watts and the output stage has the four-position negative feedback tone control used in the A.C. model. The price is £15 15s, plus £3 7s 9d purchase tax.

Bush Radio has introduced a small A.C./D.C. broadcast receiver, Type DAC901, self-contained with frame aerial and internal voltage-dropping resistor. Price 11 guineas, plus purchase tax £2 9s 8d. A Bush console television receiver at 56 guineas, plus purchase tax, is announced for early release.

R.F. Equipment, Ltd., has moved to Langley Park, nr. Slough, Bucks. Tel.: Slough 22201.

R.I. Club.—At the first meeting of the new committee of the Radio Industries Club, the following officers were elected: chairman, H. de A. Donisthorpe; vice-chairman, A. J. Dew; secretary, W. E. Miller; luncheon secretary, W. G. J. Nixon; treasurer, O. Pawsey.

CLUBS

Burton-on-Trent.—Monthly meetings are now being held in the Main Hall of the town's Education Offices of the recently formed Burton-upon-Trent and District Radio Society, particulars of which are obtainable from the Secretary, S. E. Whiteley, G2DAN, "Dalbrae," Beacon Hill, Rolleston, nr. Burton-on-Trent.

Manchester.—Regular meetings of the Whitefield and District Radio Society are now held on Mondays at 7.30 in the Stand Grammar School, Higher Lane, Whitefield. The recently appointed secretary is E. Fearn, 4, Partington Street, Newton Heath, Manchester, 10.

Salisbury.—Details of the re-formed Salisbury and District Short-Wave Club, which meets every Tuesday and Thursday, are obtainable from the Secretary, C. A. Harley, 85, Fisherton Street, Salisbury, Wilts.

Stourbridge.—The Stourbridge and District Radio Society is forming a local monitoring service of B.R.S. members who will report on the reception of local signals on all bands. This should provide useful information for transmitting members undertaking special tests. There will not be a meeting of the club in August. Secretary, D. Rock, G8PR, "Sandhurst," Vicarage Road, Amblecote, Stourbridge, Worcs.

West Middlesex.—A meeting has been arranged for August 14th at 7 at the Labour Hall, Uxbridge Road, Southall, at which the organization of a West Middlesex Radio Club will be discussed.

SHORT-WAVE CONDITIONS Expectations for August

By **T. W. BENNINGTON**
(Engineering Division, B.B.C.)

DURING June the average day-time maximum usable frequencies for this latitude were about the same as during May, while, due to the longer duration of daylight, the night-time M.U.F.s were about 2 Mc/s higher than during that month. Communication on the exceptionally high frequencies by way of the regular layers was very infrequent, and was practically negligible to the U.S.A., but it may become more frequent during August and towards the autumn, particularly on circuits to the southward of this country. There was very little ionosphere storminess during June, but storms did occur on June 7-8th, 13th, 17th, 19th and 29-30th; these, however, were of a minor character only. "Dellinger" fadeouts were not very prevalent and their effects were very limited in character.

Forecast.—During August, the working frequencies for long-distance transmission should, generally speaking, be much the same as during July, except perhaps that the night-time usable frequencies may be a little lower and the daytime frequencies a little higher. Sporadic E is likely to be somewhat less prevalent than during July, but communication up to about 1,400 miles may be possible by way of this medium on frequencies far above those usable by way of regular

layers. The normal E layer will continue to control medium-distance transmission for several hours of the day.

Below are given, in terms of the broadcast bands, the working frequencies which should be regularly usable during August, for four long-distance circuits running in different directions from this country. In addition, a figure in brackets is given, which indicates the highest frequency likely to be usable for about 25 per cent of the time during the month for communication by way of the regular layers:—

Montreal:	0000	15 Mc/s	(18 Mc/s)
	0600	11 "	(15 ")
	1000	15 "	(18 ")
	1400	17 "	(22 ")
	1800	21 "	(26 ")
2100	17 "	(22 ")	
Buenos Aires:	0000	11 Mc/s	(14 Mc/s)
	0600	9 "	(12 ")
	1000	17 "	(22 ")
	1600	21 "	(26 ")
	2000	17 "	(22 ")
2200	15 "	(19 ")	
Cape Town:	0000	15 Mc/s	(19 Mc/s)
	0500	11 "	(14 ")
	0900	17 "	(23 ")
	1400	26 "	(32 ")
	1800	17 "	(22 ")
2200	15 "	(19 ")	
Chunking:	0000	11 Mc/s	(15 Mc/s)
	0400	15 "	(19 ")
	1200	17 "	(22 ")
	1700	15 "	(19 ")
	2000	11 "	(15 ")

It is likely that as the autumnal equinox is approached ionosphere storms will become more prevalent. The most probable periods for ionosphere storms in August are those around 12-13th and 28th-29th of the month.

VIDOR TABLE MODEL

NEGATIVE feedback is employed in the output stage of the Vidor "Chanson" receiver and tone control is effected in the feedback circuit. There are six valves in all—four receiving valves in a straightforward superhet circuit, a power rectifier and an E.M.34 type tuning indicator with two degrees of sensitivity. Long, medium and short waves are covered, the last range being 13.5 to 50 metres. The price is £16 10s

plus £3 11s purchase tax, and the makers are Vidor Ltd., West Street, Erith, Kent.



THE NEW MULTITONE UNIVERSAL **pocket** hearing aid

SPECIFICATION

Size: 5½" × 2½" × 1" Weight: 9½ ozs.
Three stage amplifier with crystal microphone. Button-base international valves. Low tension drain 90 m.a. High tension drain from ½ to 2½ m.a. Maximum voltage amplification 4,000.
High tension battery 45 volts layer-built. Low tension 1½ volts. All our aids may be had on a week's home trial free of charge. Write for the address of your nearest Multitone Agent.

The new Pocket Aid makes use of a cascade circuit (Patent applied for) which we have developed. Two valves only are used, a heptode as a two stage amplifier and a H.F. pentode as an output triode. The new circuit has enabled us to produce a hearing aid of outstanding performance, at the very moderate price of 12 gns.

The new instrument will give excellent hearing to all cases of deafness responsive to instrumental help. Its controls can be adjusted to make it equally helpful to those needing clarity of reproduction rather than great volume. It can be used without alteration with any type of earpiece, including crystal or bone-conductor.

The instrument incorporates many new features, one of which regulates the high tension current to the particular requirements of the individual user, thus ensuring longest possible life for high tension batteries. It is particularly economical—the cost of replacements for a severely deaf person being estimated at 1/6d. per week.

The batteries used are of the new layer built type and are all fitted with international connections and sockets—obtainable all over the world.

The Universal Pocket Aid is small and light enough to be easily worn on the person.

MULTITONE

ELECTRIC COMPANY LIMITED

92 New Cavendish Street · London · W1

C.B.C.109

RANDOM RADIATIONS

Television Tests

THE vision tests now being broadcast from the Alexandra Palace should be very welcome to the designer, the serviceman and the amateur enthusiast, for they show up both the good and the bad set pretty clearly. Two in particular strike me as most valuable. The first of these is the image of a perfect circle, a good, straightforward test of the accuracy of the raster. The vertical and horizontal diameters are easily equalized by the height and width controls, but the "circle" will only be a circle if the scanning is linear. All too often it is far from round. It is a severe test, however, and shows up distortion which is barely noticeable on a picture. Next, there are those sets of lines which give a very good idea of the resolution abilities of the receiver. The lines are labelled 1 Mc/s, 1.5 Mc/s, 2 Mc/s, 2.5 Mc/s and 3 Mc/s. Most receivers, even those of modest price dating from pre-war days, deal not too badly with the 1 Mc/s and 1.5 Mc/s lines and many can make something of the 2 Mc/s; but it takes a pretty good receiver to bring out the 2.5 Mc/s lines clearly and well and something exceptional to reproduce the 3 Mc/s. To turn to lines of a different kind—scanning lines—some people are apt to believe that, say, a 625-line transmission is bound to produce more detailed images on a receiver C.R.T. than one of 405 lines. That is true only if the 625-line receiver is fully up to the mark; I have seen alleged 405-line receivers in pre-war days whose images were little, if any, better than those obtainable with first-

By "DIALLIST"

class equipment from 240-line transmissions. One thing that did strike me about the vision receivers of the days just before the war was that, taking those in the same price category, the T.R.F.'s had usually better resolving powers than the superhets. I haven't seen enough of post-war receivers yet to be able to say whether or not this is so today. Anyhow, a good deal was learned during the war about superhets.

□ □ □

The Charter

A PITY, perhaps, that there is not going to be a committee of inquiry before the B.B.C.'s charter is renewed. Such inquiries do ventilate things, and ventilation is usually beneficial. Some of the reasons given for not setting up a committee seem to me rather thin. It is stated, for example, that as the present charter has run for only two and a half years under normal conditions there has been no proper opportunity for conclusions of value to be formed about the entertainment provided. I'd say that if a concern had not got into its stride in two and a half years, it would never do so at all! What do you think? I'm not one of those who cannot find brickbats knobby enough to fling at the B.B.C. I think that on the whole they do a pretty good job of work, considering the size and diversity of the audience and the wide variety of its tastes. Its engineering side is certainly efficient. But there is unquestionably a certain amount of disgruntlement about the B.B.C. as a whole, and

it would probably have done a power of good if representatives of the disgruntled could have let off steam before a committee. There was no need to make the regranting of the charter dependent upon the findings of a committee; it might well have been constituted to find out what the public doesn't like about the B.B.C. and to make recommendations for improving matters.

One Good Thing

It is good, anyhow, that the authorities have set their faces firmly against sponsored programmes and advertising. I have probably done as much listening to American programmes as most people in this country and, frankly, I'm not convinced that they are as super-excellent as some would have us believe. Certainly the advertising is incredibly boring. Even Americans have begun to find it so and to wish that they could have more entertainment free from it. In one of their wireless papers recently I read an article describing a device for cutting out the publicity. It consists of a remote-control switch of the time-delay variety, and its name, the "plug-ugly eliminator," tells its own story. The thing is rather ingenious and might have certain applications here. Pulling the lever of the switch breaks the mains supply (the H.T. would be better) and at the same time makes a tightly fitting piston travel down a tube, expelling the air below it. The piston is spring-loaded, but it returns to the top of the tube, which closes the switch, is slow since air to fill the vacuum below it is admitted through a small valve. The length of the silence can be arranged at will. If the lever is pulled right down the piston has a long way to go on its return journey. But it may be pulled only part of the way down, giving a shorter delay. I suppose the device could be roughly calibrated in seconds. I think I shall make one for getting rid of my pet aversion—the wobbly singer.

The Third Programme

People have been asking what has become of the B.B.C.'s third programme, whose start was promised some time ago. The D.G. said the other day that the delay was due to the fact that the new vertical radiator at Brookman's Park was not yet finished. That can't be the whole story, for such an aerial could not possibly serve more than the London area by day as well as after

Books issued in conjunction with "Wireless World"

	Net	By
	Price	Post
FOUNDATIONS OF WIRELESS. Fourth Edition, by M. G. Scroggie	7/6	7/10
TELEVISION RECEIVING EQUIPMENT, by W. T. Cocking	10/6	10/10
RADIO LABORATORY HANDBOOK, by M. G. Scroggie. Third Edition	12/6	12/11
WIRELESS SERVICING MANUAL, by W. T. Cocking. Seventh Edition	10/6	10/10
HANDBOOK OF TECHNICAL INSTRUCTION FOR WIRELESS TELEGRAPHISTS, by H. M. Dowsett and L. E. Q. Walker. Seventh Edition	30/-	30/7
BASIC MATHEMATICS FOR RADIO STUDENTS, by F. M. Colebrook	10/6	10/11
RADIO DATA CHARTS. Third Edition, Revised by J. McG. Sowerby	7/6	7/10
LEARNING MORSE. 335th thousand	6d.	7½d.
RADIO WAVES AND THE IONOSPHERE, by T. W. Bennington	6/-	6/3

Obtainable from leading booksellers or by post from
ILIFFE & SONS LTD., Dorset House, Stamford Street, London, S.E.1

dark. Vertical radiators are anti-fading devices, the point about them being that they produce a strong ground-wave and a comparatively feeble sky-wave in the areas that they serve. I've heard that the real difficulty is to find a wavelength for the transmission, and I should not be surprised if the B.B.C.'s U-S-W. experiment had some bearing on the matter. After all, one of the features of the third programme is that it will frequently broadcast concerts of good music. What better opportunity could there be of giving listeners the full benefits of genuine high-fidelity broadcasting, which can be done only on the ultra-short waves?

□ □ □

A Matter of Killerwatts

YOU don't normally expect a pretty violent explosion to be laid on for you when you visit a friend's wireless den; yet that is just what happened to me whilst discussing this and that in the world of radio with one of mine a few evenings ago. No; it wasn't a C.R.T. implosion: it was a genuine honest-to-goodness explosion and here's how it happened. There was a small electric fire of a make unknown to me in the room—it was one of those damp and chilly evenings that go to make an English summer, and we were very glad of its warmth for a time. Presently, "Getting a bit fuggy," said my friend; "better switch off half of

this." With the toe of his shoe he flicked the switch built in to electric fire. BANG! There was a flash and a roar that made both of us jump nearly out of our skins. No great amount of damage was done, except to the fire itself, which more or less disintegrated; but it was a nerve-shattering experience. Neither of us could make out what on earth had taken place. There was no gas pipe in the room from which a leak could have occurred; nor, so far as we could discover, had there been anything else of an explosive nature. It remained a mystery until, some days after, I met another friend whose name is almost a household word in connection with electric fires. He laughed when he heard my tale. "Not the first case I've come across," he said. The output of most of the well-known makers of electric heating appliances, I learnt, is earmarked by the Government for its housing schemes and a number of small concerns, new to the game, have been quick to grasp the golden opportunity offered by the big public demand for electric fires and the small supplies available in the shops. Some of their wares are sound enough; but others incorporate ordinary lighting switches of poor type. Recesses in the porcelain or plastic bodies of these into which screws, bolts or rivets fit, are filled with paraffin wax, which volatilises under the effects of heat, and the vapour, mixed with air, can explode quite violently.

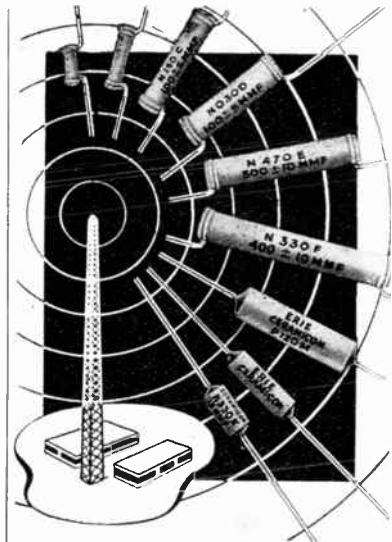

ERIE Ceramicon

**MAINTAIN SUPREMACY
IN THE FIELD OF COMMUNICATIONS
FOR TEMPERATURE COMPENSATING
& GENERAL PURPOSE CONDENSERS**

"CDP" RECORDER

MOUNTED on a cast aluminium base with levelling screws, the motor is of the synchronous turntable type and is designed to give a

torque sufficient for the heaviest cuts. The tracking gear is mounted in a cylindrical guide supported at both ends, and adjustments are provided for the rake of the stylus and also the cutting line relative to the centre of the record. Manipulation of a single lever engages the lead screw and at the same time lowers the cutter on to the record blank.

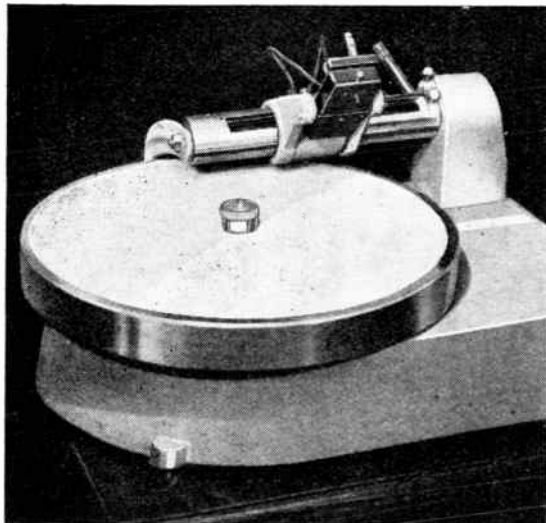

The cutting head is of the magnetic type and has an impedance of 12 ohms. A power of 4 watts will fully modulate the groove.

The price of the "CDP" recorder, which is made by the Bourne Instrument Co., Bourne, Lincs, is £25.

STYLE	CAPACITY RANGE		
	P080 P100 P120	N750	HI-K
A and K	MMF 1-9	MMF 1-51	MMF 56-560
B and L	10-18	52-110	560-1,500
C and M	19-63	111-360	1,500-4,700
D	64-93	361-510	4,700-6,800
E	94-150	511-820	6,800-12,000
F	151-200	821-1,100	12,000-15,000
G	—	—	15,000-22,000
H	—	—	22,000-33,000

Tolerance on Temperature Co-efficient is—30 parts/million, °C or ±15%, whichever is the greater.

Note: Styles A, B, C, D, E, F, G and H are non-insulated units. Styles K, L, and M are insulated.

MAY WE SEND YOU SAMPLES FOR TEST OR FOR PROTOTYPES?

ERIE RESISTOR LIMITED

CARLISLE RD • THE HYDE • HENDON
LONDON • N.W.9
TELEPHONE: COLINDALE 8011

FACTORIES: LONDON • ENGLAND
TORONTO • CANADA • ERIE, PA. • U.S.A.

UNBIASED

By FREE GRID

Troubles of Tube Travel

I SEE that a committee of experts has once more been convened to see what can be done to lessen the appalling and ear-splitting roar which travellers on the London Underground Railways have to endure. The members of the Committee all have expensive-sounding scientific qualifications but I have no doubt that like their predecessors they will labour long and hard and bring forth practically nothing in the way of a cure.

These scientific brasshats will presumably have to be paid for their deliberations and since the money for their fees as well as the Lucullan lunches, with which these sort of people expect to be provided, will ultimately come out of the pockets of you and me, we are justified in feeling some concern about the matter. Actually, I suppose that the only 100 per cent solution to the problem would be to provide passengers with oxygen masks and pump all the air out of the tube system, thus leaving no medium through which sound waves could travel.

This, however, is rather a drastic measure and would undoubtedly need several years of expensive deliberations by the scientists, and meanwhile time marches on and leaves the unfortunate tube travellers deprived of the opportunity of what Carlyle described as "enlightening and ennobling conversation."

Now the very nature of my domestic life with Mrs. Free Grid puts me into a unique position to

have been compelled to resort to the use of a compact and concealed amplifier in order that I may, when necessary, put in my spoke by *force majeure*.

The amplifier consists of an adaptation of an American "personal" receiver, little bigger than a Leica camera. It fits comfortably into my trousers pocket, but it has been necessary to use a separate L.S. mounted inside my bowler hat, in which position it is sufficiently near to my mouth for Mrs. Free Grid to be unaware of any deception. The miniature L.S. "flex" is, of course, disguised as a wind-check cord which in any case I always wear whether out with the Hunt or not. The mike is also of diminutive size and is sewn into my undervest so as to keep it firmly pressed against my midriff.

By means of this simple apparatus I can, by operating the volume control in my trousers pocket, raise the output of my voice to any desired level and can thus carry on a perfectly normal conversation with Mrs. Free Grid; in fact, when travelling in a tube with her the advantage is all on my side as I simply leave her at the post, much to the astonishment of my fellow passengers. If other tube travellers would follow my example, the extraneous noises of the underground could be effectively drowned out and the whole problem solved.

Cherchez La Femme

I WAS considerably astonished at Diallist's frankly confessed ignorance in a recent issue of this journal of the reason why both here and in America the tone control knob is almost invariably set hard over to "mellow," thus effectively cutting out the high notes.

Diallist is evidently more used to the lonely life of the misogynistic æsthete than to that of the domestic circle or he would know that the answer to his question can be given in one word: "woman." As I have often pointed out in these columns, the greater part of the B.B.C.'s programmes during the daytime are used merely as a drooling background to the "activities" of the only people who are then in the house; namely, the womenfolk lolling in luxurious ease and gossiping with each other while their breadwinners are at their daily toil.

In the early days of broadcasting, the strident shriekings of the pioneer receivers in their efforts to reproduce the upper register were such as to inhibit the ladies' mutual exchange of scandal, and naturally the tone control which was fitted in the very earliest sets was set to the "low tone" positions, as the mellow bellow resultant from the cutting of the top notes did not clash with the high-pitched twittering of the average female voice.

The outcome of all this was that listeners of both sexes became so accustomed to hearing broadcasting minus the upper musical frequencies that when sets with a decent top register did finally appear, the habit of cutting out the top notes still persisted as they seemed strange and unnatural; rather like a healthy-



"Daytime activities."

complexioned girl without any make-up on her face.

To show what a terrible grip this high-note phobia has on the minds of the community one has only to call to mind the popularity of the type of set which sounds like a carpet being vigorously beaten. The fact that set manufacturers have so basely pandered to this depraved taste by producing and even broadcasting in their advertisements about such receivers does not in any way excuse the fact that women started the whole wretched business.

The way to cure the trouble is so simple that nobody seems to have thought of it; namely, to make the tone-control knob a mere passenger like the H.F. stage of the average set of pre "Everyman Four" days. Self-deception is so deadly easy that people would really imagine that when they manipulated the knob, they could detect a marked change in reproduction, just as they fondly think that they feel better when they have swallowed a bottle of coloured H₂O which the local doctor sometimes finds it necessary to prescribe in order to avoid losing a confirmed and lucrative hypochondriac to a fellow fee-snatcher in the next street.



"Left her at the post."

solve this problem since in order to carry out any conversation at all—for the very essence of a conversation is that it shall be two-way—I

BAIRD — An Appreciation

IN our last issue we recorded the death of John Logie Baird, the television pioneer. G. W. Walton, of Scophony, now writes:

Baird and I were contemporary in television, both becoming interested in 1922-23, and we have been competitors since. We first met in 1924.

When Baird started there were many proposals for television which were already old, such as the Nipkow disc, Weiler drum, Kerr cell, photo cells, etc., but there was no integrated system and no one had succeeded in getting a picture with any of the proposed devices; in fact, no one had seriously tried to do so because of the enormity of the problems to be solved. Couple with this the fact that photo-electric cells had not been developed to a commercial state, nor had that foul thing the selenium cell; there was no satisfactory modulated light source and the Kerr cell had not been brought to a reliable state, the range of thermionic valves was strictly limited to a few triodes, many of which were soft and synchronization had not been solved even theoretically. It needed great courage and imagination to tackle television in those days, yet Baird, taking a motley assemblage of unpromising old devices, making his own selenium cells, introducing the neon lamp as a modulated light source and his synchronization, virtually flogged a



An early photograph of J. L. Baird, showing scanning apparatus described in his first published article, which appeared in *Wireless World* of 7th May, 1924.

picture out of the system. That certainly was technical achievement of no mean order, even if the results had no commercial value directly.

There can be no doubt, whatever one may think of present television, television policies and the future of

television, that present television owes more to Baird than to any other person, if everything is taken into account. The charge that Baird did not originate anything fundamental is not true, but if it were then it is a fact that others only dreamed while Baird made the



A recent photograph

dream come true. I can think of no more appropriate epitaph for J. L. Baird than "He made things work."

BOOKS RECEIVED

Inside the Vacuum Tube.—By John F. Rider. The author in his Foreword states that the purpose of this book is "to present a solid, elementary concept of the theory and operation of the basic types of vacuum tubes as a foundation upon which can be built a more advanced knowledge of tubes in general." Three two-coloured anaglyphs are included among the illustrations, which, when viewed through the red-and-blue spectacles provided, give stereoscopic pictures of, for instance, the lines of force in a triode. 407+xiii pp. John F. Rider Publishing, Inc., 404, Fourth Avenue, New York 16, N.Y., U.S.A. Price \$4.50.

Active Nitrogen—A New Theory.—By S. K. Mitra, D.Sc. This monograph embodies the lectures given by the author before the Indian Association for the Cultivation of Science. Part one deals with the properties and phenomena of active nitrogen and Part two with a new theory proposed by the author as a result of his study of the ionosphere. 73 pp. The Indian Association for the Cultivation of Science, 210, Bowbazar Street, Calcutta.

Electrician's Maintenance Manual.—By W. E. Steward. The practical problems encountered by the electrician or electrical maintenance engineer in the course of his work are dealt with in this book. Comprehensive tests for detecting faults in A.C. and D.C. motors are given, together with useful tabulated data. 144 pp, with 59 diagrams. George Newnes, Ltd., Tower House, Southampton Street, London, W.C.2. Price 6s.

ONE LOUDSPEAKER —360° COVERAGE

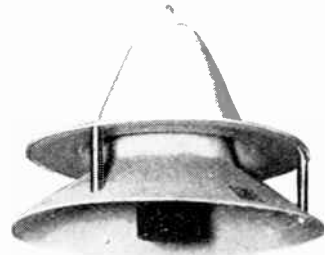

This new type, called the CIRCON, has horn-speaker efficiency together with completely uniform distribution throughout 360 deg.

Typical advantages:—ONE centrally placed will cover the whole of a medium-sized area; used on a moving vehicle results are equal approaching, passing or receding, thus ideal for street processions, elections, etc.

List price—Horn only £7 0 0.
Complete £14 5 0.



M.5
Moving Coil

MICROPHONE

No polarising current, adequate frequency response, low impedance, high output due to a very efficient magnet and careful design.

List price £5 15 0.

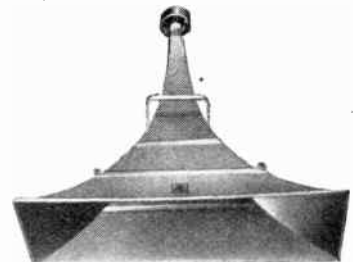

L.5.7 HORN LOUDSPEAKER

Maximum sensitivity and volume. Impedance 10 ohms; handles 12 watts 170-10,000 c.p.s. 40in. horn. List price £13 10 0.

F.I. for P.A.
FILM INDUSTRIES LTD.

60, PADDINGTON ST., W.1

Telephone: WELbeck 2385

LETTERS TO THE EDITOR

Where are the B.B.C. Stations? • Surplus Condensers • Super-regeneration and Pulses

B.B.C. Secretiveness

MAY I strongly reinforce the suggestion of A. T. Drake in your June issue. I have twice written without success to the B.B.C. asking for details of their present distribution system. What possible need is there for secrecy in the matter now?

In marked contrast to this I have received a most courteous and detailed account of the French transmitting system, with a full list of wavelengths and power used. H. BRODRIBB.

St. Leonards-on-Sea.

Surplus Components

IN his letter published in your July issue, D. A. Bell suggests that the present unsatisfactory position with regard to the disposal of surplus components is due to reluctance of the industry to reach a compromise.

So far at least as the condenser section of the industry is concerned, this is incorrect. The British condenser industry as a body put forward what we suggest was a fair and workable scheme. Briefly, we proposed that:—

(1) We would be responsible for the entire surplus which became available.

(2) We would form an organisation to deal with the surplus so as to regulate it in such a way as to secure the following advantages:—

(a) The industry would not be dislocated.

(b) Components in short supply would not be destroyed.

(c) Maximum revenue for the Treasury would be ensured, and the Government would be invited to appoint a nominee on to the Board of the disposals organisation to look after the national interest.

(d) The ultimate user would be protected by re-testing and re-stamping the goods before distribution.

After providing for the cost of

this work, we proposed to retain a nominal cover for ourselves, leaving any remaining profit to be distributed in the proportions of 25 per cent for members of the disposals group and 75 per cent for the Government—or some other proportion which the authorities might propose.

It is within our knowledge that this principle of disposing of surplus has been accepted by the Government in other industries and, in fact, in an important section of our own. However, our proposals were turned down out of hand and no amendments in principle or detail were put forward by the officials responsible. They reiterated their intention of accepting the highest initial bids irrespective of their character or origin. W. F. TAYLOR.

The Telegraph Condenser Co., Ltd., London, W.3.

Super-regeneration

I WAS particularly interested to read "Cathode Ray's" article in the June *Wireless World* on super-regenerative receivers. The similarity between the super-regenerative signal and pulse modulation struck me when investigating the super-regeneration in connection with I.F.F.

The three modes of super-regenerative operation:—

1. Separate quenching linear mode.

2. Separate quenching logarithmic mode.

3. Self-quenching mode, may be likened to the three basic forms of pulse modulation.

1. Pulse amplitude modulation.

2. Pulse length modulation.

3. Pulse frequency modulation.

The pulse nature of the demodulated signal in the various forms of super-regenerative receivers suggests a possible method whereby normally amplitude modulated signals can modulate centimetre pulse transmitters.

I found a very useful article on super-regeneration in the October,

1944, *Proc. I.R.E.*, by Kalmus. His views of the optimum quench frequency differ considerably from "Cathode Ray's"—100 kc/s at 45 Mc/s and 200 kc/s at 75 Mc/s.

G. H. L. THOMAS.
Herne Bay, Kent.

Ex-R.A.F. 1155 Sets

IT would appear that "Ex-Signals" slipped when drawing the circuit diagram of a power unit for the R.A.F. R1155 receiver in your July issue.

If the inter-connections are made as shown, the earth connection (pin 4) is positive with regard to earth (pin 8) by the voltage developed across R₄₀, and this voltage is applied to the grid of the KT63 in opposition to the negative voltage developed across the cathode resistor of this valve. The solution, of course, is the simple one of inserting a suitable condenser in series with the lead to pin 6.

Apart from this criticism I should like to say that, as the owner of one of these sets, I found "Ex-Signals'" article very helpful. At the moment I am contemplating several modifications, including the installation of a Lamb noise silencer in the space made available by the removal of some of the D.F. components.

M. C. MATTHEWS.
London, N.W.3.

[A blocking condenser of about 1μF should be suitable.—ED.]

Why Listeners Hate "Top"

THE listener does not object to the higher frequencies reproduced by the loudspeaker ("Diallist": your May issue), but he *does* like his music to be free of background noise. The simple tone control fitted to present-day receivers is quite efficient in cutting down noise when it cuts "top." I have found, from observation and enquiry, that it is for the former

property that the control is used.

Give the listener noise-free reception and he will happily accept all the "top" his loud-speaker can give.

L. J. WIGNALL.

B.A.O.R.

PRECISION RADIO MATERIEL

Products of Johnson, Matthey on Show

DURING the war the range and variety of materials and products available from Johnson, Matthey and Co., Hatton Garden, London, E.C.1, have been so much extended that it has been impossible to keep potential users acquainted with all the developments which have taken place. Accordingly, an exhibition was held at Dorland Hall, London, last month.

As is well known the background of the firm is the refining and assaying of precious metals, and the tradition of care and precision is now carried into the fabrication of basic stock parts for such trades as instrument and valve manufacture. Nickel cathodes for valves, grid support wires, light alloy tubing for instrument pointers, fine strip for galvanometer suspensions and complete hair springs in beryllium-copper and other alloys, contacts in various combinations of the precious metals and the application of rhodium plating to contacts and the interior of cavity resonators may be quoted as examples of radio interest.

Precision fuse and resistance wires are materials in which the firm has recently specialized and, by careful attention to alloying and the technique of drawing, a high degree of uniformity in terms of resistance per unit length can be guaranteed throughout any given length of wire.

Silvered mica condenser plates are another example of a basic component for wireless receiver construction which has been improved by the application of a new technique which gives a silver deposit free from fringing at the edges and hence greater freedom from random changes of capacity and temperature coefficient.

Vitreous colours and transfers with precious metal bases, which are widely used for decorative pottery and glassware, are now being applied to cathode-ray tubes. Graticules fired directly on to the glass end of the tube enable accurate measurements to be taken without parallax; it is also possible to fire a dead black mask on the inside of a television tube to frame the picture.

Bulgin Components in



Britain's Greatest Air-Liner

The Avro Tudor II is making aviation history. Huge in size, with a wingspan of 120 feet and a length of 105 feet, the Tudor II is the commercial air liner of the future, bringing the capitals of the world within easy reach of Britain. Precision-built to the last detail, this flying giant incorporates every modern accessory, including components by BULGIN. Switches and signal lamps by these famous makers play their part as they did in the mighty bombers of the R.A.F. That battle record and the skill and research of twenty-five years are behind every component that bears the BULGIN name.

★ *Bulgin Toggle Switches available in over 200 standard types from light to heavy duty.*

★ *Bulgin Signal Lamps in 36 types from miniature to wide vision-angle panel mountings for button-neons or M.E.S. bulbs.*



BULGIN

*A name Famous in Radio
for over 1,000 Components*

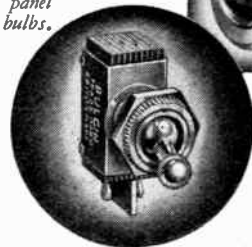

A. F. BULGIN & CO. LTD · BYE PASS ROAD · BARKING · ESSEX

Telephone: R1Ppleway 3474 (5 lines)

RECENT INVENTIONS

U.H.F. CRYSTAL DETECTOR

A CRYSTAL combination for detecting or heterodyning centimetre waves is arranged so as to match the impedance of a coaxial feed-line and prevent standing waves.

As shown, a tungsten catswhisker T, fixed to the inner conductor B of

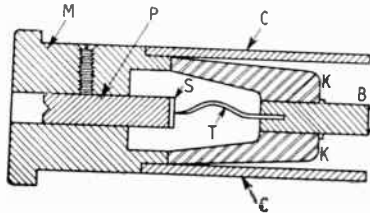

Crystal detector for coaxial lines.

the feeder, makes contact with a silicon disc S mounted on a plunger P sliding in a metal headpiece M. The latter fits into the outer conductor C of the feeder, and is cemented to a ceramic cup K, which encloses the crystal contact and also holds the inner conductor B firmly in position.

The length of the catswhisker, and the distance between the crystal point-contact and the short-circuited end of the feed line, are both equal to an odd multiple of quarter wavelengths. The impedance of the cup-shaped insulator K is offset by making it enclose the end of the inner conductor B for a length equal to one or more half-waves.

The British Thomson-Houston Co., Ltd.; T. H. Kinman; and B. A. C. Tucker. Application date, May 1st, 1944. No. 573837.

RADIO ALTIMETERS

THE height of an aircraft above ground can be found by measuring the phase-difference between an outgoing or exploring wave and one that is received after reflection from the ground. As shown, a fraction of the outgoing wave is fed in parallel to two rectifiers R_1 , R_2 through a transformer T_1 , whilst the reflected wave is simultaneously fed in push-pull to the same

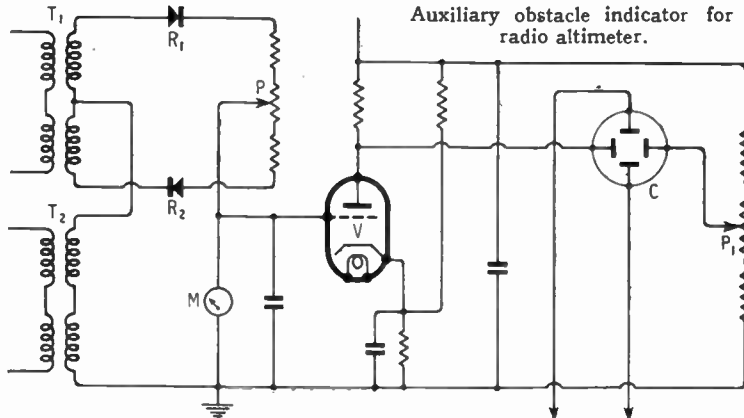

A Selection of the More Interesting Radio Developments

rectifiers via a transformer T_2 . A calibrated microammeter M is adjusted through a potentiometer tapping P to indicate the elevation of the machine.

This arrangement would not, however, register the presence of any projecting chimney, tower, or similar obstacle showing only a comparatively small reflecting surface to the exploring wave. To meet this requirement the voltage across the meter M is applied to an amplifier V, the anode of which is connected to one of the deflecting plates of a cathode-ray indicator C. The opposite plate is connected to a potentiometer tapping P_1 , whilst a 50-c/s deflecting voltage is applied to the second pair of plates. The D.C. meter M is now in parallel with an instantaneous indicator which is capable of registering the transient change in phase produced by an obstacle to which the meter M might be insensitive.

Standard Telephones and Cables, Ltd., and R. M. Barnard. Application date, April 5th, 1940. No. 574319.

SCREENING DEVICES

TO prevent interference with wireless reception, an ignition coil, H.T. distributor, or like source of radiation is screened by a closely fitting cap of "low-resistance" rubber. This contains a high percentage of carbon or graphite, and is preferably moulded over an inner layer of ordinary rubber which provides adequate insulation.

The screening cap is particularly suitable for use in tanks and other military vehicles, because it can so readily be removed to allow for inspection and repair in the field.

J. J. Davis. Application date, November 20th, 1940. No. 573660.

COURSE INDICATORS

THE indicator shown is designed to give a clear-cut distinction between the "dot" and "dash" zones lying

Auxiliary obstacle indicator for radio altimeter.

on each side of the centre-line course marked out by a blind-landing beacon of the overlapping type.

The rectified signals are fed from a valve V to the operating coil of a D.C. meter M through two parallel paths, one including a rectifier R_1 and the other a reversed rectifier R_2 . When the aircraft is in the "dot" zone, the received signals have the shape shown at (a). During the short signal period T_1 , when the anode voltage drops from A_2 to A_1 , the condenser C_1 discharges rapidly through the rectifier R_1 and the meter M. As the rectifier R_2 is then non-conducting, the condenser C can

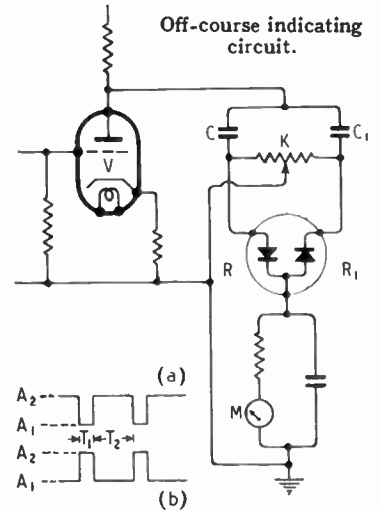

only partly discharge through the high resistance K in the time available. Condenser C therefore starts the longer spacing interval T_2 , of high anode voltage A_2 with a certain residual charge, so that the charge it draws through the meter M and rectifier R during that interval will be less than the charge lost by condenser C_1 during the period T_1 . Since the current operating the meter is proportional to the difference between these two charges, a steady downward deflection will be shown.

On the other hand, when the aircraft is in a "dash" zone, the conditions are reversed, as shown in curve (b), and the meter then gives a steady upward deflection. So long as the aircraft keeps on the centre-line course, the indicator remains at zero.

Standard Telephones and Cables, Ltd.; C. M. le G. Eyre, and D. Hamilton. Application date, February 11th, 1944. No. 572912.

The British abstracts published here are prepared with the permission of the Controller of H.M. Stationery Office, from specifications obtainable at the Patent Office, 25, Southampton Buildings, London, W.C.2, price 1/- each.

This, in the field
of physics,
is the symbol for

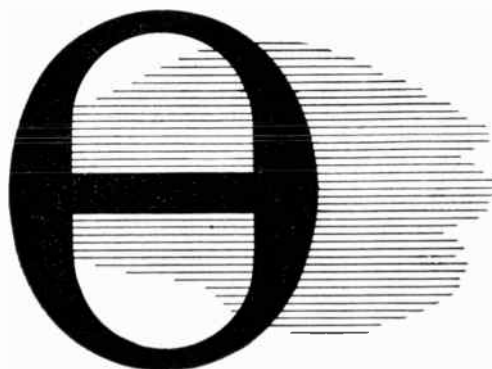

absolute temperature

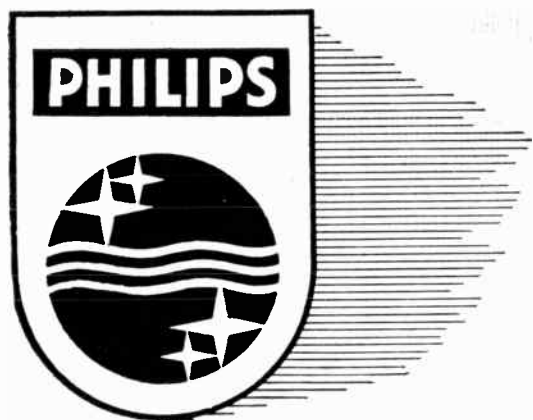

This, in the field of
electrical products,
is the symbol for

absolute dependability

PHILIPS

LAMPS RADIO X-RAY COMMUNICATIONS EQUIPMENT

AND ALLIED ELECTRICAL PRODUCTS

PHILIPS LAMPS LTD. CENTURY HOUSE, SHAFTESBURY AVENUE, LONDON, W.C.2.
(1481)

Rate 6/- for 2 lines or less and 3/- for every additional line or part thereof, average lines 5-6 words. Box Numbers 2 words, plus 1/- Press Day: September 1946 issue, first post Wednesday, August 7th. No responsibility accepted for errors.

WARNING

Readers are warned that Government surplus components which may be offered for sale through our columns carry no manufacturer's guarantee. Many of these components will have been designed for special purposes, making them unsuitable for civilian use, or may have deteriorated as a result of the conditions under which they have been stored. We cannot undertake to deal with any complaints regarding any such components purchased.

NEW RECEIVERS AND AMPLIFIERS CHARLES Amplifiers.

EXCEPTIONALLY high fidelity amplifiers incorporating the new cathode follower output circuit and flexible bass and treble tone controls, now available for home constructors or ready for use; to connoisseurs these amplifiers set a new high standard of reproduction. CIRCUIT diagrams and constructional data for 3-watt and 7-watt model and tuner unit, 5/-; kits of parts, 3-watt amplifier £10, 7-watt £15; all valves, components and ready-drilled chassis; amplifiers, factory built and tested, 3-watt model 12 gns, 7-watt 18 gns; post only, stamp for details.

CHARLES Amplifiers, 14, Lapstone Gardens, Kenton, Harrow, Middx. [5456]

ANNOUNCING Rymet feeder units, amplifiers.

NEW original designs for the connoisseur at home and abroad.—Details and delivery dates now available from Rymet, Ltd., London Rd., High Wycombe, Bucks. Tel. 1290. Specialists in custom-built radio. [5573]

RADIOGRAM, ac, all mains, all wave, H.M.V. model 661, upright walnut cabinet, perfect order, overhauled; £55.—Tel. Reliance 2821. [5286]

KITS.—Quality amplifier, push-pull output, neg. feedback, independent treble and bass; also ac/dc superhet., both first-rate jobs; send for details or our stock list; all enquiries answered by return.

R. S. ROBINSON, East St., Darlington.

WHAT is the Moreton Cheyne receiver? It gives you the performance of the communications set and the quality of local station reception at will; a precision-built instrument of fine performance with craftsmanship and reliability; something it will be worth your while to investigate; send 2½d. stamps for literature to The Moreton Cheyne Company, Gaol Rd., Stafford. [5550]

AMPLIFIERS, 12-14 watt paraphase, P×25s, complete with 7 new valves, £22; 14 watt P/P, 6L6 valves, 12 volt D.C. input to built-in rotary converter, mic. gram input with mike, £13; 12/14 watt super high quality amp., two stage, R/G, trans., coupled all 1,000 volt paper condensers, metered, finest components, £48; "Voigt" m/c P/U., £5; "Coil" P/U. (new), £8; E.M.G. Pick-up, for fibres, £4; two "Rothermel" Wilson "Hi/Fi" crystal P/U., £5 each (these are mounted with twin motors in big desk, complete with amplifier and tuner, storage for 300 records) complete for £60; Avo model "7" (new), £18; Osram HIT/LT. unit, £3; Acousticon speaker with energiser, 70/-; two super output trans., P×25 primary, 15 ohms sec., £2 each; all above guaranteed perfect, s.a.e. for reply.—A. Jinks, 30, Westwood St., Peterborough. [5614]

RECEIVERS, AMPLIFIERS—SECOND-HAND TELEVISION receiver, Pye model 815, for sale; £75.—Box 556. [5623]

EDDYSTONE 358X Xtal filter, B.F.O., 10-2,000 m.—Offers BM/EULB, London, W.C.1.

SEVERAL Trix amplifiers and speakers for disposal.—R. K. Wilson, Alnwick. [5610]

NATIONAL H.R.O. receiver, power pack and 9 coils, good condition; £30.—28, Hewlett Rd., Box E.3. [5615]

FERGUSON 378 8 valve superhet., 4 wavebands, 12½m.-2,000m., 10in speaker; offers.—Box 909. [5671]

SOUND Sales tri-channel equipment, complete speakers and all-wave Super 6 feeds, unit; £47.—Box 874. [5656]

H.R.O. Senior, 6 sets coils, power pack offers, R.C.A. Model 77E 540ks-31mcs, best over £50.—Box 222. [5561]

BRIERLEY tuner, high fidelity, local and light stations, list 5gns, scarcely used, complete with valves; 4gns.—Hunt, 109, Abbey Rd., Torquay. [5668]

TWO Savage 750watt rack amplifiers, input 15volts at 600ohms, outputs of 240-260-280-300volts; £150 each.—Johnson, 35, Portland St., Lincoln. [5510]

Partridge News

INDIVIDUAL DESIGN

The process of reverting to peace-time production continues and we are able to manufacture special transformers and chokes to your own specification in about 28 days. We would, however, draw your attention to the fact that many components can now be despatched per return (see last paragraph).

TELEVISION COMPONENTS Once again we are able to wind specially insulated high voltage transformers and chokes for television purposes. These are wound only to order and hence are suitable for use in new designs or as replacements in existing sets.

AVAILABLE STOCK

A comprehensive range of mains and audio components is now available from stock and we can despatch small quantities of these by return. We would stress that before ordering you send for our list detailing these components. Our stock range now covers almost all normal requirements, and by availing yourself of this service you will save the inevitable delay in the production of a special component. We shall be pleased to send you our stock list upon receipt of your address

Telephone:  Abbey 2244

PARTRIDGE TRANSFORMERS LTD

6-8, PETTY FRANCE, LONDON S.W.1

New Models of

Radio Cabinets

The time is very near when we shall be able to release details of our first post-war models. These will incorporate many new features. Our policy has been that rather than produce an article falling short of our pre-war quality, we would defer manufacture until we could once again make Radio Cabinets up to our usual high quality standard. This we hope to be able to do in a month or two. Under present clerical staff difficulties it is not possible to acknowledge enquiries, other than those holding licences but all names and addresses will be entered on our waiting list, and literature will be sent when available.

LOCKWOOD
& COMPANY

67, Lowlands Road, Harrow, Mdx.

Phone: BYRon 3704

HALLICRAFTER SK24 Skyriver Defiant,

stored 4 years, 545 kc/s, 43.5 M/c, good condition.—Hillside 2359, Box 248. [5587]

WIDF single signal receiver, 7 valve, 10, 20, 40 metre coils, separate power supply; £14.—10, Old Hatch Manor, Ruislip. [5577]

COMMUNICATIONS receiver No. 45, 8 valve, 9-550 metres, good condition, £30; Avomitor, good condition, £5.—Box 910. [5672]

HAMMARLUND 18-valve super pro., 1,200 kc, 40 mc, perf. offers; & model 120.—316, Forestwood Rd., Anchorsholme, Blackpool.

EDDYSTONE all-wave Four wireless set, A.C. model, with Ferranti output transformer, little used.—Strouts, Benenden, Kent.

HALLICRAFTER 8x24, modified 230v supply, R.F., I.F. circuits realigned, 500/7 Ohm speaker transformer; £31.—Buxton, 61, Eltham Rd., S.E.12. [5616]

ECHOPHONE commercial model E.C.1 communications receiver, ac/dc, 3 bands, 545 kc to 30.5 mc, new condition, hardly used; £30 or best offer; see Birmingham district.—Box 183. [5540]

FOR sale.—Baird television with Emulon aerial, screen 10x7, new cathode tube 1939, unused since; best offer over £75; buyer arranges transport.—Dodd, 21, Tudor Rd., Liverpool, 23. [5661]

G.E.C. 100watt rack amplifier, 3-channel input, electronic mixing, with 8 12watt projector horns, mike and floor stand, together with necessary leads; £120.—Johnson, 35, Portland St., Lincoln. [5509]

HALLICRAFTERS 8x28, 500 kc/s to 43 mc/s, 110-230 volts ac, 15 valves, with two 6V6 in push-pull, instruction book, some spare valves, stored 5½ years, as new; view N. London area.—Offers to Box 8107. [5597]

FOR sale.—Guthman Silver-Super communication receiver, type UV.17, six wavebands 500 kc-60 mgs continuous, 110-250 A.C., complete with matched trans. and speaker, little used; £65.—Wilson, 45, Earls St., Theford, Tel. 2122. [5667]

12 W. "Wireless World" quality amplifier, 18in Baker's spkr on baffle, 2v radio unit, £30; 6v Ultra table model, 10w output, £15; sig. gen. Mitchell's W.W. circuit, mains, £8; choke, B2, 12/6; AF5C, 12/6; heavy 9in HMV, 1,500 or 10w 'field, 15w speech, £2/10; offers accepted.—157, Underhill Rd., Dulwich, S.E.22. [5536]

RADIOGRAM, comprising Garrard electric turntable, Telefunken and Piezo type pick-ups with transformer and bass and treble controls, Lowther 2 h.f.-det. unit, S.S. 12-watt 2-stage P.P. amplifier, whistle-filter, Voigt twin-diaphragm speaker with walnut covered corner horn; offers, or consider selling separately.—12, Granville Terrace, Redcar, Yorks.

SOUND SALES 4-12-watt amplifier, £10; S.W.W. Quality receiver, £9; Hartley Turner energised speaker 2,440-ohm field £3/15; W.B. P.M. 10-watt Auditorium speaker, £3/10; Rothermel D.104 microphone, £3/10; E.D.C.C. converter in sound-proof cabinet, d.c. input 220 volts/a.c. output, 230v at 180 watts, £15; all in excellent cond.—Box 227.

TEST EQUIPMENT

AVO valve tester, £14; all wave sig. genera- tor, £10.—Box 244. [5582]

FOR sale, Universal Avomitor, as new; £6 or offer.—Box 456. [5604]

VALVE voltmeter, Scroggie's slide back, 0-250v in 4 ranges; £10/10.—Gerry, 36, Bank St., Newquay. [5570]

TAYLOR 45a/p valve tester, £18; all-wave sig. gen., £12; various meters and service sheets.—Box 873. [5657]

AVOMETER, model 7, new and unused; £19 10.—Holland, 49, Christchurch Rd., London, S.W.2. Tel. Tulse Hill 4598. [5533]

EXPERIMENTER selling all gear, oscilloscope, signal generator, pick-up, Avomitor many smaller items; £25, or separately; Box 915. [5644]

HUNT'S capacity and resistance analyzer, model C.R.B., cost £18/18, also universal avomitor, cost £8/10; offers for either or both.—Box 69. [5504]

FOR sale, Weston Analyzer 772 (20,000 o.p.v.), Yankee valve voltohmmeter, Avo's, etc.; no fancy prices.—BCM/METERS, London, W.C.1. [5651]

THERMO-COUPLE R.F. or ac ammeters, 0-500ma, 0-2.5 amp, ex-Govt., tested and calibrated before dispatch; 20/ each.—C. W. 14, Pont St., S.W.1. [5669]

MILLIAMMETERS, 2in flush mounting (square flange), moving coil dc milli-ammeters, 0-50, 0-100 and 0-500Ma, by Elliott (new boxed), 39/6 each.—Pickford, 46, Greyhound Rd., London, W.6. [5556]

COMPREHENSIVE Mullard Universal test equipment as used by makers for all American and English types to latest 1.4v, includes 525 punched bakelite cards with data, quick push-button control, self contained for all possible radio tests; nearest offer £65; Woodcroft, Merdon Ave., Chandlersford, Hants.



THE "Q-MAX"
SLOW MOTION
DIAL for
Individual
Calibration

comprises a 9-l slow motion drive. Dial (6½ × 3½) with 5 blank scales and 1 engraved 0-180°; escutcheon glass and fluted knob. 15/6



THE "Q-MAX"
CHASSIS CUTTER

ends all your tiresome drilling and scraping. For octal holes (1½"). 10/6

Our new Catalogue (illustrated) will be ready next month. Price 6d. post free—register now.

BERRY'S

(SHORT WAVE) LTD.

25, HIGH HOLBORN, LONDON, W.C.1

(Opposite Chancery Lane.) Tel.: HOLborn 6231

PITMAN BOOKS

By J. H. REYNER, B.Sc. (Hons.), A.C.G.I.,
D.I.C., A.M.I.E.E., M. Inst. R.E.

SHORT WAVE RADIO

A reliable guide to modern developments in the use of the short, ultra-short and micro-waves. This is a first-class book for everyone interested in up-to-date radio engineering. Fourth Edition. 10/6 net.

MODERN RADIO COMMUNICATION

(2 vols.)

This work is a model of clear exposition, and throws light on all branches of modern radio theory. The two volumes together provide a complete groundwork for the student of radio engineering. Each 7/6 net.

CATHODE RAY OSCILLOGRAPHS

A comprehensive account of the practical applications of cathode ray tubes and the theory underlying them. "ELECTRICAL TIMES" says "Anyone desiring a clear understanding of the cathode ray oscillograph cannot do better than purchase this moderately priced book" 8/6 net.

Order from
The Modern Book Co., (Dept. I.W.)
23, Pread St., London, W.2.

G. W. SMITH & Co. (Radio), Ltd., offers the following:—

TANNOY service type hand microphones, multi carbon, with switch, metal cases, slightly soiled, 7/6 each.

CHASSIS, strong metal, suitable for television racks, 25½x10½x4½in, 12/6 each, carriage 2/6; 10½x6x3in, 2/- each, both drilled.

CONDENSERS, 2mf 250v, 1/-; 2mf 400v, 1/6; .1 1,000v, 3/6; .25 2,500v, 3/6; .25 3,000v; .1 3,000v 4/-; .25 8,000v, 7/6; .1 10,000v; 02 10,000v, 10/-.

G. W. SMITH & Co. (Radio), Ltd., 2, Cecil Rd., Southgate, London, N.14. [5546

SCOTLAND'S largest stockists.—Anything radio we have it.

EDDYSTONE—agents—Raymart.

SEND for parts and kits list.

BUCCLEIGH RADIO MANUFACTURERS, Melville Terr., Edinburgh. Tel. Edinburgh 42803 Grams, Therm Edin. [5139

RADIO CLEARANCE, Ltd., 27, Tottenham Court Rd., W.1. Museum 9188.

MAINS Trans 300-0-300, 110ma, 5v 2a. 6. 3v 3a 22/6; Electrolytics, 2mf 250v, 1/9; 4mf 350v, 2/-; 4mf 500v, 2/11; 8mf 500v, 3/3; 16mf 500v, 4/-; 32mf 250v, 3/6; 20mf 150v, 2/9; 20mf 50v, 2/-; 40mf 50v, 2/6; 200mf 12v, 2/-; 250mf 25v, 2/-; 500mf 12v, 2/6; Mansbridge Condensers, 1mf 150v, 9d.; 2mf 400v, 1/6; 4mf 450v, 4/-; 0.5mf 200v, 6d.; Mica, 0.0001-0.0005, 4d.; 0.002-0.007, 5d.; 0.01, 6d.; 0.01 2,200v Test, 9d.

SILVER Mica, 50-50000pf, 6d.; Tubulars, 0.01, 0.02, 0.05, 6d.; 0.1 350v, 7d.; 0.1 500v, 9d.; 0.25 500v, 9d.; 0.5 350v, 1/-; Resistors, ¼w 3d., ½w, 4d.; 1w 6d., 2w 10d., 3w 1/3, all values.

SWITCHES, 3p 4w, 3/-; 1p 9w 3 bank, 5/-; 1p 2 or 3w, 2/-; Vitreous Resistors, 5w 450ohms, 1/-; 10w 50ohms, 500ohms C.T., 1,000ohms, 1,000ohms Tapped, 250 and 500, 1,200ohms C.T., 1/6; 20w with clips, 120ohms and 200ohms, 2/-; 25w 4,090ohms tapped 2.6, 0.55, 0.94ohms, 10hm, 1/6; 350, 5,000ohms, 2/6; 40w 14,000ohms tapped 2,000ohms, 3/-; 20,000ohms 50w, 3/6; Volume Controls Wire Wound, 25ohms, 32ohms, 100ohms, 300ohms, 500ohms, 2k, 5k, 2/6; Carbon with Switch, 0.1m, 0.5m, 1m, 4/-; Heavy Duty, wire wound, 44ohms 12w, 4/6; Iron Cored, 1Fs 465 K c/s, 6/11 each; Head Phones, 10/6 pr; Throat Mikes, 3/6; 3 Section Metal Rect, 108v, 50ma per Section, 5/6; Ex Army 38 Set Chassis, complete with all components, £1.

1000 0-1000 volts 350 ma transformer; Colwyn Bay, [5576

EXPERIMENTER selling surplus stock, valves, components; £18 to clear; s.a.e. list.—Box 223. [5562

TWIN mains filter chokes, 1-hole fixing, Paxolin mounted; 2/6.—Emanee Radio, 266, Nightingale Rd., N.9. [5522

UNIVERSAL ELECTRONIC PRODUCTS (GBUQ), 36, Marylebone High St., London, W.1. Tel. Welbeck 4058.

LARGE selection of components for the amateur transmitter and experimenter always in stock, send s.a.e. for list; Weymouth 3-range coil packs, 38/6; I.F. transformers, 465 kc/s, per pair, 18/6; midget I.F. transformers, iron cores, per pair, 25/-.

OUR workshops are equipped to undertake the construction of all types of radio or electronic equipment, from an extension spindle or small chassis to a complete transmitter; we are practical people, and amateur enthusiasts are always welcome. [5679

SMALL Ali Can eies, 500v 8mfd, 3/-; post extra under 12.—Cooke, 25, Langdale Rd., Sheffield, 8. [5283

CONDENSERS, 8-8 mfd, 4/11; 16mfd, 5/3; C pick-ups, 30/5; s.a.e. for list of amateur supplies.—"VIZIT", Carlton Music Salon, West Kirby, Cheshire. [5574

ADMIRALTY surplus.—New Revo electric adjustable table fans, ac-dc 220-230v, 3-speed, latest pattern, 12in silent blade, £3/12/6, carr. free.

GOVERNMENT surplus.—Ex-R.A.F. throat microphones, 5/11 pair, post free; Post Office type mike insets, 1/- ea, post free; new 4-way flexible telephone leads, tagged ends, 2 yds long, 6d ea, post 2d, 5/- doz; new 2ft twin leads, tagged ends, 1/6 doz, post free; phosphorus bronze covered, braided, screened pick-up leads, approx length 2yds long, 2/- ea, post free; 2mm screened sleeving, 1yd long, 6d ea, post free.—Hay & Son, 129, North St., Brighton. [5620

BIG stocks of radio valves all types, list prices; 8in Field energised speakers, 35/-, c.o.d. or proforma.—David Robinson, Ltd., 100, High St., Bedford [4577

ADVERTISER, going overseas, disposing of radio components, signal generator, meters, amplifiers, superhets, Garrard auto-changer, quality spkrs.; no dealers.—Box 918.

ANSWERS AT YOUR



FINGER-TIP

Answers!

FLIK-O-DISK

Quick!

ELECTRICAL AND RADIO ENGINEERS OHM'S LAW CALCULATOR

Whether you are constructing or servicing a radio set, problems involving voltage, current and resistance can delay progress.

Flik-o-Disk will give the answer in a jiffy. For example, what resistance should you use to obtain a voltage drop of 100 v, when current equals 25 ma. ? A flick of the disk and there is your correct answer—4,000 ohms. The scales read from 1 millivolt to 1,000 volts. From 1 ohm to 1,000,000 ohms. From 1 milliamp to 10 amperes. From 1/10th of a milliwatt to 10,000 watts

The calculator is sold complete and with full instructions at Radio Stores and Stationers. If unable to obtain, write to **IONIC LABORATORIES LTD.**, Dept. W., Cranbourne Terrace, **SALT HILL, SLOUGH, BUCKS.**, for name and address of your nearest stockist.

PRICE

66^d



Come to the point!

It's hot—all the time
That's because the heating element is housed inside the bit in the Solon Electric Soldering Iron. Soldering is easier: you get a neater, cleaner job in less time. All internal connections are housed at end of handle away from heat. A robust cord grip prevents sharp bending of the flexible lead. Complete with 6ft. of Henley 3-core flexible. Solon irons are made for the following standard voltages:—200/220 230 250.

Made in England.

Illustration shows a 125-watt standard model.

SOLOON

Electric

SOLDERING IRON FOR INDUSTRIAL USE

W. T. HENLEY'S TELEGRAPH WORKS CO. LTD.
Engineering Dept., 51-53, Hatton Garden, London, E.C.1

• ALL POWER •
Regulated H.T. Supply Units

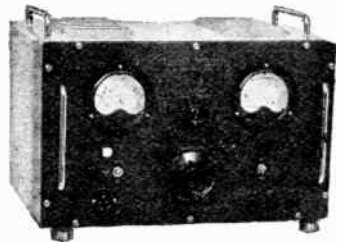

A range of standard models is available, of various output voltages and current ratings. The various output voltage is substantially independent of mains voltage or load current, within specified limits. Illustrated is the Model 101-A, which provides an output voltage from 250 to 400 volts; at up to 250 mA, with a Stabilisation Ratio greater than 100 and an Internal Resistance less than 1 ohm.

ELECTRONIC EQUIPMENT

In addition to our steadily increasing range of very high grade test apparatus, we are also prepared to produce specialised equipment to customers' requirements.

SPECIAL TRANSFORMERS

We are specialists in the manufacture of very high quality Transformers and Chokes of all types and to any specification.

EXPORT ENQUIRIES INVITED.

ALL POWER TRANSFORMERS LIMITED

8a, Gladstone Road, Wimbledon, S.W.19

MORSE CODE TRAINING



There are Candler Morse Code Courses for **BEGINNERS AND OPERATORS.** Send for this Free "BOOK OF FACTS" It gives full details concerning all Courses.

THE CANDLER SYSTEM CO., (Room 55W), 121 Kingsway, London, W.C.2
Candler System Co., Denver, Colorado, U.S.A.



NOW READY!
✓ 55R "Communication" RECEIVER
An All-British Designed and Modified Superheterodyne

- 9-Valves
- 5 Wave-Bands
- A.V.C. B.F.O.
- 3½ Watts Output

Price Complete (Excluding Loudspeaker) **£35-15-0**

ALL EXPORT OR HOME ENQUIRIES

Write Phone 20167 or call—

VOICE & VISION CO.
59-60 RUTLAND STREET, LEICESTER

MAINS trans 200-250v input, 350/0/350 80ma, 4v/6v or 5v/6v htrs, impreg and fully guar., 21/-; 5in P.M. speakers, lovely quality, 20/-; pent. I.S transfs. 42: 1.45ma, 5/-; int. Oct. v holders, 6d doz.; line cord, 3a 3w, 1/9 yd; drilled chassis 5v 9½×4¼×1½ 3/6. All postage free.—T. R. S. 33, Meadvale Rd., E. Croydon. [5691

CHARLES BRITAIN (RADIO), Ltd., lines of interest and special offers. Page mid-get speakers, 5in less trans, 22/6 ea.; Mid-get chassis drilled for 5 valves, 2/6 ea; two-gang condensers with feet, less trims, 12/-; 0.1 tubulars, 8,000v wkg, 9/6 ea; metal cased 0.1 tubulars first-class quality, 350v wkg, 5/6 doz; 0.5 350v wkg, 6/- doz; 0.01 1,000v wkg, 4/6 doz (Note: please order in dozens); also Metalmite Midget, 0.01 350v wkg, 6/- doz; mains droppers, 850 ohm 0.3 amp, 5/- ea; 1,000 ohms 0.2 amp, 4/6, both have two adjustable sliders and fixing feet; volume controls, with switch 4/6, less switch 3/-; most values in stock.

SPECIAL offers:—Parcel of resistances, 1 gross ass't'd, ¼, ½ and 1 watt, £2; parcel of tubular condensers, 1 gross of ass't'd from 0.001 to 0.5, £2/8; parcel containing new and used component I.F. transformers, speaker trans, multi-way tag bars with new resistances and condensers, also 36 new tubular condensers, £1, worth double; small moving-coil mikes undamaged, 3/6 ea; damaged 1/5 ea; moving-coil voltmeters, 0-40v, can be deshunted, 10/- ea; 0.00016 short-wave condensers, to clear, 2/6 ea; Midget radio chassis, wired and tested for long and medium wave, with speaker for use on AC or DC mains, note the price, £6/19/6. Send for list of smoothing condensers, mains transformers, coils, etc. Terms, cash or c.o.d. over £1.—Charles Britain (Radio), Ltd., Radio House, 2, Wilson St., London, E.C.2. [Phone: Bis. 2966. [5693

MAINS transformers, 2.5kv-2ma, 2v-2a, 4v-1.4a, £1; E.S voltmeters, 0-1500v 2½in dia. 37/6; Galvos M.C. centre-zero, 500/500 microamp 2½in dia., 30/-; M.C. milliammeters, 0/-100ma, 25/-; M.I. voltmeters, 0-20v, 15/-; Polar 3-gang × 0.0005 mfd ceramic insul., 7/6; ceramic air-spool, trmrs, 30mmd 1/-; 70 mmd 1/6, 50 mfd 60v elect. cond. 1/6; carbon resist. 50 for 8/-; Pots 100k 3kv 3/-; Pots 1 meg 1/-; Yaxley Sw 3-day 5-bank 3/6; Eddystone flex insul. couplers, 6d. S.a.e. list.—Heathcote, 24, Durnford Ave., Urmston, Manchester. [5501

COMPONENTS for prototypes.—Commercial buyers for large industrial organisations, requiring components for prototypes (especially when they are in a hurry—which is mostly always) are gradually finding that the quickest way to get what they want is to phone Pad. 6116, or call at 177, Edgware Road (not far from Marble Arch) and take the goods away with them. No matter what is required, if we haven't got it in stock we always do our utmost to get it quickly, and we usually know where—and how. Our own factory:—We have just acquired additional space on the premises and now have our own factory—primarily engaged on communications apparatus, transmitters, and U.H.F. receivers; mind you, it is only a little factory, but it is surprising sometimes what initiative and determined effort can do.

WHEN you have a minute to spare—call in and see us—you will be quite interested. **TELE-RADIO (1943), Ltd.**, 177, Edgware Rd., London, W. 2. Pad. 6116. [5694

THE Simplex Four, still the best, complete constructional details; Midget AC/10C (total cost of construction £29), theoretical and full scale layout diagrams, with instructions, per copy, 4/6; Midget polished wood cabinets, 35/-; Midget m. wave t.r.f. coils, high gain, 5/-; m.l. wave, with reaction, circuit, 7/6; oil filled paper condensers, high v wkg, small size, 4mfd 1,000v, 7/6; 8mfd 1,000v, 12/6; 8mfd 600v, 7/-; 100mfd 600v, 7/-; midget electrolytic 16×16mfd 350v, 7/-; 16mfd 200v, 3/-; 16mfd 350v, 3/6; all wave coil pack, wired, tested, 5 leads to receiver, boxed with AC/DC circuit, 38/6; Midget ivorine coloured dials, s.m.l. wave, 4×3½, 2/6; slow motion string drum drive, 3/-; epicycle drives, 3/3; square plane drive assembly, complete with station named dial, 4¼×3¼, m.l. wave, pointer, glass, oxidised escutcheon and mounting brackets, 11/6; full vision ditto drive assembly, size of dial 7×3¼, s.m.l. wave, 11/6; miniature rotary switches, 4p 3w, 4/-; 2p 6w, 2/6; d.p.d.t., 3/-; chokes, midget 50ma, 6/-; standard 80ma, 8/6; heavy, 150ma, 12/6; Midget Simplex chassis, fully drilled with four valve holes, etc., 11×4¼×2in, 6/6; monthly comprehensive lists, 2½d. stamp with enquiries, postage all orders.

O. GREENLICK, Ltd., 34, Bancroft Rd., Cambridge Heath Rd., London, E.1. Ste. 1334.

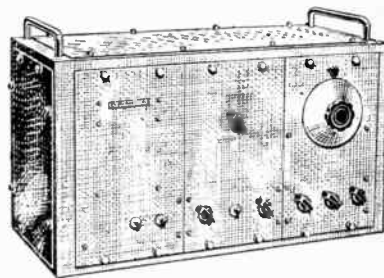

PUBLIC ADDRESS
by
ACOUSTICAL
for the very best in
REPRODUCTION DESIGN WORKMANSHIP SERVICE

We will gladly send you full details and specifications of the full range of ACOUSTICAL P. A. Equipment on request.



MANUFACTURING CO. LTD.
HUNTINGDON, TEL: 361.

ENGINEERING OPPORTUNITIES



This unique handbook shows the easy way to secure A.M.I.Mech.E., A.M.Brit.I.R.E., A.M.I.E.E., City and Guilds, etc.

WE GUARANTEE— "NO PASS—NO FEE."

Details are given of over 150 Diploma courses in all branches of Civil, Mech., Elec., Motor, Aero., Radio, Television and Production Engineering, Tracing, Building, Govt. Employment, R.A.F. Maths., Matriculation, etc.

Think of the future and send for your copy at once—FREE.

B.I.E.T., 387, SHAKESPEARE HOUSE, 17, STRATFORD PLACE, LONDON, W.1.

LONDEX for RELAYS

for A.C. and D.C.



Midget Relay M.I.

Ask for leaflet 205/WW

2VA Coil consumption from 2 to 600 volts and tested to 2,000 volts. Aerial change-over Relays, Mercury Relays, Measuring Relays, and Time Delay Relays.

LONDEX LTD
MANUFACTURERS OF RELAYS
ANSLEY 207 ANSLEY ROAD LONDON S.E.20

**THE STATIC
CONDENSER
Co. Ltd.**

★ *Manufacturers of
STATIC
CONDENSERS*

**TOUTLEY WORKS,
WOKINGHAM, BERKS**
Phone: WOKINGHAM 708

FOR
**VACUUM
IMPREGNATION**
OF
**RADIO &
ELECTRICAL
COMPONENTS**
CONSULT
**GRIFFITHS BROS.
& CO., LONDON, LTD.**

**VARNISH MANUFACTURERS
&
SPECIALISTS IN
IMPREGNATION**

**MACKS RD., BERMONDSEY,
LONDON, S.E.16. BER. 1151**

SUPREME RADIO, 746, Romford Rd., Manor Park, London, E.12. Tel. III. 1260. For 15 years we have given service. LINE cord 3-way 60-70v per foot, 1/6 yd; M.L. coils, with circuit matched, 9/6 pr., MW 6/6; L.M.S. wave coils, A and O short 14-50 metres, M20-550L, 900-2,000, with circuit, 10/6 pr.; I.F. 6/6; 10/6 switches for same, 7/6; midjet 2-gang 0005 condensers, 11/-; 3-gang 13/-; all-wave dials, 3 1/2" x 4 1/2" coloured 1/9; all-wave 5in, 2/6; glass 4 1/2" x 9in, 3/6; L and M switches, 2/3. **SPEAKERS** from 2 1/2" - 10in; send for prices valves, 6J5GT, new, boxed, 7/6; not BUA, 80, 5Y39, we have a quantity of odd valves, also over 3,000 BVA valves at BOT prices; paper and can condensers; send for prices; Airmaster 5-valve superhet chassis, 4-waveband pick-up and extension speaker tappings, all Mazda valves fitted, including PT, £15/10; also in Console model, £29/10.

MANY other lines for the service engineer S.A.E. all enquiries, 6d extra for postage. No c.o.d. [532]
TELERADIO offer 2 1/2" Sylvania CR tube, 500v, £2. 12in Ediswan television tube, 12H, £10. Multi way relays, 7/6, Muirhead &c., 2-way 4-pole switches, 7/6, Avo Minors, Mullard & Taylor res/cap bridges, D1 valves, at list prices. 3 1/2" high gain ac/dc amplifiers £6/10, with 8in speaker. Parts and blueprint only, £5/10. Res. wire 22/45swg, from 1/6. Auto transformers, 30/-. Professional midjets cabinets, new with rounded corners, 35/-; 4 pole 2 way Yaxleys, 2/-. Send id. for list. Post-war televisions now on demonstration.—Telradio, 157, Fore St., N.18. [5490]

MISCELLANEOUS

217 trader service data sheets, perfect cond., the lot, £6 post paid.—Box 455.
CHASSIS, racks, cabinets, pans, aluminium sheet, etc s.a.e. lists.—Amateur Radio Service, G6HP, Canning St. Burnley. [5552]
MODERN radio, physics, maths, electrical and other books, apparatus, etc.; offers: requirements, stamp; (Surrey).—Box 225

100 wooden cabinets, unassembled, 12in x 7 1/2" x 8in, suit midjets; s.a.e. for full particulars.—160, Marlands Rd., Sale, Cheshire. [5559]

GHIRARDI'S Radio Troubleshooters' Handbook, new, latest edition, 744 pages, 75 chapters, case histories, IF peaks of 20,816 sets, etc.; £4/10.—Box 474. [5617]

SOLDER tag strips and panels, any size, any layout, supplied by return; send sketch of requirement; 2 1/2d. per square inch.—Moreton Cheyney, Gaol Rd., Stafford. [5551]

200 wireless cabinets for sale, size 12in x 7 1/2" internal dimensions, made in 1/2" ply, some stained and varnished and some cellulosed cream.—Box 917. [5646]

"**WIRELESS** World," 1921 to 1938, card indexed, few missing; also "Radio News" and "Radio Craft"; offers for lot.—Walker, 240, Penns Lane, Sutton Coldfield.

WALNUT television cabinet for sale, 20in x 24in x 3ft 6in high, mirror in hinged top, very handsome, solid construction; best offer over £20.—Write I. H., 32, Springfield Rd., N.W.8. [5675]

WE have for disposal a substantial quantity of interohm sheets as used for switch-board panels, arc shields and dividing fillets; the standard grey is also used for bench tops; samples and prices upon request.

LANGLEY LONDON, Ltd., 161, Borough High St., S.E.1. 'Phone: Hop 2946. [5600]

IDEAS mean money!—If you have an idea, we can help you to make the most of it; write at once for full information on the technical, legal and financial services we offer to inventors.—Technico-Legal Services Bureau, 55, Romney St., Westminster, S.W.1. [4948]

WANTED, EXCHANGE, ETC.
WANTED, feeder unit, 6v, McClure preferred.—Box 245. [5583]

WANTED, a copy of the "Wireless World," January, 1944.—Box 404. [5594]

WTD., "W.W." Jan., 1940-June, 1946.—Lanresse, Hayne Rd., Beckenham, Kent.

WTD., service sheets, all makes, from 1936.—Condition and price to Box 664.

VOIGT twin unit wanted, 15ohm speech coil preferred.—51, Fairway, Stafford.

Q.T. Wearite ganged M.L. coils wanted.—T. Lawton, Oriol, Ecton Av., Macclesfield.

WANTED, Hartley Turner speaker, 2,500Ω field (approx.).—Condition and price to Box 187. [5534]

WANTED, Voigt l.s. units, horns, reflector speakers, any condition.—Lowther Mfg. Co., Bromley, Kent. [5625]

WANTED, hypersensitive P.U. and trans. must be perfect; also radiogram cabinet.—Tel. Valentine 3844. [5663]

WTD., Philips t.r.f. coils, s., m. and l., Nos. 4390 and 4400, as recently advertised by Linaglow.—Bird, 111, Cecil Rd., Norwich.

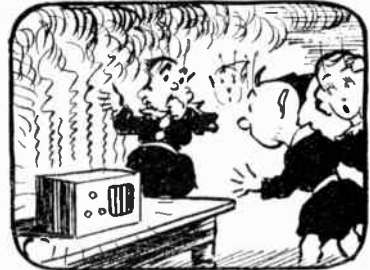

THE "FLUXITE QUINS" AT WORK

"You're the craziest tinker I've met
What on earth have you done to this set?
The darn thing's so hot
You could boil up a pot
No FLUXITE! Short circuit, I bet!"

See that **FLUXITE** is always by you—in the house—garage—workshop—wherever speedy soldering is needed. Used for over 30 years in Government works and by leading engineers and manufacturers. Of all Ironmongers—in tins, 8d., 1/4 & 2/8.

Ask to see the **FLUXITE** **POCKET BLOW LAMP**, price 2/6.

TO CYCLISTS! Your wheels will NOT keep round and true unless the spokes are tied with fine wire at the crossings AND SOLDERED. This makes a much stronger wheel. It's simple—with **FLUXITE**—but IMPORTANT.

The **FLUXITE GUN** puts **FLUXITE** where you want it by a simple pressure. Price 1/6, or filled. 2/6.



ALL MECHANICS WILL HAVE

FLUXITE
IT SIMPLIFIES ALL SOLDERING

Write for Book on the **ART OF "SOFT" SOLDERING** and for Leaflets on **CASE-HARDENING STEEL** and **TEMPERING TOOLS** with **FLUXITE**. Price 1d. each.

FLUXITE LTD.
(Dept. W.W.), Bermondsey Street, S.E.1

WARNING AND PUBLIC ADDRESS SYSTEM

The Shoreham and Southwick Civil Defence Joint Committee have for disposal apparatus comprising 180 watt Amplifier with microphone etc., 14 loud speakers and ancillary equipment, at present installed at Southwick.

Further particulars may be obtained, together with form of tender, from the Surveyor, Town Hall, Southwick.

Sealed tenders in a plain envelope endorsed "Warning Apparatus Southwick," to be sent to the undersigned not later than 19th August.

The Committee does not bind itself to accept the highest or any tender.

B. J. THICK,
Clerk to the Council

Town Hall,
Shoreham-by-Sea.

A.C.S. RADIO

FOR COMMUNICATION RECEIVERS, AMATEUR TRANSMITTING GEAR, ALL TELEVISION AND RADIO EQUIPMENT AND COMPONENTS.

Preliminary LIST NOW READY, but with new stocks constantly being added we suggest enquiry for definite items if not listed.

44, WIDMORE ROAD, BROMLEY, KENT

HILL & CHURCHILL LTD

BOOKSELLERS

SWANAGE DORSET

ENGLISH & AMERICAN BOOKS IN STOCK ON

RADIO AND TELECOMMUNICATION

CATALOGUE ON APPLICATION

POST-WAR TELEVISION

The advance in Radio Technique offers unlimited opportunities of high pay and secure posts for those Radio Engineers who have had the foresight to become technically qualified. How you can do this quickly and easily in your spare time is fully explained in our unique handbook.

Full details are given of A.M.I.E.E., A.M.Brit.I.R.E., City & Guilds Exams., and particulars of up-to-date courses in Wireless Engineering, Radio Servicing, Short Waves, Television, Mathematics, etc., etc.

We Guarantee "NO PASS—NO FEE"

Prepare for to-morrow's opportunities and post-war competition by sending for your copy of this very informative 112-page guide NOW—FREE.

BRITISH INSTITUTE OF ENGINEERING TECHNOLOGY (Dept. 388)

17, Stratford Place, London, W. 1

WANTED, autogram unit, H.M.V. or Garrard, late model, Universal preferred; state price.—Payne, 8, Avenue Gdns., Teddington, Middx. (5571)

URGENTLY wanted, cable flex P.V.C. and millimetre wire, all descriptions purchased for cash, any quantity.—Alec Davis, 8, Percy St., W.1. (5213)

G. W. SMITH & Co. (RADIO), Ltd., require the following: new or second-hand radio receivers and radiograms; all classes of radio test equipment; highest cash prices paid.

G. W. SMITH & Co. (RADIO), Ltd., 2, Cecil Rd., Southgate, London, N.14. Tel. Enterprise 5463.

WE buy for cash, new, used, radio, electrical equipment all types; especially wanted, radios, radiograms, test equipment, motors, chargers, recording gear, etc.—If you want to sell at the maximum price, call, write or 'phone to University Radio, Ltd., 22, Lisle St., Leicester Square, W.C.2. Ger. 4447. (5116)

WANTED, communication receiver, type Hallcrafters, SX28(A) or 25 or Hammarlund Super-Pro or National NC200 or IIRO. For sale, Amperite ribbon mic., £11; 40-watt 13-valve Quality amplifier (PA40s), £40; 20watt (6L6s) 12volt dc amplifier, £12; also efficient scratch filters for 15ohm.—J. Wimble, Romany Ridge, Chailey, Sussex. (5116)

DYNAMOS, MOTORS, ETC. • ROTARY converter, 110v d.c. to 230v a.c., 500 watts, complete with smoothing and starter switch; £20.—Box 34. (5497)

REPAIRS AND SERVICE MAINS transformer rewound and constructed to any specification; prompt delivery.—Brown, 3, Bede Burn Rd., Jarrow. (3460)

ACCURATE radio rewinds, mains transformers, fields, op. transformers, etc.—Southern Trade Services, 297-299, High St., Croydon. (5158)

LOUDSPEAKER repairs, British, American, any make; moderate prices.—Sinclair Speakers, 12, Pembroke St., London, N.1. Terminus 4355. (3308)

MAINS and output transformers rewound or to specification; speakers recomed.—H. Davies, A.M.I.P.R.E., 17, Church St., Cornhills Quay, nr. Chester. (5601)

TESTGEAR REPAIR SERVICE specialists in repairs, recalibration, etc, of test equipment of every description for the radio industry.—2, Tower Bridge Rd., London S.E.1. Tel. Ber. 1669. (4506)

ELECTRICAL measuring instruments skillfully repaired and recalibrated.—Electrical Instrument Repair Service, 329, Kilburn Lane, London, W.9. (5342)

TRANSFORMERS, mains units for special applications, bridges, meters, amplifiers, etc., designed, constructed.—Inquiries, J. F. Body, 22, Fabian Cres., Shirley, B'ham. (5680)

REWINDS and conversions to mains and output transformers, fields, etc. from 4/6 PP equipment a speciality.—N. L. Rewinds, 4 Brecknock Rd., N.7. Tel. Arnold 3390. (5185)

TRANSFORMERS rewound; fields from 4/6; chokes, pick-ups, etc.; all windings interleaved and impregnated; 48-hour service.—North-West Electrical, 36, Roslyn Hill, N.W.5. (5469)

"SERVICE with a Smile."—Repairers of all types of British and American receivers; coil rewinds; American valves, spares, line cord.—F.R.L., Ltd., 22, Howland St., W.1. Museum 5675. (1575)

STURDY rewinds, mains transformers, chokes and fields; we give prompt delivery and guarantee satisfaction; 14 years' experience; prices on request.—Sturdy Electric Co., Ltd., Dipton, Newcastle-on-Tyne. (4316)

TELEVISION and radio receiver serviced by certified engineers; Murphy and Pye, specialists; amplifiers rebuilt or repaired; sound repairs for 15 years.—T. E. Feyerher, F.I.P.R.E., 50, Vine St., Uxbridge. (5266)

REPAIRS to moving coil speaker, cones, coils fitted, field rewind or altered; speaker transformers, clock coils rewound, guaranteed satisfaction, prompt service.

I.S. REPAIR SERVICE, 49, Trinity Rd., Upper Tooting, London, S.W.17. (4819)

REWINDS mains transformers, speaker field coil-chokes, high-grade workmanship, 7-day delivery; new transformers constructed to customers' specification, singly or in quantities.—Metropolitan Radio Service Co., 1021, Finchley Rd., N.W.11. Speedwell 3000. (3719)

DEGALLIER'S, Ltd.—"Service with a guarantee." If you cannot get your receiver serviced, let American specialists with proper test gear do the job; first-class workmanship only; we specialise in Air-King, Belmont, Challenger, Emerson, Ferguson, Garod, Hallcrafters, Hammerlund, McMurdo, Midwest, Majestic, Pilot, Scott, etc., also any British set; send s.a.e with all enquiries.

DEGALLIER'S Ltd. 9, Westbourne Court, London, W.2 (5276)

THESE ARE IN STOCK

BASIC MATHEMATICS FOR RADIO STUDENTS, by F. M. Colebrook, 10s. 6d., postage 3d.

TESTING RADIO SETS, by J. H. Reyner, 15s., postage 4d.

TIME BASES (SCANNING GENERATORS), by O. S. Puckle, 16s., postage 4d.

THE CATHODE RAY OSCILLOGRAPH IN INDUSTRY, by W. Wilson, 18s., postage 6d.

THE SUPERHETERODYNE RECEIVER, by Alfred T. Writts, 6s., postage 4d.

RADIO RECEIVER CIRCUITS HANDBOOK, by E. M. Squire, 6s., postage 4d.

RADIO SERVICE TEST GEAR, by W. H. Cazaly, 6s., postage 3d.

FOUNDATIONS OF WIRELESS, by M. G. Scroggie, 7s. 6d., postage 4d.

RADIO CIRCUITS, by W. E. Miller, 3s. 6d., postage 3d.

NEWNES TELEVISION MANUAL, by F. J. Camm, 6s., postage 4d.

HIGH VACUUM TECHNIQUE, by J. Yarwood, 12s. 6d., postage 4d.

RADIO VALVE MANUAL, 3s. 6d., postage 2d.

WE HAVE THE FINEST STOCK OF RADIO BOOKS IN THE COUNTRY. WRITE OR CALL FOR COMPLETE LIST.

THE MODERN BOOK COMPANY (Dept. W.14), 19-23, PRAD STREET, LONDON, W.2

NON-MAGNETIC TURNTABLES

with STROMBOSCOPIC MARKING An essential accessory for serious PICK-UP DESIGN RESEARCH

SOUND SALES LIMITED West Street, Farnham, Surrey

BATTERY CHARGERS and TRICKLE CHARGERS

Trouble-free Chargers fitted with selenium all-metal rectification. Good allowance on your old Charger. Thirty years experience behind every Runbaken product. Booklet B.15 describing 12 Models, on request.

RUNBAKEN MANCHESTER 1



Be WISE and PATIENT

WE APOLOGISE to those who have been waiting

months for replies. Our post-war plans have been frustrated so far. Sorry!

VOIGT PATENTS LTD.

AMATEUR CHASSIS

The following are of aluminium; very light in weight, very rigid, very easy to work. Fitted with stout steel straps (plated) for extra rigidity, and tapped 2 B.A. for cabinet fixing. All undrilled, perfectly plain.

Owing to increased manufacturing costs we regret the following slight increases.

7 in. by 7 in. by 2 in. deep	4/-
5 1/2 in. by 9 1/2 in. by 2 in. deep	4/3
11 in. by 7 in. by 2 in. deep	5/-
17 in. by 10 in. by 2 in. deep	6/-
12 in. by 9 in. by 3 in. deep	6/6

Also midget radio type, 10 by 5 1/2 by 2 in., punched for 6 1/2 in. speaker and seven valves (or five valves and two IF transformers). 5/-

Any quantity available from stock, despatch at once. Packing and postage 1/- each extra.

WIRELESS SUPPLIES UNLIMITED 264-266 Old Christchurch Road, BOURNEMOUTH, HANTS.

RADIO CORNER

(Proprietor, T. B. WILLIAMS)

138 GRAY'S INN RD., LONDON, W.C.1
Terminus 7937

MAIL ORDER. Delivery by return. **THE BANNER CHARGER.** Type 1/1, 1 amp, ideal for Motorists, a really first-class job. Input 240 v. A.C. Output 2, 6 or 12 v. D.C., at £3. Designed for the motorist who likes to keep his batteries in tip-top condition.

RADIO VALVE MANUAL, giving American and British Valve Equivalents and Data. Price 3/6. Radio Constructors Manual. Price 3/-. Radio Tuner Unit Manual. Price 2/6. Engineers and Electricians Handbook. Price 1/-. Cathode Ray Oscilloscope Manual. Price 2/-. Radio Reference Book. Price 12/6.

American Radio Valves. Types as under at controlled prices. 45Z5GT, 5Y3G, 1A5GT, 1C5GT, 1Q5GT, 1T5GT, 80G, 35Z5, at 11/- each. 6J5GT, 12J5GT, 1H5GT, 12SF5GT, at 9/2 each. 6Q7GT, 12Q7GT, 12SQ7GT, 75G, at 11/7 each. 12SK7GT, 6K7GT, 6K6GT, 6V6GT, 42G, 43G, at 12/10 each. 6A7G, 6ABGT, 6K8GT, at 14/- each. Postage paid. Other types as they become available for distribution.

AMERICAN RADIO SERVICE MANUALS

- Volume 1. Spartan Emerson.
- II. Crosley Belmont. Part I.
- III. Crosley Belmont. Part II.
- V. Emerson. Part II.
- VI. Stewart Warren. FADA.

At 12/6 per Volume, or complete set of six manuals £3 12s. 6d. These Manuals cover the complete range of American Radio Receivers as given and are invaluable and contain all the technical data necessary.

Terms. Cash with Order only. We regret that we are unable to send goods C.O.D.

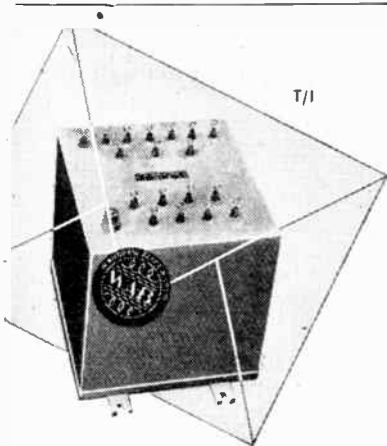

HERMETICALLY Sealed TRANSFORMERS

Designed during the war to meet Service requirements for a Transformer which would operate efficiently under extreme Tropical conditions. Sealed against humidity, termites and other pests. Now in production for general industrial use. Write for full particulars and specifications.

W. ANDREW BRYCE & CO. LTD.
Shenley Road, Boreham Wood, Herts
Telephone: ELStree 1875 & 1117.

LOUDSPEAKER repairs, any make, reasonable prices, prompt delivery, to the trade and quality fans; 25 years' combined experience with Rola, Magnavox, Goodmans, Celestion, Sound Service Radio, 80, Richmond Rd., Kingston-on-Thames, Kin. 8008. [4977]

24-HOUR service, 6 months' guarantee, any transformer rewind, mains outputs and i.f.s., etc. all types of new trans., etc., supplied to specification; business heading or service card for trade prices.—Majestic Winding Co., 180, Windham Rd., Bournemouth.

REWINDS, mains transformers, layer wound w.a.s. impregnated, O/P transformers, chokes, fields, clock coils, pick-ups, fractional hp motors, competitive prices; prompt delivery; guaranteed work.—W. Groves, Manufacturing Electrical Engineer, 154, Icknield Port Rd., Birmingham, 16. [4547]

TRANSFORMER rewinds, trans. replacement coils, machine layer wound on bakelite former, interleaved, impregnated and clearly marked; rewinds £1, standard windings to 70 watts, coils 15/6; extra secondaries and larger types pro rata; new transformers or chokes to specification singly or in quantity; trade list on application; delivery by return of post most types; state model and iron sizes when ordering coils, pick-up coils, O/P trans., field coils, etc., rewound or replaced; fully guaranteed.—Radio Services, Field St. Works, Blackpool. R.T.R.A. Service members, Ph. 1250. [5603]

WORK WANTED

WIRELESS cabinets made to order for export.—Leipsy, 71, Killick St., Kings Cross, N.1. [5203]

WE now have capacity available for wiring up assembly of small units.—Enquiries to R.M.H. Radio, Box 250. [5588]

WE are now in a position to give immediate attention to the manufacture of small quantities of radio and electronic equipment to our customers' design and specification.—Box 916. [5645]

CONSULTING electronic engineers with wide experience in both communication and non-communication electronic engineering are now able to undertake the design, development, work in these fields.—Box 444.

RADIO and television trade service.—Enquiries invited for prompt and efficient servicing of radio and television receivers of all types, we have the latest television test gear, full staff of skilled engineers, complete stocks of all spare parts, prompt service, all enquiries promptly dealt with.—Write, telephone or call Thorogood Radio, Ltd., 44-45, Tamworth Rd., W. Croydon, Croydon 741-23.

G. H. GARSIDE-TAYLOR, freelance radio engineer, now released from the R.A.F. has 10 years' pre-war servicing and 6 years as maintenance officer on radar; this experience is at the service of members of the trade requiring a maintenance or service representative in the Liverpool or Lancashire area.

COMPLETELY equipped with modern test gear, own car and comprehensive workshop facilities, capable of dealing with any problems.—65, Elmwood Rd., Liverpool, 17.

SITUATIONS VACANT

ALARGE London radio firm has vacancies on its development staff for:—**COMMUNICATION** engineer, possessing engineering degree or equivalent, and at least 5 years' experience in the design and production of communication type receivers and transmitters (including F.M. equipment).

SENIOR engineer, possessing engineering degree or equivalent, and at least 5 years' experience in the design of radar modulators, microwave transmitters, etc.

SENIOR engineer, possessing engineering degree or equivalent; at least 5 years' commercial experience in design of small transformers and similar components; knowledge of modern impregnation processes, tropical components, etc.

APPLICANTS should give fullest details of experience, academic and technical training, together with age, etc., to Box 876. [5660]

GREAT opportunity for high position for radio chief engineer.—Box 462. [5613]

TECHNICAL sales assistant with radio and electrical instrument experience; Slough district.—Write Box 247. [5585]

LAMINATION toolmakers wanted experience required; good rates.—E.S. & T.P., Ltd., 3, 4, Manor Way, Boreham Wood, Herts.

ENGINEER wanted for loud speaker production, must have experience.—Sinclair Speakers, 3, 4, Manor Way, Boreham Wood, Herts. [5607]

RADIO engineer required, skilled fault finder, television knowledge an advantage.—Apply Manager, Melody Shop, Colonnade, Maidenhead. [5728]

CHARGE hand required for radio and electrical assembly, live man; must be experienced modern methods component part and line assembly; good prospects; Warwick area.—Box 224. [5563]

EX-ARMY No. 58 Mk. 1 Self-contained 8-v. Short-Wave TRANS-RECEIVER

- 5-valve Superbet Receiver, 3-v. Transmitter.
- 2 V.C.
- Frequency range 6 mc/s to 9 mc/s (50 to 33.3 metres).
- Working range: 5 miles with 12ft. rod aerial.
- Panel Test Meter for check on batteries and various parts of circuit.
- Chassis suspended in case by rubber shock mounts.
- Three aerials in carrier (12ft. rod, 8ft. 6ins. Telescopic, 25ft. wire).

BARGAIN OFFER (less Vibrator) £7

As above but COMPLETE with set of 8 spare valves, spare Vibrator and Fuse, 2 Accumulators, 2 Differential type noise-cancelling Mikes, 2 pra. Headphones, 5,000 ohms, Connecting Cables, and

VIBRATOR POWER UNIT 21S

8-v. V.H.F. RECEIVERS

100-125 mc/s. Type 71. Complete with valves..... £45.00

TRANSMITTER for above. Complete with 7 valves..... £3.10.00

3-V. R.F. AMPLIFIERS V.H.F. 100-125 mc/s. Type 24. Complete with valves..... 35/-

EX-ARMY BATTERY'S VALVE MINE DETECTOR AMPLIFIER PANELS, size 5 1/2 in. x 8 1/2 in. (less Valves). Uses the latest type Baseless Midget Valves. Ideal for use as pre Amp. tone unit, etc. Components include 9 tubular condensers, resistors, 3 Ceramic Valve Holders, Midget Transformer, Volume Control and a heavy duty 12-way Connector strip. Bargain..... 15/-

FOR FULL TECHNICAL DATA

See Editorial Article July Issue

Ex-R.A.F. Type R1155

COMMUNICATION RECEIVERS

Comparatively new. These receivers are made to the stringent specification of the Air Ministry and are fitted with a large scale dial calibrated from 7.5 mc/s to 1,500 kc/s. Complete with 10 valves, including magic eye, they are fitted in a strong metal cabinet, and supplied in wood carrying case. They require only a power pack to be ready for immediate operation..... £15

TOGGLE SWITCHES, on-off, 1/8.

DPST TOGGLE SWITCHES, 2/8.

10-POINT DEWAR SWITCHES, 2/6.

LOUDSPEAKERS, 8in. P.M. with transformer, 32.6 3in. 3-ohm voice coil, less transformer, 27/6.

AC/DC MOTORS, 24-volt fractional H.P., 19/6.

.0005 mfd. CONDENSERS, single gang, 4/6.

MINIATURE VOLUME CONTROLS, Wire-wound, 6 ohms, 4/3.

INTERNATIONAL OCTAL VALVEHOLDERS, Paxolin, 6/6 doz.

MOVING COIL INSERTS. Can be used as Headphones, Midget Speakers, Speech Mikes or adapted for Pick-ups. Coil 30 ohms. In perfect order, 5/-.

CONDENSERS. 1 mfd. 400 v. w.kg., heavy stand-off insulated terminals, 2/- .02 mfd. 750 v. w.kg., 8d. ea., 6/6 doz. .1 mfd. 750 v. w.kg., 1,500 v. peak, metal case, 1/- ea., 9/- doz. .1 mfd. 350 v. w.kg., 1/- .1 mfd. 5,000 v. w.kg., 6/9. .025 mfd. 4,000, 500 v. w.kg., 5/-.

POTENTIOMETERS. 400 ohms, 2/3; 25,000 ohms, 2/3.

G.P.O. PLUGS AND JACKS, 3/- each.

H.V. ANODE CAPS, 6d.

PUSH BUTTON UNITS, less buttons, 4-way or 8-way, 2/6.

You are invited to call and see the stocks of R.A.F. gear we have for sale. It will pay you!

N.B. We do not issue lists and cannot deal with correspondence on the goods we offer.

LONDON CENTRAL RADIO STORES

Closed Thurs. 1 p.m. Open all day Sat.
23, LISLE STREET
LONDON GERard 2969 W.C.2.

L.R'S IN STOCK!

AVOMINOR TEST METERS
A.C./D.C. Universal £8. 10. 0
D.C. £4. 4. 0
Regd. Post 10d

CYLDON ELECTRIC DOOR CHIMES
Beautifully made. Far more pleasant than buzzer or bell. Front door push operates double chimes, back door only single. Universal model for battery, or mains with bell transformer (extra).
Postage 10d £2. 9. 6

R.A.F. Pocket Watch: (Govt. Surplus).
Brand new high grade Swiss 15-jewel movement in polished nickel case.
Regd. Post 10d. £4. 15. 0

List of Chimes 1d

ANY OF THE ABOVE SUPPLIED ON EASY TERMS

The LONDON RADIO SUPPLY Co.
(Est. 1925) BALCOMBE, SUSSEX

REWINDS

Armatures, Fields, Transformers, Pick-ups, Vacuum Cleaners, Gram. Motors, Speakers Refitted New Cones & Speech Coils.

All Guaranteed and promptly executed Valves, B.V.A. and American, good stocks. Send stamped addressed envelope for list of Radio Spares, and C.O.D. Service.

A.D.S. Co. 261-3-5, Lichfield Road, ASTON, BIRMINGHAM, 6

COVENTRY RADIO

COMPONENT SPECIALISTS SINCE 1925

READY NEXT MONTH

21st BIRTHDAY LIST

The most comprehensive published to-day, including circuit of our AC DC 5-valve Superhet. price 3d., post paid. May we reserve you a copy?

NO SURPLUS
NEW GOODS ONLY

COVENTRY RADIO
191, DUNSTABLE ROAD, LUTON

Why not let us Design, Develop and/or manufacture:

**THERMIONIC VALVES
DISCHARGE TUBES
CATHODE-RAY TUBES**

or other special Vacuum or Gas-filled devices you may require to suit your applications

PARK ROYAL SCIENTIFIC INSTRUMENTS LTD.,
52, Minerva Road, London, N.W.10.

Manufacturers of the "Pylon" Hearing Aid, and the valves which made it possible

DRAUGHTSMAN with experience in production drawing of radio apparatus; A.E.S.D. rates.—Applications in writing to Personnel Manager, E. K. Cole, Ltd., South-end-on-Sea, Essex. [5314]

LOUDSPEAKERS.—Engineer wanted to take full charge of production; send fullest particulars of experience.—E. S. & T.P., Ltd., 3 and 4, Manor Way, Boreham Wood, Herts.

MEASURING instrument mechanic for repair work, Midlands, must be first-class craftsman; opportunity partnership if desired; write in confidence for interview.—Box 920.

DRAUGHTSMAN required, with experience in design and detailing of radio equipment; A.E.S.D. rates.—Applications to be addressed to Draughtsman in Charge, E. K. Cole, Ltd., Malmesbury, Wilts. [5628]

DESIGNER-DRAUGHTSMAN required for work on test equipment and measuring instruments.—Write, giving full particulars of experience and salary required, to Taylor Electrical Instruments, Ltd., Slough, Bucks.

RADIO research and development engineers required by firm in S.E. London district with experience in design and development of commercial radio and television.—Write, stating qualifications and particulars of experience, Box 605. [5630]

VACANCIES exist for supervisors of the manufacture of pick-ups and AF amplifiers. Applicants should state details of education, practical experience and academic qualifications.—J. H. Brierley, Ltd., 46, Tithebarn St., Liverpool, 2. [5702]

EXPERIENCED radio designer, with up-to-date knowledge of handspread circuits, television, etc., required as assistant to chief designer, by prominent contract radio manufacturers.—Write, stating age, qualifications, past history, salary req., to Box 593.

WORKS manager required for firm manufacturing loudspeakers in North London area, excellent opportunity, with high remuneration; first-class man, with wide knowledge and experience of speaker production essential.—Apply, giving full details of age and experience, Box 908. [5673]

EXPERIENCED draughtsman required for development laboratory, accustomed to work on radio or electronic equipment.—Apply in writing, stating age, qualifications, and experience, to Personnel Manager, The Edison Swan Electric Co., Ltd., Ponders End, Enfield, Middx. [5622]

ELECTRICIAN engineer required in London area to control development of variety of electro-mechanical instruments, basic training in mechanical engineering and knowledge of electronics are essential. Applicants should state qualifications and experience in full and salary required.—Box 1030. [5700]

DRAUGHTSMAN-DESIGNER required; good opportunities for man who has original ideas and experience in design for mass production to combine the two in the design of household and radio equipment in London area.—Applicants should write, stating age, experience, and salary required, Box 405.

ENGINEERS.—Vacancies exist in the new works of Wright & Weaire, Ltd., at South Shields, for engineers, engineers-in-charge of component design and development. Applications are invited, preferably having had laboratory experience in the past.—Simonside Works, South Shields, Co. Durham.

SERVICE and constructional engineer wanted by radio and electrical firm in S.E. London, preferably interested in amateur radio, and ex-Service man; salary and commission; possibility of living accommodation available to suitable applicant.—Apply in first instance to Box 1032. [5698]

MANUFACTURERS and distributors of electrical appliances and radio equipment require an export manager; only those with necessary qualifications need apply, giving full details of past experience; salary £10 per week, plus bonus and commission; it is essential that the applicant has a good connection overseas.—Box 249. [5586]

RADIO engineers required by West Middlesex radio firm, must be experienced in the design and development of radio receivers, oscillators and filters for R.F. and V.H.F.; knowledge of the design of R.F. test gear is desirable, including oscillographs, B.F. oscillators, signal generators, valve voltmeters, etc.; inclusive salary £390 per annum; 41-hour week.—Write, stating age and details of experience, to Box 402. [5595]

REQUIRED by large light electrical and radio manufacturing concern in S.W. London area, first-class progress chasers, males; if possible should have progress experience dealing with a large number of small parts, should be conversant with progress charts and schedules, and mass production factory routine.—Reply, giving full details of experience and stating salary required, to Box No. 862, L.P.E., 110 St. Martin's Lane, W.C. 2

WARD ROTARY CONVERTERS

For Radio, Neon Signs, Television, Fluorescent Lighting, X-ray, Cinema Equipment and innumerable other applications

We also manufacture:—

Petrol Electric Generating Plants, H.T. Generators, D.C. Motors, Frequency Changers, etc., up to 25 K.V.A.

CHAS. F. WARD

37 WHITE POST LANE, HACKNEY WICK, E.9
Phone: Amherst 1393

TRANSFORMERS & CHOKES

To Special requirements 14 days
High Quality Vacuum Impregnated

AUSTIN MILLS LTD.
LOWER CARRS STOCKPORT

Telephone: STO. 3791 Established 20 years.

TRANSFORMERS & COILS TO SPECIFICATION.

MANUFACTURED OR REWOUND.

STANLEY CATTELL LTD.
9-11, East Street, TORQUAY, Devon

Phone: Torquay 2162.

PUBLICATIONS FOR SERVICEMEN

- AMERICAN MIDGETS HANDBOOK 2/8
- VALVE EQUIVALENTS CHARTS with quick ref. index 1/7
- ESSENTIAL VALVE DATA giving base data and diagrams of all valves listed in our valve equivalents charts 2/7
- RUNNING A RADIO REPAIR BUSINESS, with notes on starting, and including lists of valves and essential stock 7/6

V.E.S., Radio House, Ruislip, Middx.

MIDLAND INSTRUMENT CO.

For LEWCOS instrument wires, enamelled Lewnex enam s.s.c., d.c.c., Eureka wires, etc. Avo and Ever-shed equipment, S.T.C. L.T. rectifiers, Woden transformers, small asynchronous motors, L.T. motors, coils, cond. flexes, cables and electrical fittings, headphones and microphones, chargers and hundreds of other interesting Radio and Electronic items. Lists 2d. with s.a.e. Trade supplied.

18 HARBORNE PARK ROAD, BIRMINGHAM, 17
Tel.: HARborne 1308 or 2664

MATRICULATION
brings Success & Security

Whatever your age, you can now study for the all-important Matriculation Examination at home on "NO PASS—NO FEE" terms. "MATIC" is the accepted passport to all careers, and opens up opportunities which would otherwise be completely closed to you. Ensure the success and security of you and yours through post war difficulties by writing for our valuable "Guide to Matriculation" immediately—FREE

B.T.H. (Dept. 114)

356, Oxford Street, London, W.1.

RESPONSIBLE man required (B.Sc. Physics or H.N.C.), aged over 25 years, to run small mechanical and electrical testing section (5 assistants), in laboratory of radio firm in S.W. London area.—Write, with full details of previous experience, qualifications, and salary required, to Box No. 832, I.P.E., 110, St. Martin's Lane, W.C.2. [5598]

MECHANICAL designer-draftsman required, with knowledge of light electro-mechanical assemblies and vacuum cleaner design to start and develop new section for progressive manufacturer of radio and domestic appliances in London area; good prospects.—Write, giving full particulars of training, experience, age and salary reqd, Box 8700.

DRUGHTSMEN and traders required for S. London, with experience in prod. of working drawings from data supplied by designers; (1) mech. draughting; (2) elect. preferably with exp. on radio comm. equipment; workshop experience preferred.—Apply in writing, with full details, to R.T.E., Ltd., 45, Nightingale Lane, S.W.12. [5538]

SITUATIONS WANTED

EX-ARMY Sgt., 3 years civil servicing experience, 6 years' radar, seeks progressive position.—Box 557. [5619]

EX-SIGS. officer, with 7 yrs' service & 6 yrs' pre-war experience, specialist in amplifier design & recording, seeks post.—Box 186.

RADIO service engineer, 18 years' radio and television experience, requires progressive position, Southern Counties.—Box 188. [5545]

EX R.E.M. telecomm., 6 yrs. single, 29 yrs. pre-war exp., seeks progressive position; will work abroad if required.—Box 937. [5681]

SERVICE engineer seeks change, 15 years' exp., retail and renting procedure, own car and gear; 4 1/2 hrs. London area pref.—Box 935.

COMMUNICATIONS engineer, 35, desires progressive position, 4 yrs. American cable radio system, 8 yrs. B.B.C., 2 yrs. R. Signals.—Box 1031. [5699]

SERVICE engineer, release Aug., 7 yrs' experience R.A.F. and civilian servicing, pre-war training, drive, seeks progressive position, any area.—Box 663. [5633]

YOUNG man seeks position as sales representative to radio or electrical manufacturers, 5 1/2 years' radar mech., 4 years' commercial experience.—Box 875. [5655]

EX-R.A.F. Sgt., 5 1/2 years' radar, 2 years' instructor, 5 1/2 years' pre-war radio servicing and development P.A., desires progressive post; exceptional references.—Box 1108. [5753]

EX-CAPT. R. Signals, B.A. Cambridge, age 26, requires progressive post in radio, television or communication engineering.—Kirby 31, Goldsmith Avenue, Acton, W.3.

EX-CPL. wireless mechanic, age 25, 5 years' R.A.F., 12 months' servicing prior to call-up, seeks progressive post, preferably research or experimental; London area or Home Counties.—Box 911. [5670]

RA.F. signals officer (ex-W/O), 10 years' R.A.F., including 3 years' apprenticeship as wireless and electrical mechanic, desires progressive post radio industry, age 26; available immediately.—Box 228. [5567]

CTD. I.E.E., R.A.F. wireless mechanic, Sgt., 24, married, awaiting results C. & G., radio comm. inter. and tech. elec. final, seeks progressive position in radio trade; available this month.—Box 406. [5559]

GRADUATED radio engineer, with 15 years' experience in research work (specialised in designing of electronic measurements apparatus), desires suitable position; references if required.—Box 684. [5639]

A. M.Brit. I.R.E., 31, & G. Final Radio Communication, telegraph, technical electricity, 12 years' experience radio, 2 years' supervisory capacity, desires better position; salary £700 or over.—Box 243. [5581]

RADIO technician (age 38), 15 years well-known component manufacturers, test, development, tech. correspondence, C. & G. Radio Comm., some teaching exp.; requires post, research, experimental or tech. sales.—Box 919. [5650]

EX-CHIEF Radio Officer, Merchant Navy, City and Guilds radio communication, Grades I, II and III, 2nd class P.M.G., studying Gram. Brit. I.R.E., wide experience communication equipment, some servicing; will consider any progressive post, radio industry; London area.—Box 913. [5641]

RADIO man, born enthusiast, trade repair, test and sales experience, would like to contact other radio engineer or firm with view to employment; only interested in man or firm working on sound radio engineering lines where quality of work, & real service, are the first consideration; country area pref., not afraid of turning a hand to any job for the good of the business; own car; fluent French; might ultimately help financially.—Box 185.

ARMSTRONG

Model EXP53

ALL-WAVE 7-STAGE RADIOGRAM CHASSIS

This new radiogram chassis incorporates wave-band expansion on all bands, e.g., the 16-50 m. band covers just over 20 inches on the large glass scale. Volume and tone controls work on both Radio and Gram. 4 1/2 watts R.C. coupled output. **Supplied complete with full size loudspeaker.** This chassis has a lively performance, good quality reproduction, and represents excellent value. For 200-250 v. A.C. Mains.

★ A very limited number of the Home Market Model is available for immediate delivery.

Price, with speaker **£13 plus tax.**

Model EXP83

ALL-WAVE 8-VALVE SUPERHET CHASSIS

incorporating wave band expansion. Large glass scale treble boost control. Gram. switching. High quality push-pull output gives 10 watts audio. For 100-250 v. A.C. mains.

Price **14 gns. plus tax.**

Model EXP43

ALL-WAVE SUPERHET FEEDER UNIT

incorporating wave band expansion manual I.F. gain control, etc.

Price **11 gns. plus tax.**

Model EXP63

ALL-WAVE 6-VALVE SUPERHET CHASSIS

incorporating wave band expansion. Gram. switching. R.C. coupled output. For 100-250 v. A.C. or D.C. mains.

Price **12 gns. plus tax.**

Model AMP14

HIGH GRADE AMPLIFIER in well finished metal instrument case. Two inputs, bass compensating circuit, treble boost control, 14 watts push-pull output preceded by 4 triodes.

Price **15 gns.**

ARMSTRONG WIRELESS & TELEVISION CO. LTD
WALTERS ROAD, HOLLOWAY, LONDON, N.7

Phone: NORth 3213



W. BRYAN SAVAGE LTD.

Expert assistance in the solution of problems relating to

- TRANSFORMERS, CHOKES
- AMPLIFIERS
- POWER UNITS

and Specialised Equipment embodying

ELECTRONIC CONTROL

WESTMORELAND RD., N.W.9
COLINDALE 7131

TELECOM. tester and service engineer, 31, wide experience of carrier telephony and telegraphy, good knowledge radio, B.I.R.E. graduateship student; own car; present firm 10 years; anywhere Brit. Isles.—Box 184.

EX-R.A.F. Sgt. W.O.M. Instr., 5 years' exp. high fidelity audio, hf and vhf ground Tx's, maint. and constn. of domestic and comm. Tx's, electrics and test equip. incl. C.R.T.s, age 26, desires progressive post radio, electronics or electro-medical; any good opport., but research, experimental or development pref.; ambitious, adaptable, inventive; diligent worker and student.—Box 635.

FINANCIAL PARTNERSHIP

TELEVISION engineer desires financial interest in well-established radio business.—Box 914. [5643]

BUSINESSES FOR SALE OR WANTED

RADIO, electrical repairs, busy area, well equipped, takings £20 p.w., expert staff employed, modern accommodation; £6,300, inc. stock, freehold and car.—John Swait, Ltd., 34, Mall, Ealing 2866. [5627]

RADIO business, North London, main road; good living accommodation, suit two families; nice shop and basement workshop; rental £100; active business; price £650 a.a.—Full details from Jassoy & Hayes, 479, Green Lanes, N.13. (Palmer's Green 4123.)

AGENCIES

FASCO ELECTRICAL

MANUFACTURERS of battery chargers, office communicator and P.A. equipment, amplifying units, etc., etc., desire active sales representation, full time or agency, for the following:—

- (1) NORTH and South Wales.
 - (2) SCOTLAND and Border Counties.
 - (3) IRELAND to 6-8, Brighton Terrace, S.W.9.
- R**ADIO manufacturers specialists in high quality radio chassis, amplifiers, and transformers, cordially invite applications for agencies from bona fide radio dealers; export enquiries are specially welcome.—Box 7983.

WELL-KNOWN radio component makers, with speculative lines, wish to contact progressive retailers outside London area having established clientele amongst enthusiastic constructors and "hams".—Write Box 165, Phillips Advertising, Ltd., 155, Wilton Rd., London, S.W.1. [5526]

TECHNICAL TRAINING

A. M.I.E.E., City and Guilds, etc., on "No pass—no fee" terms; over 90% successes. For full details of modern courses in all branches of electrical technology send for our 112-page handbook, free, post-free.—B.I.E.T. (Dept. 388A), 17, Stratford Place, W.1. [3838]

RADIO Engineering, Television and Wireless Telegraphy, comprehensive postal courses of instruction—Apply British School of Telegraphy, Ltd., 179, Clapham Rd., London, S.W.9 (Estd. 1906). Also instruction at school in wireless for H.M. Merchant Navy and R.A.F. [9249]

RADIO BATTERY TESTER

Use "Quixo" method of battery testing.

Reliable results. Guaranteed.

Send for interesting leaflet R115 on battery testing.



RUNBAKEN • MANCHESTER

THE NORTHERN POLYTECHNIC, HOLLOWAY ROAD, N.7.

Principal: T. J. DRAKELEY, D.Sc., Ph.D., F.R.I.C., F.I.R.I.

Department of Radio and Musical Instrument Technology.

Head of Department: S. A. Hurren, M.C., M.Brit.I.R.E.

Full-time Day Courses in RADIO TECHNOLOGY

in preparation for all recognised qualifications in this subject. Practical laboratory and workshop experience provided.

Prospectus free on application to Secretary New Term begins September 23rd

Printed in Great Britain for the Publishers, LIME AND SONS LTD., Dorset House, Stamford Street, London, S.E.1, by THE CORNWALL PRESS LTD., Paris Garden, Stamford Street, London, S.E.1. "Wireless World" can be obtained abroad from the following—AUSTRALIA and NEW ZEALAND: Gordon & Gotch, Ltd. INDIA: A. H. Wheeler & Co. CANADA: Imperial News Co.; Gordon & Gotch, Ltd. SOUTH AFRICA: Central News Agency, Ltd.; William Dawson & Sons (S.A.), Ltd. UNITED STATES: The International News Co.



Photo-Electric Cells



Manufacturers of over forty different types of Photo-electric cells from standard ranges to "miniatures" and "specials" designed to meet all requirements in industry and the laboratory, with characteristics and physical dimensions over the widest possible range.

- Multiplier cells for amplification of the primary photo current.
- Geiger Muller tubes for Cosmic Ray research and other applications.
- Quartz cells for use with ultra violet radiation.
- Nitrogen Helium Discharge Lamps.

New Brochure and price list now available on application.

CINEMA - TELEVISION LTD.,
 INCORPORATING BAIRD TELEVISION LIMITED
 WORSLEY BRIDGE RD., LONDON, S.E.26
 Telephone: Hither Green 4600

Suppliers to ADMIRALTY, MINISTRY OF AIRCRAFT PRODUCTION, MINISTRY OF SUPPLY, ARMAMENT RESEARCH, etc. Manufacturers of Scientific Instruments and Photo-electric cells.

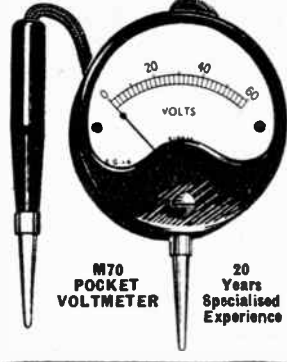

**M70
POCKET
VOLTMETER**

20
Years
Specialised
Experience

POCKET PRECISION

MODERN ROBUST
CONSTRUCTION AND
CONSTANT ACCURACY
UNDER ALL CONDITIONS

SIFAM

**ELECTRICAL INSTRUMENT
COMPANY LIMITED**
 TORQUAY • DEVON

METAL ! WORK !

(FOR THE
RADIO
TRADE)

PRECISION BUILT
CABINETS & CHASSIS
BY
CHASE PRODUCTS
(ENGINEERING) LTD.
27 PACKINGTON RD., LONDON, W.3

ERG'S HAVE THE URGE TO GO ABROAD

**SPEAKING
EXPORTLY...**

ERG Resistors have an exceptional electrical specification and performance, with mechanical strength.

High-grade Vitreous Enamels used on our Tropical Resistors give long life, and definitely assist in the trouble-free manufacture and performance of Radio Receivers, Television and Test Equipment.

ERG Resistors are processed up to the highest Service Standards at a competitive Price.

ERG INDUSTRIAL CORPORATION LTD.
 SALES OFFICE: 10 PORTMAN SQUARE,
 LONDON, W.1. TELE.: WELBECK 3892



Use **Varley** TRADE MARK

**PUSH PULL TRANSFORMERS
L.F. CHOKES
THERMAL DELAY SWITCHES
POWER POTENTIOMETERS**

*to obtain high fidelity
reproduction from your AMPLIFIER*

OLIVER PELL CONTROL LTD
 CAMBRIDGE RDW • WOODWICH • S.E.18
 TELEPHONE: WOOLWICH • 1422/6

Remember- Walter

RADIO
STAMPINGS

RADIO
CHASSIS

RADIO
PRESSINGS

FARM LANE, FULHAM, S.W.6. TELEPHONE: FULHAM 5234

C.R.C.4

BRITISH PHYSICAL LABORATORIES

17 RANGE UNIVERSAL TEST SET

1,000 ohms per volt on A.C. and D.C. ranges. Toughened glass. Size 5 7/8" x 4 1/2" x 2 3/8". Ranges A.C. and D.C. volts 0/10, 0/50, 0/100, 0/500, 0/1,000. D.C. milliamps 0/1, 0/10, 0/100, 0/500. Resistance Ranges 0/1,000 and 0/100,000 ohms. Accuracy 2%. Rotary Range Selector.

Price **£8 17s. 6d.**

If unable to obtain this high grade instrument from your dealer, apply to U.K. Trade Distributors:—

RADIO AGENCIES LIMITED,
 157, WARDOUR STREET, W.1. Phone: GERRARD 4456

TCC CONDENSERS

Only the short-sighted manufacturer gets any satisfaction from sitting back and saying "Our delivery is blanket blank weeks!" We certainly don't feel that way at T.C.C. where, in more normal times, most things were available from stock and deliveries commenced—even of elaborate special types—in 14 days or so. We are not back to that position yet (nor are our suppliers) but there is a

Improved Deliveries!

glimmer of light here and there. The "tightest" item is ELECTROLYTICS but production is increasing each week and large allocations are going out to all sections of the trade. MICA condensers are in a good position and most sizes can now be supplied Ex Stock. PAPER CONDENSERS too are doing nicely thanks! as is shown by the following tables of lines available FROM STOCK

Tropicalised PAPER BLOCK CONDENSERS
(Hermetically sealed in Metal Containers and fitted with moulded terminals.)

Capacity Mfds.	Wkg. Voltage D.C.	Type No.	List Price each.	Capacity Mfds.	Wkg. Voltage D.C.	Type No.	List Price each.
0.1	350	62	4/-	0.5	750	92	5/6
0.25	350	62	4/6	1.0	750	92	6/6
0.5	350	62	4/9	2.0	1,000	111	11/-
1.0	350	62	5/6	0.25	1,000	111	5/9
2.0	500	82	6/9	0.5	1,500	121 B	6/9
0.1	500	82	4/3	0.05	1,500	121 B	5/3
0.25	500	82	6/-	0.1	1,500	121 B	7/-
0.5	500	82	7/6	0.25	2,000	131	7/-
1.0	500	82	13/-	0.1	2,000	131	8/9
2.0	500	82	22/-	0.25	2,000	131	13/6
4.0	500	82	27/-	0.5	4,000	171 A	30/-
8.0	500						
10.0	500						



Tropicalised PAPER TUBULAR CONDENSERS
(Hermetically sealed in Metal Tubes with end wire connections.)

Capacity Mfds.	Wkg. Voltage D.C.	Type No.	List Price each.	Capacity Mfds.	Wkg. Voltage D.C.	Type No.	List Price each.
0.1	350	CP.45.N	2/1	0.25	500	CP.47.5	2/10
0.25	350	CP.48.N	2/8	0.5	500	CP.90.5	3/10
0.5	350	CP.47.N	3/-	0.02	750	CP.45.U	1/10
1.0	500	CP.91.N	4/-	0.005	1,000	CP.45.W	1/10
0.05	500	CP.45.S	2/1	0.01	1,000	CP.45.W	1/10
0.1	500	CP.46.S	2/2	0.1	1,000	CP.47.W	2/6

TELEVISION REPLACEMENTS
We are giving priority to condensers required for the above purpose. Quick delivery can be given of the T.C.C. "CATHODRAY" Condenser—0.1 Mfd., 6,000 v., D.C. working. List price 15/-

Please order through your usual factors, but in case of difficulty, communicate with us direct.

Remember these are new components direct from the source of manufacture; they are fully guaranteed—with none of the "ifs and buts" of surplus "bargains."

THE TELEGRAPH CONDENSER CO. LTD.

RADIO DIVISION

NORTH ACTON · LONDON · W. 3 TELEPHONE: ACORN 0061

KING OF THE SET

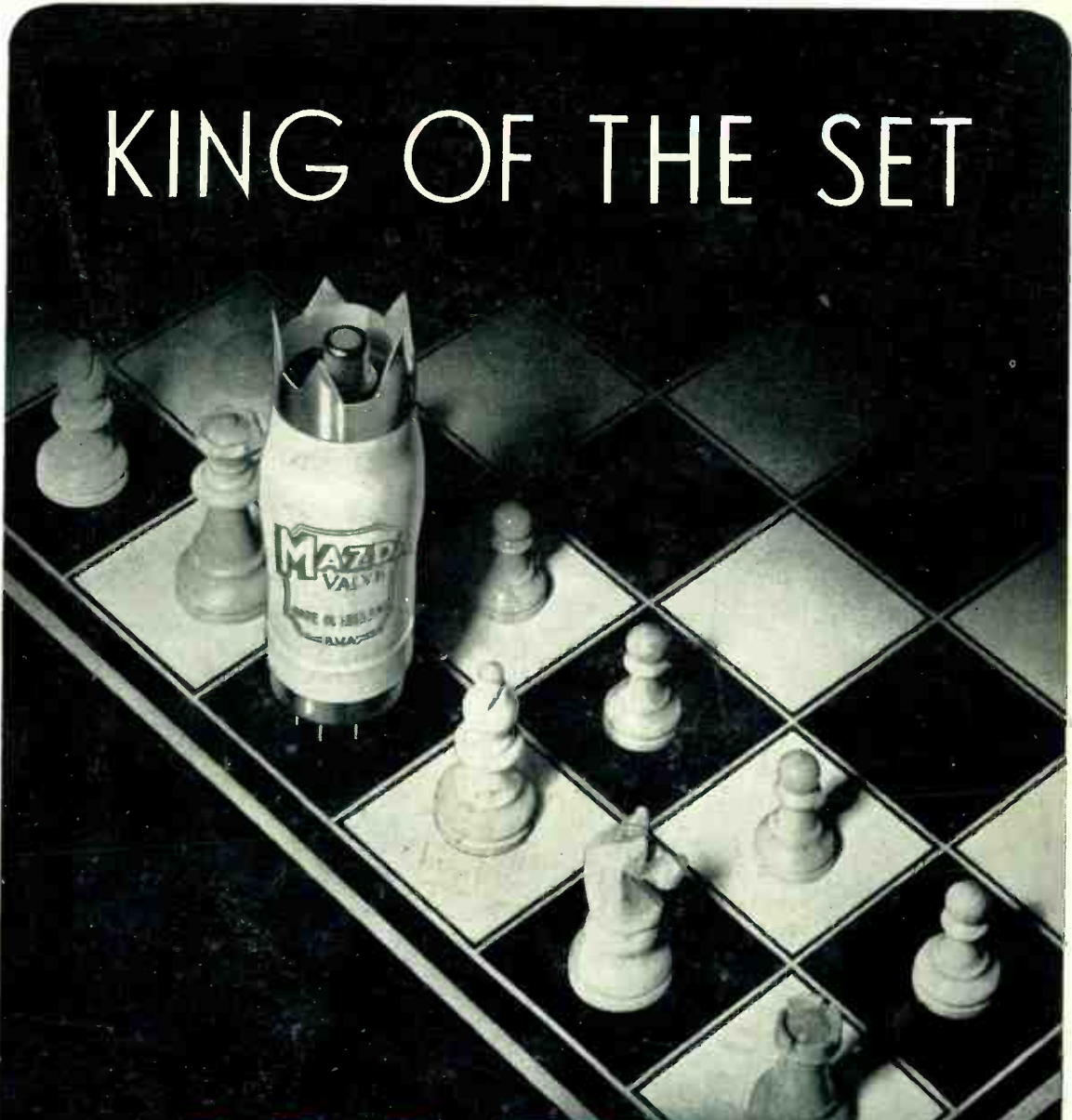

MAZDA

RADIO VALVES AND CATHODE RAY TUBES

THE EDISON SWAN ELECTRIC CO. LTD.  155 CHARING CROSS RD., LONDON W.C.2
(R.M. 42)

00