

Wireless World

RADIO AND ELECTRONICS

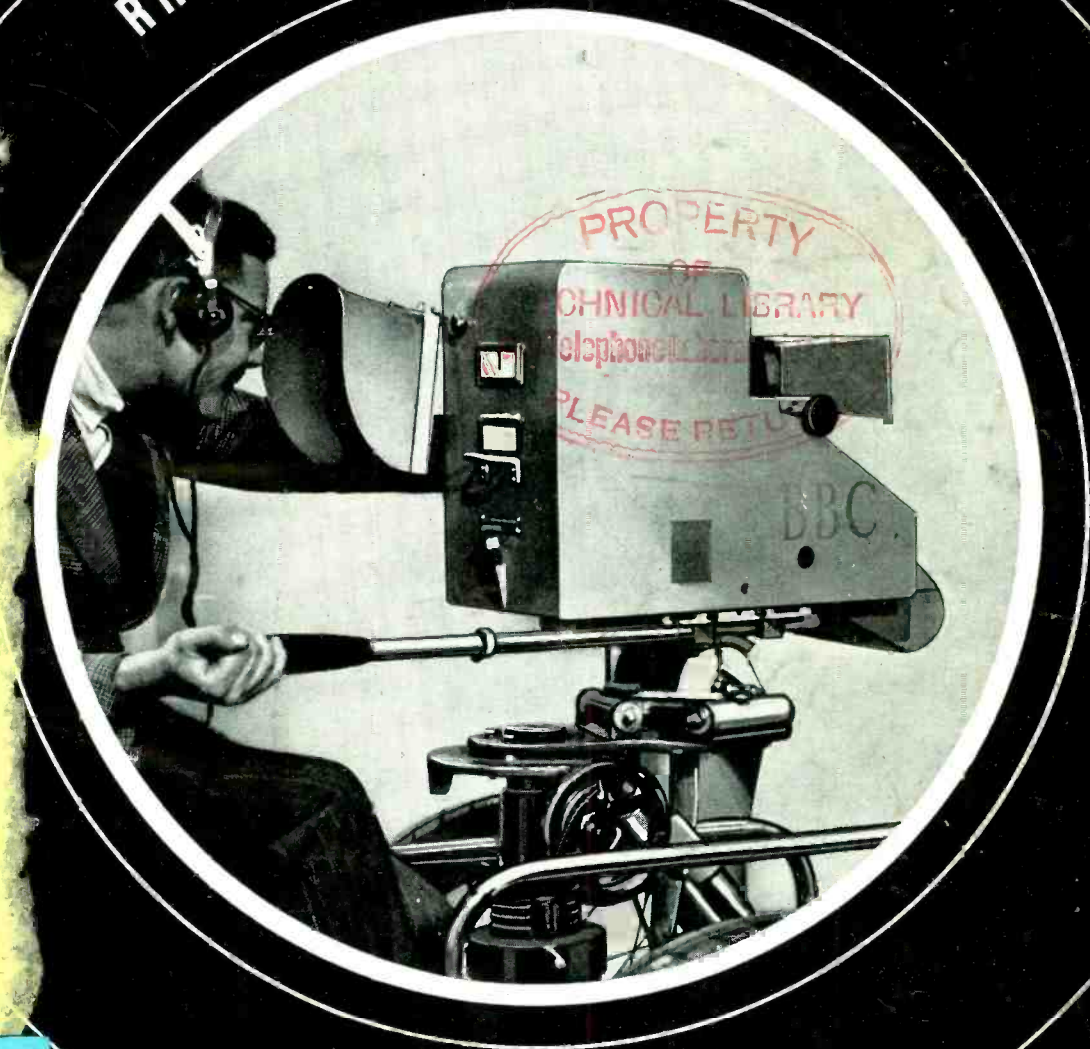

IF UNABLE TO
PLEASE RETURN

JULY 1946

1/6

Vol. LII. No. 7

IN THIS
ISSUE:

MAGNETIC DEFLECTION IN TELEVISION

RUBBER-TO-METAL BONDING

The Problem of Insulating delicate instrument panels from vibration and shock by means of Flexilant Mountings

"FLEXILANT" Mountings : Examples from the SERIES.

The "Flexilant" Mounting of which several varieties are illustrated here is so accurately made that its displacement under load can be calculated to within .010" of requirements. The series is designed to carry loads of from 1 to 45 lbs. per mounting and these may be arranged with bolt axis at 90° to position, or the complete mounting may be inverted. The mountings can be supplied with or without holder and they can be arranged so that two utilize the same bolt.

We should appreciate the opportunity of helping with your vibration problems.

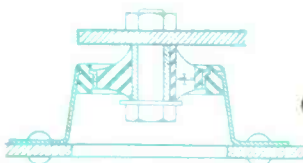

RUBBER BONDERS Ltd.
Engineers in Rubber bonded to metal

FLEXILANT WORKS · WATLING STREET · DUNSTABLE, BEDS.

TELEPHONE DUNSTABLE 715

TELEGRAMS: FLEXILANT, DUNSTABLE

A Short Review of FLEXILANT Products is available on enquiry



R. B. 12

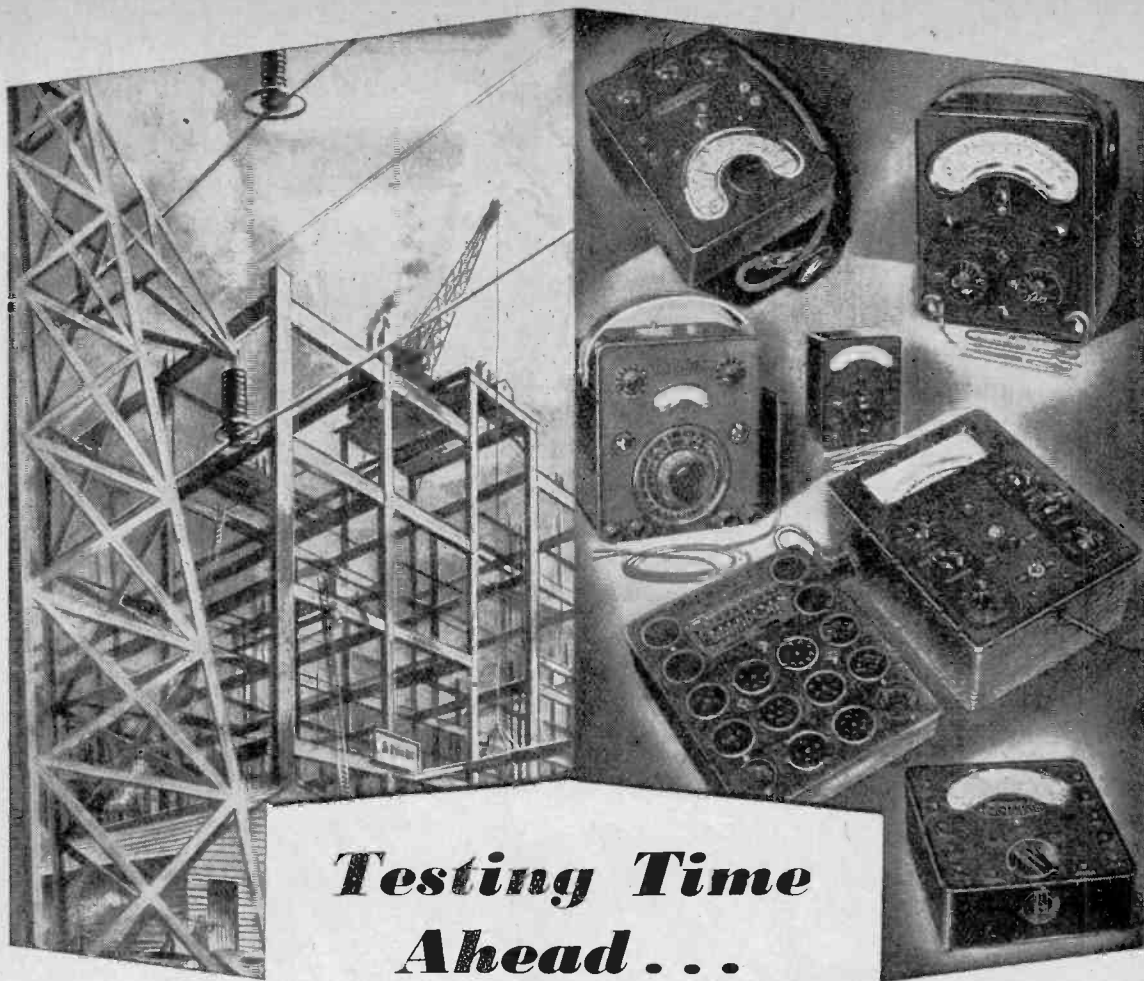

Testing Time Ahead . . .

RECONSTRUCTION, as we now know too well, means something other than enjoyment of the non-existent fruits of victory. The amenities of a world at well-earned peace are not for us until we have replaced the ravages of war with the necessities of life and the realities of universal peaceful intent for victors, victims and vanquished alike.

That is speaking collectively . . . For ourselves, we learned much and progressed far in the six years of ceaseless toil, urged on by dire necessity and peril. We are not resting now. We are still pressing on, pressing into the service of those engaged in rebuilding the body and soul of a whole world the knowledge gained, the advancements

perfected, the skill and craftsmanship that outmatched the efforts of our enemies.



Regd. Trade Mark

PRECISION ELECTRICAL MEASURING INSTRUMENTS

Sole Proprietors and Manufacturers :

THE AUTOMATIC COIL WINDER & ELECTRICAL EQUIPMENT CO. LTD., Winder House, Douglas Street, London, S. W. 1.

*Phone : VICTORIA 3404/5

"Avo" Electrical Testing Instruments set a standard by which other instruments are judged.

- THE UNIVERSAL AVOMETER
- THE "AVO" ALL-WAVE OSCILLATOR
- THE "AVO" VALVE TESTER
- THE "AVO" TEST BRIDGE
- THE UNIVERSAL AVOMINOR
- THE D.C. AVOMINOR
- THE "AVO" LIGHT METER
- THE "AVO" EXPOSURE METER
- Etc., Etc.

Catalogues on application.

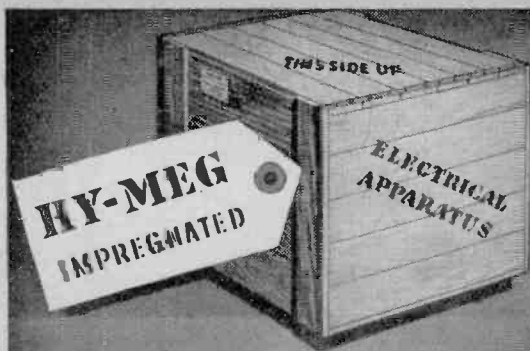

Your products, too, can be assured of a longer life under all working conditions . . .

USE **HY-MEG** THE MODERN
TIME-SAVING IMPREGNATING MEDIUM

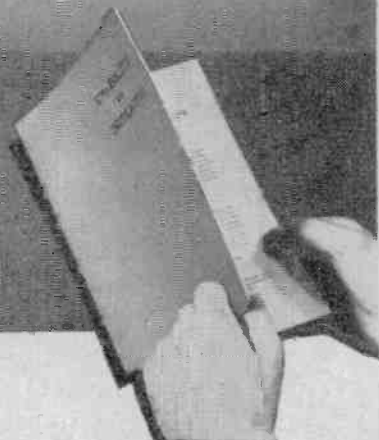

Executives in charge of the production of electrical apparatus calling for impregnation, should send for the HY-MEG Booklet "Stability in Insulation". It describes fully how HY-MEG scientifically overcomes problems arising both in production and operation. Apply on Business Heading or Card and enclose 2d. to comply with the Control of Paper Orders.

LEWIS BERGER & SONS LTD., (Established 1760) 35 BERKELEY SQUARE, LONDON, W.1
Telephone: MAYfair 9171

MANUFACTURERS OF INSULATING VARNISHES AND ENAMELS

VARNISHED ART SILK
0.5 TO 10 M.M.

VARNISHED COTTON
0.5 TO 35 M.M. TO A.M. SPECFN.

ROLLED SILK
0.5 TO 10 M.M. TO A.M. SPECFN.

DELAFLEX SLEEVINGS

DELAFLEX CAN ALSO BE SUPPLIED WITH METAL SCREENING IF DESIRED

De La Rue Insulation Limited
IMPERIAL HOUSE • 84 REGENT STREET • LONDON W1 • TEL REGENT 2901

For Peak Performance

with High Voltages

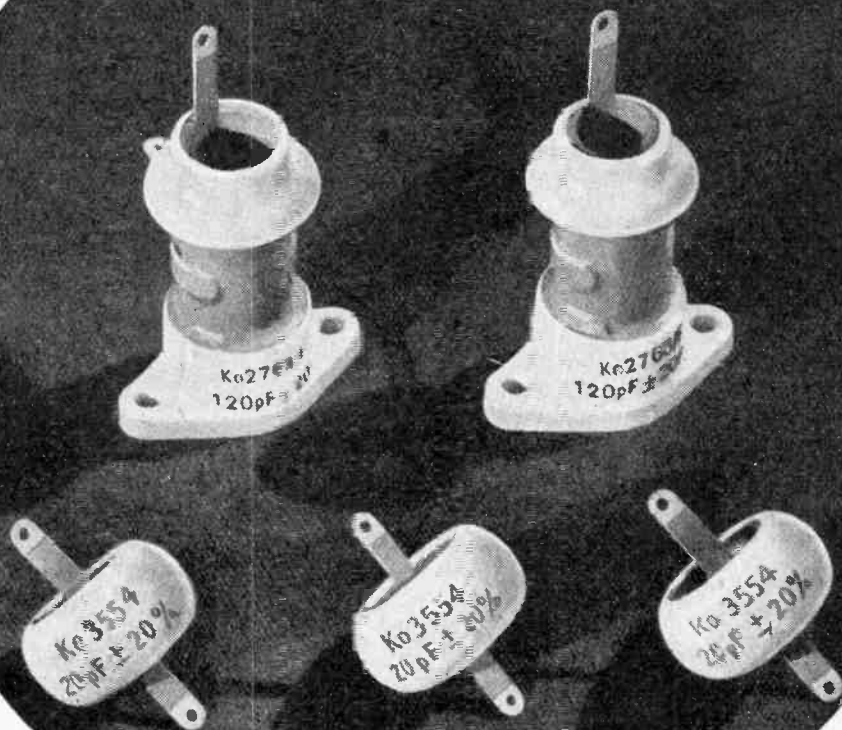

U.I.C. Fixed Ceramic Pot and Plate Capacitors have been primarily developed for use in transmitter circuits. Made only from the highest grade raw materials and subjected to the most rigorous mechanical and electrical inspection, their performance especially with H.F. loads and high voltages is unsurpassed. TYPE APPROVED. Full details on request.

UNITED INSULATOR CO. LTD.

Oakcroft Rd., Tolworth, Surbiton, Surrey.

Tel : ELMbridge 5241 (6 lines) Grams : Calanel, Surbiton



CERAMIC
High-Voltage
CAPACITORS

THE PIONEERS OF LOW-LOSS CERAMICS

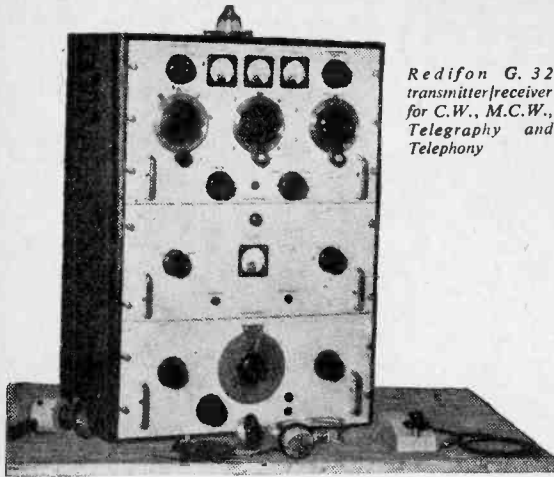

Redifon G. 32 transmitter/receiver for C.W., M.C.W., Telegraphy and Telephony

REDIFON G.32

A General Purpose Communications Transmitter/Receiver

THIS compact, portable transmitter/receiver has been specially designed and manufactured by Rediffusion Ltd. to fulfil the wide demand for this type of instrument in Colonial, trawler, police, geographical research, and harbour communications using C.W., M.C.W., Telegraphy and Telephony.

The transmitter covers 4 to 16 m/cs. (75 to 18.75 metres) in two bands, employing an electron-coupled oscillator operating as an oscillator frequency doubler. The receiver, a very sensitive set with a crystal gate, three I.F. bandwidths, beat frequency oscillator and other features, covers from 150 k/cs to 20 m/cs. (15 to 2,000 metres). Power can be taken from 24 volt accumulator batteries or 180-250v. 50 cycle, single phase A.C. mains, through alternative power units.

The transmitter/receiver unit is contained in a single robust steel housing, finished to service tropical specifications, 28 inches high by 21 inches wide and 12 inches deep. The net weight of this unit is 130 lbs.

This transmitter/receiver is available for almost immediate delivery. Further particulars can be supplied on request.

REDIFFUSION Ltd.

Designers and Manufacturers of Radio Communication and Industrial Electronic Equipment

SUBSIDIARY OF BROADCAST RELAY SERVICE LIMITED

CARLTON HOUSE, REGENT ST., LONDON, S.W.1

A red letter day IN THE HISTORY OF The Radio Industry



on this date as frequently announced

Rola-CELESTION

finally join forces in the interest of greater Speaker Production for the Radio Industry

BRITISH ROLA LTD., Georgian House, Bury St., St. James's, S.W.1. Factories: Thames Ditton & Devises.

CELESTION LTD., Kingston-upon-Thames, Surrey. CR3



No Hint of Doubt

D.C. Counter and Service Tester. 3½" Diam. Moving Coil meter. Long Scale First Grade Accuracy. Ranges: 100 mV, 2, 6, 60, 120 and 300 V.D.C. 1, 6, 60, 600 mA, 6 A.D.C. 50,000 Ohms, 2,000 in centre.

PRICE: £5 0 0 list plus 20%.

with SIFAM

20 YEARS SPECIALISED EXPERIENCE

ELECTRICAL INSTRUMENT CO., LTD., TORQUAY

POINTERS FOR DESIGNERS

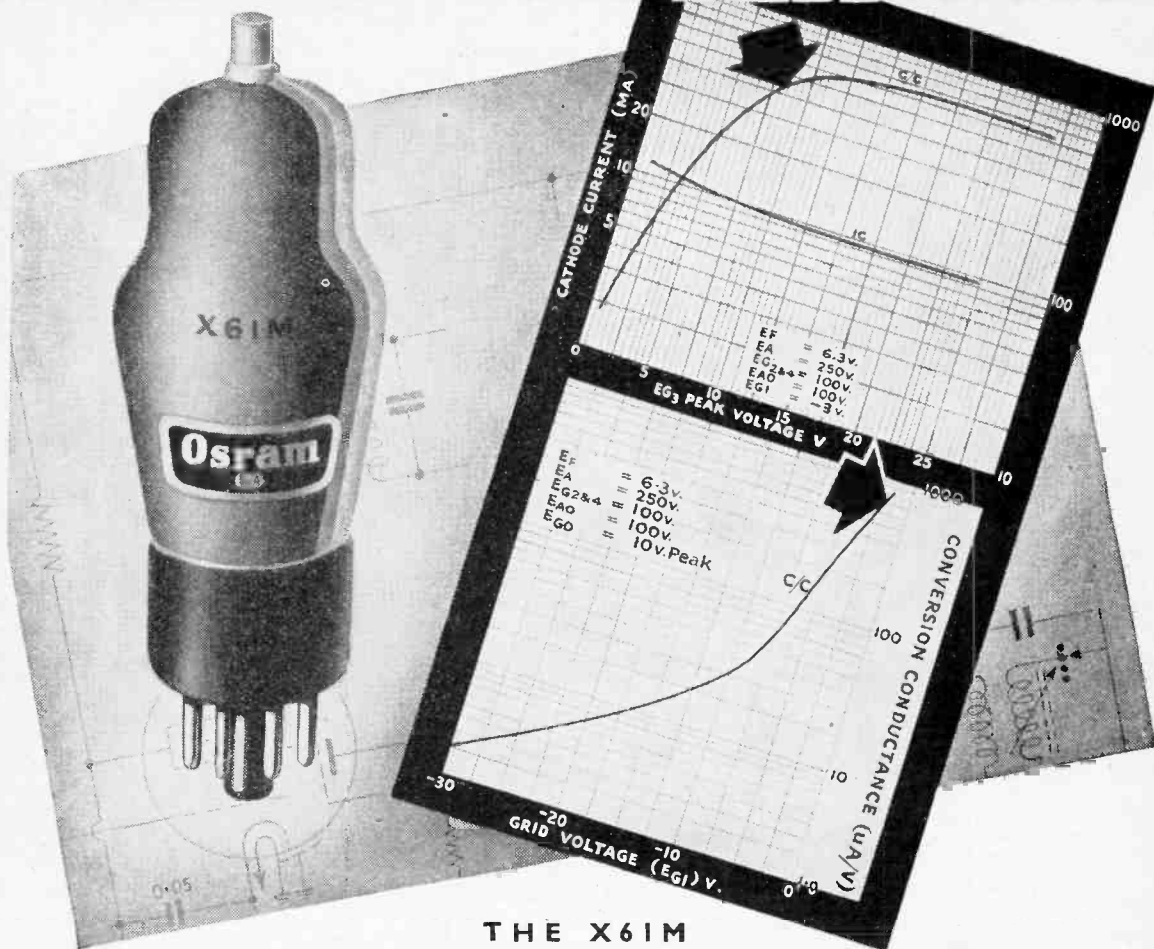

THE X61M

An indirectly heated 6.3v. frequency changer of the Triode-Hexode type, the OSRAM X61M is suitable for operation up to 60 megacycles per sec. (5 metres). Outstanding features include:—

- High conversion conductance for comparatively low cathode current, improving signal to noise ratio.
- Signal handling capacity is such that negligible distortion is apparent up to 5 volts R.M.S. on the signal grid.
- Negligible "pulling" when tuned anode oscillator is used, making ganging of tuned circuits easy.
- Control characteristic is designed to work in combination with KTW61 as IF amplifier, giving maximum control on both valves with negligible distortion.

A detailed technical data sheet is available on request.

Osram
PHOTO CELLS

G.E.C.
CATHODE RAY TUBES

Osram
VALVES

TECHNICAL DATA that *Speaks for itself!*

Here is one of the most popular of the Goodmans Loudspeakers now available—the T2/1205/15. A medium heavy duty reproducer with a frequency response ideal for small cinemas, Public Address systems and high power radiogramophones. A robust, precision made instrument under all conditions.

BRIEF TECHNICAL DATA

Overall Diam. 12 $\frac{5}{16}$ " Overall Depth 6 $\frac{3}{4}$ "
 Fundamental Resonance 75 c.p.s.
 Max. Power Capacity 12 w. peak A.C. on 4 ft. baffle
 (15 w. horn loaded)
 Voice Coil Imp. 15 ohms at 400 c.p.s.
 Flux Density 13,000 gauss
 Net weight 11 $\frac{1}{4}$ lb.

GOODMANS Type T2/1205/15
Loudspeaker

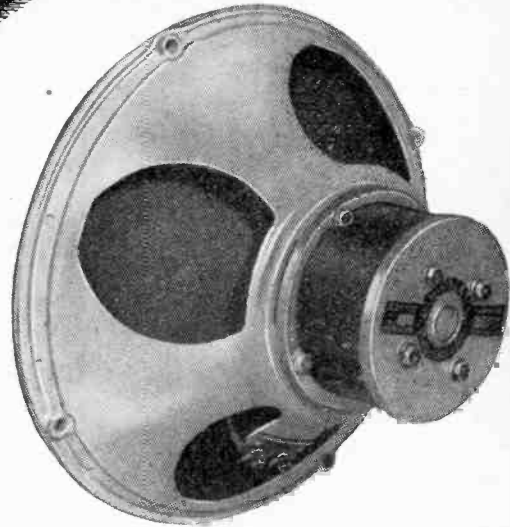

Price **£6 15s.** (Subject)
 NOW AVAILABLE

GOODMANS INDUSTRIES LTD - LANCELOT RD - WEMBLEY - MIDDX

Cathode Ray Oscilloscopes

BY

RADIO-AID LTD.

Electronic Engineers

29 MARKET STREET, WATFORD, HERTS



1 $\frac{1}{2}$ " TUBE, SELF-CONTAINED
 POWER PACK, TIME BASE
 AND AMPLIFIER.

Type Sl. £27.0.0

Sole London Agents:

WEBB'S RADIO

14 SOHO STREET, LONDON, W.1



INDIA WANTS BRITISH RADIO!

The Indian market offers unlimited
 EXPORT opportunities to British
 manufacturers.

There is a huge and urgent demand for
 the following products:—

Wireless Sets, parts and accessories •
 Amplifiers • Loudspeakers • Micro-
 phones • Gramophone Motors •
 Intercommunication, Broadcasting
 and Studio Equipment • Electrical
 Goods • Sound Projectors, etc.

We offer you the resources of our vast and skilful
 organisation with retail facilities spread all over India.

Excellent bank and trade references. Inter-
 ested to represent on exclusive basis and
 will carry stocks for distribution through
 dealers.

Please cable or airmail particulars to:—

ELECTRONICS LIMITED
GONNAUGHT PLACE, NEW DELHI, INDIA

Cables: "Radiowaves"

Codes: "Bentley's"

METALLISED CERAMICS

for

Hermetic Seals and Soldered Assemblies

FREQUENTITE BUSHES

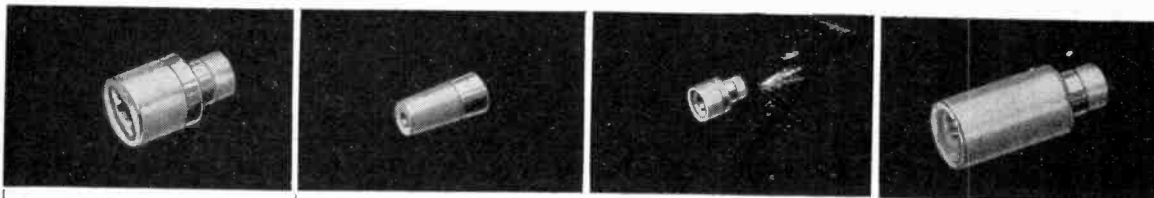

Photographs (above) actual size.
Drawings not to scale.

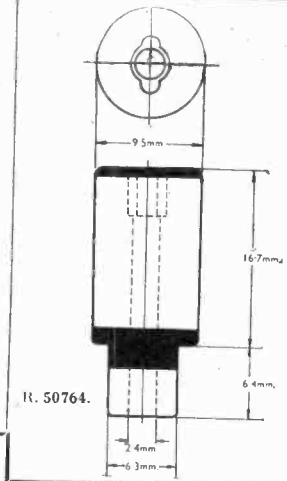
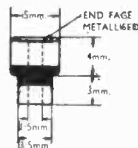
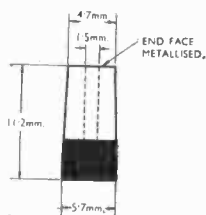
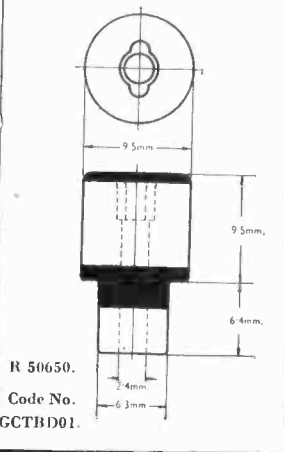

Code nos. are those used in I.S.C.Tech.C.
Specification No. R.C.L./330.11.

PORCELAIN BUSHES

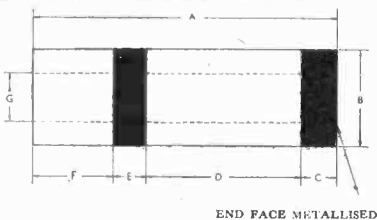

TYPE	CODE	A mms.	B mms.	C mms.	D mms.	E mms.	F mms.	G mms.
R. 50734	GCTBC01	20.3	7.6	3.8	6.4	4.6	5.5	3.0
R. 50768	GCTBC02	20.3	12.7	3.8	6.4	4.6	5.5	5.1
R. 50769	GCTBC03	20.3	15.2	3.8	6.4	4.6	5.5	6.4
R. 50770	GCTBC04	38.1	10.2	5.1	15.7	6.4	10.9	4.1
Q. 2092	GCTBC05	55.9	12.7	6.4	25.4	8.9	15.2	5.1
Q. 1982	GCTBC06	78.7	15.2	6.4	38.1	8.9	25.3	5.1

For full information and prices please write to:

STEATITE & PORCELAIN PRODUCTS LTD.

STOURPORT-ON-SEVERN, WORCS. T'phone: Stourport III. T'grams: Steatoin, Stourport.



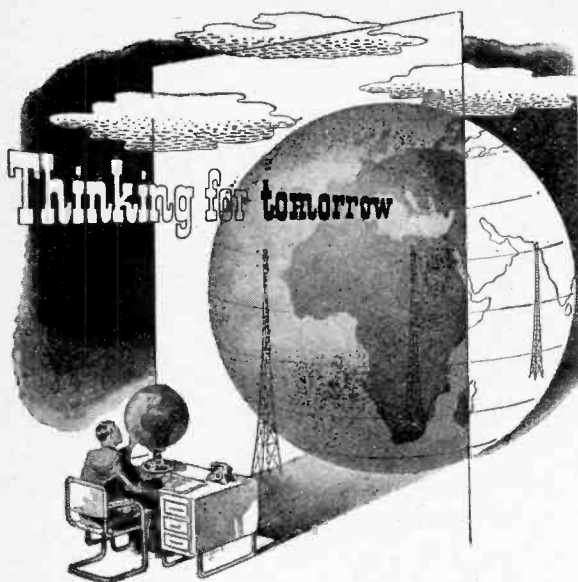

In a world whose tempo is governed by the radio wave, it is necessary to think quickly and to think ahead. Marconi engineers have an advantage in this — the advantage of a technical background that takes in the whole history of wireless communications.

In the reconstitution of old services and the development of new ones, that experience will be vital. On land, on sea and in the air, in the future as in the past, communications will be linked with Marconi — the greatest name in wireless.

MARCONI

the greatest name in wireless

MARCONI'S WIRELESS TELEGRAPH COMPANY LTD
THE MARCONI INTERNATIONAL MARINE COMMUNICATION COMPANY LTD
ELECTRA HOUSE, VICTORIA EMBANKMENT, LONDON, W.C.2

R&A

BRITAIN'S FOREMOST
REPRODUCERS

Reproducers and Amplifiers Ltd.
WOLVERHAMPTON,
ENGLAND.

ARE YOU A ONE ROOM
RADIO LISTENER?



Now that Stentorian Extension Speakers are coming back to the shops the pleasure of listening again becomes complete. Just plug in one of these superb permanent magnet speakers to your set and you can enjoy its clean, pure tone anywhere in the house: sitting-room, kitchen, bedroom, wherever you happen to be. Supplies are still short, but a Stentorian is worth looking for. Ask your local dealer about them.

PRICES

Minor Type MX (for Low Impedance Extension)	29/6
Minor Type MC (with Universal Transformer)	35/6
Baby Type BX (for Low Impedance Extension)	43/6
Baby Type BC (with Universal Transformer)	49/6



Stentorian

THE PERFECT EXTRA SPEAKER FOR ANY SET

WHITELEY ELECTRICAL RADIO CO. LTD., MANSFIELD, NOTTS.

THE MOST FAMOUS SET MAKERS ARE AGAIN FITTING

MAZDA

**RADIO VALVES AND
CATHODE RAY TUBES**

because of their

PERFORMANCE AND

RELIABILITY

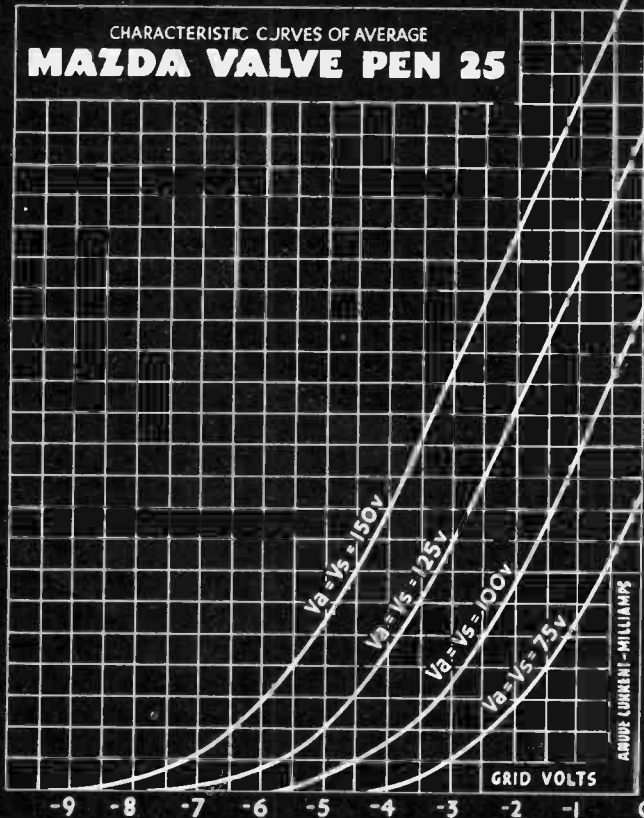

**LOW
"I_f"**

**HIGH
"g_m"**

**HIGH
OUTPUT**

THE FILAMENT CURRENT OF THE MAZDA PEN 25 IS EXCEPTIONALLY LOW: IT IS ONLY 150mA.

ITS MUTUAL CONDUCTANCE ($g_m = 4.5mA/V$) IS REMARKABLY HIGH FOR A VALVE HAVING SO LOW A FILAMENT CONSUMPTION.

WITH A 120 VOLT H.T. BATTERY IT HAS AN OUTPUT OF THE ORDER OF 400mW.

THIS VALVE MAY BE USED AS A REPLACEMENT FOR THE BVA. 162 IN THE CIVILIAN WAR-TIME RECEIVER.

THE EDISON SWAN ELECTRIC COMPANY LIMITED  155, CHARING CROSS ROAD, LONDON, W.C.2

Telling t'other from which!

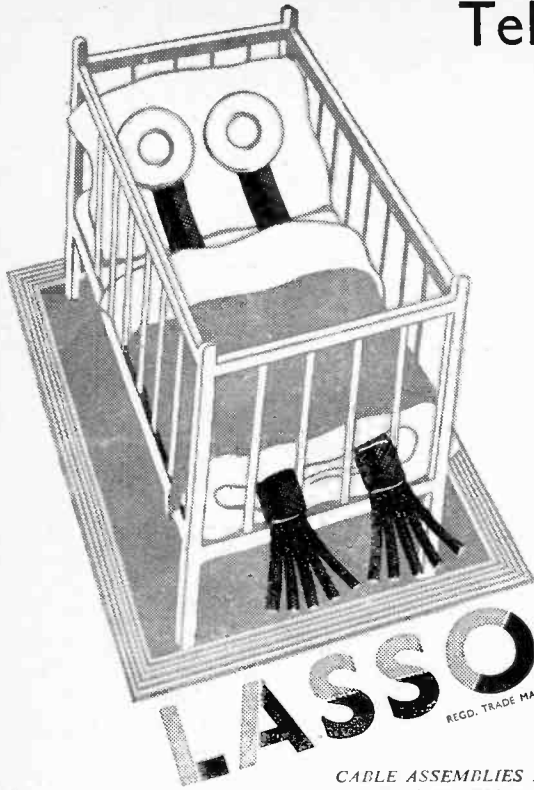

There's no difficulty in sorting out one from another when cables and components are marked with Lasso Identification Tape. Lasso Tapes are self-adhesive, resistant to water, oil, petrol and solvents, and tested for tensile strength, durability and electrical resistance. Manufactured on different bases — transparent film, cotton cloth — they are printed with your own inscriptions at intervals spaced to suit diameters and other measurements. Printing cannot be erased. In 10 yard rolls, Lasso Tapes provide permanent name tabs for containers, furniture, plastics and tools. An interesting booklet is free on request.

LASSOPHANE • LASSOVIC • LASSOLASTIC • LASSOBAND
LASSOTHENE • LASSOTHYL • LASSOFIBRE



CABLE ASSEMBLIES LTD. (Subsidiary of Herts Pharmaceuticals Ltd.)
50 Howardsgate, Welwyn Garden City, Herts. Tel. Welwyn Garden 3783/3929

(C3)

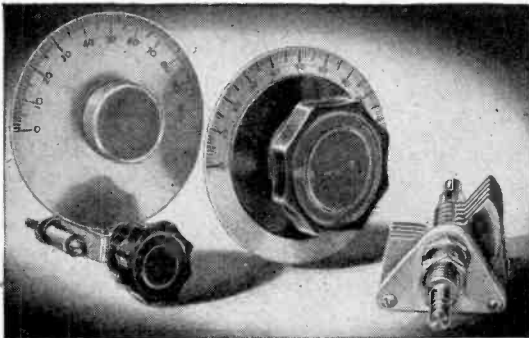

RAYMART DIALS AND KNOBS

Raymart precision dials are noted for their accurate workmanship and non-reflecting satin finish.

TYPE TXJ. 2½" Dial, graduated 0-100 complete with indicator.
TYPE TXD. 4" companion Dial to TXJ with indicator, graduated 0-100.
TYPE TXW. 2½" special Dial, without knob, but having solid metal boss and intended for use with our slow motion drive and dial locking device.
TYPE TXO. 2½" Dial, graduated 100-0, with no skirt on knob of this dial.
TYPE SMD. We manufacture a slow motion drive with dial cursor and locking device for use with the TXW, but it can be used with any of the above dials. This drive works on the edge of the dial by friction, and there is a dial cursor and lock operating at the top of the dial.
KNOBS. Black bakelite, with and without skirts. Diameters 1½", 2, 2½", 3".

RAYMART
CRAFT A CREED

NOTE: All Raymart products obtainable from — BERRY'S (SHORT-WAVE) LTD., 25 HIGH HOLBORN, LONDON, W.C.1 (Phone: Holborn 6231)

48 HOLLOWAY HEAD, BIRMINGHAM I

"Cyldon" Transmitting Capacitors

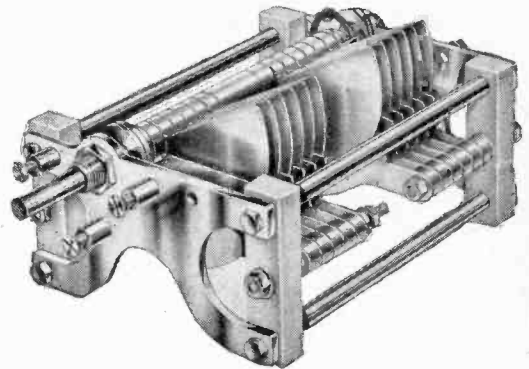

TYPE SSTR.	SQUARE LAW.	Max. Capacity	List Price
100 pF	£1 : 7 : 6		
150 "	£1 : 12 : 0		
200 "	£1 : 15 : 0		
250 "	£2 : 0 : 0		
300 "	£2 : 10 : 0		

SYDNEY S. BIRD & SONS, LTD.
Cambridge Arterial Road, Enfield, Middlesex.

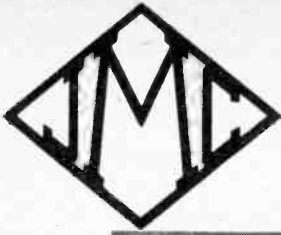

COMPREHENSIVE EXPERIENCE PERFECTS

metallised

CERAMICS and GLASS

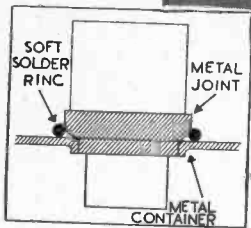
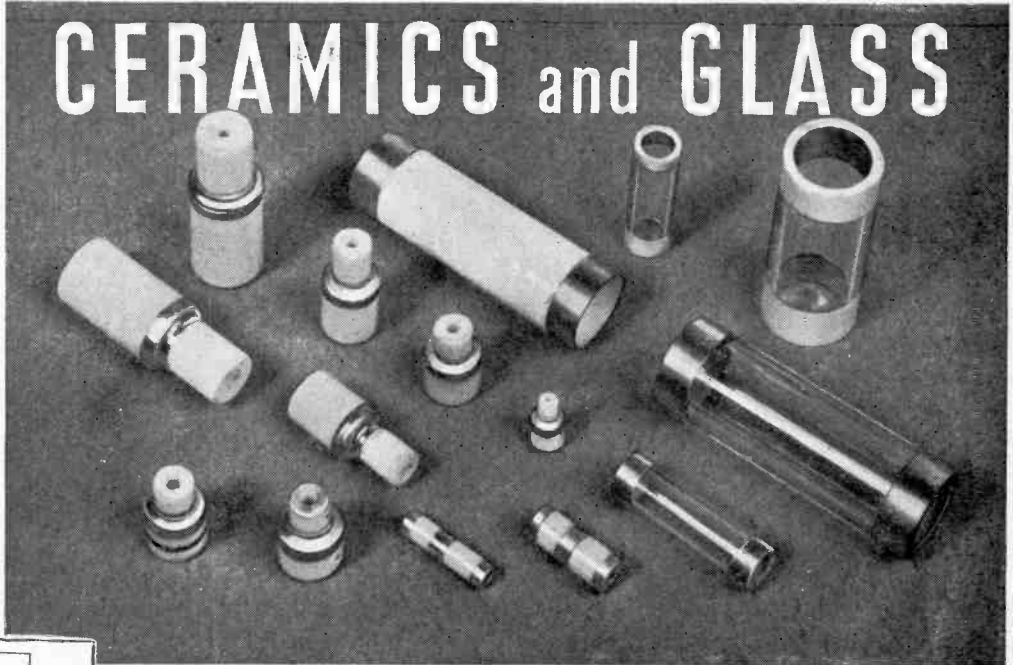

Method of Assembly :

CERAMIC BUSHINGS

The holes in the metal container should be plunged to ensure proper seating of the bushings. A ring of flux-cored solder placed round the bushing and melted with a small soft flame is better than the use of a shaped bit.

FOR HERMETIC INSULATED SEALS

The extensive experience of Johnson Matthey in the production of precious metal preparations for glass and ceramics on the one hand, and in soldering and brazing techniques on the other, provides a perfect background for these new types of hermetic insulated seals for electrical components. These include a standard range of low-loss ceramic terminal bushings, metallised and tinned ready for use with soft solder. Heat resisting glass tubes with metallised and tinned bands can also be produced for subsequent sealing with soft solder and special bushings can be supplied to individual requirements. Full details are given in J. M. C. publication 2470 which will be sent on request.

One of the specialised products of

JOHNSON, MATTHEY & CO., LIMITED

73/83 HATTON GARDEN • LONDON • E.C.1

EDXI.B



DON'T MISS
A WORD OF THIS!..
YOU WON'T
WITH

Exide
L.T. ACCUMULATORS
AND
Drydex
H.T. BATTERIES

*The perfect pair for
battery Radio sets*

THE CHLORIDE ELECTRICAL STORAGE CO. LTD.,
CLIFTON JUNCTION, NR. MANCHESTER

No Introduction needed!

If you were in any section of Radio Communication during the war period you are almost certain to have been introduced to S. G. BROWN Headphones.

The excellent service they rendered in winning the war is now available to all radio enthusiasts.

For quality reproduction and maximum results on all wavebands there are no finer headphones.

Your Dealer can supply.



Type "A"

TYPE "A" Adjustable Reed Movement **57/6**
TYPE "F" Featherweight **23/-**

Technical details of all S. G. Brown headphones are given in Brochure "W." Free on request.

S.G. Brown, Ltd.

VICTORIA ROAD, NORTH ACTON,
LONDON, W.3. Telephone : ACOrn 1174.

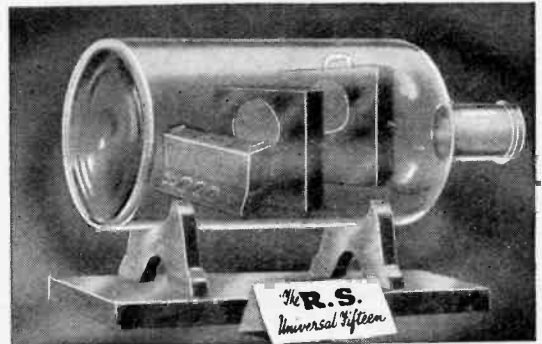

... but the R.S. "UNIVERSAL FIFTEEN"
will go almost any place & suit almost any circumstance

Unlike ships, you won't find the R.S. Universal Fifteen "sitting pretty" in a bottle. But that's about the only place and circumstance it doesn't suit. Completely and easily portable and operating on any mains either A.C. or D.C., and at all voltages from 200 to 250, the R.S. Universal Fifteen is giving sterling service in all fields of P.A. endeavour everywhere. Supplies are, of course, a little easier now but we still cannot build them fast enough to give immediate delivery—we promise however, not to keep you waiting longer than possible. May we send you full information and data on this "truly portable" Portable P.A. Equipment?



AMPLIFIERS

R. S. AMPLIFIERS LTD., 2-4 HIGHFIELD ROAD, SHEPPERTON. MIDD.
Tel. : Walton-on-Thames 1019.



THE COUNTERSIGN OF DEPENDABILITY IN ANY ELECTRONIC EQUIPMENT

Tests Prove 100% Longer Life

in this New Eimac 3-750A2

made possible by:

- NEW COOLER OPERATING PLATE
- NEW NON-EMITTING GRID
- NEW FILAMENT STRUCTURE

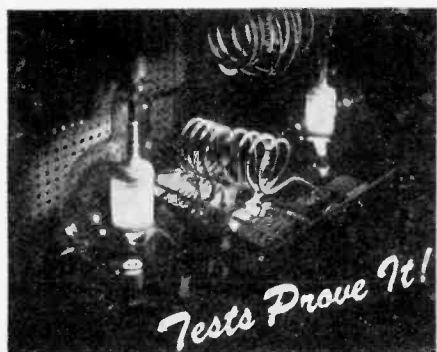

Tests Prove It!

Two Eimac 3-750A2 Valves undergoing life tests in the Eimac testing laboratory

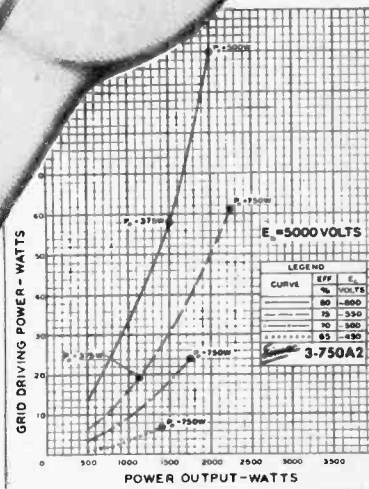
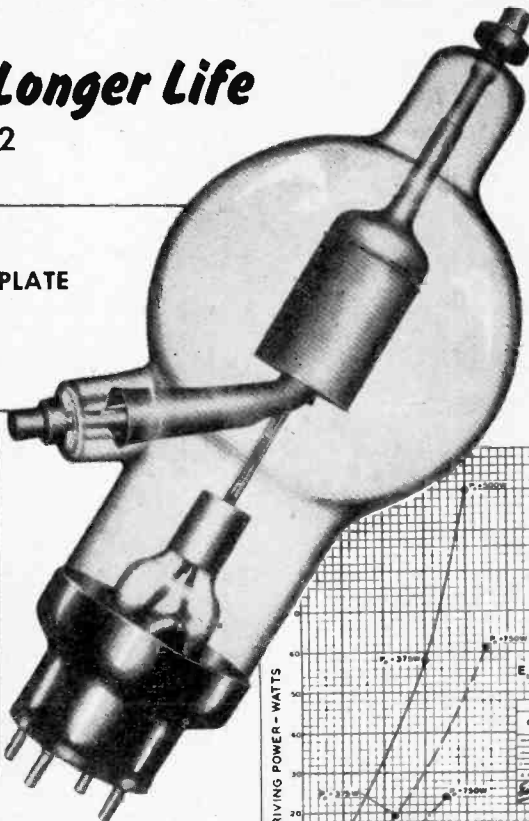

Typical of the outstanding performance of this new triode is its high power gain. With 5000 volts on the plate, the new Eimac 3-750A2 will deliver 2000 watts output with only 50 watts driving power, at a plate efficiency of 75%. (See above chart.)

Repeated tests of the new Eimac 3-750A2 in the Eimac laboratory show 100% longer life than previous models operated under the same conditions.

This increase in life expectancy is a result of continuing research, culminating in this new version of the 750TL triode. Among its many new features are a new cooler operating plate, new non-emitting grid and a new filament structure.

The new 3-750A2 is a power triode, interchangeable with the previous model 750TL, and is but one example of the constant effort made at Eimac to furnish better valves at lower cost. For further information and complete engineering data on Eimac valves, write direct or contact your nearest Eimac representative.

Follow the leaders to



ELECTRICAL CHARACTERISTICS

Filament: Thoriated tungsten	
Voltage	7.5 volts
Current	21.0 amperes
Amplification Factor (Average)	15
Direct Interelectrode Capacitances (Average)	
Grid-Plate	5.8 uuf
Grid-Filament	8.5 uuf
Plate-Filament	1.2 uuf
Transconductance (I _b =1.0 amp., E _b =5000, e _c =-100)	3500 umhos
Frequency for Maximum Ratings	40 mc

EITEL-McCULLOUGH, INC., Dept. K, 1102 San Mateo Ave., San Bruno, Calif.
 Plant located at: San Bruno, California
 Export Agents: Fraxer and Hansen, 301 Clay St., San Francisco 11, California, U. S. A.

Authorised Distributors: BERRY'S (SHORT-WAVE) LTD., 25, HIGH HOLBORN, LONDON, W.C.1.

*The better they are made
the more outstanding the results*

MADE IN THREE PRINCIPAL MATERIALS.

FREQUELEX. An insulating material of low Dielectric Loss, for Coil Formers, Aerial Insulators, Valve Holders, etc.

PERMALEX. A High Permittivity Material. For the construction of Condensers of the smallest possible dimensions.

TEMPLEX. A Condenser material of medium permittivity. For the construction of Condensers having a constant capacity at all temperatures.

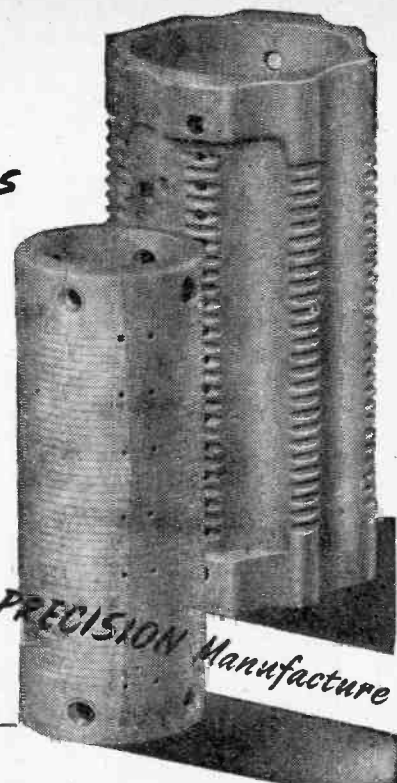

Bullers

Specialize in PRECISION Manufacture



BULLERS LOW LOSS CERAMICS

BULLERS LTD., 6, Laurence Pountney Hill, London, E.C.4. Phone : Mansion House 9971 (3 lines)
Telegrams : "Bullers, Cannon, London." Manchester Office : 196, Deansgate, Manchester

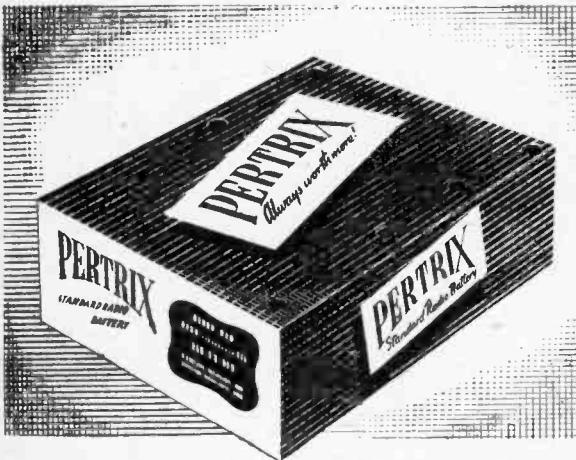

AN OLD FRIEND RETURNS Pertrix Batteries have emerged from the testing ground of war as more reliable, more efficient than ever before. You will soon see them in the smart new post-war pack shown above. It denotes the finest battery for radio use yet made.

HOLSUN BATTERIES LIMITED
137 Victoria Street London S.W.1

P.T.C.

THERE ARE THIRTY APPLIERS WITH 5-500 WATTS...

Critical users

Trust

TRIX

Quality SOUND Equipment

THE TRIX ELECTRICAL CO LTD.
1-5 MAPEE PLACE - TOTTENHAM COURT ROAD, LONDON, W.1.
Tel. MUSEUM 5-317

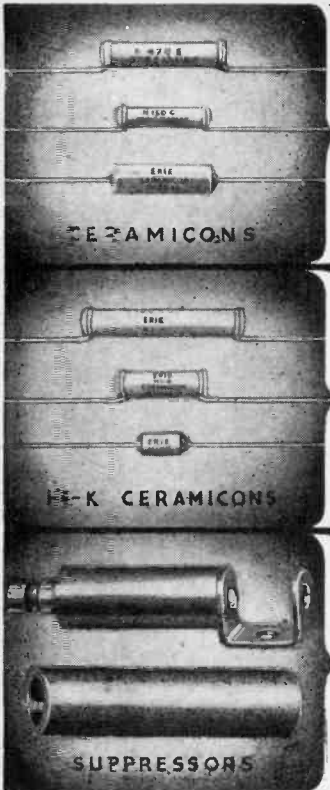

ERIE Electronic Components

The engineering resources which produced hundreds of millions of Erie components for war-time needs are now at your service. May we advise you, quote you, or send you samples?

ERIE RESISTOR LTD.
CARLISLE ROAD, THE HYDE,
LONDON, N.W.9.

Telephone: Colindale 8011

FACTORIES: London, England
Toronto, Canada • Erie, Pa., U.S.A.

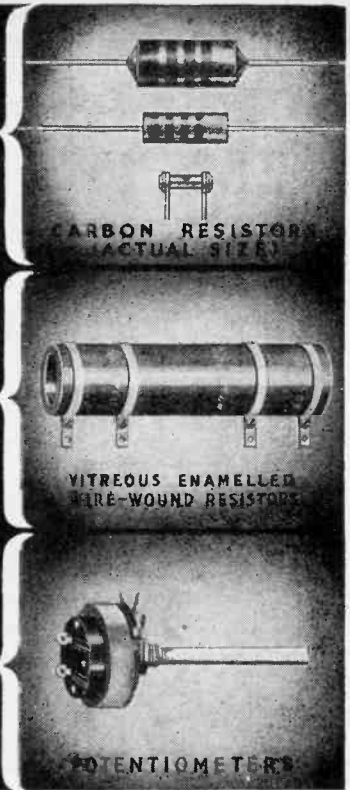

—Wharfedale—

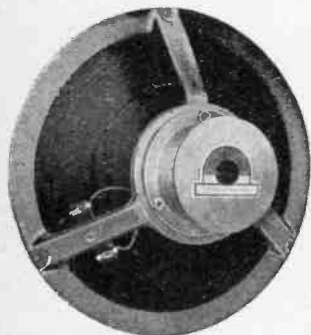

NEW GOLDEN 10 inch LOUDSPEAKER

During the last six years hundreds of Wharfedale Golden Units have been supplied, and are still being supplied, to the B.B.C. and G.P.O. It was selected by reason of

Speech Coil 3 or 15 ohms.
Impedance. PRICE 75/-

its level response. The new model is fitted with precision die-cast chassis, improved spider, and Alcomax II Magnet increasing the flux density from 10,500 to 12,500. The price is only increased by 5/-.

Made and Guaranteed by
WHARFEDALE WIRELESS WORKS

NEW ADDRESS:

BRADFORD ROAD, IDLE, BRADFORD.

Phone: Idle 461.

'Grams: "Wharfedale, Idle, Bradford."

M.R. SUPPLIES Ltd.

Offer only Radio and Electrical Material of the utmost reliability. Prompt despatch. Complete satisfaction assured. All prices nett.

ANODE CONVERTERS (Rotary Transformers). Brand new, perfect. Input 12 v. D.C., output 250 v., 125 m.a. D.C. Right for all mobile radio and amplifier work, 57/6 (despatch 1/3).

BATTERY CHARGERS, operation from 200/250 v. A.C. Charging 6 and 12 v. accumulators at full 3 amps. Fitted mains voltage selector and switch for 6, 12 v. and "off," 2-pole fuses, pilot light and strong mains and battery leads. In steel wall-mounting case, 9in. by 6in. by 5in. Employing S.T.O. Metal Rectifier. Excellent value, £4 10s. (desp. 1/6).

METAL RECTIFIERS by S.T.O. (Selenium). All for charging up to 12 volts at 1.5 amp., 12/6; 3 amp., 22/6; 6 amp., 39/6; 10 amp., 49/6. These are all full-wave, bridge connected. Suitable TRANSFORMERS, all with tapped primary, 200/250 v. Sec. —7, 11 and 15 v. at 2 amps., 20/- . Sec. —8 and 14 v. at 3 amps., 32/6 Sec. —5, 12 and 17 v. at 6 amps., 49/6 (desp. 2/-). These can be sold separately.

POWER TRANSFORMERS —With tapped primary, 200/250 v. All layer wound, interleaved and constantly rated. Sec. 1.—350/0/350 v., 120 ma., 4 v., 5 a., 4 v., 2 a., 39/6 (desp. 1/6). Sec. 2.—450/0/450 v., 150 m.a., 6.3 v., 4 a., 6.3 v., 2 a., 5 v., 3 a., 49/6 (desp. 2/-). We do not offer any "Cut-rated" transformers.

SIGNAL GENERATORS. We confidently recommend the new BPL instrument and have already supplied many of the large firms' laboratories. Operation 200/250 v. A.C. Frequencies —100/250, 250/650, 650/1,600 Kc/s. 1.6/4.5, 4.5/12, 12/30 Mc/s. Accuracy 1 per cent. 1 volt in 10 ohms. All ranges modulated to depth of 50 per cent. by internal 400 c. oscillator (off switch provided). 6in. illuminated scale. 400 c. brought out separately. Double screening, £21 nett. (desp. 2/6). Ex stock.

MEGGERS. The "Wee-Megger" by Everhed again in stock. Pressure 500 volts. Range 0/20 megohms and inf. Supplied with pocket and log books, £9 10s.

VENT-AXIA EXTRACTOR FAN3. A few of the very efficient "Silent 6" at the pre-increase price. 220/250 v. A.C. Fitted weatherproof cowling. Easy to install consumption only 95-watts, £5 8s. 6d.

MILLIAMMETERS by Taylor. High-grade moving coil, 2 1/2in. flush mtg. Deflection 0/500 milliamps (can be de-sensitized for lower reading), 29/6.

VARIABLE RESISTANCES. Cressall wire-wound p'ometers (or rheostats), 10 ohms 1 amp., with knob, 5/6. **SLIDING RESISTANCES**, fully enclosed, 100 watt range—4 ohms 5 amps, 10 ohms 3 amps, 50 ohms 1.4 amp., 100 ohms 1 amp., 200 ohms 0.7 amp. or 400 ohms 0.5 amp., any one, 27/6. Also 6 ohms 10 amps (500 watts), 50/6 (desp. 3/6).

INSTRUMENT KNOBS, 1 1/2in. with 2in. skirt, brass bushed with 1/4in. bore, with 2 set screws, 1/3 each, 11/9 dozen.

LOUDSPEAKERS. We only offer the superior types. Vitavox High-fidelity P.M. models, with high-flux ticonal magnets, 12in. die-cast chassis, 15 ohms coils, the K19/10 (10 watt), £7. K12/20 (20 watt), £11 (desp. either 5/-). The new Gramplan 7 watt, 9in. P.M. Speaker with either 5 or 15 ohms coil, 38/- (desp. 1/6). The ideal unit for horn-loading. **PROJECTOR SPEAKERS**, large range in stock for immediate delivery:—Vitavox 10 watt P.M. Unit (15 ohms) with 42in. all-metal horn (50 in., £10 10s. (desp. 7/6). With 30in. all-metal square Horn, £8 17s. 6d. (desp. 5/-) Units only:—Vitavox 10 watt, £6. G.E.C. 12 watt (with line transf.), £7 10s. Reel and Gramplan 10 watt, £7 5s.

For Callers only:—B.A.F. R1150 Receivers, in first-class condition, £15. Large range of Electric Clocks.

Please include sufficient for despatch where not stated.

M.R. SUPPLIES Ltd., 68, New Oxford Street, London, W.C.1

Telephone: MUSEUM 2958

LINAGLOW LIMITED

"MASTERADIO" CAR RADIO RECEIVERS

Here at last is a car radio that gives you true "console" quality, that brings the personality of each musical instrument right into your own car.

7-stage Super Heterodyne, Full A.V.C., special aerial circuit, eliminating the use of plug suppressors; employing International Octal Type Valves—Medium and Long wavebands, giving a high standard of selectivity and sensitivity—large P.M. Loudspeaker. Consumption, 2 amps on 12 volts and 4 amps on 6 volts. Single bolt fixing, remote control for dashboard fitting, illuminated dial with station names and wave band indication. Individual designs for 6- or 12-volt equipment. Plated steel case, finished attractively, gunmetal and chrome, size 7 1/2 in. x 6 1/2 in. x 6 1/2 in., weight 10 lbs. Can be used for either roof type, undercar, or telescopic type aerials. When ordering please state voltage required.

PRICE 17 1/2 gns. purchase tax 85/9 (carriage and packing 7/6 extra).

CAR RADIO AERIALS. Roof aerial, 22/6; Under car aerial, 21/-; Telescopic aerial, 3-section, 23/6.

ALL-WAVE COIL PACK Ranges: 19-50, 200-550, and 1,000 to 2,000 metres. Simplifies the building of a superhet. Supplied complete with trimmer and paddler condensers for use in standard 3-wave superheterodyne circuit. One hole fixing to chassis. A fourth position is fitted to wave change switch for gramophone pick-up. For use with 465 K/cs. I.F. Transformers. PRICE, complete with 38/6 diagram of connections.....

I.F. TRANSFORMERS, 465 K/cs. iron dust cores. For use with all-wave coil pack. PRICE, 12/6 per pair.

HAND GENERATORS.—Complete with handle, 300 volts 60 milliamps, 6 volts 2 amp. Dimensions: 7 in. long, 9 in. circumference. Can easily be adapted 45/- for motor drive.....

CRYSTALS.—Ex-Air Ministry, 500 K/cs. 29/6 Accuracy, .05 per cent.....

ELECTROLYTIC CONDENSERS.—Tubular, wire end, 50 mfd. 12 volt, 1/0. 25 mfd. 25 volt, 1/3. 8 mfd. 500 volt, 3/8. Tubular tag end 8 x 8 mfd. 550 volts, 5/0. 6 mfd. 50 volt, 1/6.

"LINTONE" 5-VALVE MIDGET SUPERHET CONSTRUCTORS KIT

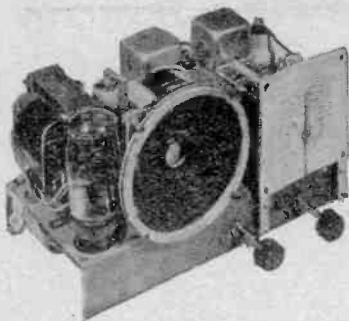

Complete with cabinet, 16-50, 200-550 metres. Brief specification: Frequency changer, 6 tuned circuits, 465 K/cs., iron-cored I.F.'s, 4-watt output, P.M. 5In. speaker and output transformer, all valves, chassis, practical and theoretical diagram, parts list, nuts, bolts, wire and modern cabinet. Dimensions: 12 in. x 8 in. x 6 in. deep. Ready to assemble, 260/250 A.C. PRICE (including purchase tax)..... 13 1/2 gns. Case and packing, 10/- extra (refunded upon return of case). Overseas enquiries invited.

"METALAIR" ELECTRIC CLOCKS 7 1/2 in. diameter, 4 in. diameter dial, 200/250 volts, A.C. 50 cycles, various colour sprayed steel. PRICE 48/- plus 10/8 purchase tax. Metal case, finish to resemble plastic in various colours. PRICE, 52/6, plus 11/8 purchase tax.



R.A.F. PORTABLE TRANSMITTERS

Used, but in good condition. Containing a wealth of valuable components, useful to the amateur, or can easily be converted for use on amateur bands. Circuit diagrams, and parts lists supplied with each instrument. Each transmitter is complete with valves, crystal, Litz wound coils, Morse key, variable condenser, relay, portable aerial, resistors, chokes, condensers and hand generator, etc. (approximate cost to manufacture, 59/6 23/). PRICE, including postage and packing, 59/6

AS ABOVE, but new and unused and guaranteed to radiate. PRICE, including postage and packing, 85/5.0

MARVELLOUS VALUE in ASSORTED PARCELS

VITREOUS WIRE-WOUND RESISTORS. 100 ohms 4 watts to 200,000 ohms 150 watts. PRICE, 12/- per parcel of 6, post paid.....

CARBON RESISTORS, 600 ohms 1/3 watt to 50,000 ohms 3 watts. PRICE per parcel of 2 dozen, post paid, 6/6

BLOCK PAPER, OIL FILLED, MICA AND ALUMINIUM CAN CONDENSERS. 1 mfd 350 volts, .5 mfd. 1,000 volts, .004 mfd. 4,000 volts, .02 mfd. 350 volts, etc., etc. PRICE per parcel of 1 dozen, post paid 12/-

VIBRATORS.—Mallory, 12 volt 4 pin, 6 volt 4 pin, 6 volt 6 pin. PRICE.....each 10/6

VALVES.—American types at B.O.T. controlled retail prices: 12F5, 1B5, 9/2; 1C5, 1N5, 25Z6, 35Z5, 11/-; 6Q7, 12Q7, 128Q7, 11/7; 1A7, 6F6, 6K6, 50L6, 12/10; 6A8, 14/-; 6L6, 18/3. British Manufacturers' Valves at list prices. 6U6, 11/-; TDD4, 11/7; ACVP2, VP41, 8P42, T41, KTW61, EF39, 12/10; ECH3 X63, 14/-; AC6FEN, 18/3; 111 diode, 11n. peanut valve with holder, 8/-. Prices include Purchase Tax. Please add 3d. per valve postage.

VALVE-HOLDERS.—Amphenol type, International or British Octal, chassis mounting. Price 6d. each. British Octal, wafer type, 4d. each, 3/6 per doz.

A comprehensive range of all types of components are available at our showrooms. We extend a welcome to all our customers.

LINAGLOW LIMITED, Dept. M.O. 66, 34, OSNABURGH ST., EUSTON RD., N.W. 1. (Nr. Gt. Portland St. Station) Telephone No. Euston 8406 (5 lines.)

RECTIFIERS
for use with
electrical
measuring
instruments

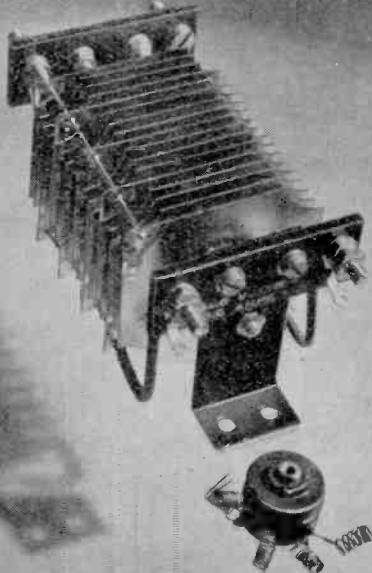

There is a Westinghouse metal rectifier to suit all measuring instruments with full-scale deflections of from 100 micro-amperes up to 500 milli-amperes. Full details are given in descriptive pamphlet No. M.R.3, a copy of which may be obtained from Dept. W.W.



WESTINGHOUSE BRAKE & SIGNAL CO. LTD., 82, YORK WAY, KING'S CROSS, LONDON, N.1

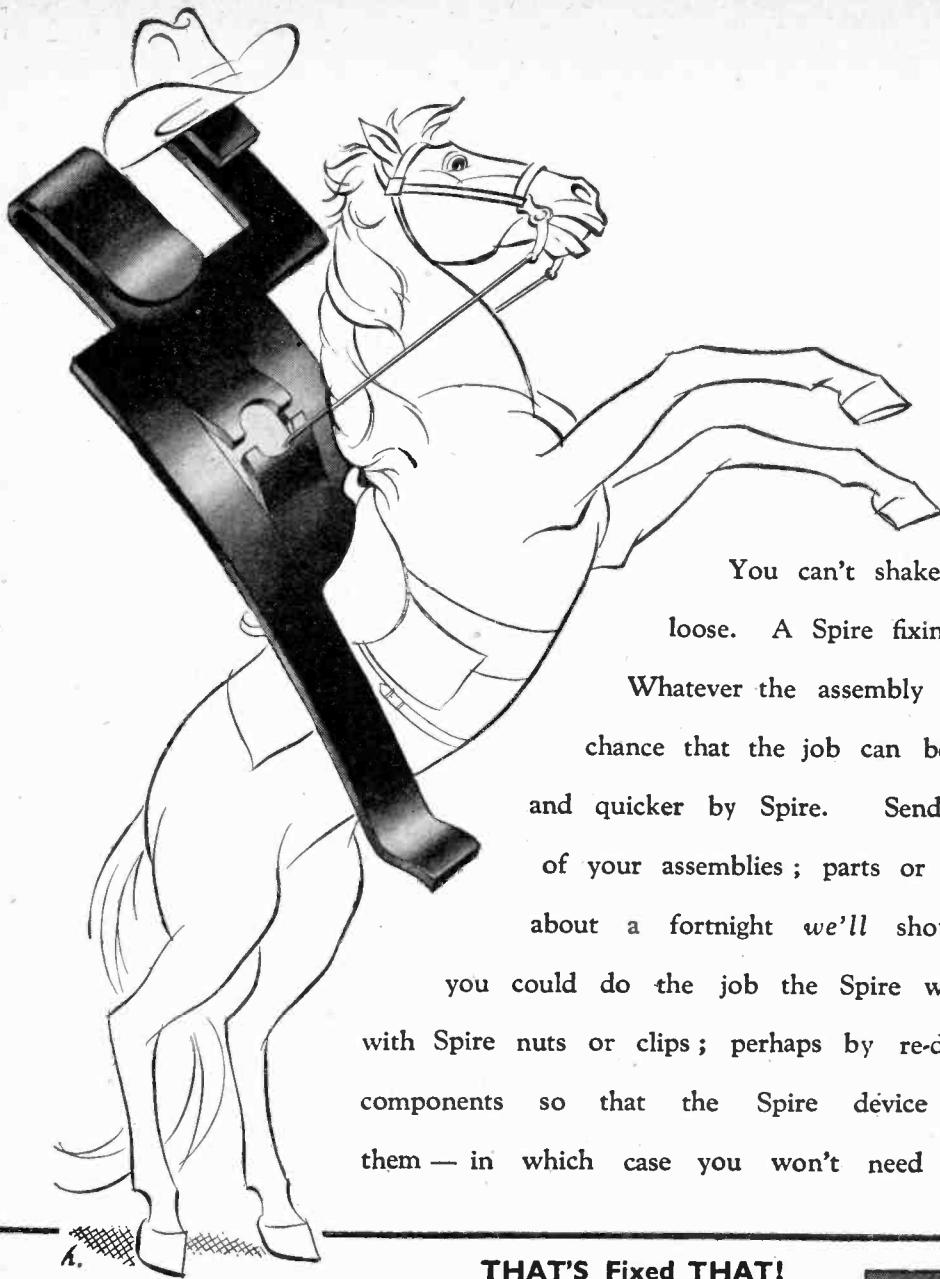

You can't shake a Spire Nut loose. A Spire fixing locks itself. Whatever the assembly there's a good chance that the job can be done better and quicker by Spire. Send us examples of your assemblies; parts or drawings. In about a fortnight we'll show you how you could do the job the Spire way — perhaps with Spire nuts or clips; perhaps by re-designing your components so that the Spire device is part of them — in which case you won't need nuts at all.

Spire
(Regd.)

*** A BETTER way of fixing**

THAT'S Fixed THAT!

This is a typical case of intelligent use of Spire fixing. This was originally a spring clamp which was screwed to its base with screw, washer and nut. Now the clamp is redesigned to incorporate its own Spire fixing, and the nut and washer have disappeared. Apart from the saving in material it is a much quicker and simpler assembly job, the clamp is 'zipped' on to the screw and tightened firmly home. Designed as a fuse holder this fixing NS 1307 is suitable also for securing any cable, rod or circular equipment from $\frac{1}{4}$ " to $\frac{3}{16}$ " diameter.

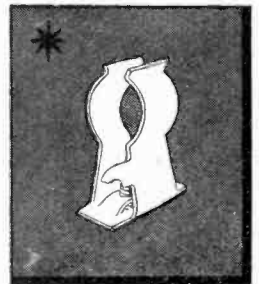

Simmonds Aerocessories Limited • Great West Road • London • A Company of the Simmonds Group

Wireless World

Radio and Electronics

36th YEAR OF PUBLICATION

JULY 1946

Proprietors:
ILIFFE & SONS LTD.

Managing Editor:
HUGH S. COCKOCK,
M.I.E.E.

Editor:
H. F. SMITH

Editorial, Advertising
and Publishing Offices:

DORSET HOUSE,
STAMFORD STREET,
LONDON, S.E.1.

Telephone:
Waterloo 3333 (50 lines).

Telegrams:
"Ethaworld, Sedist, London."



**PUBLISHED
MONTHLY**

Price: 1/6

(Publication date 26th
of preceding month)

Subscription Rate:
Home and Abroad
20/- per annum.

MONTHLY COMMENTARY	211
Ex-R.A.F. COMMUNICATION RECEIVER	212
ELECTROMAGNETIC DEFLECTION. By W. T. Cocking, M.I.E.E.	217
SHORT-WAVE CONDITIONS. By T. W. Bennington	222
AERIALS. By "Cathode Ray"	223
TEST REPORT—Sobell Type 615	226
WORLD OF WIRELESS	228
DESIGN DATA—(6). Differentiating Circuit ..	231
CONSOL. By John E. Clegg	233
A.C./D.C. VOLTAGE DROPPING	236
UNEIASED. By Free Grid	238
TOWARDS VALVE STANDARDIZATION	239
LETTERS TO THE EDITOR	241
RANDOM RADIATIONS. By "Diallist"	242
RECENT INVENTIONS	244

Branch Offices:

COVENTRY:
8-10, Corporation Street.
Telephone: Coventry 5210.

Telegrams:
"Autocar, Coventry."

BIRMINGHAM:
King Edward House,
New Street.

Telephone:
Midland 7191 (7 lines).

Telegrams:
"Autopress, Birmingham."

MANCHESTER:
260, Deansgate, 3.

Telephone:
Blackfriars 4412 (4 lines).

Telegrams:
"Iliffe, Manchester."

GLASGOW:
26B, Renfield Street, C.2.
Telephone: Central 4857.
Telegrams: "Iliffe, Glasgow."



As many of the circuits and
apparatus described in these
pages are covered by patents,
readers are advised, before
making use of them, to satisfy
themselves that they would
not be infringing patents.

VIBRATORS • TRANSFORMERS • SWITCHES • COILS

'Stratosil Sealed'
for EFFICIENCY

Wearite "Stratosil Sealed" Vibrators operate efficiently and with the utmost reliability in all situations irrespective of climatic conditions. They embody many features exclusive to this type of component and are available just now only for purposes directly connected with the war effort.

STRATOSIL
Sealed VIBRATORS

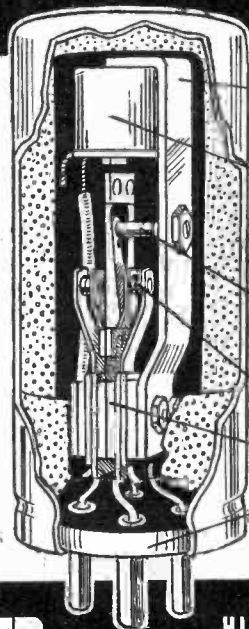

- All steel construction—even to the rivets—ensuring uniform expansion under extremes of temperature.
- Reed driving coil—wound on a bakelite moulded bobbin to meet all climatic conditions.
- Metal can, sponge rubber lined—Acoustically and electrically shielding the Vibrator.
- Driving contact of non-tarnishable precious metal—ensuring starting under the lightest of pressures and voltages.
- Contacts ground almost to optical limits.
- Stack assembly. Mica and steel only are used
- Base sealed by the WEARITE STRATOSIL process.

WRIGHT & WEAIRE LTD

HIGH RD. TOTTENHAM N.17
TELEPHONE: TOTTENHAM 3847

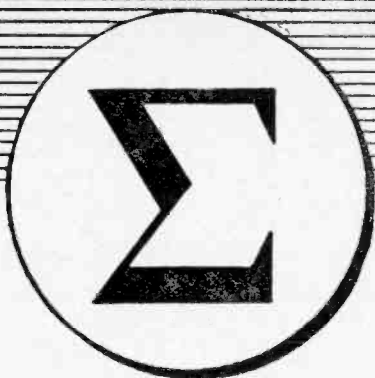

***The capital Sigma,
in mathematics, is a symbol
meaning 'the sum of'***



***The Philips emblem,
in everyday life is a symbol meaning
the sum of expert design, skilled
workmanship and good materials.***

PHILIPS

**LAMPS · RADIO · X-RAY · COMMUNICATIONS EQUIPMENT
AND ALLIED ELECTRICAL PRODUCTS**

PHILIPS LAMPS LTD., CENTURY HOUSE, SHAFTESBURY AVENUE, LONDON, W.C.2 (127J)

Wireless World

Radio and Electronics

Vol. LII. No. 7

JULY, 1946

Price 1s. 6d.

Monthly Commentary

Radio Aids to Navigation

EVEN before the end of the European War *Wireless World* began to press for immediate international discussion of the problems that must be solved before wartime radio developments can be applied to peacetime uses. Perhaps we should admit to more optimism than subsequent events have shown to be justified, but as excuse for our impatience we can plead that every branch of radio is more or less affected by international agreements. Development work cannot be carried to the final stages without knowledge of at least the frequencies on which the gear is to work.

At long last a beginning has been made. The "International Meeting on Radio Aids to Marine Navigation" held in London from 7th to 22nd May is, we hope, but the forerunner of many other international gatherings in the near future. Though the meeting was not empowered to make decisions binding on the score of nations represented, its deliberations have done much to pave the way for later conferences with fuller powers. Congratulations are due to all concerned, and especially to those who conceived the idea—the Radio Board, we believe—and to Sir Robert Watson Watt for his able chairmanship.

Sir Robert's summing-up showed that a good measure of agreement has been reached on many points. Radar naturally had most of the limelight; the meeting was convinced that it would be of very great value to navigation and for the avoidance of collisions. The kind of equipment envisaged would work on a wavelength not exceeding 10 cm—probably well below—with a Plan Position Indicator as an essential part. Cheap and over-simplified gear was thought likely to be more of a danger than a help, while even "half-price radar" would involve unwarranted sacrifice of performance. The installation of "passive" radar reflectors as navigational marks giving a characteristic geometric pattern was approved, and it was thought that there were occasions where responder beacons would be useful.

Medium-frequency direction-finding on classical

principles was concluded to be likely to remain an indispensable aid to the mariner for many years, while shore-based short-wave D.F. is valuable for rescue operations. The Consol system (described elsewhere in this issue) gives us a good deal for comparatively little. Phase-comparison systems were considered to be "unrivalled in the accuracy which they can offer in pilotage operations, but suffer certain inconveniences at greater distances." Pulse-timing systems "fall just short of the existing phase comparison systems." All these position-finding systems would, of course, be used in conjunction with, and not instead of, a P.P.I.

Position finding at very long distances was less thoroughly examined by the meeting, and it was admitted that knowledge on this subject was still inadequate. The feeling was that services of this kind should be shared with aircraft.

Preliminary International Discussions

In concluding his summing-up, Sir Robert Watson Watt emphasized the preparatory nature of the meeting, which he described as a sort of pre-digestive apparatus for future conferences. But the work of the meeting is none the less valuable on that account; indeed, radio is now so complex that a similar pre-digestive process might with advantage precede all international conferences. It is certainly a step in the right direction that the radio technicians and organizers of the nations have been able to discuss freely, both formally and informally, matters that will have to be decided internationally when the present antiquated regulations are revised.

The shipowner must now be convinced of the benefits that modern radio technique has to offer him. Much has already been done by the Ministry of Transport, who, with the help of the Admiralty Signal Establishment, have taken energetic steps to evolve and demonstrate mercantile marine radar equipment. It only remains to prove to the shipowner that the new radio aids can pay for themselves in more economical operation of his vessels.

C

EX-R.A.F.

Type R1155 Described

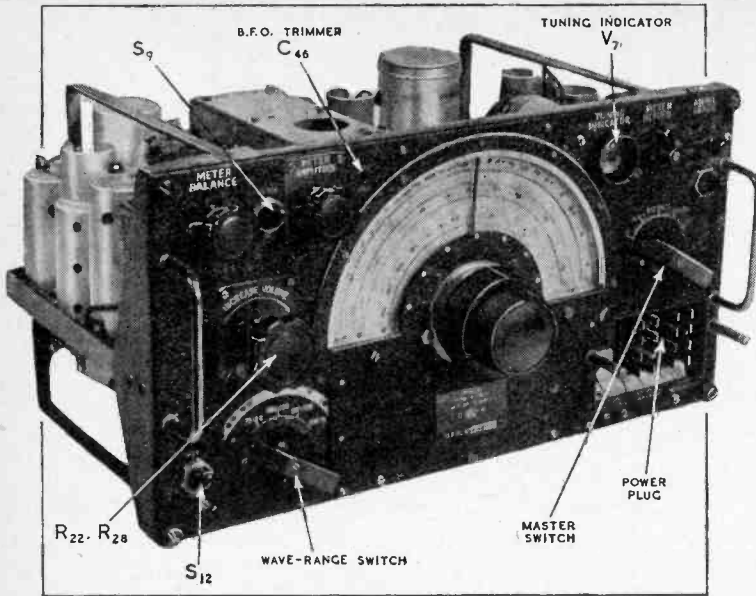

some of the redundant D.F. components. Fortunately, these circuits are quite independent of the main communication receiver; moreover, the removal of the D.F. valves will result in a considerable saving in L.T. current.

As the highest frequency covered by the set is only 18.5 Mc/s a converter will be required for the 10-metre amateur band, where the high sensitivity and selectivity of the R1155 should prove very useful. Its use may well be extended to take in the 5-metre band also, though the set's narrow bandwidth, whilst a great asset on all other amateur frequencies, may prove a little embarrassing owing to frequency stability problems at both transmitting and receiving stations.

Of the ten valves in the R1155, three are used in the D.F. circuits, one is a "magic-eye" tuning indicator and the remaining six

THE R.A.F. receiver Type R1155 was designed for use with the companion transmitter, the T1154, and at one time provided all the radio facilities needed in the air. Several modified versions of the set were produced, such as the R1155A, R1155B, etc., but they all embody

the same basic circuit in which a sensitive and selective super-heterodyne receiver is combined with facilities—generally unwanted for civilian ground use—for direction finding.

Its potentialities as a communication receiver have not yet been fully explored, but from the behaviour so far the writer feels confident that very little modification will be needed to satisfy

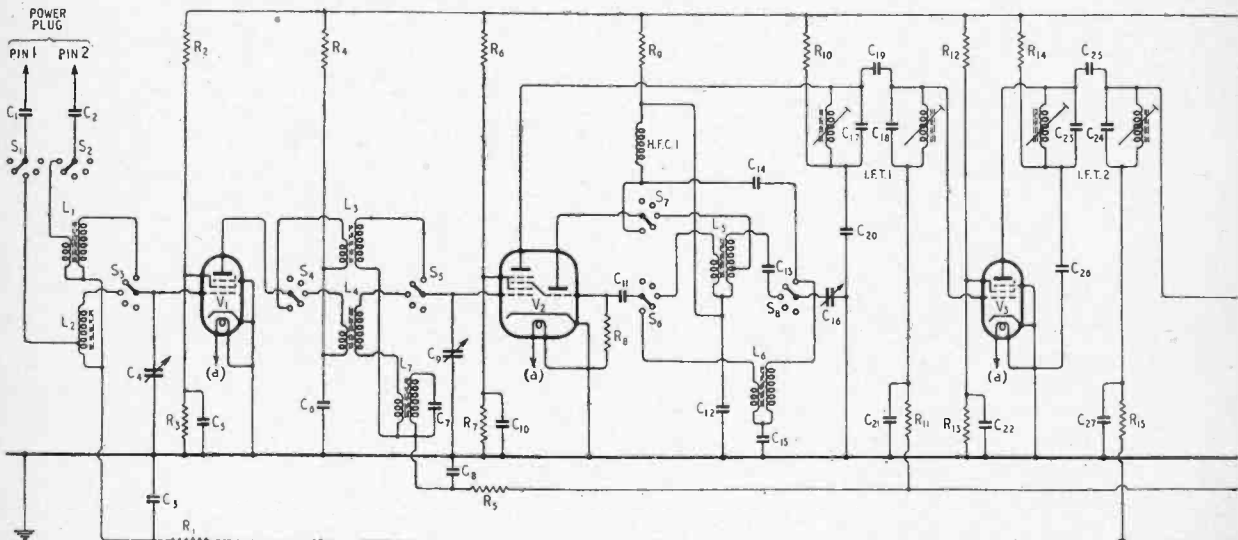

most requirements in this respect. One necessary modification is a standby switch for breaking the H.T. supply to mute the set during transmission periods. This will eventually be fitted when space has been made by removing

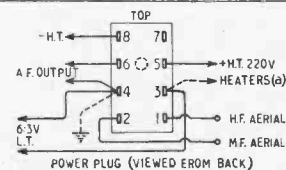

COMMUNICATION RECEIVER

Modifications for Civil Use

By "EX-SIGNALS"

are in the main receiver. Their functions are: signal frequency amplifier, frequency changer, two I.F. amplifiers operating at 560 kc/s, a double-diode-triode for second detector and output stage and another similar valve for A.V.C. and B.F.O. The B.F.O. incidentally, operates at half the intermediate frequency, e.g., 280 kc/s.

By omitting the D.F. circuits, all the D.F. switching and the less important receiver switching it is possible to produce a reasonably simple circuit showing its main features. This is reproduced here in Fig. 1.

Further simplification has been possible by including the coils for ranges 1 and 3 only, range 2 coils being the same design as for range 1, while those for ranges 4 and 5 are the same as for range 3.

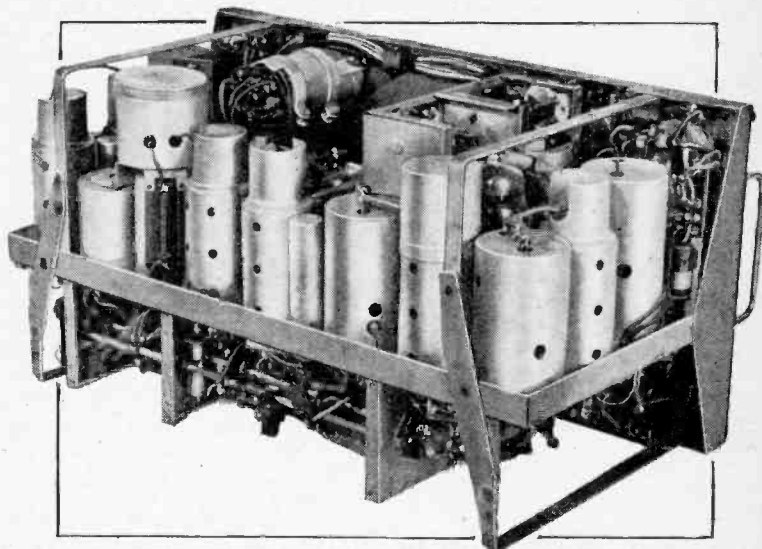

The accessibility of all valves is a feature of the receiver.

The full coverage of these five ranges is given in an accompanying table.

When used in aircraft the R1155 can be operated on any one of three different aerials. One is a

loop, another is a short fixed aerial and the third is a long trailing wire, which is let out only when the aircraft is airborne.

The switching selects the appropriate aerial of these three for the type of operation required; thus the loop is used for D.F., the fixed aerial on ranges 1 and 2, while the trailing wire comes into use on the lower frequency ranges 3, 4 and 5.

From the circuit diagram it will be seen that the two open aerials feed into the set via pins No. 1 and No. 2 on the power plug located at the bottom right-hand corner of the front panel. This is marked "From Transmitter." The position of these pins is as seen from the back, where the identifying markings are to be found. For normal reception the No. 1 and No. 2 pins can be joined together and taken to the aerial.

The simplified circuit

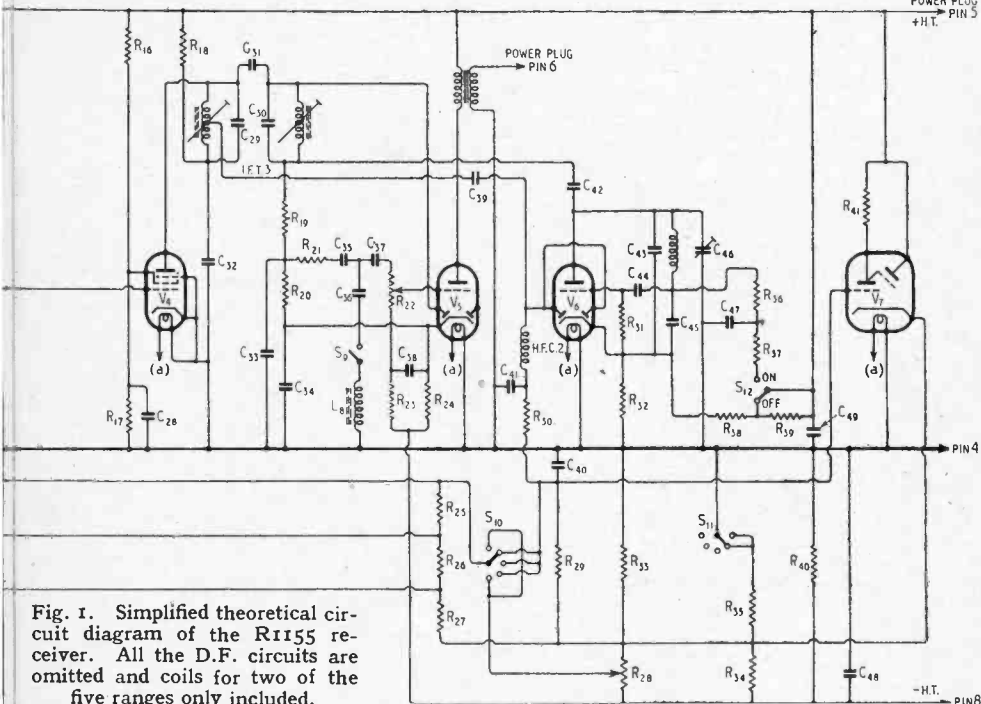

Fig. 1. Simplified theoretical circuit diagram of the R1155 receiver. All the D.F. circuits are omitted and coils for two of the five ranges only included.

VALVE POSITIONS

Ex-R.A.F. Communication Receiver— diagram is largely self-explanatory although there are a few features that might well be amplified. For example, the tuned circuit L_7, C_7 , which is an I.F. trap, has been included in the R.F. coupling on range 3 to prevent any tendency towards instability due to I.F. feedback via the signal circuits when these circuits are tuned close to the intermediate frequency.

All the R.F. and I.F. coils have iron dust cores with provision for adjustment. In the signal circuits these inductance trimmers are supplemented by small capacitor trimmers, but in the I.F. circuits trimming is effected solely by the adjustment of the cores. Furthermore, the I.F. couplings are mainly capacitive, the coupling capacitors being C_{19}, C_{25} and C_{31} .

The frequency changer oscillator is a little more complicated than usual, but it can be resolved into a tuned anode circuit with a loosely coupled grid coil. On ranges 1 and 2 the circuit is parallel fed and the associated R.F. chokes

Circuit Position	Service No.	Type	Function	Nearest Commercial Equivalents
V_1	VR100	R.F. Pentode	Sig. Freq. Amp.	Osram KTW63
V_2	VR99	Triode-Hexode	Freq. Changer	„ X65
V_3	VR100	R.F. Pentode	1st I.F. Amp.	„ KTW63
V_4	VR100	R.F. Pentode	2nd I.F. Amp.	„ KTW63
V_5	VR101	D.D. Triode	Det.; A.F. Amp.	„ DL63
V_6	VR101	D.D. Triode	A.V.C.; B.F.O.	„ DL63
V_7	VI103	C.R. Tuning Indicator	Tuning Indicator	„ Y61

are arranged to resonate just outside the low frequency end of their respective bands. Not shown in the circuit, but included in the set, are amplitude limiting resistors. These different circuit arrangements are adopted in order to render the calibration as independent as possible of valve characteristics.

Associated with the audio stage, V_6 , is a low-pass filter comprising

the capacitors C_{35}, C_{36} and C_{37} and the inductor L_8 . Its function is to filter out interference generated in the many electrical devices fitted in an aircraft. It has a cut-off at about 300 c/s.

Although there is provision for A.V.C. its use is optional and dependent on the position of the master switch, of which S_{10} is one unit. When in the extreme anti-clockwise position, marked "O," A.V.C. is inoperative and the gain of the R.F. and I.F. stages is controlled by the amount of negative bias applied by R_{28} . This bias is graded according to the requirements of these valves

This view of the receiver shows the position of the valves and most of the larger components. The annotation agrees with that on the theoretical circuit diagram.

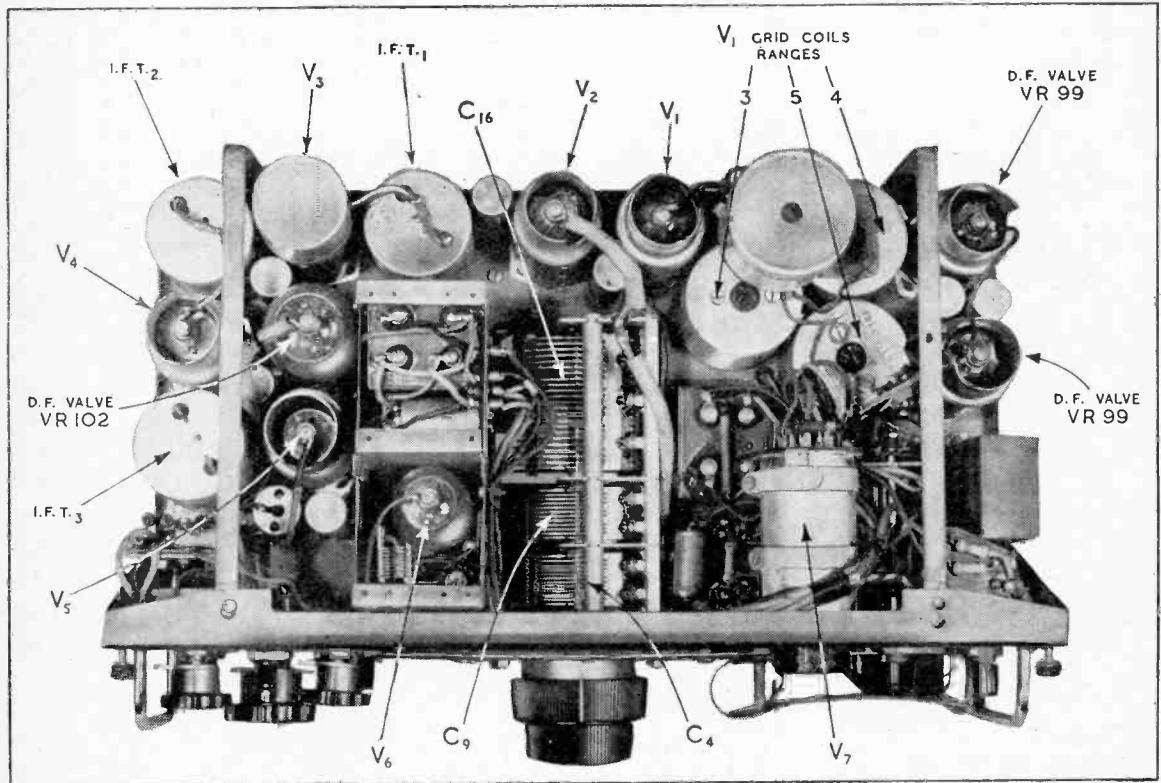

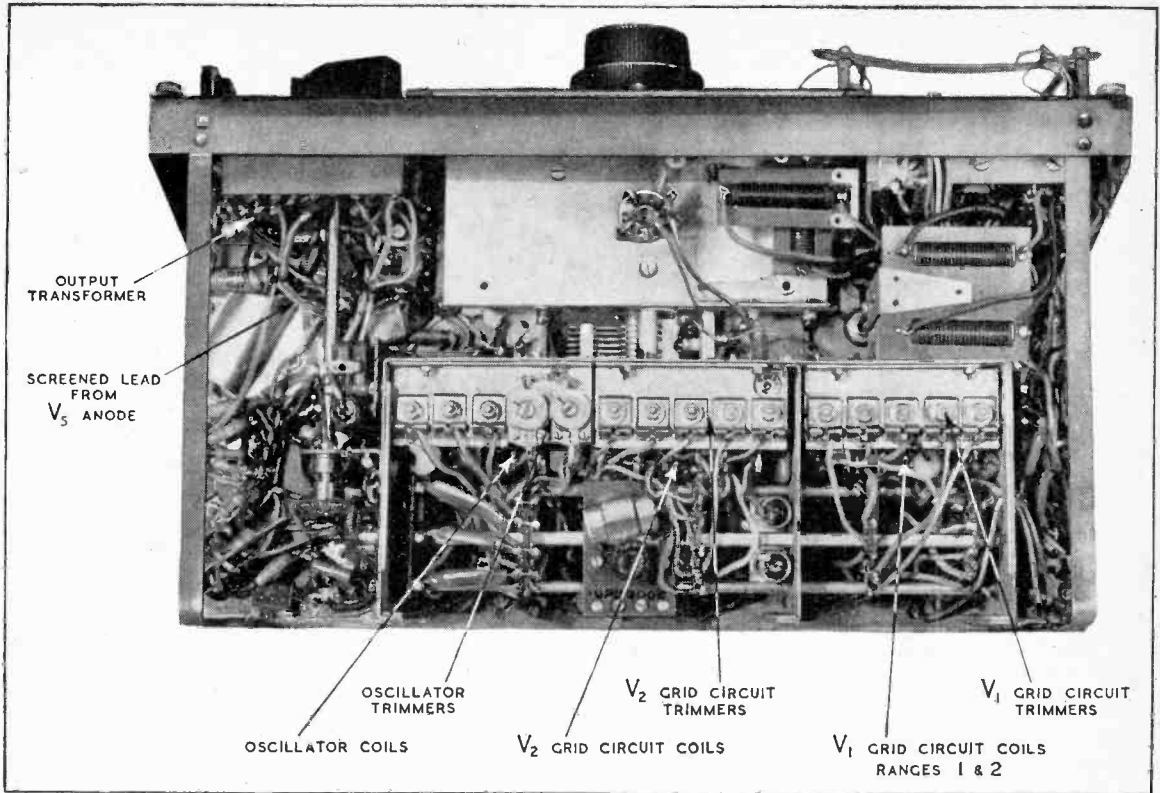

With the cover of the coil unit, which is below the chassis, removed the wavechange switches and all the trimming capacitors are accessible. Inductance trimmers are located on the vertical side of the coil box, facing the front panel.

by the resistance network R_{25} , R_{26} and R_{27} and is obtained from the resistor R_{40} connected between the H.T. negative and the earth line.

Ganged with R_{28} is another volume control potentiometer R_{22} , which functions on the A.F. signal only.

When the master switch is moved to the "A.V.C." position the gain of the R.F. and I.F. stages is controlled solely by the A.V.C. system, which has a standing delay of approximately 13 volts. The manual volume control then functions on R_{22} only, R_{28} being put out of action by S_{10} .

A minimum bias of between 3 and 4 volts is provided by R_{33} , but this is reduced slightly on the high frequency ranges 1 and 2 by bringing another resistor, R_{35} , in parallel with it. This is effected by S_{11} , which is part of the waveband switching comprising S_1 to S_8 inclusive. There are some additional switches, not included

in Fig. 1, for short-circuiting all the idle coils in the signal and oscillator stages.

The remaining three positions

of the master switch relate to direction finding so we are not concerned with them here.

When used in an aircraft the

RECEIVER CIRCUIT VALUES (FIG. 1)

Resistors

120 Ω	R_{33}
200 Ω	R_{35}
1,000 Ω	R_{24}, R_{32}
1.2 k Ω	R_{34}
1.5 k Ω	R_{37}
2 k Ω	R_{40}
2.2 k Ω	$R_4, R_{10}, R_{14}, R_{18}$
10 k Ω	R_{36}
22 k Ω	$R_3, R_7, R_9, R_{13}, R_{17}, R_{21}$
27 k Ω	$R_2, R_6, R_{12}, R_{16}, R_{27}, R_{39}$
30 k Ω	R_{38}
56 k Ω	$R_8, R_{19}, R_{30}, R_{31}$
100 k Ω	$R_1, R_5, R_{11}, R_{15}, R_{23}$
150 k Ω	R_{25}, R_{26}
470 k Ω	R_{20}
1 M Ω	R_{41}
2 M Ω	R_{29}

Potentiometers

50 k Ω	R_{28}
500 k Ω	R_{22}

Capacitors

2 pF	C_{19}, C_{25}
4 pF	C_{31}
15 pF	C_{14}
75 pF	C_{16} (pre-set)
100 pF	C_{33}, C_{42}, C_{44}
200 pF	$C_{17}, C_{11}, C_{40}, C_{41}$
300 pF	$C_{17}, C_{18}, C_{23}, C_{24}, C_{30}$
537 pF	C_{13}
600 pF	C_{29}
0.001 μ F	$C_2, C_{35}, C_{37}, C_{39}$
1,600 pF	C_{43}
0.002 μ F	C_7
0.004 μ F	C_{36}
4,550 pF	C_{45}
6,170 pF	C_{15}
0.05 μ F	C_5
0.1 μ F	$C_3, C_8, C_8, C_{10}, C_{12}, C_{20}, C_{21}, C_{22}, C_{26}, C_{27}, C_{28}, C_{32}, C_{34}, C_{38}, C_{47}$
2.5 μ F	C_{18}
4 μ F	C_{49}
Tuning Gang.	C_4, C_9, C_{15}

Ex-R.A.F. Communication Receiver—R1155 obtains its working voltages from a motor-generator, but for fixed station use a conventional-type mains supply unit is more practical.

This unit must give about 4 amps at 6.3 volt L.T. and 230 volts H.T. at between 60 and 70 mA. As the audio output is for headphones only it might be worth while to include a power output valve for operating a loudspeaker.

A saving of about 1.9 amps can be made in the L.T. supply if the three D.F. valves are removed. There will be no corresponding saving in H.T. current as these valves are virtually inoperative until the master switch is turned to one of the three D.F. positions.

The circuit diagram of a power unit found suitable for the R1155 is given in Fig. 2 and it includes a small tetrode for loudspeaker operation. Provision is also made for using headphones when required.

If a metal chassis is used for this power unit some precautions must be taken in its construction. In the receiver H.T. negative is not connected to the chassis as usual, but has the bias resistor R_{40} interposed. Thus if H.T. negative is joined to chassis in the power unit and the two chassis accidentally touch each other this resistor will be short-circuited.

The three smoothing electrolytic capacitors C_3 , C_4 and C_5 should be, therefore, either the waxed cardboard type or if assembled in metal cases be of the pattern in which the metal case is not connected to either of the capacitor leads.

It will be seen that two resistors, R_5 and R_6 are used in parallel for the grid bias supply to the KT63 valve. This is an

expedient adopted to enable standard resistors to be employed as the optimum bias resistor value for this valve is 420 ohms.

As shown in this circuit the input for the KT63 is taken from pin No. 6 on the power plug in

A simple form of tone control consisting of C_1 and R_3 is also included.

Acknowledgment is due to the

Fig. 2. Circuit diagram of a power supply unit for operating the R1155 from A.C. mains. Provision is made for headphones and loudspeaker reception.

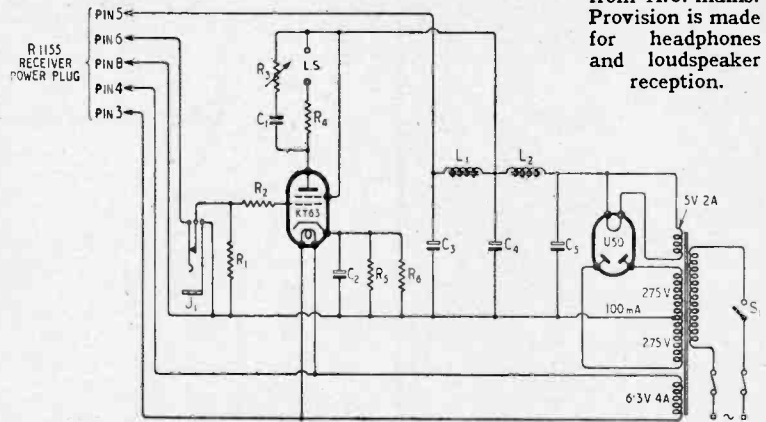

the R1155. This joins to the secondary of the telephone transformer, which in the writer's receiver has a ratio of approximately 1 to 1. It is to be found on the back of the front panel,

POWER UNIT CIRCUIT VALUES (FIG. 2)

- R_1 25 k Ω $\frac{1}{2}$ W
- R_2 5 k Ω $\frac{1}{2}$ W
- R_3 25 k Ω var.
- R_4 100 Ω $\frac{1}{2}$ W
- R_5 680 Ω 1 W
- R_6 1,200 Ω 1 W
- C_1 0.01 μ F
- C_2 25 μ F (25-V wkg.)
- C_3 16 μ F (450-V wkg.)
- C_4 8 μ F (450-V wkg.)
- C_5 8 μ F (450-V wkg.)

between the B.F.O. switch, S_{12} , and the spindle operating the wavechange switches and can be identified by the reference number 10K/12139.

This may not be the ideal method of connecting a power amplifier stage but it seems to be quite satisfactory from the performance point of view and has the advantage that no modification will be needed. The resistor R_1 is included to prevent the grid of the KT63 being "left in the air" when headphones are in use.

Controller of H.M. Stationery Office for making available technical literature giving circuit details and component values.

RADIO MATHEMATICS

THOUGH radio demands more mathematical knowledge than most other branches of electrical engineering it is a fact that students of the subject—and many whose student days, in the ordinary sense, are long past—often lack a sufficient mathematical background. A book just issued by our publishers should go a long way towards remedying this state of affairs.

In "Basic Mathematics for Radio Students" * by F. M. Colebrook, B.Sc., D.I.C., A.C.G.I., of the Radio Division National Physical Laboratory, the basic ideas of algebra, geometry and trigonometry are explained with a sympathetic understanding of the beginners' difficulties. While even very elementary matters receive attention, the principles of more advanced elements are treated in considerable detail.

While the book is written with the radio application in mind, it is almost equally helpful to students of other subjects, for these radio applications are in the main confined to the last chapter. The major part of the book deals with purely mathematical ideas.

* Pp. 270 + X : 77 figs. Published by Iliffe and Sons, Ltd., Dorset House, Stamford Street, London, S.E.1. Price 10s.6d.

WAVE-BAND COVERAGE

Range	Frequency	Wavelength (Metres)
1	18.5 Mc/s - 7.5 Mc/s	16.2-40
2	7.5 Mc/s - 3.0 Mc/s	40-100
3	1,500 kc/s - 600 kc/s	200-500
4	500 kc/s - 200 kc/s	600-1,500
5	200 kc/s - 75 kc/s	1,500-4,000

ELECTROMAGNETIC DEFLECTION

Television Line Scanning Amplifier

By W. T. COCKING, M.I.E.E.

ALTHOUGH it is employed in nearly every television receiver, the electromagnetic line-scanning system has received very little theoretical attention, if the published papers on the subject are any guide, and it is quite difficult to obtain reliable information about it. Most articles on it, and most textbook references to it, are of a purely descriptive character, and many are either incomplete or inaccurate. A notable exception is Jofeh's paper.¹

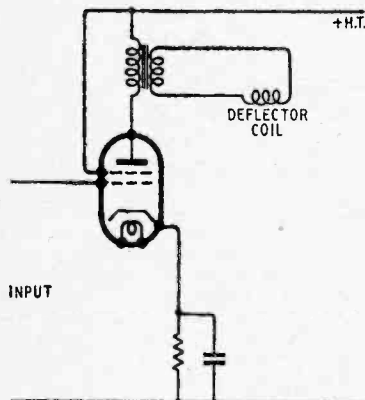

Fig. 1. Typical line scan output stage.

There are many possible circuit arrangements and even modes of operation for the same circuit. It is not possible to treat them all in a single article, and the present discussion will, therefore, be confined to the commonest practical case of a tetrode or pentode amplifier feeding the deflector coils through a transformer. The basic circuit is shown in Fig. 1, and it is assumed that the valve is supplied with a substantially perfect saw-tooth voltage input wave. This can be generated in any conventional saw-tooth oscillator.

By "substantially perfect" is

¹ "Electromagnetic Time-Base Amplifiers," by L. Jofeh, *Journ. Instn. El. Engrs.*, September 1939.

meant a wave in which the voltage rises linearly with time during the 84 μ sec allotted to the scan in the present transmission system and falls back again during the 14.8 μ sec allotted for the fly-back. The precise waveform during the fly-back need not be specified at this juncture.

The requirement is to produce a similar current wave in the deflector coils. The theory usually given is based on a Fourier analysis of a saw-tooth wave into a series of harmonically related sine and cosine waves. On this basis it is shown that the frequency response of the circuit must extend up to 20 times the fundamental, or 10 kc/s to 200 kc/s. Over this range frequency and phase distortion must be very small. As a result it is often stated that special materials are needed for the transformer core.

Now this does not agree with practical experience. It is not difficult to secure a linear scan and an adequate fly-back time using ordinary silicon steel for the transformer core. In actual fact, frequencies much greater than three times the fundamental need not be considered.

The misleading results obtained from the Fourier analysis are caused by the over-idealization

commonly the form of Fig. 2 (b) is adopted. This has a finite fly-back time, and consequently the higher harmonics in the series are of smaller amplitude and of less importance. However, the abrupt changes at the start and end of fly-back still give rise to very high frequency components.

In practice the saw-tooth wave-shape is much nearer Fig. 2 (c). The corners are rounded and very high frequencies are absent. The practical wave during fly-back is roughly that of one-half cycle of a damped cosinusoidal wave. As the fly-back time is 14.8 μ sec, the time of one-cycle is 29.6 μ sec, so that the "frequency" is 33.8 kc/s.

It is much simpler, however, to abandon all thoughts of frequency and to consider the circuit in terms of a combination of inductance, capacitance and resistance acted upon by unit impulses or linear currents at the appropriate intervals.

The circuit of Fig. 1 has the equivalent of Fig. 3 (a) in which E_a and μe_g represent the A.C. resistance of the valve and the equivalent grid voltage; r_p and r_s represent the series resistances of the primary and secondary of the transformer while L_p and L_s are the primary and secondary inductances and M is the mutual

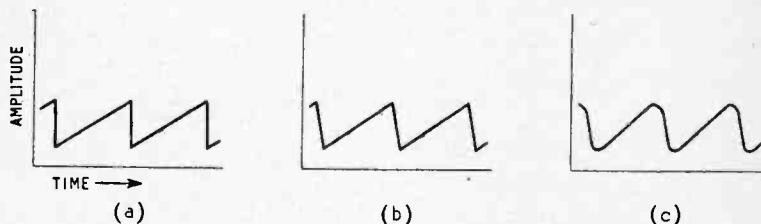

Fig. 2. Perfect saw-tooth waves with zero (a) and finite (b) fly-back times. A practical saw-tooth wave (c) is linear during the scan but curved during the fly-back.

of the saw-tooth wave. The analysis is often based on the perfect saw-tooth of Fig. 2 (a) with zero fly-back time. More

inductance between them. C_p and C_s are the total primary and secondary circuit capacitances, and R_c represents the core losses

Electromagnetic Deflection—

with any additional shunt damping included. L_L and R_L are the inductance and resistance of the deflector coil itself.

By well-known transformation theorems this circuit can be redrawn in the form of Fig. 3 (b), which is an exact equivalent of (a). Here the valve is represented by the constant current generator $g_m e_g$, where g_m is the mutual conductance. R_1 is equal to R_a and R_2 in parallel. The ratio of primary/secondary turns on the transformer is denoted by n and $k = M/\sqrt{L_p L_s}$ is the coupling coefficient.

For a period of time which we shall denote by t_1 , and which is actually $84 \mu\text{sec}$ for the present standards of transmission, it is required that the current through the coil L_L shall change linearly with time. The magnitude of the change of current depends on the deflector coil design, the tube and its operating voltage. With a value of 3 mH for L_L the current change is often about 0.6 A ; we shall denote this current change by I and the current at any instant of time t by i_L . Only times during the scan are of interest at the moment, so that t is limited to the range of values from $t = 0$ to $t = t_1$.

If the scan is to be linear the coil current must be

$$i_L = I t/t_1 + I_1$$

where I_1 represents any unidirectional unchanging current through L_L , and it is necessary so to design the circuit that this is achieved or very nearly so.

In order to simplify matters it will be assumed that in all cases the current taken by C_s , the secondary circuit capacitance, is negligible compared with the coil current i_L and that the effect of r_p is also negligible. This is usually true in practice and it enables the circuit to be simplified to the form of Fig. 3 (c).

If i_L is linear, the voltage E across L and R is simply $E = (IR t/t_1 + LI/t_1) k/n$. The first term is a linearly rising voltage, — the voltage drop across R , and the second is a constant voltage across L .

The total current required by the circuit during the scan is given by equation (1) in the

Appendix and will be seen to consist of three terms, one constant, one linear with time and one proportional to the square of time. It is usually inconvenient to make the valve supply this last term and the general course is so to choose circuit values that it is always negligible. The coil current is then no longer perfectly linear, but of exponential form. It is to be noted, however, that the normal curvature of the valve characteristics is in the right direction for the valve to supply a

linearity, and the L_p may take too much current for efficiency. Normally L_p should be at least ten times L .

The voltage E developed across the transformer primary has a maximum value of $(IR + LI/t_1) k/n$ when $t = t_1$ and it is in such a direction that it makes the valve anode negative with respect to positive H.T. It must not be too great in relation to the H.T. voltage, otherwise the anode-cathode voltage of the valve will be too small and the valve will cause serious non-linearity towards the end of the scan. Objects on the right-hand side of the picture will tend to be squeezed up.

With most valves 80 volts is a suitable minimum anode voltage, so that the minimum H.T. voltage needed is 80 volts plus the maximum scan-period back-E.M.F. across L . Equation (11) enables this to be calculated. It should be noted that the voltage so obtained does not include the drop across any cathode circuit or decoupling resistors.

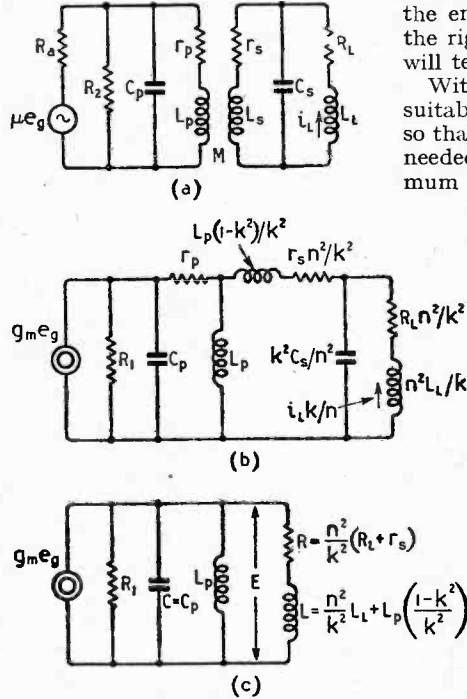

Fig. 3. The equivalent circuit of the amplifier of Fig. 1 is shown at (a) and a simplified, but exact, alternative at (b). In the latter n is the ratio of primary/secondary turns on the transformer. When C_s and r_p are small enough to be neglected, the simpler equivalent (c) can be used.

current of this form from a linear input. In practice, therefore, there is always some tendency for the valve to produce this component of current. Ignoring this tendency of the valve to correct for the non-linearity produced by a finite primary inductance, the non-linearity can be kept below some 2% if L_p is not less than the value given by equation (9).

In general, it is sufficient to choose L_p from this equation but if R is abnormally low the value obtained may be too low for efficiency. Apart from causing non-linearity the primary robs the coil of some of the linear current. If R is very low, only a low value of L_p is needed for

It is now necessary to consider what happens during the fly-back. At the end of the scan when the anode current has its maximum value the synchronizing pulse in the transmission triggers the time base. As a result the grid of the valve is driven very rapidly negative. In some cases the anode current is cut off completely, in others it is reduced to a low value.

In any case, there is an interval of $14.8 \mu\text{sec}$ during which the coil current must change by the full amount I . During the scan of $84 \mu\text{sec}$ it increases by this amount. During the shorter fly-back period it must decrease by the same amount.

The valve plays only a small part during this fly-back period. Provided that the fly-back time of its grid voltage is short compared with that of the anode circuit, its only important effect is that of its A.C. resistance in damping the anode circuit.

Time is now reckoned from the start of the fly-back and at $t = 0$, we have a resonant circuit L , C , R and R_1 in which there is a current i_0 through L and a voltage v_0 across C . The current is actually equal to I less the amount of any overshwing, of which more later. The voltage is the maximum back - E.M.F. across the circuit during the scan.

The behaviour of such a resonant circuit depends on the damping. In any case, the current must decay with time, but the way in which it does so depends on the damping. There are three possible conditions. One is called the condition of critical damping. The damping is the least possible without rendering the circuit oscillatory, and the decay of the current follows a complex exponential law.

With heavier damping the law of current decay is still more complex mathematically but the general shape of the decay curve

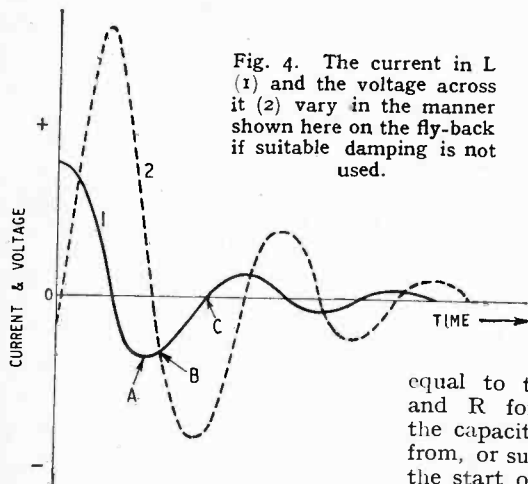

Fig. 4. The current in L (1) and the voltage across it (2) vary in the manner shown here on the fly-back if suitable damping is not used.

is very similar. The change of current takes rather longer to accomplish, however.

When the damping is less than critical the circuit is oscillatory. The coil current falls rapidly to zero, but then reverses and builds up in the opposite direction.

Having reached a negative maximum it again falls towards zero. Depending on the degree of damping, it may just fall back to zero, or it may overshoot the mark and swing positively again. The current oscillates at the natural frequency of the circuit and the number of cycles depends on the damping.

Now it is imperative that the circuit shall not be allowed to oscillate in this manner. Oscillations must not occur during the line scan for they would not only cause severe non-linearity of the scan, but through velocity modulation of the electron beam they would produce a series of light and dark streaks to appear on the left-hand side of the picture.

If oscillations were permitted they would have to be kept within the fly-back time. This would necessitate the use of a low value of inductance and the efficiency would be poor.

All this is well known and it is generally stated that the damping must be critical. This is not so, however, and an improved performance is secured with rather less damping than the critical value.

The reason for this is tied up with conditions existing at the start of the scan.

The necessary conditions which must exist if the scan is linear have already been given. At the instant of the start of the scan there must be a voltage IL/t_1 across L and if the current happens to be zero, also across C . If at this instant C is not so charged that the voltage across it is equal to that needed across L and R for a linear scan, then the capacitance will take current from, or supply current to, L and the start of the scan will not be linear.

With critical or higher damping the voltage across C is about zero at the end of fly-back, so that it must charge during the start of the scan and make it non-linear. This need not cause non-linearity during the actual picture scanning time for it is possible to

choose circuit values so that it falls within the period allotted in the transmission for fly-back. However, the fly-back proper must then be more rapid and this entails a lower value of inductance and reduced efficiency.

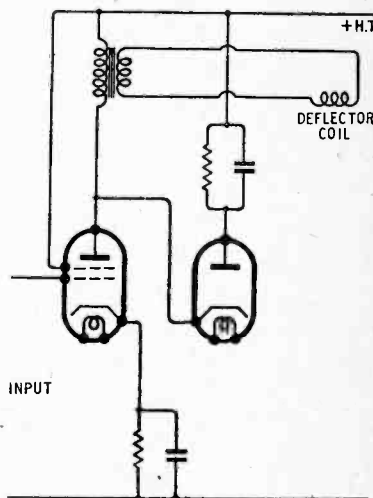

Fig. 5. In this circuit a diode is used to provide damping on the scan but not on the fly-back.

When the circuit is oscillatory and the damping is correct, matters can be so arranged that the overshwing charges the capacitance to the correct value to suit the start of the scan.

The general form of the coil current during fly-back when the circuit is oscillatory is shown by curve (1) of Fig. 4. The current falls through zero, reverses and reaches a negative maximum at A . It again passes through zero at C and in fact executes several cycles before finally ceasing. Between A and C , however, there is a point B at which the slope of the curve is the same as that of the scan stroke, so that if the subsequent tendency to oscillation could be curbed this would be the correct point at which to start the scan. As the current slope is the same as on the scan, the back-E.M.F. across L is also the same as on the scan and C is suitably charged to suit the scan conditions.

The subsequent oscillations can be curbed by increasing the damping during the scan. This necessitates the use of a diode connected as shown in Fig. 5. Curve (2) in

Electromagnetic Deflection—

Fig. 4 shows the voltage across C during the fly-back, in the form of the anode voltage of V_1 with respect to positive H.T. At the start of the fly-back it is about 100–200 volts below + H.T. It rises rapidly and reaches a maximum of 1,000–2,000 volts above + H.T. when the current is changing most rapidly and then falls back. The diode is non-conductive during this period because the charge on the capacitor in its anode circuit keeps its anode negative with respect to + H.T. during this time. When the anode potential of V_1 , and the cathode potential of V_2 , become negative again however, V_2 becomes conductive at the point B and then the capacitance and resistance in the anode circuit of the diode are effectively in shunt with the transformer primary and so increase the damping and prevent subsequent oscillation.

Although so-called damping-diodes are often used, the mode of operation and their purpose is often rather different from this. In this particular case, when the tetrode is providing current throughout the scan period, the advantage of a damping diode is insufficient to justify the difficulty of supplying its heater current.

By a critical choice of circuit values it is possible to achieve a similar result without a diode. It was shown earlier that for linearity on the scan the total current must comprise a constant and a linear current, that is, it must be a combination of a pulse and a saw-tooth. It was tacitly assumed that this would be supplied by the valve.

It need not be, however, for the overswing at the end of the fly-back can be utilized to provide the constant current and the valve need supply only the saw-tooth. This is an important simplification. The requirement is that at the time when the rate of change of current is equal to the slope of the scan current, and the voltage across C is equal to that needed at the start of the scan, the magnitude of the negative coil current shall also equal the steady current needed by R_1 and C during the scan. These equalities can be secured by the proper choice of circuit values.

In order that this small amount of overswing may be permitted, it is also necessary that the valve should not start to drive the linear current through the circuit until the end of the fly-back. A quick fly-back on the input voltage, a pause, and the start of the scan is the correct sequence of events.

It is not usually difficult to arrange this and in many cases it is obtained automatically, for the large peak voltage on the anode is fed back to the grid circuit in some degree through the grid-anode capacitance and is sufficient in many cases to inhibit the start of the scan.

Another way of looking at the matter is to consider the oscilla-

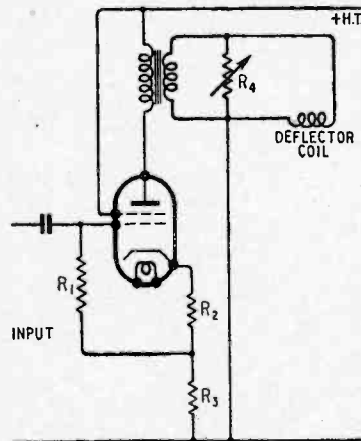

Fig. 6. Damping is provided by the resistance R_4 and negative feedback for linearizing the valve characteristic by R_2 and R_3 .

tion at the end of the fly-back as being cancelled by an equal and opposite oscillation produced by the shock of starting the scan at the correct instant.

An exact relation between the circuit values is difficult to obtain because of the complicated form of some of the circuit equations. However, an approximate solution is adequate for most requirements and is given in equations (6) to (12) in the Appendix.

It is necessary to measure or estimate certain quantities in order to employ them. These are the coupling coefficient k of the transformer, the secondary resistance r_s , and the primary circuit capacitance. The most difficult to estimate is k . It depends chiefly on the method of winding the

transformer, and there are certain approximate formulæ which are helpful in estimating it. As a rough guide, it tends to be about 0.99 when the primary and secondary are each adjacent or coaxial single sections. When they are two primary sections with one secondary interleaved between them it tends to be around 0.995.

The secondary resistance can only be estimated roughly until the transformer is designed, but one is not far wrong as a rule if it is taken as about one-half of R_L . The primary circuit capacitance depends largely upon the method of winding the transformer. In the interests of reducing the mean anode current of the valve it is important to keep it as small as possible. The inductance L is inversely proportional to C and n is approximately proportional to the square root of L . Consequently the saw-tooth current needed from the valve is nearly proportional to the square root of the capacitance.

The valve and wiring may be expected to give a capacitance of about 12 pF. In one transformer which the writer constructed, the measured primary capacitance was 130 pF. This is very high, and was caused by three factors; there was no sub-division of the primary, it was evenly layer wound with a winding length greater than the winding depth, and a plastic tape of fairly high dielectric constant was used between layers. This transformer was a first model, constructed before the importance of a low primary capacitance was fully realized.

A second transformer was wound on three concentric bobbins, the primary being split between the inner and outer, with the secondary on the middle one. In addition, each half-primary was sub-divided into three sections. In these sub-sections the primary was evenly layer wound with paper interleaving between layers. This form of construction reduced the self-capacitance from 130 pF to 39 pF and increased k from 0.99 to about 0.995.

With the first transformer the total primary circuit capacitance was 142 pF and with the second it was 51 pF. The effect of this on the other circuit constants is

shown by the figures given in Table I, for $I = 0.6$ A, $L_L = 3$ mH, and $R_L + r_s = 10\Omega$. The most important difference lies in the values of the current outputs required from the valve. The mean anode current of the valve must be one-half of Δi_a plus the minimum anode current permissible for reasonable linearity. This is usually 10–20 mA, so that with the first transformer the mean anode current must be of the order of 90–100 mA, whereas with the second it need be only 55–65 mA.

TABLE I

C	= 142 pF	51 pF
k	= 0.99	0.995
L	= 63.5 mH	176 mH
R_1	= 16.4 k Ω	46.6 k Ω
n	= 4.06 : 1	7.2 : 1
L_p	= 0.69 H	2.16 H
Δi_a	= 162 mA	91 mA
E_{HT}	= 216 v	298 v
V_{max}	= 1,280 v	1,980 v

A disadvantage of the low capacitance winding is the higher peak voltage developed during the fly-back, and it calls for correspondingly better insulation. There is nothing that can be done about it, however, and it is inevitable that a reduction of the current should increase the voltage.

Some words about R_1 may be advisable. The value calculated is not the value of a resistance to be connected across the trans-

needed will be higher than R_1/n^2 , but how much higher depends on the iron losses. In an example above, R_1 was 46.6k Ω with $n^2 = 51.5$, so that the minimum value of the secondary shunt resistance would be 910 Ω . A variable resistor with a maximum value of 5 k Ω would probably be about right.

The final circuit is, therefore, as shown in Fig. 6, in which R_2 is the bias resistance of the valve and R_3 provides additional feedback; R_4 controls the damping. The circuit is most easily adjusted with an oscilloscope connected across a resistance of some 10 Ω inserted in series with the deflector coil.

With excessive damping the picture obtained takes the form shown in Fig. 7 (a); the end of the fly-back is slow and rounded. With inadequate damping (b) there is overshoot. With the correct damping the wave takes the form (c) with quite an abrupt transition from the fly-back to the gentle slope of the scan.

This adjustment is best carried out in the first instance with quite a small input to the valve. The other adjustments are best carried out by looking at an actual picture. The input should be increased until the picture width is correct. If there is non-linearity on the left-hand side, so that objects appear increasingly

adequate linearity, the standing current in the valve should be increased by raising the screen voltage if this can be done without exceeding its rating. When the compression is abrupt rather than gradual, however, an inadequate anode voltage is the most probable cause and the H.T. voltage should be raised.

If the non-linearity is on the right-hand side of the picture, however, then provided that the input voltage to the valve is linear, the most probable cause is an inadequate anode voltage and this should be raised.

APPENDIX

When $r_s \ll R_1$ and $CR/2 \ll L/R_1$ —the usual practical case—the current required by the circuit during the scan time from $t = 0$ to $t = t_1$ is:—

$$i = \frac{I}{n} \left[\frac{L/R_1}{t_1} + \frac{t}{t_1} \left(1 + \frac{R}{R_1} + \frac{L}{L_p} \right) + \frac{t^2}{2 t_1 L_p/R} \right] \dots (1)$$

If L_p is large enough to make the term in t^2 negligible in comparison with the others, and the optimum circuit conditions exist, the linear current to be supplied by the valve is:—

$$i_a = \frac{I}{n} \cdot \frac{t}{t_1} \left(1 + \frac{R}{R_1} + \frac{L}{L_p} \right) \dots (2)$$

and the total peak-to-peak anode current is:

$$\Delta i_a = \frac{I}{n} \left(1 + \frac{R}{R_1} + \frac{L}{L_p} \right) \dots (3)$$

On the fly-back the coil current is

$$i_L = n i_o \left[\cos \omega t + \left\{ \frac{I}{\omega CR_1} - \frac{\alpha}{\omega - i_o \omega L} \right\} \sin \omega t \right] e^{-\alpha t} \dots (4)$$

and the back E.M.F. across the transformer primary is

$$v = v_o \left[\cos \omega t + \left\{ \frac{\alpha}{\omega - \omega CR_1} + \frac{i_o}{v_o \omega C} \right\} \sin \omega t \right] e^{-\alpha t} \dots (5)$$

where $\alpha = \frac{1}{2} \left(\frac{I}{CR_1} + \frac{R}{L} \right)$
 $\omega_o^2 = (1 + R/R_1)/LC$
 $\omega^2 = \omega_o^2 - \alpha^2$
 i_o = peak primary current at end of scan.
 v_o = peak primary voltage at end of scan (negative).
 I = peak-to-peak deflector coil current.

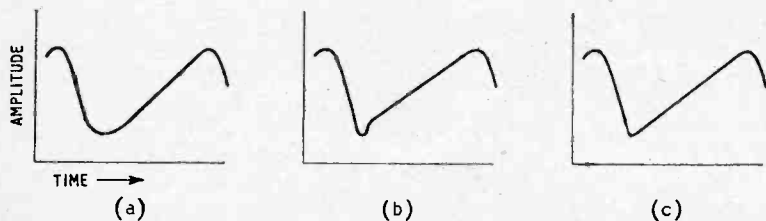

Fig. 7. The current waveforms with excessive and inadequate damping are shown at (a) and (b) respectively, while the wave with correct damping takes the form (c).

former primary, for it includes the A.C. resistance of the valve as well as transformer iron losses. In practice a variable resistor is connected across the transformer and adjusted for the best linearity. The adjustment is fairly critical.

It can be across either primary or secondary, but the latter is usually preferable since the voltage is lower. The resistance

compressed as they tend to the left, the most probable cause is valve curvature. Negative feedback should be increased by increasing R_3 , more input also being used to keep the output constant. As this increases the A.C. resistance of the valve, R_4 may have to be reduced slightly to avoid overshoot.

If this fails to bring about

Electromagnetic Deflection—

In the above equations, the fundamental units apply, i.e., volts, amperes, ohms, farads, henrys, seconds, and h has been assumed to be negligibly different from unity.

The following approximate formulæ enable circuit values to be determined for the conditions given in the text and a fly-back time of 14.8 μ sec and a scan time of 84 μ sec.

$$L = 9,000/C \text{ (mH, pF)} \quad (6)$$

$$R_1 = 2,330/C \text{ (k}\Omega, \text{ pF)} \quad (7)$$

$$n = \sqrt{\frac{L/L_L}{1 + 8.4(1-h)(R_L+r_s)/L_L}} \quad (8)$$

$$L_p^r = 4.2 n^2 (R_L + r_s) \text{ (mH, } \Omega) \quad (9)$$

$$\Delta i_a = \frac{I}{n} \left(1 + \frac{R}{R_1} + \frac{L}{L_p} \right) \text{ (mA, } \Omega, \text{ mH)} \quad (10)$$

$$E_{HT} \geq 80 + \frac{I}{n} (R + 11.9L) \text{ (V, A, } \Omega, \text{ mH)} \quad (11)$$

$$V_{max} = E_{HT} + \frac{I}{n} \cdot \frac{1.025 \times 10^6}{C} \text{ (V, A, pF)} \quad (12)$$

where

L = effective primary circuit inductance

L_p = transformer primary inductance.

L_L = deflector coil inductance.

R_L = deflector coil resistance.

r_s = transformer secondary resistance.

R_1 = shunt damping resistance on primary.

h = coupling coefficient of transformer.

n = turns ratio of transformer.

Δi_a = peak-to-peak anode current of valve.

I = peak-to-peak deflector coil current.

E_{HT} = voltage of + H.T. with respect to the valve cathode.

V_{max} = maximum anode-cathode voltage of valve during fly-back.

SHORT-WAVE CONDITIONS : Expectations for July

DURING May the average daytime maximum usable frequencies for this latitude were a little lower than during April, whilst the night-time M.U.F.'s were somewhat higher. This was in accordance with the normal seasonal trend. Frequencies up to 15 Mc/s were regularly usable over most circuits up to midnight, but long-distance communication on frequencies of the order of 28 Mc/s was relatively infrequent, except to places well to the southward of this country. Medium-distance communication on very high frequencies, though occasionally possible, was less frequent than had been anticipated, sporadic E having been less prevalent than was expected.

As was expected, short-wave conditions were less disturbed than during previous months. A few ionosphere storms did, however, occur, the main disturbance periods being 6th-7th, 9th, 11th, and 21st-24th.

Forecast.—Conditions for general long-distance short-wave communication during July should be much the same as during June; i.e., daytime M.U.F.'s will be rather low and night-time M.U.F.'s high. There should, in fact, be less difference between day and night frequencies than at any other time of year, and 15 Mc/s ought to be usable over many circuits till well after midnight. The possibilities of long-distance communication on very high frequencies should continue to be rather remote, except to places well to the south of this country. Medium-distance communication will be controlled by the E layer during a good part of the day, and so the tendency in this case will be for daytime as well as

By T. W. BENNINGTON

(Engineering Division, B.B.C.)

the month, for communication by way of the regular layers. night-time M.U.F.'s to be high. Communication to distances up to about 1,400 miles on exceptionally high frequencies should continue to be frequently possible by way of sporadic E.

Below are given, in terms of the broadcast bands, the working frequencies which should be regularly usable during July, for four long-distance circuits running in different directions from this country. In addition, a figure in brackets is given, this indicating the highest frequency likely to be usable for about 25 per cent of the time during

the month, for communication by way of the regular layers.

Montreal: 0000, 15 Mc/s (20 Mc/s); 0200, 11 Mc/s (18 Mc/s); 0900, 15 Mc/s (22 Mc/s); 1200, 17 Mc/s (25 Mc/s); 2300, 15 Mc/s (22 Mc/s).

Buenos Aires: 0000, 15 Mc/s (20 Mc/s); 0200, 11 or 9 Mc/s (15 Mc/s); 1000, 17 Mc/s (25 Mc/s); 1600, 21 Mc/s (27 Mc/s); 2000, 17 Mc/s (25 Mc/s); 2300, 15 Mc/s (20 Mc/s).

Capetown: 0000, 15 or 11 Mc/s (18 Mc/s); 0200, 11 Mc/s (15 Mc/s); 0600, 17 Mc/s (25 Mc/s); 0900, 21 Mc/s (32 Mc/s); 1400, 26 Mc/s (34 Mc/s); 1600, 21 Mc/s (31 Mc/s); 1900, 17 or 15 Mc/s (23 Mc/s); 2100, 15 or 11 Mc/s (18 Mc/s).

Chungking: 0000, 15 Mc/s (20 Mc/s); 0600, 17 Mc/s (24 Mc/s); 2000, 15 Mc/s (22 Mc/s).

During July short-wave conditions are usually relatively stable, ionosphere disturbances not being very frequent or severe at this time of year.

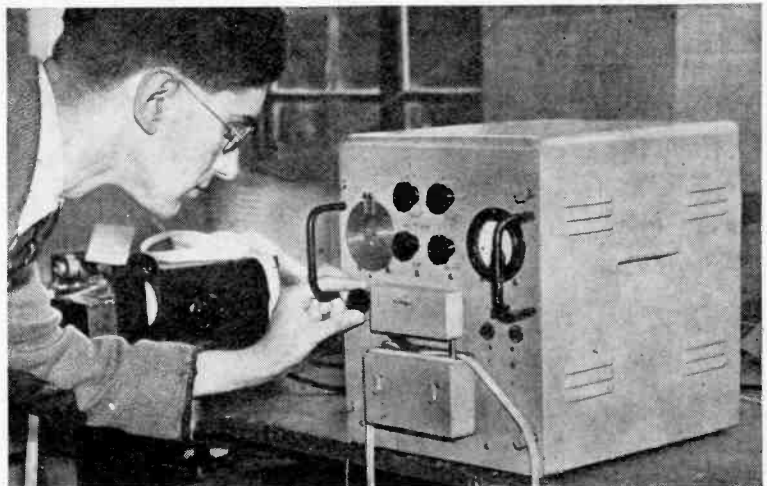

HIGH-SPEED ELECTRONIC KEYING.—This photo-electric automatic transmitter, developed by Marconi's in collaboration with Cable and Wireless, is designed for a speed of over 850 w.p.m.

AERIALS

Things Usually Taken for Granted

By "CATHODE RAY"

IT seems to be generally agreed that aerials don't get anything like their fair share of explanation. They should really get a very large share, because they are absolutely necessary in any radio system (otherwise it wouldn't be radio), and they deal with radiation, which is always a difficult thing to understand. Yet some quite substantial books on radio don't devote even one whole chapter to aerials. It was undoubtedly this ignorance that nourished the rampant growth of superstition in pre-war days, so that charlatans were able to get away with the most fantastic claims for their "patent aerials" until the shortage of metals stopped them. I am glad to see that so far it appears to be only the genuine types of proprietary aerials that have survived the war.

All the same, there is still need for more on aerials, especially as all sorts of interesting new types have cropped up during the war. I hope a good book on aerials will appear. The most I can try to do in a few pages is to help readers with an elementary knowledge to make sense of some of the things usually taken for granted by writers, such as radiation and induction fields, polarization, aerial gain, polar diagrams, and so on.

The first point is that there is no need to consider transmitting and receiving separately, because the properties of any aerial are the same—in reverse—for both. That is a rough way of stating what is called the reciprocity theorem for aerials. For example, if an aerial radiates a narrow beam in a particular direction, it will also confine its reception to that direction, given the same frequency in both cases.

The next thing to keep in mind is that electromagnetic radiation, as its name implies, is composed of travelling electric and magnetic fields. A good deal of the early stages of radio theory is given to the ordinary electric and magnetic fields produced respectively by potential differences (or voltages)

and currents. Coming later to radiation—which itself is difficult enough to grasp—one can hardly fail to be confused by the impression that its fields are the same, but different from those already studied. So let's get this clear now.

The ordinary (or induction) fields and the radiation fields are the same, as fields, but differ in the ways they are started and maintained. The induction fields are maintained by circuit voltages or currents; a constant current causes a constant stationary magnetic field of proportionate strength; and similarly for voltage and electric field, say, between the plates of a condenser—beg pardon, capacitor. Now an electric current is really a stream of moving electric charges, that is to say, centres of electric field. So a moving electric field generates a magnetic field. And (as may be confirmed by a visit to any electric power station) a moving magnetic field generates an electric field. So if you can persuade both sorts of field to move along together in the right sort of way, each will keep the other going, on a sort of "I'll scratch your back if you'll scratch mine" arrangement, and they become entirely independent of any circuit for their maintenance.

Velocity of Propagation

There must obviously be equal quantities of each field, and they can only exist so long as they keep moving. They have to move at 186,000 miles or so per second in air or empty space, but in material that multiplies the electric or magnetic lines by its permeability or permittivity, a rather slower pace is sufficient.

Another essential is that the two fields are at right angles to one another and to the direction of motion. If you imagine a piece of graph paper travelling face forwards at 186,000 m.p.s., the "X" lines could represent the

magnetic lines of force, the "Y" lines the electric force, and the paper itself any particular wave crest.

As I have already said, a constant current causes a constant stationary magnetic field. But it produces no radiation field at all. What is wanted is movement, change. Radiation is proportional to the rate at which the strength of the current is changing. The most practical way of making it keep on changing all the time is to use oscillating currents, which, of course, need oscillating voltages to drive them. The higher the frequency the faster they change. So the strength of radiation is proportional to:

- (i) the peak or r.m.s. value, and
 - (ii) the frequency of the current and voltage.
- (ii) is the reason why high frequencies are called radio frequencies, and why very low frequencies are no good for radio.

The radiation fields leave home and are independent of the parental currents and voltages the moment they are born, because of their mutual assistance pact. Another feature resulting from these circumstances is that their strength falls off only in proportion to their distance from the source, whereas the induction fields decrease as the square of the distance. So whereas the induction fields are relatively strong close to the source, they are negligible at distances over which the radiation fields can be used for communication.

As the two radiation fields are always equal, it doesn't matter which is used for specifying strength; but the electric field is nearly always chosen. If the field at any particular place is, say, 2 millivolts per metre, it means that each metre of receiving aerial wire parallel to the electric field at that place will have 2 millivolts induced in it.

At the sending end it is convenient to consider the radiation as being due to the current. A

Aerials—

given alternating current passing through 2 in of wire radiates twice as much as the same current through 1 in. That doesn't necessarily mean that the field at any point outside will be twice as

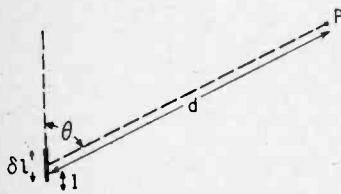

Fig. 1. The various things that decide how strong the radiation from a short length (δl) of aerial will be at any point P.

great. The whole of the 2 in can't be at exactly the same spot, and therefore the radiation from the different parts of it may have to travel slightly different distances and so not arrive in phase. If 2 in is negligible compared with the wavelength, this isn't worth quibbling about; but if the wavelength is, say, 10 centimetres, then 2 in. is about half a wavelength and the radiation from different parts of it will be considerably out of phase in some directions.

That is the basis of directional aerials; but before getting on to that important part of the subject, let us just finish listing the things radiation is proportional to. They can be put like this:

Field strength at any point P (see Fig. 1) is proportional to
$$\frac{I f \delta l \sin \theta}{d}$$

where

I = current flowing in the aerial. If the r.m.s. value is used, then the field strength will be r.m.s., too.

f = frequency of I .

δl = length of wire in which I is flowing. The δ indicates that the length must be very small compared with the wavelength. The question of how to reckon a whole aerial comes later.

θ = angle that δl makes with the line joining δl to P.

d = distance of P from δl .

We have already dealt with all these factors except $\sin \theta$. That comes in because field strength is one of those things known as vector quantities, which have direction as well as magnitude. The direction of the electric field is parallel to δl , and the magnetic field is at right angles to it. That goes for both induction and radiation fields, and as the fact that the magnetic field makes rings round the current is impressed on us in our electrical ABC it is easily remembered. Getting back to the electric field, however, it would make no difference, so far as P could tell, if δl were replaced by two bits of wire (carrying the same current, I) at right angles to one another, as shown magnified in Fig. 2. Both bits radiate at right angles to themselves and so the bit end-on to P contributes nothing to P, whereas the other bit, $\delta l \sin \theta$ in length, radiates directly towards P, and therefore is the one included in the formula.

It need hardly be mentioned that δl and P are assumed to be in empty space with nothing else anywhere near to complicate the problem. The inevitable complications, notably the earth, come later.

To calculate the actual field strength at P it is necessary to put into the formula some constants such as the inevitable π and others depending on the units used. I don't think it is worth going into farther, because in practice actual field strengths are so much messed about by the earthly complications just alluded to that this one formula is seldom of much use. So far as the aerial

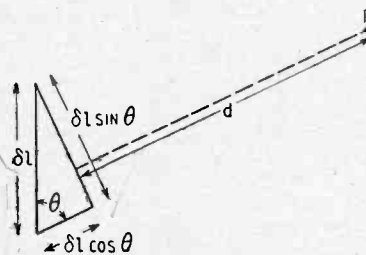

Fig. 2. The radiation from δl can be resolved into two parts, only one of which ($\delta l \sin \theta$) is any use to P.

itself is concerned, one is not so much interested in the absolute

field strength anywhere as in the relative strengths in different directions.

The best way of showing these is by a polar diagram, in which a line is drawn around a point that represents the position of the aerial, the distance of the line away from that point in any direction representing the relative radiation (or reception) in that direction. The polar diagram ought really to be a 3-dimensional model, to show all directions in space; but publishers are so unaccommodating in this matter that one has to be content with showing a single plane at a time.

For example, as the radiation from δl is proportional to $\sin \theta$ (Fig. 2) all we have to do to make

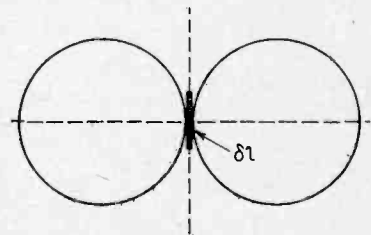

Fig. 3. Polar diagram of a small section of aerial (δl) by itself, in the plane containing δl .

the polar diagram for it is to take a good many values of θ and plot points along those directions at distances equal to $\sin \theta$. The result of joining up the points (as a little geometry would indicate without the bother of actual plotting) is a "figure 8" consisting of two circles touching at the aerial position (Fig. 3). This indicates zero radiation end-on and maximum broadside-on, with maximum much less "sharp" than the zero. It is one cross-section of the polar model, which is like a doughnut (American pattern). The polar diagram in the plane at right angles to δl is a circle with δl as centre— δl is omni-directional in that plane.

So far there has been a lot of emphasis on δl , considering that it is a figment of the imagination, quite unrealizable in practice. The current, I , can't just cease to exist after it has passed through δl . The time has come, then, to talk about whole aerials, in which the length is enough to provide capacitance paths for I to leave by,

as suggested in Fig. 4. So far we have found how the radiation field around any very small bit of aerial is calculated. The field from the whole aerial is determined by adding up the contributions of each little bit, taking account of their phases and directions. For simple aerial shapes this isn't quite so hard as it may sound, but it does involve the integral calculus. When applied to a half-wave dipole aerial, which is one of the simplest kinds that forms a complete oscillating circuit by itself, and consists of a rod or wire half a wavelength long (less a small percentage for "end effect"), the resulting polar diagram is only slightly different from Fig. 3. The circles are a trifle elongated, as if the doughnut had been lightly sat on.

This dipole is not only very

useful as a practical aerial; it is a good theoretical starting

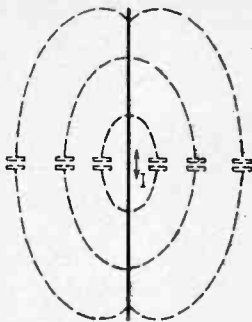

Fig. 4. The current in a dipole is greatest at the centre and tapers off at the ends because of distributed capacitance, as suggested by the dotted lines.

point for working out (next month) what more complicated aerials do.

MANUFACTURERS' LITERATURE

ILLUSTRATED lists and technical data relating to "Variac" transformers and "Ceramide" embedded resistance units, from the Zenith Electric Co., Villiers Road, London, N.W.2.

Descriptive leaflet dealing with the "Op-Timer" electronic process timer made by Process Control Gear, 56, Victoria Street, St. Albans, Herts.

Illustrated leaflet giving particulars of interchangeable instrument panels and racks from Sound Sales, West Street, Farnham.

Publication No. E.E.2 from Westinghouse Brake and Signal Co., Pew Hill House, Chippenham, Wilts, dealing with the frequency-compensated "Stabilistor" A.C. voltage stabiliser.

Illustrated supplement (1946) to "Modern Soldering" giving notes on the selection of suitable alloys and gauges, from Multicore Solders, Ltd., Mellier House, Albemarle Street, London, W.1.

AUTO RADIOGRAMPHONE

FROM a preliminary inspection of the details of the new Model 1046G there seems little doubt that it will worthily uphold the pre-war R.G.D. reputation for high quality radiogramophones. The radio chassis is of unusually clean design and all trimmers are readily accessible. Unit construction has been adopted and the R.F. coil unit and switch, I.F. coil unit, etc., can be

Comprehensive Specification in R.G.D. Post-war Model

removed separately for service.

In addition to the usual medium- and long-wave ranges there are three short-wave ranges covering 13.8 to 52 metres and a split rotor

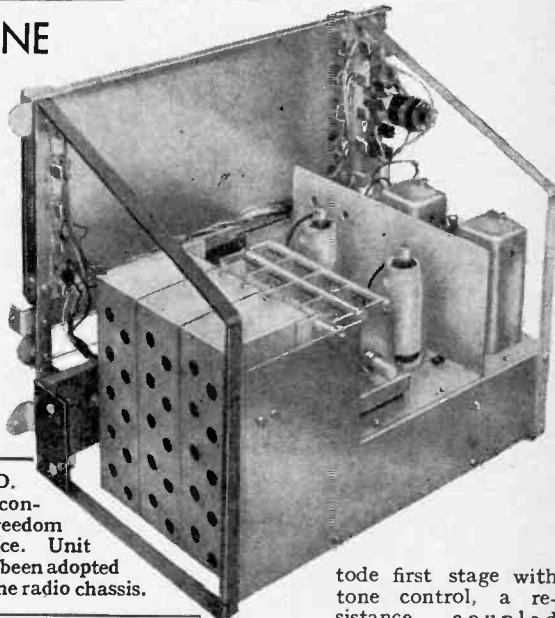

The cabinet of the R.G.D. Model 1046G is of rigid construction to ensure freedom from bass resonance. Unit construction has been adopted in the design of the radio chassis.



tone first stage with tone control, a resistance coupled "concertina" phase splitter and two PP3/250 triodes in push-pull giving 8 watts with less than 3 per cent total harmonic distortion. The loudspeaker is a 12-inch duplex cone with a frequency response of 40-10,000 c/s.

On the gramophone side, the Garrard record changer is fitted with a new lightweight pick-up using a permanent sapphire stylus.

The price of the Model 1046G is £148 is. plus £31 13s. 4d. purchase tax, and the makers are The Radio Gramophone Development Co., Bridgnorth, Shropshire.

tuning condenser gives band-spread tuning on the short waves. The frequency changer is preceded by a tuned R.F. stage and followed by one stage of I.F. amplification with three degrees of selectivity. The triode section of the double diode triode second detector is used as a pre-amplifier for the gramophone pick-up. A "magic eye" tuning indicator is included.

The amplifier and power supply unit comprises a pen-

Test Report

SOBELL Type 615

A.C. Table Model Superheterodyne
(Five Valves + Rectifier)

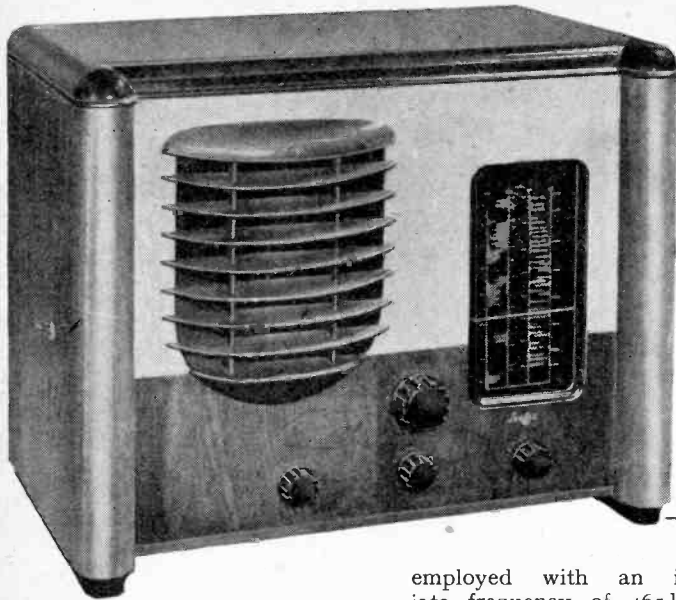

WAVERANGES

Short (1)	- 11.2 to 25.2 metres
Short (2)	- 24.8 to 53 "
Medium	- 194 to 578 "
Long	- 880 to 2,100 "

Price: £19 19s. plus
£4 5s. 10d. tax

THE receiver is housed in an imposing looking cabinet which has this technical justification that the effective baffle area is increased and the quality of reproduction is decidedly above the average for a table model.

The set is backed by a comprehensive free maintenance scheme for two years. In the event of breakdown the fault will be remedied or the chassis changed on the spot by one of the maker's servicemen.

Circuit.—The frequency changer, which is neutralized, is coupled to the aerial by tuned coupling transformers with a damped high-inductance primary on medium waves. An I.F. rejector circuit is connected across aerial and earth. On the two short-wave bands fixed condensers are connected in series with both sections of the main tuning condenser to give an extended scale.

Two I.F. stages are

employed with an intermediate frequency of 465 kc/s. A double-diode-triode follows the I.F. amplifiers and the A.V.C. diode is fed from the primary of the output I.F. transformer. The full A.V.C. voltage is applied to both I.F. valves, a fraction to the mixer stage and a smaller fraction to the first A.F. stage. Both tone and volume

control is effected in the coupling between the signal diode and the grid of the first A.F. stage, and the values are chosen to give both bass and top lift automatically when volume is reduced. A beam tetrode is used in the output stage with negative feedback from the secondary of the output transformer to the cathode of the preceding stage. The feed-

back from the secondary of the output transformer to the cathode of the preceding stage. The feed-

control is effected in the coupling between the signal diode and the grid of the first A.F. stage, and the values are chosen to give both bass and top lift automatically when volume is reduced. A beam tetrode is used in the output stage with negative feedback from the secondary of the output transformer to the cathode of the preceding stage. The feed-

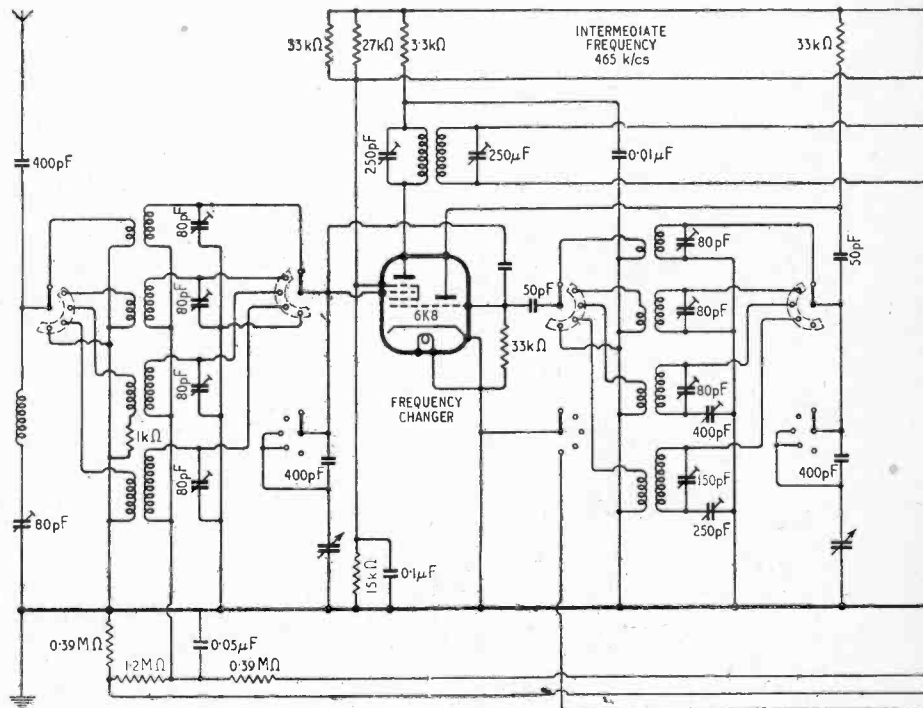

back is increased when reproducing gramophone records.

Bias for the output stage, for the A.V.C. delay and the initial bias on the mixer and I.F. stages is derived from the volt drop in a resistor in the -H.T. return. Alternative values of initial bias give two degrees of sensitivity.

Performance.—The quality of reproduction at once creates a favourable impression. In keeping with the size of the set, it is "spacious" and does not appear to emanate from a point source, as in many table models. The lower register has breadth and an extended top response gives clarity and brightness without being shrill. The top cut available in the tone control is not as drastic as usual and it is virtually impossible to extract really muffled speech or music; there is just enough cut to deal with background noise on weak distant stations. However, the average listener will find all the entertainment he wants in the wide choice of stations above threshold level. With two I.F. stages there is no lack of sensitivity and the selectivity is exceptionally good. The division of the short-wave range

The loudspeaker is small, but the baffle area provided by the large cabinet gives "console" quality.

into two parts gives a degree of band spread which makes for ease of tuning and both ranges provide a wide choice of stations. The sensitivity is well maintained at the high-frequency end.

A few whistles are distributed throughout all waveranges, but are not likely to cause any trouble. The only one of any consequence was on long waves and well clear of any stations.

Constructional Details. — The chassis is of ample size and components are well spaced. Inspection of the underside can be carried out, without removing the chassis from the cabinet, by re-

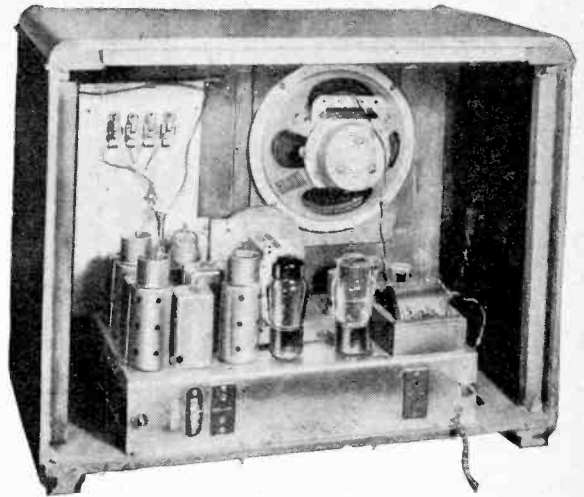

moving a panel from the base. A two-speed tuning drive is provided and the scale length is 7 in.

The finish of the cabinet work is of a high order and the only criticism we have to offer is that the on-off switch on the left-hand side is rather prominent and might have been recessed.

Makers. — Sobell Industries, Ltd., Amersham, Bucks.

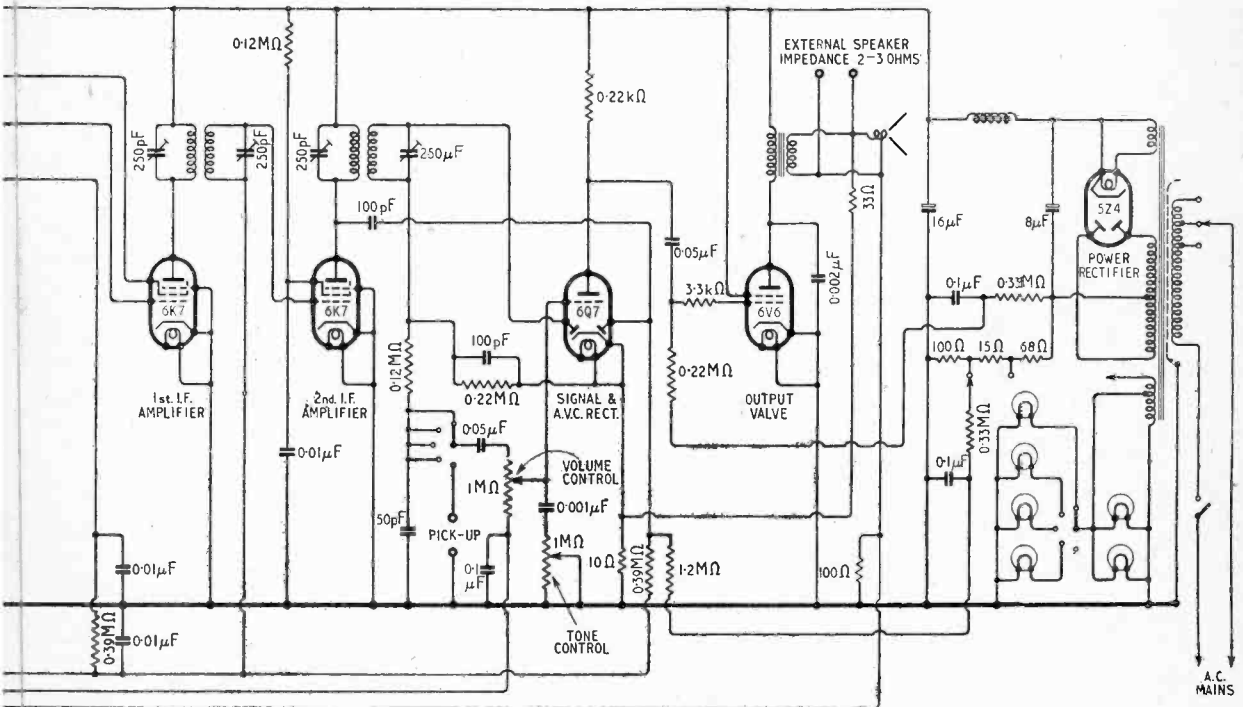

WORLD OF WIRELESS

DEATH OF BAIRD

IT is with deep regret that we have to record the death, on June 13th, of John Logie Baird at the age of 57. Baird died within a week of the post-war restarting of the British Television Service, for which he did so much to pave the way. His greatest contribution to television may be summed up in the words: "He was the first to make it work." His first real picture, with gradations of light and shade, was produced in 1926, though his earliest technical writings had appeared in *Wireless World* in 1924. Baird 30-line television was used experimentally by the B.B.C. in 1929.

NEW PICTURE TRANSMITTER

A VERY high standard of definition is reached in the Muirhead-Jarvis picture transmission system recently demonstrated. The quality of the prints with 100 or 150 lines per inch is indistinguishable from the original without the aid of a magnifying glass.

Mechanically the transmitting and receiving mechanisms are similar and have interchangeable parts. The drum is 10 in long and has an effective circumference of 10½ in; it is driven by a phonic motor assisted by a D.C. motor. The picture to be transmitted is floodlit and elements are selected by means of an objective lens and fixed aperture; the reflected light is directed on a photocell. At the receiving end a Muirhead-Duddell oscillograph is arranged to form an image on the sensitized paper and tones are defined by the movement of the reflected beam over a shaped aperture.

A conventional scanning system is

used except that the carriage is moved in discrete steps by means of a ratchet. This results in a reduction in the number of gears.

NATIONAL HEARING AIDS

A STATE production, a State monopoly," was the summary of Lord Walkden when announcing in the House of Lords the Government's scheme for the production and distribution of national hearing aids. He added: "We are not going to throw this invention over for exploitation."

This new aid, which was evolved by the Medical Research Council, with the assistance of the G.P.O. Research Station, will be supplied free to all who need it when the National Health Service comes into operation in 1948. Facilities for the servicing and maintenance of the hearing aid, including the provision of new batteries, will be provided.

It was stated by his Lordship that if the hearing aids are available before the National Health Service comes into operation they will cost about £10. In the meantime the Government "will do their best to make arrangements for the supply of hearing aids."

The Hearing Aid Manufacturers' Association takes exception to the Ministry of Health's all-embracing charges of commercial exploitation of the deaf, made earlier, and points out that in 1943 the Association co-operated with the National Institute for the Deaf to evolve a specification for a standard aid which would have sold at 10 guineas. Wartime shortages and lack of Government support to the scheme prevented it coming to fruition.

LICENCE FEES

ANY ambiguity in the statement in the House on the introduction on June 1st of the increased charges for broadcast and television licences has been cleared by a G.P.O. statement.

The increased annual licence charges of £1 for "the reception of sound only" and £2 for "the reception of television and sound for domestic use" will not become payable by holders of the 10s broadcast receiving licence until their licence becomes due for renewal.

A television set may therefore be installed in a home without extra charge during the currency of an existing 10s licence, but when that licence expires the renewal charge will be £2.

A statement on the conditions applying to licences for other than domestic use is expected from the Postmaster-General shortly.

PROVINCIAL TELEVISION

WHEN re-opening the London television service on June 7th the Earl of Listowel, Postmaster-General, stated that "preparations were now being made for the installation of a special cable to relay television programmes to Birmingham." On enquiry at the G.P.O. it was learned that this cable is in addition to the existing co-axial cable between London and Birmingham, which, although capable of being used for television, is now fully loaded by telephone traffic.

It must not be inferred from this statement that the possibility of employing a radio link has been abandoned, for it was learned on enquiry that experiments in this direction are still proceeding. The question of the best form of link, left open by the Advisory Committee, has not finally been decided.

EMPIRE COMMUNICATIONS

CONCLUSIONS drawn by Cable and Wireless after a thorough study of the recently issued White Paper in which the Government has summarized the Bermuda agreement are:—

London's position as the principal centre of world telegraphic traffic may be endangered and the British taxpayer faced with heavy financial burdens as a consequence of the agreement concluded at Bermuda between the Empire and United States Governments. Britain's loss will be largely America's gain.

The financial loss to the British overseas telegraph services is estimated, on the basis of present

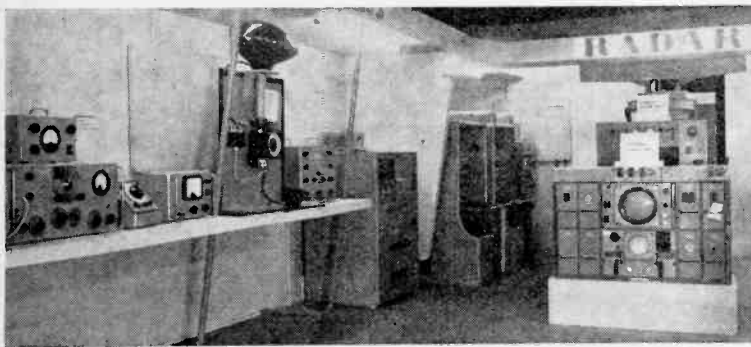

MARINE RADIO AND RADAR GEAR was displayed in great variety at a recent London exhibition arranged by the Marconi International Marine Communication Co., for the benefit of the delegates to the International Meeting on Radio Aids and Marine Navigation. Marconi Instruments—a subsidiary company—also displayed their products.

traffic, to be in the region of £2,500,000 a year.

In an analysis of the major points in the agreement the company points out that the proposal to continue the direct circuits between the Empire and the U.S., introduced as a wartime measure, will deprive British interests of the revenue previously accruing from the circulation of the traffic via London. It is emphasized that tests have shown that traffic is not more expeditiously handled over the direct circuits.

It is also pointed out that the encouragement of the opening of direct circuits between the U.S. and Greece and Saudi Arabia, where C. & W. has developed the countries' external communications, will deprive the company—and its successor, the Government—of a reasonable return on the capital expended. The British taxpayer will have to carry the burden.

CITIZENS' RADIO

SOME relaxation in the P.M.G.'s attitude towards the use of radio for communication purposes is foreshadowed by the reply to a recent enquiry at the G.P.O. regarding the use of walkie-talkie sets to control crowds at sports meetings. It is understood the P.M.G. will issue a licence for radio communication between two points in exceptional circumstances and is considering extending the facility to other users.

An official of the G.P.O. states that very high frequencies "above 25 Mc/s" will be allocated for any such service.

R.A.F. RECRUITMENT

OWING to the length of training for many of the technical trades in the R.A.F., it is considered wasteful and uneconomical to use conscripts; a campaign has, therefore, been launched to recruit 100,000 N.C.O.s and men for regular service in technical ground trades by the end of this year.

In addition to the scheme for extended service for men still in the Forces, men from 17½ to 33 years of age are invited to make application for almost any one of the 100 ground trades, among which are R/T operator, wireless operator, radar mechanic and radar operator—listed in priority of importance.

Details of the scheme, which is open to skilled, semi-skilled, or in some cases unskilled men, are obtainable from the Inspector of Recruiting, Royal Air Force, Victory House, Kingsway, London, W.C.2, or from the R.A.F. Sections of the Combined Recruiting Centres.

Details of recruitment for the R.A.F. Reserve Command will be announced later.

MERCHANT SHIP RADAR

THE Ministry of Transport has now published a booklet, "Radar for Merchant Ships," in which is included, as an appendix, the specification for a general-purpose marine radar set, which the Government hopes will be generally adopted by manufacturers.

It prescribes, among other matters, for a minimum range "at which accurate ranges can be obtained" of 300 yards, and that at which "a small object (e.g., a second-class buoy) ceases to be visible," 50 yards. The set must also give "a clear indication of coastlines at 20 miles when the ground rises to 200 feet" and at 7 miles when rising to 20 feet.

An amending slip is included in the booklet to bring the specification into line with decisions reached at the recent International Meeting on Radio Aids to Marine Navigation.

It is pointed out that radar sets which do not provide adequate safeguards may come within the scope of the existing measures preventing the use of instruments which will create added dangers at sea.

"Radar for Merchant Ships" has been edited by L. S. Harley, head of the Central Radio Bureau, and can be obtained from all branches of His Majesty's Stationery Office, or through booksellers, price 9d.

AIRCRAFT RADIO

A MICROPHONE in the pilot's cabin and loudspeakers in the main compartment of the new Handley Page "Hermes" aircraft will enable the pilot to point out places of interest as the aircraft passes over them and also to issue any necessary instructions to the passengers. The microphone control equipment and 14-watt amplifier, which operates from the aircraft 24-volt D.C. supply, a rotary converter providing the H.T., are installed in the pilot's cabin.

For the purpose of relaying broad-

cast programmes to individual passengers without interfering with the comfort of others in the 'plane a small loudspeaker is fitted into the head-rest of each chair. Volume is adjusted individually from a control fitted in the arm of the chair.

The equipment has been specially designed for the "Hermes" by the G.E.C.

INDIAN AMATEURS

IT is announced by the R.S.G.B. that, as a result of discussions between the Society and members resident in India, it is proposed to form a Radio Society of India. It is planned to operate the Society through Branch Managers, one for each of the main centres of activity.

Readers in India interested in the project are asked to communicate with J. S. Nicholson, VU2JP, Munnar P.O., Travancore, who is acting as organizer for the South, or J. McIntosh, VU2LJ, Doom Dooma P.O., Assam, organizer for the North.

PERSONALITIES

Dr. C. C. Paterson, O.B.E., F.R.S., Director of the G.E.C. Research Laboratories, was created a Knight Bachelor in the Birthday Honours. He is a past president of the I.E.E.

Among those created Commanders of the Order of the British Empire in the Birthday Honours are:—Prof. P. I. Dee, O.B.E., lately Superintendent, Telecommunications Research Establishment, M.A.P.; J. Joseph, Managing Director, Aeronautical and General Instruments; Dr. W. B. Lewis, F.R.S., for services as Superintendent T.R.E.; R. E. Relfe Luff, Managing Director, Cable and Wireless; and Dr. T. Walmsley, Chief Radio Engineer, Air Ministry.

Dr. R. H. Barfield is relinquishing his appointment on the research staff of the National Physical Laboratory to join the research and development staff of Wild-Barfield Electric Furnaces.

B. W. Beswick and C. H. Davis have resigned from the staff of the Admiralty Signal Establishment, where they have supervised the production of Admiralty radar gear, in order to

PYE Table Model television receiver with 9 in tube. The sound channel covers television sound only. The two panel controls are brilliance and sound volume. The occasional controls—contrast, focus, line and frame holds—are behind a sliding panel under the speaker grille. The price is £35, plus £7.17.3 purchase tax.

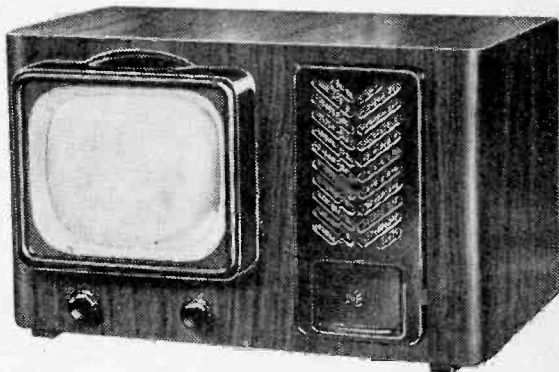

World of Wireless—

devote their full time to the Dorland Electric Company, of which Mr. Davis is a director and technical adviser.

Sydney S. Bird has retired from the post of managing director of the company bearing his name, but is remaining on the board as technical adviser. He is succeeded by S. E. C. Bird, who has been works manager since the inception of the company.

Dr. Percy Dunsheath, C.B.E., Director and Chief Engineer of W. T. Henley's Telegraph Works Company, has been elected by the London University Engineering Graduates to the University Senate for the period 1946-1950.

A. H. Reeves has taken up an important appointment with Standard Telecommunication Laboratories—the Standard Telephones research subsidiary. He joined the "Standard" organization in 1923 and was prominently associated with the 1931 micro-ray cross-channel two-way radio-telephony experiments between St. Margaret's Bay and Blanc Nez.

Sir Henry Tizard, K.C.B., F.R.S., was the guest of honour at the 23rd Annual Dinner of the British Wireless Dinner Club, when Major Gen. L. G. Phillips, C.B., C.B.E., M.C., was elected president, and A. J. Gill, vice-president.

OBITUARY

It is with regret we record the death of Admiral Sir Charles Kennedy-Purvis, G.B.E., K.C.B., on May 26th, at the age of 62. Throughout his naval career, on which he entered as a cadet in 1899, rising to Deputy First Sea Lord, Sir Charles had always been closely associated with the wireless branch. In 1915 he was promoted Commander and transferred to the Signal School when that establishment took over wireless telegraphy from the Torpedo School. He was later promoted Captain and given command of the School for two years. From February, 1927, he was for three years Director of the Signal Division and was chairman of the I.E.E. Wireless Section in 1929-30.

IN BRIEF

972 Radio Officers of the Marconi International Marine Communication Co. lost their lives during the war. This was made known by the chairman of the company at the annual meeting, when he also stated that 165 won decorations and awards for war service.

B.B.C. Transmitters.—East Anglia is to have a new broadcasting station. The B.B.C. is to erect a new transmitter at Postwick, some four miles east of Norwich. A site has also been secured for the erection of a new transmitter for the Edinburgh area.

The Thames Chain of Decca Navigator stations, with the master at Puckeridge, Herts, and slave stations near Norwich and Lewes, has been in operation experimentally for the past few weeks and will be working on a 24-hour schedule by the end of June.

Civil Aviation.—The meeting of the

Special Radio Technical Division of P.I.C.A.O. (Provisional International Civil Aviation Organization) announced in our May issue to be held in Montreal on July 1st has been postponed. The demonstrations of gear in this country and the U.S. have also been postponed. They will now be given from September 9th-30th and early in October, respectively. The first meeting of the Radio Technical Division will be held immediately after the latter.

Television Tax.—Television receivers are chargeable with Purchase Tax at 33½ per cent of the wholesale price—the same as broadcast receivers and radiogramophones.

Channel Islands.—The G.P.O. has announced that the prefix GC will be used by amateurs in the Channel Islands.

Soviet Amateurs are again operating on 160, 40, 20, 14 and 10 metres. The amateurs' journal *Radio Front*, which ceased publication at the beginning of the Russo-German war, has resumed publication under the new title *Radio*. It is published by the Committee for Radiofication and Broadcasting.

3,000,000 sets in the next five years is the target of the Soviet radio industry. Over 1,600 radio relay centres, serving nearly a million subscribers, have been put into operation in the Union since the end of the war.

Import Duty on radio equipment entering the Irish Free State has recently been revised. A duty of 75 per cent or £7 10s, whichever is the greater, is now charged on complete receivers. Other charges are:—Loudspeakers 15s and iron-cored transformers 7s 6d.

B.S.R.A.—It is announced in the latest Bulletin of the British Sound Recording Association that it is hoped to arrange for an exhibition of sound-recording gear in the autumn.

Demonstrations of the Valradio moving-coil pick-up used with the *Wireless World* Quality Amplifier are to be given each Monday at three, from July 1st, at Valradio, 57, Fortress Road, Kentish Town, London, N.W.5, in response to requests by readers, who are invited to bring test records.

Export Enquiry.—The Norwegian Co-operative organization wishes to hear from large-scale producers of British broadcast receivers and components. Address: Norges Kooperativ Landsforening (Elektrisk avdeling) Rivierstrøget 2, Oslo, Norway.

Vidor Miniature.—In the description of this set on page 160 of the May issue the H.T. voltage was given in error as 120. Actually a 67½-volt layer-built battery is employed. This receiver and the Vidor "Riviera" portable have been entered for the "Britain Can Make It" Exhibition.

A New Drive has been launched by the Waste Paper Recovery Association to raise an additional 100,000 tons of waste paper this year to alleviate the acute shortage of packing materials.

"Front Line Radar" is the title of a 40-page booklet by Sqn. Ldr. C. A. Martin which is a personal narrative of the R.A.F. Mobile Signals Units who were responsible for the operation of Eureka-H Beacons throughout the campaign in North-West Europe.

INDUSTRIAL NEWS

Addison Electric Co., Ltd., 163, Hoiland Park Avenue, London, W.11, has recently been formed to provide consultant services in electronics and telecommunications, and to undertake the design and development of instruments, radio components, prototypes, etc.

B.T.H.—A double jubilee was celebrated by the British Thomson-Houston Co. in May. It was in May, 1896, that the company was formed from the original London firm of Laing, Wharton and Down which started trading in 1886.

Marine Radio Equipment is now being manufactured by the Crampin Steam Fishing Company, of Fish Docks, Grimsby.

Ekco.—What seems to be the first post-war mains broadcast set with a built-in frame aerial has just been introduced by Ekco. It is a 3-valve (+rect.) superhet for A.C./D.C. of the compact semi-portable type and costs £13 13s, plus £2 18s 8d tax.

Ferranti broadcast and television receivers, hitherto distributed through radio wholesalers, will in future be distributed through a limited number of dealers appointed by district representatives.

Linaglow have moved to "Linaglow House," 34, Osnaurgh Street, London, N.W.1. Tel.: EUSTon 8406/9.

Philips Southport Works, Ltd., is the name given to a new company in the Philips group formed to operate a factory in the North of England which will produce machinery for valve and lamp manufacture.

Westinghouse Brake and Signal Co. announces that the Commercial Branches of the Company, which were evacuated to Pew Hill House, Chippenham, Wilts, are returning to London. On and after June 29th all correspondence should be addressed to 82, York Way, London, N.1. Tel.: TERMINUS 6432.

CLUBS

Bradford.—Meetings are held each Monday at 7.30 in the Temperance Rooms, Harewood Street, of the reformed Bradford Short-Wave Club. Negotiations are being made for premises for the erection of the Club's transmitter (G3NN). V. W. Sower (G2BYC), of 6, West View, Eldwick, Bingley, Yorks, is secretary.

Manchester.—A meeting of the pre-war North Manchester Radio and Television Society is to be held in the Stand Grammar School for Girls, Higher Lane, Whitefield, on Monday, July 8th, at 8, to discuss the future of the Society.

Stourbridge.—Future meetings of the Stourbridge and District Radio Society will be held on the first Tuesday of each month in the Lecture Room, King Edward's Grammar School, Stourbridge, at 8, D. Rock (G8PR), "Sandhurst," Vicarage Road, Amblecote, Stourbridge, Worcs, is Hon. Sec. of the Society, which has succeeded the pre-war Stourbridge and Dudley Radio Society.

★ THE TREND OF MODERN ELECTRONICS ★

THE PINT VALVE

HALF-PINT GLASS

IN THE



BRIMAR

BVA

VALVES

Bantam Range

STANDARD TELEPHONES AND CABLES LIMITED, FOOTSCRAY, SIDCUP, KENT.

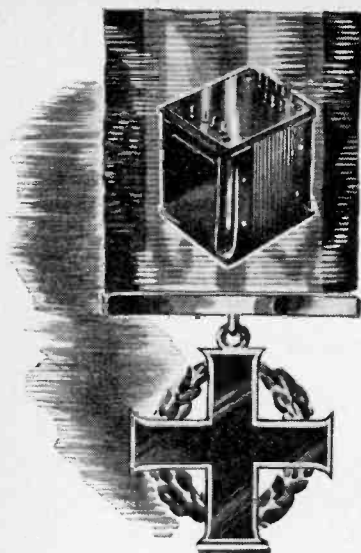

FOR ACTIVE SERVICE IN THE FIELD

Even now we are not permitted to tell you the most important of our war time achievements in Transformers and it may be that when we are allowed, the news will either be so stale by that time or we shall have developed so much further that such news will seem childish.

However we are permitted to tell you that we designed and produced the 000 0000 0 000000 00 also that we 000 00 000000 0 0000 00000 0000.

If you are not intimately connected with the field of electronics you may not be very impressed. In that case we can only say that the same resources, the same design and research facilities and production which made the above achievements possible, can now be devoted to your post war advantages.

PARMEKO of LEICESTER.
Makers of Transformers.

Standard Cases for DELIVERY NOW

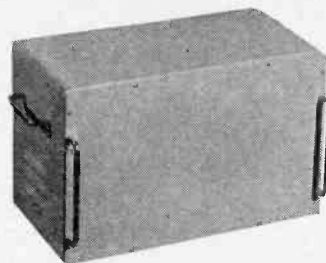

Superbly finished model of highest quality heavy gauge sheet steel, strongly welded and complete with internal metal chassis. Finished in light grey, brown, yellow, red or black.

Type 1053A	15½" w. × 8" d. × 9" h.	£4 15 0
Type 1053B	17½" w. × 9" d. × 10½" h.	£6 15 0
Type 1053C	24" w. × 12" d. × 15" h.	£8 17 6

IMHOF'S

112-116 NEW OXFORD ST. LONDON, W.C.1. Dept. 2

CAPACITORS

that are "Custom-Built"

1069

Every type in the wide range of Wego Capacitors is a "design product," built with a purpose for the purpose, thus providing you with capacitors that can virtually be described as "custom built". We will gladly send you details of the standard Wego range or co-operate closely in the design and manufacture of units to your own requirements.



**CONDENSER
COMPANY LTD**
BIDEFORD AVENUE
PERIVALE · GREENFORD
MIDDLESEX.

Telephone: PERIVALE 4277

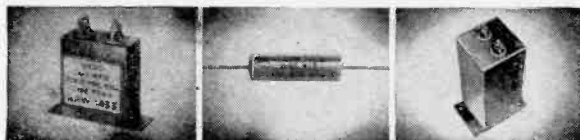

Design Data (6)

DIFFERENTIATING CIRCUIT

Choosing Component Values

THE usual analysis of a differentiating circuit is based on the assumption that the input wave is truly rectangular. This leads to the conclusion that the output wave has the same peak amplitude as the input whatever the circuit values. Very little practical experience is needed to assure one that this is not true and that the output amplitude does depend on the values assigned to the components to quite a marked degree.

The reason is that the input never is rectangular but takes a finite time to change its amplitude. The way in which it varies differs in different cases, and it is impracticable to cover all the possibilities. The most useful assumption is that the input to the differentiator is of exponential shape; it is a rectangular wave previously distorted by passing it through an integrating-type circuit of time constant T_1 . The performance of a differentiator with such an input has been dealt with by G. P. Ohman in *Electronics* for August, 1945, and the curves given here are reproduced from this paper.

It is convenient to relate the exponential input to the frequency response of the preceding circuits by the somewhat arbitrary method of assuming that this frequency response is obtained by a single R.C. circuit. In general, this is not true, but it does enable one to obtain some sort of correlation between frequency response and the input wave-shape to the differentiator. The response of an R.C. circuit is -3 db when $\omega T_1 = 1$; therefore, on this basis $T_1 = 1/\omega$ where $\omega = 6.28$ times the maximum input frequency.

As an example of the use of the data consider the design of a differentiator for television line synchron-

izing pulses. These have a duration of $10 \mu\text{sec}$, and the input frequency response will be taken as 2.5 Mc/s for -3 db. Therefore, $T_1 = 1/6.28 \times 2.5 = 0.0636 \mu\text{sec}$.

It will usually be required that the output of the differentiator be negligible compared with the input

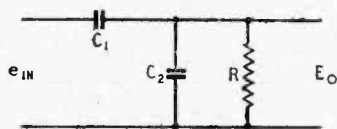

(a)

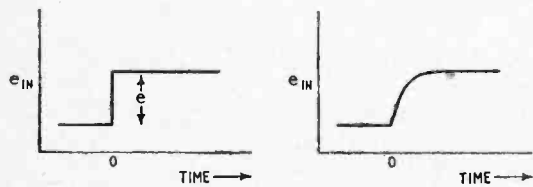

(b)

(c)

Fig. 1. A differentiator is shown at (a), with a step input voltage wave at (b) and an exponential wave at (c).

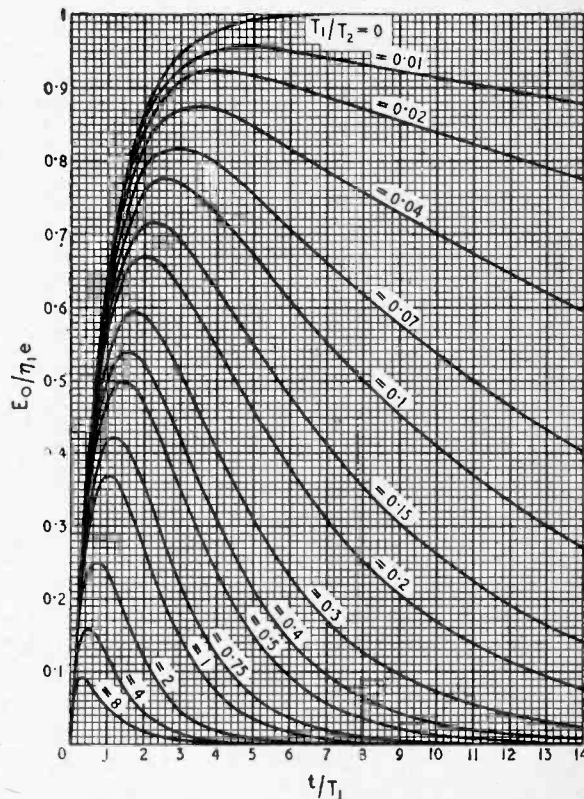

Fig. 2. These curves show the output waveform for an exponential input wave; T_1 denotes the characteristics of the input and T_2 that of the differentiator itself.

at the end of the pulse. In this case, therefore, t_2 can be taken as the input pulse duration of $10 \mu\text{sec}$, and $t_2/T_1 = 157$.

From Fig. 3, $T_1/T_2 = 0.03$ about, for an output of 1 per cent at t_2 ; hence $T_2 = 0.0636/0.03 = 2.12 \mu\text{sec}$. From Fig. 4 $\eta_2 = 0.9$, $t_1/T_2 = 3.6$, hence the maximum output occurs at $t_1 = 3.6 \times 0.0636 = 0.228 \mu\text{sec}$ after the onset of the pulse.

If $R = 0.05 \text{ M}\Omega$, then $(C_1 + C_2) = 2.12/0.05 = 42.4 \text{ pF}$, and if $C_2 = 10 \text{ pF}$, $C_1 = 32.4 \text{ pF}$. Then $\eta_1 = 0.766$ and so $\eta = 0.69$.

Differentiating Circuit—

For television purposes, it is not usually necessary for the response at the end of the pulse to be as low as 1 per cent, and a somewhat higher value is usually tolerable. The more or less standard values for a differentiator are $C_1 = 50$ pF and $R = 50$ k Ω . With $C_2 = 10$ pF, $T_2 = 3$ μ sec, and so $T_1/T_2 = 0.0212$. From the curves we then have, $t_2/T_1 = 220$, $t_1/T_1 = 3.9$, and $\eta_2 = 0.92$, while $\eta_1 = 5/6 = 0.835$. Therefore, $\eta = 0.75$, $t_1 = 0.25$ μ sec, and $t_2 = 14$ μ sec.

The curves of Fig. 2 enable the performance at any other time to be determined. Thus, continuing this last example, suppose that it is required to find out how long after the onset of the pulse a time-base will trigger when fed directly from the differentiator if it requires 2 volts to trigger it and the input pulse is of 10 volts amplitude.

As $\eta = 0.75$, the peak output amplitude is 7.5 volts. The curve in Fig. 2 for $T_1/T_2 = 0.0212$ is used. We require 2 volts output, so that the fraction of the maximum is $2/7.5 = 0.266$. The maximum is 0.9 on the $E_0/\eta_1 e$ scale, so the triggering voltage will be obtained at $0.266 \times 0.9 = 0.24$, which corresponds to $t/T_1 = 0.25$, about, or $t = 0.016$ μ sec. For most purposes this delay is negligible.

Design Data (6) : Differentiating Circuit

A step-wave, Fig. 1 (b), of amplitude e is passed through an R.C. circuit of the integrating type having a time constant T_1 , which modifies the

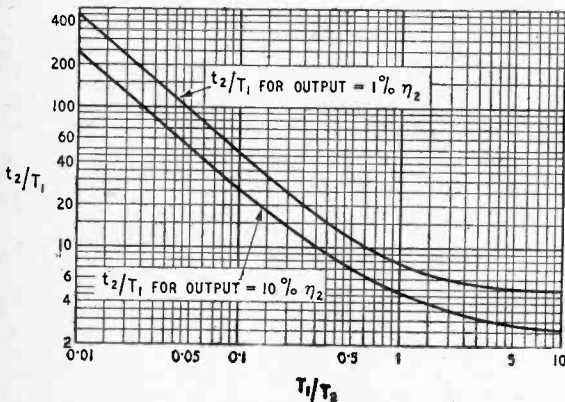

Fig. 3. These curves enable circuit values to be related to the percentage of the voltage remaining at the output at time t_2 after the onset of a pulse.

wave to the exponential form Fig. 1 (c). This wave is $e_{in} = e(1 - e^{-t/T_1})$ and is applied in its turn to the differentiating circuit Fig. 1 (a). The output is

$$E_0 = e \frac{C_1}{C_1 + C_2} \frac{(\epsilon^{-t/T_1} - \epsilon^{-t/R(C_1+C_2)})}{T_1 R(C_1 + C_2) - 1} \quad (1)$$

writing $\eta_1 = \frac{C_1}{C_1 + C_2}$
 $T_2 = R(C_1 + C_2)$

this reduces to

$$\frac{E_0}{\eta_1 e} = \frac{\epsilon^{-t/T_1} - \epsilon^{-t/T_2}}{T_1/T_2 - 1} \quad (2)$$

For design purposes this is most conveniently expressed as a family of curves relating t/T_1 and

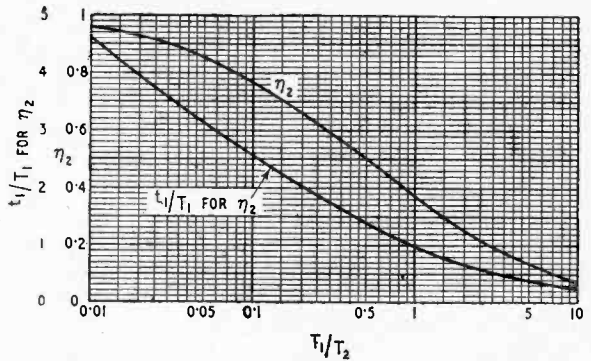

Fig. 4. The maximum values of the output pulses, η_2 , and the time t_1 of the output maximum are correlated with circuit values.

$E_0/\eta_1 e$ for a series of values of T_1/T_2 , and these are given in Fig. 2. The further derived curves of Figs. 3 and 4 enable component values to be determined.

Symbols

$T_1 = 1/6.28f$ (Mc/s ; μ sec) where f is the frequency at which the overall response of the circuits preceding the differentiator is -3 db.

$T_2 = R(C_1 + C_2)$ (pF ; M Ω)

t_1 = time interval between the onset of the pulse and maximum output (μ sec).

t_2 = time interval between the onset of the pulse and the end, the latter being the time when the output has fallen to a negligible quantity (μ sec).

$\eta_1 = C_1/(C_1 + C_2)$ = efficiency factor due to C_2 .

η_2 = ratio of maximum output to the output with a square input wave, ignoring C_2 .

$\eta = \eta_1 \eta_2$ = ratio of maximum output to input.

Procedure

In general, T_1 , t_2 , C_2 and R are known and it is required to find C_1 . Then :—

1. Evaluate t_2/T_1 , and determine T_1/T_2 from Fig. 3 for the required maximum permissible output at t_2 .

2. $C_1 = \frac{(T_1/T_2)}{T_1 R} - C_2$.

3. Determine η_2 from Fig. 4 ; $\eta_1 = C_1/(C_1 + C_2)$ and $\eta = \eta_1 \eta_2$.

4. Determine t_1/T_1 from Fig. 4 ; $t_1 = T_1 (t_1/T_1)$.

BELLING-LEE QUIZ (No. 2)

A selection of answers to questions we are continually being asked by letter and telephone

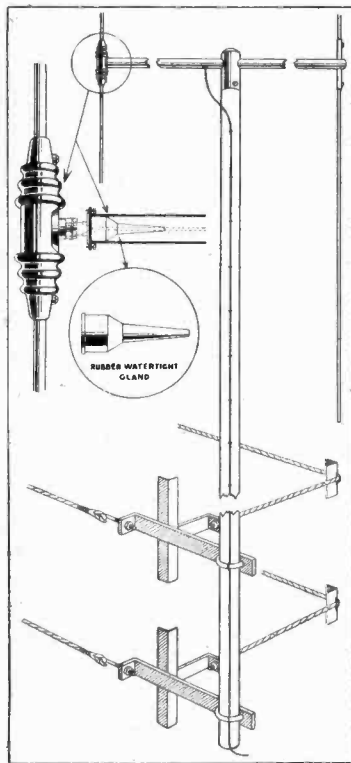

Question 8. Is there any advantage in covering the terminals of a dipole?

Answer 8. Yes, although water, ice or snow by themselves will not affect the picture, corrosion at this point would cause trouble through ultimate fracture of the leads. A sample Belling-Lee dipole assembled to a short length of 336 feeder has been submitted to an accelerated life test (full K.110 Tropical test, 1 dry cycle at 71 deg. C and 21 wet cycles at 61 deg. C). Very slight corrosion occurred on the zinc plated and passivated ferrous parts, the deposit mainly being zinc oxide with probably slight trace of zinc carbonate.

Upon removal of the flange and rubber teat encasing the connections, these (the connections) were found to be in excellent condition and practically unaffected by the test.

Question 9. Why make TV aerials of expensive rigid construction, will a wire not do just as well?

Answer 9. A TV aerial* is really a tuned circuit which has been pulled out of compact shape. It therefore possesses a measure of selectivity. The reason for making the element rigid is because it is known that this flattens the response and thus makes it more certain to produce high definition (sharp focus). This particularly applies now that the band width of the transmission has been increased, and if receiver designers take advantage of the higher quality of transmission a deterioration of definition could be observed if the present rigid dipole element was replaced by say 7/22 copper wire.

Question 10. Must a plug and socket for a television receiver be matched to the feeder?

Answer 10. Theoretically yes, and at V.H.F. and centimetre frequencies used by so many of us in the services it was most important, but at TV frequencies (45 mc/s) it just does not matter.

Where the length of the plug and socket is very short compared with the wavelength (as in Television) characteristic impedance is a wrong consideration. A two-inch plug and socket is just a capacitance, and this may be as high as 22 μ F. before signal level becomes reduced by 1 db, whereas a typical TV plug and socket has a capacitance of only 10 μ F. A mathematical paper with formulae explaining this, will be sent post free on application.

***L.502/L. Dipole, reflector and cross arm, chimney lashings (less mast) £5 5 0**

Supplied also without reflector

BELLING & LEE LTD
CAMBRIDGE ARTERIAL ROAD, ENFIELD, MIDD

Question 4. Does water at the centre of a TV dipole affect reception?

Answer 4. No, as this will only produce a parallel resistance across the dipole terminals of several thousand ohms. As an example we may assume that the parallel resistance is 10,000 ohms at 45 mc/s across a dipole of approximately 70 ohms radiation resistance. From the formula of resistances in parallel:

$$\begin{aligned} RT &= \frac{R_1 \times R_2}{R_1 + R_2} \\ &= \frac{10000 \times 70}{10000 + 70} = \frac{700000}{10,070} \\ &= 69.51 \text{ ohms.} \end{aligned}$$

It can thus be seen that the reduction in signal is less than 1 per cent. and can be neglected.

Question 5. Does a Megger test at the receiver end of the feeder whilst it is connected at the dipole, tell the whole story?

Answer 5. No, it should be remembered that the normal voltage induced in the aerial system is something less than 1 volt, whilst the Megger applies a P.D. of 500 V. or more and is therefore considered unsuitable.

Question 6. When may a Megger be used?

Answer 6. When the feeder is disconnected from the dipole, it can be used to check the insulation resistance of the feeder, but this will not indicate a variation of its characteristic impedance. This latter fault is only likely when the feeder has suffered some mechanical damage.

Question 7. How should the dipole be tested?

Answer 7. Only a visual examination is necessary in most cases, and of course it means dismantling the aerial system.

... TO BE CONTINUED

Phase Inversion

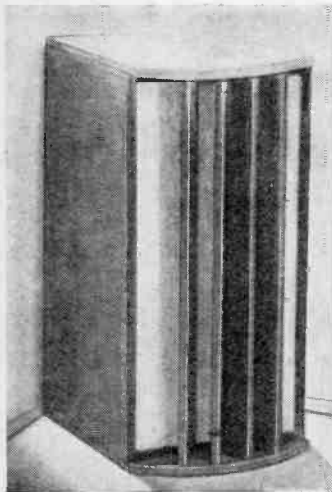

THE PHASE INVERTOR SPEAKER

Measuring only 29in. x 14in. sq. This instrument provides the music lovers perfect answer to the "Baffling" problem. Response 25 — 13,000 c.p.s. Price £12. 10. 0

AGENTS:

We regret that owing to pressure of business, it has been impossible to deal with the numerous applications received for Agencies; however, we are considering the appointment of Agents providing they are first-class Radio Engineers specialising in the sale of Quality Equipment.

Sound Sales Ltd.
WEST STREET, FARNHAM, SURREY
FARNHAM 6461-2-3

THE DX PLUS SEVEN QUALITY CHASSIS

Incorporating Paraphase Push-Pull Self Balanced Phase Inversion Circuit and Tandem Coupled Variable Selectivity.

Price £25 . 0 . 0 plus Purchase Tax.

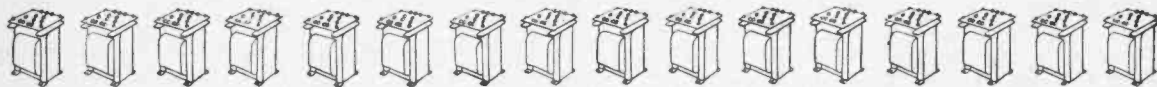
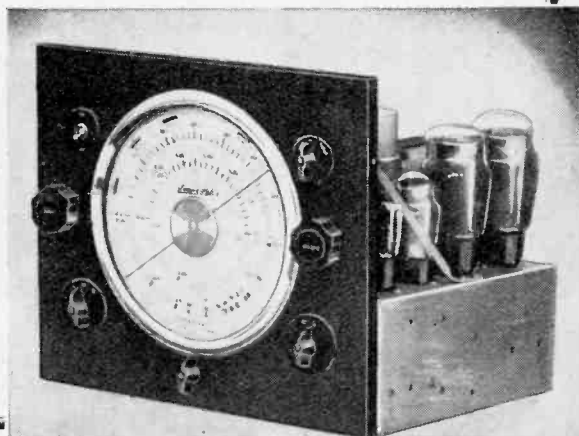

34 different

"SOMERFORD" POWER TRANSFORMERS

Now in full peace-time production, Gardners are still combining the skill of their engineers and operatives with the best of materials to give the Radio and Electronic Industry the finest range of Power Transformers. Now numbering 34, they are all different as regards their secondary outputs and tapings. No difference though in their fine Quality, Dependability, and first-class Workmanship—these remain, as always, their constant factors. There is a Gardners Power Transformer to suit the job you have in hand or the one you are planning.

Write to-day for full data and specifications. If you have a problem regarding Transformers, please consult us—our experience, developed over many years, is at your disposal.

Gardners "SOMERFORD" Power Transformers are available also through our accredited Stockist Wholesalers, a list of whom will gladly be sent on request.

GARDNERS

TRANSFORMERS & CHOKES

Gardners Radio Ltd., Somerford, Christchurch, Hants. Tel.: Christchurch 1025

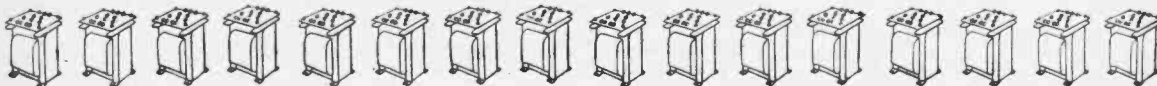

CONSOL

Beacon Direction Finding System of High Accuracy

CONSOL is the name used in England to describe a radio aid to long-range navigation originally developed by the Germans and first used by them in 1941. The Germans called the system "Sonne" meaning "Sun." This name was presumably used because of the resemblance of the radiation pattern of the beacon to the rays of the sun. So far as the author is aware there is nothing significant in the word Consol.

There were three component parts in the system:

- (i) One or more ground transmitting stations (beacons);
- (ii) A radio receiver 260 kc/s to 420 kc/s (in the aircraft);
- (iii) Maps, charts or tables of bearings (in the aircraft).

The Germans erected beacons extensively to provide overland cover over Europe. They also erected beacons on the western coastline of Europe at places such as Brest, Stavanger and the Lofoten Isles to give navigational assistance in the Atlantic to their long-range aircraft and U-boats. Most of these beacons have been destroyed except the one at Stavanger (319 kc/s) which has been kept in continuous operation. There are also two beacons in Spain, at Seville (311 kc/s), and Lugo (303 kc/s), but their operation is irregular. The U.K. has erected a beacon in Northern Ireland, which is of British manufacture and which incorporates detailed improvements over the German beacons. This beacon is expected to be on the air for testing very shortly on a frequency of 263 kc/s.

The System.—Consol has inherited many of its features from pre-war radio navigational aids. For instance, it uses a beam identified by dots and dashes as in Lorenz or S.B.A. It also bears some resemblance to the American Radio Range except that the beams are not fixed but rotating. The word "beam" is here used

By **JOHN E. CLEGG,**

M.Sc.Tech., A.M.I.E.E.

to describe the equisignal zone produced by the intersection of two overlapping lobes of a radiation pattern as in Fig. 1.

The bearing of an aircraft from the ground station is obtained by making use of the directional properties of a ground station aerial system as in ground station direction finding. However, in the Consol system the transmission is made from this directional aerial

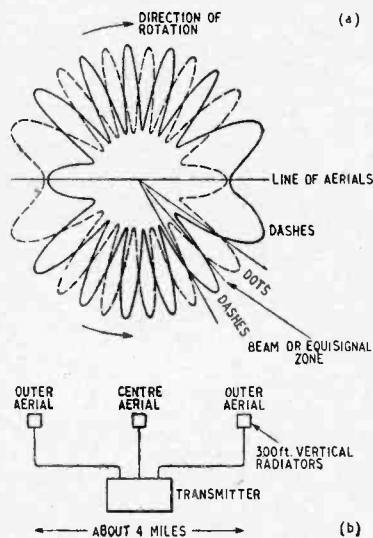

Fig. 1. (a) Polar diagram and (b) plan of Consol aerial system.

to the aircraft and only a receiver is necessary in the aircraft. Consol compares favourably with the best medium-frequency Adcock D.F. in accuracy and additionally has three important advantages. First, it is more convenient and economical to generate on the ground the powerful signals required for long-range working, especially at low frequencies where high aerials are required for

good efficiency. Second, the system can serve an unlimited number of aircraft at the same time. Third, only a one-way circuit is required instead of the two-way circuit required for ground D.F. where an operator measures the aircraft's bearing on the ground and transmits it to the aircraft.

Operating Frequency.—Consol beacons operate on low frequencies between 260 and 420 kc/s in order to obtain long distance coverage by day and night over land and sea. Except in the tropics, the reliable range of a Consol beacon is 1,000 miles by day when the path lies over the sea. When the path is entirely over land the reliable daylight range is 600 miles. At night the range is greater and not less than 1,500 miles over land and sea. These figures are based on the use of a transmitter delivering an output of 2 kilowatts to aerials 300 feet high. The precise ranges obtained depend also on the nature of the transmitting site, on the goodness of the aircraft receiver, and on the severity of interference.

In the tropics it is expected that the range will be considerably reduced by the high noise levels often experienced in these regions.

The Beacon.—This consists of a conventional low-frequency transmitter producing an unmodulated output of 2 kilowatts. This is fed into a phasing unit which is of about the same physical size as the transmitter itself. The aerials consist of three vertical radiators 300ft high which are arranged in line about two miles apart. This represents a spacing of three wavelengths. Four times as much power is fed into the centre aerial as into each of the outer aerials. Initially the phases of the currents in the outer aerials are arranged so that one leads and the other lags on the centre aerial by 90 degrees. This produces a variation in field strength as one moves around the aerial, as

Consol—

shown by the solid line of Fig. 1. If now the direction of current in the outer aerials is reversed the diagram will reverse, as shown by the dotted diagram in Fig. 1. The direction of current in the outer aerial is reversed in dot-dash rhythm and this produces 24 equisignal zones or beams along the directions of equal signal strengths from the two diagrams (see Fig. 1.).

There is a resemblance here to the Radio Range except that there are 24 courses instead of four. However, this is as far as the resemblance goes, for a clever artifice is introduced which causes the beams to rotate slowly. In one minute the beams each move steadily through one whole sector during which time the outer aerials are keyed 60 times. During the next minute the centre aerial only is fed and the current is removed from the outer aerials to dummy load resistances and the system returns to its normal state. The process is then repeated. This rotation of the beams is produced by a goniometer which advances the phase of the current in one outer aerial and at the same time retards the phase of the other aerial.

During the interval in which the system is returning to its original state an identification signal is radiated in morse characters.

The Airborne Receiver.—One of the great advantages of this system is that no special equipment is required in the aircraft. The normal receiver which is found on all long-range aircraft will receive the signals satisfactorily. The transmission is unmodulated and a beat oscillator is used to produce the heterodyne beat note as for C.W. morse reception.

Although a normal receiver can be used, improved results and longer range in bad conditions can be obtained by using a receiver with a very narrow bandwidth to improve the signal-to-noise ratio. A bandwidth of 200 c/s is amply wide enough to pass without distortion the keying of the transmitter. The best performance is obtained by limiting the band-

width before the final detector, but some improvement can be obtained by the use of a simple note filter tuned to 1,000 c/s. The system also lends itself readily to the use of an automatic recorder though this is not yet normal practice. This will enable the navigator to be dispensed with in some circumstances, and will enable higher accuracy to be obtained when fading is causing variations in the counts.

Maps, Charts and Keys.—A key is made relating the character counts to bearing at the beacon. This is done from a knowledge of the dimensions of the aerial system and its geographical position. A portion of a typical key is shown in Fig. 2 (b).

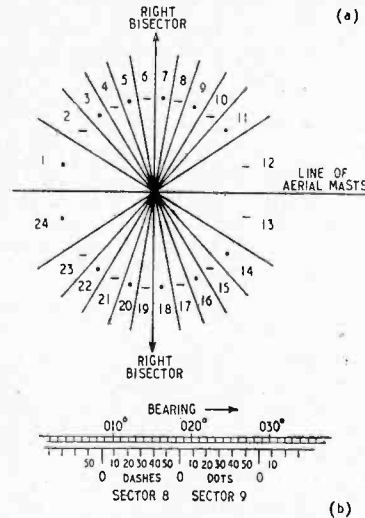

Fig. 2. (a) Sector diagram for Consol and (b) part of a typical key for use by the navigator.

Radio waves travel along great circle paths, and the simplest type of chart to use is one on which great circles are straight lines. Gnomonic projection has this property and bearings can be marked on the map or chart directly as straight lines emanating from the beacon. Bearings may also, for all practical purposes, be drawn as straight lines on the international modified polyconic maps. The Germans used Mercator's Charts overprinted with curves of constant bearing, calibrated in dot and dash counts.

For practical purposes, particularly over the longer distances, it

is usually more satisfactory to transfer a position line from a special over-printed chart, rather than to plot directly from the station.

Operating Technique.—The equisignal or beam swings through a sector of about 10 degrees in one minute, during which time 60 characters are radiated. Signals in odd sectors will start with dots and in even sectors with dashes, as shown in Fig. 2 (a). An operator listening in a dot sector hears a certain number of dots followed by a brief interval of steady tone as the beam sweeps past him and the signal changes slowly and smoothly from dots to dashes. The cycle is completed by the number of dashes required to make up the 60 characters. The operator determines his position in the sector by counting the number of dots (or dashes in a dash sector) which elapse before the beam sweeps past him. He can normally judge this to one character and thus determine his bearing to 1/6th degree.

In the absence of interference the procedure is quite simple. When conditions are difficult the beam or equisignal interval may have a duration of several seconds and then the centre of the beam can be estimated by noting the last recognizable dot (or dash, depending on the sector), and then, keeping to the same rhythm, continuing to count through the beam to the first recognizable dash. The mean of these two counts gives the centre of the beam. For example, 12 clear dots may be heard, followed by, say, four seconds of steady tone, during which time the operator would have continued counting up to the 17th character, which would be recognized as a dash. The centre of the beam would therefore be 14½ dots.

Ambiguities.—It will be obvious that there are ambiguities in the system. There are 12-dot sectors and 12-dash sectors, and therefore there are 12 possible bearings corresponding to any one count. By changing the spacing of the aerials (which, for the present case of 24 sectors, is three wavelengths) the number of sectors can be altered. Twenty-four has been chosen as

a compromise between accuracy and multiplicity of ambiguities. There should not be difficulty in deciding in which sector one is, when it is considered that the range of the beacon is at least 600 miles. At this range the nearest ambiguous position line will be 20 degrees, or 200 miles away (except in the sectors adjacent to the line of the aeriels). It is sometimes recommended that the sector be identified by a loop bearing, but this is seldom necessary.

Accuracy.—The sectors lying near to the right bisector of the line of aeriels are about 10 degrees wide and these are the most useful sectors. Those lying close to the line of the aeriels are wider. The four sectors adjacent to the line of the aeriels, numbers 1, 11, 12 and 24 are not normally used because of low accuracy and ambiguities. The beacons will therefore be sited so that the good sectors lie in the direction where good coverage is most important.

During daylight the accuracy of the system is high and in the sectors at right angles to the line of the aeriels the accuracy is 0.3 degrees. The accuracy falls to 1 degree in the sectors adjacent to the line of the aeriels. At night the situation is complex. Errors are very small in those sectors (5, 6, 17 and 18) adjacent to the right bisector of the line of the aeriels, i.e., less than 1 degree. As the angle between the bearing and the right bisector increases the bearing becomes less reliable. It is inadvisable to use sectors 1, 2, 10, 11, 12, 13, 23 and 24 at night at distances beyond 200 miles.

Night errors are, of course, due to sky-wave propagation. This has two distinct effects. A systematic error and a random variation of bearing are produced. The systematic error is always such as to swing the beam towards the right bisector. The sky waves leave the transmitting aerial at an angle inclined to the horizontal so that the path difference between the radiation from the two outer aeriels is less than is the case with ground waves which leave horizontally. Thus the waves appear to have left at a smaller angle to the right bisector than they actually have. The effect is zero along the right bisector and

hence the performance is good in this direction. The magnitude of this systematic error is also a function of distance from the beacon. Out to 150 miles where the ground wave predominates the error is negligible. As the sky wave begins to overpower the ground ray the error increases rapidly to a maximum value at about 300 miles. Beyond this distance the error decreases slowly because now although the signals are entirely due to sky waves the angle at which the waves have left the beacon decreases. Contour charts showing the error as a function of bearing and distance can be produced and their intelligent use will increase the accuracy of the system at night.

Besides the systematic error there is a random variation of bearing due to interference phenomena between the ground wave and the sky wave and between one sky wave and another. The magnitude of this variation is also a function of bearing and distance as with the systematic error. This error can obviously be reduced by taking a number of readings and finding the mean. Observations made by the author indicate that when, owing to abnormal ionospheric conditions, the variation between counts is high the systematic error is also high and, in fact, is approximately equal to the maximum variation between counts. The systematic error determined in this way can then be subtracted from the main reading to give the true reading.

The introduction of automatic recorders, as mentioned earlier, will do much to improve the accuracy when using sky waves.

Conclusion.—The Consol system whilst being far from perfect yet represents a great improvement over pre-war aids such as medium frequency direction finding. During daylight the accuracy and coverage are very good. The accuracy is of the order of 0.5 degree, the range about 1,000 miles and the angular coverage about 300 degrees. At night time the accuracy decreases to 1 to 3 degrees, the range increases to 1,500 miles but the useful angular coverage decreases to about 150 degrees.

NEW!



Tannoy are introducing many new features in their post-war range of products, and highly specialised equipment is now available. Illustrated is the latest pattern Tannoy Ribbon Velocity Microphone. Write for full details of the extensive range of Tannoy Sound Equipment.

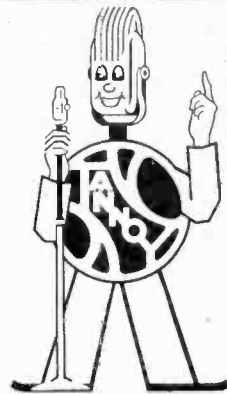

TANNOY

The Sound People

"TANNOY" is the registered trade mark of equipment manufactured by

GUY R. FOUNTAIN LTD.

"THE SOUND PEOPLE"

WEST NORWOOD, S.E.27. Gipsy Hill 1131
and at Manchester, Belfast, Newcastle, Birmingham
Bristol, Edinburgh, Glasgow, etc., etc.

The largest organisation in Great Britain
specialising SOLELY in Sound Equipment.

A.C./D.C. VOLTAGE DROPPING

Danger of a Common H.T.—L.T. Resistor

MANY of the smaller A.C./D.C. sets of American origin are designed for 115-volt mains and require modification for use on the 230-volt supplies of this country. This modification usually takes the form of an additional length of "line-cord" or other resistor to drop 115 volts, and is quite satisfactory for direct-current mains.

It is not always realized, however, that this practice is open to serious technical objection in the case of an A.C. supply, and that the performance of the set may be seriously affected. This arises because the rectifier does not draw current continuously, but only on the tips of the positive half-cycles. As a result, the voltage drop in a series resistor is greater for the H.T. than for the heater supply. When the resistor is adjusted to provide the correct heater current, the H.T. voltage is below normal.

in many cases it takes the form of an additional two-way line-cord comprising the lead D and the resistance element R_2 . This resistance carries the H.T. current as well as the heater current, and this must be taken into account when determining its value.

D.C. Conditions

For a D.C. supply of 230 volts there must be a drop of 115 volts across R_2 . The rectifier is conducting all the time on direct current, so that its input current is the same as the H.T. current, perhaps 60 mA. The heater current depends on the valves used, and in many of the newer sets is as low as 150 mA. The total current is merely the sum of the two, or 210 mA, so that

$$R_2 = 115/0.21 = 550 \text{ ohms.}$$

There is no difficulty here; but now consider the case of an A.C. supply. The rectifier no longer conducts all the time but only

fifth of this, or 0.004 sec. If the current drawn by the valve were constant throughout this conducting interval, it would be five times as great as the mean output current. In practice it is not constant, and the result is that the peak current in the valve can be ten times the mean H.T. current or even more. If the set draws 60 mA for H.T., the peak rectifier current may be 0.6 A or more.

Rectifier Current

It is clear that this is going to cause difficulty in voltage dropping. During some four-fifths of the time the rectifier is non-conductive and the heater current is the only current through R_2 . When the rectifier conducts, however, its current also passes through R_2 , and its maximum value may be much higher than the heater current. The voltage drop across R_2 is thus much greater when the valve is conducting than when it is not.

The set is designed for a peak voltage of $115 \times \sqrt{2}$ between A and B and the correct H.T. voltage will be obtained only when this is secured. The value of R_2 needed for this is the peak voltage across R_2 ($= 115 \times \sqrt{2}$) divided by the total peak current, which is the peak heater current plus the peak valve current. If the latter is 0.15 A R.M.S., the total peak current is 0.812 A, and

$$R_2 = 212/0.812 = 260 \text{ ohms.}$$

Such a value cannot be used, however, because the heater current would be excessive. During the greater part of the time the rectifier is non-conductive and only the heater current flows through R_2 . The value needed during this time is

$$115/0.15 = 765 \text{ ohms.}$$

If R_2 is adjusted so that the heater current is correct, as measured by a thermal instrument, its value will be less than 765 ohms but much greater than 260 ohms. The peak input voltage to the rectifier will be below the correct value, and as a result the

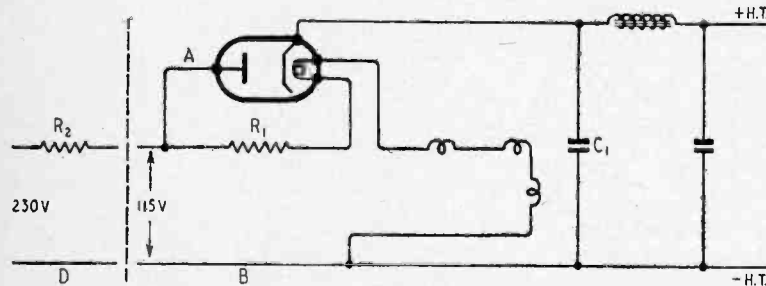

Fig. 1. The basic circuit of a typical A.C./D.C. set is shown here with a conventional extra voltage-dropper to the left of the dotted line

The basic circuit of a typical A.C./D.C. set is shown to the right of the dotted line in Fig. 1. The leads A and B together with the resistance R_1 , are usually in the form of a "line-cord." On the 115-volt supply for which the set is designed, R_1 is in the heater circuit only, and its value does not affect the H.T. The value of R_1 in ohms is equal to the mains voltage less the total heater voltage, divided by the heater current in amperes.

For a 230-volt supply, the resistance R_2 is often added, and

when the instantaneous voltage between A and B is more positive than the voltage across the reservoir capacitance C_1 . The receiver draws current continuously, and when the rectifier is not conducting it is supplied by C_1 . The valve has to supply during each short conducting interval a quantity of electricity equal to that delivered to the set during each non-conducting interval plus each conducting interval.

On a 50-c/s supply, the latter period is 0.02 sec; the conducting interval may be no more than one-

output voltage and current will be low. The performance of the set will consequently be affected. The H.T. voltage may well drop

sponds to R_2 of Fig. 2, but the H.T. resistor is replaced by R_3 , R_4 and C.

The value of $R_3 + R_4$ is chosen

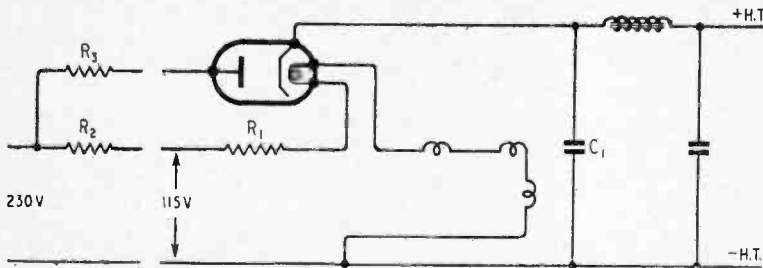

Fig. 2. Separate extra dropping resistors R_2 and R_3 are needed for the L.T. and H.T. circuits if normal operation is to be secured.

from a normal 110 volts to 80 volts—a large percentage change. The magnitude of the effect depends on many factors. The most important is the relation of the H.T. current to the heater current, and it decreases as this ratio becomes less. Unfortunately the tendency is for the ratio to increase. The total H.T. current of modern sets is higher than in the older ones, and 0.15-A heater valves are used in place of the older 0.3 A. For this reason a voltage-dropping scheme which was practicable, if not good, with older sets is now becoming useless.

The capacitance of C_1 also has an effect, and the modern tendency towards the use of very large values is detrimental. The larger the value of C_1 , the shorter is the conductive period of the valve and the higher the peak current.

A.C. Operation

On an A.C. supply the effect can be avoided by using a separate dropping resistor for the H.T. supply, as shown in Fig. 2. R_2 carries only the heater current, and its value is easily calculated; for 0.15-A valves and the voltages shown it is 765 ohms. R_3 carries only the H.T. current, and it is hardly feasible to calculate its value. It should be determined experimentally for the correct output H.T. voltage.

One snag about this arrangement is that the value needed for R_3 is in general different for a D.C. supply. It will usually need to be higher on D.C. than on A.C. This could be overcome by adopting the more elaborate arrangement of Fig. 3. Here R_2 corre-

sponds to R_2 of Fig. 2, but the H.T. resistor is replaced by R_3 , R_4 and C.

Thus, suppose the D.C. value is 1.9 k Ω and the A.C. value is 0.5 k Ω ; then $R_3 = 0.5$ k Ω and $R_4 = 1.4$ k Ω . The reactance of C might be made 0.1 $R_4 = 140 \Omega$; at 50 c/s, $C = 1/6.28 \times 50 \times 140 = 2.27 \times 10^{-5} F = 22.7 \mu F$. This is inconveniently large because it must not be an electrolytic capacitor.

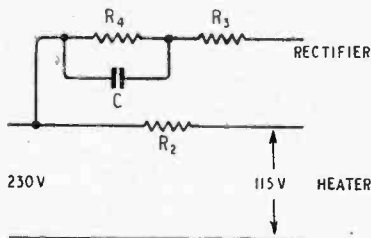

Fig. 3. A method of obtaining equal voltage dropping in the H.T. line on both A.C. and D.C. supplies is shown here.

A smaller capacitance can be used by making R_3 smaller and R_4 larger, but the values must be determined experimentally.

W. T. C.



OUR UNIT SYSTEM OF RADIO

See April issue for particulars

MIDGET 2-GANG CONDENSERS .00035 mfd. Ceramic insulation, 12/6.

MIDGET IRON CORED PERMEABILITY TUNED COILS 460 Kcs. Wavebands cover the following standard ranges: 16-47, 200-550, 800-2,000 m., A., H.F. Osc. 3/- each coil.

SMALL IRON CORED PERMEABILITY TUNED I.F. TRANSFORMERS. Screened 460 Kcs. 15/6.

VARIABLE CONDENSERS. 25 pf. ceramic plate midget single—can be ganged, 4/6. .0015 ceramic plate 2 gang, small, 12/6. .0005 ceramic insulation, 2 gang, small, 12/6. .00015 standard, 2 gang, S.W., 12/6. Reaction condensers, .0003 mica dielectric, 3/-.

TRIMMERS. 3/30 ceramic base air spaced, new, 2/-; 40 pf. S.W. pre-set neutralising cond., 2/-; T.C.C. air spaced straight line, 5/35 pt., 1/-; ceramic postage stamp type, 30/80, 1/-; 50/120, 1/-; 150/250, 1/9.

MAINS TRANSFORMERS. 350-0-350 4 v. 4 a., 4 v. 2 a., 80 m.a., 30/-; also 6.3 v. 5 a., 5 v. 2 a., 30/-; 350-0-350 4 v. 4 a., 4 v. 2 a., 6.3 v. 5 a., 5 v. 2 a., 80 m.a., 35/-.

All 200, 220, 240 v. primary. 375-0-375 6.3 v. 4 a., 6.3 v. 4 a., 5 v. 2 a., 175 m.a., 22/12/6; 10-0-200, 220, 240 v. primary. L.F. chokes, 20 hy., 500 or 1,000 ohms. 100 mA., interleaved with mounting feet, 21/-.

L.F. TRANSFORMERS, 3, 4, or 5-1 midget, 6/-; P.P. input 4-1 split sec. midget, 6/-; medium, 9/6; heavy, 12/6; Rola multi-ratio trans., 12/6; push-pull output trans. for 5, 7, 15 ohms. 4,000-0-4,000 v. (to suit 2 0v6 in push pull), 30/-.

CHASSIS. Alclad drilled for 7 or 10 valve set, 15/-; undrilled, polished, 12 1/2 x 7 1/2 x 12/6.

L.F. TRANS. Iron-cored permeability tuned, 465 K/c.s. screened, 15/-.

MIDGET PLUGS AND SOCKETS. 5-pin with plated cover, 1/-; banana plug and socket, red and black, 6d. each; standard plug, red and black, 3d. each; aluminium valve screen and base, 2/-.

COILS. 3 wave band on one former A. and H.F. Trans. with reaction, 16/50, 200/550, 900/2,000 m., 12/6; 3 wave band, A. and osc., 12/6; 3 wave band, A. H.F. and osc., 18/9; A. and H.F. med. and long, with reaction, 10/8; H.F. choke, all wave, 2/6; S.W., 2/-; 3 wave bands on one former A. H.F. and osc., 5/21, 20/54, 50/120 m., 6/3; 110/210, 200/540, 950/2,400, 6/3; colour coded. Diagrams of connections supplied.

SWITCHES. 4 pole 3 way midget single bank, 4/6; 3 bank 2 pole 6 way, standard type, with shorting plate, 8/6. We can supply switches to suit any combination of our coils.

KNOBS. Communication type—black skirted brass insert 1 1/2 in., skirt 2 1/2 in., 1/6; black pointer knobs, 1/-. Mains droppers, .2 A. 3,000 ohms, 6/-; .3 A. 750 ohms, 7/-; with mounting feet and variable sliders.

VALVE HOLDERS. 4, 5 and 8 pin English paxolin, 6d. each; 5, 6, 7 and 8UX, 6d. each; 9 pin ceramic (E.F. 50 valve), 2/6 each; Amphenol octal, 9d.; ceramic octal, 2/6.

RESISTORS AND CONDENSERS of standard values in stock.

P.V.C. wire, six bright colours, 3d. per yd.; Sleeving, highest grade, 2 mm., 4d. per yd. 1 mm., 3d. per yd.

All prices are current for this issue only. **TO OVERSEAS TRADERS** Wholesale and retail enquiries are invited. Orders can be executed for B.A.O.R., C.M.F., and S.E.A.C. customers.

307, HIGH HOLBORN
LONDON W.C.1. Phone: HOLborn 4631.

UNBIASED

By
FREE GRID

λ : 0.000,000,000,734 Metre

SOMETIMES when I read the reports of proceedings in our courts of law I wonder whether I really am living in the 20th century with its much-vaunted, scientific progress rather than in the pre-Copernician era when it was believed that it was love rather than gravitational forces which made the world go round.

I am not referring to the apparent naivete of the questions asked by some of our judges, for by long usage and custom—very important things in the eyes of the law—such remarks are expected of them. Even the infamous Judge Jeffreys thought fit to interrupt an important witness at the trial of Alice Lisle to ask "Who is Monmouth?" I have in mind cases in which the whole business turns on some simple fact which could be established in five minutes by the use of science, and radio in particular, whereas five days of rhetoric leaves the whole business in a worse state of doubt than before.

Such a case arose the other day when a Judge of the High Court was called upon to decide the precise meaning of the term "Azure" and whether a piece of cloth marked "Exhibit A" was or was not of that colour. Dictionaries galore were produced, many of which contradicted each other and learned counsel spoke at great length and called into the box dress designers of varying degrees of eminence, none of whom seemed to agree with the others even when they gave evidence for the same litigant.



"What is Free Grid?"

Eventually an eminent medical authority stated that no two persons were alike in their response to colour sensitivity and what was one shade of blue to one man could appear as a different shade to another man,

and there was, therefore, nothing strange in the lack of agreement. The learned judge thereupon decided to pass the buck by giving a decision with the remark that if he were wrong the Lords of Appeal would no doubt set him right.

Surely this is the very field in which radar, which during the war made such a spectacular descent from the metre to the centimetre wavelengths could make a still more spectacular descent in wavelength to the Ångstrom Units in which lie the ultra-short wavelengths of light and colour, such hopelessly unscientific things as blue and red and all their multifarious shades would then give place to wavelengths measured in A.U. and any piece of cloth, the colour of which was in doubt would be submitted to the searching analysis of the Ångstrom Unit radar beam. The precise wavelength which the cloth reflected would then be ascertained and would leave no room for argument.

Radiarchics and the Food Shortage

AT first sight there does not appear to be much connection between radio and milk but I have recently been endeavouring to help an unfortunate lactitian who, in his patriotic attempt to carry out the much-advertised wishes of the Ministry of Food, finds his efforts frustrated at every turn by two other departments of the Government octopus.

The lactitian in question, moved by the passionate pleadings of the Minister of Food, both to save and to produce more food, and observing the prodigious quantity of cereals consumed daily by the horse which pulled the van containing his watery wares from house to house, responded by selling the animal to the butcher, thus carrying out Mr. Strachey's requests in one operation.

To take the horse's place he invested in an electrically driven vehicle which he picked up for a song at Great Missenden. Unfortunately he soon found that his delivery time was doubled as he had to climb aboard the vehicle and drive it from house to house instead of merely having to call to it to move along as he had done in the days of the faithful quadruped.

Mrs. Free Grid brought the matter

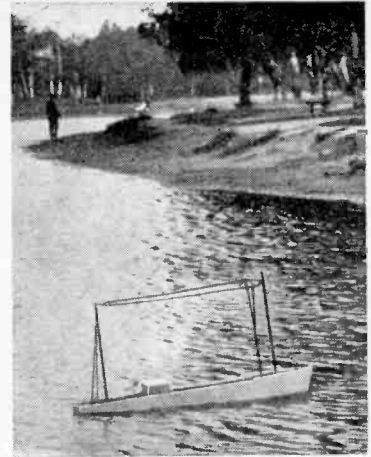

Radio-ship "Telearch I."

to my attention and I lost no time in telling the milkman that it was but a simple matter to equip his electric vehicle so that it would answer his beck and call like a horse. I need hardly tell you that the project I had in mind was a simple application of the principles of radiarchics, or radio-telearchics as the philological pedants would have me say. These principles were fully discussed in the pages of this journal twenty years ago and in case you doubt my word I reproduce herewith a photograph of the radio-ship "Telearch I" which was designed and built in the *Wireless World* laboratories to exemplify the principles of radio control.

I went even further than the mere offering of advice as I myself constructed the necessary transmitter, receiver and associated apparatus which I need hardly say was an unqualified success. I took particular care to avoid interference to local broadcast receivers by using a horizontally polarized centimetre wave and very low power. In spite of this, Government department No. 1, namely the G.P.O., was soon raising all manner of objections which only a past master in the art of obstructionism could have thought of.

This was not unexpected, but Government department No. 2, in the shape of the motor-vehicle licensing authorities are also trying to cause trouble by pointing out that the law requires every vehicle to be in charge of a qualified driver. I have freely conceded this point but have challenged the authorities to tell me of any regulation which compels the driver to be actually seated in the vehicle. If any of you legally minded people can help me out in this I shall be greatly obliged as I feel confident that I have the law as well as right on my side.

Towards VALVE STANDARDIZATION

"Significant Progress Has Been Made"

SPEAKING before the Radio Industries Club on Tuesday, May 28th, J. W. Ridgeway, O.B.E., dealt with a matter of the utmost importance to all branches of radio: his principal topic was the vexed question of valve standardization. This subject is one which has been debated in technical circles, including the columns of this journal, almost since radio began and Mr. Ridgeway's address was therefore bound to arouse the greatest interest. He is a director of Edison Swan, and also chairman of the British Radio Valve Manufacturers' Association.

The talk stressed one point which should be generally accepted but which is too frequently overlooked: namely, that the standardization of so complicated an engineering product as a radio valve is a task of almost overwhelming difficulty. It is not sufficient that a group of engineers should sit round a table to work out an ideal standard valve; if that were all the problem would have disappeared years ago. In practice one has to take into account the different manufacturing techniques in the factories of different manufacturers and the different needs and practices of all the countless valve users. Also there is the extremely complex situation resulting from differing commercial policies and differing commercial needs consequent upon the marketing, or the desire to market, radio valves in all the different countries of the world. This list of obstacles would be formidable enough by itself, but it has to be seen against a background of the disorganization of the war years.

Despite all this, Mr. Ridgeway was able to report that the valve manufacturers who constitute the membership of the British Radio Valve Manufacturers' Association had undertaken a serious study of the whole problem of valve standardization. This start had

been made at a time when the demands of war had been at their peak but, nevertheless, very marked progress had already been made. The valve manufacturers had set themselves the task of developing a range of valves "capable of manufacture by each of the member manufacturers using his own technique and methods of construction, but the working characteristics of which would be such that valves of any one type were freely interchangeable in the appropriate socket in domestic apparatus without significant change in the performance of the apparatus concerned." That was the ultimate goal before the manufacturers, and when reached it would provide all the advantages which were so frequently claimed for a true standard range of valves. In addition, however, it would provide something more, since this policy laid down that the various valve types would be capable of manufacture by the various manufacturers using their own techniques and method of construction. In this way the most serious risk of standardization would be avoided, that risk being the danger of stagnation by the elimination of the skill and individuality of competing manufacturers.

In working towards this target it had been seen that the first step was to adopt a base, or bases, acceptable to all the valve manufacturers concerned. This had been done, and the valve manufacturers had been determined that the bases adopted should incorporate the most recent advances in the art so that the range of valves to follow could be as efficient as possible. It had been found desirable to adopt two standard bases: one which offered the maximum possible saving in space (consistent with technical performance) and was satisfactory for valves of smaller dissipations, and the other for those larger valves such as certain rectifiers and power output types where

PREMIER RADIO Co.

MORRIS & CO. (RADIO) LTD.

Callers to

169 FLEET STREET E.C.4.

'Phone: Central 2833 All Post Orders to

167 LOWER CLAPTON RD., E.5.

'Phone: Amherst 4723

All goods in new condition and guaranteed. Terms of business, Cash with Order, or C.O.D. over £1. Send 2jd. stamp for 1946 list

5-WATT AMPLIFIERS. AC/DC operation, 3 stages. High gain, 3 ohm output, £8 8s.
ALUMINIUM CHASSIS. Substantially made of bright aluminium, with four sides, 10in. x 8in. x 2 1/2in., 7/-; 12in. x 8in. x 2 1/2in., 7/9; 16in. x 8in. x 2 1/2in., 8/6; 20in. x 8in. x 2 1/2in., 10/6.

MIDGET COILS. Unscreened Type, size 1 1/2in. x 1 1/2in., designed for I.P.O.F. 455 K/c. Available in the types: Osc. H.F. Tran. Aerial and in the following bands. 12-35, 16-47, 34-100, 94-261, 200-657, 250-750, 700-2,000 metres. All types 3/- each. Trimmers and Padders for all types. 8d. to 1/9. Also available, B.F.O. Coils, Aerial Filter, H.F. Filter. Same type and price as above. If Trans. Iron Core Litz wound, 465 K/c., 7/6.

PREMIER MAINS TRANSFORMERS

All primaries are tapped for 200-230-250 v. mains 40-100 cycles. All primaries are screened. All LT8 are centre tapped.

Output	Price
250-0-250 v. 60 m/a. 4 v. 2-3 a. 5 v. 2 a.	25/-
250-0-250 v. 60 m/a. 1-2 a. 4 v. 3-5 a.	25/-
300-0-300 v. 60 m/a. 6.3 v. 2-3 a. 5 v. 2 a.	25/-
300-0-300 v. 60 m/a. 4 v. 2-3 a. 4 v. 3.5 a. 4 v. 1-2 a.	25/-
350-0-350 v. 100 m/a. 5 v. 2-3 a. 6.3 v. 2-3 a.	29/-
350-0-350 v. 100 m/a. 4 v. 2-3 a. 4 v. 2-3 a.	29/-
350-0-350 v. 150 m/a. 4 v. 1-2 a. 4 v. 2-3 a.	36/-
350-0-350 v. 150 m/a. 4 v. 2-3 a. 4 v. 3-6 a.	36/-
350-0-350 v. 150 m/a. 4 v. 1-2 a.	39/-
350-0-350 v. 150 m/a. 5 v. 2-3 a. 6.3 v. 2-3 a.	36/-
425-0-425 v. 200 m/a. 4 v. 2-3 a. 4 v. 2-3 a.	47/-
425-0-425 v. 200 m/a. 6.3 v. 2-3 a. 6.3 v. 3-5 a.	47/-
500-0-500 v. 150 m/a. 4 v. 2-3 a. 4 v. 2-3 a.	47/-
500-0-500 v. 150 m/a. 5 v. 2-3 a. 6.3 v. 2-3 a.	50/-
500-0-500 v. 250 m/a. 5 v. 2-3 a. 6.3 v. 2-3 a.	65/-
500-0-500 v. 250 m/a. 6.3 v. 3-6 a.	65/-

PLAYING DESKS. A few only available. Consist of an Electrical Gramophone Motor with automatic stop and speed regulator, a quality magnetic Pick-up mounted on a strong metal frame. Price complete £6 17s. 6d. Without Pick-up £5 10s.

MIDGET RADIO KITS. Complete with drilled chassis, valves and loud speaker, only cabinet required, medium and long wave T.R.P. size 10 x 6 x 6, 4 valves, inc. rect., tone control, AC/DC operation, 200/250 v. Circuit and constructional details supplied. Price, including tax, £6 17s. 6d. Cabinet, if required, 25/- extra.

AMAZING OFFER. We have purchased the following material which must be cleared. Special prices will be quoted for large quantities. Super Quality Lease-Lend Aerovox oil-filled Paper Condensers fitted with Standoff Insulators and vertical fixing clip, 2 mfd. 1,000 volts working, 2/6 each, or 20/- per dozen, size 3 1/2in. x 1 1/2in. x 1/4in.; 2 mfd. 600 volts working, 1/3 each, or 10/- per dozen; 1 mfd. 600 volts working, 1/-, or 8/- per dozen, size 2in. x 1 1/2in. x 1/4in. 0.1 mfd. 500 v. working, miniature aluminium can, wire ends, oil filled, insulation good as mica, 9d. each, or 7/6 per dozen.

MICAMOLD POSTAGE STAMP CONDENSERS. 0.01, 0.001, 0.002 mfd., 600 volts working, 9d. each, 7/6 per dozen

CELESTION 10in. SPEAKERS. 2,100 ohms field, handle 8 watts. A super production with curved cone and dustproof voice coil, 50/-

.0005 CONDENSERS. Ceramic insulation. "Bar" Type. Single gang, 5/-; Twin gang, 8/6; three gang, 10/-; four gang, 10/-

P.M. SPEAKERS. 8in., 21/6; 6 1/2in., 22/6; 5in., 24/-; 10in. 5 watt 15 ohm, 47/6; 12in. 16 ohms 15 watts, a high fidelity job, £6 15s.

ROTARY TRANSFORMERS. Input 12 v., output 180 v. 30 m/a. 4 v. 3 a. with 19 volts input, output is 50 per cent. higher. May be used on D/C mains as L.T. Charger. With small conversion could operate as D/C Motor. Original cost over £5. Employ powerful ring magnet. Price 10/.

ROTARY TRANSFORMERS. Input 6 v., 12 v. or 24 v. D.C., output 250 v., 550 v. or 1,200 v. 70 m/a. respectively, 40/-

ELECTROLYTIC CONDENSERS. 8 mfd. 500 v.w., 3/-; 32 mfd. 550 v.w., size 4 x 2 x 1 1/2, 5/-; 16 mfd. 700 v.w., size 5 x 4 x 2, 7/6; 16 + mfd. 350 v.w., 7/6

RADIOGRAM CABINETS. Well constructed, Lowboy Type Cabinets, complete with motor and pick-up, £32 16s. With Autochanger, £42 16s. 6d. Packing and Carriage, 30/- extra. Send for Photograph.

Towards Valve Standardization—

more dissipation was required. On the score of size as well as of technical considerations, it had been considered necessary that both designs should embody what is commonly known as the "all-glass technique." These bases had been agreed.

In addition to this major step Mr. Ridgeway disclosed that the valve manufacturers had also practically completed a scheme of standardized pin connections for use on the two standard bases. The next step was to agree upon the valve types which were to be included within the standard range and to work out common specifications which the B.V.A. members could all accept and which would enable them to produce standard interchangeable valves.

Mr. Ridgeway's address was the first public intimation of the programme which the B.V.A. manufacturers had set themselves. Those directly concerned, such as the set-making side of the Radio Industry and, of course, the Service establishments, have known of this programme for some time, but it has never been overlooked that the wider technical public is vitally interested, too.

Vast numbers of users of valves have been concerned at the wide diversity of types and consequent difficulty in replacement which have grown up over the years of radio's rapid advancement, while those whose business it is to sell

radio valves have despaired of the difficulty of maintaining full and representative stocks of so widely diverse a product. All these people will be cheered to know that this crying need has not been overlooked by the B.V.A. manufacturers, and that they have set themselves the task of working towards a true standard range of British valves and that they have already made very significant progress towards this end. What is perhaps more important is the attempt to achieve that objective without sacrificing the individuality of the separate manufacturers. The co-existence of different valve designs and production techniques is an essential element in the technical advancement of radio as a whole, and that could not be maintained if standardization were effected by a slavish copying of some one range

produced elsewhere or by a standardization which was so rigid that diversity of technique and the progress which follows in its train were eliminated.

"RADIOPHARE."

DESIGN DATA : CORRECTION

In Design Data No. 2 the selectivity figure in the example should be -5.2 db instead of -5.54 db, and f_r on p. 91 should be 44.93 Mc/s instead of 45.017 Mc/s.

In Design Data No. 3, a misprint occurred in equation (2), which should read

$$nCR = \frac{225}{k} \sqrt{(S_n^2 - 1)}$$

The curve based on the equation is correct. In the example given, the value of k calculated was shown as 0.908 instead of 0.98 , this has affected some subsequent values by a few per cent.

SPECIFICATION TO ORDER

UNIT construction has been adopted in the chassis of post-war R.A.P. receivers and no fewer than nine circuit combinations can be supplied with various combinations of R.F.,

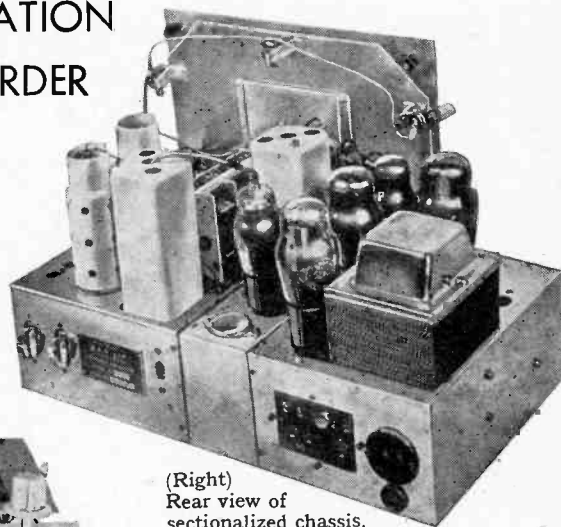

(Right)
Rear view of
sectionalized chassis.

Underside of
R.A.P. model
846 showing
tuner unit.

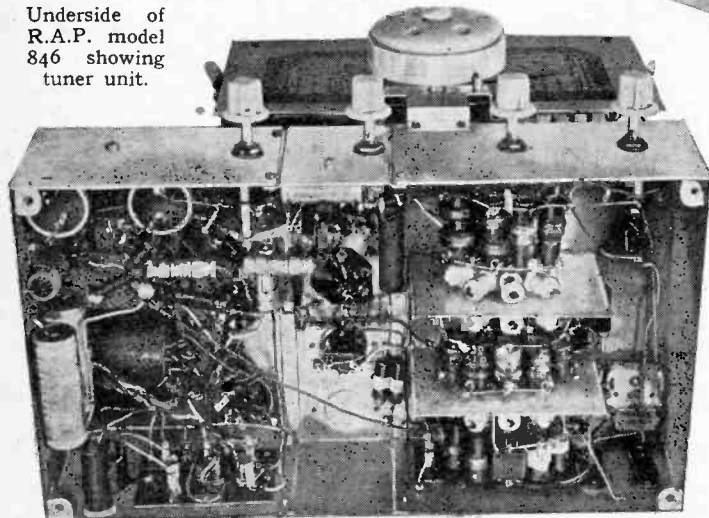

I.F. and output power units. The chassis illustrated is the Model 846, in which the single I.F. stage in the centre section is placed between an R.F. unit comprising a signal-frequency amplifier and frequency converter, and an output unit containing the second detector, a phase inverter, push-pull output pentodes and a power rectifier.

Other noteworthy features of these chassis produced by Manufacturing R.A.P., 15, Browns Road, Surbiton, Surrey, include a neat grouping of tuning coils round the wave-range switch and a vernier tuning scale.

Letters to the Editor

Ex-Government Components • Miniature Earpieces • Listeners' Tastes

Surplus Components

YOUR Editorial on the disposal of Government surplus components appears plausible at first sight, but it contains no facts to support the pessimistic picture which it suggests, and there are strong general arguments which are quite contrary to your case.

The disposal of surpluses has been the subject of lengthy negotiations between the Government and the Radio Industry, so any recent action of the Government, so long delayed, cannot be called reckless; if the method of disposal eventually adopted by the Government is considered too drastic (you give no details of the method) it is likely that the reluctance of the components industry to reach a compromise may have contributed to the situation. So far as I am aware, delivery of components to receiver manufacturers is still commonly measured in weeks and scores of weeks, rather than in days; and so far from there being a glut of components, it is said by some that production for both the home and the export markets is threatened by shortage of components.

There is at present an abnormal accumulation of civilian orders for the radio industry as a whole, representing arrears of replacements in the home market, reconstruction in devastated countries, and demands based on sterling balances held by the Dominions and certain foreign countries which represent part of Britain's war debts. The Government's policy is that the Radio Industry should be encouraged to settle down to the sort of size which can be maintained over a long period, and should not be encouraged to maintain an inflated volume of production for the next year or two, with subsequent collapse. I do not know how far this consideration affects the components section of the industry, but it would appear reasonable to use up the Government surplus in filling the immediate accumulated orders for receivers, and

maintain component production on a more modest level. In particular, the ex-Government components will all be of "tropical" quality, and therefore particularly suitable for export receivers. Early delivery of the goods is essential to building up an export trade in radio receivers, and in the national interest we cannot allow exports to be imperilled so that component manufacturers who cannot deliver now may have more work to do in a year's time. The Industry is entitled to be jealous of the home market, but it had no appreciable pre-war export market and cannot claim as of right that a foreign market created solely by war circumstances should be preserved against war surpluses. The Industry should be prepared for the present to sacrifice to Government surpluses a demand which it cannot fill immediately, in order to build up a permanent overseas trade.

D. A. BELL,
London, N. 21.

Hearing-Aid 'Phones

I WAS very interested to see the description by C. M. R. Balbi of the new miniature shell-type earpiece in your June issue.

While it embodies many desirable mechanical features which manufacturers have, for some years, endeavoured to incorporate in their miniature earpieces, these have always had to be jettisoned in favour of more efficient but less mechanically attractive designs.

From Mr. Balbi's description this earpiece is designed on the principle of a bone conductor, but applied as an air conductor, and I cannot help feeling therefore that it falls between two stools.

The bone conductor, to be efficient, requires the maximum movement of a comparatively heavy electro-magnetic structure vibrating against the mastoid bone. This earpiece does not seem to fulfil this requirement, inasmuch as there is insufficient

VORTEXION

"SUPER FIFTY WATT"

AMPLIFIER

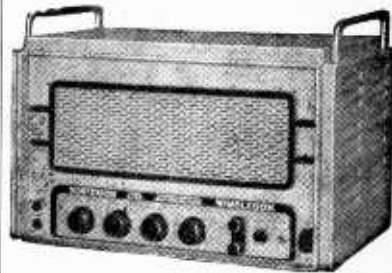

30 cps. to 15,000 cps. within $\frac{1}{4}$ db. under 2% distortion at 40 watts and 1% at 15 watts, including noise and distortion of pre-amplifier and microphone transformer. Electronic mixing for microphone and gramophone of either high or low impedance, with top and bass controls. Output for 15-240 ohms, with generous voice coil feedback to minimise speaker distortion. New style easy access steel case gives recessed controls, making transport safe and easy. Exceedingly well ventilated for long life. Amplifier complete in steel case, as illustrated, with built-in 15 ohms mu-metal shielded microphone transformer, tropical finish. Price 29½ gns.

C.P. 20A 15 Watt AMPLIFIER for 12-volt battery and a.c. mains operation. This improved version of the old C.P.20 has switch change-over from a.c. to d.c. and "stand-by" positions, and only consumes 5½ amperes from 12-volt battery. Fitted mu-metal shielded microphone transformer for 15-ohm microphone, and provision for crystal and moving iron pick-up with tone control for bass and top and outputs for 7.5 and 15 ohms. Complete in steel case, with valves. £22.10.0.

A.C. 20 AMPLIFIER.—This well-known model has been retained and has a response 30—15,000 cps., mixing arranged for crystal pick-up and microphone, large output transformer for 4—7.5 and 15 ohms to deliver 15 watt at less than 5 per cent. total harmonic distortion to the speakers Price £15 15 0

RECORD REPRODUCER.—This is a development of the A.C.20 amplifier with special attention to low noise level, good response (30—15,000 cps.) and low harmonic distortion (1 per cent. at 10 watts). Suitable for any type of pick-up with switch for record compensation, double negative feedback circuit to minimise distortion generated by speaker. Has fitted plug to supply 6.3 v. 3 amp. L.T. and 300 v. 30 M.A. H.T. to mixer or feeder unit Price £18 0 0

Dealers and Export Agents should write for special terms to:—

VORTEXION LTD.

257-261, THE BROADWAY,
WIMBLEDON, LONDON, S.W. 19

Telephones: Liberty 2814 and 6128.
Telegrams: "VORTEXION, WIMBLE., LONDON."

Letters to the Editor—

mass to vibrate against the bone, nor is the crystal capable of sufficient amplitude.

As an air-conductor, on the other hand, it is difficult to see how it can compete satisfactorily with a miniature electro-magnetic earpiece, where far more amplitude can be imparted to the diaphragm than to the "shell" of the new instrument, and where the sound waves are directed through a channel in the anatomical ear-tip into the outer ear, as against a completely random vibration of the whole shell.

Finally, with anatomical ear fittings, there are five sizes for both the left and right ears, making a total of ten different sizes. The hearing-aid manufacturer who stocks anatomical ear tips for use with his miniature earpieces must have all these sizes available if he is to provide a self-supporting earpiece, and more important still, to avoid acoustic feedback between microphone and earpiece.

Clearly, therefore, he would have to carry a very considerable stock of these earpieces in order to satisfy the requirements of each individual client.

A. P. R. MACKIE,

Allen and Hanburys (Acoustic Aids), Ltd., London, W.1.

Why Listeners Hate "Top"

IN answer to "Diallist's" question (your May issue) the main reason why the man who *listens* to his programmes chooses deliberately to distort the sound is, in one word, distortion. By this is meant anything which was not present in the original. The term includes interference of all kinds, resonance effects, high frequency beaming (mentioned by your contributor), "pentode distortion," harmonic distortion produced by overloading on crescendo passages, distortion due to mis-tuning or mis-alignment of pre-set circuits, record scratch, etcetera. All these produce their maximum effect in the higher audio-frequency range, and it is a fact that distorted top is physically more uncomfortable and unpleasant to hear than any other form of distortion. The only ready remedy for this is to apply

deliberate distortion of another kind, less unpleasant; i.e., by cutting the false top. The choice in this case is that of the lesser of two evils.

The remedy is known (to some at least), but is not easy to obtain. It consists essentially of three requirements. The first is a really good loudspeaker to be used in a room possessing reasonable acoustics; next, a high-class amplifier with ample power reserve; and finally, a faultless input to the amplifier. The last is the most difficult of all to secure, although we hope that ultimately it will be in normal

supply. The usual remark of the average listener on hearing the results from an equipment which has endeavoured to include the above requirements, and which has a full and *natural* high frequency response, is "what a lovely tone," and as this is the same as he makes when he hears an ordinary set running with minimum top (and therefore minimum high frequency distortion), I take it he means (if he means anything at all!) "how pleasant and comfortable to listen to."

G. F. REDGRAVE,

London, S.E.26.

RANDOM RADIATIONS

By "DIALLIST"

What Is Interference?

THE findings of the Committee on interference with radio reception are not known at the time of writing, but at a recent I.E.E. discussion the general opinion was that they would define interference as radiation from commercial, domestic or other electrical apparatus with a field strength sufficient to override a one-millivolt signal in neighbouring receiving sets. I suppose we must regard such a standard as satisfactory; it is at any rate better than the lack of any standard at all and it does give the B.B.C. something definite to work on. If it is recommended they will know that "service area" means the region round a station in which the field strength of its signals is not below one millivolt. So long as it is backed up by adequate penalties for those who infringe it the adoption of this definition would go a long way towards putting some sort of order into the present chaotic state of affairs. To be of real value it will have to apply to all the frequencies on which broadcasting is done, and these include the 42 Mc/s television band. What are we going to do about the owners of commercial internal combustion vehicles and private motor cars? Probably the great majority of those now in use, with the exception of Army and other service vehicles, which are effectively "suppressed," do cause strong interference on both the sound and vision channels of television. Though it probably costs less than a sovereign to buy a set of suppressors and to have them fitted

to the ignition system, I sadly fear that there will not be an order that they must be installed within a short time if heavy penalties are to be avoided. Our national make-up renders it far more likely that we shall try moral suasion, with the usual patchy results. Let us hope that this will not be so and that, whatever recommendations the Committee makes, they are adopted and enforced with an iron hand.

□ □ □

Wireless Sports Models

ALMOST all of the new wireless sets seem to be of what I call the "family bus" type: four (or in a few cases five) valves plus rectifier, with only one short-wave band and not very delicate tuning arrangements. I've heard of only one firm up to now that is catering for the long-distance enthusiast, who yearns for a "sports model" in the shape of a communication receiver, or at any rate something built on the same lines but less elaborate and less expensive. There used before the war to be a good market for sets of this kind and I am sure that there would be now if they were available. In case any manufacturer is tickled by the idea, but does not quite know what kind of receiver I have in mind, here is the sort of thing which I believe would be snapped up as fast as they could be turned out. One or perhaps two R.F. stages, separate really stable oscillator used with frequency changer, two I.F. stages, D.D.T. for detector and A.V.C., and output

stage. A B.F.O. is an advantage, though not absolutely essential. Tuning range: 10-550 metres in five or six wavebands. Adequate image suppression, electrical bandspreading between 10 and about 80 metres, tuning drive reasonably free from backlash. Controls: tuning, volume (manual), A.V.C. on-off, bandwidth (say, 3kc/s, 6kc/s and 10kc/s) B.F.O. on-off, wavechange. Cabinet: metal with crackle finish; no built-in loudspeaker. Readers who are interested may have other suggestions to make.

□ □ □

An Ingenious Tool

FROM the Bio Electric people I have just had a very neat little soldering iron, whose heating arrangements are ingenious and, I believe, of an entirely novel kind. Intended for fine radio and instrument work, the Stylus, as it is called, measures 10in overall and weighs under 4 oz. The bit, made of $\frac{3}{16}$ in round copper rod, is tapered at its business end to a shape rather resembling that of a pen nib. The bit is fixed into an aluminium body which itself fits into an aluminium tube some 2½in in length running to the well-shaped wooden handle. To return to the body of the iron, the part lying within the tube is $\frac{3}{16}$ in in diameter and has a B.S.F. screw thread cut in it. In the grooves of this thread lie the turns of heater wire. The body is anodized and the thin layer of aluminium oxide covering it forms the sole insulation for the 12-volt heater element. When I first saw the inside of the iron I confess I had my doubts about the reliability of such a thin film of insulation. The firm tells me that before the iron was put on to the market heaters were subjected to the strenuous test of six months (4,408 hours) of continuous running, at the end of which time the megger showed an infinity reading.

The heater wire is made of a special alloy with a high temperature/resistance factor. As the wire is in such close contact with the body there is almost no temperature gradient: the temperature of the body is as near that of the heater as makes no difference. Temperature control is first-rate: I have left the iron idle on the bench for a couple of hours and then found the temperature still exactly right. The loading is 25 watts at 12 volts and the iron can be heated either from a mains transformer or a secondary battery. It reaches its working temperature, by the way, in about four minutes after switching on.

HIGH FIDELITY



BULGIN

Transformers give **UNIFORM RESPONSE**
over the Entire Musical Range

High fidelity reproduction is one of the features of a Bulgin transformer effectively eliminating crackle, bringing in every radio performance with studio clarity.

Midget or heavy duty, for inter-valve, microphone and pick-up coupling, for input and output use, you will find a Bulgin transformer for every need. Nickel alloy cores are specially laminated and have high permeability. Every model is fitted with colour coded leads or metal tags for easy identification.

Built to Recognised Standards

Most Bulgin high efficiency transformers are made to recognised standards and can be fitted swiftly to any set. The Bulgin range offers individual quality at attractive prices. You will appreciate the difference.

Remember, every Bulgin transformer is the result of 25 years of pioneering in radio components. One key to the success of Bulgin transformers is Mono-Metallic Welding, an exclusive process which prevents deterioration by moisture and gives constant performance under adverse climatic conditions.

BULGIN

*Transformers for Input, Output
and Coupling uses*

A. F. BULGIN & CO. LTD., BYE PASS ROAD, BARKING, ESSEX
Telephone: RIPPleway 3474 (5 lines)

RECENT INVENTIONS

FREQUENCY MODULATION

A VALVE G is back-coupled, in known manner, through a series of resistance-capacity sections marked R, C, so as to generate oscillations at a frequency which is determined by the time-constant of the network.

According to the invention, the resistances are shunted by non-linear devices, such as the triodes V, V₁, V₂, with their grids connected in parallel to a source S of signals. The resulting changes in the impedance of the network give rise to frequency variations, which automatically adjust themselves to keep the phase difference

A Selection of the More Interesting Radio Developments

against external light coming from all directions, and at the same time offer less obstruction to an observer than the usual projecting hood.

Philco Radio and Television Corp. (assignees of G. Zindell, jun.). Convention date (U.S.A.), September 10th, 1942. No. 57233S.

wires appear to be short-circuited to the narrow walls, and therefore present little impedance to the passage of the main current. The local current in the grid will, however, cause its temperature to rise, and so give a rapid and continual indication of the power being transmitted.

J. Collard. Application date September 14th, 1943. No. 572881.

CRYSTAL RECTIFIERS

A POINT-CONTACT for rectifying ultra-high frequencies is made between a rod of synthetic silicon carbide, ground to a knife-edge, and a knife-edged wire, the two edges being set at right-angles to reduce the shunt capacity. The crystal-rod is soldered to a resilient hair-pin support, and the combination is enclosed in a casing filled with paraffin-wax.

The British Thomson-Houston Co., Ltd., and T. H. Kinman. Application date, March 6th, 1942. No. 572138.

COAXIAL FEEDERS

BOTH ends of a coaxial feed line are terminated by a device which (a) keeps the inner and outer conductors in fixed relation; (b) prevents the ingress of moisture; (c) allows the line, when required, to be filled with gas under pressure, and (d) throws no appreciable shunt capacity across the line or its associated circuits.

As shown, a quarter-wave metal cylinder C is firmly fixed at one end by a flange F to the outer conductor of the line, and is sealed at its other end by insulation S, which holds the inner conductor firmly in place. Any capacity shunt across the insulator S is now in series with the very high impedance of the closed quarter-wave section formed by the outer conductor

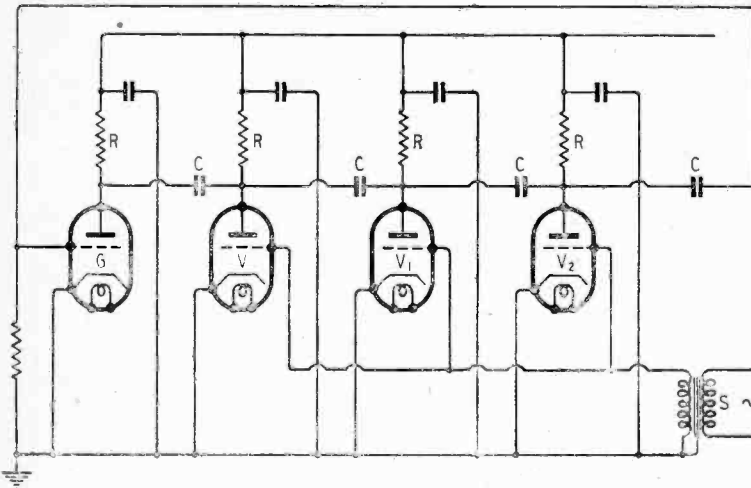

Circuit for frequency modulation.

across the network at the 180 degrees required to maintain the generator G in constant oscillation. By using pentodes instead of triodes the modulating voltage can be applied to the anodes; the grids are then biased to control the slope of each valve and therefore the mean frequency of the carrier.

Standard Telephones and Cables, Ltd. (communicated by International Standard Electric Corp.). Application date February 11th, 1944. No. 571840.

LIGHT MASKS

THE viewing screen of a cathode ray tube is shielded by two sets of louvres, which are set at right angles to each other, so as to exclude any extraneous light that has an angle of incidence greater than 45°, whilst allowing a clear view of the televised picture, or other indication, within the solid angle so defined.

Each of the spaced louvre strips is cut from laminated sheet plastic about one-sixteenth of an inch thick. The material consists of comparatively wide sections of transparent cellulose acetate, separated by thin transverse layers of an opaque cement or binder. The crossed louvres give protection

WAVE GUIDES

THE power passing through a wave guide can be measured by the rise in temperature of an insulated wire wound around a given section of the guide, but the operation is a slow one.

According to the invention, two aligned openings are made in the opposite narrow sides of a rectangular wave guide. They are then enlarged, by the addition of a suitable framework, to enclose a quarter-wave "grid," which is made by winding a wire to and fro at right angles to the axis of the guide. Assuming the waves passing through the guide to be of the H₁₀ type, currents will flow in the two narrow sides at right angles to the main axis, and the grid will accept them as an open-circuited quarter-wave section. As viewed from inside the guide, the grid

The British abstracts published here are prepared with the permission of the Controller of H.M. Stationery Office, from specifications obtainable at the Patent Office, 25, Southampton Buildings, London, W.C.2, price 1/- each.

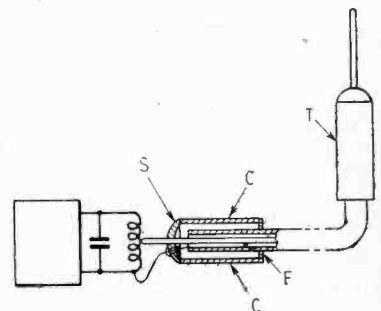

Coaxial cable termination.

and the cylinder C, and is therefore negligible at the working frequency. For a television aerial, the cylinder should be made resonant to the middle frequency of the waveband to be passed. A similar termination T is fitted to the aerial end of the line.

The British Thomson-Houston Co., Ltd. Convention date (U.S.A.), March 16th, 1943. No. 572085.



THIS *Double* BEAM TETRODE

will be popular
with Amateurs

HERE is a valve with ideal characteristics for amateur transmitters. Low anode voltage and high frequency of operation are outstanding features. It is one of a complete range of Mullard transmitting valves available to amateurs.

Write for details of Mullard Transmitting Valves for Amateurs.

QV04-20 DOUBLE BEAM TETRODE	
Vf	6.3 or 12.6 V.
If	1.6 or 0.8 A.
Va	400 V.
Vg2	145 V.
Wa	2 x 10 W.
Wo(CW)	44 W.
Driving Power	0.23 W.
Max. Freq. for full ratings	125 Mc/s.
Max. Freq. for reduced ratings	200 Mc/s.

M u l l a r d



THE MULLARD WIRELESS SERVICE COMPANY LIMITED, CENTURY HOUSE, SHAFTESBURY AVENUE, LONDON, W.C.2

EARTH FREE
& Silent as the Stars



Masteradio
VIBRATORPACKS

PROMPT DELIVERY NOW ASSURED

MASTERADIO LTD. · VIBRANT WORKS, WATFORD · HERTS



PORTABLE
ELECTRIC
GRAMOPHONE
TYPE A.G.4

BSR

The amplifier of this instrument provides an output of 10 watts from built-in gramophone unit or separate microphone. It is ideal for Hotels, Dancing Schools, educational purposes and in the home. The unit is compact, portable, has excellent reproduction and is robust in design. Full particulars including details of loudspeakers and microphones are available on request.

BIRMINGHAM SOUND REPRODUCERS LTD.

CLAREMONT WORKS, OLD HILL, STAFFS. TEL: CRADLEY HEATH 6212-3
LONDON OFFICE: 115 GOWER STREET, W.C.1 TEL: EUSTON 7515

M-W-73

Varley
TRADE MARK.
SLIDER RESISTANCES



A resistance of exceptionally robust construction, wound on high quality vitreous enamelled tubes. Nickel-copper alloy wire is used for the resistance. An ideal product for use in:—

- LABORATORIES**
- TEST EQUIPMENT**
- BATTERY CHARGING**
- SPEED CONTROL, etc.**

OLIVER PELL CONTROL LTD

CAMBRIDGE RDW · WOOLWICH · S.E.18

TELEPHONE: WOOLWICH: 1422



Manufacturers
of
LOUDSPEAKERS
·
LAMINATIONS
·
SCREENS
in
RADIOMETAL
·
PERMALLOY
·
SILICONALLOYS

ELECTRICAL SOUND & TELEVISION PATENTS LTD.

12, Pembroke Street, London, N.1. Terminus 4355
2/4, Manor Way, Boreham Wood, Herts. Elstree 2138

Rate 6/- for 2 lines or less and 3/- for every additional line or part thereof, average lines 5-6 words. Box Numbers 2 words plus 1-. Press Day: August 1946 issue, first post Tuesday, July 9th. No responsibility accepted for errors.

WARNING

Readers are warned that Government surplus components which may be offered for sale through our columns carry no manufacturer's guarantee. Many of these components will have been designed for special purposes, making them unsuitable for civilian use, or may have deteriorated as a result of the conditions under which they have been stored. We cannot undertake to deal with any complaints regarding any such components purchased.

NEW RECEIVERS AND AMPLIFIERS

MODEL P.A.3 7-valve amplifier, ideal for all P.A. work.

MODEL P.A.6 7-valve quality amplifier for music lovers who require the most perfect gramophone reproduction.

WRITE now for full details; we also manufacture mains transformers and chokes, etc., specially designed for the "Wireless World" 4, 8, 12watt quality amplifier.

CHADDERTON RADIO & TELEVISION Co., Ltd. Peel St., Chadderton, Lancs. [5110]

AIRMASTER 5-valve 4 waveband (12-2,000) metres, A.C. mains 200-240v superhet chassis, with 8in P. & A. mains energised speaker and Mazda valves.

TRUMP approx. 5 watts, chassis size 14½in x 8in x 3in, cream cellulose finish illuminated glass dial 8in x 5in, with coloured waveband scales and station names, pick-up and extra L.S. sockets.

PRODUCT of one of the largest radio manufacturers, precision made to the highest standards; ideal for incorporating in radiogram or own cabinet; art photographs available to genuine enquiries; price £17/12, carriage paid per pass. train; ready to switch on.

EXPORT enquiries for Airmaster chassis specially invited.

We are official agents for Pve, Ekco, Philips, Cosmor, Philco, Ferguson, Ultra, Alba, R.G.D., etc., and new sets are available according to manufacturers' release schedules.

MAIL orders receive prompt attention; component parts: we have good stocks of these and will be glad to forward our list on receipt of 2d. stamp.

H.P. RADIO SERVICES, Ltd. 55, County Rd., Walton, Liverpool, 4. Tel. Aintree 1445. Estab. 1935. [5390]

DOUBLE DECCA, new 1946 model vastly improved, 100-250 volts, ac/dc battery (all dry), 5 wavebands, portable, £18/4/6, including tax, rotational deliveries have commenced, order yours now.—Snell, Arcade, Swansea. Est. 1900. Tel. 3784. [5364]

HOLLEY'S RADIO—Now demonstrating the latest R.G.D. auto-radiogram, Goodman's "infinite baffle" & Sound Sales "phase inverter" loudspeakers, quality amplifiers, feeder units, crystal & solli pick-up.—285, Camberville Rd., S.E.5. Rodney 4988.

THE V55R Communication receiver is now available for immediate delivery, 9 tubes, 5 wavebands, 3½ watts output, a.v.c., b.j.o., 200/250 a.c. mains.—Write, enclosing 2½d. stamp for V55R illustrated brochure, Voice & Vision Co., 58-60 Rutland St., Leicester 53402

COIL packs, 3 waveband with switching C aligned on standard receiver, £1/16/6; 465 k/c I.F.s. suitable for above available; insist on Weymouth Radio products, available from your dealer.—Weymouth Radio Mfg. Co., Ltd., Crescent St., Weymouth.

AMPLIFIERS.—Complete equipment for P.A. industrial, dance and stage installations and portable apparatus from 15 to 150w; early deliveries; illustrations and spec. on request.—Broadcast and Acoustic Equipment Co., Ltd., Broadcast House, Tombland, Norwich 26970. [2903]

FIDELITY with sensitivity, genuine offer to build 4v T.R.F. ac/dc semi-midset receiver, Litz M. & L. coils, first-class results with improved and tested circuit, diagram and instructions to genuine enquiries 4/6 refunded on kit purchase, complete kit incl. drilled chassis, screws, etc., only £3/15, 6½in L.S. and trans. with 4 specified valves, £3/12/3.—T. R. B., 33, Meadrate Rd., E. Croydon. [5354]

BRIERLEY quality amplifiers for the reproduction of radio and gramophone records. Send s.a.c. for illustrations and specifications. **PICK-UPS**: We are now distributing booklets, describing certain aspects of pick-up design, with illustrations, response curves, specifications, etc., of our two new pick-ups.—Please write your name and address clearly and enclose 3d. (not stamped envelope), J. H. Briereley, Ltd., 46, Titebarn St., Liverpool, 2. [5508]



THREE NEW ADDITIONS

We have added three new styles to our range of mountings.

Thus do we endeavour to meet the needs of the Radio Industry and furthermore, anticipate the requirements of its forward-looking designers. To those who have already received our 1946 catalogue, we shall be glad to send upon request the three loose leaf pages containing details of the new mountings.

DELIVERY POSITION

Material supplies are more difficult now than at any time during the war, with the result that the delivery position is not improving. This is probably a natural symptom of the transition and all industries are encountering similar difficulty. We in Radio will do our best to overcome it.

May we suggest a way in which you can assist? When ordering specify wherever possible one of our stock models. We have a range of over 50 types available to suit most requirements.

If you co-operate by consulting us or our Catalogue before building your circuit, the chances are that one of our Stock Models will meet your need. This will help us to speed delivery and to deal with individual specifications for special Transformers and Chokes which now take about 28 days.

Telephone:



Abbey 2444

PARTRIDGE TRANSFORMERS LTD

76-8, PETTY FRANCE, LONDON, S.W.1

A/C/DC 5-valve super-heterodyne receiver, excellent reproduction, 6in speaker, attractive walnut cabinet, lacquered metal grill, modern design, retailing, £15/10/6; usual trade terms, facilities and service; early delivery; trade only.—Osborne & Co., Southview Rd., Warrlingham, Surrey. [5415]

A STOUNDING new 1946 console radio, obtains full marks on all counts from expert Sunday Pictorial Test Panel, Dynatron, the supreme reproducer, 11 valves, all wave, ac. 88 guineas, plus 22/6/7 tax, rotational deliveries now commencing, full details sent with pleasure, autoradiogram available soon.—Snell, Arcade, Swansea. Tel. 3784. [5376]

4 valves and speakers, £5/10; larger model kit, with polished cabinet and 6in speaker and valves, £7/10; car radio, 4v superhet kit and vibrator; line cord, 1/4 per yd, £6 10/0yds; vibrator unit, 6v in, 250v out. £1/10; details on request.—Cook, "Enharm," Old Barn Rd., Christchurch, Hants. [5486]

KITS, kits, 2 waveband, all mains 4-valve, tube line-up, 6K7, 6J7, 25Z6, 25L6, polished aluminium chassis, really first grade components, station named dial, delivered complete to last nut, full wiring instructions; price £27/8, c.w.o. or c.o.d.—Shankwoods, 21, Plungington Rd., Preston, Lancs. Tel. 3348 Preston. Radio repairs est. 1936.

ENTIRELY new 1946 R.G.D. all-wave autoradiogram, magnificent model, finest ever made, new lightweight pick-up, permanent sapphire point, very limited production, rotational deliveries now commencing, £179/14/4, including reduced tax, post orders welcomed, safe delivery guaranteed, early booking respectfully advised, a pleasure to send full details.—Snell Arcade, Swansea. Est. 1900. Tel. 3784. [5366]

BAKER'S.—New 7-valve "Wireless World" Quality amplifier with tone control stage, 8 watts push-pull triode output, price includes super Quality triple cone, 12in permanent magnet speaker, with large output transformer and all valves; also as above but with 15 watts tetrode output, ideal for realistic reproduction for public address; 2½d. stamp for parties, prices, etc.—Bakers Selhurst Radio, 75, Sussex Rd., S. Croydon. Croydon 4226.

RECEIVERS, AMPLIFIERS SECOND-HAND HALICIAFTER SX24 DeHant, as new, £35.—114, Roysds Ave., Accrington.

HALICIAFTERS SX24, 4 wavebands, 540kc to 43.5mc, recently ser. no. 821.

HALICIAFTER S.X.24, in absolutely new cond.; £55, or nearest offer. Box 68, [5503]

R.C.A. AR88 communications receiver, as brand new, 14 valves, 550kc to 43mc, £55.—Box 8215. [5385]

NATIONAL 101X receiver (for 'ham bands'), Xtal filter, etc., fair condition; £45, or offer.—Box 8181. [5359]

SPARTON 831-X, med and short-wave, 8 valve chassis (1942), complete, set in w. spare valves; offers.—Box 31.

HAMMERLUND super-pro communications receiver, crystal filter, 8 metres upwards, nearest £30.—53, Drive, Walthamstow. [5374]

TELEVISION, Marconiphone 709 Console T all-wave radio & television; what offers?—Yorath, 60, Bishops Rd., Whitecharch, Cardiff.

RADIOGRAM, ac, all mains, all wave, R.H.M.V. model 661, upright walnut cabinet, perfect order, overhauled; £55.—Tel. Reliance 2821. [5286]

14-VALVE 6-wave-band mid-West twin chassis (chromium) 12in speaker; excellent performance and condition; £40; inspection. Caterham.—Box 8337. [5433]

AMERICAN Bosch, 8 valves, 4 bands, ac rec., also V.W. S.W. Three, 1938, 6.5 190m. in polished aluminium case; offers; s.a.e. parties.—10, Moor Park Rd., Northwood, Mdx.

R.C.A. amplifier, 7-valve, 12-watt, high sensitivity, gain 100db, beautiful job, weighs 38lb, adaptable for 25-watt output; £28.—Wood, 20, Nassau Rd., W.V.13. [6285]

MURPHY television model A.56v., used few weeks only, now at maker's works being tested and adjusted following storage; still under guarantee; £60 or nearest.—Mansell, 31, Humberstone Rd., Leicester. [5477]

3 CHANNEL mixer, 2 monitors, each channel comprehensive tone control, push-pull 6L6 Class A output unit, r.f. tuner, heavy duty power pack, Jensen 12in spkr., Astatic B10 pick-up, a.c. turntable complete, with 30 valves; offers over £100.—Write Box 9228.

BRIERLEY High Fidelity 5v. amplifier, new, £7/5; 10watt amplifier chassis, feedback, £5; H.M.V. radiogram speaker 2,500 field, 45/-; Universal Avomitor, as new, £6; few 4-valve T.R.F. sets in v. smart pot. cabinets, new, unused, 8½ins.—Dumville, 66, Parkhill Rd. London, N.W.3. Gul. 1453.

GRAMOPHONE AND SOUND EQUIPMENT LEXINGTON moving coil p.u. with trans., L sapphire stylus, new, £10, or nearest.—Troupe, Dipe Lane, West Boldon. [5352]

YOU HAVE BEEN WAITING FOR THESE!

The "Q" Max Slow Motion Dial for Individual Calibration

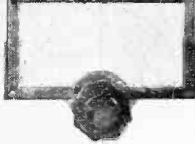

- 9-1 SLOW MOTION DRIVE.
- FIVE BLANK SCALES, AND ONE ENGRAVED 0-180.
- DIAL 6 1/2 in. x 3 1/2 in.

● COMPLETE with escutcheon glass and black fluted knobs **15/6**

The "Q" Max Chassis Cutter



No more tiresome drilling and scraping. Holes cut easily and cleanly. Punch cuts through chassis. Die prevents distortion. Spanner turns bolt to cut holes. Size of hole 1 1/4 in. (octal base) - **10/6**
(Other sizes in production.)

TWO NEW SHORT WAVE KITS

A high performance 6-valve A.C. Superhet (9-345 metres) in 5 bands. An All-dry 1 to 4-valve utilising plug-in coils covering 11-250 metres, easily built up in valve stages. Circuits of either of the above each **3/6**

OUR 20-PAGE CATALOGUE 3d. POST FREE.

BERRY'S
(SHORT WAVE LTD.)

25, HIGH HOLBORN, LONDON, W.C.1
(Phone: HOLborn 6231.) (Opp. Chancery Lane.)

'ASTRONIC'

BNN TYPE AUDIO TRANSFORMERS

Available with high or medium fidelity response for input, driver or small output applications



BNN SERIES FEATURE:—

- Semi-toroidal coil structure
- Single, dual or tri-alloy shielding, giving noise-suppression up to -80db
- High fidelity types 1db 20 to 20,000 c/s
- Medium-fidelity types 1db 50 to 10,000 c/s
- Terminations:—International Octal Base. Mounting flange with soldering spills. Flexible leads
- Hermetically-sealed if required

ASSOCIATED ELECTRONIC ENGINEERS Ltd
DALSTON GARDENS · STANMORE · MDDX

Telephone: WORDsworth 4474/5/6
Telegrams: "Electronic, Stanmore"

B.T.H. 16mm sound film projectors; limited quantity now available.—Enquiries: The British Thomson-Houston Co., Ltd., Rugby.

COILS for "W.W." tone control and filter circuits (Brierley & Hartley spec.), high fidelity mic. line and output transformers: see full list.—R. Clark, 30, Langland Cres., Stanmore, Middx. Wor 5321. [5190]

A MAZING new record reproducer, fitted super amplifier, three 12in high fidelity loudspeakers, revolutionary pick-up, mixed autochanger, large record storage space, magnificent appearance, startling reproduction realism; £220/10, including reduced tax, a pleasure to send full details, rotational deliveries soon commence; order yours now.—Snell, Arcade, Swansea, est. 1900. Tel. 3784. [5365]

POWER gramophone 20 watts self changer, 12in and 10in base and treble boost and cut, and contrast expansion control, crystal pick-up and mike, mains (AC) volts selector switch, radio unit socket and volume control all in portable oak case; two speaker units each containing 4 Goodman PM 12in speakers; suit theatre, dance hall, etc., specially designed and exceptional quality; £250 complete; demonstration.—F. L. Best, Felix Works, Felkistowe. Tel. 554. [5442]

NEW Garrard, Collaro 1946 electric gramophone motors, ac, ac/dc, from £3/8/9; automatic record changers, ac, ac/dc, from £13/4/8; electric record players, ac, £9/3/4; pedestal Plagagrams, ac, £15/6/2; gramophone pick-ups, 30/7, 31/9, 37/-, 56/3; new Goodmans 15in speaker, £18/10; new Goodmans 12in speaker, £6/15; all at reduced tax; rotational deliveries have commenced; book yours now! Full details on request.—Snell, Arcade, Swansea (est. 1900). Tel. 3784.

TEST EQUIPMENT

TAYLORMETER 81C ohms per volt 20,000, as new.—Offers to Box 67. [5502]

500 VOLT Wee Megger, as new, £6/10; approval.—Box 52. [5495]

MODEL 7 Avo, brand new; £19/19.—19.

Myddleton Rd., Wood Green, N.22. [5390]

TRIPLETT all-wave oscillator, battery model 1231A, absolutely new; 12gns.—Box 822.

MULLARD cathode ray oscillograph G.M. 3156/15, as new, £70.—Rushworths, Islington, Liverpool. [5446]

FOR sale, Universal Avominer; £8/10—101, Harwood Rd., Rishton, Blackburn.

FERRANTI 3-range test meter (0-250v, 0-10v, 0-100mA), movement 0-1mA (1,000 ohms per volt); £4/15.—Radio Service & Repairs, 1, Foundry Rd., Camborne, Cornwall.

CAMBRIDGE Unipivot, 60mA, £8; m.c. meters, 100ma, 500ma, 30amp, 2 1/2in, £1 each; R.K. Senior a.c., 1939, £8; 220 dc vent. axia fan, 6in blades, £4.—Box 8236.

AVO universal 36-range meter, Pye de luxe all-wave Trimeasy, complete, both instruments in excellent condition; prices reasonable.—Llewellyn, radio engineer, Stoke Ferry, King's Lynn. [5538]

F. D. COSGROVE, radio and electrical equipment engineers, are now producing various types of radio and test equipment; details free on request.—185, Langley Rd., Slough, Bucks. [5369]

TEST equipment, Universal Avominors, £8/10, c.w.o.; immediate delivery. Avometers, valve testers, signal generators, bridges, short waiting period only, send for list "A".—Young, Radio Service, Southwick, Sussex.

10,000ohms per volt, a new 40-range multi-meter of this high sensitivity is being added to our range; particulars of this and of oscillators, bridges, V.V.M.s, etc., on request.—MacLachlan & Co., Strathyre. [5371]

MULTI-RANGE measuring instruments, immediate delivery; guaranteed, reliable, standard model (dc volts and amps, ac volts, ohms), or made to suit individual requirements; other equipment to specification.—Clifford, 38, Dalkeith Grove, Stanmore, Middx.

6-INCH cathode ray oscilloscope, one only, laboratory built and never used, time base to over 200 kc/s, two stage high gain/wide band amplifier, eleven controls, beautifully finished in black crackle with chromium fittings, size 22in x 16in x 9in. Best cash offer over £50. Oscilloscope must be collected London.—Box 8751. [5471]

1000 reconditioned meters, 2in scale, moving coil, 500 microamps, 26/-; 1ma 25/-; any range 5ma to 250ma, 23/-; thermo-couple r.f. meters, 300ma, 350ma, 3 amps or 3.5 amps, 2in scale, 36/-; moving iron, 2 1/2in scale, 7.5 or 15 volts ac, 17/6; moving coil, 2 1/2in scale, 500 microamps, 32/6; 1ma 31/-; any range 5ma to 200ma, 28/6. New M.C. meters, 2 1/2in scale, 100 microamps, 66/-; 1ma 22/-, 5ma 48/6; 3, 10 or 150 volts 38/6, 300 volts 42/-. Moving iron, 1, 3 or 10 amps, 13/6; ex G.P.O. relays 2v, 10ma 7/6; vacuum mercury switches, 20 amp, 5/-; Westinghouse meter rectifiers, 5ma, 10/-.—R. Massey, 58, Wakefield Ave., Hull. [5449]



SOLDER electrically with the SOLON

Designed by engineers for engineers, the Solon Electric Soldering Iron gives neater, cleaner, more efficient work in less time. The heating element is right inside the bit, giving constant heat at the point—where you want it. All internal connections housed at end of handle—away from heat and easy to get at. Complete with 6ft. of Henley 3-core flexible. Made for the following standard voltages:—200/220, 230/250.

Made in England



W. T. HENLEY'S TELEGRAPH WORKS CO. LTD.
51/53, HATTON GARDEN, LONDON, E.C.1.

YOU can become a first-class RADIO ENGINEER

We are specialists in Home-Study Tuition in Radio, Television and Mathematics. Post coupon now for free booklet and learn how you can qualify for well-paid employment or profitable spare-time work.

T. & C. RADIO COLLEGE
North Road, Parkstone, Dorset

(Post in unsealed envelope, 1d. stamp)

Please send me free details of your Home-Study Mathematics and Radio courses.

NAME.....
ADDRESS.....
W.W.50.

NEW LOUDSPEAKERS.

£5 18/6—New Baker Super Quality 12in Auditorium permanent magnet speaker with triple cone, manufactured by Bakers Selhurst Radio, the pioneer manufacturers of moving coil speakers since 1925, wide frequency range, even response, ideal for quality reproduction, fitted with magnet, having exceptionally high flux density in the air gap suitable for public address equipment when quality reproduction is first consideration; send 2½d. stamp for leaflet giving details of above, and constructional details of a new acoustic chamber designed to extend loud speaker frequency range.

£8/19/6—New Baker super power cinema permanent magnet speaker with 18in triple cone of new design, giving wide frequency response free from objectionable resonances; speech is clear and natural and music is reproduced with exceptional realism; fine engineering job, extremely sensitive; ideal for public address equipment when power handling capacity, plus realistic reproduction, is required; prompt delivery per pass. train.—Bakers Selhurst Radio, 75, Sussex Rd., S Croydon (Croydon 422).

LOUDSPEAKERS, SECOND-HAND

VOIGT 4ft wood horn for sale; offers.—Box 8752. [5475]

EPOCH Domino 101½ J, 230v ac, 150kms; offers.—65B, St. Mary's Rd., Oxford. [5395]

TRANSMITTING EQUIPMENT

£9/10—R.A.F. 1154 transmitter complete. free delivery London.—Scott, 66, Braxted Park, Streatham, S.W.16. [5355]

DYNAMOS, MOTORS, ETC.

E.D.C.O. rotary converter, new, in silence cabinet, £24, do to 230 ac, 180watts; £12/10 or offer.—Box 8217. [5387]

E.D.C. converter in silence cabinet, 120watt 100/230 ac, E16, Mullard M482 cabinet with tuning assembly, etc., £2.—MacGillivray, Cherryrears, Roke, Oxon. [5361]

JANNETTE (U.S.A.) rotary converter, d.c. 220/230v to 230v a.c., 120 watts, elec. and mech. silent, £15 or best offer; transformer, 130v input, 1200v output, 0.25kva, suitable X-rays etc., offers.—Forbes 58 Thornton Ave., Croydon. [5483]

VALVES

IR5 155, 114, 384; £1 each, all unused.—Box 8761. [5478]

BARGAIN—High frequency enthusiast's valves, 954, £1/15 each; 9004-9003, £1/7/6 each, suitable for Midget broadcast receivers 0.15amp heaters; can supply most American valves, 68J7, 68A7, etc.; send order on p.c.; goods sent c.o.d.—Rondeau, 197, Ardleigh Green Rd., Hornchurch, Essex. [5391]

AMERICAN G.T. valves at B.o.T. prices:
A15GT, 1C5GT, 1T5GT, 6AG6GT, EA6, 6A8GT, 6I8GT, 6P6GT, 6H6GT, 6J7, 6K8GT, 6L7GT, 6K7GT, 6N6, 6N7, 6P5GT, 6Q7GT, 6SA7GT, 6V6GT, 12Q7GT, 12SA7GT, 5Y3GT, 12S7GT, 12S9GT, 12S9GT, 25Z6GT, 5Y3GT, 12S7GT, 50L6GT; cash or c.o.d.—Tregunna, High Cross St., St. Austell [5515]

COMPONENTS—SECOND-HAND, SURPLUS VALUE! Matt has it.

SPECIAL offer, all new goods.
CONDENSERS (canned), all 500v working, 8mid 3/-, 16mid 3/6, 8+8 5/3, 0.1, 0.01, 0.002 6/- dozen.
RESISTORS, ½ watt, ass'd, values, 4/- doz. **ROTHERMEL** pick-ups (crystal), de lux. £2/16/3.

LINE cord, 0.3 amp (60 ohms per ft), 2-way 1/- per yd, 3-way 2/- per yd.

GLASS accumulators, 2 volt 45 amp, 12/6.

SPEAKERS, 6in p.m. Celestion, 1/trans, 16/6; 8in p.m. Celestion, 1/trans., 22/6.

LARGEST stock of B.V.A. and U.S. valves in England; list prices; let us have your enquiries.

MATT RADIO SERVICE, Kingston 4881, 152, Richmond Rd., Kingston-on-Thames, Surrey

384, 174, etc., 807, new, offers; or exchange

3 Vortex out trans. or what.—Box 8443.

WURLITZER have the following high quality equipment for disposal. All goods new stock, surplus to our requirements.

POWER transformers, 500-0-500, 300 ma 6.3v 4a, C.T. 6.3v 4a, C.T. 5v 4a, £4/2.

PUSH-PULL driver transformer split secondary Hi-Fi, 30-15,000 e.p.s., £2/10.

P.P. output transformers 6,600 ohms primary sec., 15 & 7½ ohms, 70w, £2/12.

SWING chokes 300 ma 60 ohms do, £1/16.

SMOOTHING chokes 30 by 300 ma, £1/16. Carriage, etc., 2/6 extra. Cash with order. Not Government surplus.

WURLITZER, Charlton Kings Rd., Kentish Town, N.W.5. Tel. Gulliver 2294. [5476]

ELECTROLYTIC condensers, brand new, not surplus stock; 8mid, 500volt, 3/1 (1 doz. £1/16); valves, English and American, at list prices, c.w.o.; enquiries invited.—E. F. Symons, Church Rd., North Ferryby, York.

BARGAINS BY ELECTRADIX

PORTABLE MAINS AMPLIFIER by Gram-phon, with detachable lid, P.M. speaker, Garrard 12in. elec. turntable, Marconi pick-up, tone and vol. control, output and input control, 25 watts, 4-valve 2 stages, plugs and leads for mains, speaker and mike or other input.

PHILLIPS A.C. playing turntable gram. motor, Marconi pick-up and tone arm, P.M., M.C. speaker on baffle, 10 watts, 3 valves, 2 stages.

HEADPHONES. Ex-G.P.O. high resistance double headphones, light weight, bakelite ear-pieces and cap, double headband and cord, 22/6. Low resistance single phone with headband and cord, 8/6. Headphone cords, 2/- pair. Telephone plugs and jacks, 3/6 pair.

AERIALS. 7/22 copper aerial wire, 50ft., 3/-; 100ft., 5/6; 30ft. indoor aerial wire, on reel, 1/-; 30ft. single spiral copper indoor aerial, 1/9; twin with bakelite end-piece and loop, 2/6. Egg and Shell insulators, 3d. each. Lead-in Wire, rubber covered, 3/- dozen yards.

POLE STAY STRAINERS for transmitting and television aerials, 1/6 ea.

SWITCHES. Dewar key switches D.P.C.O., new surplus G.P.O. 5/- ea. Yaxley type (new) 1 pole 8-way switches, 3/6; 3 pole 3-way, 3/6. Ex-W.D. Rotary switches, 10 contact studs with laminated brush gear on ebonite panel, 6/6. Rotary selector switches, new, 8 banks of 25 contacts, 65/- ea.

AUTO TRANSFORMERS 230 volts to 110 volts, 50 cy. 80 watts, 25/-; 150 volts, 35/-; 300 watts, 60/-; 350 watts, 65/-; 900/0,000 watts, £7 10s.

TRANSFORMERS, FOR RE-WIND 3kW. New type with stampings 4½×6×7½in., windings damaged by blitz. Can be taken apart to make a number of smaller units. Weight with damaged wire is 65 lbs. Limited number at 45/-, carriage extra. ¼ kW. Transformer for re-wind, 35/-, 150/200 watt size, 30/-.

FANS. 110 volt and 220 volt D.C. Table Fans, 12in. blade and guard, 35/- each. Oscillating type, 45/-, 24 volt D.C. 10in. blade and guard, 25/-; 230 volt A.C. Table Fans, 10in. blade and guard, 75/-.

SPARK COILS. Ex-G.P.O., ½ to 1in. coil for model work, 25/-, Spark transmitter with coil gap condenser in canvas-covered mahog. case, with folding key, 55/-.

MICROPHONES. The Lexid No. 11A Hand Mike is again available; a carbon inset in solid brass case, the sensitive diaphragm protected by a perforated metal panel, 8/6. Metal clad inset only, 5/-. Pedestal mikes for desk or pulpit, 25/-; High rad transformer, 4/6 extra. Mike Buttons, G.P.O. sound transmitter units, 1in. dia., 2/6 each. H.R. Transformer, 4/6. Recording and announcers' hand-mikes, multi-carbon, metal clad, service type, by Tannoy and Truvox, with neat switch in handle, 21/-. As illustrated.

Special high ratio transformer, 7/6.

MAGNETS. AC/DC mains magnets, 2-pole 220 volts, 7/6 each. The wonder magnet Magnet, alni perm. steel disc, weight only ½ oz., ¾in. dia., ¾in. thick with 3/16in. centre hole, 3/6 each. Large selection of horseshoe Magnets in stock. Send for leaflet "W".

SEND FOR SPECIAL LEAFLETS ON RELAYS, CHARGERS, DYNAMOS, MICROPHONES AND LABORATORY GEAR AND LET US HAVE YOUR ENQUIRIES FOR INSTRUMENTS AND APPARATUS YOU ARE WANTING.

PARCELS. 7 lb. parcel of useful odds for your junk box, all clean and dismantled from Government and other apparatus, 7/6 post free.

ELECTRADIX RADIOS

214, QUEENSTOWN RD., LONDON, S.W.8

Telephone: MACaulay 2159

SOUTHERN RADIO'S wireless bargains.

LATEST radio publications: RADIO Valve Manual equivalent and alternative American and British types, with all data, 3/6; Radio Circuits, fully illustrated, receivers, power packs, etc., 2/-; Amplifiers, fully descriptive circuits, 2/-; Radio Coil and Transformer Manual, 2/-; Short Wave Handbook, 2/-; Manual of Direct Disc Recording, 2/-; Test Gear Construction Manual, 1/6; Radio Pocket Book formulas, tables, colour code, etc., 1/-; Ten Hows for Radio Constructor, 1/-; Radio Reference Hand Book, comprehensive and up to date, covering all branches of radio, 10/6; American Service Manuals, Sparton-Emerson, Crosley-Belmont (Part 1 & 2), Stewart-Warner-Fada, Emerson, 12/6 per vol.; Radio Resistor Chart (colour code values at a flick), 1/- each; Bulgin Radio Service Manual, 2/6; postage extra.

ACE P.O. microphones, complete with transformer, usable with any receiver, 7/6; permanent crystal detector, 2/6; insulated push-back wire, 25 yards, 5/-; insulated sleeving, assorted sizes and colours, 3/6 per dozen yard lengths; single screened wire, 7/6 per dozen yards; twin screened, 15/- per dozen yards; aluminium panels, undrilled, 16 gauge, 18 inches x 7 inches, 3/6; 18 inches x 9 inches, 4/6; ceramic and paxoline postage stamp trimmers, 30pf, single 1/3 each, double bank 2/-; reaction condensers, 0.0005, 0.0005, 4/- each; differential reaction, 4/6; tubular and mica condensers, 1/- each; knobs (pointer and round), 1/- each; valve holders, 1/- each; power rheostats, 30 ohms, 4/6; power rheostats, 10 ohm, 4/6.

HUNDREDS more bargain lines; postage extra to be added.

SOUTHERN RADIO Supply Co., 46, Lisle St., London, W.C.1. Gerrard 6653. [4987]

NEW heavy steel chassis 8in x 8in x 1¾in, 1/9, N reduction quantity; fully drilled, 3-valve holes, etc.—Cooke, 25, Langdale Rd., Sheffield, 8.

BARGAIN sell-up; Serviceman selling up stock, valves, condensers, resistors, etc., all brand new £250 the lot, worth more than double.—Box 8255. [5442]

RADIO CLEARANCE Ltd., Museum 9188, R. 27, Tottenham Ct. Rd., W.1.

MAINS trans., 500-0-300, 110ma, 5v 2a, 6.3v 3a, 22/6; electrolytics, 500mf, 12v, 2/6; 30mf, 100v, 3/-; 4mf 350v, 2/-; 4mf 500v, 2/11; 20mf 150v, 2/9; 250mf 25v, 2/-; 200mf 12v, 2/-; Mansbridge condensers, 4mf 450v, 4/6; 2mf 400v, 1/6; 1mf 350v, 9d.; 0.5mf 4,000v wks, 10/-; 0.5 400v, 6d.; silver mica, 50 to 5,000pf 6d.; mica, 0.0001-0.0005, 4d.; 0.001-0.007, 5d.; 0.01, 6d.; 0.01, 2,200v test, 9d.; 0.01, 2,200v, 0.01, 0.02, 0.04, 6d.; 0.1 350v 7d.; 0.25 375v, 1/-; switches, 4p 3-way, 3/-; 3p 4-way, 3/-; 1p 10-way, 3/-; 1p 12-way, 3/6; 1p 9-way, 3 banks, 5/6; resistors, ¼w, 3d.; ¼w, 4d.; 1w, 6d.; 2w, 10d.; 3w, 1/3; all values; vitreous resistors, 50Ω, 500Ω c.t., 1,000Ω, 1,000Ω tapped, 25Ω and 50Ω, 1,300Ω tapped, 600Ω, 10w, 1/6; 20w, with clips, 120Ω, 200Ω, 2/-; 25w, 350Ω, 5,000Ω, 40w, 14,000Ω tapped, 2,000Ω, 3/-; 50w, 2,000Ω, 3/6; toggle switches, double 1p, 2/11; 1p, 1/-; transformers, 465 kilocycles, iron core, 6/11 each; headphones, 10/6 pair; throat mikes, 3/6, 50pf ceramic trimmers, 9d.; wire-wound volume controls, 25v, 32Ω, 100Ω, 300Ω, 2,000Ω, 5,000Ω, 2/6; 8-way tag panels, with resistors and condensers, to the value of approx. 5/-, 2/- complete; numerous other lines in stock; cash with order or c.o.d.; postage extra; post paid orders over 7/6. [5065]

CHARLES BRITAIN (RADIO), Ltd., offers interesting items in radio spares. **MIDGET** cabinets, size 11½×5½×9in, polished, with speaker silk, 27/6 ea. midget radio chassis drilled for 5 valves, size 9½×4½in, 2/6 ea.; Celestion midget speakers, 5in, less trans., 22/6; T.R.F. coils with circuit dia. HF and Ae for long and medium waves, 8/6; superhet coils Ae and Osc, 465 K/c, 10m-30m, 30-60m, 200m-550m, with dia, 12/6 pr., also L.M.S., 12/6; I.F. trans, 465 Kc/s, in all cans with trimmer, 1d/6.

MAINS transformers, fully shrouded, 80ma., 350-0-350, 4v and 6v types, 25/-; Bryce trans., 100ma, 32/6; multi-ratio output trans. for 3 ohm sec., 6/6, nuts and bolts, 4ba and 6ba, 2/- gross each.

SPECIAL offer, reconditioned mains energised speakers 8in, various fields, less trans., 17/6 ea.; replacement mains transformers, 4v standard type, 19/6 ea.; many other lines in stock; send for list; terms: cash or c.o.d. over £1.—Charles Britain (Radio), Ltd., Radio House, 2, Wilson St., London, E.C.2. Tel. Bis. 2966. [5555]

TRANSFORMERS, M.R. output 5/11, M.R. with c/t Prim, 6/3; Class B intervalve, 6/4 mains, Brit. or Amer. types, 28/6; silent chokes for 80-watt fluorescents, high-grade output, P.P.P.X.s or 6L6s, for 3-ohm S.C., 27/6 —S.B.C., Richmond St., Walsall. [5430]



DALY

ELECTROLYTICS



Tube—size 2 1/4" x 1"



Can—size 4 1/2" x 1 1/2"



Block—size 4 1/2" x 1 1/2"

The DALY range covers all requirements
 Note—All Condensers bear the date made
DALY (CONDENSERS) LTD
 Condenser Specialists for over 20 years
 West Lodge Works, The Green, Ealing, W5
 Phone—Ealing 4841

WARD ROTARY CONVERTERS

For Radio, Neon Signs, Television, Fluorescent Lighting, X-ray, Cinema Equipment and innumerable other applications

We also manufacture :—
 Petrol Electric Generating Plants, H.T. Generators, D.C. Motors, Frequency Changers, etc., up to 25 K.V.A.

CHAS. F. WARD

37, WHITE POST LANE, HACKNEY WICK, E.9
 Phone : Amherst 1393

LONDEX FOR RELAYS

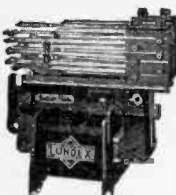

Multiple contact Relay LF.

for A.C. and D.C.

2 VA Coil consumption from 2 to 600 volts and tested to 2000 volts, Aerial Changeover Relays, Mercury Relays, Measuring Relays and Time Delay Relays

Ask for leaflet 205/WVV

LONDEX LTD

MANUFACTURERS OF RELAYS
 ANERLEY 207 ANERLEY ROAD LONDON S.E.20

A LIGNED INSTRUMENTS SERVICES, 25.
 Park Grove Rd., Leytonstone, E.11. Tel. Leytonstone 5601.
 ALL-WAVE superhet kit, 16.47, 200-550. 800-2,000 metres, a.v.c. high q i.f.s. ext. i.s. and p.u. sockets,碧. sph., uses model 20 coil pack, fully aligned and tested, ac model, £12, ac/dc, £12/10.
 MODEL 20 coil pack, aligned and tested, only 5 connections, 39/6; i.f. trans. 465Kcs. high "q," aligned and tested for gain, 17/6 pair; model 20 tuning heart, fully assembled, with 3 valves, £6/15/10; handsome tuning scale, glass, etc., and s/motion drive for above, 12/6; amplifier kits, really well-designed, ac models, 5 watt, £7, 12 watt, £11; ac/dc, 5 watt, £7, 15 watt, £12; tuning units, 3w/ band s het type, assembled opte. with valves, ac or ac/dc, £6/17/6; "TRF" type, two med. wave stations only, high fidelity design ac or ac/dc, £6; other kits available, send 1d. for lists, circuits and tech. desc. for any above, 2/6; post trade only at present, send c.v.o. if possible—saves clerical work, orders over £5 post free, no c.o.d. under £2.
HENRY'S, Radio and Electrical Components, 5, Harrow Rd., Edgware Rd., W.2, Paol. 2194, Hours, 9.30-6 o'clock Mon-Sat., half-day Thursday.
METAL rectifiers, input 200-600volts, output 300ma, 30/- each; 4mtd 1,000v wkg., 7/6 each, oil filled; 1mtd 1,000v wkg., 3/- each, oil filled; 3-gang 0.0005 standard condenser with trimmers, 12/6; 4-gang 0.0005 standard condenser, 10/-; amphenol valveholders, 4, 5- and 7-pin, English and Mazda Octal, Int. Octal 4- and 5-pin, U.X., 9d. each. 7/6 doz.; Paxolin types, 5/- doz.; t.r.f. m. and l. wave with reaction, 8/6 pr., with circuit coils; t.r.f. med. wave coils, 5/- pr., with circuit; i.f. transformers, midjet iron cored, 465k/cs, 10/6 each; standard 465k/cs iron cored, 15/- pr.; standard 110k/cs small cans, air spaced trimmers, 12/6 pr.; large selection of cabinets in stock; callers only. [5409
Q.C.C. Q5/100kcs crystal, certificate, circuit details, components less value, all unused; offers.—Box 8226, 15398

S.M.A.I. All Can elec's, 500v 8mf, 3/-; post extra under 12.—Cooke, 25, Langdale Rd., Sheffield, 3, 5283
COULPHONE RADIO, Station Rd., New Longton, Nr. Preston.—The return of Post Mail Order Service. C.O.D. or cash with order. Orders over 5/- post free Note prices. **EDDYSTONE** Model 504 communications receiver; deliveries commence August.
 ALL Tungram and B.V.A. valves; list prices. **LINE** Cord 3 amp, 60f per foot, 2-way 1/6 yd., 5-way 1/9 yd.; mains droppers, Feet. 2 sliders, 2 amp 4/3, 3 amp 4/3.
GOODMANS T2/1205/15 12in P.M. quality speakers, £6/15; Goodmans T10/1501/3/5 15in P.M. super quality speakers to handle 25 watts, weight 28 1/2lb, £18/10.
 1946 Airmaster 5v superhet chassis with 8in M.E. speaker, all ready to switch on; 13/30. 30/60, 200/550, 800/2,000 metres, high-class job, £16/10.
WEYMOUTH 3-wavelength coil packs, completely wired and tested, for 465 kcs, 38/6; matched pairs, iron-cored I.F. trans., 13/6.
MAINS transformers, highest quality primaries tapped, 200/250 volts, 300/300, 60 ma. 4v 3a, 2a or 6.3v 2a, 5v 2a, 17/6; 350/0/350 100 ma., 4v 6a, 4v 2.5a, 0r 6.3v 3a, 5v 2a, 24/-; bobbins 15/6; 450/0/450 200 ma., 4v 8a, 4v 4a, 4v 4a or 6.3v 4a, 6.3v 4a, 5v 3a, 42/6; or 6.3v 6a, 4v 2a, 4v 2a 5v 3a, 45/-.
EDDYSTONE short-wave components. **TUNING** units; model A3, R.F. stage, 16/50. 200/550, 800/200, completely assembled and aligned with 3-gang condenser, drive scale and escutcheon, £5/15; model B3 as above, but with I.F. stage and D.D. stage, £8/1. Everything from a set to a partition 50-watt amplifier; send 2d stamp for new 12-page catalogue. [5334
COILS, high gain t.r.f. combined med. and long wave, 2 3/4in long, a really first-class job; aerial and hf. 7/- pair, post paid, suitable switch, 2/3; trimmers, 9d; 2-colour station scale, 1/3.—Aneloy Radio, 36, Hindmans Rd., E. Dulwich, London, S.E.22. [5379
B. & H. RADIO offer all sizes of electrolytics, 2- and 3-core line cord, transformers, chokes, volume controls, etc. transformers, etc. made to specification; quality amplifier components and designs; trade only; send for list.—Huntley St., Darlington. [5195
16x16 mid electrolytics, 6/3; 3 gang condensers with trimmers, 13/6; ivoryine dials MW/LW, 1/2; 48 assorted carded fuses, 16/-; Midjet grub screwdrivers, 5d.; valveholders, 5d.; knobs, 6d.; "Radio Inside Out," 4/6; trimmer tool kits, 30/-; 1R5, 1R5, 1T4 miniature valves, 17/6 each; 0.01mf Mansbridge block condensers, 6d. or 5/- dozen. Order on bill or r.w.o. postage under £1.—M. O. S., 24, New Rd., E.1. [5470

The "PYROBIT" SOLDERING IRON

Brit. Patent No 56050

for Precision Instrument Work

Can be operated like a pencil

With only 45 watts a Bit Temperature of over 300°C is obtained.

or all Voltages from 6—250 volts

THE AGRU ELECTRIC TOOL MFG. Co.Ltd.,
 123, HYDE ROAD, ARDWICK,
 Phone : ARDwick 4284 MANCHESTER, 12

THE POLYTECHNIC REGENT STREET

SCHOOL OF ENGINEERING

Head of School: PHILIP KEMP M.Sc.Tech., M.I.E.E., A.I.Mech.E.

RADIO ENGINEERING. A Full-Time Day Course in Telecommunications, extending over a period of three years, prepares students for the National Diploma and other examinations, and for the radio and telephone industries.

The School re-opens on September 17th, 1946.

EVENING CLASSES in these subjects commence on September 23rd. (Enrolment: September 16th to 18th, 6-8 p.m.)

Prospectuses, giving full particulars of courses, fees, etc., may be obtained on application to the undersigned :—

J. C. JONES, Director of Education,
 The Polytechnic, 309 Regent Street,
 London, W.1.

MATRICULATION

Brings Success & Security

Whatever your age, you can now study for the all-important Matriculation Examination at home on "NO PASS—NO FEE" terms. "MATRIC" is the accepted passport to all careers, and opens up opportunities which would otherwise be completely closed to you. Ensure the success and security of you and yours through post war difficulties by writing for our valuable "Guide to Matriculation" immediately—FREE

B.T.I. (Dept. 114)
 356, Oxford Street, London, W.1.

BATTERY charger kits, 12- or 6-volt. 2 amp. 77/6; Standard Telephone's selenium rectifier, Foster multi-fix transformer, Walsall electrical ammeter, switches, flexible and clips, black frosted enamelled, steel case.—S. B. C., Richmond St., Walsall. [5429

RADIO Amateurs, E.C.O. transmitters: R. new 25/30watts, 160-80-40-20 metres; coils supplied for 160-80 metres, grey finish, meter-switched; price, including meter, 99ns. (c.w.o.); any TX gear built to your specifications; racks and panels supplied.—Radio Technicians (G8UR/G8KL), 65, Trysull Rd., Wolverhampton. Tel. Penn 36082. [5417

MAINS transformers, first-grade and brand new, screened primary, 350-0-350v 80ma. 4v 4a and 4v 2.5a or 6.3v 3a and 5v 2a. £1 ea, post 1/-; larger type 120ma 6.3v tapped 4v, and 5v tapped 4v, unbeatable value at 27/6, post 1/-; similar quantity multi-ratio output transformers, 6/-; 30watt multi-ratio 18/6, post 1/-; s.a.e. for list of other bargains. Aneloy Radio, 36, Hindmans Rd., E. Dulwich, London, S.E.22. [5378

SELECTED bargain from our stock.—Mains transf. tapped input 200/250v 350/0-350 70ma, 4v/6v or 5v/6v H tra., static screen, impreg. chassis mounting, guar., 20/-, postage 1/- Replacement bobbins for most core sizes, windings, as above, 15/6. Mains droppers, feet, 2 sliders, 5s., 87s/4/3. Line coil, 3a 3 way 180r, 1/9 yr. Trf. comb. 2 M Litz High Q coils with reaction, 7/- matched pair. Postage extra, no c.o.d., approval. T. R. S., 33, Meadvale Rd., E. Croydon. [5493

METAL rectifier 12v 2 amp type with transformer and ballast bulb for 2v, 6v, 12v charger, no rheostat or ammeter required, a really foolproof charger kit, weight 5lb, 39/6, post 10d; ditto for 2v, 6v, 32/6; ditto 2v, 6v, 12v 1.5 amp, 35/-; metal rectifier, 2v, 0.5 amp with transformer, makes ideal trickle charger for 2v cell, 13/6, post 7d. DE luxe charger kits, 12v 3 amp rectifier with transformer and ballast bulb for 2v to 12v charger, the ideal motorist's kit, as supplied to Government bodies, 59/6, post 1/-; ditto with 4 amp rectifier, 70/-.

RECTIFIER and transformer only for 12v 3 amp, 50/-, post 1/-; ditto 4 amp, 57/6; heavy duty charger kit with 140 watt transformer, 5 amp rectifier for 6v, 12v, weight 1lb, 24/10; with ammeter, 25/5.

METAL rectifiers, 12v 0.75 amp, 7/6; 12v 1.5 amp, 10/6, post 6d; 12v 2.5 amp, 16/6; 12v 3 amp, 21/-, post 9d; 12v 4 amp, 27/6. **CHARGER** kit for small radio store, up to 20 cells in series at one ampere, 140 watt transformer, selenium rectifier, ballast bulb and holder, no rheostat and ammeter needed. £5/10; ditto for 2 amp, £7/15; chargers, 2v to 12v up to 1 amp variable, weight 18lb, 43/8; fitted sliding resistance and ammeter, carrying handle, unusual value, and ammeter, M.B.S.I. instrument rectifiers, one milliamp. 18/6; ditto 5 milliamp for Avo, Avominox, 18/6; all goods offered are new and not surplus or soiled stock: H.T. rectifiers, selenium, 120v, 25 ma, 7/6, post 4d; 250v 60 ma, 11/9; for midgets, 120v 60 ma, 10/6.

ELIMINATOR kit, transformer, metal rectifier, two 8 mfd condensers, for 120v 20 ma output, 32/6; ditto with 2v trickle charger, 40/-; 8 mfd 500v condensers, tubular, best makes, new, 3/6 ea, not surplus.

CHAMPION, 43, Uplands Way, London, N.21. Tel. Lab. 4457. [5580

FOR sale, second-hand radio equipment: steel standard racks, 4ft 8 1/2 in, with covers, less panels; Granpion 30watt amplifier, rack mounting with valves; similar I.C. ex. valves; 5-valve 5-range rack mounting receiver; 60watt amplifier, mounted on 2ft 9 in rack; complete.—Write to S. H. R., c/o Downs, 43, Gt. Marlborough St., London, W.1

THE Simplex Four, still the best, complete constructional details; Midget ac/dc (total cost of construction £9), theoretical and full-scale layout diagrams, with instructions, per copy 4/6; Midget polished wood cabinets, 55/-; Midget m. wave t.r.f. coils, high gain, 7/6; m.l. wave, with reaction, circuit, 10/6; oil-filled paper condensers, high v. wkg, small size 4mfd 1,000v, 7/6; 8mfd 1,000v, 12/6; 3mfd 600v, 7/-; 10mfd 600v, 7/-; Midget electrolytic 8x16mfd 500v, 7/6; 16mfd 200v, 3/-; 16mfd 350v, 3/6; all-wave coil pack, wired, tested, 5 leads to receiver, boxed with ac/dc circuit, 40/-; Midget ivorine coloured dials, s.m.l. wave, 4x3 1/2, 2/6; coloured s.m.l. dials on glass, 9x4 1/2, 3/6; slow motion drives, 2-speed with driving disc, 3/6; ditto string drum drive, 1 speed, 2/6; epicyclic drives, 3/-; miniature rotary switches, 4p 3v 5/-, 2p 6v 2/6; 3p d.c., 3/-; chokes, midget, 50ma 6/-; standard, 80ma, 8/6; heavy, 150ma, 12/6; Midget Simplex chassis, fully drilled with 4 valve holes, etc., 11x4 1/2x2 1/2 in, 7/6; monthly comprehensive lists; 2/- d stamp with enquiries, postage all orders.

O. GREENLICK, Ltd., 34, Bancroft Rd., Cambridge Heath Rd., London, E.1. Ste. 1334

A New Purchase!

EX-ARMY No. 58 Mk. 1

Self-contained 8-v. Short-Wave TRANS-RECEIVER

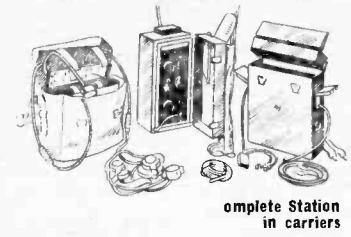

complete Station in carriers

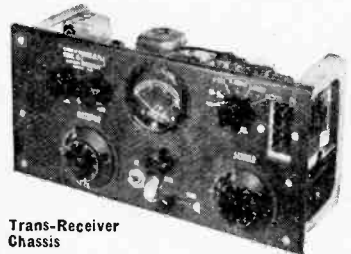

Trans-Receiver Chassis

Study this specification:—

- 5-valve Superhet Receiver, 3-v. Transmitter.
- A.V.C.
- Frequency range: 6 mc/s to 9 mc/s (50 to 33.3 metres).
- Working range: 5 miles with 12ft. rod aerial.
- Panel Test Meter for check on batteries and various parts of circuit.
- Chassis suspended in case by rubber shock mounts.
- 2 Differential type noise-cancelling Mikes.
- 2 prs. Headphones, 6,000 ohms.
- Connecting Cables.
- Three aeriials in carrier (12ft. rod, 8ft. 6ins. Telescopic, 25ft. wire).

BARGAIN OFFER (less Vibrator) £7

VIBRATOR POWER UNIT £15

As above but COMPLETE with set of 8 spare valves, pure Vibrator and Fuses, 2 Accumulators and

NEW 3-Way TWIN BANK YAXLEY Type SWITCHES 29.
.005 mfd. CONDENSERS, single gang, 4/6.
CONDENSERS, 1 mfd. 400 v. wkg., heavy stand-off insulated terminals, 2/- .02 mfd. 750 v. wkg., 8d. ea. 6/6 doz. .05 mfd. 500 v. wkg. in aluminium case, 8d. ea. 6/8 doz. 1 mfd. 750 v. wkg., 1,300 v. peak, metal case, 1/- ea. 2/6 doz. 1 mfd. Electrolytic 250 v. wkg., metal case, 9/6 ea.
MINIATURE VOLUME CONTROLS, Wire-wound, 6 ohms, 4/3.
INTERNATIONAL VALVE HOLDERS, Paxolin, 6/8 doz.
MOVING COIL INSERTS, Can be used as Headphones, Midget Speakers, Speech Mikes or adapted for Pick-ups. Coil 30 ohms. In perfect order, 5/-.

R.A.F. Model 1155 COMMUNICATION RECEIVERS

Comparatively new. These receivers are made to the stringent specification of the Air Ministry and are fitted with a large scale dial calibrated from 7.5 mc/s. to 1.500 kc/s. Complete with 10 valves, including magic eye, they are fitted in a strong metal cabinet, and supplied in wood carrying case. They require only a power pack to be ready for immediate operation. **£15**

You are invited to call and see the stocks of R.A.F. gear we have for sale. It will pay you!

N.B. We do not issue lists and cannot deal with correspondence on the goods we offer.

LONDON CENTRAL RADIO STORES

Closed Thurs. 1 p.m. Open all day Sat.
23, LISLE STREET
 LONDON GERRARD 7969 W.C.2.

G. A. RYALL, 65, Nightingale Lane, London, S.W.12.—Mail order only, at present, no C.O.D. under £1 please; postages extra. Many new lines: delays 150 ohm 2v 15ma, 2p M.B.I. 1P C.O. high class insulation. British make, unused, good magnets, 5/-; moving coil meters, 2in face, good scales, 0.5ma, 32/6, and 0.500 micro amperes, 45/-, unused, first grade; U.S.A. make tubular condensers, 0.1mfd, 500v wkg, wire end metal cased, 5/- dozen; also 0.5mfd 500v, 3/2-, or 6/6 dozen; British make upright 1ml 350v, 6/6 dozen; also 2Mf 600v, 18/- dozen; 4mf 250v, will work O.K. at 350v, made for Air Ministry, 18/- dozen; per back type stranded wire, 12vds 1/-, or 500yd coils, 30/-.

CONTROL boxes, ex-Govt., unused, single type only, each contain two 5P sockets No. 57A, black pointer knob, 3 4-way distribution boards, 250ma fuse and holder. **YAXLEY** type switch, 3P, 3w 2-bank, box size 4 1/4 x 4 1/4 x 2 1/4 deep, 2/6 each, post 8d; all packed in original cartons as manufactured. Yaxley type switches, 5w 2P 2-bank, 2/6; 4w 2P 1B, 2/-; also single pole DT, 2-bank, 1/6; and 3-bank 2P 4w, with middle screen, 3/9.

BEST make insulated resistances, 1/4 watt sizes 47, 100, 270, 500, 900, 1,000, 2,000, 5,000, 22,000, 50,000, 220,000 2meg, all 3/- dozen including a few non-insulated; best make 2watt carbon resistances, 6,800, 140,000, 150,000, 220,000, 470,000, 820,000, 5/- dozen; good assortment of 1/4, 1/2 watt resistances at 1/6 dozen, and 1,800 wire wound, 1/6 dozen; 2,200 ohms, 1/- dozen; vitreous 300hm, 1/6 dozen; 200hm H.D., 1/-; well-made robust buzzers, 6v 20ma, 2/-; panels with screened 0.1mfd and 12 1/2 resistances, and condensers, 2/3 each; pre-set pots, 300ohm, 2/-; pairs 300m trimmers, 8d; multi insert mikes, unused, power type, 20/- each; double type mike and phone transformers, secs 175.45.10 ohms, 5/-; five 30mm trimmers on metal base, 1/-; all perfect goods.

SUPREME RADIO, 746, Romford Rd., S. Manor Park, London, E.12. Tel. III. 1260. For 15 years we have given service. **LINE** cord 3-way 60-70v per foot, 1/6 yd; M.C. coils with circuit matched 9/6 pr, MW 6/6; L.M.S. wave coils, A and O short 14-50 metres, M200-550L, 900-2,000, with circuit, 10/6 pr; I.F. 465 kc, 10/-; switches for same, 7/6; midget 2-gang 0005 condensers, 11/- 3-gang 15/-; all-wave dials, 3 1/2 in x 4 in, coloured 1/9; all-wave 5in, 2/6; glass 4 1/2 in x 9in, 3/6; L and M switches, 2/3. **SPEAKERS** from 2 1/2 in to 10 in; send for prices valves, 6.15GT, new, boxed, 7/6; not BUA, 80, 5Y39. we have a quantity of odd valves, also over 3,000 BVA valves at 8/9 per price list; paper and can condensers; send for prices; Airmaster 5-valve superhet chassis, 4-waveband pick-up and extension speaker tappings, all Mazda valves fitted, including TP, £15/10; also in Console model, £29/10. MANY other lines for the service engineer. S.A.E. all enquiries, 6d extra for postage. No c.o.d. [533*

ROTARY transformers, 12 volts D.C. input, output 275 volts, 110 ma and 500 volts 50/80 ma simultaneously, ideal for P.A. or mobile transmitters; bargain, £37/16 each, carriage extra; tough rubber-covered 8/9 cable, 7d per yard, 50 mfd 12 volt tubular electrolytics, 11d each; 0.5 mfd 450-volts tubular paper.—Austin Mills, Ltd., Lower Carrs, Stockport. [5432

ELECTROLYTIC block condensers, 16x16 mfd. card, 450v, 6/9; 8mfd, 500v can, 2/10; 1500v aluminium can tubular, 0.01mfd, 1,000v, 1/9; 0.02 750v, 1/3; 0.1mfd, 1,000v, 1/-; block paper, 1mfd, 1,000v, 3/3; 4mfd, 1,000v, 8/9; s.a.e. for enquiries and current list; country dealers send for particulars of our country dealers' service; post orders only: c.w.o. or c.o.d. postage under £1.—U.E.I. Corp., 32 St. Gabriels Rd., London, N.W.2. [5589

C.C. instrument wire, 1/4 lb reels, 18s, 20, 22, 2, 24g, 1/6; 26, 28g., 1/9; 30, 32g., 2/-; 34g., 2/3 enamelled do., same prices, including 36g., 2/3, 38g., 2/6; silk covered do., 2oz reels, 24, 26, 28g., 1/6; 30, 32, 34, 36g., 1/9; 40, 42g., 2/-; 16g. D.S.G., 1lb, 5/-; 18g. D.S.C., 1lb, 7/-; laminated baffle panels, 1 1/2 in thick, 6in x 4in, 1/3; 6in x 6in, 1/9; 8in x 6in, 2/3; 10in x 6in, 2/9; 10in x 8in, 3/6; 12in x 8in, 4/-; ditto, 1/16in thick, same sizes, 10d, 1/2, 1/6, 1/10, 2/4, 2/8; polished ebonite panels, 3/16in thick, sizes as above, 1/9, 2/9, 3/6, 4/6, 6/-, 7/- respectively; B.A. screws, gross useful sizes, 2/6; ditto, nuts, 2/6 gr.; assorted gross screw and nuts, 2/6; ditto, brass washers, 1/6; 1/8; fibre washers, 1/6 gr.; assorted soldering tags, 2/- gr.; assorted small eyelets and rivets, 1/3 gr.; finest quality stranded and single push-back wire, 12 yards 2/3; resin-cored solder, 1lb, 3/6; heavy insulated aerial wire, 50ft 1lb, 75ft 2/3, 100ft 3/-; lead-in tubes, 4in 9d, 6in 1/-, 9in 1/4; all postage extra; trade supplied.—Post Radio Supplies, 33, Bourne Gdns., E.4.

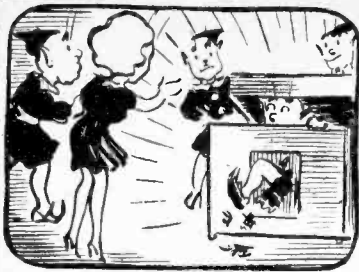

THE "FLUXITE GUNS" AT WORK

Said EH to OO "Well that's queer,
Set's switched off yet it growls, can you hear!"
Came a shout "It's all right,
fixing wires with FLUXITE,
But you want room to move round in here!"

See that FLUXITE is always by you—in the house—garage—workshop—wherever speedy soldering is needed. Used for over 30 years in Government works and by leading engineers and manufacturers. Of all Ironmongers—in tins, 8d., 1/4 & 2/8.

Ask to see the FLUXITE POCKET BLOW LAMP, price 2/6.

TO CYCLISTS! Your wheels will NOT keep round and true unless the spokes are tied with fine wire at the crossings AND SOLDERED. This makes a much stronger wheel. It's simple—with FLUXITE—but IMPORTANT.

The FLUXITE GUN puts FLUXITE where you want it by a simple pressure. Price 1/6, or filled, 2/6.



ALL MECHANICS WILL HAVE

FLUXITE

IT SIMPLIFIES ALL SOLDERING

Write for Book on the ART OF "SOFT" SOLDERING and for Leaflets on CASE-HARDENING STEEL and TEMPERING TOOLS with FLUXITE. Price 1d. each.

FLUXITE LTD.

(Dept. W.W.), Bermondsey Street, S.E.1

ACCURATE radio rewinds, mains transformers, fields, op. transformers, etc.—Southern Trade Services, 297-299, High St., Croydon. [5158]

LOUDSPEAKER repairs, British, American, any make; moderate prices.—Sinclair Speakers, 12, Pembroke St., London, N.1. Terminus 4355. [5308]

ELECTRICAL measuring instruments skillfully repaired and recalibrated.—Electrical Instrument Repair Service, 329, Kilburn Lane, London, W.9. [5344]

RADIO repairs efficiently and speedily executed by experts; comprehensive modern test equipment.—Radio Maintenance Service, 139, Goldhurst Terrace, N.W.6. Mai. 6133.

REWINDS and conversions to mains and output transformers, fields, etc. from 4/6. P.P. equipment a speciality.—N. L. Rewinds, 4, Brocknock Rd., N.7. Tel. Arnold 3390. [5185]

RADIO repairs quickly executed to all makes, English or American; lowest possible prices.—The Music Box, 89, London Rd., London, S.E.1 (Tel. Waterloo 4460 and 6766)

TRANSFORMERS rewound; fields from 4/6; chokes, pick-ups, etc.; all windings interleaved and impregnated; 48-hour service.—North-West Electrical, 36, Rosslyn Hill, N.W.3. [5469]

SERVICE with a Smile.—Repairers of all types of British and American receivers; coil rewinds; American valves, spares, line cord.—F.R.L., Ltd., 22, Howland St., W.1. Museum 5675. [1575]

STURDY rewinds mains transformers, chokes and fields; we give prompt delivery, and guarantee satisfaction; 14 years' experience; prices on request.—Sturdy Electric Co., Ltd., Dipton, Newcastle-upon-Tyne. [4316]

TELEVISION and radio receiver serviced by certified engineers; Murphy and Pye specialists; amplifiers rebuilt or repaired; sound repairs for 15 years.—T. E. Fevver, F.I.P.R.E., 50, Vine St., Uxbridge. [5266]

DURRANT RADIO Co.—Repairs to any make and type of radio apparatus. Prompt and efficient attention. Special apparatus built to your specification for any purpose.—49a St. James' Rd., Northampton. [5489]

LOUDEST SPEAKER Repairs.—We are now in a position to undertake repairs of all types at keen, competitive prices, with quality workmanship.—Send to L. Cottenham, Loud Speaker Repair Factory, 113, Whetley Lane, Bradford, Yorks. [5489]

REPAIRS to moving coil speaker, cones, coils fitted, field rewound or altered; speaker transformers, clock coils rewound, guaranteed satisfaction, prompt service.

L.S. REPAIR SERVICE, 49, Trinity Rd., Upper Tooting, London, S.W.17. [4819]

REWINDS, mains transformers, speaker field coils, chokes, high-grade workmanship, 7-day delivery; new transformers constructed to customers' specification, singly or in quantities.—Metropolitan Radio Service Co., 1021, Finchley Rd., N.W.11. Speedwell 3000. [3719]

24-HOUR service, 6 months' guarantee, any transformer rewind, mains outputs and i.f.s., etc., all types of new transf., etc., supplied to specification; business heading or service card for trade prices.—Majestic Windings Co., 180, Windham Rd., Bournemouth. [4977]

LOUDEST SPEAKER repairs, any make, reasonable prices, prompt delivery, to the trade and quality fans; 25 years' combined experience with Rola, Magnavox, Goodmans, Celestion.—Sound Service Radio, 80, Richmond Rd., Kingston-on-Thames, Kin. 8008. [4977]

ALL makes and kinds of electrical and radio instruments repaired by skilled technicians A.I.D. approved; over 60,000 instruments repaired for R.A.F.; all work quoted by return without charge.—C. Gertler, Dept. D, 29-31, Cowcross St., E.C.1. Cle. 6783. [4829]

REWINDS, mains transformers, layer wound, wax impregnated, O/P transformers, chokes, fields, clock coils, pick-ups, fractional hp. motors, competitive prices; prompt delivery; guaranteed work.—W. Groves, Manufacturing Electrical Engineer, 154, Leifield Port Rd., Birmingham, 16. [4547]

NATIONAL Radio Service & Television Co.—Repairs to all makes radio and television receivers, immediate service, any district, television aerial installations, rewinds to any type transformer, choke, armature, field coils etc.—40, Northiam, Woodside Park, Finchley, London, N.12. Hillside 7076.

DE GALLIERS', Ltd.—"Service with a guarantee." If you cannot get your receiver serviced, let American specialists with proper test gear do the job; first-class workmanship only; we specialise in Air-King, Belmont, Challenger, Emerson, Ferguson, Gard, Hall-crafter, Hammerlund, McMurdo, Midwest, Majestic, Pilot, Scott, etc., also any British set; send s.a.e. with all enquiries. DE GALLIERS', Ltd., 9, Westbourne Court, London, W.2. [5276]

GALPINS

GOVT. SURPLUS ELECTRICAL STORES

408 High St., Lewisham, London, S.E.13

Telephone: Leo Green 0309. Near Lewisham Hospital

TERMS: CASH WITH ORDER, NO C.O.D.

EX-R.A.F. 10-VALVE CHASSIS (sold for components only). Consisting of: 2, 150 Ohm Mult. Contact Relays, 9 British type Octal Base Valve Holders, 30 Tubular Condensers, ranging from 10 P.F. to 1 M.F. 25/30 Resistances $\frac{1}{2}$, $\frac{1}{4}$, 1 and 2 watts, all mounted on chassis, size 12in. x 8in. x 2in. Components all in good condition. "A real bargain" at 12/6 each, postage 1/6.

PRE-PAYMENT ELECTRIC LIGHT CHECK METERS, 200/250 volts 20 cy. 1 phase, 5 amp. load calibrated, 6d. per unit, 1d. slot, 15/- each, carriage 2/-, or shilling slot 25/-, carriage 2/-. All electrically guaranteed.

MAINS TRANSFORMERS, all by well-known makers and fully guaranteed, input 200/250 volts, 50 cy. 1 phase; output 2,000/0,2000 volts at 250 M/amps with 2 LT. tappings, 75/-, Ditto, 475/0/475 volts at M/amps, with 3 LT. tappings, 4v. and 6v., price 42/6. Ditto, 80, 100, 120, 140, 200, 220, 240 volts at 3,000 watts, £12 10s. Ditto, 6, 16 volts at 14/90 amps output, £15. Transformer cores, suitable for winding 2,000 watts, 27/6; 100 watts, 7/6 each.

EX-R.A.F. CHASSIS TYPE NO. C2. Useful for making your own oscillator. The components consist of condensers, chokes, transformer, volume controls, octal base, valve holders, tube holders, and various other components. Price 27/6 each. Carriage 2/6.

SULLIVAN MOVING COIL VOLTMETERS, 0 to 10 volts, 2 1/2 in. dial, new boxed, 35/-, 4 M.F. 300 v., A.C. wkg. condensers, 3/6 each. Ditto, 2 M.F. 2/- each. Mult. contact relays, ex-G.P.O., 5/- each.

ELECTROLYTIC CONDENSERS, 500 M.F. 25-v. wkg., 3/6 each. 2,000 M.F. 12-v. wkg., 10/-, 2,000 M.F. 25-v. wkg., 15/-, 50 M.F. 50-v. wkg., 2/6. 50 M.F., 12-v. wkg., 1/6 each. 80 M.F. 250-v. wkg., 7/6 each.

VOLTAGE CHANGER TRANSFORMERS. Auto-wound, fully guaranteed, immediate delivery. 350 watts, 55/-; 500 watts, 70/-; 1,000 watts, £5 15s.; 2,000 watts, £8 15s. All tapped 0, 110, 200, 220 and 240 volts.

EX-GOVT. R.A.F. ROTARY CONVERTERS, suitable for car radio, etc., all in new condition, fitted with automatic switching and reduction gearing operating 3 relays, complete with smoothing, input 6 to 9 volts, output 450 volts at 50/80 m/amps, 37/6 each, carriage 2/6; or in quantities of 3, 32/6 each, carriage 5/-; in lots not less than 12, 30/- each, carriage per dozen, 15/-, Ditto, 12 to 18 volts, input same as above.

ELECTRIC LIGHT CHECK METERS, guaranteed electrically, 200/250 volts 50 cy., 1 phase, input 5-amp type, 12/6, 10 amp. type, 15/- each. Carriage 1/-.

D.C. MOTORS, approx. $\frac{1}{4}$ h.p. series wound, all guaranteed electrically for 110 or 250 volts mains. Price 15/- each. Carriage 1/-.

EX-R.A.F. ROTARY CONVERTERS, 20/24 volts D.C. input, 450 volts 40/60 m/amps D.C., output complete with smoothing, 25/- each. Carriage 2/-.

X-RAY TRANSFORMERS, by well-known makers and fully guaranteed; input 120 volts, output 30,000 volts at 750 watts, £8 10s. Ditto, 110/250 volts, input 90,000 volts at 2 1/2 kW. with Coolidge winding, £25. Ditto, 120 v., input 40,000 volts at 80 watts, £15. Ditto, 120 volts, input 58,000 volts at 2 Kva, £17 10s. Ditto, Dental type, 110/240 v., input 95,000 volts at 1 m/a., output with Coolidge winding, £10.

HIGH-GRADE SWITCHBOARD TYPE AMP. METERS, 5in. dial for A.C. or D.C. calibrated 50 cycles, 0 to 30 amps, 32/6 each. Ampmeters moving coil, 3in. dial 0 to 10 amps, 20/- each.

LARGE TYPE RECTIFIERS, 12 volts 4 amps, 45/-; 12 volts 6/8 amps, 55/-; 6 volts 1 amp, 12/6; 50 volts at 2 amps, 42/6. All fully guaranteed.

MAINS TRANSFORMERS, to suit the above 12 volt rectifiers, with tapped output of 6, 12 and 24 volts at 6 to 8 amps, 40/-, Carriage 2/-.

MAINS TRANSFORMERS, by well-known makers, 200/250 volts input, output 300/0/300, 100 m/a. Price 21/-, Carriage paid. Ditto, 275/0/275, 100 m/a. 5 volts 3 amps, 6.3 at 2 amps. Price 21/-, Carriage paid. Transformers wound to your own specification, please let us quote.

OUR LATEST



Model A36. Audio Amplifier De Luxe. For A.C. mains. 200/250 v. 50/100 cps. Seven valves, using KT66's in P.P. Class AB1, with neg. feedback. 36 watts. Stabilized voltage, electronic mixing mic. high-gain stage, with gram. stage. Attractive, practical case, with new recessed control panel at front. Ready to use. Complete £22 10 0

Summary of other amplifiers available.

A18 Gramo, only 12 watts.....	£9 18 0
A18 HG with mic. stage.....	£11 15 0
A18 PPC for film input.....	£12 5 0
A23 Public address.....	£15 10 0

All factory assembled and tested.

Transformers for those building their own equipment, massive mains and output models. Write for "Spring List."

Dealers, you must get acquainted with these lines—the sales are increasing daily.

EXPORT. We are packing as much equipment abroad as ships will take. Write us from any country—we shall reply with all possible speed.

RADIO INSTRUMENT CO.



Radio Products
294, BROADWAY,
BEXLEYHEATH, KENT
Bexleyheath 3021

COVENTRY — RADIO

Component Specialists since 1925

"NAPP" MAINS TRANSFORMERS

Primarys, 0-200, 220, 240 v. 50 c/s. Secondarys:—
275-0-275 volt 80m/a., 6.3v. 3a., 4v. 2a. 21/-
350-0-350 volt 90m/a., 6.3v. 3a., 5v. 2a. 24/-
350-0-350 volt 90m/a., 4v. 4a., 4v. 2a. 24/-
350-0-350 volt 100m/a., 6.3v. 4a. c.t., 5v. 3a. 26/6
350-0-350 volt 100m/a., 4v. 4a. c.t., 4v. 3a. 26/6
350-0-350 volt 120m/a., with 6.3v. 4a. tapped at 4v., and 5v. 3a. tapped at 4v. 29/6
425-0-425 volt 250m/a., with 4-4v. 4a. l.t.'s. 49/6
L.F. Chokes, 340 ohm 16 h., 80m/a. 6/9

Prompt service, complete satisfaction.

COVENTRY RADIO
191, DUNSTABLE RD., LUTON

THE COIL PICKUP

complete with equalizer costs

£5-15-0. Purchase Tax £1-5-7.

WILKINS & WRIGHT, LTD.,
Holyhead Road, Birmingham, 21.

TRANSFORMERS & COILS TO SPECIFICATION.

MANUFACTURED OR REWOUND.

STANLEY CATTELL LTD.
9-11, East Street, TORQUAY, Devon

'Phone: Torquay 2182.

WORK WANTED

PICK-UPS of all makes, including crystals. Rebuilt, reconditioned and tuned.
EXPERT GRAMOPHONES, Ltd., Ingerthorpe, Gt. North Rd., London, N.2. [5274
WIRELESS cabinets made to order for export.—Leipsy, 71, Killick St., Kings Cross, N.1. [5208
UNIVERSAL ELECTRONIC PRODUCTS (G8UQ), 36, Marylebone High St., London, W.1. Tel. Welbeck 4058.

OUR workshops are equipped to undertake the construction of all types of radio or electronic equipment, from an extension spindle or small chassis to a complete transmitter. We are practical people, and amateur enthusiasts are always welcomed.

LARGE selection of components, including Raymart products, always in stock. Pakolin sheet up to 1/4 in thick cut to your dimensions. INSTRUMENT knobs, 2 in black bakelite, brass inserts, 1/9; flexible couplers for 1/4 in spindles, 1/; micro switches, 4/9; polystyrene sheet 1/4 in Highbury New Park, N.5 (Tel. Can. 5193).

CAPACITY available for light assembly, wiring and soldering work, radio equipment, etc.; London district.—Box 8618. [5460

ENGRAVING; precision instrument firm in West London can undertake specialised machine engraving of knobs, dials, panels or sundry components; excellent delivery on small quantities.—Box 6903. [5131

CONSULT Novoltra Products, electro-mechanical engineers and model makers, for prototype work in electronics, cinematography, and illumination. Design and working drawings prepared.—Novoltra Products, 131, Highbury New Park, N.5 (Tel. Can. 3193).

SITUATIONS VACANT

EXPERIENCED radio and television serviceman required.—Cineluxe. 1725, London Rd. Leigh-on-Sea. [5498

EXPERIENCED salesman required for City radio shop.—Full details, experience, salary, etc., to Box 8335. [5428

REPAIRER, thoroughly experienced all makes, to take charge or interest.—Brayne, 1, Church St., Folkestone. [5418

RADIO service engineer, experienced, knowledge of television useful.—Apply Frank Gale & Son, Ltd., Friar St., Reading. [5437

SENIOR mechanical designer draughtsman required by progressive radio factory, North London area.—Apply, stating age, qualifications, experience and salary required, to Box 33. [5498

RADIO chief engineer and designer required with first-class experience and good references; very good position offered.—Reply Box 8520. [5451

ENGINEER wanted for retail service dept., radio, television, P.A. previous commercial experience essential; details and salary required.—Courtney Davis, Ltd., Harpenden.

FOREMAN required, able to take full charge of shop combining armature winding for fractional hp motors and coil winding for small transformers; S.E. London.—Box 8658.

RADIO & television service engineer wanted; pre-war experience essential; good wages and congenial cond.; house available.—Fancourt, Radio Dealer, Tring, Herts.

SERVICE manager for valve debt aids, thorough knowledge of amplification, able to take full control, permanent post.—Write age, experience and wage required, to Box 22. Brandis-Davis, 231, Strand, W.C.2. [5466

EXPERIENCED foreman required by progressive radio factory, North London area, for radio coil and transformer winding shop.—Apply, stating age, qualifications, experience and salary required, to Box 8344.

SERVICE engineer required with good knowledge of audio-frequency amplification, experience of repair of carbon microphone and magnet earpieces desirable.—Details of experience, age & salary, Box 8341. [5441

DRAUGHTSMAN with experience in production drawing of radio apparatus; A.E.S.D. rates.—Applications in writing to Personnel Manager, E. K. Cole, Ltd., South-end-on-Sea, Essex. [5314

CAPABLE man wanted to take charge of radio-television department of progressive retail shop, experience essential; good wages and permanency to right man.—City Sale & Exchange, Ltd., 90-94, Fleet St., E.C.4. [5373

AN excellent opportunity arises in a new firm of radio component manufacturers; keen young man required to supervise 25 female workers engaged on mass production; must be practical and have production experience; Central London area.—Box 8616.

CHIEF of test and inspection required by leading radio manufacturers in West London; applications are invited from men under 45 who are qualified by knowledge and experience for this position; progressive ideas together with ability to organize are essential; good progressive salary.—Full details in confidence to Box 8522. [5452

TRANSMITTING GEAR AT VALLANCE'S

Values
RK34. Twin Triode 300 ϕ 10 watts anode dissipation, 6.3 v. 0.8 amp. £1 10s. RK25. Pentode 500 v. 10 watts anode dissipation, 6.3 v. 0.9 amp. £2. 807. Beam Power Tetrode 750 v. 30 watts anode dissipation, 6.3 v. 0.9 amp. £1 10s. 6d. 866. Rectifier (Mercury Vapour), 10,000 v., Inverse peak 1,000 ma., half-wave 2.5 v. 5 amp., £1 7s. 6d. 35T. Triode 2,000 v. 160 ma. 70 watts anode dissipation. 5 v. 4 amp., £2 15s. 8L6 (metal) Beam Power Tetrode, 500 v. 21 watts anode dissipation, 6.3 v. 0.3 amp., 18s. 3d. Telephone 72 ohm feeder, 10/4d. per yard. Aerial Strain Insulators, long leakage path (glass), 1/- each. Transposition Blocks, 4/d.

Aerial T. Pieces, 1/2.
H.M.V. Anti-Static Aerials comprise:—
1707T. Shielded Twin Feeder Cable. 1 only Aerial Anti-Static Transformer. 1 only Receiver Anti-Static Transformer. 1 only Receiver A.S. Transformer Clamp and Screws, 5/6 complete (boxed).
Finest quality Perbital Sleeve Lin. at 6d. per yard.
1 mm. Blue. 1.5 mm. Green or Yellow. 2 mm. Yellow. 3 mm. Green.

Instrument Wire. Finest hard-drawn enamelled copper. 36 S.W.4. in 1-lb. reels, only 3/6 per lb. Single Rayon-enamelled. 42 S.W.6. 4-oz. reels only, 5/3 per reel.

Mains Transformers. We specialise in Mains Transformers for every purpose. Here are just a few types we call offer from stock.

Type MT/R. 350-0-350 v., 100 m.a., 4 v. 2 a., 4 v. 2 a., 4 v. 5 a., CT, 33/9. MT/A 350-0-350 v. 100 m.a., 5 v. 3 a., 6.3 v. 4 a. CT, 33/9. MT/E150 350-0-350 v. 150 m.a., 4 v. 3 a., 4 v. 3 a., CT, 4 v. 5 a., CT, 42/9. MT/A150. 350-0-350 v. 150 m.a., 5 v. 3 a., 6.3 v. 5 a., CT, 41/3. MT/G. 450-0-450 v. 250 m.a., 4 v. 3 a., 4 v. 3 a., CT, 4 v. 3 a., CT, 4 v. 6 a., 51/9. MT/7. 450-0-450 v. 250 m.a., 5 v. 3 a., 4.3 v. 3 a., CT, 6.3 v. 5 a., CT, 60/3. MT/8. 500-0-500 v. 250 m.a., 4 v. 3 a., 4 v. 3 a., CT, 4 v. 3 a., CT, 4 v. 6 a., CT, 52/6.

Mains Transformers built up to your own specification

Other Lines. Include tuning condensers of every description, switches, Precision Dials, and others, Coils and Coil Assemblies, 7 mc/s. Crystals, Rectifiers, Test Prods, in fact, everything in radio for constructor, amateur and professional.

Send your orders for our prompt attention. Goods despatched C.W.O. or C.O.D., whichever best suits you. 1/- sending C.W.O. please include sufficient for postage and packing.

VALLANCE'S

144, BRIGGATE, LEEDS. 1

REWINDS

Armatures, Fields, Transformers, Pick-ups, Vacuum Cleaners, Gram. Motors, Speakers Refitted New Cones & Speech Coils.

All Guaranteed and promptly executed
Valves, B.V.A. and American, good stocks. Send stamped addressed envelope for list of Radio Spares, and C.O.D. Service.

A.D.S. Co. ASTON, BIRMINGHAM, 6

"VIBRO-ARC" Engraving Pen



For rapid engraving any metal—hard or soft.
Operates from 4-6v. Battery or A.C. Transformer giving 6-10 amps.

HOLBOROW,
46, Boroughbridge, Yorks.



BATTERY CHARGERS AND TRICKLE CHARGERS

Trouble-free Chargers fitted with selenium all-metal rectification. Good allowance on your old Charger. Thirty years experience behind every Runbakens product. Booklet R.15. describing 12 Models, on request.

RUNBAKEN-MANCHESTER 1



Be WISE and PATIENT

WE APOLOGISE to those who have been waiting months for replies. Our post-war plans have been frustrated so far. Sorry!

VOIGT PATENTS LTD.

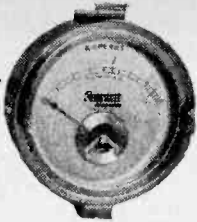

AMMETER (Crypton)
0-4 amp., direct wound, 15s. 6d.

B.A. SOCKET SET in sliding lid box; saves carrying seven sizes of spanners. 6/6.
TRIMMER TOOL KITS. Complete tool outfit for set aligning. 12 Assorted Screwdrivers and Box Spanners with two extension handles in wallet. 30/-.

WEYMOUTH COIL PACK. Covers 19-50, 200-550, 800-2,000 metres. One hole fixing only 5 leads (coloured) to connect. Gives really sharp tuning. Elaborate Circuit enclosed. £1 18s. 6d.
The Universal Avometer. An accurate moving coil meter providing 22 ranges of readings of A.C. voltage, D.C. voltage, current and resistance, on a 3in. scale. Complete with leads, testing prods, crocodile clips and instruction booklet. £8 10s. D.C. Model. £4 4s.

RESISTANCE AND CAPACITY TEST INSTRUMENT. This device facilitates the simple and speedy insertion of a condenser or resistor across another whose goodness is suspected. It gives resistance values between 50 ohms and 2.2 megohms and Capacity values between 50 mfm. and 25 mfd. Price complete and ready for immediate use, £3 17s. 6d.

SIGNAL GENERATORS. 100 Kc/s to 30 Mc/s. A mains operated precision all-wave signal generator designed for the accurate alignment and testing of all types of radio receivers. £21.

PORTABLE TRANSMITTER AND RECEIVER. 58MK.1. Comprising: 8 valves, telescopic antenna 103in., also another 16 sections antenna, working instructions card, all in carrying case. £8 12s. 6d.

Radio Receiver CIRCUITS Handbook, by E. M. Squire. 6/- Book List Sent.

A.C. ELIMINATORS WITH TRICKLE CHARGER. 200/250 v. Very efficient. In green crackle finished case, £4 15s.
TRAYS Partitioned in 36 Compartments most useful for your outfit. 30/-.

VALVES:
See our June advertisement and/or ask for any type even if not listed. Lists sent.

EXPORT:
Orders safely packed and fully insured. Forces and DEMOBilised Special Attention.
ORDER C.O.D.
or Remittance with order under 10/-.

COMPONENTS
Full Range of tested quality in stock.

J. BULL & SONS
(W.W.)
246, High St., Harlesden, N.W.10

RADIO service engineer required, experienced in all makes and in television, able to drive; good wages and commission for competent and conscientious man.—Apply or write Hastings, Ltd., Clapham Junction, S.W.11.

SERVICE engineer required to undertake radio repairs, retail service department supervision, and assist in proposed extension of facilities, opportunity offered to right man of working directorship; would prefer ex-Serviceman; must have pre-war experience; London district; write fullest partic.—Box 8142.

RADIO manufacturers in Scotland require engineers for their laboratory, (a) testing and investigation of radio components and receivers; (b) maintenance and design of electronic test gear; academic qualifications an advantage; salary £200-£350 per annum according to qualifications.—Box 166. [5523]

MECHANICAL designer-draughtsman required, with knowledge of light electro-mechanical assemblies and vacuum cleaner design to start and develop new section for progressive manufacturer of radio and domestic appliances in London area; good prospects.—Write, giving full particulars of training, experience, age and salary reqd, Box 8700.

LABORATORY steward, age not more than 35, wanted for department of Physical chemistry, experience in physical or chemical laboratory essential, salary according to qualifications.—Apply, giving full particulars of education, training and experience, with names of three referees to the Registrar, The University, Liverpool, 3. [5554]

DRAUGHTSMAN and traders required for D.S. London, with experience in prod. of working drawings from data supplied by designers; (1) mech. draughting; (2) elect.; preferably with exp. on radio comm. equipment; workshop experience preferred.—Apply in writing, with full details, to R.T.E., Ltd., 45, Nightingale Lane, S.W.12. [5538]

SPLENDID opportunity occurs for draughtsman-designer to join staff of progressive electrical equipment manufacturers; range covers line of h.t. communication, acoustic and rectifier equipment; modern factory, situated in S.W. London; salary in line with past experience and personal ability.—Reply, with full details and past salary rate, to Box 8678.

LARGE radio manufacturing firm in S.W. London area have vacancies for technical supervisors (electrical assistant foreman); must have passed Grade III of City and Guilds in radio or equivalent, plus good practical experience in the industry; salary from £6/10 to £7/10 per week of 47 hours.—Reply, giving full details, to Box 700 L.P.E., 110, St. Martin's Lane, W.C.2. [5461]

WORKS superintendent required by leading radio manufacturers in West London; must be capable of installing and controlling manufacturing and assembly departments of components and complete receivers; must be fully experienced and may be required to work abroad for short periods; responsible and energetic post.—Full details in confidence to Box 8523. [5453]

MASTER wanted for newly formed radio college in London, correspondence lecture and practical courses; science degree (or equivalent) and good practical outlook essential; amateur transmitting experience an advantage; age preferably not over 30; salary £250-£500, according to age, qualifications and experience; cost-of-living allowance £60 and superannuation benefits.—Apply E.M.I. Institutes, Blyth Rd., Hayes, Middx. [5463]

REQUIRED, an experienced technician for development work on micro wave relay and co-axial cable links; degree in physics or engineering, with 4 or more years' experience in industrial or service research establishments on similar work; salary comparable with Scientific Civil Service scale; applications considered for early commencement or for later in the year.—Cinema-Television Ltd., Worsley Bridge Rd., Lower Sydenham, S.E.26. [5474]

PHYSICIST, with knowledge of metallurgy required for development work on magnetic and other materials in radio engineering and tele-communications, technical experience of modern developments in electronics desirable.—Apply, with full particulars of qualifications, experience, age, salary required, etc., to the Manager, Development and Research Dept., The Mond Nickel Co., Ltd., Grosvenor House, Park Lane, W.1. Mark envelope 'Confidential'. [5487]

FIRST-CLASS man required for commercial department by important national and international electrical manufacturing organisation, to specialize in sales development and export of public address, and other audio-frequency products; excellent opportunity for right person with sound experience in this field; University graduate preferred, but developments are drive, imagination and ability to develop ideas and markets; age 30 to 40; salary according to abilities.—Reply, giving complete particulars of personal, educational, and business experience, to Box 8615. [5457]

ARMSTRONG

Model EXP53

ALL-WAVE 7-STAGE RADIOGRAM CHASSIS

This new radiogram chassis incorporates wave-band expansion on all bands, e.g., the 16-50 m. band covers just over 20 inches on the large glass scale. Volume and tone controls work on both Radio and Gram. 4½ watts R.C. coupled output. Supplied complete with full size loudspeaker. This chassis has a lively performance, good quality reproduction, and represents excellent value. For 200-250 v. A.C. Mains.

Price, with speaker **£13 plus tax.**

Model EXP83

ALL-WAVE 8-VALVE SUPERHET CHASSIS

incorporating wave band expansion. Large glass scale treble boost control. Gram. switching. High quality push-pull output gives 10 watts audio. For 100-250 v. A.C. mains.

Price **14 gns. plus tax.**

Model EXP43

ALL-WAVE SUPERHET FEEDER UNIT

incorporating wave band expansion manual I.F. gain control, etc.

Price **11 gns. plus tax.**

Model EXP63

ALL-WAVE 6-VALVE SUPERHET CHASSIS

incorporating wave band expansion. Gram. switching. R.C. coupled output. For 100-250 v. A.C. or D.C. mains.

Price **12 gns. plus tax.**

Model AMP14

HIGH GRADE AMPLIFIER in well finished metal instrument case.

Two inputs, bass compensating circuit, treble boost control, 14 watts push-pull output precede; by 4 triodes.

Price **15 gns.**

Demonstration Sets are now available for interested callers to hear and illustrated technical specifications are now ready.

ARMSTRONG WIRELESS & TELEVISION CO. LTD

WARLTERS ROAD, HOLLOWAY, LONDON, N.7

'Phone : NORth 3213

POST-WAR TELEVISION

The advance in Radio Technique offers unlimited opportunities of high pay and secure posts for those Radio Engineers who have had the foresight to become technically qualified. How you can do this quickly and easily in your spare time is fully explained in our unique handbook.

Full details are given of A.M.I.E.E., A.M.Brit.I.R.E., City & Guilds Exams., and particulars of up-to-date courses in Wireless Engineering, Radio Servicing, Short Waves, Television, Mathematics, etc., etc.

We Guarantee "NO PASS—NO FEE"

Prepare for to-morrow's opportunities and post-war competition by sending for your copy of this very informative 112-page guide NOW—FREE.

BRITISH INSTITUTE OF ENGINEERING TECHNOLOGY (Dept. 3E8)

17, Stratford Place, London, W.1

MINISTRY OF CIVIL AVIATION

Appointment of Radio Mechanics

Candidates must have a knowledge of the fundamental principles of radio and radar, with a general knowledge of one or more of the following radio aids for navigation: D.F., Loran, Gee, Radar Beacons, A.C.R. or G.C.A., also practical experience in use of tools, filing, drilling, hard and soft soldering, cabling and wiring of electrical and radio measuring instruments, including C.R. oscilloscopes. Possession of City and Guilds Certificate in Radio Communication and Technical Electricity an advantage. Pay 125/- week inclusive with annual increments of 3/- to 140/-.

Write stating date of birth, details of qualifications and experience, quoting Ref. C.A.Est./R.M. to Establishment Officer,

MINISTRY OF CIVIL AVIATION,
10, FLEET ST., LONDON, E.C.4.

SITUATIONS WANTED

DEMOBBED radar mech. seeks employment, 4½ years R.A.F. and 12 years servicing experience.—Box 8174. [5558]

R.A.F. tech. sigs. radar officer, age 25, release August, C. & G., lic. amateur, seeks permanent progressive position.—Box 8213.

RADIO engineer (ex-R. sigs., R/Mech. class R. A1), pre-war exp. radio and television, desires position, any district; married.—Box 182. [5539]

RADIO refidusion engineer and manager, 14 yrs. exp., I.E.E., Brit.I.R.E. exams., requires position of superior responsibility.—Box 165. [5524]

EX-R.A.F. Flt. Lt., 6 years' radar, 5 years' pre-war radio manufacturing experience, desires progressive post in electronics industry.—Box 8356. [5431]

FOREMAN, coil and transformer winding and test for pass, 10 years, now disengaged, age 36, seeks post; good references.—Box 8359. [5455]

YOUNG technician, demobbed, seeks employment in development, representation or maintenance of electronics, television or p.a.—Box 8210. [5380]

RADIO engineer, 38, 15 years' all-round experience, at present senior development engineer to well-known radio manufacturer; salary 2750.—Box 8340. [5456]

RADAR mechanic (26) seeks employment as maintenance engineer with concern using electronic equipment; R.A.F. recommendation: "A very good mechanic.—Box 71.

YOUNG, energetic ex-R.A.F. Flt. Sgt. seeks progressive post, any capacity, Norfolk area, good appearance approach, education, 9 years radio, C. and G., Grade II; good driver.—Box 8617. [5459]

EX-FOREMAN of signals, 27, grad. exam., Brit. I.R.E., C. & G., Final Rad. Comm., technical electricity, 7 years' exp. radio and telephony eqpt., seeks progressive technical position.—Box 8214. [5394]

FLT. LT. (26), Grad. I.E.E., Inter. B.Sc. (Eng.), 6 years radar, good all-round knowledge C.W. and pulse receiver design, requires progressive post; South of England; available July.—Box 8343. [5444]

EX-FOREMAN of signals, 30, exp. all types radio/p.a. capt., also telephony, 5 years prewar service/sites, could manage business or any other position where good knowledge and drive means progress.—Box 8212. [5382]

GRAD. I.E.E. Assoc. Brit. I.R.E., 9 years wireless relay, 3½ years development staff Gov. research est. (component information and testing, etc.), age 36½, desires post. any branch wireless or light elect. industry considered.—Box 163. [5519]

RADIO engineer, with experience in the Colonies, has taken private interest in broadcast receivers abroad; their faults and servicing difficulties; frequently repaired receivers beyond local service capabilities; would consider joining English firm interested in export market, in technical export capacity.—Box 167. [5522]

TUITION
RADAR—RADAR—RADAR.

THE British National Radio School, first in the field in this new science (see W.W. for April), now offers a three months' practical course in radio physics and general laboratory practice. Correspondence courses for C. & G., Brit. I.R.E., and I.E.E. Examinations. Our "Four Year Plan for the ambitious Radio Officer" may be had on application to The Studies Director, B.N.R.S., 66, Addiscombe Rd., Croydon. [5484]

PATENT AGENTS
A. E. HILL chartered patent agent, 27, Chancery Lane, London, W.O.2. [4368]

PATENTS
THE proprietor of British patent No. 531963, entitled "Device for Producing Vibrato in Sound-amplifying Systems and the Like," offers same for licence or otherwise to ensure practical working in Great Britain.—Enquiries to Singer, Ehler, Stern & Carlsberg, Steger Buildings, Chicago, 4, Illinois, U.S.A. [5263]

AGENCIES
BOMBAY businessman wishes to contact manufacturers, exporters and those who bought Govt. surplus radio, electrical accessories and machinery; send details or literature.—Kantilal Doshi, 2, Rosalyn Hill, N.W.3.

AGENCIES required for electrical and wireless goods, components and light tools, etc., by ex-Serviceman calling on radio, retail and hardware stores in the counties of Dorset, Hampshire and Sussex.—Write in confidence in the first instance to Box 8338. [5434]

MANAGING director of old-established London house, proceeding shortly by air to China, India, Malaya and Java, solicits propositions from United Kingdom manufacturers and other houses interested in developing exports to these markets.—Box 72. [5507]

RI

TRANSFORMERS

Best for all Purposes

RADIO INSTRUMENTS LTD
PURLEY WAY, CROYDON.
Telephone: THORnton Heath 3211

Aladdin

RADIO CORES

for all purposes

GREENFORD, MIDDx. WAXLOW 2300

QUARTZ CRYSTAL UNITS

FOR AMATEURS
For your TRANSMITTER

HIGHER ACCURACY

COMPETITIVE PRICES
Delivery FROM STOCK

For your FREQUENCY STANDARD

SALFORD ELECTRICAL INSTRUMENTS LTD.
PEEL WORKS, SALFORD 3
Proprietors: THE GENERAL ELECTRIC Co., Ltd., of England

LASKY'S RADIO

EVERYTHING FOR THE HOME SET CONSTRUCTOR, AMATEUR RADIO EXPERIMENTER, AND SERVICEMAN.

ELECTROLYTIC CONDENSERS, 500v. WORKING.—8 mfd., 3/-, 16 mfd., 4/9; 8 x 8 mfd., 5/8; 8 x 16, 9/9; 16 x 16, 7/8.

HIGH VOLTAGE OIL-FILLED CONDENSERS.—8 mfd., 600 v.w., 5/-; 4 mfd., 1,000 v.w., 7/-; 10 mfd., 600 v.w., 7/-; 2 mfd., 1,000 v.w., 4/6; 4 mfd., 450 v.w., 3/9; 1 mfd., 1,000 v.w., 3/6; 4 mfd., 400 v.w., 3/3; 1 mfd., 750 v.w., 3/-.

All with china stand-off insulators and fixing clip (feet), 0.1 mfd., at 8,000 v.w. (tubular), 10/6; 0.5 mfd., 6,000 v.w., 10/-.

YAXLEY TYPE SWITCHES.—4-pole, 3-way, 2/6; 2-pole, 5-way (Midget), 2/3.

COILS.—Medium and long-wave with reaction and circuit, 8/6 per pair. Whearite "P" coils from 2/3 each. I.F. Trans., 465 kc/s., 15/- pair. Whearite Midget I.F.T.'s 460 Kc/s., 10/6 each. L.M. & S. Wave, A.B. and O.S.C., 465 Kc/s with superhet circuit 10/8 pair. Weymouth all-wave coil pack with all switches, padder trimmers, and circuit, 38/6.

MAINS TRANS., ALL TYPES. 350-0-350 120 m.a., 6.3 and 5v. (Tapped at 4v.) Input 200-250v., with mains tapping board and fixing feet, 37/6. 350-0-350 50 m.a., 6.3 and 5v. or 4v. and 4v., 29/6.

RADIO VALVES.—English and U.S.A. types, 6,000 at B.O.T. prices. A few examples: 014, 0133, PP35, PEN383, R3, APV4, MS/PEN., PENA4, VP4B, EF9, EF99, AZ31, CV31, CV1, UR30, AZ1, etc., etc. 4525, 2525, 2526, 5013, 3513, 2029, 128K7, 138A7, 68A7, 1A47, 12B7, 7A7, 2B7, 128A7, 25Y6, 25A6, 128J7, 6K7, 6J7, 6U7, 6KA, 6FB, 6V6, 6L6g, etc., etc., etc.

ENERGISED SPEAKERS WITH OTRANS.—8in., 2,000 Field, 35/-; 6in., 2,000 Field, 32/6; 10in., 5,000 Field, 45/-.

P.M. SPEAKERS, LESS OTRANS.—2½in., 27/-; 3½in., 29/6; 5in., 22/-; 6in., 23/6; 8in., 21/-; With trans., 6in., 27/6; 8in., 27/6; 10in., 39/6. Goodmans, 10in., 39/6; 12in., £6 15/-.

Midget Chokes, 5/9; Midget O/Trans., 4/10; Universal O/Trans. Multiratio, 7/6.

SPACE IS NOT AVAILABLE TO ADVERTISE ALL OUR GOODS. SEND 1d. FOR OUR CURRENT LIST. ALL OUR PRODUCTS ARE GUARANTEED. WE AIM TO GIVE SATISFACTION AND VALUE. TERMS.—CASH WITH ORDER C.O.D. or Proforma.

LASKY'S RADIO
370, Harrow Road, Paddington, W.9
(Opp. Paddington Hospital). Phone: Cunningham 1979

A.C.S. RADIO

FOR COMMUNICATION RECEIVERS, AMATEUR TRANSMITTING GEAR, ALL TELEVISION AND RADIO EQUIPMENT AND COMPONENTS.

Preliminary LIST NOW READY, but with new stocks constantly being added we suggest enquiry for definite items if not listed.

24, WIDMORE ROAD, BROMLEY, KENT

AMBASSADOR

INDUSTRIAL RADIO AMPLIFIER

TYPE P.A. 145

SPECIFICATION
20 Watt A.C. Amplifier with built-in Super-het Receiver covering 200-560 Metres. Specially recommended for Schools, Factories, Hospitals, etc. Full specification on request.

R. N. FITTON, LTD.
HUTCHINSON LANE, BRIGHOUSE. Tel.: 283
Scottish Distributors:
BRITISH ELECTRICAL & MFG. CO. LTD.
133 West Campbell St., GLASGOW. Tel.: Cen. 3286.

L-R-S IN STOCK!

STUART Centrifugal Electric PUMPS

for machine tool cooling, garden fountains and all pumping purposes. Three sizes.

AVOMINOR A.C./D.C. Universal Test Meters £8. 10. 0

AVOMINOR D.C. Test Meters £4. 4. 0
Reg. post 10d.

CYLDON ELECTRIC DOOR CHIMES
Beautifully made. Far more pleasant than buzzer or bell. Front door push operates double chimes, back door only single. Universal model for battery, or mains with bell transformer (extra).
Postage 10d. £2. 9. 6

R.A.F. Pocket Watches (Govt. Surplus).
Brand new high grade Swiss 15-jewel movement in polished nickel case.
Reg. post. 10d. £4. 15. 0
List of Pumps or Chimes 1d.

The LONDON RADIO SUPPLY Co.
(Est. 1925) BALCOMBE, SUSSEX

RADIO receivers, valves and radio accessories; established wholesale distributing house with centrally situated office in Belfast and six travellers covering Northern Ireland, anxious to contact reputable manufacturers of above lines with view to representations in Northern Ireland. Box 1393. Eason's Advertising Service. Belfast. [5106]

"ENGINEERING OPPORTUNITIES"



This unique handbook shows the easy way to secure A.M.I.Mech.E., A.M.Brit.I.R.E., A.M.I.E.E., City and Guilds, etc.

WE GUARANTEE— "NO PASS—NO FEE."

Details are given of over 150 Diploma courses in all branches of Civil, Mech., Elec., Motor, Aero., Radio, Television and Production Engineering, Tracing, Building, Govt. Employment, R.A.F. Maths., Matriculation, etc.

Think of the future and send for your copy at once—FREE.

B.I.E.T., 387, SHAKE SPEARE HOUSE, 17, STRATFORD PLACE, LONDON, W. 1.

NEW DUAL TESTSCOPE



Ideal for high and low voltage testing; 1/30, 100/850 A.C. and D.C.

Allowance made on old models. Send for interesting leaflet (R.14) on Electrical and Radio Testing, from all Dealers or direct.

RUNBAKEN MANCHESTER-1

RADIO SPARES

MAINS TRANSFORMERS.		Primaries 200/250 volts.
TYPE C.	100 ma. 4 v. 6a., 4 v. 3 a.	34/6
TYPE D.	100 ma. 6.3 v. 5 a., 5 v. 3 a.	34/6
TYPE E.	120 ma. L.T.s as Type C.	37/6
TYPE F.	120 ma. L.T.s as Type D.	37/6
TYPE H.	200 ma. Three L.T.s of 4 v. 6 a. + 4 v. 3 a. Rectifier	52/-
TYPE I.	200 ma. Three L.T.s of 6.3 v. 6 a. + 5 v. 3 a. Rectifier	52/-
Secondaries 500-0-500.		
TYPE J.	200 ma. Three L.T.s of 6.3 v. 6 a. + 5 v. 3 a. Rectifier	56/-
TYPE K.	200 ma. Three L.T.s of 4 v. 6 a. + 4 v. 3 a. Rectifier	56/-
TYPE L.	250 ma. Three L.T.s of 6.3 v. 6 a. + 5 v. 3 a. Rectifier	60/-
TYPE M.	250 ma. Three L.T.s of 4 v. 6 a. + 4 v. 3 a. Rectifier	60/-
Secondaries 400-0-400.		
TYPE R.	120 ma. 4 v. 5 a., 4 v. 3 a.	40/-
TYPE S.	120 ma. 6.3 v. 5 a., 5 v. 3 a.	40/-

SPECIAL UNITS MANUFACTURED TO FRIENDS' REQUIREMENTS

Please note that owing to dimensions and weight of TYPES H to M, kindly add 2/6 for carriage and packing.

HEAVY DUTY MULTI-RATIO OUTPUT TRANSFORMER. 120 ma. 15 watts, tappings for 6L6s in push-pull, 6X4s in push-pull, low impedance triode, low impedance pentode, high impedance triode, 27/6; complete instructions with each unit.

OUTPUT TRANSFORMERS. Special offer. Multi Ratio 30 : 1, 45 : 1, 60 : 1, 90 : 1, 6/-.

SMOOTHING CHOKES. 20 henrys 100 or 120 ma., 10/-; 20 henrys 150 ma., 12/6; 30, 35 or 40 henrys 200 ma. or 250 ma., 21/8.

LINE COBD. Special offer, .3 amp. 3-way, 180 ohms per yard, 1/9. Best quality.

Orders accepted by post only. Please help us to eliminate clerical work by sending cash with order. Please include postage with order. PRICE LIST 1d. stamp.

H. W. FIELD & SON, Colchester Road, HAROLD PARK, ESSEX
Telephone: INGrebourn 2642.

MIDLAND INSTRUMENT CO.

Offer brand new unused ex-R.A.F. Landing Lights. (Originally cost £15). Consists of ball-bearing, reversing 12-24-volt A.C./D.C. motors. Clearing, various automatic switch conditions, 8-in. dia. glass front reflector lamp. Easily adapted for many uses, 30/- each complete, carton, packing & postage 2/- extra. Avometers, Model 40, £17-10-0, carton, packing, postage & registration, 2/6 extra. Lewcos Instrument Wires & many other Radio & Electronic items, new June lists, 2d. s.a.e. 18, Harborne Park Rd., Birmingham. 17. Tel. HAR. 1308 or 2664.

Even 24 hours' immersion in sea-water cannot affect impervious **Welwyn Resistors**

Tested independently, a standard Welwyn Vitreous Resistor worked perfectly after 24 hours' immersion in sea-water. Sizes—1 w. to 300 w. Also High Stability Carbon Resistors—1/4 w. to 2 w.

New Trade catalogue available
WELWYN ELECTRICAL LABS. LTD
Welwyn Garden City, Herts.
Phone: WEL. GAR. 3816-8

5 mm/ft

NEW LOW LEVELS in capacity and attenuation of CO-AX Cables mean new possibilities in electronic equipment design both for the war effort and for the post-war electronic age.

BASICALLY BETTER AIR-SPACED

CO-AX LOW LOSS CABLES

TRANSRADIO LTD. 16 THE HIGHWAY-BEACONSFIELD-4-BUCKS

Superspeed SPECIAL

CORED SOLDER

A.I.D. APPROVED

H. J. ENTHOVEN & SONS LTD.
230 THORNTON ROAD, WEST CROYDON, SURREY
THORNTON Meath 2461

ERG'S HAVE THE URGE TO GO ABROAD

SPEAKING EXPORTLY...

ERG Resistors have an exceptional electrical specification and performance, with mechanical strength.

High-grade Vitreous Enamels used on our Tropical Resistors give long life, and definitely assist in the trouble-free manufacture and performance of Radio Receivers, Television and Test Equipment.

ERG Resistors are processed up to the highest Service Standards at a competitive Price.

ERG RESISTORS LTD.
1021a, FINCHLEY ROAD, LONDON, N.W.11. PHONE: SPEEDWELL 6967

Printed in Great Britain for the Publishers, LIFFE AND SONS LTD., Dorset House, Stamford Street, London, S.E.1, by THE CORNWALL PRESS LTD., Paris Garden, Stamford Street, London, S.E.1. "Wireless World" can be obtained abroad from the following—AUSTRALIA and NEW ZEALAND: Gordon & Gotch, Ltd. INDIA: A. H. Wheeler & Co. CANADA: Imperial News Co.; GORDON & GOTCH, Ltd. SOUTH AFRICA: Central News Agency, Ltd.; WILLIAM DAWSON & SONS (S.A.), Ltd. UNITED STATES: The International News Co.

S.E.M. 1/2 h.p. MOTOR

A STANDARD 1/2 h.p. single phase, capacitor motor that is ideal for all normal purposes has been designed and manufactured by S.E.M. engineers.

The motor, which is equipped with capacitor starting, is suitable for use on all the normal supply voltages. It is equipped with a simple and substantial centrifugal switch; has a high starting torque, and can be equipped with sleeve bearings in place of the standard ball-bearings, where specially quiet running is required. It is enclosed ventilated, speed 1425 r.p.m.

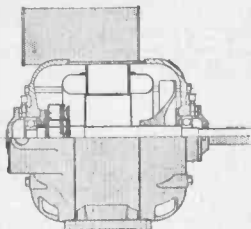

S.E.M. standard 1/2 h.p. single phase capacitor motor

In common with all S.E.M. machines, this motor is manufactured to the highest standards of mechanical detail and has passed rigid inspection tests.

SMALL ELECTRIC MOTORS LTD.

have specialized for over 30 years in making electrical machinery and switchgear up to 10 kW capacity. They are experts in the design and manufacture of ventilating fans and blowers, motors, generators, aircraft and motor generators, high-frequency alternators, switchgear, starters, and regulators.

A SUBSIDIARY OF BROADCAST RELAY SERVICE LTD.
BECKENHAM · KENT

MINIATURE or MIDGET

We specialise in their manufacture



HIVAC LIMITED. Greenhill Crescent, Harrow on the Hill, Middx. Phone: HARROW 0895

WHEN CHARACTERISTICS COUNT

TENAPLAS

EXTRUDED PLASTICS
are always specified

We make :—
INSULATED WIRES,
CABLES, TUBING, SOLID
SECTIONS, STRIPS, Etc.,
& CO-AXIAL CABLES
FOR ALL KINDS OF
HIGH-FREQUENCY
EQUIPMENT

Write to :—
TENAPLAS LTD.,
UPPER BASILDON,
NR. PENBOURNE,
BERKS.
Tel. : Upper Basildon 228 & 267

TENAPLAS LTD

WALTER SWITCHES

ARE MADE FOR



WALTER
INSTRUMENTS. LTD.

Earls Court Exhibition Buildings, Earls Court, London, S.W. 5
FULHAM 6192



Radio & Television
Components

Manufacturers of

- Plugs and Sockets
- Panel Mounting Sockets
- Coil Pins and Valve Pins
- Chassis Mounting Strips
- Panels
- Terminals and Connectors
- Tag Strips
- Cartridge Fuses
- Valveholders
- Cathode Ray Tube Holders
- Valve Bases

BRITISH MECHANICAL PRODUCTIONS LTD.

21 BRUTON STREET, BERKELEY SQUARE, W.1
Grams : Trolox, Wesdo, London Phone : Mayfair 5343

55 variations on a SINGLE theme

STANDARD

List No.	Cap. Mfd.	Peak D.C. Wkg. Volts	Peak D.C. Surge Volts (See Note 1 Page A3)	Construction	Dimensions in inches		Sketch Ref. (See Page A4)	Mounting Clips (See Page A5)	
					L.	D.		Vertical	Horizontal
J19	250	6	6	Reversible	2 1/2	1	1	V2	H1
K13	1000	6	6	Miniature	2 1/2	1 1/8	1	V3	H2
J4	50	12	12	Reversible	1 1/2	1	1	V1	H1
J22	250	12	12	Miniature	2 1/2	1 1/8	1	V2	H2
J23	500	12	12	"	3 1/2	1 1/8	1	V3	H3
K14	500	12	12	"	1 1/2	1 1/8	1	V5	H3
K15	1000	10	25	"	1 1/2	1 1/8	1	V2	H1
J25	25	25	25	"	2 1/2	1 1/8	1	V3	H2
J28	100	25	25	"	2 1/2	1 1/8	1	V5	H3
J29	250	25	25	"	3 1/2	1 1/8	1	V1	H1
K16	500	25	25	"	1 1/2	1 1/8	1	V2	H2
K17	12	50	50	"	2 1/2	1 1/8	1	V5	H3
J30	25	50	50	"	1 1/2	1 1/8	1	V1	H1
K18	250	50	150	Reversible	2 1/2	1 1/8	1	V2	H2
J32	32	175	175	Miniature	1 1/2	1 1/8	1	V1	H1
J5	8	200	200	"	1 1/2	1 1/8	1	V1	H1
J33	2	200	200	"	2 1/2	1 1/8	1	V1	H1
J34	8	200	200	"	1 1/2	1 1/8	1	V1	H1
J35	8	200	200	Etched	1 1/2	1 1/8	1	V1	H1
K19	40	350	350	"	1 1/2	1 1/8	1	V1	H1
J37	2	350	350	"	2 1/2	1 1/8	1	V1	H1
J38	4	350	350	"	1 1/2	1 1/8	1	V1	H1
J39	8	350	350	"	2 1/2	1 1/8	1	V1	H1
J40	24	350	350	"	1 1/2	1 1/8	1	V1	H1
J41	32	350	350	"	2 1/2	1 1/8	1	V2	H2
J42	32	350	350	"	1 1/2	1 1/8	1	V3	H3
K20	4	450	500	"	1 1/2	1 1/8	1	V1	H1
J43	8	450	500	"	2 1/2	1 1/8	1	V1	H1
J44	8	450	500	"	1 1/2	1 1/8	1	V1	H1
J45	16	450	500	"	2 1/2	1 1/8	1	V1	H1



MINIATURE

List No.	Cap. Mfd.	Peak D.C. Wkg. Volts	Peak D.C. Surge Volts (See Note 1 Page A3)	Construction	Dimensions in inches		Sketch Ref. (See Page A4)	Mounting Clips (See Page A5)	
					L.	D.		Vertical	Horizontal
J11	1 1/2	2	1	Plain	1 1/2	1	1	V1	H1
J12	2 1/2	2	1	Reversible	2 1/2	1	1	V2	H1
J13	1 1/2	2	1	Plain	1 1/2	1	1	V1	H1
J14	1 1/2	2	1	"	1 1/2	1	1	V1	H1
J15	2 1/2	2	1	"	2 1/2	1	1	V2	H1
J16	1 1/2	2	1	"	1 1/2	1	1	V1	H1
J17	1 1/2	2	1	"	1 1/2	1	1	V1	H1
J18	1 1/2	2	1	"	1 1/2	1	1	V1	H1
J19	1 1/2	2	1	"	1 1/2	1	1	V1	H1
J20	1 1/2	2	1	"	1 1/2	1	1	V1	H1
J21	1 1/2	2	1	"	1 1/2	1	1	V1	H1
J22	1 1/2	2	1	"	1 1/2	1	1	V1	H1
J23	1 1/2	2	1	"	1 1/2	1	1	V1	H1
J24	1 1/2	2	1	"	1 1/2	1	1	V1	H1
J25	1 1/2	2	1	"	1 1/2	1	1	V1	H1
J26	1 1/2	2	1	"	1 1/2	1	1	V1	H1
J27	1 1/2	2	1	"	1 1/2	1	1	V1	H1
J28	1 1/2	2	1	"	1 1/2	1	1	V1	H1
J29	1 1/2	2	1	"	1 1/2	1	1	V1	H1
J30	1 1/2	2	1	"	1 1/2	1	1	V1	H1
J31	1 1/2	2	1	"	1 1/2	1	1	V1	H1
J32	1 1/2	2	1	"	1 1/2	1	1	V1	H1
J33	1 1/2	2	1	"	1 1/2	1	1	V1	H1
J34	1 1/2	2	1	"	1 1/2	1	1	V1	H1
J35	1 1/2	2	1	"	1 1/2	1	1	V1	H1
J36	1 1/2	2	1	"	1 1/2	1	1	V1	H1
J37	1 1/2	2	1	"	1 1/2	1	1	V1	H1
J38	1 1/2	2	1	"	1 1/2	1	1	V1	H1
J39	1 1/2	2	1	"	1 1/2	1	1	V1	H1
J40	1 1/2	2	1	"	1 1/2	1	1	V1	H1
J41	1 1/2	2	1	"	1 1/2	1	1	V1	H1
J42	1 1/2	2	1	"	1 1/2	1	1	V1	H1
J43	1 1/2	2	1	"	1 1/2	1	1	V1	H1
J44	1 1/2	2	1	"	1 1/2	1	1	V1	H1
J45	1 1/2	2	1	"	1 1/2	1	1	V1	H1

TWO pages from the Hunt General Catalogue, yet the complete answer to most dry electrolytic questions of capacity, size and type. And every Hunt Capacitor type can be supplied in enough variations to make possible a "made to measure" choice for most specialised purposes... with standardised dependability, at a cost no greater than the second best.



DRY ELECTROLYTIC capacitors

A. H. HUNT LTD • LONDON • S.W.18 • ESTABLISHED 1901

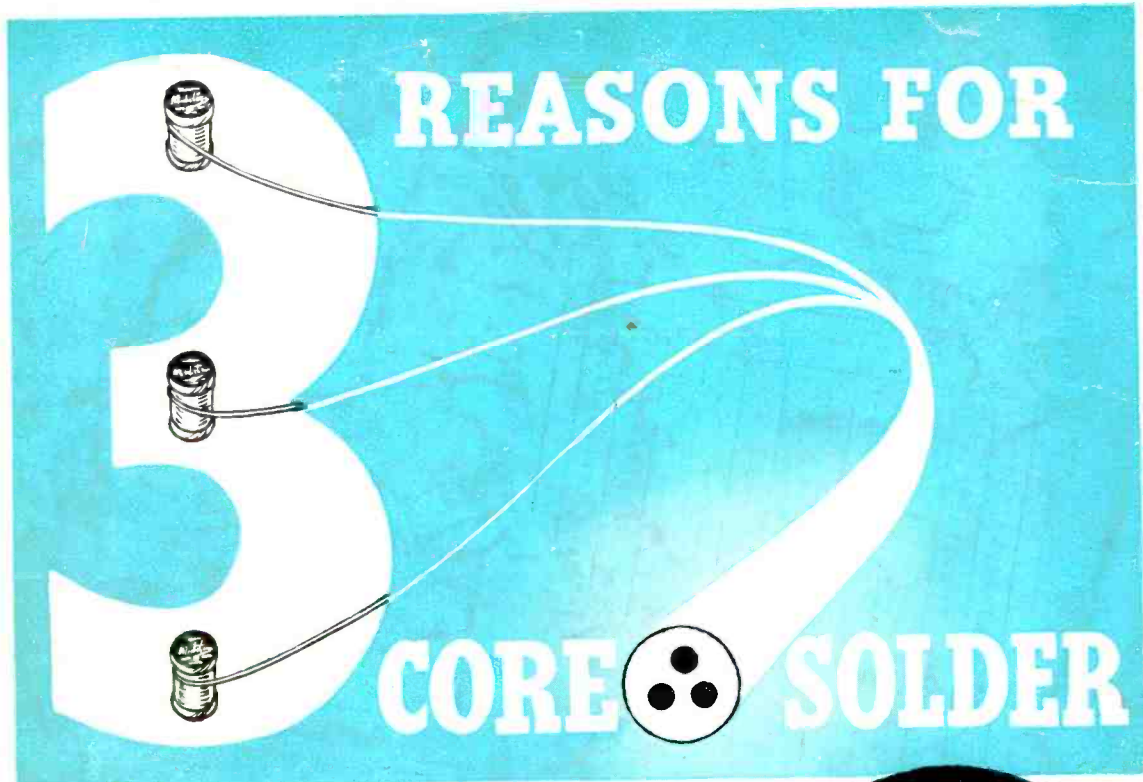

1 The even distribution of the three cores of Ersin Multicore Solder over the cross section of the wire provides thin solder walls. Rapid melting is thus obtained, and soldering is speeded up.

2 Three cores of flux ensure flux continuity and eliminate waste as there are no lengths of wire without flux. The flux does not tend to run out of the cores, so there is always a supply available for the next joint.

3 Ersin, the non-corrosive flux contained in the three cores of Ersin Multicore Solder, not only prevents oxidation during soldering, but actually cleans the surfaces to be soldered. This enables joints to be speedily made on "difficult" surfaces such as nickel.

Ersin Multicore Solder is made in most gauges between 10 and 22 S.W.G. For radio production and maintenance 13-18 S.W.G. are in most demand. Manufacturers and service engineers are invited to write for free technical information and samples.



ERSIN MULTICORE

MULTICORE SOLDERS LTD.

MELLIER HOUSE, ALBEMARLE STREET, W.1. Tel: REGent 1411 (P.B.X. 4 lines)