

Wireless World

RADIO and ELECTRONICS



MAY 1946

1/6

Vol. LII. No. 5

IN THIS
ISSUE :

RADAR COMPONENTS AND CIRCUITS

**MOUNTING THE
REQUIREMENTS OF PEACE
UPON THE EXPERIENCE
OF WAR -**

To all Trades:

RUBBER BONDERS LTD. offer their help in the solution
of problems of **VIBRATION, NOISE, SHOCK** and
MISALIGNMENT by the use of **RUBBER** bonded to metal.

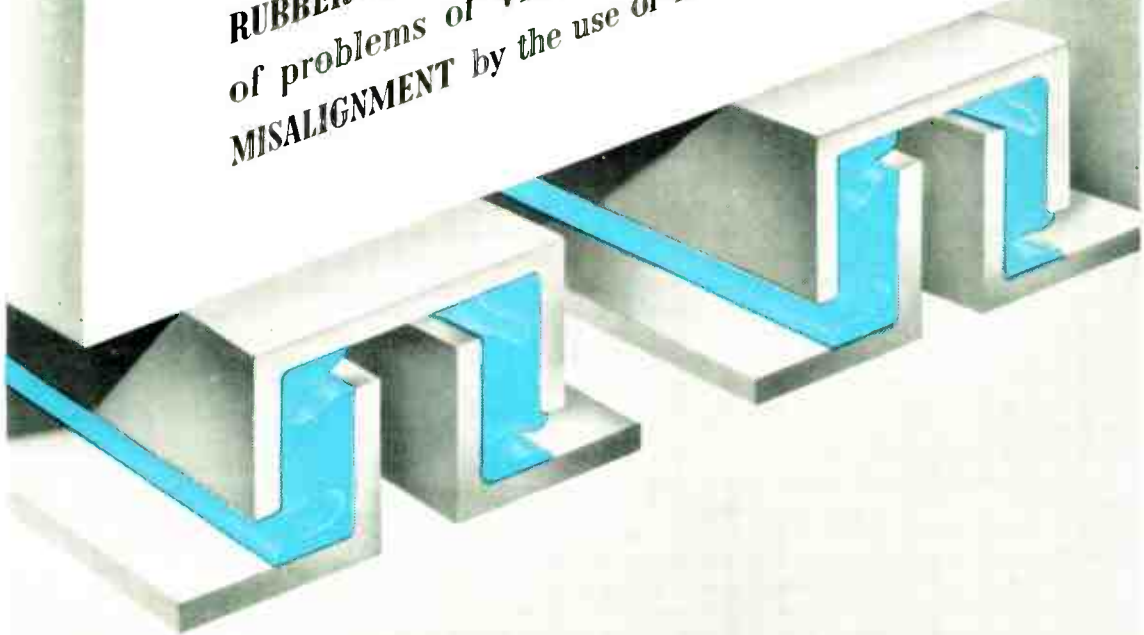

RUBBER BONDERS LIMITED

ENGINEERS IN RUBBER BONDED TO METAL

FLEXILANT WORKS • DUNSTABLE • BEDS.

TELEPHONE: DUNSTABLE 80345



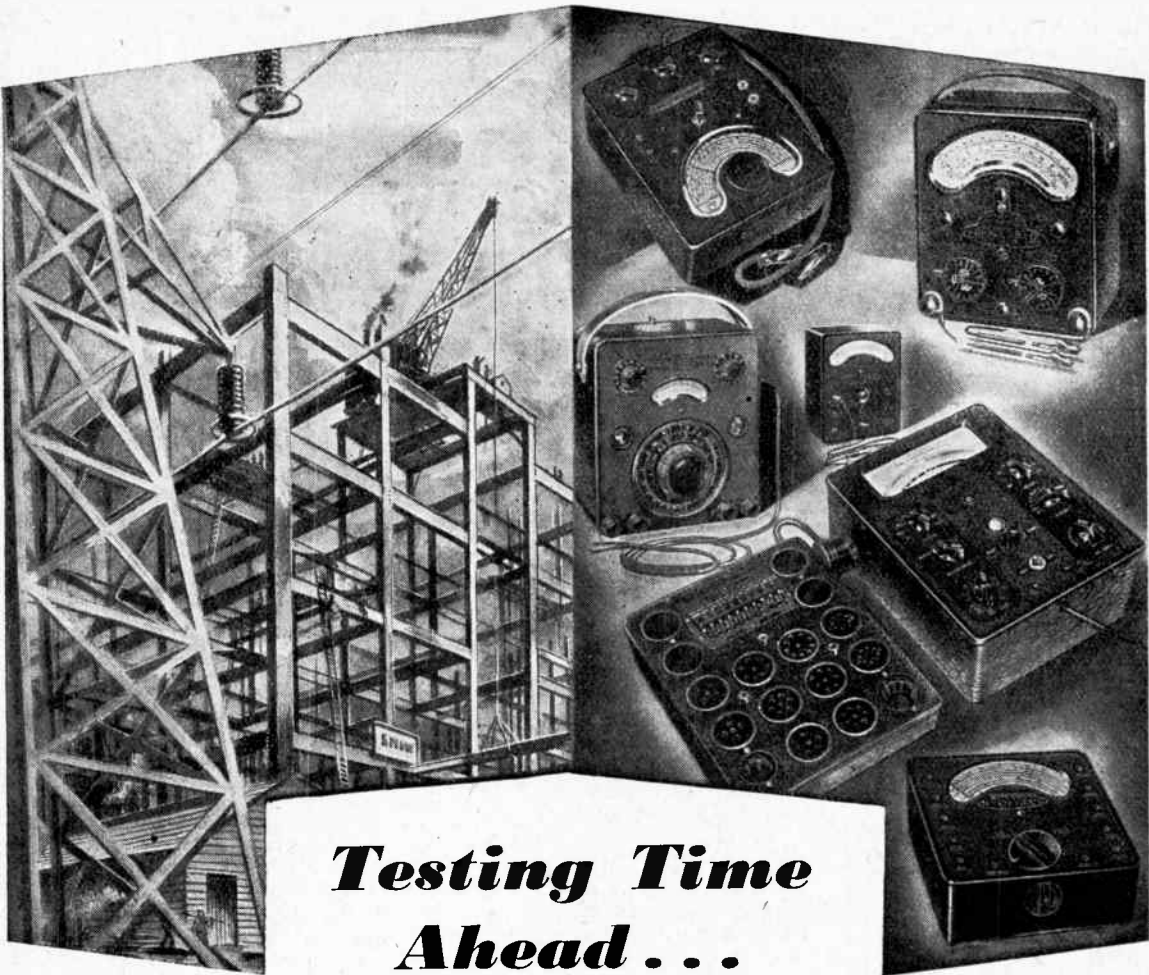

Testing Time Ahead...

RECONSTRUCTION, as we now know too well, means something other than enjoyment of the non-existent fruits of victory. The amenities of a world at well-earned peace are not for us until we have replaced the ravages of war with the necessities of life and the realities of universal peaceful intent for victors, victims and vanquished alike. That is speaking collectively . . . For ourselves, we learned much and progressed far in the six years of ceaseless toil, urged on by dire necessity and peril. We are not resting now. We are still pressing on, pressing into the service of those engaged in rebuilding the body and soul of a whole world the knowledge gained, the advancements perfected, the skill and craftsmanship that outmatched the efforts of our enemies.



Regd. Trade Mark

PRECISION ELECTRICAL MEASURING INSTRUMENTS

Sole Proprietors and Manufacturers:

THE AUTOMATIC COIL WINDER & ELECTRICAL EQUIPMENT CO. LTD., Winder House, Douglas Street, London, S.W.1.

Phone: VICTORIA 3404/8

"Avo" Electrical Testing Instruments set a standard by which other instruments are judged.

- THE UNIVERSAL AVOMETER
- THE "AVO" ALL-WAVE OSCILLATOR
- THE "AVO" VALVE TESTER
- THE "AVO" TEST BRIDGE
- THE UNIVERSAL AVOMINOR
- THE D.C. AVOMINOR
- THE "AVO" LIGHT METER
- THE "AVO" EXPOSURE METER
- Etc., Etc.

Catalogues on application.

...in the spring TELEVISION

TCC

★ (Spring will be a little late this year!)

CAPACITORS for special applications



"CATHODRAY"

A paper type tubular capacitor specially designed for high tension circuits of television receivers. Constructed for chassis mounting, the insulated case provides, in effect, a H.T. terminal which eliminates the possibility of flash-over.

Available in a wide range of capacities and voltages. Illustration shows a 0.1 mfd. capacitor for working up to 6,000 volts D.C.

Television and other high-voltage electronic equipment provide a truly exacting test of capacitor efficiency.

T.C.C. Capacitors are used extensively in Service Radar equipment; the experience gained during the war in supplying capacitors to withstand tests of extraordinary vigour (never likely to be met with in standard commercial television receivers) can now be applied to the peace-time needs for better and more reliable television.

That is why discerning manufacturers have already decided to use T.C.C. capacitors, including one or more of the types illustrated, and have placed orders accordingly. Samples and information are available to other set manufacturers contemplating new models the details of which are not yet decided.

T.C.C. Capacitors are found in all sets where quality and reliability are primary considerations

MICA CAPACITORS



"MICADISC"



TYPE C.M.20



TYPE M.W. (Side Wires)

"MICADISC"

A new T.C.C. development for capacities of between .0001 and .0005 mfd. for use in signal frequency circuits. Connecting lugs are provided for chassis mounting. The other connection is by a central eyelet which provides a convenient means of taking wire through chassis and also providing a fixed capacity to ground.

TYPE C.M.20 MOULDED

This is a miniature moulded type available in capacities up to a maximum of .001 mfd. Because of its compactness it is very suitable for decoupling at the higher frequencies.

TYPE M.W. MOULDED (Side wire connections)

This is also a decoupling capacitor, slightly larger than type C.M.20, but with side wire connections which, with certain chassis layouts, facilitates the mounting of the capacitor closer to the "hot" points, giving a reduction in lead-length and consequently a minimum inductance.

THE TELEGRAPH CONDENSER CO. LTD.

RADIO DIVISION

NORTH ACTON · LONDON · W. 3

Telephone. ACORN 0061



THE COUNTERSIGN OF DEPENDABILITY IN ANY ELECTRONIC EQUIPMENT

**HERE IS A RADICALLY IMPROVED
VERSION OF THE EIMAC
MULTI-UNIT 304TL TRIODE**

NEW NON-EMITTING GRIDS

NEW LOW-TEMPERATURE PLATES

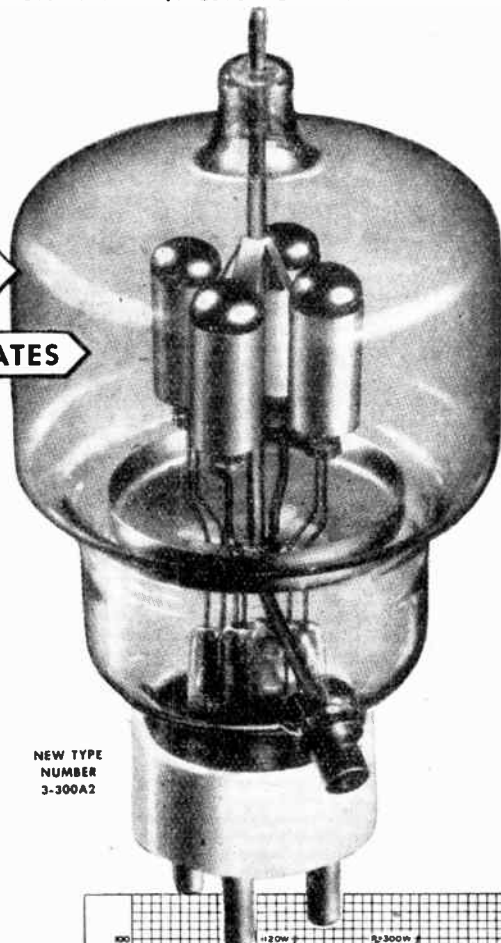

NEW TYPE
NUMBER
3-300A2

The Eimac Multi-Unit triode 3-300A2 pictured above is a radically improved version of the original 304TL which has been establishing outstanding performance records for a number of years in both civilian and military equipment.

The use of Eimac developed, non-emitting grids, contributes greatly to its already high stability, efficiency and long life, and the new type plates enable it to operate at much lower temperatures.

One of its outstanding characteristics is its ability to handle high current at relatively low voltages. For example: as a class-C amplifier the Eimac 3-300A2 will handle 1200 watts plate input with only 2000 volts on the plate. Under these conditions, the valve will deliver a power output of 900 watts, with a driving power of only 36 watts. The chart at right shows driving power requirements vs. power output. The symbols P_p indicate plate dissipation. Further information will be promptly supplied without cost or obligation.

ELECTRICAL CHARACTERISTICS	
Filament: Thoriated tungsten	
Voltage	5.0 or 10.0 volts
Current	25.0 or 12.5 amperes
Amplification Factor (Average) 12	
Direct Interelectrode Capacitances (Average)	
Grid-Plate	9.1 uuf
Grid-Filament	8.5 uuf
Plate-Filament	0.6 uuf
Transconductance ($I_b = 1.0 \text{ amp.}, E_b = 3000, e_c = -200$) 16,700 umhos	

FOLLOW THE LEADERS TO



EITEL-McCULLOUGH, INC., 1176 San Mateo Ave., San Bruno, Calif.
Plants located at: San Bruno, Calif., and Salt Lake City, Utah
Import Agents: Frasier and Hansen, 381 Clay St., San Francisco 11, Calif., U.S.A.

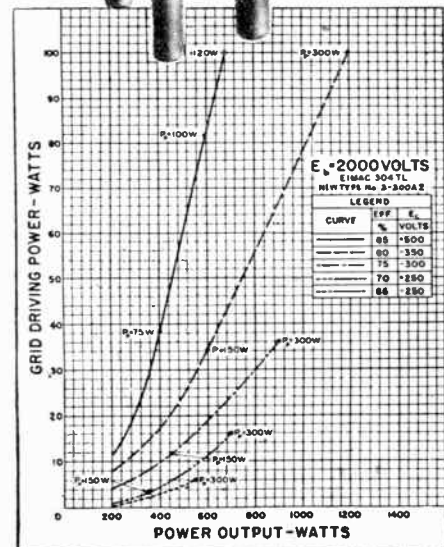

Authorised Distributors : BERRY'S (SHORT-WAVE) LTD., 25, HIGH HOLBORN, LONDON, W.C.1.

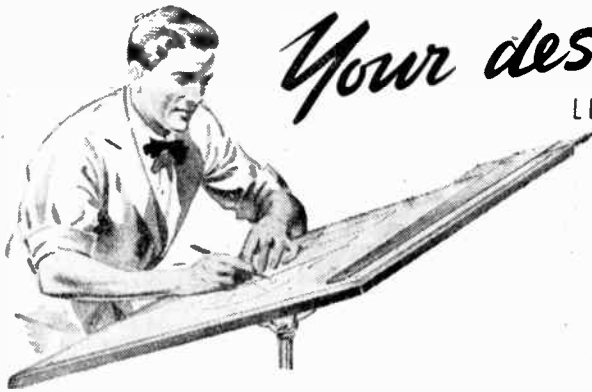

Your designs

LET US BRING THEM TO

LIFE!

Made in Three Principal Materials

FREQUELEX

An insulating material of Low Dielectric Loss, for Coil Formers, Aerial Insulators, Valve Holders, etc.

PERMALEX

A High Permittivity Material. For the construction of Condensers of the smallest possible dimensions.

TEMPLEX

A Condenser material of medium permittivity. For the construction of Condensers having a constant capacity at all temperatures.

the most difficult problems solved by . . .



Bullers

BULLERS LOW LOSS CERAMICS

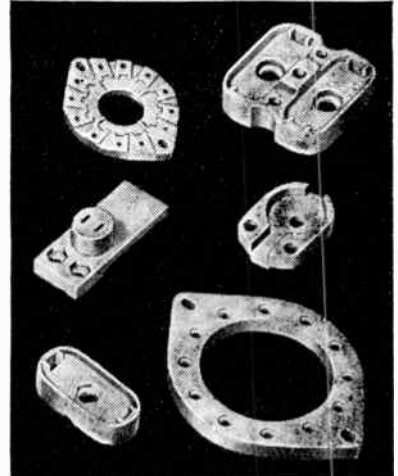

BULLERS LTD., 6, LAURENCE ROUNTNEY HILL, LONDON, E.C.4
 Telephone: Mansion House 9971 (3 lines) Telegrams: "Bullers, Cannon, London" Manchester Office: 196, Deansgate, Manchester



RADIO-AID LTD.

have pleasure in announcing that the following products are available for early delivery.

MOVING-COIL METERS

B.S. 1st grade 2", 2½" and 3½" flush and projecting mounting bakelite cased meters for all standard ranges A.C. and D.C.

CRYSTAL FILTERS

Complete band-pass filter units, single and triple switched band-widths for modern communication receivers. CRYSTALS by Piezo Crystals Ltd.

OSCILLOSCOPES

A series of self-contained instruments having unique features to meet the needs of both amateur and professional. 1½" and 3" screen sizes now ready.

ELECTRONIC VOLTMETERS

A necessity in every laboratory. Interchangeable probes for D.C., A.C. up to 500 v. at 100 mcs., E.H.T., and for U.H.F. Tests.

RADIO-AID LIMITED

Manufacturers and Distributors of Electronic Equipment and Components.

29, MARKET STREET, WATFORD, HERTS.

Telephone: Watford 5988

Sole London Agents: WEBB'S RADIO, 14, SOHO ST., W.1.

M.R. SUPPLIES

The business which handles only dependable Radio and Electrical material at the right price and effects immediate despatch from stock. All prices nett. All goods brand new.

Measuring Instruments of the highest grade. B.P.L. 3½in. flush mtg. precision M/coil Instruments. 0/100 micro-amp., 75/-; 0/500 micro-amp., 85/-; 0/1 milliamp., 59/6; 0/100 milliamp., 55/- Also by same maker. Combined instrument in crash-proof bakelite portable case, 6 by 4 by 3ins., with carrying handle, 1,000 ohms/volt, universal A.C./D.C. Readings: 0/1, 0/10, 0/100 and 0/500 m.a., 0/10, 0/50, 0/100 and 0/500 volts. 0/10,000 ohms. Each range brought in by a positive contact, self-cleaning switch. Complete with cell, 23 15s. Also limited offer of Taylor 2½in. flush mtg., 0/600 milliamp m/coil meters (can be dehubbed), brand new, at 35/-.

Insulation Testers. We now have the famous Evershed Wee-Meggers in stock. Pressure 500 volts. Range 0/20 megohms and kΩ. Supplied with pocket and log books, 29 10s.

Microphones, excellent range of reliable products. Rothermel D.104, original model in plated housing, with suspension rings, 25 5s. Same make BR28 Sound Cell Studio Model for serious work, 210 10s. Also Rothermel-Brush Miniature Inserts, 1½in. dia., 29/6 (all the foregoing are piezo-crystal. Gramplan Moving Coil type MOR (16 ohms), in square suspension frame, with ½in. or 5/16in. fittings, 24 4s. Same make, senior model, in all-plated housing with internal switch. Response 60/8,000 o/s.—42 db., 27 5s. The new Reslo VMC (12 ohms) in black and chrome, with internal switch, for ½in. mtg., 25 10s. Mu-metal Microphone Transformers to suit all above M/coil mics., 25/- Floor stands to suit all, all-chrom., collapsible, ext. to 5ft. 6in., 47/6. Chrom. cradles (for D.104 only), 8/6.

Loudspeakers.—High-fidelity models, by Vitavox. K12/10 (10 watt), 12in., 15 ohms coil, with 14,500 lines Ticonal perm. magnet, 27 (despatch, 5/-). Also K12/20 (20 watt), same details, but 17,000 lines, 211 (despatch, 6/-). Also the Vitavox, Bitone, with 12in. Unit and Tweeter, with 6-cell horn and filter in cabinet, 39in. x 17in. x 15in.—a challenge to any other high-fidelity reproducing system, 231 10s. despatch, 6/-). Note.—The Bitone is in very limited supply, and if we are out of stock on receipt of order, we will despatch within three weeks.

Projector Speakers for outdoor P.A. Obtain now before the seasonal rush Latest Vitavox P.M. 15 ohm Unit with 30in. all-metal horn, 29 10s. (despatch, 7/6) or with 42in. all-metal exponential horn, 210 10s. (despatch, 7/6). Also "A" type G.E.C., P.M. 15 ohm Unit, with line transformer incorporated, on 30in. horn, 211 (despatch, 7/6). On 42in. horn, 212 (despatch, 7/6). Immediate despatch. Battery Charging Equipment.—STC Metal Rectifiers. For charging up to 12 volts in conjunction with suitable transformers (see below). 3 amps., 22/6; 6 amps., 39/6; 10 amps., 49/6 (despatch, last two, 1/6).

Step-Down Mains Transformers.—All prima. tapped 200/250 v.. Sec.: 8 and 14 v. 4 amps. (for 23/6 Rect.), 32/6. Sec.: 5, 12 and 17 v. 6 amps. (for 39/6 Rect.), 49/6 (despatch, 2/-). Sec.: 15v. 10 amps. (for 49/6 Rect.), 75/- (despatch, 3/6. Also 22 v. 2 amps., 18/6).

Condensers, hermetically sealed paper, by Aerovox, Sprague, etc. 4 mf. 350 v., 3/8; 4 mf., 1,000 v., 3/8; 8 mf., 1,000 v., 12/6; 10 mf., 400 v., 6/9; 0.5 mf., 1,000 v., 2/11; 0.1 mf., 1,000 v., 1/3 (12/6 doz.); 10 mf., 600 v., 8/8.

IN STOCK.—Vent-axis Extractor Fans, Pyrobraze Soldering and Brazing Equipment, Fuzit Wire Joints, Loxley Relays, Stage Dimmers, Amplifiers, Headphones, Stuart Turner Centrifugal Pumps. Regret no lists at present. Please pay us a visit.

M.R. SUPPLIES, 68, New Oxford Street, London, W.C.1

Telephone: MUSEUM 2958

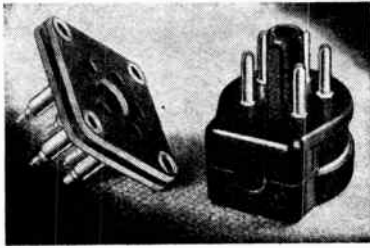

5-way Flex Plug Chassis Socket

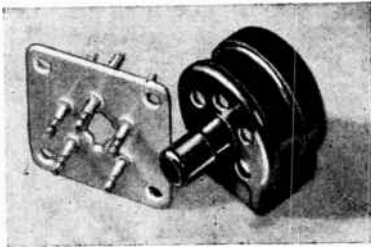

5-way Flex Socket Chassis Plug

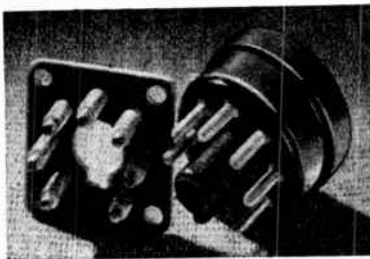

7-way Flex Plug Chassis Socket

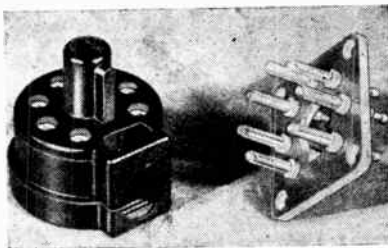

7-way Flex Socket Chassis Plug

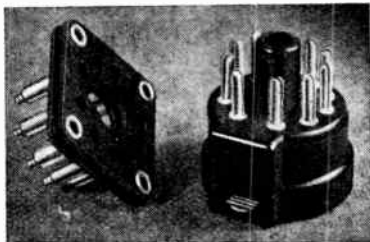

10-way Flex Plug Chassis Socket

MULTI-CONNECTORS

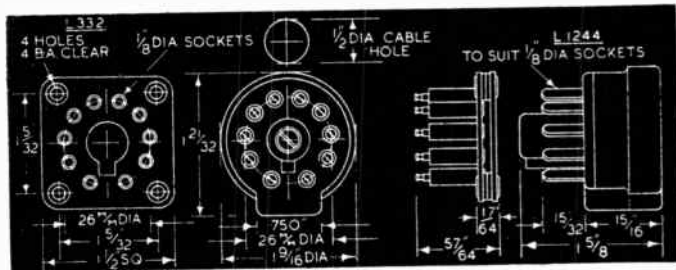

THESE carefully designed connectors are specially suitable for connecting power pack to chassis, amplifier to receiver, etc., but their application to the electronic and electrical industry is very wide. They really do go together nicely, all pins making contact every time. All metal parts silver plated giving low resistance contact and facilitating soldering. The flex part is in black moulded bakelite with locating key and side entry, to discourage withdrawal by pulling cable.

Pin $\frac{1}{8}$ in. and semi-floating. Can be connected with eyes shut; single screw assembly. The socket panel is punched from sheet bakelite; standard fixing holes; two contacts are widely spaced for carrying mains. Plugs and sockets are provided with sensible solder spalls, worth using even with idle pins.

L.1258 and L.1244 have really efficient cord grip, and the corresponding chassis parts, L.331 and L.332, have a shield panel raised well above the socket panel to ensure safety. With these types no single pin can make contact until the locating key has found its position the right way round.

L.1258	5-pin Flex Plug with Cord Grip	2/- each
L.331	5-way Chassis Socket with Shield Panel	1/2 ..
L.528	5-pin Flex Plug without Cord Grip	2/4 ..
L.529	5-way Chassis Socket Single Panel	10d. ..
L.550	5-way Flex Socket without Cord Grip	1/10 ..
L.551	5-pin Chassis Plug	1/4 ..
L.530	7-pin Flex Plug without Cord Grip	3/- ..
L.531	7-way Chassis Socket Single Panel	1/- ..
L.532	7-way Flex Socket without Cord Grip	2/2 ..
L.533	7-pin Chassis Plug	1/10 ..
L.1244	10-pin Flex Plug with Cord Grip	4/- ..
L.332	10-way Chassis Socket with Shield Panel	1/9 ..

BELLING & LEE LTD
CAMBRIDGE ARTERIAL ROAD, ENFIELD, MIDDXX

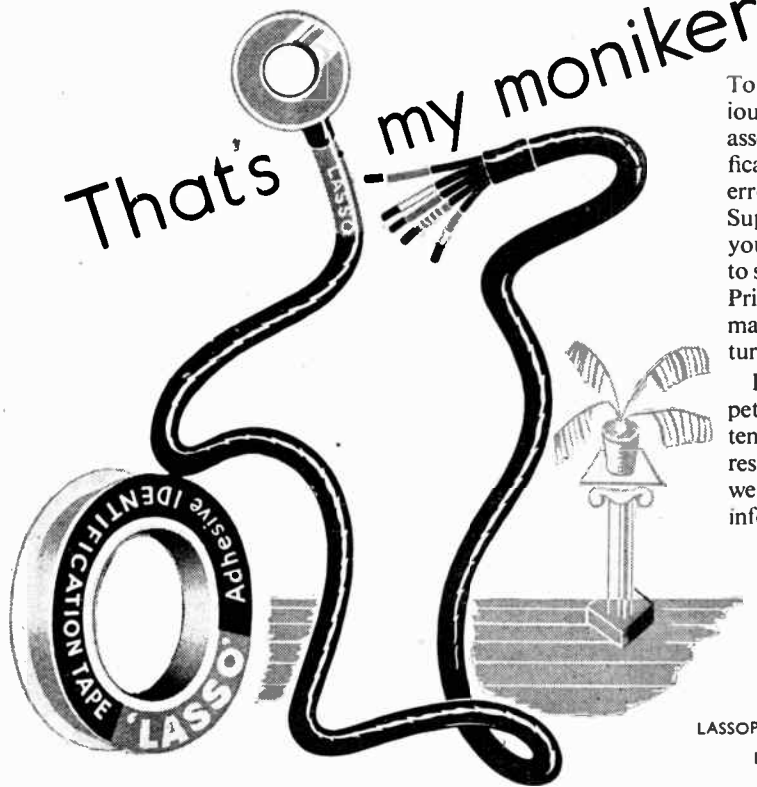

To solve the problem of identifying various components quickly, before and after assembly, mark them with Lasso Identification Tape—saves time, labour and error. No special tools are required. Supplied in 10 yard rolls, printed with your own inscription at intervals spaced to suit diameters and other measurements. Printing is indelible. Lasso Tapes also make neat permanent name tabs for furniture, tools, containers and plastics.

Lasso Tapes are resistant to water, oil, petrol and solvents, and are tested for tensile strength, durability and electrical resistance. If you have a marking problem we can supply Lasso Tape to solve it. An informative booklet is free on request.

LASSO
REGD. TRADE MARK
Identification TAPES

LASSOPHANE · LASSOVIC · LASSOLASTIC · LASSOBAND
LASSOTHERE · LASSOTHYL · LASSOFIBRE

Cable Assemblies Ltd., 50 Howardsgate, Welwyn Garden City, Herts. (Subsidiary of Herts Pharmaceuticals Ltd.) (c2)

FLOATING ROTOR

DOUBLE CONTACT

Only in the famous

OAK SWITCH

Other British N.F.S. Products include: PAPER CAPACITORS, SILVERED MICA CAPACITORS, WIRE WOUND RESISTORS AND VOLUME CONTROLS—Write for full details.

Manufactured by
BRITISH N.F.S. CO. LTD.
KEIGHLEY, YORKSHIRE

Phone: Keighley 4221/4. Grams: Enesef, Keighley

(Sole Licensees of OAK Manufacturing Co., Chicago)

DENCO COIL TURRETS

A DISTINCT ADVANCE IN RADIO RECEIVER TUNING UNIT DESIGN. NOW AVAILABLE IN 2 TYPES

Complete Tuning assemblies for Superhet receivers using mixer and oscillator stages.

C.T.1. for 1.6 Mc. I.F. covering:—150—750: 550—1500 kc.: 5.0—11.75 and 11.5—25 Mc.

C.T.2. for 465 Kc. I.F. covering:—150—350: 530—1700: 5—12.5: 12.3—30 Mc.

C.T.3. A three section turret allowing for one R.F. stage and band spreading, will be available shortly.

DENCO (CLACTON) LTD.,
Old Road, Clacton-on-Sea. 'Phone: 151.

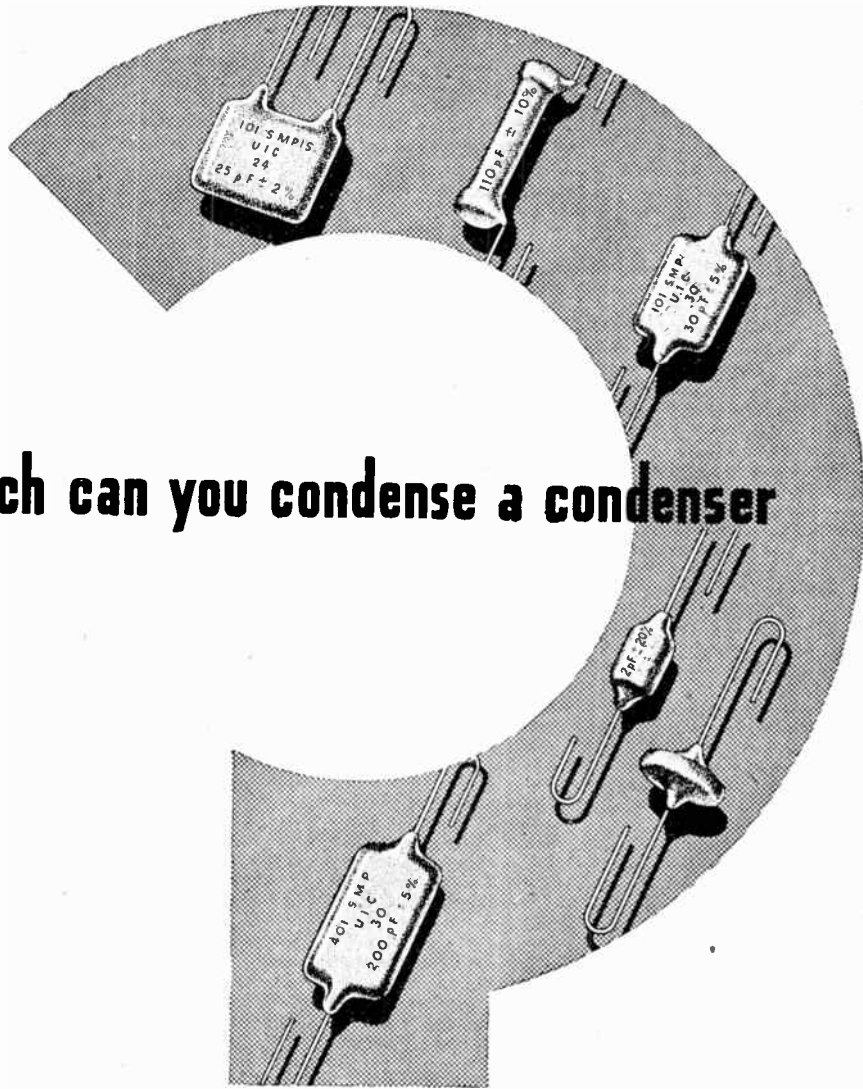

How much can you condense a condenser

Midget  *Condensers*

Midgets in size but giants in performance are these U.I.C. Miniature Condensers. Especially suitable for use in the latest design of miniature radio transmitters and receivers, they are efficient and dependable under all climatic conditions. Made to specification K. 110. Type approved. Full details on request.

UNITED INSULATOR CO. LTD., 12-22, LAYSTALL STREET, LONDON, E.C.1.

Tel: Terminus 7383 (5 lines) Grams: Calanel, Smith, London.

T H E P I O N E E R S O F L O W - L O S S C E R A M I C S

RELIABILITY is the Keynote of



GARDNERS range of "SOMERFORD" POWER TRANSFORMERS

The reliability that experience has proved is inherent in all Gardners products, is fully exemplified in the range of "Somerford" Power Transformers, some of which are listed below. We will gladly send you complete information and prices of the full range of these units, as well as those of Chokes and other Gardners components, on request.

Type No.	SPECIFICATION	Retail Price	Type No.	SPECIFICATION	Retail Price
All Primaries wound 0-210 230 250 v. 50 CYCLES.					
R.106	Secondary 250 0-250v. 80 mA. 0 4-5v. 2.5 A. 0 4-6.3v. 4 A.	37/6	R.137	Secondary 450-400-0- 400-450v. 180 mA. 0 4-5v. 3 A. 0 4-6.3v. 3 A. 0 4-6.3v. 3 A. 2-0-2v. 2 A. 2-0-2v. 2 A.	92/6
R.107	Secondary 250 0-250v. 80 mA. 0 4-5v. 2.5 A. 0 4-6.3v. 4 A.	39/6	R.138	Secondary 500-0-500v. 80 mA. 0 4-5v. 2.5 A. 0 4-6.3v. 2 A. 0 4-6.3v. 2 A.	55/-
R.108	Secondary 250 0-250v. 100 mA. 0 4-5v. 2.5 A. 0 4-6.3v. 4 A.	43/6	R.139	Secondary 500-0-500v. 100 mA. 0 4-5v. 2.5 A. 0 4-6.3v. 3 A. 0 4-6.3v. 3 A.	67/6
R.109	Secondary 250 0-250v. 120 mA. 0 4-5v. 2.5 A. 0 4-6.3v. 4 A.	49/6	R.140	Secondary 500-0-500v. 120 mA. 0 4-5v. 2.5 A. 0 4-6.3v. 3 A. 0 4-6.3v. 3 A.	75/6
R.111	Secondary 350 0-350v. 80 mA. 0 4-5v. 2.5 A. 0 4-6.3v. 4 A.	42/6	R.141	Secondary 500-350-0- 350-500v. 120 mA. 0 4-5v. 2.5 A. 0 4-6.3v. 3 A. 0 4-6.3v. 3 A.	82/6
R.114	Secondary 350 0-350v. 80 mA. 0 4-5v. 2.5 A. 0 4-6.3v. 4 A.	44/6	R.142	Secondary 500-350-0- 350-500v. 180 mA. 0 4-5v. 3 A. 0 4-5v. 3 A. 3.15 2-0-2 3.15v. 3 A. 3.15-2-0-2 3.15v. 3 A.	108/6
R.116	Secondary 350 0-350v. 100 mA. 0 4-5v. 2.5 A. 0 4-6.3v. 5 A.	52/6	R.143	Secondary 500-450-0- 450-500v. 180 mA. 0 4-5v. 3 A. 0 4-6.3v. 4 A. 0 4-6.3v. 4 A. 2-0-2v. 2 A. 2-0-2v. 2 A.	105/-
R.121	Secondary 350 0-350v. 120 mA. 0 4-5v. 2.5 A. 0 4-6.3v. 3 A. 0 4-6.3v. 3 A.	61/6	R.147	Secondary 500-400-0- 400-500v. 250 mA. 0 4-5v. 3 A. 0 4-6.3v. 3 A. 2-0-2v. 2 A.	97/6
R.121A	Secondary 350 0-350v. 120 mA. 0 4-5v. 2.5 A. 3.15 2-0-2- 3.15v. 3 A. 3.15 2-0-2- 3.15v. 3 A.	63/6	R.148	Secondary 500-400-0- 400-500v. 250 mA. 0 4-5v. 3 A. 0 4-6.3v. 3 A. 2-0-2v. 2 A.	132/6
R.123	Secondary 350 0-350v. 180 mA. 0 4-5v. 3 A. 3.15 2-0-2- 3.15v. 3 A. 3.15 2-0-2- 3.15v. 3 A.	76/6	R.148	Secondary 500-400-0- 400-500v. 250 mA. 0 4-5v. 3 A. 0 4-6.3v. 3 A. 2-0-2v. 2 A.	155/-
R.125	Secondary 350 0-350v. 180 mA. 0 4-5v. 3 A. 0 4-6.3v. 3 A. 0 4-6.3v. 4 A.	75/-			
R.127	Secondary 325-0-325v. 100 mA. 0 4-5v. 3 A. 0 4-6.3v. 3 A. 0 4-6.3v. 3 A. 2-0-2v. 2 A.	63/-			
R.132	Secondary 400-350-0- 350-400v. 180 mA. 0 4-5v. 3 A. 0 4-6.3v. 3 A. 0 4-6.3v. 3 A. 2-0-2v. 1 A. 2-0-2v. 1 A.	85/-			
R.133	Secondary 400-300-0- 300-400v. 180 mA. 0 4-5v. 2.5 A. 0 4-6.3v. 2.5 A. 3.15-2-0-2- 3.15v. 3 A. 3.15-2-0-2- 3.15v. 3 A.	88/6			



MODEL 44

Previously only available on high priority contracts, this precision multi-range measuring instrument can now be supplied with quick delivery.



ELECTRONIC INSTRUMENTS LTD
17 PARADISE ROAD · RICHMOND · SURREY



Masteradio VIBRATOR PACKS

PROMPT DELIVERY NOW ASSURED

MASTERADIO LTD · VIBRANT WORKS · WATFORD · HERTS

GARDNERS RADIO LIMITED
SOMERFORD : CHRISTCHURCH : HANTS
TELEPHONE : - - - CHRISTCHURCH 1025

LINAGLOW LIMITED

ALL-WAVE COIL PACK

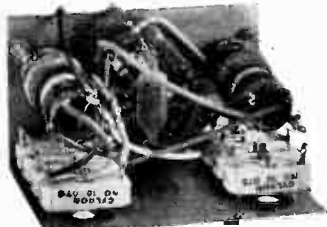

Ranges: 19-50, 200-550, and 1,000-2,000 metres. Simplifies the building of a superhet. Supplied complete with trimmer and padder condensers for use in standard 3-wave Superheterodyne circuit. One hole fitting to chassis. A fourth position is fitted to wave change switch for gramophone pick-up. For use with 465 K/C's, I.F. Transformers. Price complete with diagram of connections. **38/6**

METALAIR ELECTRIC CLOCKS. 7in. diameter, 4in. diameter dial, 200/250 volts, A.C. 60 cycles. Various colours sprayed steel. Price, 48/-, plus 10/8 purchase tax. Metal case finish to resemble plastic, in various colours. Price 52/6, plus 11/8 purchase tax.

CONDENSERS.—Brand new ex-G.P.O. fixed tubular paper aluminium can Sprague type. .001 mfd. 1,000 v. D.C., .002 mfd. 1,000 v. D.C., .005 mfd. 1,000 v. D.C., .01 mfd. 1,000 v. D.C., .02 mfd. 750 v. D.C., .05 mfd. 500 v. D.C., .1 mfd. 500 v. D.C., .25 mfd. 500 v. D.C., .1 mfd. 350 v. D.C., .25 mfd. 350 v. D.C. Fixed paper moulded case (Micamold), .001 mfd. 600 v. D.C., .002 mfd. 600 v. D.C. Paper block .5 mfd. 1,000 v. D.C. with mounting brackets (Aerovox). Pixed paper block, .25 mfd. 600 v. D.C. and 400 v. D.C. (Isolair). 8d. each.

ELECTROLYTIC CONDENSERS—tubular.—.6 mfd. 50 v., 1.6, 50 mfd. 12 v., 1/9, 25 mfd. 25v., 1/9, 8 mfd. 500 v., 3/3. Tubular tag end, 8 x 8 mfd. 550 v., 5/9.

THE R.A.R. ELECTRIC HEATER.—Indispensable as a food-warmer, brass alier, clothes alier, car anti-freezer, etc. Thermostatically controlled to provide a constant warmth. 200/250 v. 40 watts. 35/-, plus purchase tax, 8/9. (Woollen covers available. 6/-, plus P.T. 1/6.)

VALVES.—American types at B.O.T. controlled retail prices, 12F5, 12F5 1H5, 9/2; 1C5, 1N5, 3Q5, 35Z5, 11/-; 6Q7, 11/7; 6F6, 6K5, 50L5, 12/10; 1A7, 6A8, 6B8, 14/-.

British Manufacturers' Valves at List prices. 6X5, 10U6, 11/-; 2DD4, 11/7; AC/VP2, EF35, KTW61, PEN45, 8P41, 8P42, T41, VP41, 12/10; ECH3, X63, 14/-; ACPEN, E135, PEN46, U21, 6L6, 18/3; D. diode, 1in. peanut valve, with valvholder, 8/-; Prices include purchase tax. Please add 3d. per valve postage.

CHIME DOOR BELLS

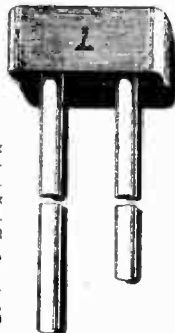

American type. Ring with a mellow "ding-dong." Chimes 2ft. 10in. and 2ft 6in. long. Striking mechanism, 7in. x 3in. Finish highly polished brass lacquered. **55/-**

8 to 10 volts bell transformer to suit the above. **17/6**

R.A.F. PORTABLE TRANSMITTERS

used but in good condition. Containing a wealth of valuable components, useful for the amateur or can easily be converted for use on amateur bands. Circuit diagrams and Parts List supplied with each instrument. Each Transmitter is complete with valves, crystal, Litz wound coils, Morse key, variable condenser, relays, portable aerial, resistors, chokes, condensers, etc. Limited quantity (approx. cost to manufacture, £39). Price, including postage and packing, **59/6**



CLAROSTATS

Genuine American Clarostats for use in American Midget Radios as mains dropping resistance. Improved substitute line cord. 665 ohms, 445 ohms or **10/6** 376 ohms. .3 amp.

VOLUME CONTROLS.—1 meg, 1 meg, 20,000 ohms, 10,000 ohms, without switch, 3/- each; 1 meg, 50,000 ohms, 100,000 ohms, with switch, 4/6.

A Comprehensive Range of all types of Components are available at our Showrooms. We extend a welcome to all our customers.

(We regret owing to pressure of business, we are unable to handle C.O.D. trade).

FERRANTI TEST METERS



Complete in leather and velvet-lined case. Spec., 1,000 ohms per volt on all ranges; 600 volts A.C./D.C.; 0-750 milliamps, 0-50,000 ohms, without external batteries, up to 20 megohms, with external batteries. New and unused, complete with test leads, multipliers and instructions. **£8/16/6**

MICROPHONES, PICK-UPS AND HEADPHONES, Etc., by R. A. ROTHERMEL LTD.

Brush Piezo-crystal Pick-ups. Models 8/8 and 8/12. Needle to centre of base, 8in. and 9in., respectively, 42/- plus 3/6 purchase tax.

Brush Piezo-crystal Pick-Ups, Senior Model. Needle to centre of base, 9in., 45/-, plus 3/9 purchase tax.

Sound Cell Microphones, Type BR25. Characteristics—Output level—66 db. Impedance is similar to capacity of .005 mfd. **£10 10s.**, complete with socket.

Piezo-Electric Crystal Microphone, Type D.104. Characteristics—Frequency response 50 cycles to approx. 6,000 cycles with a slightly rising characteristic up to 7,500 and slowly cutting off to 10,000 cycles. Output level approx. -60db. **£5 5s.**

Brush Piezo-Electric Crystal Microphone, Type B.H. Frequency response 50 to 6,000 cycles. Output level -60 db. Impedance approx. 80,000 ohms at 60 cycles. **£4 4s.**

Miniature Hearing Aid Crystal Microphone, Type DA.1. Output level on open circuit -51 db, 25/-.

Brush Types "A" and "B" Piezo-Electric Headphones. Wide range response 60 to 10,000 cycles per second. Type "A" impedance over 50,000 ohms at 400 cycles. Type "B" impedance over 25,000 ohms at 400 cycles. Complete with cords and headband. **£4 10s.**

Crystal Pick-up Needle Pressure Adjusting Unit. Needle Pressures may be adjusted to suit all types of recordings, with pressure ranging from 1 oz. to 2 1/2 ozs. 10/-, plus 7/6 purchase tax.

5-way INDUSTRIAL RUBBER CABLE.—D.V. 14/36 at 6d. per yard.

B.P.L. UNIVERSAL TEST SET

D.C. Volts.	D.C. Milliamps.	A.C. Volts.
0-75 MV	0-1	0-10
0-10	0-10	0-50
0-50	0-100	0-100
0-100	0-500	0-500
0-500		

Resistance 0-10,000 ohms. 1,400 ohms per volt on all voltage ranges. Accuracy, 2 per cent., except for lower voltages on the 10 volt A.C. range. Dimensions, 6in. x 4 1/2in. x 3 1/2in.

PRICE **£8 . 17 . 6**

● PLEASE NOTE ● Dept. MO 62, 34. OSNABURGH STREET, Telephone: NEW ADDRESS: EUSTON 8406 (4 lines)

WALTER SWITCHES ARE MADE FOR



WALTER INSTRUMENTS LTD.

Earls Court Exhibition Buildings, Earls Court, London, S.W 5 FULHAM 6192

450° is a normal working temperature for vitreous enamelled

Welwyn resistors

Such is the quality of enamel on Welwyn Vitreous Resistors. They operate continuously at 450°C.—over twice the safe temperature for ordinary vitreous resistors. Sizes—1 w. to 300 w. Also Carbon Resistors—1 w. to 2 w.

New Trade catalogue available.

WELWYN ELECTRICAL LABS. LTD.
Welwyn Garden City, Herts. Ph: Wel. Gar. 3818

DIMENSO

REGISTERED

MULTI-COURED

HAMMERED

SPLATTERED

OVERTONED

SEMI-BLENDED

DIFFUSED



ONE NOZZLE · ONE TRIGGER · ONE SPRAY

The sole licence for the gun throughout the British Empire is vested in Lewis Berger & Sons Ltd., and will be marketed and serviced by

The beginning of a new world in finishes

Two colours in a single spray operation

The patent Dimenso Gun sprays a background and dimensional colour simultaneously through one nozzle, producing a smooth uniform finish.

DIMENSO is a synthetic finish of highest quality—fits every baking schedule, bakes to a crack-free finish that resists wear, cleans easily. Two colours applied in one operation and only one baking.

The Dimenso Gun with the exclusive Dimenso finishes are now in course of manufacture. The Dimenso Service behind the gun will be complete and outstanding.

D I M E N S O

A member of the Berger Group

35 BERKELEY SQUARE, LONDON, W.1. WAIT FOR FURTHER ANNOUNCEMENTS

An Apology!

THIS company prior to the war always prided itself on sending replies to all letters and deliveries of all goods the same day as orders were received, and we have selected our Distributors with a view to giving the same sort of service. Inasmuch as we are unable to live up to this standard, we feel that it is only fair that our customers should be told why.

LABOUR—This is extremely short, and whilst we could increase here, we have made a point that wherever possible we will only employ lads from the Services, and we are awaiting their return.

MATERIALS—Owing to the necessity of the Government's export policy, manufacturers in general cannot give delivery dates, the control of their material is completely out of their hands with the result that porcelains, ceramics and bakelite in particular are holding up all firms that consume them, and they are not getting anything like adequate deliveries. In the case of porcelain deliveries are less than one-fiftieth of what they were, and no delivery dates can be obtained.

PRICES—Practically every item has advanced since the end of the war. Quite a number of lines have gone up by 100% since "VE" Day. Even this advertisement space will be costing more as and from the JULY issue.

IN CONCLUSION—we would remind our customers that we are NOT pessimists. We were born the other way, and we are going ahead with the design of new lines. We will still endeavour to give our customers as good or better service than they are likely to receive elsewhere.

RAYMART
CRAFT A CREED

48 HOLLOWAY HEAD, BIRMINGHAM 1



Manufacturers
of
LOUDSPEAKERS
•
LAMINATIONS
•
SCREENS
in
RADIOMETAL
•
PERMALLOY
•
SILICONALLOYS

ELECTRICAL SOUND & TELEVISION PATENTS LTD.
12, Pembroke Street, London, N.1. Terminus 4355
2/4, Manor Way, Boreham Wood, Herts. Elstree 2138

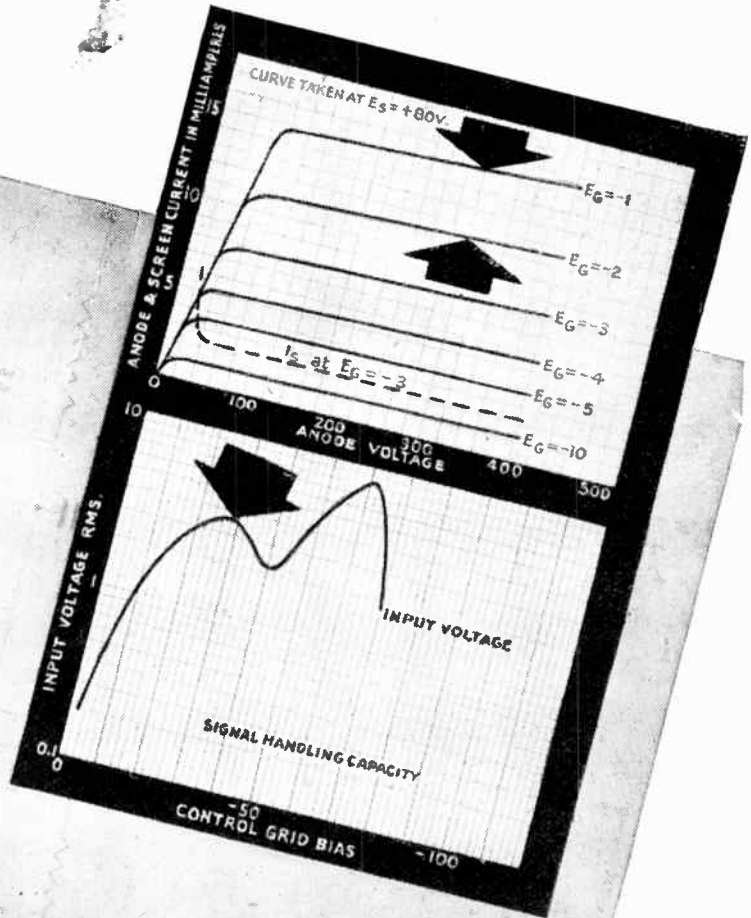

POINTERS FOR DESIGNERS

THE KTW61

A screened tetrode with suppressor plates and with variable- μ characteristics, the OSRAM KTW61 is specially suitable for use as an R.F. or I.F. amplifier in superhet receivers. Its outstanding features include:—

- ▶ High order of mutual conductance (2.9 mA/Volt) combined with low leakage capacitance (0.0025 $\mu\mu F$), which facilitates high stage gain.
- ▶ Negligible distortion with the maximum signal likely to be encountered in practice. Conditions of use — as an I.F. amplifier with screen dropping resistance, and in conjunction with OSRAM frequency changer X61M.
- ▶ Marked improvement in signal to noise ratio, particularly on the short waves, when used as an R.F. amplifier with fixed screen voltage.

A detailed technical data sheet is available on request.

Osram
PHOTO CELLS

G.E.C.
CATHODE RAY TUBES

Osram
VALVES

ARE YOU USING THE
SLEEVING BEST SUITED
TO THE JOB



"Best suited" means an insulating sleeving that meets every Service or general requirement. The DELAFLEX range includes non-fraying Woven Fibre Glass and Tropical Grade ROLLED SILK in a complete range of colours and in sizes from 0.5 mm. to 35 mm. Thus, a recommendation from De La Rue Insulation Limited is unbiased... you get the sleeving best suited to your needs, not only from the standpoint of efficiency, but of economy as well. Fullest details, samples and prices gladly sent on request.

Delaflex

Insulating Sleeving

DE LA RUE INSULATION LTD
84 REGENT STREET • LONDON • W.1
TELEPHONE : REGENT 2901

- ROLLED SILK
- METAL SCREENED
- VARNISHED COTTON
- WOVEN FIBRE GLASS
- VARNISHED ART SILK

Reliable L.T. or H.T. Supply where weight and space factor is all important

A range of Dynamotors has been designed and produced by S.E.M. engineers which combines the minimum of weight and size with the highest possible dependability of performance.

The dynamically balanced armature, built on a high-tensile steel shaft, is mounted on ball bearings. Commutation insulation is of mica, and the whole armature and field coils are vacuum impregnated.

All the machines are adaptable to meet manufacturers' individual requirements. The possible combinations of input and output ratings are numerous. Full details can be supplied on request.

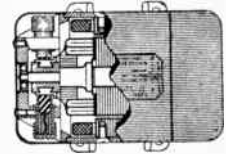

The S.E.M. D.100 Dynamotor is only 4½" x 2½" x 3½".
Input voltages: 6—480.
Maximum output: 3750.
25w. It is entirely enclosed.
Mountings can be adjusted to individual requirements.

SMALL ELECTRIC MOTORS LTD.

have specialized for over 30 years in making electrical machinery and switchgear up to 10kW capacity. They are experienced in the design and manufacture of ventilating fans and blowers, motors, generators, aircraft generators and motor generators, high-frequency alternators, switchgear, starters, and regulators.

A SUBSIDIARY OF BROADCAST RELAY SERVICE LTD.
BECKENHAM • KENT

Your new STENTORIAN is being made now...

Extension Speakers, inc. Cabinet and Volume Control, available from

29/6

It may even be waiting for you at your local Radio Dealer's. Keep in touch with him; these attractive extension speakers with their superb reproduction offer such amazing value that they are being bought faster than they can be produced. More and more people appreciate the convenience of not being confined for their radio to the room the set occupies.

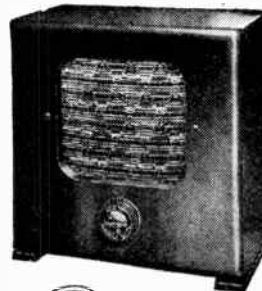

PRICES

- Minor Type MX (for Low Impedance Extension) - 29/6
- Minor Type MC (with Universal Transformer) - 35/6
- Baby Type BX (for Low Impedance Extension) - 43/6
- Baby Type BC (with Universal Transformer) - 49/6



Stentorian

THE PERFECT EXTRA SPEAKER FOR ANY SET

WHITELEY ELECTRICAL RADIO CO. LTD., MANSFIELD, NOTTS.

EDDYSTONE

SHORT-WAVE

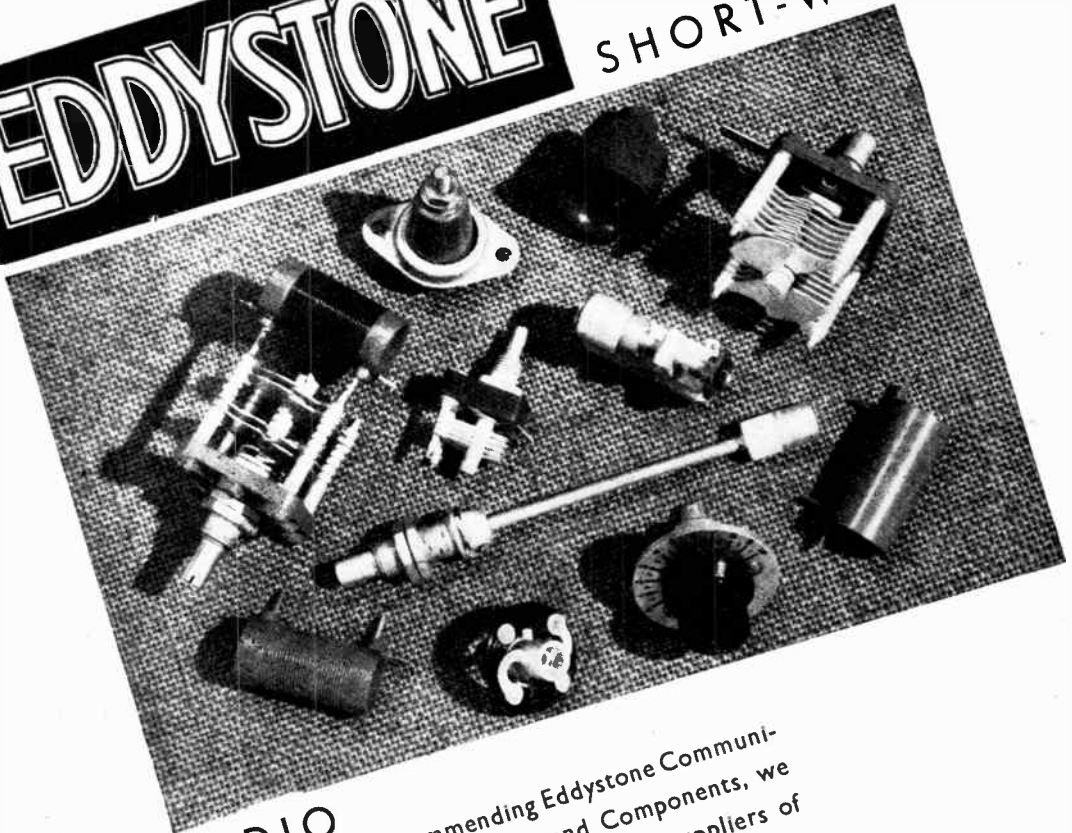

RADIO

In recommending Eddystone Communication Receivers and Components, we uphold our reputation as suppliers of high efficiency apparatus for the laboratory and the discriminating amateur.

WEBB'S

RADIO

The Short-Wave Specialists

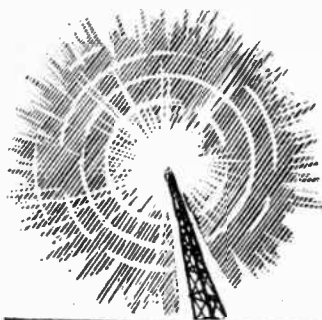

'Grams : "Criswebco, Rath, London"

14, SOHO ST. OXFORD ST. LONDON, W. I. Telephone. GERRARD 2089

PLOTTING THE COURSE



IN TOMORROW'S WORLD

In the world of to-morrow, as in the world of yesterday and to-day, Marconi's will carry forward the tradition of meticulous workmanship in communications apparatus.

New problems have been met as they have arisen by a team of experts with all the experience of a pioneer organisation behind them. Still newer problems are now arising in a post-war world. These too will be handled with the same resourceful skill. Whatever the demands of a new age—you know where you are with Marconi.

MARCONI

the greatest name in wireless

MARCONI'S WIRELESS TELEGRAPH COMPANY LTD
 THE MARCONI INTERNATIONAL MARINE
 COMMUNICATION COMPANY LTD
 ELECTRA HOUSE, VICTORIA EMBANKMENT, LONDON, WC2

WHEN CHARACTERISTICS COUNT

TENAPLAS

EXTRUDED PLASTICS
 are always specified

We make :—
 INSULATED WIRES,
 CABLES, TUBING, SOLID
 SECTIONS, STRIPS, Etc.,
 & CO-AXIAL CABLES
 FOR ALL KINDS OF
 HIGH-FREQUENCY
 EQUIPMENT

Write to :—
TENAPLAS LTD.,
 BLACKWOOD WORKS,
 QUEEN ELIZABETH RD.,
 KINGSTON-on-THAMES

TENAPLAS LTD

There are TRIX
 amplifiers from
 5-500 WATTS FOR
 PRIORITY WORK

Critical users

Trust
TRIX

Quality SOUND Equipment

THE TRIX ELECTRICAL CO. LTD.
 1-5 MAPLE PLACE - TOTTENHAM COURT ROAD,
 LONDON, W.1.
 Tel: MUSEUM 5817 *Speakers & Cables TRIXRADIO WESDO-LONDON.*

THE MOST FAMOUS SET MAKERS ARE AGAIN FITTING

MAZDA

**RADIO VALVES AND
CATHODE RAY TUBES**
because of their
**PERFORMANCE AND
RELIABILITY**

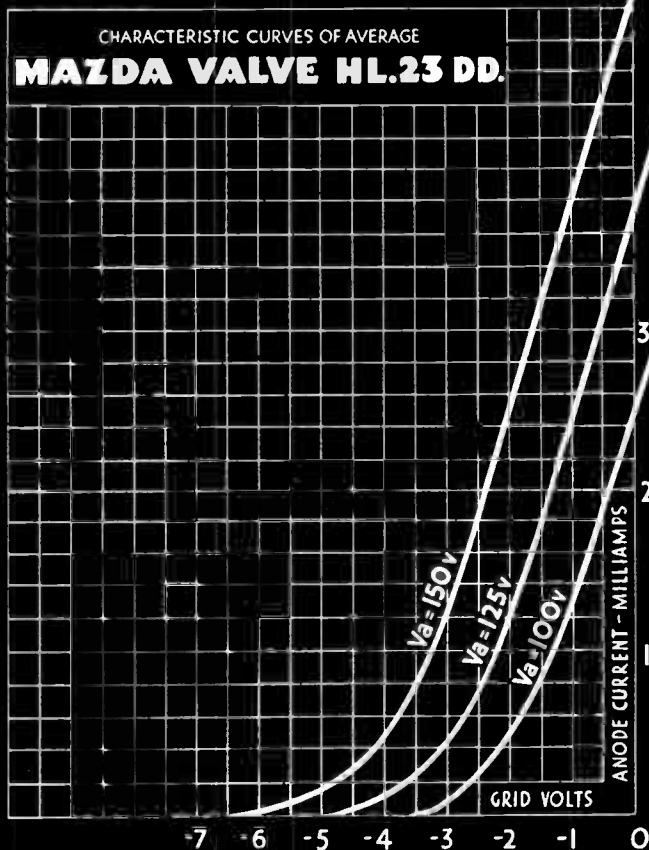

**LOW
"I_f"**

**HIGH
"g_m"**

**LOW
"r_a"**

THE FILAMENT CURRENT OF THE MAZDA HL.23 DD IS EXCEPTIONALLY LOW; IT IS ONLY 50mA.

ITS MUTUAL CONDUCTANCE ($g_m=1.2mA/V$) IS REMARKABLY HIGH FOR A VALVE HAVING SO LOW A FILAMENT CONSUMPTION.

THE ANODE A.C. RESISTANCE IS ONLY 21,000 OHMS WHICH, COUPLED WITH THE HIGH g_m MAKES THE VALVE PARTICULARLY SUITABLE FOR SIMULTANEOUS FUNCTIONS OF DETECTION, A.V.C. AND AUDIO FREQUENCY AMPLIFICATION.

THIS VALVE MAY BE USED AS A REPLACEMENT FOR THE BVA.132 IN THE CIVILIAN WAR-TIME RECEIVER.

THE EDISON SWAN ELECTRIC COMPANY LIMITED



155, CHARING CROSS ROAD, LONDON, W.C.2



The G.12T is housed in three bays, and individual units can be withdrawn without disturbing connections

A radio transmitter with a proved record for reliability

THROUGHOUT the war, under the most exacting conditions, the Redifon G.12T transmitter gave sterling service in a vast range of essential installations. These included airfield controls, D.F. installations, harbour controls, the jamming and deviation of enemy D.F. transmissions, and the broadcasting of entertainment programmes to troops in the field.

It is suitable for long-range aircraft beacons and communication, for shipping control and services, and general telegraphic transmissions over distances extending to upwards of 1000 miles. The power is 2000 watts on C.W. or 450 watts telephony or M.C.W. The G.12T covers the very wide frequency range of 102/1200 kc/s, divided into four overlapping bands with continuous tuning throughout. The M.O. and drive circuits are ganged, and the tuning dial very accurately calibrated directly in frequencies. Six crystals may be used, also a number of pre-set M.O. settings.

Many of these Redifon transmitters have been used on arduous service involving continuous operation at full load, with only one 3-hour break for maintenance each three months. This is typical of their overall reliability.

The extremely compact design of the Redifon G.12T makes it suitable for mobile use, particularly in areas undergoing reconstruction. The three bays take up a floor space of only 8 feet 8 inches by 2 feet 4 inches, and the overall height is 5 feet 5 inches.

A special version of the Redifon G.12T can also be used as a 1 kW broadcast transmitter with an overall frequency response between ± 2 db over a range of 30-7,500 cps. This transmitter is available for almost immediate delivery. Further particulars can be supplied on request.

REDIFFUSION Ltd.

Designers and Manufacturers of Radio Communication and Industrial Electronic Equipment

SUBSIDIARY OF BROADCAST RELAY SERVICE LIMITED
CARLTON HOUSE, REGENT STREET, S.W.1

CELESTION

LOUDSPEAKERS VALVEHOLDERS

Celestion Limited
Kingston-upon-Thames
Telephone: KINGSTON 5656-7-8



'Hoggets and Shearlings' on the air; a juicy point steak under the grill, Dagenite and Pertrix Batteries available for everybody. Times to look forward to! Meanwhile we're sorry that Dagenite and Pertrix are still in short supply. Most of them, you see, have been helping to beat the Jap. But they'll be back, soon now!

DAGENITE AND PERTRIX

BATTERIES FOR CAR AND RADIO

HOLSUN BATTERIES LIMITED • 137 Victoria Street, London, S.W.1

D 14-4

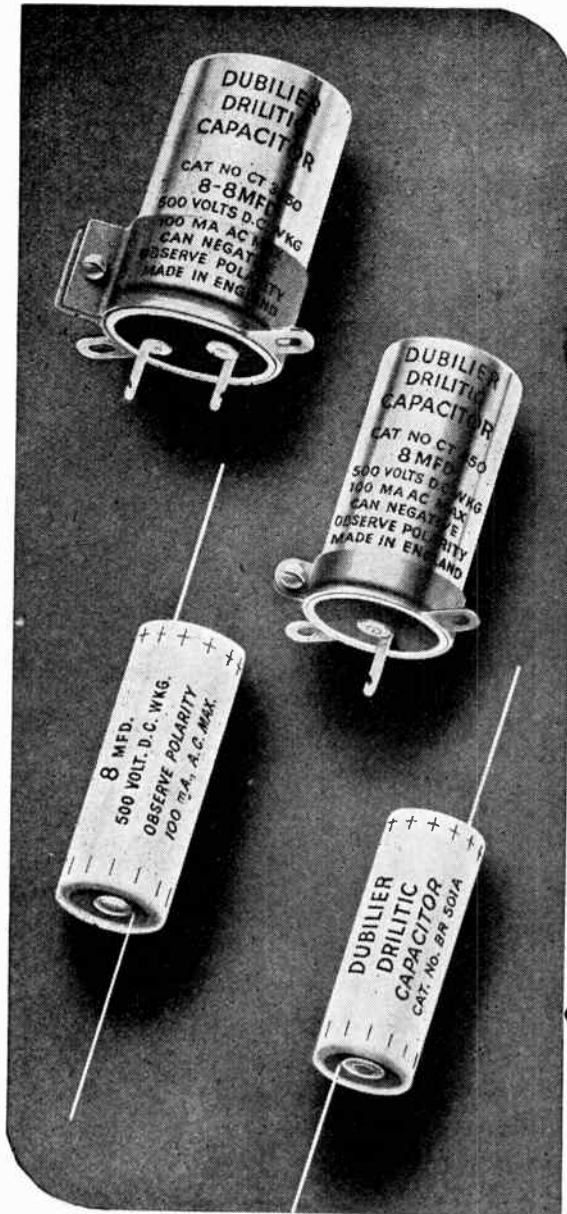

Now!
a full range

**"DRILITIC"
ELECTROLYTIC CAPACITORS**

Physically small, these B.R. and C.T. capacitors embody many technical advantages and their comprehensive coverage of every electrolytic requirement will be readily appreciated by users. The electrical characteristics of these capacitors are a marked advance in electrolytic design, the leakage current and equivalent series resistance are reduced, the audio and radio frequency impedance improved, the breakdown voltage and life expectancy have been increased together with an improvement in temperature characteristics. They are contained in seamless drawn aluminium containers hermetically sealed and the container is always negative.

DUBILIER
CONDENSER CO. (1925) LTD
LONDON. W.3

"DRILITIC" CAPACITORS

Capacitance	MAXIMUM Working Voltage	SIZE INCHES		MAXIMUM Ripple Current mA.	TYPE Number	RETAIL PRICE EACH
		D.	L.			
50	12	1/4 x 1/2	1 1/2	55	BR501	2s. 6d.
25	25		1 1/2	75	BR252A	2s. 6d.
50	50		2	190	BR505	3s. 6d.
8	150		1 1/2	110	BR815	2s. 9d.
8	500		2	100	BR850	4s. 0d.
8	500	1/2 x 1	2	100	CT850	4s. 6d.
16	500		2	110	CT1650	6s. 6d.
8-8	500-500		2	*100-100	CT8850	6s. 6d.
16-8	500-500		2	*110-100	CT16850	8s. 6d.

Vertical mounting clips supplied with C.T. types. *The total max. ripple current for both sections must not exceed the larger figure.

D2 DUBILIER CONDENSER CO. (1925) LTD. · DUCON WORKS · VICTORIA RD. · NORTH ACTON LONDON · W.3

Wireless World

Radio and Electronics

36th YEAR OF PUBLICATION

MAY 1946

Proprietors:
ILIFFE & SONS LTD.

Managing Editor:
HUGH S. POCOCK,
M.I.E.E.

Editor:
H. F. SMITH

Editorial, Advertising
and Publishing Offices:

DORSET HOUSE,
STAMFORD STREET,
LONDON, S.E.1.

Telephone:
Waterloo 3333 (50 lines).

Telegrams:
"Ethaworld, Sedist, London."



PUBLISHED
MONTHLY

Price: 1/6

(Publication date 26th
of preceding month)

Subscription Rate:
Home and Abroad
20/- per annum.

MONTHLY COMMENTARY	141
NEGATIVE FEEDBACK AND HUM. By "Cathode Ray"	142
RADAR TECHNIQUE—I.E.E. CONVENTION. Cavity Magnetrons	146
Other Valve Developments	149
Aerial Systems	151
Transmitters and Receivers	154
Pulse Circuits	156
WORLD OF WIRELESS	159
DESIGN DATA—(4). Wide-Band Amplifiers	161
GERMAN ELECTRONIC EQUIPMENT	163
SHORT-WAVE CONDITIONS. By T. W. Bennington	165
MINE DETECTORS	166
A NEW MURPHY SET	169
LETTERS TO THE EDITOR	170
RANDOM RADIATIONS. By "Diallist"	172
UNBIASED. By Free Grid	174

Branch Offices:

COVENTRY:
8-10, Corporation Street.
Telephone: Coventry 5210.
Telegrams:
"Autocar, Coventry."

BIRMINGHAM:
King Edward House,
New Street.
Telephone:
Midland 7191 (7 lines).
Telegrams:
"Autopress, Birmingham."

MANCHESTER:
260, Deansgate, 3.
Telephone:
Blackfriars 4412 (4 lines).
Telegrams:
"Iliffe, Manchester."

GLASGOW:
26B, Renfield Street, C.2.
Telephone: Central 4857.
Telegrams: "Iliffe, Glasgow."



As many of the circuits and apparatus described in these pages are covered by patents, readers are advised, before making use of them, to satisfy themselves that they would not be infringing patents.



ACOUSTICAL RESEARCH

THE TANNOY LABORATORY can provide a skilled and specialised service in the investigation of all problems connected with vibration and sound. This covers most aspects of acoustical research and is available to industry and Government Departments engaged on priority projects.



"TANNOY" is the registered trade mark of equipment manufactured by GUY R. FOUNTAIN LTD., the largest organisation in Great Britain specialising SOLELY in Sound Equipment.

TANNOY
RESEARCH LABORATORY
CANTERBURY GROVE, S.E.27
PHONE: GIPSY HILL 1131

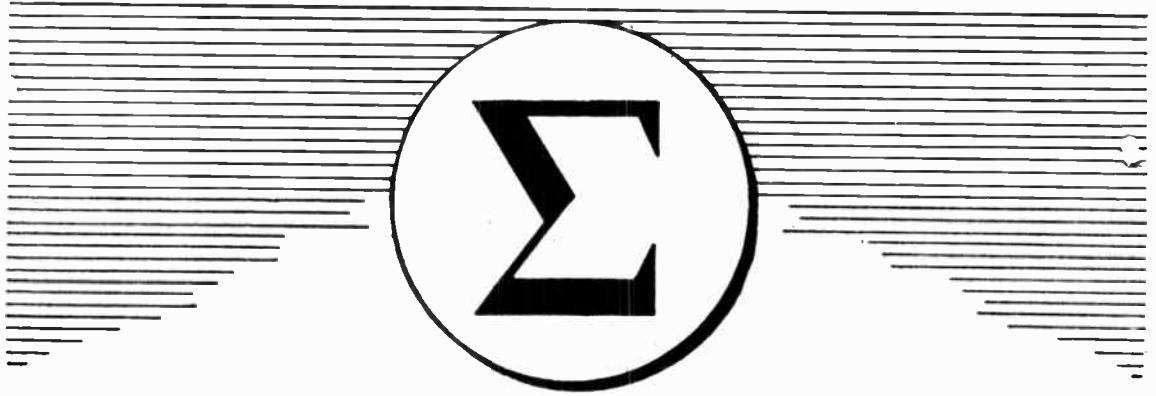

***The capital Sigma,
in mathematics, is a symbol
meaning 'the sum of'***



***The Philips emblem,
in everyday life is a symbol meaning
the sum of expert design, skilled
workmanship and good materials.***

PHILIPS

**LAMPS · RADIO · X-RAY · COMMUNICATIONS EQUIPMENT
AND ALLIED ELECTRICAL PRODUCTS**

PHILIPS LAMPS LTD., CENTURY HOUSE, SHAFTESBURY AVENUE, LONDON, W. C. 2 (1271)

Wireless World

Radio and Electronics

Vol. LII. No. 5

MAY 1946

Price 1s. 6d.

Monthly Commentary

The Radar Convention

IN our March issue we referred to what we considered to be the grave harm done to British prestige in the field of radio by ill-conceived and ill-executed arrangements for releasing accounts of wartime developments to the Press.

In this issue we put on record accounts of some of this wartime work as disclosed at the Radar Convention conducted by the Institution of Electrical Engineers.

We wish to take this early opportunity to congratulate the Institution on the way in which they have carried out their part of a concerted plan to give simultaneous release to as much as possible of the work of development of Radar by Government Departments and others responsible at Universities and industrial research laboratories.

But, having paid this proper tribute to the work of the Institution, we do not in the least depart from the attitude we have already taken up that the plan for this release was an unfortunate conception. Many months have been lost during which time much of the information only just released could have been made available to the technical public through the channels of the Press as well as the professional institutions. Now that it is at last revealed much of it comes after publication abroad has already taken place.

The British technical Press has been deliberately deprived of the opportunity of spreading throughout the world the story of Britain's part in radio and radar development during the war, officialdom having preferred to make the arbitrary decision to allow priority of publication through one channel alone. If it was thought that all this material would subsequently be repeated in the technical Press so as to reach the vast readership covered by the Press, such wishful thinking could not have taken into account the severity of the paper restrictions under which the Press suffers, which makes it quite impossible to cope with the sudden release of so vast a quantity of material. The alternative of a gradual release over past months would have made it possible for most of

this material to have received publication by the present date, and much of it earlier.

Regrettably one is forced to the conclusion that this concerted plan has had as its main object to revert to the satisfying of individual claims to prestige rather than the prestige of Britain which, has been the guiding principle of team work in this country during the years of war.

In this issue we have made no attempt to cover the work of the Radar Convention with any completeness, but rather have tried to concentrate upon those aspects of the releases which may be new to many of our readers, and particularly those which have future applications to peacetime needs. In later issues also we shall endeavour to look forward to Radar's future rather than its past which has been put on record so effectively by this major effort carried out by the Institution.

B.B.C. Publications

SOME years ago, as a result of strong opposition from the Press of this country and after protracted negotiations, the B.B.C. accepted the position that they should not extend their publishing activities in competition with private publishers. The B.B.C. did more than this, for in 1929 they gave an undertaking that they would issue no more periodicals beyond *The Listener* which they had already planned to launch and that this journal would be run on a non-profit-making basis with sufficient advertisements only to cover costs.

How, we would ask, does the B.B.C. reconcile with this undertaking the announcement now made that they are about to publish a quarterly journal devoted to technical articles on broadcasting and other features? It is true that the indication has been given at this stage that the material to be published in this quarterly will be of such a character that it would not be acceptable for publication in other media, but we cannot conceive that articles would be of so very specialized a character that no existing journal would accept them in times of normal paper availability.

c

NEGATIVE FEEDBACK AND HUM

Results Depend on the Type of Circuit Employed

IF by any chance there are superior readers of my previous discussion of negative feedback who consider themselves to have been had, because it contained no information not already published, they should not on that account dismiss this tailpiece without a trial. Although I have looked up nearly all I could find on feedback, the only information regarding its effects on hum boiled down to (a) that it reduces hum in the same ratio as amplification, distortion and certain sorts of noise, and (b) that as it reduces the high internal resistance of pentodes and tetrodes it tends to increase hum. As (b) contradicts (a) it sheds doubt upon what, if true, would at least be quite a definite and useful piece of information. So I resolved to see if something a little more helpful could be said on the subject, and the results follow. I realise, of course, that such an introduction invites hosts of letters pointing out that (1) all this has appeared years ago, or (2) it is entirely original and wrong; but one must take risks sometimes.

Although "hum," strictly speaking, is a particular sort of sound, it saves time to make the word include the alternative voltages and currents in an amplifier, etc., which cause that sound to issue from the associated loud-speaker, if there is one, or corresponding undesirable effects to appear on the screen of a television receiver, or whatever the apparatus may be.

Sources of Hum

There are quite a number of ways in which hum can insinuate itself (apt verb, that) into the circuits. It can be picked up inductively from transformers or smoothing chokes; or capacitively from wires and things (such as cathode heaters) at alternating potential; or along with the signal from a previous stage; or from an imperfectly smoothed anode or screen or grid bias or loud-speaker field supply. Inductive or capacitive pick-up is dealt with

By "CATHODE RAY"

mainly by screening and suitable placing of components, and loud-speaker field trouble by a "hum bucking coil" in series with the moving coil. Hum from a previous stage must originate in one of the other ways, so can be deleted as a separate item. Grid bias supplies are easily smoothed because they need little or no current. So I am going to narrow the field of inquiry to anode and (to a less extent) screen current supplies.

The Output Stage

Obviously the greater the amplification following the point at which the hum enters the more necessary it is to exclude it. But, generally, the early stages require little current and comparatively low voltages, so effective supplementary filtering by condensers and resistors (or small chokes) is simple and cheap. Although what follows can be applied to these stages, it is the output stage that I have had chiefly in view, because it uses by far the largest part of the H.T. supply, and smoothing chokes to carry a heavy current and drop few volts, and at the same time iron out the hum ripple are heavy and expensive. So it may be worth while seeing if negative feedback (which you may have decided to instal in any case) also allows you to cut down the smoothing components.

Most of the literature on the subject includes, along with (a) and (b) above the obvious information that feedback can't cope with hum entering from a previous stage, because it reduces hum and signal together, and so leaves the signal-hum ratio as before. That is true, and so I am considering only what happens to hum introduced by the H.T. supply to the stage to which feedback is applied. This is not a difficult mathematical problem (if minor complications are ignored) and when solved for various typical circuits gives a variety of re-

sults; so to make the practical outcome easier to grasp than from an array of formulæ, I present them in the accompanying chart. As a further assurance that they are practical results, they were obtained by actual tests on representative circuits.

In case the method is of interest, Fig. 1 shows the test circuit. To ensure constancy of hum voltage it was supplied from the 50 c/s mains via a heavy transformer, and the power unit itself rendered virtually hum-free by an auxiliary 24 μ F smoothing condenser, which also provided a path of negligible impedance for the artificial hum, ensuring that all its voltage (33 peak) was divided between the valve resistance r_a and the impedance in the anode circuit. The grid bias voltage, controlled by R_c , was adequately smoothed, and so, when necessary, was the screen voltage. Z was the point of application for 100 per cent feedback, and Y for 20 per cent. The hum voltage was measured by a cathode ray tube, which also served to indicate phase shifts and detect instability or any other funny business that would have vitiated the results.

Triodes and Pentodes

To represent triodes, an AC/P1 was used, with 100 per cent feedback, 200 volts anode-to-cathode, 26 milliamps anode current, -30 volts grid bias, and 5,000 ohms load (R_L). The pentode was an AC2/Pen, with 20 per cent feedback, 200 volts to anode and screen, 22½ milliamps anode current, 5 milliamps screen current, -6 volts grid bias, and 7,000 ohms load.

The results with the triode in three different circuits are shown at A, B and C in the chart, and for the same three circuits with the pentode at D-I, D-F being with the screen fed direct from the H.T.-plus-hum source, and G-I with an effectively smoothed screen supply. In A, D and G the load is coupled by a 1:1 transformer and the feedback is taken

from the anode; in B, E and H the load is in the same place but the feedback is taken from across the secondary; and in C, F and I the load is parallel-fed, using the primary of the transformer as a choke. The feedback connection is shown dotted in each case.

Hum Voltage Diagrams

Underneath each of the little circuit diagrams that indicate the essentials of these arrangements is a voltage diagram. The constant hum voltage is represented by the distance between the two horizontal lines marked "H.T." and "Cathode" and the relative hum potential of the anode is shown by one dot for "Without feedback" and another for "With feedback." So one can see at a glance how the hum divides itself. The percentage of it across the load, and therefore a nuisance, is indicated by the vertical line and the number alongside.

In A, assuming an ideal transformer, there is the equivalent of an AC resistance of 5,000 ohms between +H.T. and anode and, of course, the valve resistance, r_a (about 2,000 ohms) between anode and cathode. The hum divides between these in proportion to their resistances, so without feedback the load gets 72 per cent of the total. With feedback, r_a is reduced to about 350 ohms, so 95 per cent of the hum is passed on to the load. Considered another way, when the hum voltage tends to increase, the anode current it makes the anode more positive; this, fed back to the grid, increases the anode current still more. In this case, then, feedback makes hum go from bad to worse.

At this point it is easy to get confused. If, as I have just said about circuit A, the effect of feedback is to make every change of anode current greater than it would otherwise have been, it looks as if the feedback were *positive*. Yet obviously a positive half-cycle of incoming signal on the grid, which also increases the anode current, makes the anode go negative, and so feeds negative back to the grid. The catch is that, unlike an incoming signal (which raises the anode current by reducing the valve resistance), the effect of a positive half-cycle

of hum is to increase the H.T. voltage; and therefore although there is an increase in anode current and a consequent increased voltage across the anode load, this increase is not at the expense of the anode voltage, which on the contrary receives its own share of the hum voltage. *Relative to +H.T.*, the anode end of the transformer primary goes *negative*.

It is essential to grasp this point as it is the key to the modification shown at B. Here the lower ends of both transformer windings go negative relative to the upper ends when anode current increases, but owing to the primary upper end being attached to the hum supply the whole winding, including the lower end, goes positive relatively to the cathode, whereas the secondary lower end obviously goes negative, and when connected to the grid opposes hum anode current as well as signal anode currents. Here, then, is what the books are talking about

impedance was a good deal larger than that of R_L and r_a in parallel; and mainly inductive, so our voltage diagram would really have to be a triangle to show the hum voltage across it to scale. However, the important point is shown clearly; namely, that as feedback reduces r_a , the hum voltage across it—and across the load—is brought much nearer the ideal zero. This is obviously a first-rate anti-hum circuit, even without feedback; and would show up better still at the higher hum frequencies which audibly are the most annoying.

In circuits D—F the situation is complicated by the hum being fed in to the screen, whence it is amplified by the valve, so causing a voltage to be developed at the anode, which is nearly double the original hum voltage from the source. Feedback from the anode (circuit D) tends to oppose this amplified voltage, but, as in A, it tends to increase the hum arriv-

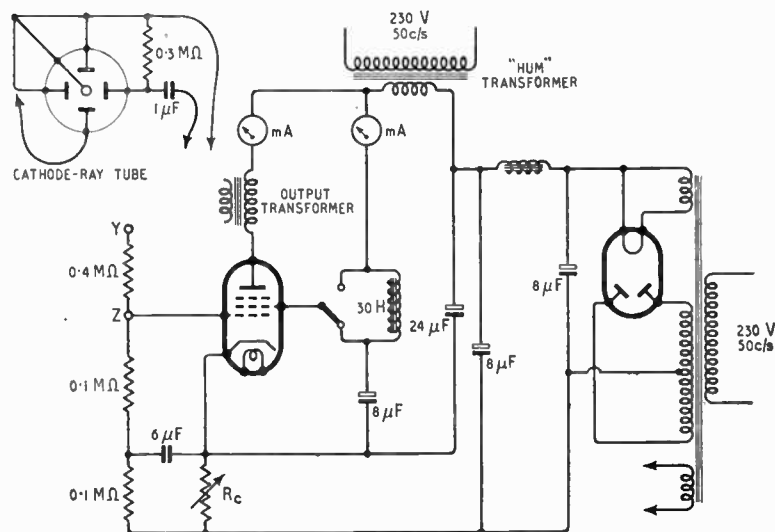

Fig. 1. Test circuit used for measuring liability to hum of various circuit arrangements, with and without negative feedback.

when they say that feedback reduces hum in the same ratio as amplification, etc. The reduction obtained in the practical test, from 72 to 15 per cent, agrees with this theory.

If the choke in circuit C had an infinitely high impedance, as ideally it would, there would be no hum at all, with or without feedback. In the actual test its

ing direct from the anode supply. The net result in this case is an improvement; but it is pretty horrible anyway. Feedback from the secondary (circuit E) opposes both causes of hum, effecting a great improvement, as one would expect. And so with F; but, unlike C, it is not an arrangement to adopt without feedback. This

(Continued on page 145)

Negative Feedback and Hum—

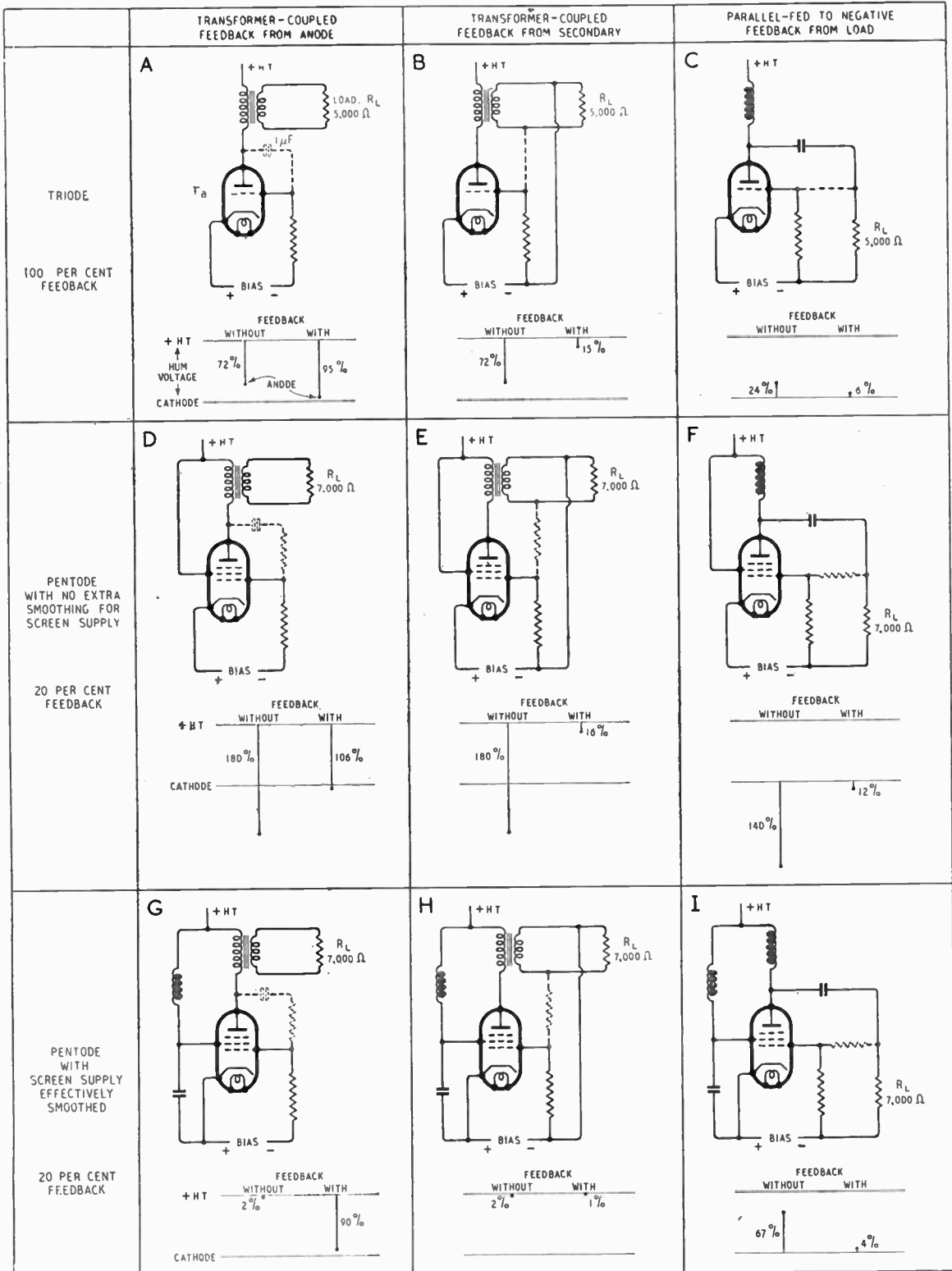

Fig. 2. Percentages of hum passed on to load, with typical circuits and valves.

whole second row is a dreadful warning against leaving the screen supply badly smoothed. Having taken it to heart and put in a massive filter, we look at the corresponding results, G—I.

Of course, we know that pentodes have much higher internal resistance than triodes, and the AC₂/Pen is perhaps higher than average. But the 2 per cent hum shown at G makes it out to be nearly 350,000 ohms. This, I feel, is a slight exaggeration, caused partly by the fact that at 50 c/s the transformer is by no means ideal, and shunts the 7,000-ohm load by an appreciable susceptance. (That is a term seldom used even by highbrow types, but is dead right here. It refers to a path provided by an inductance or capacitance, and is the reciprocal of its reactance.) The other part is the fact that the small amount of hum that does get past the screen filter has suffered a reverse in phase, and so does a little private negative feedback on its own. When the real feedback is applied, however, the valve resistance goes down drastically, with disastrous results so far as hum is concerned—it is magnified 45-fold.

Passing hastily on to H, the

feedback system that has worked so well with triode and unsmoothed screen has very little lift to do, and all one can say is that it makes a noble effort to reduce the 2 per cent to a still smaller proportion. The 1 per cent marked is actually rather nominal—it was difficult to measure it at all.

Lastly, I. Here the results correspond to those for the triode in C, after allowing for the pentode's r_a being higher. The hum voltage across the choke, being out of phase, is larger than one would gather from the voltage diagram, being more than 60 per cent of the hum supply voltage.

Conclusions

The conclusions seem to be:—

(1) Never feed back from the anode when the load is transformer-coupled, unless the H.T. supply is very smooth (A, D, C).

(2) With triodes, when feedback is generally not employed, use parallel feed (circuit C).

(3) With tetrodes and pentodes, make sure either that the screen supply is well smoothed or that feedback is used.

(4) A transformer-coupled pentode is remarkably hum-free without feedback.

Circuit G with feedback is a case to note, because it is so commonly recommended. The advantage of substituting H is clear enough from the diagrams.

Finally, one of the arguments in favour of push-pull is that it cancels out hum from the H.T. and screen supply, and permits economies in the smoothing components. If carried to excess, however, such economies may cause distortion by modulating the signal; and feedback from the secondary of the output transformed is then a good line to take.

E.M.I. PICK-UP FOR EXPERIMENTERS

ARRANGEMENTS have been made to supply a limited number of Type 12 lightweight pick-ups to quality enthusiasts. Purchasers are asked to state that it is for their personal use and a certificate for completion to this effect will be supplied on request to E.M.I. Service, Ltd., Radio Amateur Division, Sheraton Works, Hayes, Middlesex.

The Type 12 is an improved version of the "Hypersensitive" pick-up and the makers state that with "Silent Stylus" needles it has a bass resonance at 15 c/s and top resonance at 9,000 c/s with a substantially flat response between 50 and 8,000 c/s. A new type of tone arm has been designed and the pressure at the needle point is equivalent to a weight of 1½ oz.

The price is £2 (plus 8s 8d purchase tax) and a coupling transformer incorporating a bass compensation network is available at 10s 6d.

I.E.E. SCHOLARSHIPS

FOUR research scholarships are to be awarded by the Institution of Electrical Engineers this year. They are: Ferranti, £250 per annum for two years; Oliver Lodge, £250 for one year, but may be extended for a second year; Swan Memorial, £120 for one year; C. P. Sparks War Thanksgiving Fund, not exceeding £100.

The awards will be made subject to the regulations laid down by the Ministry of Labour and National Service regarding the candidates' ages at the commencement of their courses.

Full particulars of the scholarships, and nomination forms, may be obtained from the Secretary, I.E.E., Savoy Place, London, W.C.2. The closing date for receiving applications is June 1st.

OUR COVER

The array of aerials on a modern aircraft carrier, *H.M.S. Ocean*, form the subject for this month's cover illustration. With the help of this key picture, readers will be able to see the purposes for which the various aerials are employed. Radar aerials are marked A, V-H-F transmitting aerials B, V-H-F receiving aerials C, and the aircraft W/T homing beacon D.

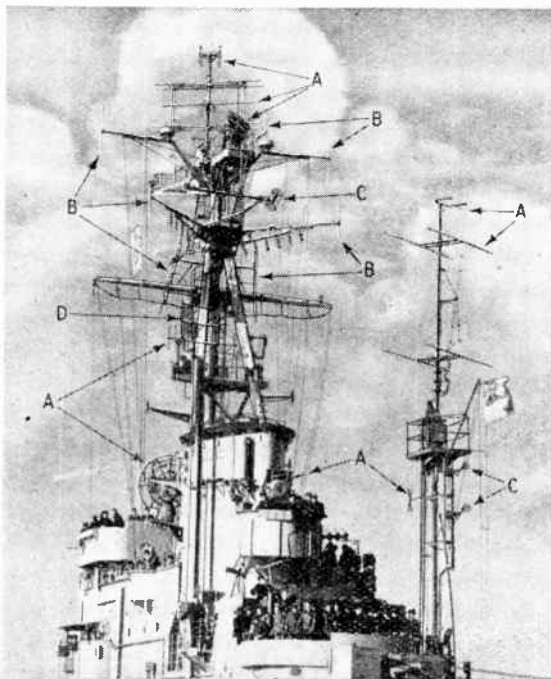

RADAR TECHNIQUE

Salient Features of Components and Circuits

WE have already given in this journal an outline of the fundamentals of radar (issues of February and March, 1945, and October, 1945, to February, 1946, inclusive). Details of the practical construction of many parts of the equipment, e.g., the magnetron, have now been disclosed and in the following pages we are able to clothe the bare bones of the previous story.

It would be quite impossible to deal adequately in a single issue with the wealth of material contained in the sixty odd papers which were read before the Radiolocation Convention held at the Institution of Electrical Engineers, March 26th-29th, 1946. Accordingly we have selected those items which we think will be of greatest interest to readers who have not been closely associated with radar development during the war, and to whom radar techniques—particularly those employed for centimetre waves—will be opening up new and fascinating fields. Later we hope to deal with other important aspects of the subjects discussed at the Convention, e.g., propagation, methods of measurement, etc.

CAVITY MAGNETRONS

THE greatest scientific invention of the war" is the level at which a prominent scientist has assessed the cavity magnetron. The atomic bomb may have shortened the war, but after having heard Sir Robert Watson Watt measure radar in terms of the invisible reinforcements by which it effectively multiplied every aeroplane, gun, ship, tank, searchlight, etc., one doubts more than ever whether the war could have been won at all without radar. It is true that radar would have established itself in history by its part in the Battle of Britain alone, in which the magnetron was not present; but at least a year before then it had been realised that radar of quite a different kind would before long be urgently needed. It was; in the Battle of the Atlantic, when a few magnetron-equipped radar sets checked the disastrous increase in ship losses.

What was wanted was something to provide a narrow beam of radio waves from an aircraft without reducing its speed. Because sharply directional aeri-als are necessarily large in comparison with the wavelength, this meant

waves not longer than a few centimetres. And because only a very small fraction of the transmitter power reaches and is reflected by a distant target, and only a small fraction of that small fraction can be caught by the receiver, the transmitter power must be large—many times larger than had ever been generated, up to the outbreak of war.

This was the dilemma: the

general method of reducing the wavelength is to make the oscillator smaller, whereas the general method of increasing the power is to make the generator larger, in order to prevent it from being burnt up by that part of the input power not converted into useful output. To make matters worse, the tendency was for that undesirable part to become a larger percentage of the input as the wavelength was reduced.

The Klystron, developed in America, had got over the transit time difficulty very neatly, and had shown what could be done by bringing the tuned circuits—highly efficient cavity resonators—right into the valve, to be excited directly by the electron stream; but that stream proved incapable of introducing power of the required many-kilowatt order, even in pulses.

The magnetron as then known had produced only a few not-too-reliable watts; but in 1939, Prof. J. T. Randall and Dr. H. A. H. Boot at Birmingham University had the idea that if the magnetron principle were combined with directly-excited cavity resonators a great increase in centimetre power would result. An experimental valve designed for 10 centimetre wavelength was

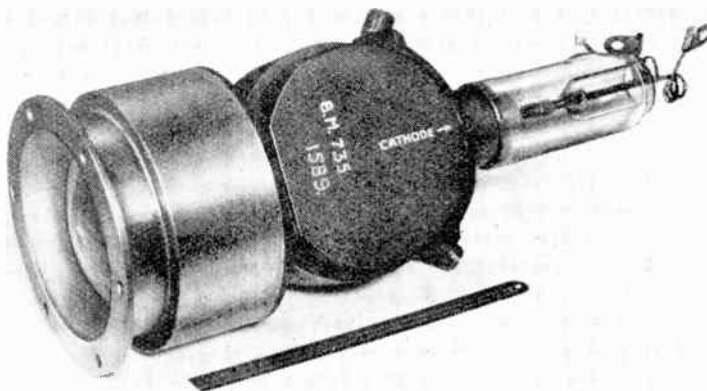

Fig. 1. High-power magnetron, B.T.-H. B.M.735, with a peak output of 2,500 kilowatts, photographed alongside a 6" rule.

on paper in November, 1939, and on the test bench three months later; and when at the first trial it yielded 500 watts of C.W. at 9.8 centimetres the originators knew that they had been right. By June, 1940, a workable sealed-off type of cavity magnetron, made by the General Electric Co. and Marconi-Osram Valve Co., was giving a peak output of 10 kilowatts. A sample was taken to the U.S.A. in August, 1940, as part of the first British contribution to the Anglo-American interchange of technical information, and a very sensational contribution it was. From then on progress has

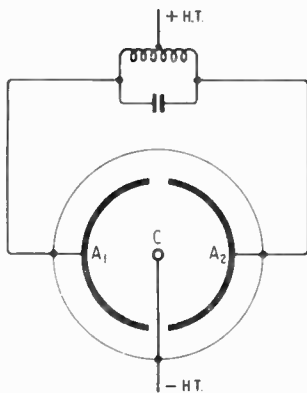

Fig. 2. The early type of split-anode magnetron with external tuned circuit, from which the cavity magnetron evolved.

continued, and in 1945 a magnetron was produced by British Thomson-Houston with an output in the 10 cm (3,000 megacycle) band of 2,500 kilowatts, or about 50 times as much as a B.B.C. high-power medium-wave broadcasting station.

Now admittedly this power is on a peak or pulse rating, that is to say, it lasts for periods of the order of 1 microsecond, recurring about 1,000 times per second (the pulse recurrence frequency), so that the mean output is only about 2,500 watts; but even so, bearing in mind the size of the "bottle" (seen in Fig. 1), it still seems rather fantastic.

Compared with many modern valves of conventional grid-controlled type the magnetron is an amazingly simple device. It consists of a straight cathode surrounded by a cylindrical anode

divided into two or more segments. A steady magnetic field must be provided, acting parallel to the cathode throughout the space. Fig. 2 illustrates a pre-

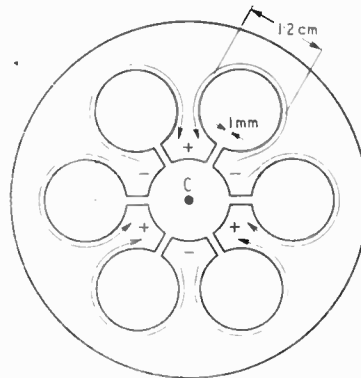

Fig. 3. Cross-section of the first experimental 10 cm. cavity magnetron. C, the directly-heated cathode, was a 0.75 mm. tungsten wire.

war split-anode magnetron with external oscillatory circuit. Under the influence of the anode voltage alone, electrons would take straight radial paths from the cathode. But directly they start to do so, they come under the influence of the magnetic field, which forces them into curved paths, so that an electron starting off towards A_1 may actually alight on A_2 , or even back on the cathode, depending on the anode voltage and magnetic field strength. If the tuned circuit is oscillating, the potentials of the

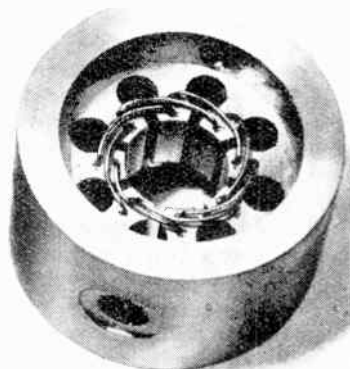

Fig. 4. Example of anode construction, showing anti-mode strapping.

two anodes alternate in opposite phase above and below the H.T. voltage, and given a suitable magnetic field, react on the electrons, making them take routes such that their energy maintains oscillation.

Randall and Boot converted this valve to the integral-cavity principle in the beautifully simple way shown in Fig. 3, where cylindrical cavities are cut out of a solid copper anode. There are various ways in which such a set of resonators can oscillate; the most useful is that in which current flows round the cavities as shown, charging adjacent anode segments to opposite polarity. As there is thus a phase difference of π radians between any segment and its neighbour (one cycle = 2π) it is called the π mode. The frequency at this mode is fixed mainly by the diameter of the cavity. Oscillations in other modes (for example, from one-half

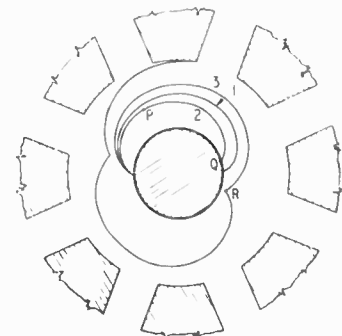

Fig. 5. Typical electron paths in a magnetron.

of the anode block to the other) are at somewhat different frequencies, and it is obviously most undesirable that they should occur instead of or in addition to the desired mode. A great improvement in operating stability, and an increase in efficiency from 10-15 per cent to 35-50 per cent was effected by connecting together anode segments of like polarity, as shown in Fig. 4. These connections are duplicated at the other end of the anode. A second advantage of these straps is that within narrow limits the working frequency can be adjusted by bending them. Other ways of tuning magnetrons have been devised, but during the war they

Radar Technique—

were generally manufactured for fixed frequency bands, spot frequencies within a band being obtained by selection.

Electrical engineers can hardly

that they receive energy from the oscillating electric field and are driven back on to the cathode, where their excess energy causes heat. Such a path is No. 2 in Fig. 5, and can be compared with

anode, and if they rotate around the cathode at about the same rate as one of the field patterns they may continue to energize the oscillations in several loops, such as path No. 3.

For efficiency, it is obviously desirable that the electrons should as far as possible fall into the second class. Nevertheless the others, although not adding directly to the oscillatory output, do provide most of the enormous electronic emission necessary for such high peak powers. For example, the CV.76 gives a peak output of 500 kW, and as the efficiency is 50 per cent the input must be 1,000 kW. With an anode voltage of 28,000, the anode current is thus 35 amperes. Most of this is secondary emission due to bombardment by returning electrons, the primary emission being only a few milliamps. After the magnetron has warmed up, the heater current can be switched off. The limiting factor in a magnetron is not so much the heat that can be put into the cathode as the heat that can be carried away from it.

Fig. 6 shows the construction of a typical cavity magnetron, which follows the original experimental model of Randall and Boot remarkably closely. The output is extracted by a small loop feeding a coaxial cable or waveguide. The older "hands," at least, find it hard to believe that this curl of a safety pin carries hundreds of kilowatts of R.F., even momentarily. The loop and its external projection, as well as other constructional features, can be seen in Fig. 7.

For the 3-centimetre band it is

fail to be struck by the resemblance of Fig. 4 to the stator of an A.C. machine. The resemblance is rather more than superficial, if one interchanges current and voltage, electric and magnetic fields. For example: in the stator, currents circulate through windings in the slots, while magnetic fields alternate in the metal between; in the magnetron the reverse happens.

The oscillating potential distribution around the anode is equivalent to two patterns, such as that indicated roughly in Fig. 3, rotating in opposite directions (compare standing waves). Of the electrons emitted from the cathode, some arrive on the scene at such times and places

path No. 1, representing the non-oscillating condition. Other electrons give up energy to the

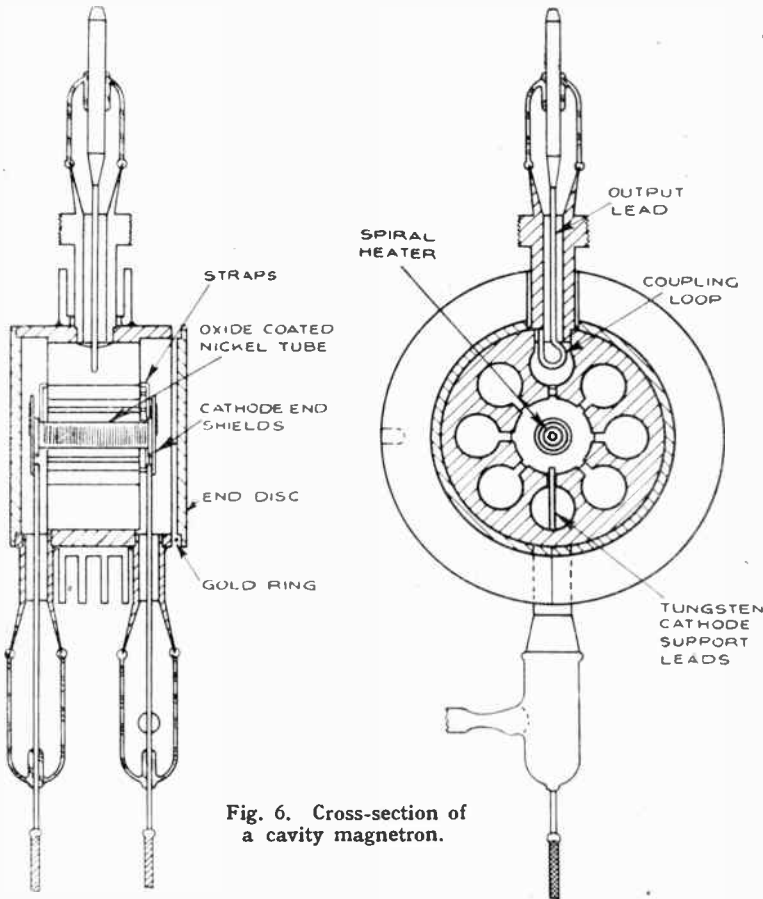

Fig. 6. Cross-section of a cavity magnetron.

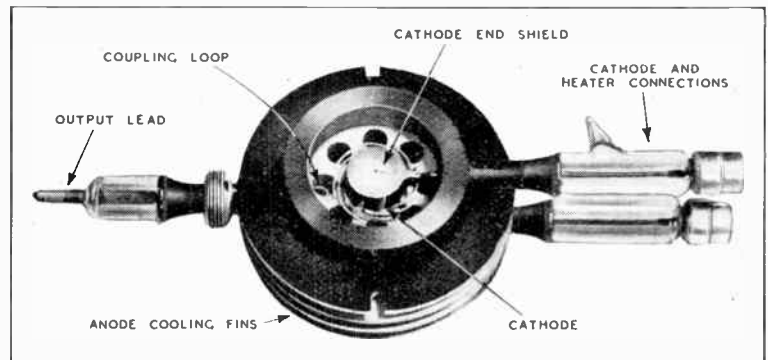

Fig. 7. Internal view of the CV.64, much used by the R.A.F.

of course necessary to reduce the dimensions; and in order to retain as high an efficiency and output as possible it is usual to have about twice as many cavities as in the 10-cm types. The output

maximum very rapidly and hold it for the duration, dying away again rapidly to zero.

The frequency depends also to some extent on the load, and in fact the waveguide coupling has

been used as a means of frequency adjustment within about 1 per cent. For the same reason, variations in load and standing wave ratio must be minimized.

No fewer than 200,000 magnetrons were manufactured in Britain alone for war purposes. In addition to peacetime military requirements, there is no doubt that increasing quantities of magnetrons will be needed for civil uses. The scope of radar in civil aviation is not very clear at the moment, but there can be little question that it will come into general use on ships, for which the optimum wavelength is between 3 and 6 cm, right in the magnetron's territory.

M. G. S.

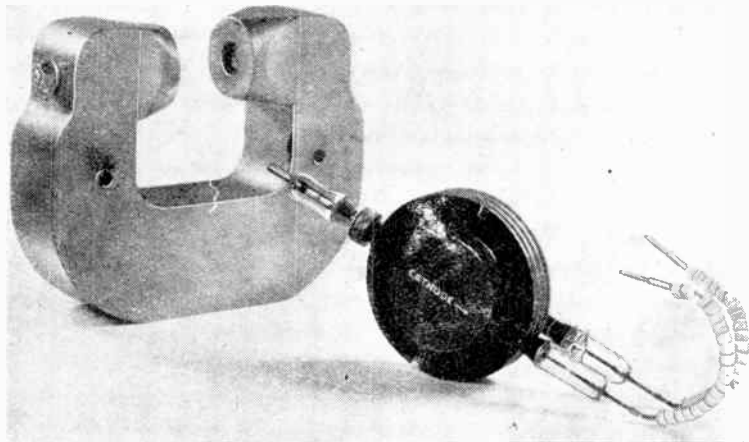

Fig. 8. CV.56 and field magnet.

coupling leads as directly as possible into a waveguide.

The high conductivity copper that best satisfies the electrical requirements is not at all suitable for accurate and rapid machining, the dimensional tolerances being no more than ± 0.0005 inch. This problem was solved by using copper alloyed with 0.5-1 per cent of tellurium. The American solution was to build the anode up from laminations, increasing still more the resemblance to a stator.

The magnetic field is normally provided by a permanent magnet of alnico or alcomax. Fig. 8 shows the CV.56 with its magnet; an early version of a type used by the Royal Navy.

Fig. 1 is the BM.735, the high-power magnetron already mentioned, with a peak output of 2,500 kW at an anode voltage of 40,000-45,000.

The anode is obviously a much "earthier" electrode than the cathode, so the normal practice is to earth the anode and supply high voltage negative pulses to the cathode by methods described elsewhere in this issue. As the mode and frequency of oscillation depend on the H.T. voltage, it is important that the pulse reaches its

OTHER VALVE DEVELOPMENTS

AFTER a lapse of nearly twenty years the commonplace catwhisker crystal detector once again figures as an important item in an otherwise essentially modern radio receiver. As R.F. amplification is virtually unobtainable on the extremely short wavelength of 3 cm the successful operation of the equipment depends largely on the efficiency and reliability of these new crystal detectors.

Although generally known as a crystal valve, it is basically a silicon-tungsten detector, but externally bears no resemblance whatsoever to its early prototypes. As the sectional drawing in Fig. 1 shows the crystal and tungsten catwhisker are contained in a small ceramic tube closed at each end by brass plugs and completely filled with wax. This form of construction results in a mechanically robust device in which the contact is quite undisturbed by normal shocks.

When used as a superheterodyne mixer careful control of the local oscillations is needed, and

the best guide is a measurement of the rectified current passing through the crystal. This should be between 0.5 and 1 mA for average crystals.

Physically these crystal capsules are quite small, the overall size being just under 1 in long and $\frac{1}{4}$ in in diameter.

The velocity modulation valve is used in the transmitters of certain beacon devices, but its main application in modern radar equipment is as the local oscillator for the mixer stage in the centimetre wavelength superheterodyne receivers.

The valves used for this purpose take the form of either reflection oscillators or coaxial line oscillators. For the former a single rhumbatron, or cavity resonator, is used, the electron stream being velocity modulated during the first passage through the rhumbatron emerging as bunches of electrons. These are reflected back to the cavity by a negatively biased electrode spaced a critical distance from the back of the aperture.

I.E.E. Convention Papers

1. Griffiths, J. H. E. "The Development of Radio Valves."
2. Randall, J. T., and Boot, H. A. H. "Early Work on the Cavity Magnetron."
3. Willshaw, W. B., and Rushforth, L. "The High Power Pulsed Magnetron."

Radar Technique—

The coaxial line tubes are generally arranged so that the electron beam passes through apertures cut in the inner and outer tubes, four such apertures being in line. Bunching of the electrons takes place in the passage through the first gap formed by the inner and outer tubes, and the catching effect occurs at the second gap. It is the correctly timed arrival of the bunched

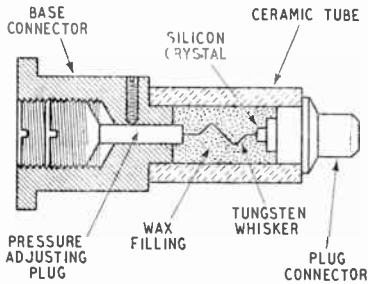

Fig. 1. Construction of the silicon-tungsten crystal valve.

electrons at the second gap of the coaxial tube, and after reflection in the reflection klystron, that produces self-oscillation in the valve. Magnetic focusing is generally used in the coaxial line tubes.

In Fig. 2 is shown, diagrammatically, the basic construction of a reflection klystron, and this is typical of such valves as the CV35, which has a tunable range of about 8.9 to 10.9 cm, and dissipates 10 watts. Other examples are the CV67 and the CV237.

Typifying the coaxial line valves is the CV234, designed to plug into the end of a coaxial line resonator and so enabling a tuning range of about one octave to be obtained.

The majority of these valves are constructed with a part of the cavity resonator within the glass envelope and a part without, glass to metal seals being used at these points. This enables tuning devices, generally in the form of screwed metal plungers, to be incorporated in the outer portion, together with coupling loops for the R.F. feeder.

Further variation of the resonant frequency can be achieved by adjustment of the reflector voltage, and within the range of

± 15 Mc/s the variation is approximately 1 Mc/s per volt change on this electrode.

In the case of valves designed for the 3 cm band the junction areas between the glass and the metal resonator have been found to be a source of considerable R.F. loss. There are two ways of avoiding this, one is to employ a special harmonic resonator, having the property of producing a potential node at that part of the glass envelope within the resonator, and the other is to totally enclose the resonator within the bulb and fit a flexible metal diaphragm at one end for varying the frequency.

Various forms of gas-discharge cells have been evolved to enable radar equipment to be operated with a common transmitting and receiving aerial system. The purpose of these switches and their manner of use is described elsewhere, so it will suffice here to deal only with the actual device itself.

The T.R. cells now generally used consist of a cavity resonator tuned to the frequency of the transmitter to which it is connected. Each time the transmitter pulses a high potential is built up in the cell cavity, which causes an internal gap to break down and so short circuits the transmission line at this point.

In one position it is used to protect the delicate crystal detector in the receiver, and consequently the breakdown of the gap must be almost instantaneous, yet restoration of the open circuit

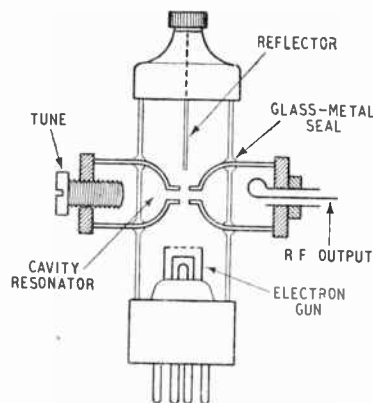

Fig. 2. Details of the latest reflection klystron.

condition has to be effected as soon as possible after the pulse terminates. Any appreciable delay keeps the receiver inoperative during that time and the minimum distance from which an echo can be detected is consequently lengthened.

Rapid ionization of the gap within the cell is assisted by including an auxiliary electrode to which a D.C. voltage is applied.

The rate of recovery of the cell on the termination of the pulse is governed by the nature of the gas in it, and so far the best results have been obtained with the cell filled either with water-vapour or a gas mixture containing a high percentage of water-vapour. With a pressure of 6 mm of mercury the recovery time of a typical cell is 2 μ secs.

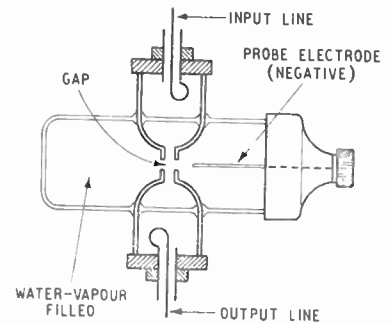

Fig. 3. Water-vapour filled T.R. spark gap switch.

The basic construction of the T.R. cell is given in Fig. 3, which represents one of the type in which the cavity resonator is contained partly within and partly without the glass envelope. This form of construction is typical of the CV43.

The chief developments from this basic cell have been mainly modifications for higher transmitter powers and smaller types for insertion in waveguides for use on the 3 cm waveband.

Further modifications were also applied in the design of automatic switches of the A.T.R. type, the main difference being that the priming voltage is omitted since the ionization of the gap need not be quite so rapid as there is no crystal, or other delicate equipment, to protect.

The last few years has produced a better understanding of the be-

behaviour of the common triode valve on the very short waves and although attention has been paid to the reduction of electron transit time, satisfactory operation on the centimetre wavelengths has been achieved mainly by designing the valve as an integral part of the circuit structure. This has led to a radical departure from the hitherto accepted form of construction.

In these new valves the contacts are brought out at points on the glass envelope where they most conveniently fit into the external circuit, which in many cases on the centimetre waves is a coaxial line.

The majority of oscillatory circuits consist of two tunable elements and one valve electrode is common to both. In normal H.F. and L.F. practice this is the cathode, but in V.H.F. and centimetre practice it is more convenient to make the common electrode either the grid or the anode. Examples of the common anode style are the VT90 and the CV52.

Further development of the disc-seal form of construction led to the production of the latest type of triodes which have a good performance as oscillators up to frequencies as high as 3,000 Mc/s (10 cm). The majority of these are designed for use as common grid oscillators, both for transmission and reception, and included in this class are such valves as the CV90, CV273 and CV288.

The construction of the CV90, for example, is such that it can be plugged into the end of a concentric line circuit, the anode being connected to the

CV273 disc-seal triode for insertion in concentric line circuits.

outer conductor. This provides good heat dissipation and as a consequence the valve can be operated with an anode dissipation of 10 watts and provides about 5 watts R.F. output at

50 cm and 0.5 watt at 10 cm.

Early radar transmitters were often modulated by the thyatron class of valve, the main requirement of which is the ability to pass very large peak currents for

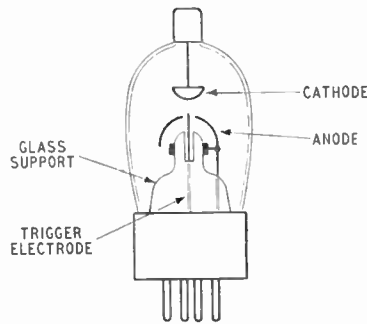

Fig. 4. Constructional details of the Trigatron modulator valve.

a very short duration, usually of the order of $1 \mu\text{sec}$.

In order to obtain high pulse powers an extremely rapid build-up of current through the valve is essential. With the majority of the types so far produced the limit of build-up appears to be about 600 amperes per μsec and with a maximum current limit of some 200 amperes.

Certain types of airborne radar equipments, particularly H₂S, A.I. and A.S.V. need high pulse recurrence frequencies to obtain good definition of the image and as

the ordinary thyatron is not very satisfactory above about 500 pulses per second a new type of modulator emerged.

Known as the Trigatron, and exemplified by the CV85, it will handle considerable pulse power at the high P.R.F. of 1,200. Actually this device is more in the nature of a triggered spark gap than a thyatron.

Constructionally it consists of two mushroom-shaped electrodes made of molybdenum, between which the main discharge takes place. Protruding through the centre of one is a third electrode made of tungsten, the function of which is to trigger the main gap at the correct instant. Fig. 4 typifies the general form of construction adopted.

The CV85 operates at an anode voltage of 7 kV and will handle 150 kW peak pulse power. Higher powers are delivered by such types as the CV100 and CV125, which give outputs of 250 and 500 kW respectively.—H. B. D.

I.E.E. Convention Papers

1. Bell, J. "Triodes for Very Short Waves."
2. Bleaney, B. "The Crystal Valve."
3. Broadway, L. F. "Velocity Modulation Valves."
4. Cooke, A. H. "Gas-Discharge Switches for Single Aerial Working."
5. Griffiths, J. H. E. "The Development of Radio Valves."
6. Knight, H. de B. "The Development of Gas-filled Triodes for Radar Modulation Service."

AERIAL SYSTEMS

IN the early days of radar, one of the greatest difficulties lay in obtaining accurate measurement of the bearing of a target. The established technique was to employ a directional aerial, such as a horizontal half-wave dipole, and to take a bearing on the minimum of signal strength. This was normal D.F. practice.

One practical objection to this was that the signal disappears at the moment of making an observation. Another, and more serious, is that if the signal is weak, the minimum is lost in noise, and the signal may disappear over an arc of several degrees.

Now, in radar, echo signals are always weak. The necessity for

swinging the aerial through the minimum to take a bearing is also particularly bad, for it means that the bearing of the target cannot be presented continuously, but only at intervals.

The obvious course was to work on the maximum of the aerial response, but in the days of wide-beam metre-wave radar this was impracticable. With modern narrow beam centimetre-wave technique it is, of course, quite possible for some purposes.

The difficulty was resolved by the invention of "split." The technique is most easily understood by considering an example which is not representative of its practical form. Suppose the



Radar Technique—

aerial system has a polar diagram in the horizontal plane as shown in Fig. 1 (a). It is obvious that the nose of the curve is very flat and there is but little variation

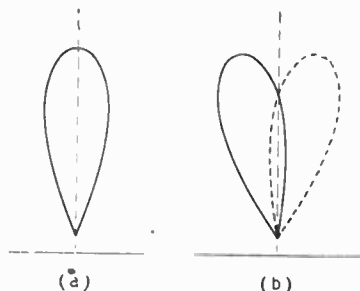

Fig. 1. A normal aerial lobe is shown at (a), and the way in which it is swung between two limiting positions (b) for "split."

in output for an aerial swing of perhaps $\pm 10^\circ$.

Now suppose that two identical aerials are mounted to rotate together, and are so disposed that they are pointing in slightly different directions to give a double polar diagram of the form shown in Fig. 1 (b).

If there are two identical receivers, one connected to each aerial, the output of each receiver will vary in accordance with the aerial lobe pertaining to it. As the whole aerial system is rotated the variations of output of the

This position of equal outputs is quite sharp because it occurs on the sides of the lobes where the outputs are changing rapidly in opposite directions with bearing. The receiver output is not its maximum, but is at a high enough level to give a sharp bearing.

In practice, largely because it is difficult to obtain two identical receivers, a single one is used, and the aerials are connected to it alternately in rapid succession by some form of switching. The receiver output is synchronously switched to provide two indications of output. In some equipments, the radar echoes are viewed on a C.R. tube and appear as pips off the trace of the base line.

and are connected by a length of feeder. The two aerials together give a single lobe the angle of which, relative to the aerial plane, can be varied by varying the position of the receiver connection along this feeder. Sometimes this is done by a mechanical switch, but in other cases an electronic switch is employed.

On centimetre waves a similar result is secured with a mutating dipole. This is a dipole mounted in a paraboloid reflector with its centre off the axis of the paraboloid so that the beam is displaced. The whole dipole travels at high speed with its centre on the circumference of a circle centred on the axis of the paraboloid but

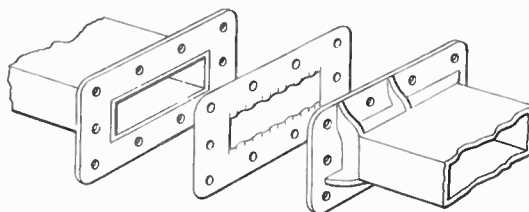

Fig. 3. Typical method of joining lengths of waveguide using a serrated washer between the flanges.

The synchronous switch then places a bias on the deflector plates when one aerial is in operation and removes it when the other is connected.

The outputs then appear as two pips side by side, one due to each aerial, and the operator rotates

in such a way that the dipole itself always remains vertical or horizontal, according to the plane of polarization required. The centre line of the beam thus sweeps out a cone centred on the paraboloid, and when the aerial system is "on target," the aerial output is constant at all positions of the dipole. Both bearing and elevation are thus secured from a single aerial.

On metre waves a separate set of aerials is necessary for elevation finding. Except at high angles, elevation finding then depends on ground reflections. For accuracy each equipment must be calibrated on site and the calibrations must be frequently checked.

In the early days the transmitting aerial gave substantially all-round coverage and only the receiver was highly directional. In more recent apparatus the transmitter is beamed as sharply as the receiver and the aerial systems must move together. This has led to the use of a common aerial for transmitter and receiver with a considerable saving of space. Such a common aerial is practical, because transmitter and

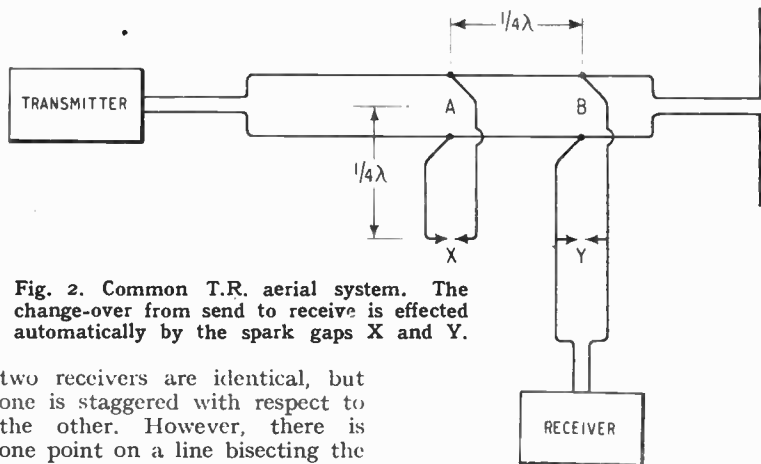

Fig. 2. Common T.R. aerial system. The change-over from send to receive is effected automatically by the spark gaps X and Y.

two receivers are identical, but one is staggered with respect to the other. However, there is one point on a line bisecting the angle between the maxima of the lobes at which the receivers give equal output. This occurs when the lobes are displaced equally in opposite directions from the true bearing of the target.

the aerial system to keep the two pips of equal height.

In many, perhaps most, cases true aerial switching is not used. The aerials themselves are parallel

receiver are not required to function together but in sequence. The transmitter radiates a short pulse of perhaps 1 μ sec duration and then is inert for perhaps 999 μ sec. The receiver must function during the major part of this period but not when the transmitter is operating.

Such single aerial systems are known as common T.R. systems, and the problem is to obtain automatic switching of the aerial between transmitter and receiver without mismatching in the feeder system. The usual course is to employ $\lambda/4$ -lines together with spark gaps. A $\lambda/4$ -line is of low impedance when open-circuited at its far end and of high-impedance when short-circuited. The spark gap becomes virtually a short-circuit when the transmitter is on, and the other end of the line then has low impedance on receive and high on send.

Thus in Fig. 2 "X" and "Y" represent the spark gaps and are inoperative on receive. The line between A and X is then low impedance at A, but AB is also $\lambda/4$, so the whole circuit to the left of B is of high impedance and has little or no effect. Although Y is open-circuited the $\lambda/4$ line between B and Y is not open, for it is terminated correctly by the receiver feeder. The incoming

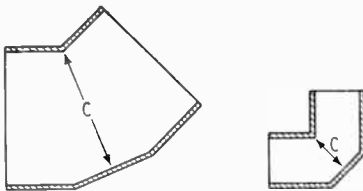

Fig. 4. The distance C across a bend in a waveguide is critical.

signals thus go straight through to the receiver.

When the transmitter functions, the high voltage breaks down the spark gaps; X is a short-circuit so that line AX is high impedance at A and absorbs little energy. Similarly at Y; the short circuit here makes A of high impedance and little energy travels down BY to the receiver. The transmitter output thus travels straight through to the aerial. Similar arrangements are used in waveguides on centimetre waves.

On metre waves it is customary

to use dipoles with and without directors and reflectors and they are usually fed through coaxial cables. On centimetre waves,

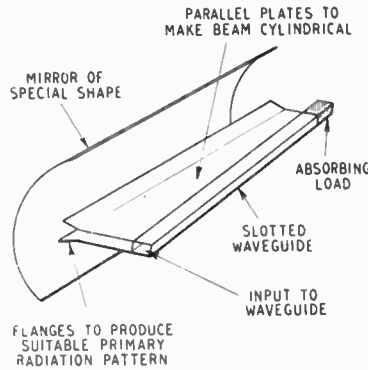

Fig. 5. The waveguide has a series of resonant slots in the wall facing the reflector.

however, waveguides are adopted. Cables are still used in many cases for coupling to the guides. Thus, there may be a cable link between the magnetron and the waveguide. The tendency is, however, to eliminate such links and employ waveguides throughout.

Two standard sizes of rectangular guide are employed; 3in x 1in for 8.5 - 11 cm waves and 1in x 1/2in for 3 cm. Propagation is in the H_{10} mode in which the electrical field is parallel with the shorter dimension. When made of high-conductivity copper the attenuation at 3 cm is about 0.1 db per metre. Jointing is best arranged by flanges which can be bolted together with a serrated shim between—as shown in Fig. 3.

Bends are usually arranged by means of special corner sections and Fig. 4 shows a typical section. The cross-dimension C is critical.

Rotating joints are often needed, since the radiating system must rotate. The rectangular horizontal section feeds into a vertical circular section at right angles, with a step for matching. This transforms the H_1 wave into an E_0 . The filter ring suppresses any residual H_1 wave and allows only the E_0 to pass. The top half is rotatable and there are flanges at the joint to provide capacitance coupling. A further $E_0 - H_1$ transformer is provided and an upper filter ring to prevent

any of the H_1 wave getting back into the coupling. The transformation to an E_0 wave is necessary because this mode has a field symmetrical about the axis and the plane of polarisation is then unaffected by rotating the radiator.

The radiators are of many types. Horns as such are not often used, because their length is considerable. Short horns feeding into a paraboloid mirror are used, however, and give similar results in less space. The beams produced tend to circular symmetry and are used when a pencil beam is needed. Fan beams are often wanted, however, especially broad in the vertical plane and narrow in azimuth. These are used in search equipment in which a simple rotation of the aerial system gives the bearing of a target and sufficient coverage is

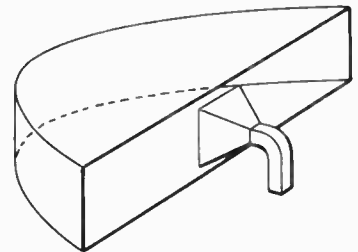

Fig. 6. Cheese aerial fed from a small horn.

obtained for both surface vessels and aircraft.

One method is to use a slotted waveguide and a mirror in the form shown in Fig. 5 and another is to use a "cheese." This is shown in Fig. 6 and consists of a section of a parabolic cylinder with flat top and bottom plates. It is fed from the flared mouth of a waveguide.

Mention has just been made of a slotted waveguide. This is an extension of the slot aerial. The end of the guide is provided with a number of resonant slots which are energised by the guide and act as radiating elements.

The slot aerial itself can be considered as the inverse of a dipole which is a resonant conductor in an insulating plane. The slot aerial is an insulating resonator in a conducting plane. It consists of a slot of length about $\lambda/2$ in a sheet of metal and

Radar Technique—

energised by a transmission line connected to opposite sides at the centre. The electric field is across the slot so that unlike a vertical conducting aerial a vertical slot radiates a horizontally polarized wave. W. T. C.

I.E.E. Convention Papers

1. Böhm, O. "Cheese Aerials."
2. Booker, H. G. "Slot Aerials."
3. Fry, D. W. "Slotted Linear Arrays."
4. Pryce, M. H. L. "Wave Guides."
5. Ratcliffe, J. A. "Aerials for Radar Equipment."
6. Wild, E. "Wave-Guide Matching Technique."

the R.F. components are grouped round the T.R. waveguide unit and there is no clear distinction between transmitter and receiver sections.

Having provided means of generating the required frequency at a power level sufficient to give an effective range, the next most pressing problem is to be able to pulse that power reliably and cleanly without undesirable after-effects which might break the silence while the receiver is searching for echoes. The square-topped pulse shape required is formed by charging a concentric line, or its near equivalent in a series of lumped inductances and capacitances, and then discharging it into the oscillator load through a switch—usually a thyatron, Trigatron or a blown spark gap. The current flows into

TRANSMITTERS and RECEIVERS

CIRCUITS and methods are as numerous as the wavelengths which are employed for radar. Thus on the metre wavelengths used for long-range early warning we find normal triodes and tetrodes associated with tuned line oscillatory circuits which are outside the glass (or silica) valve envelope. On the decimetre band the electrodes tend to act as transmission lines; the circuit literally shrinks into the valves and the difficulty is to keep a workable length of circuit outside for tuning (to avoid jamming). The push-pull CV92 valves (NT99) generally used for 50cm working oscillate by themselves at a lower frequency than this even when the grid line operating the $\frac{1}{2}\lambda$ mode is short-circuited as close as possible to the glass seal, and it becomes necessary to reduce the effective inductance by using large parallel plates for the grid and anode straps. Variation in the spacing of the plates gives an effective tuning range of 50-60cm in conjunction with an adjustable cathode line of manageable length operated on the $\frac{3}{4}\lambda$ mode.

No such subterfuge is available

to the designer of centimetre valves and in the magnetron we find that the tuned circuit has disappeared not only into the valve, but into one of the electrodes, namely, the anode block where it appears as a series of cavity resonators. In 3-centimetre installations such as the H₂S blind-bombing equipment contraction is carried to the point where all

R. A. F. 50 cm transmitter T3501 using two CV92s (NT99s) in push-pull. It delivers a peak power of 100 kW.

Valves and line circuits of metre band C.H.L./G.C.I. transmitter are illustrated below.

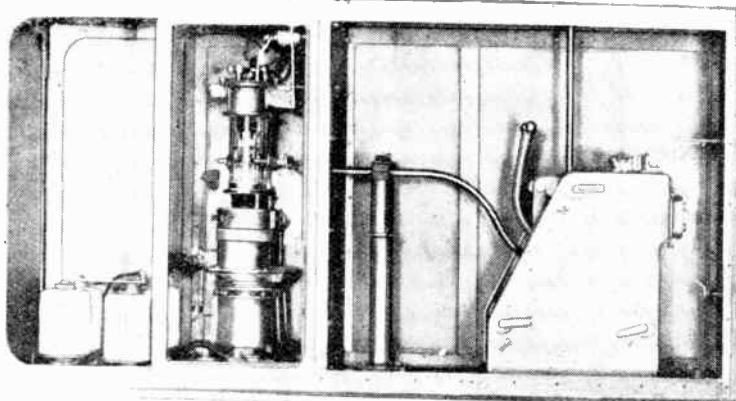
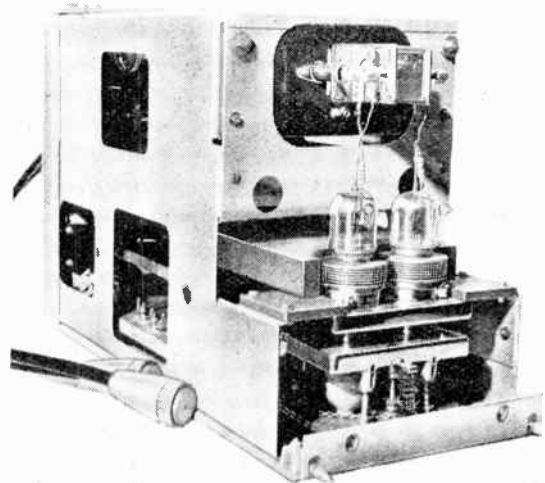

the load in the form of a series of flat-topped steps of diminishing amplitude resulting from the reflection of waves travelling up and down the line. When the surge impedance of the cable is equal to the load the discharge is confined to one rectangular pulse with a voltage amplitude half that of the charge on the line, and a trail of minor pulses. When the load is a magnetron the trail may assume greater importance since the valve becomes virtually an open circuit when the anode voltage falls at the end of the main pulse. This difficulty is overcome in practice by the use of a reverse diode to

supply the necessary damping. The voltage available on discharge is restored either by a twin cable

if too narrow the rectangular pulse is rounded and resolving power and accuracy of measurement are affected.

Suppression of the I.F. amplifier gain is necessary while the transmitter is sending its pulse and this is effected by applying a large negative pulse to the screen grid of one or more of the valves through a circuit of very short time constant so that

Admiralty 500
kW magnetron
transmitter for
9cm.

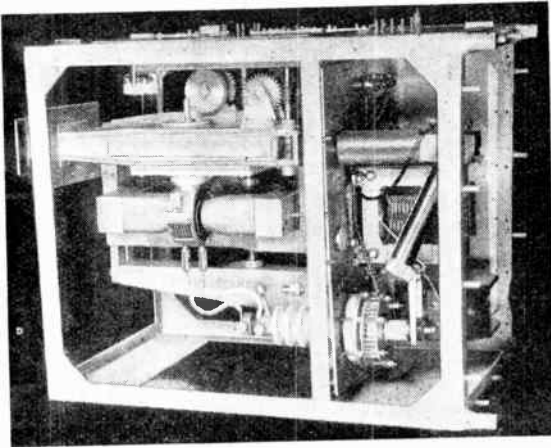

circuit due to Blumlein in which the cables are charged in parallel and discharged in series, or by means of a pulse transformer. The latter method has the advantage of flexibility as a pulse of either polarity can be obtained, with or without earth connection.

The effective utilization of the feeble reflected energy from a target involves a high degree of amplification and a low background noise level. The reduction of noise is the limiting factor and must be watched at every stage from the aerial to the output from the I.F. amplifier. Direct R.F. amplification down to about 300 Mc/s is possible with "low noise" pentodes of the EF50 type such as the RL7 (VR136); with disc seal, grounded grid triodes such as the CV90 and CV153 (known in America as "lighthouse tubes") the useful limit is extended to at least 600 Mc/s. In valves of this type the grid acts as a screen and feedback through the anode-grid and cathode-grid capacitances is avoided.

In centimetre-wave receivers working at 3,000 Mc/s or more direct amplification is impracticable and a crystal mixer and reflection klystron local oscillator are used to convert to an intermediate frequency for amplification. The I.F. lies usually between 10 and 60 Mc/s and the bandwidth of the amplifier must be chosen with care. If too wide the signal/noise ratio suffers and

full gain is recovered as soon as possible after the cessation of the pulse. This is particularly important for close-range fire control.

For convenience of operation it is desirable that reflections from all distances should give approximately equal responses on the C.R. tube. To this end a "swept gain" control is incorporated. This consists of a saw tooth oscillator locked to the pulse frequency, which applies a varying voltage to the suppressor grids and increases gain as the spot sweeps across the tube. If desired, over-compensation can be applied to remove "clutter"

from fixed local objects near the origin. Automatic gain control is often employed where it is desirable to keep a constant level of background noise.

Automatic frequency control is essential to follow drift in the transmitter, since from consideration of signal/noise ratio the I.F. amplifier bandwidth is only just wide enough to accommodate the pulse. Discriminator circuits based on broadcast practice are used and the resulting D.C. component is applied to the reflection target of the klystron local oscillator to keep the intermediate frequency constant. Thermo-mechanical and motor-driven controls have also been used.

The I.F. amplifier is usually divided and the first stage or pre-amplifier is mounted, together with the A.F.C. circuit, near the crystal mixer on the T.R. switch.

In the compact receivers used in interrogator and beacon radar equipment the super-regenerative principle is employed. Intensive study has tamed this one-time rather temperamental circuit and we hope to deal with some of the more interesting developments at an early date.

Super-regenerative receivers in I.F.F. equipment operated at frequencies of the order of 200 Mc/s with a sinusoidal quench voltage at 300 kc/s. To ensure stability an automatic gain stabilization circuit was developed with a fre-

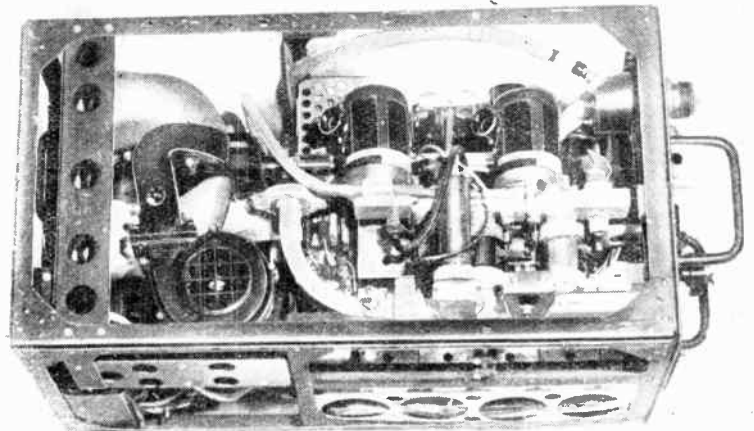

In the R.F. unit of H₂S radar equipment, both receiver and transmitter elements are grouped round the branched wave guide which forms the T.R. switch.

Radar Technique—

quency-selective input stage tuned to the quench frequency component of the receiver output. With this arrangement large numbers of sets were mass produced in which the triggering sensitivity did not deviate by more than ± 5 db from the required mean value. The long-term stability of any individual equipment was much better even than this. F. L. D.

I.E.E. Convention Papers

1. Ratsey, O. L. "Radar Transmitters: A Survey of Developments."
2. Whelpton, R. V., and Dodds, J. M. "Metre-wave Ground Radar Transmitters."
3. England, T. S. "Decimetre-wave Transmitter Development."
4. Wilkinson, K. J. R. "High-power Modulators for Radar."
5. Gibbs, D. F., and Lythall, B. W. "Pulsed Transmitters for 3,000 Mc/s."
6. Lewis, W. B. "Radar Receivers."
7. Watton, W. L. "I.F. Amplifiers for Radiolocation Receivers."
8. Macfarlane, G. G., and Whitehead, J. R. "The Super-regenerative Receiver in the Linear Mode."

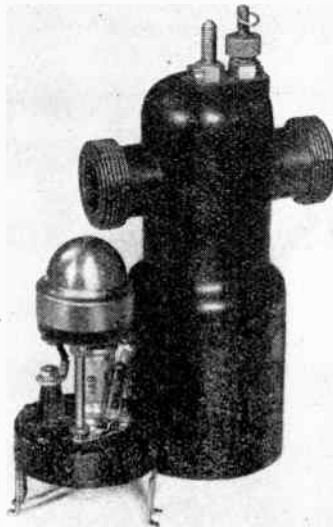

Blown spark gap with housing showing connections for transverse air current.

production of new circuits—although there most certainly are new circuits—as in a better understanding of the mode of operation of existing ones and in obtaining a design technique which enables the performance to be pre-determined with good accuracy. This last factor is of considerable importance since it enables the effect of component and valve tolerances to be determined and so leads to the development of a piece of equipment in which changes, such as the replacement of a valve, have a minimum effect.

Probably the most important single development lies in the adoption of circuits in which the valve acts merely as a switch. The input applied to a valve is always very large compared with

PULSE CIRCUITS

AMONG the radar wartime developments the least spectacular is undoubtedly the circuit technique adopted for pulse generation and shaping. To many people, however, it is by far the most interesting because

entiaters were used in nearly every television receiver, multivibrator pulse generators were by no means unfamiliar and saw-tooth generators formed a part of every television set and oscilloscope. The blocking oscillator, indeed, was a favourite scanning generator.

D.C. restoration or clamping circuits were widely used in television and there is a remarkable affinity between the most modern pulse transformers and the line scanning output transformer of an electromagnetic television receiver.

Wartime circuit development has not lain so much in the

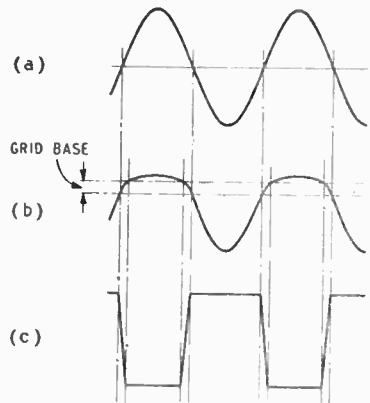

Fig. 3. A sine wave (a) applied to the slicer of Fig. 1 produces the waveform (b) on the grid and (c) on the anode.

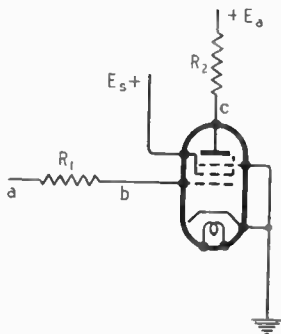

Fig. 1. A double-limiter or slicer.

it has an immediate use in television receivers and cathode-ray oscilloscopes. It is not a matter merely of academic interest but of direct practical application.

Many of the circuits and methods employed were well known before the war, but often by different names. Integrators and differ-

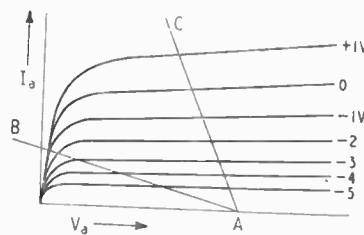

Fig. 2. Typical pentode characteristics. With a load such as AB, the true slicing action is obtained.

the grid base and the characteristics of the valve then have a minimum effect on the performance. It is run very close, however, by the application of negative feedback to pulse circuits for this permits the attainment of a linear integrator and, hence, of a linear saw-tooth generator. The use of delay lines, too, in pulse generation is a new technique of the first importance.

There are, in the main, three ways of using valves. The most common is as linear amplifiers. This is the customary way and a performance reasonably independent of normal changes in characteristics is readily obtained with the aid of negative feedback,

The second use for valves is as rectifiers. Here operation depends on non-linearity of characteristic and the characteristics usually show their most pronounced variations over this region. The

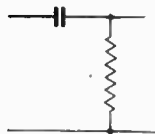

Fig. 4. Differentiating circuit.

variations are minimized by using the valves as peak rectifiers with a large input. This is well known practice; changing a diode detector may affect the output by only 1 per cent or so when the input is 50 volts or more and the load resistance is large, but it may affect it by 20 per cent when the input is only 1 volt and especially if the load is low.

The third use of valves has only come to its full use in radar and it is their use as switches. This mode of operation was approached before the war in the amplitude limiters, pulse generators and saw-tooth oscillators of television, but the implications of the technique were not fully realized and there was not the same need for precision.

A good example of this technique is the single-valve "slicer," so called because the output wave is effectively a slice through the input. It is a double limiter. The circuit is shown in Fig. 1, the valve characteristics in Fig. 2 and the waveform in Fig. 3. A pentode is used with zero grid bias and a fairly high grid resistance R_1 .

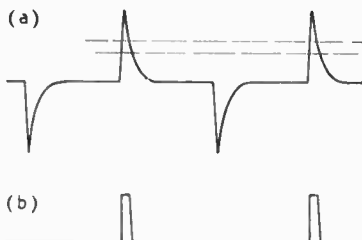

Fig. 5. When the wave of Fig. 3 (c) is differentiated the form (a) is obtained. Passing this through a slicer produces narrow pulses (b),

With a sine-wave input of large amplitude, Fig. 3 (a), the valve is driven into grid current and the positive half-cycles are largely suppressed. The grid-cathode

waveform is thus like that of Fig. 3 (b). When the output is negative, the major part is beyond the current cut-off point of the valve. It can be seen from Fig. 2 that this occurs for a grid voltage of perhaps -8 and this point is indicated by the lower dotted line in Fig. 3 (b). Everything below this line is suppressed in the output for when the current is cut off the anode voltage rises to positive H.T. and cannot change further. This is colloquially known as "topping."

If R_2 is of low value, the operation is determined by the load line AC in Fig. 2. The output is then like Fig. 3 (c) for the positive half-cycles, but cut off at the lower dotted line for the negative. With a high value load, however,

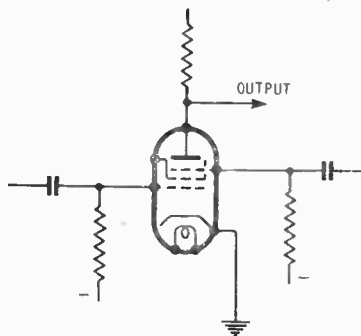

Fig. 6. In this typical gating circuit an output is obtained only when both control and suppressor grids have coincident inputs.

operation takes place along AB and it will be seen that it cuts the valve curves below the knee, at a point where they coalesce. For voltages less negative than -1 volt the anode current and voltage do not change and this in itself gives a limiting action represented by the upper dotted line in Fig. 3 (b). Operation of a valve in this way is known as "bottoming" because the anode voltage drops to a minimum beyond which it cannot change.

The grid base of the valve between "topping" and "bottoming" is indicated by the dotted lines in Fig. 3 (b). The output is limited to changes within these limits and it is consequently a slice through the input bordered by these lines. The output wave

thus takes the form shown in Fig. 3 (c) to an enlarged scale. The output has become a close approach to a square wave and it is obvious that the larger the

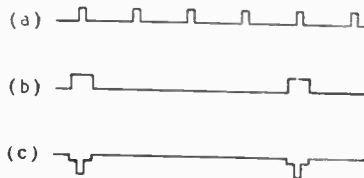

Fig. 7. With an input (a) to the control grid, and (b) to the suppressor of a gate, the output has the form (c).

ratio of the input voltage to the grid base of the valve the steeper are the sides of the output wave.

Passing the output wave through a differentiator, Fig. 4, produces the wave of Fig. 5 (a) and further slicing as indicated by the dotted lines gives narrow rectangular pulses as at (b).

The use of pulses applied to two electrodes of a valve is a common method of sorting out pulses. In Fig. 6 the suppressor grid is biased so that the anode current is normally cut-off. The input pulses Fig. 7 (a) to the control grid then have no effect. Gating or strobing pulses (b) are applied to the suppressor and "turn on" the anode current while they last. When they coincide with a control grid pulse, therefore, the latter drops the anode voltage and the output is of the form (c).

Here the gating-pulse recurrence frequency is one-fifth of that of the input, and so only every fifth pulse appears in the output. It appears on a pedestal formed by the gating pulse, but this can be removed by a simple limiter such as a diode. This type of circuit is often used to select a particular echo for the display system.

The application of negative feedback to the integrator is a development of the greatest importance, particularly as it leads to a simple linear saw-tooth oscillator of wide use for television and oscilloscope purposes. The ordinary simple integrator gives an output voltage which rises exponentially with time from an input step voltage.

Radar Technique—

The Miller integrator, so called because it depends on the well-known Miller effect, is shown

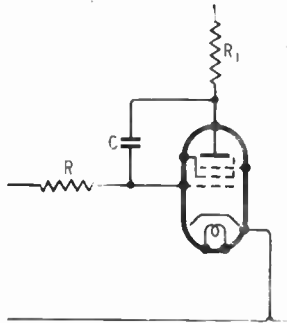

Fig. 8. Miller integrator giving a linear output wave.

basically in Fig. 8. Bias to avoid grid current must be provided, but is not shown. When a step-voltage is applied the initial current in C is limited only by the circuit resistance. As C charges and the voltage across it rises the current decreases and the grid potential changes positively. The anode current rises and the anode voltage falls by A times the grid voltage change, where A is the amplification provided by the valve.

Along the circuit R, C and R₁, the voltage across C is rising and that across R is falling. If the two were equal, they would cancel and leave a constant current in R and therefore in C. A constant

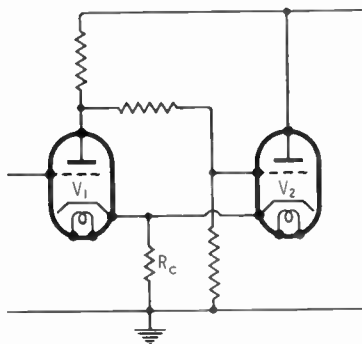

Fig. 9. Shaping circuit with positive feedback.

current in C, however, means a linear rise of voltage across it.

The two cannot be equal for there would then be no change of grid potential to produce the anode voltage change. As the

latter is much greater than the grid voltage because of the amplification of the valve, the voltage can be very nearly linear. The amplification can easily be 100 times and this gives a 100-fold improvement in linearity.

Space does not permit its full description here, but the Miller integrator can be combined with a transitron multivibrator to give a single-valve oscillator with a linear saw-tooth output.

Positive feedback is used naturally in pulse-generators of the multivibrator type, but it is also adopted in shaping circuits. In the circuit of Fig. 9, V₁ is normally cut-off by the voltage drop along R produced by the current of V₂. When the input voltage, of whatever wave shape, raises the grid potential of V₁ sufficiently for this valve to draw current, the

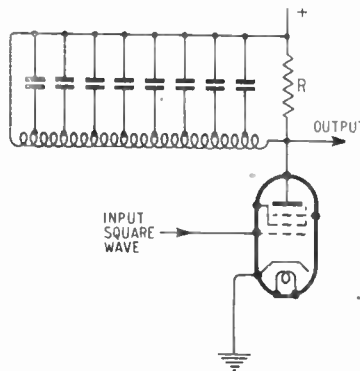

Fig. 10. Pulse generator utilizing a delay network.

anode voltage of V₁ falls and also the grid potential of V₂. Therefore, V₂ draws less current and the bias on V₁ is reduced making it take more current. The action is cumulative, and when V₁ starts to draw current it very quickly snaps over to a condition inverse to the initial one, with V₂ cut-off and V₁ taking a heavy current.

Conditions stay like this until the grid voltage drops sufficiently for V₂ to start taking current again. Then the reverse retro-active action sets in and the circuit reverts rapidly to the initial condition. The circuit is really a form of multivibrator shorn of the capacitances which make it self-oscillating.

Delay lines are employed when

it is necessary to produce a pulse at some definite time after another pulse. The usual circuit is shown in Fig. 10 and the inductances are arranged for a definite amount of positive mutual inductance between them. The number of

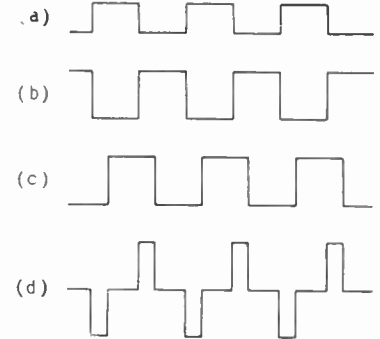

Fig. 11. With current pulses (a), the primary voltage on the anode is (b). The delayed wave is (c), and the two add to produce (d) as the final anode voltage.

sections is equal to the number of inductances and approximately equal to 1.28 times the total delay required divided by the time of rise of the pulse wavefront. Thus if the time of rise is 0.1 μsec and a delay of 10 μsec is needed, the delay line would have 128 sections.

If a current pulse is applied to the input of a delay line from a source matched to it and the remote end of the line is short-circuited the pulse travels down the line and is reflected with reversed polarity at the short-circuit. It travels back to the input but as the matching here is correct no further reflection takes place. The effect is shown in Fig. 11 where (a) represents the current pulse supplied by the valve and (b) the voltage at the output produced directly from this. The reflected delayed pulse sets up a voltage (c) and the two combine to give the wave (d).
W. T. C.

I.E.E. Convention Papers

1. Benjamin, R. "Blocking Oscillators."
2. Moody, N. F. "Low-Power Pulse Transformers."
3. White, E. L. C. "The Use of Delay Networks in Pulse Formation."
4. Williams, F. C. "Introduction to Circuit Techniques for Radiolocation."

WORLD OF WIRELESS

TELEVISION REOPENING

At a luncheon given by the Radio Industry Council to 400 radio dealers on April 8th, Sir Noel Ashbridge, Deputy Director-General of the B.B.C., announced the date for the reopening of the television service from Alexandra Palace.

The first programme will be transmitted at 3 p.m. on Friday, June 7th. The normal programme hours will be 3-4.30 p.m. and 8.30-10 p.m., and there will also be a dealers' test transmission from 11 to 12 a.m.

Outside broadcasts will, if necessary, take place at other than scheduled transmission times.

U.S. AMATEUR FREQUENCIES

TWO new bands have recently been allocated to American amateurs—1215-1295 and 420-430 Mc/s. The latter is a third of the promised allocation in this band, the remaining 20 Mc/s above 430 being temporarily retained for navigational aids until such time as it has been internationally agreed in what part of the spectrum they will be accommodated. Because this band is shared with navigational aids amateurs are limited to a power of 50 watts in the aerial.

Readers may like to have the following list of American amateur bands. The types of transmission permitted, indicated beside each band, are: A1, C.W.; A2, M.C.W.; A3, A.M. phone; A4, facsimile; and A5, television. Both phone and Morse are permitted when employing frequency modulation.

- 28.00-29.7 A1.
- 28.10-29.5 A3.
- 28.95-29.7 F.M.
- 56.00-60.0 A1, A2, A3, A4.
- 58.50-60.0 F.M.
- 144.00-148.0 A1, A2, A3, A4, F.M.

- 420-430
 - 1215-1295
 - 2800-2450
 - 5250-5650
 - 10000-10500
 - 21000-22000
- } A1, A2, A3, A4, A5, F.M.

RADIO CONTROL

A FREQUENCY has now been allocated by the G.P.O. for the radio remote control of models. It is 460.5 Mc/s. Five watts is the maximum permissible power and the regulation stipulates that there must be no radiation outside the limits of 460-461 Mc/s.

Notification of the intention to use radio control should be given to Radio Branch W2/6, Engineering Dept., G.P.O., London, E.C.1, quoting Ref. 16311/46.

CANADIAN AMATEURS

CHANGES in the amateur call areas in Western Canada to provide three additional districts were introduced on April 1st.

The new call areas are:—

- VE1 Maritime Provinces.
- VE2 Province of Quebec.
- VE3 " " Ontario.
- VE4 " " Manitoba.
- VE5 " " Saskatchewan.
- VE6 " " Alberta.
- VE7 " " British Columbia.
- VE8 A-L Yukon Territories.
- VE8 M-Z North-west Territories.

PERSONALITIES

T. L. Eckersley, senior Research Engineer of Marconi's, has been awarded a Fellowship of the American Institute of Radio Engineers "For his outstanding contributions to the theory and practice of radio-wave-propagation research." The citation adds that both his approach to the problem from the standpoint of practical communications and his invention of mathematical tools useful in the computation of radiated fields are "achievements of lasting value acclaimed by the whole radio world, and form a monument of which he may be justly proud." Some of the earliest work on the problems of propagation was carried out by an expedition, headed by Eckersley, sent out by Marconi's to Australia in 1922

H. L. Kirke, head of the Research Department of the B.B.C., has been awarded a Fellowship of the I.R.E. "For his services to broadcasting in the British Isles and in particular for his leadership in the research activities of the B.B.C."

R. V. L. Hartley, whose name is a household word in the world of wireless, has been awarded the 1946 Medal of Honour by the I.R.E. for his early work on oscillating circuits and his exposition of the fundamental principles giving the information-carrying capacity of a communication channel.

Alfred Clark, one of the founders of the group of companies controlled by Electric and Musical Industries, has retired from the Chairmanship of the Board. He commenced his career in the organization set up by Edison in America to start the talking machine industry 56 years ago, and for the past 46 years has held a responsible position in the Gramophone Company. He will continue as a Director and be President of E.M.I.

Sir Alexander Aikman, the Deputy Chairman of E.M.I., succeeds Mr. Clark as Chairman of the Board.

H. W. Bowen, O.B.E., has been appointed Managing Director of the new company, E.M.I. Factories, Ltd., which is taking over the operation of the E.M.I. manufacturing plant throughout the world, covering E.M.I., "His Master's Voice," Columbia, Marconiphone, Parlophone and H.M.V. Household Appliances. He joined the Gramophone Company as Production Manager in 1940.

F. B. Duncan, of Marconiphone, has resigned from the chairmanship of the Radio Industry Council which he has held since its inauguration in July, 1943. He was previously Chairman of the Radio Manufacturers' Association.

L. J. Davies, head of the B.T.H. Research Laboratory, has been elected a Director of the Company. He joined the Research Laboratory on its formation in 1924.

R. C. G. Williams, Ph.D., is leaving Murphy Radio, where he is General Manager of the Electronics Division, to go to the U.S.A. to obtain experience of technical and industrial aspects of radio and electrical engineering in that country.

K. S. Davies will succeed Dr. Williams as General Manager of Murphy's Electronics Division. He was responsible for the Company's television developments before the war.

N. H. Blundell, who was on the editorial staff of *The Trader* for eight years prior to the war, joined the Secretariat of the Radio Industry Council on his release last year from Royal Signals, in which he held the rank of Major. He is now taking up free-lance journalism and publicity, specialising in radio. His address is 45, Chancellor Grove, London, S.E.21.

OBITUARY

It is with regret we record the death on March 20th of R. Milward Ellis, who had been a Director of Pye, Ltd., since its incorporation in 1929.

IN BRIEF

Amateur Transmitters.—It is learned on enquiry from the G.P.O. that 2,114 amateur transmitting licences had been re-issued at the beginning of April.

Amateurs' Examination.—Although it was originally planned that the Radio Amateurs' Examination for a transmitting licence would be held annually, it is announced by the G.P.O. that it is possible that a further examination may be held before the end of this year.

U.S. Amateurs in Germany.—American amateurs in the Army of Occupation in Germany, like their British counterparts, are to be allowed to operate transmitters with 25 watts in the aerial. They will be allocated D4 calls and will be permitted to operate in the 21-21.5, 29-30 and 58.5-60 Mc/s bands.

Raw Materials.—The transfer of the Raw Materials Department from the Ministry of Supply to the Board of Trade took effect from April 1st. The address of the Department is now I.C. House, Millbank, London, S.W.1 (Tel.: Franklin 2211). Certain materials, hitherto dealt with by the Raw Materials Department, will, however, remain with the Ministry of Supply. Among them are: quartz crystals, tungsten, molybdenum, tin, nickel, cobalt

World of Wireless—

and copper. Details are given in the Orders "The Ministry of Supply and Board of Trade (Various Controls—Nos. 1 and 2)."

Civil Aviation.—A meeting of the Radio and Technical Division of P.I.C.A.O. (Provisional International Civil Aviation Organization) will be held in Montreal on July 1st. It will be preceded by a demonstration of technical equipment in the U.K. about May 20th and a demonstration of American equipment in the U.S. early in June.

Car Radio.—The question of issuing car radio licences at a reduced rate for holders of domestic receiving licences was raised in the House, and in reply the Assistant Postmaster-General stated: "It is not considered that such a concession would be warranted."

Sponsored programmes were reintroduced in the transmissions from Radio Eireann, Athlone, at the beginning of April. Ireland's 100-kW transmitter radiates on 565 kc/s.

"The Trader."—Our associated journal, *The Wireless & Electrical Trader*, published its thousandth number on April 6th. Since its appearance in March, 1923, *The Trader* has consistently put the interests and welfare of the wireless industry above all other considerations and its analyses of receiver circuits are of untold value to the serviceman.

Photo-telegrams.—Reduced rates for photo-telegrams transmitted between London and New York are announced by Cable and Wireless. The new rates will be £5 for pictures measuring up to 150 sq cm (approximately 6in x 4in), plus £2 10s for every additional 100 sq cm. The old minimum rate was £10.

Miniature Superhet.—A four-valve superhet in a moulded case 8½in x 3½in x 3½in has been designed by Vidor, Ltd., West Street, Erith, Kent, and will be on the market shortly; the price will be in the region of £12. It operates from 1½-volt L.T. and layer-built 120-volt H.T. and grid-bias batteries. The case is provided with a leather carrying strap and the action of opening the lid switches on the set.

Disposal.—According to details recently issued by the Board of Trade 365,000 surplus valves had been disposed of by the Government up to January 31st, the receipts for which totalled £40,000. In addition, £30,000 worth of other radio equipment had been sold.

The Midland Office of our Publishers, the Associated Iliffe Press, has moved to King Edward House, New Street, Birmingham, 2. Telephone: Midland 7101; telegrams: Autopress, Birmingham.

Decca in Scandinavia.—A company is to be formed in Stockholm to market the Decca Navigator in Scandinavia, with the exception of Norway.

British Rola ask us to advise readers that loudspeakers returned for service should be sent to the company's Service Department at Pans Lane, Devizes, and not to their Sales Office at Georgian House, Bury Street, London, S.W.1.

Baird.—With the formation of a new company—John Logie Baird and Co.—with offices and a laboratory at 4, Upper Grosvenor Street, London, W.1, J. L. Baird's laboratory at Sydenham, where he has worked throughout the war, has been closed. Details of the proposed activities of the company have not yet been disclosed. The chief engineer is E. G. O. Anderson.

New Company.—As a result of negotiations between Cossor and the Sylvania Electric Products, Inc., of America, a new company has been formed to manufacture valves in this country. It is to be known as Electronic Tubes, Ltd., and will take over a Government factory at High Wycombe, Bucks, which is at present occupied by Cossors.

Pye, Ltd., have extended their activities to the scientific instrument field by the acquisition of W. G. Pye and Co., Granta Works, Cambridge, which was established in 1896.

McMichael.—The sales and order department of McMichael Radio is now at 190, Strand, London, W.C.2. The service department is remaining at Slough, Bucks.

Henley's have opened a new store at 14, Kirby Lane, Canterbury.

Marconi Instruments have established a sales and service branch at 10, Portview Road, Avonmouth, Bristol. Tel.: Avonmouth 438.

Change of Address.—Wharfedale Wireless Works are moving to Blakehill Works, Bradford Road, Idle, Bradford.

CLUBS

Blackpool.—Regular meetings of the Blackpool and Fylde Amateur Radio Society have been resumed on the first and third Thursdays of each month. The Hon. Sec. is H. D. Ashworth (G4PY), 5, Albion Avenue, Blackpool.

Coventry.—Fortnightly meetings are now held by the Coventry Amateur Radio Society in "John Hough's Mission," New Buildings, Coventry, on Mondays at 7.30. The Hon. Sec. is C. G. Taylor (G2ZT), 19, Anthony Way, Stoke, Coventry. At the next meeting, on April 29th, the Secretary will speak on "Testing Methods for the Radio Amateur."

R.A.F.A.R.S.—A General Meeting was recently held at No. 1 Radio School, Cranwell, to mark the resumption of normal activities of the R.A.F. Amateur Radio Society, founded in 1938 primarily to meet the needs of radio amateurs serving in the Royal Air Force. Associate Membership is, however, open to ex-R.A.F., Dominion or Colonial Air Force personnel. The Society's H.Q. station is expected to be operating under its old call-sign, G8FC, shortly. All particulars are obtainable from the Hon. Sec., R.A.F.A.R.S., No. 1 Radio School, R.A.F., Cranwell, Lincolnshire.

Romford.—A meeting has been arranged by the Romford and District Amateur Radio Society at the Greyhound Hotel, High Road, Chadwell Heath, for April 28th, at 2.30, to organize R.S.G.B. activities in South-west Essex.

Southend.—With a present membership of 70, meetings of the Southend and District Radio and Scientific Society are held fortnightly at the Art School, Victoria Circus, Southend. A "Field Day" has been arranged for May 5th. J. M. S. Watson (GoCT), 23, Eastwood Boulevard, Westcliff-on-Sea, is Secretary.

South Shields.—The first meeting of the South Shields Short-wave Radio Club was held on April 4th, when J. J. Monaghan (G5SB) was elected Secretary. Weekly meetings are held on Thursdays, at 7.30, at St. Paul's Hall, Westoe Lane, South Shields. The Secretary's address is 60, Lemon Street, Tyne Dock, South Shields.

Stourbridge.—Amateurs in the Stourbridge, Dudley and Kidderminster areas are invited to the meetings of the Stourbridge and District Radio Society which are held at eight on the second Tuesday of each month in the Lecture Room, King Edward's Grammar School, Stourbridge. W. Rock (G8PR), "Sandhurst," Vicarage Road, Amblecote, Stourbridge, is Secretary/Treasurer.

Watford.—The Watford and District Radio and Television Society has recommenced its activities and meets at 7.30 on the first Tuesday of each month at the Carlton Tea Rooms, 77a, Queens Road, Watford. Hon. Sec., J. C. Warren, 29, Market Street, Watford, Herts.

MEETINGS

Institution of Electrical Engineers

Radio Section.—"Radar Navigation," introduced by Dr. R. A. Smith, followed by four papers—"Gee," by R. J. Dippy; "Obboe," by F. E. Jones; "H2S," by C. J. Carter; "Radar Beacons," by K. A. Wood, on May 1st.

Discussion on "New Insulating and Dielectric Materials in Radio Engineering," to be opened by Dr. Swallow and G. P. Britton on May 21st.

The above meetings commence at 5.30 and will be held at the I.E.E., Savoy Place, London, W.C.2.

Cambridge Radio Group.—"The Suppression of Impulsive Interference in Amplitude Modulation Receivers," by D. Weighton, M.A., at 6 at the Technical College, Collier Road, Cambridge, on April 29th.

"Plastics for the Engineer," by I. W. A. Kirkwood and Dr. P. D. Ritchie, at 6 on May 17th at the University Engineering Laboratory, Trumpington Street, Cambridge.

Students' Section.—Annual General Meeting at 7 on May 22nd at the I.E.E., Savoy Place, London, W.C.2.

Institution of Electronics

North-West Section.—"Electronic Semi-conductors," by Dr. R. W. Sillars, at 7 on May 17th at the University, Manchester. Joint meeting with Institute of Physics. Tickets can be obtained from Dr. F. A. Vick, The University, Manchester, or L. F. Perry, 105, Birch Avenue, Chadderton, Lancs.

British Institution of Radio Engineers

London Section.—"Sound Reproduction," by S. W. Amos, at 6.15 on May 20th at the Institution of Structural Engineers, 11, Upper Belgrave Street, London, S.W.1.

RADIO TIMES

Here is told for the first time the story of a British radio achievement... the story of the growth of radio during the years of war. The story begins in 1939 when the BBC had nineteen transmitters to serve listeners in Commonwealth and Empire, and in Europe. It describes the merging of the National and Regional systems into a single country-wide Home Service to deny the enemy the use of BBC radio stations as beacons for raiding air-ports, to counter the enemy's jamming, the Voice became stronger and stronger until after five years the most powerful station—800 kilowatts on long or medium wavelengths—at Ottringham, near Hull



Students at the B.B.C.'s Engineering Training School. During the war 2,500 were trained for operational duties.



The aerial installation at Ottringham, the world's most powerful broadcasting station.

The story of BBC Transmitters in the War told by L. HAYES, O.B.E., M.I.E.E., Head of the BBC Overseas Engineering Information Department

'Never Off the Air'

In the House of Commons the other day, in answer to a question, the Minister of Information said that the BBC's capital expenditure on equipment during the period from September 1, 1945, to August 31, 1946, was about £3,550,000. In addition, Lend-Lease equipment valued at £350,000 was brought into service by the BBC. Some of the money was spent—a story that is a tribute to those engineers of several departments of the BBC who designed, built, installed, and operated the system adopted was to increase the length so that the system could be separated into sections.

Standard Radio TRANSMITTING VALVES

THE 50 kW water-cooled triodes Type 4030-C seen in the picture above are part of the "Standard" range of valves to be found in radio transmitters of all ratings and grades: doing their jobs steadily—reliably—year in, year out—giving their best whatever the conditions.

Standard Telephones and Cables Limited

Telecommunication Engineers

CONNAUGHT HOUSE, 63, ALDWYCH, LONDON, W.C.2

Telephone: Holborn 8765



CONVERSATION PIECE
ON TYPE 5080 . . .

CHIEF DESIGNER. What in hades has gone wrong with that new control gear job ?

PRODUCTION FOREMAN. Well if you smart design johnnies would only give us a reliable Transformer in the job then nothing need have gone wrong. As it is the ????? is going wrong, the ?????????? is all haywire, the ????? simply does not exist. What can you expect ?

C. D. Well you're so smart in picking our work to pieces, suggest something to put it right.

P. F. Don't tell me you've not heard of those Parmeko people at Leicester. Why bother me with Transformer problems, get in touch with them! Let them carry the can . . after all, if it's Transformers it is their can!

PARMEKO of LEICESTER.
Makers of Transformers.



for
**RELIABLE
PERFORMANCE**
specify



CAPACITORS

WEGO CONDENSER COMPANY LIMITED
BIDEFORD AVE · PERIVALE · GREENFORD · MIDDX TEL: PERIVALE 4277

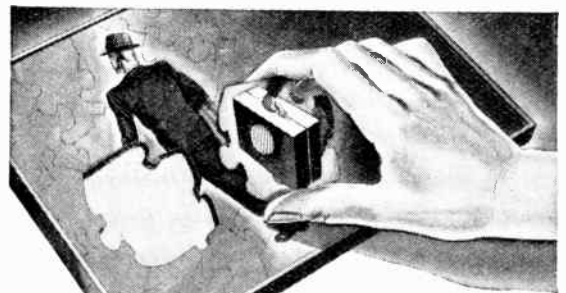
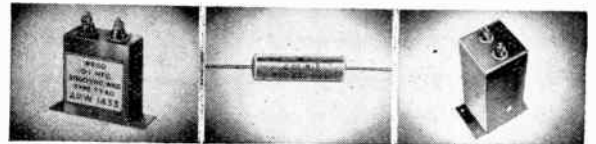

When you want **REAL**
PORTABILITY in Amplifiers

R.S.
PUT ~~IT~~ THERE !

There is no puzzle about choosing the right portable P.A. Equipment, for the R.S. Universal Fifteen adequately completes the picture of **REAL PORTABILITY** Delivery of this tried and tested equipment is now considerably improved, so write NOW for full information.

The R.S. Universal Fifteen is entirely self-contained and is carried "suitcase" fashion. It operates on both A.C. and D.C. mains at all voltages from 200-250.



AMPLIFIERS

R.S. Amplifiers Ltd., 2-4 Highfield Rd., Shepperton, Middx.
Tel: Walton-on-Thames 1019

Design Data (4)

WIDE-BAND AMPLIFIERS

III.—Double-Circuit Couplings

INTERVALVE couplings of the so-called band-pass type, comprising two resonant circuits coupled by a mutual reactance, are quite frequently used in wide-band amplifiers. The performance depends largely upon the method of damping and the degree of coupling adopted. The highest gain is usually secured by damping one only of the two circuits and adopting a degree of coupling rather above the critical value.

This leads to an arrangement which requires high precision of initial adjustment and the maintenance of a high degree of stability of circuit constants. The latter is not always easy to achieve, for the input capacitance of a valve depends on its electrode potentials, and when its grid bias is varied for gain control the capacitance is liable to change appreciably.

Because of effects of this nature it is often wise to adopt a system which is less critical in its operating conditions, even if this means somewhat lower amplification per stage. Such an arrangement is a pair of equally damped circuits with critical coupling between them. The design formulae become much more complex than with the single-circuit intervalve couplings hitherto considered. Exact formulae, in fact, become rather too complex to be convenient for computation.

The difficulty has been met by a semi-graphical solution and the relation between nCR and the attenuation at the edges of the pass-band is presented only as a graph. The error involved in this is only of the order of 3 per cent and this is negligible in determining component values. Stray couplings alone in the complete amplifier will cause a much larger error than this.

A word about CR is perhaps necessary, for the actual circuit elements are $C_1 R_1$ and $C_2 R_2$; C and R are a fictitious capacitance and resistance which are equal to C_1 and R_1 and C_2 and R_2 only when $C_1 = C_2$ and $R_1 = R_2$. At all times $C = \sqrt{C_1 C_2}$ and $R = \sqrt{R_1 R_2}$.

In considering the single-circuit couplings values of $n = 5$ Mc/s, $f_m = 13$ Mc/s, $g_m = 8$ mA/V, and $C = 30$ pF were taken. It was found that for two stages with a drop of 3 db at the edges of the pass-band, stagger-tuned circuits gave an amplification of 69.2 times.

With coupled circuits, if the total capacitance is still taken as 30 pF and as being divided equally between primary and secondary, $C = C_1 = C_2 = 15$ pF, and $R = R_1 = R_2$. For a drop of 1.5 db per stage the curve shows $nCR = 183$, so that $R = 183/15 \times 5 = 2.44$ k Ω and from (2) $A = 9.75$ per stage, or 95 times for two stages.

This seems a considerable improvement over stagger tuning, but unfortunately it is not realizable

in practice. The capacitances are not divided equally between the two circuits, and the self-capacitance of the additional coil increases the total. Table I gives an estimate of the actual capacitances, which probably errs on the optimistic side. Taking $C_1 = 13$ pF and $C_2 = 24$ pF, equations (1) give $R_1 = 2.81$ k Ω and $R_2 = 1.52$ k Ω so that from (2) $A = 8.26$ and the gain of two stages is 68 times. This is negligibly different from the case of stagger tuning.

Equation (3) gives $f_r = 12.75$ Mc/s, and (4) gives $L_1 = 11.5$ μ H, and $L_2 = 5.75$ μ H. From (5) the coupling coefficient $k = 0.321$ and then (6) gives $M = 0.321 \sqrt{5.75 \times 11.5} = 2.61$ μ H.

TABLE I

Primary Circuit		Secondary Circuit	
Capacitance of	(pF)	Capacitance of	(pF)
1st valve, output	4.75	2nd valve, input	15.5
coil, L_1	5	coil, L_2	5
wiring to earth	3	wiring to earth	3
Total = 12.75		Total = 23.5	

It was said above that the estimate of capacitances in Table I erred on the optimistic side. This is largely because no provision has been made for tuning adjustments. In the case of single circuits such adjustments are easily provided either by using an iron-dust core or a metal-slug arranged to be movable with respect to the winding. The dust-core or slug can be mounted at the earthy end of the coil and it need not, therefore, increase the self-capacitance to any large extent.

With coupled circuits this is not the case, for the two coils have to be coupled together. Coupling difficulties arise unless the coils are mounted with their earthy ends adjacent and if they are, the cores or slugs cannot be in the earthy ends without the adjustment of one greatly affecting that of the other. If the cores or slugs are placed at the high potential ends the self-capacitances are increased considerably.

The alternative is to use capacitance trimmers, but this again increases the total capacitance, since it is necessary to allow an increase of at least 5 pF per circuit to give room for adjustment. This is of the same order as the increase likely if cores or slugs at the high-potential ends of the inductances are used.

Unless, therefore, one abandons adjustable circuits and carries out the initial adjustment by altering the number and position of the turns on the coils—an inconvenient procedure—it is necessary to add at least a further 5 pF to each capacitance. This makes $C_1 = 18$ pF and $C_2 = 29$ pF. Then $R_1 = 2.03$ k Ω and $R_2 = 1.26$ k Ω , so that the amplifica-

Wide-band Amplifiers—

tion falls to 6.4 per stage, or 41 times for two stages. This is considerably inferior to stagger tuning.

The curve can also be used to estimate the response outside the pass-band. Thus, if it is desired to know the response 3.5 Mc/s away from mid-band we find it for nCR corresponding to 7 Mc/s. In the example given earlier, nCR is 183 for $n = 5$ Mc/s, so it is clearly 256 for 7 Mc/s, and the response is - 4 db per coupling.

This is only an estimation. The actual figures will be different on the two sides of the pass-band. High accuracy is rather unnecessary, however, for the figure is needed only for calculating the attenuation of interfering signals. An accurate formula is quite easy to derive, but rather laborious to evaluate.

In general, stagger tuning is to be preferred to coupled circuits in a wide-band amplifier. Because there are twice as many circuits per stage, however, the latter can give higher selectivity outside the pass-band, and in some cases this may make it preferable in spite of the reduced amplification.

Then in cases where stagger tuning is adopted, it is sometimes desirable to employ a coupled pair in one stage. Stagger-tuning demands an even number of couplings. When the necessary gain can be obtained with an odd number, one coupling must be either a single circuit tuned to the middle of the band or a coupled pair and the latter gives the higher gain of the two.

In spite of the fact that stagger-tuned single circuits are the best of the three couplings for amplification and coincidence-tuned are the worst, it will be clear that all three have their uses.

Design Data (4) : Wide-Band Amplifiers III

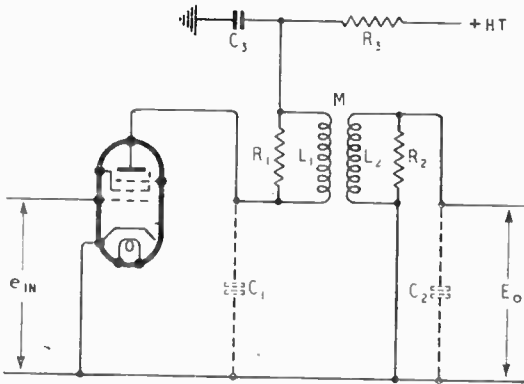

- Let f_m = required mid-band frequency
- n = required band-width
- $f_1 = f_m - n/2$ = lower limit of pass-band
- $f_2 = f_m + n/2$ = upper limit of pass-band
- $f_r = f_m \sqrt{(1 - n^2/4f_m^2)} = \sqrt{f_1 f_2} = 159 \sqrt{LC}$
= resonance frequency of each tuned circuit alone
- g_m = mutual conductance of valve.

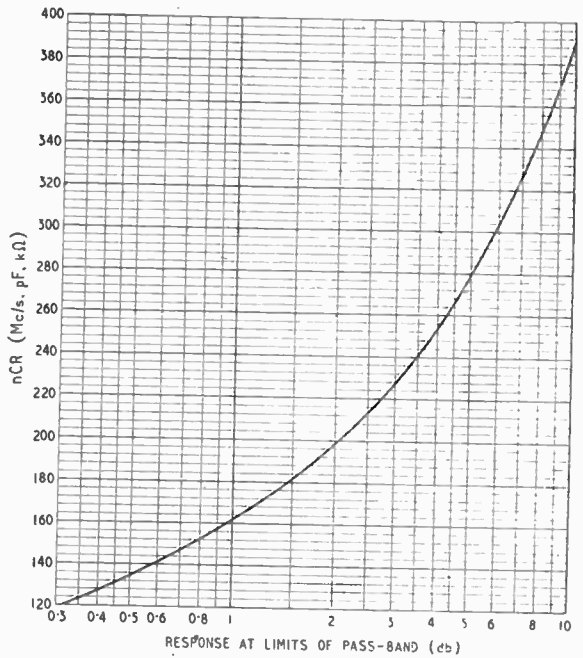

Units

Frequency (Mc/s) ; mutual conductance (mA/V); inductance (μ H) ; capacitance (pF) ; resistance ($k\Omega$).

Procedure

Determine (nCR) from the curve for the required drop at the edges of the pass-band f_1 and f_2 .

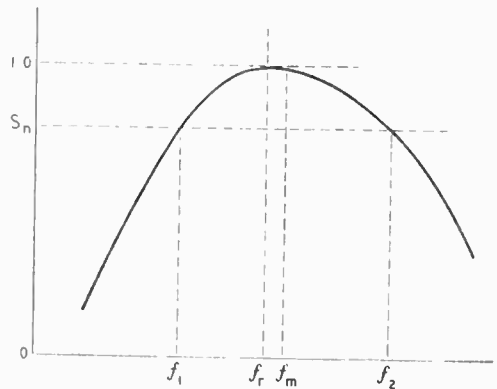

$$R_1 = (nCR)/nC_1 ; R_2 = (nCR)/nC_2 \quad \dots (1)$$

$$A = E_0/e_{in} = \frac{g_m \sqrt{(R_1 R_2)}}{2} \quad \dots (2)$$

$$f_r = f_m \sqrt{(1 - n^2/4f_m^2)} \quad \dots (3)$$

$$L_1 = \frac{24,400}{f_r^2 C_1} ; L_2 = \frac{24,400}{f_r^2 C_2} \quad \dots (4)$$

$$\text{Coupling coefficient } k = 1/\sqrt{(1 + 3.94 \times 10^{-5} (f_r CR)^2)} \quad \dots (5)$$

$$\text{Mutual inductance } M = k\sqrt{(L_1 L_2)} \quad \dots (6)$$

A SIGNAL EVENT
in the History of Sound...

..the new **WODEN 50 watt**

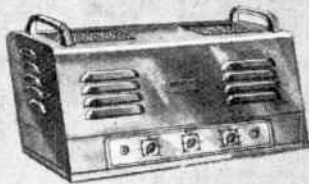

**'CLASSIC'
AMPLIFIER**

Without peer in the world of standard amplifying equipment, this new Woden model, when used with the correct speakers, is capable of filling the largest halls and delivering perfect speech to the widest audiences. **BRIEF SPECIFICATION:** MAINS SUPPLY: 200-250 volts A.C. 50 cps. VALVES: Seven. INPUTS: Microphone and Gram. Output: 50 watts undistorted. Tapped at 0, 8, 15 and 200 ohms. RESPONSE: 50-10,000 cycles ± 2 db. CONTROLS: Microphone and Gram feeders and tone control. SIZE AND WEIGHT: 19" x 11 $\frac{1}{2}$ " x 11"; 56 lbs. approx. FINISH:

Light grey glossy stove enamel and chromium.

RETAIL PRICE: £45-0-0.

..and here's the new **15 watt**



**'JUNIOR'
AMPLIFIER**

Ideal for small and medium sized buildings and for normal outdoor use, this new Woden model employs five valves, has built-in transformer to suit all M.C. Microphones. Gramophone input. Undistorted output is 15 watts. Transformer tapped at 0, 8 and 15 ohms. Flat from 50-10,000 cycles ± 1 db. Controls consist of Mic. and Gram feeders and tone control. Overall size is 13 $\frac{1}{2}$ " x 10 $\frac{1}{2}$ " x 10 $\frac{1}{2}$ ". Weight about 29 lbs. Finish: Light grey glossy stove enamel and chromium. Retail price £24-10-0

WODEN Amplifiers
BUILT FOR THE DISCERNING FEW
MOXLEY ROAD · BILSTON · STAFFS · TEL: BILSTON 41939

**THE
ALL METAL
WAY**

This handbook on A.C. mains radio has been **out of print** for the greater part of the war years. A new abridged edition is being prepared, however, but will not be ready for some months yet. In the meantime, we can offer the following literature:—

- Data Sheet 24-H.T. rectifiers
- Data Sheet 30-L.T. rectifiers
- Data Sheet 31-Instrument rectifiers
- Data Sheet 47-Westectors



METAL RECTIFIERS

WESTINGHOUSE BRAKE & SIGNAL CO. LTD.

Pew Hill House : Chippenham : Wilts

Yours Faithfully

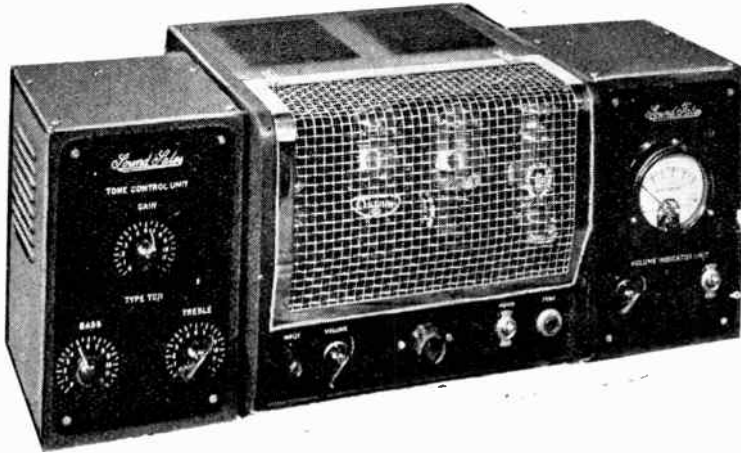

INTRODUCING A SERIES OF QUALITY AMPLIFIERS WITH INTERCHANGEABLE INPUT CIRCUITS TO SUIT EVERY PURPOSE.

THE 12/14 WATT MODEL WITH TONE CONTROL INPUT AND V.U. OUTPUT METER.

Sound Sales Ltd.

WEST STREET, FARNHAM, SURREY

FARNHAM 6461/2/3

WHY YOU PREFER ACOUSTICAL—One of a series

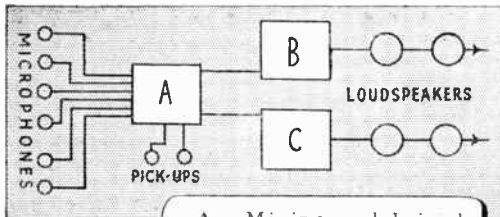

A Mixing and Initial Amplifier Stages.
 B & C Power Stages, including Master Volume Controls, Independent Treble and Bass Controls.

Coupling FOR POWER

The advanced design and unit construction of the "U" series Amplifier enables two of them to be coupled to provide 60-70 watts output. It then becomes possible to mix eight inputs in any proportions. The output is divided into two channels, each independently controlled for volume and frequency balance. Just one more reason why you prefer Acoustical.



CASE by IMHOF'S

ESTABLISHED 1845

THE HALLMARK OF A GOOD INSTRUMENT

If you are inclined to the view that your instruments deserve a case that is better built and of more attractive and functional design, or you build equipment that needs precision sheet metal work, you will be interested to have this catalogue. A penny stamp and the request on your business letterhead will bring it you.

ALFRED IMHOF LTD. 112-116 NEW OXFORD STREET, LONDON, W.C.1. MUSEUM S944

GERMAN ELECTRONIC EQUIPMENT

Highlights of the Recent Earl's Court Exhibition

AN exhibition of German apparatus organized by the Ministry of Supply and Aircraft Production, was held in London from 4th-16th March. It was designed primarily to show the state of development of German radio and electronic equipment for the benefit of industry and scientists generally, and it comprised communications and radar apparatus of the Army, Navy and Air Force. A certain amount of other electronic apparatus—such as proximity fuses, television equipment and infra-red apparatus—was also shown.

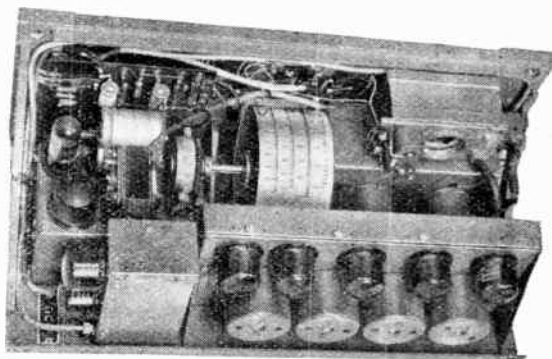

Rhode and Schwarz communication receiver covering 90-470 Mc/s in four bands.

The main impression left by an inspection of the apparatus is that of beautiful mechanical design and workmanship, especially in the case of the older equipment, but little of special merit in the electrical design. The use of light-alloy castings is widespread, and it is common practice to construct a set as a series of sub-assemblies, each sub-assembly having a die-cast frame to provide screening, with plugs for the inter-connections. The main frame of the set is again a casting, containing little more than the sockets for the sub-assemblies and their wiring.

This form of construction is almost universal in apparatus of pre-war design, but was probably found unsuitable under the stress of war conditions. Widespread use of castings virtually prohibits changes, with the result that the design must reach finality before even the initial stages of production can be started. It is probable that this use of castings would add at least a year to the time needed to carry a new set to the production stage, and it is noable that in the later designs castings are less widely used.

The Germans planned for a two-year war and virtually closed down on radio research at the start of the war. Only about 1941 did they start again, and this lapse proved fatal to technical development, which was also hindered by being spread in small units over a large geographical area. The interruption of communications by Allied bombing made

close liaison between these units impracticable, and as a result there was much duplication of effort. In addition, there was a lack of young scientific workers.

A complete description of the apparatus is obviously impossible, and in this review attention will be concentrated on the highlights. It is necessary to guard against receiving a false impression here. Because attention is thus focused on the outstandingly good points, one may be tempted to conclude that German design was superior to our own. This is very far from being the case, for a detailed inspection of the apparatus gives the impression that on the whole it was definitely inferior.

The most striking feature of German receivers for communications work is the common use of rotary coil turrets in place of the usual switching. In the usual construction a central shaft carries a number of radial fins and the coil assemblies drop into the V-shaped segments so formed. Each coil assembly comprises a dust-core coil and ceramic trimmer for each R.F. circuit, together with the individual coil screens and contact strips.

There are usually three sets of coils per band—for aerial circuit, R.F. coupling and oscillator—and either four or five bands. The turret is usually mounted with its shaft parallel to the panel and operated through bevel bearing. A "click" mechanism is provided to ensure that the turret comes to rest always in precisely the same position, and the contacts are frequently gold-plated.

It is interesting to note here a departure from normal practice. Rubbing contacts—which are usually considered desirable—are carefully avoided. A

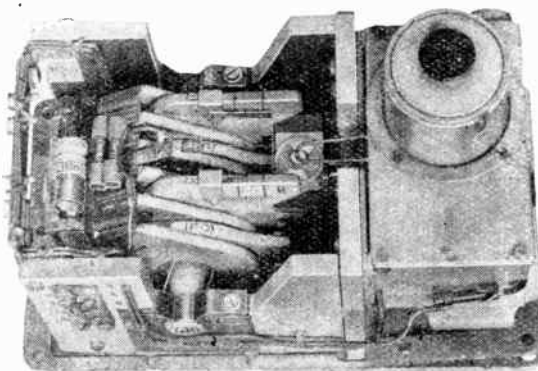

Plated-ceramic local oscillator (145 Mc/s) used in Mannheim radar equipment.

special lifting mechanism is provided to separate the contact strips while the turret is rotating and only drop them into contact as it comes to rest. The reason for this is apparently to prevent wear on the plating, which is unusually thin.

Variable capacitance tuning is adopted and, par-

German Electronic Equipment—

ticularly in V.H.F. sets, it is the rotor sections which are insulated. The stator is a casting with a machined finish on the plates. The rotor is a ceramic rod carrying thick alloy plates; these often have a circumferential cut so that a single thick vane is virtually two thin ones. In this way the virtual thickness of the vane is adjustable by bending so that the matching of the sections can be accomplished.

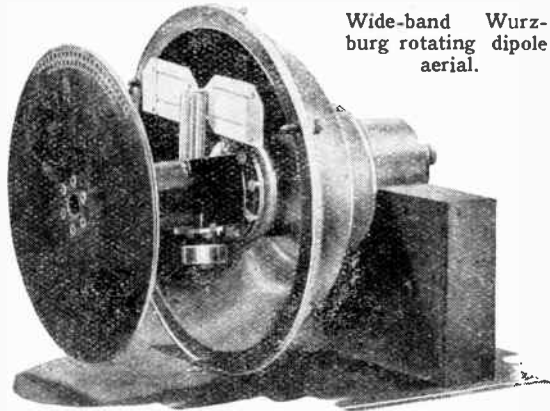

Wide-band Wurzburg rotating dipole aerial.

Nearly all tuning devices embody high-quality gearing. Considerable use is made of the conventional type of split spring-loaded gear to reduce backlash. In at least one case, however, a worm drive is used, meshing with a fibre pinion. Instead of splitting the pinion the worm wheel is cut through at the bottom of the "thread," so that it forms a helical spring. Assembled under tension, this is very effective in reducing backlash.

The calibrated tuning scales tend to be very large, but in one case optical magnification is used. The scale itself is printed photographically on a glass disc carried by the capacitor shaft. A pilot lamp, lens and mirror throw a magnified image on a screen and an effective scale length of $7\frac{1}{2}$ ft is obtained. This method is adopted in the Telefunken E3815 receiver, which covers 15 kc/s to 20 Mc/s in ten bands. It is an all-wave set for ship use.

These interesting points of design are found chiefly in interception and naval receivers. The Army sender-receivers of more mobile character are more ordinary, and many of them seem clumsy to British eyes. Man-pack sets, in particular, are much larger and heavier than their British counterparts. An exception is the U.H.F. transceiver, which is a one-man pack set covering 32-38 Mc/s and with a range of 1.5-3 miles on telephony. This is as small and light as a British set of similar range, but the receiver is only a two-valve reflex type, so that the selectivity would be very poor in comparison.

Centimetre-wave apparatus seems well behind British, and there is a marked preference for resonant lines instead of resonant cavities. One receiver, covering 8-12 cm, has a simple two-anode magnetron for the oscillator. The glass envelope of the magnetron is about the size of a neon tuning indicator, and the anodes are longitudinal strips on each side, capacitively coupled to the resonant line by extend-

ing this on either side of the bulb. An H.T. control is ganged with the line-length control for tuning. A dust-iron "core" fits partially around the magnetron to suppress unwanted modes of oscillation.

Relatively little use was made of centimetre waves for communication purposes. One equipment working on the fairly long wavelength of 50-60 cm has only two channels—one for telephony and one for supersonic two-tone telegraphy. Frequency modulation is used. Separate aerial arrays are employed for the sender and receiver, and each consists of a bank of five full-wave dipoles with a reflector.

More use was made of centimetre waves in radar, and here much was copied from captured Allied equipment. Prior to the capture of a British H2S, German radar was on frequencies below 600 Mc/s (50 cm), and was very vulnerable to jamming. Although there are ingenious points of detail, the equipment as a whole is not very interesting.

The infra-red apparatus is perhaps the highlight of the exhibition. Although it was not of great value operationally, it might well have become so if the war had lasted longer. The apparatus is small and yet gives a picture of good detail in complete darkness. "Illumination" is provided by a car headlamp, or in some cases by a searchlight, fitted with a screen cutting off all visible light but permitting the passage of infra-red of wavelengths of 1.5 microns.

The receiver comprises an optical system and an image converter. This last follows television practice in essentials. The infra-red image is focused on a photo-electric mosaic at one end of the tube and an electron image is formed. This is focused electrostatically and accelerated to produce a visible image on a fluorescent screen at the other end of the tube.

Examples were shown fitted to a vehicle for driving in complete darkness, and also to a machine gun. The chief practical snag appears to lie in the high voltage needed by the tube—17,000 volts. The diffi-

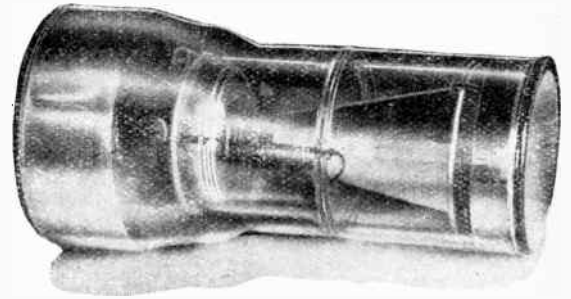

Image converter used in infra-red equipment.

culty of maintaining adequate insulation in the field can be imagined.

Exceedingly compact television equipment for use in gliders was shown, the idea being to direct a glider-bomb on to its target by remote control. The equipment functions on 78 Mc/s and the picture is of 220 lines, 25 frames without interlacing. Magnetic deflection and focusing are used. The line scan circuit is of the self-oscillatory type, with a damping diode, and the high peak voltage developed on the fly-back is used for the H.T. supply for the cathode ray tube.

SHORT-WAVE CONDITIONS

Expectations for May

By T. W. BENNINGTON

(Engineering Division, B.B.C.)

SHORT-WAVE conditions during the undisturbed days of March were such that the average maximum usable frequencies for this latitude were considerably higher than during February, both for noon and midnight. During the daytime, in fact, *exceptionally* high frequencies—well over 30 Mc/s—might have been regularly used, this being due, no doubt, to the high sunspot activity which prevailed.

A considerable amount of ionosphere storminess occurred, however, and conditions were disturbed on at least nine days during the month. The ionosphere storms occurred on the 4th, 10th-11th, 13th, and—an exceptionally protracted one—24th-29th.

Forecast.—During May, apart from times of ionosphere storminess, the working frequencies for long distance transmission should be about the same as for April during the daytime, but during the night considerably higher frequencies than for April should become usable. In fact frequencies as high as 15 Mc/s may remain *regularly* usable up to midnight over many circuits. For distances up to about 2,000 miles daytime transmission during May will be controlled largely by the E or F₁ layers, and so, for these distances, daytime as well as night-time working frequencies should be higher than at present.

Now a word about the Sporadic E. This is the name given to the "clouds" of intense ionisation which frequently appear within the E layer but whose presence there is not predictable. However, the frequency of occurrence of Sporadic E usually increases sharply in May, and it is likely to be present in these latitudes for from 20 to 25 per cent of the total time. Radio propagation by way of these intensely ionised clouds is possible on frequencies far above those which would be propagated by the normal E layer, at least out to distances which can

be covered in one hop—about 1,400 miles. Multi-hop transmission by Sporadic E, though possible, is rather unlikely, for the phenomenon is not very widespread, and the possibility of the "clouds" being present at the ionosphere locations necessary for multi-hop transmission is not great. Sporadic E transmission up to 1,400 miles—this includes nearly all of Europe—may thus frequently occur during May, and at this distance on frequencies up to 30 Mc/s commonly, up to 50 Mc/s frequently, and up to 100 Mc/s occasionally.

Below are given, in terms of the broadcast bands, the working frequencies which should be *regularly* usable during May, for four long-distance circuits running in different directions from this country. In addition a figure in brackets is also given; this indicates the highest frequency likely to be usable for about 25 per cent of the time during the month, for communication by way of the *regular* layers.

Montreal: 0000, 15 or 11 Mc/s (20 Mc/s); 0100, 11 Mc/s (17 Mc/s); 0400, 9 Mc/s (15 Mc/s); 0800, 11 Mc/s (18 Mc/s); 1000, 15 Mc/s (22 Mc/s); 1400, 17 or 15 Mc/s (24 Mc/s); 2200, 15 Mc/s (22 Mc/s).

Buenos Aires: 0000, 11 or 9 Mc/s (16 Mc/s); 0600, 9 Mc/s (15 Mc/s); 1000, 17 or 15 Mc/s (25 Mc/s); 1400, 21 or 17 Mc/s (28 Mc/s); 2100, 17 or 15 Mc/s (24 Mc/s); 2300, 11 Mc/s (19 Mc/s).

Cape Town: 0000, 11 Mc/s (17 Mc/s); 0600, 17 Mc/s (26 Mc/s); 0900, 21 Mc/s (30 Mc/s); 1400, 26 Mc/s (35 Mc/s); 1800, 21 Mc/s (30 Mc/s); 2000, 17 Mc/s (24 Mc/s); 2100, 15 Mc/s (21 Mc/s); 2300, 11 Mc/s (19 Mc/s).

Chungking: 0000, 11 Mc/s (17 Mc/s); 0500, 15 Mc/s (22 Mc/s); 0800, 17 Mc/s (24 Mc/s); 1600, 15 Mc/s (22 Mc/s); 2000, 11 Mc/s (18 Mc/s).

During May short-wave conditions are less likely to be disturbed than during months nearer the equinoxes. Although one cannot be at all certain, it would appear that, if disturbances do occur, they are more likely to happen within the periods 1st-4th, 10th-14th and 28th-31st than during the other parts of the month.

M. WILSON LTD

OUR UNIT SYSTEM OF RADIO

See last month's issue for particulars

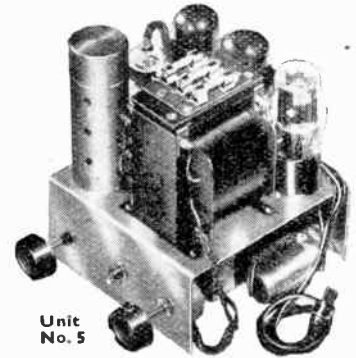

Unit No. 5

English craftsmanship combined with quality components go into the individualist design and building of these units.

These are not mass produced but each unit is individually built and tested by a staff of highly paid men. Every component is new and made by firms of the highest repute. We use no surplus components however efficient they may be.

By this means do we ensure that the Performance, Reliability and Quality of Reproduction leave little to be desired in these days of continuous progress in the science of electronics.

Delivery date and prices on application

When in London call and listen to these units.

A combination of Yorkshire and London courtesy awaits you.

NEW VERSIONS OF CIRCUITS Nos. 5 & 6

We have replaced our earlier 4-valve circuits with greatly improved versions using International Octal Valves.

No. 5 A.C. 5-valve Superheterodyne
No. 6 A.C./D.C. 5-valve Superheterodyne

Three wavebands: 16-50, 200-550, 800-2,000 m.

To OVERSEAS TRADERS

Wholesale and Retail enquiries are invited.
Orders can be executed for B.A.O.R., C.M.F., M.E.F. and S.E.A.O. customers.

307, HIGH HOLBORN.
LONDON W.C.1. Phone: HOLborn 4631

MINE DETECTORS

Principles With Many Peacetime Applications

MOST early mine detectors included two oscillators and depended on the change of frequency of one when the search coil inductance was altered by the presence of a mine or other metallic object. The resulting change of beat note warned the operator of the presence of the mine.

A more recent device, the Army "Detectors, Mine, No. 4," to be described here, is normally in a non-oscillating condition and commences to oscillate at an audible frequency when a metal object comes within the field of the search coils. In essence it consists merely of two coils, critically placed to have zero mutual inductance, one being connected to the input and the other to the output of an amplifier.

amplifier goes into oscillation at an audio frequency.

Although this is the basic principle there are many refinements in the practical form of the apparatus. The complete circuit diagram is shown in Fig. 1 and the gear comprises three main units:—the search coils, the amplifier and control box. This last is shown surrounded by dotted lines, with connections brought out, for clarity, at points where they naturally fall on the diagram. In practice, they are made through a multi-way cable.

The amplifier itself is a straightforward three-stage resistance-coupled affair with an input transformer having a balanced primary. One search coil is connected to this primary and the other is in the anode circuit of the out-

Any desired portion of the output on the anode can be tapped off by P_1 and fed back through a capacitance or a resistance to one side or the other of the grid coil. The four switches S_1 , S_2 , S_3 and S_4 are ganged and there are two working positions, the third being "off." The switch S_5 is normally closed and need not concern us for the moment.

The two coils are mounted in a slightly overlapping position in the search shoe and in such a position that the mutual inductance is zero. In addition, an iron dust-core, mounted off-centre in a rotatable moulding, is placed at the overlap and by its adjustment the optimum balance can be secured.

In the middle position of the switch, C_2 is placed across the grid

Fig. 1. The circuit diagram of an Army mine detector is shown here. It can distinguish between ferrous and non-ferrous metals.

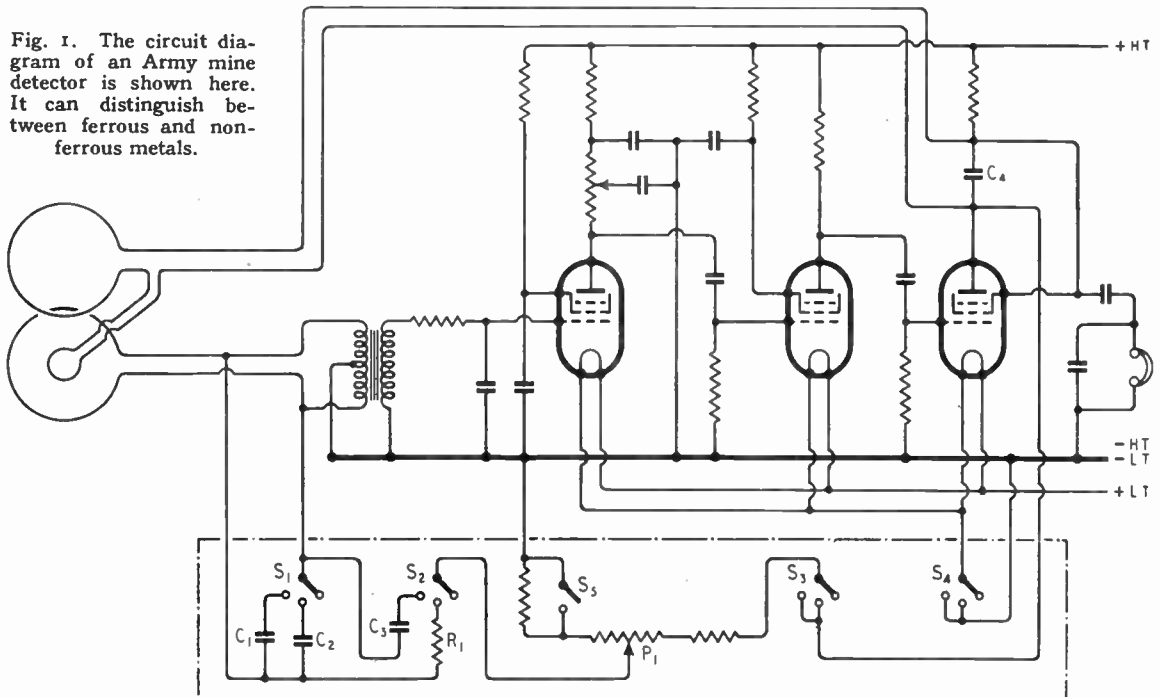

The gain of the amplifier is adjusted so that it is just not oscillating. Any metal object near the coils serves to couple them in some degree and so increases the feedback and the

put valve. The connections here may seem a little peculiar, for the valve is arranged to function as a pentode as far as the coil is concerned, but as a triode looked at from the phones.

coil and the feedback from P_1 is applied to one side of the input through R_1 . The anode coil is tuned by C_4 . Both input and output coils are tuned to the same frequency and at this frequency

they have substantially zero phase-shift. The amplifier phase angle at this frequency is also very small and the feedback circuit P_1 , R_1 is resistive and causes no phase-shift.

Now it is a fundamental property of any amplifier that it oscillates at the frequency for which the loop gain is unity and the phase-shift zero. Any ampli-

stantially resistive it will not itself cause a phase-shift. When the coupling is sufficient for the loop gain, which includes the transfer efficiency of this coupling, to reach unity the amplifier oscillates, and thereby reveals the fact that the coils are coupled and therefore that there is a metallic object within their field to give the coupling.



The individual units of the mine detector are shown above. The search shoe A, telescopic handle B, amplifier C and control box D are carried, together with the phones, in the canvas case.

fier in the oscillating condition always adjusts itself to these conditions. It meets the phase requirement by a suitable shift of frequency and the gain requirement by the amplitude. If the loop-gain when quiescent exceeds unity, the amplitude of oscillation builds - up until grid - current damping or some similar effect brings it down to this value.

If the amplifier phase-shift is zero, and the input and output tuned circuits are tuned to the same frequency, the phase-shift from coil to coil is zero at a frequency for which the gain is a maximum and, measured from coil to coil, the amplification very greatly exceeds unity. If a metallic object is placed within the field of the coils, it serves to couple them together, and if the impedance of this object is sub-

stantially reactive it will still provide coupling between the coils but it will also cause a phase-shift in the coupling. Because of this phase-shift, oscillation will not commence at the same degree of coupling as before, since at the frequency for which the loop-gain is unity the phase-shift is not zero, and where the phase-shift is zero the loop gain is less than unity on account of the selectivity characteristics of the tuned coils.

When the coupling is increased, therefore, oscillation commences at a frequency different from before, but again one at which the essential conditions of zero phase-shift and unity loop gain are obtained. Because more coupling is needed, the sensitivity of the

(Continued on the next page.)

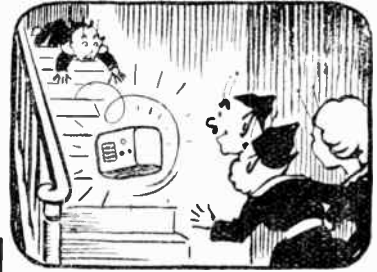

THE "FLUXITE QUINS" AT WORK

"He's dropped it! Well, what d'ye know, just look at our new radio!"
 "Don't worry, old chap, it won't hurt a scrap.
 Wiring's soldered with FLUXITE" grinned OH.

See that FLUXITE is always by you — in the house — garage — workshop — wherever speedy soldering is needed. Used for over 30 years in Government works and by leading engineers and manufacturers. Of all Iron-mongers—in tins, 8d., 1/4 & 2/8.

Ask to see the FLUXITE POCKET BLOW LAMP, price 2/6.

TO CYCLISTS! Your wheels will NOT keep round and true unless the spokes are tied with fine wire at the crossings AND SOLDERED. This makes a much stronger wheel. It's simple—with FLUXITE—but IMPORTANT.

The FLUXITE GUN puts FLUXITE where you want it by a simple pressure. Price 1/6, or filled, 2/6.



ALL MECHANICS WILL HAVE

FLUXITE

IT SIMPLIFIES ALL SOLDERING

Write for Book on the ART OF "SOFT" SOLDERING and for Leaflets on CASE-HARDENING STEEL and TEMPERING TOOLS with FLUXITE. Price 1d. each

FLUXITE LTD.

(Dept. W.W.), Bermondsey Street, S.E.1

Mine Detectors—

equipment as a detector of metallic objects is reduced.

The maximum phase-shift introduced by the coupling is $\pm 90^\circ$, and the sensitivity is a minimum at these extremes, and a maximum mid-way between them with a phase-shift of zero.

When the coupling is of a reactive nature the sensitivity can be restored by introducing an opposite phase-shift in the amplifier. This is done in the third position of the switch. The input coil is then tuned by C_1 instead of C_2 and the feedback is arranged through C_3 to the opposite side of the input.

The sensitivity is then a maximum for a phase-shift in the coupling of 90° one way and a

P_1 is adjusted so that the amplifier is just not oscillating. The area concerned is then swept with the search coil. When a note in the phones indicates the presence of an object, the sensitivity can be reduced by P_1 , if necessary, to narrow down the area.

The sensitivity is very high and the apparatus will detect an ordinary pin at a distance of about 100 ft. when it is at the centre of the search coil. The switch S_3 is provided to enable the operator to check that the equipment is operating. The apparatus is normally silent and if a lengthy search is made without detecting anything, the operator naturally begins to wonder if the equipment is in order—particularly when he knows that if it is not his next

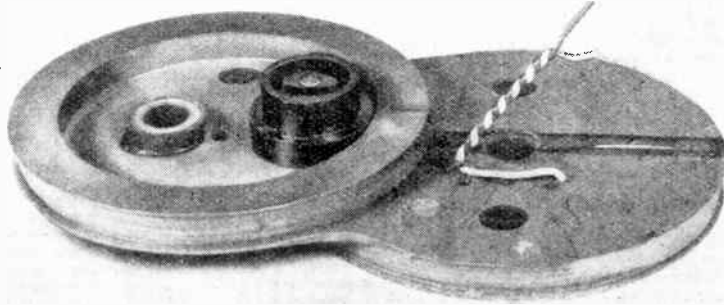

This photograph shows the coils contained in the search shoe. The adjustable iron "core" can be seen towards the edge of the upper coil.

minimum for one of 90° the other way, while a resistive coupling gives an intermediate sensitivity. This is because the input circuit is now tuned so that without the coupling the phase-shift around the circuit is 90° .

These effects enable a discrimination to be made between metallic objects introducing different phase-shifts in the coupling. Non-ferrous metals such as brass, aluminium, copper, etc., behave in a substantially resistive manner at the audio frequency employed, but ferrous metals have a very appreciable reactive element. As a result the mine detector enables one to distinguish between ferrous and non-ferrous metals and to detect the one in the presence of the other.

In operation the switch is placed in the required position for ferrous or non-ferrous objects and

step may set off a mine! He can then at any time press S_3 and satisfy himself. This increases the feedback slightly and so makes the amplifier oscillate.

The principles of this mine detector are by no means confined to war, but should find many peacetime applications. The detection of metal fragments in wood is an obvious benefit in the saw-mill, particularly just after a war when many trees from battle areas may contain shell splinters. The ability to distinguish between ferrous and non-ferrous metals is also a great help, particularly in finding buried objects in cities.

Surprising as it may seem gas and water mains are sometimes "lost," and their exact location is one obvious use for the detector.

The apparatus has been developed and, to a large extent, produced by Cinema Television.

BOOK REVIEW

The Electron Microscope. By D. Gabor, Dr.-Ing., F.Inst.P. Pp. 104. Hulton Press, 43-44, Shoe Lane, London, E.C.4. Price 4s 6d.

THE author says in the Foreword that "This monograph is an amplified version of a lecture delivered on the 4th of March, 1943. . . . In its present form it intends to be both an introduction to the electron microscope and a critical contribution to its theory." The book is dated June, 1945, and is divided into fourteen chapters and an appendix.

The first three chapters contain an exposition of the principles of electron optics, making use of the Hamiltonian analogy and with special reference to lens aberrations likely to affect the resolving power. The next two chapters describe the electron optics of practical emission and transmission microscopes. Chapters six to eight deal with the origin of contrast in transmission microscope images, and the limits of resolution and detection obtainable at present. The next three chapters describe commercial American instruments and a few of their achievements, and also (very briefly) the R.C.A. metallurgical scanning microscope. Most of the remainder of the book (about one-third) is taken up with a discussion of future possibilities—mainly concerned with the improvement of the present limit of resolution which stands at about 25 A.U.

Although the first part of the book forms an interesting and useful introduction to the electron optics of the microscope, the less specialized reader will perhaps be a little disappointed that so little space has been devoted to specimen mounting and sampling techniques, and that almost all reference to ancillary circuit design and high-vacuum technique has been omitted.

Readers will be interested in the author's summary of his own and others' works in electron optics, and here the emphasis of the discussion is laid on the possibilities of improvement of the resolving power; lens distortions (pincushion, etc.) are not specifically treated.

This book will be of interest principally to physicists, and those engineers with a background of electronics, who now want an introduction to electron optics with special reference to the problems and limitations of the electron microscope. Further reading is simplified by a very good bibliography of 89 references, dealing with theory, design and performance.

J. McG. S.

A NEW MURPHY SET

Unconventional Chassis Design in the U102

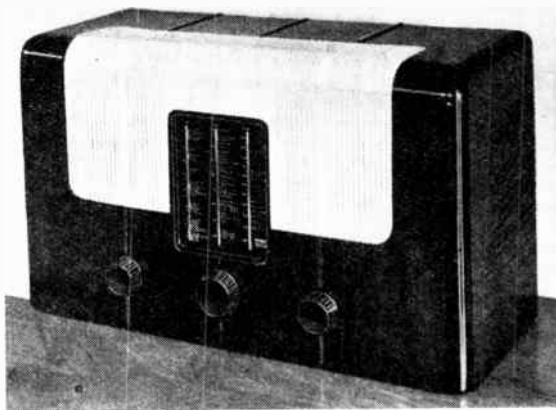

IN the new Murphy U102 receiver the chassis takes the form of a vertical panel instead of the conventional horizontal channel or box chassis. Not only does this enable the tuning dial and drive to be rigidly fixed without the use of brackets, but it gives better access to components both for assembly and servicing. The back of the panel is protected by two steel

The four-valve superheterodyne circuit makes use of AC/DC valves, and there are three waveranges, 17-51, 200-550 and 1,000-2,000 metres. The tuning condenser drive has a fixed high reduction suitable for the short-wave band, and a fly-wheel enables the control to be spun rapidly from one part of the scale to another.

Illumination of the tuning dial is by a single pilot lamp which carries both the heater and the H.T. current. No thermal delay switch is necessary, and as the valves warm up, the initial excess heater current is replaced by the H.T. current; adequate lighting is provided without danger of overloading the lamp.

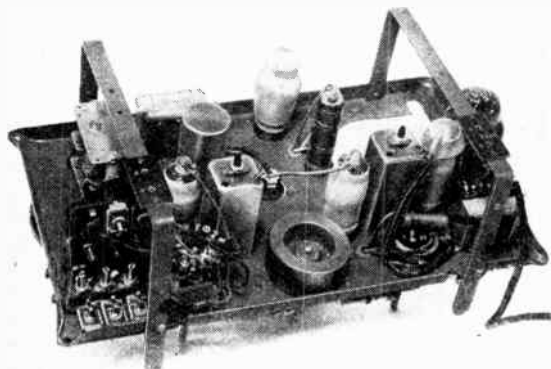

Most of the circuit trimmers are grouped in the bottom left-hand corner of the chassis (above). The scale of the U102 is detachable and the cord drive is easily replaced.

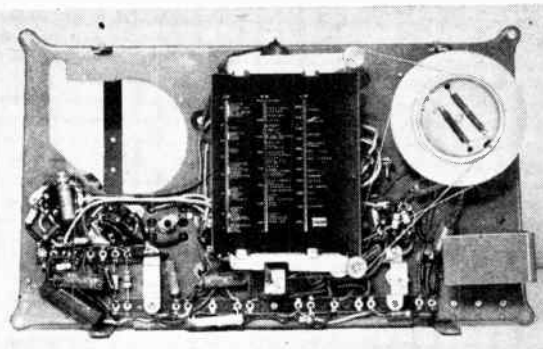

straps, and it can be laid on the bench in any position without the possibility of damage to components; four screws at the corners fix the chassis to the moulded cabinet.

The price of the set, which is made by Murphy Radio, Welwyn Garden City, is £15, plus £3 6s. 8d. purchase tax. A wood cabinet is being supplied for early deliveries.

VORTEXION "SUPER FIFTY WATT" AMPLIFIER



30 cps. to 15,000 cps. within $\frac{1}{4}$ db. under 2% distortion at 40 watts and 1% at 15 watts, including noise and distortion of pre-amplifier and microphone transformer. Electronic mixing for microphone and gramophone of either high or low impedance, with top and bass controls. Output for 15-240 ohms, with generous voice coil feedback to minimise speaker distortion. New style easy access steel case gives recessed controls, making transport safe and easy. Exceedingly well ventilated for long life. Amplifier complete in steel case, as illustrated, with built-in 15 ohms mu-metal shielded microphone transformer, tropical finish. Price 29½ gns.

C.P. 20A 15 Watt AMPLIFIER for 12-volt battery and a.c. mains operation. This improved version of the old C.P.20 has switch change-over from a.c. to d.c. and "stand-by" positions, and only consumes 5½ amperes from 12-volt battery. Fitted mu-metal shielded microphone transformer for 15-ohm microphone, and provision for crystal and moving iron pick-up with tone control for bass and top and outputs for 7.5 and 15 ohms. Complete in steel case, with valves. £22.10.0.

We have pleasure in announcing the opening of our **CONTINENTAL SALES DIVISION** with headquarters established in Bruxelles. All enquiries from our Belgian, Swiss, Dutch and French customers should in future be sent to the address below, and they will receive the same prompt and courteous attention as was given in pre-war days by Head Office.

Continental Division Director:—Mr. **CONSTANT BISMAN**.
Continental Export Manager:—Mr. **R. BRYAN-CARNEY**.

VORTEXION LTD., of LONDON,
Rue des Palais 189, BRUXELLES.
Tel.: BRUXELLES 16.10.31.

Dealers and Export Agents should write for special terms to:—

VORTEXION LTD.
257-261, THE BROADWAY,
WIMBLEDON, LONDON, S.W.19

Telephones: LIBerty 2814 and 6128.
Telegrams: "VORTEXION, WIMBL., LONDON."

Letters to the Editor

F.M. Crystal Experiments • Phase and Waveform • Wartime Condensers • B.B.C. Quality

Crystal-Controlled Frequency Modulation

THE simplicity of the method of frequency modulation, as proposed in your December, 1945, issue by S. K. Lewer, is very attractive indeed.

Attacking with high voltage the quartz plate itself is the most direct approach to the problem, and the cleanest, too. It seems, however, to be very inefficient, in view of the too little frequency variation, produced by thousands of volts' modulation voltage.

Many years ago I have had to vary crystal-produced frequencies by very simple means, and have recorded the following figures: The variation of 60 cycles on 6.8 Mc/s as mentioned by the author, can be obtained without any difficulty by using a variable capacity of 5-10 pF across the plate circuit of the oscillator (in my case this capacity was formed by the membrane of an earphone against a solid plate). This variation has been measured in a very stable and linear portion of the oscillator frequency curve. Outside the limits of good stability the variations may be much higher. Furthermore, the cut of the crystal is not essential, and low drift quartzes may be used.

For obtaining a higher degree of modulation many other elements of the entity—crystal, valve and adjoining circuits—may be varied. The highest influence on frequency should be obtained by using a varying capacity in series with the crystal resonator itself, but not involving the somewhat high static capacity of the plate and the holder. This latter way presents some physical difficulties in separating the crystal and its static capacity but, I suppose, there should be some not very complicated solution in using bridge circuits to neutralize this capacity.

A medium approach, in varying the crystal gap, is well known. I have measured in this case a

variation of 400 cycles on 1.5 Mc/s for every 0.1 mm gap extension.

If the air of the gap be evacuated in order to suppress resonance phenomena of the air layer, the variation could be extended over $\pm 1,000$ cycles on this frequency, or about 3,000 cycles on 5 Mc/s. A certain non-linearity of frequency deviation in so wide limits is naturally inevitable, but should be easily corrected with any needed precision by forming the moving condenser surfaces in appropriately curved form.

A. TRESKINSKY.

Chief Engineer, Radio-Tehran.

Phase Relationships

THE question of phase discussed by C. E. Cooper in your April issue interests me, because at one time I shared his belief that it is wrong to say a resistance-coupled amplifier introduces 180° phase change between grid and anode. I even went so

published in your April, 1945, issue, that this demonstration is fallacious.

One fallacy is to assume that a phase difference is necessarily a time difference. When a three-phase alternator is started up, all three phases, electrically spaced 120° start and continue simultaneously. The same fallacy leads one into a dreadful hole when one has to explain how, in a capacitive circuit, the current (without the gift of prophecy) leads the voltage that causes it!

Another fallacy is corrected by the B.S.I. definition of phase difference (B.S.205:1943, No. 1512) which is: "The difference of phase (usually expressed as a time or as an angle) between two periodic quantities which vary sinusoidally and have the same frequency." (My italics). Fig. 1, on the other hand, depends on the use of a non-sinusoidal waveform. If a mere arbitrary definition is objected to, a physical basis is indicated by C. E. Cooper himself, who agrees that in a valve

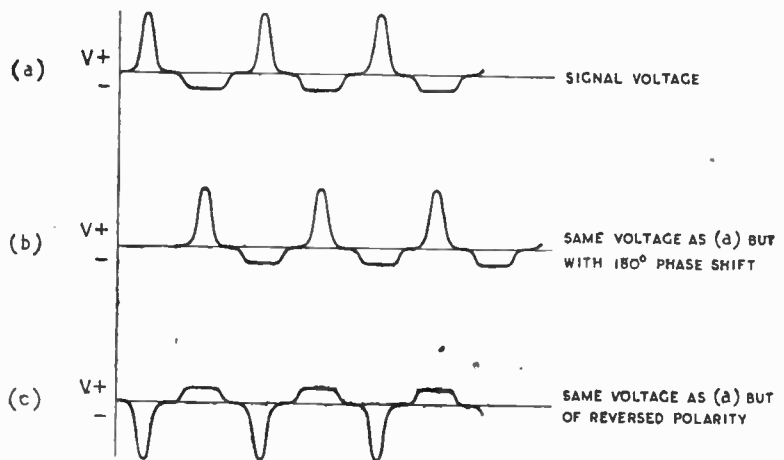

Fig. 1.

far as to demonstrate the supposed error to students in exactly the same way as C. E. Cooper's Fig. 1 (repeated here). However, "Cathode Ray" succeeded in convincing me, by the arguments

with a very high internal resistance there is a genuine phase shift of nearly 90° in the output voltage when a small inductive load is substituted for a resistive one. If this process were applied twice to

Fig. 1(a) the result would be much more like (c) than (b), as can be seen in Fig. 2, where C. E. Cooper's peaky waveform is assumed to consist of fundamen-

fundamental only were changed by 180° , the waveform of the resultant voltage would, in general be different from that of the applied voltage.

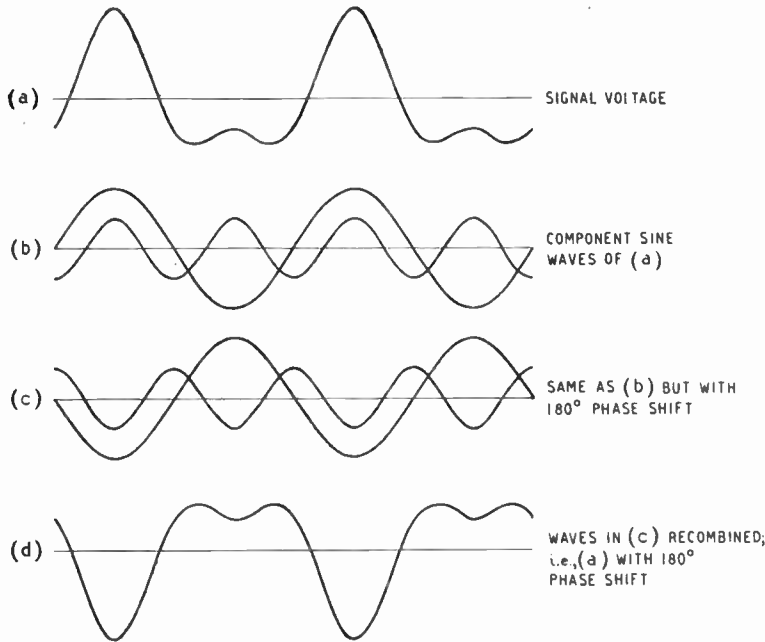

Fig. 2.

tal and 2nd harmonic. A physical device (such as the two inductive systems in cascade) for bringing about a 180° phase shift would not in fact yield zero output during the first half cycle of input, as in Fig. 1(b); the output would start at once, and after a number of cycles would settle down to the condition shown at (c).

One other point: C. E. Cooper's statement that the phase difference between I_a sig. and V_g sig. cannot exceed 45° requires some explanation, as I for one find it rather mystifying.

M. G. SCROGGIE.

Bromley, Kent.

WITH reference to C. E. Cooper's article on "Phase Relationships," the only way in which I can interpret " 180° phase change" is that every Fourier component of the resultant voltage is shifted by 180° with respect to the applied voltage. In this circumstance, this is exactly equivalent to a reversal of polarity.

However, if the phase of the

That which C. E. Cooper refers to as 180° phase change is a delay time of one, or another odd number, of half periods of the fundamental.

J. H. BARRETT.

London, S.W.4.

Surplus Condensers

"BARGAINS" in the form of surplus radio components are being offered to the radio trade and public. Condensers made by T.C.C. are included, and it is concerning these that we want to issue a word of warning.

Such articles were generally made for special war purposes and many of them will have been in store for long periods and under adverse conditions. They have not been retested by us and we accept no responsibility for their performance nor—of course—for any damage their failure may cause.

We know their origin from their markings, but apart from the question of disclaiming liability, we are anxious that the reputation we have built up over a period of

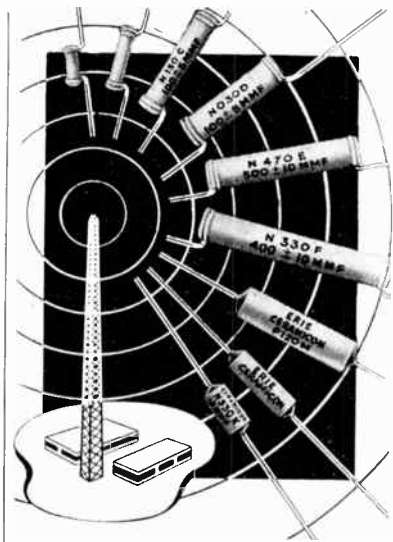

ERIE *Ceramicon*

**MAINTAIN SUPREMACY
IN THE FIELD OF COMMUNICATIONS
FOR TEMPERATURE COMPENSATING
& GENERAL PURPOSE CONDENSERS**

STYLE	CAPACITY RANGE		
	P080 P100 P120	N750	Hi-K
	MMF	MMF	MMF
A and K	1-9	1-51	56-560
B and L	10-18	52-110	560-1,500
C and M	19-63	111-360	1,500-4,700
D	64-93	361-510	4,700-6,800
E	94-150	511-820	6,800-12,000
F	151-200	821-1,100	12,000-15,000
G	—	—	15,000-22,000
H	—	—	22,000-33,000

Tolerance on Temperature Co-efficient is—30 parts/million/°C or $\pm 15\%$, whichever is the greater.

Note: Styles A, B, C, D, E, F, G and H are non-insulated units. Styles K, L, and M are insulated.

**MAY WE SEND YOU SAMPLES
FOR TEST OR FOR PROTOTYPES?**

ERIE RESISTOR LIMITED
 CARLISLE RD · THE HYDE · HENDON
 LONDON · N.W.9
 TELEPHONE: COLINDALE 8011
 FACTORIES: LONDON · ENGLAND
 TORONTO · CANADA · ERIE, PA. · U.S.A

Letters to the Editor—

40 years shall not be damaged in the eyes of your readers by our products being used for purposes for which they were never intended and in an unfit state for use as a result of long and bad storage conditions.

W. F. TAYLOR,
The Telegraph Condenser Co.,
London, W.3. Ltd.

Too Many Recordings ?

YOUR correspondent, R. W. Lowden, in his anxiety to defend the quality of B.B.C. recordings falls into the error of supposing that critics of these recordings cannot distinguish between them and "live" broadcasts. I hasten to assure him that with high quality receiving

equipment recordings are easily identifiable and in my view fall short (in some cases deplorably so) of the quality one may reasonably demand from the B.B.C.

Many of us armchair critics have gone to considerable trouble and expense to ensure the best possible quality of reproduction. It is, therefore, a little galling to be fobbed off with so many transmissions of second-rate quality merely because the B.B.C. is reluctant to give up the recording habit acquired during the war.

Recorded "repeats" and "special" recordings have a place in broadcasting, but it should be a very small place. They cannot be a satisfactory substitute for the direct broadcast.

E. T. KNAPP.

Hounslow.

pulses from the locating station trigger off in the target apparatus which transmits the pulses that form the return signal. That seems to me to be eminently sound.

Precision Radar

W. A. S. Butement, who gave the lecture on precision radar, was the pioneer of the "split" system, on which most if not all precision radar apparatus is based. ["Split" is described elsewhere in this issue.—Ed.] With some equipments—(L2, for example—you could check your operators when a practice target was flying by watching it through a gratulated telescope, whose movements in elevation and in azimuth were followed by them as they turned their hand wheels. The telescope was, of course, accurately lined up so that its optical axis coincided with the radio axis of the set.

Interesting Results

Many interesting results emerged from these tests if they were properly and systematically carried out. Operators, for example, might be found in an early stage of their training to have a tendency to lag or lead on the target: they would be behind or below it if the angles of bearing or of elevation were increasing rapidly; ahead or above it if there was a rapid decrease. The telescope, again, showed up that worst of all faults in a radar operator: "bracketing." Offenders in this last way made first one break and then the other the bigger, and never kept them equal except for brief periods. The result was a jerky stream of data instead of the smooth stream required. A few operators proved to be incapable of matching breaks and had to be put to jobs where this was not necessary; but most people who were reasonably handy and intelligent could be trained to match breaks accurately. Some very ingenious training devices were produced and many of them were of great use, particularly at times when the weather was too bad for actual aircraft to provide practice targets.

□ □ □

So They Do It Too !

INTERESTING to read in the article on American broadcasting in last month's *W.W.* that listeners over there make much the same use of the tone-control knob as those in this country. One gathers that, as in Britain, the normal position of this knob in the broadcast receiving set is as far anti-clockwise as it will

RANDOM RADIATIONS

By "DIALLIST"

A Big Success

FROM its very first moments there could have been no doubt that the I.E.E. Radiolocation Conference was going to be a real success. The whole thing was thoroughly well planned and organized. After a reception in the Library by the President the Conference was opened by the Minister of Supply and the first paper, introducing the whole enormous subject, was read by Sir Robert Watson-Watt, the pioneer of practical radiolocation. His paper gave a good survey of the development of the art from the "prehistoric" days of 1936 when a small nucleus of picked men assembled at Bawdsey, to the spacious times of 1945, when radiolocation workers ran into tens of thousands. In the days that followed the opening meeting each department of the subject was thoroughly dealt with, the method chosen being admirable. In each case the proceedings were opened by a survey paper, read by a leading man in that particular branch; then followed shorter contributions, covering subsidiary issues in detail, and a general discussion to clear up any point on which further explanations were wanted. The quality of the papers was high, but I do wish that some of their authors had realized that there is far more in a paper than the writing of it and

the preparation of the slides and demonstration apparatus. No matter how good the subject matter may be it cannot be put across worthily by a monotonous and sometimes rather stumbling, line-by-line reading. The most successful papers were—and always will be—those whose authors have memorized what they are going to say and need to make no more than occasional brief references to their manuscripts.

Radiolocation Defined

With, I suspect, his tongue in his cheek, Sir Robert Watson-Watt said that the definition of radiolocation was more difficult than the thing itself. He then treated us to a definition that must have run to the equivalent of the best part of a page of *Wireless World*. But I am not referring to that in this paragraph. Up to now many people, myself included, have regarded as true radar only that in which pulses sent out by an equipment return to that equipment as echoes from the target. Methods such as Rebecca-Eureka, Gee and Oboe, didn't fall into that category and, therefore, could not be regarded as genuine radar. Watson-Watt's solution is to call "Primary Radar" systems of location by radio in which the target does not co-operate, and "Secondary Radar" those in which

go. I wish that someone would investigate this problem scientifically and give us the real reason why the average listener likes his loudspeaker to deliver music with no top. Why should people "like it better that way?" Why should they be so fond of woomphiness when they are listening to music from the wireless set or merely using it as a background to conversation? The same is not true when they listen direct to an orchestra (I don't mean a dance band) playing in a hotel. There, whether they talk or not, they demonstrate their affection for "top" by the hearty applause with which they greet a violinist's gymnastics on the E string or a soprano's final high note. Would they not be more than resentful were violinists forbidden to indulge in harmonic displays and sopranos forced to sing through blankets? Or, if you provided an "average listener" with a pair of ear muffers which made Albert Sandler heard direct sound just like Albert Sandler as habitually heard on the said listener's own wireless set, would he not tear the things off, vowing that they ruined the music? There must be a mysterious something in wireless reproduction which makes listeners dislike top only when it comes from the loudspeaker. Possibly it is due, in part at any rate, to the fact that the output of a loudspeaker is markedly directional on the higher frequencies.

CATALOGUES RECEIVED

LIST No. 3K.C. describing rotary converters and other power plant for radio and public address work, from Electro Dynamic Construction Co., St. Mary Cray, Kent.

New catalogue of loudspeakers, transformers and volume controls from Wharfedale Wireless, Blakehill Works, Bradford Road, Idle, Bradford.

Illustrated catalogue of amplifier and instrument case from Alfred Imhof, 112-116, New Oxford Street, London, W.C.1.

Interim catalogue of beat-frequency oscillators, amplifiers and components, from Birmingham Sound Reproducers, Claremont Works, Old Hill, Staffs.

Illustrated leaflet describing the Pyrobrazz No. 2 portable electric soldering and brazing machine, from the Acru Electric Tool Manufacturing Co., Ltd., 123, Hyde Road, Ardwick, Manchester, 2.

"Coil" Pick-up:—The purchase tax on this pick-up, which was reviewed on page 123 of the previous issue, is £3 16s. 8d.

PREMIER RADIO Co.

MORRIS & CO. (RADIO) LTD.

CALLERS to 169 FLEET STREET, E.C.4. 'Phone: Central 2833
 ALL POST ORDERS to 167 LOWER CLAPTON RO., E.5. 'Phone: Amherst 4723
ALL GOODS IN NEW CONDITION AND GUARANTEED.
TERMS OF BUSINESS, CASH WITH ORDER, OR C.O.D. OVER £1

Send 2½d. stamp for 1946 list

5-WATT AMPLIFIERS. A.C./D.C. operation, 3 stages, high gain, 3 ohm output, £8 8s.

ALUMINIUM CHASSIS. Substantially made of bright aluminium, with four sides. 10in. x 8in. x 2½in., 7/-; 12in. x 9in. x 2½in., 7/9; 16in. x 8in. x 2½in., 8/6; 20in. x 8in. x 2½in., 10/6.

I.F. TRANSFORMERS. Iron core, litz wound, with or without flying lead. 460/465 K/c, 7/8.

MIDGET COILS. Unscreened Type, size 1½in. x ½in., designed for I.F. O.F. 465 K/c. Available in the types 0sc. H.F. Trans. Aerial and in the following bands, 12-35, 16-47, 34-100, 94-261, 200-557, 260-750, 700-2,000 metres. All types 2/3 each. Trimmers and Padders for all types, 8d. to 1/9. Also available, B.F.O. Coils, Aerial Filter, H.F. Filter. Same type and price as above.

YAXLEY TYPE SWITCHES. 2-pole 3-way 2-bank, 5/6; 2-pole 6-way 2-bank, 5/6; 2-pole 3-way 3-bank, 7/-; 2-pole 6-way 3-bank, 7/-. Any of the following types at 4/- ea. 1-pole 8-way, 1-pole 11-way, 2-pole 3-way, 2-pole 5-way, 3-pole 3-way.

S/W VARIABLE CONDENSERS. All Brass "Polystyrene Insulation," extended spindle for ranging. X0sc. 15 mmfd., 2/11; 25 mmfd., 3/3; 40 mmfd., 3/3; 100 mmfd., 3/11; 160 mmfd., 4/8; 250 mmfd., 5/8.

FULL VISION 8/M DRIVES. Calibrated 16-47, 200-557 and 700-2,000 with station names, 8-1 Escutcheon, size, 7½in. x 4½in., 10/6. Junior Model. Calibrated 200-557 and 700-2,000 and station names. Escutcheon size, 5½in. x 4½in., 8-1, 10/6.

EPICYCLIC DRIVES. 8-1 reduction, 2/9.

UTILITY MICRODIAL. Communication Type. Slow and Fast Motion Dual Knob and silver engraved, 6in. circular dial with hairline cursor 100-1 reduction. Fits entirely on front of panel, 8/6.

MAINS DROPPER RESISTANCES. Variable Type with sliding adjustment. 1,000 ohms, 3 amp., 5/6; 800 ohms, 3 amp., 5/6.

PREMIER MAINS TRANSFORMERS

All primaries are tapped for 200-230-250 v. mains 40-100 cycles. All primaries are screened. All LTS are centre tapped.

Output	Price
175-0-175 v. 50 m/a. 6.3 v. 2-3 a. 5 v. 2 a.	25/-
175-0-175 v. 50 m/a. 4 v. 1 a. 4 v. 2-3 a.	25/-
250-0-250 v. 60 m/a. 6.3 v. 2-3 a. 5 v. 2 a.	25/-
250-0-250 v. 60 m/a. 4 v. 1-2 a. 4 v. 3-5 a.	25/-
300-0-300 v. 60 m/a. 6.3 v. 2-3 a. 5 v. 2 a.	25/-
300-0-300 v. 60 m/a. 4 v. 2-3 a. 4 v. 3-5 a. 4 v. 1-2 a.	25/-
350-0-350 v. 100 m/a. 5 v. 2-3 a. 6.3 v. 2-3 a.	29/-
350-0-350 v. 100 m/a. 4 v. 2-3 a. 4 v. 2-3 a. 4 v. 3-6 a.	29/-
350-0-350 v. 150 m/a. 4 v. 1-2 a. 4 v. 2-3 a. 4 v. 3-6 a.	38/-
350-0-350 v. 150 m/a. 4 v. 2-3 a. 4 v. 3-6 a. 4 v. 1-2 a.	39/-
350-0-350 v. 150 m/a. 5 v. 2-3 a. 6.3 v. 2-3 a. 6.3 v.	38/-
425-0-425 v. 200 m/a. 4 v. 2-3 a. 4 v. 2-3 a. 4 v. 3-6 a.	47/-
425-0-425 v. 200 m/a. 6.3 v. 2-3 a. 6.3 v. 3-5 a. 5 v.	47/-
2-3 a.	47/-
500-0-500 v. 150 m/a. 4 v. 2-3 a. 4 v. 2-3 a. 4 v.	47/-
2-3 a. 4 v. 3-5 a.	47/-
500-0-500 v. 150 m/a. 5 v. 2-3 a. 6.3 v. 2-3 a. 6.3 v.	50/-
3-5 a.	50/-
500-0-500 v. 250 m/a. 5 v. 2-3 a. 6.3 v. 2-3 a. 6.3 v.	65/-
3-5 a.	65/-

PLAYING DESKS. A few only available. Consist of an Electrical Gramophone Motor with automatic stop and speed regulator, a quality magnetic Pick-up mounted on a strong metal frame. Price complete £8 8s.

MIDGET RADIO KITS. Complete with drilled chassis, valves and loud speaker, only cabinet required, medium and long wave T.R.F., size 10 x 6 x 2. 4 valves, inc. rect., tone control, A.C./D.C. operation, 300/250 v. Circuit and constructional details supplied. Price, including tax, £8 17s. 6d. Cabinet, if required, 25/- extra.

AMAZING OFFER. We have purchased the following material which must be cleared. Special prices will be quoted for large quantities. Super Quality Lease-Lend Aerovox oil-filled Paper Condensers fitted with Stand-off Insulators and vertical fixing clip, 2 mfd. 1,000 volts working 2/6 each, or 20/- per dozen, size 3½in. x 1½in. x ½in.; 3 mfd. 600 volts working 1/3 each, or 10/- per dozen; 1 mfd. 600 volts working, 1/-, or 8/- per dozen, size 2½in. x 1½in. x ½in. 0.1 mfd. 500 v. working, miniature aluminium can, wire ends, oil filled, insulation good as Mica, 9d. each, or 7/6 per dozen.

MICAMOLD POSTAGE STAMP CONDENSERS. 0.01, 0.001, 0.002 10in., 600 volts working, 9d. each. 7/6 per dozen.

CELESTION 10in. SPEAKERS. 2,100 ohms field, handle 8 watts. A super production with curved cone and dustproof voice coil, 50/-.

.0005 CONDENSERS. Ceramic insulation. "Bar" Type. Single gang, 5/-; Twin gang, 7/6; three gang, 10/-; four gang, 10/-.

P.M. SPEAKERS. 5in., 21/6; 6in., 22/6; 8in., 24/-; 10in. 6 watt 15 ohm, 47/6; 8in. 15 ohms, 16 watts when horn loaded, 55/-; 12in. 15 ohms 15 watts, a high fidelity job, £6 15s.

Brand New GOVT. SURPLUS. Many items at less than COST

ROTARY TRANSFORMERS. Input 12 v., output 110 v. 30 m/a. 4 v. 3 a. with 19 volts input, output is 50 per cent. higher. May be used on D/C mains as I.T. Charger. With small conversion coil operate as D/C Motor. Original cost over £5. Employ powerful ring magnet. Price 10/- each.

ROTARY TRANSFORMERS. Input 15 v., output 200 v. 60 m/a. 8 v. 2 a. with 19 v. input, output is 50 per cent. higher. Price 30/- each.

ROTARY TRANSFORMERS. Input 6 v., 12 v. or 24 v. I.C., output 250 v. 350 v. or 1,200 v. 70 m/a., respectively, 40/-.

MOTOR GENERATORS. Completely screened with smoothing. Input 6 v. output 220 v. 60 m/a. Price £4 each.

MOTOR GENERATORS. Input 24 v. output 1,700 v. 150 m/a. Price £6 each.

MOTOR GENERATORS. Input 12 v. output 240 v. 100 m/a. 6 v. 10 a. £4 10s.

VIBRATOR POWER PACKS. Input 6 v. output 120 v. 15 m/a. Price 40/- each.

ELECTROLYTIC CONDENSERS. 8 mfd. 500 v.w., 3/-; 8+8 500 v.w., 3/11; 16 mfd. 150 v.w., 3/-; 12 mf. 500 v.w., 4/6; 32 mf. 550 v.w., size 4 x 2 x 1½, 5/-; 16 mf. 700 v.w., size 5 x 4 x 2, 7/6.

MAINS TRANSFORMERS. All 230 v. primary, 4 v. 1-2 amps., 7/6; 1,250+1,250 v. 250 m/a., £5; 4 v. 22 a., 10/-; 6 v. 4 a. twice, 20/-.

CO-AXIAL CABLE. Super quality, consisting of a stranded centre core, a low-loss ribbed polyvulc resin type insulator, a flexible screen, a weatherproof P.V.C. outer cover. Just the thing for Television Lead-in or Super Mike Cable, 6d. per foot.

TRANSFORMER CARCASSES. Ideal for rewinding. All in perfect order with 230 v. primaries but odd type secondaries. 50 watt size, 7/6; 100 watt, 10/-; 105 watt, 12/6; 250 watt 15/-.

FIRST GRADE MOVING COIL METERS

Flush Mounting Bakelite Cases			
	1 millamp.	500 microamp.	100 microamp.
3½in. dia.	£2 12 0	£2 18 6	£3 8 3
4½in. dia.	£3 5 0	£3 11 6	£4 11 0
Internal Resistance	100 ohms	600 ohms	900 ohms

UNBIASED

Stimulating Set Sales

IT is not often that I have any truck with wireless manufacturers but I possess a naturally kind heart, and the other day when I saw a well-known set maker emerging from a government office whither he had been to obtain a permit for something or other, the poor fellow wore such a dazed and bewildered expression that I should have been less than human had I not offered him a lift to the nearest first-aid post. When we were comfortably



"Dazed and bewildered."

seated with a bottle of first-aid mixture in front of us, I found that under the surface he was quite a human and likeable fellow.

Among the things we discussed was the possibility of the revival of the annual wireless exhibition. He said that he was extremely doubtful if the exhibition, in pre-war days, fulfilled its true function of inducing people to invest in a new set each year. For the moment I thought that he was merely thinking of such a sordid thing as profit. Evidently he saw the danger signal in my eyes for he hastened to add that profit was the very last thing that he and his fellow manufacturers ever considered. As long as they made sufficient to enable them to use up their clothing and food coupons they were satisfied.

What concerned him was that unless the public did buy a new set each year they were not getting full value for their licence fee. In support of his argument he quoted a pre-war statement of Sir Noel Ashbridge to the effect that the people with sets giving poor quality of reproduction eventually became so drugged to bad quality that when they heard really first-class quality they didn't like it. My manufacturer friend pointed out that the whole business was more or less analogous to what would happen if the present austerity in goods and clothing were brought to a sudden end; such an event would immediately lead to

By
FREE GRID

serious digestive and psychological disturbances. It is, he added, the realization of this that led to many of the "Criptic" utterances of certain members of the Government which had been the subject of much ill-informed criticism.

Manufacturers were, he told me, not without a plan to remedy this state of affairs, and if adopted it would have a far more compelling effect than an annual exhibition in inducing the public to buy a new set. Briefly, the plan was that all first-grade B.B.C. programmes like Bach and Itma should be "scrambled" by means well known to technicians, and only receivable by sets fitted with the necessary unscrambling apparatus, the B.B.C.'s inferior programmes such as wobbly sopranos being sent in the ordinary manner. Each year the scrambling arrangement at the B.B.C. transmitters would be altered so that the first-grade programmes could only be received on the new seasons' sets, and so on.

I can only say that the whole theory leaves a nasty taste in my mouth, like that of immature whisky, but I may be biased. What do you think yourselves?

Radio-psycheurator

THE truly astonishing uses to which radar was successfully put during the late war is only equalled by the uses to which it is being put in these piping (whatever that may mean) times of peace. I do not refer so much to the obvious everyday things as to what I may term its more esoteric uses, known only to people like myself who read the more serious scientific journals. One of the most interesting of these new and unusual applications of radar concerns its use for the exploration of what is termed the knowledge-content of the human brain.

Apparently if you choose the correct wavelength you penetrate the hard matter of the human skull and reach the actual brain structure, this scientific fact having been elucidated by some determined go-getter of an American scientist who had set himself the task of getting a certain type of joke into a Scotsman's head. In so doing he made the amazing discovery that the degree to which the

radio wave is reflected depends on what he terms the knowledge-content of the brain.

It seems that the acquisition of knowledge causes a chemical change in the brain structure which alters its co-efficient of radio-wave reflection. It is, therefore, suggested that before long this new discovery may sweep away the whole system of examinations and examiners on which our educational set-up depends. Apparently radar can readily distinguish between the pupil of real knowledge and ability and the one who is a mere examination passer.

I am of the opinion that a far more important find is that of another American scientist to the effect that radio waves of a certain length are readily reflected by ghosts and similar unpleasant manifestations that disturb the peace of some of our more ancient buildings. I am perfectly well aware that among you there may be many who may be inclined to scoff and jeer, not only at the truth of this application of radar but at the existence of ghosts.

I can only say that if you had been pestered as much as I have been by the late Queen Elizabeth on the occasions when I have been sleeping in one of the many beds up and down the country which she has occupied you would change your tune. I particularly recollect one occasion on which I was awakened from a troubled sleep to find the indignant figure of that good lady standing with a shocked face at the foot of the bed and pointing imperiously to the door. I had little option but to retire from the room covered

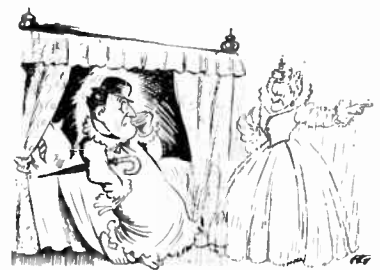

"Pointing imperiously to the door."

in confusion and my nightshirt in much the same manner as Mr. Pickwick had to do when he unwittingly found himself occupying a lady's bed in the "Great White Horse" at Ipswich. Like him, I spent a miserable and unhappy time in the passage endeavouring to seek other quarters, but unlike him I had not the redoubtable Sam Weller to come to my rescue.

MULLARD VALVES



FOR DOMESTIC RECEIVERS

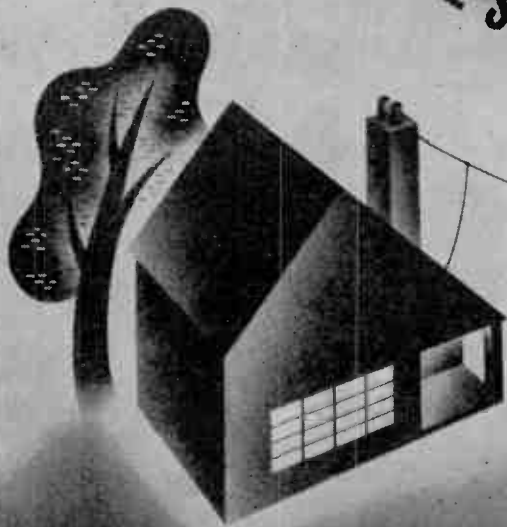

**Recommended Types for A.C./D.C.
Mains Operated Receiver.**

- CCH 35 Frequency changer.
- EF 39 Intermediate Frequency Amplifier.
- EBC 33 Detector L.F. Amplifier.
- CL 33 Output Pentode.
- CY 31 Rectifier.

*Other recommended types are available for A.C.,
battery and portable receivers.*

MULLARD THE DOMINANT NAME IN ELECTRONICS

THE MULLARD WIRELESS SERVICE COMPANY LIMITED, CENTURY HOUSE, SHAFTESBURY AVENUE, LONDON, W.C.2. (143)

Radio Communication!

One can say without exaggeration that the transmission of instructions in code and plain language played an all important part in winning the war. It too, was essential that highly sensitive and robustly constructed Headphones should play their part. In this important sphere, S. G. BROWN Headphones gave reliable service under all conditions of use.

The excellent service they rendered in winning the war is now available to all radio enthusiasts.

Your Local Dealer can supply.



Type "A"

- TYPE "A" Adjustable Reed Movement 57/6
- TYPE "F" Featherweight 23/-

Interesting technical details of all types of S. G. Brown headphones are given in Brochure "W." Free on request.

S.G. Brown, Ltd.

VICTORIA ROAD, NORTH ACTON, LONDON, W.3.

Telephone: ACOrn 1174.

Sound Understanding

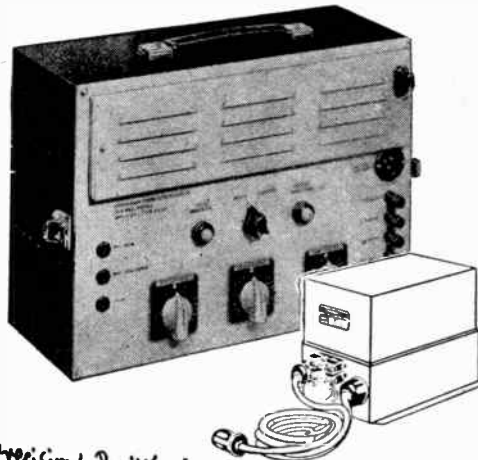

Precision Built for Perfect Reproduction

A Portable Amplifier capable of providing an undistorted output of 20 watts. Separate volume control for microphone and pickup. AC Mains or from 12 volt accumulator, used with the B.S.R. Vibrator Power Unit VP 60.A.

BIRMINGHAM SOUND REPRODUCERS LTD. CLAREMONT WORKS OLD HILL STAFFS.

BSR

W-58

"Cyldon" Transmitting Capacitors

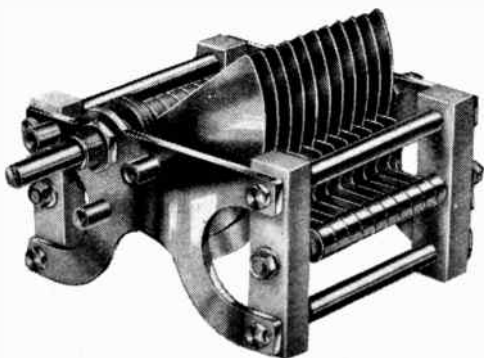

TYPE T.R. SQUARE LAW

Max. Capacity	List Price	Max. Capacity	List Price
100 pF.	19s.6d.	300 pF.	27s.6d.
150 ,,	20s.0d.	350 ,,	30s.0d.
200 ,,	22s.6d.	400 ,,	32s.6d.
250 ,,	25s.0d.	500 ,,	35s.0d.

SYDNEY S. BIRD & SONS LTD.
Cambridge Arterial Road, Enfield, Middlesex.

Wharfedale

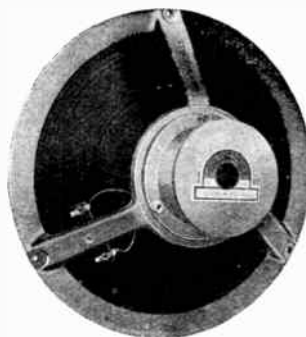

NEW GOLDEN 10 inch LOUDSPEAKER

During the last six years hundreds of Wharfedale Golden Units have been supplied, and are still being supplied, to the B.B.C. and G.P.O. It was selected by reason of

its level response. The new model is fitted with precision die-cast chassis, improved spider, and Alcomax II Magnet increasing the flux density from 10,000 to 12,500. The price is only increased by 5/-.

Made and Guaranteed by

WHARFEDALE WIRELESS WORKS
HUTCHINSON LANE, BRIGHOUSE, YORKS.

'Phone : Brighouse 50.

'Grams : " Wharfedel, Brighouse."

Rate 6/- for 2 lines or less and 3/- for every additional line or part thereof, average lines 1-40 words. Box Numbers 2 words plus 1/- Press Day: June 1946 issue, first post Wednesday, May 8th. No responsibility accepted for errors.

NEW RECEIVERS AND AMPLIFIERS

MODEL P.A.3 7-valve amplifier, ideal for all P.A. work.

MODEL P.A.6 7-valve quality amplifier for music lovers who require the most perfect gramophone reproduction.

WRITE now for full details; we also manufacture mains transformers and chokes, etc., specially designed for the "Wireless World", 4, 8, 12watt quality amplifier.

(HADDERTON RADIO & TELEVISION Co., Ltd., Peel St., Chadderton, Lancs. 15110)

ARMMASTER 5-valve 4-waveband (12-2000 metres) ac mains 200-240v superhet chassis with 8in R & A mains energised speaker and Mazda valves.

OUTPUT approx 5watts, chassis size 14 1/2in x 8in x 3in, cream cellulose finish, illuminated glass dial 8in x 5in with coloured waveband scales and station names, pickup and extra L.S. sockets.

PRODUCT of one of the largest radio manufacturers, precision made to the highest standards; ideal for incorporating in radiogram or own cabinet; art photographs available to genuine enquiries; price £17/12, carriage paid per pass. train; ready to switch on.

WE are official agents for Pye, Ekco, Philips, Cosmor, Philco, Ferguson, Ultra, Alba, R.G.D., etc., and new sets are available according to manufacturers' release schedules.

MAIL orders receive prompt attention. COMPONENT parts; we have good stocks of these and will be glad to forward our list on receipt of 2d stamp.

I.P. RADIO SERVICES, Ltd., 55, County Rd., Walton, Liverpool, 4. Tel. Aintree 1445. Estab. 1935.

COMMUNICATION receivers. - Dale will have them as soon as trading conditions allow. Remember-Dale Electronics, Ltd., 105, Bolsover St., W.I. Mus. 1023.

BRIERLEY Quality amplifiers, 5 watt, 8 1/2 gns.; 12 watt, £14; comprehensive tone control types, radio units, P.A. and S.O.F. amplifiers available; send s.a.e. for copy of "Design for Quality," and lists stating requirements.

PICKUPS. No magnetic type pickup designed to give the highest quality with small downward pressure can satisfactorily be used with a steel turntable—J. H. Brierley, Ltd., 46, Titchbarn St., Liverpool, 2. [5085]

ANELOY RADIO now offer improved set of components for med. and long wave semi-midget 4-valve a.c.-d.c. t.r.f. receiver, including cream cabinet, valves, drilled chassis, 6 1/2in speaker, screws, etc.; nothing more to buy, £8/10.—Aneloy Radio, 36, Hindmans Rd., E. Dulwich, S.E.22. [5020]

QUALITY.—We offer you a receiver combining all the features of local quality reception and communications receiver sensitivity; something new it will be worth while investigating.—2/6d stamp for descriptive brochure from the Moreton Cheyne Co., BCM/CFME, London, W.C.1. [5146]

RECEIVERS, AMPLIFIERS—SECOND-HAND

NATIONAL H.R.O. receiver, in good condition.—Write Box 6249. [4994]

AMPLIFIER, H.I.J. leak, 30watt class A, 6 Vitavox horn speakers, £40; copies "Wireless World", 1933-46, £5.—Box 6898.

H.R.O. power pack, 10in spkr, new cond., little used; best offer over £50.—Box 6669.

25-WATT 11-valve amplifier, with radio unit.—"Dodbrook", Rosera Rd., Canvey, Essex. [5072]

SKYRIDER Commercial, SX12, 11.5 m/cs-107kc/a, X stal., P.P.61.68; £30; callers only.—20, Clifton Ave., London, E.17. [5112]

SOUND SALES 20w 230v ac qual. amplifier, complete with radio & twin turntable gram. units, needs servicing; £50.—Box 6667.

NATIONAL NC45 8-valve communications receiver, 9-550 metres, as new; offers over £30.—GSCP, 33, Manley Rd., Sale, Manchester.

H.R.O. Senior, complete range of coils and power pack, guaranteed as new, £95.—Haymarket, Radio, Haymarket, Newcastle-on-Tyne. Tel. 27110. [5073]

25 push-pull amplifier, 2 power packs, 11 valves, £12; Shaftesbury ribbon £6; energised G.12. £4; Grampian 10in, energised, £1.—Box 6468. [5059]

AMPLIFIER by R.P. Amplifiers, Ltd., in excellent condition, complete with twin 10in speakers and microphone; best offer over £30 will secure.—Box 6670. [5101]

HARTLEY-TURNER 12-watt receiver and diode speaker, excellent condition, superb reproduction, records and radio; £35.—Pawson, Baslow, Bakewell, Derbyshire. [5155]

S.W. receiver, 6.17 regen, H.F. £F6 regen. £12. £F6 output, separate power pack, aluminium chassis, Eddystone parts, coils 12 170 metres; offers about £8.—Box 6665. [5090]

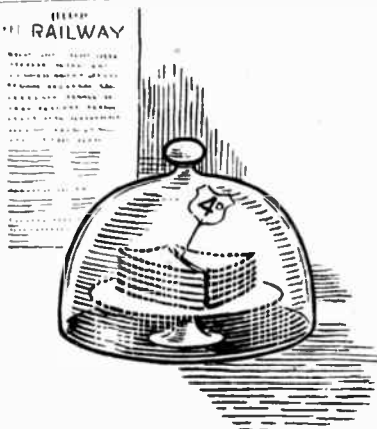

STOCK

At first glance our illustration may suggest that stock lines are not particularly desirable, but as a railway catering manager recently stated, the old order has changed.

So far as PARTRIDGE PRODUCTS are concerned there has been no change as we have always set ourselves a high objective—to produce the best.

To earn and maintain a good reputation one has to achieve:

- A Standard of Quality,
- A Standard of Efficiency,
- A Standard of Reliability,

to which in these days must be added:

- A Standard of Economy.

Modesty is not lacking when we claim that our Mains and Audio Components embody all four of these necessary qualifications.

In emphasizing Stock Models we are endeavouring to assist you to get quick delivery. We have built a comprehensive range, which for most purposes, will meet your need. Small quantities of these can be despatched from stock by return.

Whenever and wherever you can, we urge you to employ a stock item and so lessen the delay in our production of specials.

May we send you our list of components available from stock?

SPECIALS

We are now able to manufacture transformers and chokes to your specification in about 28 days.

Telephone: **Abbey 2244**

PARTRIDGE TRANSFORMERS LTD

76-8, PETTY FRANCE, LONDON, S.W.1

2-VALVE S.W. (battery) set, 10.360m. 8M bandspread tuning, on chassis and panel; £7; s.a.e. for details; also Brown's headphones, type A, as new; £2.—Box 7244. [5167]

DON'T miss this.—Amplifier and components at pre-war prices; all new goods by leading makers; clever bulk buying and low profits enable us to make this astounding offer.—See below.

1946 De Witt 30-watt amplifier chassis, with all valves, heavily built on a 12in x 8in x 3in grey cellulose chassis, two outputs, 15 and 2.5 ohms, superb reproduction with the new De Witt HiFidelity bass and treble uplift circuit for ac mains; 10gns complete.—Below.

COMPONENTS.—Mains transformer, 350v 120 ms. 5 and 6.3v secondaries, 29/6 ea.; 12hy 120ma chokes, 10/6 ea; 25-watt push-pull output transformer, massive job, 19/6; push-pull driver transformer, 8/6; octal 5- and 7-pin CM valveholders, super quality, 6d ea.—Below.

RESISTANCES.—1/2-watt 56,000 ohm, 27,000 ohm, 680 ohm, 3d ea; 0.2amp mains droppers, 2/11 ea; distributor and plug suppressors, 1/3 ea; black control knobs, very superior, 10d ea; loudspeakers 8in. p.m., less trans, 18/11; many other lines; send cash with order to British Radio Co., 106, Lozells Rd., Handsworth, Birmingham, 19. [5119]

HALLICRAFTER S.X.24 Skyrider Defiant. 345kc, 43.5mc., variable selectivity, etc., all new valves, first-class condition; £40; delivered free 50 miles from London; South of Thames.—Box 6467. [5066]

CIVILIAN wartime receivers get the whole l.w. band with Douglas coils, fitted by any amateur; 15/- batt., 18/- mains; dealers enquiries invited.—Douglas Electronic Industries, Ltd., Brinklow, Rugby. [5123]

PHILCO and Masteradio 6v car radios, 1939 models, with aerials, £20 each; Plusagram, £12; Majestic upright radiogram cabinet, £4; all in perfect condition; near offers considered.—Box 6512. [5075]

MAGNIFICENT Garol console, 24 tube, two auditorium speakers, 5 wave bands, 5 metres to 2,000 metres, 60 watts high fidelity output; £68.—Drury & Beardow, 45, Wangey Rd., Chadwell Heath, Essex. [5117]

NATIONAL H.R.O. Senior, new 1939, stored during war, complete with National power pack, speaker, six coils, spare set of new matched valves, two spare crystals and holders, condition as new.—Offers to Box 7245.

SPECIAL Marconi communication receiver, 0-5,000 metres, in oak cabinet, 45in x 39in x 19in, with 10watt push-pull output stage, gram., with piezo pick-up; full details on receipt of stamp; highest offer.—Box 6666.

FOR sale, quality amplifier, 50watt output, complete with twin electric turntables, 1 18in Baker speaker, 4 B.F.I. flares, rotary converter, 2 moving coil mikes, in perfect working order.—Apply to L. Cliffe, Electrical Engineer, 29, West St., Bourne, Lincs. [5168]

QUALITY equipment, ac, comprising amplifier 14w, feeder unit, variable selectivity, Super p.m. spkr., gram., motor, crystal pick-up, prestage unit and crystal mike, chromium floor stand, ideal home or club; £60; details; consider separating.—Dobson, P.O. Gasstown, Dumfries. [5051]

GRAMPHONE AND SOUND EQUIPMENT

WILKINS & WRIGHT moving coil pick-up with equalizer, new; £8.—Box 7314.

R.T.H. 16mm sound film projectors; limited quantity now available.—Enquiries: The British Thomson-Houston Co., Ltd., Rugby.

ROTHERMEL p.m., super model, now unobtainable, as new, special hi-fi crystal; offers over £4.—Rowell, Market Hill, St. Ives, Hunts.

TABLE record player, 33 1/3 to 78 rpm, crystal pick-up by Webster, twin motors, clockwork; what offers?—Russell, 12, Oakthwaite Rd., Windermere. [5098]

COILS for "W.W." tone control and filter circuits (Brierley & Hartley spec.), high fidelity mic. line and output transformers; see full list.—R. Clark, 30, Langland Cres., Stanmore, Middx. Wor 5321. [5190]

PROFESSIONAL recording equipment.—Condenser microphone, 12watt amplifier with tone stage, studio recording machine, full guarantee, superb results; £125; playing desk with 11-wt. pick-up extra.—Box 6354.

AUTOMATIC radiogram, superb Ferguson, Rola G.12. (1), push-pull output, 8 watts, Garrard autochanger, beautiful cabinet, as new throughout, £100, carriage paid, properly packed.—Box 7367. [5222]

TWO electrically operated Garrard turntables and pick-ups, 200-250volt universal motors mounted in cases and fitted with volume controls suitable for P.A. work; may be inspected on application to Assistant to Engineer (Signals), 29, Crescent West, Hadley Wood, Barnet, Herts.—Offers should be submitted to Purchasing Agent, London & North Eastern Railway, Sales Office, Gidea Park, Romford, Essex. [4950]

RADIO CORNER

(Proprietor, T. E. WILLIAMS)
138 GRAY'S INN RD., LONDON, W.C.1
 Terminus 7937

Mail Order. Delivery by return. Sexton Electric Smoothing Iron, made in two weights, 3½ lbs. and 5 lbs., 200/220 volts, 230/250 volts, 450 watts. Price 26s. 8d., plus 6s. 8d. Purchase Tax. Sexton Electric Bowl Fire for radiant heat. A really first class Bowl Fire, suitable for every room in the home. Price 33s. 4d.

American Radio Valves. Types as under at controlled prices. 45Z5GT, 5Y3G, 1A5GT, 1C5GT, 1Q5GT, 1T5GT, 80G, 35Z5, 11s. each. 6J5GT, 12J5GT, 1H5GT, 12SF5GT, at 9s. 2d. each. 6Q7GT, 12Q7GT, 12SQ7GT, 75G, at 11s. 7d. each. 12SJ7GT, 12SK7GT, 6K7GT, 6J7GT, 6K6GT, 6V6GT, 42G, 43G, at 12s. 10d. each. 6A7G, 6ABGT, 6K8GT, at 14s. each. Postage paid. Other types as they become available for distribution.

AMERICAN RADIO SERVICE MANUALS

- Volume I. Spartan Emerson.
- II. Crosley Belmont. Part I.
- III. Crosley Belmont. Part II.
- IV. R.C.A. Victor G.E. Admiral
- V. Emerson. Part II.
- VI. Stewart Warren. FADA.

At 12s. 6d. per volume or complete set of six manuals, £3 12s. 6d. These manuals cover the complete range of American Radio Receivers as given and are invaluable and contain all the technical data necessary.

Terms. Cash with Order only. We regret that we are unable to send goods C.O.D.

YOU can become a first-class RADIO ENGINEER

We are specialists in Home-Study Tuition in Radio, Television and Mathematics. Post coupon now for free booklet and learn how you can qualify for well-paid employment or profitable spare-time work.

T. & C. RADIO COLLEGE

North Road, Parkstone, Dorset

(Post in unsealed envelope, 1d. stamp)
 Please send me free details of your Home-Study Mathematics and Radio courses.

NAME

ADDRESS

W.W.48.

HIGH grade amplifiers of special design for recording, modulation of transmitters, musical instruments, P.A. shortly available, push button operated automatic disc recording machines.—Reoromat Co. Ltd., 19, Exmouth Market, London, E.C.1.

M.S.S. recording machine, 20watt amplifier [5170]
 special matching transformer m/c mike on floor stand, complete professional block, £100; immediate delivery; blank discs, cutters, etc., P.A. amplifiers, playing desks, light-weight pick-ups, external transformers giving 1,000-3,000ohms from 5 or 15ohms, 63/-.
 LIVERPOOL Sound Studios, 83a, Bold St., Liverpool. [4943]

TEST EQUIPMENT

WEE megger, 500-volt, as new; £10.—Dawson, 59, Alfred St., Gloucester. [5182]
 MULLARD E46/G10 10in E.C.R. tube, unused, as new; list 12gns.—Box 7247.

WESTON analyzer, complete, £17/10 quick sale.—Harris, 37, Edgeworth Crescent, Hendon, N.W.4. [4952]

TAYLORMETER 83A, C. of L. adaptor, intended for radio servicing, used one week only; £17.—15, Linden Ave., Bradford, Yks.

AVO model 40, first-class working order, just overhauled by manufacturers; £15.—Clayton, 20, Withy Croft, Slough, Bucks. [5169]

20000 O.P.V. Avo with extra shunts, £4; power pack, 750 milli, 6.3v, £3.—Cole, 4, Pearson St., Worthington.

TRIPLET type 1,200a ac/dc meter (separate meters) requires adjustment; £8.—Haywood, 30, Moor Park Villas, Leeds, 6.

TINSLEY moving coil mirror, galvd., 100 ohms, reflecting 2½ microamps per inch of scale at 1 metre; best offer over 75/-.—35, Cotswood Rd., Westcliff-on-Sea, Essex. [5146]

AVO valve-tester, latest type panel, £16/16; Hickok signal generator, 6 ranges, built in output meter, £16; solar capacity and resistance bridge, £10; 5in scope with time base, £9/10.—Box 6518. [5082]

NFW instruments in stock.—De Avo, £4/4; Avo Minor, £8/10; Taylor test bridge, £14 14; Huuts' capacitor, £18/18; Avo 40, £17/10; Weston analyser, £24.—Elettrico, 99, George St., Croydon. [5050]

21IN flush m.c. meters, Ferranti 250 volts, £2 1,000 o.p.v.; G.E.C. ditto, £2; Ferranti 150ma G.E.C. ditto, Ferranti 5mA, 15mA, £1/10; Ferranti electrostatic, 3,000 volts, £1 15; Ferranti 2in flush m.c. meters, 1mA £2, 5mA £1/10; 25 volt rectifier, 1,000 o.p.v., £2/5; s.a.c. with all replies.—Haigh, 42, Haigh market, St. Annes-on-Sea, Lancs. [5126]

BRITISH Physical Laboratories 14-range Universal test set; 1,000 ohms per volt on ac and dc ranges; shock resisting bakelite case, toughened glass, size 4in x 4in x 5½in, ranges ac and dc, volts 0/10, 0/50, 0/100, 0/500, dc milliamps 0/1, 0/10, 0/100, 0/500, resistance range 0/10,000 ohms, rotary range selector, accuracy 2%; retail £8/17/6; if unable to obtain this high-grade instrument from your dealer, apply to U.K. trade distributors: RADIO AGENCIES, Ltd., 157, Wardour St., W.1. Tel. Gerrard 4456. [5120]

CONSTRUCT your own crystal controlled frequency standard, using the new Q.C.C. type Q5 100kc/s quartz crystal unit; in a single valve Colpitts oscillator circuit it provides check points of 0.01% accuracy at 100kc/s intervals from 100kc/s to 15,000kc/s, making an ideal radio frequency source for receiver calibration and alignment; price 45/-, complete in octal based mount; send stamp for leaflet Q5, which gives full technical details and circuit.—The Quartz Crystal Co., Ltd., 63-71, Kingston Rd., New Malden, Surrey. Tel. Mal. 0334. [4694]

WE are now able to undertake the adjustment of resistors and capacitors over a wide range to within 0.1%, customers own apparatus, including audio oscillators and wave-meters, carefully calibrated to any required degree of accuracy; we can supply special precision radio and mechanical components from the small gear of coil to the complete apparatus for the solution of unusual problems; facilities also available for instrument finishing, including engraving panels and dials, black crackle enamelling, silver, nickel or chrome plating instrument parts.—Lydiat Ash Labs, near Bromsgrove, Worcs.

DYNAMOS, MOTORS, ETC.

ROTARY converter, in new cond., 12v dc to 275v dc and 500v dc; £9/10.—Box 7180.

FOR sale, rotary step-up converter, 1 phase 50 volts dc to 220 ac.—Further particulars from Box 6985. [5137]

BATTERY charger, 120volt lamp, Tungars ac 220v, dc 120v, 50 cycles, lamp, excellent order.—Clifford & Co. (Sidcup), Ltd., Main Rd., Sidcup. [4955]

50 used electric motors for sale, 2hp 400 volts, 3 phase 50 cycles, 1,430 rpm, all in perfectly new condition, immediate delivery; £10 each.—J. H. Hutcheson, 50, Cottingham Rd., Hull. [5133]

DALY

ELECTROLYTICS



Tube—size 2½" x 1"



Can—size 4½" x 1½"



Block—size 4½" x 1½"

The DALY range covers all requirements

Note—All Condensers bear the date made

DALY (CONDENSERS) LTD

Condenser Specialists for over 20 years

West Lodge Works, The Green, Ealing, W5

Phone—Ealing 4841

HENRY'S

Radio and Electrical Components

5, HARROW RD., EDGWARE RD.,

W. 2. PAD. 2194.

Hours : 9.30 - 6, Mon.-Sat. Half-day Thursday

- 8 mfd. Midget Condenser, 500 v., 4/-.
 - 16 mfd. Midget Condenser, 500 v., 5/-.
 - 8 mfd. Tubular Condenser, 450 v. wkg., 3/-.
 - 8 mfd. Tubular Can Condenser, 250 v. wkg., 2/6.
 - 16 x 16 Block Elec., 350 v. wkg., 8/-.
 - 25 mfd., 25 v. wkg., 1/9.
 - 2 mfd. Tubular, 350 v. wkg., 2/-.
 - 4 mfd. Tubular, 200 v. wkg., 2/-.
 - 8 mfd. Oilfilled, 600 v. wkg., 3½ x 3½ x 1½, 7/-.
 - 10 mfd. Oilfilled, 600 v. wkg., 4½ x 3½ x 1½, 7/-.
 - 4 mfd. Oilfilled, 1,000 v. wkg., 4½ x 2½ x 1½, 7/6.
 - 2 mfd. Oilfilled, 1,200 v. wkg., 6/-.
 - 1 mfd. Oilfilled, 10,000 v. wkg., 3/-.
 - T.R.F. AC DC Midget Kit of Parts, 200/250 v. wkg., £4.
 - Valves, £2/9/6.
 - Speaker, £1/7/6.
 - Cabinet, £1/7/6.
 - 3 Gang .0005 Standard Condenser, with Trimmers, 12/6.
 - 4 Gang .0005 Standard Condenser, 10/-.
 - Celestion Amphenol Valveholders. 4-, 5- and 7-pin English and Mazda Octal, Int. Octal and 4- and 5-pin U.X. 9d. each, 7/6 dozen. Paxolin Types, 5/- dozen.
 - T.R.F. M. & L. Wave, with Reaction, 8/6 pr. With Circuit. Coils.
 - T.R.F. Med. Wave Coils, 5/- pr. With Circuit.
- Send for 5 page Catalogue. 3d. Cash with Order or C.O.D.

TANNOY rotary converter, 100v d.c., 210v a.c., 90-watts; Rola G12.1.500ohm field, 7½ sp. coil.—Offers to County Radio Co., 26, St. Leonard's Rd., Northampton (5070)
ROTARY converter by E.D.C. 12v dc to 230v dc, perfect. £3; Yaxley type switches, 11-pole, 4-bank, used but perfect, 10/-.—Graney, Woodside, Derby Rd., Mansfield.

MORSE EQUIPMENT

MORSE practice equipment for classroom or individual tuition; keys, audio oscillators for both bat. or main operation.—Webb's Radio, 14, Soho St., W.1. Ger 2089. [5291]

NEW LOUDSPEAKERS

LATEST model broadcast pm loudspeakers, standard model, 12in, 15watt, £7/10; Hi-Fi model, 12in, 15watt, £8/15; 15in and 18in models to follow shortly; Ticonal magnets, detachable diaphragms, die-cast chassis; early deliveries; spec. upon request.—Broadcast and Acoustic Equipment Co., Ltd., Broadcast House, Tombland, Norwich 26970. [4027]

£5/18/6.—New Baker Super Quality 12in 15watt Auditorium permanent magnet speaker with triple cone, manufactured by Bakers Selhurst Radio, the pioneer manufacturers of moving coil speakers since 1925, wide frequency range, even response, ideal for quality reproduction, fitted with magnet, having exceptionally high flux density in the air gap suitable for public address equipment when quality reproduction is first consideration; send 2/6d. stamp for leaflet giving details of above and constructional details of a new acoustic chamber designed to extend loud speaker frequency range.

£8/19/6.—New Baker super power cinema permanent magnet speaker with 18in triple cone of new design, giving wide frequency response free from objectionable resonances; speech is clear and natural and music is reproduced with exceptional realism; fine engineering job, extremely sensitive; ideal for public address equipment when power handling capacity, plus realistic reproduction, is required; prompt delivery per pass. train.—Bakers Selhurst Radio, 75, Sussex Rd., S. Croydon (Croydon 6813).

LOUDSPEAKERS, SECOND-HAND

VOIGT h.c. horn with bass chamber for sale.—Offers to Rushton, 8, Broad Walk, Wilmsholm, Cheshire. [5241]

MAGNAVOX double 2,500Ω field with trans, 15/-; ac field kit, £1.—Box 6671 [5102]

VOIGT horn and tmbr. for bass chmbrs., port. gram. and p.u.; offers.—1, Hurst Court Rd., Sutton, Surrey. [5096]

VALVES

IR5, 184, 185, 174; 25/- each, all unused.—[5061]

Box 6489.
VALVES.—012, 70/-; 9002, 15/-; 9003, 15/-; 832, 10/-; 1625, 25/-; 1622, 12/6; 7193, 17/6; 6F8, 13/6; 1629, 17/6; 12AH7GT, 10/-; VR150, 30/-; 41; 68Q7GT, 12/-; 174, 184, 185, 25/-; 957, 25/-; 923, 4/-; 2051, 25/-; Metal valves: 12K8, 12SK7, 12SQ7, 12A6, 6SA7, 6SK7, 6K7, 6P6, 12/-; 60 RSGB Bulls, £2/15; copy tech. instns. for W.T., £1.—Box 6668. [5097]

COMPONENTS—SECOND-HAND, SURPLUS
VALVE. Matt has it!

SPECIAL offer.

U.I.X. International octal valve holders, 3d. doz., 4d. gross lots.
CONDENSERS (canned), all 500v working, 8mfid 3/3, 16mfid 3/9, 8x8 5/6; 0.1 0.002 6/- per dozen.

VOLUME controls (central lab), less switch 2/6, with switch 3/6.

TWO and three gang condensers, 0.0005, 2 gang 11/6, w/slow motion 13/6, 3 gang 14/6.

ROTHERMEL (crystal) pick-ups De Luxe £3/18/9.

ALL goods new, large asst., B.V.A. and V.S. valves in stock, and we have your enquiries.
MATT RADIO SERVICE, 152, Richmond Rd., Kingston-on-Thames. (Kin. 4881).

"DORSET" 5-valve 3-wave superhet.

THE finest drawings and instructions ever produced for the enthusiastic set builder; theoretical circuit, under chassis layout, above chassis layout, drilling template, heater wiring, group board assembly and point to point wiring instructions, also parts list, price 5/-, available April; this set can be made without previous radio experience, and can be built in stages out of income; 3-wave coil pack specially designed for the job; group board assembly obtainable ready made; also available "Wizard" 4-valve TRF ac/dc circuit, 5/-; "Dorset" battery 3 circuit, 3/6; "Dorset" amplifier circuit, ac/dc, 6/7 watts, 5/-.—Write Weldon Radio Accessories, Ltd., 12, Gilbert Rd., Swanage, Dorset. [4988]

RESISTORS (including wire wound), cut & selection; mail orders only; cash with order.—Component Exchange, 130, Camberwell Rd., S.E.5. [5108]

ELECTRADIX
More excellent Bargains

MOTORS. Special offer of 110 volt and 220 volt D.C. Fan Motors, robust machines on table stand with blade, 35/- each; oscillator type, 45/-.

CONDENSERS. Few only Sprague U.S.A., .05 mfd. 16,000 volts D.C. in metal case with heavy insulated terminal, 25/- each. 2 mfd., 250 volts smoothers, metal case, G.P.O., 2/6. Dubilier and T.C.C., .25 mf., 230 volts, 2/- H.T. Mica 4,000 volts, 25 mf., 10/-, 2,000 volts, 1 mf., 10/6. B.I. oil-filled, 6,000 volts, 1 mf., 35/-, 4,000 volts, 2 mf., 45/- Ultra Short Wave variable air condensers. 16 m.mfd. Trolitrol insulation ball-bearings. Surplus to a Govt. contract and new, 5/-.

MOTOR BLOWERS. Small valve cooling or lab blowers, 12 volts input, £5 10s. 32 volt D.C. motor blower, ½ H.P. motor, 500 cub. ft. per min., £8 10s.

METERS. Switchboard type, D.C., moving-coil ammeters 1/C 0-30 amp., 4½in. dia., 55/- Flush panel, moving-coil ammeter, 0-1 ma. 2½in. dia. bakelite case, 55/- Westinghouse metal rectifier, 1 ma, 10/6. Precision moving iron voltmeters, AC/DC, 3½in. dia., flush panel type, 0-60 volts, 45/-.

MEGGERS. Evershed bridge megger, with decade resistance box. As new. Cases store soiled. Few only.

GALVOS. Tinsley moving-coil reflecting mirror galvo, 100 ohms resistance, £5 10s. G.P.O. vertical circuit test galvos, 35/- Reid horizontal galvo on heavy brass stand, mirror scale, 75/-.

RELAYS. Siemens' High-speed Relays in heavy brass case, £3 5s. Telephone type No. 6. 2-coil polarised, S.P.C.O., 6 volts 25 ma., 325 ohms. 8/6. No. 1A S.P. on-off, 2 volts 40 ma., 5/- Relay movements 1,000 ohms, less blade and contact, 2/6. Moving-coil relays by Weston, Elliott and Sullivan. Send for New Relay Leaflet.

RECORDING OF MORSE SIGNALS. Ex G.P.O. Morse Inkers, record on paper tape, clockwork drive, fine workmanship; Siemens make, in first-class order, £12 10s. Special field H.Q. Morse Inker, Key and Indicator, £15.

MAGNETS. AC/DC winder magnets, 2-pole 220 volts, 7/6 each. The wonder midget Magnet, alni perm. steel disc, weight only ½ oz., ½in. dia. ½in. thick with 3/16in. centre hole, 3/6 each. Large selection of horseshoe Magnets in stock. Send for leaflet "W."

COIL ASSEMBLIES. Midget short wave with trimmer mounted on paxolin base, 3/6 each, with can, 4/6. Medium and long-range midget coil with circuit, 6/-, or matched pair with circuit for 3-valve set, 10/6.

ROTARY CONVERTERS. New D.C./A.C. 220/110 vlots 100 watts, £12; 110/110 volts 100 watts, £10. All with smoothing units.

TRANSFORMERS. 3 kW Crypto 230 v to 115 v, shrouded, £9 10s.; 3 kW Metvick, 50 cy, 400 v. to 600 v., £9 10s.; 500 watts, Foster 50 cy, 440 v. to 110 v. 5 amps. £4 15s.; 230 v. 50 cy. to 20 volts 2 amps. 30/-; 230 v. 50 cy. to 12 v. 3 amps, 32/6; 5 watts H.T. test Transformers, 110/220 v. to 1,000 v. 5 ma.

LABORATORY AND TEST GEAR



Gambrell Universal Shunt Box, 10,000 ohms. £5. Gambrell Resistance Box, 10-20-50-100-200-500 ohms, as new, £4. Tinsley Res Box, four 125-ohm coils with terminals, 45/-. We have a number of these resistances boxes, some less plugs, at special prices. Write for list. Wheatstone Bridges, 100 ohms to sub-divided ohms, £5 10s. P.O. pattern 10,000 ohms, £10. G.P.O. Resistance Box, 8,000 ohm by 10 ohm steps, switch and plug type, £4 15s.

PARCELS. 7 lb. parcel of useful oddments for your junk box, all clean and dismantled from Government and other apparatus. 7/6, post free.

ELECTRADIX RADIOS
214, Queenstown Rd., London, S.W.8

Telephone: MACaulay 2159

SOUTHERN RADIO'S wireless bargains

LATEST radio publications:
RADIO Valve Manual equivalent and alter native American and British types, with all data, 3/6; Radio Circuits, fully illustrated receivers, power packs, etc., 2/-; Amplifiers, fully descriptive circuits, 2/-; Radio Oil and Transformer Manual, 2/-; Short Wave Hand book, 2/-; Manual of Direct Disc Recording 2/-; Test Gear Construction Manual, 1/6. Radio Pocket Book, formulas, tables, colour code, etc., 1/-; Ten Hows for Radio Construction, 1/-; Radio Reference Hand Book, comprehensive and up to date, covering all branches of radio, 10/6; American Service Manuals, Sparton-Emerson, Crosley-Belmont (Part 1 & 2), Stewart-Warner-Fada, Emerson, 12/6 per vol.; Radio Resistor Chart (colour code values at a flick), 1/- each; Bulgin Radio Service Manual, 2/6; postage extra. ACE "P.O." microphones, complete with transformer, usable with any receiver, 7/6; permanent crystal detector, 2/6; insulated push-back wire, 25 yards, 5/-; insulated sleeving, assorted sizes and colours, 3/6 per dozen yard lengths; single screened wire, 7/6 per dozen yards; twin screened, 15/- per dozen yards; aluminium panels, undrilled, 16 gauge, 18 inches x 7 inches, 3/6; 18 inches x 9 inches, 4/6; ceramic and paxoline postage stamp trimmers, 30pl, single 1/3 each, double bank 2/-; reaction condensers, 0.0003, 0.0005, 4/- each; differential reaction, 4/6 tubular and mica condensers, 1/- each; knobs (pointer and round), 1/- each; valve holders, 1/- each; Cutler Harmer power rheostats, 30 ohms, 4/6. power rheostats, 10 ohm, 4/6.
HUNDREDS more bargain lines; postage extra to be added.

SOUTHERN Radio Supply Co., 46, Lisle St London, W.C.1. Gerrard 6653. [4987]

COULPHONE RADIO, New Longton, ur. Preston.

THE return of post mail order service; exclusively mail order; new goods only supplied; terms c.o.d. or cash with all orders; over 5/- post free; quantity discounts.

ALL Tungram and B.V.A. valves; list prices. **MAINS** transformers, interleaved, impregnated windings; primaries for 200-250 volts, 300-0-300 60mA, 4v 3a, 4v 2a, or 6.3v 2v 5v 2a, 17/6; 350-0-350 100 mA, 4v 6a, 4v 2.5a or 6.3v 3a, 5v 2a, 24/-; 450-0-450 200 mA, 4v 8a, 4v 4a, 4v 4a or 6.3v 4a, 6.3v 4a, 5v 3a, 42/6; 450-0-450 200 mA, 6.3v 6a, 4v 2a, 4v 2a, 5v 3a, 45/-.

SMOOTHING chokes, 40 mA 4/6, 60 mA 6/-, 90 mA 7/-, 100 mA 12/6, 200 mA, 21/6; speaker transformers, Midget Pen 4/6, Power/pen 5/-; std. size univ. with c.t., 6/-; large univ, 10/6; H.D. push-univ multi ratio 15-watt, 21/-; ex H.D., 37/6; superhet 3 wave-band coil packs, completely wired, 5 connections only to make with circuit, 32/6; matched iron cored i.f.t.s, 465 kc/s, 13/6 pair; full size t.r.f. 4-valve ac/dc kits, 2 waveband, £7/19/6; superhet kits, 5v with 3 wave-band, coil pack, ac 11/16; ac/dc 10/10; 2-gang condensers 11/-; reduction drives with scale and escutcheon, 7in x 3¼in, 12/6; speakers, p.m., less transf, 2¼in 24/-, 3¼in 27/6, 5in 19/6, 6¼in 20/-, 8in 21/-, 10in 30/-; with transf, 6¼in 24/-, 8in 25/-, 10in 36/-; energised 6¼in, 2,000, with transf 28/6. 8in, 1,200 or 2,000, 32/6; Goodmans T2/12. latest type £6/15; mains droppers feet, 0.2 amp 4/3, 0.3 amp 4/6; line cord, 60Q per ft., 0.3a, 2-way 1/6 yd, 3-way 1/9 yd; B.P.L. testmeters, £8/17/6; send stamped addressed envelope for 10-page catalogue. [5186]

UNIVERSAL ELECTRONIC PRODUCTS.

WE cater for all the requirements of the amateur radio experimenter and transmitter; large selection of components, meters, coils, condensers; sheet polystyrene and laminated bakelite cut to your dimensions.

CONSULT us for your requirements in light metal turning, chassis, transmitter racks, etc. **TRANSFORMERS**, chokes, etc., wound to specification.

AMATEUR enthusiasts.—We are always ready, as practical people, to talk over your problems, however large or small.

UNIVERSAL ELECTRONIC PRODUCTS, 36, Marylebone High St., W.1. Tel. Welbeck 4058.

SCOTLAND'S largest stockists.—Anything radio we have it.

EDDYSTONE—agents—Raymart. SEND for parts and kits list.

BUCCLECH RADIO MANUFACTURERS, Melville Terr., Edinburgh. Tel. Edinburgh 42803. Grams, Therm. Edin. [5139]

H.R.O., 5 coils, 900-14,000 kc/s, power pack, 1 phone, speaker; offers.—Box 7098. [5141]

Big stocks of radio valves all types, list prices; 8in Field energised speakers, 35/-, c.o.d. or proforma.—David Robinson, Ltd., 100, High St., Bedford [4577]

Are you ready for VICTORY PARADE (JUNE 8th)

AMPLIFIERS

Wired for use, or complete outfits for assembly.
A.18 Kit. 15 watts. £8 18 0
A.23 " 23 " £14 0 0

SPEAKERS, MICROPHONES and STANDS IN STOCK

TRANSFORMERS

Several additions to our range—i.e.,
REPLACEMENT TYPE 350v. 100ma.
IMPROVED DUAL MOUNTING.
FITTED MAINS VOLTAGE PANEL.
LIST PRICE 35/-

DEALERS' DISCOUNTS INCREASED.
 NEW ABRIDGED POCKET SIZE LISTS (2jd.). EXPORTS! PROMPT DELIVERIES, AGENTS IN ALL PRINCIPAL COUNTRIES.

RADIO INSTRUMENT CO.

Radio Products
 294, BROADWAY, BEXLEYHEATH, KENT
 Bexleyheath 3021

MORSE CODE TRAINING

There are Candler Morse Code Courses:



for Beginners and Operators.
SEND NOW FOR THIS FREE "BOOK OF FACTS"
 It gives full details concerning the following Courses:—

JUNIOR Scientific Code Course for beginners. Teaches all the necessary code fundamentals scientifically.
ADVANCED High-speed Telegraphing for operators who want to increase their w.p.m. speed and improve their technique.
TELEGRAPH Touch Typewriting for those who wish to become expert in the use of the typewriter for recording messages and for general commercial uses.
Code Courses on Cash or Monthly Payment Terms.
IRREFUTABLE EVIDENCE of the value of the Candler System of Morse Code Training is given in the "Extracts from students' letters," included with every "Book of Facts."

COUPON

Please send me a Free Copy of Candler "Book of Facts."

Name.....
 ADDRESS.....
 Post Coupon in 1d. unsealed envelope to London Manager
THE CANDLER SYSTEM CO. (Room 55W),
121, Kingsway, London, W.C.2
 Candler System Co., Denver, Colorado, U.S.A. (643)

SUPREME RADIO, 746B, Romford Rd., Manor Park, London, E.12. Tel. III. 1260.
 WE have supplied the service engineer for the past 15 years, why not you? Here are a few clearance lines to offer. We are having our yearly stocktaking sale: 0.1mfd 500v working, 6/6 doz; 0003 reaction condensers, 1/1 ea; Mansbridge .01 condensers, 4/- doz; I.F. transformers, 10/- doz; T.C.C. 1+1mfd 350v working dc and 250v working ac, 18/- doz; 6JS (G.T. valves, new, boxed, 7/6 ea; type 80 IDS, 5Y3, G equivalent non-ring, 9/- ea; 6v 3A pilot bulbs, 8/- doz; P.P. 30w transformers, tapped primary and secondary, for any matching, 25/- ea; 1watt wire-wound resistances, 200-240,000ohms, 24 in-pkt, assorted 7/6 pkt; or in selected sizes, 5/- doz; volume controls, all sizes, 4/- ea with switch, less switch, 3/9; wire-wound controls, 2,000ohms, 2/6; 10,000ohms, long spindle, less switch, 2/6; line cord, 60-70ohms per ft, 2/- yd; droppers 0.2, with feet 4/6, less feet 3/9; 0.3, 5/3; Pye replacement, less feet, 3/3; tubular condensers, all sizes, ask for prices per doz; send s.a.e. all enquiries; orders over £5 send 6d extra for postage and packing; no c.o.d.
RADIO CLEARANCE, Ltd., Museum 9188, 27, Tottenham Ct. Rd., W.1.
**MAINS trans., 300-0-300 110ma, 5v 2a, 6.3v 3a, 22/6; electrolytics, 8mf 250v, 2/6; 4+4, 450v, 3/6; 4mf 350v, 2/-; 4mf 500v, 2/11; 20mf 150v, 2/9; 50mf 50v, 2/6; 250mf 25v, 2/-; 200mf 12v, 2/-; Mansbridge condensers, 4mf 450v, 4/6; 2mf 400v, 1/6; 1mf 350v, 9d; 5.5mf 4,000v wkg, 10/-; 0.5, 400v, 5/-; silver mica, 50 to 5,000pf, 6d; mica, 0.0001-0.0005, 4d.; 0.001-0.007, 5d.; 0.01, 6d. 0.01 2,200v test, 9d.; tubulars, 0.01, 0.02, 0.04, 6d.; 0.1 350v, 7d.; 0.25 375v, 1/-; switches, 4p 3-way, 3/-; 3p 4-way, 3/-; 1p 10-way, 3/-; 1p 12-way, 3/6; 1p 9-way, 3 banks, 5/6; resistors, 1/4w, 3d.; 1/2w, 4d.; 1w, 6d.; 2w, 10d.; 3w, 1/3; all values; bargain parcel 100 asstd. resistors, 1/4w to 3w, 17/6; all useful sizes; vitreous resistors, 50k, 500k c.t., 1,000k, 1,000k tapped, 250 and 500, 1,300k tapped, 600k, 10w, 1/6; 20w, with clips, 120k, 200k, 2/-; 25w, 350k, 5,000k, 75,000k, 2/6; 40w, 14,000k tapped, 2,000k, 3/-; 50w, 50,000k, 20,000k, 3/6; toggle switches, single p, 2/-; double p, 2/11; screened octal top caps, 6d.; valve holders, 4-pin, 1d.; 5-pin, 4d.; 7-pin, 5d.; octal, 6d.; volume controls, 600,000k, with switch, 3/6; wire wound, 100k to 20,000k, 2/6; alloy chassis, undrilled, 7in x 5 1/2in x 3 1/2in, 2/6; 4 1/2in x 3 1/2in x 3 1/2in, 2/1; 3 1/2in x 3 1/2in x 3in, 9d.; numerous other lines in stock; cash with order or c.o.d.; postage extra; post paid on orders over 7/6. [5065]
CHARLES BRITAIN (RADIO), Ltd., offers bargains in radio apares.
MAINS TRANSFORMERS, woden fully shrouded with feet, a first-class job, 350-0-350 100ma, 4v and 6v types, 27/6 ea; standard replacement drop through type, 80ma, 4v and 6v types, £1; fully shrouded drop through type, 100ma, 6v only, 25/-; all the above are wound for standard mains voltages; speaker transformers, midget multi ratio, 4/6; standard multi-ratio, 6/6; pentode type, pen A4, etc. made by Philips, 5/-; large heavy duty for P.A. etc., multi-ratio, 15 ohm secondary, 30/-; smoothing chokes, midget type, 360 ohms, 60ma, 5/-; 450 ohms, 80ma, 6/6; 360 ohms, 250ma, heavy duty type, £1.
ELECTROLYTIC condensers, TCC wet cans, 16 mfd, 440v wkg, 7/- ea; 8 mfd dry cans with fixing base, 450v wkg, midget type, 4/6; 8 mfd dry cans TCC 350v wkg, 3/6; 3+8 mfd 450v wkg, with fixing base dry cans, 6/6 ea; 11ufts and B.I. blocks, 450v wkg, 4/-; 11ufts tubulars 450v wkg, 3/6; 25-25, 50-12, 12-50, 75-12, 1/9 ea; tubular condensers, Phillips, -1, 400v wkg, 5/6 dz; -05, -04, -03, -02, -01, 1,000v test, 5/- dz; -005, -004, -002, -001, 4/6 dz; mica condensers, -005, -002, -001, 4/6 dz; -0005, -0003, -0002, -0001, 4/- dz; resistances, 1 watt Eric and Morganite, most values in stock, 6/6 dz; 1/2 watt, 4/6 dz.
SPECIAL OFFERS: Small moving coil mikes, undamaged cones, 5/-; damaged, 1/6; parcel of new assorted tubular and mica condensers, including every size from -0001 to -15, 1 gross in each, £2 8; parcel of new assorted 1 watt, 1/2 watt and 1/4 watt resistors, 1 gross in each, £2; band pass aerial coils, ex-Ekco, with diagram, 2/6; wave-change switches for the above, 2/6; write for our new April list "W"; terms, cash or c.o.d. over £1—Charles Britain (Radio), Ltd., Radio House, 2, Wilson St., London, E.C.2. Tel. Bis, 5995, ext. 7. [5223]
UNUSED guaranteed goods at low prices.— Can type electrolytics, 8mfd 450vw, 3/6; 600vw 6/-, 10x10mfd 450vw, 6/9; 20x20mfd 450vw, 7/6; 4mfd 450vw, 2/6; 8mfd 750vw, 8/6; 0.25mfd 2,000vw, 2/9; 25mfd 25vw, 1/6; condensers, 12 assorted, 5/6; resistors, 1/4 to 2 watts, 12 assorted, 3/6; chokes mains, and P.P. transformers; stamp for list.—Preston, 230, Healey Lane, Batley, Yorks. [5087]**

The **"PYROBIT"** SOLDERING IRON

Brit. Patent No. 560,806

for Precision Instrument Work

Can be operated like a pencil.

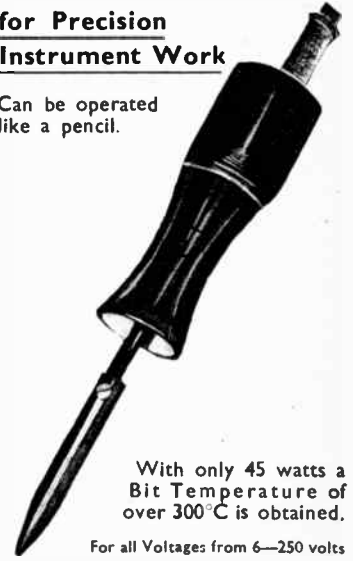

With only 45 watts a Bit Temperature of over 300°C is obtained.

For all Voltages from 6—250 volts

THE **ACRU ELECTRIC TOOL MFG. Co. Ltd.**
 123, HYDE ROAD, ARDWICK,
 'Phone: ARDwick 4284 MANCHESTER, 12

What causes Record wear? **NEEDLE IMPEDANCE!**

Low Needle Impedance is obtained with light damping which, in turn, depends on low needle point pressure.

THE **Lexington MOVING COIL PICK-UP**
 Scientifically Engineered

reduces these to a minimum by the introduction of precision watchmaking mechanics into the Radio Industry.



The new features are:

- Robust design. Accidental dropping on record will not damage Pick-up.
- Extreme low moment of inertia (80 milligrams total weight of movement).
- Pure sine wave with no harmonic distortion.
- Response curve flat from 30 c/s to 12 Kc/s
- Automatic needle or sapphire changing opens new fidelity field to the amateur.
- Can be used with normal record changer without fear of damage.

*end stamp for illustrated pamphlet giving full technical details and price.

Demonstrations can be given by appointment.

COOPER MANUFACTURING CO.,
 134, Wardour Street, London, W.1
 MUSEum 9779

GALPINS

GOV'T. SURPLUS ELECTRICAL STORES
408 High St., Lewisham, London, S.E.13

Telephone: Lee Green 0309. Near Lewisham Hospital.
D.C. MOTORS, approx. 1/2 h.p. series wound, all guaranteed electrically for 110 or 220 volts mains. Price 15/- each. Carriage 1/-. We also have a few with **LAMINATED FIELDS**, which are easily convertible to work off A.C. mains. Price 20/- C.F.

ELECTRIC LIGHT CHECK METERS, by well-known makers, all electrically guaranteed, for A.C. mains, 200/230 volts, 50 cycles, 1-phase, 5-amp. type, 12/6 each. 10-amp. type, 15/- 20/25 amps., 17/6 each.

EX-GOVT. ROTARY CONVERTERS for car radio, etc., 6 to 9 volts, D.C. input, 450 volts 50/80 M/amps, output complete with automatic regulator, smoothing, consisting of condenser, dropping resistances, etc., and a specially designed gearing operating 3 multi-leaf relays, all mounted on chassis, size 12in. by 8in. by 2 1/2in., weight approx. 16 lb., condition as new, to clear 37/6 each, carriage 2/6. Ditto, same output, but with an input of 12 to 18 volts at 3.3 amps. Price 37/6 each, 2/6 carriage.

EX-GOVT. EIGHT VALVE CHASSIS, size 12in. by 8in. by 2 1/2in., short wave, comprising of two highly sensitive multi-contact relays, dropping resistances, approx. 36 fixed condensers ranging from 10 P.F. to 1 N.F., also approx. 28, 1/2, 1 and 2 watt resistances. To clear, 18/6 each, 1/6 carriage.

STANDARD TELEPHONE, block condensers 10 mfd. at 550 volt wkg., 7/6 each. T.C.C. 4 mfd-300 volt A.C. wkg., 4/6 each. Ditto, 2 mfd. 2/8 each. T.C.C. 2,000 mfd., dry electrolytic condensers, 25 volt wkg., 15/-, Ditto, 500 mfd., 50 volt wkg., 12/6 each. All fully guaranteed.

"WESTON" MOVING COIL MILLIAMMETER, model 505, 2in. dial, flush mounting 0 to 5 ma, 0 to 10, 0 to 20, 0 to 50, 0 to 300. All at 27/6 each.

X-RAY TRANSFORMERS, in oil input 100 240 volts 50 cy. 1 phase, output 40,000 volts, £25; 40,000 volts 5 K.V.A., with Coolidge winding, £35; 90,000 volts at 2 1/2 K.V.A., £27 10s., all in perfect condition, fully guaranteed.

EX-GOVT. ROTARY TRANSFORMERS, input 12 to 24 volts D.C., output, 480 volts 40/60 M/amps., complete with smoothing and a special gearing operating a multi-leaf relay. Price 30/-, carriage 2/-.

EX-G.P.O. HIGHLY SENSITIVE RELAYS, small type, with multi-contact Q.M.B. action, 5/- each. Also same type, new and unused, 10/-. All fully guaranteed.

RECTIFIERS, all large type, fully guaranteed, output 50 volts 1 amp., 35/-; 12 volts 4 amps., 45/-; 12 volts 6/8 amps., 55/-. All carriage paid.

AUTO-CHANGING TRANSFORMERS, tapped 0, 110, 220, 240, step up or down, 500-watt type, 70/-. Ditto, 1,000 watts, £5 15s. Ditto, 2,000 watts, £8 15s. Extra tappings if required at 10/- per tapping. All fully guaranteed.

AUTO-WOUND TRANSFORMERS, 2 to 1 ratio, step up or down, 250 watts, 45/-; 400 watts, 57/6 each.

X-RAY FLUORESCENT SCREENS, 15 x 12in., with lead glass as new, 75/-. We also have in stock other sizes of screens and cassettes. Please state your requirements.

MOVING COIL VOLTMETERS, 2 1/2in. dial, makers Sullivan, 0 to 10 volts, all new and unused, 35/- each.

AUTO-WOUND TRANSFORMER, approx. 5 kilowatt, in new condition. Voltages which can be obtained are up to 18 in steps of 2 volts, 80 to 240 in steps of 20 volts, price £15.

ROTARY CONVERTOR, input 220 volts D.C. at 9 amps.; output 68/125 volts, 500 cycles, 1 phase, 1,250 watts, in perfect condition, £15. Ditto, 230 volts D.C. input, output 240 volts 1 phase 50 cycles, 1,250 watts, price £25. C.F.

FIXED RESISTANCES, wound on fireproof mounts, size 12in. by 1in., 2 ohms resistance to carry 10 amps., 2/6 each.

All articles advertised sent on approval against cash. Terms: Cash with order.

G. A. RYALL, 65, Nightingale Lane, London, S.W.12.—Callers welcome 2 p.m. to 8 p.m. No c.o.d. under £1, please, postages extra.
SPRAGUE tubular wire ends, 1mf 500v wkg. metal cased, 5/- dozen; British make, 1 350v pairs mtd on paxolin, 6/- per six pairs; 450v ditto, 7/-.

MORGANITE volume controls, 1/4meg metal-cased medium spindle, 2/-; short spindle, 1/9; fully tropical type bakelite cased, 1/4meg, short spindle, 1/6; Dubilier 1meg 2 1/2in spindle, 2/-; wire-wound panel mtg preset 300 ohm bakelite, 2/-.

TCC 2mf 600v wkg at 160.F, 2/-; 1mf 350v wkg at 140.F, 1/-; TMC 1mf 250v wkg. 2/-; metal-cased V 5mf 500v wkg, 3 for 2/6, all perfect insulation; tubular Yaxley type switches, single bank 2-pole 4-way, 2/-; ditto two bank single-pole 4-way, 2/-; ditto single pole double throw, single and double bank, need stops, 1/6; ditto three bank two-pole 4-way, with middle screen, 3/-, with three earthing plates.

BRITISH-made paxolin valve holders, chassis type, USA 4.5 6-pin, British 5. and 7-pin, International octal, all 4/- dozen, 29/- 100; octal 8-pin plugs and metal shells with chassis VII, 3 for 2/6, 8/- dozen; with solder tags 1/- each, 10/- dozen; miniature 4-pin plugs, shells and sockets, 4/6 dozen; anchor 5-way mtg strips, 2/6 dozen; input terminal strips, 2-way, 2/6 dozen; meter switches, 11-way, 3/-; paxolin panels, 12x12 quarter in, 5/-; small terminals 3/6 dozen, large 5/6 dozen; push-back wire, blue, 12 yds 1/-, 500 yds coils 30/-; twin screened wire, 3 yds 1/6.

MORGANITE 1gwatt resistances, 500, 1,000, 50,000, 2meg, 3/- dozen; Erie 5,000, 22,000, 220,000, 470,000, 3/9 dozen; Erie 2,000, 6,800, 140,000, 150,000, 220,000, 470,000, 820,000, 5/- dozen; bakelite knobs, 1/4in, 4/- dozen; Clydon five 30mm trimmers on metal base, 1/-.

[5243

ALIGNED INSTRUMENTS SERVICES, 25, Park Grove Rd., Leytonstone, E.11. Tel. Leytonstone 5601.

ALL-WAVE superhet kit, 16-47, 200-550, 800-2,000 metres, a.v.c., high "q" i.f.s. ext. i.s. and p.u. sockets, 8in spkr., uses model 20 coil pack, fully aligned and tested, ac model, £12, ac/dc, £12/10.

MODEL, 20 coil pack, aligned and tested, only 5 connectives, 39/6; i.f. trans. 465Kcs, high "q", aligned and tested for gain, 17/6 pair; model 20 tuning heart, fully assembled, with 3 valves, £6/15/10; handsome tuning scale, glass, etc., and s/motion drive for above, 12/6; amplifier kits, really well-designed, ac models, 6watt, £7, 12watt, £11; ac/dc, Swatt, £7, 15watt, £12; tuning units, 3w/band s/het type, assembled, etc., with 3 valves, ac or ac/dc, £8/17/6; PRT type, two med. wave stations only, high fidelity design ac or ac/dc, £6; other kits available, send 1d. for lists, circuits and tech. desc. for any above, 2/6; post trade only at present, send c.w.o. if possible—saves clerical work, orders over £5 post free, no c.o.d. under £2.

COILS, high gain combined med. and long wave, t.r.f., 2 1/2in long; a really first-class job; aerial and h.l. 7/- pair, post paid. Ancoy Radio, 36, Hindmans Rd., S.E.22.

MAINS transformers, vertical or chassis mounting, with primary tag panel, standard tapped mains, secondaries 325-0-325, 60ma., heaters 6.3x4amps; 5v-2 1/2amps; 10ff, 17/6; 5 off, 16/6; 25 off, 15/6; carriage extra, orders over 25 off quoted for, immediate delivery.—Box 6460. [5053

5-VALVE 3-band superhets, 4-valve 2-band t.r.f. Midgets, communication receivers, 7-valve W.W. Quality amplifiers, h.t. super-seders work off 2volt accumulator; kits and complete instruments supplied; details on request.—R. E. S., "Marfrel," Maurice Rd., Canvey, Essex. [5071

MAINS droppers, 4/-; mains transformers, 23/-, 6 1/2in. or 8in P.M.S., 19/6, 2 1/2in. 23/-, 6 1/2in. w. h.f., 23/9; condensers, 4mf 450v, 2/6; electrolytic, 5mf, 3/6; 8 1/2in, 5/6; 2 gangs, 9/6; pointer knobs, 6d.; speaker fabric, 2/6 ft; resistors, 1 watt, 7d.; mike plug and socket, 1/- comp.; DPDT rotary switch, 2/6; test clips, 4d.; rubber feet, 1/4d.; bushes, 1d.; push back, 2/6 50ft; full list 1d.—Beam, 76, Canwick Rd., Lincoln. [4932

4V ac/dc 2-band T.R.F. chassis, complete with valves, speaker, etc., guaranteed working order, £7; as kit of parts complete, £5/10; tuning units, 2-band T.R.F. with 2-gang condensers, £1/5; 3-band superhet with H.F. stage with 3-gang condenser, £2; pretuned I.F. coils, 465k/cs, 15/- per pair; 2-band T.R.F. coils, 6/6 pair, 2-gang condensers, 7/6 each; 3-gang condensers, 9/- each; Acorn valves, 954, 955, £1 each; new Dubilier resistances, 1/2watt, 3/- doz, £1 per 100; 1watt 5/-, £1/10 per 100.—Cook, Enham Old Barn Rd., Christchurch, Hants. [5163

In sound working order! EX-R.A.F. AIRBORNE G.P. TRANSMITTERS

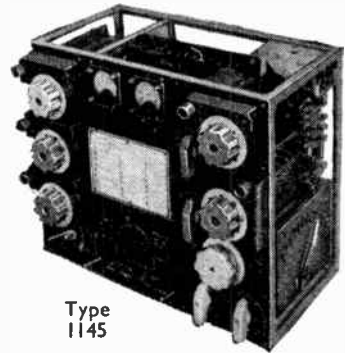

Type 1145

Complete with 4 valves. Frequency coverage: 500 kc/s, 200 kc/s, 10 mc/s, 3 mc/s, 2.35 mc/s, 8 mc/s, 2.5 mc/s. Power input 1,200 v., 200 ma. H.T., 6 v., 4 amp. I.T. Chassis size 15in. x 13 1/2in. x 8 1/2in. In metal cabinet. Supplied in strong wood case, with metal bound corners and carrying handles, easily adapted for Amateur use. Less Power Pack..... **10 gns.**

R.A.F. Model 1155 COMMUNICATION RECEIVERS Comparatively new

These receivers are made to the stringent specification of the Air Ministry and are fitted with a large scale dial calibrated from 7.5 mc/s to 1,500 kc/s. Complete with 10 valves, including magic eye, they are fitted in a strong metal cabinet and supplied in wood carrying case. They require only a power £15 pack to be ready for immediate operation...

—For Callers Only—

BAIRD TRANSFORMERS & TUBES
 Electromagnetic Cathode Ray
 Tubes. 15 inch. . . . £6 10 0
 High Voltage Transformers for the
 above. 6,500v. 3m/a. . . £1 0 0

SMALL FRACTIONAL H.P. MOTORS. 24v. DC/AC. Universal and Reversible. Weight 20 ozs. Size 2 1/2 x 2 1/2 in. £2 6

D.C. MOVING COIL AMMETERS. 0-50 amp. Centre zero reading. £12 6

5-WAY PUSH-BUTTON UNITS, without buttons. . . 2-CONDENSERS, 2 mfd 250 v. and 500 v. wkg. 1/3 each. 1 mfd., 5,000 v., wkg., 6/9 each. 1 mfd. 350 v. wkg., 8d. each of 6 doz.

MOVING COIL INSERTS. Can be used as Head-phones, Midget Speakers (without transformer) Speech Mikes, or adapted for Pick-ups. In perfect order but without grille. Coil, 30 ohms. 3 6

—AN OPEN INVITATION—

We cannot list all the R.A.F. gear we have for sale. You are invited to call and see the stocks of chassis, receivers, transmitters, instruments and components. It will pay you to come in and walk around.

N.B. We do not issue lists and cannot deal with correspondence on the goods we offer.

LONDON CENTRAL RADIO STORES

Closed Thurs. 1 p.m. Open all day Sat.
**23, LISLE STREET
 LONDON GERard 2969 W.C.2.**

BARGAINS ! SELECTION ! QUALITY !

Just read down this List.
CONDENSERS AND RESISTORS.
A special "Buy" enables us to offer you the following at very competitive prices:—

Block Types.—Paper.
4 mfd. 500 v. w., 1,000 v., test, 4/6 ; 2 mfd., 400 v., 3/3 ; 1 mfd., 1,000 v. w., 3/6 ; 0.25 mfd., 2,000 v. w., 4/-.

Tubular Types.
0.02 mfd. 750 v. 11d. ; 0.025 mfd. 350 v. 7d. ; 0.05 mfd., 1,000 v. 11d. ; 0.05 mfd., 500 v. 8d. ; 0.1 mfd., 1,000 v. 1/3 ; 0.25 mfd. 750 v. 1/4 ; 0.5 mfd. 500 v. 1/8 ; 0.5 mfd. 500 v. (aluminium case), 2/6. Mica types, .001 mfd. 2,250 v. 11d., 0.05 T.C.C. mica metal case, 1/8.

Resistors.
150, 220, 270, 1,000, 15,000, 20,000, 27,000, 33,000, 40,000, 100,000, 1 meg., 1.8 meg., 1 watt, 4/- doz. 600, 25,000, 50,000, 2 watt, 10d. All are Erie, and brand new stock.

Meters and Test Equipment.
If it is available we have it, only best makes handled. Present stocks include: Record Insulation Testers, £11 2s. 3d. Hunts C. & R. Bridges, £18 15s. Nullard C. & R. Bridges, £15 15s. Taylor C. & R. Bridges, £14 14s.

Mains Transformers.
We specialise in mains transformers for every purpose. Here are just a few of the types we can offer from stock:
Type MT/E 350-0-350 v., 100 m.a., 4 v. 2 a., 4 v. 5a, CT, 33/0. Type MT/A 350-0-350 v., 100 m.a., 5 v. 3 a., 6.3 v. 4 a., CT, 33/0. Type MT/EA 350-0-350 v., 100 m.a., 4 v. 3 a., 6.3 v. 4 a., CT, 33/0. Type MT/E150, 350-0-350 v., 150 m.a., 4 v. 3 a., 4 v. 3 a., CT, 4/ 5 a., CT, 42/0. Type MT/A150, 350-0-350 v., 150 m.a., 5 v. 3 a., 6.3 v. 4 a., CT, 41/3. Type MT/E, 450-0-450 v., 250 m.a., 4 v. 3 a., 4 v. 3 a., CT, 4/ 5 a., CT, 4/ 6 a., CT, 51/0. Type MT/7, 450-0-450 v., 250 m.a., 5 v. 3 a., 6.3 v. 4 a., CT, 6.3 v. 5 a., CT, 50/3. Type MT/8 500-0-500 v., 250 m.a., 4 v. 3 a., 4 v. 3 a., CT, 4 v. 3 a., CT, 4 v. 6 a., CT, 52/6.

Mains transformers built up to your own specifications. Other Lines.
Include Tuning Condensers of every description, Switches, Precision Dials, and others; Coils and Coil Assemblies, Feeders, Strainers, Co-axial Cables, 7 Mc. Crystals, Rectifiers, in fact, everything in radio for constructor, amateur and professional.
Now send us your orders for our Prompt Attention. Goods supplied against C.W.O., or C.R.D., whichever best suits you. When sending C.W.O., please include sufficient for Packing and Postage.

VALLANCE'S
144, Briggate, Leeds 1

Aladdin RADIO CORES
for all purposes
GREENFORD, MIDDx. WAXLOW 2300

MIDLAND INSTRUMENT CO.
Comprehensive range of Lewcos instrument wires, eureka and nickel chrome res. wires. Flexes and cables, electric accessories, sleeving. Empire tape, rubber grommets, L.T. rectifiers, Avometers, Wee-Meggers, Ohmmeters, speakers, chassis, dual-range and a.w. coils, var. cond., counters, synchronous motors, microphones, plugs and jacks, etc., etc.
New April lists, id. a.s.e. Trade lists, id. a.s.a.
18, Harborne Park Rd., Birmingham, 17
Tel. HAR. 1308 or 2664.

WARD ROTARY CONVERTERS
For Radio, Neon Signs, Television, Fluorescent Lighting, X-ray, Cinema Equipment and innumerable other applications
We also manufacture:—
Petrol Electric Generating Plants, H.T. Generators, D.C. Motors, Frequency Changers, etc., up to 25 K.V.A.
CHAS. F. WARD
37, WHITE POST LANE, HACKNEY WICK, E.9
Phone: Amherst 1393

NORMAN ROSE'S 1946 illustrated components price list now available to radio dealers, 2/4d., post paid.—Now open trade counter and showrooms at 53, Hampstead Rd., London, N.W.1 (corner of Tottenham Ct. Rd. and Euston Rd.). Norman Rose (Electrical) Ltd., 53, Hampstead Rd., N.W.1. [4666

SERVICEMEN.—The following products are well designed and of high quality; volume controls, carbon type, all values, with or less switch, wire-wound resistors, 1 to 60 watts; dropper resistors, 0.2 and 0.3 amp; line cords and razor resistors; terms and quotations on req.—Dagole, Ltd., 5, Torrens St., London, E.C.1.

SANGAMO synchronous motors, self-starting, exceptionally good torque, rotor speed 200 rpm, 200-250v ac, 50c, consumption 2 1/2 watts, size 2" x 2, geared 1 rev 60 min, can be reset to zero by friction drive from front or back shaft 1/4" x 1-10th to run clockwise, ideal movements for making electric clocks, time switches, etc., nickel-plated finish, price 22/6 ea, 12 to 1 dial trains to fit above spindle, per set 2/6.

CHAMBERLAIN and Hookham synchronous motors (enclosed type), self-starting, exceptionally good torque, rotor speed 200 rpm, 200-250v ac, 50c, consumption 3 watts, size 2 1/2" x 2, geared 1 rev 60 min, can be reset to zero by friction drive from front or back shaft 1/4" x 1-10th to run clockwise, ideal movements for making electric clocks, time switches, etc., nickel-plated finish, price 25/- ea; 12 to 1 dial trains to fit above spindle, per set 2/6.

15-AMP mercury switches, enclosed bakelite tubular cases, 2 1/2" x 1/4", fitted swivel saddle, connector block, etc; 5/6 ea.

CASH with order post paid on all above goods. To callers only, a comprehensive stock of scientific instruments, meters, gears, relays, etc. H. FRANKS, Scientific Stores, 58, New Oxford St., W.C.1, Tel. Mfg. 256.

AMATEUR RADIO PRODUCTS have now available a four waveband short wave coil unit, 4 coils covering, 9.8 to 206 metres, for 2-valve short wave battery receiver, with blue print, 30/-; individual coils with reaction winding, 3/3 each; R.F. chokes, 2.5mh, 200 m/amps, 3/6 each; R.F. chokes for transmitters, from 8/6 each; ready shortly: transmitter inductances with and without swinging link, etc., neutralising condensers, tuning condensers suitable for transmitters. All products made by highly experienced amateur constructors for amateurs. Send us your problems and remember our advice and assistance is free.

AMATEUR RADIO PRODUCTS, 50, Glasslyn Rd., Crouch End, London, N.8. Tel. Mount View 4745. [4678

C.C. instrument wires, 1/4lb reels, 18, 20 22, 24g, 1/6; 26, 28g, 1/9; 30, 32g, 2/-; 34g, 2/3; enamelled ditto, same prices including 35g, 2/3; 38g, 2/6; 40g, 2/6; silk covered, 2oz reels, 24, 26, 28g, 1/3; 30g, 32, 34, 36g, 1/9; 40, 42g, 2/-; 16g, D.S.C. 1lb, 5/-; R.C. stranded wires, 1 1/2d, 2 1/2d, yard; stranded pushback wire, coloured, tracered, 2/3 doz. yards; good quality resin-cored solder, guaran tee fresh, 1lb reel, 3/6.

TRADE enquiries invited.—Post Radio Supplies, 33, Bourne Gardens, London, E.4. [5019

CHARLES AMPLIFIERS now offer to the serious music lover and home constructor circuit details of superb high fidelity amplifiers and tuning units embodying up-to-the-minute post-war developments; these circuits set a new high standard of thrillingly realistic reproduction, and incorporate cathode follower output stages and flexible bass and treble tone controls; comprehensive circuit diagrams and constructional layout of push-pull 7 watt and single ended 3 1/2 watt amplifiers and radio tuning unit, 5/- complete set; all components available.—Charles Amplifiers, 14, Lapstone Gdns., Kenton, Harrow, Middlesex. [4941

THE Simplex Four, still the best, complete constructional details; Midget ac/dc (total cost of construction £9), theoretical and full-scale layout diagrams, with instructions, per copy, 4/6; Midget polished wood cabinets, 35/-; Midget m. wave T.R.F. coils, high gain, 7/6; m.l. wave, with reaction, circuit, 10/6; the latest, iron cored m. and l. wave, T.R.F. coils, adjustable cores, with circuit, 12/6; ditto a. and osc. coils, m. and l. wave, for the pocket receiver, i.f. at 465 kc/s, with circuit, 12/6; a. and osc. coils, s.m.l. wave, ditto i.f. with circuit, 15/- pair; Midget i.f. transformers, 465 kc/s, 15/- pair; all wave coil pack, wired, tested, 5 leads to receiver, boxed, with circuit, 40/-; Midget ivoryine coloured dials, s.m.l. wave, 4 x 3 1/2, 2/6; coloured s.m.l. dials on glass, 9 x 4 1/2, 3/6; slow motion drives, 2-speed, with driving disc, 3/6; ditto string drum drive, 1-speed, 2/6; Midget Simplex chassis, fully drilled with 4 valve holes, etc., 1 1/2" x 2 1/2", with speaker cut-out, the best for Midgets, 7/6; monthly comprehensive lists, 2/4d stamp with enquiries; postage all orders.
O. GREENLICK, Ltd., 34, Bancroft Rd., Cam bridge Heath Rd., London, E.1. Ste. 1334

SOLON
INDUSTRIAL
ELECTRIC APPLIANCES

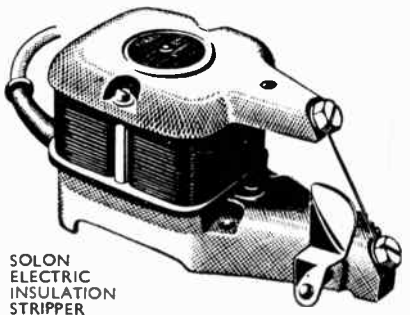

SOLON ELECTRIC INSULATION STRIPPER

The **SOLON Electric Insulation Stripper** provides a quick method of severing the insulation neatly without damaging the conductor, by means of an electrically heated wire. Full details are given in Folder Y.9, which also describes the range of **SOLON Electric Soldering Irons** and the **SOLON Electric Solder Pot**.

W. T. HENLEY'S TELEGRAPH WORKS COMPANY, LIMITED,
51-53, HATTON GARDEN, E.C.1

REWINDS
Armatures, Fields, Transformers, Pick-ups, Vacuum Cleaners, Gram. Motors. Speakers Refitted New Cones & Speech Coils.
All Guaranteed and promptly executed.
Valves, B.V.A. and American, good stocks. Send stamped addressed envelope for list of Radio Spares, and C.O.D. Service.
A.D.S. Co. 281-3-5, Lichfield Road, ASTON, BIRMINGHAM, 6

BATTERY CHARGERS & TRICKLE CHARGERS
Trouble-free Chargers fitted with selenium all-metal rectification. Good allowance on your old Charger. Thirty years experience behind every Runbaken product. Booklet R-15, describing 12 Models, on request.
RUNBAKEN-MANCHESTER-1

"ENGINEERING OPPORTUNITIES"
This unique handbook shows the easy way to secure A.M.I.Mech.E., A.M.Brit.I.R.E., A.M.I.E.E., City and Guilds, etc.
WE GUARANTEE— "NO PASS—NO FEE."
Details are given of over 150 Diploma Courses in all branches of Civil, Mech., Elec., Motor, Aero., Radio, Television and Production Engineering, Tracing, Building, Govt. Employment, R.A.F. Maths., Matriculation, etc.
Think of the future and send for your copy at once—FREE.
B.I.E.T., 387, SHAKESPEARE HOUSE, 17, STRATFORD PLACE, LONDON, W.1.



IDENTITY

Symbol of individual identity. Bull's known Symbol is a Valve; a known fact, too, is that, apart from the (almost) complete Valve Stock, Bulls are first out with Radio novelties and Specialities, both popular and rare:

Resistance and Capacity Test Box, £3 17s. 6d.
STANDS for Soldering Irons, with compartment for holding one-pound reels of solder, 6/6.
MECHANICAL HAMMER and DRILL GUN, 120 revolutions per minute (Rawplug Product) 52/6.

RAYMART PRODUCTS

Ceramic Valveholders, Ceramic Couplers, Couplers, Speed Keys, High Note Buzzers, Hand-off Insulators, Beehive Hand-off Insulators, H.F. Pillar Insulators, Feed-through Bushes, Feed-through Insulators, Lead-in Insulators, Feeder Spreaders, Transposition Blocks, Aerial "T" Pieces, Transmitting Aerial Insulators, Toggle Switches, Variable Condensers, Knobs and Dials, S.W. Coils, Coll. Formers, Coil Holders, S.M.V. Utility Micro Dials.

UNIVERSAL MULTIMETER

Made by British Physical Laboratories. Specification: 1,000 ohms per volt on A.C. and D.C. ranges. In shock-resisting bakelite case, with toughened glass. Size, 4in. x 4in. x 5 1/2in. Ranges A.C. and D.C. volts 0/10, 0/50, 0/100, 0/500. D.C. milliamperes 0/1, 0/10, 0/100, 0/500. Resistance Range 0/10,000 ohms. Rotary Range Selector. Accuracy 2 per cent. Price, £5 15s.

Also **FERRARIS** and **AVONMINOR** AMMETER, Moving Coil, 30 amps, discharge, as fitted to cars and suitable when external shunt has been removed, for Circuit Testers, Trickle Charges, etc., 18/6.

ELIMINATORS, Output 120 v. and 60 v. on 2 Tappings at 20 m.a. Regulated Transformer for A.C. mains, 45/-.

BATTERY CHARGERS, "Overnight" Model 6 of 12 volts 1 amp. With ammeter, £4 14s. 5d.; without, £3 10s. 6d.

TRICKLE HOME CHARGER, Input 200-250 volts A.C. Output 6/12 volts to 1.0 amps. D.C., £4 10s.

RAWPLUG WORKSHOP OUTFIT, over 200 parts in a handy box with eight compartments and 24-page booklet, complete, 15s.

VARIABLE and **ACCUMULATORS**, 20 A.H., 16/3
CONDENSERS: 8 mfd., 3/1. Small can 3/8. 8-8, 5/-, Small can, 7/6. 16 mfd., small can, 5/- 8-16 small can, 8/3.

SPECIAL OFFER:

3 Ivorine articles: **FLIKODISC**, ohms-volts-amps-watts calculator; Colour Code **INDICATOR**; All wave **DIAL**. All three, 10/-.
NEON TESTER, Universal V.C. pocket Instrn., 12/6.
VOLTMETERS, pocket model, 0-120, 13/6.
SPEAKERS, 3 1/2in. Goodman's, 30/-.
TRIMMER TOOL KITS available again, 30/-.
CAR HEATERS, 200/250 v., 100 watts, 12/-.
TOM THUMB, Gramo Amplifier, ready to assemble, £3 18s., complete with case.

VALVE STOCK

See List in April issue. Also enquire for types not listed; we may have them.

SPARES

We maintain a well-assorted stock of Components of tested quality.

LITERATURE. All books in stock. Order C.O.D. Under 10/- c.w.o. Enquiries 21d.

EXPORT

Orders safely packed and fully insured. Forces and DEMOBilised—Special Attention.

J. BULL & SONS (W.W.)

246, HIGH STREET, HARLESDEN, N.W.10.



W. BRYAN SAVAGE LTD.

Expert assistance in the solution of problems relating to

- TRANSFORMERS, CHOKES
- AMPLIFIERS
- POWER UNITS

and Specialised Equipment embodying
ELECTRONIC CONTROL

WESTMORELAND RD., N.W.9
COLINDALE 7131

KINSEY'S RADIO ELECTRIC.—Rola moving coil speakers, 8in, 19/6; output trans., 2 Ratio, 4/9; multi ratio, 22-1. 36-1, 45-1. 58-1, 72-1, 116-1, 7/6 each; mains trans., 4v 4A, 4v 2A, 350-350, 100 MA, or 6.3v 3A, 5v 2.5A, 25/-; T.C.C. 10mfd 50v wkg., 1/-; hand lamps, takes twin cell batt., 1/-; genuine transformer aerial, just join to earth, 5/6; Bell transformers, 5/6; electric bells, 5/8; B.I. 8mfd 500v wkg. condensers, 2/9; 8x8 550v wkg., 4/6; tub. condensers, 0.1, 0.01, 0.001, 0.05, 0.02, 7/6 doz.; Midget smoothing chokes, 4/-; vol. controls, W.S., all values, 4/-; L.S., 3/-; Wearite P. coils, 2/3; all types Yaxley type switches, 4-pole 3-way, 4/-; 3,000 valves in stock.

CALLERS: 499, Rochdale Rd., Colyhurst Manchester, 9.
MAIL order: 1, Plymouth Grove West, Manchester, 13; Tel. Col. 2139, Ard. 3638.
TERMS: Cash with order, c.o.d. or pro forma. Orders over £1 post free, 1/- charge for post and packing under £1. No c.o.d. under £1. Send for current list. [5043

A MERICAN condensers, Sprague, Aerovox, and Solar, 1mfd, 750v dc wkg., block, 2/6; 1,000v, 5/-; 4mfd, 1,000v, 9/-; 8mfd, 600v, 5/6; 1,000v, 14/-; 10mfd, 400v, 5/-; 600v, 6/-; 8mfd, 500v electrolytic can, 3/6; 18mfd, 500v 4/-; 8-8mfd, 500v, 4/6; M.O.S., 24, New Rd., London, E.1. Postage under £1. [5062

METAL rectifiers, charger kits, mikes, Pick-ups, condensers, eliminator kit, metal rectifier 12v 1.5 amp with 50w transformer and ballast bulb for 2v to 12v charger, 37/6, post 10d. ditto with larger 2 amp rectifier, 45/-; ditto 2 amp but for 2v, 6v only, 36/-, postage 10d. Metal rectifier, 2v 0.5 amp, with small transformer for 2v trickle charger 13/6, post 7d. De Luxe car owner kit, metal rectifier 12v 3 amp, with transformer and ballast bulb for 2v to 12v charger, 2 rate charging, 59/6. All kits fully guaranteed. Heavy duty transformer and rectifier for 6v/12v charger, 4 amp £4, 5 amp £4/10. Metal rectifier, transformer, ballast bulb for 3 cell to 20 cell at one amp charger, one year guarantee, £5/10. Rectifiers, 12v 1.5 amp, 10/6, post 7d.; 12v 2.5 amp 16/6, 12v 2 amp 25/-, 12v 4 amp 32/6. Complete range of rectifiers for converting valve type chargers to metal rectifier. Type M.B.S.1 1ma instrument rectifiers 18/6, ht rectifiers 250v 60ma 14/-, 120v 20ma 7/9. Transformer, rectifier, two condensers for 120v 20ma eliminator 35/-, with 2v trickle 43/-, post 8d. Dubilier, Hunts, T.C.C. 8mfd 450v tubular electrolytics 12/- for 4, post 6d. **CHAMPION**, 43, Uplands Way, London, N.21. 'Phone Lab. 4457. [5064

REPAIRS AND SERVICE

MAINS transformer rewind and constructed to any specification; prompt delivery.—Brown, 3, Bede Burn Rd., Harrow, [3460
ACCURATE radio rewinds, mains transformers, fields, op. transformers, etc.—Southern Trade Services, 297-299, High St., Croydon. [5158
LOUDSPEAKER repairs, British, American, any make; moderate prices.—Sinclair Speakers, 12, Pembroke St., London, N.1 Terminus 4355. [3308
AL types of radio receivers serviced; Murphy and Pilot specialist; valves in stock; sound repairs for 13 years.—E. Fevry, F.I.P.R.E., 50, Vine St., Uxbridge.
SINGLE and multi-range meters promptly repaired, British or American; accuracy guaranteed, expert workmanship; quotations free.—Wilson, 35, Stella St., Mansfield. [5049
REWINDS and conversions to mains and PP output transformers, fields, etc. from 4/6. Equipment a speciality.—N. L. Rewinds, 4, Brecknock Rd., N.7. Tel. Arnok 3390. [5185
RADIO repairs quickly executed to all makes, English or American; lowest possible prices.—The Music Box, 89, London Rd., London, S.E.1 (Tel Waterloo 4460 and 6766.)
STURDY rewinds, mains transformers, chokes and fields; we give prompt delivery and guarantee satisfaction; 14 years' experience; prices on request.—Sturdy Electric Co., Ltd., Dipton, Newcastle-upon-Tyne. [4316
REPAIRS to moving coil speaker, cones, coils fitted, field rewind or altered; speaker transformers, clock coils rewind, guaranteed satisfaction, prompt service.
L.S. REPAIR SERVICE, 49, Trinity Rd., Upper Tooting, London, S.W.17. [4819
TRANSFORMERS rewind, mains from 15/6; outputs, field coils wound or altered, etc.; 48-hour service; price list on request.—North-West Electrical, 36, Rosslyn Hill, N.W.3. [5184
TELEVISION and radio service.—Repairs to all makes, British and American; specialists in the repair of pick-ups, mikes, p.a. equipment, and test gear; enquiries invited for trade rates.—Craig Bros., 141, Park Rd., London, N.W.8. [4862

ARMSTRONG

Model EXP83

ALL-WAVE 8-VALVE SUPERHET

CHASSIS incorporating wave band expansion. Large glass scale treble boost control. The latter together with tone and volume controls work on both radio and gram. High quality push-pull output gives 10 watts audio. For 100-250 v. A.C. mains.

Provisional price 14 gns. plus tax.

Model EXP43

ALL-WAVE SUPERHET FEEDER

UNIT incorporating wave band expansion, manual I.F. gain control, etc. Now fitted with own power supply and smoothing.

Price to be announced later.

Model EXP63

ALL-WAVE 6-VALVE SUPERHET

CHASSIS incorporating wave band expansion on all bands, e.g., the 16-50 metre band covers just over 20 inches on the large illuminated glass scale. Tone and volume controls work on both radio and gram. R.C. coupled, output. For 100-250 v. A.C. or D.C. mains.

Provisional price 11 gns. plus tax

The above chassis are of entirely new design and capable of a high performance. Demonstration Sets are now available for interested callers to hear and illustrated technical specifications are now ready.

Model AMP14

HIGH GRADE AMPLIFIER in well-finished metal instrument case. Two inputs, bass compensating circuit, treble boost control, 14 watts push-pull output preceded by 4 triodes.

Provisional price 15 gns.

ARMSTRONG METAL WORKING DIVISION

We manufacture high-grade Metal Instrument Cabinets, detachable front and back panels, satin ripple finish, with plated handles. Stock sizes, 15 in. long x 8 1/2 in. x 10 in. high and 18 in. long x 8 1/2 in. x 10 in. high. Prices 50/- and 55/- Special sizes to order.

ARMSTRONG WIRELESS & CO. LTD.

TELEVISION
WARLTERS ROAD, HOLLOWAY, LONDON, N.7

'Phone : NORth 3213

MATRICULATION

brings Success & Security

Whatever your age, you can now study for the all-important Matriculation Examination at home on "NO PASS—NO FEE" terms. "MATRIC" is the accepted passport to all careers, and opens up opportunities which would otherwise be completely closed to you. Ensure the success and security of you and yours through post war difficulties by writing for our valuable "Guide to Matriculation" immediately—FREE

B.T.I. (Dept. 114)

356, Oxford Street, London, W.1.

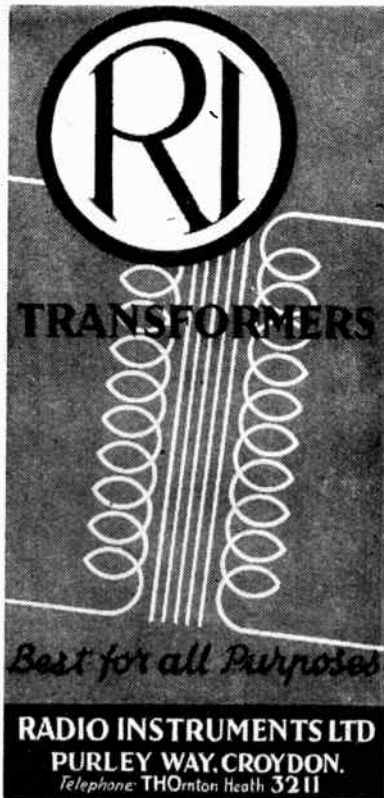

TRANSFORMERS

Best for all Purposes

RADIO INSTRUMENTS LTD
PURLEY WAY, CROYDON.
 Telephone: THORnton Heath 3211

THE COIL PICKUP
 FIRST THE PIONEER AND NOW THE LEADING QUALITY INSTRUMENT

Deliveries from:—
WILKINS & WRIGHT LTD.
 Utility Works,
 Holyhead Road, Birmingham, 21

hams

HAVE YOU HAD OUR
 1946 (20 PAGE)
 CATALOGUE ?

—IT'S WELL WORTH
 WRITING FOR—

Send 3d. stamp for
 a Post Free copy.

BERRY'S (SHORT WAVE) LTD.

25 HIGH HOLBORN
 LONDON, W.C.1.
 (Opposite Chancery Lane).

Phone: H101.born 6231.

"SERVICE with a Smile."—Repairers of all types of British and American receivers; coil rewinds; American valves, spares, line cord.—F.R.I., Ltd., 22, Howland St., W.1. Museum 5675. [1575]

DEGALLIER'S, Ltd., for Service with a Guarantee; let American specialists with proper test gear do your work; we can handle any receiver from a Midget to the 24-tube Scott; send chassis and valves only; all railway companies deliver daily; s.a.e. with all enquiries. [1575]

DEGALLIER'S, Ltd., 9, Westbourne Court, London, W.2. [4650]

REWINDS, mains transformers, speaker field coil-chokes, high-grade workmanship, 7 day delivery; new transformers constructed to customers' specification, singly or in quantities.—Metropolitan Radio Service Co., 1021, Finchley Rd., N.W.11. Speedwell 3000. [3719]

24-HOUR service, 6 months' guarantee, any transformer rewind, mains outputs and i.f.s., etc., all types of new transf., etc., supplied to specification; business heading or service card for trade price.—Majestic Windinz Co., 180, Windham Rd., Bournemouth.

LOUDSPEAKER repairs, any make, reason-able prices, prompt delivery, to the trade and quality fans; 25 years' combined experience with Rola, Magnavox, Goodmans, Celestion.—Sound Service Radio, 80, Richmond Rd., Kingston-on-Thames. Kin. 8008. [4977]

REWINDS, mains transformers, layer wound, wax impregnated, O/P transformers, chokes, fields, clock coils, pick-ups, fractional hp motors, competitive prices; prompt delivery; guaranteed work.—W. Groves, Manufacturing Electrical Engineer, 154, Arkfield Port Rd., Birmingham, 16. [4547]

TRANSFORMER rewinds and replacement coils, machine layer wound on bakelite former, interleaved, impregnated and clearly marked, rewinds, £1; standard windings to 70watts, coils, 15/6; extra secondaries and larger types pro rata, new transformers or chokes to specification, singly or in quantity; trade list on application; delivery by return of post most types; state model and iron sizes when ordering coils, pick-ups, o/p trans., field coils, etc., rewound or replaced; fully guaranteed.—Radio Services, Field St., Works, Blackpool, R.T.R.A. Serv. Members. Tel. 1250-1774.

MISCELLANEOUS

BARRETT, ex-club Harry, please contact Monks, 119, Fielding Rd. London, W.4.

TIME Recorders.—Write for particulars.—Gledhill-Brook Time Recorders, Ltd., 84, Empire Works, Huddersfield. [2419]

FOR disposal, Amer. I.R.E. Journals, 1923-38, 147 copies; Q.S.T., 1923-39, 180 copies; what offers?—Box 6731. [5113]

23 copies of the "Wireless Engineer," Oct., 1942 to Aug., 1944; £2/17/6, carriage paid.—Dowsett, 48, Grove Rd., Eastbourne.

SPARKS' data sheets.—These data sheets provide complete constructional details, together with full-size prints, etc., of tested and guaranteed designs.

ELECTRIC guitar units (3rd edition), 5/-.
ELECTRONIC one-string fiddle, 3/6; 6.8watt ac/dc amplifier; phase inverter; push-pull output; neg. feedback; portable for use with above or mike, p.u., etc., 3/6.
SPARKS' DATA SHEETS (W.), 9, Pheobeth Rd., Brockley, London, S.E.4. [3622]

MIDGET polished wood cabinets, inside meas. 10¼x5inx5½in deep; plain or cut for speaker only 17/6, plus 1/- post and packing; cut to your requirements 2/- extra.—Morris, 9, Wicklow Av., Stockport. [5074]

ADVERTISERS desire to contact manufacturer capable of undertaking supply of small carbon microphones associated transformers and single earphones suitable for incorporating into hearing aids.—Box 6899.

IDEAS mean money!—If you have an idea, we can help you to make the most of it; write at once for full information on the technical, legal and financial services we offer to inventors.—Technico-Legal Services Bureau, 55, Romney St., Westminster, S.W.1. [4948]

INTERNATIONAL relay rack assemblies, 3½in panel space rack, carriage paid, £2; 14 gauge Alodid black crackle panels, 4/1 to 7/6; 16 gauge aluminium chassis with panel fixing brackets and screws, 10/-; s.a.e. lists amplifiers, etc.

AMATEUR RADIO SERVICE G6HP, 27-29, Canning St., Burnley. [5157]

WANTED, EXCHANGE, ETC.

RADIO service data sheets, all makes.—Box 7313. [5188]

VOIGT twin unit, 400v field, also Voigt pick-up.—Box 7252. [5183]

PROFESSIONAL magnetic recording cutter required.—Box 6676. [5105]

VOIGT corner horn speaker, complete; offers to: 51, Fairway, Stafford. [5142]

WD., tracking gear, suitable 12in discs.—Taylor, Allarburn, Elgin, Scotland. [5130]

THESE ARE IN STOCK

PRACTICAL WIRELESS SERVICE MANUAL. By P. J. Canin. 3s. 6d. Postage 4d.

THE ELECTRON MICROSCOPE. By D. Gabor 4s. 6d. Postage 3d.

ULTRA-HIGH-FREQUENCY RADIO ENGINEERING. By W. L. Emery. 16s. 6d. Postage 6d.

SHORT WAVE WIRELESS COMMUNICATION. By Lander and Stoner. 35s. Postage 6d.

WIRELESS WORLD VALVE DATA. 2s. Postage 2d.

MODERN RADIO COMMUNICATION, Vol. 1. By J. H. Keyner. 7s. 6d. Postage 4d.

TELEVISION RECEIVING EQUIPMENT. By W. T. Cocking. 10s. 6d. Postage 4d.

NEWNES TELEVISION MANUAL. By F. J. Corgan. 6s. Postage 4d.

FOUNDATIONS OF WIRELESS. By M. G. Scroggie. 7s. 6d. Postage 4d.

RADIO UPKEEP AND REPAIRS. By A. T. Witte. 7s. 6d. Postage 4d.

WORKED RADIO CALCULATIONS. By A. T. Witte. 6s. 6d. Postage 4d.

THE AMATEUR RADIO HANDBOOK. Second Edition. 3s. 6d. Postage 6d.

AN INTRODUCTION TO THE THEORY AND DESIGN OF ELECTRIC WAVE FILTERS. By F. Scowen. 15s. Postage 6d.

PLASTICS IN INDUSTRY. By "Plastes." 15s. Postage 6d.

WRITE OR CALL FOR COMPLETE LIST, 1d.

THE MODERN BOOK CO.,
 (Dept. W.12), 19-23, PRAE STREET,
 LONDON, W.2

THE INFINITE IMPEDANCE ADAPTOR.

An Ultra Modern Servicing Instrument, designed to facilitate simple and positive tests of Oscillator, circuit, detector circuits, A.V.C. components and voltages, etc., etc. With this instrument also many other special operations can be performed; for instance, alignment is possible without a Signal Generator. Price 8s 17s. 6d. complete. Instruction manual, which is a text-book in itself, 5s., post free.

V.E.S. (W) RADIO HOUSE, RUISLIP, MIDDLESEX

NEW DUAL TESTOSCOPE



Ideal for high and low voltage testing; 1/30, 100/850 A.C. and D.C.

Allowance made on old models

Send for interesting leaflet (R.14) on Electrical and Radio Testing, from all Dealers or direct.

RUNBAKEN-MANCHESTER-I

AMBASSADOR

TYPE P.A. 145

SPECIFICATION

20 Watt A.C. Amplifier with built-in Super-het Receiver covering 200-550 Metres. Specially recommended for Schools, Factories, Hospitals, etc. Full specification on request.

INDUSTRIAL RADIO AMPLIFIER



R. N. FITTON, LTD.
 HUTCHINSON LANE, BRIGHOUSE. Tel: 283

Scottish Distributors:
BRITISH ELECTRICAL & MFG. CO. LTD
 133 West Campbell St., GLASGOW. Tel.: Cen. 3286

R.76 10 0
 P.U.S. Tax 2 2 0

LASKY'S RADIO

FOR ELECTROLYTIC CONDENSERS
MIDGET ALUMINIUM CANS

500 volts working.
8 mfd. ... 3/- 8-16 mfd. ... 5/6
16 mfd. ... 4/9 8-16 mfd. ... 6/9

MIDGET TUBULAR CARDBOARD
500 volts working.
8 mfd. ... 3/6 4 mfd. ... 2/10

HIGH-VOLTAGE OIL-FILLED
CONDENSERS.

mfd.	Volts working	mfd.	Volts working
8	1,000 ... 12/6	4	450 ... 3/9
8	600 ... 7/-	1	1,000 ... 6/-
10	600 ... 7/-	1	750 ... 3/6
10	400 ... 6/-	0.5	5,000 ... 12/6
4	1,000 ... 9/6	0.1	6,000 ... 10/-

ALL WITH FIXING CLIPS
ELECTROLYTIC BLOCK
CONDENSERS

mfd.	Volts working	mfd.	Volts working
16 + 16	350 ... 7/-	24	650 ... 12/6
8	500 ... 4/-	4	350 ... 3/6

ALL TYPES OF BIAS AND BY-PASS
CONDENSERS IN STOCK

0.1, 0.01, etc.,
25 mfd., 25 volts; 50 mfd., 12 volts, etc.

SEE PREVIOUS ADVERTISEMENTS
Send Id. for latest current List,
NOW IN PRINT

Terms: C.O.D., pro forma and cash with
order.

Everything for the Home Set Constructor,
Ham and Serviceman.
Trade Enquiries Invited.

LASKY'S RADIO

370, Harrow Road
PADDINGTON, LONDON, W.9

(Opposite Paddington Hospital).
Tel.: Cunninham 1979.

'ASTRONIC'

BNN TYPE AUDIO TRANSFORMERS

Available with high or medium
fidelity response for input, driver
or small output applications



BNN SERIES FEATURE:—

- Semi-toroidal coil structure
- Single, dual or tri-alloy shielding, giving noise-suppression up to —80db
- High fidelity types 1db 20 to 20,000 c/s
- Medium-fidelity types 1db 50 to 10,000 c/s
- Terminations:—International Octal Base.
- Mounting flange with soldering spalls. Flexible leads
- Hermetically-sealed if required

ASSOCIATED ELECTRONIC ENGINEERS Ltd
DALSTON GARDENS · STANMORE · MDDX

Telephone: WORDsworth 4474/5/6
Telegrams: "Electronic, Stanmore"

WTD, set back numbers "Wireless World,"
1935-Jan.-1942; price.—Box 6520. (5085

WANTED, Ferranti car radio, 12-volt,
latest (1939-40) model.—Box 7127. (5147

WTD, "Wireless World," March, 1946;
high price.—Hubble, 42, Station Rd., N.21.

HAYNES, duophone, feed choke.—Wignall,
Bond Ter., Walmer Br., Longton, Preston.

AVO oscillators, good condition: Mr. Gass-
man 6, Argyll Rd., Westcliff-on-Sea.

WANTED, M.S. 4-valve radio, Marconi or
Osram.—Barber, 24, Mill Rd., Haverhill.

WANTED, duode speaker, engraved type,
state particulars.—12, Hollydale Drive,
Bromley, Kent. (5121)

WANTED, Tungsram valves, HP2118,
R2018, PV3018.—Lawton, Oriol, Ecton
Ave., Macclesfield. (5128)

WANTED, Rothermel Piezo electric speaker,
model H85 or R95.—33, Huxley Gardens,
West Twyford, N.W.10. (5118)

VOIGT corner cabinet, not H.C. horn—
Richardson, 107, Norman Ave., Eccles-
hill, Bradford, Yorks. (5191)

WANTED, service sheets, battery, dc, ac/dc
sets, all makes 1935 onward; state con-
dition and price.—Box 7161. (5156)

WANTED, coil winder, hand or auto, for
mains or audio transformers, IF and RF
coils.—A. S. L. 95, Morley Hill, Enfield, Mdx.

"WIRELESS World" Vol. XLIII, Nos. 7 &
8, for binding; also 8, W.M. Vol. 2 com-
plete, and 1938 or 1939 Call Book.—Box 6861.

SEVERAL Electrostatic speakers wanted,
e.g., Primustatic or similar, in working
order if possible; collection arranged in London
area.—Box 6675. (5104)

G. W. SMITH & Co. (RADIO), Ltd., require
the following: new or second-hand radio
receivers and radiograms; all classes of
test equipment; highest cash prices paid.

G. W. SMITH & Co. (RADIO), Ltd., 2, Cecil
Rd., Southgate, London, N.14. Tel.
Enterprise 5463. (5116)

WANTED, electric gramophone motors,
complete with turntable and speed regu-
lator, Garrard 201 preferred, must be in good
condition; details and price required to R. B.
Ransome, Sproughton, Nr. Ipswich. (5148)

URGENTLY required, high grade all-wave
receivers, radio gramophones communi-
cation receivers, Hamerlunds, R.M.E.s, H.R.O.,
Hallicrafters, etc.—Alert Radio Co., 27, Temple
Fortune Mans., N.W.11. Speedwell 4352.

WE buy for cash, new, used, radio, electri-
cal equipment all types; especially
wanted, radios, radiograms, test equipment,
motors, chargers, recording gear, etc.—If you
want to sell at the maximum price, call, write
or phone to University Radio, Ltd., 22, Lisle
St., Leicester Square, W.C.2. Ger. 4447.

TUITION
RADIO training.—P.M.G. exams. and I.E.E.
Diploma; prospectus free.—Technical
College, Hull. (0611)

GENTLEMAN interested small repair busi-
ness requires personal practical radio
tuition; substantial fee offered; own modern
equipment and workshop.—Box 6016. (4953)

RADIO Engineering, Television and Wire-
less Telegraphy, comprehensive postal
courses of instruction.—Apply British School
of Telegraphy, Ltd., 179, Chatham Rd., Lon-
don, S.W.9 (Estd. 1906). Also instruction at
school in wireless for H.M. Merchant Navy
and R.A.F. (9249)

THE Tuitionary Board of the Institute of
Practical Radio Engineers have avail-
able home study courses covering elemen-
tary, theoretical, mathematical, practical and
laboratory tuition in radio and television
engineering; the text is suitable coaching
matter for I.P.R.E., Service-entry and pro-
gressive exams, tuitionary fees—at pre-war
rates are moderate.—The Syllabus of Instruc-
tional Text may be obtained post free from
Secretary, 20, Fairfield Rd., Crouch End, N.8.

THE BRITISH NATIONAL RADIO
SCHOOL is a long-established and highly
successful correspondence school, specialising
in transforming operators into engineers, and
in this chosen field it stands supreme; during
the war years we have been unable to accept
students other than radio officers serving in
the Merchant Navy; hence we have not adver-
tised, but now we are again free to enrol a
limited number of students from "Wireless
World" readers seeking personal tuition in
preparation for C. & G., Brit. I.R.E. and
I.E.E. examinations; our Radar course is now
ready.—Please write fully to Director of
Studies, B.N.R.S., 66, Addiscombe Rd., Crow-
don (5008)

SITUATIONS VACANT
DRAUGHTSMEN and tracers required for
S. London, with exp. in prod. of working
drawings from data supplied by designers:
(1) Mech. draughting; (2) Elect., preferably
with exp. on radio comm. equipment; work-
shop exp. preferred.—Apply in writing, with
full details, to R.T.E., Ltd., 45, Nightingale
Lane S.W.12 (4635)

SURPLUS STOCKS

A word of Warning

"Bargains" in the form of surplus radio com-
ponents are being offered to the radio trade
and the public. Condensers made by T.C.C.
are included. And it is concerning these that
we issue this warning.

Such articles were generally made for special
war purposes and rarely will they have any
safe peace-time application. Furthermore,
many of them will have been in store for long
periods and under adverse conditions.

They have not been re-tested by us and we
accept no responsibility for their perfor-
mance, nor—of course—for any conse-
quential damage their failure may cause.

Our warning could apply equally well to the
large quantities of components imported (but
not used during the war), and now being
dumped on this market—but it is with our
own products that we are chiefly concerned.
We know their origin from their markings.

Better be safe than sorry!

Issued by the makers of



THE TELEGRAPH CONDENSER CO. LTD.
RADIO DIVISION
NORTH ACTON, LONDON, W.3
Telephone: Acorn 0061



FOR THE RADIO SERVICE MAN, DEALER AND OWNER

The man who enrolls for an I.C.S. Radio
Course learns radio thoroughly, com-
pletely, practically. When he earns his
diploma, he will KNOW radio. We are
not content merely to teach the principles
of radio, we want to show our students
how to apply that training in practical,
every-day, radio service work. We train
them to be successful!

Special terms for members of H.M.
Forces and discharged disabled members
of H.M. Armed Forces.

INTERNATIONAL CORRESPONDENCE SCHOOLS

Dept. 38, International Buildings,
Kingsway, London, W.C.2
Please explain fully about your instruction in
the subject marked X.

Complete Radio Engineering
Radio Service Engineering
Elementary Radio Television

And the following Radio examinations:
British Institution of Radio Engineers
P.M.G. Certificate for Wireless Operators
City and Guilds Telecommunications
Wireless Operator & Wireless Mechanic, R.A.F.

Name Age
Address

**An EXHIBITION of
MODERN RADIO
COMPONENTS and
AMATEUR COMMUNICATION
EQUIPMENT**

9 a.m. to 5.30 p.m.
Every Day except Thursday (9 a.m. to 1 p.m.)



Staffed by:—
G3AD - G8ZD - SPIHH/SP2HH
TELE-RADIO (1943) LTD.
177 Edgware Road,
LONDON, W.2.
Telephone: PADdington 6116.

HILL & CHURCHILL LTD
BOOKSELLERS
SWANAGE DORSET

ENGLISH & AMERICAN
BOOKS IN STOCK ON
RADIO AND
TELECOMMUNICATION
CATALOGUE ON APPLICATION

"VIBRO-ARC" Engraving Pen

10/-



For rapid engraving any metal—hard or soft.
Operates from 4-6v. Battery or A.C. Transformer giving 6-10 amps.

HOLBOROW,
46, Boroughbridge, Yorks.

QUARTZ PLATES

for
Communication
Equipment



Made by
SALFORD ELECTRICAL INSTRUMENTS LTD.
PREL WORKS SALFORD 2
Proprietors: THE GENERAL ELECTRIC Co Ltd. of England

EXPERIENCED sound equipment service engineer for the Midlands; ability to service "Music while you work" installations; must own car; salary, bonus, car exp.—Box 6725.

E. K. COLE, Ltd., require fault-finders and testers for radio and television receivers.—Apply, giving full particulars of experience, to Personnel Manager, Ekco Works, South-end-on-Sea. [4999]

DRAUGHTSMAN with experience in production drawing of radio apparatus. A.E.S.D. rates.—Applications in writing to Personnel Manager, E. K. Cole, Ltd., South-end-on-Sea, Essex. [4969]

RADIO service engineer required for retail service dept.; must have commercial experience; good prospects. Details and salary required to: Anelo; Radio, 36, Hindmans Rd, E. Dulwich, S.E.22. [5021]

BUYER required by progressive radio factory in North London area; sound knowledge of trade essential.—Apply fully, stating age, qualifications, experience, salary required, to Box 7401. [5240]

CHIEF draughtsman required for company manufacturing radio test equipment.—Applications are invited from men with suitable experience, giving full particulars and salary required, to Box 7157. [5151]

3 draughtsmen required, experienced in radio and electro-mechanical apparatus.—Write in confidence, giving details of training, experience, age, salary required, to Sobell Industries, Ltd., Plantation Rd., Amersham. [5171]

PRODUCTION manager wanted by Northern radio and component manufacturer; experience modern production methods essential; progressive post for applicant with energy & initiative; comm. £500-£600.—Box 7156.

DESIGNER draughtsman required for S. London by Philips Laboratories, exp. in communications equipment (elect. and mech.).—Apply in writing, giving full details to P.T.E., Ltd., 45, Nightingale Lane, S.W.12.

SENIOR foreman required by progressive radio factory, North London area; able to control labour, previous identical experience essential.—Apply fully, stating age, qualifications, experience, salary required to Box 7400.

TECHNICAL advertising and catalogues; capable assistant required, able to assist generally with layouts, copy and similar work, excellent prospects for right applicant; S.E. London; state age, experience and wage required.—Box 7126. [5145]

RADIO development engineer required by Midlands radio manufacturer, experience of commercial radio design essential.—Write details of qualifications, experience and salary required, to Box 107, c/o Era, 166, Camden High St., London, N.W.1. [4972]

WANTED for the Continent, experienced engineer in the manufacture of micro-wave valves for Radar; excellent opportunity and interesting job for the right man.—Please write fully to Box 159, c/o Phillips Advertising, Ltd., 15, Wilton Rd., London, S.W.1. [5089]

GRADUATE (preferably communication or electrical engineering) wanted for research and development work with experience in the design and testing of audio frequency equipment, particularly microphone. Write, stating age, fullest details of academic qualifications, experience, and salary reqd., to Box 6104.

LABORATORY assistants required for company manufacturing radio test equipment; good technical qualifications and practical experience essential.—Write, giving full details and salary required, to Taylor Electrical Instruments, Ltd., 419-424, Montrose Ave., Slough, Bucks. [5152]

ENGINEER interested in quantity production of high quality, reliable, high value for money, loud speakers for domestic radio receivers; state qualifications, salary required and when free.—Frank Murphy of London, Ltd., 7, High Grove, Welwyn Garden City, Tel. Welwyn Garden 3277. [5227]

SECOND assistant radio engineer required by the Government of Iraq for the Basrah Port Directorate for a tour of one year in the first instance; salary, Iraq dinars 40 a month, plus a high cost-of-living allowance of between Iraq dinars 11½ and Iraq dinars 14½ a month, according to number of dependents. (Iraq dinar, 1=£1.) Provident fund; free passages; candidates must be Associate Members of the British Institute of Radio Engineers or hold the City and Guilds of London Institute's Diploma in Radio Communications (Part III), and the Postmaster General's First Class Certificate in Radio Communication; they must have had at least five years' experience of radio engineering work, including not less than two years on radio transmitters.—Write, stating age and full particulars of qualifications and experience, to the Crown Agents for the Colonies, 4, Millbank, London, S.W.1, quoting M/W/14691. [5099]

**COVENTRY—
RADIO**

COMPONENT SPECIALISTS since 1925

- Rotary Switches 1 pole, 18-way ... 4/6
 - " " 2-pole, 6-way ... 3/9
 - Rotary Q.M.B. Switches, D.P.D.T. ... 3/9
 - I.F. Transformers, 465 kc. New type 7/6
 - Socket Strips, A.E., P.U. or L.S. ... 4d.
 - Chargers for 2, 6 or 12 volt, 1½ amp. ... 66/6
- Send for our K.46 List, fd. Details of hundreds of components.

PROMPT SERVICE, COMPLETE SATISFACTION

COVENTRY RADIO,
191, DUNSTABLE ROAD, LUTON.

POST-WAR TELEVISION

The advance in Radio Technique offers unlimited opportunities of high pay and secure posts for those Radio Engineers who have had the foresight to become technically qualified. How you can do this quickly and easily in your spare time is fully explained in our unique handbook.

Full details are given of A.M.I.E.E., A.M.Brit.I.R.E. City & Guilds Exams., and particulars of up-to-date courses in Wireless Engineering, Radio Servicing, Short Waves, Television, Mathematics, etc., etc.

We Guarantee "NO PASS—NO FEE"

Prepare for to-morrow's opportunities and post-war competition by sending for your copy of this very informative 112-page guide NOW—FREE.

BRITISH INSTITUTE OF ENGINEERING TECHNOLOGY (Dept. 388)
17 Stratford Place, London, W.1

A.C.S. RADIO

FOR COMMUNICATION RECEIVERS, AMATEUR TRANSMITTING GEAR, ALL TELEVISION AND RADIO EQUIPMENT AND COMPONENTS.

Preliminary LIST NOW READY, but with new stocks constantly being added we suggest enquiry for definite items if not listed.

44, WIDMORE ROAD, BROMLEY, KENT



WE APOLOGISE to those who have been waiting months for replies. Our post-war plans have been frustrated so far. Sorry!

Things are improving.

VOIGT PATENTS LTD.
Be WISE and PATIENT

LONDEX for RELAYS

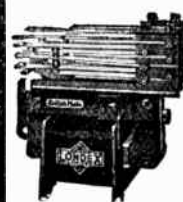

for A.C. and D.C.

2 VA Coil consumption from 2 to 600 volts and tested to 2000 volts, Aerial Changeover Relays, Mercury Relays, Measuring Relays and Time Delay Relays

Multiple contact Relay LF. Ask for leaflet 205/VW

LONDEX LTD
MANUFACTURERS OF RELAYS
207, ANERLEY ROAD, LONDON S.E.20

TELEPHONE RENTALS, Ltd., require an experienced engineer and also a draughtsman to assist in design and development work on telephone, audio amplifier and associated equipment.—Apply in writing, with full details of experience, age and salary required, to Telephone Rentals, Ltd., Eng. Dept., Kent House, Knightsbridge, S.W.7. [5197]

DRAUGHTSMEN; responsible senior draughtsmen, with workshop experience, required, able to work on own initiative, for radio, television, electronic instruments and domestic appliances; permanent employment, North London; Superannuation scheme.—Write, giving full particulars of age and experience, to "S. D.," Box A.K. Adv., J5774, 212a, Shaftesbury Ave., W.C.2. [5149]

WIREFMAN and service mechanic required for the construction and maintenance of test equipment; some knowledge of radio circuits and ac and dc bridges desirable; must be capable of wiring correctly from diagrammatic sketches; excellent prospects in large company for suitable applicant.—Write, with details of experience, to Box 5455, A.K. Adv., 212a, Shaftesbury Ave., W.C.2. [4964]

MECHANICAL designer-draughtsman required with knowledge of light electric mechanical assemblies and vacuum clean design for progressive manufacturers of radio and domestic appliances in London area.—Write, giving full particulars of training, experience, age and salary required, to Box 3520, A.K. Adv., 212a, Shaftesbury Ave., W.C.2. [4957]

REQUIRED, technical assistant in applications department of well-known valve manufacturers; North London district; duties include technical correspondence, circuit development and analysis, compilation of technical data, etc.; salary £300 to £400 p.a.—Write in first instance, giving details of age, qualification, experience, to Box 6983. [5135]

ENGINEER, required to take charge of laboratory developing radio test equipment and electrical measuring instruments; good technical qualifications and experience essential.—Apply by letter, giving full particulars of experience and salary required, to Taylor Electrical Instruments, Ltd., 419-424, Montrose Ave., Slough, Bucks. [5136]

RADIO manufacturers require assistant to take charge of standards office, compiling material and process specifications, providing documentations service and managing company's library; person with technical background, librarianship training and familiar with I.D.C. preferred.—Full details of experience, age and salary reqd. to S. O., Box J8622, A.K. Adv., 212a, Shaftesbury Ave., W.C.2.

DRAUGHTSMEN for design of radio and communication equipment; previous experience in this class of work desirable, but not essential, but drawing office experience in electrical-mechanical apparatus essential; salary up to £420 per annum, inclusive of cost-of-living bonus, according to experience and ability.—Write to Staff Department, Marconi's Wireless Telegraph Company, Ltd., Chelmsford. [5109]

EXPERIENCED faultfinders required for large radio manufacturers situated in Mitcham, Surrey, district; only men who have had considerable experience on this type of work, preferably under factory conditions as distinct from the usual service engineer conditions, and with some considerable technical knowledge, should apply; good rates of pay.—Apply, giving full details of past experience and stating wages required, to Box No. 509, L. P. E., 110, St. Martin's Lane, W.C.2. [5159]

ELECTRICAL testing equipment; a designer is required to take charge of a new department producing test equipment for factory use; sound knowledge of high-grade equipment and ability to produce same is essential; please give full details of training and experience.—Box 6248. [4993]

SITUATIONS WANTED
YOUNG electrical engineer (21½), requires position, electronic industry.—Box 7354.

R.A.F. tech. sigs. F/Lt., released May, seeks progressive position in electronics, research and development preferred.—Box 7357.

FLT. Lt. (26), grad. I.E.E., Inter.B.Sc.(Eng.), 6 years tech. radar, release due May, requires progressive post, South England.—Box 7318. [5201]

RADAR officer, R.A.F., release June, 4 yrs. pre-war recording, P.A., 6½ yrs. radar installation, maintenance, seeks permanent progressive position.—Box 7248. [5179]

R.A.F. technical officer, released, 20 years' practical experience radio, electrical also administration organisation, personality, tact, requires position with future.—Box 7396.

FLT. Sgt., released, age 26, seeks progressive post in Midlands; 6 years R.A.F. radar mechanic, all types radar, including navigational aids; pre-war radio servicing experience. Box 7320. [5203]

NAVAL radar officer seeks progressive technical or executive post, 5 years' experience radar and wireless, Assoc. Brit. I.R.E., C. & G. Finals, radio comm., technical electricity.—Box 7243. [5172]

NAVAL officer, released, experienced radio and radar installations, seeks partnership or situation on profit-sharing basis; excellent references and qualifications; £500-£1,000 available.—Box 6732. [5114]

SIGNALS officer (F/Lt.) ex-apprentice, 13 years' R.A.F. experience, C. & G. II, studying C. & G. final, sound technical knowledge and good organising ability, seeks progressive position in radio trade.—Box 7355.

C.Q.M.S. (foreman of Signals), 28, 8 yrs. Army, experienced radio and telephony eqpt., interested P.A., also electronic devices, seeks post, London or Home Counties, as sales rep., production or service supervision; avail. May.—Box 7181. [5161]

FLT. Sgt., radar mech., 35 yrs., released, 18 yrs. radio and electrical exp., inc. 2½ yrs. instructing, thoroughly sound theoretical and practical knowledge, desires progressive post, preferably development work, radio or electronics.—Box 7399. [5238]

EX-SIGNALS radar officer, R.A.F. (6 yrs.), 12 yrs. pre-war experience service, sales including television, domestic electrical equipment, mainly retail; initiative and admin. ability; min. sal. £400; keen export trade; would consider position overseas.—Box 7330.

ADVERTISER, late A.I.D., 25 years' experience design, test, and management, seeks supervisory position.—G. M., 4, Burt Ash Villas, Lee, London, S.E.12. [5215]

SERVICE engineer, 14 years' experience, City and Guilds certificate, own car, seeks permanent position with reasonable remuneration.—Write Box 7356. [5218]

CAPT. R. Signals, demobbed, latterly in stallation engineer Indian Posts and Telegraphs, qualified officers' advanced wireless course, vast experience of wireless line and electrical apparatus, desires post giving scope for initiative and inventiveness; interested purchase partnership small progressive firm.—Box 7397. [5235]

NAVAL officer, specialist radar, technical administrator, age 39, secondary education, 18 years' thermionic and electronic experience, radio, sound films, naval controller of production and supply, knowledge mechanics, optics, acoustics, seeks responsible permanent position with good salary or partnership or directorship in established concern; capital available.—Box 7253. [5181]

AGENCIES
RADIO and electrical export to Norway.—Advertiser with 10 years' import and wholesale experience desires Norwegian agency.—Apply A/S, Elra, Huitfeldtsgt, 3, Oslo.

EXPORT to Belgium, wholesaler seeks to buy, or take over, agencies in all radio components, automatic record-changers, pick-up motors, receivers, rotary converters.—Offers to: F. P. Librairie Decock, 204, Rue de Ribeaucourt, Brussels. [5205]

TWO radio engineers, sailing for South Africa approximately May 15, with excellent opportunities to act as representative agents for radio industry, require appointment; first-class contacts with wholesale and retail trades throughout Union.—Box 7242.

RADIO receivers, valves and radio accessories; established wholesale distributing house with centrally situated office in Belfast and six travellers covering Northern Ireland, anxious to contact reputable manufacturers of above lines with view to representations in Northern Ireland.—Box 1393, Eason's Advertising Service, Belfast. [5106]

FINANCIAL PARTNERSHIP
ADVERTISER desires financial interest in a substantial wireless business in London; non-technical but would work on administrative side; first-class connections and qualifications.—Box 7097. [5143]

WORK WANTED
ENGRAVING; precision instrument firm in West London can undertake specialised machine engraving of knobs, dials, panels of sundry components; excellent delivery on small quantities.—Box 6903. [5131]

PATENTS.
THE proprietors of British Patents Nos. 516110, 516111, 516167, 516168, entitled Improvements in Electron Discharge Tubes, and No. 516169, entitled Improvements in Bases or Caps for Electron Discharge Tubes, offer same for licence or otherwise to ensure their practical working in Great Britain.—Enquiries to Singer, Ehlert, Stern & Carlberg, Chrysler Bldg., New York City 17, N.Y., U.S.A. [4962]

BUSINESSES FOR SALE OR WANTED
PROVINCIAL radio business or premises wanted, strict confidence.—Box 7158.

BOOKS, INSTRUCTIONS, ETC.
WEBB'S radio map of the world locates any station heard, size 40x30in., 4/6, post 6d.; on linen, 10/6, post free.—Webb's Radio, 14, Soho St., W.1. Gerrard 2089. [9947]

TRANSFORMERS & COILS TO SPECIFICATION.

MANUFACTURED OR REWOUND.

STANLEY CATTELL LTD.

9-11, East Street, TORQUAY, Devon

Phone: Torquay 2182.

Superspeed
SPECIAL
CORED SOLDER
A.I.D. APPROVED
H. J. ENTHOVEN & SONS LTD.
230 THORNTON ROAD, WEST CROYDON, SURREY
THORNTON Heath 2461

ERG'S HAVE THE URGE TO GO ABROAD

SPEAKING EXPORTLY...

ERG Resistors have an exceptional electrical specification and performance, with mechanical strength.

High-grade Vitreous Enamels used on our Tropical Resistors give long life, and definitely assist in the trouble-free manufacture and performance of Radio Receivers, Television and Test Equipment.

ERG Resistors are processed up to the highest Service Standards at a competitive Price.

ERG RESISTORS LTD.
1021a, FINCHLEY ROAD, LONDON, N.W.11.
PHONE: SPEEDWELL 6967

Varley

TRADE MARK.

SLIDER RESISTANCES



A resistance of exceptionally robust construction, wound on high quality vitreous enamelled tubes. Nickel-copper alloy wire is used for the resistance. An ideal product for use in:—

- LABORATORIES**
TEST EQUIPMENT
BATTERY CHARGING
SPEED CONTROL, etc.

OLIVER PELL CONTROL LTD
 CAMBRIDGE ROW · WOOLWICH · S.E.18
 TELEPHONE: WOOLWICH · 1422

R & A

*Suppliers of Loud Speakers
 to Britain's foremost
 Radio Manufacturers.*

REPRODUCERS & AMPLIFIERS LTD.
 WOLVERHAMPTON. ENGLAND.

MINIATURE or MIDGET

We specialise in their manufacture

HIVAC
 THE SCIENTIFIC VALVE
 BRITISH MADE

*Originators,
 designers & manufacturers of Midget Valves*

HIVAC LIMITED. Greenhill Crescent, Harrow on the Hill, Middx. Phone: HARROW 0895

INSTRUMENTS
 FOR
 SPECIAL
 PURPOSES

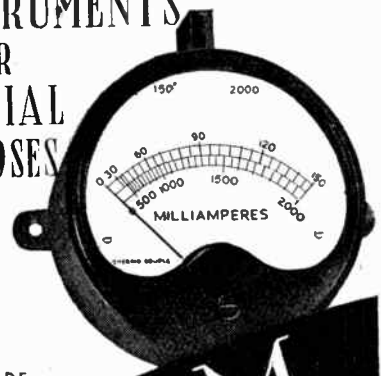

HIGH-GRADE
 MODERN
 DESIGN.

SIFAM
 ELECTRICAL INSTRUMENT
 COMPANY LIMITED
 TORQUAY DEVON

Printed in England for the Publishers, LIPFEE AND SONS LTD., Dorset House, Stamford Street, London, S.E.1, by THE CORNWALL PRESS LTD., Paris Garden, Stamford Street, London, S.E.1. "Wireless World" can be obtained abroad from the following—AUSTRALIA and NEW ZEALAND: Gordon & Gotch, Ltd. INDIA: A. H. Wheeler & Co. CANADA: Imperial News Co.; GORDON & GOTCH, LTD. SOUTH AFRICA: Central News Agency Ltd; WILLIAM DAWSON & SONS (S.A.), LTD. UNITED STATES: The International News Co.



THE LONDON SYMPHONY ORCHESTRA SWELLS IN . . . AGAIN

SOON the highway and the byways will come to life with cars. Soon the people of this land will want to enjoy the fruits of peace. Soon, thousands of cars, radio equipped, will be tuned in to the London Symphony Orchestra — or Geraldo — or the News . . .

To you who make miniature sets or radio sets for cars, Hunts supply the dual Miniature Electrolytic Capacitor Type L31A. This is a dual type capacitor of minimum size but possessing the latest technical design improvements, and capable of giving long life and performance under appropriate

voltages and temperatures, with an ability to withstand reasonable ripple current conditions.

This is just one more example of the Hunt ability to supply capacitors for any and every type of radio, based on a sound manufacturing policy of "capacitors only."



A. H. HUNT LTD • LONDON • S.W.18 • ESTABLISHED 1901
7343

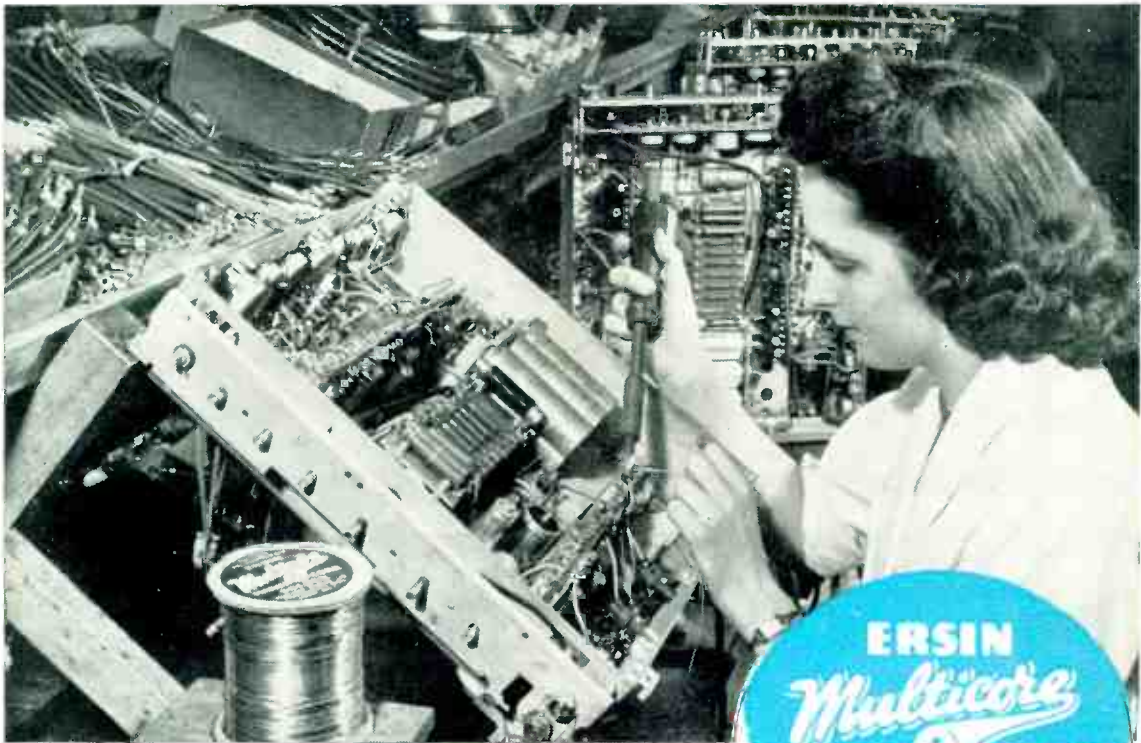

By courtesy of H.M.V.

3 cores of flux—no extra flux required—quick melting and speedy soldering—fastest non-corrosive flux—most economical solder to use—constant high precision standard of soldered joints.

These are just some of the advantages you enjoy when you use Ersin Multicore Solder.

60/40 High tin content alloy is now available without restriction. Ersin Multicore Solder is made for manufacturers in a wide range of alloys and gauges. Nominal 1-lb. reels in 4 specifications are available from factors for service engineers. Small cartons for home use are obtainable from most radio, electrical and hardware shops. If you make or service radio or television equipment and are one of the very few who have not yet standardised on "The finest cored solder in the World"—Ersin Multicore—please ask us to send you technical information and samples.



ERSIN MULTICORE

MULTICORE SOLDERS LTD., MELLIER HOUSE, ALBEMARLE STREET, LONDON, W.1

Telephone: Regent 1411 (P.B.X. 4 lines)