

Wireless World

RADIO and ELECTRONICS

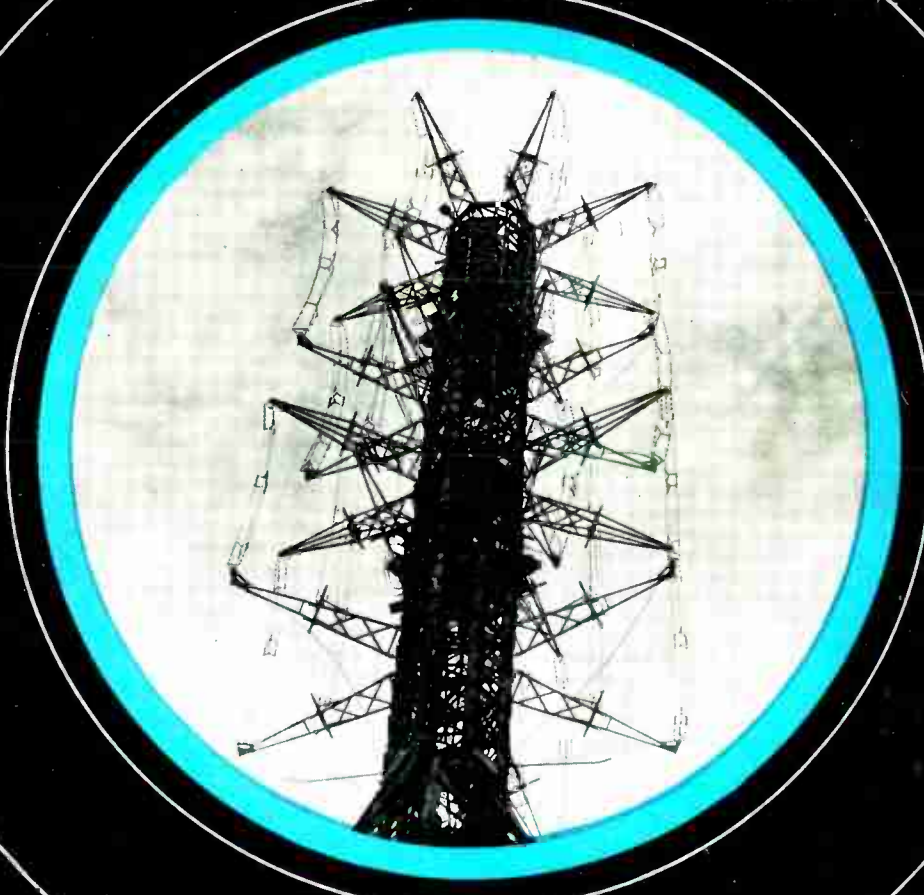

APRIL 1946

1/6

Vol. LII. No. 4

IN THIS
ISSUE :

REVIEW OF POST-WAR COMPONENTS

AH! BUT THAT ONE WAS A ROLA

Rola SPEAKERS
SELL THEMSELVES ON THEIR REPUTATION

*...and the Receivers
in which they have
been installed!*

BRITISH ROLA LTD. • GEORGIAN HOUSE • BURY STREET • ST. JAMES'S • LONDON S.W.1, ENG.

THE Services and war-time industry are familiar with the high standard of dependable accuracy of "AVO" Electrical Testing Instruments. They will be an equally dominant factor in the post-war rebuilding of our great industries and the advancement of amenities worthy of a world at well-earned peace.

The instrument illustrated is the well-known and widely-used Model 7 Universal AvoMeter, a compact multi-range A.C./D.C. meter of B.S. 1st grade accuracy. It provides on a 5-inch hand calibrated scale direct readings of A.C. and D.C. volts, A.C. and D.C. amperes, resistance, capacity, audio-frequency power output and decibels. Range selection is effected by means of two rotary switches.

Current consumption is 1 mA. or 2 mA. at full scale deflection, and the total resistance of the meter is 500,000 ohms. An automatic cut-out affords protection against damage through severe overload, and compensation is provided for variations in ambient temperature. Full details of the 50 ranges of readings are set out in a fully descriptive pamphlet which will be sent free on application.

NON-HYGROSCOPIC

Just one point which the wise set-maker has to consider when selecting cored solder. The export drive makes it imperative that a radio receiver, which may be used 2,000 or more miles from the place it was made, should have sound, soldered joints. The flux residue must not absorb moisture under tropical conditions. Now, more than ever, it is a true economy to use "The finest cored solder in the World." It is an insurance against faulty joints to standardise on

ERSIN MULTICORE SOLDER

| CATALOGUE REFERENCE NO. | ALLOY TIN/LEAD. | S.W.G. | APPROX. LENGTH PER NOMINAL 1-LB. REEL. | PRICE PER NOMINAL 1-LB. REEL (SUBJECT TO USUAL DISCOUNT) |
|-------------------------|-----------------|--------|--|--|
| 16014 | 60/40 | 14 | 64 feet | 6/- |
| 16018 | 60/40 | 18 | 178 feet | 6/9 |
| 14513 | 45/55 | 13 | 45 feet | 4/10 |
| 14516 | 45/55 | 16 | 94 feet | 5/3 |

Above are specifications available for Service Engineers. Bulk prices and additional specifications are available for Manufacturers.

Manufacturers, Factors and Service Engineers are invited to write for technical information and free sample of Ersin Multicore Solder 60/40 alloy.



MULTICORE SOLDERS LIMITED

MELLIER HOUSE, ALBEMARLE STREET, LONDON, W.1. (Tel.: REGENT 1411 P.B.X. 4 lines)

Your new **STENTORIAN** is being made *now...*

Extension Speakers, inc. Cabinet and Volume Control, available from

29/6

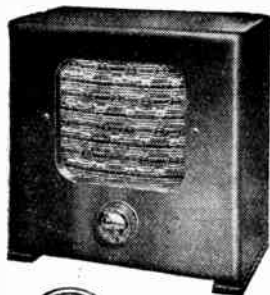

Stentorian
THE PERFECT EXTRA SPEAKER FOR ANY SET

WHITELEY ELECTRICAL RADIO CO. LTD., MANSFIELD, NOTTS.

It may even be waiting for you at your local Radio Dealer's. Keep in touch with him; these attractive extension speakers with their superb reproduction offer such amazing value that they are being bought faster than they can be produced. More and more people appreciate the convenience of not being confined for their radio to the room the set occupies.

PRICES

| | |
|---|------|
| Minor Type MX (for Low Impedance Extension) - | 29/6 |
| Minor Type MC (with Universal Transformer) - | 35/6 |
| Baby Type BX (for Low Impedance Extension) - | 43/6 |
| Baby Type BC (with Universal Transformer) - | 49/6 |

M.R. SUPPLIES

proudly maintain their reputation for SUPERIOR QUALITY RADIO AND ELECTRICAL MATERIAL and prompt despatch. All prices nett.

POWER TRANSFORMERS: Prim. (on terminal board), 210/230/250 v.: Secs., 350-0-350 v. 120 m.a., 4 v. 5a. (C.T.) and 4 v. 2a.; in cast brackets, weight 9 lbs., 39/6. Also Prim. 210/230/250 v.: Secs., 450-0-450 v. 150 m.a., 6.3 v. 4 a., 6.3 v. 2a., 5 v. 2a., all loose leads, in brackets, weight 13 lbs., 49/6 (despatch 2/6).
S.T.C. METAL RECTIFIERS (Selenium). For battery charging up to 12 volts, in conjunction with suitable transformers (see below). 3-amps., 22/6; 6-amps., 39/6. Also small relay-operating or bias type, 25 v. 75 m.a. (half-wave), 4/6. 25 v. 80 m.a. (bridged—full-wave), 7/6.
STEP-DOWN MAINS TRANSFORMERS, all primaries 200/250 v. (tapped); Secs., 22 v. 2 amps., 18/6. Sec., 7; 11 and 15 v. 2 amps., 20/-. Sec., 8 and 14 v. 4 amps. (for 22/6 rectifier), 32/6. Sec., 5, 12 and 17 v. 6 amps. (for 39/6 rectifier), 49/6 (despatch, 2/6).

OUTPUT TRANSFORMERS. Heavy duty model handling 25 watts. Improved "Wireless World" spec., providing 11 ratios from 19/1 to 75/1, with C.T. for push-pull, in cast brackets, with terminal boards, weight 9½ lbs., 59/6 (despatch 2/6). Graupian small replacement type providing 8 ratios, tapped prim. and sec., 9/6.
GRAMPIAN MOVING COIL MICROPHONES (highly recommended). Type MCR (15 ohms), in suspension frame, for 1in. or 5/16th fitting (adapter free), 24 ½s. Type MCS, a very fine instrument, in all-plate housing, with internal on-off switch (15 ohms), same mtg., 27 ½s. **MU-METAL MICROPHONE TRANSFORMERS** to suit either, 25/-. **FLOOR STANDS**, all chromium, ext. to 5ft. 6in., and collapsing to 2ft., 47/6.

DEAF-AID TYPE MICROPHONE INSERTS, Rothermel-Bruah Piezo-Crystal, only 1½in. dia., highly efficient for all purposes, 29/6.

ROTHERMEL PIEZO-CRYSTAL FIGURES, Senior streamlined black bakelite model. Best being made to-day, 78/9. **STROBOSCOPIC SPEED TESTERS** for grammo-motors, showing 78, 79 and 80 r.p.m. on 50-cycle viewing (cardboard only), 1/-.

MICRO-AMMETERS (special limited supply only), flush mtg. for 2in. hole with 2½in. square flange, high-grade m/coil. Readings: 0/150, 0/200, 0/300 microamps, any one, 28/6.

INSTRUMENT CABINETS in mahogany, with plated hinges and clip fasteners. Internal dimensions, 10½in. long, 3½in. wide, 4½in. deep, with another ½in. in lid. Inside fittings easily removed. Very well made, 10/6.

ELECTRIC SOLDERING IRONS (two very popular models). "Fyrbit" Instrument model for the finest instrument work—can be held like a pencil—only 9½in. long, 230/250 v., 22/-. Spare elements, 3/6. Also the new Staneco 100-watt 230/250 v. model, with long pointed bit and ingenious heated insulation stripper, 35/-. **S.T.C. RESIN-CORED SOLDER**, 40 per cent. tin, on 1 lb. reels, 4/5.

VENT-AXIA STALE AIR EXTRACTOR FAN UNITS, again in stock. The most efficient and silent ventilation units available. Easiest to install. 230/250 v. A.C. only. Fitted weatherproof cowling. With 6in. impeller (25 watts), 25 8s. 6d. With 9-in. impeller (35-watts), 29 13s. 6d. (both carriage paid).

R. & A. LOUSPEAKERS, 8-watt 10in. P.M. with 4 ohms coil. Dependable for good quality reproduction, 37/6 (despatch 2/-).

VITAVOX HIGH-FIDELITY SPEAKERS, P.M., with 15 ohms coil, 12in., on die-cast chassis with Ticonal bi-flux magnet, K12/10 (10 watt), 27; K12/20 (20 watt), 211 (despatch, either, 5/-).

G.E.C. MOBILE 30-watt AMPLIFIERS, 12 v. operation with mike/gram., tone, volume and "stand-by" controls. Auto-polarising for T.C. carbon mike. Compact and very efficient, 228 (callers only).

Please include sufficient for despatch, where not stated.

M.R. SUPPLIES, 68, New Oxford Street, London, W.C.1

Telephone: MUSEum 2958

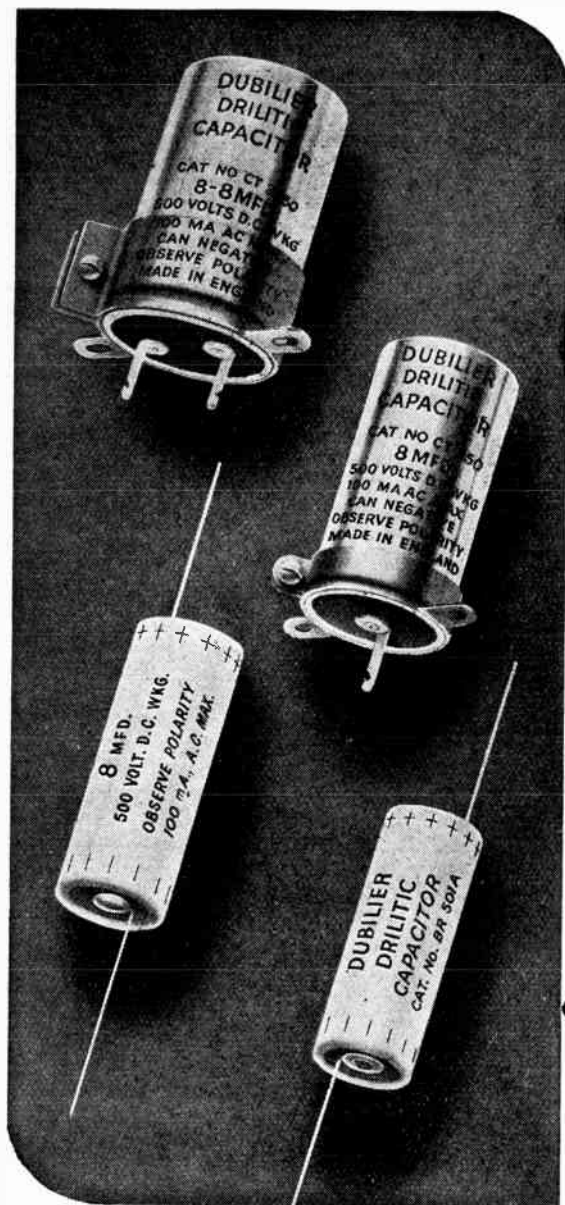

Now!
a full range

**"DRILITIC"
ELECTROLYTIC CAPACITORS**

Physically small, these B.R. and C.T. capacitors embody many technical advantages and their comprehensive coverage of every electrolytic requirement will be readily appreciated by users. The electrical characteristics of these capacitors are a marked advance in electrolytic design, the leakage current and equivalent series resistance are reduced, the audio and radio frequency impedance improved, breakdown voltage and life expectancy have been increased together with an improvement in temperature characteristics. They are contained in seamless drawn aluminium containers hermetically sealed and the container is always negative.

DUBILIER
CONDENSER CO. (1925) LTD
LONDON. W.3

| "DRILITIC" CAPACITORS | | | | | | |
|-----------------------|-------------------------|-------------|-------|----------------------------|-------------|-------------------|
| Capacitance | MAXIMUM Working Voltage | SIZE INCHES | | MAXIMUM Ripple Current mA. | TYPE Number | RETAIL PRICE EACH |
| | | D. | L. | | | |
| 50 | 12 | 1 1/2 | 1 1/2 | 55 | BR501 | 2s. 6d. |
| 25 | 25 | | 1 1/2 | 75 | BR252A | 2s. 6d. |
| 50 | 50 | | 2 | 190 | BR505 | 3s. 6d. |
| 8 | 150 | | 1 1/2 | 110 | BR815 | 2s. 9d. |
| 8 | 500 | | 2 | 100 | BR850 | 4s. 0d. |
| 8 | 500 | 1 | 2 | 100 | CT850 | 4s. 6d. |
| 16 | 500 | | 2 | 110 | CT1650 | 6s. 6d. * |
| 8-8 | 500-500 | | 2 | * 100-100 | CT8850 | 6s. 6d. |
| 16-8 | 500-500 | | 2 | * 110-100 | CT16850 | 8s. 6d. |

Vertical mounting clips supplied with C.T. types. *The total max. ripple current for both sections must not exceed the larger figure.

D2 DUBILIER CONDENSER CO. (1925) LTD. · DUCON WORKS · VICTORIA RD. · NORTH ACTON LONDON · W.3

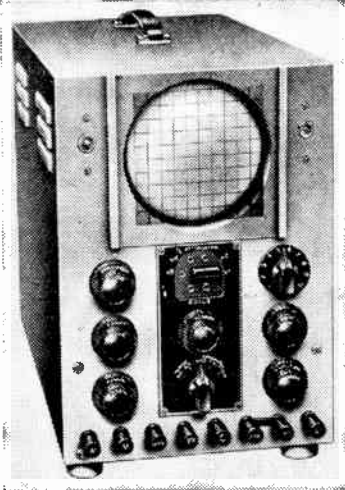

STATIC TWO-DIMENSIONAL
visual delineation of any recurrent law.

RELATIVE TIMING OF EVENTS
and other comparative measurements with extreme accuracy.

PHOTOGRAPHIC RECORDING
of transient phenomena.

SIMULTANEOUS INDICATION
of two variables on a common time axis.

INDUSTRIAL INDICATING and TESTING afford increasing scope for the Cathode Ray Tube as the only device with the above inherent features of which the last is unique in the Cossor DOUBLE BEAM Tube.

The Model 339 Cossor Oscillograph thus equipped is invaluable on all problems of research, production or operational testing, when the effect examined is applied as a voltage. When recurrent the traces are studied visually and when transient are recorded photographically, using Model 427 camera.

A. C. COSSOR LTD..
INSTRUMENT DEPT.

Cossor House, London, N.5

*Phone: CANonbury 1234 (33 lines).
*Grams: Amplifiers Phone London.

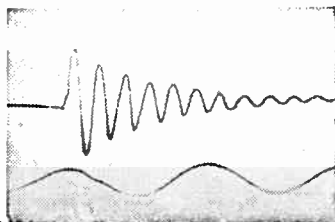

Manufacturers
of
LOUDSPEAKERS
•
LAMINATIONS
•
SCREENS
in
RADIOMETAL
•
PERMALLOY
•
SILICON ALLOYS

ELECTRICAL SOUND & TELEVISION PATENTS LTD.

12, Pembroke Street, London, N.1. Terminus 4355
2/4, Manor Way, Boreham Wood, Herts. Elstree 2138

IF YOU USE WAX

We Are At Your Service

THE WIDE RANGE OF
OKERIN DI-ELECTRICS

created in our own laboratories, fulfils almost every need of the Electrical Industries. Grades have been designed for the most severe and varied conditions. Most are resistant to mould and fungus growth, whilst special types are evolved whenever new applications arise.

We invite technical discussion on difficult problems.

**ASTOR BOISSELIER
& LAWRENCE LTD.**

(Sales Dept.), Norfolk House, Norfolk Street, Strand, W.C.2
Telephone: Temple Bar 5927.

April 1946

Wireless World

Eimac
VALVES

THE COUNTERSIGN OF DEPENDABILITY IN ANY ELECTRONIC EQUIPMENT

NEW EIMAC EXTERNAL ANODE TRIODE 3X2500A3

Rugged mechanical construction Outstanding electrical efficiency

In the new 3X2500A3, Eimac engineers have developed a highly efficient external anode triode which, in Class C service, delivers up to 5 KW output at a plate voltage of only 3,500 volts. The mechanical design is radically simple, incorporating a "clean construction" which gives short, low inductance heavy current connections that become an integral part of the external circuits at the high frequencies.

The external anode, conservatively rated at 2500 watts dissipation, has enclosed fins so as to facilitate the required forced air cooling.

Non-emitting vertical bar grid does not cause anode shadows ordinarily created by heavy supports in the grid structure.

Thoriated tungsten filament. Note unusually large filament area, and close spacing.

Filament alignment is maintained throughout life of the valve by special Eimac tensioning method.

New glass-to-metal seals do not have the RF resistance common to iron alloy seals, nor the mechanical weaknesses of the feather-edged types.

Grid ring terminal mounts a cone grid support which acts as a shield between plate and filament.

A coaxial filament stem structure forms the base of the valve. This makes possible proper connections to the filament lines.

Grid and filament terminal arrangements make it possible to install or remove the 3X2500A3 without the aid of tools.

The new mechanical and electrical features of the Eimac 3X2500A3 external anode triode make it valuable for use on the VHF as well as low frequencies. More complete data and information yours for the asking.

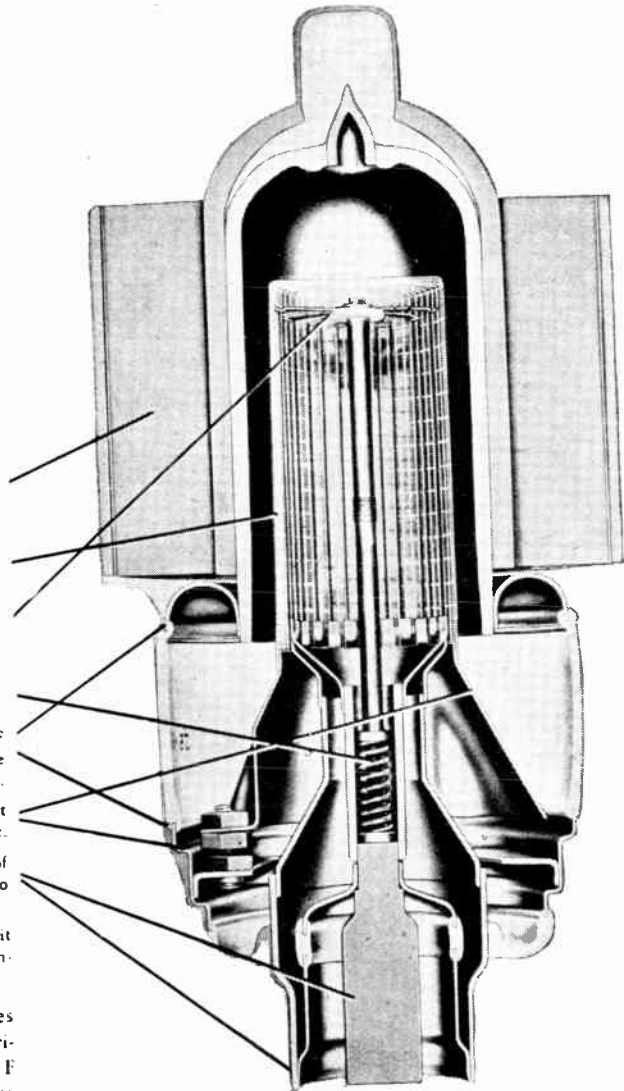

FOLLOW THE LEADERS TO

Eimac
VALVES

EITEL-McCULLOUGH, INC., 1123 San Mateo Ave., San Bruno, Calif.

Plants located at: San Bruno, Calif. and Salt Lake City, Utah

Export Agents: Frasar and Hansen, 301 Clay St., San Francisco 11, Calif., U.S.A.

Authorised Distributors: BERRY'S (SHORT-WAVE) LTD., 25 HIGH HOLBORN, LONDON, W.C.1.

TYPE 3X2500A3 - MEDIUM MU TRIODE ELECTRICAL CHARACTERISTICS

| | |
|--|-------------------|
| Filament: Thoriated Tungsten | |
| Voltage | 7.5 volts |
| Current | 48 amperes |
| Amplification Factor (Average) | 20 |
| Direct Interelectrode Capacitances (Average) | |
| Grid Plate | 20 μ fd. |
| Grid Filament | 48 μ fd. |
| Plate Filament | 1.2 μ fd. |
| Transconductance ($E_b = 830$ ma., $E_c = 3000$ v.) | 20,000 μ mb/s |

1123

EDDYSTONE

Radio Products

Stratton & Co., Ltd., West Heath, Birmingham, makers of the well-known "EDDYSTONE" SHORT AND ULTRA SHORTWAVE RECEIVERS, TRANSMITTERS AND COMPONENTS have pleasure in announcing that they are now commencing to deliver components, and in the near future will be in production with a new Communications Receiver—the "504."

Priority is at present being given to Overseas orders, and the "556" Receiver (for Export only) is on the production lines. Limited supplies of components for the Home trade will be evenly distributed to accredited Registered Dealers throughout Great Britain and Eire.

In addition to the new model "504" Communications Receiver there will be a wide range of HF, VHF and UHF components and new editions of the popular "Eddystone" shortwave Manual and ultra shortwave Guide. Developments are in hand to cater for the needs of all branches of the shortwave field—the Listener, the "Amateur" Experimenter and the Specialist Expert—and we shall always be glad to co-operate with Manufacturers in producing parts for Set and Instrument construction. Watch the Technical Press for further announcements of "Eddystone" Radio Products. . . .



STRATTON & Co., Ltd.

Manufacturers of UHF, VHF & HF Radio Communication Equipment

WEST HEATH, BIRMINGHAM, 31



EQUIPPING A LABORATORY . . . ?

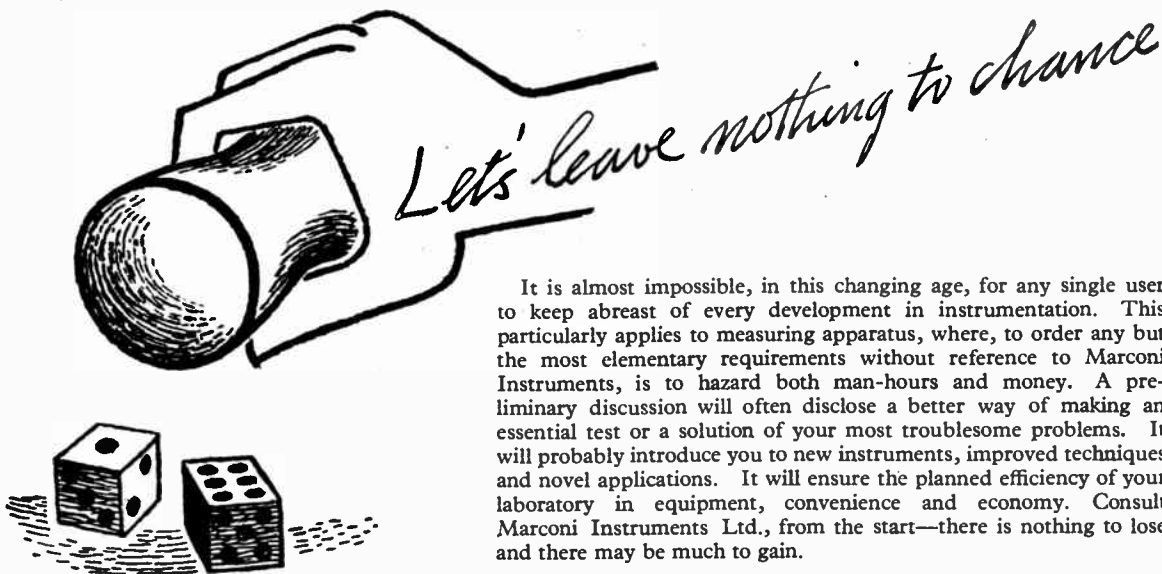

It is almost impossible, in this changing age, for any single user to keep abreast of every development in instrumentation. This particularly applies to measuring apparatus, where, to order any but the most elementary requirements without reference to Marconi Instruments, is to hazard both man-hours and money. A preliminary discussion will often disclose a better way of making an essential test or a solution of your most troublesome problems. It will probably introduce you to new instruments, improved techniques and novel applications. It will ensure the planned efficiency of your laboratory in equipment, convenience and economy. Consult Marconi Instruments Ltd., from the start—there is nothing to lose and there may be much to gain.

MARCONI INSTRUMENTS LTD.

ST. ALBANS, HERTFORDSHIRE. 'Phone: ST. ALBANS 4323/6.

Northern Office: 30, ALBION STREET, HULL. 'Phone: HULL 16144.

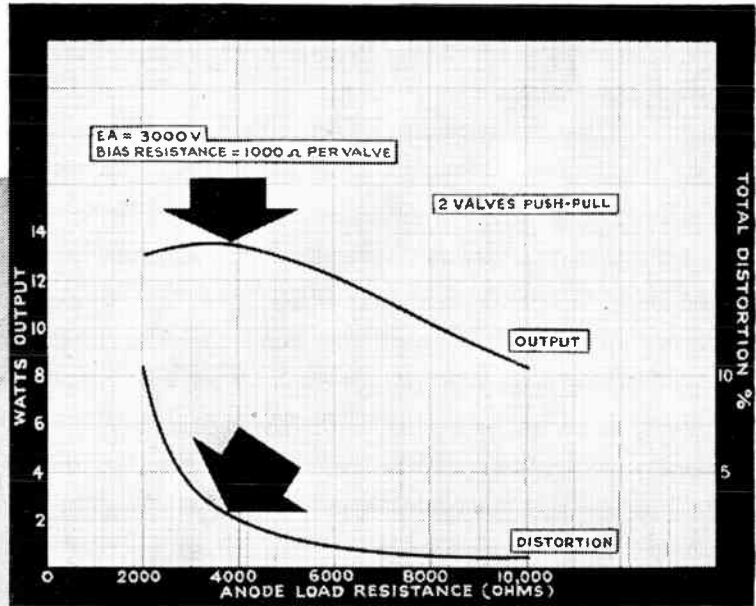

POINTERS FOR DESIGNERS

THE PX 4

A low impedance power triode, the OSRAM PX4 has achieved an almost unique popularity as an output valve (usually in push-pull pairs) for high quality Audio Frequency amplifiers at moderate power. Its outstanding features include:—

- Large undistorted power output — ample for all domestic purposes — up to 13.5 watts per push-pull pair.
- Very low harmonic content — only 2% distortion in push-pull at full output.
- Long life at a continuous anode dissipation up to 15 watts per valve.

A detailed technical data sheet is available on request.

Osram
PHOTO CELLS

G.E.C.
CATHODE RAY TUBES

Osram
VALVES

TECHNICAL DATA that *Speaks for itself!*

Here is one of the most popular of the Goodmans Loudspeakers now available—the T₂/1205/15. A medium heavy duty reproducer with a frequency response ideal for small cinemas, Public Address systems and high power radiogramophones. A robust, precision made instrument under all conditions.

BRIEF TECHNICAL DATA

Overall Diam. 12 $\frac{3}{4}$ " Overall Depth 6 $\frac{1}{2}$ "
 Fundamental Resonance..... 75 c.p.s.
 Max. Power Capacity..... 12 w. peak A.C. on 4 ft. baffle
 (15 w. horn loaded)
 Voice Coil Imp..... 15 ohms at 400 c.p.s.
 Flux Density..... 13,000 gauss
 Net weight..... 11 $\frac{1}{2}$ lb.

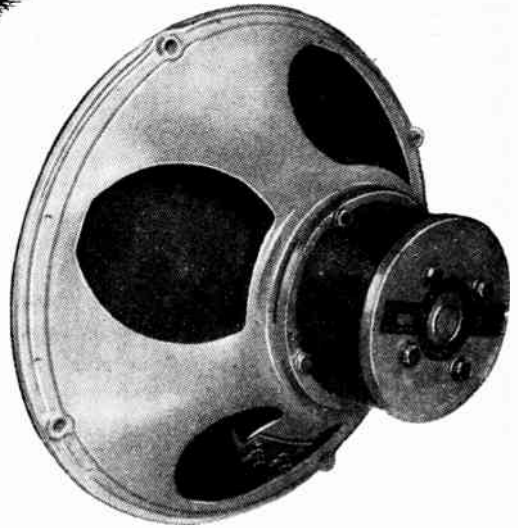

GOODMANS Type T₂/1205/15
Loudspeaker

Price **£6 15s.** (Subject)
 NOW AVAILABLE

GOODMANS INDUSTRIES LTD · LANCELOT RD · WEMBLEY · MIDDX

MINIATURE or MIDGET



We specialise
 in their
 manufacture

HIVAC
 THE SCIENTIFIC
 VALVE
 BRITISH MADE

Originators,
 designers & manufacturers of Midget Valves

HIVAC LIMITED. Greenhill Crescent, Harrow on the Hill, Middx. Phone **0895**

★ RADIOMART 'SPECIAL' OFFERS! ★

The following list of goods have been purchased ex-Government Stores. These goods are all perfect stock to A.I.D. standards.

HIGH VOLTAGE OIL FILLED CONDENSERS.

2 mf. 2,500 v. working 15/- 4 mf. 800 v. working 14/-
 4 mf. 1,000 v. working 15/- 8 mf. 500 v. working 11/-

TRANSMITTING BYPASS AND COUPLING CONDENSERS.

.03 mfd. 2,500 v. Bypass, 2/-; .001 mfd. 3,000 v. Bypass 2/6
 .01 mfd. 1,000 v. Sprague Screened Bypass 1/-
 .1 mfd. 1,000 v. Tubular decoupling 1/6
 .5 mfd. 450 v. Tubular decoupling 1/6
 .0001 mfd. 2,200 v. Tropical Mica Coupling 1/6
 65 pf. 7,500 v. Ceramic low loss Coupling 3/6

TRIMMING AND TUNING CONDENSERS (Ceramic, silver-plated vanes).

20 pf. Double spaced $\frac{1}{4}$ " spindle 2/11
 25 pf. Single spaced with rotor lock 2/8
 50 pf. Single spaced with rotor lock 3/3
 All the above fit inside our standard coil formers, CF4, CF6, CT4, CT6, etc., and make a complete plug-in pretuned circuit of low loss.
 15-29 pf. Midget Ceramic circular plate Trimmer 1/-
 15-15 pf. Split-stator and Series Gap Condenser 3/8

ELECTROLYTIC CONDENSERS (NOT WD, but as these are in short supply they are offered).

8 mf. 500 v. Cardboard, 4/8; 4 mf. 500 v. Aluminium can midget 4/-
 25 mf. 50 v. Aluminium can Midget, 2/8; 25 mf. 12 v. Tubular 2/-

MISCELLANEOUS. High voltage Polystyrene sleeving, silk braided overall: Red, Blue, Yellow, Black, 4 $\frac{1}{2}$ doz. yds. 8-way 2-pole Yaxley type midget switches. Ideal for meter switching and multiband exciters, 2/8. Potentiometers. 5-watt C.T.S. The finest wire-wound Pot made; preset type, 2,000, 3,000, 20,000, 3/8 each. Westcoats W8, 3/9 each. 1,000 ohm 20-watt Vitreous Resistors, 2/- .5 mf. 500 v. Block Condensers, 9d. each.

ALL ABOVE CAN BE BOUGHT FROM 'RAYMART' DISTRIBUTORS
 (See page 8 February issue and page 10 March issue).

RADIOMART
 GSI (HAM) LTD.

48, HOLLOWAY HEAD, BIRMINGHAM, 1

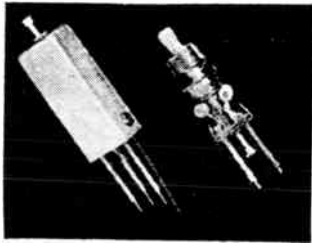

WORLD'S LARGEST RADIO COIL MANUFACTURERS

- RADIO FREQUENCY INDUCTORS
- INTERMEDIATE FREQUENCY TRANSFORMERS
- RADIO FREQUENCY COIL CHOKES
- MICA COMPRESSION CONDENSERS
- AIR DIELECTRIC CONDENSERS
- MICA MOULDED CONDENSERS
- SICKLES SILVER CAP CONDENSERS
- GANGED PERMEABILITY TUNING COMMUNICATIONS EQUIPMENT
- F.M. EQUIPMENT PARTS
- U.H.F. RADIO EQUIPMENT
- SPECIAL ELECTRONIC EQUIPMENT

The F. W. SICKLES Co.
CHICOPEE, MASS., U.S.A.



RAYTHEON "FLAT" Hearing Aid Tubes

You need a jeweller's "eye-loop" to see the intricate construction, painstaking workmanship and engineering genius that go into each of these tiny Raytheon high-fidelity tubes. The result is such clear, rich tone that they're used in the finest hearing aids.



P. R. MALLORY & CO. Inc.
MALLORY VIBRATORS
 ARE ALWAYS DEPENDABLE

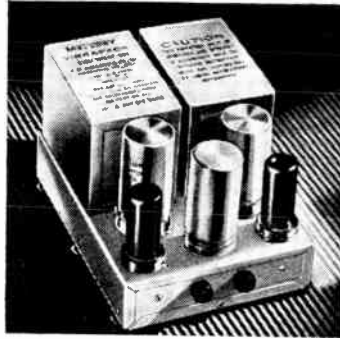

Along every front Mallory has pioneered in vibrator design to ensure safety, dependability and long service. Mallory offers synchronous and non-synchronous Vibrators for 6, 12 and 32 volt input, also a complete range of "STRATOSPHERE" Vibrators plus the world-famous Mallory "VIBRAPACK" (Reg. Trade Mark).

* Vibrapack is a registered trade mark, the property of P. R. Mallory & Co., Inc. Indianapolis, U.S.A. Units which do not bear this trade mark are not of genuine Mallory manufacture.

P. R. MALLORY & CO. INC.
INDIANAPOLIS, INDIANA, U.S.A.

Radio and Electronics Division

- ALSO
- "MYKROY" CERAMIC INSULATING MATERIALS
 - GENERAL ELECTRONIC VACUUM CONDENSERS

FOR THE FUTURE

These Manufacturers will help solve your post-war problems. Register your name now for full details which will be sent you when supply conditions again permit.

FRANK HEAVER

LIMITED

Kingsley Road, BIDEFORD, N. Devon



VICTORY PRODUCTION

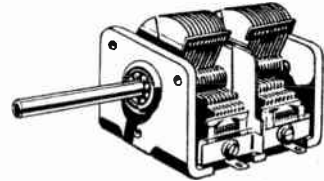

TYPE 2600 MIDGET VARIABLE CONDENSER

WE are now ready to help win the peace by making the best use of the still greater knowledge and experience gained in the manufacture of variable condensers, mechanical tuners, drives, etc.

THE GENERAL INSTRUMENT CORPORATION
ELIZABETH, N.J., U.S.A.



- RADIO**
- AIR CONDITIONING**
 - HEATING**
 - and
 - REFRIGERATION EQUIPMENT**

DOMESTIC APPLIANCES
 etc., etc.

Ad. Auriema, Inc.
 Manufacturers' Export Managers
 89 BROAD STREET,
 NEW YORK, 4 N.Y.
 U.S.A.

The

TAYLOR A.C. BRIDGE

MODEL 110A

These instruments give quick and accurate measurements of Capacity and Resistance. There are six Capacity ranges covering from .00001 to 120 mfd. and the Power factor can also be measured on each range. Six Resistance ranges are available measuring from 1 ohm to 12 megohms. This bridge is A.C. mains operated and a leakage test is also available for detecting leaky paper or mica condensers. Price £14 14s. 0d.

Please write for technical leaflet.

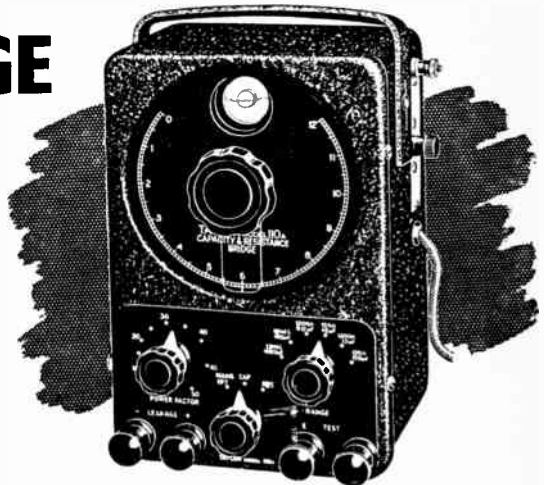

6 RANGES OF CAPACITY
RANGES OF RESISTANCE



Send your enquiries to:—

TAYLOR ELECTRICAL INSTRUMENTS LTD.

419-424 MONTROSE AVE., SLOUGH, BUCKS.
Tel: Slough 21381 (4 lines) * Grams: "Taylins", Slough.

Wharfedale BIJOU Extension Speaker

With Standard
8-in. Unit
60/-

With Bronze
8-in. Unit
65/-

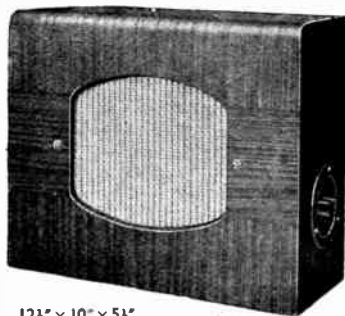

12½" x 10" x 5½"

The production of Wharfedale Cabinet Speakers is still restricted, but the Quality and Finish are up to the highest standards. The BIJOU is outstanding in appearance and performance.

WHARFEDALE WIRELESS WORKS
HUTCHINSON LANE, BRIGHOUSE, YORKS.

*Phone: Brighouse 50.

*Grams: "Wharfedel, Brighouse."

NEW ROMAC RADIO & ORAL COMMUNICATION COMBINED

25 Watt, Model 25/HII.

Incorporated Radio Tuning Unit, Provision for Moving Coil or Crystal Microphone and High Impedance Gramophone Pick-up to meet the demand of the present day for High Grade Equipment.

Delivery Ex Stock

Also our Model 25/HI. Amplifier for Microphone and Gramophone input only, also with high quality output of 25 watt.

Delivery Ex Stock.

Gramophone Playing Desk Unit in attractive case with lid available with either Amplifier.

ROMAC RADIO CORPN. LTD.
THE HYDE • HENDON • LONDON, N. W.9

*The better
they are made
the more outstanding
the results*

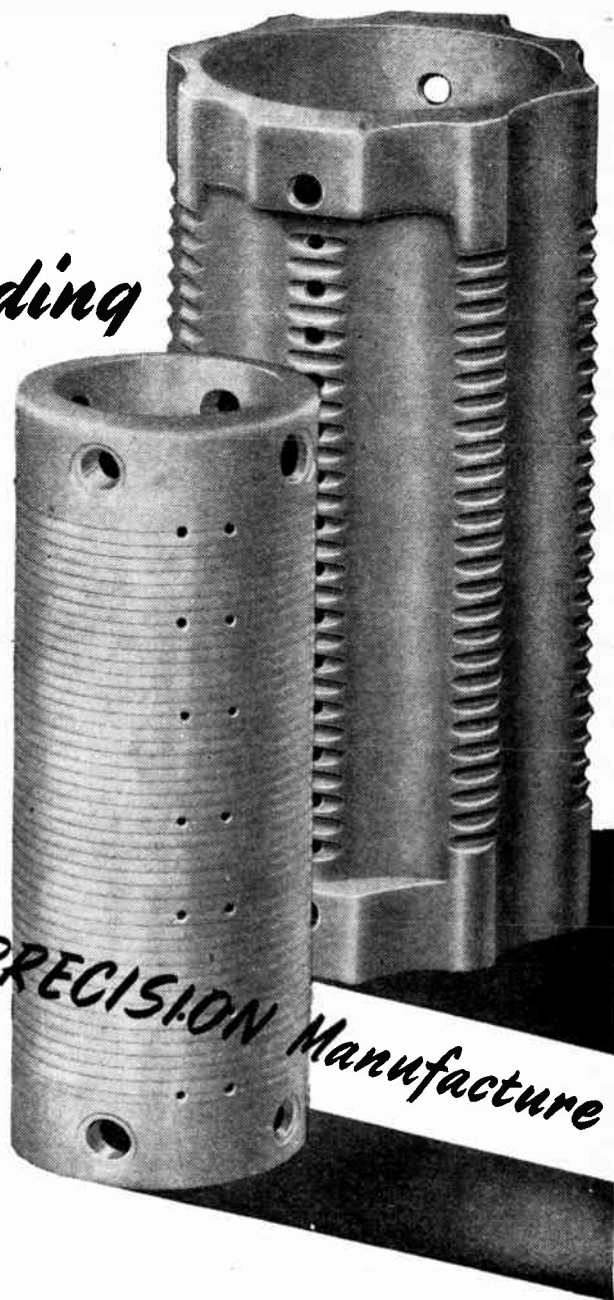

Bullers

Specialize in PRECISION Manufacture

**MADE IN THREE
PRINCIPAL MATERIALS**

FREQUELEX

An insulating material of Low Di-electric Loss, for Coil Formers, Aerial Insulators, Valve Holders, etc.

PERMALEX

A High Permittivity Material. For the construction of Condensers of the smallest possible dimensions.

TEMPLEX

A Condenser material of medium permittivity. For the construction of Condensers having a constant capacity at all temperatures.



BULLERS LOW LOSS CERAMICS

BULLERS LTD., 6, Laurence Pountney Hill, London, 'E.C.4.
Telegrams: "Bullers, Cannon, London"

Phone: Mansion House 9971 (3 lines)
Manchester Office: 196, Deansgate, Manchester



**PORTABLE
SUB-STANDARD
INSTRUMENTS**

BY

PULLIN

THESE instruments have been primarily developed for use in Meter Test Rooms, Research Laboratories and Works Testing Departments. They are sufficiently robust to withstand severe industrial use.

The movements are of the iron-free dynamometer type or of the D'Arsonval moving coil type, and have a high torque to weight ratio. They are well damped, but will respond to minute changes of supply. They are effectively shielded from the influence of external magnetic fields, by means of double mu-metal shield.



Please address all correspondence to: Dept. J., Phoenix Works Great West Road, Brentford, Middlesex. Ealing 0011

Constant Voltage

TRANSFORMERS
LINE VOLTAGE VARIATIONS OF $\pm 15\%$ REDUCED TO $\pm 1\%$

TYPICAL SPECIFICATION
 Input Voltage ... 190-260 v. 50 c/s.
 Output Voltage ... 250 v. $\pm 1\%$
 Max. load ... 150 watts.
 Input power factor over 90%
 Prices on application. Write for details.

ADVANCE COMPONENTS LTD.
 BACK RD., SHERNHALL ST., WALTHAMSTOW, E17. PHONE: DARKSWOOD 43662

**THE STATIC
CONDENSER Co. Ltd.**

★ *Manufacturers of
STATIC
CONDENSERS*

**TOUTLEY WORKS,
WOKINGHAM, Berks**

Telephone: WOKINGHAM 708

Double Purpose AERIALS

IF you are erecting an aerial now, you must seriously consider two important facts:

- (a) The coming of television in the very near future.
- (b) An anti-interference aerial for normal broadcast reception.

You can cover both these important points by using a combined system. The method of installation is shown in the diagram. It will be a permanent system designed on sound engineering principles, and, remember, you will be saving 25% on the price.

SPECIFICATION

A "combined" television and anti-interference aerial for use when separate aerial and earth terminals are correctly provided for medium and long wave.

By using the reflector of a television aerial as a collector, one aerial can be used for vision reception and normal broadcast reception, with all the advantages of an "Eliminoise" anti-interference installation.

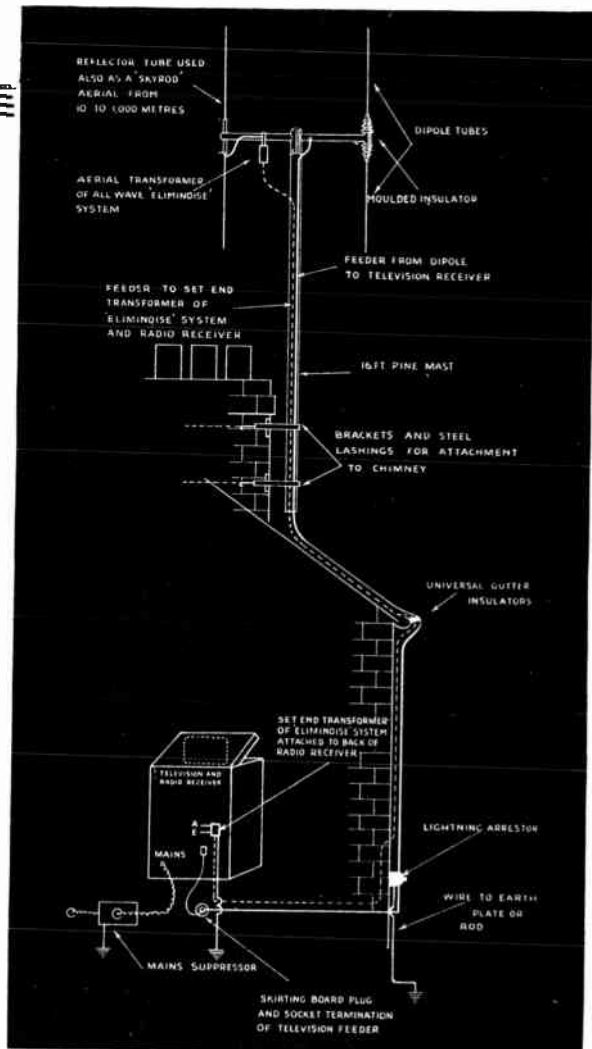

(U.K. Registered Designs applied for)

PRICES

Combined Television and Broadcast Aerials with 100 ft. cable, but without wooden masts: L.502 and L.392/100 ... Price £13 : 0 : 0

Combined Television and Broadcast Aerials with 120 ft. cable, but without wooden masts: L.502 and L.392/120 ... Price £13 : 16 : 0
L.336 Balanced twin feeder Price 9d. per yard

BELLING & LEE LTD
CAMBRIDGE ARTERIAL ROAD, ENFIELD, MIDDX

WEBB'S *Radio*

FOR HIGH GRADE TEST GEAR

We introduce two instruments of exceptional merit and interest for both laboratory work and home experimentation.

"RADIO AID" VALVE VOLTMETER MODEL A



Gives high stability, suggesting the performance of a D.C. moving coil instrument. The ranges and probe-unit combine to make the meter of universal application.

FEATURES:

Desk-type steel case, instrument grey, 9in. x 8in. x 8in. Miniature H.F. diode rectifier fitted in specialised probe-unit, balanced valve-bridge circuit. Ranges 2, 10, 100 and 500 volts. The detachable probe-unit allows H.F. measurements to 50 mc/s, and can be used for comparative work at considerably higher frequencies.

Price (complete with Probe) **£27.10.0**

The probe-unit is also available as a separate item. Complete with diode, screened lead and 4-pin British plug. Price **£3.15.0**

"RADIO AID" OSCILLOGRAPH MODEL IA

An excellent general purpose 'scope of GUARANTEED RELIABILITY. Portable in size and weight combining accuracy and flexibility of use for the serious industrial investigator and the amateur. Waveform can be studied up to 100/150 kc/s, carrier envelopes, modulation characteristics and frequency comparisons up to 100 Mc/s.

FEATURES:

Overall size of case 12in. by 7½ in. high by 7in. wide. Linear time base to 15 kc/s. "Y" Amplifier responds 5 to 200 kc/s. Can be used separately and is supplied from independent rectifier circuit, thus avoiding usual troubles found with earthed positive supplies. 1½ in. C.R. Tube, green trace of medium duration. Fitted in attractive smooth grey instrument-finished case, self-contained power supply 200-250 volts A.C.

Price **£22.10.0**

All the usual controls found on larger and more expensive instruments are incorporated. Reasonable stocks are available at Webb's.

WEBB'S RADIO

14 Soho Street, Oxford Street, London, W.1

Telephone: GERRARD 2089

Open 9 a.m. to 5 p.m. Sats., 9 a.m. to 1 p.m.

FAMOUS FASTENERS

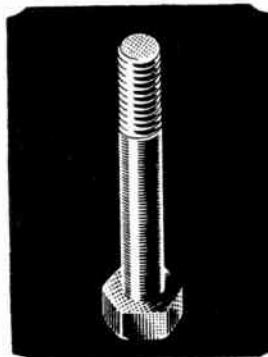

HIGH TENSILE HEXAGON BOLT

Three distinct tests ensure the standard of Linread Bolts. The first is checking of raw material, the second is specialised Quality Control during manufacture, and the third, inspection of finished products. Specialists in Cold Forging; Roll Threaded Screws; Solid and Tubular Rivets; Nuts and Bolts in all metals; Small Pressings; Auto and Capstan-turned Parts.

LINREAD LTD., STIRLING WORKS, COX ST., BIRMINGHAM, 3.
TELEPHONE No.: GEN. 3951 P.B.X.
TELEGRAMS: "LINREAD BIRMINGHAM."

London Office: Clifton House, Euston Road, London, N.W.1.
Tele. No.: Euston 8261.

Linread
SPECIALISTS IN COLD FORGING

PERSONALITY by P.A.



THE DIFFERENCE THE MIKE MAKES

War - shortage of sensitive microphones has caused mass-murder of "personality" over many workshop sound-systems. Even the work-manager's voice giving staff-talks has been unrecognisable. But now Gramplan are able to release again the Gramplan Pressure Microphone Type M.C.S., there is no longer any excuse for poor "local" transmissions. Replace the war-emergency "mikes" you have been using in any P.A. systems you maintain with the high-sensitivity Gramplan Type M.C.S., and get rid of one of your worst sources of trouble.



GRAMPLAN MICROPHONE TYPE M.C.S.
Pressure operated. Swivel stand-adaptor. Frequency 70-8000c. Impedance 20 ohms. Sensitivity 42 d.b. PRICE **£7.5**

GRAMPLAN SPEAKER
Projector Type PVH.
Unit Max. Loading 10 watts. Impedance 15 ohms. Horn, length 42 in., diam. 24 in. Cut off, 170
C. P. S. PRICE **£13.5**

GRAMPLAN
LOUDSPEAKERS
GRAMPLAN REPRODUCERS LTD.,
Hampton Road, Hanworth, Middlesex.

Available for early delivery
Phone: Feltham 2657

Scientific G.6A

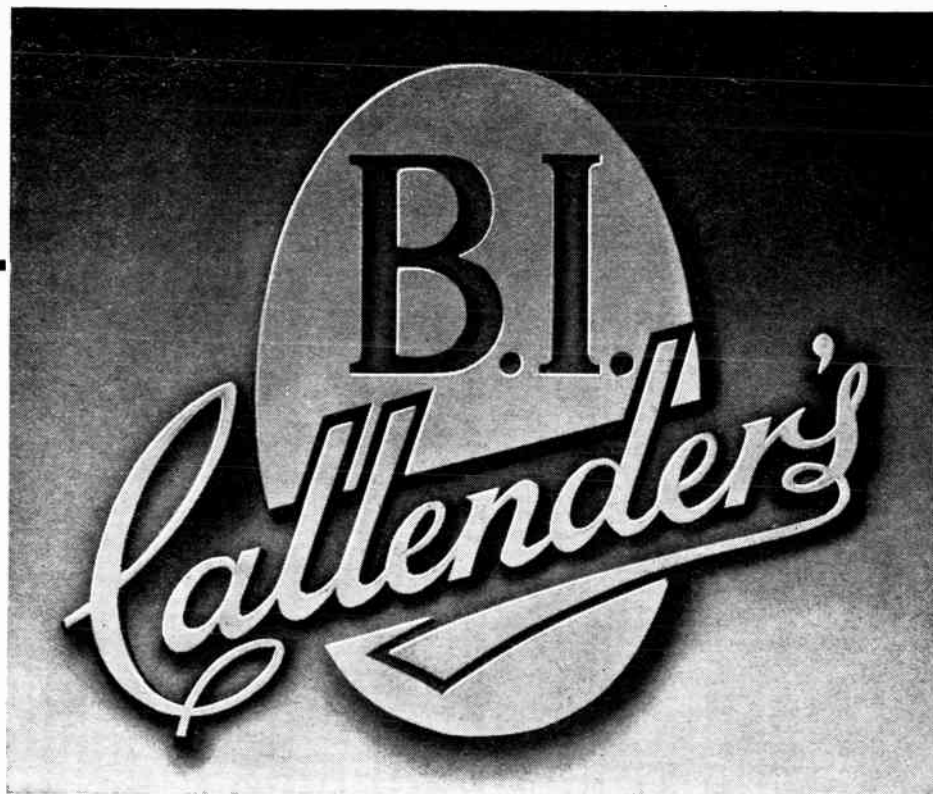

Moulded Tubular CAPACITORS

**HERMETICALLY SEALED TO RESIST
HEAT AND MOISTURE**

Manufactured in a wide range of capacities and for working voltages up to and including 6,000 D.C. For high-voltage operation they provide the most effective solution where size and weight are important considerations and are designed to operate continuously in extremely arduous conditions of temperature and humidity. Manufactured in three sizes and supplied with soldering tags at each end, or alternatively with one soldering tag and a stud for base fixing.

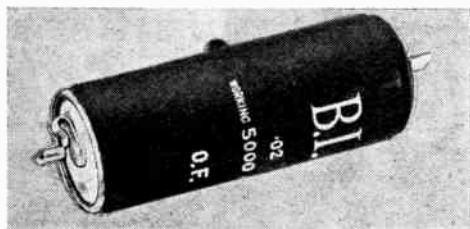

BRITISH INSULATED CALLENDER'S CABLES LIMITED

NORFOLK HOUSE, NORFOLK STREET, LONDON, W.C.2

How much can you
condense a condenser

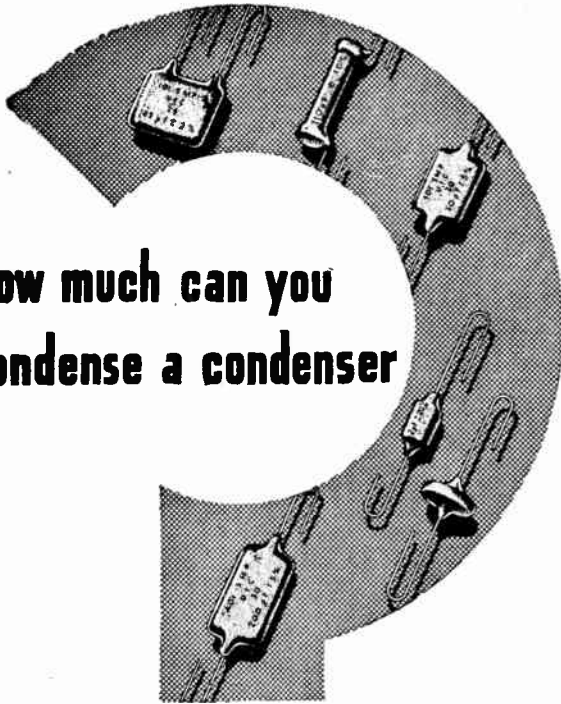

Midget Condensers

Midgets in size but giants in performance are these U.I.C. Miniature Condensers. Especially suitable for use in the latest Service type miniature radio transmitters and receivers, they are efficient and dependable under all climatic conditions. Made to specification K.110. Type approved. Full details on request.

UNITED INSULATOR CO. LTD.
12-22 LAYSTALL ST., LONDON, E.C.1
Tel: TERminus 7383 (5 lines) Grams: Colanel, Smith, London

THE PIONEERS OF LOW-LOSS CERAMICS

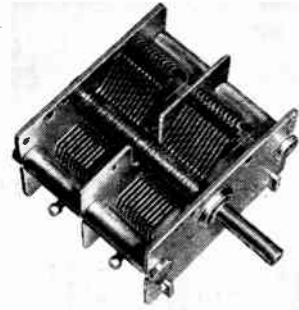

M.G. 1, 2 or 3 GANG CONDENSER

This small size condenser is of rigid construction, and is made in various capacities up to 540mmf. with tropical finish. It can be supplied with trimmers built in if required. The 2 Gang Frame is $2\frac{3}{4} \times 1\frac{3}{4} \times 2\frac{1}{4}$ " over all.



JACKSON
BROS (LONDON) LIMITED
KINGSWAY · WADDON · SURREY
TELEPHONE: CROYDON 2754-5
TELEGRAMS: WALFILCO, PHONE, LONDON

★
ADASTRA ★
GALVANISED SECTIONAL STEEL
RADIO MASTS
Send for Catalogue **WQ/530**
TYBURN ST. - EDINGTON
POLES LTD BIRMINGHAM 24

METALLISED CERAMICS

for

Hermetic Seals and Soldered Assemblies

FREQUENTITE BUSHES

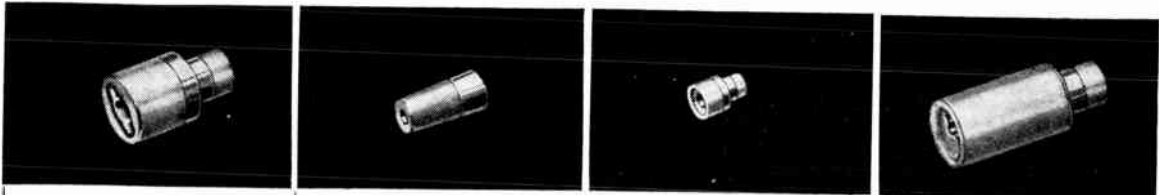

Photographs (above) actual size.
Drawings not to scale.

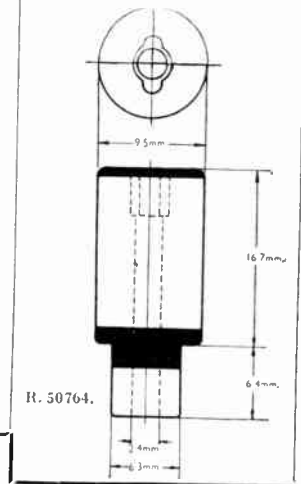
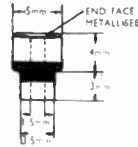
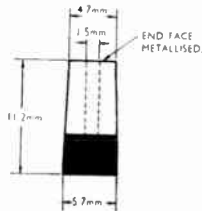
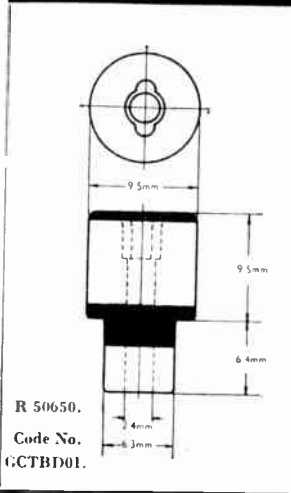

Code nos. are those used in I.S.C.Tech.C.
Specification No. R.C.L./330.11.

PORCELAIN BUSHES

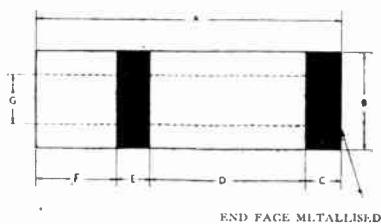
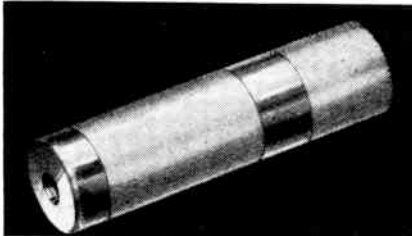

| TYPE | CODE | A mms. | B mms. | C mms. | D mms. | E mms. | F mms. | G mms. |
|----------|---------|-----------|-----------|-----------|-----------|-----------|-----------|-----------|
| R. 50734 | GCTBC01 | 20.3 | 7.6 | 3.8 | 6.4 | 4.6 | 5.5 | 3.0 |
| R. 50768 | GCTBC02 | 20.3 | 12.7 | 3.8 | 6.4 | 4.0 | 5.5 | 5.1 |
| R. 50769 | GCTBC03 | 20.3 | 15.2 | 3.8 | 6.4 | 4.0 | 5.5 | 6.4 |
| R. 50770 | GCTBC04 | 38.1 | 10.2 | 5.1 | 15.7 | 6.4 | 10.9 | 4.1 |
| Q. 2092 | GCTBC05 | 55.9 | 12.7 | 6.4 | 25.4 | 8.9 | 15.2 | 5.1 |
| Q. 1982 | GCTBC06 | 78.7 | 15.2 | 6.4 | 38.1 | 8.9 | 25.3 | 5.1 |

For full information and prices please write to:

STEATITE & PORCELAIN PRODUCTS LTD.

STOURPORT-ON-SEVERN, WORCS. T'phone: Stourport III. T'grams: Steatoin, Stourport.



Coil winding MACHINES

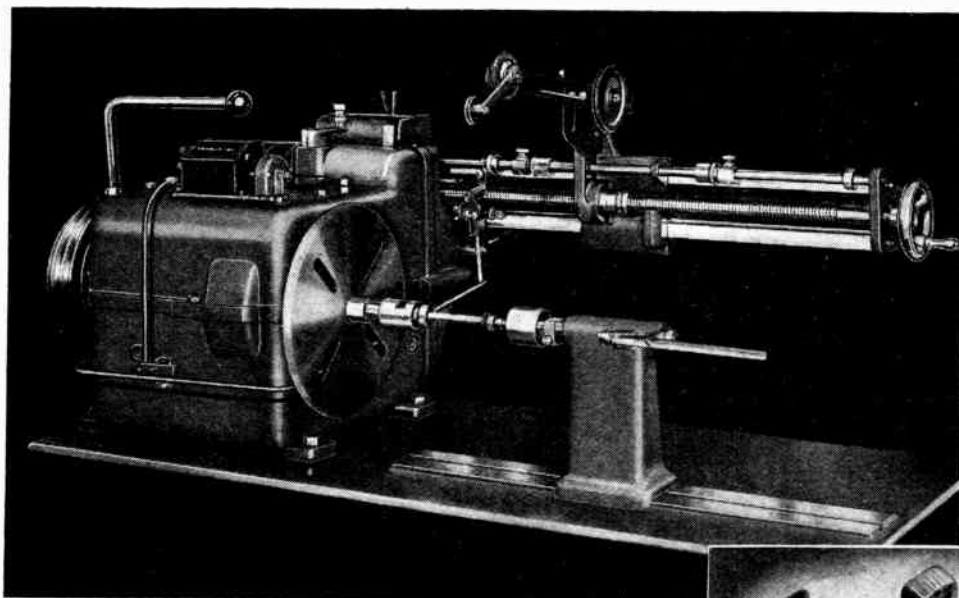

A representative group of coils wound on the Type MW machine.

TYPE-MW MACHINE Suitable for 11 to 47 S.W.G.

Wire gauges from 11 to 47 S.W.G. can be wound on the Neville's Type MW automatic coil winder. Such a wide range of coils would normally require three different sizes of machine. The very complete specification includes a pre-determined re-set revolution counter registering up to six figures, three speed geared drive, and ball bearings throughout. Coils of 12" maximum diameter from $\frac{3}{8}$ " to 10" in length are within its capacity, and faceplate speeds from 283 to 1435 R.P.M. are obtainable. An experienced staff of highly skilled technicians is always prepared to give individual attention to coil winding problems. Your enquiries are invited.



NEVILLE'S (LIVERPOOL) LTD

THE SIMMONDS TOWER · GREAT WEST ROAD · LONDON
A COMPANY OF THE SIMMONDS GROUP



Wireless World

Radio and Electronics

36th YEAR OF PUBLICATION

APRIL 1946

Proprietors:
ILIFFE & SONS LTD.

Managing Editor:
HUGH S. POCOCK,
M.I.E.E.

Editor:
H. F. SMITH

Editorial, Advertising
and Publishing Offices:

DORSET HOUSE,
STAMFORD STREET,
LONDON, S.E.1.

Telephone:
Waterloo 3333 (35 lines).

Telegrams:
"Ethaworld, Sedist, London."



PUBLISHED
MONTHLY

Price: 1/6

(Publication date 26th
of preceding month)

Subscription Rate:
Home and Abroad
20/- per annum.

| | |
|--|-----|
| MONTHLY COMMENTARY | 105 |
| POST-WAR COMPONENTS | 106 |
| PULSE MODULATION By "Cathode Ray" | 113 |
| WORLD OF WIRELESS By J. G. White | 117 |
| CONTRAST EXPANSION. By J. G. White | 120 |
| SHORT-WAVE CONDITIONS | 124 |
| DESIGN DATA—3. Wide-Band Amplifiers | 125 |
| PHASE RELATIONSHIPS. By C. E. Cooper | 127 |
| RADAR CABLES. By Dr. E. W. Smith | 129 |
| BROADCASTING IN U.S.A. By A. Dinsdale | 132 |
| LETTERS TO THE EDITOR | 136 |
| RANDOM RADIATIONS. By "Diallist" | 138 |
| RECENT INVENTIONS | 140 |

Branch Offices:

COVENTRY:

8-10, Corporation Street.
Telephone: Coventry 5210.

Telegrams:
"Autocar, Coventry."

BIRMINGHAM:

Guildhall Buildings,
Navigation Street, 2.

Telephone:
Midland 2971 (5 lines).

Telegrams:
"Autopress, Birmingham."

MANCHESTER:

260, Deansgate, 3.

Telephone:
Blackfriars 4412 (4 lines).

Telegrams:
"Iliffe, Manchester."

GLASGOW:

26B, Renfield Street, C.2.
Telephone: Central 4857.

Telegrams: "Iliffe, Glasgow."



As many of the circuits and apparatus described in these pages are covered by patents, readers are advised, before making use of them, to satisfy themselves that they would not be infringing patents.

VIBRATORS • TRANSFORMERS • SWITCHES • COILS

'Stratosil Sealed'
for EFFICIENCY

Wearite "Stratosil Sealed" Vibrators operate efficiently and with the utmost reliability in all situations irrespective of climatic conditions. They embody many features exclusive to this type of component and are available just now only for purposes directly connected with the war effort.

STRATOSIL
Sealed VIBRATORS

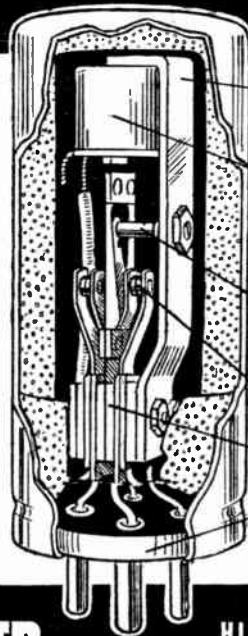

All steel construction—even to the rivets—ensuring uniform expansion under extremes of temperature.

Reed driving coil—wound on a bakelite moulded bobbin to meet all climatic conditions.

Metal can, sponge rubber lined—Acoustically and electrically shielding the Vibrator.

Driving contact of non-tarnishable precious metal—ensuring starting under the lightest of pressures and voltages.

Contacts ground almost to optical limits.

Stack assembly. Mica and steel only are used.

Base sealed by the WEARITE STRATOSIL process.

WRIGHT & WEAIRE LTD

HIGH RD. TOTTENHAM N. 17

TELEPHONE: TOTTENHAM 3847

MULLARD

VALVES



FOR DOMESTIC RECEIVERS

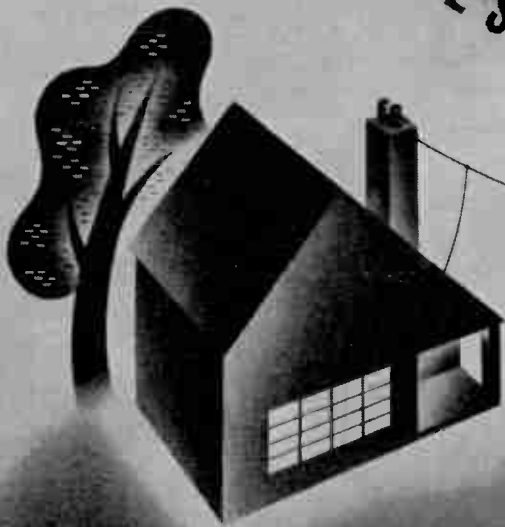

Recommended Types for A.C./D.C. Mains Operated Receiver.

- CCH 35 Frequency changer.
- EF 39 Intermediate Frequency Amplifier.
- EBC 33 Detector L.F. Amplifier.
- CL 33 Output Pentode.
- CY 31 Rectifier.

Other recommended types are available for A.C., battery and portable receivers.

MULLARD THE DOMINANT NAME IN ELECTRONICS

THE MULLARD WIRELESS SERVICE COMPANY LIMITED, CENTURY HOUSE, SHAFTESBURY AVENUE, LONDON, W.C.2. (143)

Wireless World

Radio and Electronics

Vol. LII. No. 4

APRIL 1946

Price 1s. 6d.

Monthly Commentary

Lessons from U.S.A.

AN article from a contributor in America, printed in this issue, gives food for thought, especially as it comes at a time when the new B.B.C. Charter is under consideration. Of course, there is no serious suggestion at the present time that we should adopt the American system of financing broadcasting by advertising revenue, but, in spite of the wide difference between conditions in the two countries, we here can learn something from the problems of transition from war to peace which are facing broadcasting in the U.S.A. At the start, one conclusion is inescapable; in that country so many conflicting financial and commercial considerations come into operation that purely technical factors must play a secondary part.

In America the over-riding consideration is "how can the public be made to pay for any technical development?" Here the problem is much simpler; having decided that a certain development is in the public interest, it can be put into use at once, provided B.B.C. revenue is sufficient. On these latter grounds there should be little difficulty; a correspondent whose letter is published elsewhere in this issue makes a good case in support of the opinion that the projected £1 licence fee should provide a large surplus of revenue. Even in 1937 there was no difficulty in financing a full-dress television service—which is still "around the corner" in America.

Arguing on the same lines, there seems no reason why we should not have ultra-short-wave broadcasting quite soon. The eternal problem of the chicken and the egg need not worry us; the service could be started without waiting for listeners to equip themselves with special receiving equipment before the transmissions start. But before we are committed to this new venture we should like to know a little more about the uses to which U-S-W broadcasting might profitably be put.

Many responsible critics of British broadcasting urge that one of its weaknesses is over-centralization; that new life would be infused into it if we were to have a multiplicity of stations catering

for local groups and for listeners with rather specialised interests. Though we hear such views with respect, we are far from convinced that they are correct. Broadcasting of any kind—certainly medium-frequency broadcasting—seems a most unsuitable medium of distribution for material of merely parochial interest. On purely technical grounds, U-H-F, with its restricted range, is more suitable, but even here we think that the whole idea is out of sympathy with the true concept of radio distribution. But in this matter, again, we might learn much from studying the activities of the American low-powered "small-town" stations. It is perhaps significant that the number of such independent stations (not taking network programmes), seems to be declining.

★ ★ ★

B.B.C. and Government

TIMIDITY is widely held to be an inherent shortcoming of a public-service corporation like the B.B.C. The fear of giving offence overrides the desire to please. Although that weakness can be exaggerated, we believe that it is responsible for a certain colourlessness in the way that the B.B.C. handles many highly controversial topics, particularly those of a political nature. It has long been considered abroad that the Corporation reflects the views of the British Government; not unnaturally, that opinion has been strengthened by the effects of the war, during which a large measure of official control was inevitable. As a result, it is necessary to consider both the susceptibilities of the home listener and the probable reactions of the foreigner to something that the latter will certainly regard as Government-inspired. The programme director would be rather more than human if he always resisted the urge to play for safety.

To some extent the matter is just another regrettable hangover from the war. But it goes rather deeper than that, and we hope that the new B.B.C. Charter will emphasise the principle of freedom of expression for broadcasting.

c

Post-War Components—

ures silent operation. Mumetal screened microphone transformers suitable for single-hole chassis mounting are made by this firm, and also by Parmeko.



Woden screened microphone transformer.

A very wide range of transformers and chokes is offered by Parmeko. Type 5080 is designed for radio receivers and small amplifiers and includes power transformers from 15 to 250 VA, chokes and audio output transformers handling up to 65 watts of A.F. power. In the Type 5081 series the power transformers are rated up to 2 kVA and the output or modulation transformers up to 750 watts. Small power transformers up to 15 VA for pilot bulbs, etc., are included in the 5082 range which is primarily an audio-frequency group comprising intervalve transformers, microphone input transformers, tone control and small smoothing chokes. Finally, the Types 5084 and 5085 are set manufacturers' components for sub-chassis wiring with power handling capacities from 4 to 60 VA.

The "Astronic" interlock coil winding bobbins produced by Associated Electronic Engineers provided a wide choice of sizes for transformer manufacturers. No cement is used and the cheeks are locked mechanically to the centre former. For export the bobbins can be packed flat, when they occupy only one sixth of their normal volume. Pressed steel clamping assemblies are also available and the firm produces a range of complete transformers using these components in sizes from 5 VA to 5 kVA.

An interesting miniature output transformer suitable for use in per-

sonal portable sets has been added to the range of "Hyperloy" transformers made by Wright and Weaire.

Chassis Fitments.—Metal chassis manufacture demands considerable skill and knowledge of the behaviour of metals. This work is one of the specialities of J. and H. Walter, who manufacture chassis of all kinds in steel, aluminium, copper and brass.

Specialised items of presswork and stampings and the host of small parts used in the manufacture of radio apparatus and components are produced for the radio industry by Carr Fastener.

That metal cabinets for housing such apparatus as PA amplifiers, battery chargers, laboratory gear and test equipment need not be unattractive is very conclusively proved by the modern designs prepared and manufactured by Alfred Imhof.

Retaining devices for holding valves firmly in their holders are now becoming generally available. Those made by Electrothermal Engineering are fabricated from woven glass material, plastics and steel springs, while a simple saddle-type retainer is produced by Long and Hambly. This firm also make rubber and synthetic rubber masks and supports for CR tubes, rubber grommets and a variety of rubber- and metal-bonded items, some of which are for use as shock-proof mountings.

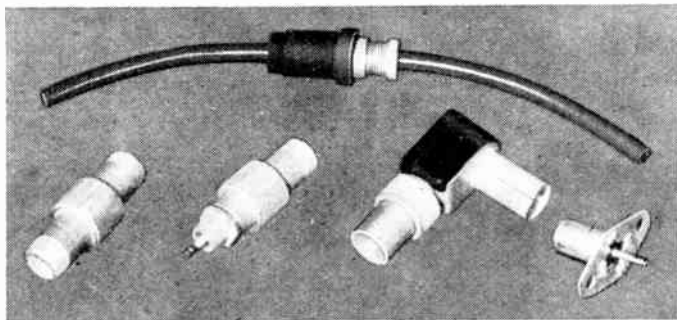

Selection of Belling-Lee co-axial plugs and sockets.

A metal base retainer is now made by Belling-Lee for the all-glass type valves such as the EF50.

Plugs and Sockets.—There has been a general improvement in the resilience characteristics of the

materials employed in plugs. The new ceramic co-axial models developed by Belling-Lee are of the type used as R.F. outlets on H.F. and V.H.F. receivers and transmitters. They are fully screened and designed for use with solid dielectric and air-spaced cables.

Examples of the miniature types are included among Clix, Belling-Lee and Bulgin products.

Valveholders.—The main improvements effected to valveholders are in manufacture and have been directed to increasing the resilience in the sockets and decreasing the contact resistance, sometimes by the use of silver-plated springs.

These features are now to be found in all the latest Clix, Belling-Lee and Celestion models.

The chassis style is now almost universal, and high-grade insulators, such as ceramics and silica-loaded polystyrene are now being pressed into service for valveholder plates, the last mentioned being used for the B9G 9-pin models made by Clix.

The Belling-Lee range also includes a 9-pin model for the new all-glass valves, as well as special types of top-cap connectors of anti-corona design.

Switches.—The trend of switch development is by no means obvious on a casual inspection for it is confined more to details than to the general form. A better

understanding of the metallurgical problem involved in contact design has led to improvements in the materials employed, with the result that springy contacts can be relied upon to retain their springiness for longer periods.

In general form the switches fall into three categories. There are the rotary stud switches employed chiefly in attenuators and high-grade potentiometers. The developments here are the adoption of a floating mounting for the wiper arm and the use of contact studs moulded into the insulant to avoid their loosening with age.

The well-known Q.M.B. switches are now commonly made with open sides, permitting access to the interior for cleaning.

Rotary wafer-type switches are now almost universally employed for wave-band switching and in appearance are little, if any, different from the pre-war patterns. Detailed improvements in materials have been made, however, and the types now in production should give much better service.

Some near-miniature types are made and should find great application in compact equipment. Push-button operated types, too, are made with a great variety of contact arrangement and are finding their way into test equipment as well as broadcast sets.

Cables and Wires.—By reason of the bright and clean colours in which it is obtainable, the most striking of the new radio materials is connecting wire with polyvinyl-chloride insulation. This plastic is remarkable in being unaffected by water, salt solutions, inorganic acids and alkalis, and oils. It will also withstand a wide range of temperature. The exact figures vary somewhat with the grade but a typical range is -25°C to $+70^{\circ}\text{C}$.

P.V.C., as it is usually abbreviated, is now very commonly used for insulated connecting wires and is made with both solid and flexible conductors. It is also frequently employed as an outer protective covering for coaxial cables. Most of the wire and cable manufacturers now adopt this insulant. Although it is also made in the form of insulating sleeving, the older fabric types of sleeving are by no means dead, and silk-base tubing in both tropical and non-tropical grades is made by Symons in sizes ranging from 0.75 mm bore.

For radio-frequency cables the most usual insulant is now polyethylene, which is available under

various trade names, such as Polythene and Telcothene. The coaxial type is probably the most widely used, but twin screened feeders are also made. A solid or stranded centre conductor is embedded in polyethylene which is surrounded by the outer conductor. In the non-flexible types

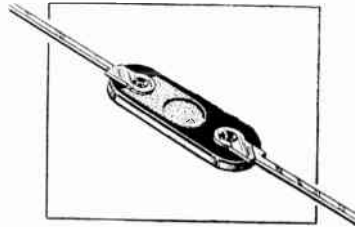

Standard Telephones Uniplate selenium rectifier.

this takes the form of a lead sheath, but in the flexible it is copper-braiding covered by P.V.C.

The twin types have two conductors embedded in polyethylene and the whole is usually covered with a copper-braided screen. The impedance is around 70 ohms for coaxial and about 80-130 ohms for the twin types.

Cable development has not been confined to the communications and radar patterns, for special kinds are now made for radio-heating purposes. B.I.-Callender's, for instance, produce a water-cooled coaxial cable in which the centre conductor is a tube carrying the cooling water. The main purpose of this is to convey the water to the work circuit in a neat and tidy manner rather than to cool the cable itself, although the cable may be expected to heat up somewhat since it carries up to 300 A.

For some applications, particularly on centimetre waves, special cable connectors are needed to avoid an impedance mismatch. These are obtainable in moulded polyethylene from the cable manufacturers.

Protected moulded rubber junction sleeves are available for more ordinary purposes from Hellerman Electric, who also have special tools for use with them.

Metal Rectifiers.—An entirely new range of small selenium rectifiers, described as the Sentercel Uniplate series, has been intro-

duced by Standard Telephones. Their main application is in A.F. and V.F. circuits, but there are also assemblies for incorporating in measuring instruments. Four sizes are available, with ratings of 1 to 40mA. Television and CRT types are also included in the Sentercel series.

To the Westinghouse range of Westalite selenium rectifiers has now been added some new models designed primarily for use in A.C./D.C. apparatus. They are half-wave rectifiers, and are intended to be used in the same manner as a valve rectifier. Three sizes are made with current handling capacities of 30, 60 and 120mA.

Vibrators.—Vibrators were, of course, well-known before the war when they provided the standard means of obtaining the H.T. supply in car sets. They have been widely used by the Services and considerable detail development has taken place which has resulted mainly in increased reliability. These improvements have been chiefly in spring and contact materials and in methods of manufacture.

Six-volt and 12-volt types are the most common, but the Wimbledon Engineering Co., include 24-volt types in their range. All types have a maximum input

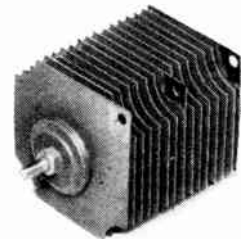

Westalite AC/DC rectifier, Type HT 250/120.

current rating of 5A, so that the power rating is proportional to the input voltage.

British N.S.F., the Plessey Co., and Wright & Weaire also market ranges of vibrators; this last firm also produces a Vibrapower unit, consisting of a transformer, vibrator socket and the RF filtering.

Loudspeakers.—The phenomenal performance of modern

Post-War Components—

magnet steels has influenced the design of loudspeakers in many ways, not the least important

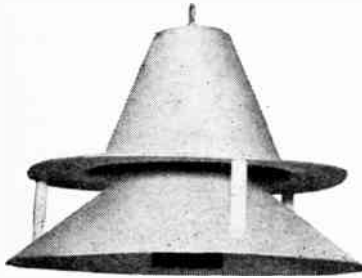

"Circorn" loudspeaker unit
(Film Industries).

being the reduction in physical size. Goodmans are producing a range of 5-in and 6-in shallow-angle moving coil units for midget and car radio sets which take up little more space than a saucer. At the other end of the scale they have a series of cinema and PA speakers up to 18-in diameter and 50 watts power handling capacity in which the permanent magnets are little heavier than those required for pre-war 10- or 12-in cones.

In some of the Celestion loudspeakers using the new magnet steels it had been found possible to dispense with clamping bolts for the magnet end-plates; deliberate mishandling fails to produce the slightest relative movement between the parts. Celestion have also designed a system of dust-proofing which permits an air relief behind the corrugated centring diaphragm. By flanging the relief holes and disposing them correctly it has been found possible to trap all magnetic dust particles before they can find their way into the speech-coil gap.

New loudspeakers for 360-degree sound distribution have been introduced. In the Tannoy Type LS/394/CIR bowl loudspeaker the unit is mounted in an ellipsoidal casing suspended from a cone reflector and can be quickly detached for inspection or cleaning. Two standard sizes are available with 4-in and 8-in units respectively. In the Film Industries "Circorn" the efficiency

of horn loading has been combined with 360-degree radiation.

Gramophone Equipment.—The range of Garrard gramophone motor units has been extended and now includes a heavy duty transcription motor—model 201B. This is a governor-controlled induction motor which can be run at 78 or 33 $\frac{1}{3}$ rpm. Special precautions have been taken to ensure constancy of speed, and the main thrust bearing is an optically-finished ball race. The motor windings are designed to reduce stray fields. A 12-in turntable is used, but there is a model with an extended speed indicator plate for 16-in discs.

The Garrard Model V radiogram units employ a new coil spring suspension designed to eliminate acoustic feedback. The Model RC60 record-changer plays up to eight mixed records, the time of the record-changing cycle being only six seconds.

A record-changer of unusual design was shown by Plessey. In this the records are stacked on retractable pawls on a vertical centre spindle of simple design.

Cosmocord are now supplying piezo-crystal recording cutters in addition to a range of magnetic and crystal pick-up reproducing heads and tone arms.

Materials.—One of the most obvious developments is in the increasing use of ceramic materials. At one time confined almost

capacitors, and, in a few cases, for insulating the rotors also; for the bases of trimming capacitors and switch plates; for valveholders and coil formers, to mention only a few of their applications.

They are now widely employed as the dielectric in small capacitors and different types are obtainable giving either positive or negative temperature coefficients of capacitance. The latter are commonly used in oscillator circuits to offset the normal positive coefficient and give to the circuit as a whole a zero coefficient. Whereas the positive coefficients of ceramic materials are in the neighbourhood of $100-300 \times 10^{-6}$ per °C, the negative are around -800×10^{-6} per °C.

Inductances are obtainable in which the "wire" consists of a metal coating fired on to a ceramic former. This same technique is

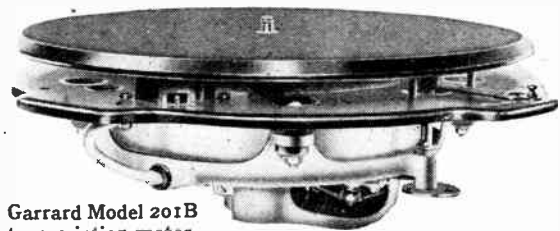

Garrard Model 201B
transcription motor.

adopted for sealing elements. A bush has a deposited metal coating and can be soldered in place.

As an alternative, metal-glass seals for hermetically sealed components are coming into favour. In these a bead of glass carries a lead-through wire and an external metal flange, both of which are sealed to the glass by a technique similar to that adopted by the valve manufacturer. The flange is soldered into a hole in the metal case of the component. Ferranti have a copper-glass seal, other firms have Kovar-glass types, and T.C. & M. Co. use Telcoseal—a material developed for this work.

The older insulators have by no means been ousted by the latest developments and many of them have been considerably improved. Mycalex, for instance, is not only easily machined, but can now be moulded. It is a mica-glass compound which will withstand temperatures up to 400° C without deformation. Micanite consists of mica splittings bonded with insulating cement and is obtainable in

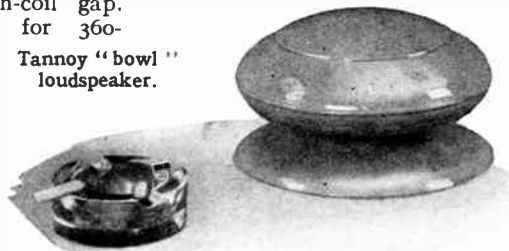

Tannoy "bowl"
loudspeaker.

entirely to aerial insulators, ceramics now find wide application to small pressed insulators of nearly every kind. They are used for supporting the stators of variable

large sheets and in flexible form. It can also be moulded.

For that most important process in all wireless assembly, soldering,

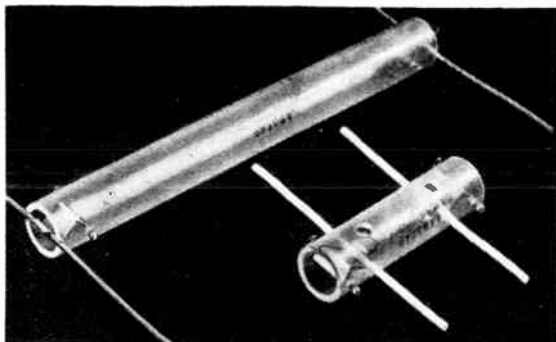

the use of resin-cored solder is now very common. It is usual to employ an activated form of resin, but different forms of core and different solder alloys themselves are available to suit various kinds of work. Multicore Solders produce a solder having three cores of Ersin flux, but most firms adopt a single core. Dubois and B.I.-Callender's both manufacture the latter, and B.I.-C. also market a range of fluxes separately.

In discussing switches it was said that one of the improvements had been in the spring material. One of these materials is beryllium copper, an alloy which becomes as hard as steel with suitable heat treatment. Its outstanding quality is its fatigue strength, particularly under corrosive conditions, but it also has high wear resistance when running against hard steel; making it particularly useful for cams. It is produced by T.C. & M. Co. who also manufacture the well-known magnetic alloys, Radiometal, Mumetal and Rhometal.

Magnetic & Electric Alloys also produce Mumetal and Rhometal as well as Laminic and Permalloy, and various types of Silcor and Vicor among the silicon alloys.

Permanent magnets have undergone great strides in recent years and some alloys now have phenomenal characteristics. The Mullard Ticonal, for instance, has a saturation value of B of 17,000 gauss and a normal working value of 10,000 gauss.

Aerial Equipment.—Active preparations are being made for the

resumption of the television service and many reflector dipole aerials are now available. The "Aerialite" adjustable universal reflector makes use of flexible cable conductors stretched on a diagonal wooden frame. The advantage is that the length can be adjusted easily to any required wavelength present or future.

Transmission line spreaders (Lab-gear).

In the "Antiference" television dipole, Type WD₃R, a simple swivel mounting facilitates the work of erection. The dipole elements are detachable and the

various parts can be taken up the ladder in easy instalments.

A 50-ft. "Skytower" lattice mast has been designed by Belling and Lee for mounting their "Skyrod" aerials. The lattice structure is of galvanised steel and is divided electrically by porcelain compression insulators.

For amateur transmitters, Lab-gear have introduced a rotatable beam antenna suitable for mast mounting. Reflector and director elements are placed on either side of the dipole which is folded to compensate for the change of impedance introduced by the parasitic elements. Spreaders for spaced transmission lines are another new product of this firm. They are made from light extruded tubing of low-loss insulating material and are provided with snap-action clips for ease of assembly.

LIST OF MANUFACTURERS

Showing at R.C.M.F. Exhibition

A.B. Metal Products, Ltd., Hatton Works, Feltham, Middx.

Aerialite, Ltd., Castle Works, Stalybridge, Cheshire.

Aeronautical & General Instruments, Ltd., Purley Way, Croydon, Surrey.

Antiference, Ltd., Plender Place, Plender Street, London, N.W.1.

Associated Electronic Engineers, Ltd., Dalston Lane, Stanmore, Middx.

Associated Technical Manufacturers, Ltd., Vincent Works, New Islington, Manchester, 4, Lancs.

Automatic Coil Winder & Electrical Equipment Co., Ltd., Winder House, Douglas Street, London, S.W.1.

Belling & Lee, Ltd., Cambridge Arterial Road, Enfield, Middx.

Bird, Sydney S., & Sons, Ltd., Cambridge Arterial Road, Enfield, Middx.

Bray, Geo., & Co., Ltd., Leicester Place, Blackman Lane, Leeds, 2, Yorks.

British Electric Resistance Co., Ltd., Queensway, Ponders End, Middx.

British Electrolytic Condenser Co., Ltd., 52, Vicarage Lane, Ilford, Essex.

British Insulated Callender's Cables, Ltd., Surrey House, Embankment, London, W.C.2.

British Mechanical Productions, Ltd., 1, Church Road, Leatherhead, Surrey.

British N.S.F. Co., Ltd., Dalton Mill, Dalton Lane, Keighley, Yorks.

British Rola, Ltd., Georgian House, Bury Street, London, S.W.1.

Bulgin, A. F., & Co., Ltd., By-pass Road, Barking, Essex.

Bullers, Ltd., The Hall, Oatlands Drive, Weybridge, Surrey.

Carr Fastener Co., Ltd., Nottingham Road, Stapleford, Notts.

Celestion, Ltd., London Road, Kingston, Surrey.

Colvern, Ltd., Mawneys Road, Romford, Essex.

Cosmocord, Ltd., 700, Great Cambridge Road, Enfield, Middx.

Daly (Condensers), Ltd., West Lodge Works, The Green, London, W.5.

Dubilier Condenser Co. (1925), Ltd., Ducon Works, Victoria Road, N. Acton, London, W.3.

Du Bois Co., Ltd., 15, Britannia Street, Kings Cross, London, N.W.1.

Duratube & Wire, Ltd., Faggs Road, Feltham, Middx.

Electrothermal Engineering Co., Ltd., 270, Neville Road, London, N.7.

ERG Resistors, Ltd., 1021a, Finchley Road, London, N.W.11.

Erie Resistors, Ltd., Carlisle Road, The Hyde, London, N.W.9.

Ferranti, Ltd., Hollingwood, Lancs.

Film Industries, Ltd., 60, Paddington Street, London, W.1.

Fox, P. X., Ltd., No. 2 Factory, Hawksworth Road, Horsforth, Yorks.

Garrard Engineering & Manufacturing Co., Ltd., Newcastle Street, Swindon, Wilts.

Goldsmen, J. L., Ltd., 5, Torrens Street, City Road, London, E.C.1.

Goodmans Industries, Ltd., Lancelot Road, Wembley, Middx.

Hellerman Electric Co., Ltd., Goodtric Works, Brewer Street, Oxford.

Hunt, A. H., Ltd., Bendon Valley, Garratt Lane, London, S.W.18.

Imhof, Alfred, Ltd., 112/6, New Oxford Street, London, W.C.1.

Post-War Components—

Jackson Bros. (London), Ltd., Kingsway, Waddon, Surrey.

Labgear, Ltd., Willow Place, Fair Street, Cambridge.

London Electrical Manufacturing Co., Ltd., 459, Fulham Road, London, S.W.6.

Long & Hambly, Ltd., 51, Highgate Hill, London, N.19.

Magnetic & Electrical Alloys, Ltd., 101/3, Baker Street, London, W.1.
Micanite & Insulators Co., Ltd., Empire Works, Blackhorse Lane, London, E.17.

Morgan Crucible Co., Ltd., Battersea Church Road, London, S.W.11.

Mullard Wireless Service Co., Ltd., Century House, Shaftesbury Avenue, London, W.C.2.

Multicore Solders, Ltd., Commonwealth House, New Oxford Street, London, W.C.1.

Mycalex & Co., Ltd., Ashcroft Road, Cirencester, Glos.

Painton & Co., Ltd., Kingsthorpe, Northampton.

Parmeko, Ltd., Percy Road, Aylestone Road, Leicester.

Plessey Co., Ltd., Vicarage Lane, Ilford, Essex.

Reliance Electrical Wire Co., Ltd., Staffa Road, Leyton, London, E.10.

Reliance Manufacturing Co. (South-wark), Ltd., Sutherland Road, Higham Hill, London, E.17.

Reproducers & Amplifiers, Ltd., Frederick Street, Wolverhampton, Staffs.

Ripaults, Ltd., Southbury Road, Enfield, Middx.

Sifam Electrical Instrument Co., Ltd., Leigh Court, Hr. Lincombe Road, Torquay, Devon.

Spicers, Ltd., 19, New Bridge Street, London, E.C.4.

Standard Telephones & Cables, Ltd., Connaught House, Aldwych, London, W.C.2.

Static Condenser Co., Ltd., Toutley Works, Wokingham, Berks.

Steatite & Porcelain Products, Ltd., Stourport-on-Severn, Worcs.

Stratton & Co., Ltd., 2/5, Station Street, Birmingham, 5.

Symons, H. D., & Co., Ltd., Park Works, Kingston Hill, Surrey.

Tannoy Products (Guy R. Fountain), Ltd., Canterbury Grove, London, S.E.27.

Taylor, Tunncliffe & Co., Ltd., 124, High Holborn, London, W.C.1.

Telegraph Condenser Co., Ltd., Wales Farm Road, North Acton, London, W.3.

Telegraph Construction & Maintenance Co., Ltd., 22, Old Broad Street, London, E.C.2.

Telephone Manufacturing Co., Ltd., Hollingsworth Works, W. Dulwich, London, S.E.21.

United Insulator Co., Ltd., 12/20, Lay-stall Street, London, E.C.1.

Varley Dry Accumulators, Ltd., By-pass Road, Barking, Essex.

Varley (Oliver Pell Control, Ltd.), Cambridge Row, Woolwich, London, S.E.18.

Walter Instruments, Ltd., Exhibition Buildings, Earls Court, London, S.W.5.

Walter, J. & H., Ltd., 2, Caxton Street, London, S.W.1.

Wego Condenser Co., Ltd., Bideford Avenue, Perivale, Middx.

Welwyn Electrical Laboratories, Ltd., 70, Bridge Road East, Welwyn Garden City, Herts.

Westinghouse Brake & Signal Co.,

Ltd., 82, York Way, Kings Cross, London, N.1.

Wimbledon Engineering Co., Ltd., Garth Road, Lower Morden, Surrey.

Wingrove & Rogers, Ltd., Broadway Court, Broadway, London, S.W.1.

Woden Transformer Co., Ltd., Moxley Road, Bilston, Staffs.

Wright & Weaire, Ltd., 740, High Road, Tottenham, London, N.17.

CLASSIFIED LIST OF PRODUCTS*Shown at R.C.M.F. Exhibition*

Aerial Equipment. Aerialite; Antiference; Belling-Lee; Labgear; Ripaults; T.C. & M.

Alloys, Magnetic & Electrical Alloys; T.C. & M.

Attenuators. Aeronautical & General; Labgear; Painton.

Bobbins. Associated Electronic Engrs.

Cables and Wires. Aerialite; Associated Tech. Mfrs.; B.I.-Callenders; Duratube; Reliance Electrical Wire; Ripaults, Standard Telephones; T.C. & M.

Capacitors, Fixed. British Electrolytic Condenser; B.I.-Callenders; British N.S.F.; Bulgin; Daly; Dubilier; Erie; Ferranti; Hunt; London Elect. Mfg.; Mycalex; Static Condenser; T.C.C.; T.M.C.; United Insulator; Wego.

Capacitors, Variable and Pre-set. Aeronautical & General; Sydney Bird; Erie; Jackson; Labgear; Mullard; Plessey; Stratton; United Insulator; Walter Instruments; Wingrove & Rogers.

Ceramics. Geo. Bray; Bullers; Steatite; Taylor, Tunncliffe.

Chassis. Imhof; J. & H. Walters.

Chokes, Iron-cored. Aeronautical & General; Bulgin; Ferranti; Labgear; Parmeko; Plessey; Reproducers & Amplifiers; Stratton; Varley; Wright & Weaire.

Chokes, R.F. Aeronautical & General; Bulgin; Labgear; Plessey; Stratton; Varley; Wright & Weaire.

Coils, R.F. and I.F. Aeronautical & General; Bulgin; Labgear; Plessey; Stratton; Varley; Wright & Weaire.

Connectors. Belling-Lee; British Mechanical Productions; B.I.-Callenders; Bulgin; Carr Fastener.

Crystals, Quartz. Standard Tele-phones.

Ear Phones, Crystal. Cosmocord.

Fuses and Fuseholders. Belling-Lee; British Mechanical Productions; Bulgin; Carr Fastener.

Gramophone Motors, Units, Record Changers. Garrard; Plessey.

Instruments, Measuring and Test. Automatic Coil Winder; Ferranti; Labgear; Sifam.

Insulators. Belling-Lee; Geo. Bray; Bullers; Steatite; Stratton; Taylor, Tunncliffe.

Insulating Materials and Sleeving. Associated Tech. Mfrs.; Duratube; Hellerman; Long & Hambly; Micanite; Mycalex; Spicers; Symons; T.C. & M.

Interference Suppressors. Antiference; Belling-Lee; Dubilier; Morgan Crucible. Jacks. Bulgin; Plessey; T.M.C.

Laminations, Iron-core. British Rola; Magnetic & Electrical Alloys; T.C. & M.

Loudspeakers. British Rola; Celestion; Film Industries; Goodmans; Plessey; Reproducers & Amplifiers; Tannoy.

Magnets, Permanent. Mullard.

Microphones. Cosmocord; Film Industries; Tannoy.

Pick-ups. Cosmocord; Garrard.

Plugs and Sockets. Belling-Lee; British Mechanical Productions; Bulgin; Carr Fastener; Long & Hambly; Painton; Plessey; T.M.C.; Wright & Weaire.

Potentiometers and Rheostats. British Electric Resistance; British N.S.F.; Bulgin; Colvern; Dubilier; Erie; Fox; Goldsman; Morgan Crucible; Painton; Plessey; Reliance Mfg.; Varley, Welwyn Laboratories.

Recording Heads, Crystal. Cosmocord.

Rectifiers, Metal. Standard Tele-phones; Westinghouse.

Relays. Labgear; Standard Tele-phones; T.M.C.

Resistors, Fixed. British Electric Resistance; British N.S.F.; Bulgin; Colvern; Dubilier; Erg Resistors; Erie; Goldsman; Morgan Crucible; Mullard; Painton; Varley; Welwyn Laboratories.

Rubber, Moulded. Long & Hambly; Painton.

Solder. B.I.-Callenders; Du Bois; Multicore.

Switches. A.B. Metal Products; Aeronautical & General; British Electric Resistance; British N.S.F.; Bulgin; Painton; Plessey; T.M.C.; Walter Instruments; Wright & Weaire.

Thermal Switches and Cut-outs. Belling-Lee; Bulgin; Varley.

Thermostats. Electrothermal.

Transformers, A.F. Aeronautical & General; Associated Electronic Engrs.; British Rola; Bulgin; Celestion; Ferranti; Goodmans; Labgear; Parmeko; Plessey; Reproducers & Amplifiers; Varley; Woden; Wright & Weaire.

Transformers, I.F. and R.F. Bulgin; Labgear; Plessey; Stratton; Wright & Weaire.

Transformers, Power. Aeronautical & General; Associated Electronic Engrs.; Belling-Lee; Bulgin; Ferranti; Labgear; Parmeko; Plessey; Varley; Woden; Wright & Weaire.

Valve Bases, Holders, Top Connectors, etc. Aeronautical & General; Belling-Lee; British Mechanical Productions; Bulgin; Carr Fastener; Celestion; Electrothermal; Plessey; Stratton; United Insulator.

Valve Retainers. Belling-Lee; Electrothermal; Long & Hambly.

Vibrators. British N.S.F.; Bulgin; Plessey; Wimbledon Eng.; Wright & Weaire.

PULSE MODULATION

Important New Factor in Communications

By "CATHODE RAY"

A THING we are hearing about quite a lot nowadays, and will certainly hear much more about before long, is pulse modulation. When pulses are mentioned one tends to think, if not of doctors, then of radar. They also come, though incidentally, into television. They are beginning to come into radio communication of many different kinds, and that is what you may be finding rather confusing. Perhaps the best thing is to take a general view of the whole subject.

Until recently, "modulation" to most people has meant amplitude modulation of a carrier wave. It is the sort that has always been used by the B.B.C. In America it is now strongly challenged by frequency modulation, to which is closely related a third method—phase modulation. All of these have their counterparts in pulse modulation, so we had better be sure first of all that the distinctions between them are quite clear.

Fig. 1 (a) is how a brief sample of plain unmodulated carrier wave is represented. Below, at (b) is one cycle of a simple audio-frequency modulating wave. (In practice there are generally far more carrier-frequency cycles per audio-frequency cycle than are shown here, but one does get so tired of drawing them). Amplitude modulation of (a) by (b) is shown at (c). Deeper modulation, corresponding for example to sound of the same pitch but greater volume, is illustrated at (d). If the modulating waveform is more complicated than (b), the variations in amplitude of the carrier correspond. So far we are on familiar ground.

Frequency and phase modulation are more difficult to show clearly in an amplitude/time diagram, which may partly be why they are less generally understood. Phase modulation is represented by (e), and for convenience the unmodulated carrier (a) is repeated just below it, so that the phase shifts (that is to say the

amounts by which the modulated cycles start earlier or later than they would if unmodulated) can be measured by the lengths of the horizontal kinks in the lines joining corresponding cycles. These phase shifts can be seen to be proportional to the varying height of the modulating waveform (b), it being conventionally assumed that distance above the base line in (b), and phase advance in (e), are positive; and vice-versa. The maximum phase displacement in (e) happens to be half a cycle, or 180 deg. To double the depth of modulation,

all the phase shifts would have to be doubled, giving a maximum displacement of one whole cycle.

It is easy enough to guess that in frequency modulation the modulating waveform is made to vary the frequency of the carrier wave, instead of its amplitude of phase. Unfortunately, in the sort of diagram we have been using, frequency is not shown directly, but it can to some extent be estimated (Fig. 1 (f)) because frequency and phase are close relations. For example, if the frequency of a wave is raised by some fixed amount, a steadily increasing phase advance begins, and lasts as long as the frequency rise. The cycles are thus packed

more closely. To anybody who has gone as far as the first few lessons of the Calculus, the relationship between phase and frequency shifts, such as those due to the correspondingly named methods of modulation, is something quite simple and definite: frequency shift is rate of change of phase shift, and, conversely, phase shift is frequency shift integrated with respect to time. But it is not at all necessary to have studied any calculus or be able to put the matter in these particular terms to see what

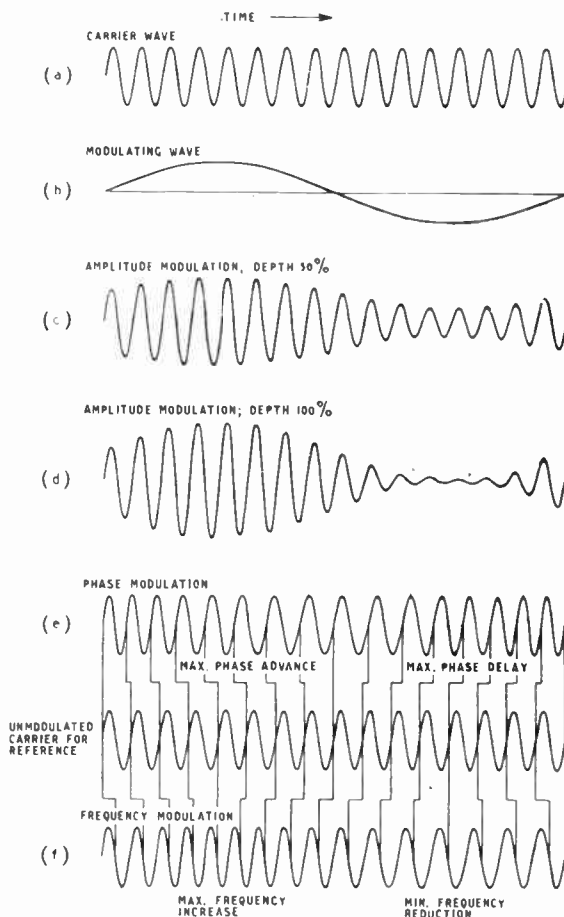

Fig. 1. Comparison of different ways of modulating a continuous carrier wave.

Pulse Modulation—

phase and frequency modulation mean. It is clear from Fig. 1 (e) and (f) that when either is present both must be, but they cannot both at the same time *correctly* represent the modulating waveform. For example, Fig. 1 (e) may be regarded as either phase modulation or frequency modulation: if the former, then it is an undistorted representation of the modulating waveform (b); if the latter, then it is a distorted representation of (b), but one could draw another waveform, of which it would be a faithful frequency-modulated version. I'm afraid that sounds rather involved, but I hope not too much so to follow.

Another important feature of phase and frequency modulation is that as the amplitude is normally constant the transmitter can work at full power all the time, and many of the things that cause distortion and noise in amplitude modulation receivers are avoided.

Readers (except, of course, you) have no doubt been thinking exclusively in terms of modulation derived from telephony, sound, speech, music or what you will. You, with exceptional perspicacity, have realized that Fig 1 (b) stands not only for these but for morse and other "on/off" signals. To emphasize the point, and also to give a further demonstration of the different

will be gone into soon, it is sometimes advantageous to complicate the issue by pulse modulation. This is not just a fourth name to add to the list of types of modulation we have already compiled, although it may sound like it. What makes things still more confusing is that "pulse modulation" has two meanings, which we shall consider presently, but first—what is a pulse? It is a very short-lived current or voltage, usually repeated at more or less regular and relatively long intervals. Fig. 3 (a) is a typical amplitude/time diagram of a train of pulses. There is general agreement that in order to qualify for the name "pulse" the ratio of length to period, p/P in Fig. 3 (a),

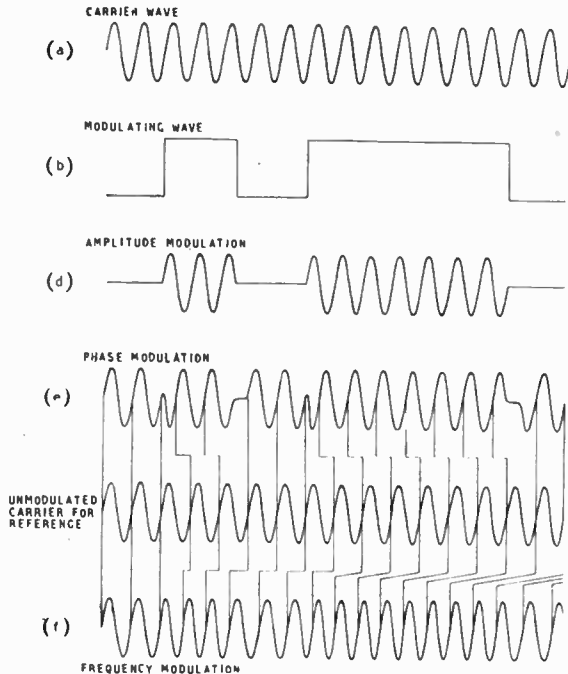

Fig. 2. The same series as in Fig. 1 but with a morse modulating waveform (b) instead of a single sine wave. (e) is omitted, because modulation by morse signals is almost invariably 100 per cent. Phase and frequency modulation are shown for comparison, but the latter is seldom used now for morse, and the former is of little or no practical importance. Note that as the modulating wave has a D.C. component a phase shift is likely to accumulate when the frequency is modulated.

In passing, it may be noted that both phase and frequency methods are less liable to over-modulation than the amplitude method, which suddenly reaches its limit when the amplitude touches zero as in Fig. 1 (d).

sorts of modulation, the Fig. 2 series does for a morse "A" what Fig. 1 does for one audio frequency sine wave.

So now for the three main methods of modulating continuous carrier waves. For reasons which

must be "small," but so far as I know an official dividing line between pulses and, say, rectangular waves or morse dots has never been laid down. It is commonly of the order of 1 : 100 but may be much more or less.

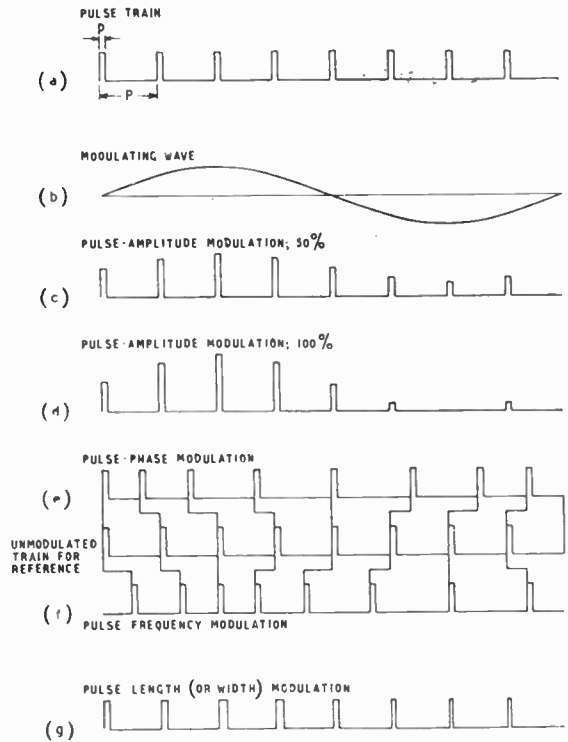

Fig. 3. All except the last of these ways of modulating pulses can be compared with modulation of a carrier wave in Figs. 1 and 2. Method (g) is used in the Pye system of combined vision and sound with a single transmitter.

The number of pulses per second is the *pulse recurrence frequency*.

In the first meaning of pulse modulation a train of pulses such as is shown in Fig. 3 (a) is substituted for a train of high-frequency waves (Figs. 1 (a) or 2 (a)) as raw material available for modulation. Fig. 3 (c-f) corresponds with Fig. 1 (c-f) in showing the results of such modulation. These, and Fig. 3 (g) I will comment on later; in the meantime, according to the second meaning of pulse modulation a train of pulses (Fig. 4 (b)) is used to modulate our familiar continuous carrier wave (Fig. 4 (a)), the result being shown at (c). In this sense it is merely a case of amplitude modulation of a carrier wave, and Fig. 4 (a-c) corresponds with Figs. 1 and 2 (a-c), especially Fig. 2.

The products, Fig. 4 (c), are often called pulses, but this is asking for confusion with Fig. 4 (b). In the absence of any lead from authorities, I intend to call the things shown at (c) *wave pulses*.

Pulse modulation as illustrated in Fig. 4 is the sort used in radar, and calls for no further comment here. Pulse modulation as used in communications may be confined to what is shown in Fig. 3, but more often is a combination of the two, finally yielding modulated wave pulses. There are two ways of arriving at this result: either the modulated pulses shown in Fig. 3 (c-g) can be used in place of Fig. 4 (b) to modulate a carrier wave; or the uniform wave pulses, Fig. 4 (c), can be modulated. The latter method suffers from practical limitations, so the former is the one generally used; it is just a matter of design, anyway, so we are not going to bother about the processes of production but will concentrate on the final product—a series of wave pulses, modulated by the audio-frequency "intelligence" it is desired to convey.

Compared to the simpler modulated carrier wave, the modulated wave pulses may be considered to be the result of sampling, just as in a factory every hundredth unit (say) coming off a production line may be sent up for inspection. Such samples are taken to repre-

sent the bulk production, and any gradual changes ("modulation") in the dimensions or other qualities of the product are reflected in the samples. This procedure is justifiable (both in the factory and in the pulse modulator) provided that changes are not liable to occur rapidly between one sample and the next. Applied to modulation this means that it would never do for several cycles of the modulation frequency to occur between successive pulses; there would be nothing, in those great blank spaces, to represent them. In extreme cases, and with special care in design, it is possible for the pulse recurrence frequency to be not much more than double the modulation frequency, but things are easier if it is much greater.

When the modulated pulses are in turn used to modulate a carrier wave there must be another and even bigger step-up in frequency. Each wave pulse consists of carrier-frequency cycles, and in practice they cannot be made, like Venus, to start life full grown. When the transmitter is "switched on" by the pulse it takes a considerable number of cycles to build up to full amplitude, and a further number to die away at the end, besides the main body in between. It tends to be difficult if there are much fewer than a hundred cycles per pulse. Remembering that the periods between pulses may last a hundred or more times as long as the pulses themselves, we see that the carrier frequency may easily be of the order of 10,000 times the pulse frequency, which in turn is at least several times the *highest* modulation frequency. From this it appears that to handle speech or music by a pulsed carrier-wave system the carrier frequency is likely to be at least of the V.H.F. order. On the other hand, for Morse signals,

in which the highest modulation frequency is much lower, there is a wider choice for both pulse and carrier frequencies.

Summing up; you take the highest modulation frequency, multiply it by at least $2\frac{1}{2}$ and preferably much more to get the pulse frequency, multiply that by

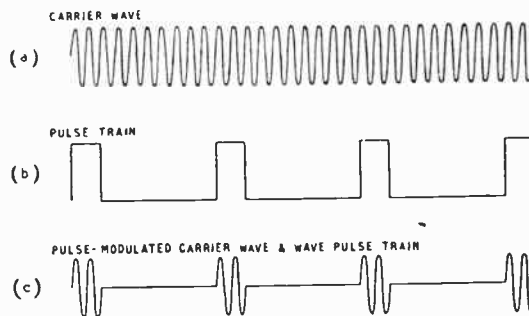

Fig. 4. Modulation of a carrier wave by pulses. In practice the relative frequency of the carrier wave is many times greater than shown, so that although the pulses are generally narrower each wave pulse seldom contains less than about 100 cycles.

the ratio p/P (Fig. 3 (a)) and again by the number of carrier cycles in each wave pulse, and that gives the carrier frequency.

An alternative to the sampling way of looking at pulse modulation (and one that fits some cases better) is to imagine the continuous carrier to be swept up into heaps at regularly spaced intervals, like fallen leaves along an avenue. Any modulation that the original carrier carried will appear also in the heaps or wave pulses; again provided that the heaps are not spaced too widely in relation to the modulation frequency. Fig. 5, a picture of a row of heaps, tells us that the fall of leaves was below average at the left-hand end and above it at the right, but it cannot indicate the variations from tree to tree, because they are smoothed out in the sweeping process.

Now we shall examine the different ways in which pulses can be modulated. (It goes without saying that any of the rows of pulses in Fig. 3 can be supposed to represent *wave pulses*). First there is amplitude modulation (Fig. 3 (c) and (d)), which hardly needs explanation. The only thing you may be worrying about is what happens at the receiver. What about all the

Pulse Modulation—

long gaps in between the pulses? Well, of course, we have already stipulated that they must not be long in relation to the shortest cycles of music or morse or whatever is ultimately put out by the receiver, and therefore after the

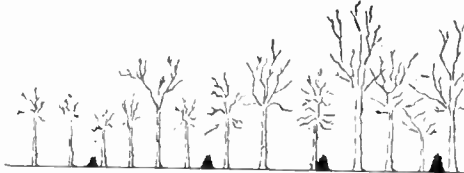

Fig. 5. The varying density of fallen leaves along an avenue is reflected in the relative sizes of the heaps when they are swept up at regular intervals, provided that the variations are gradual compared with the heap frequency.

wave pulses have been rectified into pulses (Fig. 3 (d)) by the detector they can be smoothed out by a filter to yield a reconstituted modulation waveform (Fig. 3 (b)). In fact, there is nothing special about the receiver at all, unless the pulse frequency is near its lower limit, necessitating a rather more elaborate filter than one finds in the ordinary receiver.

Phase modulation, too (Fig. 3 (e)), corresponds closely with its continuous wave counterpart (Figs. 1 (e) and 2 (e)). As a matter of fact, it is easier to see in a diagram, because the pulses are more obvious "marks" than any points on sine waves. In practice, phase modulation may be arranged to make all the shifts *delays*, instead of as shown.

Pulse frequency modulation is shown at Fig. 3 (f). Unlike CW frequency modulation, it doesn't seem to have been used much, if at all; whereas the reverse situation exists with phase modulation. Although there is no law to the effect that in frequency modulation the variation in frequency must amount to many cycles per second each side of normal whereas in phase modulation the maximum variation must be less than one cycle, it generally seems to work out that way. There are technical reasons why wide variations of frequency suit CW systems and narrow variations of phase suit pulse systems.

Pulses can be modulated in a fourth way, not available to CW;

it is shown in Fig. 3 (g). This is often called pulse *width*, but perhaps more appropriately pulse *length*, modulation. Our road sweeper, faced with gradual variations in leaf density, could deal with the situation either by making the evenly-spaced heaps of differing heights (amplitude modulation) or alternatively, adopting a standard height, could accommodate the varying quantities of leaves by corresponding variations in the lengths of the heaps. (He might also be intrigued by the problem of keeping the size of the heaps constant and adopting either phase or frequency modulation, but if so he would obviously be misemployed as a road sweeper.)

To dispel a possibly growing suspicion that all this is a mere outlet for doing simple things in a complicated way, it may be as well at this stage to consider the reasons why. There is no need to justify the use of wave pulses (unmodulated) in radar; it is fundamental to the echo method of range finding. The use of synchronizing pulses in television is equally obvious. But for communications, either morse or phone, which can quite well be done by modulating a carrier wave directly, it may seem an unnecessary complication to insert pulses as an intermediate stage. One reason for doing so is that the spaces between the pulses may be occupied by something else. A good example is the new Pye method of making one television transmitter do for both vision and sound.* In between successive lines of vision there is a short interval—10 microseconds to be exact—to allow the scanning beam to flash back to the beginning of the next line. This interval constitutes the line synchronizing pulse, but inside it there is room for a modulated pulse to carry the sound. Pulse length modulation (Fig. 3 (g)) is

* "Television Developments," *Wireless World*, December 1945.

the type adopted, with a mean length of 3 microseconds, varying between 1 and 5 at maximum depth of modulation. To the receiver, these are equivalent to amplitude modulated pulses.

Another example is the Army Set Type 10†, in which the spaces in one set of speech-modulated pulses are interlaced with seven other sets, thus enabling eight conversations to go on at once over the same carrier wave. Pulse length modulation is again the favoured method. At the receiving end the sets of pulses have, of course, to be sorted out, but that is just a matter of routine circuitry.

The G.P.O. have been experimenting with a similar system but with pulse amplitude modulation‡.

All of these examples come into the category of *multiplex*; that is to say, methods of making one line or carrier wave bear several communications at once. Pulse multiplex is described as a *time allocation* system, because each communication gets the whole channel to itself in turn, like the three mythical sisters with only one eye between them, in contrast to *frequency allocation* systems, in which all share the same channel all the time but each must be on a different sub-carrier frequency.

Another reason for pulse modulation is that in the centimetre wave bands the available generators—principally magnetrons—like to work at full power or nothing, so do not lend themselves

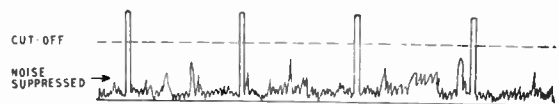

Fig. 6. Because pulses of very high intensity can be generated from moderate mean power, they can be made to cut through noise or other interference. But this is not quite the whole story.

to amplitude modulation. Neither do they like frequency modulation. Pulse length modulation suits them admirably, however.

A third object of pulse modulation is noise reduction. Benefit is obtained in this respect by

† *Wireless World*, December, 1945.

‡ "Multichannel Communication Systems," *Wireless Engineer*, November and December 1945.

going on to centimetre waves, for a start, and that inclines one to pulse modulation as just mentioned. Then, for a given power input to the transmitter, a wave pulse can be given a vastly greater amplitude than a continuous carrier, and is thereby able to compete more effectively with noise. If the pulse occupies, say, one hundredth of the pulse period P (Fig. 3) the pulse power is one hundred times the mean power. That is why radar transmitters are able to radiate pulses of kilowatts while the transmitter input averages only watts. This high power is likely to stand well above interference, noise, etc., which can be cut off in the receiver by a limiter (such as an over-biased valve) which allows any peaks above a certain level to get through (Fig. 6). There is a catch in this, however, because pulses occupy a much wider band of frequencies than a carrier wave, so the receiver cannot be made nearly so selective, and that offsets a lot—but usually not all—of the advantage of power.

Aid to Secrecy

Yet another reason for using pulses is secrecy. Pulse modulation increases the number of things that an eavesdropper may have to get just right before he can intercept and decypher the message. In addition to normal coding the pulses can be "scrambled" in various ways. By the time he has caught on, the code may be changed.

One of the snags of pulses has already been mentioned—the wide frequency band needed. Roughly, if each pulse lasts $1/n$ th of a second, it makes the carrier wave spread out at least n cycles per second on each side. That is liable to interfere with other services, and it necessitates an unselective and therefore interference-prone receiver. We have already seen, too, that pulse systems need a high carrier frequency. So everything tends to the same conclusion: pulse modulation is unsuitable for low radio frequencies, but its advantages are greatest and its disadvantages least at high radio frequencies, especially in the centimetre wave region.

WORLD OF WIRELESS

GOVERNMENT SURPLUS

IT seems that facilities for the purchase of ex-Government surplus radio equipment by members of the Radio Society of Great Britain are not to be granted. Protracted negotiations between the R.S.G.B. and Government departments have culminated in the asking of questions in Parliament. It has been officially decided that "generally it is preferable that the needs of radio amateurs should continue to be met through trade channels. . . . Surplus radio sets and components have been sold to the trade by competitive tender and further such sales will be made."

EXTRA AMATEUR FREQUENCIES

THE "10-metre" band has been extended to cover 28-30 Mc/s. British Isles amateurs have also been granted the 1800-2000 kc/s band, subject to possible withdrawal and the use of 10 W max power.

U.S.-U.K. TELECOMMUNICATIONS

SOME two months having elapsed since the conclusion of the U.S.-British Commonwealth Telecommunications Conference at Bermuda and no statement having been made as to the findings of the Conference, Garry Allighan raised the question in the House of Commons on Feb. 21st.

The communiqué issued by the British Information Service in Washington at the conclusion of the conference has now been made available in this country. It states:—

"By the agreements reached at the Conference . . . a great step forward has been taken to bring order out of the chaotic telecommunications system; and ensure a balanced combination of cable and wireless services for the world. . . .

"The interest of the United States is primarily in the radio field, with a lesser interest in cable communication; while in the British Commonwealth the emphasis is on cables. But the United States delegation accepted the British view that the reckless and unrestricted use of new radio circuits would unbalance the world system and deprive the United States themselves of the certain services and the security of the Commonwealth cable systems."

Reduction of all telecommunication rates between the U.S. and

nations of the British Commonwealth were also agreed upon. The gold franc as the measure of telecommunication charges has been abandoned as impracticable and a dollar basis agreed on.

A protocol has been signed discouraging the principle of one country obtaining exclusive concessions for conducting the external tele-communications for another.

TELEVISION SETS

THE Board of Trade announced on March 7th that licences had been issued to fourteen manufacturers to produce 78,300 television receivers.

Licences have also been granted for the production of a total of 937,100 broadcast sets for the home market and 583,380 for export.

During the last five months of 1945 nearly 73,000 sets were manufactured. Of this number 12,000 were for export.

"AIRMET" BROADCASTS

WEATHER reports, forecasts and navigational warnings for civil aviation are now broadcast daily from Daventry on 245 kc/s (1,224 metres). Transmissions are continuous from 0700 to 1800 G.M.T. in winter and from 0600 to 2100 G.M.T. in summer.

Navigational warnings providing urgent information regarding the unserviceability of aerodromes, radio facilities and air light beacons are given during the first 10 minutes of each hour. Weather reports and forecasts follow every ten minutes. Each transmission is prefaced by "This is Airmet."

RESEARCH

THE need for a central electronic research organisation supported by the Government and engaged on regular work for the Services, but with freedom also to study and meet industrial demands, is stressed by Charles Davy, writing in *The Observer* for March 10th. Doubt is expressed by the writer as to the possibility of any one industry being competent or having the necessary incentive to undertake "comprehensive electronic research."

The article has been written to answer the question: "What is going to happen to the scientific research units built up under Government direction during the war?" which has been brought to the fore by a decision to reduce the staff at

World of Wireless—

the Royal Aircraft Establishment at Farnborough. After outlining briefly some of the projects in hand, or in view, at the Telecommunications Research Establishment at Malvern, he expresses the hope that T.R.E.—perhaps rechristened Electronics Research Establishment—might become the centre of electronic research.

WHAT THEY SAY

RADAR PATENTS.—The patent situation in radar is said to be so complicated that no company on earth could safely proceed to manufacture radar with any confidence that it would be immune from suits of infringement.—*Paul A. Porter, Chairman, U.S. Federal Communications Commission.*

ADMINISTRATIVE TECHNICIANS.—Refresher courses would provide an opportunity for engineers whose main duties were administrative to bring their technical knowledge up to date, and would prevent any tendency towards control of staff by seniors whose knowledge of modern techniques is inadequate.—*A speaker at the I.E.E. discussion on "Post-Graduate Courses in Electrical Engineering."*

MANUFACTURING COSTS.—The [American] Office of Price Administration is attempting to force what they call a "reconversion formula" down the unwilling throats of the parts manufacturers. . . The O.P.A. contends that this "reconversion pricing formula" is fair because war-born technological advances have created so many improvements in manufacturing efficiency that any increase in labour and material prices can be fully absorbed by the manufacturer.—*The Editor, "Parts Jobber," New York.*

PERSONALITIES

Lord Louis Mountbatten has accepted election as President of the British Institution of Radio Engineers for the year 1946-47, in succession to Leslie McMichael. He has been a member of the Institution since 1935 and was elected Vice-President in 1938.

Vice-Admiral J. W. S. Dorling, C.B., R.N. (retd.) has been appointed Director of the Radio Industry Council. He has been connected with radio since 1912 and during the first world war was chiefly concerned with high-power continuous-wave installations in shore stations and warships. During the years between the two wars he served as Fleet Wireless Officer, Director of Signal Department, Admiralty, and Captain of H.M. Signal School, Portsmouth.

T. W. Bearup, who has been Assistant Manager of the Australian Broadcasting Commission since 1943, is

now acting as its London representative. He will also supervise A.B.C.'s New York office.

M. J. Smith, O.B.E., B.Sc., has been appointed Electrical Engineer to the Copper Development Association. As a Wing Commander in the R.A.F. he was Senior Training Officer at the R.A.F. School of Electrical and Instrument Training.

L. R. Vincent rejoins Ritchie Vincent and Telford, consultants, of Harrow, as Managing Director, having been released from his appointment as Technical Specialist (Communications and Broadcasting), Ministry of Information.



Vice-Admiral J. W. S. Dorling, C.B., R.N. (retd.) the Radio Industry Council's first Director.

IN BRIEF

Ten Million.—It was announced by the G.P.O. on February 20th that the number of wireless licence holders in Gt. Britain and Northern Ireland was 10,266,300. This figure includes 47,300 licences issued free to the blind. It is of interest to note that the 5,000,000 mark had been reached in the first ten years of broadcasting—by 1932.

Another Record?—C. G. Allen asks if he set up another record at his station, G8IG, on Saturday, March 9th, when he worked, on 10 metres, all continents in 4½ hours and the British Empire in 5 hours 20 minutes. His log was: 0845, W4KDA (Okinawa); 1100, VK4LP (Australia); 1138, XABY (Greece); 1203, SU1USA (Egypt); 1230, W3BDL (New Jersey); 1300, HK4AX (Colombia); 1405, VE4EK (Canada).

Canadian FM.—Canada's first broadcast FM transmitter started operating a few months ago from Mount Royal, Montreal. The transmitter, employing a frequency of 48.8 Mc/s with a power of 25 W, uses the call VE9CM.

A.R.R.L. Bulletins giving the latest official information regarding U.S. amateur activities are broadcast regularly by the League's headquarters station W1AW at West Hartford, Connecticut. The frequencies used are

3.555, 7.145, 14.280, 28.245 and 56.968 Mc/s and the times of operation are 0100, 0200 and 0300 G.M.T., Tuesday to Saturday. Transmissions on each of the above frequencies open with a bulletin in morse at 15 w.p.m., which, with the exception of that on 28.245 Mc/s, is followed by 'phone announcements.

Burma.—English transmissions from the short-wave station of the Burma Broadcasting Service are now radiated on 6.04 Mc/s from 0015-0100 and 0515-0600 G.M.T. and on 11.85 Mc/s from 0200-0230, 0615-0645 and 1230-1400.

Servicing Examination.—Applications to sit for the next examination of the Radio Trades Examination Board must be received by the Secretary of the Board at 9, Bedford Square, London, W.C.1, not later than March 31st. It will be held at various centres on May 4th. Copies of the papers set by the Board for the last two examinations may be obtained from the Secretary, price 2s per set.

Radar Stations.—Experimental licences for stations undertaking development and research of radar navigational aids are now being issued by the American F.C.C.

Policing the Ether.—The checking centre of the International Broadcasting Union, which was removed from Brussels during the war and set up at the Union's headquarters in Geneva, has now returned to its original home in the Belgian capital.

New I.E.E. Group.—The Council of the I.E.E. has sanctioned the formation of a Radio and Measurement Group at the Institution's North-Eastern Centre.

Research Endowment.—A new laboratory is to be constructed at McGill University, Montreal, equipped with the latest apparatus for research in radio, radar, atomic energy and other scientific fields. The money is to be provided out of an endowment to be known as the Eaton Electronics Research Laboratory Fund.

Our Cover.—The reconditioned television aerial arrays on the 300ft mast at Alexandra Palace are illustrated on this month's cover. The vision aerial is uppermost. Test transmissions are still being radiated from 11.30 to 12.30 and 4.0 to 5.30 on 45 Mc/s (vision) and 41.5 Mc/s (sound).

W.W. Index.—Copies of the Index for Vol LI, 1945, of *Wireless World* will shortly be available from our Publishers; price 1s 1½d by post.

Back Numbers.—Our Publishers are anxious to obtain copies of *Wireless World* for December, 1945, and January and February, 1946. Readers who are prepared to dispose of these back issues are asked to communicate with our Publishers.

"Code of Practice" for Valves.—A new edition (1945) of British Standards publication B.S.1106, issued during the war and reviewed in this journal in September and October, 1943, has just been published. The precautions necessary to ensure reliable operation and long life in all types of electronic valves

other than cathode-ray tubes are dealt with, and copies can be obtained from the British Standards Institution, 28, Victoria Street, London, S.W.1, price 2s, postage paid.

"Radio Valve Vade Mecum."—Many readers have asked if this valve data book of British, Continental and American valves, by P. H. Brans, of Antwerp, mentioned in our February issue, is obtainable in this country. We understand that arrangements have now been made to distribute a limited number and that copies will be obtainable from A. F. Bird, 66, Chandos Place, London, W.C.2, price 12s 6d, postage 7d.

Installing Car Radio.—Useful hints on the installation of car radio receivers, including the suppression of vehicle-generated static as well as all types of ignition interference, are contained in a booklet written by S. L. Robinson, A.M. Brit. I.R.E., and issued by Masteradio, Ltd., 193, Rickmansworth Road, Watford. Copies are available to radio dealers free of charge.

"Britain Can Make It."—A committee has been appointed to assist the Council of Industrial Design in arranging for the submission of radio, television and gramophone designs for the "Britain Can Make It" Exhibition in September. The members of the committee are: G. J. Freshwater (E.M.I.), H. J. Dyer (Philips), G. P. Wickham-Legg (Bush) and A. Middleton (Ferranti).

An Appeal has been made by Field-Marshal Lord Chetwode to the radio and electrical industries in aid of the Victory (Ex-Services) Club, a social, cultural and welfare centre which is to be established as industry's memorial to those who fought in the 1939-45 war. Enquiries should be addressed to M. A. Browning, 15, King Street, London, S.W.1.

Rehabilitation.—Cable and Wireless and Marconi's have each promised £1,000 towards the training and research sections of the Roffey Park Rehabilitation Centre, Horsham, Sussex.

Webb's Radio.—Through a printer's error the two lines heading the Webb's Radio advertisement in our March issue were transposed. The heading should have read "The hub of the 'ham' world."

H.M.V. Works.—Among the Government factories recently allocated by the Board of Trade to various firms for civilian production is one at Treorchy, Wales, to be used by the Gramophone Co.

Bulgin has issued a brochure outlining the war work undertaken by their factories. Whereas the output of components in 1940 was 1,994,503, by December, 1944, it had risen to 4,378,979.

Philco.—Among the latest allocation of Government factories to industry is one at Ossett, Yorks, which is to be taken over by the Radio and Television Trust—Philco's new name.

Ekco are to open 5, Vigo Street, in the vicinity of Regent Street, as their London showrooms.

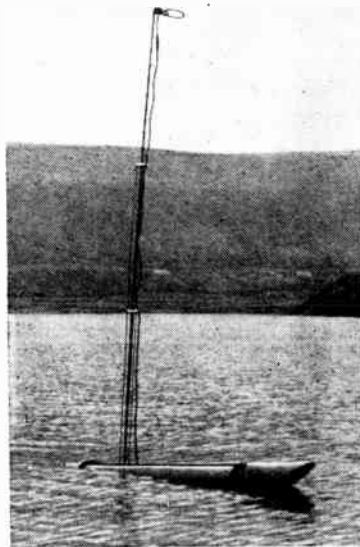

THE JELLY FISH or radar marker buoy. When launched into the sea two operations, one mechanical and the other electrical, are automatically performed. The first is concerned with the buoyancy and extension of the telescopic aerial and the second, accomplished by the action of a "sea-cell" and "corrosion cell", provides power for, and switches on, the radar gear and arms the buoy for self-destruction. The bulk of the development on the buoy was done by Ferranti.

CLUBS

Merseyside.—Recent attendances at the meetings of the Merseyside Section of the R.S.G.B. have been so great as to necessitate the duplication of the monthly meetings. They will now be held on the second Wednesday at 6.30 and the last Saturday at 2.30 each month. Details of the Section's activities may be obtained from R. A. Spears (G8AZ), 72, Rocky Lane, Broadgreen, Liverpool, 16.

Manchester.—New members will be enrolled at a meeting of the recently formed Whitefield and District Radio Society, at the Stand Grammar School, Higher Lane, Whitefield, Manchester, at 8 on April 1st. The Society's Hon. Sec. is R. Purcell, 28, Stanley Street, Prestwich, Manchester.

Leicester.—The next meeting of the Leicester Radio Society will be held at 7.30 on April 9th at the Charles Street United Baptist Church (entrance in side passage). A review of the "Historical Development of Radio" will be given by C. F. Atkinson.

Liverpool.—The Liverpool District Short-wave Club is now holding weekly meetings on Wednesdays at 8 at St. Barnabas Parish Hall, Penny Lane, Liverpool. Hon. Sec., T. W. Carnev (G4QC), 9, Gladeville Road, Aigburth, Liverpool, 17.

B.S.W.L.—The first post-war transmission to be arranged by the British Short-wave League will be radiated from the Ankara short-wave station, TAP, on 9.465 Mc/s at 2130 G.M.T. on Sunday, April 14th. Reception reports should be sent to Box A3, B.S.W.L., 53, Madeley Road, London, W.5.

Short-wave Enthusiasts are invited by Arthur E. Bear, European and Colonial Representative of the International Short-wave Club, to communicate with him at 100, Adams Gardens Estate, London, S.E.16, for details of membership. Members receive the Club's publications, "On the Air" and "Short-wave News Letter."

MEETINGS

Institution of Electrical Engineers

Radiolocation Convention.—The four-day convention arranged by the I.E.E. opens on March 26th at 5.30. The meetings on each of the following days will begin at 9.30 a.m.

Radio Section.—A symposium of papers on "Naval Gunnery Radar" will be read by J. F. Coales, M.A., J. G. Calpine, M.A., D. S. Watson, B.Sc., R. V. Alred, M.A., C. A. Laws, H. W. Pout, B.Sc.Eng., H. A. Prine, W. D. Mallinson, B.Sc.Eng., and T. C. Finmore on April 3rd.

Discussion on "Interference Problems arising from Industrial Electronics," opened by M. R. Gavin, on April 16th. "Nuclear Physics and the Future," Thirty-seventh Kelvin Lecture by Prof. M. L. Oliphant, F.R.S., on April 25th.

The above meetings commence at 5.30 and will be held at the I.E.E., Savoy Place, London, W.C.2.

Cambridge Radio Group.—"A Method of Increasing the Range of V.H.F. Communication Systems by Multi-Carrier Amplitude Modulation," by J. R. Brinkley, at 6 on April 2nd at the University Engineering Laboratory, Trumpington Street, Cambridge.

British Institution of Radio Engineers

London Section.—"The Electron Gun of the Cathode-Ray Tube—Part II," by Hilary Moss, Ph.D., at 6.15 on April 17th at the Institution of Structural Engineers, 11, Upper Belgrave Street, London, S.W.1.

North-Eastern Section.—"Ship's Distress Automatic Alarm Apparatus," by H. Armstrong, at 6 on April 10th at Neville Hall, Westgate Road, Newcastle-on-Tyne.

Institute of Physics

Electronics Group.—"Velocity Modulation Tubes," by Dr. J. H. Fremlin, at 5.30 on April 9th at the Royal Society, Burlington House, Piccadilly, London, W.1.

Institution of Electronics

North-West Branch.—"Recent Advances in Electronics Applied to Medicine," by G. Parr, at 6.30 on March 29th at Reynolds Hall, College of Technology, Manchester.

Radio Society of Great Britain

"Amateur Transmitter Design," by Capt. R. L. Varney (G5RV), at 6.30 on April 12th at the I.E.E., Savoy Place, London, W.C.2.

CONTRAST EXPANSION

Some Practical Results Using Negative Feedback

By J. G. WHITE

IN the September and October 1945 issues of this journal, a review was made of various forms of contrast expander, and details were given of a proposed new circuit using variable negative feedback to produce expansion of the volume range as received. Since then it has been possible to carry out some experiments with the circuit. In addition, a method has been devised to overcome the effects of current feedback in the first stage, which, as predicted, reduces the degree of expansion attainable for any given set of component values. This modification will be explained before details are given of the experimental results obtained.

Eliminating Current Feedback.

In Fig. 1 (a) is shown a simple RC coupled amplifier in which R_2 and C are the anode decoupling components. Current negative feedback occurs because the cathode resistor R_1 is un-bypassed. By connecting the low-potential end of C to cathode instead of to earth, as shown in Fig. 1 (b), the alternating component of the anode current is returned to cathode direct, and, provided that R_2 is much larger than R_1 , as will normally be the case, the signal voltage across R_1 will be negligible. The gain of the stage will therefore be unaffected by the omission of the cathode bypass condenser.

When the circuit of Fig. 1 (b) is used, however, it is essential that the hum content of the HT supply be low. R_1 is connected between grid and cathode of the valve and any voltage produced across it by ripple on the HT current will be amplified and so increase the hum level of the amplifier.

Except that the modification just detailed has been included, the circuit of Fig. 2 will be seen to correspond in general to that of Fig. 9 (October issue). The signal voltage developed across R_1 is now proportional only to

that across the anode load of V_2 . However, not only is it introduced into the input of V_1 , but also into that of V_2 . Examination of the circuit will show that in each case the feedback is negative. Thus, subsidiary feedback still occurs, but, unlike the current feedback of the circuit in Fig. 9, it varies in the same ratio as the main feedback when the impedance of V_3 is changed.

Assuming the same terminology as applied to the amplifier in Fig. 7 (October issue) the expres-

equation (1), (October issue) may be used with sufficient accuracy to meet normal design requirements.

Experimental Circuit—An amplifier was assembled in accordance with the circuit of Fig. 2, Mazda SP41 valves being used in all three positions, V_1 and V_2 as pentodes and V_3 as a triode. A variable source of bias was applied between control grid and cathode of V_3 and measurements of gain were made with various values of anode load for V_1 and V_2 . Each measurement was

carried out with the anode decoupling condenser of V_1 connected alternately to the common earth line and to the junction of R_1 and R_2 .

A triode-connected SP41 has a high mutual conductance and

Fig. 1. Current feedback in (a) is eliminated by returning the alternating component of the anode current direct to cathode (b).

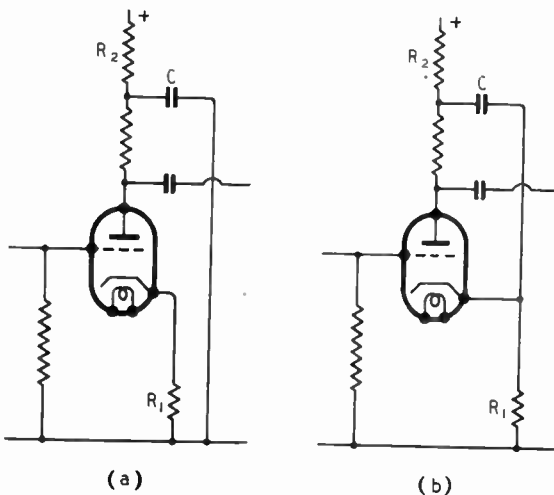

sion for the gain of the amplifier in Fig. 2 may be written

$$M_2 = \frac{M_0}{1 + \beta M_0 + \beta \frac{\mu_2 R'_5}{R_4 + R'_5}} \dots \dots \dots (1)$$

When V_1 and V_2 in Fig. 2 are RF pentodes, equation (1) may be written

$$M_2 \doteq \frac{g_{m1} R_3 g_{m2} R'_5}{1 + \beta g_{m1} R_3 g_{m2} R'_5 + \beta g_{m2} R'_5} \dots \dots \dots (2)$$

In practice, β is unlikely to exceed 0.04, so that the subsidiary feedback may be neglected in the majority of cases, and the expression given in the original

a short grid base; thus, widely different values of anode resistance may be obtained within a comparatively small range of control grid volts. With the particular valve used, the AC resistance was about 10,000 ohms at a bias of 1 volt negative, and rose to some 5 megohms at 8 volts negative. As this latter value is exceedingly high compared with R_1 , the gain of the amplifier under these conditions is not reduced to any great extent and the expansion range obtainable is greater than with the values of impedance suggested in the original article.

The mutual conductance of the

SP41 valve under working conditions is higher than that assumed for the EF 50, and, when R_3 and R_5 were 50,000 ohms and

any degree of feedback in the range quoted above. This output is sufficient to load a push-pull output stage consisting of

this circuit requires a negative bias increasing as the signal amplitude increases. Thus the problem is similar to that of producing AVC bias and similar circuits may be employed.

The question of time-constants is one which has been dealt with at some length, notably in D. T. N. Williamson's article in *Wireless World*, September, 1943. The provision of a suitably slow decline in gain is quite straightforward, and it may easily be arranged to be variable at will. Difficulties arise, however, when an attempt is made to produce the rapid rise in gain which is generally agreed to be desirable.

If the time-constant of the circuit is too long, a sudden crescendo will be drawn out and the programme will lose the necessary qualities of attack and brilliance.

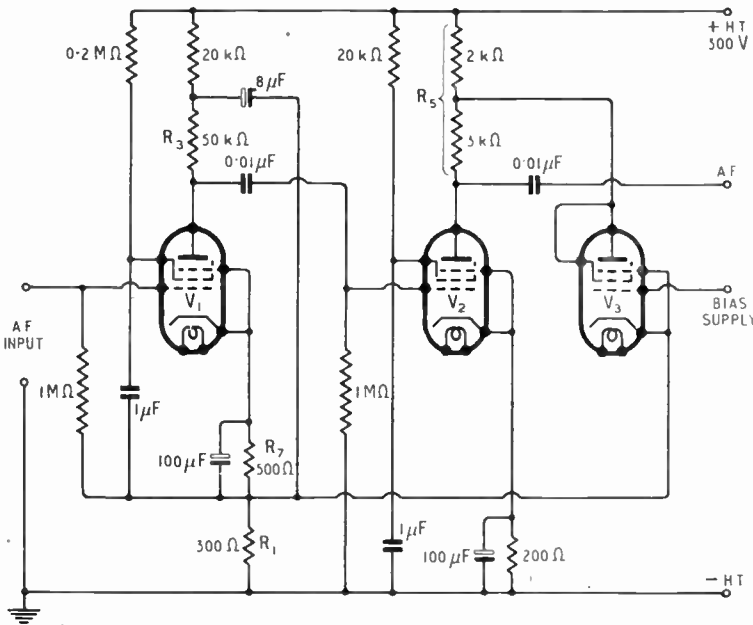

Fig. 2. Revised circuit of negative feedback contrast expander.

5,000 ohms, respectively, an overall gain of 6,300 times was obtained without feedback. Using the circuit of Fig. 9 (October issue) the maximum and minimum gains with 8 volts and 1 volt negative on the grid of V_3 were 2,240 and 200 times, respectively. This represents an expansion of 21 db. When current feedback was eliminated by use of the circuit of Fig. 2, the extremes of gain obtained were 5,600 and 200 times respectively, giving an expansion of 29 db. The elimination of current feedback is therefore well worthwhile. It will be noted that the minimum gain is the same in each case (within the limits of experimental accuracy). That this may be expected is apparent from equations (7) and (8), in which the term for current feedback diminishes in importance as β increases, becoming negligible for high values of βM_0 .

The output waveform was examined on an oscilloscope and, with an output of 30 volts RMS maintained across R_5 by increasing the input as the gain decreased, no distortion was noticeable with

two PX4 or PX25 valves through a phase-splitting stage.

Other values of anode load were substituted, and similar measurements were carried out. In each case the advantage of eliminating current feedback was apparent in the results obtained. Representative curves illustrating these results are shown in Fig. 3, which indicates the general shape of the expansion curve.

Replacement of the 3,000 ohm resistor next to the anode in R_5 by one of 5,000 ohms, permits an output of 40 volts RMS to be obtained with no noticeable distortion of the waveform. As βM_0 is unaffected by this change, the expansion is unaltered although the overall gain is increased.

Control Circuit.—We now have an amplifier with gain variable over the required range and a satisfactory level of distortion. It only remains to produce the control bias from the signal and to apply it to the grid of V_3 so that the desired effect may be obtained. Unlike most other valve-operated expanders,

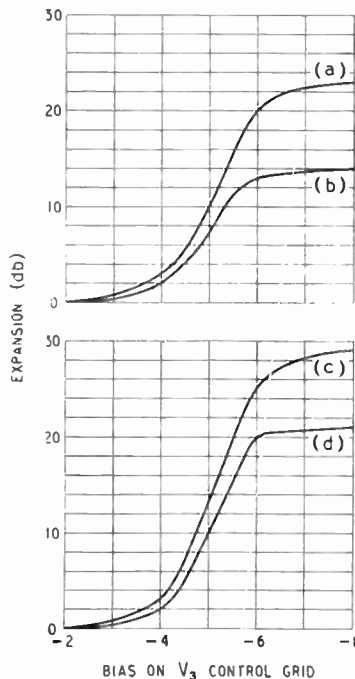

Fig. 3. Measured expansion curves for various working conditions. (a) and (c), with voltage feedback only; (b) and (d), with current and voltage feedback. For curves (a) and (b), R_3 is 15,000 ohms and for curves (c) and (d), 50,000 ohms. R_5 consists of 3,000 ohms (nearest anode) and 2,000 ohms in series giving a gain at zero expansion of 200. If 5,000 ohms is substituted for the 3,000-ohm resistor the expansion curve is not affected, but the gain at 0 db is 280.

Contrast Expansion—

If the time-constant is too short, the gain of the amplifier will vary at the frequency of the applied signal, with unpleasant results

type duo-diode. The time of rise of gain is appreciably less than 0.05 second and the time of fall is about one second. By making R_{10} variable, it is possible to

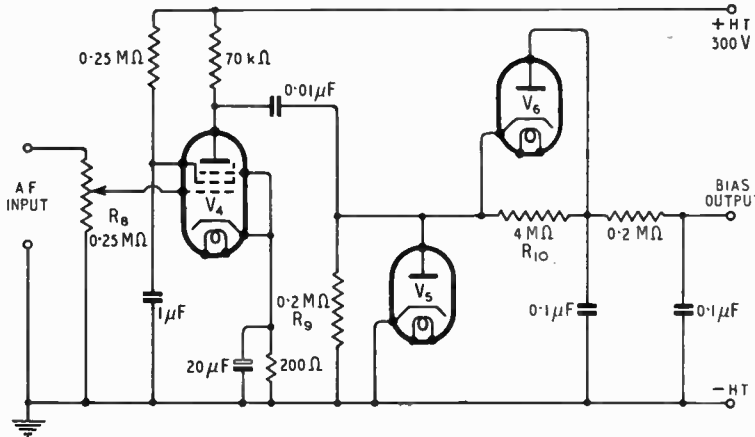

Fig. 4. Circuit for providing control bias for the expansion amplifier.

that must be heard to be fully appreciated. Thus, a compromise is necessary and is a feature common to the majority of expansion circuits. In addition, with the amplifier under consideration, another factor makes a very short time-constant difficult to use.

Examination of the circuit of Fig. 2 shows that any superimposed audio frequencies applied with the control bias to the grid of V_3 will appear in the cathode circuit of that valve, and therefore of V_1 , amplified by a factor approximately equal to the product of R_1 and the mutual conductance of V_3 . At low gain, that is, when the bias on V_3 is at a minimum, this factor is appreciable, and the result is that very quiet passages are distorted. The effect may be reduced either by increased filtering of the control bias, which reduces the rate of rise of gain, or by setting the initial bias of V_3 at such a point that the gain from its grid to cathode is negligible. The latter method may restrict the expansion range.

The theoretical circuit of an auxiliary amplifier and rectifier to produce the control bias is shown in Fig. 4, and has proved satisfactory when used with the amplifier of Fig. 2. V_4 is an SP41 type valve and V_5 and V_6 may be the two sections of a 6H6

adjust the rate of fall of gain to suit the programme which is being heard. The audio-frequency component passed to the grid of V_3 is negligible, no measurable AF voltage appearing across R_1 when the grid of V_1 was connected to earth. This result was obtained without increasing the initial bias on V_3 . The control bias developed across C_1 was measured for a range of AF inputs to V_4 , and this is plotted in Fig. 5. If it is considered desirable to reduce the effect of the initial curved portion, the DC output may be taken from a tapping on R_9 instead of from the junction of R_9 and the anode of V_5 . This necessitates a higher voltage across R_9 , but the curve of Fig. 5 shows that this may easily be achieved. If the tapping on R_9 be made adjustable, a method of varying the degree of expansion is obtained which is preferable to using R_8 as the control, because the input to the diode V_5 may then always be maintained at a high value. The effect on the discharge time-constant of the circuit as the tapping is adjusted may be neglected.

The value of the initial bias on V_3 will largely determine the shape of the expansion curve for the amplifier, and attention may now be directed to the curves in

Fig. 3. It will be seen that, as the control bias increases, the rise in gain is at first very slight and then becomes very high. Thus a change of bias from -2 to -4 volts may produce an increase in gain of 2 db. and a further change from -4 to -6 volts, an increase of 18 db. Assuming a linear rectifier system, this means that changes of input level to the amplifier of 6 db. and 9.5 db., referred to the signal input corresponding to a bias of -2 volts, appear at the output as changes of 8 db. and 27.5 db. respectively. The effect is completely to ruin the reproduction of any broadcast programme or record by the completely unnatural contrasts introduced.

It is desirable that the expansion be more nearly linear, and this may be achieved by increasing the standing bias on V_3 to the value at which the expansion curves begin to rise rapidly, i.e., about 3.5 to 4 volts negative. The simplest method of doing this is to increase the current in R_1 by connecting a resistor between HT positive and the cathode of V_3 . If the resistor is made variable, it may be adjusted quite simply to the correct value. The control grid

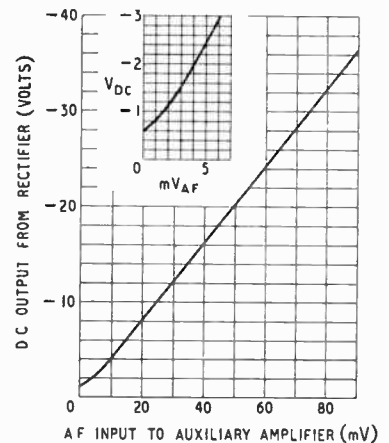

Fig. 5. Characteristic of control bias circuit.

of V_3 is connected to earth and the resistor decreased in value until a slight increase in volume is apparent. The resistance may then be increased slightly and left at that value. This same adjustment obviously may also be used to introduce delay if this is con-

sidered desirable, but that is a matter which must be decided by the individual listener.

The oscillograms in Fig. 6 are included to illustrate the action of the expander, and show a 6 db.

Parnum,* foresaw the possibility that an unacceptable degree of distortion might be introduced because V_3 is a non-linear resistance. Most of the work described had been completed before Dr.

small value of β at maximum gain, which ensures that only a negligibly small fraction of any distortion due to the non-linearity of V_3 appears across R_1 . A check was also made that distortion does

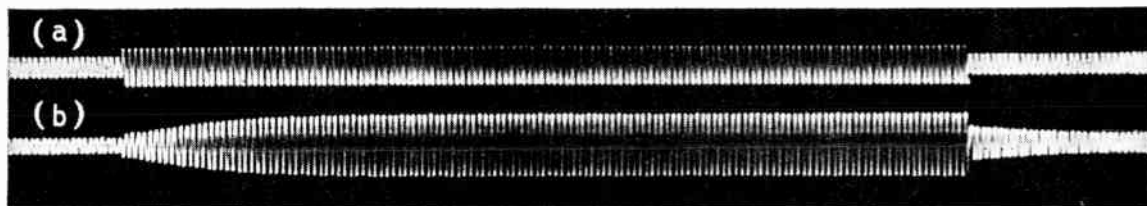

Fig. 6. Oscillogram at 80 c/s showing difference in rates of rise and fall of gain. (a) input increased 6 db, (b) output increased 12 db.

increase in input producing a 12 db. increase in output. This degree of expansion was chosen solely to provide an illustration of the action of the circuit, and is not intended to represent any specific input conditions which may be encountered in normal use. The difference in the rates of rise and fall of gain are readily seen.

It is hoped that the practical results detailed above will interest readers of the original article, and reassure those who, with Dr.

Parnum's valuable comments were received, but further experiments were carried out to ascertain as far as possible the distortion introduced by this characteristic of V_3 . Apparatus of the standard necessary to make reliable quantitative results possible was unfortunately not available, but it is felt that an estimate of not more than 2 per cent. total distortion at the outputs quoted earlier is fully justified by the observations made. This is no doubt partly due to the very

* See page 136 of this issue.

not increase at intermediate levels, where β is considerably larger.

In conclusion, an error which unfortunately occurred in the second part of the original article must be pointed out. The last line of the second column on page 309, following equation (3), should read "If R_1 is much less than R_{a2} ."

The writer is indebted to Mr. P. L. Stride for suggestions and assistance in carrying out the practical work on which this article is based.

NEW MOVING-COIL PICK-UPS

THE "Coil" pick-up is now being made by Wilkins and Wright, Holyhead Road, Birmingham, 21. It employs a circular coil working between shaped pole-pieces and a centre core similar to a d'Arsonval galvo.; the coil is suspended by a stretched flat metal strip. No rubber is used and the damping medium is thick grease. It is designed to take miniature chromium-plated needles such as the "99" or "Silent Stylus." The weight of the head is counter-

The output transformer and bass compensating filter are incorporated in the arm of the "Valradio" pick-up.



ranging from $\frac{1}{4}$ to 1 oz. A screened coupling transformer and bass equalizer unit is supplied for mounting between the pick-up and the amplifier. The output is 0.05 V (average) into an impedance of 100,000 ohms, and the makers

is £5 15s exclusive of purchase tax.

In the "Valradio" pick-up the coil is in the form of a long ellipse and is lightly rubber-damped. The whole pick-up head measures only one inch cube. It is mounted in a long tone arm which contains the bass compensating circuit, and the Mumetal shrouded output transformer is carried in an extension and acts as a counterbalance; the weight at the needle point is $\frac{1}{2}$ oz. The pick-up is designed to take special needles, but ordinary needles can be used. The makers state that the response from 25 to 12,000 c/s is constant within ± 2 db and the output is approximately 50 mV. The price, including 50 needles, is £5 15s plus purchase tax (£4 0s 6d), and it is obtainable from Wolsey Television, 107, Brixton Hill, London, S.W.2.

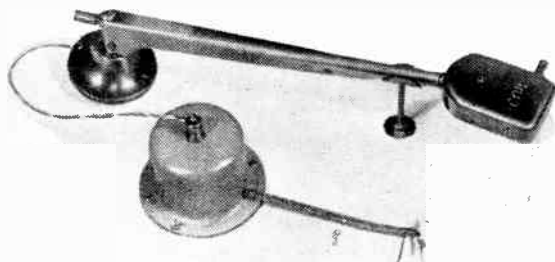

No organic damping material is used in the movement of the "Coil" pick-up made by Wilkins and Wright.

balanced by a coil spring inside the pick-up arm which can be adjusted to give weights at the needle point

state that the response is flat within 3db between 30 and 9,000 c/s. The complete

SHORT-WAVE CONDITIONS

Expectations for April

By T. W. BENNINGTON

(Engineering Division, B.B.C.)

THE feature of short-wave conditions during February was the effect upon propagation of the very large sunspot group—the one which received all the publicity—which, appearing on the sun's east limb on January 29th, crossed the central meridian on February 5th and reached the west limb on February 11th. It then survived the journey across the "reverse" side of the sun and reappeared on the east limb on February 27th, being due on the central meridian again on March 6th, but it now appears to have considerably decreased both in size and in activity.

First, as to the *general* conditions during February. These, themselves dominated by the influence of the above sunspot group, were such that the *average* maximum usable frequencies for this latitude were somewhat higher than for January, both for noon and midnight. During those periods of the month, however, when the sunspot group "faced" the earth, its *general* effect was to increase the atmospheric ionisation considerably and so to give rise to very "high-frequency" conditions. Thus, between February 1st and 10th, and again from February 27th to the end of the month, maximum usable frequencies were much *above* the average and some remarkably good communication was achieved on the higher frequencies. Conditions on the higher frequencies were also good from 15th to 17th.

Now for the *disturbing* effects produced by the solar activity. A very remarkable number of "Dellinger" fade-outs occurred in connection with the large sunspot, some 20 or more of these having been reported from various parts of the world during the month, whilst the "hissing" phenomenon was several times observed. These fade-outs were reported as occurring mainly between February 1st and 14th and from February 27th to the end of the month.

After the sunspot crossed the central meridian the expected

ionosphere storm occurred. It appeared to start on February 6th, but, strangely enough, cleared up again very quickly, re-starting with great severity about 11.00 G.M.T. on February 7th and lasting till about 13.00 G.M.T. on February 9th. This period therefore made a break in the first period of "high frequency" conditions above referred to. Another disturbance occurred during the period February 20th-22nd.

Forecast.—Conditions during April—apart from ionosphere storm effects—should be such that somewhat higher night-time and somewhat lower daytime frequencies than during March will be generally usable. The daytime frequencies will, of course, be usable over a longer period than during March, and, furthermore, there will be a tendency for peak usable frequencies to occur later in the day. Sporadic E—that unpredictable phenomenon which often makes possible communication on frequencies much higher than those usable by way of the *regular* layers—should begin to increase in the frequency of its occurrence in April, but more about this in the forecast for May, when this phenomenon should begin to become really prevalent.

Now a word of explanation about the tables of predicted best frequencies for use during April which are given below for various directions from this country. For certain significant times of day the unbracketed figures give the best frequencies, in terms of the broadcast bands. These are based on the *average* predicted MUF for the month, and indicate the frequencies which could reasonably safely be used by a communication or broadcasting organisation which has to operate services on *every* day throughout the month. But it is known that the *average* MUF is exceeded on many days during

the month, and, furthermore, it is possible roughly to estimate the amount by which it will be exceeded during a given percentage of the total time; that is, unless some very exceptional variations in solar activity occur. Whilst attempted operation on such higher frequencies would not be a useful expedient for regular services there are others whose interest lies, not in the continuous operation of a service, but in the exploitation of a particular frequency band. Furthermore, because the power at the disposal of such experimenters is usually limited, the very highest frequency will practically always yield the best results *while and if it is open*, because the absorption is there the lowest.

In order to meet these requirements a figure in brackets is therefore included for each significant hour, indicating the highest frequency likely to be usable for about 25% of the time during the month, for communication by way of the *regular* layers, *not* by way of Sporadic E.

Montreal: 0000, 11 or 9 Mc/s (16 Mc/s); 0300, 9 Mc/s (14 Mc/s); 0900, 11 Mc/s (16 Mc/s); 1100, 15 Mc/s (21 Mc/s); 1500, 17 or 15 Mc/s (24 Mc/s); 2000, 15 Mc/s (22 Mc/s); 2200, 11 Mc/s (17 Mc/s).

Buenos Aires: 0000, 11 or 9 Mc/s (14 Mc/s); 0400, 7 Mc/s (13 Mc/s); 0800, 11 Mc/s (17 Mc/s); 1000, 17 Mc/s (24 Mc/s); 1400, 21 or 17 Mc/s (28 Mc/s); 2100, 17 or 15 Mc/s (23 Mc/s); 2200, 11 Mc/s (17 Mc/s).

Capetown: 0000, 11 Mc/s (17 Mc/s); 0600, 15 Mc/s (21 Mc/s); 0700, 17 Mc/s (25 Mc/s); 0900, 21 Mc/s (30 Mc/s); 1800, 17 Mc/s (24 Mc/s); 2000, 11 Mc/s (17 Mc/s).

Chungking: 0000, 9 Mc/s (13 Mc/s); 0400, 11 Mc/s (17 Mc/s); 0700, 15 Mc/s (22 Mc/s); 1100, 17 or 15 Mc/s (24 Mc/s); 1500, 15 Mc/s (21 Mc/s); 1700, 11 Mc/s (17 Mc/s); 2000, 9 Mc/s (14 Mc/s).

A *moderate* amount of ionosphere storminess is usual during April, and although one cannot be at all certain, it would appear at the time of writing that during the periods 3rd-6th, 14th-18th and on 30th conditions are likely to be more disturbed than on other days.

**FOR SHEER
DEPENDABILITY
AND
MAINTENANCE
OF
CHARACTERISTIC**

BRIMAR
(8VA)
VALVES

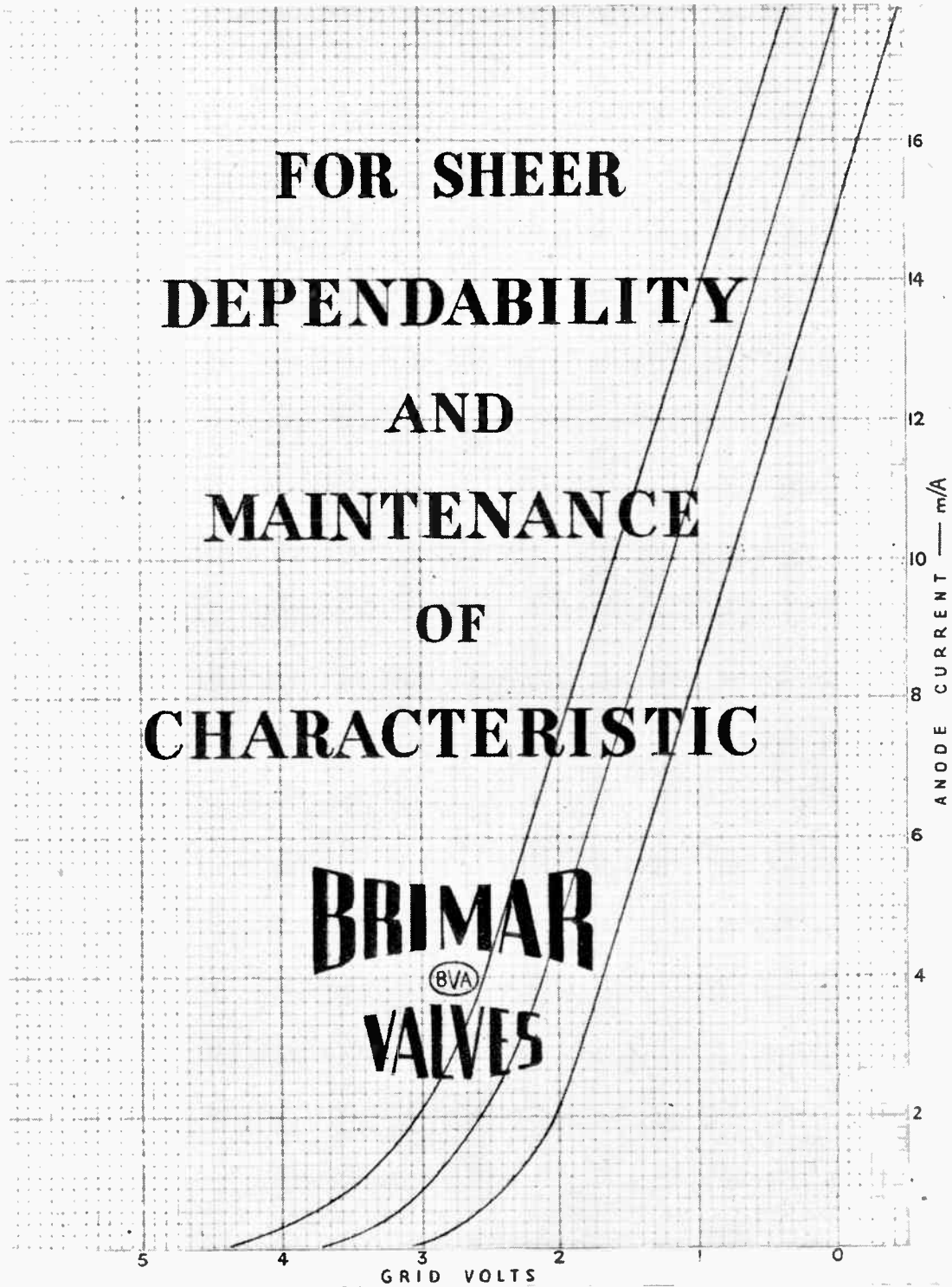

ADVERTISEMENT OF STANDARD TELEPHONES AND CABLES LIMITED FOOTSCRAY, SIDCUP, KENT

VORTEXION

"SUPER FIFTY WATT" AMPLIFIER

This **AMPLIFIER** has a response of 30 cps. to 15,000 cps., within 1 db, under 2 per cent. distortion at 40 watts and 1 per cent. at 15 watts, including noise and distortion of pre-amplifier and microphone transformer. Electronic mixing for microphone and gramophone of either high or low impedance with top and bass controls. Output for 15/250 ohms with generous voice coil feedback to minimise speaker distortion. New style easy access steel case gives recessed controls, making transport safe and easy. Exceedingly well ventilated for long life.

Amplifier complete in steel case, with built-in 15 ohm mu-metal shielded microphone transformer, tropical finish Price **29/ 6s.**

RECORD REPRODUCER.—This is a development of the A.C.20 amplifier with special attention to low noise level, good response (30—18,000 cps.) and low harmonic distortion (1 per cent. at 10 watts). Suitable for any type of pick-up with switch for record compensation, double negative feedback circuit to minimise distortion generated by speaker. Has fitted plug to supply 6.3 v. 3 amp. L.T. and 300 v. 30 m/A. H.T. to a mixer or feeder unit. Price **13 0 0**

C.P.20A 15-WATT AMPLIFIER for 12 volt Battery and A.C. Mains operation. This improved version of the old O.P.20 has switch change-over from A.C. to D.C. and "stand by" positions and only consumes 5 1/2 amperes from 12 volt battery.

Fitted mu-metal shielded microphone transformer for 15 ohm microphone, and provision for crystal or moving iron pick-up with tone control for bass and top and outputs for 7.5 and 15 ohms. Complete in steel case with valves **£22 10 0**

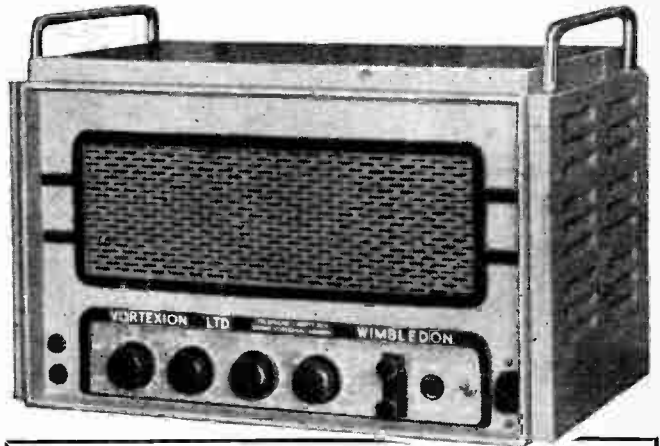

We have pleasure in announcing the opening of our **CONTINENTAL SALES DIVISION** with headquarters established in Bruxelles. All enquiries from our Belgian, Swiss, Dutch and French customers should in future be sent to the address below, and they will receive the same prompt and courteous attention as was given in pre-war days by Head Office.

Continental Division Director:—**Ms. CONSTANT BISMAN.**

Continental Export Manager:—**Mr. R. BRYAN-CARNEY.**

VORTEXION LTD., of LONDON, Rue des Palais 189, BRUXELLES.
Tel.: **BRUXELLEO**

DEALERS AND EXPORT AGENTS should write for special terms to:—

VORTEXION LTD. 257-261 THE BROADWAY, WIMBLEDON, S.W.19

Telephones: **LIBerty 2814 and 6128**

Telegrams: **VORTEXION, WIMBL., LONDON**

QUARTZ PLATES

Standard Crystals cover 3.5/10 Mc/s., — but can be supplied for other frequencies and for a wide range of frequency-temperature characteristics.

Made in hundreds of thousands per annum for the services all over the world.

Made by

SALFORD ELECTRICAL INSTRUMENTS LTD.

PEEL WORKS, SALFORD, 3.

Proprietors: **THE GENERAL ELECTRIC Co. Ltd., of England**



for
Communication Equipment

Design Data (3)

WIDE-BAND AMPLIFIERS

II.—Single-Circuit Couplings : Stagger Tuning

IF the band-width of a multi-stage amplifier employing single resonant circuits as intervalve couplings, is too narrow, it can be broadened either by increasing the damping of the circuits or by staggering their individual resonance frequencies about the mid-band frequency. It is found that the latter method leads to a considerably higher gain per stage and is consequently usually to be preferred.

The possible ways of achieving stagger-tuning are very large, for each circuit has two variables—its damping and its degree of mistuning. The most generally satisfactory result is obtained, however, when the amplifier is divided into pairs of stages, each pair having identical response characteristics. Each pair of stages comprises two valves and two couplings employing single tuned circuits, one being mistuned to one side of the mid-band frequency and the other being mistuned to the other. The circuits are equally damped, but need not have identical capacitance or resistance, nor need the valves be the same.

Such a circuit with coincidence tuning gives a performance calculable by the formulæ of Design Data No. 2. If the circuits are tuned away from coincidence in opposite directions the response curve broadens and the amplification falls. There is a critical degree of mistuning beyond which the response curve becomes double-humped and similar to that given by a pair of over-coupled tuned circuits. This critical degree of stagger is analogous to critical coupling in such a pair of coupled circuits. Only the case of this critical stagger is considered here

Higher gain for a given band-width can be secured with greater stagger, especially if the pair of stages is combined with a third tuned to the mean frequency. The system then becomes much more critical in its adjustment, however, and more liable to be seriously affected by small changes in circuit constants, notably the input capacitance of the valves. It is usually better, therefore, to adopt critical stagger.

Practical Example

The formulæ given enable the circuit values to be calculated and their use is best illustrated by an example. Suppose $C_1 = C_2 = C = 30$ pF., $g_{m1} = g_{m2} = 8$ mA/V, $n = 5$ Mc/s, $f_m = 13$ Mc/s; and $S = 1.414$ (-3 db.), then from equation (2) or the curve $nCR = 225/k$. From (3) $f_r = 12.75$ Mc/s, and from (9) $k = 1 - \frac{(5/12.75)^2}{8} = 0.908$; therefore, $nCR = 248$ and $R = 1.65$ k Ω . From (4) $L = 5.0$ μ H and from (5) $y = 0.2975$.

$$\text{Consequently } a^2 = \frac{2 + 0.2975 \sqrt{4 - 0.0886}}{2 - 0.0886} = 1.355 \text{ and } a = 1.16.$$

Then (7) gives $R_1 = 1.92$ k Ω ; $R_2 = 1.425$ k Ω ; $L_1 = 6.77$ μ H; $L_2 = 3.69$ μ H, $f_{r1} = 11$ Mc/s; $f_{r2} = 14.8$ Mc/s; lastly $A = 69.2$.

This should be compared with the gain of two coincident-tuned stages with the same capacitance values, band-width and valves. The figure given in Design Data No. 2 was 26.3 times, so that stagger tuning in this instance gives 62 per cent. more amplification per stage.

If four stages are used with the same overall response, the drop per pair of stages is 1.5 db., so that $S^2 = 1.414$, and $nCR = 200$. Consequently $R = 1.33$ k Ω , and $A = 51.5$ per pair, or 2,650 times overall. This compares very favourably with the 182 times of four stages with coincidence tuning.

Equation (10) can be used to determine the response at other frequencies. Thus if we wish to know the response at $13 \pm 3.5 = 16.5$ and 9.5 Mc/s, $m = 16.5 - 12.75 = 3.75$ Mc/s and $9.5 - 12.75 = -3.25$ Mc/s in the two cases. Then $x = 1.294$ and 0.745 , giving $x^2 + 1/x^2 = 2.276$ and 2.352 .

Then in the first case the relative response is

$$-10 \log \left[1 + \frac{2.276 \times 2.09 - 4}{0.088} + \frac{(2.276 - 2.09)^2}{0.0077} \right] = 11.46 \text{ db.}$$

and in the other

$$-10 \log \left[1 + \frac{2.352 \times 2.09 - 4}{0.088} + \frac{(2.352 - 2.09)^2}{0.0077} \right] = -12.6 \text{ db.}$$

This is the attenuation of two stages at a frequency 3.5 Mc/s different from the mid-band frequency of 13 Mc/s.

Effect of Mid-band Frequency

The circuit constants and performance are to a first approximation independent of the mid-band frequency. When n becomes an appreciable fraction of f_m , however, the values are affected slightly and the amplification increases somewhat as the frequency is lowered. This is not immediately apparent for in equation (8) $A \propto k$ and k decreases with decreasing frequency. However, in equation (2) $R \propto 1/k$, and $R^2 = R_1 R_2$ appears in equation (8); consequently, in reality $A \propto 1/k$. The effect of k is to increase the gain of two stages by about 10 per cent. at 13 Mc/s, as compared with, say, 45 Mc/s, so that it is quite small.

It would not influence the choice of intermediate frequency as long as this is above 7 Mc/s and there are usually objections to a lower value. It is usually permissible to take $k = 1$, and therefore to ignore it.

In order to reduce computation, a curve is included to show the relation between the attenuation at the

Wide-band Amplifiers—

edges of the pass-band and nCR (for $k = 1$). It must be remembered that the data all applies to a pair of valves with two tuned circuits — one resonant at f_{r1} and the other at f_{r2} .

Design Data (3): Wide-Band Amplifiers II

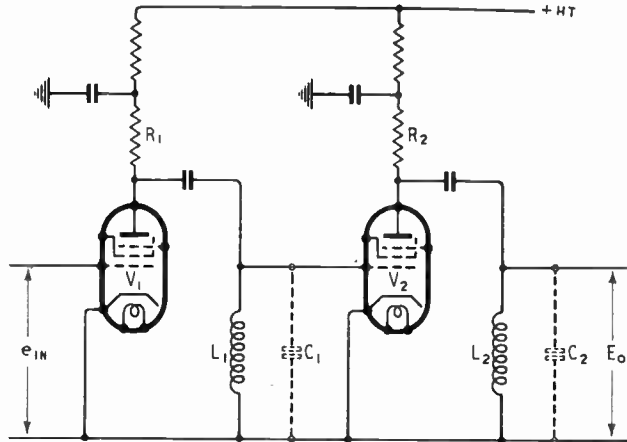

$$a^2 = \frac{2 + y\sqrt{4 - y^2}}{2 - y^2} \dots \dots \dots (6)$$

$$\left. \begin{aligned} R_1 &= RaC/C_1 & f_{r1} &= f_r/a \\ R_2 &= RC/aC_2 & f_{r2} &= f_r a \\ L_1 &= La^2C/C_1 \\ L_2 &= LC/a^2C_2 \end{aligned} \right\} (7)$$

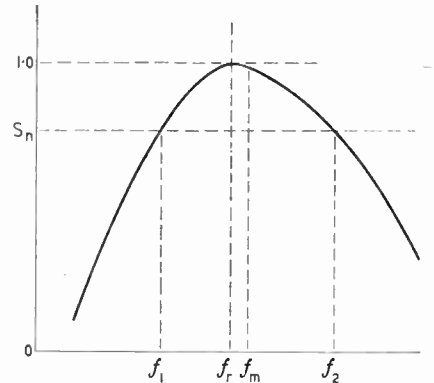

- Let f_m = required mid-band frequency
- n = required band-width
- $f_1 = f_m - n/2$ = lower limit of pass-band
- $f_n = f_m + n/2$ = upper limit of pass-band
- $f_r = f_m \sqrt{1 - n^2/4f_m^2} = \sqrt{f_1 f_2} = 159/\sqrt{LC}$
= frequency of maximum response
- f_{r1} = resonance frequency of circuit 1
- f_{r2} = resonance frequency of circuit 2
- m = frequency difference from f_r
- $S_n = \text{Ratio} \frac{\text{response at } f_r}{\text{response at } f_1 \text{ and } f_2}$
- $S_m = \text{Ratio} \frac{\text{response at } f_r}{\text{response at } (f_1 + m)}$
- g_{m1} = mutual conductance of V_1
- g_{m2} = mutual conductance of V_2

$$A = e_o/e_1 = \frac{g_{m1}R_1g_{m2}R_2}{2} \cdot k \dots (8)$$

where k = a correction factor

$$= 1 - \frac{n^2/f_r^2}{8\sqrt{(S_n^2 - 1)}} \dots \dots \dots (9)$$

Units

Frequency (Mc/s); mutual conductance (mA/V); inductance (μ H); capacitance (pF); resistance (k Ω).

Given $f_m, n, S_n, C_1, C_2, g_{m1}$ and g_{m2} , to determine R_1, R_2, L_1, L_2 and A :—

$$C = \sqrt{C_1 C_2} \dots \dots \dots (1)$$

$$nCR = \frac{225}{k} \sqrt{(S_n^2 - 1)} \dots \dots (2)$$

$$f_r = f_m \sqrt{1 - n^2/4f_m^2} \dots \dots (3)$$

$$L = \frac{24,400}{f_r^2 C} \dots \dots \dots (4)$$

$$y = \frac{159}{f_r CR} \dots \dots \dots (5)$$

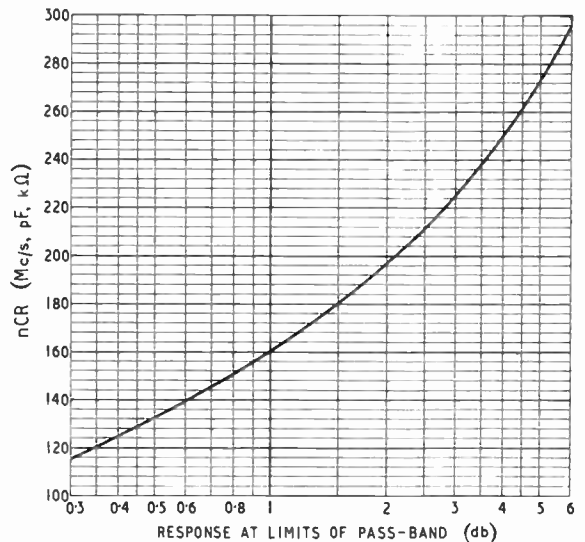

Relative response at any frequency = $-10 \log S_m^2$

$$= -10 \log \left[1 + \frac{1}{y^2} \{ (x^2 + 1/x^2)(a^2 + 1/a^2) - 4 \} + \frac{1}{y^4} \{ x^2 + 1/x^2 - a^2 - 1/a^2 \}^2 \right] \dots (10)$$

where $x = 1 + m/f_r$

PHASE RELATIONSHIPS

"180 Degrees Out of Phase" or "Reversed Polarity"?

By C. E. COOPER

EXPLANATIONS of phase difference between grid and anode signals of a valve stage, which include the subterfuge of an imaginary generator, are apt to leave the student, at least, with a somewhat hazy idea of the effect being explained. Such subterfuges are not essential to a completely accurate explanation, as the writer hopes to show.

It is worth while considering first the case of a valve with no anode load impedance, i.e., where the anode-to-cathode voltage does not fluctuate in accordance with a signal voltage applied between grid and cathode. This point is of some small importance, since otherwise, as will later be shown, the phase relationship between I_a and V_g sig. is dependent upon both the nature of the load and the valve amplification factor.

If we consider a resistor placed between grid and cathode, the current through this resistor will be in phase with the voltage across it, i.e., electrons will flow from the cathode end of the resistor towards the grid end at the highest rate at the instant at which the grid end is most positive.

Inside the valve, electrons will flow from the cathode towards and past the grid at the highest rate at the instant at which the grid is most positive (or most nearly positive, i.e., least negative). Thus, in the no load condition where I_a is varied only by V_g sig., the current past the grid, i.e., the I_a sig., is exactly in phase with V_g sig., if we neglect the time taken for the electrons to travel. This time is so small that it may be ignored unless the input signal is reversing its polarity in less than, say, one twenty millionth of a second.

Dealing now with the case of a valve with a load impedance, the I_a sig. will develop a signal voltage across the load, causing the anode to cathode voltage to fluctuate. These fluctuations will also

affect I_a , which is controlled by both V_a and V_g , in the ratio of the valve amplification factor. To maintain the simplest possible explanation for the moment, let us now consider only the case of a pentode valve of such high amplification factor that the control over I_a exerted by V_a is negligible by comparison with that exerted by V_g .

Considering such a valve in its steady state or DC conditions, with a resistive anode load, there will be a certain voltage dropped across the resistor. The valve anode is negative to the HT+ terminal by this voltage, and positive to its cathode by this amount less than the HT voltage.

When an input signal is applied, at the peak of the half-cycle which makes the grid positive to cathode, the I_a will be highest, and the voltage dropped across the load resistor will be greatest.

but erroneous statement, that V_a and V_g are in antiphase (with a resistive load).

Naturally, the writer is now required to justify the word "erroneous."

Fig. 1 (a) shows a waveform having a large amplitude, short duration positive half-cycle and a small amplitude, long duration negative half-cycle. Fig. 1 (b) shows the same waveform 180 degrees out of phase with the first. A positive peak is still a positive peak, but occurs at a different instant of time. This is certainly not what would be obtained from a valve whose input was represented by Fig. 1 (a).

What would be obtained is shown in Fig. 1 (c), where the large amplitude, short duration half-cycle occurs at the same instant of time as in Fig. 1 (a), but where it has now become a negative half-cycle. This is not

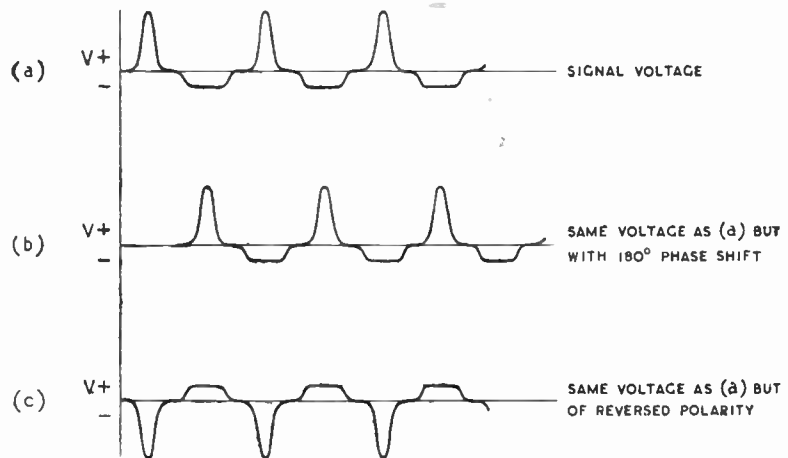

Fig. 1. Illustrating the difference between "phase" and "polarity."

This means that the anode becomes least positive to cathode and most negative to HT+, so that the maximum change of V_a in a negative direction occurs at the instant of maximum change of V_g in a positive direction, from which arises the usually accepted,

a phase reversal, but is instead tantamount to a reversal of polarity or direction of connection.

This point may perhaps be clarified by a brief consideration of Fig. 2. With the circuit shown in Fig. 2 (a), there is a certain phase relationship between V_p and

Phase Relationships—

V_a , and therefore the same relationship between V_p and V_{xy} . In Fig. 2 (b) the connections to x and y have been reversed, resulting in exactly the same effect as would be produced by the addition of a valve stage to Fig. 2 (a). This reversal of connections can, however, hardly be said to have changed the phase (or time) relationship between V_p and V_s .

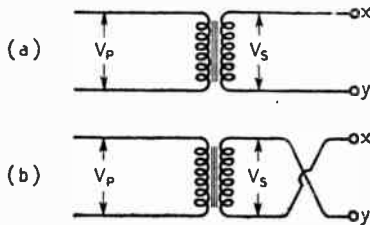

Fig. 2. Reversal of the secondary connections of a transformer has a similar effect to the introduction of a valve stage.

We may take the matter a stage further, and consider the input voltages to a Class "B" push-pull stage, where it is normally stated that the two inputs need to be in antiphase. Bearing in mind that a Class "B" (cut-off biased) valve can amplify only the positive half-cycle of an input signal, it should be realised that the application of the signals shown in Fig. 3 would only result in sinusoidal output, though the inputs are far from being sine waves. What, in fact, the two valves require are signals of opposite polarity, or direction, not signals with a time difference.

The next step is to consider a reactive load, still dealing with the high- μ valve, where I_a is virtually unaffected by V_a .

I_a is in phase with V_g sig., and this I_a flows through both valve and anode load without any change of phase (a general rule of series circuits, irrespective of the nature of the impedances). Thus if the load is inductive, the signal voltage across it will lead the I_a sig. by 90 deg. This genuine time change will now add to the reversal of polarity. The net result for an input signal of similarly shaped positive and negative half-cycles would be exactly similar in effect to V_a sig. lagging by 90 deg. on V_g sig.

For dissimilar half-cycles, in circuits where this is of importance, the only accurate view is of V_a sig. being 90 deg. leading on, but of opposite polarity to V_g sig.

It is worth while considering the case of an inductively loaded amplifier from the viewpoint of changes in steady state conditions, instead of from the viewpoint of signal voltages. With no signal input, there will be a certain steady anode current through the inductor. Assuming this inductor to have negligible resistance, there will, however, be no voltage drop across it, so that V_a will equal the HT voltage. A stationary magnetic field will have been built up round the inductor by the current through it.

If the grid is now made more negative, I_a , and therefore the current through the inductor, tends to fall. This reduced current cannot maintain the previous strength of magnetic field, some of the flux of which therefore collapses back into the inductor, inducing an EMF between its ends. The direction of the EMF

can momentarily rise as high as eight or more times the HT voltage.

Where the load is capacitive, as would be the case with a parallel tuned circuit resonant to a frequency lower than that of the input signal, the voltage across the load will lag on the I_a signal. This phase lag will be in addition to the polarity reversal, since making the grid more negative will always result in the anode becoming more positive, even though a time difference exists between the instants of maxima in the two directions.

In conclusion, mention may be made of the case where the amplification factor is sufficiently low that V_a exerts appreciable control over I_a . With a resistive load, where V_a sig. and V_g sig. are in phase but of opposite polarity, the effect is merely a reduction of working mutual conductance. With a reactive load, where V_a sig. will not be in the same phase as V_g sig. the net result will be that I_a sig. is no longer in phase with V_g sig.

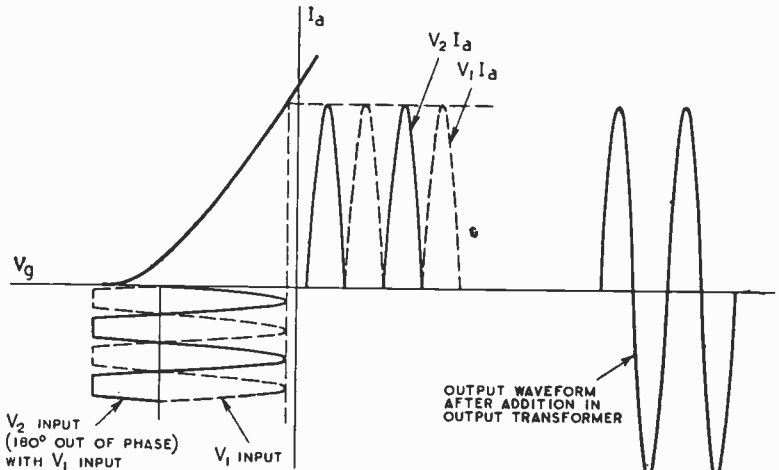

Fig. 3. "Distorted" signals with 180-degree phase difference applied to the grids of a Class B stage might result in a pure sine wave output.

is such as to oppose the change (of I_a) producing it, resulting in the anode being made positive to HT+. Thus V_a will rise above the HT voltage, a possibility which does not often seem to be realised. In fact, where I_a is suddenly considerably reduced, with a considerable amount of inductance in the anode circuit, V_a

This phase difference, which cannot exceed 45 deg., will be greatest when the amplification factor is lowest and the voltage developed at the valve anode is highest, a low μ indicating considerable anode control over I_a , and a high load compared with R_a indicating anode signal voltage being large.

LINAGLOW LIMITED

R.A.F. Portable Transmitters

— NEW and UNUSED —

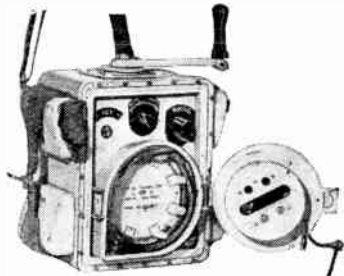

Complete Transmitter

Containing a wealth of valuable components, useful for the amateur or can easily be converted for use on amateur bands. Circuit diagrams and Parts List supplied with each instrument.

EACH UNIT IS COMPLETE with valves, crystal, Litz wound coils, morse key, variable condenser, relays, portable aerial, resistors, chokes, condensers, etc.

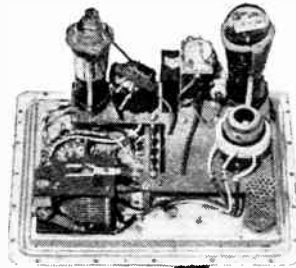

Top Panel of Transmitter

LIMITED QUANTITY (Approx. cost to manufacture £39). **PRICE inc. post & pkg. £5.5.0**

RESISTANCES

½ watt 270,000 ohms, 560,000 ohms, 47,000 ohms, 100,000 ohms, 1 meg-ohm, 5d. each.

½ watt 180 ohms, 330 ohms, 470 ohms, 1,000 ohms, 1,500 ohms, 3,300 ohms, 10,000 ohms, 22,000 ohms, 33,000 ohms, 47,000 ohms, 220,000 ohms, 7d. each.

1 watt 150 ohms, 470 ohms, 3,300 ohms, 4,700 ohms, 10,000 ohms, 22,000 ohms, 33,000 ohms, 47,000 ohms, 100,000 ohms, 11d. each.

TELEVISION COMPONENTS
High voltage Transformers 200/250 volts, 4,000 volts, 2 volts, 2 amp. For use with type U.21 rectifier. 21/-.
Mansbridge type Condensers. 1 mfd 4,000 volt. 7/6.

VARIABLE CONDENSERS. 3-gang less trimmers, 2 qualities. 16/- and 12/6.

I.F. TRANSFORMERS 465 kc/s. Dimensions—1½ in. x 4 in. x 1½ in. For use with 3 wave coil pack. 12/6 per pair.

OAK SPEAKER CABINETS. For 8in. loudspeaker. Polished dark finish. Without fret or silk. 17/6.

LOUD SPEAKERS. 10in. P.M. with transformer, 25/6; without transformer, 22/6. 8in. P.M. with transformer, 22/6; without transformer, 20/-. 2½in. P.M. without transformer, 20/-. 3½in. P.M. 3 ohms voice coil, without transformer, Celestion, 29/6. 8in. Energised, 2,000 ohms with transformer, 25/6.

3-WAVE COIL PACK

Simplifies the building of your superhet. Supplied complete with trimmer and padder condensers for use in standard 3 wave super-heterodyne circuit. One hole fixing to chassis. Ranges: 19-50 metres, 200-550 metres, and 1,000-2,000 metres. A fourth position is fitted to wave change switch for gramophone pick-up. For use with 465 kc/s. I.F. Transformers. PRICE complete with diagram of connections, 38/6.

AMERICAN TYPE CHIME DOOR BELLS
Ring with a mellow 'Ding-Dong'
55/- each

8/10 volt BELL TRANSFORMER 17/6

CATHODE RAY OSCILLOSCOPES CONSTRUCTORS KITS

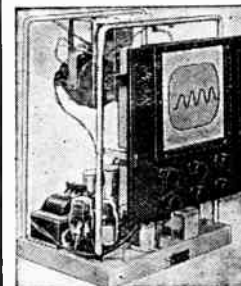

Designed by prominent well-known radio engineer. All parts supplied — theoretical and practical wiring diagrams and full instructions for assembling and operation. All parts new, ex-manufacturers pre-war stock. Specification: Magnetic deflection and focusing, C.R.T. 7in. screen, multi-stage amplifier and linear time base incorporated. Mains input 200/250 volts 50 cycles. Anode potential 5,000 volts. Oscilloscope when completed is in chassis form, mounted on tubular metal frame. Limited quantity. **PRICE £22.17.6**
(Case and packing 7/6 extra)

VALVES

American Types at B.O.T. controlled retail prices.

12F5, 12J5, 1H5, 9/2; 1C5, 11/-; 6Q7, 11/7; 6F6, 6K6, 12/10; 3Q5, 1N5, 12/10; 6A8, 6B8, 1A7, 14/-; 35Z5, 11/-; 50L6, 12/10. All G.T. type.

BRITISH VALVES at Manufacturers' list prices.

6X5, UU4, UU6, 11/-; TDD4, 11/7; AC/VP2, CL4, EF39, KTW61, PEN45, SP41, SP42, T41, VP41, 12/10; D1 diode, lin. peanut valve, with valveholder, 12/10; ECH3, X63, 14/-; A.C.6PEN, EL35, PEN46, U21, 6L6, 18/3. Prices include purchase tax.

Please add 3d. per valve postage.

ELECTROLYTICS

Tubular 8 x 8 mfd. 500 volt working, tag end, 5/9 each. 25 mfd. 25 volt working, 1/9 each. 8 mfd., 3/6 each.

MODEL R.K. 10in. Mains energised LOUDSPEAKERS.

1,000 ohms field, 100 volt, 15 ohms speech, weight 28 lbs., reconditioned as new. Ideal for P.A. work. **PRICE £2 15s.** Carriage 5/-.

● POST ORDERS ONLY ●

We regret that due to pressure of business we are unable to handle showroom, caller or C.O.D. trade until further notice

LINAGLOW LTD., Dept. MO 60, 61, HIGHGATE HIGH ST., N.6

'Phone: MOUntview 9432



CERAMICONS



HI-K CERAMICONS



SUPPRESSORS

1093

ERIE

Electronic Components

The engineering resources which produced hundreds of millions of Erie components for war-time needs are now at your service. May we advise you, quote you, or send you samples?

ERIE RESISTOR LTD.
 CARLISLE ROAD, THE HYDE,
 LONDON, N.W.9.
 Telephone: Colindale 8011
 FACTORIES: London, England
 Toronto, Canada • Erie, Pa., U.S.A.



CARBON RESISTORS (ACTUAL SIZE)



VITREOUS ENAMELLED WIRE-WOUND RESISTORS



POTENTIOMETERS



When you want REAL PORTABILITY in Amplifiers

R.S.

PUT ~~IT~~ THERE !

There is no puzzle about choosing the right portable P.A. Equipment, for the R.S. Universal Fifteen adequately completes the picture of REAL PORTABILITY. Delivery of this tried and tested equipment is now considerably improved, so write NOW for full information.

The R.S. Universal Fifteen is entirely self-contained and is carried "suitcase" fashion. It operates on both A.C. and D.C. mains at all voltages from 200-250.



AMPLIFIERS

R.S. Amplifiers Ltd., 2-4 Highfield Rd., Shepperton, Middx.
 Tel: Walton-on-Thames 1019

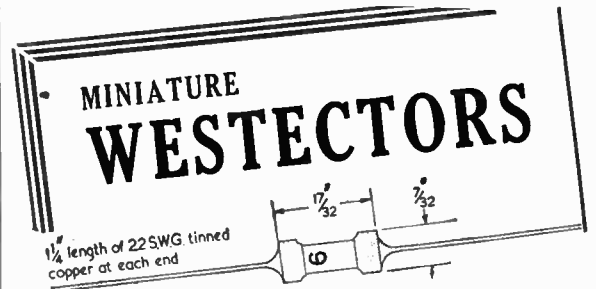

The Miniature Westector is designed to carry 1, 2, 3, 4 or 6 series elements protected from the outside atmosphere by compressing a neoprene ring between the metal end caps and the phenolic body to give a positive seal; this Westector is therefore suitable for tropical use and no reduction in the rating is necessary at ambient temperatures up to 55°C. (131°F.).



METAL RECTIFIERS

Westinghouse Brake & Signal Co. Ltd., Pew Hill House, Chippenham, Wilts.

RADAR CABLES

Recent Developments in Conductors for Very High Frequencies

By E. W. SMITH, Ph.D., M.I.E.E.

(The Telegraph Construction and Maintenance Co., Ltd.)

THE key to progress in radar technique has always been the use of increasingly high frequencies for the exploring wave.

It is evident that all the numerous current-carrying components in the equipment have had to keep pace with these increases of frequency so that none imposed undue limitations. It is here proposed to review the development of the cables which, among other components, have performed a vital function throughout. While the rate of this development has been most marked in the period 1935-1945, there is a background, as in radar itself, of theory and manufacturing experience, going back a hundred years to the days when the first cables insulated with extruded plastics were made for submarine use.

Dielectric Loss in Cables.—The chief objective in the drive for better cables has been the reduction of the power factor of the dielectric, for ten years or so ago the lowest figure obtainable in otherwise suitable dielectrics was about 0.005. We can express the attenuation constant in high-frequency cables as $R/2Z + GZ/2$, where R is the high-frequency resistance of the conductors, Z the characteristic impedance of the cable, and G the conductance (= power factor \times admittance) of the dielectric. Analysis shows that, for the average cable, Z varies inversely as the square root of the dielectric permittivity, and that this permittivity can only be improved over comparatively narrow limits, and is usually independent of frequency. We know, however, that the resistance R varies approximately as the square root of the frequency, while G usually varies directly as

the first power of frequency. It will thus be seen that as frequency rises, the dielectric loss can very easily outstrip that due to the resistance of the conductors. An example of this in a pre-1935 cable is shown in Fig. 1, from which it will be seen that the dielectric loss alone could be about 0.7 db./100ft. even at the low frequency of 30 Mc/s, and no less than 5 db./100ft. at 200 Mc/s.

What is the practical significance of losses of this order? The reader will remember that the height of the aerial masts in the original "CH" system was given as 350ft. for transmitting and 240ft. for receiving. The conductance loss in a connection, say, 300ft. from aerial to operating hut by cable of power factor 0.005 would be appreciable (2 db.) at 30 Mc/s and serious (15 db) at 200 Mc/s, while the use of such a cable at 3,000 Mc/s would be quite out of the question. It should be remembered that cable losses help to determine the signal/noise ratio and therefore cannot be compensated for *ad lib.* by increasing amplifier gain.

Air Dielectric Cables.—Before the advent of polythene, by the

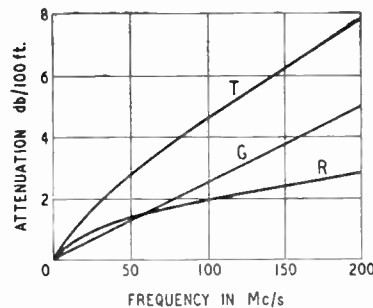

Fig. 1. Loss in a 0.3 inch diameter coaxial cable using dielectric with power factor 0.005. R, loss due to series resistance; G, loss due to shunt conductance; T, total loss.

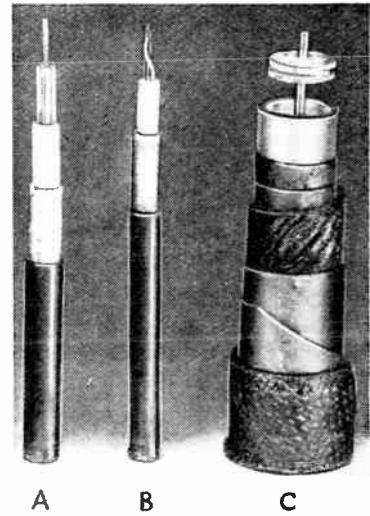

Fig. 2. Three types of air dielectric cable. A, "fin" type; B, "spiral thread" type; C, "disc-spaced" type.

aid of which the solution of most radar cable problems was eventually found, considerable attention was paid to air dielectric cables.

Three types of air dielectric cable are illustrated in Fig. 2, in which A shows the "fin" type, B the "spiral thread" type, and C the "disc spaced" type. Type A was originally made by extruding first the star-shaped fin on to a flexible conductor and then applying the enclosing cylinder of dielectric in a separate operation. In 1935, with this combination of air and materials of the old type, the power factor discussed above was halved, while the effective dielectric constant was reduced from about 3 to about 1.5. Similar electrical results were obtained with Type B, and these types were both characterised by desirable flexibility and robustness.

With Type C it was possible to make the spacing discs of relatively hard inflexible dielectric, and a particularly suitable one, namely polystyrene, had been available for some time. In the cable illustrated the outer conductor consists of an extruded lead sheath, which when required is protected with a steel tape or wire armouring. Owing to the very low loss of polystyrene and the small amount of this material

Radar Cables—

used, the power factor of this type of cable is of the order of 0.0002, while the effective dielectric constant is about 1.1. For a 300ft. connector the dielectric loss would be quite negligible at 30 Mc/s, practically negligible (0.3 db.) at 200 Mc/s and quite tolerable (5 db.) at 3,000 Mc/s, although for frequencies of this order modifications in the normal disc spacing might be required.

The disc-insulated cables were thus electrically suitable for radar use when the art was in the early stages of development, and in fact are still incorporated in many systems. Their disadvantage is in their relative inflexibility, and in the vulnerability of their somewhat delicate construction. As will be seen later, most stringent mechanical requirements must be satisfied by most cables before they are approved for radar use.

Polythene Insulated Cables.—

Readers will be familiar with the properties of polythene (polyethylene), the plastic dielectric material invented by Imperial

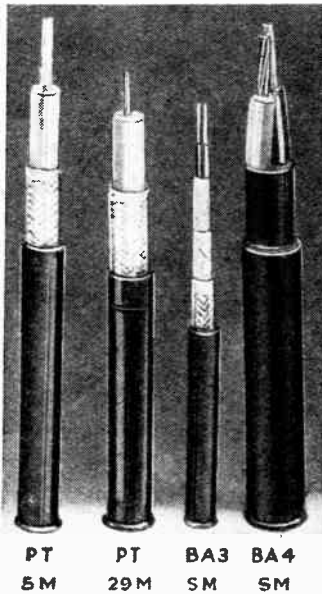

Fig. 3. Examples of coaxial and balanced twin feeder cables.

Chemical Industries, and first produced in appreciable quantities in 1938. It has already

been recorded that the construction of polythene insulated cables was undertaken by the Telegraph Construction and Maintenance Company as soon as the material was available. Actually "Telcothene," a mixture of polythene and polyisobutylene (a material of similar electrical characteristics) was used. In 1938 and early 1939 several types of radar cables were made with this dielectric. Very soon the demand grew to such an extent that the Ministry of Aircraft Production sponsored an auxiliary T.C.M. factory, solely for radar cable production, and in 1940 obtained the co-operation of other cable-making firms so that the enormous demands could be satisfied and freed, by the dispersal of plant, from the danger of serious interruption by enemy action.

Types of Radar Cable.—It must not be imagined that the invention of polythene solved all radar cable problems at a stroke. A good deal of work in the processing of the material had to be carried out before its full value could be realised in practice. Thus the prevention of oxidation and the avoidance of air inclusion and of irregularities in extrusion had to be ensured, and it was in the solution of such problems that a long experience of plastic extrusion proved most valuable. By 1940, however, most of the desired refinements in production had been attained, and at this time an inter-Service committee was formed to standardise the variations in cable sizes and characteristics which were required. This committee framed specifications covering between 30 and 40 different cables, based mainly on a pre-war series of coaxials, known to many as "PT" types, and on a corresponding series, "BA" types, of balanced twin feeders. Fig. 3 shows, approximately half size, two examples of each type.

Generally speaking, the coaxial types have single or 7-strand centre conductors, insulation applied in two or three layers, outer conductors composed of a braid of fine copper wires, and sheaths of extruded PVC (polyvinyl chloride). On most of the balanced twin types the two

separately insulated conductors are twisted and filled with the polythene-polyisobutylene dielectric to circular section.

The most important refinement desired in coaxial cables is regularity in diameter. If this dimension varies along the length of the cable, even by a few thousandths of an inch, reflections

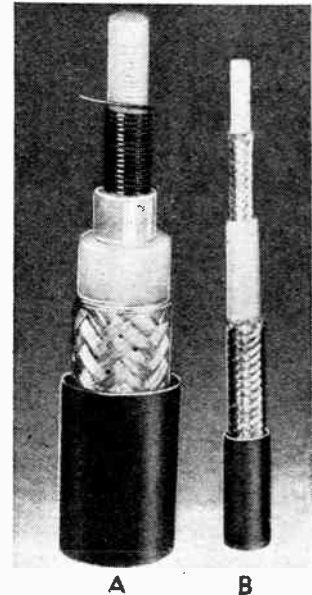

Fig. 4. Special coaxial cables. A, "delay" cable with helical centre conductor and B, "low impedance" cable with braided cylindrical centre conductor.

will occur and standing waves of undesirable magnitude will be set up. While great progress has been made in uniformity of diameter, work in this direction is still in progress, for dimensional tolerances even as low as ± 0.001 in. would be well worth attaining.

In balanced twin cables, the degree of electrical balance to earth of the two conductors is of similar importance. A notable feature in such cables is a double screen, the inner screening component being a helical wrapping of metallised paper, and the the outer one a braid of fine wires. Prior to the introduction of this construction by T.C.M. in 1942 the stability and ageing properties of twin cables left much to be desired.

Special Types.—The impedance of the polythene insulated coaxial cable is normally about 70 ohms, and that of the twin 90-roo ohms. Departures from these average figures have, however, been required for special purposes, and two extreme cases may be mentioned here. One is the "delay" cable, in which a helix of wire takes the place of the single central wire in a coaxial cable, and the other the "low impedance" cable in which the centre conductor, as well as the outer, is a braid of fine wire. These are illustrated in Fig. 4.

The chief features of the "delay" cables are their high characteristic impedance and low propagation velocity. Several types are made, the impedances ranging from 130 to 2,000 ohms and the velocities from one-seventh to one-hundredth that of light. These cables are mainly used to produce artificial echoes for calibration purposes.

Mechanical and Electrical Testing.—Mechanical testing of solid dielectric cables includes tension, bending, twisting, hot deformation, and "cold crack" tests. Tension is applied to short lengths to see that the dielectric tightly embraces the centre conductor and is in turn firmly held within the outer braid. To determine the effects of bending, the cable is wound and unwound several times, the diameter of the winding being normally ten times that of the cable itself. Twisting tests comprise twists and untwists on a short, straight sample

through a specified angle. In the hot test the cable is kept under load for 16 hours at a temperature of 70 deg. C.; the tempera-

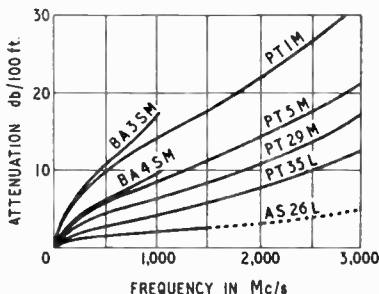

Fig. 5. Losses in radar cables, diameters 0.13in. (PT1M) to 0.8in. (PT35L).

ture generally chosen for the "cold crack" test is -30 deg. C.

The radio-frequency characteristics of radar cables are determined by "resonant line" and "standing wave" methods, details of which have appeared in recent papers.* Fig. 5 shows a few typical results. In addition to RF tests, all cable is subjected to DC measurements to determine conductor and dielectric resistances, the latter being usually at least 10⁸MΩ—100ft. A high-tension test at 50 c/s is also applied, the voltage chosen being such that the maximum stress in the dielectric is 90 kV(peak)/cm. Radio-frequency characteristics must remain unaffected by this application, and by the mechanical treatment outlined above.

* Journal Brit. I.R.E., Aug., Sept., 1945. Wireless Engineer, Nov. and Dec., 1944.

Books issued in conjunction with "Wireless World"

| | Net Price | By Post |
|--|-----------|---------|
| FOUNDATIONS OF WIRELESS. Fourth Edition, by M. G. Scroggie | 7/6 | 7/10 |
| TELEVISION RECEIVING EQUIPMENT, by W. T. Cocking ... | 10/6 | 10/10 |
| RADIO LABORATORY HANDBOOK, by M. G. Scroggie. Second Edition | 12/6 | 12/11 |
| WIRELESS SERVICING MANUAL, by W. T. Cocking. Seventh Edition | 10/6 | 10/10 |
| HANDBOOK OF TECHNICAL INSTRUCTION FOR WIRELESS TELEGRAPHISTS, by H. M. Dowsett and L. E. O. Walker. Seventh Edition | 30/- | 30/7 |
| RADIO DATA CHARTS. Third Edition, Revised by J. McG. Sowerby | 7/6 | 7/10 |
| RADIO INTERFERENCE SUPPRESSION, by G. W. Ingram ... | 5/- | 5/4 |
| LEARNING MORSE. 335th thousand | 6d. | 7d. |
| INTRODUCTION TO VALVES, by F. E. Henderson | 5/- | 5/4 |
| RADIO WAVES AND THE IONOSPHERE, by T. W. Bennington | 6/- | 6/3 |

Obtainable from leading booksellers or by post from ILIFFE & SONS LTD., Dorset House, Stamford Street, London, S.E.1

ONE LOUDSPEAKER — 360° COVERAGE

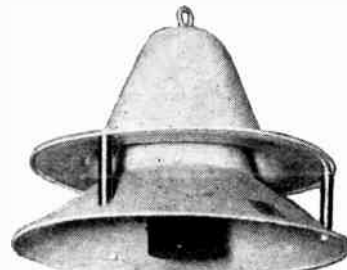

This new type, called the CIRCON, has horn-speaker efficiency together with completely uniform distribution throughout 360 deg.

Typical advantages:—ONE centrally placed will cover the whole of a medium-sized area: used on a moving vehicle results are equal approaching, passing or receding, thus ideal for street processions, elections, etc. Full details will be available shortly. List price—Horn only £7 0 0. Complete £14 5 0.



M.5 Moving Coil MICROPHONE

No polarising current, adequate frequency response, low impedance, high output due to a very efficient magnet and careful design. List price £5 15 0.

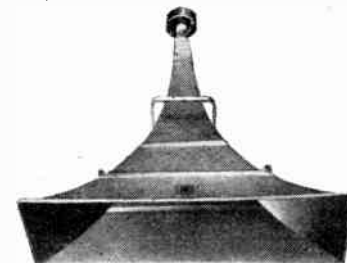

L.S.7 HORN LOUDSPEAKER. Maximum sensitivity and volume. Impedance 10 ohms; handles 12 watts 170-10,000 c.p.s. 40in. horn. List price £13 10 0.

F.I. for P.A. FILM INDUSTRIES LTD.
60, PADDINGTON ST., W.1
Telephone: WELbeck 2385

BROADCASTING IN U.S.A.

Report on Post-war Trends

By A. DINSDALE

As shown in this article from a correspondent in U.S.A., the problems of war-to-peace transition in American broadcasting and television are very different from those prevailing under the British system of distribution.

that as much of the station's time is sold as possible. In America, radio is just as much an advertising medium as newspapers, magazines or posters. You probably know that already, but it is necessary to emphasize it.

During the war years, the demand for radio time increased by leaps and bounds. One of the principal causes of this was the increasing shortage of newsprint for the papers. Another potent factor was the vast increase in radio's power as an advertising medium. Everybody listened constantly and attentively for the latest war news.

According to the new 1946 Broadcasting Yearbook, the total spent on radio advertising (including station time and talent) in the United States in 1945 (American radio's 25th year) is estimated at \$383,450,000, an increase of 7.5 per cent over 1944. That puts radio up in the category of Big Business.

The effects of radio's sensational rise are many and varied. In the first place, at the end of 1945 there were 1,004 standard broadcasting stations in the United States, compared with 943 in 1944. I might explain that the term "standard broadcasting station" has come to be used to describe an A.M. station, as distinct from F.M.

One immediate effect of the radio bonanza is apparent in the numbers of applications on file before the Federal Communications Commission. The F.C.C. was swamped with over 500 applications for new standard broadcasting stations, more than 800

IN considering post-war radio prospects in the United States we must start with the listener. His problem is the simplest and therefore the easiest and quickest to dispose of. All the listener asks is: "When do I get a new radio?" The manufacturers' easy answer to that one is: "As soon as the current strike situation is cleared up, and we can get materials and parts." (First it was "reconversion." Now it's strikes.) Privately, the manufacturers are still debating just how much provision to make for F.M. and television. Even more important from their point of view are the ceiling prices they will ultimately be permitted to charge. American production of consumer goods for domestic consumption will not get under way in real earnest until these two vital factors, wages and prices, have been settled.

Until such time as new radios become available, the average listener can manage to get his old set fixed, now that service men are returning, although certain parts and some types of valves are still in short supply, or unavailable.

Some listeners, while pondering the possibilities of a new radio receiver, are asking "What about television? Is it ever going to come around that corner? And what's this F.M. thing I keep hearing about? Is it any good?" But it must be reported that the majority of listeners appear to be apathetic towards both these developments.

That just about disposes of the listener. From here on, this report is going to get complicated, as it must delve into the grim realities of Big Business.

Radio is Big Business.—First of all, you must never for a moment lose sight of the fact that American broadcasting is conducted on a commercial basis. Generally speaking, the principal function of a station manager is to see to it

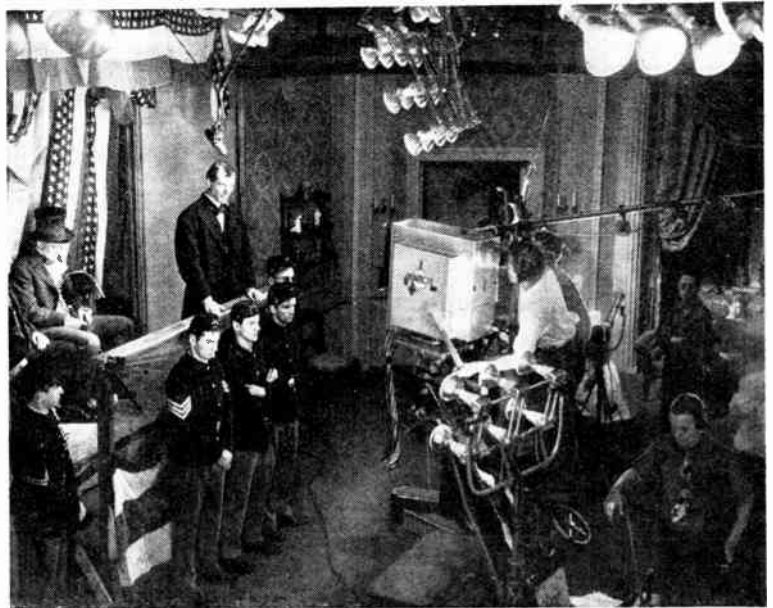

A scene in the studio of the American National Broadcasting Company's television station during the transmission of a programme. Only "a small handful" of Americans have sets with which to receive these transmissions.

applications for new F.M. stations, and between 40 and 50 applications for television stations. The figure for television applications was much greater at one time, but many applications were withdrawn for reasons which will be made clear later. In addition, the F.C.C. has before it hundreds of applications from existing stations for increases in power and/or changes in frequency. In the face of this apparently hopeless situation, many would-be station owners are shopping around, trying to buy existing stations. Naturally, prices have risen to astronomical heights, with few stations for sale.

Goodness only knows how room can be made for 500 additional A.M. stations, although much has already been done by the use of directional antenna systems, arranged so that at night a station's signal can be cut off in the direction of a nearby station on the same frequency, thereby protecting it from interference.

Frequency Modulation.—Radio manufacturers obviously face a tremendous post-war boom, both in transmitters and receivers. There is a demand for new transmitters both as replacements and for new stations. There is a stupendous market for replacement receivers. But this, apparently, is not enough. Hence the pressure for F.M.

This pressure for F.M. has been brought to bear on station managers and owners by transmitter manufacturers. It went on relentlessly all through the war years, increasing in tempo as the war drew to a close. I know. As a station manager I was exposed to it. Manufacturers bombarded owners and managers with the constantly reiterated argument that of course they wanted to be first in their locality to exploit this new post-war development. "Place your order now, and be first on our list when we are able to deliver."

American broadcasting is a competitive business. Every station tries to outdo its competitors with all sorts of stunts to attract new listeners. Just as some newspapers run circulation-building stunts, so American broadcasting stations strive to

build listeners. The more listeners you have the more advertising you can attract. Or you can raise your rates. So F.M. has been "sold" to owners as a means of attracting new listeners.

But the catch is that it costs from \$50,000 up to build and equip an F.M. station, and until somebody buys a new receiver you have no listeners. The comparatively few F.M. receivers sold before the war are now useless, due to a recent change in the F.M. band, which is now 88-104 Mc/s. But it's the old story of the chicken and the egg. Which came first? Unless somebody puts up an F.M. transmitter there is no incentive for a listener to buy an F.M. receiver. But while waiting for people to buy receivers the station owner has to bear the expense of keeping his F.M. transmitter operating as a sort of auxiliary to his A.M. transmitter. In time, enough people will have bought F.M. receivers (or combination receivers capable of receiving both A.M. and F.M.), so that the station owner will have an audience sufficiently large to attract advertisers. When that happens the owner should begin to get his investment back. At least, that is the theory. Will it work out?

Suppose you own the only station in town. Suppose, for the sake of argument, you have just two listeners. Either they both ignore F.M. and continue to listen to the A.M. station, or they both listen to F.M. and abandon the A.M. station. More likely, they will divide their listening between the two stations. Thus, instead of increasing your audience, all you have done is *split your audience*, reducing by half the potential advertising value of both stations. You just *can't* increase your audience, because everyone ever likely to own a radio has one already, and has established his listening habits.

If there's more than one station in town, competition will force the other fellows to build F.M. stations, too, and anyone interested in the novelty of F.M. will continue to listen to the auxiliary of the station he usually tunes in.

From a revenue point of view,
(Continued on page 134.)



THE "FLUXITE QUINS" AT WORK

"Bang goes another valve, see?
The total to date's twenty-three!"
Something's not right,
Why the brute's dynamite
"Try using FLUXITE" cried EE.

See that FLUXITE is always by you—in the house—garage—workshop—wherever speedy soldering is needed. Used for over 30 years in Government works and by leading engineers and manufacturers. Of all Ironmongers—in tins, 8d., 1/4 & 2/8.

Ask to see the FLUXITE POCKET BLOW LAMP, price 2/6.

TO CYCLISTS! Your wheels will NOT keep round and true unless the spokes are tied with fine wire at the crossings AND SOLDERED. This makes a much stronger wheel. It's simple—with FLUXITE—but IMPORTANT.

The FLUXITE GUN puts FLUXITE where you want it by a simple pressure. Price 1/6, or filled, 2/6.



ALL MECHANICS WILL WANT
FLUXITE
IT SIMPLIFIES ALL SOLDERING

Write for Book on the ART OF "SOFT" SOLDERING and for Leaflets on CASE-HARDENING STEEL and TEMPERING TOOLS with FLUXITE Price 1d. each.

FLUXITE LTD.

(Dept. W.W.), Bermondsey Street, S.E.1

Broadcasting in U.S.A.—]

one advertiser put it to me like this: "Look, Dinsdale. I've got just one advertising dollar to spend. Go ahead and build an F.M. station if you've a mind to. And when you get it built you can put my advertising on either station, or split it between them, according to your judgment of what'll do me the most good. But don't come and ask me for a *second* advertising dollar for your F.M. station. I just haven't got it."

That is the dilemma facing American station owners and managers to-day. They want to keep in the van of progress, but it means a heavy investment, both in first cost and in operation, and they cannot see clearly where the return is coming from, or when. Splitting the audience between A.M. and F.M. may force a reduction in advertising rates of both stations, with a consequent heavy reduction in overall yield from an increased investment.

In large metropolitan areas like New York or Chicago, the case is different. In such areas there are many would-be radio advertisers who simply can't get on the air because (1) there aren't enough A.M. stations to accommodate them, and (2) the rates are too high. In metropolitan centres there is room for some F.M. stations to accommodate these people. With range, and thus marketing area, limited to the horizon, the rates can be low enough so that service can be extended to thousands of new advertisers.

Why F.M., Anyway?—At this point one is forced to ask the question: "Why introduce F.M., anyway? The only one sure to profit is the manufacturer of transmitters and receivers. The position of the station owner is most dubious, to say the least of it, and the listener doesn't seem to care." So let's take a look at the listener again.

F.M. is being sold to the American public on two counts: (1) It is interference-free (but the word "practically" is now being inserted); (2) it provides unequalled tone quality.

Let's examine this interference-free claim. Since F.M. is limited

to the horizon, we can compare an F.M. signal to that provided in the same area by an A.M. station—that is, the so-called primary service area, where the signal strength is not less than a half millivolt. As things stand to-day, with a reasonably good receiver, properly installed, there is no interference to speak of in the primary service area of an A.M. station, unless a thunderstorm is raging in the immediate vicinity. If you get beyond the primary service area of an A.M. station you'll get plenty of interference natural and man-made. But at the same distance from an F.M. station you'll get no signal at all. So wherein lies the value of the argument?

Let's consider quality. I will make the flat statement that if you walk into any number of American homes to-day you'll find that in 95 per cent. of them the tone control on the radio is turned *down*, to cut out the high frequencies. If you ask about it, you will be told vaguely that they like it better that way. With the tone control up, the radio sounds "harsh," "raspy," or it interferes with conversation or reading.

In that last you have it. The radio is on only to provide a pleasant background. It is only really listened to when a comedy programme comes on, or a news broadcast, or a favourite commentator, or a dramatic programme. And for such programmes high quality is not necessary. Only a few music lovers take the trouble to buy the best in radios, and then get the most out of them.

An educational campaign? Futile. About 12 years or so ago, set manufacturers improved their receivers so that they would reproduce up to 7,500 cycles. They spent millions to advertise the fact. A number of so-called "high-fidelity stations," like WQXR in New York, explained and explained and *explained* this business of high quality, and demonstrated it for years by playing the highest quality recordings they could get. In fact, they forced improvements in recording quality.

And what happened? People still turned down the tone control as soon as the first novelty wore off.

So now along comes F.M., with transmitters capable of putting out even higher quality, and receivers capable of reproducing it.

However, you can't take out what you don't put in. By that I mean that F.M. transmitters are capable of putting out much higher quality than is readily available to them. At first, much of the programming will come from high-quality electrical transcriptions and some records. But even the highest quality transcriptions that it is now possible to make cannot equal F.M.'s potentialities. Network programmes, received by the station over ordinary telephone lines, will not sound much better than they do over A.M. The cost of a network of high-quality concentric cable would be prohibitive. In the end, networks of F.M. stations will have to be fed network programmes by means of chains of F.M. relay stations.

However, it is the opinion of top network executives that, eventually, service in metropolitan areas will be by F.M. exclusively. Existing A.M. stations in such areas will be scrapped, with the exception of a limited number of high-power A.M. transmitters which will be moved out to the wide open spaces to serve rural areas where the population density is so low that F.M. service would be uneconomical. However, it is expected that about ten years will elapse before this change takes place.

The major factor in forcing this change will be economic. The time will come when broadcasters, one by one, will find it uneconomical to operate two transmitters, one A.M. and one F.M., and they will either scrap the A.M. or move it out into the country.

Gradually, there will be still another economic change. With the range of F.M. limited to the horizon, the number of radio homes which can be covered will be greatly reduced, especially in the case of the higher powered A.M. stations. That means a reduction in circulation, which in turn means that advertising rates will have to be reduced. Yet, first costs and operating expenses will remain about the same. Add to that a vast increase in the total number of broadcasting stations

when F.M. becomes general, and the result is that the total radio advertising revenue will be spread among many more stations, so that the average revenue per station will be greatly reduced. This factor may discourage many station owners and become the controlling factor which will limit the total number of stations.

The vast potential increase in the number of stations possible with F.M. has already attracted trade unions and other organizations with a special cause to plead, and they are busily filing applications for "non-commercial educational" F.M. stations.

Television's Future.—Television's future in America can be summed up in one word—Uncertain.

Technically, black-and-white images, seen under the best conditions, are good. I've just checked on them in New York. The Columbia colour television is very good. To get the colour, they use a revolving colour disc at the receiver, synchronized with a similar disc at the transmitter. I described this system in its original form in *Wireless World* several years ago.

Programme material cannot be so highly praised. Frankly, producers are still experimenting, searching for the proper material and methods of presentation for television. "Telev viewers" are limited to a small handful. Only a few thousand receivers were distributed before the war, and these must be modified before they can be used on to-day's limited transmissions. This is so because, as in F.M., frequency assignments have been changed. A start is being made now on the 60-78-Mc/s band, and eventually, television will move to the 160-288-Mc/s band. Columbia is experimenting with its colour system on frequencies above 450 Mc/s. New television receivers are not yet on the market, although a few of the bigger manufacturers are beginning to advertise combination receivers capable of handling A.M., standard band and short-wave; F.M. and television; they incorporate a phonograph turntable with automatic record-changer. As to delivery, it is hoped that this may be "some time this

year." No one ventures to quote even an approximate price for these new "all-in" sets.

Economics of Television.—Even more so than in the case of F.M., economics seems destined to play an important part in television. About the lowest figure I have heard quoted for a television station is \$200,000. But it is generally agreed that the minimum cost of a fully-equipped television station is likely to be closer to \$350,000. It is also agreed that the cost of operation for the first year is likely to be in the neighbourhood of \$350,000. By the end of the second year, it can be hoped that a substantial number of television receivers will have been purchased within the service area of the station. But by that time, the television broadcaster will have spent *one million dollars*. Bear in mind that in America, television seems destined to become another advertising medium, like sound broadcasting. Where, after two years of operation, is a television broadcaster to find sufficient revenue to make his investment worth while? It is generally agreed that advertising rates over television will have to be several times those now charged for present radio advertising, and programme production costs will also be several times higher. Thoughtful persons in the radio industry are beginning to wonder just who will be able to stand such high advertising costs. In large cities, perhaps a few big department stores will be able to stand it, but the overall revenue possibilities are so doubtful that quite a number of would-be television broadcasters have withdrawn their applications.

Obviously, those who stand to profit most by the development of television are the manufacturers who expect to produce and sell transmitters and receivers. It may be that eventually they will have to shoulder the cost of television broadcasting and accept as their sole return the wide sale of receivers. But before that can happen, present restrictive laws will have to be modified.

So, all in all, I feel justified in saying that the future of television in America can only be described as uncertain. **World Radio History**



Save Valuable
Executive Time
by installing

THE
TANNOY
LOUDSPEAKER
SOUND SYSTEM

For Staff Location,
Announcements,
'Music While You
Work' Programmes,
Canteen Concerts,
Alarm and Time Signals,
the TANNNOY
is an assurance of
greater general
efficiency, both in
Factory and in Office

TANNOY
The Sound People

TANNOY is the registered trade mark of
equipment manufactured by

GUY R. FOUNTAIN LTD.
WEST NORWOOD, LONDON, S.E.27, & Branches

Phone: Gipsy Hill 1131

The largest organisation in Great Britain
specialising SOLELY in Sound Equipment

Letters to the Editor

Expansion Circuits • The £1 Broadcast Licence Quality of B.B.C. Recordings

Contrast Expansion

I HAVE read with much interest Mr. White's articles on contrast expansion in the September and October, 1945, issues, but there is one important point on which I should like to be re-assured before accepting his final circuit as satisfactory. It is the amount of harmonic distortion introduced by the controlled valve (V_3 , Fig. 9) being a non-linear resistance.

Suppose first that the output voltage at the anode of V_3 is applied to V_3 and R_1 in series, but that the voltage across R_1 is not fed back into the amplifier. Since the resistance of V_3 cannot be strictly linear, the current through the circuit will contain harmonics and so, therefore, will the voltage across R_1 . When R_1 is connected into the cathode circuit of V_1 , these harmonics will be amplified and will appear in the output. Simple analysis indicates that, if the harmonic percentage across R_1 (before connection to V_1) is p , the harmonic percentage in the output will also be not far short of p . From this point of view, therefore, the circuit is probably not superior to variable-resistance circuits not using feedback.

Mr. White claims that his expander will drive an output stage directly. The output stage of a quality amplifier will need something like 45V peak for full drive (this means nearly 20V applied to V_3). Since at full drive V_3 has maximum negative bias, its resistance will be in the most non-linear state, and I should have guessed that with 20V applied to the anode it would generate appreciable distortion, which will sound worst at maximum output. But the matter can only be settled by the figures, and if Mr. White can supply these (i.e., output distortion for given amounts of output voltage) I think he should do so, in order to prove his claims that the circuit will drive an output stage directly and that it introduces less distortion than other types (he remarks that push-pull vari-

able-gain expanders do not remove the odd harmonics, implying that his circuit is superior).

Although this may not have been intended, the article gives the impression that the distortion produced by a variable-resistance valve is inherently reduced by placing the valve in the feedback path. This is obviously not fundamentally true; negative feedback will reduce the effects of non-linear components in the amplifying path, because this is its function, but it does so by using a feedback path which is strictly linear (usually a resistance divider). If the feedback path is itself non-linear then it will produce distortion even with a strictly linear amplifier.

These remarks are not meant to detract from the value of Mr. White's article, but rather to add to it. If the distortion figures are satisfactory, the circuit may well prove to be superior to all others on grounds of simplicity, ease of control, and relatively high gain.

D. H. PARNUM.

Helensburgh.

[These comments are referred to on p. 120.—ED.]

B.B.C. Finance

MAY I be allowed to point out some anomalies which seem to have escaped other commentators on B.B.C. finance?

First, the radio critics in the lay Press seem to have swallowed unquestioningly the extraordinary idea that the 10s licence fee would not now suffice to pay for the home (sound) broadcasting services, and that an increase to £1 is reasonable. Now the B.B.C. in 1938 had only 7s 6d out of each of a smaller number of licences than exist now, but was able to pay for the following: The home (sound) broadcasting services; the Empire service (on short waves); the London television service; capital expenditure on new transmitters and buildings; income tax (charged on that part of the Corporation's revenue

which was devoted to capital expenditure). It is therefore my guess that 6s per licence would have covered the maintenance of the home (sound) broadcasting services before the war; allowing for the 50 per cent rise in prices since 1938 the B.B.C. would need 9s now. Out of a 10s licence fee this would still leave the Post Office 1s for cost of collection, compared this with 2d which is charged for issuing and cashing a 10s Postal Order. An increase in the licence fee to, say, 12s 6d. might be within the bounds of reason, but an increase to £1 is not. The additional 10s on the ordinary radio licence is therefore not required to pay for the services which the licensee receives, but is probably intended for one or more of the following purposes:—

(i) To pay for the overseas propaganda services, which ought to be charged directly to the Exchequer, on a par with the expenses of the British Council.

(ii) To pay for television, which the Government's Television Committee has shown cannot be paid for by the owners of television receivers.

(iii) To serve as a tax, pure and simple. (However unpalatable, this is fairly logical, since other forms of entertainment are taxed.)

It seems that many people have been misled by the fact that during the war the B.B.C. has had a total expenditure roughly equal to twice the proceeds of the 10s licence fee. But the reasons for this are now emerging from secrecy: the number of overseas programme hours, the numerous additional high-power stations to carry these programmes, the re-organisation of the home services to meet air-raid dangers. The wartime figures are therefore no guide to future requirements.

One other point deserves mention. In the past, the B.B.C. has financed all capital expenditure out of income; if a substantial step forward in B.B.C. services is re-

quired, whether for television or for U.H.F. sound broadcasting stations in sufficient number to provide real "freedom of the air," part at least of the capital expenditure might perhaps be met by a loan secured on the capital assets of the broadcasting system.

D. A. BELL.

London, N.21.

Too Many Recordings ?

SEVERAL of your correspondents have complained about the poor quality of the B.B.C. transmissions and the excessive use and poor quality of gramophone recordings.

An analysis of the Home Service programme for March 3-9 inclusive shows a total time of 121 hours and 5 minutes, of which 35 hours 5 minutes, or some 29%, was taken up by recordings, of which 14 hours 50 minutes were commercial pressings, and 20 hours 15 minutes B.B.C. recordings. It would therefore appear reasonable to say that the use of recordings is excessive.

Regarding the quality of recorded programmes, commercial pressings are far too often worn and even scratched, and in a number of instances badly presented. But the B.B.C. recordings are, in almost all cases, of really excellent quality, and I cannot help feeling that if the many armchair critics were not made aware of their origin by announcements or printed programmes, it would not occur to them that the programme was recorded. As regards this type of recorded programme, I disagree entirely, as do very many of my friends, with your correspondents, and consider that the B.B.C. have done, and are doing, a first-class job.

R. W. LOWDEN.

Camberley.

Soldering v. Spot Welding

"DIALLIST," in your March issue, is not quite fair to soldering. We cannot agree that it necessarily produces "too many dry joints," or that "the dry joint is a menace." Also, may we remind your readers that the merits of spot welding, which he seems to advocate as an alternative, have yet to be proved?

There may have been too many dry joints at one time, due to poor

solder (incorrectly alloyed or made from reclaimed metal), poor flux, or, in cored solder, lack of flux in lengths of the solder wire. Multicore Solders, Ltd., endeavoured in 1938 to overcome these troubles by producing a cored solder which (a) was made from virgin metal; (b) incorporated non-corrosive activated rosin flux; (c) provided three flux cores, so the risk of absence of flux in appreciable lengths was negligible.

The results of introducing this solder was very encouraging, but after the fall of Malaya there was some increase in the incidence of dry joints in radio equipment. This was because the 45-55 alloy solder used to conserve tin supplies had a higher melting point than the 60-40 alloy mainly used before. Many electric soldering irons had too low a bit temperature for wartime solder. We investigated the matter in collaboration with manufacturers, and as a result of our efforts dry joints again fell to a reassuringly low level.

Cored solder of 60-40 alloy is again available, and if the radio industry will use it in the correct manner with a soldering iron bit temperature of about 250°C there is no reason for any dry joints in bulk production. In fact, it should be practically impossible to make one.

RICHARD ARBIB,
Multicore Solders, Ltd.

London, W.1.

CATALOGUES RECEIVED

PAMPHLET No. W9795 describing Pirelli-General radio-frequency cables, issued by the General Electric Co., Magnet House, Kingsway, London, W.C.2.

Abridged illustrated list of amplifiers, loudspeakers and microphones from Trix Electrical Co., 1-5, Maple Place, Tottenham Court Road, London, W.1.

Illustrated catalogue of dry electrolytic capacitors in aluminium containers from the Telegraph Condenser Co., Wales Farm Road, North Acton, London, W.3.

Folder giving characteristics, base connections and prices of Osram receiving valves in tabular form from the General Electric Co., Magnet House, Kingsway, London, W.C.2.

Leaflet describing the "Quixo" battery test meter made by Runbaken Electrical Products, Burtons Buildings, Oxford Road, Manchester, 1.

differential compression

A new development
in Hearing Aid
Technique

WE believe we have made considerable advances in the most complicated problem of fitting deaf people with hearing aids with a performance most suitable to their needs. In the past a great deal has been written and said of taking an audiometric curve of a patient and adjusting the hearing aid to the curve with the same certainty as an optician deals with the prescription for lenses.

Those familiar with the subject know that the problem is actually of great complexity, and it is possible for two people with identical audiometric curves to react quite differently to a particular type of hearing aid. We have given the name of "Differential Compression" to the type of amplification in which the relative amplification of the higher speech frequencies and the rest of the scale is a function of the total sound level handled by the amplifier. This it is believed will make it much easier to fit difficult inner ear deaf cases with hearing aids, and be of benefit to children in special schools for the deaf. We now manufacture a very complete range of Hearing Aids, including tiny pocket aids self-contained with batteries. Our Universal Model which combines excellent performance with low price, and various other models are designed to meet special purposes. There is also our new Radio Set for the Deaf, which is a combined Wireless Set and Hearing Aid and gives great amplification with very high quality.

MULTITONE

ELECTRIC CO. LTD.

92 New Cavendish Street, London, W.1

RANDOM RADIATIONS

By "DIALLIST"

A Sun Spot Effect

WHEN the two enormous spots were passing across the sun's face earlier in the year some very peculiar wireless effects were noticed. One of the queerest that came my way concerned not the short waves but the long waves. On rare occasions in the past I have known fading on wavelengths up to 900 metres or a little above though it has seldom been of a very severe kind over about 750-800 metres. During the sun-spot period I found Luxembourg on 1,200 metres behaving almost like a very distant short-wave station. Fading was very marked indeed, the transmission at times almost disappearing amidst the horrible distortion that so often occurs on distant short-wave stations or on stations at the lower end of the medium-wave band during high-speed fading. But fading was sometimes slow and rhythmic; at other times it was found to be a good deal more rapid. I wonder if readers noticed anything of the kind; perhaps some of them found fading on even higher wavelengths during that queer period. I only wish that the data of solar activity which one used to get before the war were now available. They should make interesting reading.

□ □ □

Standard Voltages

SO there is some chance that we shall have standard main voltages in the not-too-distant future. A good many people must have been surprised by the announcement by the Minister of Fuel and Power that it had been decided that the national standard voltage should be 240. This, I suppose, applies to A.C. and there is no suggestion that any alteration is to be made in the frequency. The original aim was to standardise 230 volts, 50 cycles, A.C. throughout the country, but in a good many districts (parts of Scotland for instance) the supply is 240 volts. The figures are in effect surprising. Out of nearly ten million consumers rather more than five and a half million now have supplies at 230 volts and two million, one hundred and seventy thousand supplies at between 240 and 250 volts. The present permitted variation is ± 6 per cent., which, as the Minister suggests, probably means that many, if not all, of the 230-volt consumers have at one time or another been working their apparatus,

even if they knew it or not, at 240 volts or more. The idea is that a good deal of apparatus designed for 230 volts will therefore prove satisfactory at 240 volts, and as something like seven and three quarter million consumers have hitherto had supplies at 230 volts or more, the choice of 240 volts means the smallest expenditure in replacing apparatus.

Worth Noting

The Minister stated that the cost of replacing or converting existing apparatus which would not work on 240 volts would fall upon the supply authorities when the change-over was made. I am no lawyer, but I think that I am right in saying that supply authorities become liable only if they have been informed of the apparatus that is in use in a particular house and have approved it. I imagine that most of us have any amount of electrical gadgets in our homes whose use has not been reported to our suppliers. I know I have! I suppose the sound thing to do is to make a list of what one has and to send it in with a formal report. Being myself on 200V I must remember to do so; much of my gear would not work as it stands on 240V.

□ □ □

"All-wave" Receivers

A FEW of the new receiving sets are beginning to find their way on to the market, and they are apparently being snapped up by an eager public as soon as they appear. This is not surprising, for the majority of listeners must own sets which are more than five years old, so that replacements are, to say the least of it, desirable. At present almost any kind of set will sell, so long as it works; but I do hope that manufacturers will remember that this cannot go on for ever. To have a ready market in this country the sets will have not only to be good performers on the local stations, but also, if they are of the "all-wave" type, to be easy to use on the short waves. Short-wave listening is so fascinating that it would have caught on as a popular hobby much more markedly than it did if only sets had been made reasonably easy to tune on their short-wave range. Well do I remember one set of bygone years on the tuning dial of which the rich 19-metre band occupied a space of less than one-eighth of an inch! As there were twenty-

two stations working in this band at the time when the receiver made its bow to the public you can imagine that it was not exactly a fine short-wave performer in the hands of the average listener. If the "all-wave" set is to be a success the short-wave range must not be just stuck into it as a sales-talk trill. There is no reason why, with band-spreading of one kind or the other, short-wave tuning should not be made a perfectly simple business. I am sure that the public would be quite willing to pay a bit more for an "all-wave" receiver whose short-wave range was really usable by the ordinary man or woman. I am equally sure that a short-wave range as difficult to handle as some of those of past years is not really an attraction.

□ □ □

The Gas Blowlamp

THE little gas blowlamp which I described in these columns recently seems to have been known to only a few readers; those who did know it speak highly of its performances and of its usefulness. A brother of mine, who is not only the owner of a splendidly equipped workshop, but is also a skilled amateur mechanic, has made himself a *de luxe* model—a lovely thing. You may remember that the essentials of this blowlamp are as follows: a nozzle about $\frac{1}{4}$ in. in diameter is supplied with gas from the mains and gas, issuing from a minute aperture an inch or so away, carries air with considerable velocity into the flame at this nozzle. The result is an intensely hot "blown" flame from six to eight inches in length according to main pressure. The "super" model to which I refer is mounted on a heavy stand with a ball and socket joint. You thus have both hands free to hold the work and can direct the flame just where you want it. Another refinement made is to fit the nozzle with a control valve so that the amount of gas issuing from it can be regulated to a nicety. In this way a very hot flame can be obtained from about $1\frac{1}{2}$ -6 inches or more in length to suit the work in hand. I have shown this little tool to several people, some of whom were sceptical about its efficiency until they actually saw it in action. But that scepticism does not endure long when you show them how quickly a piece of steel can be brought to bright red heat in the flame. One of the most useful applications that I have found for the lamp is for sweating. You can do the work cleanly and quickly and there is no bother about pumping up to maintain pressure.

AMATEUR TRANSMITTER'S EXAMINATION

IN view of the changed status of the radio amateur it has been decided that those wishing to operate a transmitting station must either satisfy the Postmaster-General that they possess the required qualifications or alternatively sit for an examination which will be arranged by the City and Guilds of London Institute. The first examination will take place on May 8th, 1946, between the hours of 7 p.m. and 10 p.m. and it may be taken at one of several centres throughout the country, details of which can be obtained from most technical colleges; failing that, from the Superintendent of the Institute, 31, Brechin Place, London, S.W.1. Closing date for entries is March 31st, 1946.

A fee of 10s. will be charged by the Institute to cover examination costs. Local centres may also make a small charge for accommodation.

In addition, the Post Office will require applicants to pass a test in Morse at 12 words per minute, which will be held at local Head Post Offices on payment of a fee of 5s.

The following abridged syllabus gives an indication of the subjects covered by the examination:—

1. **Electricity and Magnetism.**—Elementary theory of electricity conductors and insulators. (Ohm's Law, resistance and capacitance in series and in parallel.) Permanent magnets and electromagnets in radio. Self and mutual inductance, capacitance.

2. **Radio Principles** (elementary treatment only).—Alternating currents; series and parallel A.C. circuits incorporating inductance, capacitance and resistance. Coupled circuits, acceptor and rejector circuits. Simple theory of electromagnetic wave propagation.

3. **Thermionic valves and circuits.**—Principles and characteristics of modern valves, methods of use in receiver and transmitter R.F. and A.F. circuits and power supply equipment.

4. **Receivers.**—Essentials of a radio receiver, including T.R.F., superheterodyne and super-regenerative principles of operation (C.W. and telephony).

5. **Low-power Transmitters.**—Oscillator circuits, use of quartz crystals in oscillators for frequency control, frequency multiplication, R.F. power amplification, modulation and keying technique. Avoidance of interference (over-modulation, harmonic radiation and keying).

6. **Aerials.**—Simple types of receiving and transmitting aerials, feeder systems and simple directional arrays.

7. **Measurements.**—Measurement of frequency, use of crystal-controlled frequency meters, artificial aerials and their use in lining up transmitters. Measurement of anode current and voltage; computation of power input to individual stages in a transmitter.

8. **Licence Conditions.**—Understanding of the conditions laid down for operation and procedure.



WE WERE THERE
before the stork...

Even before the birth of broadcasting . . . before the days when to hear the programmes of 2LO was regarded as the ninth wonder of the world, the House of Bulgin was designing and building efficient components for "wireless telegraph instruments." And with the passing of the years the name of BULGIN has figured prominently in every radio and electronic development. To-day, this wealth of experience is at your disposal, not only in the wide range of BULGIN Standard Components but in the design and manufacture of special units to fulfil a particular need as well.

BULGIN

"The Choice of Critics"

A Name Synonymous with Radio

A. F. BULGIN & CO., LTD.
BYE PASS RD., BARKING, ESSEX.
TELEPHONE: RIPPLEWAY 3474



RECENT INVENTIONS

TRANSMISSION LINE ELEMENTS

PAIRS of conductors, having distributed inductance and capacity, are commonly used as impedances and resonators in short-wave technique. A more recent application is to radio-location, where it is necessary to transmit periodic pulses of high-powered energy, at regular intervals, and where the time constant of a transmission line element lends itself to the formation of suitable square-shaped modulating voltages.

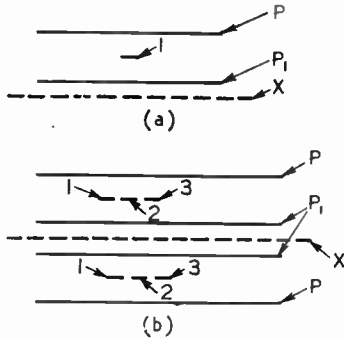

"Delay" cable construction

An element which is geometrically short, but electrically long, and therefore well adapted for the purpose in view, is based on the combination of a conductor 1, in the diagram (a), of finite cross-section, placed midway between two infinite parallel conducting planes P,P₁. This is wound helically about an axis X to give the assembly shown in diagram (b), where 1, 2, 3, are successive turns of the inner conductor, and the parallel planes become two concentric tubes, P,P₁. Further similar windings can be built up around the two shown. The different inner layers are connected in series, and the tubes P,P₁ are connected together and earthed, to simulate the inner and outer conductors of a coaxial line.

The General Electric Co., Ltd., and C. R. Dunham. Application date May 26th, 1943. No. 570087.

TUNING SYSTEMS

ONE end of an inductance coil is enclosed in a movable sleeve which is connected, directly or through a capacity, to the free end of the winding. If the distance between the inner surface of the sleeve and the coil is small, compared with the distance between consecutive windings, a part of the current will flow through the capacity between the covered windings and the sleeve. The circuit is stated to be equivalent to the inductance of the uncovered windings, in series with a pair of Lecher wires formed by stretching out the covered windings, and the bending the straightened wire back on

A Selection of the More Interesting Radio Developments

itself to form a Lecher pair, the two wires being separated by a distance equal to that between the sleeve and the coil.

If the Lecher wires are terminated by a load equal to their surge impedance, the transition resistance between the covered and uncovered parts of the coil is independent of the position of the sleeve. Also if the uncovered coil is shunted by a condenser, the resonance resistance of the loaded oscillation-circuit so formed can be made constant over a wide range of movement of the tuning sleeve. The invention is particularly applicable to ganged tuning control, and to the balancing of push-pull couplings.

"Patelhold" Patentverwertungs- und Elektro-Holding A. G. Convention date (Switzerland) December 17th, 1942. No. 570474.

INSULATORS

AROMATIC sulphones, mixed with known insulating materials such as those derived from vegetable and mineral oils, are found to possess unexpectedly favourable dielectric properties. When used, for instance, in the type of condenser built up from paper-spaced aluminium foil, the impregnating mixture gives a substantial increase of capacity and reduced power losses.

The preferred sulphones are produced by the addition of an SO₂ group to selected aromatic hydrocarbon radicals.

The British Thomson-Houston Co., Ltd., Convention date (U.S.A.) March 31st, 1942. No. 571498.

PIEZO-ELECTRIC OSCILLATORS

A SLAB of crystal, cut in the known A-T manner, will oscillate so that a number of parallel nodal lines are set up along its surface. The fundamental frequency of such a crystal can be varied to a small but useful degree by employing a pair of narrow exciting electrodes; but these in turn, limit the power that can be taken from the crystal.

According to the invention, the electrodes are made in the form of a

The British abstracts published here are prepared with the permission of the Controller of H.M. Stationery Office, from specifications obtainable at the Patent Office, 25, Southampton Buildings, London, W.C.2, price 1/- each.

number of parallel ribs, spaced apart by the distance that separates the nodal-lines. The ribs are originally placed directly over the nodes, and the maximum change of frequency is secured by adjusting them to lie halfway between. Thus to obtain the full advantage of the frequency-shift, the crystal surface need be very little larger than the effective area of the electrode.

The General Electric Co., Ltd., and S. K. Lower. Application date February 24th, 1943. No. 571623.

ADJUSTABLE VALVE ELECTRODES

IN certain types of short-wave valves, such as the grounded-grid triode, the clearance between the grid and cathode may be less than one-tenth of a millimetre, and is a critical factor in performance. It is difficult to meet this requirement in mass production, and the invention provides means for making a final or vernier adjustment after the valve has been sealed off.

As shown, the indirectly-heated cathode comprises two coaxial tubes, the flat top of the upper tube A being coated with emissive material. The lower tube B is welded to a metal thimble T, and can expand when heated, so as to adjust the gap between

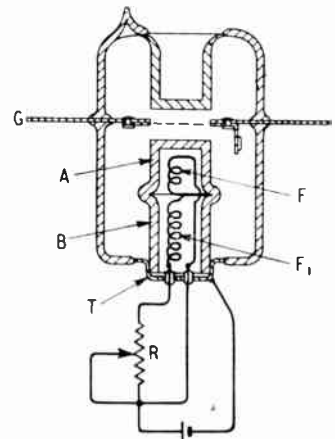

Thermal electrode adjustment

A and the grounded grid G. The heating filament F is divided into two parallel branches F, F₁, the current through F₁ being adjusted by a resistance R, until the correct clearance is obtained. Once this is secured, the corresponding resistance is permanently included in the heating circuit. The tubular cathode structure may form part of a quarter-wave resonant-line input circuit.

G. Liebmann and Cathodeon, Ltd. Application date November 20th, 1941. No. 570834.



NEW UNIT SYSTEM OF RADIO DESIGN

Last month we announced our new series of Radio Units, which enable you to select any combination to satisfy your own desire with regard to range and power.

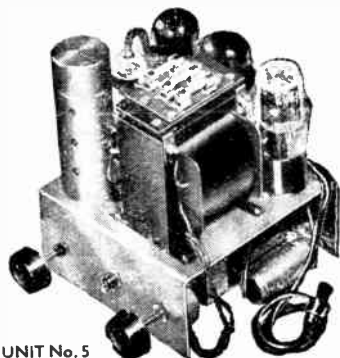

UNIT No. 5

DELIVERY DATE ON APPLICATION.

UNIT No. 6: Power pack consisting of mains transformer (400-0-400 v., 150 mA.), high-voltage surge-proof electrolytic condenser, 20-henry choke, 12in. P.M. speaker with output transformer, mains fuses. (The above Unit can also be supplied for A.C./D.C. working.)

To OVERSEAS TRADERS
Wholesale and Retail enquiries are invited.

UNIT No. 1: A/C. Complete H.F. and I.F. stages, 3-waveband coil unit (16-50, 185-550 and 800-2,000 metres), 3-gang, ceramic insulated rubber-mounted condenser. R.F. stage with R.F. gain control, H.F. and Oscillator all A.V.C. controlled feeding into an I.F. stage of 465 kc/s. and fitted with I.F. gain control. Cathode-ray tuning indicator (tuning eye), dial lamps, dial and show-motion drive, pointer and knobs, mounted on 16 S.W.G. aluminium chassis with output plug. The Unit is complete in itself, ready wired up, calibrated and tested. All parts brand new, standard components, Octal valves.

UNIT No. 2: A/C. Complete L.F. Output and Power stages, comprising 2nd detector A.V.C. and 1st L.F. amplifier, feeding into output tetrode 4½ watt output complete with mains transformer 350-0-350 v., 80-100 mA., L.F. choke and 8in. P.M. speaker with multi-ratio transformer.

UNIT No. 3: As No. 1, but with 6-waveband coil unit, 5-2,000 metres.

UNIT No. 4: A second I.F. stage 465 kc/s.

UNIT No. 5: Second detector A.V.C. and 1st L.F. Phase inverter, 2 output tetrodes in push-pull, 12 watts output.

UNIT No. 7: High Fidelity Output and Power Stages —two L.F. valves feeding two PX4 valves in push-pull (triodes). Controls: Volume, Mains on/off, radio-gram, switch and Tone.

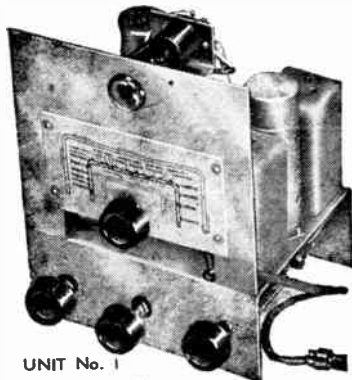

UNIT No. 1

PRICES ON APPLICATION



307, HIGH HOLBORN, LONDON, W.C.1.

'Phone: Holborn 4631

LEAK

"POINT ONE" RANGE OF ALMOST DISTORTIONLESS AMPLIFIERS

Here are performance figures, inclusive of output transformer, for the type 15:—

TOTAL DISTORTION, including hum and noise, for 15 watts output:—

1,000 c.p.s. — 0.1% (one-tenth of one per cent)
60 c.p.s. — 0.2% (one-fifth of one per cent)

FREQUENCY RESPONSE: level within 0.25db. 20-20,000 c.p.s.

LOAD DAMPING FACTOR: 20 (10 times better than for average Class A triode).

GAIN: The basic amplifier requires 0.5v RMS at grid impedance. An additional two stages can be supplied built into the chassis, thus reducing the input to 0.005v R.M.S.

Full information on leaflet S.15

SPECIAL NOTE: The above figures establish such radically new standards that they may occasion some surprise. We therefore wish to stress that no error appears in this announcement. The circuits are original, and result from war-time research in our laboratory.

H. J. LEAK & COMPANY LIMITED
470 UXBRIDGE ROAD · LONDON · W.12
TELEPHONE: SHEPHERDS BUSH 5626

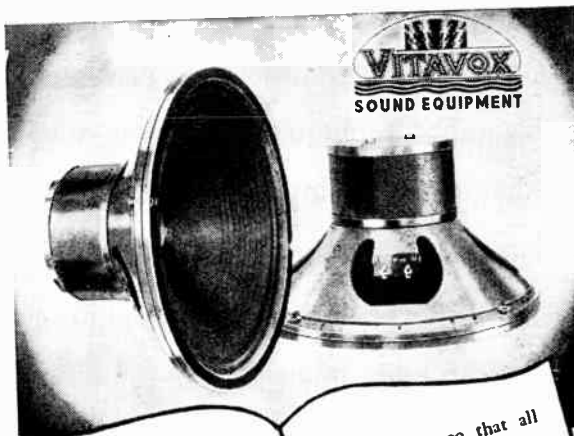

It is a fact that although VITAVOX K12/10 and K12/20 P.M. Speakers are not available in unlimited quantities, their quality is such that they are well worth waiting for.

It is a fact too that all specification figures are actual and not nominal.

VITAVOX LIMITED,
WESTMORELAND
RD., LONDON, N.W.9.
Phone Colindale 8671/3

Rate 6.- for 2 lines or less and 3.- for every additional line or part thereof, average lines 5-6 words. See Numbers 2 words, plus 1.-. Press Day: May 1946 issue, first post Friday, April 5th. No responsibility accepted for errors.

NEW RECEIVERS AND AMPLIFIERS

AMPLIFIERS.—Complete collection for P.A. industrial, dance and stage installations and portable apparatus from 15 to 150w; early deliveries; illustrations and spec. on request.—Broadcast and Acoustic Equipment Co., Ltd., Broadcast House, Tombland, Norwich 26970.

ANLEYO RADIO now offer improved set of audio components for med. and long wave semi-midget 4-valve a.c.-d.c. t.r.f. receiver, incl. striking cream cabinet, valves, drilled chassis, 6½in speaker, screws, etc.; nothing more to buy, £8/10.—Anleyo Radio, 36, Hindmans Rd., E. Dulwich, S.E.22. [5020]

NOW ready, the Model P.A.3 7-valve amplifier; order now, immediate deliveries.

MAINS transformers, output transformers, chokes, specially designed for the Wireless World, 4, 8 and 12 watt Quality amplifiers.

READY soon, the Wireless World 8 watt Quality amplifier with pre-amplifier and variable record compensation; write now for full details and lists.—Chadderton Radio & Television Co., Ltd., Peel St., Chadderton, Lancs. Special terms to factors and export agents.

RECEIVERS, AMPLIFIERS—SECOND-HAND

H.R.O., 9 coils, less power pack, once used. [4935]

NATIONAL H.R.O. receiver, in good condition.—Write Box 6249. [4994]

BAKER'S 7v PX4 quality amplifier, good condition; offers.—Box 6513. [5076]

20-WATT p.a. amplifier, well-known make, perfect; £20.—Box 5815. [4903]

NATIONAL 1-10 receiver, complete, spare parts, little use, £20.—Box 6519.

HALLICRAFTERS SX24, preselector and spare set of valves; £35.—Cundy, Park 9685 after 5.30. [4908]

SCOTT Phantom 16-valve with Garrard auto-change, condition perfect; offers over £125.—Box 6195. [4989]

R.C.A.-VICTOR Communications rec., model 88D, 6 wavebands 535-32,000 kc. as new; offers.—Box 6459. [5052]

MODERN, powerful, Philco, 5v ac, all wave radiogram, just overhauled, repolished, £45; carr. paid, securely packed.—Box 6514.

SUPERB His Master's Voice, 6v ac, all wave, 5 waveband, autodiagram, as new, £90; carriage paid.—Box 6515. [5078]

HALLICRAFTERS 820R, unused since 1940, recently overhauled by Webb's, excellent condition; what offers?—Box 5813.

A.C.S. RADIO, 44, Widmore Rd., Bromley, Kent, offer small selection com. sets, radio receivers, amp. and televisions; list free.

AMPLIFIERS, 30watt, 12in speaker, mike stand, Garrard a.c. turntable and p.o., £45; 15watt two 10in speakers, £14; Malroy vibrator unit (6volt), 35/-.—10, Newport Rd., Shifnal. [4926]

PUSHPULL, PX4 amplifier, a.c. mains, 4 separate inputs 2 gram, 1 mic, m.w. pre-power built in, also 3ft Trivox horn speaker, 15Ω £18; or offers to P. A. Shears, 49, Shooters Hill Rd., S.E.3. [4992]

VORTEXION super 50watt amplifier, brand new, with 12in Goodmans TT205/15 p.m. and all-wave quality tuner unit, 2 RF (6SH7) and infinite impedance detector (6J5), laboratory built; £40 or offer.—Box 5818. [4906]

£75—Complete radio station, Hallicrafters Sky Champion receiver and 10watt transmitter with power pack crystals and coils for 10, 20, 40 metres, wavemeter, etc., all 230 a.c.—631/C, 65 Baker St., Burton-on-Trent. [5005]

SUPER American Pilot radio, 2 s.w. bands and mw, hf stage, 7 valves, cabinet french polished by ex-Maples man, looks as new; first offer of £25 secures.—Muir, 36, Stoneyfields Lane, Edgware, Middx. Mill Hill 901.

BRIERLEY Quality amplifiers, 5 watt, 8Ω gns.; 12 watt, £14; comprehensive tone control types, radio units, P.A. and S.O.F. amplifiers available; send s.a.e. for copy of "Design for Quality," and lists stating requirements.

PICKUPS. No magnetic type pickup designed to give the highest quality with small downward pressure can satisfactorily be used with a steel turntable. [5085]

ARMSTRONG 9v 6w PP receiver, £10; Universal gramo motor and turntable, £5; Rothermel P.T. and arm, £3; double spring motor and turntable, £2/10; rgram cabinet, £5; Marconi heavy duty P.M. (15lb), £3; £27/10 the lot.—Box 5943. [4939]

FOR sale, Eddystone 1-valve S.W.H.F. amplifier or short-wave converter a.c. model, £5/10; Ferranti output transformer, type O.P.1 25/-; Weston galvanometer, model 375 20/-; all new cond.—Box "M," c/o Corbett Stationer, Brook St., Broughty Ferry, Angus.

Partridge News

A 5-DAY WEEK

From March 4th, 1946, our works and offices will be working a five-day week. In future, therefore, we shall be unable to answer technical queries or arrange for the collection of goods on Saturdays.

This change is instituted in the interests of optimum production and the well-being of our staff, and consequently, we trust, in an improved service to the ultimate benefit of our customers.

SPECIALS

We are gradually getting back to peace-time production, and are able to manufacture special transformers and chokes to your specification in about 28 days.

STANDARD TYPES

A comprehensive range of mains and audio components is now available from stock, and we can despatch small quantities of these by return. We urge you to employ a stock item wherever possible, as this will ease the delay in the production of specials.

May we send you our list detailing these components available from stock?

Telephone:



Abbey 2244

PARTRIDGE

TRANSFORMERS LTD

76-8, PETTY FRANCE, LONDON, S.W.1

Beautiful Cabinetwork

Gradually we are getting into our stride and soon shall be able to manufacture articles of the exquisite standard attained before the war. The timber problem is very difficult and we are fussy as to what we use, but good times will come again and we shall be ready... with very interesting cabinetwork, so in the meantime get your name on our lists to facilitate our planning for the future.

If you have Licences to manufacture we shall be pleased to receive your enquiries for Radio Cases, Instrument Cases, Baffles, Horns, etc., and in fact any articles in wood for Radio and Scientific Instruments.

Lockwood

& COMPANY

67, Lowlands Road, Harrow, Mdx.

Phone: BYRon 3704

R.M.F. 69 communications receiver, with DR.20 preselector and speaker, all as new; £60 or nearest offer. Croll, 264 Salisbury Rd., Totton, Southampton. [4990]

W.W. Super Seven and Q.A. 3-unit radiogram, complete with £50 worth fibre used only records, mainly classic; £85.—Neville, 51, Colverley Rd., S.E.6. Hither Green 3096.

LOUDSPEAKERS, SECOND-HAND

VOIGT twin unit, perfect condition; £18.—400y H.C. corner, Sheffield. [4927]

VOIGT 8pk, 16gns; Rothermel deluxe pick-up, £2/15.—88, Beaconsfield Rd., Enfield.

VITOVOX K12 10 12in speaker, new, boxed; 5gns., carriage extra.—34, George Rd., Birmingham, 23. [5045]

HARTLEY Turner P.M. twin cone, in perfect condition; £5.—Jackson, 24, Downs Way, Southwick, Sussex. [5068]

MAGNAVOX "Duode," 2.500Ω field, 151 speech coil less transformer; £5.—90, Fairbank Rd., Bradford, Tel. 2812. [4947]

VOIGT twin cone speaker, energising unit 400v H.C. corner horn and base chamber, professionally built, finished natural wood; £30.—Box 6410. [5030]

6 LOUISPEAKERS, 10in Rola, 10in Auditorium model, etc., clockwork turntables with pick-ups, 1 Broadcast receiver made G.E.C. Telephone Works in steel cabinet, Emerson car radio with aerial, rotary converter, 220 ac, 47 amps, 1 microphone and amplifier, 6watts; various other wireless articles.—Giles, 112, Belize Rd., Hampstead, 10 minutes Swiss Cottage Station. [5011]

GRAMPHONE AND SOUND EQUIPMENT

PORTABLE disc recorder, p.a. spk., microphones, Graham Newbery, Radio, Axminster

SIMPLAT style tracking gear, 12in, suit serious recordist; best offer; perfect, as new.—Box 6463. [5056]

AUTORADIOGRAM, all-wave Lissen-Garrard, 1940, ac model, perfect, as new; £60.—Maythorne, Epsom Rd., Guildford.

R.C.A. recording machine, 30hm, better fitted Saja motor & transit case; £44 or nearest.—3, Emscote Rd., Stoke, Coventry.

G also Hertley Turner duode 33, field 2.500ohm; £22 or separate offers.—Box 6250.

COILS for filters, tone controls, all types of transformers for "Wireless World" circuits.—R. Clark, 30, Langland Crescent, Stanmore, Wor 5321. [4584]

H.M.V. hyper-sensitive pick-up, pre-amplifier and rejector unit, as Hartley's circuit, W.W.—July and August, 1944; £15. Tel. Winkfield Row 284. [5024]

PROFESSIONAL recording equipment—Condenser microphone, 12watt amplifier with tone stage, studio recording machine, full guarantee, superb results; £125; playing desk with lt-wt pick-up extra.—Box 6354.

COLLARO mixed automatic record changer with crystal pick-up, ac; Cosmocord player desk, walnut, crystal pick-up; B.T.H. motor 90-250v ac/dc; Baker's Selhurst 15w quality amplifier (6v6's) and 12in p.m. speaker; all in new condition, offers.—Box 6447. [5041]

M.S.S. recording machine, 20watt amplifier, special matching transformer, m/c mike on floor stand, complete professional block, £100; immediate delivery; blank discs, cutters, etc., P.A. amplifiers, playing desks, lightweight pick-ups, external transformers giving 1,000-3,000ohms from 5 or 15ohms, 63/-.

LIVERPOOL Sound Studios, 83a, Bold St., Liverpool. [4943]

TEST EQUIPMENT

TAYLOR 65B signal generator, Mullard GM 4140 bridge, universal Avominer, all new.—Offers to Box 6461. [5054]

AVOMETER, No. 7, 56 range, complete in case, with complete list clips and prods, new, never used; makers' price.—Box 6110.

PHILCO sig. gen., £10; Supreme multi-meter, £30; 2 Eddystone transceivers, 5mc, £4 each.—3, Campden Rd., Swindon.

TAYLORMETER model 83c (20,000 ohm/v) and model 313c inductance/capacity adaptor, both new; Avominer Universal, new condition, offers.—Box 6448. [5040]

AVO oscillator, small battery type, new cond., £5; Avominer universal, £7; B.T.H. transverse current microphone and instr., £5.—19, Canpion Rd., Isleworth, Middx.

FURZEHILL Laboratories Beat Frequency Oscillator, type A.F.2, 0-11,000 cycles, output 10 to 600ohms; 0-5v and 0-50v a.c. meter; offers wanted.—5, Upper Brook St., Rugeley, Staffs. [4975]

WE are now able to undertake the adjustment of resistors and capacitors over a wide range to within 0.1%, customers own apparatus, including audio oscillators and wavemeters, carefully calibrated to any required degree of accuracy; we can supply special precision radio and mechanical components from the small gear or coil to the complete apparatus for the solution of unusual problems.—Lydiat Ash Labs., near Bromsgrove, Worcs.

DYNAMOS, MOTORS, ETC.
 A new, G.E.C. 1/2hp 220-240v ac motor. £5.-G.5.4, Du Cane Court, S.W.17.
CRYPTO rotary converter, complete with starter & smoothing, 220v dc to 220v ac, good condition, silent; £25.—Precision-Electric, Ltd., 21-23, St. Paul's Sq., Birmingham, 3.
NEW ac motors, 1/2hp, high starting torque, 200-250v, £5; 1/4hp, £5 10/-; 1/8hp, £7 10/-; 1hp, £9/15; all other sizes available, also machinery.—John W. Steel, Bingley, Yorks.
PETROL charging sets, consisting of 1hp J.A.P. engine, direct coupled to 13-32v 20amp B.B. generator, complete with regulator, amp meter, cutout, etc., similar to Iron Horse; £30, plus carriage.—Mathew Bros., Matbro Works, Sandy Lane North, Wallington, Tel. Wallington 4050. [4785]
COMPONENTS—SECOND-HAND, SURPLUS
SPECIAL offer for this month.

WHILE existing stock lasts.
SPEAKERS—Celebration P.M. 6" in. L/Trans. 16/6; 6" in. P.M. Multi ratio trans. 26/6 8in. M. energized (1,500 coil), 18/11.
CENTRAL A/V controls L/S, 2/6; w/s, 3/6
CONDENSERS, .1, .01, .05, .002; 6/- doz.
STANELCO & Solon soldering irons; 13/6 ea.
TWO- and three-gang condensers, .0005, 2-gang, 1/16; 2-gang s/motion, 13/6; 3-g. 14/6.
ROTHERMEL crystal p/ups de luxe; £3/18/9.

LINE cord, 3amp (60ohms p-ft) 2-way, 1/6 per yard; 3-way, 2/6 per yard.
SILVER mica cond., assorted values, 4/6 per dozen.
 1/2W resist, 1/2mag. 1/4meg. 1 mag., 4/700 etc. 4/6 doz.

ALL goods are new; many other lines in stock; large assortment B.V.A. and U.S. valves.
MATT RADIO SERVICE, 152, Richmond Rd., Kingston-on-Thames. [4728]
"DORSET" 5-valve 3-wave superhet.

THE finest drawings and instructions ever produced for the enthusiastic set builder; theoretical circuit, under chassis layout, above chassis layout, drilling template, heater wiring, group board assembly and point to point wiring instructions, also parts list, price 5/-, available April; this set can be made without previous radio experience, and can be built in stages out of income; 3-wave coil pack specially designed for the job; group board assembly obtainable ready made; also available "Wizard" 4-valve TRF ac/dc circuit, 5/-; "Dorset" battery 3 circuit, 3/6; "Dorset" amplifier circuit, ac/dc, 6-7 watts, 5/-.—Write Weldonia Radio Accessories, Ltd., 12, Gilbert Rd., Swanage, Dorset. [4988]
UNIVERSAL ELECTRONIC PRODUCTS.

WE cater for all the requirements of the amateur radio experimenter; large selection of meters, coils, switches, condensers, etc.; polystyrene laminated bakelite sheet to your dimensions.
TRANSFORMERS: Chokes, etc. wound to specification.
CONSULT us for your requirements in light metal turning, castings, chassis, etc.
BRIDGE connected metal rectifiers, 18volt, 75ma; 7/6.

CONDENSERS—Metal cased Mansbridge type, 0.5mfd, 250volt, 2/2; 2mfd, 250volt, 2/9 B.I. moulded type, 0.001mfd, 4,000volt, 2/3; Hunt's moulded mica, 0.001mfd, 4c; micro switches.
UNIVERSAL ELECTRONIC PRODUCTS, 36, Marlebone High St., W.1. Welbeck 4058.

EXPERIMENTER'S surplus quality components, s.a.e. list.—Box 6462. [5055]
SUPREME RADIO, 746, Romford Rd., Manor Park, London, E.12. Est. 15 years Tel. III. 1260.

LINE cord 60-70 ohms per ft. 3-way, 2/4-vard; dials, all-wave, 3/4in x 4in, coloured, 2/3; M.W. dials, coloured, 3/4in x 4in, 1/9; 5/4in x 5/4in, all-wave, 2/6; glass dials, 3/6; slow motion drives, 2/9; M. and L. coils with circuit, 10/6 pair; M.W. coils, 8/6; switches for same, 2/7; L.M.S. wave coils, aerial and oscillator (short 14-50 metres, med. 200-550 metres, long 900-2,000 metres) with circuit, 12/6; T.P. 465 k/c, 12/6; switches for same, 7/6; Midget 2-gang, 0.0005 condensers, variable, 11/6; 3-gang, 13/-; mains droppers, 0.2amps, 1,000ohms, fixing feet, 4/-; less feet, 3/9; Pvc replacements, 3/3; 10/-; all values, with sw., 4/-; 2,000ohms less sw. 2/6; 10,000ohms less switch, wire wound, 5/6; 0.0005 reaction condensers, 2/3; Midget chokes, 60 mils, 6/-; heavy duty, 100 mils, 10/-; Midget speaker trans., 4/6; P.P. trans., 6/6; 30watt P.P. trans., 25/-; mains trans. from 25/-; send for our bargain packet of wire wound resistances, 24 in. pkt., 200-240,000ohms, 7/6 pkt., alling like hot cakes; also assorted bakelite condensers at 7/6; all useful sizes for servicing; large stock of 615GT valves, new, boxed, not salvage, 7/6 each to clear; send a.s.e. for list, or prices pro forma 6d. extra; for post orders under £ no c.o.d.

PREMIER RADIO

MORRIS AND CO. (RADIO) LTD.
CALLERS TO: 169, FLEET ST., E.C.4. (Central 2833)
ALL POST ORDERS TO: 167, LOWER CLAPTON RD., LONDON, E.8. (Amherst 4723)
ALL GOODS NEW AND GUARANTEED
 Terms of Business: Cash with order or C.O.D. over £1. Send 2/1d. stamp for our latest list.

5-WATT AMPLIFIERS. AC/DJ operation, 3 stag; high gain, 2 ohm output, 25 8/6.
ALUMINIUM CHASSIS. Substantially made of bright aluminium, with four sides, 10in. x 8in. x 2 1/2in., 7/-; 12in. x 8in. x 2 1/2in., 7/6; 16in. x 8in. x 2 1/2in., 8/6; 20in. x 8in. x 2 1/2in., 10/6.

PREMIER MAINS TRANSFORMERS
 All primaries are tapped for 200-230-250 v. mains 40-100 cycles. All primaries are screened. All L.T.s are centre tapped.

| | Output | Price |
|-----------------------|---|-------|
| 175-0-175 v. 50 m/a. | 6.3 v. 2-3 a. 5 v. 2 a. | 25/- |
| 175-0-175 v. 50 m/a. | 4 v. 1 a. 4 v. 2-3 a. | 25/- |
| 250-0-250 v. 60 m/a. | 6.3 v. 2-3 a. 5 v. 2 a. | 25/- |
| 250-0-250 v. 60 m/a. | 4 v. 1-2 a. 4 v. 3-5 a. | 25/- |
| 300-0-300 v. 60 m/a. | 4 v. 2-3 a. 4 v. 2 a. | 25/- |
| 300-0-300 v. 60 m/a. | 4 v. 2-3 a. 4 v. 3-5 a. 4 v. 1-2 a. | 25/- |
| 350-0-350 v. 100 m/a. | 5 v. 2-3 a. 6.3 v. 2-3 a. 3-0 a. | 29/- |
| 350-0-350 v. 100 m/a. | 4 v. 1-2 a. 4 v. 2-3 a. 4 v. 3-5 a. | 36/- |
| 350-0-350 v. 150 m/a. | 4 v. 2-3 a. 4 v. 3-6 a. 4 v. 1-2 a. 4 v. 1-2 a. | 39/- |
| 350-0-350 v. 150 m/a. | 5 v. 2-3 a. 6.3 v. 2-3 a. 6.3 v. 2-3 a. | 36/- |
| 425-0-425 v. 200 m/a. | 4 v. 2-3 a. 4 v. 2-3 a. 4 v. 3-5 a. | 47/- |
| 425-0-425 v. 200 m/a. | 6.3 v. 2-3 a. 6.3 v. 3-5 a. 5 v. 2-3 a. | 47/- |
| 500-0-500 v. 150 m/a. | 4 v. 2-3 a. 4 v. 2-3 a. 4 v. 3-5 a. 4 v. 3-5 a. | 47/- |
| 600-0-600 v. 150 m/a. | 5 v. 2-3 a. 6.3 v. 2-3 a. 6.3 v. 3-5 a. | 50/- |
| 500-0-500 v. 250 m/a. | 5 v. 2-3 a. 6.3 v. 2-3 a. 6.3 v. 3-5 a. | 65/- |

PLAYING DESKS. A few only available. Consist of an Electrical Gramophone Motor with automatic stop and speed regulator, a quality magnetic Pick-up mounted on a strong metal frame. Price complete £8 9s.

MIDGED RADIO KITS. Complete with drilled chassis, valves and loud speaker, only cabinet required, medium and long wave T.R.F., size 10 x 6 x 4, valves, inc. rect., tone control, AC/DC operation, 200/250 v. Circuit and constructional details supplied. Price, including tax, £6 17s. 6d. Cabinet, if required, 25/- extra.

METER KITS. Consist of a 50 microamp (20,000 ohms per volt) meter size 4 x 4 1/2. Calibrated volts, milliamps, ohms, complete with Multiplier for 5 to 1,000 volts in six ranges for 20, 100, 500, 1,000 volts. Circuit and constructional details supplied. Price, including tax, £2 15s.

SUPER QUALITY AC/DC AMPLIFIERS. 12 watts output, contained in steel case. Output Transformer matches any speaker 2-20 ohms. Push-Pull Output. Complete with Electric Record Playing Desk with Pick-up. Price £18 18s.

A pair of suitable Loudspeakers can be supplied, Goodmans 10in. P.M. Type at 47/6 each. A suitable Transverse Current Microphone with Transformer at £3 15s.

ELECTROLYTIC CONDENSERS. 8 mfd. 500 v.w., 3/-; 8-8 500 v.w., 3/11; 16 mfd. 150 v.w., 3/-; 12 mfd. 500 v.w., 4/6; 32 mfd. 500 v.w., size 4 x 2 x 1 1/2; 16 mfd. 700 v.w., size 5 x 4 x 2, 7/6.
P.M. SPEAKERS. 6in., 21/6; 6 1/2in., 22/6; 8in., 24/-; 10in., 6 watt horn loaded, 47/6; 8in., 15 ohms, 22/6; 15 watt when horn loaded, 55/-; 12in., 15 ohms, 15 watts, a high fidelity job, £8 15s.

OUTPUT TRANSFORMERS. A super production. By means of ingenious series-parallel arrangement all windings are used at all times. Match any tube, single or push-pull to any voice coil, D.C. mains, 7 watts, 22/6; 15 watt, 30/-; 30 watt, 49/6; 60 watt, 59/6. Brand new GOVT. SURPLUS. Many items at less than cost.

ROTARY TRANSFORMERS. Input 12 v., output 180 v. 30 m/a. 4 v. 3 a. with 19 volts input, output is 50 per cent. higher. May be used on D.C. mains as L.T. Charger. With small conversion coil operate as D/C Motor. Original cost over £5. Employ powerful ring magnet. Price 10/- each.

ROTARY TRANSFORMERS. Input 12 v., output 200 v. 60 m/a. 8 v. 2 a. with 19 v. input, output is 50 per cent. higher. Price 20/- each.

ROBEY TRANSFORMERS. Input 24-28 volts. Output 1,200 v. 70 m/a. Price £22 each.

MOTOR GENERATORS. Completely screened with smoothing. Input 6 v., output 220 v. 60 m/a. Price £3 10s.

MOTOR GENERATORS. Input 12 v., output 240 v. 100 m/a. 6 v. 10 a. Price £4 10s.

MANSBRIDGE TYPE (PAPER) CONDENSERS. Super quality, oil filled, 8 mfd. 500 v.w., 5/-; 4 mfd. 750 v.w., 5/-; 4 mfd. 1,000 v.w., 7/6; 1 mfd. 1,000 v.w., 3/6; 1 mfd. 2,500 v.w., 10/-; 2 mfd. 2,500 v.w., 15/-; 1 mfd. 2,000 v.w., 15/-.

SOUTHERN RADIO'S wireless bargains.

LATEST radio publications: R.A.D.I.O. Valve Manual equivalent and alternative American and British types, with all data, 3/6; Radio Circuits, fully illustrated, receivers, power packs, etc., 2/-; Amplifiers, fully descriptive circuits, 2/-; Radio Coil and Transformer Manual, 2/-; Short Wave Handbook, 2/-; Manual of Direct Disc Recording, 2/-; Test Gear Construction Manual, 1/6; Radio Pocket Book, formulas, tables, colour code, etc., 1/-; Ten Hows for Radio Constructor, 1/-; Radio Reference Hand Book, comprehensive and up to date, covering all branches of radio, 10/6; American Service Manuals, Sparton-Emerson, Crosley-Belmont (Part 1 & 2), Stewart-Warner-Fada, Emerson, 12/6 per vol.; Radié Resistor Chart (colour code values at a flick), 1/- each; Bulgin Radio Service Manual, 2/6; postage extra.

UNIVERSAL 14-range test meters, 1,000 ohms per volt (ac/dc), volts ranges up to 500, milliamperes dc up to 500, assistance range 0.10-0.00 ohms, contained in unbreakable bakelite case with carrying strap; £8/15 (postage and packing 2/6).

YALEY type 11-way rotary switches, 5/-; tubular condensers, 0.1-0.1-0.1 (cans), 2/6; resistances, brand new wire-ended, 1/4, 1/2 and 1 watt, assorted values, 30/- per 100; 1/2 watt only, assorted values, 20/- per 100; 1/2 watt, 22/6 per 100.

ACB "P.O." microphones, complete with transformer, usable with any receiver, 7/6; permanent crystal detector, 2/6; insulated push-back wire, 25 yards, 5/-; insulated sleeving, assorted sizes and colours, 3/6 per dozen yard lengths; single screened wire, 7/6 per dozen yards; twin screened, 15/- per dozen yards; aluminium panels, undrilled, 16 gauge, 18 inches x 7 inches, 3/6; 18 inches x 9 inches, 4/6; ceramic and paraffin postage stamp trimmers, 30pts. each, double bank 2/-; reaction condensers, 0.0003, 0.0005, 4/- each; differential reaction, 4/6; tubular and mica condensers, 1/- each; knobs (pointer and round), 1/- each; valve holders, 1/- each; Cutler Harmer power rheostats, 30 ohms, 4/6; power rheostats, 10 ohm, 4/6.

HUNDREDS more bargain lines; postage extra to be added.

SOUTHERN Radio Supply Co., 46, Lisle St., London, W.C.1. Gerrard 6655. [4987]

CHARLES BRITAIN RADIO offers new C and U. used bargains in radio spares.
ELECTROLYTIC smoothing condensers, 16mfd wet cans 440v wkg, 7/6 ea; 8mfd dry cans, 6/6; Hunts blocks 450v, 3/6; Hunts tubulars, 3/-; small 8mfd cans with fixing base, 500v wkg, 4/3; 4mfd 350v Hunts tubs, 2/3; 2mfd, 2/-; 25mfd 25v, 1/9; 50-12, 12-50, 75-12, 1/9 ea; Phillips tubular condensers, non-inductive all high voltage types, 0001-05, 4/6 ea; 0.1 500v, 6/6 doz.

COILS, all-wave Aerial and Osc with complete circuit diagram, 12/3 pr; dual-range TRF coils with reaction and diag., 7/- pr; wave change switches 6-pole 5-way 3-bank, 4/- ea; 4-pole 3-way, 4-pole 4-way, 3/6 ea; 2-pole 2-way, 2/9 ea; tuning condensers, 2-gang, 12/-; 4-gang and 3-gang, 10/- ea; I.F. transformers, 465 kc, Litz wound in small brass cans, 21/- 12/- pr; iron-cored in small brass cans, 21/- pr; dial, all-wave ivoryine, 2/6 ea; clock-face dials dual band, 2/6 ea; small paper dials for midgets, 8/- doz; midget chassis, size 9 1/4in x 4 1/2in, 5/9 ea; mains droppers with feet and sliders, 0-2, 4/6 ea; 0-3, 5/6 ea; volume controls with switch, Centralab 1/4, 1/2 and 1 mg, 4/6 ea; most values, less switch, Dubilier, 3/- ea; L.F. chokes 360 ohm 50 m.a., 6/- ea.

SPECIAL offers: Band pass aerial coils with diag, 2/6 ea; I.F. trans 110kc, 3/6 pr; wave-change switches for the above coils, 2/6 ea; all the above items are stripped from Elco chassis; also 0-2 mains droppers, 2/6; 6ba. nuts and bolts, 4/- gross; moving coil mikes, undamaged, 5/6 ea; damaged, 1/6 ea; 1mfd Mansbridge condensers 4/6 doz; 2mfd 25v wkg cans, 6/- doz; parcel of mixed resistors, block smoothing and tubular condensers containing about 24 items, 6/- ea; send for list "W" Terms cash or C.O.D. over £1.—Charles Britain Radio, Radio House, 2, Wilson St., London, E.C.2. Tel. Bis. 5985 ext. 7. [5086]

1000 ex R.A.F. throat mikes, 5/11 pair, post free. Hay & Son, 129, North St., Brighton. [5046]

CONDENSER bargains.—4, 8, 16, 8 x 8, 8 x 16mfd, all 450v, 8mfd 500v, 1 1/2 and 2 mfd 350v, 25mfd 25v, 50mfd 50v.

L.O.T. No. 1—One of each of the above, £1/15/3
L.O.T. No. 2—Two of each of the above, £2/7/6
L.O.T. No. 3—Three each of above, £4/14/6
L.O.T. No. 4—Four of each of the above, £6 S.A.E. for enquiries and lists of new values at list prices, and radio components; terms cash with order.

SCOTT'S, 14, Gardner St., Brighton 6891.

LASKY'S RADIO

We have purchased a large quantity of Electrolytic Condensers.

All of the Midget type, Aluminium Can, 500 volt working.

- 8 mfd., diam. 1in., length 2in., 4/- (1 doz., £2 5s.).
- 16 mfd., diam. 1in., length 2in., 5/- (1 doz., £2 17s.).
- 8 x 8, diam., 2in., length 2in., 6/- (1 doz., £3 9s.).
- 8 x 16, diam., 2in., length 2in., 6/9 (1 doz., £3 18s.).

MIDGET TUB CARDBOARD ELECTROLYTIC CONDENSERS, 500 volts.
8 mfd., 3/6. 4 mfd., 2/10.

BIAS CONDENSERS, TUB ELECTROLYTIC.
50 mfd., 50 volts, 3/-; 25 mfd., 25 volts, 1/9; 50 mfd., 12 volts, 1/6; 75 mfd., 12 volts, 1/6; 12 mfd., 50 volts, 2/6.

All goods are brand new and guaranteed. Money refunded if dissatisfied!

HIGH VOLTAGE CONDENSERS. First grade china insulators. All with mounting clip and feet.

- 8 mfd., 1,000 volts working, 15/-; 8 mfd., 600 volts working, 7/-; 4 mfd., 1,000 volts working, 10/-; 10 mfd., 600 volts working, 7/-; 1 mfd., 1,000 volts working, 6/-; 1 mfd., 750 volts working, 3/-; 10 mfd., 400 volts working, 6/-; 4 mfd., 450 volts working, 3/9; 5 mfd., 5,000 volts working, 12/6; 1 mfd., 6,000 volts working, 10/-.

See our previous adverts. for other goods.
TERMS: Cash with order, C.O.D., or pro forma (no C.O.D. under £1).

Send 1d. for our current list of components. Trade enquiries invited.

LASKY'S RADIO
364 & 370, Harrow Road,
PADDINGTON, LONDON, W.9
(Opposite Paddington Hospital).
Tel.: Cunningham 1979.

YOU can become a first-class RADIO ENGINEER

We are specialists in Home-Study Tuition in Radio, Television and Mathematics. Post coupon now for free booklet and learn how you can qualify for well-paid employment or profitable spare-time work.

T. & C. RADIO COLLEGE
North Road, Parkstone, Dorset

(Post in unsealed envelope, 1d. stamp)
Please send me free details of your Home-Study Mathematics and Radio courses.

NAME

ADDRESS

W.W.47.

COULPHONE RADIO, Station Rd., New Longton, Nr. Preston.

RETURN of post mail order service. Exclude mail order. C.o.d. or cash with order. Orders over 5/- post free.

NEW goods only. Compare these prices. Quantity discounts.

LINE cord, 0.3amp 60Ω per ft. 3-way, 1/9 yd.; 2-way, 1/6 yd.

MAINS transformers, interleaved, impregnated, primaries for 200/250v, 300-0-300v. 60mA, with 4v or 6.3 and 5v L.T.s, 17/6 350-0-350v 100mA with 4v or 6.3 and 5v L.T.s, 24/-; 450-0-450v 200mA with 4v 8a, 4v 4a, 4v 4a; 4v 6.3v 4a, 6.3v 4a, 5v 3a, 42/6; 450-0-450v 200mA, 6.3v 6a, 4v 2a, 4v 2a, 5v 3a, 45/-

CHOKES—40mA, 4/6; 60mA 6/-; 90mA, 7/-; 100mA, 12/6; 200mA, 21/6.

OUTPUT transformers, Midget pen. 4/6; Midget power/pen, 5/-; standard size univ. with C.T., 6/-; 8watt univ., 10/6; 15watt, 21/-; 30watt, 37/6.

SUPERHET coil packs, S.M.L. wave, completely wired with 5v circuit, 32/6; matched pairs iron cored I.F. trans., 465 kc/s, 13/6 pair; Midget iron cored I.F.T.s, 22/6 pair.

MAINS droppers, feet, 2 sliders, 0.2amp, 4/3; 0.3amp, 4/6.

TUNING coils, boxed with circuit, M and L wave, T.R.F. with reaction, 12/6 pair; S.M.L. wave superhet., 13/6 pair.

AIRMASTER 5-valve superhet chassis and 8in energised speaker, 4 waveband, 13/30. 30/70. 200/550 and 1,000/2,000, super job. all ready to switch on, price including P.T., £16.

STAMPED addressed envelope for latest 10 page catalogue.—Coulphone Radio. [5026] RADIO CLEARANCE, Ltd., Museum 9839, 27, Tottenham Ct. Rd., W.1.

MAINS trans., 300-0-300 110ma, 5v 2a. 6.3v 3a, 22/6; electrolytics, 8mf 250v, 2/6; 4.4. 450v, 3/6; 4mf 350v, 2/-; 4mf 500v, 2/11; 20mf 150v, 2/9; 50mf 50v, 2/6; 250mf 25v, 2/-; 200mf 12v, 2/-; Mansbridge condensers, 4mf 450v, 4/6; 2mf 400v, 1/6; 1mf 350v, 9d.; 0.5mf 4,000v wkg, 10/-; 0.5 400v, 6d.; silver mica, 50 to 5,000pf, 6d.; mica, 0.0001-0.0005, 4d.; 0.001-0.007, 5d.; 0.1, 6d.; 0.01 2,200v test, 9d.; tubulars, 0.01, 0.02, 0.04, 6d.; 0.1 350v, 7d.; 0.25 375v, 1/-; switches, 4p 3-way 3/-; 3p 4-way, 3/-; 1p 10-way, 3/-; 1p 12-way, 3/6; 1p 9-way, 3 banks, 5/6; resistors, 1/4w, 3d.; 1/4w, 4d.; 1w, 6d.; 2w, 10d.; 3w, 1/3; all values; bargain parcel 100 asstd. resistors, 1/4w to 3w, 17/6; all useful sizes; vitreous resistors, 50Ω, 500Ω c.t., 1,000Ω, 1,000Ω tapped, 250 and 500, 1,300Ω tapped, 600Ω, 10w, 1/6; 20w, with clips, 120Ω, 200Ω, 2/-; 25w, 350Ω, 5,000Ω, 75,000Ω, 2/6; 40w, 10,000Ω tapped, 2,000Ω, 3/-; 50w, 50,000Ω, 20,000Ω, 3/6; toggle switches, single p. 2/-; double p. 2/11; screened octal top caps, 6d.; valve holders, 4-pin, 1d.; 5-pin, 4d.; 7-pin, 5d.; octal, 6d.; volume controls, 600,000Ω, with switch, 13/6; wire wound, 100Ω to 20,000Ω, 2/6; alloy chassis, undrilled, 7in x 5 1/2 in x 3in, 2/6; 5 1/2 in x 3 1/2 in x 3in, 1/6; 4 1/2 in x 3 1/2 in x 3in, 1/-; 3 1/2 in x 3 1/2 in x 3in, 9d.; numerous other lines in stock; cash with order or c.o.d.; postage extra; post paid on orders over 7/6.

ALIGNED INSTRUMENTS SERVICES, 25, Park Grove Rd., Leytonstone, E.11. Tel. Leytonstone 5601.

ALL-WAVE superhet kit, 16.47. 200-550. 800-2,000 metres. a.v.c., high "q" i.f.s. ext. i.s. and p.u. sockets. 8in spkr., uses model 20 coil pack, fully aligned and tested, a-model, £12, ac/dc, £12/10.

MODEL 20 coil pack, aligned and tested, only 5 connections, 39/6; i.f. trans., 465Kcs, high "q" aligned and tested for gain, 17/6 pair; model 20 tuning head, fully assembled, with 3 valves, £6/15/10; handsome tuning scale, glass, esc. and s/notion drive for above, 12/6; amplifier kits, really well-designed, ac models, 6watt, £7, 12watt, £11; ac/dc, 5watt, £7, 15watt, £12; tuning units, 3w/band s/het type, assembled cpte. with valves, ac or ac/dc, £6/17/6; TRF type, wo med. wave stations only, high fidelity design ac or ac/dc, £6; other kits available, send 1d. for lists, circuits and tech. desc. for any above, 2/6; post trade only at present, send c.w.o. if possible—saves clerical work, orders over £5 post free, no c.o.d. under £2.

COULVERN Perrotcart coils G1, G2, G8, i.f. trans. 110kc (2) and 110A kc (1), £3/15, 29, Boxall's Lane, Aldershot. [5037]

MULLARD 10in electrostatic C.R. tube, £5/12; electrolytics, 8mf, 500v, 2/10. —D. White, 17, Upland Rd., London, S.E.22.

MAINS transformers, first grade, brand new, 350-0-350v 80ma, 4v 4a and 4v 2.5a, or 6.3v 3a and 5v 2a, 20/- ea; post 1/-.

ELECTRONIC TUBES, 8mf 500v, 3/-; 8 x 8mf 550v, 5/-; 16 x 8mf 350v cans, 6/6; 16 x 8mf 450v, 6/6; 25v 25mf, 1/9; 50mf 12v, 1/4; 8in P.M., with trans., 25/-; s.a.e. for list of other bargains.

ANELOY RADIO, 36, Hindmans Rd., E. Dulwich, London S.E.22. [4865]



H.A.5 DEAF-AID CRYSTAL MICROPHONE

ASTATIC is ready to serve you again with high quality piezo-electro devices now that the 'All Clear' of Victory has sounded. Astatic deaf-aid microphones can be supplied only if Import Permits are established. Model H.A.5 illustrated is used as standard by America's leading hearing-aid instrument makers.



THE ASTATIC CORPORATION
CONNEAUT, OHIO, U.S.A.
and
TORONTO, CANADA.
—Exclusively Represented by—
Frank Heaver Ltd., Kingsley Road,
Bideford, N. Devon

POST-WAR TELEVISION

The advance in Radio Technique offers unlimited opportunities of high pay and secure posts for those Radio Engineers who have had the foresight to become technically qualified. How you can do this quickly and easily in your spare time is fully explained in our unique handbook.

Full details are given of A.M.I.E.E. A.M.Brit.I.R.E. City & Guilds Exams., and particulars of up-to-date courses in Wireless Engineering, Radio Servicing, Short Waves, Television, Mathematics, etc., etc.

We Guarantee "NO PASS—NO FEE"

Prepare for to-morrow's opportunities and post-war competition by sending for your copy of this very informative 112-page guide NOW—FREE.

BRITISH INSTITUTE OF ENGINEERING TECHNOLOGY (Dept. 388)
17 Stratford Place London, W.1



W. BRYAN SAVAGE LTD.

Expert assistance in the solution of problems relating to

- TRANSFORMERS, CHOKES
 - AMPLIFIERS
 - POWER UNITS
- and Specialised Equipment embodying

ELECTRONIC CONTROL
WESTMORELAND RD., N.W.9
COLINDALE 7131

"HAMS"—here is your opportunity!

Did you see the report in the daily press on our huge purchase?

EX-R.A.F. Airborne G.P. TRANSMITTERS

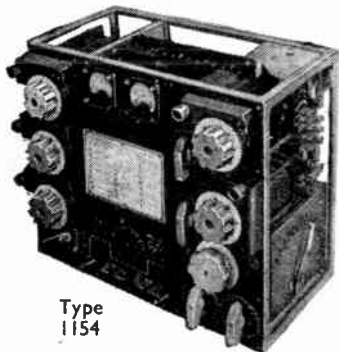

Type 1154

Complete with 4 valves

Frequency coverage: 500 kc/s, 200 kc/s, 10 mc/s, 3 mc/s, 2.35 mc/s, 8 mc/s, 2.5 mc/s. Power input 1,200 v., 200 m/a. H.T., 6 v. 4 amp. L.T. Chassis size 15 in. x 13½ in. x 8½ in. In metal cabinet. Supplied in strong wood case, with metal bound corners and carrying handles, 22 in. x 17 in. x 14 in.

Easily adapted for Amateur use

Price 10 gns.

EX-R.A.F. RECEIVER CHASSIS — FOR CALLERS ONLY —

We have a large and varied stock of chassis fitted with numerous components, for sale at prices far less than the component value. There are too many types to itemise so you are invited to

CALL and INSPECT

TWO NEW PURCHASES

FLEXIBLE LIQUID DIELECTRIC CO-AXIAL FEEDER CABLE. Diameter approx. ¼ in. Plastic covered. 18 per yard.
D.C. MOTOR GENERATOR. 9 v. input, 450 v. output, complete with cooling fan and switching device; fitted on chassis 12½ x 8 x 2½, weight 17 lb. £1 17s. 6d. Also for 18 v. and 24 v. input.

See last issue for many other interesting bargains.

N.B. We have no lists and cannot deal with correspondence on the goods we offer.

LONDON CENTRAL RADIO STORES

23, LISLE STREET
 LONDON GERARD 2969 W.C.2.
 Closed Thurs. 1 p.m. Open all Sa.

G. A. RYALL, 65, Nightingale Lane, London, S.W.12.—Mail order callers welcome, hours 2 p.m. to 8 p.m.: Tube, Clapham South; bus stop, Ramsden Rd.; no c.o.d. under £1 please; postage extra.

VOLUME controls, Morganite ¼ meg short spindle, 2/-; Dublier long spindle, 1 meg, 2/-; both less switch; condensers, tubular 0.1 350v wkg, 7/6 dozen; pairs 0.1 450v wkg on pax strip, 8/6 per 6 pairs; tubular 0.002 450v wkg, 4/- dozen; Mansbridge 4mi, base-horn, tube, with terminals, perfect insulation, 250v wkg, 2/6 each; Celestion 10in permanent magnet speakers, pentode trans, powerful magnets, 30/- each.

METER switches, 11 way, 3/- each; Yaxley type switches, 3 bank, 2 pole, 4-way, with middle screen, 4 shorting bars, long spindle, 3/9 each; Yaxley type switches, require stop fitting, single pole double throw, 1 and 2 bank, 1/6 each; push back wire, blue, 12yds 1/6, 50yds 5/6; knobs, brown thimble pattern, ¼in spindle, 4/- dozen; set 5 Clydon 30mm trimmers on metal base, 1/-.

MORGANITE carbon resistors, colour coded, 500, 1,000, 50,000, 2meg, 3/- dozen; Erie resistors, insulated type, 450, 5,000, 22,000, 220,000, 470,000, 3/9 dozen, all half-watt types; Erie 2watts 680, 6,800, 140,000, 150,000, 220,000, 470,000, 820,000, 5/- dozen.

VALVE holders, chassis type, British 5- and 7-pin, American UX 4-, 5-, 6-pin and International Octal, all 4/- dozen, 25/6 100; Octal 8-pin plugs, metal cap and chassis type socket, 3 for 2/6, 8/- dozen, ditto with solder tags, 3 for 3/-, 10/- dozen.

TWIN screened microphone cable, 3yds 2/6; aluminium coil cans, 2½in high, 2½ across base, 3 for 1/6.

RESISTANCE mtg strips, 5-way, 2/6 doz; 2-way input panels terminals, 2/6 dozen; panel with screened 0.1 & 11 Erie res & cond. 2/3.

BIG stocks of radi valves, all types, list prices; 8in Field energised speakers, 35/-; c.o.d. or pro-forma.—David Robinsom Ltd., 100, High St., Bedford, [4577]

AMPLIFIER (Parmeko) 250v, 50watts, professional cinema model, all controls, steel case for easy transport.—Offers to:—Cinema, Blandford, Dorset, [5042]

COIL units.—HF and OSC (465), for sheet, with all trimmers, padders, switching, etc., wired and assembled; 35/- ea. one hole fixing.

MW coils, matched pairs, boxed, with circuit, 5/6 ea.

OSC. coils, MW 465 Midget, 2/3 ea.

VOL. controls, w. and w.o. sw., 5/6 and 4/6.

VALVEHOLDERS, knobs, resistors, condensers, solder, flux, sleeving wire, all smalls; 1d. for 4p. list; 2½d. s.a.c. for free advice; c.w.o. or c.o.d.

RADIOSALES, 91, Balfour St., Hanley, S.O.T., Staffs, [5067]

MAGNOVOX 66 2,000ohm field, metal field rectifier, baffle, £10; B.T.H. magnetic pick-up, £2, Senior Piezo loud £3.—Barber, 53, Grosvenor Rd., Petts Wood, Kent, [5032]

COILS, high gain combined med. and long wave, t.r.f., 2½in long; a really first-class job; aerial and h.f., 7/- pair, post paid.—Anelay Radio, 36, Hindmans Rd., S.E.22.

TELEVISION.—Pye vision channel and time base, complete with 13 valves, good order; circuit diagram & for power pack & tube, £11; radiogram cabinet, £5.—Box 6109.

B. & H. RADIO offer all sizes of electrolytics, an 2- and 3-core line cord, transformers, chokes, volume controls, etc.; everything for the service man; competitive prices; trade only; send for list.—Victoria Garage, Haregrave Terrace, Darlington, [4690]

GANG condensers, cer. insul., 0.0005, 10/- ea; mains transf., 2,500v-2ma, 4v-1.4a, 2v-2a, 25/- ea; M.C. milliammeters, 2½in movement, 0-100ma, 30/- ea; M.C. galvanometers, 500-0-500 microamps, cent. zero, 2½in movement, 45/-; 50 astnd resistors, ½ and 1 watt, carbon wire ends, 10/6; 0.01 mica condensers, 4d. ea; s.a.c. for list.—Heathcote, 24, Durnford Ave., Urmston, Manchester, [4922]

EVERYTHING for the amateur! So many of our customers tell us that we have the finest display of new radio components in England that we are beginning to believe it ourselves. Frankly, we are pleased—because, despite the shortage of supplies and other difficulties, we have worked hard to make our shop a centre of attraction for the amateur. If you are building a transmitter, communications receiver, high fidelity audio equipment or test apparatus, come along and see us—we can help you—and supply all the components you want. Even if you are only starting on your first crystal set, you will be just as welcome and will receive the same courtesy and skilled attention that has made some of the best known amateurs in the country our frequent and regular customers. If you cannot yet call, send along a 2½d stamp for our price list.—Tele-Radio (1943), Ltd., 177, Edgware Rd., London, W 2 Tel. Paddington 6116. 14RPS

ELECTRADIX OFFERS LABORATORY AND TEST GEAR



Gambrell Universal Shunt Box, 10,000 ohms, £5. Gambrell Resistance Box, 10-20-50-100-200-500 ohms, as new, £4. Tinsley Res Box, four 125-ohm coils with terminals, 45/-.

We have a number of these resistances boxes, some less plugs, at special prices. Write for list. Wheatstone Bridges, 100 ohms to sub-divided ohms, £5 10s. P.O. pattern 10,000 ohms, £10. G.P.O. Resistance Box, 8,000 ohm by 10 ohm steps, switch and plug type, £4 15s.

RELAYS. We have just taken delivery of consignment of new Siemens Relays, 500 + 1,000 ohms, 2 makes, 10/-; 2 makes 1 S.P.C.O., 12/6; 3 makes 1 break, 12/6. 500-500 ohms S.P.C.O., 10/-; 200 ohms 1 break 1 S.P.C.O. slugged, 12/6; 10,000 ohm S.P.C.O., 21/-.

Send for Special Leaflet. Relay Contact assembly, thermal action. 12/6. Siemens' High-speed Relays in heavy brass case, £3 5s. Telephone type No. 6, 2-coil polarised, S.P.C.O., 6 volts 25 ma., 325 ohms, 8/6. No. 1A, S.P. on-off, 2 volts 40 ma., 5/-.

Relay movements 1,000 ohms, less blade and contact, 2/6. Moving-coil relays by Weston Elliott and Sullivan.

FANS. 110 volt and 220 volt D.C. Desk Fans, 12" blade and guard, new condition, 35/- each. Oscillating type, 45/-.

A.C. 230 volt 10" blade and guard, 45/-.

MAGNETS. AC/DC mains magnets, 2-pole 220 volts, 7/6 each. The wonder midget Magnet, alni perm. steel disc, weight only ½ oz., ¼in. dia., ¼in. thick with 3/16in. centre hole, 3/6 each.

Large selection of horseshoe Magnets in stock. Send for leaflet "W."

COIL ASSEMBLIES. Midget short wave with trimmer mounted on paxolin base, 3/6 each, with can, 4/6. Medium and long-range midget coil with circuit, 6/-, or matched pair with circuit for 3-valve set, 10/6.

SWITCHES. Yaxley Switches, 1 P.S., 8-way; 3/6; 3-pole 3-way, 3/6. Lucas 8-way ex R.A.F. switch boxes, 3/6.

A.C. SLOT HOUSE METERS for 1-coin, 200 volts, new Chamberlain and Hookham, 10 amps. 75/-



SEND-RECEIVE Hand Coms.

All-metal Field Hand Coms. for portable or fixed stations. The famous No. 16 Govt. type, used in field telephones; mike and earpiece with damaged finger switch, easily repaired, 7/6.

AUTO TRANSFORMERS. 230 volts to 110 volts, 50 cy. 80 watts, 25/-; 150 watts, 35/-; 300 watts, 60/-; 350 watts, 65/-; 900/1,000 watts, £7 10s.

TRANSFORMERS, FOR RE-WIND 3kW. New type with stampings 4½ x 6 x 7½in., windings damaged by blitz. Can be taken apart to make a number of smaller units. Weight with damaged wire is 65 lbs. Limited number at 45/-, carriage extra. ¼ kW. Transformer for rewind, 35/- 150/200 watt size, 30/-.

DIMMER RHEOSTAT SWITCHES. 1 ohm to 0 and off up to 3 amps., for regulation of 6 v. AC/DC. Charger subcircuit regulators. Model speed control, etc., 1-hole fixing and extra bracket for rack. Hollow knob has base for miniature bulb to glow when "ON". New Aetna Co. U.S.A. Price 2/6 each. Postage 6d. G.P.O. Connection Strips of soldering tags, telephone type moulded mounting, 60-way, 3/6 each.

G.P.O. Electric Counters 25/50 volts DC 500 ohm coil, counting to 9999, 5/6.

ELECTRADIX RADIOS

214, Queenstown Road, London, S.W 3

Telephone MACaulay 2159

SEXTON'S of

138, Gray's Inn Rd., London, W.C.1

for

SALES, SERVICE & SATISFACTION

The "Sexton" Electric Smoothing Iron, made in two weights, 3 1/2 lb. and 5 lb., 200/220 volts, 230/250 volts, 450 watts. Beautiful anodised and nickel plated finish in Green, Blue, Gold, Red and Chrome. Strong bakelite handle and thumb button, sure and safe connector guard, complete with two yards of heavy three core flex. Price 2/6/8, plus 6/8 Purchase Tax.

American Radio Valves.—Types as under at controlled prices. 45Z5GT, 5Y3GT, 1A5GT, 1CSGT, 1Q5GT, 1T5GT, 3Q5GT, 80G, 35Z5, at 11/- each. 6J5GT, 12J5GT, 1H5GT, 12F5GT, at 9/2 each. 6Q7GT, 12Q7GT, 12S7GT, 75G, at 11/7 each. 12J7GT, 12SK7GT, 6J7GT, 6K7GT, 6K6GT, 6V6G, 42G, 43G, at 12/10 each. 6A7G, 6A8GT, 6K8GT, at 14/- each. 6C6G, 6D6G, at 11/- each. Postage paid. Other types as they become available for distribution. (Under B.O.T. regulations we are not allowed to accept orders from the trade for these valves).

American Radio Service Manuals

- Volume I. Spartan Emerson.
 - II. Crosley Belmont, Part I.
 - III. Crosley Belmont, Part II.
 - IV. R.C.A. Victor G.E. Admiral.
 - V. Emerson, Part II.
 - VI. Stewart Warren, FADA.
- At 12/6 per Volume, or complete set of six manuals, £3 12s. 6d.

These manuals cover the complete range of American Radio Receivers as given and are invaluable and contain all the technical data necessary.

Terms—CASH WITH ORDER ONLY. We regret that we are unable to send goods C.O.D. Telephone: TERMINUS 1304 and 4842.

CAN YOU—

pass the Morse Code test for a G.P.O. Amateur Wireless Transmitting Licence?

The ability to accurately Send and Receive Morse Code is quickly acquired through the

CANDLER SYSTEM of Morse Code Training

There are Candler courses for the absolute **Beginner** and for **W/T Operators** who desire to increase their speeds and to improve their technique.

Send for the

Candler 'Book of Facts'

It gives full details of all courses. No classes to attend.

Courses supplied on Cash or Monthly payment terms.

THE CANDLER SYSTEM CO.

(Room 55W) 121 Kingsway, London, W.C.2
Candler System Co., Denver, Colorado, U.S.A

SERVICEMEN. The following products are well designed and of high quality: volume controls, carbon type, all valves, with or less switch, wire-wound resistors, 1 to 60watts; dropper resistors, 0.2 and 0.3 amp; line cords and razor resistors; terms and quotations on req.—Dagole, Ltd., 5, Torrrens St., London, E.C.1.

RADAR surplus.—A selection of gear from our lists: 25pf air trimmers, 2/9; 15-29 pf ceramic trimmers, 7d.; 65pf 7,500v pot capacitors; 0.1µf 1,500v block paper condensers, 2/-; 5,000v or 6,000v block paper, 20/-; diode valveholders, 6d.; all types mica and ceramic condensers, 5-800pf, close tolerance, 5d.; 7-point colour coded terminal blocks, 1/6; s.a.e. brings you complete list, including all types valves.—M.O.S. Co., 24, New Rd., London, E. Postage under £1. [4924]

C.C. instrument wires, 1 1/2 lb reels, 18, 20, 22, 24g, 1/6; 26, 28g, 1/9; 30, 32g, 2/-; 34g, 2/3; enamelled ditto, same prices including 36g, 2/3; 38, 40g, 2/6; silk covered, 2oz reels, 24, 26; 28g, 1/6; 30, 32, 34, 36g, 1/9; 40, 42g, 2/-; 16g, D.S.C., 1lb, 5/-.

R.C. stranded wires, 11 d., 2 1/2 yard; stranded pushback wire, coloured, traced, 2/3 doz. yards; good quality resin-cored solder, guaranteed fresh, 1lb reel, 3/6.

B.A. thread screws, gross useful sizes, 2/6; ditto, nuts, 2/6 gr.; assorted gross screws and nuts, 2/6; ditto, brass washers, 1/6 gr.; fibre washers, 1/6 gr.; assorted soldering tags, 2/- gr.; assorted small eyelets and rivets, 1/3 gr.; all postage extra.

TRADE enquiries invited.—Post Radio Supplies, 33, Bourne Gardens, London, E.4. [5019]

CONDENSERS, 0.1mfd, 4,000v wkg, 6/-; 0.01 mica ceramic pot, 6,600v ac wkg, 15/-; transmitting ceramic, 50 pf, 4,000v wkg, 25 pf, 170 pf, 7,500v wkg, 800 pf, 900 pf 5,000v wkg, 5/- ea; 6600Ω low wire-wound resistors, 6 - doz, postage 9d. extra; c.w.o.; enquiries invited.—Parfect, Swithland Lane, Rothley, Leicester. [4917]

HENRY'S offer.—T.R.F., M and L wave coils with reaction, 8/6 pair; M and S wave, A.E. and Osc., iron cored, 12/6 set; M.L. and S. coils, 10/6 set; circuits supplied with all coils, I.F. trans., 465 kcs, small cans, 15/-; same but 110 kcs, 12/6; 3-wave-band ivorine dials, 5 1/2 x 5 of 4 1/2 x 2 1/2, 2/-; 3 wave-band coil pack with switching and padlockers, 465 kcs with full circuit, 31/-; 2-pole 6-way min. rotary switches, 2/6; 2-pole 2-way, and 3-pole, 3-way, 2/6; single pole 11-way 2-band, 4/6; 4-pole 2-way 3-band with screen, 4/6; Bulgin indicators, 2/6; 0.3 line-cord three way 65 ohms per ft. 3/- yd; Blueprint for 4-valve T.R.F. AC/DC set, th. and practical wiring, 2/-; single 0.0005 cond, brass vanes, 4/-; 3-gang ceramic ins, 10/-; with trim, 12/6; 2-gang with trim, 12/6; T.C.C. 2mfd 0.1 200v wkg, 7/6; 16mfd 300v wkg, 5/-; 16x16 350v wkg, 8/-; Philips 8mfd 450v wkg, 5/-; wet-ber 8mfd can, 250v wkg, 2/6; 8mfd 450v wkg, 3/-; Midget can, ele, 500v wkg, 8mfd 4/-; 8x8, 6/-; 16mfd 5/-; Mainsbridge 8mfd 1,000v wkg, 15/-; 4mfd 1,000v wkg, 10/-; 8mfd 600v wkg, 7/-; 1mfd 1,000v wkg, 6/-; 0.1 2,000v wkg, 5/-; 500mfd 12v wkg, 5/-; 4-pin vibrators, 6 or 12 volts, 10/-; relays 100ohms, 7/6; all above new & unused; send for latest list.

HENRY'S 5, Harrow Rd., Edgware Rd., Paddington, W.2. Parl. 2194. [5018]

THE Simplex Four, still the best, complete constructional details; Midget ac/dc (total cost of construction £9), theoretical and full-scale layout diagrams, with instructions, per copy, 4/6; Midget polished wood cabinets, 35/-; Midget m. wave T.R.F. coils, high gain, 7/6; m.l. wave, with reaction, circuit, 10/6; the latest, iron cored m. and l. wave, T.R.F. coils, adjustable cores, with circuit, 12/6; ditto a. and osc. coils, m. and l. wave, for the pocket receiver, i.f. at 465 kcs, with circuit, 12/6; a. and osc. coils, s.m.l. wave, ditto i.f. with circuit, 15/-; coils, Midget i.f. transformers, 465 kcs, 15/- pair; all wave-coil pack, wired, tested, 5 leads to receiver, boxed, with circuit, 40/-; Midget ivorine coloured dials, s.m.l. wave, 4x3 1/2, 2/6; coloured s.m.l. dials on glass, 9x4 1/2, 3/6; slow motion drives, 2-speed, with driving disc, 3/6; ditto string drum drive, 1-speed, 2/6; Midget Simplex chassis, fully drilled with 4 valve holes, etc., 11x4 1/2x2in. with speaker cut-out, the best for Midgets, 7/6; Midget 2 gang variable condensers, 0.0005mfd, 13/6; push-pull driver trans, split secs, 12/6; p.p. output trans, 6,600 a to a load, for 616, P.X.4 valves, etc., tapped output, 7.5 and 15 ohms, 21/-; Midget chokes, 6/-; standard ditto, 8/-; heavy ditto, 150-200ma, 12/6; Midget rotary d.p.d.t. switches, 3/-; standard 3-way 4-pole, 5/6; Midget ditto, 5/-; Midget ditto 6-pole 2-way, 2/6; etc., etc., etc.; monthly comprehensive lists, 2nd stamp with enquiries; postage all orders

O. GREEN, I.C.K. Ltd., 34, Baneroff Rd., Canbridge Heath Rd., London, E.1. Ste 1334

BAKERS 'Selhurst' RADIO

18" and 12" P.M. QUALITY SPEAKERS

8 and 15 WATT AMPLIFIERS

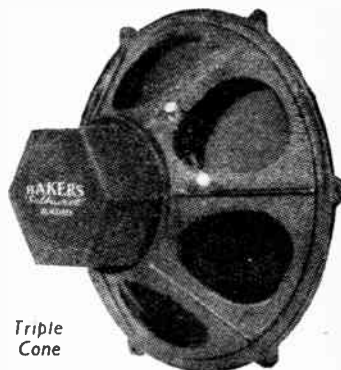

PIONEERS OF MOVING COIL SPEAKERS

Improved 1946 MODELS available.
CINEMA Model - £8 19 6
AUDITORIUM Model - £5 18 6

Send 2/6 stamp for Illustrated List to:
BAKERS 'SELHURST' RADIO
75-77 Sussex Road, South Croydon, Surrey
Telephone: CROUDON 4226.

The Radio Amateur's Dream!

Think of all the really good Radio shops you know of; imagine them all under one roof—and even then you'll have only a slight idea of the comprehensive stocks of Components we carry. Unfortunately we have no lists at present, but detailed enquiries, clearly worded will be dealt with speedily. Please enclose a stamped addressed reply envelope.

WIRELESS SUPPLIES UNLIMITED

The best Radio Components suppliers since 1925
264-266 Old Christchurch Road, BOURNEMOUTH, HANTS.

LONDEX for RELAYS

for A.C. and D.C.



Midget Relay M.L.

2VA Coil consumption from 2 to 600 volts and tested to 2,000 volts, Aerial change-over Relays, Mercury Relays, Measuring Relays, and Time Delay Relays.

Ask for leaflet 205 WW

LONDEX LTD
MANUFACTURERS OF RELAYS
207-AMERLEY ROAD-LONDON S-E 20

ARMSTRONG

Model EXP63

ALL-WAVE 6-VALVE SUPERHET CHASSIS

incorporating wave band expansion on all bands, e.g. the 16-50 metre band covers just over 20 inches on the large illuminated glass scale. Tone and volume controls work on both radio and gram. R.C. coupled, 5 watts output. For 100-250 v. A.C. or D.C. mains.

Provisional price 11 gns. plus tax.

Model EXP83

ALL-WAVE 8-VALVE SUPERHET CHASSIS

incorporating wave band expansion. Large glass scale treble boost control. The latter together with tone and volume controls work on both radio and gram. High quality push-pull output gives 10 watts audio. For 100-250 v. A.C. mains.

Provisional price 14 gns. plus tax.

Model EXP43

ALL-WAVE SUPERHET FEEDER UNIT

incorporating wave band expansion manual I.F. gain control, etc. Fitted in high-grade instrument cabinet, ripple finished with plated handles.

Provisional price 12 gns. plus tax.

The above chassis are of entirely new design and capable of a high performance. Demonstration Sets are now available for interested callers to hear and illustrated technical specifications will be ready soon.

Model AMP14

HIGH GRADE AMPLIFIER

in well finished metal instrument case. Two inputs, bass compensating circuit, treble boost control, 14 watts push-pull output preceded by 4 triodes.

Provisional price 15 gns.

ARMSTRONG METAL WORKING DIVISION

We manufacture high-grade Metal Instrument Cabinets, detachable front and back panels, satin ripple finish, with plated handles. Stock sizes, 15 in. long x 8 1/2 in. x 10 in. high and 18 in. long x 8 1/2 in. x 10 in. high. Prices 50/- and 55/-. Special sizes to order.

ARMSTRONG WIRELESS & TELEVISION CO. LTD.

WALTERS ROAD, HOLLOWAY, LONDON, N.7

Phone: NORth 3213

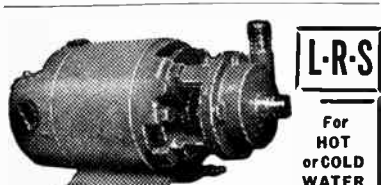

L-R-S

For HOT or COLD WATER

STUART CENTRIFUGAL ELECTRIC PUMPS

With foot-valve, strainer and hose union. FOR ALL PUMPING PURPOSES, MACHINE TOOL COOLING, GARDEN FOUNTAINS, etc. All parts non-rusting. Low current consumption. Fan cooled, ball-bearing motor. Immediate delivery. Send stamp for details.

LONDON RADIO SUPPLY CO. BALCOMBE, SUSSEX. Estd. 1925

METAL rectifiers, charger kits, mikes, 12 pick-ups, condensers, eliminator kit, metal rectifier 12v 1.5 amp with 50w transformer and ballast bulb for 2v to 12v charger, 37/6, post 10d. ditto with larger 2 amp rectifier, 45/-; ditto 2 amp but for 2v, 6v only, 36/-, postage 10d. Metal rectifier, 2v 0.5 amp, with small transformer for 2v trickle charger 13/6, post 7d. De Luxe car owner kit, metal rectifier 12v 3 amp, with transformer and ballast bulb for 2v to 12v charger, 2 rate charging, 59/6. All kits fully guaranteed. Heavy duty transformer and rectifier for 6v/12v charger, 4 amp 24, 5 amp 24/10. Metal rectifier, transformer, ballast bulb for 3 cell to 20 cell at one amp charger, one year guarantee, 25/10. Rectifiers, 12v 1.5 amp, 10/6, post 7d.; 12v 2.5 amp 16/6, 12v 2 amp 25/-. 12v 4 amp 32/6. Complete range of rectifiers for converting valve type chargers to metal rectifier. Type M.B.S.1 1ma instrument rectifiers 18/6. ht rectifiers 250v 60ma 14/-. 120v 20ma 7/9. Transformer, rectifier, two condensers for 120v 20ma eliminator 35/-. with 2v trickle 43/-. post 8d. Dubilier, Hunts, T.C.C. 8mfd 450v tubular electrolytics 12/- for 4, post 6d. ROTHERMEL Senior bakelite pick-ups, latest type. 75/9. Rothermel Bullet mikes, black crackle finish, 65/-; D.104 crystal mike 84/-. Instraphone moving coil mikes 24/15, moving coil mike transformers 12/6, stands in stock; fluorescent 80 watt chokes 19/-; 4 amp chargers complete, 12v, 26/17/6. CHAMPION, 43, Uplands Way, London, N.21. *Phone Lab. 4457. [5064

REPAIRS AND SERVICE

S. E. BLAND, B.Sc., A.C.G.I., North St., Exeter, trade and retail radio repairers; second-hand sets exchanged.—Tel. 2906. [4967 MAINS transformer re-wound and constructed to any specification; prompt delivery.—Brown, 3, Bede Burn Rd., Furrow, [3460 LOUDSPEAKER repairs, British, American. L any make; moderate prices.—Sinclair Speakers, 12, Pembroke St., London, N.1. Terminus 4355. [3308

ALL types of radio receivers serviced; A. Murphy and Pilot specialist; valves in stock; sound repairs for 13 years.—T. E. Fevver, F.I.P.R.E., 50, Vine St., Uxbridge.

RADIO repairs quickly executed to all makes, English or American; lowest possible prices.—The Music Box, 89, London Rd., London, S.E.1 (Tel. Waterloo 4460 and 6766.)

REWINDS and conversions to mains and output transformers, fields, etc., from 4/6. P.P.P. equipment a speciality.—N. L. Rewinds, 4, Brecknock Rd., N.7, Arnold 5390

"SERVICE with a Smile."—Repairers of all types of British and American receivers; coil rewinds; American valves, spares, line cord.—F.R.L., Ltd., 22, Howland St., W.1. Museum 5675. [1575

TESTGEAR REPAIR SERVICE, specialists in repairs, recalibration, etc., of test equipment of every description for the radio industry.—2, Tower Bridge Rd., London, S.E.1. Tel. Ber. 1669. [4506

STURDY rewinds, mains transformers, S chokes and fields; we give prompt delivery and guarantee satisfaction; 14 years' experience; prices on request.—Sturdy Electric Co., Ltd., Dipton, Newcastle-upon-Tyne. [4316

LOUDSPEAKER repairs and mains transformer rewinds; we can now give prompt service at reasonable prices to dealers and service engineers; send 1d. for our latest list.—A.W.F. Radio Products, Borough Mills, Sharpe St., Bradford. [4495

REPAIRS to moving coil speaker, cones, R coils fitted, field re-wound or altered; speaker transformers, clock coils re-wound, guaranteed satisfaction, prompt service. L.S. REPAIR SERVICE, 49, Trinity Rd., Upper Tooting, London, S.W.17. [4819

REWINDS, mains transformers, speaker field coil-chokes, high-grade workmanship, 7-day delivery; new transformers constructed to customers' specification, singly or in quantities.—Metropolitan Radio Service Co., 1021, Finchley Rd., N.W.11. Speedwell 3000. [3719

24-HOUR service, 6 months' guarantee, any 24 transformer rewind, mains, outputs and i.f.s., etc., all types of new transf., etc., supplied to specification; business heading or service card for trade prices.—Majestic Wind-inz Co., 180, Windham Rd., Bournemouth. [4829

LOUDSPEAKER repairs, any make, reasonable prices, prompt delivery, to the trade and quality fans; 25 years' combined experience with Rola, Magnavox, Goodmans, Celestion.—Sound Service Radio, 80, Richmond Rd., Kingston-on-Thames, Kin. 8008. [4977

ALL makes and kinds of electrical and radio instruments repaired by skilled technicians A.I.D. approved; over 60,000 instruments repaired for R.A.F.; all work quoted by return without charge.—C. Gertler, Dept. D, 29-31, Cowcross St., E.C.1. Cle. 6783. [4829

GALPINS

GOV'T. SURPLUS ELECTRICAL STORES

408 High St., Lewisham, London, S.E.13

Telephone: Lee Green 0303. Near Lewisham Hospital.

D.C. MOTORS, approx. 1 h.p. series wound, all guaranteed electrically for 110 or 220 volts mains. Price 15/- each. Carriage 1/-. We also have a few with LAMINATED FIELDS, which are easily convertible to work off A.C. mains. Price 20/- C.F.

ELECTRIC LIGHT CHECK METERS, by well-known makers, all electrically guaranteed, for A.C. mains, 200/250 volts, 50 cycles, 1-phase, 5-amp. type, 12/6 each. 10-amp. type, 15/-, 20/25 amps., 17/6 each.

EX-GOV'T. ROTARY CONVERTERS for car radio, etc., 6 to 9 volts, D.C. input, 450 volts, 50/80 M/amps., output complete with automatic regulator, smoothing, consisting of condenser, dropping resistances, etc., and a specially designed gearing operating 3 multi-leaf relays, all mounted on chassis, size 12in. by 8in. by 2 1/2in., weight approx. 16 lb., condition as new, to clear 37/6 each, carriage 2/6. Ditto, same output, but with an input of 12 to 18 volts at 3.3 amps. Price 37/6 each, 2/6 carriage.

EX-GOV'T. EIGHT VALVE CHASSIS, size 12in. by 8in. by 2 1/2in., short wave, comprising of two highly sensitive multi-contact relays, dropping resistances, approx. 36 fixed condensers ranging from 10 P.F. to 1 N.I.F., also approx. 28, 1, 1 and 2 watt resistances. To clear, 18/6 each, 1/6 carriage.

STANDARD TELEPHONE, block condensers, 10 mfd. at 550 volt wkg., 7/6 each. T.C.C. 4 mfd. 300 volt A.C. wkg., 4/6 each. Ditto, 2 mfd., 2/6 each. T.C.C. 2,000 mfd., dry electrolytic, condensers, 25 volt wkg., 15/-. Ditto, 500 mfd., 50 volt wkg., 12/6 each. All fully guaranteed.

"WESTON" MOVING COIL MILLIAMMETER METERS, model 505, 2in. dial, flush mounting, 0 to 5 m.a., 0 to 10, 0 to 20, 0 to 50, 0 to 300. All at 22/6 each.

X-RAY TRANSFORMERS, in oil input 100/240 volts 50 cv. 1 phase, output 40,000 volts, 225; 80,000 volts 5 K.V.A., with Coolidge winding, 235; 90,000 volts at 2 1/2 K.V.A., 227 10s., all in perfect condition, fully guaranteed.

EX-GOV'T. ROTARY TRANSFORMERS, input 12 to 24 volts D.C. output, 480 volts 40/60 M/amps., complete with smoothing and a special gearing operating a multi-leaf relay. Price 30/-, carriage 2/-.

EX-G.P.O. HIGHLY SENSITIVE RELAYS, small type, with multi-contact Q.M.B. action, 5/- each. Also same type, new and unused, 10/-. All fully guaranteed.

RECTIFIERS, all large type, fully guaranteed, output 50 volt 1 amp., 35/-; 12 volt 4 amps., 45/-; 12 volts 8/8 amps., 55/-. All carriage paid.

AUTO-CHANGING TRANSFORMERS, tapped 0, 110, 220, 240, step up or down, 500-watt type, 70/-. Ditto, 1,000 watts, 25 15s. Ditto, 2,000 watts, 28 15s. Extra tappings if required at 10/- per tapping. All fully guaranteed.

AUTO-WOUND TRANSFORMERS, 2 to 1 ratio, step up or down, 250 watt, 45/-; 400 watts, 57/6 each.

X-RAY FLUORESCENT SCREENS, 15x12in., with lead glass as new, 75/-. We also have in stock other sizes of screens and cassettes. Please state your requirements.

MOVING COIL VOLTMETERS, 2 1/2in. dial, makers Sullivan, 0 to 10 volts, all new and unused, 35/- each.

AUTO-WOUND TRANSFORMER, approx. 5 kilowatt, in new condition. Voltages which can be obtained are up to 18 in steps of 2 volts, 80 to 240 in steps of 20 volts, price 215.

ROTARY CONVERTOR, input 220 volts D.C. at 9 amps.; output 68/125 volts, 500 cycles, 1 phase, 1,250 watts, in perfect condition, 215. Ditto, 230 volts D.C. input, output 240 volts 1 phase 50 cycles, 1,250 watts, price 225. C.F.

FIXED RESISTANCES, wound on fireproof mounts, size 12in. by 1in., 2 ohms resistance to carry 10 amps., 2/6 each.

All articles advertised sent on approval against cash. Terms: Cash with order.

• ALL POWER •
Precision Wound Transformers

of the highest class now available in limited numbers. As hitherto we specialise in Laboratory and Test components and will be pleased to give quotations.

ELECTRONIC INSTRUMENTS

We have recently opened an Electronic Instrument Section for the design and production, on a limited scale, of Electronic Laboratory Equipment of the highest possible standard.

Our standard range of products will include Electronically Regulated Power Supply Units, Laboratory Oscillographs, Wide-Band Oscillograph Amplifiers, Linear Time-Base Generators, Pulse Generators for Impulse and Square Wave Testing, Measuring Bridges, etc.

Our engineers are fully qualified to deal with any problem involving the application of electronic methods in all branches of physical measurements and Industrial Control, and will be pleased to advise and assist in the development of any specialised apparatus.

Export enquiries invited

ALL POWER TRANSFORMERS LIMITED

2a, Gladstone Road, Wimbledon, S.W.19
Phone: L1Berty 3303

ANSWERS AT YOUR FINGER-TIP



FLIK-O-DISK
Quick!

ELECTRICAL AND RADIO ENGINEERS OHM'S LAW CALCULATOR

Whether you are constructing or servicing a radio set, problems involving voltage, current and resistance can delay progress.

Flik-o-Disk will give the answer in a jiffy. For example, what resistance should you use to obtain a voltage drop of 100 v. when current equals 25 m.a.? A flick of the disk and there is your correct answer—4,000 ohms. The scales read from 1 millivolt to 1,000 volts. From 1 ohm to 1,000,000 ohms. From 1 milliamp to 10 amperes. From 1/10th of a milliwatt to 10,000 watts.

PRICE 6/6

The calculator is sold complete and with full instructions at Radio Stores and Stationers. If unable to obtain, write to **IONIC LABORATORIES LTD.**, Dept. W., Cranbourne Terrace, SALT HILL, BLOUGH, BUCKS, for name and address of your nearest stockist.

REWINDS, mains transformers, layer wound, was impregnated, O/P transformers, chokes, fields, clock coils, pick-ups, fractional hp motors, competitive prices; prompt delivery; guaranteed work.—W. Groves, Manufacturing Electrical Engineer, 154, Icknield Port Rd., Birmingham. 16. [4547]

MISCELLANEOUS

WIRELESS World, Jan., 1940, to Dec., 1945, complete except 5 issues.—Offers, write, Shooter, Sycamore Lane, Hollingwood, Chesterfield. [4923]

SOUNDPROOF room which has to be disposed, comprising special doors, glass wall and floor.—Write Box 6293. [5003]

SPARKS' data sheets.—These data sheets provide complete constructional details, together with full-size prints, etc., of tested and guaranteed designs.

ELECTRIC guitar units (3rd edition), 5/-. **ELECTRONIC** one-string fiddle, 3/6; 6-watt ac/dc amplifier; phase inverter; push-pull output; neg. feedback; portable for use with above or mike, p.u., etc., 3/6.

A.C. two-valve, med. wave, coil details, 2/6; 3½-watt ac amplifier, 2/6. **SPARKS' DATA SHEETS** (W.), 9, Phoenix Rd., Brockley, London, S.E.4. [3622]

ALUMINIUM sheets, 18 × 16½ × 1/16, 2/6. A postage 6d.; special price quantities; s.a.e. for lists.—Amateur Radio Service G6HP, Canning St., Burnley. [4971]

WANTED, EXCHANGE, ETC.

WANTED, 250 or less radio cabinets.—Box 6251. [4996]

EXCHANGE test equipment or sell, 2 832s, 3 955s, 3 9003s.—Box 6333. [5009]

W.D., W. & E. Trader's Service Sheets 12, Westcott Terrace, Bideford, Devon.

WANTED, Avo valve tester, details, price.—18a, Ashfield Pile., Southgate, N.14.

EKCO A.D. 76 cabinet required.—Woodmansey, 9, Garfield Rd., Ryde, I.O.W. [4926]

URGENTLY req., 25D8 radio valve.—K. Bright, 74, North Court Ave., Reading.

WANTED, H.R.O. coils, 3.5 to 7.3 mc/s. 14 to 30 mc/s, 0.9 to 205 kc/s; good price paid.—Box 6105. [4968]

EXCHANGE 4 doz. engineer's dial gauges (or separately) for anything radio or electrical.—Box 5946. [4946]

WANTED, Mallory 6v 6-pin type 525 vibrator for Crosley car radio.—Thyng, 1a, Clarence Rd., Norwich. [5036]

HARTLEY Turner duode wanted, 1.250 or 2.500ohms, price please.—Allen, 23, Braunstone Av., Leicester. [5034]

WE offer cash for good modern communication and all-wave receivers.—A.C.S. Radio, 44, Widmore Rd., Bromley, Kent.

WANTED privately, RAC communications receiver, model AR.88-E (latest type); good price offered if in super cond.—Box 6247

EXCHANGE, Hunte 1946 C & R Bridge for oscilloscope; cash adjustment, or sell £16.—Surtees, 78, High St., Felling-on-Tyne.

ONE, Phillips 3-gang spiral valve condenser.—Price and parties, for genuine article to Edwards, 48, Church St., Fonthill Magna, Shaftesbury, Dorset. [4983]

WANTED privately, late model Communication receiver, in new condition, at reasonable price for spot cash.—Roberts, 41, The High, Streatham High Rd., S.W.16. [4951]

WE buy for cash, new, used, radio, electrical equipment all types; especially: wanted, radios, radiograms, test equipment, motors, chargers, recording gear, etc.—If you wish to sell at the maximum price, call, write or phone to University Radio, Ltd., 22, Lisle St., Leicester Square, W.C.2. Ger. 4447.

TUITION

THE Tuitionary Board of the Institute of Practical Radio Engineers have available home study courses covering elementary, theoretical, mathematical, practical and laboratory tuition in radio and television engineering; the text is suitable coaching matter for I.P.R.E., Service-entry and progressive exams, tuitionary fees—at pro-rata rates are moderate. The Syllabus of Instructional Text may be obtained post free from Secretary, 20, Fairfield Rd., Crouch End, N.9.

THE BRITISH NATIONAL RADIO SCHOOL is a long-established and highly successful correspondence school, specialising in transforming operators into engineers, and in this chosen field it stands supreme; during the war years we have been unable to accept students other than radio officers serving in the Merchant Navy; hence we have not advertised, but now we are again free to enrol a limited number of students from "Wireless World" readers seeking personal tuition in preparation for C. & G., Brit. I.R.E. and I.E.E. examinations: our Radar course is now ready.—Please write fully to Director of Studies, B.N.R.S., 66, Addisoncombe Rd., Croydon. [5008]

THESE ARE IN STOCK

WIRELESS SERVICING MANUAL, by W. T. Cocking, 10s. 6d., postage 4d.

RADIO UPKEEP AND REPAIRS, by A. T. Witte, 7s. 6d., postage 4d.

FOUNDATIONS OF WIRELESS, by M. O. Scroggie, 7s. 6d., postage 4d.

THE TECHNIQUE OF RADIO DESIGN, by E. E. Zepier, 21s., postage 6d.

LUMINOUS TUBE LIGHTING, by Henry A. Miller, 10s. 6d., postage 4d.

TIME BASES (Scanning Generators), by O. S. Puckle, 16s., postage 6d.

SHORT-WAVE RADIO, by J. H. Reyner, 10s. 6d., postage 4d.

EVERYMAN'S WIRELESS BOOK, by F. J. Cannon, 6s., postage 4d.

WORKED RADIO CALCULATIONS, by A. T. Witte, 8s. 6d., postage 4d.

RADIO INTERFERENCE SUPPRESSION, by G. W. Ingram, 5s., postage 4d.

WIRELESS WORLD VALUE DATA, 2s., postage 2d.

CLASSIFIED RADIO RECEIVER DIAGRAMS, by E. M. Squire, 10s. 6d., postage 4d.

RADIO DATA CHARTS, by R. T. Beatty, 7s. 6d., postage 4d.

WRITE OR CALL FOR COMPLETE LIST. 1d.

THE MODERN BOOK CO., (Dept. W.11), 19-23, PRAED STREET, LONDON, W.2.

BERRY'S (SHORT WAVE) LTD.

Send 3d. stamp for

ILLUSTRATED CATALOGUE of the Best in RADIO AND ELECTRONIC PRODUCTS

25, HIGH HOLBORN (Opposite Chancery Lane), LONDON, W.C.1

THE INFINITE IMPEDANCE ADAPTOR.

An Ultra Modern Servicing Instrument, designed to facilitate simple and positive tests of Oscillator, circuits, detector circuits, A.V.C. components and voltages, etc., etc. With this instrument also many other special operations can be performed: for instance, alignment is possible without a Signal Generator. Price £8 17s. 6d. complete. Instruction manual, which is a text-book in itself, 5s., post free.

V.E.S. (W) RADIO HOUSE, RUISLIP, MIDDLESEX

A.C.S. RADIO

FOR COMMUNICATION RECEIVERS, AMATEUR TRANSMITTING GEAR, ALL TELEVISION AND RADIO EQUIPMENT AND COMPONENTS.

Preliminary LIST NOW READY, but with new stocks constantly being added we suggest enquiry for definite items if not listed.

44, WIDMORE ROAD, BROMLEY, KENT

BATTERY CHARGERS & TRICKLE CHARGERS

Trouble-free Chargers fitted with selenium all-metal rectification. Good all-ways on your old Clerks. Thirty years experience behind every Runbaken product. Booklet R.15, describing 12 Models, on request.

RUNBAKEN-MANCHESTER 1

AMPLIFIERS



Tom Thumb Gramo Amplifier.
PP output 15 w.; case 9x8x6½".
Kit price £8 18s. (assembled 20/-).
Available with Mike or PEC input at
extra cost (add 2/6 packing).

The A23 Public Address Model.
PP output 23 w.; with mike stage.
Case 14x8x8½". Kit £14.

The A36 P.A. Model with 6L6's in
PP. Mixing H.G. and gram. Shortly
ready. Write details.

TRANSFORMERS for all circuits.
New ranges, fitted voltage adjustor
panels and shrouds, O.P. trans., etc.

Write for lists (3d.), Illust. Cat. 1/-.
Dealers: Apply for Trade discounts.

RADIO INSTRUMENT CO.

Radio Products
294, BROADWAY,
BEXLEYHEATH, KENT.
Bexleyheath 3021

HILL & CHURCHILL LTD
BOOKSELLERS
SWANAGE DORSET

ENGLISH & AMERICAN
BOOKS IN STOCK ON
RADIO AND
TELECOMMUNICATION

CATALOGUE ON APPLICATION

"ENGINEERING OPPORTUNITIES"



This unique handbook shows the easy way to secure A.M.I.Mech.E., A.M.Brit.I.R.E., A.M.I.E.E., City and Guilds, etc.

WE GUARANTEE—
"NO PASS—NO FEE."

Details are given of over 150 Diploma Courses in all branches of Civil, Mech., Elec., Motor, Aero, Radio, Television and Production Engineering, Tracing, Building, Govt. Employment, R.A.F. Maths., Matriculation, etc.

Think of the future and send for your copy at once—FREE.

**B. E. T., 387, SHAKESPEARE HOUSE,
17, STRATFORD PLACE, LONDON, W.1.**

RADIO development engineer required by Midlands radio manufacturer, experience of commercial radio design essential.—Write details of qualifications, experience and salary required, to Box 107, c/o Era, 166, Camden High St., London, N.W.1 [4972]

MANAGER wanted for relay service operating within a few miles of Glasgow; must have technical and practical experience, enormous scope for development, good prospects for suitable person.—Apply City Relay Services, Ltd., 24, New Chapel St., Blackburn.

WELL-KNOWN scientific instrument manufacturers require a young man to assist in the development and assembly of new electronic instruments; previous electronic or electrical experience necessary and some knowledge of optics useful.—Box 6106.

ELECTRONIC laboratory engineers and research worker required for experimental and development work on H.F. heating equipment and application of dielectric heating to particular industrial problems; degree in Physics and Electrical Eng. essen.—Box 6103.

ELECTRICAL and mechanical engineer for varied and interesting duties in small works; competence and initiative essential, knowledge of electronics desirable; good pay to live man under 40; full or part-time.—Box No. 466, c/o Dawsons, 31, Craven St., London, W.C.2. [4639]

TELECOMMUNICATIONS engineers, company of repute, London area, requires graduates with several years' experience in development operating or manufacturing of radio or line communication equipment; applicants should give full details of age, training and experience & state salary required.—Box 5627.

ASSISTANT radio engineer required for a new project and documentation department, preferably exempt Military Service; City and Guilds radio part 3 minimum qualification.—Apply to Personnel Department, 45, Nightingale Lane, S.W.12, Philips' Laboratories (Communications). [4930]

FOREMAN required for assembly and wiring shop, with company engaged in the manufacture of radio and allied products, good prospects for right man.—Write, stating previous experience and salary required, Box 156, Phillips Advertising, Ltd., 15, Wilton Rd., London, S.W.1. [4959]

GRADUATE (preferably communication or electrical engineering) wanted for research and development work with experience in the design and testing of audio frequency equipment, particularly microphone. Write, stating age, fullest details of academic qualifications, experience, and salary reqd., to Box 6104.

DRAUGHTSMEN and tracers required for S. London, with exp. in prod. of working drawings from data supplied by designers; (1) Mech. draughting; (2) Elect., preferably with exp. on radio comm. equipment; work shop exp. preferred.—Apply in writing, with full details, to R.T.E., Ltd., 45, Nightingale Lane S.W.12. [4635]

PHILIPS Laboratories Communications invite applications from keen technicians to fill posts as laboratory assistant; only applicants to a standard of City & Guilds Grade 3 in radio engineering should apply in writing, with full details, to Personnel Manager, Philips Laboratories, 45, Nightingale Lane, S.W.12. [4758]

ELECTRICAL testing equipment; a designer is required to take charge of a new department producing test equipment for factory use; sound knowledge of high-grade equipment and ability to produce same is essential; please give full details of training and experience.—Box 6248. [4993]

SENIOR draughtsman required for North London, fully experienced in design and production of small mechanical and electrical apparatus, including domestic appliances and radio.—Write, giving full details of experience and age, to 'S. D.' Box 5493, A.K. Adv., 212a, Shaftesbury Ave., W.C.2. [4986]

WIREMAN and service mechanic required for the construction and maintenance of test equipment; some knowledge of radio circuits and ac and dc bridges desirable; must be capable of wiring correctly from diagrammatic sketches; excellent prospects in large company for suitable applicant.—Write, with details of experience, to Box 5455, A.K. Adv., 212a, Shaftesbury Ave., W.C.2. [4964]

CORRESPONDENCE invited from ex-officers interested in joining the staff of a rapidly expanding civilian radio school for wireless and Radar operators and mechanics; qualifications (which should be fully stated) are: technical ability, capacity for training men, practical experience, willingness to work, and take a financial stake in the undertaking.—Replies to Box 488, The E.C. Advertising Co., 54, Old Broad St., E.C.2.

COVENTRY

RADIO

COMPONENT SPECIALISTS SINCE 1925

| | |
|--|------|
| SWITCHES, Rotary, 1 pole 18-way | 4/6 |
| SWITCHES, Rotary, 2 pole 6-way | 3/9 |
| CERAMIC TRIMMERS, 3-30 pf., 8d.; 30-80 | 10d. |
| CERAMIC S.W. CONDENSERS | 4/6 |
| ELECTROLYTIC, 8 mfd., 500-volt | 3/9 |
| CABLE PLUGS, screened octal | 1- |
| RESISTORS, 20-watt, 3,000 | 2/6 |

A few items from our 1946 K list of components sent per return on receipt of 1d. stamp.

PROMPT SERVICE. SATISFACTION GUARANTEED
COVENTRY RADIO
191, DUNSTABLE ROAD, LUTON

REWINDS

Armatures, Fields, Transformers, Pick-ups, Vacuum Cleaners, Gram. Motors. Speakers Refitted New Cones & Speech Coils.

All Guaranteed and promptly executed. Valves, B.V.A. and American, good stocks. Send stamped addressed envelope for list of Radio Spares, and C.O.D. Service.

261-3-5, Lichfield Road,
A.D.S. Co. ASTON, BIRMINGHAM, 6

MIDLAND INSTRUMENT CO.

Comprehensive range of Lewcos instrument wires, eureka and nickel chrome res. wires. Flexes and cables, electrical accessories, sleeveins. Empire tape, rubber grommets, L.T. rectifiers, Avometers, Wee-Meggers, Ohmmeters, speakers, chassis, dual-range and s.w. coils, var. cond., counters, synchronous motors, microphones, plugs and jacks, etc., etc. New Feb. lists, 1d. s.a.e. Trade lists, 1d. s.a.e.

18, Harborne Park Rd., Birmingham, 17
Tel. HAR. 1308 or 2684.



WE APPOLOGISE to those who have been waiting months for replies. Our post-war plans have been frustrated so far. Sorry!

VOIGT
Be WISE and PATIENT **PATENTS LTD.**

IT'S HER VOICE YOU WANT TO HEAR!



LUSTRAPHONE
Moving Coil Microphones

84 BELSIZE LANE · LONDON · N-W-3
TEL. HAMPS TEAD 5389 & 5515.

RADIO engineer, with pre-war experience design and development commercial radio and television receivers, wanted for laboratory of radio manufacturers and engineers in London area; only first-class men need apply.—Write, stating age, experience, salary required, Box K2080, A.K. Advgt., 212a, Shaftesbury Av., W.C.2. [5058]

TRANSFORMER designer required, must be able to design for large scale production, small power and audio transformers for radio and television, also to supervise small experimental production unit, practical experience essential; write in confidence, giving full qualifications and experience, age and salary required.—Box 6373.

DEVELOPMENT engineer required for the design of audio frequency amplifiers; the successful applicant, in addition to having a good theoretical knowledge, must have had practical experience of design work for quantity production.—Write, stating previous experience and salary required, Box 156, Phillips Advertising, Ltd., 15, Wilton Rd., S.W.1.

MECHANICAL designer-draughtsman required with knowledge of light electric mechanical assemblies and vacuum clean design for progressive manufacturers of radio and domestic appliances in London area.—Write, giving full particulars of training, experience, age and salary required, to Box 3520, A.K. Advgt., 212a, Shaftesbury Ave., W.C.2. [4957]

SENIOR laboratory assistant wanted for department of physics, knowledge of lecture demonstration, lantern slide making and laboratory arts essential, must be efficient, capable and hardworking; salary £300-£360 per annum, according to qualifications (super-annuation).—Apply, giving full particulars of education, training and experience, with names of at least two referees, to the Registrar, University of Liverpool. [4944]

SALES representative required by old-established leading storage battery manufacturer and electrical engineers for Eastern Counties to operate from London, also similar vacancy for South-East Counties; applicants must possess personality, initiative and drive; salary, commission and expenses; excellent opportunity for young men with ambition.—Write, stating age, salary required, and full details of past training and experience, Box 6107. [4961]

V.H.F. development work.—Radio manufacturers have vacancies for two high calibre senior engineers, fully experienced in V.H.F. receiver design; good prospects, generous salary and congenial working conditions in well-equipped laboratories are offered; applicants must be capable of originating design and developing apparatus in detail up to the stage of production; must be well acquainted with current services technique, tropicalisation requirements, etc.; must also have had similar experience in a senior capacity either in Government establishment or in commercial development laboratories of first-class firm.—Write, stating in confidence details of pre-war and wartime experience, technical education and qualifications, present salary, age, salary required and date when engagement could start, to Box 5707. [4955]

SITUATIONS WANTED

RADAR officer, 15 years' commercial and ship service, exp., microwave, commun. and ship work, desires suitable commercial post, available immed.—Box 6409. [5028]

YOUNG woman, B.Sc. mathematics, seeks post.—Box 6516. [5079]

R.A.F. Flt. Sgt., 6 yrs. radar, 5 yrs. pre-war radio and television servicing, age 28, seeks progressive situation, preferably in London or southern area; demobbed.—Box 5940.

FLT. I.T. signals (ex Warrant Officer), 12 years' experience R.A.F., possesses sound technical knowledge, seeks progressive position in any branch of radio trade.—Box 6175.

RADAR tech. officer, Assoc. Brit. I.R.E., requires perm. progressive post, London, release May, 5½ yrs. R.A.F. Radar, inc. 2 yrs. instructing, 12 yrs. pre-war radio sales, service, maint.—Box 6411. [5029]

WIRELESS mechanic, released class "A", over 20 yrs.' experience pre R.A.F.; Signals; seeks situation preferably development work requiring keen theoretical and practical worker; excellent refs.—Box 6521.

RADIO engineer (38), 16 years' radio development experience including centimeter radar, 10 years as senior engineer to large, well-known radio manufacturers, seeks responsible position; salary £700-£800.—Box 6408.

RADIO development engineer, 6 years' experience at principal M.A.P. research and development establishment on radio communications, navigational aids (including flying), and tropicalisation; age 31; seeks position in industry.—Box 6517. [5080]

WARRANT OFFICER, R.E.M.E., released, desires situation in development or research with manufacturer radio or electronic equipment anywhere, but preferably Northern counties, education to Inter. B.Sc., experience in design of high-fidelity audio, test, and standard equipment, domestic and communications receivers, tropic proof equipment.—Box 5941. [4937]

RADIO engineer, 6 years' technical officer R.A.F., all types radar equipment, including centimetre radar and oboe, 16 years' pre-war experience in radio industry, keen interest high-fidelity audio equipment, also thorough knowledge modern deal aids; expecting early release, desires position where ability to develop ideas and produce practical results would be an asset.—Box 5944. [4934]

**STAND BY for—
New Lists and
New Ideas!**

**SOUND SALES LIMITED,
WEST STREET, FARNHAM, SURREY.
Phone: Farnham 6461.**

RADIO BATTERY TESTER

Use "Quixo" method of battery testing.

Reliable results. Guaranteed.

Send for interesting leaflet
R115 on battery testing.



RUNBAKEN • MANCHESTER 1

FLT. SGT., radar mech., age 25, release this month, seeks employment in development or maintenance of P.A., television or radio, experienced in circuit development, layout, design, servicing and supervision; keen and preferring variety; car driver.—Box 6353. [5012]

RADIO communication engineer seeks progressive position, Home or South Africa, 10 yrs. exp. radio trade, shop management, all types servicing, fitting and installations, fully qualified radio relay engineer, C. and G. certs., would consider partnership.—Box 6121. [4979]

PATENTS.

THE proprietor of British Patent No. 549485, entitled Improvements in and relating to electrodes and other metal parts of electron discharge devices, offers same for licence or otherwise to ensure its practical working in Great Britain.—Enquiries to Singer, Ehlert, Stern and Carlberg, Chrysler Bldg., New York 17, N.Y., U.S.A. [4749]

THE proprietors of British Patents Nos. 516110, 516111, 516167, 516168, entitled Improvements in Electron Discharge Tubes, and No. 516169, entitled Improvements in Bases or Caps for Electron Discharge Tubes, offer same for licence or otherwise to ensure their practical working in Great Britain.—Enquiries to Singer, Ehlert, Stern & Carlberg, Chrysler Bldg., New York City 17, N.Y., U.S.A. [4962]

PATENT AGENTS

A. E. HILL, chartered patent agent, 27, Chancery Lane, London, W.C.2. [4368]

PARTNERSHIP

DIRECTORSHIP in established radio and electrical company on South Coast, and quarter share at £1,500 offered to person able to develop existing radio manufacture and repair.—Box 6013. [4949]

AGENCIES

WELL-KNOWN Central London retailers require exclusive line, compact mains receivers.—Box 6379. [5016]

IMPORTANT.—Manufacturers wanting live representation in Belgium, France, Switzerland, Spain; new organisation (ex-Servicemen), commencing energetic activities these markets invite your co-operation.—R. Bryan-Carney, 12, Bartlemas Close, Oxford. [4998]

TRADE MARKS

THE Trade Mark Clarostat, No. 492651, registered in respect of variable electrical resistances, was assigned on January 31st, 1946, by Claude Lyons, Ltd., of 76, Old Hall St., Liverpool, to Clarostat Manufacturing Co., Inc., of 285, North 6th Street, Brooklyn, New York, U.S.A., without the goodwill of the business in which it was then in use. [4965]

WORK WANTED

PICK-UPS of all makes, including crystals, rebuilt, reconditioned and tuned. EXPERT GRAMOPHONES, Ltd., Ingerthorpe, Gt. North Rd., London, N.2. [4954]

RADIO or test equipment built to specification, 1st class job by experts; estimates free.—Cosgrove, 185, Langley Rd., Slough.

COIL winding to specification.—Scientific Acoustics, Ltd., have immediate coil winding capacity available in very modern and well-equipped plant; all types Douglas machines, including wave winders, Leeson's multi winders, wax and varnish impregnation plant, bitumastic dipping.—Scientific Acoustics, Ltd., Exhibition Building, Earls Court, London, S.W.5. [4942]

Remember-Walter
RADIO RADIO RADIO
STAMPINGS • CHASSIS • PRESSINGS
FARM LANE, FULHAM, S.W.6. TELEPHONE: FULHAM 5234
C.R.C.4

Varley
TRANSFORMERS AND CHOKES
for Reliability
OLIVER PELL CONTROL LTD
CAMBRIDGE ROW • WOOLWICH S.E.18
TELEPHONE: WOOLWICH 1422



consult us on your

PLASTIC PROBLEMS

COSMOCORD LTD · ENFIELD

R. A. ROTHERMEL LTD.

are now in production for the well-known Piezo Electric Products.

- PICKUPS
- MICROPHONES
- HEADPHONES
- THE HUSHATONE
- DEAF AID MICROPHONES
- CONTACT MICROPHONES
- A.C. AMPLIFIERS

Send for informative literature.

NOW READY!

A specially designed A.C. Amplifier, Type V.R.2, rated at 4½ watts, is available from stock, for use in connection with all types of Crystal Microphones and Crystal Pickups. For many years R. A. ROTHERMEL Ltd. has made intensive research in Amplifier design, and we confidently present the V.R.2 as representing the ultimate in quality of reproduction, workmanship and material.

Write for Bulletin.

R. A. ROTHERMEL LTD.

ROTHERMEL HOUSE, CANTERBURY ROAD, KILBURN, N.W 6
Telephone : Maida Vale 6066 (6 lines).



FOR THE RADIO SERVICEMAN DEALER AND OWNER

The man who enrolls for an I.C.S. Radio Course learns radio thoroughly, completely, practically. When he earns his Diploma, he will KNOW radio. We are not content merely to teach the principles of radio, we want to show our students how to apply that training in practical, every-day radio service work. We train them to be successful!

Special terms for Members of H.M. Forces and discharged disabled members of H.M. Armed Forces

.....You may use this Coupon.....

INTERNATIONAL CORRESPONDENCE SCHOOLS Ltd.
DEPT. 38, INTERNATIONAL BUILDINGS, KINGSWAY, LONDON, W.G.2

Please explain fully about your instruction in the subject marked X
Complete Radio Engineering. Radio Service Engineering.
Elementary Radio.

And the following Radio Examinations :—
British Institution of Radio Engineers.
P.M.G. Certificates for Wireless Operators.
City and Guilds Telecommunications.
Wireless Operator and Wireless Mechanic, R.A.F.

Name..... Age.....
Address.....

ERG'S HAVE THE URGE TO GO ABROAD

SPEAKING EXPORTLY...

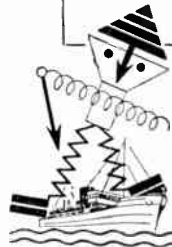

ERG Resistors have an exceptional electrical specification and performance,

with mechanical strength. High-grade Vitreous Enamels used on our Tropical Resistors give long life, and definitely assist in the trouble-free manufacture and performance of Radio Receivers, Television and Test Equipment. ERG Resistors are processed up to the highest Service Standards at a competitive Price.

ERG RESISTORS LTD.

1021a, FINCHLEY ROAD, LONDON, N.W.11. PHONE : SPEEDWELL 6967

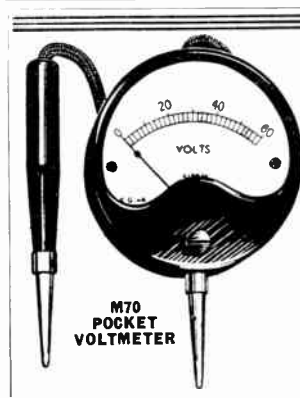

POCKET PRECISION

MODERN ROBUST CONSTRUCTION AND CONSTANT ACCURACY UNDER ALL CONDITIONS

SIFAM

ELECTRICAL INSTRUMENT COMPANY LIMITED
TORQUAY · DEVON

THE first of our post-war Lists to come off the press deals comprehensively with T.C.C. Dry Electrolytic Capacitors of "All - Aluminium" construction. A copy will be gladly sent on application.



THE TELEGRAPH CONDENSER CO. LTD

RADIO DIVISION

NORTH ACTON · LONDON · W.3

Telephone, ACORN 0061

THE MOST FAMOUS SET MAKERS ARE AGAIN FITTING

MAZDA

**RADIO VALVES AND
CATHODE RAY TUBES**
because of their
**PERFORMANCE AND
RELIABILITY**

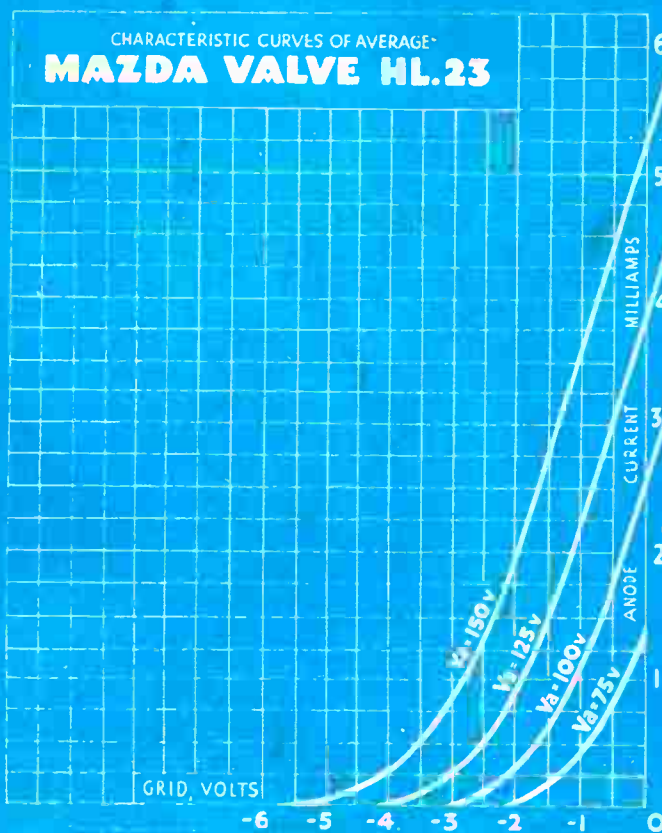

LOW
" I_f "

HIGH
" g_m "

LOW
" r_a "

THE FILAMENT CURRENT OF THE MAZDA HL.23 IS EXCEPTIONALLY LOW; IT IS ONLY 50mA.

ITS MUTUAL CONDUCTANCE ($g_m = 1.5mA/V$) IS REMARKABLY HIGH FOR A VALVE HAVING SO LOW A FILAMENT CONSUMPTION.

THE ANODE A.C. RESISTANCE IS ONLY 21,000 OHMS WHICH, COUPLED WITH THE HIGH g_m MAKES THE VALVE PARTICULARLY SUITABLE FOR USE IN EITHER OSCILLATOR, DETECTOR OR L.F. STAGES OF A RECEIVER.

THE EDISON SWAN ELECTRIC COMPANY LIMITED



155, CHARING CROSS ROAD, LONDON, W.C.2