

Wireless World

RADIO and ELECTRONICS



MAR. 1946

1/6

Vol. LII. No. 3

IN THIS
ISSUE :

SUNSPOTS: EFFECTS ON COMMUNICATIONS

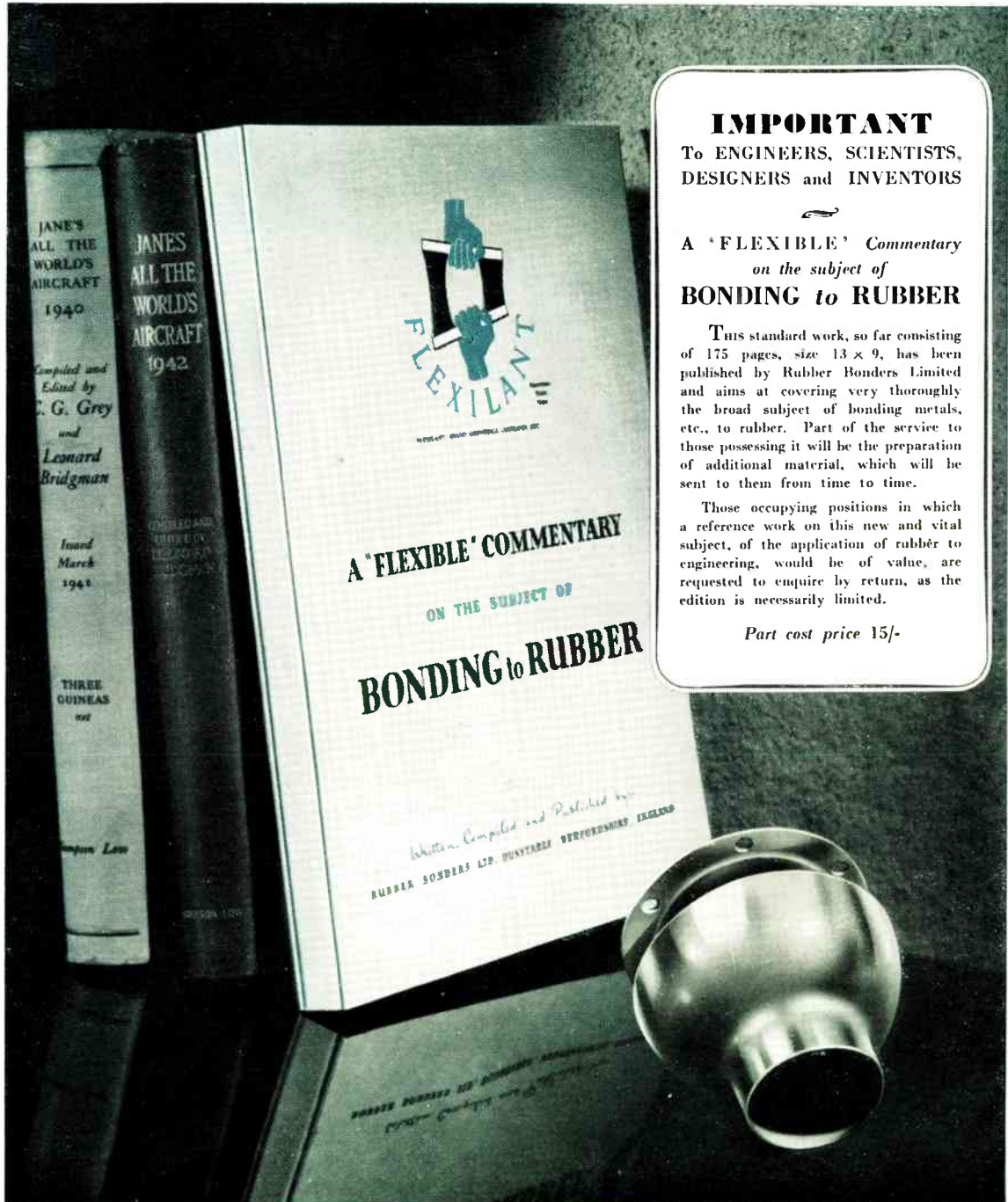

IMPORTANT

To ENGINEERS, SCIENTISTS,
DESIGNERS and INVENTORS

A 'FLEXIBLE' Commentary
on the subject of
BONDING to RUBBER

This standard work, so far consisting of 175 pages, size 13 x 9, has been published by Rubber Bonders Limited and aims at covering very thoroughly the broad subject of bonding metals, etc., to rubber. Part of the service to those possessing it will be the preparation of additional material, which will be sent to them from time to time.

Those occupying positions in which a reference work on this new and vital subject, of the application of rubber to engineering, would be of value, are requested to enquire by return, as the edition is necessarily limited.

Part cost price 15/-



RUBBER BONDERS LTD.

ENGINEERS & RUBBER BONDERS LTD. ENGLAND

FLEXILANT WORKS, DUNSTABLE, BEDFORDSHIRE

TELEPHONE: DUNSTABLE 803

Robert Sharp & Partners

8110



Regd. Trade Mark

PRECISION

TESTING INSTRUMENTS

HIGH accuracy, simplicity, exceptional versatility and proven reliability have won for "AVO" Instruments a world-wide reputation for supremacy wherever rapid precision test work is demanded. There is an "AVO" Instrument for every essential electrical test.

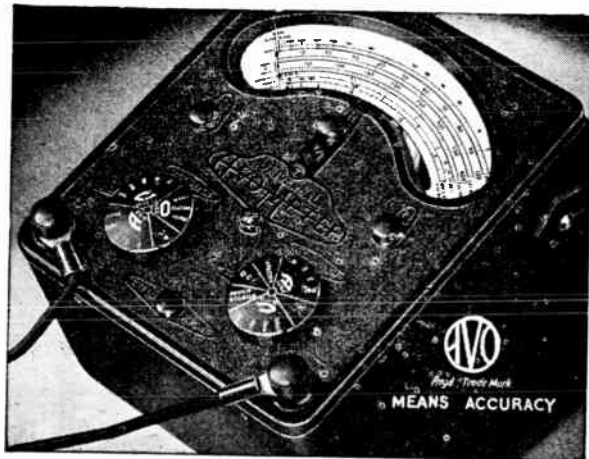

The MODEL 7 50-Range Universal

AVOMETER

Electrical Measuring Instrument

A self-contained, precision moving-coil instrument, conforming to B.S. 1st Grade accuracy requirements. Has 50 ranges, providing for measuring A.C. & D.C. volts, A.C. & D.C. amperes, resistance, capacity, audio-frequency power output and decibels. Direct readings. No external shunts or series resistances. Provided with automatic compensation for errors arising from variations in temperature, and is protected by an automatic cut-out against damage through overload.

Sole Proprietors and Manufacturers

THE AUTOMATIC COIL WINDER & ELECTRICAL EQUIPMENT CO. LTD., Winder House, Douglas Street, London, S.W.1. 'Phone: VICTORIA 3404/8

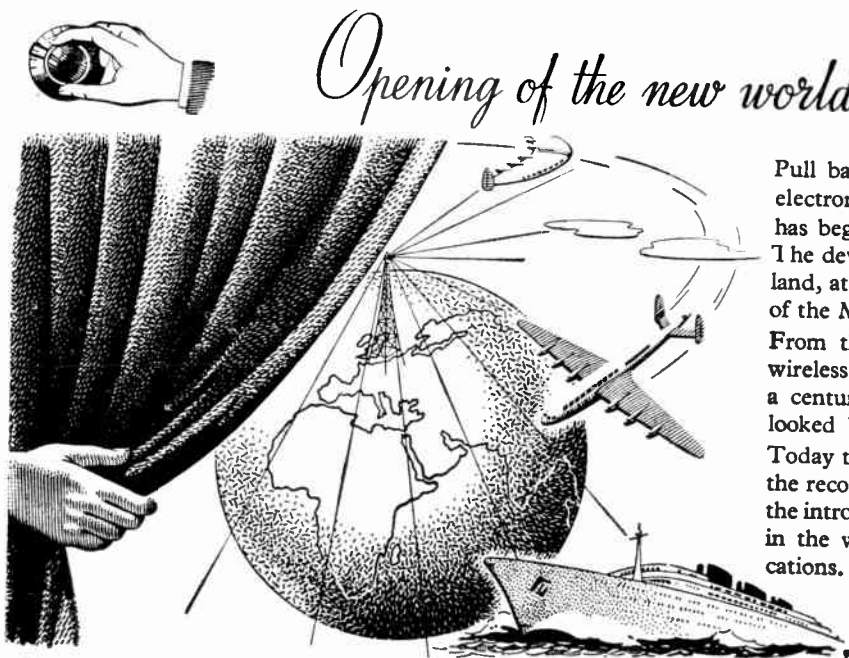

Opening of the new world of adventure

Pull back the curtain on the age of electronics—the era of industry that has begun with the end of the war. The development of new services on land, at sea and in the air are all part of the Marconi post-war plan.

From the first great adventure of wireless communication nearly half a century ago Marconi's have never looked back.

Today they are looking *forward*—to the reconstitution of old services and the introduction of new achievements in the world of wireless communications.

MARCONI *the greatest name in wireless.....*

THE MARCONI INTERNATIONAL MARINE COMMUNICATION COMPANY LTD • ELECTRA HOUSE, VICTORIA EMBANKMENT • LONDON, W.C.2

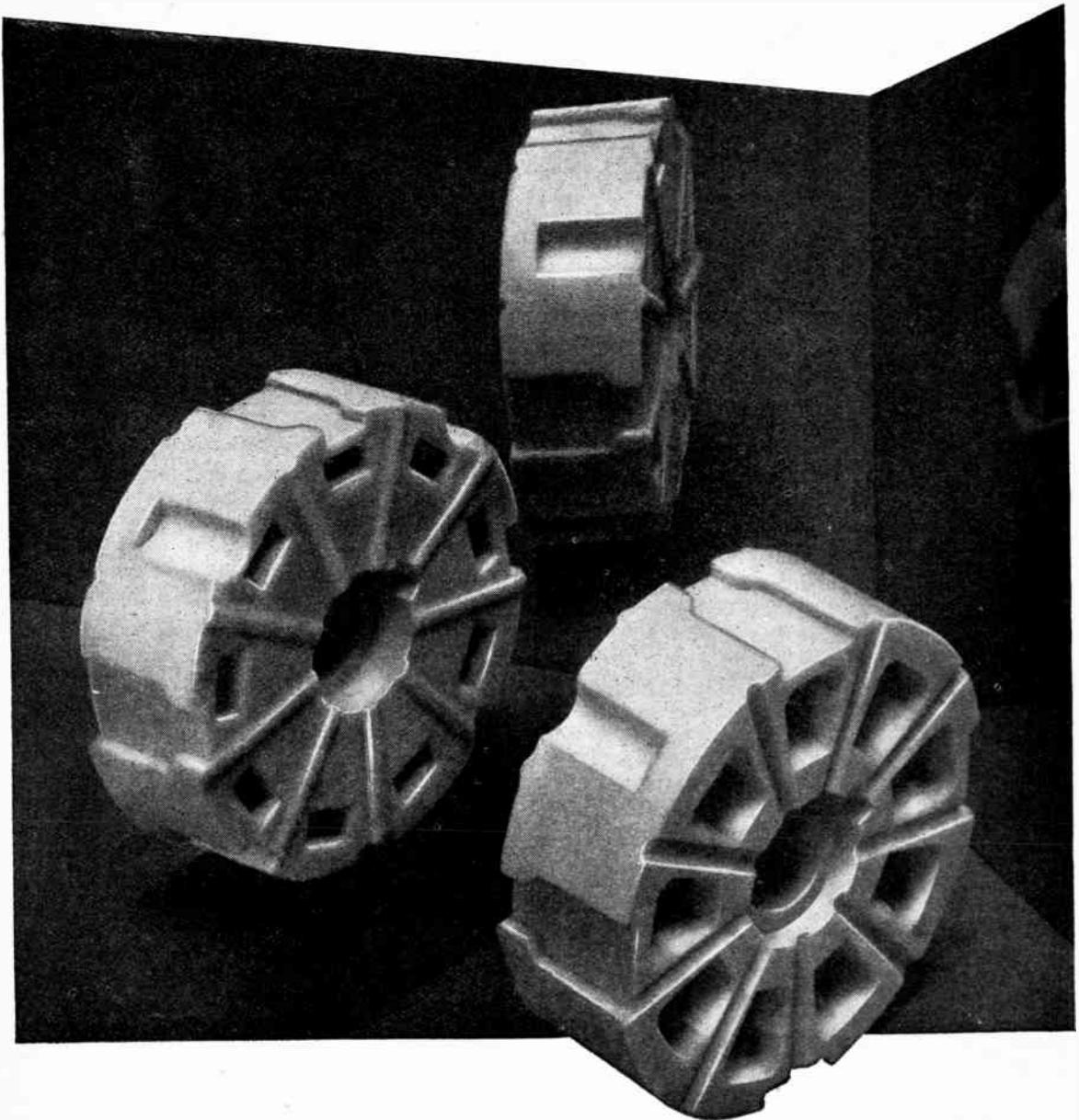

From every point of view
specify **FREQUENTITE**



Before finalising the design of new components consult **STEATITE & PORCELAIN PRODUCTS LTD.**
Head Office : Stourport-on-Severn, Worcs. 'Phone : Stourport 111. 'Grams : Steatoin, Stourport
S.P.39



THE COUNTERSIGN OF DEPENDABILITY IN ANY ELECTRONIC EQUIPMENT.

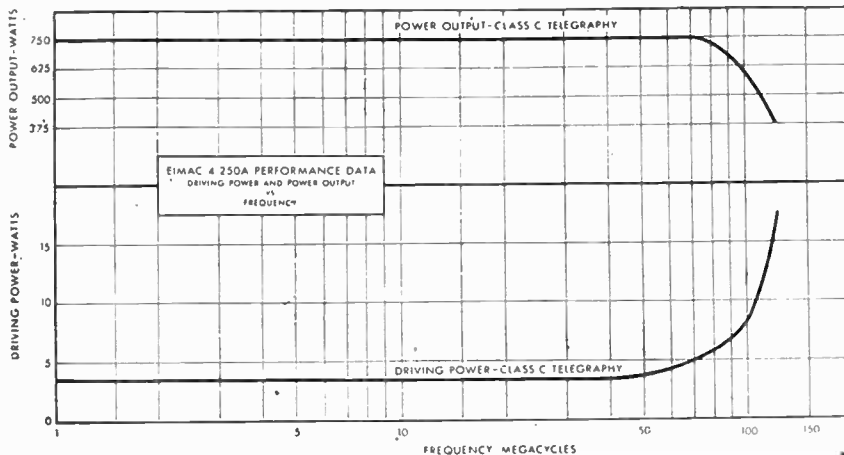

NEW EIMAC 4-250A TETRODE

Heading a parade of sensational new valves now in production, the Eimac 4-250A, Tetrode—introduced several months ago—is already in great demand. It may pay to check these performance characteristics against your own requirements.

As can be seen by the chart above, the new Eimac 4-250A Tetrode will deliver 750 watts output at frequencies up to 70 Mc. with a driving power of only 5 watts. At frequencies up to 40 Mc. an output of 750 watts may be obtained with a driving power of 3.5 watts.

The grid-plate capacitance of 0.12 *μ*fd. is extremely low, allowing operation at high frequencies without neutralization. Use of Eimac "X" process control grid reduces both primary and secondary emission which provides utmost stability.

You are invited to supplement the information given here with a technical bulletin on Eimac 4-250A Power Tetrode. It contains an elaboration of the valve's characteristics and constant current curves. Send your name and address and a copy will go to you by return mail.

The Lid's Coming Off...

Watch your favorite trade journals for announcements of other new Eimac valves to be released this year.

CAUTION! Check serial numbers on Eimac valves before you buy. Be sure you're getting newest types. Look for latest serial numbers.

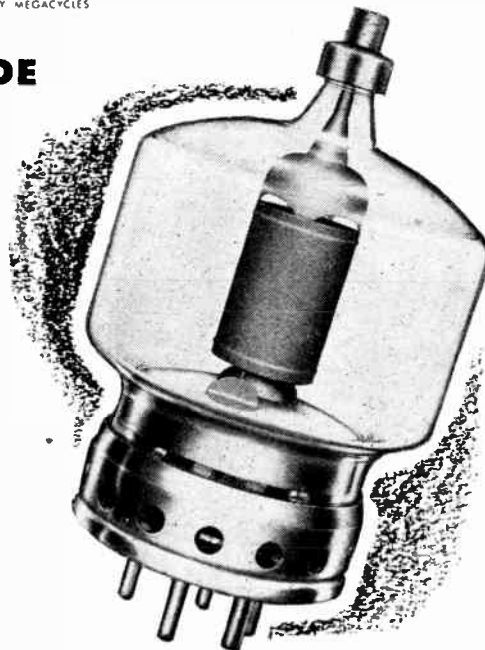

FOLLOW THE LEADERS TO



EITEL-McCULLOUGH, INC., 1086 San Mateo Avenue, San Bruno, Calif.
Plants located at: San Bruno, California and Salt Lake City, Utah
Export Agents: Frazer & Hanson, 301 Clay St., San Francisco 11, Calif., U. S. A.

TYPE 4-250A—POWER TETRODE
ELECTRICAL CHARACTERISTICS

Filament—Thoriated Tungsten	
Voltage	5.0 volts
Current	14.5 amperes
Plate Dissipation (Maximum)	250 watts
Direct Interelectrode Capacitances (Average)	
Grid-Plate	0.12 <i>μ</i> fd.
Input	12.7 <i>μ</i> fd.
Output	4.5 <i>μ</i> fd.
Transconductance (<i>i</i> _b = 80 ma., E _a = 3000 v., E _{c2} = 500 v.)	4000 <i>μ</i> mhos

Authorized Distributors: BERRY'S (SHORT-WAVE) LTD., 25, HIGH HOLBORN, LONDON, W.C.1.

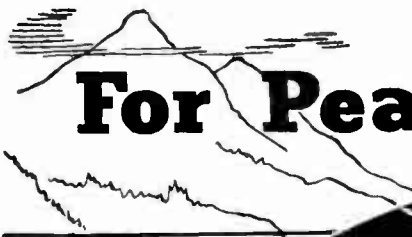

For Peak Performance

with High Voltages



U.I.C. Fixed Ceramic Pot and Plate Capacitors have been primarily developed for use in transmitter circuits. Made only from the highest grade raw materials and subjected to the most rigorous mechanical and electrical inspection, their performance especially with H.F. loads and high voltages is unsurpassed. TYPE APPROVED. Full details on request.

UNITED INSULATOR CO. LTD.
12-22 LAYSTALL STREET, LONDON, E.C.1
Tel: TERminus 7383 (5 lines) Grams: Calanel, Smith, London



CERAMIC
High-Voltage
CAPACITORS

THE PIONEERS OF LOW-LOSS CERAMICS

ELECTRONICS



made it possible!

Ten-tenths cloud and thick smoke over the target—but still the giant bombers droned their way to a pin-point and released their bombs on the scheduled spot. The science of electronics made it possible, for at the heart of every electronic aiming device lies the valve. OSRAM VALVES were in the forefront of electronic development during the war, and will now bring to the pursuits of peace many well-tried electronic devices to speed, smooth, and make safer, our way of life.



One of the famous Magnetron valves used in many centimetric Radar devices.

Osram

PHOTO CELLS

S.E.C.

CATHODE RAY TUBES

Osram

VALVES

Advt. of The General Electric Co. Ltd., Magnet House, Kingsway, London, W.C.2.

'PERSPEX'

TRADE MARK

TRANSPARENT SHEET

... which helped to win the Battle of Britain, the Battle of Germany and the War in the East

is available NOW for essential civilian requirements



IMPERIAL CHEMICAL INDUSTRIES LTD.
LONDON, S.W.1

P. 170

Your new STENTORIAN is being made now...

Extension Speakers, inc. Cabinet and Volume Control, available from

29/6

It may even be waiting for you at your local Radio Dealer's. Keep in touch with him; these attractive extension speakers with their superb reproduction offer such amazing value that they are being bought faster than they can be produced. More and more people appreciate the convenience of not being confined for their radio to the room the set occupies.

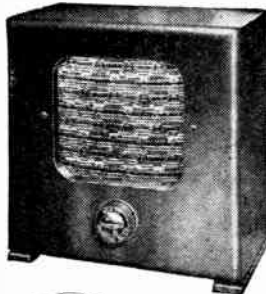

PRICES

- Minor Type MX (for Low Impedance Extension) - 29/6
- Minor Type MC (with Universal Transformer) - 35/6
- Baby Type BX (for Low Impedance Extension) - 43/6
- Baby Type BC (with Universal Transformer) - 49/6



Stentorian

THE PERFECT EXTRA SPEAKER FOR ANY SET

WHITELEY ELECTRICAL RADIO CO. LTD., MANSFIELD, NOTTS.

WHEN CHARACTERISTICS COUNT

TENAPLAS

EXTRUDED PLASTICS
are always specified

We make:—
INSULATED WIRES,
CABLES, TUBING, SOLID
SECTIONS, STRIPS, Etc.,
& CO-AXIAL CABLES
FOR ALL KINDS OF
HIGH-FREQUENCY
EQUIPMENT

Write to:—
TENAPLAS LTD.,
BLACKWOOD WORKS,
QUEEN ELIZABETH RD.,
KINGSTON-on-THAMES

TENAPLAS LTD

the "HAM" world The HUB of

WEBB'S *Radio*

Keen amateur experimenters know Webb's as the centre where the latest developments can be seen, explained and obtained. Expert technicians test and perfect all classes of radio equipment. A courteous and practical staff is ready to help you at our showrooms. That is why Webb's are recognised as Britain's leading specialists in Radio, Television and Electronics.

PRECISION CONTROL DIALS

We have a very wide selection of instrument controls by Muirhead, Eddystone, etc., including the National HRO Type, now made by Muirheads. This is a dial giving an equivalent of 10 ft. of calibration scale, 500 degrees, each degree $\frac{1}{2}$ in. long and is too well known for us to emphasise its superlative qualities.

Muirhead type D206A (National PWO), two driving shafts parallel to panel ... £5 2s. 6d.
Muirhead type D115A (National N PWO), single drive shaft at right angles to panel. £4 15s. 0d

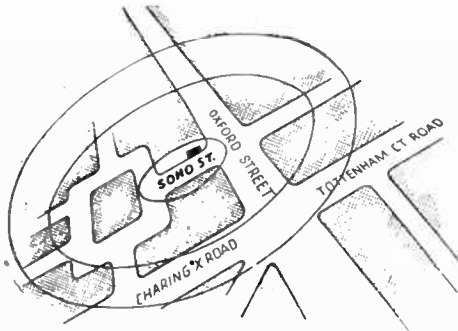
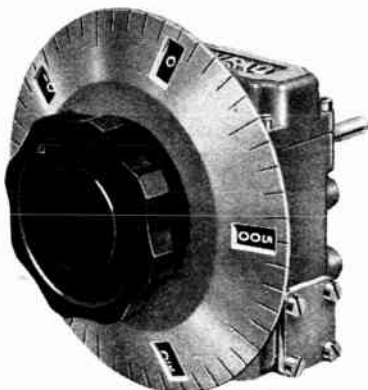

TRANSMITTING VALVES

Well known U.S.A. type now available, made by Standard Telephones.

- RK34 £1 18s. 6d. (Std. Tels. 4074A)
- 834 £3 17s. 6d. (Std. Tels. 4304CA)
- 807 £1 10s. 5d. (Std. Tels. 58250A)
- RK 20 £7 2s. 6d. (Std. Tels. 4052A)
- 813 £7 5s. 0d. (Std. Tels. 5C100A)
- 83 15/- (Std. Tels. 22V310A)

AERIAL ARRAYS

Pending our production of complete rotatable arrays we can supply DURALUMIN TUBE for home construction. In light but rigid 8ft. 6in. lengths $\frac{1}{2}$ in. outside diameter, $\frac{1}{6}$ per length.
NOTE: CALLERS ONLY
—REGRET NO MEANS OF DISPATCH.

AUTOMATIC KEY TYPE "RA"

Heavy cast gunmetal base finished fine grey crackle, rubber feet, no desk fixing necessary. Incorporates completely balanced electrical action of improved design. Heavy tungsten contacts, adjustable from 10 to 50 WPM—a key for the really discriminating speed fiend. A shorting switch is incorporated in the base for CW/Phone operation. Key type "RA" 47/6

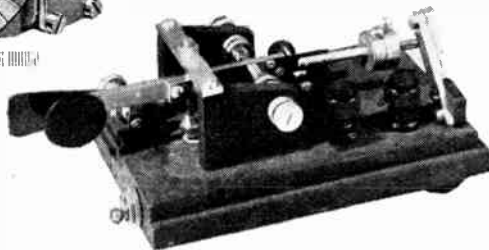

WODEN TRANSFORMERS

now available in full range from immediate stock, including Filament, all voltages of H.T., Modulation and Driver types. Input and Smoothing Chokes for all current ratings are included. These are the standardised LF Inductors made to match in appearance with grey cast metal end plates, and black laminations. Their use ensures a professional finish to your apparatus. Full list of types and prices available on application.

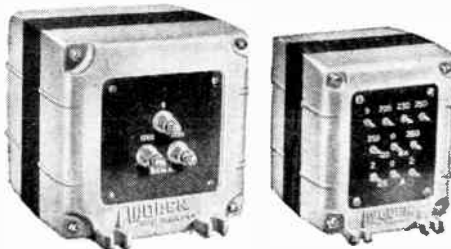

TAPPED "BLEEDER" RESISTORS

Vitreous enamel wire-wound resistors, power type with adjustable tapping clip.
50-watt rating :
25,000 ohms ... 11/3
50,000 ohms ... 14/9

Second printing of our INTERIM CATALOGUE is held up through paper control, etc.—Our apologies to many hundreds eagerly waiting for it. As a temporary measure we are sending details of selected items such as are of interest to the home experimenter.

WRITE, CALL OR TELEPHONE
14 SOHO STREET, LONDON, W.1.
TELEPHONE: GERRARD 2089

OFFICIAL BUSINESS HOURS : 9 a.m. to 5.30 p.m. SHOP HOURS : 9 a.m. to 5 p.m. (SAT. 9 a.m. to 1 p.m.)

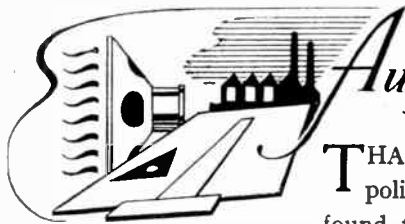

Augury for **TOMORROW...**

THAT tomorrow must be taken care of today has always been Goodmans policy. Constantly thinking and planning ahead Goodmans inevitably found themselves leaders in the field of Sound Reproduction. As a result, during the past critical years Goodmans have been entrusted with many onerous tasks in the designing and production of Loudspeakers, Microphones, and Earphones. True to their policy Goodmans tested and sifted to build data which might serve in the days to come. Now Goodmans stand ready to give of their greatly enhanced knowledge to the no less onerous tasks of Peace.

★
The GOODMANS RANGE
 Includes Loudspeakers from 2½ dia. (¼ watt output) to 18 in. cone models and Industrial Types up to 20 watts output.

The **TYPE T2/12.** Overall Dia. 12¾ in. Voice Coil Impedance 15 ohms at 400 C.P.S. Power Handling Capacity 12 w. Peak A.C. on flat 4 ft. baffle (15 w. horn loaded). Flux. Density 13,000 gauss.



GOODMANS
Loudspeakers

GOODMANS INDUSTRIES LTD · LANCELOT RD · WEMBLEY · MIDDX

PORTABLE BEAT FREQUENCY OSCILLATOR



BSR

A PRODUCT of **PRECISION**

BIRMINGHAM SOUND REPRODUCERS LIMITED. OLD HILL, STAFFS.

BSR
 TYPE
 LO.50

0-600 CPB
 0-15000 CPB

M-W. 47

INSTRUMENTS FOR SPECIAL PURPOSES

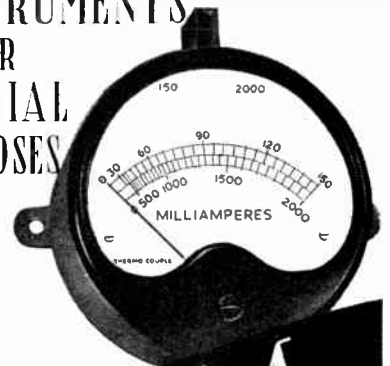

HIGH-GRADE
 MODERN
 DESIGN.

SIFAM

ELECTRICAL INSTRUMENT
 COMPANY LIMITED
 TORQUAY DEVON

BELLING-LEE AERIALS

(U.K. Reg'd Designs applied for.)

Aerials are already in production. Many thousands have been sold, and set makers, in finalising arrangements, are discussing the possibility of riggers undertaking television aerial installations in and around London. Have you an aerial problem . . . of any description?

SKYTOWER A 50 ft. vertical aerial suitable for relay undertakings, factories, laboratories, blocks of flats, offices, hotels, etc. List No. 574 Price £90 : 0 : 0

SKYROD Each kit complete with 12 ft. or 18 ft. vertical collector, matching transformers, screened downlead, available with pole clamps and lashings for chimney.

List No.	Type of Mounting	Price
355 CK	With clamps for mast	£7 : 2 : 6
355 LK	For chimney lashing	£8 : 8 : 0
370 LK	For mast and chimney lashing	£9 : 10 : 0*
392 CK	As 355 CK but with 18 ft. collector	£11 : 5 : 0
	120 ft. downlead	
392 LK	As 370 LK but with 18 ft. collector	£14 : 0 : 0*
	120 ft. downlead	

*Less mast, normally supplied by us—but at present not available.

VIEWROD Television aerials with and without reflector, normally supplied with pole (when available) and all lashings. Kits from £1 : 17 : 6

WINROD Vertical aerial 8 ft. for use in flats, etc., or where access to roof is considered undesirable. To fix on window ledge, very versatile fixing arrangements. List No. L.581 Price 18/6d.

CAROD Highly polished stainless steel aerial for fixing to car, extendable rod. List No. 582 Price £1 : 2 : 6

AEROD Vertical aerial 6 ft. complete with heavy bakelite moulded insulator designed in conjunction with Office of Works and officially specified for use in pre-fabricated houses. List No. 573 Price £3 : 19 : 0

BELLING & LEE LTD
CAMBRIDGE ARTERIAL ROAD, ENFIELD, MIDDX

The illustration on the left is the Skyrod Aerial. List No. 370LK. Mast is normally supplied by us—but at present not available.



The illustration above shows the Belling-Lee Skytower Aerial—a 35 ft. lattice mast surmounted by an 18 ft. Skyrod.

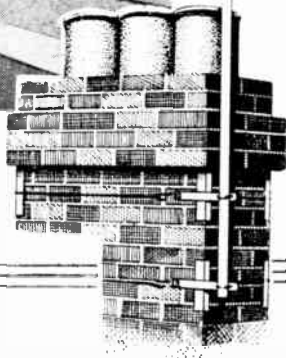

Difficult Problems?

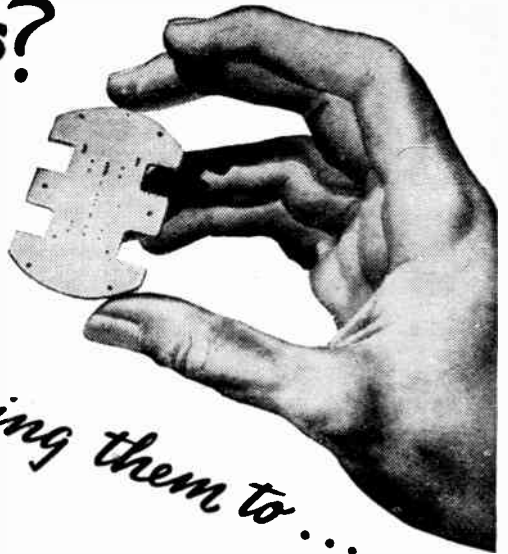
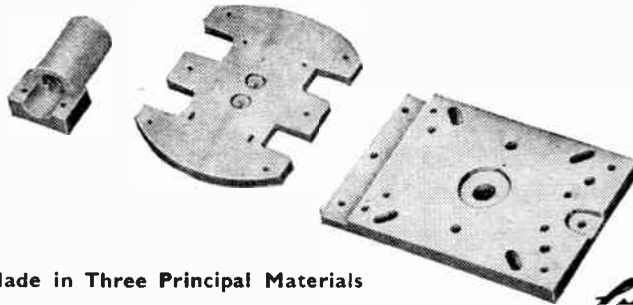

Made in Three Principal Materials

FREQUELEX

An insulating material of Low Di-electric Loss, for Coil Formers, Aerial Insulators, Valve Holders, etc.

PERMALEX

A High Permittivity Material. For the construction of Condensers of the smallest possible dimensions.

TEMPLEX

A Condenser material of medium permittivity. For the construction of Condensers having a constant capacity at all temperatures.



Bullers

BULLERS LOW LOSS CERAMICS

BULLERS LTD., 6, LAURENCE POUNTNEY HILL, LONDON, E.C.4

Telephone: Mansion House 9971 (3 lines)

Telegrams: "Bullers, Cannon, London"

Manchester Office: 196, Deansgate, Manchester

Wharfedale BIJOU Extension Speaker

With Standard
8-in. Unit
60/-

With Bronze
8-in. Unit
65/-

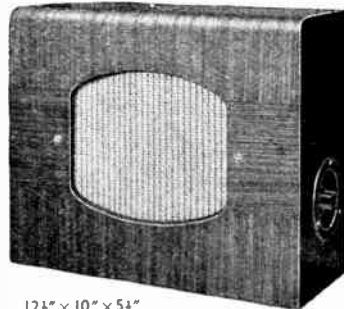

12½" x 10" x 5½"

The production of Wharfedale Cabinet Speakers is still restricted, but the Quality and Finish are up to the highest standards. The BIJOU is outstanding in appearance and performance.

WHARFEDALE WIRELESS WORKS
HUTCHINSON LANE, BRIGHOUSE, YORKS.

'Phone: Brighouse 50.

'Grams: "Wharfedel, Brighouse."

More Suppliers of RAYMART products

For previous list see page 8 of February Issue.

- ALFRETON Radio Services, 12, King Street.
- ASHTON-UNDER-LYNE Ashton Radio Repair Service, 33, Mill Lane.
- BROMLEY, Kent A.C.S. Radio, 44, Widmore Road.
- BURNLEY Thos. B. Wimbush, 27-29, Canning Street, Stoneholme.
- CONWAY J. Bevan Evans, 15, Bangor Road.
- DARLINGTON, Co. Durham C.R.S.S., 91, High Northgate.
- EDGWARE Electrical Service (Edgware), Ltd., 39/40, South Parade, and 13, North Parade.
- KETTERING H. York & Son, 93-97, Montague Street.
- LONDON Park Electric Co., 3, New Park Road, Brixton Hill, S.W.2.
- LONDON Amateur Wireless Supplies, 16, Crystal Palace Road, Upper Norwood, S.E.19.
- NOTTINGHAM Wm. B. Martin, 208, Lower Parliament Street.
- REDDITCH D. R. Cockings, 101, Evesham Road, Headless Cross.
- SOUTHPORT R. W. Rogers, 72, Sandon Road, Hillside.
- SOUTHPORT Harmony House Sound Service, 118, Cambridge Road, Churchtown.
- TOTTEN, Hants. Holgate Radio Co.
- WOLVERHAMPTON F. T. Smith, 26, Moor Street, South.

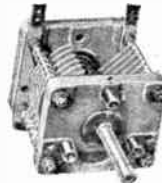

SPLIT STATOR CONDENSERS

Ideal for U.H.F. work, both transmitting and receiving

We have been fortunate enough to obtain supplies of these (surplus to Government requirements) Condensers which are first grade quality, with double end plates and ball bearings at each end of the spindle. Both rotor and stator vanes are silver plated. Matching is extremely accurate on each section. Take advantage of our special purchase, we offer them to you at

RAYMART
CRAFT A CREED

ONLY 3/9 EACH.

48, HOLLOWAY HEAD, BIRMINGHAM 1

PREMIER RADIO COMPANY

MORRIS & CO. (RADIO) LTD.

CALLERS to 169 FLEET STREET, E.C.4. 'Phone: Central 2833
 ALL POST ORDERS to 167 LOWER CLAPTON RD., E.5. 'Phone: Amherst 4723
 ALL GOODS NEW AND GUARANTEED. TERMS OF BUSINESS, CASH WITH ORDER, OR C.O.D. OVER £1

5-WATT AMPLIFIERS. AC/DC operation, 3 stages, high gain, 3 ohm output, £8 8s.

ALUMINIUM CHASSIS. Substantially made of bright aluminium, with four sides. 10in. x 8in. x 2 1/2in., 7/-; 12in. x 8in. x 2 1/2in., 7/9; 16in. x 8in. x 2 1/2in., 8/6; 20in. x 8in. x 2 1/2in., 10/6.

I.F. TRANSFORMERS. Iron core, litz wound, with or without flying lead, 460/465 K/c, 7/6 each.

PLUG-IN S.W. COILS. Four and six pin types now have Octal Spacing and will fit International Octal Valve Holders. Four-pin type (two windings). Six-pin type (three windings).

4 PIN		6 PIN	
Type	Range	Type	Range
04	9-15 m.	06	9-15 m.
04A	12-26 m.	06A	12-26 m.
04B	22-47 m.	06B	22-47m.
04C	41-94 m.	06C	41-94 m.
04D	76-170 m.	06D	76-170 m.
04E	150-350 m.	These Ranges are with .00016 Condenser.	
04F	265-550 m.		
04G	490-1,000 m.		
04H	1,000-3,000 m.		

MIDGET COILS. Unscreened Type, size 1 1/4in. x 1/4in., designed for I.F. O.P. 465 K/c. Available in the types Oct. H.F. Tran. Aerial and in the following bands: 19-35, 15-47, 34-100, 94-251, 200-577, 250-750, 700-2,000 metres. All types 2/3 each. Trimmers and Padders for all types, 8d. to 1/8. Also available, B.F.O. Coils, Aerial Filter, H.F. Filter. Same type and price as above.

YAXLEY TYPE SWITCHES. 2-pole 3-way 2-bank, 5/6; 2-pole 6-way 2-bank, 5/6; 2-pole 3-way 3-bank, 7/-; 2-pole 6-way 3-bank, 7/-; Any of the following types at 4/- ea. 1-pole 3-way, 1-pole 11-way, 2-pole 3-way, 2-pole 5-way, 3-pole 3-way.

S.W. VARIABLE CONDENSERS. All Brass "Polystyrene Insulation," extended spindle for ganging. Noiseless. 15 mmfd., 2/11; 25 mmfd., 3/3; 40 mmfd., 3/3; 100 mmfd., 3/11; 160 mmfd., 4/8; 250 mmfd., 5/8.

FULL VISION S/M DRIVES. Calibrated 16-47, 200-557 and 700-2,000 with station names, 8-1 Escutcheon, size, 7 1/4in. x 4 1/4in., 10/6. Junior Model. Calibrated 200-557 and 700-2,000 and station names. Escutcheon size, 5in. x 4in., 8-1, 10/6.

EPICYCLO DRIVES. 8-1 reduction, 2/9.

UTILITY MICRODIAL. Communication Type. Slow and Fast Motion Dual Knob and silver engraved, 6in. circular dial with hairline cursor 100-1 reduction. Fits entirely on front of panel, 8/6.

AIR-DIELECTRIC TRIMMERS. Ceramic Base 5-35P4, 1/6.

MAINS DROPPER RESISTANCES. Variable Type, with sliding adjustment, 1,000 ohms, .3 amp., 5/6; 800 ohms, .3 amp., 5/6.

WIREWOUND RESISTANCES. 6 watt. Any value from 40 ohms to 20,000 ohms, 2/-.

PREMIER MAINS TRANSFORMERS

All primaries are tapped for 200-230-250 v. mains 40-100 cycles. All primaries are screened. All LTS are centre tapped.

Output	Price
175-0-175 v. 50 m/a. 6.3 v. 2-3 a. 5 v. 2 a.	25/-
175-0-175 v. 50 m/a. 4 v. 1 a 4 v. 2-3 a.	25/-
250-0-250 v. 60 m/a. 6.3 v. 2-3 a. 5 v. 2 a.	25/-
250-0-250 v. 60 m/a. 4 v. 1-2 a. 4 v. 3-5 a.	25/-
300-0-300 v. 60 m/a. 6.3 v. 2-3 a. 5 v. 2 a.	25/-
300-0-300 v. 60 m/a. 4 v. 2-3 a. 4 v. 3-5 a. 4 v. 1-2 a.	25/-
350-0-350 v. 100 m/a. 5 v. 2-3 a. 6.3 v. 2-3 a.	29/-
350-0-350 v. 100 m/a. 4 v. 2-3 a. 4 v. 2-3 a. 4 v. 3-5 a.	29/-
350-0-350 v. 150 m/a. 4 v. 1-2 a. 4 v. 2-3 a. 4 v. 3-5 a.	36/-
350-0-350 v. 150 m/a. 4 v. 2-3 a. 4 v. 3-5 a. 4 v. 1-2 a. 4 v. 1-2 a.	39/-
350-0-350 v. 150 m/a. 5 v. 2-3 a. 6.3 v. 2-3 a. 6.3 v. 2-3 a.	36/-
425-0-425 v. 200 m/a. 4 v. 2-3 a. 4 v. 2-3 a. 4 v. 3-5 a.	47/-
425-0-425 v. 200 m/a. 6.3 v. 2-3 a. 6.3 v. 3-5 a. 5 v. 2-3 a.	47/-
500-0-500 v. 150 m/a. 4 v. 2-3 a. 4 v. 2-3 a. 4 v. 2-3 a.	47/-
500-0-500 v. 150 m/a. 5 v. 2-3 a. 6.3 v. 2-3 a. 6.3 v. 3-5 a.	50/-
500-0-500 v. 250 m/a. 5 v. 2-3 a. 6.3 v. 2-3 a. 6.3 v. 3-5 a.	65/-

PLAYING DESKS. A few only available. Consist of an Electrical Gramophone Motor with automatic stop and speed regulator, a quality magnetic Pick-up mounted on a strong metal frame. Price complete £8 8s.

MIDGET RADIO KITS. Complete with drilled chassis, valves and loud speaker, only cabinet required, medium and long wave T.R.F.P., size 10 x 6 x 6, 4 valves, inc. rect., tone control, AC/DC operation, 200/250 v. Circuits and constructional details supplied. Price, including tax, £8 17s. 6d. Cabinet, if required, 25/- extra.

METER KITS. Consist of a 60 microamp (20,000 ohms per volt) meter size 4 1/2 x 4 1/2. Calibrated volts, milliamps, ohms, complete with Multipliers for 5 to 1,000 volts in six ranges for DC. 10 to 1,000 volts in 5 ranges for AC two six-way switches, a full-wave metal Rectifier, a quantity of resistance wire to construct any current shunt required by the "Trial and Error" method. Price £6 10s.

SUPERHET TUNING KIT. Nine midget coils to cover 16-47 200-557, 700-2,000 metres for H.F. Aerial and Osc. All padders and trimmers. Pair 465 K/c Iron-cored I.F. Trans. 3-gang Condenser with calibrated S/M Drive, 3-bank wave-change Switch. Price £3 15s.

SUPER QUALITY AC/DC AMPLIFIERS. 12 watts output, contained in steel case. Output Transformer matches any speaker 2-30 ohms. Push-Pull Output. Complete with Electric Record Playing Desk with Pick-up. Price £18 18s.

A pair of suitable Loudspeakers can be supplied, Goodmans 10in. P.M. Type at 47/6 each. A suitable Transmans 10in. P.M. Type with Transformer at £3 15s. verse Current Microphone with Transformer at £3 15s.

BATTERY CHARGER KIT. Consists of a Metal Rectifier, Mains Transformer, and Variable Resistance to charge a 6 or 12 volt battery at four amps. Price £4. Senior Model, output eight amps, £6.

EMERGISED SPEAKERS. 8in. diameter, 7,500 ohm field. Require 20-30 m/a. 3 ohm V.C. handle, 4 watts, 10/- each.

.0005 CONDENSERS. Ceramic insulation. "Bar" Type. Single gang, 5/-; Twin gang, 7/6; three gang, 10/-; four gang, 10/-.

GRAMOPHONE MOTORS. Double spring, complete with handle and speed regulator, no turntable. Price 30/- each.

FOUNDATION AMPLIFIER KIT. Consists of 16 x 8in. chassis, 2 PX4 valves, 350 v. 150 m/a. Trans., 1 MH41 valve, 2 8 mfd. 500 v.v. oil-filled condensers, 1 Rectifying Valve, 1 Output Transformer to match any voice coil between 2 and 30 ohms, 1 Smoothing Choke. Price £6 6s.

MIDGET I.F. TRANSFORMERS. 465 K/c. Permeability tuned, size 1 1/4 x 1 1/4 in. Price 7/6 each.

CERAMIC VALVE HOLDERS. 5-pin U.X., 4-pin U.X., 1/- each. International Octal, 2/- each.

BUTTERFLY CONDENSERS. Split Stator 50+50 pf. variables. All soldered joints, ceramic end plates. Price 3/6 each.

MOVING COIL METERS. 30-0-30 amps., 2in. diam., 19/6.

P.M. SPEAKERS. 5in., 21/6; 6in., 22/6; 8in., 24/-; 10in. 6 watt 15 ohm, 47/6; 8in. 15 ohms, 15 watts when horn loaded, 55/-; 12in. 15 ohms 15 watts, a high fidelity job, £6 15s.

OUTPUT TRANSFORMERS. A super production. By means of ingenious series-parallel arrangement all windings are used at all times. Match any tube, single or push-pull to any voice coil 2-30 ohms. 7 watts, 22/6; 15 watt, 30/-; 30 watt, 49/6; 60 watt, 59/6.

ENAMELLED COPPER WIRE

	8 oz.	16 oz.
16g.	1/11	3/6
18g.	1/11	3/6
20g.	2/-	3/9
22g.	2/2	3/10
24g.	2/2	3/10
26g.	2/5	4/2
28g.	2/6	4/2
30g.	2/6	4/4
32g.	2/8	4/6
34g.	2/10	5/-
36g.	3/1	5/6
38g.	3/7	6/4
43g.	-	12/6

Brand new GOVT. SURPLUS. Many items at less THAN COST

ROTARY TRANSFORMERS. Input 12 v., output 160 v. 30 m/a. 4 v. 3 a. with 19 volts input, output is 50 per cent. higher. May be used on D/C mains as L.T. Charger. With small conversion could operate as D/C Motor. Original cost over £5. Employ powerful ring magnet. Price 10/- each.

ROTARY TRANSFORMERS. Input 12 v., output 200 v. 60 m/a. 8 v. 2 a. with 19 v. input, output is 50 per cent. higher. Price 30/- each.

ROTARY TRANSFORMERS. Input 24-28 volts. Output 1,200 v. 70 m/a. Price £3 each.

MOTOR GENERATORS. Completely screened with smoothing. Input 6 v. output 220 v. 60 m/a. Price £4 each.

MOTOR GENERATORS. Input 24 v. output 1,700 v. 150 m/a. Price £6 each.

MOTOR GENERATORS. Input 12 v. output 240 v. 100 m/a. 6 v. 10 a. £4 10s.

VIBRATOR POWER PACKS. Input 6 v. output 120 v. 15 m/a. Price 40/- each.

MANSBRIDGE TYPE (PAPER) CONDENSERS. Super quality, oil filled, 8 mfd. 500 v.v., 5/-; 4 mfd. 750 v.v., 7/6; 8 mfd. 750 v.v., 10/-; 4 mfd. 1,000 v.v., 10/-; 1 mfd. 1,000 v.v., 3/6; 1 mfd. 2,500 v.v., 10/-; 3 mfd., 2,500 v.v., 15/-; 1 mfd. 5,000 v.v., 15/-.

CONSTANT VOLTAGE TRANSFORMERS. Input 190-220 v., output 230 v. 150 watts. Price £6 each.

ELECTROLYTIC CONDENSERS. 8 mfd. 500 v.v., 3/-; 4 mfd. 500 v.v., 2/6; 8+8 500 v.v., 3/11; 16 mfd. 150 v.v., 3/-; 12 mfd. 600 v.v., 4/6; wet type, 16 mfd. 440 v.v., 7/-; 16+16 250 v.v., 7/6; 32 mfd. 550 v.v., size 4 x 2 1/4, 5/-; 16 mfd. 700 v.v., size 5 x 4 x 2, 7/6; 16+16 450 v.v., size 5 x 2 1/4 x 1 1/2, 5/6.

MAINS TRANSFORMERS. All 230 v. primary, 4 v. 1-2 amps., 7/6; 1,250+1,250 v. 250 m/a., £5; 4 v. 32 a., 10/-; 6 v. 4 a. twice, 20/-.

MIDGET TRANSFORMERS. Output 10,000 ohms to 600 ohms, 2/6. Power, Pentode or P.P. to 3 ohms, 6/6.

SWITCHES. 4-position switches, carry 30 amps. Price 10/- each.

RHEOSTATS. Met-Vick Worm Slider, 7.5 ohms, 5 amp., 15/-.

2-GANG VOLUME CONTROLS. Each 1 meg. Price 7/6 each.

11.85 KV.A. TRANSFORMERS. Oil filled, 3,630-0-3,630 v. with 4 taps. Tropical hand wheel adjustment. Price £10 each.

CO-AXIAL CABLE. Super quality, consisting of a stranded centre core, a low-loss ribbed polyvinyl resin type insulator, a flexible screen, a weatherproof P.V.C. outer cover. Just the thing for Television Lead-in or Super Mike Cable, 6d. per foot.

WESTON MICROAMETERS. 3 1/4in. diameter, 250-0-250 microamps. Price 35/4 each.

TURNER 2 MILLIAMP METERS. 3 1/4in. diameter. Calibrated 300 and 600 v., complete with external wire-wound shunt. Price 35/- each.

2 1/2 MILLIAMP METERS. Size 4 1/2 x 4 1/2. Calibrated volts, milliamps, ohms. Price 45/- each.

MOVING COIL MIKES. Speech only, close speaking, in bakelite case with four ears for spring mounting. Complete with matching transformer. Price 30/- each.

TRANSMITTING CRYSTALS. X Cut, high output, most frequencies between 7006 and 7289 K/c.s., 15/-; TRANSFORMER CARCASSES, ideal for rewinding. All in perfect order with 230 v. primaries but odd type secondaries. 50 watt size, 7/6; 100 watt, 10/-; 150 watt, 12/6; 350 watt, 15/-.

P.O. TRANSMITTER INSERT. Carbon type, makes a satisfactory speech microphone. Complete with Transformer, 10/-.

FIRST GRADE MOVING COIL METERS

	Final Mounting Bakelite Cases	1 milliamper	500 microamp	100 microamp
3 1/4in. dia.	£2 12 0	£2 18 6	£3 8 3	£4 11 0
4 1/4in. dia.	£3 5 0	£3 11 6	£4 11 0	

Internal Resistance 60 ohms 550 ohms 900 ohms

WESTINGHOUSE METER RECTIFIERS

Bridge Type	Price
100 microamp	16/8
500 microamp	10/-
10 milliamper	10/-
1 milliamper	10/-
5 milliamper	10/-
10-100 milliamper	8/6

HY-MEG IMPREGNATED

ELECTRICAL APPARATUS

USE HY-MEG THE MODERN TIME-SAVING IMPREGNATING MEDIUM

Executives in charge of the production of electrical apparatus calling for impregnation, should send for the HY-MEG Booklet "Stability in Insulation". It describes fully how HY-MEG scientifically overcomes problems arising both in production and operation. Apply on Business Heading or Card and enclose 2d. to comply with the Control of Paper Orders.

LEWIS BERGER & SONS LTD., (Established 1760) LONDON, E.9 Phone: AMHerst 3321

MANUFACTURERS OF INSULATING VARNISHES AND ENAMELS

M.R. SUPPLIES

now offer from stock the following useful range of brand new **RECTIFYING** and other **ELECTRICAL EQUIPMENT**. Prompt despatch. All prices nett.

S.T.C. METAL RECTIFIERS (Selenium). For battery charging up to 12 volts in conjunction with suitable Transformers (see below). 1.5 amp. 12/6; 3 amps., 22/6; 6 amps., 39/6; 10 amps., 49/6 (despatch last 2 items 2/-). Also a few 24 volts 80 amps., 210 10s. (despatch 3/-). Also small relay-operating or bias type, 25 volts 75 m.a. (half-wave), 4/6; 25 volts 75 m.a. (bridged—full wave), 7/6. Small make H.T. RECTIFIERS 240 v. 60 m.a. 16/6; 320 v. 60 m.a. 19/6. (For field excitation or anode supply.)

STEP-DOWN MAINS TRANSFORMERS. All primaries, 230/240 v. (tapped). Sec. 7, 11 and 15 v. at 2 amps. (for 12/6 rectifier) 20/- Sec. 8 and 14 v. at 3 amps. (for 22/6 rect.), 32/6. Sec. 5, 12 and 17 v. at 6 amps. (for 39/6 rect.), 49/6.

SLIDING RESISTANCES, fully enclosed, 4 ohms 5 amps, 10 ohms 3 amps 50 ohms 1.4 amp, 100 ohms 1 amp, 200 ohms 0.7 amp, 400 ohms 0.5 amp, any one 25/-, Also 1100 ohms 0.375 amp, 29/6. Also 6000 ohms 0.25 amp 85/- (desp. 2/6). Also 500 ohms 1 amp, 59/6. **DIMMERS** with hand-wheel control (220/240 v.), 1000 watt, 26 17s. 6d.; 1500 watt, 28 8s.; 2500 watt 29 17s. 6d. (des. either 7/6 plus 20/- for returnable case).

L.F. CHOKES, 10 h. 150 m.a. (150 ohms) 18/6; 15 h. 100 m.a. (320 ohms), 12/6.

CONNECTING WIRE (Hamödl). Rubber covered 20 SWG tinned copper in various colours, 18ft. coils, 1/-; 6 coils for 5/-. Spec. price for quantities in length.

SCREENED CONDUIT woven, flexible reinforced 1/4 in. bore, 1.9 yard; 1/2 in. bore, 2/9 yard. **CO-AXIAL CABLE**, best quality 2/9 yard. **SCREENED WIRE**, single 20 SWG conductor, 4d. yard.

ROTHERMEL-BRUSH PIEZO-CRYSTAL MICROPHONES D.104 specially housed with knuckle-joint mount, with 6ft. screened lead 78/6. Also special miniature piezo-crystal Microphone Inserts, 1 1/2 in. dia. 29/6.

GRAMPIAN MOVING COIL MICROPHONES, 15-ohms imp. mounted in square suspension frame, fine performance 24 4s. **FLOOR STANDS** (folding), all chrom. ext. to 5ft. 6in., 47/6.

LOUDSPEAKERS (first-grade models only offered). **VITAVOX**, high fidelity, 12in. P.M. Units, 15 ohms coil, K12/10 (10 watt) 27. K12/20 (20-watt), 211 (desp. either 5/-). **VITAVOX BI-TONE**, 231 10s. (desp. 6/-) **G.E.C.** 8 watt P.M. in 10 1/2 in. dual-direction metal drum with mounting bracket and fitted tapped transformer, 75/- (desp. 2/6). **PROJECTOR SPEAKERS**, Vitavox 10-watt P.M. Unit (15 ohms) with 30in. all-metal Horn 23 17s. 6d. (desp. 7/6).

PYROBRAZE ELECTRIC SOLDERING AND BRAZING EQUIPMENT, 200/250 v. A.C., complete instruments, ready for use. No. 1 (Portable), 3/5 minute rating, 30/120 amps, 218 10s. No. 2, also suitable for welding up to 18 SWG metal sheet, 20/30 minute rating, 30/130 amps, 216 10s. (desp. either 6/-). Further details upon request.

RELAYS (P.O. type, brand new), 200 ohms coil. s.p.co. switching, 7/6.

TOGGLE SWITCHES, snap action, 5 amp 2/- each, 20/- dozen.

S.T.C. SOLDER resin-cored 13 SWG, 40 p.c. tin 1 lb. reels, 4/6.

ROTHERMEL PIEZO-CRYSTAL PICKUPS, senior mode, with black bakelite arm, 78/9. **STROBOSCOPIC SPEED TESTERS** (50 c.), 78. 79 80 rpm, 1/-.

IN STOCK (inspection invited): **GRAMPIAN 15-watt AMPLIFIERS**, **ROTHERMEL 8-watt AMPLIFIERS** **STANDARD COMBINED MEASURING INSTRUMENT** (by Hartmann & Braun—Germany) D.C. volts, milliamps and amps (11 readings), 0.1 per cent. accuracy.

Please include sufficient for despatch where not stated

M.R. SUPPLIES, 68, New Oxford Street, London, W.C.1
Telephone: MUSeum 2958

MINIATURE or MIDGET

We specialise in their manufacture

HIVAC
THE SCIENTIFIC VALVE

BRITISH MADE

Originators, designers & manufacturers of Midget Valves

HIVAC LIMITED, Greenhill Crescent, Harrow on the Hill, Middx. Phone: O895

R.G.D.**announce**

that they have in production a new high quality radiogramophone which is expected to be available for delivery during March. Full details, specification and price will be announced to coincide with the approximate release date.

Distribution Policy The R.G.D. radiogramophone will be distributed through the under-mentioned wholesalers to dealers approved and accepted under the following conditions:

" A retail radio dealer shall mean any person, firm or corporation of good financial standing, having suitable shop or showroom premises rated as business premises open to the public during ordinary business shopping hours, trading on his, their or its own account as a dealer or dealers in radio re-

ceiving sets or radiogramophones, who continuously maintains and displays a reasonable stock of such products for resale to users only at prices neither more nor less than the Company's fixed retail prices and who also is prepared and qualified within reasonable limits to offer efficient service."

Wholesalers**LONDON**

John E. Dallas & Sons Ltd., 5-13 Shorts Gardens, W.C.2. Tel. Temple Bar 0643.
E. R. Harveyson & Co. Ltd., Albert Place, Finchley, N.3. Tel. Finchley 1121-2.
Lugton & Co. Ltd., 210-212 Tottenham Court Road, W.1. Tel. Museum 3261.
Selecta Gramophones Ltd., 1-3 Brixton Road, S.W.9. Tel. Reliance 1145.
Sun Electrical Co. Ltd., 118-120 Charing Cross Road, W.C.2. Tel. Temple Bar 3500. And Branches.
Thompson, Diamond & Butcher, 34 Farringdon Road, E.C.1. Tel. Clerkenwell 5492.
" Z " Electric Lamps & Supplies, 21 Newman Street, W.1. Tel. Museum 8531. And Branches.

BIRMINGHAM

Electrical Components Ltd., 102 Snow Hill. Tel. Central 3081. And Branches.

MANCHESTER

Duwe (Wholesale) Ltd., 12 Hilton Street, 1. Tel. Central 5266.
Hirst, Ibbetson & Taylor Ltd., 47 Chapel Street, Salford 3. Tel. Blackfriars 9381. And Branches.

GLASGOW

Michael Black Ltd., 138 West George Street, C.2. Tel. Douglas 6681.
James Robertson, 95 West Nile Street. Tel. Douglas 6611. And Branch.
James Whiteford & Co., 17-21 Wellington Street, C.2. Tel. Central 1528.

LIVERPOOL

Downes & Davies, 1-9 Stanley Street. Tel. Central 5491. And Branches.
Drury Radio Co. Ltd., 15 Sweeting Street, 2. Tel. Central 2133. And Branch.

BELFAST

Eirco Wholesale Ltd., 29 Wellington Place. Tel. 26406.

BRADFORD

J. Dyson & Co. (1944) Ltd., 111 Thornton Road. Tel. 6037. And Branch.

BRISTOL

H. R. Cleave (Radio) Ltd., 116 Victoria Street, 1. Tel. 23452. And Branch.

EXETER

F. D. Newcombe & Co. Ltd., 39-40 North Street. Tel. 4116.

IPSWICH

Flinders (Wholesale) Ltd., 14-20 St. Peter's Street. Tel. 3781/2. And Branches.

LEEDS

Albion Electric Stores, St. Ann's Buildings, 125 Albion Street, 1. Tel. 20196/7/8. And Branches.

MIDDLESBROUGH

Arthur Jones & Co. (Elec. Wholesalers) Ltd., Norton Street. Tel. 3223. And Branch.

NEWCASTLE-ON-TYNE

J. Gledson & Co. Ltd., 48-50 Blackett Street. Tel. 24137.

PLYMOUTH

T. Brand, 160 King Street. Tel. 3181.

SHEFFIELD

Robert Neill & Co. (Sheffield) Ltd., 28-30 Trippet Lane. Tel. 23519.

STOKE-ON-TRENT

R. J. S. Services Ltd., 1 Richmond Terrace, Shelton. Tel. 2854.

RADIO GRAMOPHONE DEVELOPMENT Co., Ltd., Bridgnorth, Shropshire

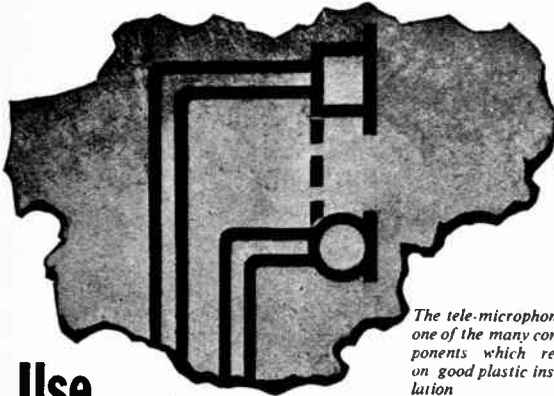

*The tele-microphone,
one of the many com-
ponents which rely
on good plastic insu-
lation*

Use

Radio Pre-Heated Plastics and be certain of Uniform Insulation

TO be a good insulator throughout, a component made of a plastic compound must have cured simultaneously in every part of the moulding. The thin sections must not be overcooked, and the centre of the thick sections must not be spongy.

The only way to be certain that this is the case with plastic components that you use, is to be sure that the plastic powder or preform was pre-heated by a Redifon radio heater before moulding. Redifon heaters plasticize simultaneously *throughout*, which ensures a perfect cure.

Redifon radio heaters have been specially designed to do this particular work. They can deal with between 2 oz. and 3 lbs. of plastic material per minute, using radio-frequency outputs of 250 watts to 5 kilowatts. Saving in production time is usually over 50 per cent.

Redifon radio heating sets have all the necessary safety devices for use by unskilled operators. They are fully enclosed and simple to operate. Manufacturers who wish for further particulars of the use of radio heating should get in touch with Rediffusion engineers now.

REDIFFUSION Ltd.

*Designers and Manufacturers of Radio Communication and
Industrial Electronic Equipment*

SUBSIDIARY OF BROADCAST RELAY SERVICE LTD.

CARLTON HOUSE, REGENT STREET, S.W.1

CELESTION

LOUDSPEAKERS VALVEHOLDERS

Celestion Limited
Kingston-upon-Thames
Telephone : KINGSTON 5656-7-8

Varley

TRADE MARK.

SLIDER RESISTANCES



★ WE KNOW

YOUR CHOICE WILL BE VARLEY

*The name which has stood for quality, reliability
and good service for over twenty years.*

**TEST EQUIPMENT • LABORATORIES
BATTERY CHARGING • SPEED CONTROL**

OLIVER PELL CONTROL LTD

CAMBRIDGE ROW · WOOLWICH · S.E.18

TELEPHONE : WOOLWICH · 1422

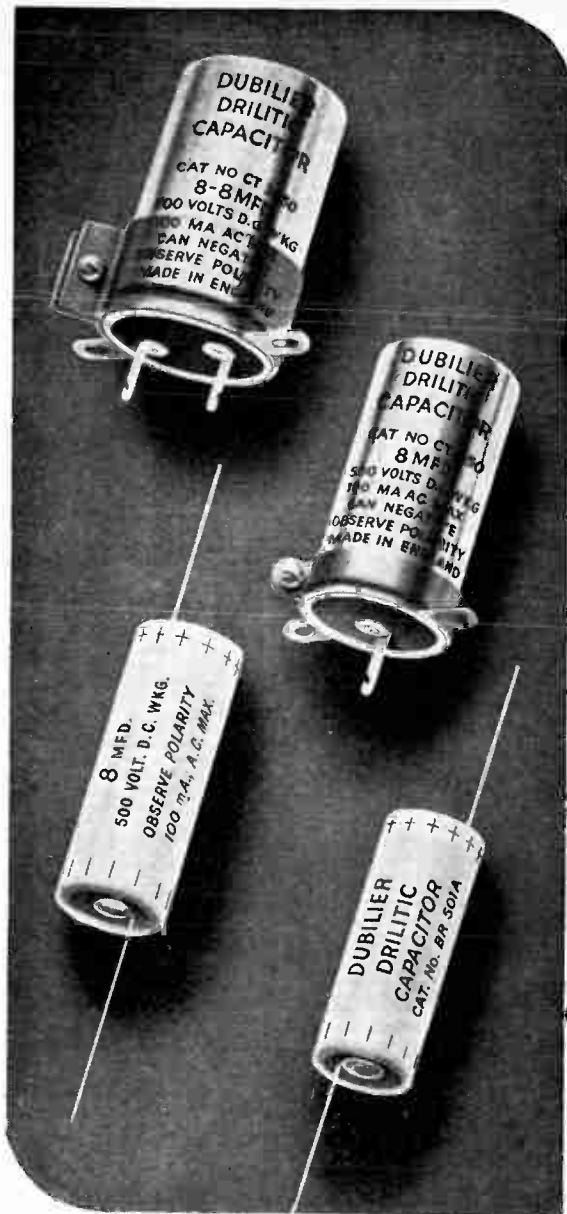

Now!
a full range

**"DRILITIC"
ELECTROLYTIC CAPACITORS**

Physically small, these B.R. and C.T. capacitors embody many technical advantages and their comprehensive coverage of every electrolytic requirement will be readily appreciated by users. The electrical characteristics of these capacitors are a marked advance in electrolytic design, the leakage current and equivalent series resistance are reduced, the audio and radio frequency impedance improved, break-down voltage and life expectancy have been increased together with an improvement in temperature characteristics. They are contained in seamless drawn aluminium containers hermetically sealed and the container is always negative.

DUBILIER
CONDENSER CO. (1925) LTD
LONDON. W.3

"DRILITIC" CAPACITORS						
Capacitance	MAXIMUM Working Voltage	SIZE INCHES		MAXIMUM Ripple Current mA.	TYPE Number	RETAIL PRICE EACH
		D.	L.			
50	12	1/4"	1 1/2	55	BR501	2s. 6d.
25	25		1 1/2	75	BR252A	2s. 6d.
50	50		2	190	BR505	3s. 6d.
8	150		1 1/2	110	BR815	2s. 9d.
8	500	2	100	BR850	4s. 0d.	
8	500	1	2	100	CT850	4s. 6d.
16	500	1	2	110	CT1650	6s. 6d.
8-8	500-500	1	2	*100-100	CT8850	6s. 6d.
16-8	500-500	1	2	*110-100	CT16850	8s. 6d.

Vertical mounting clips supplied with C.T. types. *The total max. ripple current for both sections must not exceed the larger figure.

D2 DUBILIER CONDENSER CO. (1925) LTD. · DUCON WORKS · VICTORIA RD. · NORTH ACTON LONDON · W.3



LASSOLASTIC · LASSOBAND
 LASSOPHANE · LASSOVIC
 LASSOTHENE · LASSOTHYL
 LASSOFIBRE

A leading clue

Lasso Identification Tapes give cables and components a permanent "identity card" and save time, labour and error. Indelibly printed to your own requirements at intervals spaced to suit various measurements, Lasso Tapes are quickly applied at any point before or after assembly. Available in 10 yard rolls. Self-adhesive, resistant to water, oil, petrol and solvents. Lasso Tapes also make neat, permanent name tabs for furniture, containers, tools and plastics. Informative booklet free on request.

LASSO



Identification TAPES

CABLE ASSEMBLIES LTD. (Subsidiary of Herts Pharmaceuticals Ltd.) 50 Howardsgate, Welwyn Garden City, Herts. (C1)

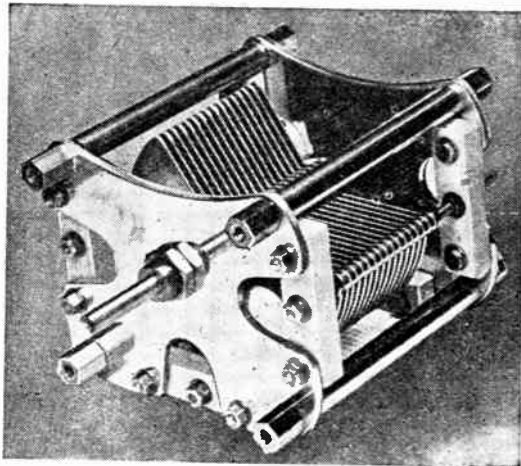

TYPE S.L.C. LINEAR CAPACITY

"Cyldon"
Variable Capacitors

SYDNEY S. BIRD & SONS LTD.
 CAMBRIDGE ARTERIAL ROAD, ENFIELD.

THERE ARE TRIX AMPLIFIERS FROM 5-500 WATTS FOR PRIORITY WORK

Critical users

Trust
TRIX

Quality SOUND Equipment

THE TRIX ELECTRICAL CO. LTD.
 15 MAPLE PLACE · TOTTENHAM COURT ROAD,
 LONDON, W.1.
 Tel: MUSEUM 5817 *Gramme & Cable* TRIXRADIO · WESDO LONDON.



CAPACITORS for special applications

Television and other high-voltage electronic equipment provide a truly exacting test of capacitor efficiency.

T.C.C. Capacitors are used extensively in Service Radar equipment; the experience gained during the war in supplying capacitors to withstand tests of extraordinary vigour (never likely to be met with in standard commercial television receivers) can now be applied to the peace-time needs for better and more reliable television.

That is why discerning manufacturers have already decided to use T.C.C. capacitors, including one or more of the types illustrated, and have placed orders accordingly. Samples and information are available to other set manufacturers contemplating new models the details of which are not yet decided.

T.C.C. Capacitors are found in all sets where quality and reliability are primary considerations.



"CATHODRAY"

A paper type tubular capacitor specially designed for high tension circuits of television receivers. Constructed for chassis mounting, the insulated case provides, in effect, a H.T. terminal which eliminates the possibility of flash-over.

Available in a wide range of capacities and voltages. Illustration shows a 0.1 mfd. capacitor for working up to 6,000 volts D.C.

MICA CAPACITORS

"MICADISCS"

A new T.C.C. development for capacities of between .0001 and .0005 mfd. for use in signal frequency circuits. Connecting lugs are provided for chassis mounting. The other connection is by a central eyelet which provides a convenient means of taking wire through chassis and also providing a fixed capacity to ground.

TYPE C.M.20 MOULDED

This is a miniature moulded type available in capacities up to a maximum of .001 mfd. Because of its compactness it is very suitable for decoupling at the higher frequencies.

TYPE .W. MOULDED

(Side wire connections) This is also a decoupling capacitor, slightly larger than type C.M.20, but with side wire connections which, with certain chassis layouts, facilitates the mounting of the capacitor closer to the "hot" points, giving a reduction in lead-length and consequently a minimum inductance.



"MICADISC"

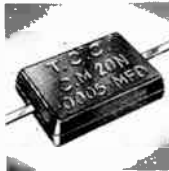

TYPE C.M.20

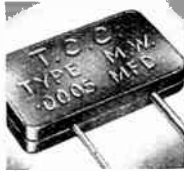

TYPE M.W.
(Side Wires)

THE TELEGRAPH CONDENSER CO., LTD.

RADIO DIVISION

NORTH ACTON · LONDON · W.3

Telephone. ACORN 0061

WEIGHT REDUCING

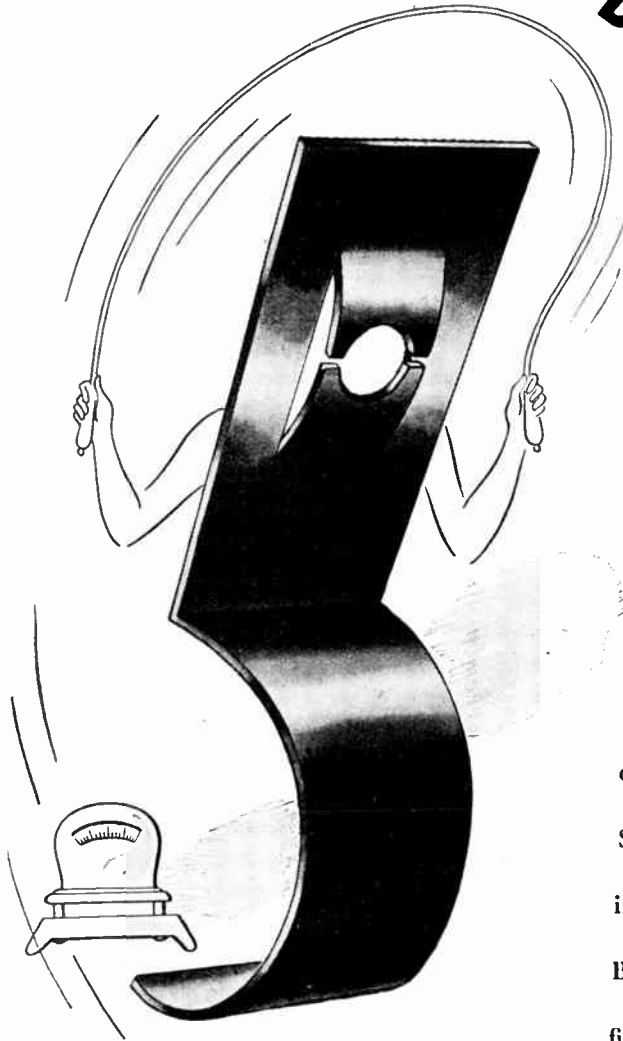

THAT'S Fixed THAT! You may say the NB 1455 is obvious. So it is once it exists—like a lot of other good ideas. The Spire nut device is made part of the component and so these cable clips are screwed direct to their base without need of separate washer or nut. The NB 1455 was developed for a Government Department but it has found wide uses throughout industry.



WHEN you adopt some form of Spire fixing for a light assembly job, you certainly save weight. For one thing you won't need washers. For another the Spire nut is lighter than an ordinary nut. And if we can make the Spire device part of the component you won't even need a Spire nut. You may say that weight saving in your case is a minor matter any way. But is it a minor matter to cut out all that fiddling and fumbling with nuts and washers? Is the saving in cost a minor matter? Or the strength and permanence of the fixing?

Spire

* **A BETTER way of fixing**

Simmonds Aeroaccessories Limited • Great West Road • London • A Company of the Simmonds Group

Wireless World

Radio and Electronics

35th YEAR OF PUBLICATION

MARCH 1946

Proprietors:
ILIFFE & SONS LTD.

Managing Editor:
HUGH S. POCOCK,
M.I.E.E.

Editor:
H. F. SMITH

Editorial, Advertising
and Publishing Offices:

DORSET HOUSE,
STAMFORD STREET,
LONDON, S.E.1.

Telephone:
Waterloo 3333 (35 lines).

Telegrams:
* Ethaworld, Sedist, London.



PUBLISHED
MONTHLY

Price: 1/6

(Publication date 26th
of preceding month)

Subscription Rate:
Home and Abroad
20/- per annum.

MONTHLY COMMENTARY	71
VENTILATION PROBLEMS By W. Tusting	72
NEGATIVE FEEDBACK—2 By "Cathode Ray"	76
CATHODE-FOLLOWER DANGERS By W. T. Cocking	79
THE NEW SUNSPOT CYCLE By T. W. Bennington	83
WORLD OF WIRELESS	86
NAVIGATIONAL RADAR	89
DESIGN DATA—2. Wide-Band Amplifiers	90
DECCA NAVIGATOR	93
IS THE B.B.C. DOING ITS JOB? By "Cataractacus"	96
UNBIASED	98
By Free Grid	99
LETTERS TO THE EDITOR	102
RANDOM RADIATIONS	104
By "Diallist"	
RECENT INVENTIONS	

Branch Offices:

COVENTRY:
8-10, Corporation Street.
Telephone: Coventry 5210.
Telegrams:
"Autocar, Coventry."

BIRMINGHAM:
Guildhall Buildings,
Navigation Street, 2.
Telephone:
Midland 2971 (5 lines).
Telegrams:
"Autopress, Birmingham."

MANCHESTER:
260, Deansgate, 3.
Telephone:
Blackfriars 4412 (4 lines).
Telegrams:
"Iliffe, Manchester."

GLASGOW:
26B, Renfield Street, C.2.
Telephone: Central 4857.
Telegrams: "Iliffe, Glasgow."



As many of the circuits and
apparatus described in these
pages are covered by patents,
readers are advised, before
making use of them, to satisfy
themselves that they would
not be infringing patents.

VIBRATORS • TRANSFORMERS • SWITCHES • COILS

MEET A GREAT LITTLE I.F.!

Specially designed to give the maximum gain and selectivity combined with lilliputian dimensions". Wearite I.F. Transformers are provided with one-hole fixing, the terminal wires being fed through insulated bushings thus preventing movement after mounting. They are available in the following "preferred" frequencies.

M.400.....460 Kc/s M.405.....1.6 Mc/s
M.411.....2.1 Mc/s M.415.....4.86 Mc/s
M.418.....9.72 Mc/s

as well as in frequencies for particular applications.

- Coils enclosed in pot-type iron dust cores
- Tuning by means of adjustable iron dust centre cores
- Fixed tuning condensers contained in screening can

* Dimensions: — $\frac{1}{8}$ " square x $1\frac{1}{8}$ " high.

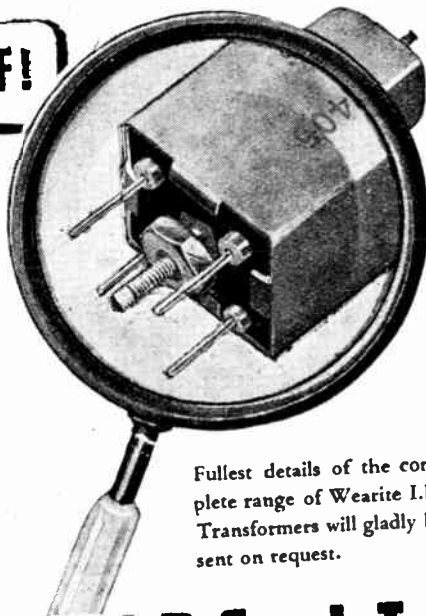

Fullest details of the complete range of Wearite I.F. Transformers will gladly be sent on request.

WRIGHT & WEAIRE LTD

A Name as Old as the Radio Industry

HIGH ROAD TOTTENHAM LONDON N 17 TELEPHONE: TOTTENHAM 3847-9

NEW OSCILLOGRAPH

Usable up to 5 Mc/s

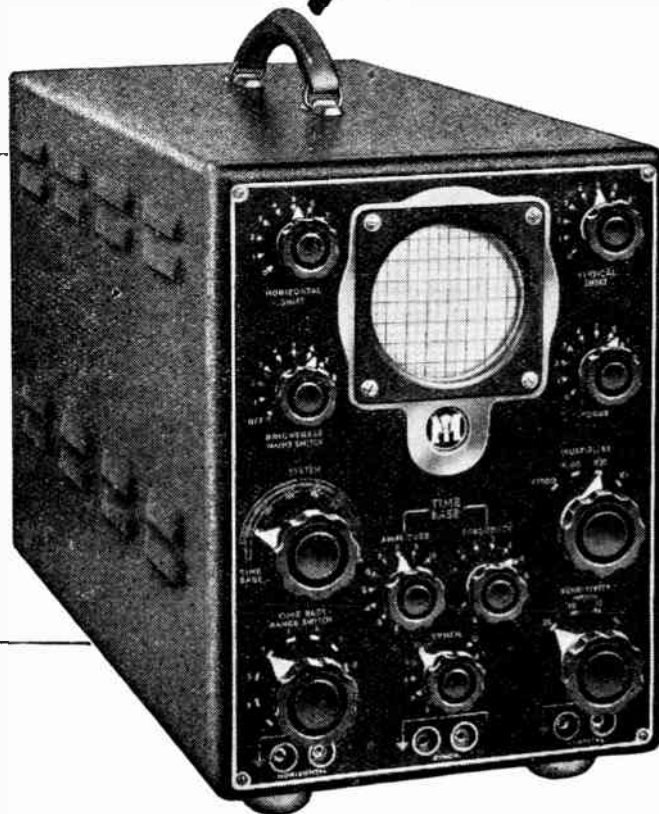

PRICE
£75



The Mullard High Frequency Cathode Ray Oscilloscope type E.805 sets a new standard for portable instruments and embodies many features previously found only in instruments twice its size and price. Special features include: High impedance Input Circuit. High gain, wide band Vertical Amplifier (Sensitivity 5 mV/cm, frequency range 2 c/s - 5 Mc/s). Electronically stabilised power supply. This instrument is now available in limited quantities. Write for leaflet M.503 to:— THE MULLARD WIRELESS SERVICE CO. LTD., Measuring Apparatus Section, Century House, Shaftesbury Avenue, W.C.2.

MULLARD

MEASURING
APPARATUS

(174B)

Wireless World

Radio and Electronics

Vol. LII. No. 3

MARCH 1946

Price 1s. 6d.

Monthly Commentary

Lost Prestige

GRAVE harm to the prestige of British radio has been done by ill-conceived and ill-executed arrangements for releasing to the Press information on wartime developments. When so many Government departments are concerned, it is impossible to pick out any particular offender to stand all the blame, but, on the face of it, a body with the cumbrous title of "Committee on Post-war Publication of Results of Wartime Scientific Research," must be considered as largely responsible. The C.P.-W.P.R.W.-T.S.R., under the chairmanship of Prof. A. V. Hill, is supposed to co-ordinate broad policy on publication between British Commonwealth Government departments and with U.S.A. At a lower level, the Radio Board seems to be responsible for implementing policy on the publication of radio matters.

Presumably with the approval of these bodies, the Government departments, including the research organisations, are still withholding from publication in British technical journals detailed information on wartime radio developments. "Security" is sometimes invoked as a reason, though that blessed wartime word can no longer apply to devices and processes about which information has been divulged during the war to thousands who owe no allegiance to the British Crown. Another excuse is that the information is being withheld in order that it may be disclosed later, in papers to be read before learned societies or professional institutions. Under normal conditions one could have little quarrel with this principle, but, as all wartime research has been done directly or indirectly at the public expense, the public has the right to demand quick release if that is in its interest.

Most definitely, the delays that have occurred are not in the public interest. During the past three or four months many devices of British origin, still "secret" here—the cavity magnetron, the reflex klystron, the crystal valve, for example—have been described in detail in American journals. The descriptions have subsequently been repeated in the technical Press of the world with, naturally, little

emphasis on their country of origin. Consequently, British radio has lost a golden opportunity to acquire the world-wide prestige that it has earned.

We sympathise with the desire of individual research workers and of development departments and similar organisations to establish priority in accepted form for their great wartime contributions. But they need have had little fear that their thunder would have been stolen by prior publication in the technical Press of this country, which is still so severely restricted by paper rationing that it is quite unable to deal with abstruse matters in the prodigal style of the typical scientific "paper."

A third excuse—that information is being withheld until inventors can obtain patent protection—seems to be no longer plausible. Prior publication in foreign journals has surely invalidated any claims for patents on the devices described. When the "official" disclosures eventually appear, they will have a "non-intrusive" circulation, and, worse still, will deal with matters that are already stale news to most of the world. The lingering shadow of "security," plus delays inherent in reconciling conflicting claims for precedence in matters of development, have brought about a state of affairs that cannot fail to have unfavourable repercussions on the export trade.

★ ★ ★

**The B.B.C. :
A Reminder** WE must not lose sight of the fact that the B.B.C. Charter expires at the end of the year. Interest in this subject ran high until recently, but now, faced with many

other and perhaps wider issues, the public tends to forget that, in a few months' time, decisions must be taken that must have a profound and lasting effect, for good or evil, on British radio. Although *Wireless World* does not expect or wish for any drastic change in the fundamental nature of the existing system, we think that the possibilities of remedying its major defects should be fully explored before legislation is rushed through. Time is short, and those with proposals to make should have their case ready.

VENTILATION PROBLEMS

Preventing Overheating and Frequency Drift

THE avoidance of an excessive temperature rise in wireless equipment is not always given the attention which it deserves in the early stages of design. The difficulties involved in disposing of the heat generated in valves and resistors are all too often underestimated, with the result that the designer finds himself faced with serious difficulty at a late stage of the development.

The proper time to think about heat dissipation is when the general mechanical design of the equipment is first considered. The electrical design is then largely finished; that is, the circuit has been decided on and circuit values have been chosen. At this stage the types of valves and their operating conditions have also been settled, so that the power dissipated as heat and the components in which it will appear are known.

By W. TUSTING

The electrical requirements, the ease of fabrication, the accessibility for maintenance and the appearance of the finished product usually dictate the mechanical form of the apparatus to a large extent. It is only at this stage that the problem of removing the heat generated within the equipment to the outside air as quickly and freely as possible can be satisfactorily tackled.

This problem of heat dissipation has been recognised in transmitters from the earliest days of wireless, but it is only comparatively recently that it has received any serious attention in receivers. This is rather surprising when it is remembered that practically the whole of the power consumption of a set is dissipated as heat within it, and that the consumption is

around 60 watts for small sets up to about 200 watts for really large ones.

Two bad effects result from this internally generated heat. In the first place, the life of certain components, especially capacitors, may be materially shortened by a high temperature. Secondly, changes of temperature, which are at their greatest when the maximum temperature is high, affect the resonance frequency of the oscillator circuit and so cause tuning drift.

Oscillator Drift

From the point of view of the ordinary user of receiving equipment tuning drift is the more noticeable effect. The rising temperature causes the trouble by altering the inductance and capacitance of the oscillator, and so, its frequency. The components comprising the oscillator circuit all have electrical values which depend in some degree on temperature. Usually, the temperature coefficient is positive, which means that the inductance and capacitance both increase with a rising temperature; the oscillator frequency consequently falls.

When a set is switched on, its parts are at the ambient temperature of the room and the oscillator functions at a certain frequency. As time goes on and heat is generated continuously the internal temperature rises—at first quickly and then more slowly as the equilibrium temperature is approached. The oscillator frequency falls, and if the set is a selective one, it requires re-tuning.

If the set can lose heat only slowly, the internal temperature will become very high and it will be a long time before equilibrium is reached. This means that oscillator drift will not only be large but will continue for a long time. In the early days of the super-heterodyne a drift of 10 kc/s or more was not uncommon on the medium waveband, and it occurred over a period of fifteen to thirty minutes. During this

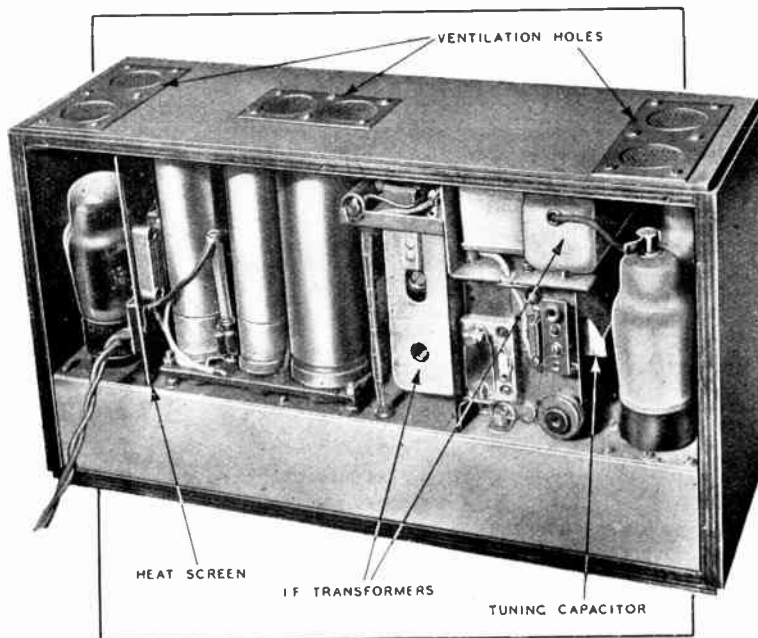

This rear view of a particularly cramped AC/DC set shows the outlet ventilation holes in the top. The two holes at the left are over the output and rectifier valves and those at the right are over the frequency-changer and IF valves. The middle holes are above the heater-circuit voltage-dropping resistor. The edge of a heat screen can be seen between the rectifier and the electrolytic capacitors.

time the set required periodical re-tuning.

As the drift tends to be a constant percentage of the frequency, it is always more apparent at high frequencies than at low. Thus, a drift of 10 kc/s at 1 Mc/s, becomes about 200 kc/s at 20 Mc/s! The switching-on drift should not exceed a small fraction of the band-width of the IF amplifier at even the highest frequency. The band-width of a set intended for broadcast reception might well be 8 kc/s, and the drift should certainly not exceed 2 kc/s and would preferably be considerably lower. At 20 Mc/s (15 metres), the oscillator stability must then be 1 part in 10,000. This is probably impossible to achieve without taking great care in design.

Even perfect cooling of the set, so that it never departed from the ambient temperature, would not give perfect frequency stability. It would completely eliminate the short-term drift when the set is switched on, but as the ambient temperature changes with the weather and the seasons, there would still be a long-term alteration. This would be important only in sets with pre-set or automatic tuning devices, but in those it might well be very important.

Temperature Compensation

It can reasonably be assumed that a broadcast set will not normally be used at a lower temperature than that of a living room. One might well take the minimum ambient temperature as 50° F to allow a little in hand. The maximum in this country is unlikely to exceed 90° F, and, in fact, will rarely be greater than 80° F.

The maximum normal temperature range is therefore only about 30° F, or 16.5° C. This is very small in comparison with the changes encountered in Service equipment, where the temperature may be -40° C under Arctic or high-altitude aircraft conditions and 60° C under a desert sun. That is a range of 100° C.

The broadcast problem is relatively easy of solution and for the small normal changes practically perfect compensation can be obtained by using capacitors having a negative temperature co-

efficient of capacitance. This method of balancing the positive coefficient of one component by the negative of another can usually be perfect only at one frequency, and in general there is a tendency to have a positive oscillator drift at one end of a wave-band with a negative drift at the

regard it only as the finishing touch to compensate for unavoidable temperature changes. Every effort should be made to get rid of the unwanted heat and so limit the rise above the ambient temperature and then to apply compensation to prevent this unavoidable rise and the unavoid-

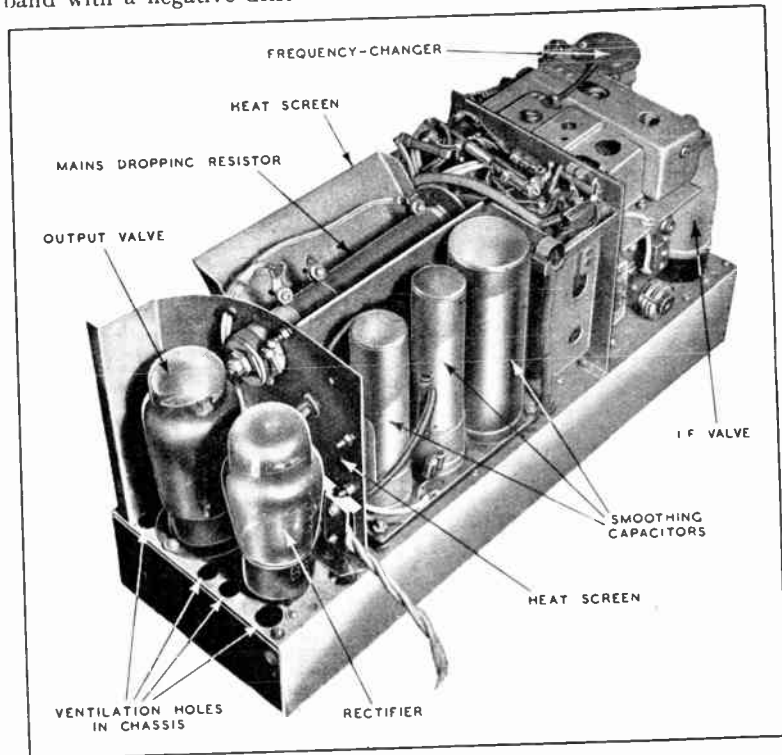

This view of the set out of its case clearly shows the heat screens erected around the output and rectifier valves. There is also a screen round the mains-dropping resistor and this has inlet holes for air immediately beneath the resistor.

other and zero drift at the middle of the band.

Temperature compensation need not be confined to correcting for the effect of changes in the ambient temperature, but can also compensate for the internal rise of temperature and so reduce the short-term switching-on drift. It is, in fact, widely used for this purpose, but it is clear that as no compensation of this nature is ever quite perfect, it is wise to keep the range of temperatures over which it is required to function as small as possible.

This means that temperature compensation should not be regarded as the solution of heating problems. The right outlook is to

able changes of ambient temperature from causing appreciable drift.

It may well be asked at this stage, "How does one get rid of heat?" The answer is by convection, conduction and radiation. The heat is generated in valves and resistances—sometimes also in appreciable quantity in transformers and chokes (!)—and the surrounding air is heated by its contact with them. This air gives up some of its heat to the cabinet, which, in turn, loses it to the surrounding space by radiation and convection.

The rate at which heat is lost through the cabinet depends chiefly on the material used in its

Ventilation Problems—

construction. Wood and plastics are poor conductors of heat and metal is a good one. Other things being equal, therefore, a metal case will lead to a lower internal temperature than one made of a poor heat conductor.

The radiation loss of heat depends on the colour of the case and is highest for a matt black finish and lowest for a bright polished surface. For maximum cooling in this way, therefore, the cabinet should be made of metal with a dull black finish both inside and outside.

Ventilation

In general, however, cooling through the cabinet is inadequate and the need for a good external appearance often prohibits the dull black finish. It is usual, therefore, to provide ventilation for the interior. The object of this is to remove the warm air from the inside as quickly as possible and to replace it by cooler air from the outside. This can be done naturally with the aid of suitably placed openings in the case, for on absorbing heat from the components the air expands. It thus tends to rise and escape from openings at the top of the case and to be replaced by cooler air entering at the bottom.

The openings provided for ventilation are often singularly ill-adapted to this purpose. A common arrangement is the provision of a number of louvres at the back. While some warm air may escape from the upper ones and some cool air enter at the lower, there is no guarantee that the air flow is near the hot components.

If ventilation is to be effective it is essential that there should be an outlet right at the top and another at the extreme bottom with an unrestricted air path between them and that the components generating the heat should be in this air path. What this means in practice can best be seen by considering a typical receiver constructed in the conventional way on a chassis.

The major part of the heat is generated in the rectifier and output valves, but the heater power of some RF pentodes and frequency-changers is by no means

negligible. It is important to keep the heat away from capacitors to ensure a long life and from the oscillator components to avoid frequency drift.

As heat tends to rise, the top of the case will be warmer than the bottom, and this will be especially so if there is adequate ventilation, for the cool air will enter at the bottom. The first essential, therefore, is to place capacitors and frequency-changer parts as near the bottom as possible. This means in the first

Coupling and by-pass capacitors also fall naturally into position here. Smoothing capacitors, being physically large, are more difficult, and it will often be necessary to mount them above the chassis and protect them in other ways.

The resistors which it is natural to put below the chassis are chiefly ones dissipating only low power, such as grid leaks, AVC filter resistors, RC coupling resistors, and small bias resistors. There is usually little harm in so

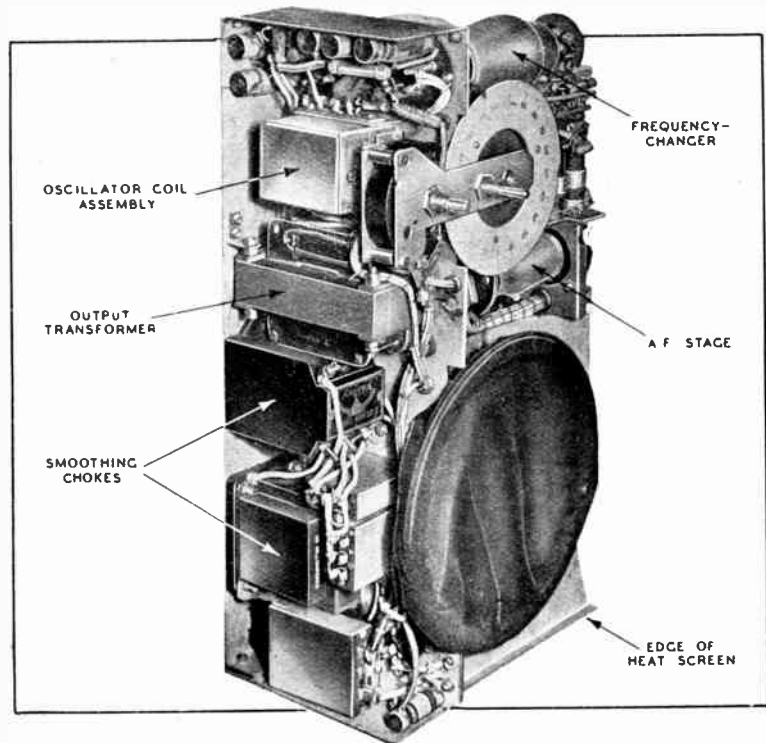

The oscillator coil and padding capacitors are mounted beneath the chassis in the coolest place. In spite of the crowded appearance, the components offer little obstruction to the flow of air at important points, for the inlet holes in the bottom of the cabinet are placed so as to bring the air in at points giving a clear path between parts.

place mounting them under the chassis, and in the second place avoiding placing any heat generating parts, such as resistors dissipating any appreciable power, under the chassis.

It is not usually difficult to arrange the oscillator coil assembly and its associated padding capacitors beneath the chassis, for this position is convenient for wiring to the frequency-changer.

placing them for the power in each resistor is on the average no more than 1/10th watt, and rarely exceeds 1/4 watt for any individual component.

Power dissipation is greater in the output stage bias resistor, screen-feed potentiometers, etc., and there is rarely little difficulty in placing them above the chassis.

In laying out the above-chassis components it is often advisable

to collect the hot ones together in a group—or in two or three groups, well spaced from components which must be kept cool, such as smoothing and tuning capacitors. Holes of large area should be placed in the cabinet immediately above and below these hot groups and in the intervening chassis. This last is very important, for the bottom entry holes will do little good if the chassis offers a barrier to the air flow.

Ventilation will usually be adequate if there is a 1 in. hole above each hot valve. Such a hole has an area of nearly 0.8 sq. in., but as it must normally be covered with gauze to prevent the entry of small objects, its actual area will not be much more than one-half of this, or, say, 0.5 sq. in. The bottom hole does not need to be so large, because a gauze cover is unnecessary, and a diameter of around 3/4 in. is adequate. Holes of total area not less than this should be placed around the valveholder to permit an unrestricted flow of air. Some 6 to 8 holes of 3/4 in. diameter are suitable, but it is often more convenient to use a larger number of smaller holes.

Having provided this ventilation it is advisable to do something to prevent the heat spreading sideways from the hot components and to make sure that it takes the direct path to the outlet. This is particularly advisable in cases where components have to be cramped together. This is easily done by erecting heat screens around the hot parts and they can often be combined with electrical screens. The screens should run from the chassis to the top of the cabinet and fit fairly well. They should be of polished metal since it is undesirable for them to absorb or radiate heat. In extreme cases such a screen can be a sandwich of two sheets of polished metal with a non-conductor of heat between them—*asbestos sheet*, say—but this is rarely necessary.

Chimneys

Individual valves on the RF side are easily taken care of by turning the valve screens into chimneys. The valve screen should be tall enough for its top

only just to clear the cabinet, and the top of the screen should be open. If a metal cover is needed for screening this can be provided by gauze—the usually solid top to the can is wrong. The can should not have holes in its side, but there should be holes in the chassis around the valveholder and inside the can. There must be a hole in the cabinet above the valve screen and, of course, one in the bottom under the valveholder. With a polished screen it will be found that relatively little heat escapes, and the current of air through the chimney keeps the valve itself quite reasonably cool.

By attention to detail on these lines, it is possible to build quite a compact set which remains unusually cool and suffers but little from drift. The photographs illustrating this article show how the points discussed have been put into practice in a particular case.

The greatest difficulty usually lies in so disguising the exit holes that the appearance of the set does not offend. In the set illustrated no attempt at disguise was made and the holes were covered with gauze held down by brass plates. Incidentally, these plates become too hot to touch during operation!

In the case of a radio gramophone the gramophone equipment often prevents ventilation holes being placed in the top, but the set itself usually occupies only a small part of the total cabinet space. It is then easy to mount the set at the bottom of the cabinet and to arrange a cowling over it to collect the hot air and lead it out at the back just below the motor board. Alternatively, the set itself can be provided with its own light case and tubing fitted to the outlet holes in it in order to carry the hot air to the top-back of the main cabinet.

One further point should be mentioned. Having arranged good ventilation and so obtained adequate cooling, care should be taken to see that the set is so placed in the room that it does not absorb heat unnecessarily from other objects. The very factors which act to assist in the removal of heat from the set also make it particularly liable to gain heat from outside. It will not actually absorb external heat unless the external temperature is higher than the internal, but it will most definitely retard the loss of heat from the set. It is, therefore, more than ever unwise to place the set on a radiator or other heating unit!

AUTOMATIC CAPACITOR TESTER

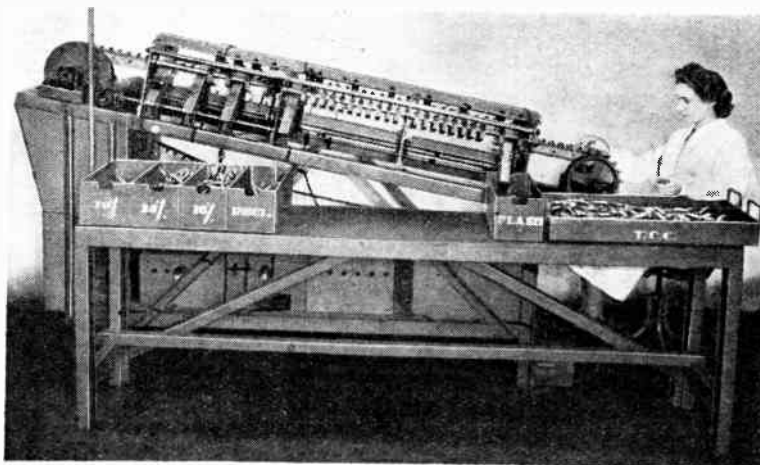

A fool-proof, labour-saving, electro-mechanical device developed and manufactured by the Telegraph Condenser Company for automatically testing and grading tubular paper capacitors. Volts are applied and failures ejected at the first test; survivors are then given an insulation test and, if up to specification, graded, in three further tests, to capacitance limits of $\pm 20\%$, 15% or 10% .

NEGATIVE FEEDBACK

2. Its Effect on Optimum Load and on Distortion

IN the first part of this article we got quite used to thinking of the load impedance of a valve in relation to the fictitious valve resistance, r'_a (rather than r_a), and are all set for falling heavily into a trap. Authorities have explained in this journal and elsewhere that the optimum load impedance is related to the valve anode resistance, being equal to it, or twice as much, or some other ratio; but at all events, as the valve resistance appears to the load to be reduced by feedback from r_a to r'_a , one might reasonably expect the optimum load impedance to be reduced in the same proportion. What more natural than to base it on r'_a ?

This is where it is essential to adopt a strictly Joadian attitude and insist on knowing what is meant by optimum load impedance. One man's optimum is another man's . . . well!

One sort of optimum load is the impedance — assume it is resistance — that gives the greatest power output for a given voltage input. It is a general law, which can be proved to apply to a valve, that in such cases the optimum load is equal to the resistance of the source. If the input is assumed to be the total signal voltage to the grid (v_g), the source for this purpose is undoubtedly r'_a when feedback is in use. To take the extreme case of the cathode follower, this leads to an optimum load of only a few hundred ohms at most. As the current that can be passed through the valve is strictly limited, the available power is clearly going to be very small, even at its maximum. The reason for this unsatisfactory situation is our definition, which stipulates fixed input voltage. Unless the load resistance is so small as to reduce substantially the voltage fed back, very little of the gross input voltage is available for driving the valve. If, on the other hand, one decides it is the net input voltage, v_{g_c} , that is fixed, the feedback does not

By "CATHODE RAY"

enter into the problem at all, and the load resistance for the greatest output is r_a .

The input voltage is seldom the real bottleneck, however, generally the limiting factor is the amount of distortion that the listener (or other consumer) can stand when the input is increased. A more sensible sort of optimum load, then, is that which gets the greatest power when the input is increased to the point at which a specified proportion of distortion is caused. We know, of course, that feedback if properly contrived reduces distortion; but it is not at all obvious how, if at all, its use affects the optimum load resistance as just defined. There are two ways of finding the optimum, with or without feedback; by experiment, or by drawing load lines on the valve characteristic curve sheet until the one which appears to give the best results is found. We are going to try both these ways, and as a preliminary to the latter one it may be necessary to explain how valve-with-feedback curves are derived from the valve-alone sort.

Fig. 4 displays (in unbroken lines) a set of anode-current/anode-voltage curves for a typical output tetrode. The makers' working point, 300 volts 85 milliamps, is marked with an o, and is on the " $V_g = -15$ " line, which means that the negative grid bias is 15 volts. The recommended load, 2,200 ohms, is represented by a line AB drawn at such a slope that if produced to cut the V_a and I_a scales their ratio would, by Ohm's Law, be 2,200. The valve curves themselves for the most part slope very gradually, indicating a very high resistance r_a . Equal changes of grid voltage (represented by the spacing of the curves) result in unequal changes of anode current and anode voltage; which means distortion. The object of the game is to draw through o a line which represents

the greatest output power without too much distortion.

Suppose the input swings 15 volts each way. This is represented by the distance AB. The output power is given by the peak-to-peak anode voltage multiplied by the peak-to-peak anode current divided by 8. From A to B is 385 volts and 175 milliamps; so the output power is 8.4 watts. Quite an impressive output, but a dreadful amount of distortion — the output voltage, starting from rest at 300, swings down to 60 (240 volts) and up to only 445 (145 volts)! The curves are so unequally spaced that even at a much smaller volume, and along any load-line that can be chosen, distortion is appreciable.

Now to put in the "with-feedback" curves. A different set of them is needed for every degree of feedback used, so one must first decide how much to use. For damping purposes, 1,000 ohms r'_a would probably be about right for 2,200 ohms load. In this valve, r_a is about 50,000 ohms and μ is 300,

$$r'_a = \frac{50,000}{1 + 300\mu}$$

From which B works out to about 1/6. Call it 1/5 to be on the safe side and to make the calculations easier. The new curves can be called V_1 curves, because they show the input voltages; and the method of putting them in is to suppose for the time being that the V_a scale is multiplied by B—one fifth in this case—making a BV_a scale. For convenience, this has been marked along the top of the diagram. Start, say, with the curve for $V_1 = -10$. It cuts the $V_g = 0$ curve at the point where $BV_a = 10$, which is point C. Other points can be marked on the other V_g curves, reducing BV_a in each case by the same amount as V_g decreases. For example, the point on the $V_g = -5$ curve must be 5 on the BV_a scale; on $V_g = -10$ it must be 0 on the BV_a scale — and that is as far as the $V_1 = -10$ curve (shown dotted) can go. Now

Negative Feedback—

start the $V_i = -20$ curve, at $BV_a = 20$ on the $V_g = 0$ curve, and move 5 volts to the left on the BV_a scale for every 5 volts more negative on the V_g curves. It can be done very quickly when one gets the idea. The key is that wherever a V_i curve cuts the $V_g = 0$ curve the number on the V_i curve must always agree with the BV_a scale.

The resulting dotted curves slope much more steeply than the original ones, indicating that r'_a is much lower than r_a . They are also much more evenly spaced than the V_g curves, so now almost any load line is acceptable as regards distortion and one is free to concentrate on sloping it so as to get the maximum output, within the limits of grid current at one end and anode current cut-off at the other. It generally

turns out that with a tetrode or pentode there is not much advantage in departing from the normal load resistance on account of feedback. If one sticks to the same R_L , the main result is that the same output is obtainable with far less distortion, or, for the same distortion, far less output is obtainable without feedback. Actually, in our example a load of 3,200 ohms appears to raise the maximum output slightly (to about $9\frac{1}{2}$ watts). The input swing is measured by the V_i figures at the ends of the load line, and is, of course, much greater because of feedback (65 volts peak each side of -75). But as regards grid bias *the old V_g figures still apply* and the curve $V_g = 0$ is still the no-grid-current limit, on the left-hand side. Another detail; we have been making the load line turn about

the point o because we have been assuming — I have, anyway — that the load is transformer-coupled so that there is no DC voltage drop in the load. If the load were a resistance directly in the anode circuit, the load line would have to pass through the point representing the HT voltage at zero anode current.

I haven't shown a sample of feedback curves for a triode, because feedback is seldom applied to triodes, the reasons being that they are pretty good already as regards freedom from distortion, and the input required tends to become excessive. But Fig. 5 shows some experimental results for a small output triode. A 400 c/s signal was used, and the load resistance—fed through a large condenser to cut out the DC—was varied, keeping the 2nd harmonic distortion at 5 per cent.

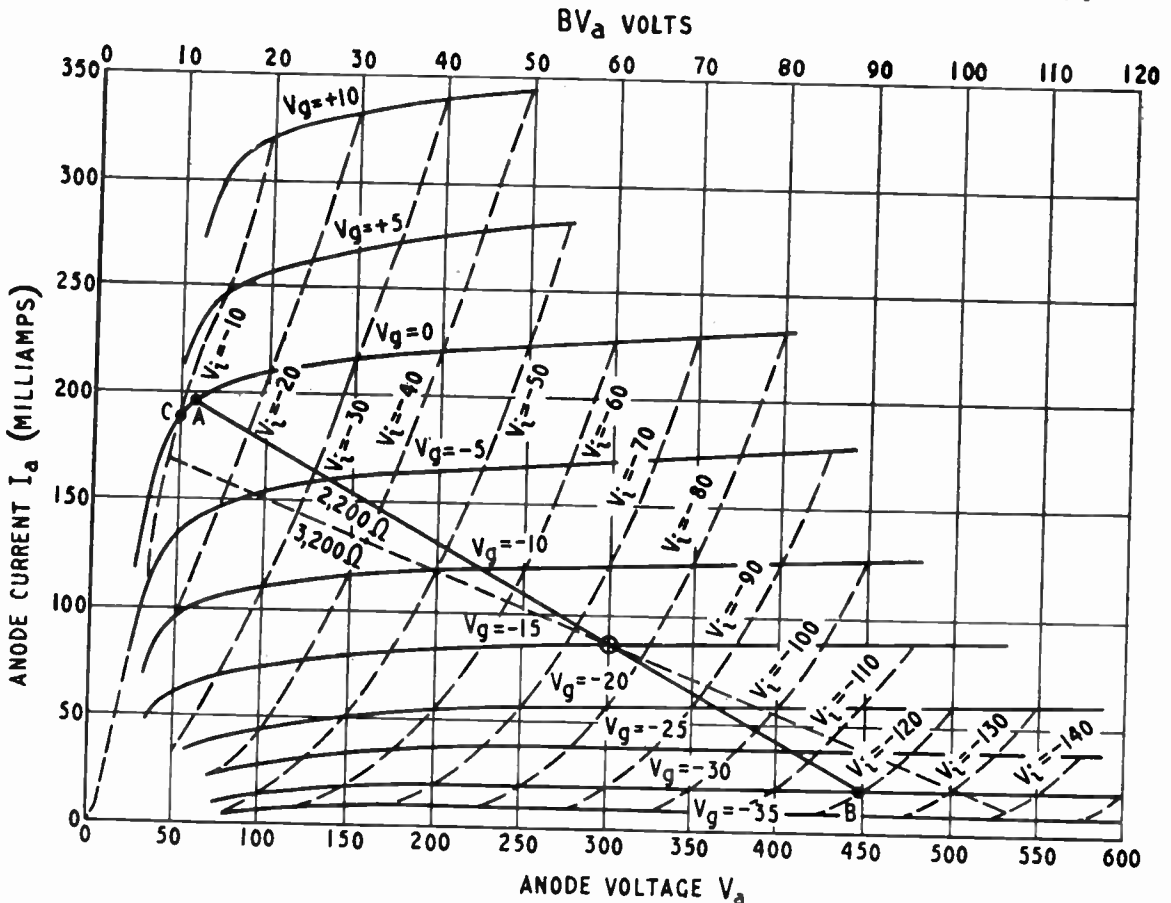

Fig. 4—The full-line characteristic curves are those of a typical output tetrode. With 20 per cent feedback, this valve performs as if its characteristics were those represented by the dotted line curves, which are derived from the others as explained. The straight sloping lines represent loads of different resistance.

Negative Feedback—

every time. As you see, without feedback this distortion limit kept the output remarkably low (the characteristics were unusually curved for a triode). With 100 per cent. feedback the curves were straightened out so thoroughly that the output could be

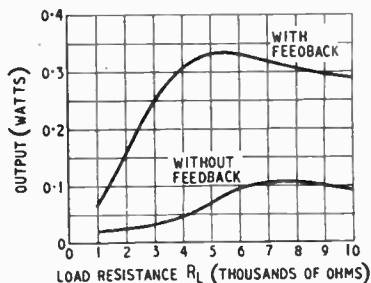

Fig. 5.—Results of an experiment on a small output triode, showing how the output—limited to 5 per cent. harmonic distortion—varies with load resistance.

raised threefold, until it was limited by grid current. The optimum load was reduced by feedback—from 7,500 to 5,400 ohms—but, of course, nothing like as much as r'_a . The output with feedback was very nearly as much at 5,400 ohms as at the optimum, 7,500.

Fig. 6 shows similar results for a small output pentode. Again, feedback resulted in a slight reduction in optimum R_L , but the difference was not very important, and in this case was difficult to judge accurately because of the distortion being a mixture of 2nd and 3rd harmonics in varying proportions. (As I have often emphasised, the harmonics are not themselves the really important part of the distortion, but are a convenient rough measure of the badness of the distortion.)

By the way, the impression is sometimes given that you can use or misuse the valves anyhow, grossly overload them, and so on—negative feedback will reduce the resulting distortion in the ratio $(1 + AB)$ to 1. And a mathematical "proof" of the latter statement may be submitted. It is true that feedback irons out the curves, but it can't make them continue on the negative side of the zero anode current line. So

the current cuts off all the more suddenly, and when distortion begins it is bad, whereas without feedback its onset is more gradual. When an amplifier with feedback is good it is very, very good, but when it's overdriven it's horrid.

When I was dealing with the cathode follower (November, 1945) I pointed out that if a tetrode or pentode is used it automatically ceases to be such and reverts to triode status, because the screen and anode are unavoidably "commoned." There is an alternative way of using 100 per cent. feedback, while retaining the power efficiency of the multi-grid valve, and avoiding difficulties connected with grid bias and cathode insulation. Fig. 7 shows how. It is the essence of the circuit used for drawing Figs. 5 and 6, and is a practical alternative to the cathode follower output stage for loudspeakers, advocated by some writers. The only difference between it and a perfectly normal amplifier is that the input is from grid to anode instead of grid to earth.

The use of 100 per cent. feedback like this, or even much less as in Fig. 4, demands a much increased input signal, and if it becomes badly distorted in the effort there is not much, use following it by a beautifully distortionless output stage. That is the chief argument for feeding

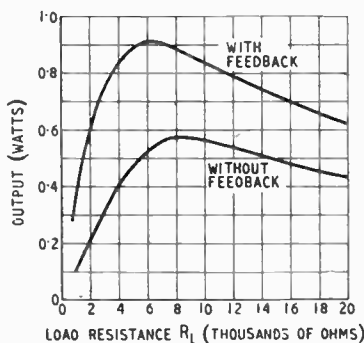

Fig. 6—Similar to Fig. 5, but using a small pentode.

back over two or even three stages. And a very sound argument it is; but it needs to be backed up by very sound practice, because the more valves and couplings are included in the feedback loop the greater the

chance that at some frequency (which may be right outside the working range) the total phase shift may cause the feedback to become positive, which means plenty of trouble. Up till now we have been making the convenient assumption that the voltage fed back is exactly 180° out of phase with the input. Within limits, the inevitable departures from this ideal are checked by feedback; but, as with amplitude distortion, once the limits are exceeded the situation gets out of hand.

That is all pretty generally understood, however. But there

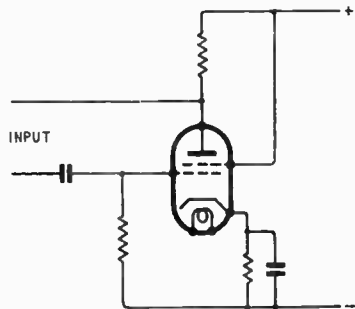

Fig. 7—Simple method of obtaining 100 per cent. feedback without certain disadvantages of the cathode follower.

is one thing—the effect of feedback on hum—on which the most conflicting statements have appeared, and very little real information. So I think it justifies an article to itself, which will appear, Editor permitting, in due course.

QUALITY AMPLIFIERS

THE January, 1946, issue of *Wireless World*, in which were given circuit details of 4-, 8- and 12-watt "Quality" amplifiers, is out of print. A reprint of the descriptive article has now been issued by our Publishers, price $7\frac{1}{2}$ d. by post.

CORRECTION

IT is regretted that on p. 52 in our February, 1946, issue the butterfly oscillator circuit covering the range 250–900 Mc/s was incorrectly credited to M.O. and G.E.C. This was actually shown by British Thomson-Houston.

CATHODE-FOLLOWER DANGERS

Output Circuit Capacitance

By W. T. COCKING,
A.M.I.E.E.

THE virtues of the cathode follower have been so much stressed lately that one might almost be forgiven for considering it the panacea for all ills. Most writers on the subject point out that it employs heavy negative feedback and that its characteristic is consequently extremely linear. Very few, however, even hint that a cathode follower can cause very severe distortion in spite of this linear characteristic.

This distortion may not be serious in the audio frequency applications of the cathode follower, but it is of highly probable occurrence with the pulse waveforms of television and radar. At really high frequencies great care in design is necessary to avoid distortion, and in consequence some at least of the attractiveness of the cathode follower disappears.

In view of the amount of published material on this stage it is not proposed here to review its general characteristics in detail. Those who are unfamiliar with it are recommended to study the excellent description by "Cathode Ray."*

The basic circuit of the cathode follower is shown in Fig. 1, and it will be seen that it differs from the usual one only by the inclusion of a capacitance C_c shunting the cathode resistance R_c . This makes the circuit look like an infinite input impedance detector, and in fact it is identical with it. It is just because the presence of this capacitance turns the cathode follower into such a detector that it distorts.

The capacitance, unfortunately, is inevitably present in all circumstances and cannot be avoided. Even if it is no more than the stray circuit capacitance it may easily total 30 pF; for there are the cathode-to-anode and cathode-to-heater capacitances of the cathode follower itself, the input capacitance of the following stage and the various wiring capacitances to earth.

Whenever resistance and capacitance are used in association the current cannot respond instantaneously to a change of input voltage. The current changes exponentially with time and only reaches its final value after an interval. The time taken for the current to reach this final state depends on the values of resistance and capacitance, and the product of the effective values is called the time-constant of the circuit.

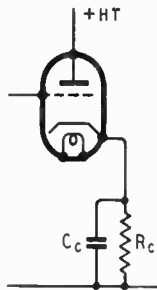

Fig. 1. The basic circuit of a cathode follower with capacitance C_c across the cathode resistance R_c .

In a circuit such as Fig. 1 the capacitance is C_c and the effective resistance is R_c in parallel with the output resistance of the valve. It has been shown many times that this output resistance is $R_a/(1 + \mu)$, where R_a is the anode AC resistance of the valve and μ is its amplification factor.

The time-constant of the cathode follower thus appears to be $C_c R_c / \{1 + \frac{R_c}{R_a} (1 + \mu)\}$. In a typical case, one might have $\mu = 20$, $R_c = R_a = 10k\Omega$, giving $T = C_c R_c / 22$. The cathode follower connection has reduced the time-constant to 1/22 of that of C_c and R_c alone, and it has done this by virtue of its low output resistance. This is all perfectly straightforward, and is a great advantage of the cathode follower. It is an advantage, because it makes the capacitance have little adverse effect on the frequency response, and so far as this alone is concerned the cathode follower

can feed a high capacitance circuit quite easily. In the example quoted, the capacitance could be twenty-two times as large as usual for a normal frequency response.

It is facts such as these which make some people so enthusiastic about the cathode follower. Unfortunately, they are true only when the valve is handling quite small signals. The cathode follower is not nearly as simple as it looks, and it contains one very definite trap for the unwary. In spite of its apparently large signal-handling capacity it is very easily driven beyond anode current cut-off when there is capacitance in shunt with the load and all its beautiful characteristics then disappear. As soon as it becomes non-conductive the time-constant at once reverts to $C_c R_c$.

It might be thought that there is little risk of the valve's anode current being cut off in practice, but this is not so. Except with quite a small input, the valve will inevitably be cut off by a sufficiently rapid change of grid potential in the negative direction, even although the magnitude of the change is too small to produce cut-off without C_c .

The mechanism of the effect is probably most easily understood by an example. Suppose that in the circuit of Fig. 1 R_c is 10 kΩ, and that the anode current is 0.5 mA when the grid is joined to earth and that it is 5 mA when the grid is +50 volts with respect to earth. In the former case the cathode is $0.5 \times 10 = 5$ volts above earth, and in the latter it is $5 \times 10 = 50$ volts. The change of cathode voltage is $50 - 5 = 45$ volts for a change of input of 50 volts, so that the voltage "amplification" is $45/50 = 0.9$ times. The grid-cathode voltage is the grid-earth voltage minus the cathode-earth voltage, or -5 volts in the first case and 0 volts in the second. Let us suppose that anode-current cut-off occurs at -10 volts grid-cathode potential.

These are steady-state conditions which hold dynamically only

* Wireless World, November, 1945.

Cathode-Follower Dangers

if C_c is zero. Let us now see how the presence of this capacitance modifies them. Assume initially that the grid is +50 volts above earth, so that the anode current is 5 mA, the cathode-earth potential is +50 volts and the grid-

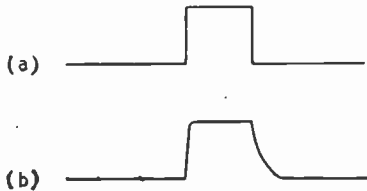

Fig. 2. An ideal input pulse is shown at (a) and the output pulse from a cathode follower at (b).

cathode voltage is zero. Now from this reference level, let the grid-earth voltage drop instantaneously from +50 volts to zero; that is, let a negative-going pulse of 50 volts amplitude be applied from the reference level of +50 volts.

If it were not for C_c , the anode current would fall to 0.5 mA and the cathode-earth voltage to +5 volts instantaneously. The presence of this capacitance, however, prevents the current from changing instantaneously. The voltage across C_c can only fall as the charge on the capacitance is released through the circuit resistance, and this takes time to accomplish.

Because of this, at the instant when the grid-earth potential becomes zero, the cathode is still 50 volts above earth, and the grid-cathode potential is thus -50 volts. As cut-off occurs at -10 volts, the valve is well and truly beyond current cut-off. It stays so cut-off until the cathode voltage drops to +10 volts. It drops to this value eventually, because C_c discharges through R_c , but the time it takes to do so is governed only by $C_c R_c$. The normal low output resistance of the cathode follower has no effect at all, for as the valve is cut-off its output resistance is not low, but infinite.

An analogous undesirable effect also occurs on a rising input voltage, but the valve is now driven heavily into grid current instead of being cut-off. Suppose that the grid-earth potential is initially zero, that the anode

current is 0.5 mA and the cathode is 5 volts above earth. Let the grid potential be changed instantaneously to +50 volts. Because of C_c the cathode voltage cannot rise at once, and at this instant it is still +5 volts only. The grid-cathode voltage is thus +45 volts.

As the valve is not cut off the time constant is not $C_c R_c$, as in the case of a negative input voltage, but

$$C_c R_c / \{1 + (1 + \mu) R_c / R_a\}.$$

This is much smaller, so that the cathode voltage rises to its final value much more quickly than it falls with a negative input. If the grid voltage change is of the form (a) in Fig. 2, the cathode voltage change has the shape sketched in (b). On the rise at the leading edge, the pulse is reproduced well, the low time-constant of the output circuit causing only a slight alteration in the shape. The trailing edge, however, is badly distorted, for with the high time constant existing with the valve cut off, the voltage can fall only slowly.

In the case considered the grid-cathode potential has been taken as zero at the start of a negative-going change of input voltage, and anode current cut-off occurs at -10 volts between grid and cathode. Moreover, at the instant of the input change the cathode-earth potential remains constant. It follows, therefore, that the maximum input voltage change to avoid current cut-off is -10 volts—the same value as that for the valve without feedback. This is what one would expect, because the feedback in the cathode follower arises from the change of cathode-earth voltage, and if this does not change there is no feedback. The trouble really arises, therefore, because the capacitance across the load prevents feedback during the change of input voltage. To avoid the effect, the input must be limited to the value which the valve will handle without feedback.

All this would suggest that the cathode follower is a singularly useless device. Fortunately, however, matters are not as bad in practice as all this might lead one to believe. The saving fact is that no input pulse can ever have perfectly vertical sides; an instan-

taneous change of input voltage is a practical impossibility. The most perfect pulse which can be generated does take a finite time to change the grid from one potential to another, even if this time is exceedingly small. If the cathode follower time-constant is made small enough to permit the cathode potential to change at least as rapidly, then the current cut-off and grid-current effects can be avoided.

This demands quite a small time-constant in many cases, and so far from the cathode follower being able by virtue of its low output resistance to feed a circuit of high capacitance it is usually necessary to restrict the capacitance to the lowest possible value. Even then it is often necessary to reduce R_c below the value which would otherwise be desirable.

By assuming that the valve has ideal characteristics, it is not difficult to calculate the performance of a given circuit. One investigation, confined to the cases of perfect input pulses and to a sine wave input, has already been carried out.*

The former case is not of much practical help in design because perfect pulses do not occur. The sinusoidal case is also of little

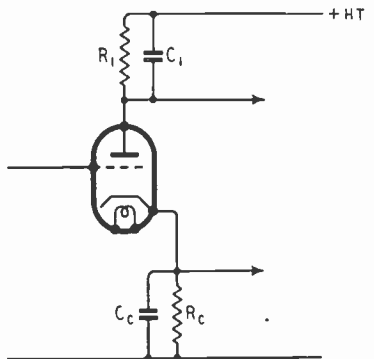

Fig. 3. The push-pull phase splitter is only a modified cathode follower and the analysis in the text applies to both if $R_c = R_1$ and $C_c = C_1$.

help when considering the pulse waveforms of television and radar. No general exact solution is possible, however, for the reason that it must depend on the precise

* "Cathode follower Internal impedance." By Harold Goldberg. Proc. Instn. Radio Engrs., November, 1945.

form of the input wave, and this will differ in nearly every case.

The writer has analysed the conditions with an input voltage of exponential form, since this represents a closer approximation to the edge of a practical pulse. The analysis has been carried out for the push-pull phase-splitter of Fig. 3 as well as for the true cathode follower of Fig. 1, since the two circuits are closely related. The results are best presented in graphical form and in Fig. 4 are given a series of curves relating the quantity βT_c to the cut-off factor. Each curve is for a different value of B, which equals

$$(1 + \mu)R_c/R_a$$

in the case of the cathode follower of Fig. 1 and $(2 + \mu)R_c/R_a$ in the case of the phase-splitter of Fig. 3, assuming that $R_1 = R_c$ and $C_1 = C_c$ in the latter case.

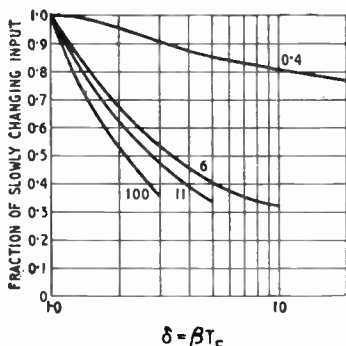

Fig. 4. These curves show how the cut-off factor is related to time-constants of the cathode circuit and input voltage, defined by βT_c , and the valve characteristics, defined by B.

The cut-off factor indicates the maximum input which can be applied without cutting off anode current, expressed as a fraction of the input which the valve would handle if C_c were zero. The quantity βT_c is the ratio of the time-constant of the cathode circuit to that of the input voltage. The former, of course, is $T_c = C_c R_c$, and the latter is $1/\beta$ and needs some explanation. If a perfectly rectangular pulse is applied to an RC circuit of the integrating type, the output voltage has an exponential shape. If the input pulse is like (a) Fig. 5, the output is like (b). The amount of rounding of the corners and the steepness

of the sides depends on the time constant of this circuit.

The wave applied to the cathode follower is imagined to be a perfect pulse passed through such an integrator, so that its time-constant $1/\beta$ is a measure of the input wave.

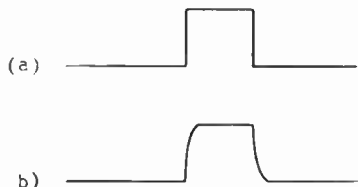

Fig. 5. An ideal pulse has the rectangular shape (a). Its passage through an integrating-type circuit makes the changes of voltage at beginning and end exponential in shape (b).

For practical purposes this must be related in some way to the frequency response of the earlier circuits. A simple way of doing this is to assume that the passage of a perfect pulse through equipment having a response of -6 db. at a frequency f modifies the pulse in the same way as would the simple integrator of time-constant $1/\beta$ if this also has a response of -6 db. at f . This leads to $\beta = \omega/\sqrt{3}$ where ω is 6.28 times the frequency in cycles per second.

In practice, of course, the fact that the circuits have the same attenuation at a particular frequency does not mean that they will affect a pulse in the same way. In general they will not. The method however does give one some idea of the requirements of the cathode follower.

The first point to be noticed from Fig. 4 is that for $\beta T_c = 1$ or

less, there is no limitation of input. Physically, this means that if the valve is to handle as big an input when it is changing rapidly as when it is changing slowly, then the cathode voltage must be capable of changing at least as rapidly as the input.

The second point to notice is that when βT_c is greater than unity the results are affected only to a minor degree by the value of B. This means, in effect, that the values of C_c and R_c are more important than the valve characteristics.

When the input is of sine waveform, the curves of Fig. 6 apply. These show the cut-off factor plotted against ωT_c for several values of B. In most cases B is of the order of 5 to 50, and it will be seen that again the value of B has only a second-order effect on the performance.

The use of these curves and the magnitude of the cut-off effect is best illustrated by numerical examples, and the following will exhibit its characteristics.

Example 1

Push-pull phase-splitter (Fig. 3)

Let $\mu = 40$; $R_a = 15 \text{ k}\Omega$; $R_c = R_1 = 47 \text{ k}\Omega$; $C_c = C_1 = 100 \text{ pF}$; $f = 10 \text{ kc/s}$. What reduction of input is needed at this frequency to avoid anode current cut-off?

$B = 132$ and $\omega T_c = 0.295$. From Fig. 6 the input is 0.96 of that at low frequencies.

Example 2

Cathode follower for television (Fig. 1)

Let $\mu = 10$; $R_a = 3 \text{ k}\Omega$; $C_c = 30 \text{ pF}$; and the applied

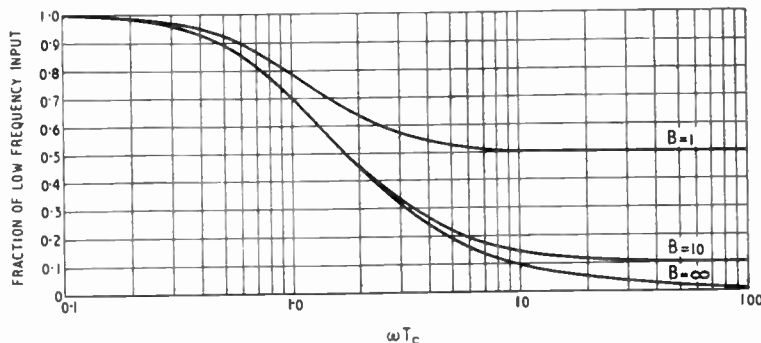

Fig. 6. The relation between the cut-off factor and ωT_c is shown here for sine waves.

Cathode-Follower Dangers—

pulse be passed through a circuit of response — 6 db. at 2.5 Mc/s. What is the maximum value of R_c (a) to avoid cut-off at full input, and (b) for cut-off at inputs exceeding 0.9 of the full?

(a) Since $\beta = \omega/\sqrt{3}$ and the maximum value of T_c is $1/\beta$, to avoid cut-off $R_c = \sqrt{3}/\omega C_c = 3.67 \text{ k}\Omega$.

(b) B is unknown, since R_c is unknown. However, in the region of 0.9 for the cut-off factor the results are only slightly dependent on B. We may expect R_c to be a little above the value in (a), and we can estimate B on a basis of R_c being about 5 k Ω . This would give $B = 18.35$, and from Fig. 4 $\beta T_c = 1.16$, about. As R_c is proportional to βT_c , its value is $1.16 \times 3.67 = 4.25 \text{ k}\Omega$.

Example 3

Phase-splitter for television (Fig. 3)

Let the values be as in Example 2, with $C_1 = C_c$ and $R_1 = R_c$. It is required to determine R_c for no limitation of input.

As the presence of R_1 only affects the value of B, and B does not influence the cut-off when $\beta T_c = 1$, the value of R_c is 3.67 k Ω , as in Example 2 (a).

Example 4

Cathode follower for television (Fig. 1)

Let $\mu = 20$; $R_a = 10 \text{ k}\Omega$; $C_c = 50 \text{ pF}$; and $\beta = 9.05 \times 10^6$ (— 6 db. response at 2.5 Mc/s). What is the cut-off factor when $R_c =$ (a) 20 k Ω , (b) 10 k Ω , and (c) 5 k Ω ?

(a) $B = 42$; $\beta T_c = 9.05$; cut-off factor = 0.15 (estimated).

(b) $B = 21$; $\beta T_c = 4.525$; cut-off factor = 0.31 (estimated).

(c) $B = 10.5$; $\beta T_c = 2.26$; cut-off factor = 0.575.

Now what conclusions may be drawn from this? In the first place, Example 1 shows that the cut-off effect is likely to be negligible in AF work. The fractional cut-off is 0.96 in this example, so that it is small. Then a phase-splitter is usually employed fairly early in an AF amplifier where it handles only small signals, so that it is never likely to be fully loaded. Then again, a signal of full intensity at as high a frequency as 10 kc/s is never likely to be found in any ordinary musical programme.

The remaining examples for pulses show quite clearly that it is the values of C_c and R_c in relation to the input wave which are important. If the valve is to handle its full input, then these must be kept sufficiently small. The valve itself has only a secondary influence on this aspect, but in general if R_c is small R_a should be small also if adequate output is to be secured. Thus, if an output of 50 volts is wanted and R_c is 2 k Ω , the current change in R_c must be 25 mA and the valve must be capable of providing this. In general, therefore, the value of R_c reacts on the choice of valve through the output required, and usually a low value of R_c needs a low-resistance valve.

Before concluding it may be as well to point out that the curves of Fig. 6 give an indication of the minimum capacitance needed for an infinite input impedance de-

terminator. The requirement here is that the valve should cut off for at least part of every RF cycle. B should be large and ωT_c around 100. If $R_c = 0.1 \text{ M}\Omega$ and the frequency is 1 Mc/s, $C_c = 159 \text{ pF min.}$

There is one other point to mention. The calculations on which the curves of Figs. 4 and 6 are based assume an ideal valve characteristic. In practice, characteristics are curved near the cut-off point. This is likely to ease matters somewhat, and the valve will probably cut-off rather less easily than the curves would indicate. In general, the curves should be taken as a guide to the choice of correct circuit values rather than a means of accurately determining them. The accuracy increases as the real valve characteristics approach the assumed ideal and, in the case of pulse waveforms, as the actual wave approaches the exponential shape.

RENEWAL OF B.B.C. CHARTER*Views of "The Economist" on State Monopoly*

THE Prime Minister stated in reply to a Parliamentary question some weeks ago that the Government had not yet made up its mind whether to set up a public Committee on the subject of broadcasting before proceeding to the renewal of the B.B.C.'s charter this year. Commenting on this in its January 5th issue, *The Economist* states:

"This is a point of considerable importance—indeed, in the long run, of supreme importance in any free democracy. It would be a pity if each of the many criticisms of the B.B.C. that flare up in the Press and elsewhere from time to time were turned into a party controversy, and a Committee that developed into a witch-hunt would be very harmful. Such criticisms are quite inevitable, and not even the perfect B.B.C. could expect to be immune to them. The majority view is probably that Sir William Haley and his staff do their job about as well as any State-appointed monopolists could be expected to do it.

"But this is not the point. The real point is whether broadcasting should be entrusted to a

State-appointed monopoly, no matter how high-minded its intentions. Any suggestion of a State monopoly of the printing press would be met with a storm of protest. Yet any writer or journalist who has broadcast will testify that the effect of his words is infinitely greater, more direct and immediate when spoken through the microphone than in any form of printing. It is really astonishing that in a country so jealous of its liberties the monopoly by the State of such an enormously powerful organ of instruction and persuasion should be so placidly accepted. Nor is it true that the only alternative to a State monopoly is the dominance of the advertiser, as in America (though even that might be less dangerous in the long run). . . .

"A renewal of the charter on the present terms might very well settle the matter for ever. It is of the first importance that an opportunity should be given for the very far-reaching issues of political health that are raised by the monopoly of such a powerful organ of speech to be thrashed out by a Commission of the necessary breadth and competence . . ."

THE NEW SUNSPOT CYCLE

Retrospect and Prospect : Forecasts for Short-wave Working : USW for Long Distances?

By T. W. BENNINGTON

IN *Wireless World* nearly a year ago* it was mentioned that, although it was then too early to say with certainty, the epoch of minimum solar activity appeared to have occurred about the middle of 1944. It now transpires that it was a little earlier than that, and so, considerably more than a year of increasing solar activity having passed, it is interesting to review, so far as possible, the course of the new cycle up to the end of 1945. And now that it is no longer necessary to keep all ionosphere data a close secret, we may take the opportunity of examining some of this in order to see how the solar cycle has actually affected the atmospheric ionisation—and hence short-wave communication—during the past few years. It is a little difficult, however, to keep really up to the minute with solar data, since some time elapses before this becomes available in its final form; again, as will appear later, the most informative method of correlating the solar data with those of the ionosphere critical frequencies is one involving a few months' time delay. However, by making use of provisional solar data, and by a little extrapolation, we can gather a fairly accurate idea as to how solar and ionospheric events were shaping themselves at the end of 1945. Our aim will be to see how the changing solar activity is likely to affect practical short-wave communication during 1946 and after.

In order to show the general course of the last and present sunspot cycles the curve of Fig. 1 is given, this being a plot of the

annual means of the relative sunspot numbers. The data for 1945 are provisional only. The relative sunspot numbers—records of which extend back for many years—are an index of the solar activity, and are obtained from the observations made at a number of different observatories, by taking the sum of the total number of sunspots observed plus ten times the number of spot groups, this sum being multiplied by a factor depending upon the telescope used and the seeing conditions, in order to bring the different observations into general consistency. Although this method of assessing solar activity may seem to be somewhat arbitrary, the fact remains that, because of its excellent correlation with

in 1944 and that during 1945 it increased considerably. In fact, the activity during the present cycle has increased much more rapidly from the epoch of minimum activity than has been the case during most—though not all—of the preceding cycles, which leads us to speculate upon its course during the next few years. Does the rapid increase mean, for example, that the coming maximum will be an exceptionally high one? It is not possible to say with any certainty, for, although there are numerous methods for the prediction of future solar activity, all devised by men eminent in the subject of mathematical analysis, none of these have claimed to achieve very great accuracy in the long-distant future and none, so far, have proved much more accurate than they claimed to be. There are, in fact, insufficient solar data on which to predict with any degree of certainty very far ahead. Nevertheless, most authorities indicate that there is a distinct probability of the next maximum being considerably higher than the last, and that the "rising" period of the cycle will be of relatively short duration, while, according to one authority, the next maximum is likely to occur before May, 1948. Other methods indicate 1949 as the year of the next maximum. Incidentally, if this is indeed a "high" one it will break the "high-low" sequence for maxima which has persisted since the maximum of 1848, and in which the maximum of 1937 was a high one.

From Fig. 1 we see that the sunspot activity was at a minimum

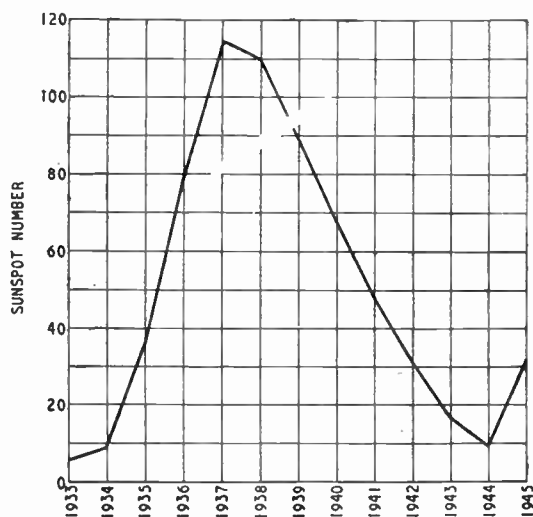

Fig. 1. Annual means of relative sunspot numbers.

ionospheric data and with other phenomena which are dependent on the solar activity, it does appear to give a true criterion of the activity which it seeks to represent.

From Fig. 1 we see that the sunspot activity was at a minimum

in 1944 and that during 1945 it increased considerably. In fact, the activity during the present cycle has increased much more rapidly from the epoch of minimum activity than has been the case during most—though not all—of the preceding cycles, which leads us to speculate upon its course during the next few years.

Effects upon Short-wave Communication.—We may now examine some data indicative of the

* "Sunspot Minimum," *Wireless World*, March, 1945.

The New Sunspot Cycle—

way in which the changing solar activity affects the atmospheric ionisation and hence short-wave communication. In Fig. 2 are plotted (top curve) the monthly means of the relative sunspot numbers for the years 1941 to 1945, and (bottom curve) the monthly means of the noon critical frequencies of the F_2 layer as measured in England.

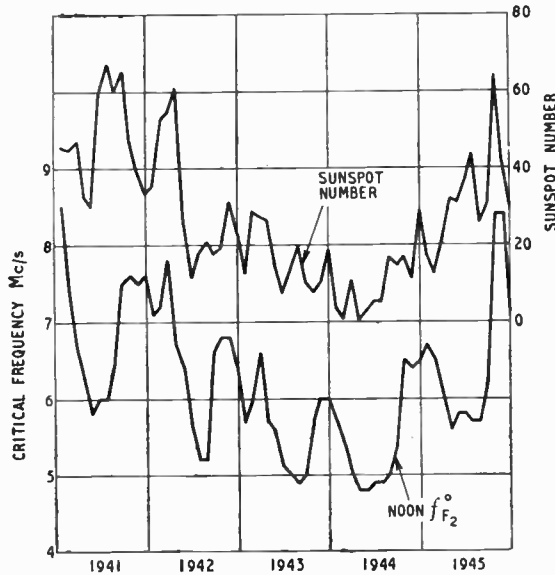

From the top curve it is seen that there were large and erratic variations in the sunspot activity from month to month, though, from the general sweep of the curve, the fall in activity towards April, 1944, and the general rise since then can be clearly seen. In that month the relative sunspot number reached its lowest value for any month since August, 1933—the time of the preceding minimum.

In the bottom curve of Fig. 2 the large seasonal variations in F_2 layer ionisation are reflected as increases in the critical frequency in the winter and decreases in the summer, and these are seen to occur with unfailling regularity as year follows year. In spite of these seasonal variations the general effect of the varying solar activity is also apparent, for there is a general downward sweep in the curve towards April, 1944, and then an upward sweep towards the end of 1945, in sympathy with

the general trend of the sunspot curve. The critical frequencies towards the end of 1945—roughly $1\frac{1}{2}$ years after the minimum—were, in fact, back to approximately the same values as obtained early in 1941—roughly 3 years before it. The effects of this rather surprising increase will be apparent if we consider the change in the Maximum Usable Frequency for the longest distance

possible in one hop, and, taking this to be roughly 3.5 times the critical frequency, observe that between April, 1944, and October, 1945, it would have increased from 16.8 Mc/s to 29.4 Mc/s.

If the two curves of Fig. 2 are examined for

Fig. 2. Monthly means of F_2 critical frequencies for noon and of relative sunspot numbers for the minimum period of the sunspot cycle.

detailed correlation it is seen that, despite the seasonal effects which are superimposed on the critical frequency curve, this is not entirely absent. It can best be noticed as a retardation in a seasonal rise of critical frequency by a temporary fall in sunspot

example. The ionosphere is, in fact, surprisingly quick to react to temporary fluctuations in the solar activity around the minimum of the cycle, which is not the case around the maximum.

Detailed Correlation.—But to observe in detail the dependence of the critical frequency upon the varying solar activity it is best to smooth the curve of relative sunspot numbers so as to remove the temporary fluctuations, and to smooth the curve of critical frequency by removing the seasonal effects. This is done by taking twelve-month running averages of both these quantities; i.e., by taking for the mean for the epoch at the centre of any month the average of the twelve monthly means having that month as centre. Such curves of twelve-month running averages are given in Fig. 3, the last few points in the full line curves being obtained on the basis of provisional data and the dashed portions being obtained by extrapolation. The correlation between the two curves is seen to be exceptionally good, the relationship being approximately linear. It may be said that this same good correlation between twelve-month running averages of critical frequencies and relative sunspot numbers may be obtained over the whole sunspot cycle, and applies to the critical frequencies of all the ionosphere layers and for all times of day, though the magnitude of the critical frequency changes varies with the layer and time of day, being greatest for the F_2

Fig. 3. Twelve-month running average of noon F_2 critical frequencies and of relative sunspot numbers.

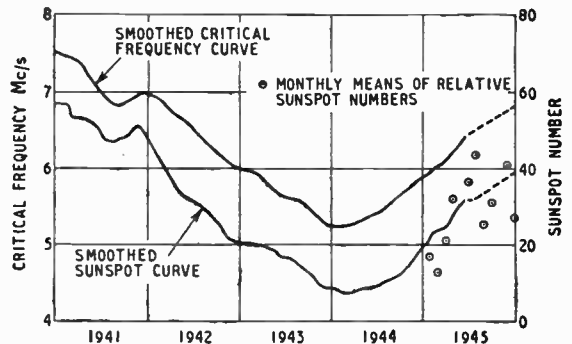

activity, or by an enhanced seasonal rise due to a sudden increase in activity, the last six months of 1945 affording one good

layer and least for the E and greater at noon than at other times.

The two curves of Fig. 3 should,

it is hoped, suffice to remove any remaining doubts as to the dependence of short-wave working frequencies upon the degree of solar activity. Thus, in the 12-month running average of sunspot numbers we have a good criterion as to the variation in critical frequencies, and hence in usable frequencies for short-wave communication, and if we can predict the variations in the one quantity this should enable us to forecast the other. It seems that we ought, as a matter of fact, to be able to estimate the long period, though not the short period, variations in both of these quantities for a short time ahead with good accuracy.

Future Working Frequencies.—

What, then, may be said of the future that will be applicable to practical short-wave work. We had best confine ourselves in the main to the immediate future—say the year 1946. As has already been mentioned, the critical frequencies in England were back, towards the end of 1945, to values of the order which were recorded early in 1941, and the daytime MUF for this particular latitude had therefore reached a value roughly of the order of 29.4 Mc/s. But the working frequency for a particular transmission path depends upon the condition of the ionosphere—not only at the end of a transmission path—but upon its condition along most of the route which the wave is to traverse. And ionosphere conditions vary, not only with the time of day, season of year and epoch of the sunspot cycle, but also with geographic and with geomagnetic latitude. In general, the critical frequencies increase as the low latitudes are approached and fall towards the high latitudes, and thus they vary very considerably over a long transmission path. In short, the detailed prediction of working frequencies for various distances and directions—although now commonly achieved with good accuracy—is far too complex to deal with in this article, involving, as it does, the use of world-wide ionospheric charts for the months in question. A few practical indications for a few specific directions from this country are all, therefore, that

can be given and these will all deal with communication over distances exceeding 4,000 km, it being understood that these refer to frequencies regularly workable and not to freak results occurring on exceptional days.

For daytime transmission in a direction directly to the south of this country, i.e., to Africa, frequencies as high as 26 Mc/s are already workable for considerable periods. During 1946 it is probable that these will increase to well over 28 Mc/s, the highest working frequencies being attained around the equinoxes, though 28 Mc/s should be workable during peak daylight hours most of the year. As to the night, frequencies up to 10 Mc/s ought usually to be workable the night through, and by next winter this may be increased to 12 Mc/s.

For communication with South America daytime frequencies up to 24 Mc/s are already usable for good periods and it is probable that this will increase to 28 Mc/s during the year, with the equinoxes giving the best high-frequency results. 8 Mc/s is probably the highest frequency on which good results will be obtained during the deep night at first, increasing to 10 Mc/s during the year.

Frequencies up to 22 Mc/s ought to be usable for good periods during the day in the early months for communication with U.S.A., falling to about 17 Mc/s during the summer and increasing to about 24 Mc/s next winter. When all the path is in darkness 7 Mc/s will at first be the highest safe frequency, but next summer frequencies up to 14 Mc/s should be usable most of the night. By next winter 10 Mc/s may be usable throughout the night.

For the Far East and India frequencies up to 22 Mc/s or slightly higher should be usable during daytime in the early part of the year, falling to about 20 Mc/s in June. Next winter it should be possible to get through on 24 Mc/s during the day. During darkness 7 Mc/s or even lower will be the highest safe frequency in the early part of the year, increasing to 13 Mc/s in the summer and falling to about 9 Mc/s next winter.

It may be thought that the above frequencies are somewhat

high, and they are certainly higher than it is commonly thought necessary to use. They are, in fact, intended to indicate the extreme highest limits of the *regularly* usable frequency bands, and, whilst good communication should be regularly maintained on lower frequencies where sufficient power is available, they will no doubt be exceeded on certain days when "freak" conditions prevail.

And what of the years beyond 1946—the time towards the sunspot maximum? Well, as we now know, the higher short-wave frequencies were not sufficiently exploited at the last maximum; we could, generally speaking, have used higher frequencies than were commonly put to use. And if the next maximum is to exceed the last one by the amount suggested by some eminent authorities—it is quite possible that 50 Mc/s may become a usable frequency for long-distance communication from this country for periods during the daytime.

Postscript.—An unusually large sunspot group—one visible to the naked eye—appeared on the sun's east limb on Jan. 29th, and, crossing the central meridian on Feb. 5th, was due to reach the west limb on Feb. 11th. It is possible that it may survive its journey across the "reverse" side of the sun and, if so, reappear on the east limb about Feb. 24th, but, on the other hand, it may die out and disappear before that date.

In addition to being large the group appears to have been extremely active, growing rapidly after its first appearance, and several solar flares taking place in its vicinity. Short-wave "Delinger" fade-outs—most probably caused by the flares—were reported to have occurred on Jan. 31st, Feb. 1st, 2nd and 5th, while disturbed short-wave conditions were expected to start late on Feb. 6th.

But apart from these disturbing effects, the increased solar activity had a very definite ionising effect upon the atmosphere, and the ionosphere critical frequencies were very high from Feb. 1st to 6th. "High frequency" short-wave working conditions therefore prevailed, and 28-Mc/s amateur communication with the U.S.A. was frequently established.

WORLD OF WIRELESS

GOVERNMENT SURPLUS VALVES

IT is believed that the disposal of surplus Government valves is being regularised by the conclusion of an arrangement whereby the very large stocks in the hands of Government Departments will be repurchased by the manufacturers concerned.

MERCHANT NAVY RADAR

THE recent demonstrations of radar equipment for the Merchant Navy raises the question of training and that of the position of Radio Officers in relation to radar.

There has been no suggestion in official quarters that "Radar Officers," as such, should be carried by merchant ships. On enquiry from the Radio Officers' Union it is learned that it has been agreed with other Merchant Navy officer organisations that radar gear should be in the radio room and be the responsibility of the Radio Officer in the same way as the other radio aids to navigation, such as DF. It will, of course, be expedient for the navigating officer to operate the remote control unit so that the PPI picture

can be superimposed on the navigation chart as was done during the tests in H.M.S. "Pollux," described elsewhere in this issue.

Two naval schools are at present training selected Merchant Navy officers in the use of radar. A six-weeks' course is being given to Radio Officers and a 3-day operational course to navigating officers.

NEWS IN MORSE

THE latest schedule of morse transmissions of official news bulletins radiated by Post Office stations is given below. Although these transmissions are intended for overseas reception they may sometimes be receivable in this country.

0130-0315 GBV GBC5 GDB2 GIU GPJ.
1100-1200* GBV GIA GID GIJ GYB8.
1600-1700* GBV GBC5 GIA GIJ GYM.
1800-1900* GBV GBC5 GBL GIM.
1930-2030* GBV GBC5 GBL GAY GIJ GIM.
2200-2300 GBV GBC5 GBL GIJ.
2300-2400* GBV GBC5 GAY GIJ.

The wavelengths are:

GBV 3846; GDB2 44.15; GIJ 42.95; GIU 36.81; GBC5 34.56; GAY 33.67; GPJ 27.56; GIM 22.13; GID 22.13; GBL 20.47; GIA 15.27; GYB8 10.57.

* Weekdays only.

B.A.O.R. AMATEURS!

AMATEURS serving with the British Forces in Germany are to have the opportunity of operating their own stations, on the same frequency bands as those on which transmitters in this country are now allowed to work; 28—29 and 58.5—60 Mc/s.

A block of call signs, comprising four letters and numerals prefixed by "JE," has been allotted to the Secretary of the recently formed B.A.O.R. amateur transmitters society who will allocate them to applicants. The secretary is Flt./Lt. E. J. Fowler, 84 Group R.A.F. (Disarm) B.A.F.O., B.A.O.R.

Authority has been obtained for German equipment to be used by the transmitters, who, if they have not previously held a licence, will be required to pass a test similar to that suggested by the G.P.O.

FARADAY MEDALLIST

THE twenty-fourth award of the Faraday Medal has been made to Sir Edward Appleton, G.B.E., K.C.B., D.Sc., F.R.S., for the conspicuous services rendered by him in the advancement of electrical science, particularly in the field of radio propagation. Sir Edward has been Secretary of the Department of Scientific and Industrial Research since 1939. He was made a Fellow of the Royal Society in 1927, is Chairman of the British National Committee for Radio-Telegraphy, Vice-President of the American Institute of Radio Engineers and President of the International Scientific Radio Union.

The Faraday Medal is awarded by the Council of the I.E.E. not more frequently than once a year, either for notable scientific or industrial achievement in electrical engineering or for conspicuous service rendered to the advancement of electrical science. The award is not restricted as regards nationality, country of residence or membership of the Institution.

"THE MIRACLE OF RADIO"

HERE is a book* that is long overdue. It tells the man in the street, in the words of its own subtitle, "the story of Radio's decisive contribution to victory." The story is a non-technical one and well illustrated; the 120-odd pages of this small book contain a mass of information on all the more spectacular applications of radio to purposes of war. Particular emphasis has been laid on the part played

* THE MIRACLE OF RADIO, by Miles Henslow. Evans Bros. Ltd. 2s. 6d.



PHOTOTELEGRAPHY. The first of forty picture transmitter-receivers ordered by Cable & Wireless from the G.E.C. and Marconi's, was installed at the Company's headquarters, Electra House, Victoria Embankment, London, W.C.2, for a demonstration when the reduction in the rates for phototelegrams was announced by Sir Edward Wilshaw (right). The prototype of this self-contained set was designed by the G.P.O. research workers at Dollis Hill.

by the industry in providing the radio equipment needed for victory.

THE REASON WHY

REPRESENTATIVES of the industry and the technical and lay Press were recently given the opportunity of touring the B.B.C. television station at Alexandra Palace, in order that we might see what was going on behind the scenes in preparation for the re-starting of the service.

Whatever may have been the intention of the Director of Television in extending the invitation, the visit certainly showed why it will be "some time" before television re-starts. The whole station was humming with activity, but there is a tremendous amount to be done before the station can provide a reliable service. So far as the engineering side is concerned, every section of the equipment is being tested, measured and reconditioned. We were reminded that there are 2,500 valves alone to be tested!

B.B.C. ACCOUNTS

IT is interesting to learn from the Government White Paper issued recently giving the B.B.C. accounts for the year ended March 31st, 1945, that 30 per cent. (£2,592,788) of the Corporation's expenditure was for engineering.

Another interesting item is the £45,000 worth of Lease-lend equipment received and put into service during the year.

The Corporation did not receive a proportion of the revenue from licence fees, but was given a Government grant-in-aid amounting to £8,300,000. Its income also included £637,286 from publications.

OBITUARY

We regret to record the death on January 24th of **Charles B. Gregory**, technical recording manager of the E.M.I. Abbey Road recording studios. He joined the Columbia firm in 1894, thus celebrating his jubilee in the sound-recording world in 1944.

PERSONALITIES

The Rt. Hon. The Earl of Mount Edgcumbe, T.D., has been elected an Honorary Member of the Institution of Electrical Engineers in recognition of his distinguished work as an electrical engineer and the services rendered by him to the Institution. He was President for the year 1928/29.

Drs. L. G. Brazier and **J. L. Miller** have been appointed Research Manager and Chief Engineer (Equipment and Telecommunications), respectively of the Engineering and Research Division of British Insulated Callender's Cables.

S. Whitehead, M.A., Ph.D., has been appointed director of the British Electrical and Allied Industries Research

Association (E.R.A.). **Dr. Whitehead** joined the Association twenty years ago as assistant director of the E.R.A. Laboratories.

Eric Megaw, B.Sc., M.B.E., has been appointed by the Admiralty to take charge of Naval Radar Research. He was a pioneer in short-wave radio and has contributed several articles to our sister journal, *Wireless Engineer*.

J. W. Ridgeway, O.B.E., Manager of the Radio Division of the Edison Swan Electric Co., has now been appointed a Director of the company.

IN BRIEF

An exhibition of German electronic equipment, sponsored by the Ministries of Supply and Aircraft Production, will be held at Earls Court Exhibition from March 4th to 16th (closed Sunday, 10th). The exhibition is not open to the general public, but is intended for the radio industry and radio research workers. Tickets are, therefore, being distributed by the trade associations, professional institutes and direct to Government departments and research establishments.

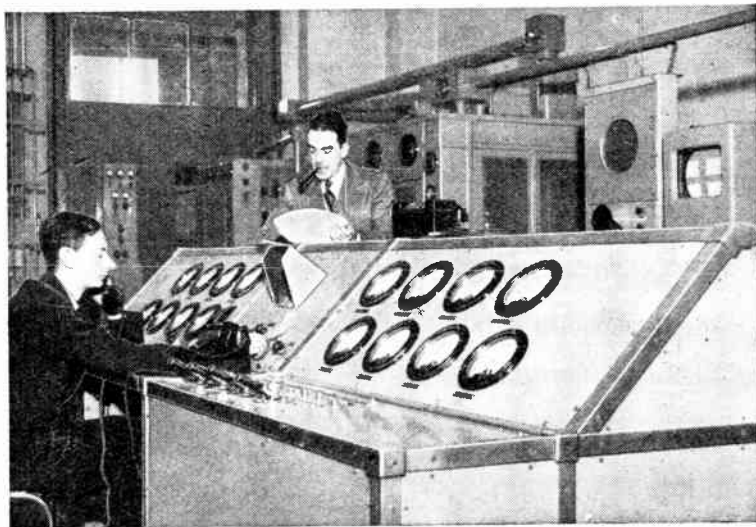

TEST TRANSMISSIONS of a still pattern started from the Alexandra Palace on February 1st and are being radiated each weekday from 11.30 to 12.30 and from 4.0 to 5.30. A black cross on a white background is transmitted on the vision frequency 45 Mc/s (6.67 m) and a tuning note and interval signal on the 41.5-Mc/s (7.25 m) sound channel. The test pattern can be seen on the monitoring tube on the right of this picture—note the frame has slipped!—taken in the vision transmitter room. **D. C. Birkenshaw**, television superintendent engineer, is standing behind the control desk.

J. G. Wright and **T. G. Weaire** have retired from the Board and all activities connected with Wright and Weaire, Ltd., the company which they formed in 1919.

H. F. Schwartz is to be Vice-Chairman and **Grp. Capt. E. Fennessy**, O.B.E., a Director of The Decca Navigator Company.

D. M. Sheil-Small has been appointed works manager of Alfred Imhof, Ltd., and will be chiefly connected with the development of their instrument cases.

R. M. Fiske was awarded the M.B.E. in the New Year's Honours List for his work in organising and building up a machine shop at the Philco radio factory at Perivale during the peak period of the war.

Dr. P. Dunsheath, President of the I.E.E., and **W. K. Brasher**, Secretary, have been on an official visit to Canada at the invitation of the Engineering Institute of Canada. They have also visited the American I.E.E. and I.R.E.

Amateur UHF.—The bands 420-430 and 1,215-1,295 Mc/s have been opened to amateurs by the Canadian and United States authorities.

Aeronautical radio and radio-controlled weapons are included in an exhibition of German aircraft and equipment being held under the auspices of the Ministry of Education at the Science Museum, South Kensington, London, which was reopened on February 14th. The exhibition is open on weekdays from 10.0 to 6.0 and on Sundays from 2.30 to 6.0. Admission is free and the exhibition will remain open for three months. The exhibits are provided by the Royal Aircraft Establishment, M.A.P.

A Course of lectures on elements of the design of automatic control (servo) systems will be given at the Northampton Polytechnic, St. John Street, London, E.C.1, at 6.0 on Tuesday evenings, commencing March 5th. Particulars of the course and tickets, costing 21s., are obtainable from the secretary. The lecturers are: **Dr. A. Porter**

World of Wireless—

(Ministry of Supply), M. L. Jofek (Cossor) and Prof. K. A. Hayes (Military College of Science).

Change of Name.—The Marconi School of Wireless Communication, Chelmsford, will now be known as Marconi College.

"Music While you Work."—The Government agreement made in 1943 whereby music was permitted to be relayed in industrial premises without payment of individual licence fees expired on February 24th. It is now necessary for firms wishing to relay music in factories to secure a licence from the licensing organisations—Performing Right Society, 33, Margaret Street, London, W.1, and Phonographic Performance, 144, Wigmore Street, W.1.

Standard Telephones.—A new organisation—the Industrial Supplies Division—has been set up by S.T.C. for the distribution of the company's products in industry. The Division absorbs Stanelco Products, but the trade name Stanelco will continue to be used. Among the products to be marketed by the Division, which has sales offices in London, Birmingham, Bristol, Leeds, Manchester and Glasgow, are rubber- and plastic-covered wires and cables, soldering equipment and wire strippers.

Changes of Address.—The Central Research Laboratory of the Permanent Magnet Association has moved from the Physics Department, University of Sheffield, to 84, Brown Street, Sheffield, 1. Sea Rescue Equipment, Ltd., has moved to Chiltern Works, Clarendon Road, Watford, Herts (Tel.: Watford 6238). The address of the associated distributing company, Radio-Aid, Ltd., is 29, Market Street, Watford (Tel.: Watford 5988). Dawe Instruments, Ltd., are now at Harlequin Avenue, Great West Road, Brentford, Middlesex (Tel.: Ealing 1850).

Philco.—Under a new agreement with the Philco Corp., of Philadelphia, the Philco Radio and Television Corp., of Great Britain, is permitted to export radio and television receivers under the trade name Airmec or any other name, except Philco which is still to be used for the corporation's products sold in this country. The name of the company is also to be changed to Radio and Television Trust, Ltd.

Belling and Lee.—A catalogue of components and accessories (1946-47) has just been issued by Belling and Lee, Ltd., Cambridge Arterial Road, Enfield, Middlesex. It gives full dimensions and electrical characteristics of the firm's products, which now include heavy-duty industrial suppressors for use with radio-heating equipment, a wide range of interconnector plugs and sockets, miniature fuse holders, glass seals, valveholders and a soft "Skytower" lattice mast. For the time being circulation of the catalogue is restricted to engineers and designers.

R.G.D.—The Radio Gramophone Development Co., Bridgnorth, Shropshire, announce that they have in production a new high-quality radiogramophone which will be available this month. The company is opening depots in London, Manchester and Birmingham.

Department of Overseas Trade.—This department has now moved to 35,

Old Queen Street, London, S.W.1, and all enquiries should be sent to the Comptroller-General at this address.

"Britain Can Make It."—A National Exhibition of Design is to be opened at the Victoria and Albert Museum on September 24th. Many industries are preparing new designs in time for the exhibition, and radio and television are in the list of commodities from which exhibits will be selected.

Quartz Crystals.—The tremendous expansion in the production of quartz crystals during the war is revealed by the Telecommunication Quartz Committee. Whereas in 1938 the output was about 10,000, in 1944 production had reached 1½ million.

A Record?—Within half an hour of receiving his amateur transmitting licence on January 10th at 16.16 GMT, C. G. Allen, G8IG, of McMichael Radio, established, with the Norwegian station LA8C, what is probably the first official international amateur communication since the imposition of the ban in 1939.

Edgware Short-wave Society has changed its name to Edgware and District Radio Society and will in future meet each Thursday at the Constitutional Club, Manor Park Gardens, Edgware. The secretary is P. A. Thorogood (G4KD), 35, Gibbs Green, Edgware.

Amateurs in the vicinity of Chichester and Bognor may like to communicate with L. Frost (G5PF), of Pixies West Parade, Bognor, for details of the West Sussex Short-wave and Television Society which has been revived.

Stockport Amateurs.—The reference to the re-formation of the Stockport Amateur Short-wave Radio Society in last month's issue was a little misleading. The Society was re-formed a few months ago and, with a membership of some 50, now meets every Monday at 7.45 at the Textile Hall, Chestergate, Stockport, Cheshire. The secretary, G. Wood, c/o 121, Garners Lane, Davenport, Stockport, will gladly send particulars of the Society's activities to interested readers.

I.R.T.S.—The following officers were elected at the recent annual general meeting of the Irish Radio Transmitters' Society:—President, Dr. T. D. O'Farrell (EI6F); Vice-President, H. A. Hodgins (EI5F); Hon. Sec., Capt. E. C. Woods (EI3L); Hon. Treas., T. J. Green (EI9N).

"EI" Transmitters.—Although the transmitting gear impounded by the authorities in Eire was returned to the owners some months ago there are no signs of a revocation of the order prohibiting its use. At the annual meeting of the Irish Radio Transmitters' Society a strong plea was made for facilities similar to those granted in the U.K., U.S. and Canada.

B.S.R.A.—The first general meeting of 1946 of the British Sound Recording Association, held in the Kingsway Hall, London, on January 30th, was attended by members from many parts of Gt. Britain. Plans for the future development of the Association were discussed. Details of membership and leaflets outlining the work of the Association can be obtained from the Technical Sec., D. W. Aldous, BCM/BSRA, London, W.C.1.

Slade Radio.—The meetings of the Slade Radio Society are held on the fourth Friday in each month and not the last as was stated in our last issue.

A.R.R.L. Handbook.—The 1946 edition of the American Radio Relay League's "Radio Amateur's Handbook" is now available, but in limited supply, from Arthur F. Bird, 66, Chandos Place, London, W.C.2, price 10s. 6d.; postage 7d.

Year Book.—The Electrical Industries Benevolent Association have issued a Year Book for 1945, copies of which can be obtained from the Secretary, 32, Old Burlington Street, London, W.1. A list of 33 local committees and secretaries throughout the country is included.

For Newcomers.—"Amateur Radio Simply Explained" is the title of a 32-page booklet (price 1s. 3d.) issued by the British Short-wave League, 53, Madeley Road, Ealing, London, W.5.

MEETINGS

Institution of Electrical Engineers

Radio Section.—"Tuning Devices for Broadcast Radio Receivers," by Dr. R. C. G. Williams, B.Sc. (Eng.), at 5.30 on March 6th.

Radiolocation Conference.—A four-day radiolocation conference will be opened by a lecture by Sir Robert Watson Watt, C.B., F.R.S., on "The Evolution of Radiolocation," at 5.30 on March 26th. Meetings will be held on subsequent days at 9.30 a.m., 2.30 and 6.15.

Students' Section.—Address by the President, Dr. P. Dunsheath, C.B.E., M.A., at 7 on March 5th.

All the above meetings will be held at the I.E.E., Savoy Place, London, W.C.2.

Cambridge Radio Group.—"A Method of Transmitting Sound on the Vision Carrier of a Television System," by D. I. Lawson, M.Sc., A. V. Lord, B.Sc., and S. R. R. Kharbanda. Special meeting with demonstration on March 1st at 6.45 at Pye, Ltd., Radio Works, Cambridge.

"The Design of Band-Spread Tuned Circuits for Broadcast Receivers," by D. H. Hughes, at 6 on March 12th at the Technical College, Collier Road, Cambridge.

British Institution of Radio Engineers

London Section.—"The Effects of Solar Eclipses on the Ionosphere," by Dr. R. L. Smith-Rose, at 6.15 on March 20th at the Institution of Structural Engineers, 11, Upper Belgrave Street, London, S.W.1.

North-Eastern Section.—"Carrier Current Protection," by D. H. Towns, B.Sc., and C. Ollerenshaw, B.Eng., at 6 on March 13th at Neville Hall, Westgate Road, Newcastle-on-Tyne.

Radio Society of Great Britain

"Recent Advances in Frequency Measurement," by Dr. L. Essen, B.Sc., at 6.30 on March 15th at the I.E.E., Savoy Place, London, W.C.2.

Royal Institution of Great Britain

"Acoustic Control of the Flight of Bats," by Dr. H. Hartridge, M.A., M.D., F.R.S., at 5.15 on March 1st at The Royal Institution, 21, Albemarle Street, London, W.1.

**FOR SHEER
DEPENDABILITY
AND
MAINTENANCE
OF
CHARACTERISTIC**

BRIMAR
(BVA)
VALVES

16
14
12
10
8
6
4
2
ANODE CURRENT — mA

5 4 3 2 1 0
GRID VOLTS

ADVERTISEMENT OF STANDARD TELEPHONES AND CABLES LIMITED FOOTSCRAY, SIDCUP, KENT



ANALOGY ON THE GOOSE STEP

There are various kinds of goose step - here we show the delicate tread of dear old mother goose herself; there is also the gentle Prussian variety which did so well for a time until old Joe objected.

The only thing these two goose steps have in common is that each step is identical, in fact just like the Transformers we delight in producing, whether it is one or ten thousand they are all identically the same - giving exactly the same ????? - not the slightest variation to cause trouble at a later stage.

To us it is a stirring sight to see our beloved Transformers goose stepping along the production lines and if you saw them for yourself you would no longer wonder how it is that we produce the best Transformers so swiftly and economically . . .

PARMEKO of LEICESTER.
Makers of Transformers.



... but the R.S. "UNIVERSAL FIFTEEN" is **TRULY PORTABLE**

The need for really efficient portable public address equipment was never more urgent than it is today And when a truly portable outfit such as the R.S. "Universal Fifteen" is available—although only in limited quantities—putting up with unconnected unwieldy equipment is not only unnecessary but uneconomic. The "Universal Fifteen" operates efficiently on either A.C. or D.C. mains at all voltages from 200-250. We will gladly send you fullest details on request.



R.S. Amplifiers

R.S. AMPLIFIERS LTD • 9-4 HIGHFIELD RD • SHEPPERTON • MIDDLESEX
TELEPHONE • WALTON-ON-THAMES • 1059

CASE

by

IMHOF'S

ESTABLISHED 1845

THE HALLMARK OF A GOOD INSTRUMENT

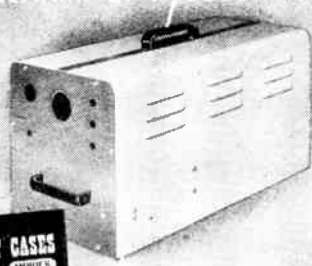



If you are inclined to the view that your instruments deserve a case that is better built and of more attractive and functional design, or you build equipment that needs precision sheet metal work, you will be interested to have this catalogue. A penny stamp and the request on your business letterhead will bring it you.

ALFRED IMHOF LTD. 112-116 NEW OXFORD STREET, LONDON, W.C.1. MUSEUM 5944

NAVIGATIONAL RADAR

Experimental Equipment for Use in Merchant Ships

A DEMONSTRATION of experimental radar equipment designed for pilotage and collision prevention in narrow waters was given recently in the Thames Estuary by the Ministry of War Transport and the Admiralty. The object was to prove to shipowners the value of radar as a safety device, and to indicate to the radio industry possible forms which the apparatus might take. The suggestions embodied are the result of experiments carried out by the Admiralty Signal Establishment in H.M.S. "Pollux."

Technically the principal difference between the navigational radar shown and standard service equipment is in the minimum useful range, which has been reduced from something like 500 yards to better than 50 yards by using a pulse duration of only one-fifth microsecond. In addition the receiver circuits have been modified to suppress "clutter" due to random wave reflections near the origin, with the result that the centre of the display in the plan position indicator showing the ship's position is always clearly pin-pointed.

The bulk of the equipment has been designed for installation in any convenient part of the ship, and a separate display unit with the minimum practicable number of controls is available to the navigator in the chart room, or alternatively on the bridge. By means of a half-silvered mirror mounted at 45 degrees to the 9-inch cathode-ray tube the PPI display can be viewed in coincidence with a chart placed on a table immediately below; thus all the essential information of surrounding obstacles above and below the waterline is available at a glance. When out of use the mirror is closed flush with the front of the control unit and the act of pulling it out operates relay switches on the transmitter and receiver. A pilot lamp shows when the set is working.

The controls available to the

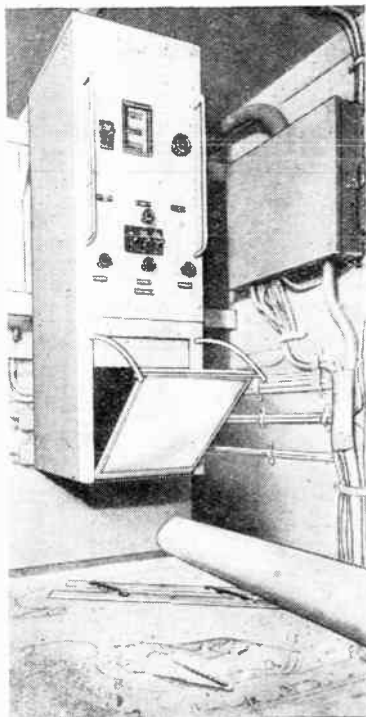

Chart Comparison Unit as used in H.M.S. "Pollux."

navigator include a "strobe" ring which can be expanded to touch any point in the display when the range can be read off directly in yards from a Veeder counter type of indicator. Three ranges are available with maxima of approximately 5,000, 15,000 and 40,000 yards. The first is the one normally used for pilotage and coincides with the charts. Special care has been taken to secure linearity in the time base and the registration is remarkably accurate.

The PPI display drifts with the movement of the ship but does not rotate with alteration of course, as it is locked to the gyro compass repeater supply and always keeps true north at the top of the picture. The direction of the ship's head is indicated by the brightening of a radial line at each revolution of the scanning time base.

Standard Admiralty charts are not altogether suitable for use with this equipment and the Hydrographic Department have produced experimentally some special charts in which the navigational marks are in black and soundings and fathom marks in grey. This is much easier to read in the subdued light required by the cathode-ray display. In addition the charts have been overprinted with contours and other salient features of the land likely to show up on the PPI display.

Experiments are also being made with corner reflectors on navigation marks to increase the return of energy and hence the range at which they can be picked up. Identification of marks by arranging a number of reflectors in simple geometric patterns is also being tried with success. This method has the virtue of simplicity and reliability when compared with the obvious alternative of fitting and maintaining radio beacons.

The corner reflectors consist of hollow sheet metal cones shaped as if cut from the corners of a hollow cube. Four or five of these are arranged in a cluster to trap energy arriving in a horizontal plane and reflect it back approximately in the direction of the transmitter.

A demonstration run of nearly an hour's duration down one of the busiest shipping channels in the Thames Estuary showed that the ship could be conned with complete confidence through the traffic leaving ships and buoys a cable's length on either hand. During the whole time the navigator based his helm orders solely on information given by the PPI display.

OUR COVER

THE 3-cm. aerial of H.M.S. "Pollux," illustrated on the front cover of this issue, rotates at 18 r.p.m. and transmits a beamwidth $1\frac{1}{2}^\circ$ in azimuth and 30° in elevation.

Design Data (2)

WIDE-BAND AMPLIFIERS

1.—Single-Circuit RF and IF Couplings : Coincidence Tuning

THE formulae employed for the design of IF intervalve couplings for sound channels are often of little use for the wide-band amplifiers used in television and in pulse technique generally. They are almost invariably approximations based on the assumption that the bandwidth n is small in comparison with the mid-band frequency f_m . This normally introduces negligible error, for it is but rarely that the bandwidth exceeds 15 kc/s at a mid-band frequency of 450 kc/s, making n/f_m rarely more than 1/30. For television purposes, however, the bandwidth is of the order of 5 Mc/s, and even at the television carrier frequency of 45 Mc/s, n/f_m is 1/9. Intermediate frequencies down to 10 Mc/s, or even less are widely used, so that n/f_m is often 1/2 or more.

It is essential, therefore, to employ formulae relieved from the limitation of $n \ll f_m$. It is, however, possible to adopt other approximations which would be invalid for the narrow-band case, but which here introduce negligible errors. In order to secure the necessary band-width, the circuit must be heavily damped and this is usually effected by means of a resistance connected in parallel with each tuned circuit.

Tuned Circuit Losses

The tuned circuit itself has losses which can be represented by series and shunt resistance ; the latter is chiefly dielectric loss and can be allowed for by lumping it in with the added damping resistance. The series resistance represents chiefly the copper losses of the inductance and cannot be included accurately without greatly complicating the equations. In wide-band amplifiers, however, its effect is small in comparison with the total shunt resistance and it can be neglected without serious error. A resonance circuit can, therefore, be considered as merely an inductance, a capacitance, and a resistance all in parallel.

There are many forms which an intervalve coupling can take. In general, the flatness of the response within the pass-band, the sharpness of the cut-off outside and the gain per stage all increase with the number of elements forming the coupling. However, the cost and the difficulty of adjustment both increase with the number of elements and a sharp cut-off outside the pass-band tends to produce a poor transient response.

On account of the difficulty of adjustment and the cost it is not usual to employ more than two resonant circuits in each intervalve coupling, and they are connected as a coupled pair in the familiar band-pass style. With this maximum of two circuits per coupling, the main classes of intervalve coupling are as follows :—

1. Coincidence-tuned single-circuits (i.e., single-circuit couplings, all circuits being tuned to the same frequency).
2. Stagger-tuned single-circuits (i.e., single-circuit couplings with the resonance frequencies of some displaced on one side of the mid-band frequency and of others displaced on the other side).
3. Coupled circuits (i.e., couplings each with a pair of resonant circuits coupled together by a mutual reactance).

Stagger-tuning can be applied to the coupled circuits of Class 3, but there is no advantage to be gained by it and it is normal for both circuits to be tuned to the same frequency. Even then, both Classes 2 and 3 can be sub-divided into groups with different characteristics depending on the amount of stagger and coupling respectively. Then, the same types of coupling need not be used throughout an amplifier, and it is sometimes advantageous to adopt different forms in different stages.

It will be seen, therefore, that with the restriction to a maximum of two resonant circuits per coupling, the possible variations in a multi-stage amplifier become quite large. In addition to the actual capabilities of a coupling, it is necessary also to consider its practical form and its ease and stability of adjustment. In many cases, some of the possible arrangements may be rejected because of adjustment difficulties, although on paper they offer a superior performance.

Coincidence-tuned Couplings

The data given here is confined to Class 1 circuits which are the simplest and easiest to adjust, but which have a rather poor performance. In spite of this, they are often used in the RF circuits of a superheterodyne, because their simplicity is particularly advantageous at very high radio-frequencies. A coupling of this type is also sometimes useful in one stage of an IF amplifier.

In the circuit shown, the tuned circuit com-

prises L, C, and R. As R is usually fairly low in value it is convenient to place it in the anode circuit of the valve where it carries the direct anode current. Because of its low value, the voltage drop is quite small. R₁ and C₂ are merely decoupling components and C₁ is the coupling capacitance. It is necessary only that C₁ should have negligible reactance at the frequencies employed. Usually, it suffices to make C₁ ≫ C and a value of 500-1,000 pF is adequate.

The capacitance C is not a component but is the sum total of the stray capacitances. Table I shows how they are distributed in a typical case and it is quite difficult to make the total much less than 30 pF. As the amplification per stage is inversely proportional to this capacitance, it is of the first importance to keep it at a minimum.

TABLE I

	Capacitance of	pF
1st valve, output	4.75
2nd valve, input	15.5
Coil L	5
Wiring to earth	3
C ₁ to earth	2
Total	30.25

The amplification per stage is the product of the mutual conductance of the valve and the resistance R and the latter is inversely proportional to both band-width and capacitance. It is quite independent of the mid-band frequency. The formulae enable the circuit values to be calculated for any likely band-width, attenuation at the limits of the pass-band and circuit capacitance. In addition, a curve is given for nCR against attenuation, expressed in db. instead of as a voltage ratio, in order further to simplify computation.

As an example of the use of the data, suppose a stage is required for a band-width of 5 Mc/s with a drop in response of 2 db. at the edges of the pass-band. Suppose also that the mid-band frequency is to be 13 Mc/s, that the valve has a mutual conductance of 8 mA/V and that the total capacitance is 30 pF. The value of S corresponding to 2 db. is 1.26, so that √(S² - 1) = 0.765, and equation (2) gives nCR = 122; alternatively, this value can be read directly off the curve. Then R = 122/(5 × 30) = 0.813 kΩ, and equation (5) gives A = 6.5.

Equation (3) gives the resonance frequency f_r as 12.75 Mc/s, and hence (4) gives L = 2.44 × 10⁴/(12.75² × 30) = 5 μH. It should be noted that the resonance frequency f_r is different from the mid-band frequency f_m because the resonance curve is not symmetrical.

At really high frequencies, the two are negligibly

different. Thus at 45 Mc/s, f_r = 45 √(1 - (5/180)²) = 45.017 Mc/s. At this frequency R is unchanged, but L becomes 2.44 × 10⁴/(45² × 30) = 0.402 μH. It should be noted that while R is unchanged the actual component used in the circuit in this position may be altered. R is the total damping resistance and the actual component used is only equal to this if other sources of damping are negligible. This is roughly the case at 13 Mc/s, but not at 45 Mc/s. At the latter frequency the second valve may have an input resistance of 2 kΩ or so only. With this value and R = 0.813 kΩ the actual component used would be 2 × 0.813/(2 - 0.813) = 1.37 kΩ.

With more than one stage the overall amplification is the product of the amplification of the individual stages. As the number of stages increases, however, the gain per stage drops if the overall band-width remains constant. Thus, if n = 5 Mc/s for a drop of 2 db. at the edges of the pass-band, and this is an overall requirement, the drop becomes 1 db. per stage for two stages, 0.5 db. for four and so on.

As a result of this there is a limit to the maximum possible amplification obtainable for a given band-width requirement, and this limit depends on the value of g_m/C. It is of the first importance to make this as high as possible.

Table II shows how the gain per stage varies with the number of stages in a particular case and the slow way in which the overall gain increases. With more stages it would reach a maximum, and with still more it would become less!

As gains of the order of 10,000 times are not uncommonly required, it is easy to see that coincidence-tuned resonant circuits form a most unsuitable coupling for a wide-band amplifier. The use of one or two such circuits, however, is sometimes desirable so that it is necessary to be able to calculate the performance.

TABLE II

n = 5 Mc/s for an overall drop of 3 db. at f₁ and f₂
g_m = 8 mA/V; C = 30 pF.

No. of stages	Drop at f ₁ & f ₂ per stage db.	R (kΩ)	Amplification per stage	Overall Amplification
1	3	1.06	8.48	8.48
2	1.5	0.642	5.13	26.3
3	1	0.54	4.32	79
4	0.75	0.46	3.68	182
6	0.5	0.368	2.94	640
8	0.375	0.313	2.5	1,520
10	0.3	0.28	2.24	3,160

The response at any frequency can be calculated from equation (1). In television the main use of this is to estimate the discrimination against the sound channel. As an example, with f_m = 13

Design Data—

Mc/s, and $f_r = 12.75$ Mc/s, the sound channel can be either 16.5 Mc/s or 9.5 Mc/s. If it is the former $m = 16.5 - 12.75 = 3.75$ Mc/s and if the latter $m = 9.5 - 12.75 = -3.25$ Mc/s. From

equation (1) in the former case the relative gain is -4.38 db. and in the latter -5.54 db. From the selectivity point of view it is nearly always as well to arrange for the sound channel to be lower in frequency than the video channel.

Design Data (2): Wide-band Amplifiers

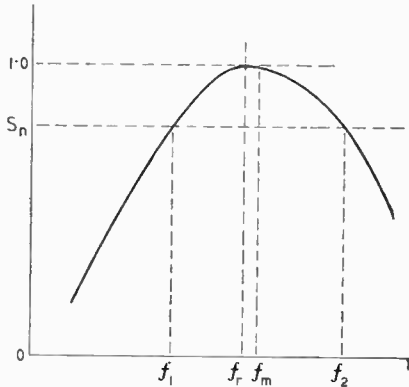

- Let f_m = required mid-band frequency
- n = required band-width
- $f_1 = f_m - n/2$ = lower limit of pass-band
- $f_2 = f_m + n/2$ = upper limit of pass-band
- $r = f_m \sqrt{1 - n^2/4f_m^2} = \sqrt{f_1 f_2} = 159/\sqrt{LC}$
- = resonance frequency of tuned circuit.
- = frequency of maximum response
- m = frequency difference from f_r .
- $S_n = \text{Ratio} \frac{\text{response at } f_r}{\text{response at } f_1 \text{ and } f_2}$
- $S_m = \text{Ratio} \frac{\text{response at } f_r}{\text{response at } (f_r + m)}$
- g_m = mutual conductance of valve.

Units

Frequency (Mc/s); mutual conductance (mA/V); inductance (μ H); capacitance (pF); resistance ($k\Omega$).

Relative response at any frequency = $-10 \log S_m^2$.

$$= -10 \log [1 + 3.94 \times 10^{-5} (mCR)^2 \left(\frac{2 + m/f_r}{1 + m/f_r} \right)^2] \text{ db.} \quad \dots \quad (1)$$

Given f_m , n , S_n , C , and g_m , to determine R , A , and L .

$$nCR = 159 \sqrt{(S_n^2 - 1)} \quad \dots \quad (2)$$

$$f_r = f_m \sqrt{1 - n^2/4f_m^2} \quad \dots \quad (3)$$

$$L = \frac{24,400}{f_r^2 C} \quad \dots \quad (4)$$

$$A = E_o/e_{in} = g_m R \quad \dots \quad (5)$$

Conditions of Validity

1. That the series RF resistance of L damps the circuit negligibly in comparison with R .

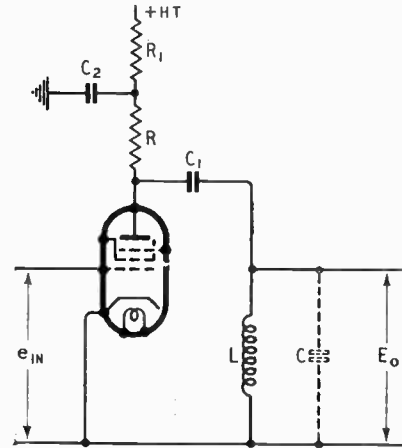

2. That R represents the total parallel damping resistance of the tuned circuit, i.e., the combined value of the AC resistance of the first valve, the

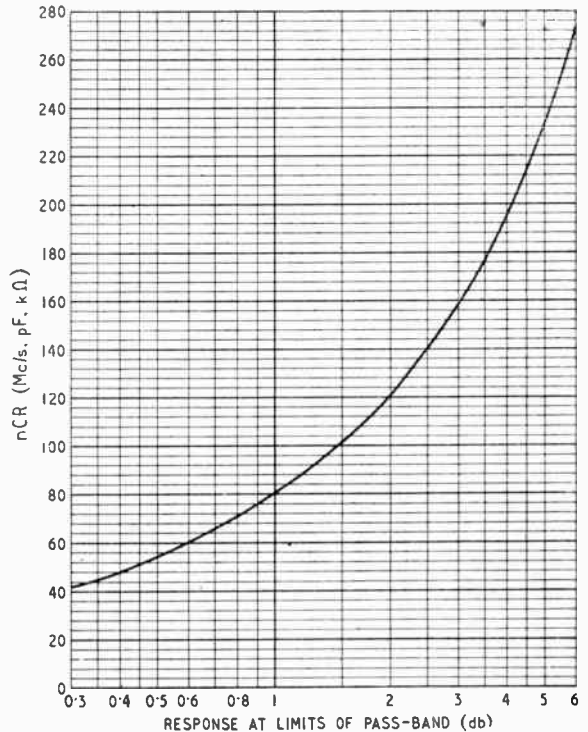

input resistance of the second, the various dielectric losses and the actual physical resistance used for coupling.

LINAGLOW LIMITED

R.A.F. Portable Transmitters

— NEW and UNUSED —

Containing a wealth of valuable components useful to the amateur or can easily be converted for use on Amateur Bands

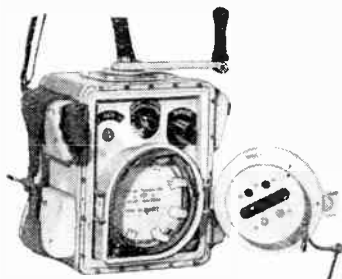

Complete Transmitter

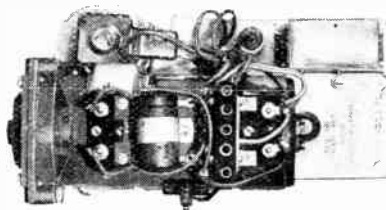

Power Pack
With Hand Generator giving 6 volts & 350 volts

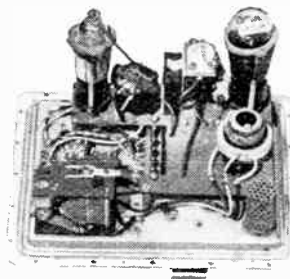

Top Panel of Transmitter

CIRCUIT DIAGRAMS AND PARTS LIST
supplied with each instrument

EACH UNIT IS COMPLETE with valves, crystal, Litz wound coils, morse key, variable condenser, relays, portable aerial, resistors, chokes, condensers, etc.

LIMITED QUANTITY (Approx. cost to manufacture £39). **PRICE inc. post & pkg. £5.5.0**

Just Arrived!
AMERICAN TYPE
CHIME DOOR BELLS
Ring with a mellow 'Ding-Dong'
55/- each
8/10 volt BELL TRANSFORMER 15/6

CARBON RESISTANCES
by famous Manufacturers. Up to 1 watt, 3d.; up to 10 watts, 5d. All + or - 5 per cent.
Please quote Ref. No. when ordering.

(74) 300,000 ohms 1/3rd w.; (75) 240,000 ohms 3 w.; (77) 200 ohms 3 w.; (78) 25,000 ohms 2 w.; (79) 80,000 ohms 3 w.; (81) 4,000 ohms 2 w.; (83) 80,000 ohms 1/2 w.; (84) 5,000 ohms 1 w.; (85) 1,000 ohms 1/2 w.; (86) 100 ohms 1 w.; (87) 3,000 ohms 1/3rd w.; (88) 5,000 ohms 1/2 w.; (90) 2,000 ohms 1/2 w.; (91) 4,000 ohms 1/2 w.; (93) 600 ohms 1/3rd w.; (94) 500 ohms 1/3rd w.; (95) 25,000 ohms 1/3rd w.; (96) 30,000 ohms 1/3rd w.; (97) 15,000 ohms 1/3rd w.; (98) 130,000 ohms 3 w.; (99) 250,000 ohms 1/3rd w.; (100) 50,000 ohms 1/3rd w.; (105) 25 ohms 1/2 w.; (106) 500 ohms 2 w.; (107) 100 ohms 2 w.; (108) 1/2 meg. 2 w.; (109) 1/2 meg. 1/2 w.; (110) 1/2 meg. w.w.

AMPLION ALL-DRY PORTABLE



£16.12.2

inc. Purchase Tax

SPECIFICATION:
DIAL: Full vision type. CABINET: Red or blue rexine. CHASSIS: Built in frame aerial attached to metal chassis. VALVES: Osram type X14, Z14, HD14 and N14. CALIBRATION: Medium Wave, 190-550 metres. Long Wave, 700-2,500 metres. **IRON CORED COILS. BATTERY EMPLOYED:** Ever-Ready all-dry No. 3 or alternatively new B104 which is called Battery-max.

ENGINEERS' or RADIO MECHANICS' TOOL BOXES

Size 13in. wide, 10in. high, 17 1/4in. long (external dimensions), 1/2in. thick. Beautifully made. Dovetail joints, handles, etc.

21/- EACH

B.P.L. UNIVERSAL TEST SET

D.C. Volts.	D.C. Milliamps.	A.C. Volts
0-75 MV	0-1	0-10
0-10	0-10	0-50
0-50	0-100	0-100
0-100	0-500	0-500
0-500		

Resistance, 0-10,000 ohms.

1,000 ohms per volt on all voltage ranges. Accuracy, 2 per cent. except for lower values on the 10 volt A.C. range. Dimensions, 6in. x 4 1/2in. x 3 1/2in.

PRICE £8.17.6

● POST ORDERS ONLY ●

We regret that due to pressure of business we are unable to handle showroom, caller or C.O.D. trade until further notice

LINAGLOW LTD., Dept. MO 58, 61, HIGHGATE HIGH ST., N.6

'Phone: MOUntview 9432

GARDNERS
range of
"SOMERFORD"
POWER TRANSFORMERS

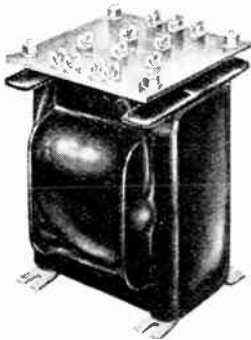

... DESIGNED FOR
EXACTING
WAR-TIME SERVICE . . .

NOW AVAILABLE
FOR YOUR POST-WAR NEEDS

All the Gardner skill and craftsmanship that was for six years concentrated on producing Transformers to withstand arduous service conditions are now being used to make these new "SOMERFORD" Power Transformers for you. The range is unusually wide and fullest data and prices will gladly be sent on request.

GARDNERS RADIO LIMITED
 SOMERFORD · CHRISTCHURCH · HANTS
 TELEPHONE: CHRISTCHURCH 1025

WESTINGHOUSE
METAL RECTIFIERS,
WESTECTORS, and
CONSTANT VOLTAGE
A.C.&D.C.EQUIPMENTS

See them on
Stand 78
R.C.M.F. EXHIBITION

●
 WESTALITE AND COPPER-OXIDE
 RECTIFIERS

●
 DOUBLE - VOLTAGE UNITS

●
 MINIATURE WESTECTORS

●
 HIGH VOLTAGE RECTIFIERS
 AND SPECIAL UNITS FOR THE
 SERVICES

●
 MODULATORS AND
 INSTRUMENT RECTIFIERS

●
 "WESTAT" CONSTANT
 VOLTAGE D.C. RECTIFIER

●
 "STABILISTOR" CONSTANT
 VOLTAGE A.C. EQUIPMENT

●
 Etc., etc.

or write for literature to Dept. W.W.

●
Westinghouse Brake & Signal Co., Ltd.,
Pew Hill House, Chippenham, Wilts.

DECCA NAVIGATOR

Continuous-Wave Navigation System

IT is well known that if the distance of a ship from each of three known fixed points, or the bearings of two fixed points from the ship, can be found the position of the ship relative to these points is completely determined. The measurement of the bearings is the basis of normal position-finding by directional reception. With ordinary DF equipment the operator in the ship takes bearings on two or more signals of known and fixed origin and the ship's position is easily calculated from these figures.

More recently distance measurement has come to the fore, largely because it is possible to measure distance more accurately than bearing by using the pulse technique of radar. The Gee system operates on this principle and proved its value during the war. The disadvantage of a pulse system is that it occupies a large frequency band. Sharp pulses are necessary for accurate range measurement and sharp pulses mean a large band-width. This in turn means a high operating frequency and this again means that the useful range is limited. The really high frequencies most suited to pulse work are limited substantially to ranges within the visual. This places a limit of 20-50 miles range at sea level, depending on the height of the

transmitting aerials. For air navigation much larger ranges are possible, because of the great height of the aircraft, and it was largely this which made Gee usable over the Continent.

The use of lower frequencies permits long ranges to be obtained because of sky-wave reception, but the accuracy is reduced. Sky waves inevitably reach the receiver by a longer path than the direct and so give a false measurement of range. This could be allowed for if it were a constant, but in practice it is usually subject to variation.

If accurate range measurement is to be made at great distances it is necessary to work on frequencies which provide a direct ray and preferably, but not essentially, do not provide any sky wave. This means low radio frequencies of, say, 100 kc/s or lower, depending on the range required. But such frequencies can hardly be used with pulses and some alternative method of measuring range is very desirable.

Such an alternative is used in the Decca Navigator. Only continuous waves, normally unmodulated, are used, and the band-width needed is thus negligible. Range is measured by comparing at the receiver the phase of signals from known spaced stations.

As an example of the basic

principle, suppose that there are two stations A and B in Fig. 1 a distance d_3 apart and that each is radiating a wave of 100 kc/s in the same phase. That is to say,

Fig. 1. Transmitters A and B spaced d_3 apart are at distances d_1 and d_2 from a receiver at C. The text explains how this gives a phase difference in the signals at C.

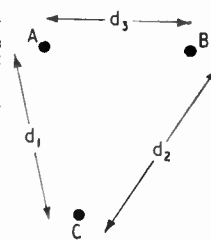

at any instant of time when the wave at A reaches its positive maximum that at B also reaches its positive maximum.

If this maximum is imagined to travel outwards from A with the velocity of light it will reach the receiver at C, after a time $t_1 = d_1/c$ where c is the velocity of light. Similarly, the maximum from B reaches the receiver at $t_2 = d_2/c$. At C, therefore, the two waves are not in phase because they have travelled different distances, and the difference of phase is a measure of the difference of distance.

The transit time of one cycle is $1/f = \lambda/c$, so that the time intervals representing distances are d_1/λ and d_2/λ expressed as fractions of a wavelength. In terms of phase there are 360° to each wavelength so that the phases at C relative to the transmitters are $\theta_1 = 360 d_1/\lambda$ and $\theta_2 = 360 d_2/\lambda$. The relative phase of the two signals at the receiver, which is all that can be measured, is $\phi = \theta_1 - \theta_2 = 360(d_1 - d_2)/\lambda$. The relative phase of the two signals at the receiver is thus a direct measure of the difference of distance from the two transmitters.

It may well be asked at this point how the signals from the two stations are distinguished since they appear to be two continuous waves of the same frequency. In fact, they are not. The frequencies transmitted are different but have a common



A marine model of the Decca Navigator. World Radio History

Decca Navigator—

harmonic. Thus, A might radiate on 85 kc/s and B on 113.3 kc/s. The receiver at C receives these signals separately and generates harmonics of each. The fourth harmonic of 85 kc/s is 340 kc/s, and the third of 113.3 kc/s is also 340 kc/s, so that in this way the effect of two signals of the same frequency is produced and it is the phase difference between these harmonics which is actually measured.

This is done by a phase-meter. The signals are applied to discriminators which produce direct currents proportional to the sum and difference of the phases. These are passed through coils at right angles and a magnet in the field, coupled to an indicating pointer, takes up a position along the resultant. The phase-differences can thus be read directly from a dial.

This measurement of the phase-difference between the signals from two stations does not enable one to determine one's position, for there are an infinite number of points of equal difference of distance from the stations. It is easy to see that a receiver on a line bisecting at right angles the line joining the transmitters is always at the same distance from each, and hence that the phase difference is zero. All that the reading tells one is that one is somewhere on that line.

Similar imaginary lines exist for each phase angle and take a hyperbolic form. Such a set of lines can be drawn as a grid on a map or chart, and would take the form shown in Fig. 2 by the solid lines. An indicator reading of 2.40 would then indicate that one was somewhere on a line passing through Dover.

This difficulty is resolved by

using a third station, in the example of 127.5 kc/s, in conjunction with the 85 kc/s transmitter. The second harmonic of the one (255 kc/s) and the third of the other are the same frequency, and these two stations lay down a further grid, shown dotted. The receiver is provided with a second phase-meter to measure the phase difference between these signals and the two readings give a definite fix. Thus, if the phase reading is 2.40 on the solid grid and 7.10 on the dotted, the two cross at Dover. For Brussels, the readings are 2.42 solid and 7.60 dotted.

There is another point of possible ambiguity. The phase angle does not indicate only one line on the grid, for a given phase angle can represent many differences of distance. The formula given earlier can be written $d_1 - d_2 = \phi \lambda / 360$, but this is not

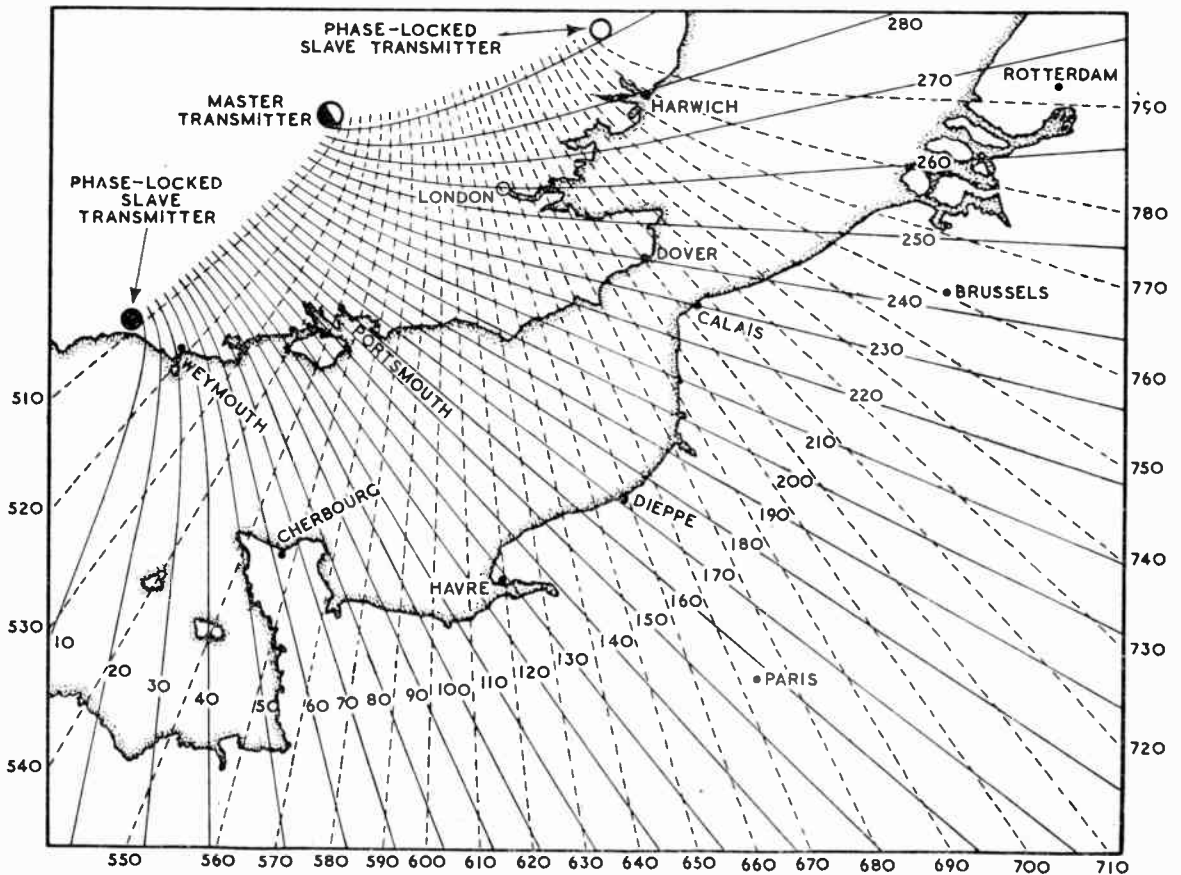
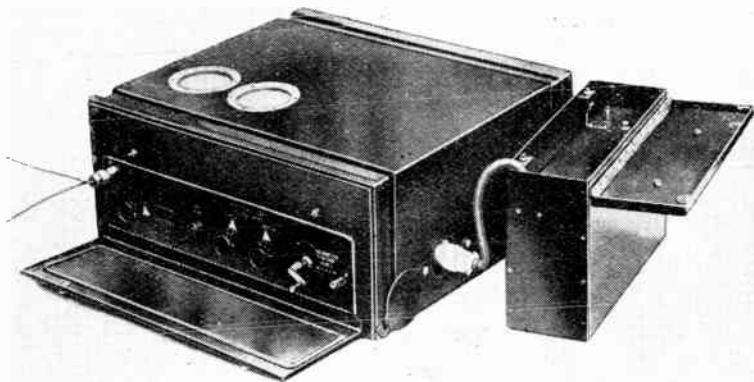

Fig. 2. This diagram shows how the use of three transmitters enables a double-grid to be placed on a map to indicate the position of a receiver. The solid lines indicate a grid produced by one pair of stations and the dotted lines that caused by the second.

necessarily correct, for the phase difference repeats itself every wavelength. The addition to ϕ of 360° makes no difference, so that the formula is more correctly $d_1 - d_2 = (\phi \pm 360^\circ n) \lambda / 360 = \phi \lambda / 360 \pm n \lambda$ where n is any integer. A given phase difference thus indicates any number of differences of distance varying by whole numbers of wavelengths.

ceivers of high stability and incorporating an oscillator with the aid of which a zero adjustment for phase drift can be made at any time. Usually, a daily check is sufficient. Two indicators are provided each with a series of dials rather like a gas-meter and calibrated in "lanes."

In use, the operator starts from a known position and sets the



The aircraft version of the equipment is produced in this form.

With a third transmitter this leads to a number of possible positions. Some of these may be excluded on extrinsic grounds; thus in a surface vessel any positions on land are obviously ruled out.

In order to overcome this two means are adopted. The first is to start from a known position and keep the receiver operating continuously. The phase difference indicator makes a complete revolution for every wavelength passed through, so that a revolution-counter attached can indicate the total number of waves passed through and ties the reading down definitely.

This fails, of course, if reception is interrupted and to enable a fix to be obtained at any time, an 85-kc/s signal is periodically transmitted in addition to the normal signals from the other stations. This has the effect of swinging the grid and from the second set of readings the true position can be obtained.

All this sounds very complicated, but the apparatus is actually very simple to use. It consists essentially of three straight re-

dials to read correctly by a hand control. The gear is in continuous operation and to find the position at any time it is necessary only to read the dials and refer to the gridded chart. If the initial position is not known or if reception has been interrupted, the operator takes additional readings at a time when the 85-kc/s signal is being transmitted from the other stations and from this additional data a simple calculation gives the true position.

Reference has been made to the indicators being calibrated in lanes. They actually measure phase difference and one revolution of the main indicator covers 360° degrees. This is called one lane and sub-divided into 100 divisions. The subsidiary dials geared to it as revolution counters read tens and hundreds of lanes. The lane is thus a purely arbitrary measure and is adopted as more convenient for the non-technical than a calibration in phase angles.

The apparatus is produced by the Decca Navigator Company, a subsidiary of the makers of Decca broadcast receivers and gramophone records.

SOUND SALES

SOUND IDEAS BY THE ORIGINATORS

THE NEW PHASE INVERTER SPEAKER

Solves the baffling problem of Baffles and measures only 29in. x 14in. x 18in. deep incorporating the S.S. Dual Suspension P.M. Auditorium Unit. This Speaker, in its attractive light oak cabinet, sets a new standard in reproduction and is entirely free from "Dialect." We regret that present stocks are exhausted. Delivery £12.10.0 now 7 days. Price £12.10.0

THE S.S. TONE CONTROL UNIT

Based on the successful "Tri-Channel" principal introduced by this company, can be instantly plugged-in to the majority of Sound Sales' Equipments and is equally suitable for use with other high-grade apparatus; using three independent thermionic channels via valves additive tone control is obtainable up to 26db. Price TYPE T.C. £7.17.6

INTRODUCING THE NEW D.X. PLUS 1 QUALITY FEEDER UNIT

A quality super-het design, plus a unique system of tandem coupled variable selectivity. Covering short, medium, and long wave bands, this unit surpasses the ever popular D.X. Plus Unit. £15 Price TYPE D.X. Plus 1

INTRODUCING THE NEW D.X. PLUS 7 QUALITY CHASSIS

An entirely new, laboratory built, quality super-het chassis, designed especially for the music lover via radio, incorporating all the attractive features of the D.X. Plus 1, Feeder Unit, together with a paraphased P.X.4 Push-pull Output Stage. The new chassis replaces and easily surpasses in both performance and appearance, the original D.X. Plus Feeder Unit, together with the Type 346 amplifier. £25 Price TYPE D.X. Plus 7

PLUS PURCHASE TAX

COMING!!!

A complete new series of quality Amplifiers, P.A. Equipment and Television Components

SOUND SALES

TRANSFORMERS-QUALITY RADIO & AMPLIFIERS.
WEST ST., FARNHAM, SURREY.

IS THE B.B.C. DOING ITS JOB ?

Unwanted Legacies from the War

By "CATARACTACUS"

IT cannot be denied that the well-being of the wireless industry, and therefore that of many readers of *Wireless World*, is closely bound up with the success of broadcasting as a national source of entertainment. The telecommunications side of wireless is large and important, and the electronics branch is growing rapidly, but in volume of business and the number of people employed, both are small in comparison with the manufacture of broadcast receiving sets. The sale of these sets, and therefore the prosperity of the industry, depends almost entirely upon the quality of the programmes put out by the B.B.C. Admittedly there are not a few enthusiasts whose interest in wireless lies in other directions, but they are a small part of the whole body of wireless users, and it is ultimately upon the ordinary listener who wants his receiving set to bring him in good entertainment from the local station or stations that the industry as a whole must mainly depend.

Austerity Programmes

Is the B.B.C. really doing its stuff? Recently I have had a unique opportunity of going rather thoroughly into that question. For more years than I care to remember wireless has been the greatest of my hobbies; but until recently I have never had to rely upon B.B.C. programmes as my chief—almost my only—source of entertainment. I have had to do so for the last two months, and it happened in this way. I lost the sight of one eye during the war and the other began to fail about three months before this article was written. So rapid was the loss of sight that I passed in a few weeks from stronger and stronger spectacles to a reading-

glass and then to complete inability to read. There followed three weeks in hospital and further almost sightless weeks at home. Now, if anybody is qualified to judge whether wireless offers a reasonable amount of reasonably good entertainment it is one who cannot see to read. I very soon came to the conclusion that what the present B.B.C. broadcasts do provide is a small amount of really good entertainment, a larger, but still not great, amount of fairly good entertainment, some items which are neither entertaining nor definitely annoying and a much too large amount of noises of various kinds which are not entertaining in any way. Lest I should be thought to be a crank of some kind with marked predilections for the high-brow, low-brow or middle-brow type of programme, let me say that I had ample opportunities, which were used to the full, of discussing the question with other victims in hospital. They agreed heartily with my conclusion that it was high time that the B.B.C.'s austerity programmes came to an end and that Broadcasting House should take imme-

mediate and long-overdue steps to set itself in order.

It has been stated (I remember seeing it in print somewhere) by some B.B.C. official that the listening public "did not mind canned programmes." Let me hasten to disabuse that official and the B.B.C. at large of this idea. The public, though it accepted reproductions by various methods as a wartime necessity, is now most heartily sick of them and most completely convinced that they should cease except, of course, when some outstanding item is repeated at a later date. Please do not think that my cross-section was confined to hospital patients. I have raised the point with dozens of other people, and the only voice I have heard in favour of broadcast reproductions was one who said, "I like the fill-up gramophone records because they often give you such jolly music."

I agree with this lone voice up to a point. What I do regard as little short of disgraceful is that gramophone records as broadcast should still be scrappy, that records with a radial scratch which pro-

diate and long-overdue steps to set itself in order.

I agree with this lone voice up to a point. What I do regard as little short of disgraceful is that gramophone records as broadcast should still be scrappy, that records with a radial scratch which pro-

diate and long-overdue steps to set itself in order.

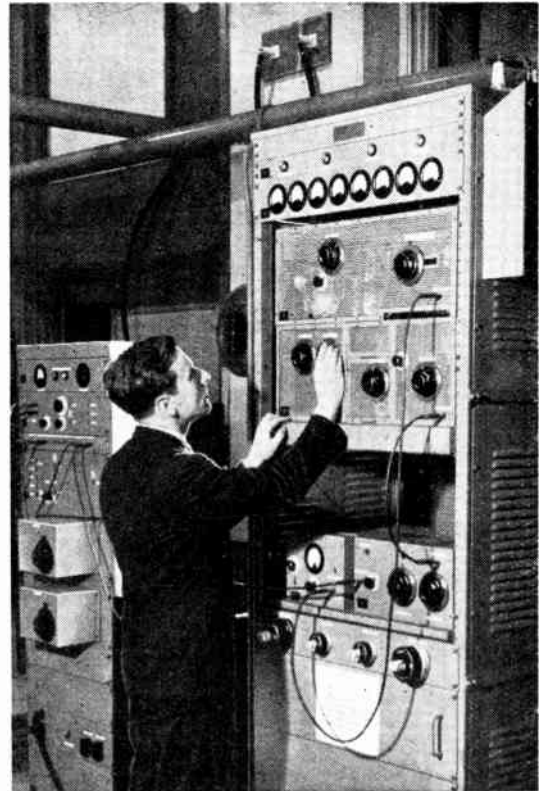

Is the B.B.C. making full use of the technical advances in radio? At any rate, the engineering division is active in testing new methods: this photo shows an experimental FM transmitter recently installed at Alexandra Palace. Tests are being made on about 90 Mc/s.

duces a tick at every revolution should be retained in the library, and that such things as a wobbly record should be allowed in the studio.

"That Was a Recording . . ."

If you are sceptical about the amount of use made by the B.B.C. of recorded programmes at the present time, do a bit of solid listening and make a note of the number of times that the announcer says "that was a recorded item." I remember once even hearing "that was a recording of a recorded programme." Is there any excuse for the very large proportion of canned stuff that we now have in our broadcast programmes? I cannot think that there is. The B.B.C. has drawn a large income during the last six years, and must have been put to comparatively small expense in the entertainment which it has provided. We still have only two main programmes, though a third, the "C" programme, is stated to be coming shortly. If financial stringency is the excuse, that will not hold water when the licence fee is increased to £1, but even now there must be plenty of money available. The only other excuse for excessive use of recordings is shortage of staff. At the present rate of demobilisation the B.B.C. must have a continual inflow of returning members of all branches of its staff; but the programmes do not reflect this.

They strike one in general as utterly lacking in life and liveliness. The use of so much recording is symptomatic of both these things. Surely one way in which wireless should score over other forms of entertainment is that it enables sounds to be sent out to listeners as they actually occur. There is much the same fundamental difference between wireless and the gramophone as there is between television and the cinema. Wireless and television can broadcast actual happenings; the gramophone record and the cinema screen reproduce sounds and events that took place some time previously. In the recorded programme one of the strongest appeals of wireless is entirely lost.

And there are other points to be considered. The general level of

recording is not particularly good. In this respect we appear to be far behind the German broadcasting stations which, in the magnetophone, had developed something much better than we possess. If we must have recorded programmes they should be of the very highest quality. No one, I think, will maintain that this is so at the present time. Again and again, if you happen to switch on in the middle of an item you can say, from obvious shortcomings in quality, "that's a recording."

To turn to another side of the question, one is puzzled that so many mediocre artists should be allowed to appear before the studio microphones. With its great financial resources, the B.B.C. should be able to pay for the best in any entertainment category. I can see no excuse for their presentation of alleged funny men, who are not merely second-rate but fifth- or even tenth-rate. Not long ago I heard one of the last tell a story which I well remember my grandfather citing as a typical example of the stale joke of his boyhood days.

I do not see why we should suffer the puddingy contralto, the wobbly soprano or the adenoidal tenor. Yet they are inflicted upon us time and again.

A Gloomy Outlook

Unless the B.B.C. realises its responsibilities and makes real efforts to bring the programmes up to the standard which we ought to be able to expect of them I can see a real slump in the wireless market. Already there is a tendency to make use of the receiving set for the news and just for odd outstanding musical and other items. Should this grow, it will be a sad day for one of the biggest industries of this country, for if little use is made of the receiver the feeling will grow that any old set will do. I find even now that quite a number of people are beginning to say that the old set which has gone quite well during the war still does all they want and that they therefore do not see the point of getting a new one. Let this tendency grow by providing unattractive programmes, and the results will be too horrible to contemplate.

VORTEXION
"SUPER FIFTY WATT"
AMPLIFIER



30 cps. to 18,000 cps., within 1/2 db, under 2 per cent. distortion at 40 watts and 1 per cent. at 15 watts, including noise and distortion of pre-amplifier and microphone transformer.

Electronic mixing for microphone and gramophone of either high or low impedance with top and bass controls. Output for 15/250 ohms with generous voice coil feedback to minimise speaker distortion. New style easy access steel case gives recessed controls, making transport safe and easy. Exceedingly well ventilated for long life.

Amplifier complete in steel case as illustrated with built-in 15 ohm mu-metal shielded microphone transformer tropical finish - - - Price **29 1/2 gns.**

Chassis only with valves - - - **25 1/2 gns.**

or complete with fixed microphone transformer - - - **26 1/2 gns.**

Laboratory Model, 10 cps. to 35,000 cps. in above case - - - **42 gns.**

SPECIAL 8-WAY MIXING UNIT

for use with any amplifier but in particular the **Super Fifty Watt**. It is fitted in steel case standard instrument grey to match above amplifier and can be assembled with same to form one unit. Standard model for six 15 ohm microphones and two high or low impedance pick-ups (with switched record compensation) built in mu-metal shielded transformers and metering jacks for each valve. Price complete for A.C. Mains - **27 1/2 gns.**

C.P.20A 15 WATT AMPLIFIER

for 12 volt Battery and A.C. Mains operation. This improved version of the old C.P.20 has switch change-over from A.C. to D.C. and "stand by" positions and only consumes 5 1/2 amperes from 12 volt battery.

Fitted mu-metal shielded microphone transformer for 15 ohm microphone, and provision for crystal or moving iron pick-up with tone control for bass and top and outputs for 7.5 and 15 ohms. Complete in steel case with valves - - - **£22 10 0**

DEALERS AND EXPORT AGENTS should write for special terms to:—

VORTEXION LTD.

257-261, THE BROADWAY, WIMBLEDON, LONDON, S.W.19

Telephones: LIBerty 2814 and 6128.

Telegrams: "VORTEXION, WIMBL., LONDON."

UNBIASED

Differential Cookery

NOWADAYS everywhere seems to be infested with preview exhibitions of the so-called wonders which, so the manufacturers threaten us, we are going to have installed in our homes when production gets into its full stride once more. As a result of all this I have been dragged hither and thither from exhibition to exhibition by Mrs. Free Grid until I scarcely know what I am doing.



Even I was surprised.

Probably the least boring of these exhibitions was one staged a few weeks ago in Lower Regent Street by the electrical industry. At one stand the attendant female expatiated at some length on the ultra-modern "stream-lining" of the post-war electric cookers. It was at this moment, I think, that I first realised what the late lamented Adolf really meant when he talked about his patience being exhausted, and I somewhat tartly asked what benefit streamlining conferred unless it was proposed to mount the cooker on the roof of a car. Even I was surprised at the ferocity with which the assembled females rounded on me, and I was rescued with difficulty by a wild-eyed, long-haired young man who asked me if I would like to see something really interesting in cookers which was being deliberately kept off the market by certain vested interests.

At his suggestion we took a taxi to the wilds of Camden Town and before long I was enjoying such cooking and such a variety of dishes that even Lucullus himself might have envied. My surprise was intense when my host said that the sole ingredients were Spam and dried eggs and that the apparent variety of dishes was obtained by a method of cooking which he had been inspired to develop by reading an article on diathermy in this journal some six years ago.

By means of the diathermic radio cooker which my new-found friend had developed he could not only do

By FREE GRID

such simple tricks as heating the middle of a cake before the outside, in contrast to ordinary methods of cooking, but by means of various adjustments he could take a cake, a lump of Spam or anything else and arrange that alternate layers of it could be cooked and uncooked, or semi-cooked to any desired degree. It was by this method of differential cooking that he obtained such superb and varied culinary effects. His *pièce de résistance* was to take me to a tank of live trout and invite me to select my victim just as they used to do in certain restaurants. Having done so it was but the work of a moment for him to cook it alive *in situ* without the slightest raising of the surrounding water temperature.

I thoroughly enjoyed the occasion until shortly after we left in the taxi I noticed that we were passing through Hilldrop Crescent which figured so prominently in the B.B.C.'s Crippen broadcast of a little while ago. It is a far cry to 1910, but nevertheless, thinking of the variety of dishes I had tasted, I felt distinctly uncomfortable.

Pictures in the Fire

ONE of the things which never ceases to astound me is the extraordinary lack of imagination possessed by those whom one might expect to be the very people to have it in abundance. The cause of my astonishment on this occasion is a discussion which has been going on in a Sunday newspaper about television, a discussion to which some of the leading lights of the technical world have been contributing.

The discussion has mainly revolved round the question of the correct position, in the average living room, of the receiver so that the picture may be looked at in comfort by the whole family. It has been rightly pointed out that the average Englishman is so much a creature of habit that he still in-

sists on sitting round the fireplace just as though there were a fire in the grate as in pre-war days.

Amid the welter of utterly absurd suggestions which have been made, including the projection of the picture on to the ceiling, it has apparently not occurred to any of the leading lights of the technical world who have been taking part in the discussion that there is one obvious place for the screen which is not only ideal from a seeing point of view but ideal also from the technical aspect. I refer, of course, to the usual rectangular fireplace aperture into which the viewing screen would fit nicely. It would also be in the correct position for everybody seated round the fireside circle to obtain first-class entertainment.

The innards of the television receiver itself would be built into the space behind the screen, usually occupied by the grate, and the control knobs would be suitably arranged at the top of the screen. Not the least of the advantages of this arrangement would be that the television set, an ugly and cumbersome thing at its best, would be stowed away out of sight: but the greatest advantage of all from a technical point of view would be that the chimney would form a short and direct path for the connection to the aerial perched on the chimney pot above.

As for those who would attempt to throw cold water on my suggestion by asking what about the days when we *do* get some coal, my reply is that by this time every house will be centrally heated. But, as a concession to the old-world sentimentalists who enjoy the "flickering firelight's fitful gleam," as the poet puts it; why, even they could be catered for, as the B.B.C. could very appropriately adopt the flickering

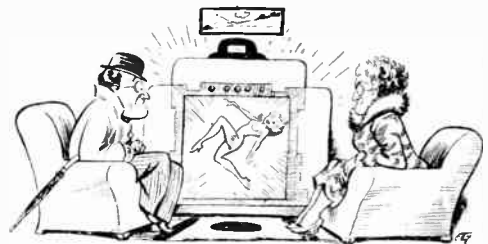

Fireside Flicks.

gleam as an interval signal and throw a recorded moving picture of it on to the screen. Any objections, please?

Letters to the Editor

Solar Signals • Distorted Definitions • B.B.C. Quality

"Signals from the Sun"

RECENT pronouncements on the radio and in the Press, also your extract from *Nature*, in the January *Wireless World*, would appear to credit Sir Edward Appleton with some interesting discoveries and theories, in connection with the radiation known as the hissing phenomenon. I think credit should have been given to myself for more than just "sending reports on a strange hissing sound"!

In actual fact, I, together with several other people, particularly Mr. E. J. Williams and Miss N. Corry, did a very considerable amount of observation and theoretical work on the subjects between 1936 and 1939, and I think I am correct in claiming to be the first to have pointed out the reception of the radiation, also to conclude that it was a radiation originating on the sun. Its relation with ionosphere storms and short-period fade-outs was also pointed out by myself, and Mr. E. S. Williams showed that the appearance of the radiation coincided with the times of chromospheric eruptions on the sun.

Published letters and articles, together with my own correspondence on the subject, will confirm the above claims.

D. W. HEIGHTMAN.

Clacton-on-Sea, Essex.

Defining Distortion

YOU may be interested to know that I have recently written to the British Standards Institution to urge reconsideration of certain definitions given in BS204 (Glossary of Terms used in Telecommunications). Some of the definitions to which I take exception are:—

1301 Distortion.—"The change in wave-form. . . ."

Distortion is not necessarily a change in wave-form. Suppose an amplifier used in conjunction with a constant-output variable-frequency audio oscillator fails to amplify to the same extent over

the whole range of frequency. It is then guilty of frequency distortion, notwithstanding which it may preserve the original sinusoidal wave-form of the oscillator unsullied. In quite a practical case, therefore, the definition breaks down.

1302. Attenuation Distortion.—The deprecated alternative "Frequency Distortion," is the generally accepted term, whereas "Attenuation Distortion" is rarely if ever used. The former might be attacked by purists on the ground that it is not distortion of frequency (but see 1305 below) but at least the term is descriptive, and accurate as normally understood. "Attenuation Distortion" on the other hand is not only self-descriptive but is misleading, e.g., an amplifier subject to this distortion may not attenuate at any frequency concerned. Nor is it distortion necessarily associated with the function of attenuation; on the other hand, there are other sorts of distortion that may accompany attenuation. It is difficult to discern a motive for attempting to displace a universally and internationally used term by one which is obscure and ambiguous. A few writers may be led to adopt the new term, thereby introducing non-uniformity and confusion.

There appears to be some involuntary "distortion" of the text in the description of the method of measurement. Incidentally, if definition No. 1301 were sound, there would be no need to say "when harmonics are present"—they would necessarily be present.

1304. Delay Distortion.—It is not quite clear why "Transient Distortion," the commonly understood meaning of which is correctly defined in BS661 No. 4135, is given as an alternative. Transient distortion may take place in systems into which the consideration of propagation time does not enter. "Transient Distortion" has therefore been introduced as an alternative to a term with a



THE "FLUXITE QUINS" AT WORK

"I've fixed up this set with FLUXITE
But you won't get it working to-night,
I was soldering, see
and the iron" cried EE
"Went cold, and now it's stuck tight."

See that FLUXITE is always by you—in the house—garage—workshop—wherever speedy soldering is needed. Used for over 30 years in Government works and by leading engineers and manufacturers. Of all Ironmongers—in tins, 8d., 1/4 & 2/8.

Ask to see the FLUXITE POCKET BLOW LAMP, price 2/6.

TO CYCLISTS! Your wheels will NOT keep round and true unless the spokes are tied with fine wire at the crossings AND SOLDERED. This makes a much stronger wheel. It's simple—with FLUXITE—but IMPORTANT.

The FLUXITE GUN puts FLUXITE where you want it by a simple pressure. Price 1/6, or filled, 2/6.



ALL MECHANICS WILL HAVE

FLUXITE

IT SIMPLIFIES ALL SOLDERING

Write for Book on the ART OF "SOFT" SOLDERING and for Leaflets on CASE-HARDENING STEEL and TEMPERING TOOLS with FLUXITE. Price 1d. each.

FLUXITE LTD.
(Dept. W.W.), Bermondsey Street, S.E.1

Letters to the Editor—

different meaning, leaving no term to cover its own meaning. Here again, the result of the more recent work is likely to be confusion.

1305. Non-Linear Distortion.— If it is necessary to be pedantic enough to reject "Frequency Distortion," surely this term fails too, as it is not the distortion that is non-linear. Strictly speaking, it should be "Non-Linearity Distortion."

1307. Harmonic Distortion.— The words "of a network" introduced an unnecessary limitation in meaning, and are inconsistent with preceding definitions, which refer to a "system."

1308. Intermodulation Distortion.— The use of the word "tone" here is inconsistent with the only definitions of that term given in either of the Glossaries. The word is not used at all in No. 1307, so there seems to be no need for it in 1308.

M. G. SCROGGIE.

Bromley, Kent.

Marking Variable Condensers

I WONDER why manufacturers hardly ever supply any data concerning capacitance and characteristics of variable condensers.

Would it not be very easy to stamp this information on one of the endplates, whereby one could tell at a glance what to expect of any particular component, instead of having to trust one's judgment (or luck) or to go through repeated capacity-bridge measurements?

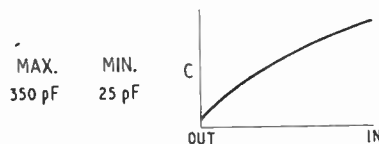

All that is needed is something like the above.

G. KIRSCHNER.

[It seems doubtful if anything useful about the capacity law can be conveyed in a graph of practicable size. One could learn as much by looking at the vanes. Minimum and maximum values are highly desirable—they could very simply be marked, to take the example given, as 25/350 pF.—ED.]

Wartime Hangovers

I CANNOT allow your reference to the quality of BBC transmissions to pass without endorsing your opinion in the strongest terms.

BBC quality before the war often left much to be desired. During the war and since its termination, as you point out, the distortion introduced by the BBC has in many instances been deplorable. It is, of necessity, admitted that under wartime conditions undue criticism in this direction would be unfair. To-day, however, it is high time that steps were being taken to rectify this state of affairs. Apart from the psychological aspect, recordings, however good (and most are far from good) can never provide the high quality that may result from direct transmission. Notwithstanding this, how often it is that the majority of the principal evening broadcasts consist of recordings?

Furthermore, direct broadcasts are subject to varying degrees of distortion of such diverse types as to defy definition. It is not simply absence or excess of top or bass, which can be corrected quite easily in the receiving circuit, but additional extraneous matter, which I suppose would be classed as amplitude distortion, which it is quite impossible to correct. Clarity, atmosphere and intimacy of the broadcast are problems in themselves which one finds rarely solved to the satisfaction of the listener. We hear of the coming of high-fidelity television sound channels, but mere increase in frequency range will only make matters worse if the more important types of distortion are not prevented from appearing in the modulated carrier.

The BBC can and does sometimes transmit excellent quality. In most cases, however, this is confined to studio broadcasts of either plays or dance bands.

In view of this, may I suggest that listeners with high-quality receiving gear tabulate broadcasts to which they listen, and set out briefly their opinions and criticisms, with a view to ascertaining if there is general agreement as to which broadcasts are good, and which are bad? A scale could be

devised such as Deplorable, Bad, Poor, Moderate, Fairly Good, Good, Excellent, with a short note stating the reason for such comment. These criticisms would, of course, involve the audio quality alone, and not relate in any way to the subject-matter of the programme.

The tabulated results, epitomised, might be published in *Wireless World* in a like manner to readers' views on gramophone recordings.

I suggest that quality enthusiasts forthwith commence to agitate for a considerable improvement in the acoustic quality of our broadcasting system.

A. A. COTTERELL.

Wednesbury.

Surplus Disposal

THERE will be general support for the suggestion that test equipment should be available to ex-Service technicians on favourable terms. At the same time, it becomes difficult to know where to draw the line.

There are many now returning to their former occupations, or starting new, who have been working in the various establishments designing and developing equipment for the Services. The decision as to being Service or civilian workers was not always theirs to make.

I feel that these people also should be given an opportunity to buy test equipment on terms similar to, though not necessarily identical with, the men from the Services proper.

I think that in either case there should be some assurance that the equipment is for their own use, for experimental work or business purposes, and not for resale.

W. H. O. BANHAM.

Mersea Island, Essex.

BOOK RECEIVED

The Cathode-Ray Tube Handbook. By S. K. Lewer, B.Sc. This brief handbook gives an elementary description of how the cathode-ray tube works and of the associated time-base, amplifier and power supply which are needed to form a complete oscilloscope. It concludes with a chapter illustrating some of its applications. Pp. 100+xviii. Published by Sir Isaac Pitman and Sons, Ltd., Pitman House, Parker Street, Kingsway, London, W.C.2. Price 6s.

SHORT-WAVE CONDITIONS

Expectations for March

DURING January, 1946, short-wave conditions were somewhat more stable than during the previous few months, though a few ionosphere storms did occur. The first and most serious of these started on the 2nd, became severe on the 3rd and 4th and did not finally clear up till early on the 7th. Conditions were then stable until the 11th, when a slight deterioration in reception occurred and persisted through the 12th. Further slight disturbances occurred during the periods 18th to 21st and 24th to 25th, the latter being the more serious of the two. During the rest of the month stable conditions prevailed, apart from a sharp "Dellinger" fade-out, which occurred between 1240 and about 1330 GMT on the 31st. It is thought that this was associated with a very large sun-spot which was near the sun's east limb.

Apart from the effects of ionosphere disturbances conditions during January were such that the maximum usable frequencies for this latitude were somewhat higher than for the previous month, both for noon and midnight. This followed the normal seasonal trend—mid-winter being past—but the increase appeared to be enhanced by an increase in solar activity which occurred during the month.

Forecast. — Conditions during March—apart from ionosphere storm effects—should be such that considerably higher night-time frequencies would be usable, whilst the daytime frequencies should, in general, be slightly higher than at present. Below are given, in terms of the broadcast bands, the wavelengths which should be most reliable during March, for four long-distance circuits running in different directions from this country. It is to be noted that other wavelengths—generally longer—will often be usable at the same time of day, and also that shorter wavelengths will sometimes be usable. For example, during the

times when the 11 m. broadcast band is given as usable the 10-m. amateur band is most likely to yield results.

Montreal: 0000, 25 or 31 m; 0500, 41 m; 1000, 25 or 31 m; 1100, 16 or 19 m; 1300, 13 or 16 m; 2000, 16 or 19 m; 2200, 25 m.

Buenos Aires: 0000, 25 or 31 m; 0400, 41 m; 0800, 25 or 31 m; 1000, 13 or 16 m; 1400, 11 or 13 m; 1700, 13 or 16 m; 2000, 16 or 19 m; 2200, 25 m.

Capetown: 0000, 25 or 31 m; 0600, 25 or 19 m; 0700, 13 or 16 m; 0900, 11 or 13 m; 1600, 13 or 16 m; 1800, 16 or 19 m; 2000, 25 m.

Chungking: 0000, 41 m; 0500, 25 m; 0700, 16 or 19 m; 0900, 13 or 16 m; 1300, 19 or 25 m; 1500, 25 m; 2100, 31 or 41 m.

A considerable amount of ionosphere disturbance usually occurs around the equinoxes, so that conditions during March are quite likely to be erratic, particularly over dark transmission paths. Although it is impossible to say with certainty, it would, at the time of writing, appear probable that during the periods 7th-8th, 17th-21st, and 26th-28th, conditions are more likely to be disturbed than on other days.

TRADE NOTES

Agents.—The Dubilier Condenser Company has now appointed agents in all the principal centres of the country for the sale of its products. The address of the local representative can be obtained from the Company's Head Office, Victoria Road, North Acton, London, W.3.

New Stroboscopes.—Two new models have been introduced by Watford Instruments, Loates Lane, Watford. The "Strobospeed" has been redesigned and gives greater light intensity up to speeds of 50,000 r.p.m., and the "Stroboflood," which makes use of a new Ferranti tube, is designed to give good illumination over an area of several square yards.

Leaflets describing the "Pylon" hearing aid are issued by the makers, Park Royal Scientific Instruments, Ltd., 52, Minerva Road, London, N.W.10.

The "Labpress," made by Wright and Weaire, High Road, Tottenham, London, N.17, for small-scale laboratory production of plastic mouldings, is described in a recent leaflet.

Comprehensive illustrated catalogue of public address, intercommunication and other acoustic products has been issued by Arden Acoustic Laboratories, Guildford.



Save Valuable
Executive Time
by installing

THE TANNOY LOUDSPEAKER SOUND SYSTEM

For Staff Location, Announcements, 'Music While You Work' Programmes, Canteen Concerts, Alarm and Time Signals, the TANNOY is an assurance of greater general efficiency, both in Factory and in Office

TANNOY

The Sound People

TANNOY is the registered trade mark of equipment manufactured by

GUY R. FOUNTAIN LTD.
WEST NORWOOD, LONDON, S.E.27, & Branches
Phone: Gipsy Hill 1131

The largest organisation in Great Britain specialising SOLELY in Sound Equipment

RANDOM RADIATIONS

By "DIALLIST"

The Magnetophone

A FRIEND home on leave from BAOR has given me a few facts about the Magnetophone which may be of interest to readers. He couldn't tell me if this German recording system has been greatly modified since it was first described in 1937, but he says that the strip used for magnetophone recording is not just provided with a metal coating; it is actually impregnated with minute particles of metal. Anyway, the results are said to be so good that (unlike too many of the B.B.C.'s efforts) a recording can hardly be distinguished from the original. My friend understood that during the war, and probably for some time before it, no speaker in a German broadcast studio ever poured his words direct into the transmitter via the microphone. He may have thought that he was doing so; but actually the microphone before him was connected to Magnetophone recording apparatus. Everything he said was carefully monitored and if he should let fall anything indiscreet or unwelcome to the then authorities, the words disliked were removed by the simple process of cutting the tape and quickly joining it up again. The actual delay between the microphone and the transmitter was only a matter of seconds, but the intervening Magnetophone thus made it impossible for any speaker to bring off a *coup* by dropping a few surprise words into his talk.

□ □ □

Radiolocation at the I.E.E.

THE I.E.E. is running a Radiolocation Conference (I am glad they call it Radiolocation, for I do prefer that genuine English word to the American Radar) from March 26th to 29th. In those four days ten important papers will be given dealing with many aspects of radiolocation. Further, the Radio Section of the Institution has provisionally allotted five more evenings between April 3rd and May 21st for papers or discussions on this thrilling subject. I hope that all readers who can do so will attend either in their own right or as guests for this is a unique opportunity of learning something about one of the most hush-hush developments of the war. Authors of papers other than the introductory one by Sir Robert Watson Watt have not yet been an-

nounced but I trust that amongst them will be some of the pioneers of radiolocation, too many of whom still remain unknown and unsung. I know something of the hard slogging work put in by some of these and of the genius which they displayed in overcoming problems of the most perplexing kind. The country owes them a big debt of gratitude and I do sincerely trust that something may be done at the I.E.E. Conference to let us know more of the men who were responsible for the work of development in all branches of radiolocation.

□ □ □

Tuning Indicators

AT a meeting of the Radio Section of the I.E.E. held some months ago there were considerable differences of opinion on the subject of tuning indicators. Some, following the lead of one eminent designer, heartily damned all tuning indicators and expressed particular hatred of those of the "magic eye" type; others, less vehement, held that there was something (though not much) to be said in favour of T.I.'s; yet others contended that they were highly desirable parts of any "broadcast" receiver. Personally, I belong to the third school of thought, for my experience is that very few average wet-nose listeners can tune a superhet correctly by ear alone. How often does one hear a good receiver producing horrible distortion simply because it is mistuned! Perhaps you show the owner how tuning should be done: he is interested and admits that it "sounds a lot better like that"; yet the next time you hear that set it is being worked as far from resonance as it was on the first occasion.

□ □ □

The £1 Licence

THE announcement that wireless licences were going to be increased in cost from 10s. to £1 came rather out of the blue, and no-one can yet say what its general effects are likely to be. I think that the majority of listeners are agreed that they want better programmes and that if doubling the licence fee means increasing the quality of the broadcasts 100 per cent., there will not be much general grumbling. On the day when these notes were written I happened to attend an in-

formal meeting of about a dozen people who are keenly interested in wireless. When the opportunity arose I asked for their reactions to the increase, and these were distinctly interesting. One section felt that wireless had become so much a part of our everyday life that we simply had to have it and that people would pay the additional amount with the same shrug of the shoulders that accompanies the payment of other increased prices for ordinary everyday things. Others held that if the licence fee went up there would be insistence upon a real change of heart on the part of the B.B.C. Another suggestion was that more expensive licences would lead to a great increase in wireless piracy. I think that all agreed that the only people who would really feel the draught were those with small fixed incomes who had found even 10s. something of a drain on their resources. Everyone was of the opinion that even at a £1 a year wireless was by far the cheapest and most generally appealing form of entertainment that had ever been devised. Only one of those present took a gloomy view and predicted that the increase would lead to a marked falling off in the number of licensed listeners. Personally, I believe that the increased cost of wireless licences will not be generally resented. Nor do I hold that there will be any marked falling off in the number of licensed listeners, or any great increase in piracy. I do, though, hope that something will be done to help those who have little or no financial margin. This could very well be done by making the licence payable in two or even four instalments. The licence itself might be issued on payment of the first instalment, with, say, a five-shilling stamp fixed to it. Further five-shilling stamps to be stuck on at three monthly intervals.

□ □ □

An American Spot of Bother

A LETTER from an American friend who is rather a big noise in the radio industry there gives some surprising news about the present position in the world of wireless in the United States. Many radio set manufacturers do not make their own components, any more than they do in many other countries: they order them in pretty large quantities from component manufacturers. In the United States

price control is still in force in quite a few industries, including that concerned with the making of radio components. The price-fixing authorities are fired with a desire to prevent the public from being exploited by any kind of ramp to push the cost of components up to unduly high levels. That is a laudable aim; but so far as radio components are concerned they seem to have gone rather too far. They have fixed prices so low that component makers complain that they cannot even cover expenses, let alone make any profit if they turn them out at the prescribed cost. The result is that the manufacture of wireless components of many kinds is now going on on a very small scale and set manufacturers cannot obtain the parts that they need. Some set manufacturers make their own components and they are going ahead, though not at full pressure. The nett result is receivers of many kinds are scarce and that there is a big market in second-hand sets of the larger kind. Prior to America's entry into the war the value of second-hand receivers was small but it seems to have rocketed of late. Another friend out there who wanted to buy a communication receiver has spent some time making the rounds of the Chicago shops. He told me that "the price ceiling was not just the sky; it was far above that."

□ □ □

Spot Welding

MORE than once in these notes I've suggested that the spot-welding of wiring connections in radio sets might be a big step forward in construction. Soldering is all very well, but no-one can deny that it does produce too many dry joints, even in the best-regulated establishments—and the dry joint is a menace. A kind reader, who returned some time ago to this country after two years as a prisoner of war in Austria, sends me some interesting facts about the development of a simple spot-welder for radio and electrical wiring which was developed by the Germans. It was in two parts. The first was a metal box, probably containing a power rectifier. Stout flexible leads connected this to the actual welding tool, which was in the shape of a pistol or "gun." The trigger of the gun brought the electrodes together when pressed. He was convinced that it was the most admirable tool for making completely reliable wiring connections. I've heard that spot-welding is used in wireless receiver construction by some American firms, though I've never come across a set made up in this way. I wonder if any readers have?



WE WERE THERE
before the stork...

Even before the birth of broadcasting . . . before the days when to hear the programmes of 2LO was regarded as the ninth wonder of the world, the House of Bulgin was designing and building efficient components for "wireless telegraph instruments." And with the passing of the years the name of BULGIN has figured prominently in every radio and electronic development. To-day, this wealth of experience is at your disposal, not only in the wide range of BULGIN Standard Components but in the design and manufacture of special units to fulfil a particular need as well.

BULGIN

"The Choice of Critics"

A Name Synonymous with Radio

A. F. BULGIN & CO., LTD.
BYE PASS RD., BARKING, ESSEX.

TELEPHONE: RIPPLEWAY 3474



RECENT INVENTIONS

DIRECTIVE AERIALS

The dipole of a parabolic beam aerial is set in the focal plane of the mirror, and is usually energised by a coaxial feeder which, in order not to interfere with the field of the beam, is brought in from the rear through a small opening at the apex of the mirror. In order to keep the beam centred about the axis of the mirror, the dipole should radiate symmetrically, so as to simulate a "point source," but in practice it is found difficult to connect the coaxial feeder to the dipole with the necessary precision.

According to the invention, the coaxial feeder is replaced by a solid wave guide made of an insulator of high permittivity, such as "Faradax"; a rod 1.5 cm. in diameter will be suitable for transmitting a 15 cm. wave. The guide may be arranged to radiate freely from its open end towards a small plate, which reflects the waves back on to the main parabolic mirror. Alternatively a metal rod or dipole is thrust through a transverse hole in the wave guide so as to lie in the focal plane of the system.

The General Electric Co., Ltd., and R. J. Clayton. Application date January 7th, 1942. No. 570038.

INDICATOR FOR WAVE GUIDES

STANDING waves are usually detected by inserting a probe at different points along the length of a wave guide, so as to indicate the potential prevailing at each point. Obviously a number of such tests must be made in order to secure the desired information.

To simplify matters, it is now proposed to fit a glow discharge tube into a longitudinal slot made in the wall of the wave guide, the tube being long enough to indicate by bright zones the distance between two successive nodal points in the standing-wave formation. The tube lies mainly on the outside wall of the guide, projecting only a small distance inside, so as not to interfere with the normal transmission. It may contain two electrodes, one a graphite deposit on the inside wall, and the other a longitudinal wire which is earthed at one end to the outside wall of the guide.

Application date February 23rd, 1943. C. J. Carter and Pye, Ltd. No. 570080.

RADIO BEACONS

RELATES to blind-approach systems of the kind in which an equi-signal path is marked out by the overlapping fields from a centre dipole flanked by two reflectors which are alternatively switched into and out of action. Actually three fields are radiated, one is the circular field due to the dipole alone, the other two being divergent lobes produced by the side reflectors.

The width of the approach path,

A Selection of the More Interesting Radio Developments

which is determined by the mutual inclination of the two lobes should be as narrow as possible. Moreover, within the equi-signal zone, all three fields should be of equal strength; otherwise signal-keying "clicks" are heard, and tend to confuse the pilot.

According to the invention, the centre dipole is replaced by two separately excited dipoles, which are displaced along the line of the approach path. By adjusting the distance between them and their spacing from the side reflectors, the approach path can be narrowed and keying clicks eliminated.

Standard Telephones and Cables, Ltd., and L. J. Heaton-Armstrong. Application date January 12th, 1942. No. 570201.

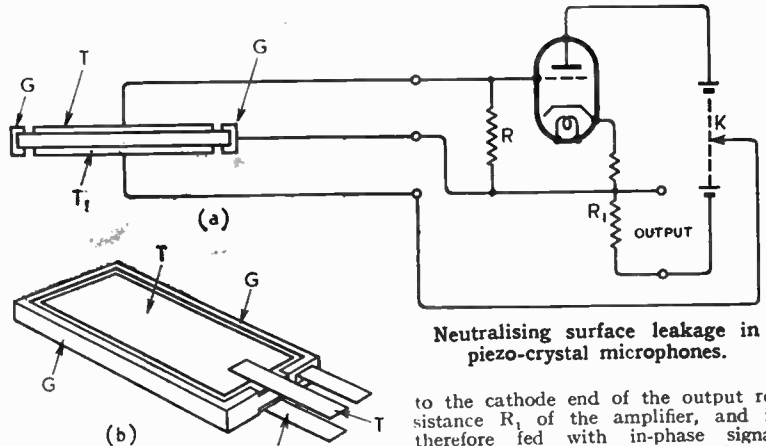

Neutralising surface leakage in piezo-crystal microphones.

to the cathode end of the output resistance R_1 of the amplifier, and is therefore fed with in-phase signal voltage, to reduce any leakage that is in shunt with the valve input. Leakage between the electrodes T_1 and the guard ring is immaterial, since it is in shunt with the low-impedance output of the amplifier.

The Brush Development Co. Convention date (U.S.A.) January 8th, 1942. No. 570043.

WATER-COOLED VALVES

THE surface in contact with the cooling fluid should not be at a higher temperature than the boiling-point of the fluid, otherwise vapour-bubbles will form and act as a heat-insulating layer. If water is to be used, say for a valve that is required to dissipate 2,000 watts per square inch, and if the highest temperature at which the anode can be worked, without injury to the valve, is 320 degrees C, then it becomes necessary to interpolate a temperature fall of over 220 degrees before the circulating fluid can be brought into action.

According to the invention, the anode is fitted with metal fins having the length, breadth, and width required to bring the temperature down to less

than 100 degrees, preferably with the assistance of external spraying. The water-cooling pipes are laid along the outer edges of the fins, to maintain and dissipate the flow of heat.

Standard Telephones and Cables Ltd. (assignees of C. V. Litton). Convention date (U. S. A.) October 5th, 1942. No. 570679.

PIEZOELECTRIC CRYSTALS

If a piezoelectric microphone is coupled to a high-impedance amplifier, any leakage across the surface of the crystal will adversely affect the response of the amplifier, particularly at the lower frequencies.

A guard ring is therefore mounted between the two electrodes on the crystal, and is fed with a voltage that is in phase with the signal voltage and as nearly as possible equal to it, so that there is little or no potential-gradient along which current can flow.

As shown, the crystal electrodes T, T', are respectively connected to the grid of the amplifier and to a tapping K on the HT supply adjusted to the same DC potential as the grid leak R. The guard ring G is connected

The British abstracts published here are prepared with the permission of the Controller of H.M. Stationery Office, from specifications obtainable at the Patent Office, 25, Southampton Buildings, London, W.C.2, price 1/- each.

BLOWERS for Electronic Equipment

Manufacturers of Electronic Equipment are invited to let us know their requirements.

We shall be very happy to discuss with you any Air Treatment problems in connection with your products, equipment or premises.

COMPACT · ECONOMICAL
EASY TO INSTALL

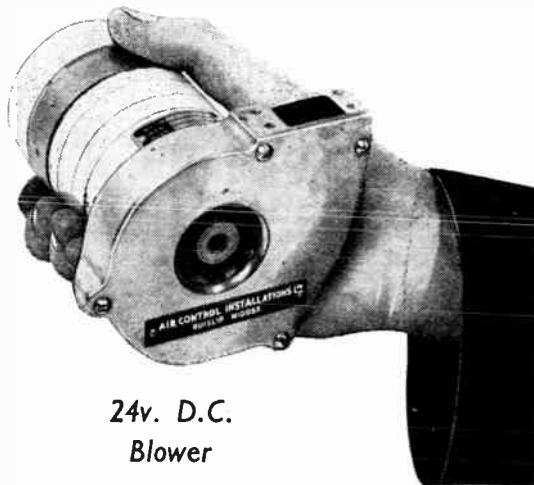

24v. D.C.
Blower

AIR CONTROL INSTALLATIONS LTD.
RUISLIP · MIDDLESEX

Phone : RUISLIP 4066 (10 lines)

Grams : "Controlair" Ruislip



CAPACITORS

that are "Custom-Built"

1069

Every type in the wide range of Wego Capacitors is a "design product," built with a purpose for the purpose, thus providing you with capacitors that can virtually be described as "custom built". We will gladly send you details of the standard Wego range or co-operate closely in the design and manufacture of units to your own requirements.



CONDENSER COMPANY LTD
BIDEFORD AVENUE
PERIVALE · GREENFORD
MIDDLESEX.

Telephone: PERIVALE 4277

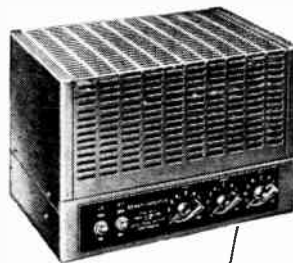
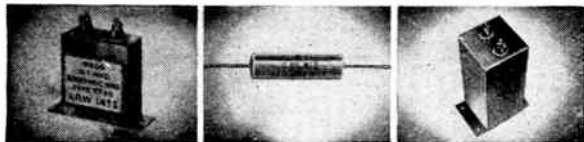

**TRULY
UNDISTORTED
OUTPUT**

The design of the M.31 amplifier incorporates an entirely new output circuit, resulting in a very low percentage of harmonic distortion with loudspeaker or resistive load. Efficiency is extremely good and has enabled a really compact quality amplifier to be produced. The mechanical design is exceptionally robust and reliability is assured.

SPECIFICATION :

30 Watts output ● A.C. 200-250 volts operation.
Overall gain 90 db. ● Mic/Gram mixing ● Frequency weighted microphone control ● Two microphone input impedances ● Tapped output impedance, Tone control, etc.

1016

ACOUSTICAL MANUFACTURING COMPANY LIMITED
HUNTINGDON · TELEPHONE 341



Manufacturers of
the famous

OAK SWITCH

The only switch with
**FLOATING & DOUBLE
ROTOR & CONTACT**

Available in a wide range of circuit combinations for radio, television and other applications.

BRITISH N.S.F. CO. LTD.
KEIGHLEY, YORKS.

(Sole Licensees of OAK Manufacturing Co., Chicago.)

'Phone : Keighley 4221/4.

'Grams : "Enesef, Keighley."

EARTH FREE & Silent as the Stars



Masteradio VIBRATORPACKS

PROMPT DELIVERY NOW ASSURED

MASTERADIO LTD · VIBRANT WORKS · WATFORD · HERTS

'SUNSHINE-
WITH LOCAL
SHOWERS'

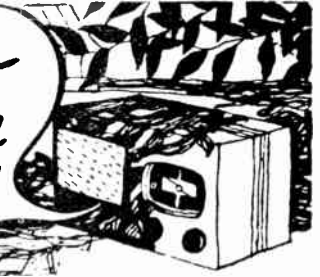

With the weather off the 'secret' list and petrol back in the tank we begin to feel ourselves again. True, Dagenite and Pertrix Batteries are still in short supply—they have been busy 'on the job' in the East. Now that is over they'll soon be plentiful again in shops everywhere.

DAGENITE AND PERTRIX



BATTERIES FOR CAR AND RADIO

HOLSUN BATTERIES LIMITED · 137 Victoria Street, London, S.W.1
D 15-45

ERG'S HAVE THE URGE TO GO ABROAD

**SPEAKING
EXPORTLY...**



ERG Resistors have an exceptional electrical specification and performance, with mechanical strength.

High-grade Vitreous Enamels used on our Tropical Resistors give long life, and definitely assist in the trouble-free manufacture and performance of Radio Receivers, Television and Test Equipment.

ERG Resistors are processed up to the highest Service Standards at a competitive Price

ERG RESISTORS LTD.

1021a, FINCHLEY ROAD, LONDON, N.W.11.
PHONE : SPEEDWELL 6967



Even 24 hours' immersion in sea-water cannot affect impervious

Welwyn Resistors



Tested independently, a standard Welwyn Vitreous Resistor worked perfectly after 24 hours' immersion in sea-water. Sizes—1 w. to 300 w. Also High Stability Carbon Resistors— $\frac{1}{4}$ w. to 2 w.

New Trade catalogue available

WELWYN ELECTRICAL LABS. LTD
Welwyn Garden City, Herts.
Phone : WEL. GAR. 3816-8

Rate 6/- for 2 lines or less and 3/- for every additional line or part thereof, average lines 5-8 words. Box numbers 2 words, plus 1-. Press Day: April 1946 issue, first post Thursday, March 7th. No responsibility accepted for errors.

NEW RECEIVERS AND AMPLIFIERS
COMMUNICATION receivers.—As soon as civilian supplies recommence we shall be at your service.—A.C.S. Radio, 44, Widmore Rd., Bromley, Kent. [4528]

COMMUNICATION receivers.—"Dale" will have them as soon as trading conditions allow.—Remember—Dale Electronics, Ltd., 105, Bolsover St., W.1. Mus. 1023.

T.R.F. ac/dc medium and long wave kit of parts, with drilled chassis, size $9\frac{1}{2} \times 4\frac{1}{2} \times 1\frac{1}{2}$, and all components, condensers, etc., and circuit, nothing else to buy, £4; valves £2 10; 5in speaker, trans., 27/6.

HENRY'S, 5, Harrow Rd., Edgware Rd., W.2.

QUALITY—We offer you a receiver combining all the features of local quality reception and the communications receiver sensitivity, something new, it will be worth while investigating.—2yd. stamp for descriptive brochure from the Moreton Cheyne Company, BCM/REME, London, W.C.1. [4832]

5-VALVE 3-wave superhets complete; kits for W.W. amplifiers, or built to order; communication receivers available, maints lit eliminators, ht units, work that battery set off 2volt accumulator only; details on request.—R.E.S. Marfrel, Maurice Rd., Canvey, Ex.

AMPLIFIERS—P.A. industrial, dance and stage installations and portable apparatus from 15 to 150w; early deliveries; illustrations and spec. on request.—Broadcast and Acoustic Equipment Co., Ltd., Broadcast House, Tombland, Norwich 26970. [2903]

ANEROY RADIO offer set of components for making M.W. semi-midget 4-valve ac/dc t.r.f. receiver, including cabinet, valves, drilled chassis, 6½in speaker, screws, etc.; nothing more to buy; complete with circuit, £8, packing and post 5/-—Aneroy Radio, 316, Hindmans Rd., E. Dulwich, S.E.22. [4663]

BAKER'S—New 7-valve "Wireless World" Quality amplifier with tone control stage, 8 watts push-pull triode output, price includes super Quality triple cone, 12in permanent magnet speaker, with large output transformer and all valves; also as above but with 15 watts tetrode output, ideal for realistic reproduction for public address; 2yd. stamp for particulars, prices, etc.—Bakers, Selhurst Radio, Tel. Croydon 4226. [3680]

NOW ready, the Model P.A.3 7-valve amplifier; order now, immediate deliveries.

MAENS transformers, output transformers, chokes, specially designed for the "Wireless World," 4, 8 and 12 watt Quality amplifiers.

READY soon, the "Wireless World" 8 watt Quality amplifier with pre-amplifier and variable record compensation; write now for full details and lists.—Chadderton Radio & Television Co., Ltd., Peel St., Chadderton, Lancs. Special terms to factors and export agents.

RECEIVERS, AMPLIFIERS—SECOND-HAND

SOUND Sales W.W. 3-wave super six tuner; £20.—Box 5674. [4840]

7-VALVE ac wireless, walnut, foreign make, pre-war £150; what offer?—Box 5773.

MATEUR—Built 8v s.w. superhet; £18.—Godier, 9, Warner Rd., N.8. Mou. 3044.

SOUND Sales tri-channel amplifier, complete with speakers; offers.—Box 5761.

RADIOGRAM, H.M.V. and automatic record change; £60 (no offers).—Box 5766.

TROPHY six communication receiver, very little used, perfect cond., £16.—Box 5017.

TWO B.T.H. cinema amplifiers, each weighing 140lb, P.X.25's in output; £22 each.—Myers, 222, Jack Lane, Leeds, 10. [4872]

5-VALVE receiver, battery operated with tuner, type C.H. less coils, made by Marconi Scientific Inst. Co.; offers?—Box 5492.

HOME—Constructed superhet communications set, 230v a.c., 9-valve, 13-60 meters coils, B.F.O., A.V.C., etc.; £40.—Box 5765.

H.R.O. with 230volts ac power pack, coils for 50c/s to 430kc/s, and 900 kc/s to 30mc/s in 7 bands.—Offers to Box 4949. [4702]

HALLICRAFTERS SX25 communications receiver, 7 watts P.P. output; £39/10; advise collection.—Dean, 35, High St., Hailsham, Tel. 102. [4771]

MIDWEST 7 valve 5 waveband AC Console, beautiful condition throughout, better than new, specially polished, fine performance; £35; carriage paid.—Box 4867. [4676]

HALLICRAFTERS Skyriter Defiant 8X24, 545kc-43.5mc, bandspread, crystal filter, variable selectivity, noise limiter, perfect; £40 or nearest offer.—Box 5018. [4717]

H.R.O. Senior, 230-250 volts, coils 1.4 to 30 meg., one very accurately calibrated, power pack, speaker, few spare valves, first class condition; offers.—Box 5734. [4868]



COMMERCIAL and DOMESTIC

Transformers and chokes for commercial and domestic purposes are again in full production. Now that priority permits are no longer necessary we are able to supply the needs of our old friends and many new ones.

All these will benefit by the experience we have gained during the last six years when the reliability and performance of our products were vital.

1946 CATALOGUE

This is now ready and illustrates various styles of mounting. We shall be pleased to send you a copy upon request together with a comprehensive list of components available from stock.

SPECIALS

Transformers manufactured to your specification can now be delivered in 28 days.

CONSULTATIVE SERVICE

The Partridge Organisation is again at your service. Our technical department will be pleased to assist you in your transformer problems.

Telephone:  Abbey 2244

PARTRIDGE TRANSFORMERS LTD

76-8, PETTY FRANCE, LONDON, S.W.1

A.C.S. RADIO, 44, Widmore Rd., Bromley, Kent, offer small selection com. sets, radio receivers, amp. and televisions; list free.

MATEUR transmitter giving up all to be sold, incl. meters, high voltage transf., conds., etc.; offers for part or lot, s.a.e. or call.—38, Church Lane, N. Featherstone, Yorks.

RADIOGRAM ac Pilot 8-valve, beautiful walnut cabinet, perfect order, £80; also rotary converter, in. 230v dc, out. 230v ac, 50 cycles 0.25hp, £16.—58, Eccles Rd., S.W.11.

WESTERN Electric 7-valve super heterodyne receiver, complete with frame aerial, battery box and Western Electric 2-valve amplifier and loud speaker; offers.—Box 5491. [4812]

4-VALVE battery operated Geophone complete with mahogany cabinet, Waylaver Major portable receiver, and Osram Music Magnet 2-valve receiver; offers the lot?—Box 5494.

SUPERB His Master's Voice, 11 valve, 5 waveband AC autoradiogram, magnificent appearance, performance, special model, cost £356; accept £130; carriage paid.—Box 4866.

BURNDIP all-wave super heterodyne 7-valve receiver, complete with coils in mahogany cabinet, and 4-valve battery operated Britphone No. 4a receiver, less valves; what offers for the lot?—Box 5493. [4814]

THE output stage of a 500watt amplifier, comprising a pair of Standard Telephones, type 212E, 250watt valves (listed at £30 each), ESU40 rectifier, with special holders, h.t. transformer, filament transformer, output and smoothing chokes and condensers; £35 the lot.—Harris, Strouds, Bradford, Berks.

COMPONENTS—SECOND-HAND. SURPLUS SPECIAL offer for this month.

WHILE existing stock lasts.

SPEAKERS—Cecilston P.M. 6½in. L/Trans., 16/6; 6½in. P.M. W/Multi ratio trans., 26/6; 8in. m. energised (1.50 coil), 18/11.

CENTRALAB v/controls 1/S, 2/6; w/s, 3/6.

CONDENSERS, .1, .01, .05, .002; 6/- doz.

STANLCO & Solon soldering irons; 13/6 ea.

TWO- and three-gang condensers, .0005, 2-gang, 11/6; 2-gang s/motion, 13/6; 3-g. 14/6.

ROTHERMEL crystal pups de luxe; £3/18/9.

LINF. cord, 3amp (60ohms p.ft) 2-way, 1/6 per yard; 3-way, 2/6 per yard.

T.R. cable, 1/044 asstd, lengths 7d, per yard.

EIRE resis, ½ watt, ¼ meg., 1 mag., 4/700, etc.; 4/6 doz.

ALL goods are new; many other lines in stock; large assortment B.V.A. and U.S. valves.

MATT RADIO SERVICE, 152, Richmond Rd., Kingston-on-Thames. [4728]

SOUTHERN RADIO'S wireless bargains:—

LATEST radio publications:

"Radio Valve Manual," equivalent and alternative American and British types with all data, 3/6; "Radio Circuits," fully illustrated receivers, power packs, etc., 2/-; "Amplifiers," fully descriptive circuits, 2/-; "Radio Coil and Transformer Manual," 2/-; "Short Wave Handbook," 2/-; "Manual of Direct Disc Home Recording," 2/-; "Test Gear Construction Manual," 1/6; "Radio Pocket Book for amateurs, tables, colour-coding, etc., 1/10.

How for Radio Constructor, 1/. Just published, "Radio Reference Handbook," comprehensive and up-to-date, covering all branches of radio, 10/6.

PAPER condensers Post Office type, upright, 2mf, high working (used but guaranteed perfect), 2/6 each. Brand new 2mf mains-bridge, 3/6, 1mfid 3/-, 1-1-1, 2/6; 4 C.C. electrolytic reversible 4-4mfid 70v, 3/6. multi-conic condensers, 28 capacities in one, 4/-.

ACE "P.O." microphones, complete with transformer, usable with any receiver, 7/6. Permanent crystal detectors, 2/6. Crystals 6d., with cat's-whisker 1/-. Insulated push-back wire, 25 yards, 5/-. Insulated sleeving, assorted sizes and colours, 3/6 per dozen yard lengths. Single screened wire, 10/- per doz. yards. Twin screened wire, 17/- per dozen yards.

Power rheostats, cutler hammer, 30 ohms and 10 ohms, 4/6 each. Press-button switches, 3 way 4/1-, 8-way 6/- (all complete with knobs). Escutcheons for 8-way switches, 1/6. Xaxley type rotary switches, 11-way single bank, 6/6. Hundreds more bargain lines.

SOUTHERN RADIO SUPPLY Co., 46, 1,isle St., London, W.C. Gerrard 6653. [4234]

COLPAK tuning unit G10, 11, 12, 14; 4G condst.; as new.—Offers to Pursell, 16, Goldwell Rd., Thornton Heath, [4730]

BIG stocks of radio valves, all types, list B prices; 8in Field energised speakers, 35/-; c.o.d. or pro-forma—David Robinson, Ltd., 100, High St. Bedford. [4577]

B. & H. RADIO offer all sizes of electrolytics, chokes, volume controls, etc.; everything for the service man; competitive prices; trade only; send for list.—Victoria Garage, Hargreave Terrace, Darlington. [4690]

LASKY'S RADIO

LARGE STOCKS OF ELECTROLYTIC CONDENSERS ALL NEW AND GUARANTEED BY WELL-KNOWN MANUFACTURERS

8 mfd., 450 v.w. tub 3/6. 8 mfd., 500 v.w. tub can 5/6. 8 mfd., 500 v.w. 4/-. 16 mfd., 440 v.w. wet can 7/6. 8 x 8 mfd., 150 v.w. tub 3/6. 8 x 8 mfd., 450 v.w. tub 5/9. 16 x 16 mfd., 450 v.w. tub 7/9. 16 x 16 mfd., 350 v.w. block 7/-. 4 mfd., 650 v.w. block 5/9. 2 mfd., 250 v.w. tub 2/-. 8 mfd., 200 v.w. tub 2/3. 4 mfd., 200 v.w. tub 2/-.
ELECTROLYTIC BIAS CONDENSERS—25 mfd., 25 v.w. tub 1/8. microcap 2/6. 50 mfd., 12 v.w. tub 1/8. microcap 2/6. 75 mfd., 12 v.w. tub 1/8. microcap 2/6. 12 mfd., 50 v.w. 3/-. 50 mfd., 50 v.w. 3/6.
TUB CONDENSERS—1, .01, .001, .05, .02, .003, etc., mfd., 400 v.w. 8/4. each, 8/-. doz. These are only a few examples of our extensive stocks.

THIS MONTH'S SPECIAL OFFER—SUPER SERVICE KIT—48 assorted condensers, including: one of 8 mfd. 600 v.w., 8 mfd. 450 v.w., 16 mfd. 440 v.w., 16 x 16 mfd. 350 v.w., 8 x 8 mfd. 450 v.w., 4 mfd. 650 v.w., 2 mfd. 250 v.w., 25 mfd. 25 v.w., 75 mfd. 12 v.w., 50 mfd. 12 v.w., and 35 assorted resistances. **ES 10/- 8d. POSTAGE AND PACKING FREE.**

MIDGET YALEY TYPE WAVECHANGE SWITCHES—5-way 2-pole, 2/9; 2-way 3-pole, 2/6.
MIDGET COILS AERIAL AND H.F.—Medium wave high gain, 5/9 matched pair. Medium wave high gain, 6/9 with circuit. M. and L. wave with circuit, 8/6; with reaction, 10/6.
VALVES—6,000 mains and battery types in stock, B.V.A. or Tangram. Most types of American glass, metal, G.T. and U.X. and Octal at B.O.T. prices. Send us your queries.

LOUD SPEAKERS P.M. ENERGISED 2 1/2" to 12" all sizes. 4 1/2", 6" and 10".
SPEAKER TRANSFORMERS—Midget Pentode, 5/9. Multi ratio universal, 7/6.
MIDGET SMOOTHING CHOKES, 500Ω, 6/6.
LINE CORD—2/6 per yd., 2- and 3-way.
MAINS VOLTAGE DROPPERS—3 amp. 800Ω, 5/9. 2 amp. 1,000 Ω, 5/9.
MAINS TRANS.—350-0-350 v., 6.3 v. and 5 v., or 4 v. and 4 v., 29/6.
 We have too little space to advertise all our goods. Send us a list of your requirements and let us quote you. Terms: Satisfaction guaranteed or money returned. Terms: Cash with order, C.O.D., or pro. forms. Orders over £5 post free. No. C.O.D. under £1.

LASKY'S RADIO

364 & 370 Harrow Rd., Paddington, W.9 (Opp. Padd. Hospital.) Phone: Cunningham 1979-

YOU

can become a first-class RADIO ENGINEER

We are specialists in Home-Study Tuition in Radio, Television and Mathematics. Post coupon now for free booklet and learn how you can qualify for well-paid employment or profitable spare-time work.

T. & C. RADIO COLLEGE
 North Road, Parkstone, Dorset

(Post in unsealed envelope, 1d. stamp)

Please send me free details of your Home-Study Mathematics and Radio courses.

NAME

ADDRESS.....
 W.W.46.

H.P. RADIO SERVICES, Ltd., offer:

NEW receivers; Airmaster 5-valve superhet chassis and 8in R. and A. energised speaker, all British product with valves, 1 1/2in long, 8in wide, 3 1/2in high, cream cellulose finish, large illuminated dial 8in x 5 1/2in, four wavebands 13-2,000m, factory built product of the highest standard, sockets for P.U. and ext. L.S., ac mains, 200-250v, £16/10; Alba 1946 5v all-wave superhet, £18/4/6; K.B. 6v all-wave superhet super model, £32/3/11; Gramplan 1946 Ensa amplifier, mike and two speakers, 12w portable outfit, £36; Philip's 15w amplifier, mike and two horn speakers, 12v dc or 110-250v ac. £59/10; 5w ac/dc amplifier, neat chassis with valves, £6/10.

LOUDSPEAKERS: 5in Rola, 18/6; Rola 8in, 19/6; Celestion 8in with trans, 25/-; Celestion 8in energised, 2,000ohms field, with transformer, 36/-; R. and A. 10in with trans, 45/-; Vitavox 10w 12in, £7.
BOOKS: "Radio Circuits," 2/-; "Radio Manual," 1/-; "Amplifier Manual," 2/-; "Modern Radio Test Gear Construction," 1/6; "Radio Inside Out," 4/6; "Manual of Disc Recording," 2/-; "Radio Valve Manual," 3/6; "Short Wave Handbook," 2/-; all new goods, prompt dispatch, satisfaction guaranteed; postage extra under £4.
H.P. RADIO SERVICES, Ltd., 55, County Rd., Walton, Liverpool, 4. Tel. Aintree 1445. Estab. 1935. 4914

COULPHONE RADIO, Station Rd., New Longton, Nr. Preston.

THE return of most mail order service, cod or cwo, exclusively mail order.
 NEW goods only, no surplus, all orders over 5/- post free; compare these prices; special quantity discounts.
LINE CORD, .3 amp 60 ohm, 2-way 1/6 yd., 3-way 1/9.

MAINS transformers, wax impregnated, primaries for 200-250 volts; 300-0-300 60ma, 4 or 6v. 17/6; 350-350 100ma, 4 or 6v., 24/1; bobbins as last model, 15/6; 450-450 200ma, 4v 8a, 4v 4a, 4v 4a, or 6.3v 4a, 6.3v 4a, 5v 3a, 42/6.

SMOOTHING chokes, 40ma, 4/6; 60ma, 6/-; 90ma, 7/-; 100ma, 12/6; 200ma, 21/6; fluorescent lighting chokes, 80 watt, 25/-.

SPEAKERS, Magnavox, Rola, Plessey, Celestion, P.M., less transf., 2 1/2in, 24/-; 3 1/2in, 27/6; 5in, 19/6; 6 1/2in, 20/-; 8in, 21/-; 10in, 30/-; with transf., 6 1/2in, 24/-; 8in, 25/-; 10in, 36/-; energised with trans. 8in 1,200 or 2,000 ohm, 32/6.

SUPERHET coil packs, S/M/L wave, completely wired with 5-valve circuit, 465kc/s, 32/6; I.F. transf., iron cored, 465 matched, 13/6 pr.

MAINS droppers, feet, 2 sliders, 0.2amp, 4/3; 0.3amp, 4/6.

OUTPUT transformers, Midget pen, 4/6; mid. power/pen, 5/-; std. size Univ. with C.T., 6/-; 8 watt Univ., 10/6; 15 watt, 21/-; 30 watt, 37/6.

COLLAR radiogram equipment, rotational deliveries begin March; motors, £4/13/6, with pick-up, 27/9/8. [4861]

FOR sale, National M.F. and L.F. coils for H.R.O.—Box 5450. [4806]

MAINS transformers, first grade, brand new, 350-0-350v 80ma, 4v 4a and 4v 2.5a, or 6.3v 3a and 5v 2a, 20/- ea; post 1/-.

ELECTROLYTICS, 8mfd 500v, 3/-; 8x8mfd 550v, 5/-; 16x8mfd 350v cans, 6/6; 16x8mfd 450v, 6/6; 25v 25mfd 1/9; 50mfd 12v, 1/4; 8in P.M., with trans., 25/-; s.a.e. for list of other bargains.

ANELOY RADIO, 36, Hindmans Rd., E. Dulwich, London, S.E.22. [4865]

HENRY'S offer—Phillips wet electrolytics. small cans, 8mfd, 450v wkg, 8mfd 320v wkg, midget, 25mfd 320v wkg, at 6/6; also 8x8 450v wkg, 6/9; 8mfd 350v wkg, 2/3; 8mfd, 450v wkg, 4/-; 16x16 block, 35v wkg, 8/-; 4mfd, 200v wkg, 2/-; 2mfd, 1,200v wkg, 7/6.

T.R.F. m and l wave coils with reaction, 8/6 pr, with circuit; T.R.F. med wave midget coils, 6/6 pr, with circuit; 3-bank 3-way, 3-pole, with screen, 4/6; toggle switches, 2/-.

GOODMANS 3in P.M. 3 or 150hms, 35/-, with trans; 2-gang 0.0005 midget condensers with trimmers and feet, 12/6; and 2-gang 0.0005 ceramic ins with feet drum and drive spindle, 14/-; 3-gang 0.0005 ceramic ins, 12/6; Litz wire wound h.f. chokes, 2/-; midget strong steel chassis, size 9 1/2 x 4 1/2 x 1 1/2, with cut-out for 5in speaker, holes for 5-valves and drilled for components, 4/6; s.a.e. for latest price list, 4-page.

HENRY'S, 5, Harrow Rd., Edgware Rd., W.2. Pad 2194. [4426]

TOGGLE press by Stanelco, suitable for radio chassis work; sheet metal bender by A.A. Tools for chassis; transformer clamps, etc.; 2 Avo capacity bridges; all unused—C. T. Kennedy & Co., 555, Sauchiehall St., Glasgow, C.2. [4799]

DALY ELECTROLYTICS



Tube—size 2 1/2" x 1"



Can—size 4 1/2" x 1 1/2"



Block—size 4 1/8" x 1 1/4"

The DALY range covers all requirements
 Note—All Condensers bear the date made
DALY (CONDENSERS) LTD
 Condenser Specialists for over 20 years
 West Lodge Works, The Green, Ealing, W5
 Phone—Ealing 4841

"VIBRO-ARC" Engraving Pen



For rapid engraving any metal—hard or soft.
 Operates from 4-6v. Battery or A.C. Transformer giving 6-10 amps.

HOLBOROW,
 46, Boroughbridge, Yorks.

TRANSFORMERS & COILS TO SPECIFICATION.

MANUFACTURED or REWOUND
STANLEY CATTELL LTD.
 9-11, East Street, TORQUAY, Devon.
 Phone: Torquay 2182.

Aladdin RADIO CORES
 for all purposes
 GREENFORD, MIDDx. WAXLOW 2300

NEW DUAL TESTSCOPE



Ideal for high and low voltage testing; 1/30. 100 850 A.C. and D.C.
 Allowance made on old models.
 Send for interesting leaflet (R.14) on Electrical and Radio Testing, from all Dealers or direct.

RUNBAKEN HANDESTER-I

CHARLES BRITAIN RADIO offers several new and interesting lines this month. T.R.F. ac/dc midget chassis, long and medium waveband, wired up, tested and complete with 4 valves and speaker. £7/10. Short-wave coil pack, T.R.F. covering, 917-24m, 12.45m, 39.5-95m, 85.4-208m, with diagram and instructions, 30/-; all-wave superhet coil pack with all padders, trimmers and switch, etc., and diagram, 30/-; midget I.F. trans., 465 k/c, iron cored, 22/6 pair; standard type with trims, 12/- pair; all-wave coils with diagram, superhet, 14/-; dual-range T.R.F. coils, I.F. and Ae, 7/- pair.

5- and 4-gang .0005 tuning condensers, ceramic insulated, 10/- ea; 2-gang midget type, short spindle, with feet, 8/6 ea; 2-gang with feet, trimmers and tapped spindle for pointer, 12/-; complete dial assembly, comprising all-wave dial escutcheon, drum drive, pointer and spring, 5/6; small dials for midgets, 8/- doz; all-wave ivorine dials, 2/6 ea; dual-band clock-faced dials, 2/6 ea; Bulgin panel light, chromium finish, red glass, to take standard bulb, 2/6 ea.

SPECIAL offers: Philco mains, energised speakers with new cones and transformers, field 1,200ohm, £1; L.F. chokes, 360ohm, 100ma, ex Ekco, 4/6 ea; band-pass aerial coils with dia., 2/6 ea; oscillator coils, 110k/c, with dia., 2/6; I.F. trans with trims in all cans, 110k/c, 3/6 pair; wavechange switches, suitable for coils, 2/6 ea; three-gang condensers, one section tracked for 10k/6, 3/6 ea; 0.2 mains droppers, ex Ekco, 2/6 ea; parcel of assorted tubular condensers, incl. 0.1s and bias types and block smoothing condensers, 6/- ea; mains trans for C.R. tubes, ex Ekco television, 35/- ea; send for list "W" terms, cash or c.o.d. over £1.—Charles Britain Radio, Radio House, 2, Wilson St., London, E.C.2. Tel. Bis 5985, ext. 7. [4882]

CHOKES, output, and mains transformers of lowest prices, etc. particulars.—Ponder, 8b, New Green, Kew, Surrey. [4800]

VALVE panel, 250ac, as new, charts, books, etc., stock resistances, condensers, etc.; suit beginner; bargain price lot; no separation.—Geo, Essendon, Herts. [4768]

SERVICEMEN—The following products are well designed and of high quality; volume controls, carbon type, all values, with or less switch, wire-wound resistors, 1 to 60watts; dropper resistors, 0.2 and 0.3 amp; line cords as per Dagole, Ltd., 5, Torrains St., London, E.C.1

WIRE-WOUND non-inductive resistances, 2 watt, ideal for meter shunts, resistance boxes, etc., 2 1/2% accuracy, wound on bakelite bobbins, 7/16in x 1/4in, one of each of the following ratings, 25, 100, 200, 400, 600, 1,000 and 2,000 ohms; 5/6 per lot, postage paid; quantities available.

ELECTRO-MAGNETS, 200-250 volts, ac resistance, 30 ohms, 1 1/2 x 1 1/2in; 3/6 ea.

MOVING coil headphones, p.m., energised by Alni magnets, 45 ohms, 1/2in coil, ideal for mikes, miniature loudspeakers, 1 1/2in overall in bakelite cases with 3in front flange, 7/6 ea.

MOVING coil microphones, fitted as hand mic., with switch in handle, 45 ohms speech coil, 12/6 each.

THROAT microphones, with elastic bands, phone, plug, 15 ohm speech coils, etc.; 7/6 ea.

SYNCHRONOUS motor, enclosed type, by G. & H., self-starting, exceptionally good torque, rotor speed 200rpm, 200-250v ac, 50r, consumption 3 watts, size 2 1/2 x 2, geared 1R.60 min., can be reset to zero by friction drive from front or back, shaft 1/2in x 1 1/16th, to run clockwise, ideal movements for making electric clocks, time switches, etc. nickel-plated finish; price 27/6 each, reg. post and packing 1/1; 12 to 1 dial trains to fit above spindle, per set, 7/6.

H. FRANKS, Scientific Stores, 58, New Oxford St., W.C.1. Tel. Museum 9594. [4860]

NORMAN ROSE'S 1946 illustrated components price list now available to radio dealers, 2d. incl. post paid.—Now open trade counter and showrooms at 53, Hampstead Rd., London, N.W.1 (corner of Tottenham Ct. Rd. and Euston Rd.). Norman Rose (Electrical) Ltd., 53, Hampstead Rd., N.W.1. [4646]

C.O. instrument wires, 1/4lb reels, 18, 20, 22, 24g, 1/6; 26, 28g, 1/9; 30, 32g, 2/-; 34g, 2/3; enamelled ditto, same prices; also 36g, 2/3; 38, 40g, 2/6; silk-covered, 2oz reels, 24, 26, 28g, 1/6; 30, 32, 34, 36g, 1/9; 42g, 2/-; 16g D.S.C., 1lb, 5/-; R.C. stranded wires, 1d., 1 1/2d., 2 1/2d. yard; stranded push back wire, 2/3 doz yds.

LAMINATED bakelite panels, 1/2in thick, 6in x 4in, 1/3; 6in x 6in, 1/3; 8in x 6in, 2/-; 6in x 6in, 2/-; 10in x 6in, 1/2; 12in x 6in, 4/6.

B.A. thread screws, gross useful sizes, 2/6; ditto nuts, 2/6 gr.; assorted gross screws and nuts, 2/6 gr.; ditto brass washers, 1/6 gr.; fibre washers, 1/6 gr.; assorted soldering tags, 2/- gr.; assorted small eyelets and rivets, 1/3 gr.; all postage extra.—Post Radio Supplies, 33, Bourne Gdns., London, E.4. [4532]

ELECTRADIX

More excellent Bargains

RELAYS. Siemens' High-speed Relays in heavy brass case, £5 5s. Telephone type No. 6. 2-coil polarised, 5.P.C.O., 2 volts 25 ma., 325 ohms, 8/6. No. 1A 5.P. on-off, 6 volts 40 ma., 5/-.

Relay movements 1,000 ohms, less blade and contact, 2/6. Moving-coil relays by Weston, Elliott and Sullivan.

SOLENOIDS. 24 volt solenoids, massive type to lift 14 lbs., 15/-; small 12 volt solenoids, pull 1 oz., 1 in., 6/6.

CUTOUTS. Air Ministry enclosed type cut-out, 12 volt 40 amp, or 24 volt 40 amp, in bakelite case, 35/-; 6 or 12 volt triple auto. car type cut-out, dynamo control box, armature field and battery, 21/-; 24/30 volt D.C., 30 amp contactors, 30/-; 12/24 volt D.C., 500 amp 1/1C contactors, 50/-.

CHARGING DYNAMOS. We are now able to offer a line of Charging Dynamos for prompt delivery. 6 volts 10 amp, £4; 12 volt 10 amp, £4 10s.; 12 volt 15 amp, £5; 24 volt 40 amp, £10; 30 volt 5 amp, £7 10s.; 32 volt, 6/8 amp, £8 10s. These machines are all in first-class condition, circular body; by leading makers.

BATTERY CHARGERS. "Lexid" Nitriday models, metal rectification, 2 volts 1/2 amp, for wireless cells, to large chargers for your car accumulator. Send for special leaflet "W.W."

TRANSFORMERS. 3 k.w. Crypto 230 v. to 115 v., shrouded, £9 10s.; 3 kW Metvick, 50 cy. 400 v. to 600 v., £9 10s.; 500 watts, Foster 50 cy. 240 v. to 110 v. 5 amps, £4 15s.; 250 v. 50 cy. to 2 v. 10 amps, 230 v. 50 cy. to 20 volts 2 amps, 30/-; 230 v. 50 cy. to 12 v. 3 amps, 32/6; 5 watts H.T. test Transformers, 110/220v. to 1,000 v. 5 ma., 10/-.

TRANSFORMERS FOR RE-WIND 3 kW. New type with stampings 4 1/2 x 6 x 7 1/2 in., windings damaged by blitz. Can be taken apart to make a number of smaller units. Weight with damaged wire is 65 lbs. Limited number at 45/-, carriage extra. 1/2 kW. Transformer for rewind, 35/- 150/200 watt size, 30/-.

AUTO TRANSFORMERS. 230 volts to 110 volts, 50 cy. 80 watts, 25/-; 150 watts, 35/-; 300 watts, 60/-; 350 watts, 65/-; 900/1,000 watts, £7 10s.

SUPERSEDERS H.T. Battery Superseders for Radio Receivers, 6 volts input, 110 v. 15 ma. output, 12 volts input, 230 v. 30 ma. output. Size is only 5 1/2 x 3 1/2 x 3 1/2 in., beautifully made, model finish, ball bearings, etc., and takes small current from your accu. Latest model. Price £3 15s.

BELLS. Large Tangent ironclad bells, 6in. gong 230/250 volts, A.C., new condition, 42/-.

Circular A.C. Bells, 5/8 volts, 3in. diam., bakelite base, 2 1/2in. diam. metal gong, 6/6.

House bells, bakelite base, with 2 1/2in. gong, 6/9.

Bell Transformers, 230/3-5-8 volts, 7/6.

MAGNETS. The wonder midget Magnet, alni perm. steel disc, weight only 1/2 oz., 3/6 in. dia., 3/6 in. thick with 3/16in. centre hole, 3/6 each. Large selection of horseshoe Magnets in stock. Send for leaflet "W."

MICROPHONES. The Lexid No. 11A Hand Mike is again available; a carbon inset in solid brass case, the sensitive diaphragm protected by a perforated metal panel, 5/6. Metal clad inset only, 5/-.

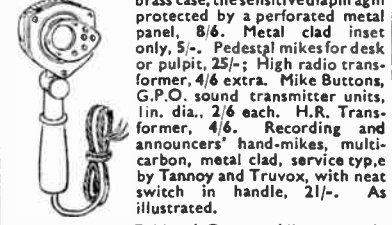

Pedestal mikes for desk or pulp, 25/-; High radio transformer, 4/6 extra. Mike Buttons, G.P.O. sound transmitter units, 1in. dia., 2/6 each. H.R. Transformer, 4/6. Recording and announcers' hand-mikes, multi-carbon, metal clad, service type by Tannoy and Truvox, with neat switch in handle, 21/-.

SEND-RECEIVE Hand Coms. All-metal Field Hand Coms. for portable or fixed stations. The famous No. 16 Govt. type, used in field telephones; mike and earpiece with damaged finger switch easily repaired, 7/6.

PARCELS. 7 lb. parcel of useful oddments for your junk box, all clean and dismantled from Government and other apparatus. 7/6, post free.

ELECTRADIX RADIOS
214, Queenstown Rd., London, S.W.8
Telephone: MACaulay 2159

G. A. RYALL, 65, Nightingale Lane, London, S.W.12.—Mail order callers welcome, hours 2 p.m. to 8 p.m.; Tube, Clapham South; bus stop, Ramsden Rd.; no c.o.d. under £1 please; postage extra.

VOLUME controls, Morganite 1/4mg short spindle, 2/-; Dublier long spindle, 1mg, 2/-; both less switch; condensers, tubular 0.1 350v wkg, 7/6 dozen; pairs 0.1 450v wkg on pax strip, 8/6 per 6 pairs; tubular 0.002 450v wkg, 4/- dozen; Mansbridge and Inter-board, lmc, with terminals, perfect insulation, 2/6 each; Celestion 10in permanent magnet speakers, pentode trans, powerful magnets, 50/- each.

METER switches, 1 way, 3/- each; Yaxley type switches, 3 bank, 2 pole, 4-way, with middle screen, 4 shorting bars, long spindle, 3/9 each; Yaxley type switches, require stop fitting, single pole double throw, 1 and 2 bank, 1/6 each; push back wire, blue, 12yds 1/6; 50yds 5/6; knobs, brown thimble pattern, 4in spindle, 4/- dozen; set 5 Clydon 30mm trimmers on metal base, 1/-.

MORGANITE carbon resistors, colour coded, 500, 1,000, 50,000, 2mg, 3/- dozen; Erie resistors, insulated type, 450, 5,000, 22,000, 220,000, 470,000, 3/9 dozen, all half-watt types; Erie 2watts 680, 6,800, 140,000, 150,000, 220,000, 470,000, 820,000, 5/- dozen.

VALVE holders, chassis type, British 5 and 7pin, American UX 4, 5, 6pin and International, Octal, all 4/- dozen; Octal 8pin plugs, metal cap and chassis type socket, 3 for 2/6, 8/- dozen, ditto with solder tags, 3 for 3/-, 10/- dozen.

TWIN screened microphone cable, 3yds 2/6; aluminium coil cans, 2 1/2in high, 2 1/2 across base, 3 for 1/6.

RESISTANCE mtg strips, 5-way, 2/6 doz; 2-way input panels terminals, 2/6 dozen; panel with screened 0.1 & 11 Erie res & cond, 2/3.

LARGE mains transformer from H.M.V. 1,000, 1,000 volts and 1.4 amp; large cinema type speaker for ac mains; Colpak tweeter (G1, 2, 3); Rola and other items; offers.—Gains, Ashcombe, Shanklin. [4752]

PUSH-PULL, for those that require that little extra quality, large heavy duty push-pull output transformers, wound for PX4s type P, also 6L6s type L to 30hm sec, 27/6; valves supplied with these if reqd., list prices plus P.T.—S.B.C., Richmond St., Walsall.

TRANSFORMERS, multi-ratio output, 5/9; C.T. prim, 6/3, class B intervalve, 6/0; high grade mains transformers, 4v or 6v lt, enclosed, 27/6; silent chokes for 80w fluorescents, high class, not made for cut prices; trade discounts.—S.B.C., Richmond St., Walsall. [4888]

EXPERIMENTER'S surplus. Telefunken T.O.1001 pick-up and tube £5; Ferranti p.m. speaker (M.1), £3; B.2, 15/-; F.5, 10/-; mains trans., usual input; Rich & Bundy, 500-0-500, 150ma, 4v 2.5a, 4v 2a, 4v 1a, 4v 6.8a, all c.t.c., £3; Healyber, 240v, 4v 1a, 4v 5a (with Westinghouse H.T.9, 300v 60ma), £2; Partridge, 350-0-350, 150ma, 4v 2.5a, 4v 2a, 4v 7a, 6.3v 0.4a, 25/-.—Box 5737. [4871]

MAINS transformer bobbins, exact replacements, Marconi, G.E.C., Ferranti and all leading makes supplied by return, with full set primary, sec. and fl. windings, interleaved, impregnated; single 19/6 ea, 1/2 doz. assorted, 18/6 ea, 1/2 doz. same, 17/6 ea.; cash with order please, simply give make and model No.—Televox Sound Service, 142, Stanshaw Rd., Portsmouth, Hants. (Estab. 1938).

ELECTROLYTICS, 8md 450v, 4/6; 8x16, 7/-; 5 1/2in ls., 21/6; silk flex, 6d yd, 50yds 1/-; HIT42 rect, 38/6; phones, 25/-; Xstal £4/10, Xstal mikes, 63/-; Solon irons, 12/4; twin testscopes, 47/6; 0.25v 250v, 25ma meters, 21/-; ex ls. oak cab, 50/-; cwo or pro forma, all radio parts avail, send wants aae.—L. E. Healey, Radio Engineer, Old Rd., Clacton-on-Sea, Phone 105. [4891]

MATEURS and constructors, send your enquiries to me for show you the components, valves, resistors, transformers, condensers and speakers, etc.; example 1md paper, 750v working and 2md paper 500v working, 4/6; 8in. P.M. speaker, 25/-; 10in. P.M., 33/-; all above goods new and tested before despatch; complete kits of parts for any apparatus supplied; stamp for quotation & prices.—Barton, Oxlyneh, Stonehouse, Glos.

CARDING'S world-renowned 20-watt amplifier again, 2 6L6s, sw. push-pull, transformer coupled, assembled on grey stoved chassis, fitted with separate tone control, volume control and on-off switch, rockers, potentiometer and low impedance p.m. speaker, excellent quality reproduction, no hum, 200-250v ac only, brand new and complete with all valves, £8/15, carriage 5/-, c.w.o.; also mains trans., 350-0-350 volts, 90 ma, 6.3v 5a, C.T., 5v 3a, 200-230-250v input, boxed, 14/- each, minimum quantity 12.—M. Carding, 28, Dudley St., Wolverhampton. [4598]

SEXTON'S of

164, Gray's Inn Rd., London, W.C.1
for
SALES, SERVICE & SATISFACTION

The "Sexton" Electric Smoothing Iron, made in two weights, 3½ lb. and 5 lb., 200/220 volts, 230/250 volts, 450 watts. Beautiful anodised and nickel plated finish in Green, Blue, Gold, Red and Chrome. Strong bakelite handle and thumb button, sure and safe connector guard, complete with two yards of heavy three core flex. Price 26 8, plus 6/8 Purchase Tax.

American Radio Valves.—Types as under at controlled prices. 45Z5GT, 5Y3G, 1A5GT, 1C5GT, 1Q5GT, 1T5GT, 3Q5GT, 80G, 35Z5, at 11/- each. 6J5GT, 12J5GT, 1H5GT, 12SF5GT, at 9/2 each. 6Q7GT, 12Q7GT, 12SQ7GT, 75G, at 11/7 each. 12J7GT, 12SK7GT, 6J7GT, 6K7GT, 6K6GT, 6V6G, 42G, 43G, at 12/10 each. 6A7G, 6A8GT, 6K8GT, at 14/- each. 6C6G, 6D6G, at 11/- each. Postage paid. Other types as they become available for distribution.

Loud Speakers.—Special Offer. Celestion size 10in. Mains energised with 2,000 ohms field less Transformer. The perfect speaker for public address equipment.

American Radio Service Manuals
Volume I. Spartan Emerson.
II. Crosley Belmont, Part I.
III. Crosley Belmont, Part II.
IV. R.C.A. Victor G.E. Admiral.
V. Emerson, Part II.
VI. Stewart Warren. FADA.
At 12/6 per Volume, or complete set of six manuals, £3 12s. 6d.

These manuals cover the complete range of American Radio Receivers as given and are invaluable and contain all the technical data necessary.

Terms:—CASH WITH ORDER ONLY. We regret that we are unable to send goods C.O.D. Telephone: TERMINUS 1304 and 4842.



FOR THE RADIO SERVICE MAN, DEALER AND OWNER

The man who enrolls for an I.C.S. Radio Course learns radio thoroughly, completely, practically. When he earns his diploma, he will KNOW radio. We are not content merely to teach the principles of radio, we want to show our students how to apply that training in practical, every-day, radio service work. We train them to be successful!

Special terms for members of H.M. Forces and discharged disabled members of H.M. Armed Forces.

INTERNATIONAL CORRESPONDENCE SCHOOLS

Dept. 38, International Buildings, Kingsway, London, W.C.2

Please explain fully about your instruction in the subject marked X.

Complete Radio Engineering;
Radio Service Engineering;
Elementary Radio Television

And the following Radio examinations:

British Institution of Radio Engineers;
P.M.G. Certificate for Wireless Operators
City and Guilds Telecommunications
Wireless Operator & Wireless Mechanic, R.A.F.

Name.....Age.....
Address.....

METAL rectifiers, charger kits, etc.—Metal rectifier, 12v 1.5a type, with transformer and ballast bulb for 2v to 12v charger, no rheostat or ammeter needed. 37/6, post 10d; ditto, with larger 2.5amp rectifier. 46/6, post 10d; ditto, with 6v 2amp rectifier for 2v and 6v only, 37/6 post 10d; de luxe car owner kit, transformer, 12v 2amp rectifier and ballast bulb for 2v to 12v charger. 59/6; metal rectifier, 2v 0.5amp type with transformer, makes ideal trickle charger for 2v cell. 13/6, postage 7d; metal rectifiers, 12v 1.5amp 10/6, post 6d; 12v 2amp, 16/6; 2.5amp, 18/6, post 7d; 12v 3amp, 25/-; 12v 4amp, 32/6, postage 8d; Type M.B.S.1 instrument rectifiers, 1 milliamp, 18/6; chargers 2v to 12v up to 4amp, variable, with ammeter, £6/17 6, carriage 5/-.

ROTHERMEL crystal mikes, and bakelite pick-ups in stock. Dubilier and Hunts, 8mids 450v and 500v electrolytics, 4/- each; metal rectifiers of all types in stock for conversion of valve type chargers to metal rectification. **CHAMPION**, 43, Uplands Way, London, N.21, Tel. Lab. 4457. [4743

EVERYTHING for the amateur! So many of our customers tell us that we have the finest display of new radio components in England that we are beginning to believe it ourselves. Frankly, we are pleased—because, despite the shortage of supplies and other difficulties, we have worked hard to make our shop a centre of attraction for the amateur. If you are building a transmitter, communications receiver, high fidelity audio equipment or test apparatus, come along and see us—we can help you—and supply all the components you want. Even if you are only starting on your first crystal set, you will be just as welcome and will receive the same courtesy and skilled attention that has made some of the best known amateurs in the country our frequent and regular customers. If you cannot yet call, send along a 2d stamp for our price list.—Tele-Radio (1943), 1,td., 177, Edgware Rd., London, W.2. Tel. Paddington 6116. [4885

THE Simplex Four, still the best, complete constructional details; Midget ac/dc (total cost of construction £9), theoretical and full-scale layout diagrams, with instructions, per copy, 4/6; Midget polished wood cabinets, 35/-; Midget m. wave t.r.f. coils, high gain, 7/6; the latest, iron cored m. and l. wave, t.r.f. coils, adjustable cores, with circuit, 12/6; ditto a. and osc. coils, m. and l. wave for the pocket receiver, i.f. at 465 kc/s, with circuit, 17/6; a. and osc. coils, s.m.l. wave, ditto i.f., with circuit, 15/- pair; midget i.f. transformers, 465 kc/s, 15/- pair; midget ivoryine coloured dials, s.m.l. wave, 4x 3½, 2/6; coloured s.m.l. wave dials, on glass, 9x4½, 3/6; slow motion drives, 2-speed, with driving disc, 3/6; ditto string drum drive, one speed, 2/6; midget Simplex chassis, fully drilled with 4 valve holes, etc, 11x4½x2½, with speaker cut-out, the best for midgets, 7/6; midget 2-gang variable condensers, 0.0005mfd, with trimmers, 13/6; push-pull driver trans, split secs, 12/6; p.p output trans, 6,600 a. to a. load, for 6L6, PX4 valves, etc, tapped output, 7.5 and 15 ohms, 21/-; Midget chokes, 6-; standard ditto, 8-; heavy ditto, 150-200 ma, 12/6; midget rotary d.p.d.t switches, 3-; standard 3-way 4-pole, 5 6, etc, etc, etc; monthly comprehensive lists, 2d. stamp with enquiries; postage all orders. **O. GREENLICK**, Ltd., 34, Bancroft Rd., Cambridge Heath Rd., London, E.1. Ste. 1334.

SUPREME RADIO, 746, Romford Rd., Manor Park, London, E.12. Est. 15 years.—More new lines, this month's "don't miss them" list—metal-wave dials, 3½x4½, coloured, 1/9; large 5½x5½, 2/5; slow motion drives, 2/9; M. and L coils with circuit, 10/6; switches for same, 2/3; M.W. coils, 8/6 pair; L.M.S. wave coils, aerial and oscillator, short, 14-50 metres, medium 200-550 metres, long 900-2,000 metres, 12/6, with circuit; i.f. 465 kc high efficiency, 12/6; switches for same, 7/6; midget 2-gang condensers, 0.0005 variable, with trimmers, fixing feet, 11/6; 3-gang condensers, 13/-; mains droppers, 0.2A 1,000v, fixing feet, 2 sliders, 4/-; 0.2A 800v, 5/-; 0.2A less feet, 3/9; Pve replacements, 3 3; line cord, 60-70ohms per ft., 2/-yard; volume controls, all values, with switch, 4/-; less sw, 3 9; 2,000v W.W. controls, 2/6; 10,000 W.W., 5 6; assorted resistances, 24 in pkt. 200-240,000v wire wound, 7/6 pkt; resistances, 200v-1meg 1½w, 5/- doz, only doz lots supplied. 0.1 condensers, 7/- per doz; midget h.f. chokes, 2/-; 0.0005 reaction condensers, 2/9; midget chokes, 60 mils, 6-; heavy duty, 100 mils, 10-; p.p. trans, 6/6; long pointer knobs 10d, ea; short, 8d, ea; large stock of 6J5 9T valves, new, boxed to clear, 7/6 ea, not salvage; many other lines not advertised; send s.a.e. for price list. 1d. orders over £5 post free. 6d. extra all other orders; no c.o.d. [4845

Get this Catalogue NOW!

BERRY'S
25 HIGH HOLBORN
LONDON, W.C.1
(Opposite Chancery Lane)
Telephone HOLborn 6231

The House for Quality Radio and Electronic products

A.C.S. RADIO for— Communication Receivers, Amateur Transmitting gear, all Television and Radio equipment and components.

Preliminary LIST NOW READY, but with new stocks constantly being added we suggest enquiry for definite items if not listed.

A.C.S. RADIO, 44, Widmore Rd., Bromley, Kent.



Be WISE and PATIENT

WE APOLOGISE to those who have been waiting months for replies. Our post-war plans have been frustrated so far. Sorry!

VOIGT PATENTS LTD.

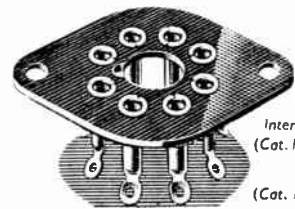

International Octal (Cat. No: VH 232/8)

Mazda Octal (Cat. No: VH 92/8)

CLIX OCTAL VALVEHOLDERS

(Standard 1½" fixing centres)

These valveholders, incorporating the latest "CLIX" resilient sockets, will retain the valve under most exacting conditions. In use by leading Set Manufacturers for Home and Export Sets.

RETAIL PRICE 4d. EACH

also available in Tropical Grade

See current Price List for details of all Clix Components

BRITISH MECHANICAL PRODUCTIONS LTD
21 BRUTON STREET, BERKELEY SQUARE, W.1
Grams: Tralinx, Wesda, Landon Phone: Mayfair 5543

POLAR 3-gang condensers, 0.0005 ceramic 10/-; ca. 0.0005 reaction, 1/6; moving-coil milliammeters, 100ma, 2 1/2 in, 30/-; mains transformers, 230v/2,500v-2ma, 2v-2a, 4v-1.4a, 50/-; suitable CRO, 30/-; Nicore h.f. chokes 1/6; 50 asstd. carbon resistors, 10/6; 12 1/4 asstd. condensers, tub. mica, elec., etc., 7/6; 30mfd/50v elect., 2/6; volume controls, 1 and 2 meg, 2/-; Yaxley switches, 5-bank 3-way, 6/-; s.a.e. full list.—Heathcote, 24, Durnford Ave., Urmston, Manchester. [4759]

AMATEUR RADIO PRODUCTS have now available a four waveband short wave coil unit, 4 coils covering, 9.8 to 206 metres, for 2-valve short wave battery receiver, with blue print, 30/-; individual coils with reaction winding, 3/3 each; R.F. chokes, 2.5mh, 200 m/amps, 3/6 each; R.F. chokes for transmitters, from 8/6 each; ready shortly: transmitter inductances with and without swinging link, etc., neutralising condensers, tuning condensers suitable for transmitters. All products made by highly experienced amateurs for amateurs. Send us your problems and remember our advice and assistance is free.

AMATEUR RADIO PRODUCTS, 50, Glasslyn Rd., Crouch End, London, N.8. Tel. Mount View 4745. [4678]

THE mail order house offering highest grade gear at the keenest prices.—A selection from our lists: 5-29 PF. ceramic trimmers, 7d.; 2-gang variables with trimmers, 11/-; 0.5mf 5,000v block capacitors, 20/-; 0.0005mf/2 2-gang ceramic capacitors, 20/-; 3-pin diode valveholders, 6d.; 10mfd 12v, 3/9; 20mfd 40v, 4/-; 48 carded resistors, 1/4 and 1/2 watt, 17/-; 6-position 2-pole Yaxley switches, 1/2; Midgett I.F. chokes, 70ma, 5/3; 8in M.E. speakers, with trans., 2,000 ohms, 29/-; 807, 866/866A, 813 and all rare types of valves at list prices; order c.o.d. or c.w.o.; everything guaranteed; s.a.e. for lists.—M.O.S., 24, New Rd., E.1. [4678]

954 955, 956, 9001, 9002, 9003. 6J4, 6C4, 6T4, new, boxed, 25/- each; screening cans and bases; 807, 832 JHF transmitting valves, offers; Mullard 3 1/2 in high speed CRT and base, absolutely unused but no longer wanted, £4 or offers; all guaranteed.—Taylor, 92, Ash St., London, S.E.17. [4883]

NEW LOUSPEAKERS
CELESTION P.M., 8in, 21/-; trans. 24/-; 10in, with trans., £2; carriage 1/-; the real thing, Vitavox 12in. P.M., 10 watts, £6/10; carriage 2/-; cash with order.—Pearce, 66, Great Percy St., W.C.1, nr. Angel. [4741]

£5 Auditorium permanent magnet speaker with triple cone, manufactured by Bakers Selhurst Radio, the pioneer manufacturers of moving coil speakers since 1925, wide frequency range, even response, ideal for quality reproduction, fitted with magnet, having exceptionally high flux density in the air gap suitable for public address equipment when quality reproduction is first consideration; send 2/4d. stamp for leaflet giving details of above and constructional details of a new acoustic chamber designed to extend loud speaker frequency range £8/19/6.—New Baker super power cinema permanent magnet speaker with 18in triple cone of new design, giving wide frequency response free from objectionable resonances; speech is clear and natural and music is reproduced with exceptional realism; fine engineering job, extremely sensitive; large capacity, plus realistic reproduction, is required; prompt delivery per pass. train.—Bakers Selhurst Radio, 75, Sussex Rd., S. Croydon (Croydon 6813)

LOUDSPEAKERS, SECOND-HAND
VOIGT H.C. type corner horn; £7/10 or best offer.—Box 5090. [4751]

RK, 12in in cabinet, 220 volt field, 15v suit speech, £5; rectifier unit for above, £2; Philips vib. converters, square type, require attention, 200-250dc to ac, 15v.—6, Beaufort Terr., Beaufort, Mon. [4679]

GRAMOPHONE AND SOUND EQUIPMENT
MARCONI playing desk (ac motor and n.k-up), perfect con.; £7/10.—Box 5169.

H.M.V. hyper-son. P.V. and transformer, as new.—Offers to 101, High St., Barnstaple. [4674]

M.S.S. recording machine, 20w amplifier. Special matching transformer, new, guaranteed. £25; suit professional.—Box 4559.

ELECTRIC record player with lid, £10; also B.T.H. heavy duty AC/DC gramotor, £10.—Box 4865. [4674]

HIGH quality A.C. outfit, owner moved to U.K., super W.W. 10 watt P.P. amplifier, Rola G12 L.S., local-station feeder unit, H.M.V. motor and hyper-sensitive P.U., handsome walnut R/G cabinet; £45, or would separate.—53, Dartmouth Park Hill, N.W.5.

SUPER quality radio gram., consisting two speakers and very large output, nice looking cabinet, £50, or nearest offer; also G.E.C. wireless, table grand, in good condition, best offer over £18; odd component parts also for sale.—6, West Heath Avenue, N.W.11. [4793]

M. WILSON LTD

1946 RADIO NEW UNIT SYSTEM OF RADIO DESIGN

We have developed and are now placing on the market a system of Radio Units, which enables you to select any combination to satisfy your own desire with regard to range and power.

UNIT No. 1: A/C Complete H.F. and I.F. stages, 3-waveband coil unit (16-50, 185-550 and 800-2,000 metres), 3-gang, ceramic insulated rubber-mounted condenser. R.F. stage with R.F. gain control, H.F. and Oscillator all A.V.C. controlled feeding into an I.F. stage of 465 kc/s. and fitted with I.F. gain control. Cathode-ray tuning indicator (tuning eye), dial lamps, dial and slow-motion drive, pointer and knobs, mounted on 16 S.W.G. aluminium chassis with output plug. The Unit is complete in itself, ready wired up, calibrated and tested. All parts brand new, standard components, Octal valves.

UNIT No. 2: A/C Complete L.F., Output and Power stages, comprising 2nd detector A.V.C. and 1st L.F. amplifier, feeding into output tetraode 4½ watt output complete with mains transformer 350-0-350 v., 80-100 mA., L.F. choke and 8in. P.M. speaker with multi-ratio transformer.

UNIT No. 3: As No. 1, but with 6-waveband coil unit, 5-2,000 mc/s.

UNIT No. 4: A second I.F. stage 465 kc/s.

UNIT No. 5: Second detector A.V.C. and 1st L.F. Phase inverter, 2 output tetraodes in push-pull, 12 watts output.

UNIT No. 6: Power pack consisting of mains transformer (400-0-400 v., 150 mA.), high-voltage surge-proof electrolytic condenser, 20-henry choke, 12in. P.M. speaker with output transformer, mains fuses. (The above Unit can also be supplied for A.C./D.C. working.)

UNIT No. 7: High Fidelity Output and Power Stages—two L.F. valves feeding two 6X4 valves in push-pull (triodes). Controls: Volume, Mains on/off, radio-gram. switch and Tone.

This system gives a good theoretically correct application to practical radio, as each stage is completely screened from the others, making possible reproduction of the very highest quality.

Delivery date and prices on application.

NEW TUNING HEART

Tuned R.F. stage, transformer coupled to the plate circuit of the F.C., the grid of which is tuned by the second section of the tuning condenser. The Oscillator section is tuned by the third section of 3-gang ceramic insulated condenser, mounted on rubber. Switching is by a 3-ban switch shorting out coils not in use and carefully screened. The Tuning Heart chassis—screening, etc., is of aluminium fitted with two Amphenol Octal valve-holders. The Tuning Heart consists of R.F. stage gain potentiometer, minimum bias resistor and condenser, A.V.C. resistors and decoupling condensers, bias resistors and condensers for the F.C., Oscillator plate and grid resistors and condensers. Colour-coded leads, screened where necessary. Padders and trimmers. Designed for an I.F. of 465 kc/s. Slow-motion drive, 3-waveband dial, dial lamp and holder, 3-waveband coils (16-50, 180-550 and 800-2,000 metres) calibrated and tested ready for use. Complete with circuit diagram. **£5**

To OVERSEAS TRADERS
Wholesale and Retail enquiries are invited. Orders can be executed for B.A.O.R., C.M.F., M.E.F. and S.E.A.C. customers.

307, HIGH HOLBORN.
LONDON W.C.1. Phone: HOLborn 4631

16mm sound film projector, 500watt lamp, 1,600ft, 12watt amplifier; offers over £100. Write Box 5711.

COILS for filters, tone controls, all types of transformers for "Wireless World" circuits.—R. Clark, 30, Langland Crescent, Stanmore. Wor. 5321 [4584]

B.T.H. 16mm sound film projectors, as supplied in large quantities to the Services during the war for instructional purposes; a limited number are now available for civilian use, immediate delivery against B.O.T. licence.—Apply Electronic and Sound Reproducer Sales, B.T.H. Rugby. [4555]

TEST EQUIPMENT
AVO, £25; all-wave osc., £8; both as new.—Box 5212. [4773]

COSSOR oscilloscope, model 3332; £20.—51, Sudbury Croft, Wembley. [4736]

AVO model N7, £17/10; Garrard ac/dc turntable, £5/10.—Box 5820. [4905]

MUIKHEAD modulated oscillator, all wave, equal new; £15.—Box 5735. [4869]

MC, milliammeter, 0.5ma, perfect cond.; £5.—Miller, 52, Grantham Drive, York.

AVO valve tester, needs new rectifier, otherwise perfect, bargain—10 gns.—Box 5812.

FOR sale, Weston oscillator, model E 692; what offers? Perfect cond.—Box 5762.

BRAND new Avominer Universal, in tea case; £8/10.—Heighway, Bangor, N.W.

WESTON model 375 galvo., 3 1/2in, flush; offers.—Cook, 83, Woodcote Rd., Reading.

TAYLORMETER 81A, C & L adapter; £17.—49, Buckingham Ave., Welling, Kent.

UNIVERSAL Avometer, complete, as new, £7/10.—Apply W. H. Wood, Trevor Rd., Hincley, Leics. [4791]

ULTRA 2 1/2in Mark II oscilloscope, as new, £25; Philco signal generator, ac mains, £10.—Box 5168. [4765]

COOD selection of s/hand meters and other goods; s.a.e. for list.—R. Massey (W), 58, Wakefield Ave., Hull. [4835]

AVOMINER, universal ac/dc model, new, unused; first cash £8 secures. G2XV.—89, Perrone Rd., Cambridge. [4797]

TEST meter, Triplett model 1200 sc for sale, ac-dc, amps, farads, decibels, ohms, etc.; £25 or nearest offer.—Box 5764. [4879]

E & V. Wee-Megger, Simpson ohmmeter, 2,000 ohm and 200,000 ohm, both as new.—Offers to 44, Lindum Ave., Lincoln. [4849]

COSSOR 2-beam oscilloscope 3339a, perfect, offers over £45; part exchange 7-8hp car or m/c.—F.T., 16a, Rockmount Rd., S.E.19.

WESTON 665 analyser, as new, in case, wanted.—18, Bourne View, Greenford, Middx.

PORTABLE C.R.E. oscilloscope, 5in tube, linear time-base, amplifier power supply, little used; £20.—Martin, 3, Cliff Ave., Longborough, Leics. [4715]

UNIVERSAL Avominors, £8/10; No. 7 model Avometers, £19/10; new, immediate delivery.—Young, 134, Old Shoreham Rd., Southwick, Sussex. [4683]

SIGNAL generators, Taylor model 65B, £14/14; also send for details of other test equipment in stock.—Electrocraft, BCM/Electrocraft, London, W.C.1. [4873]

WANTED, Taylormeter, 25,000v/v, A.F. oscillator, oscilloscope, sig. gen., replies in strict confidence.—D. C., c/o R. Middleton, Grafton House Hotel, The Vale, Acton, W.3.

AVO 40, perfect, £17/10; Triplett sig-gen battery, needs slight attention; £4; Ferranti transformers, AF5C, AF5, £11/10 the two.—3, Hungerford Ave., Slough, Bucks. [4893]

AVO No. 7, new, unused; Avo valve tester, A single panel, as new; British valves; radio lab. meter, ac/dc, 1,000v per volt on all 28 ranges; offers.—Pearce, 66, Great Percy St., W.C.1, nr. Angel or King's Cross. [4740]

VALVE testers.—Particulars of new inexpensive kit, together with brief specifications of multimeters, oscillators, bridges, etc. (see Nov. and Dec. ads.), is given in supplementary list, free on application.—MacLachlan & Co., Strathyre. [4848]

VALVE voltmeters, diode probe head, rf af 0-1, 0-10, 0-100volts, input cap. 6mfmd 50c, 60mc flat, avc, etc., 0-5, 0-50, 0-500volts input res. 15Mohms, 3 1/2in scale meter, black crackle cabinet; 15gn.—H. French, Cottam Hill Lane, Ingol, Preston.

WESTON Sangamo 2 1/2-inch scale flush-mounting meters, 100 microamp, full scale deflection, fitted with internal rectifier and scaled in decibels, complete with matching transformer to 600 ohm line; £3/10.—Douglas Price, Claybrooke Grange, Rugby, Tel. Leire 287. [4744]

MULTI-METERS, ac/dc, volts, milliamps and ohms, £8/17/6; immediate delivery; the Infinite Impedance adaptor makes your multi-meter suitable to detect A.V.C., volts, oscillator, auto-bias and detector volts, and many other equally useful functions; manuscript giving full constructional details 7/6 post free.—V.E.S., Radio House, Ruislip, Mdx.

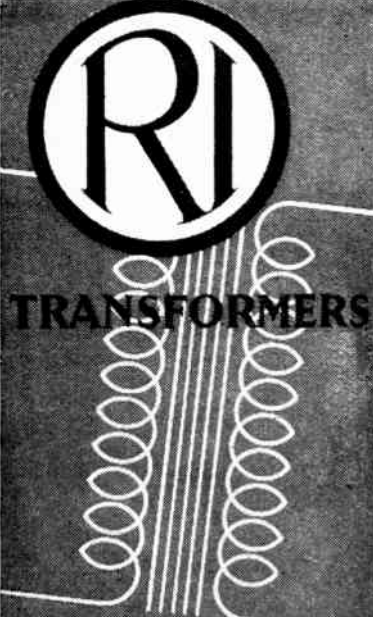

RI
TRANSFORMERS

Best for all Purposes

RADIO INSTRUMENTS LTD
PURLEY WAY, CROYDON.
Telephone: THORnton Heath 3211

Improved Terminal CLIPS



Wingard

Weld made of steel, double rigidged for strength. Teeth on three sides of lower jaw and special design of upper jaw ensure firm grip and good contact.

CHURCH ROAD · HENDON · LONDON · N.W.4

LONDEX for RELAYS



AERIAL CHANGE-OVER RELAY
for Radio Frequency
Type A.E.C.O. 4.

3 V.A. Coil Consumption, especially designed for Transmitters, High Frequency Heating, Amateur Stations, experimental purposes, etc.

Ask for leaflet 112 WW

LONDEX · LTD
MANUFACTURERS OF RELAYS
207 ANERLEY ROAD, LONDON S.E.20

MARCONI instruments, output power meter, type TF340; wavemeter, type TF630A/3; thermocouple milliammeters, 0-50, 0-20, 0-1 amp; metal-cased condensers, 0.25mfd 5,000volt working; relay adjusting tools; high and low resistance ohmmeters (see W.W., Aug. and Sep., 1943); 500volt mains operated meggers; Mullard measuring bridge; Coubro & Scrutton portable self-supporting telescopic mast with tripod, extending to 30ft; seen N, London; s.a.c. for details.—Box 5813.

WE are now able to undertake the adjustment of resistors and capacitors over a wide range to within 0.1%, customers own apparatus, including audio oscillators and wavemeters, carefully calibrated to any required degree of accuracy; we can supply special precision radio and mechanical components from the small gear or coil to the complete apparatus for the solution of unusual problems.—Lydiat Ash Labs., near Bromsgrove, Worcs.

CONSTRUCT your own crystal controlled frequency standard, using the new Q.C.C. type Q5 100kc/s quartz crystal unit; in a single valve Colpitts oscillator circuit it provides check points of 0.01% accuracy at 100kc/s intervals from 100kc/s to 15,000kc/s, making an ideal radio frequency source for receiver calibration and alignment; price 45/-, complete in octal based mount; send stamp for leaflet Q5, which gives full technical details and circuit.—The Quartz Crystal Co., Ltd., 63-71, Kingston Rd., New Malden, Surrey. Tel. Mal. 0334. [4694]

DYNAMOS, MOTORS, ETC.

NEW ac motors, 1/4hp, high starting torque, 200-250v, £5; 1/4hp, £5/10; 1/2hp, £7/10; 1hp, £9/15; all other sizes available; also machinery.—John W. W. Steel, Bingley, Yorks.

A types of rotary converters, electric motors, battery chargers, petrol-electric generator sets, etc., in stock, new and second-hand.—WARD, 37, White Post Lane, Hackney Wick, E.9. Tel. Amherst 1393. [4677]

SURPLUS at conclusion of development, two B.T.H. dc generators, 720v 140ma at 2,000rpm, £4 each; one Vactric dc generator, 200-220v, half amp, at 2,800rpm, shunt wound, £3.—Lydiat Ash Laboratories, Near Bromsgrove, Worcs. [4756]

PETROL charging sets, consisting of 1hp J.A.P. engine, direct coupled to 13-32v 20amp B.B. generator, complete with regulator, ammeter, cutout, etc., similar to Iron Horse; £30, plus carriage.—Mathew Bros., Matbro Works, Sandy Lane North, Wallington, Tel. Wallington 4050. [4785]

MOTOR alternator bargains.—220v dc to 230v 50 cycle ac, 200watt, £12; 220v dc to 115v, 60 cycle, 2,000watt, G.E.C., £25; 110v dc to 230v, 50 cycle ac, 200watt, £15; high voltage transformer, 230v 50 cycle to 4,600v at 0.97amps, £5; G.E.C. oscillating table fans, 220dc, 30/-.—Wilkinson, 8, Railway Walk, Birkdale. [4761]

ELECTRADIX dynamos and motors at bargain prices, dynamos, ht and lt G.E.C. double current, 6v and 600v, weight 17lb, 37/6, pkg. and carr. paid; supplied Eng. and Wales only; refund 5/- on returned cases; dc motors, 1-5th hp and 1/4hp dc motors, enclosed, silent, 220 to 250v, 1,500 revs, double-end 1/2in shaft, first grade make, guaranteed, 1-5hp, £3/10 each; 1/4hp, £4 each; all carr. paid Eng. and Wales; others in stock.—Electradix, 214, Queenstown Rd., Battersea, London.

REPAIRS AND SERVICE

REWINDS—24-hour service; best quality, guaranteed; low price.—Radiowinds, Brundall, Norfolk. [3606]

REWINDS and conversions to mains and output transformers, fields, etc., from 4/6.—N. I. Rewinds, 4, Brecknock Rd., N.7. [4442]

MAINS transformer rewind and constructed to any specification; prompt delivery.—Bown, 3, Bede Burn Rd., Jarrow. [5460]

LOUDSPEAKER repairs, British, American any make; moderate prices.—Sinclair Soakers, 12, Pembroke St., London, N.1. [3308]

SINGLE and multi-range meters promptly repaired, British or American; accuracy guaranteed, expert workmanship; quotations free.—Wilson, 35, Stella St., Mansfield. [4755]

ALL types of radio receivers serviced; Murphy and Pilot specialist; valves in stock; sound repairs for 13 years.—T. E. Fevver, F.I.P.R.E., 50, Vine St., Uxbridge.

RADIO repairs quickly executed to all makes, English or American; lowest possible prices.—The Music Box, 89, London Rd., London, S.E.1 (Tel. Waterloo 4460 and 6766.)

DEGALLIER'S, Ltd., for Service with a Guarantee; let American specialists with proper test gear do your work; we can handle any receiver from a Midget to the 24-tube Scott; send chassis and valves only; all railway companies deliver daily; s.a.c. with all enquiries.

DEGALLIER'S, Ltd., 9, Westbourne Court, London, W.2. [4650]



SOLON INDUSTRIAL ELECTRIC APPLIANCES

SOLON ELECTRIC SOLDER POT

The **SOLON** Electric Solder Pot maintains 1/2 lb. solder at working temperature. Full details are given in Folder Y.9, which also describes the range of **SOLON** Electric Soldering Irons and the **SOLON** Electric Insulation Stripper. Models are available for low voltage supply as well as for standard voltages. Please write for details of **SOLON** INDUSTRIAL ELECTRIC APPLIANCES.

W. T. HENLEY'S TELEGRAPH WORKS CO., LTD.,
51-53, HATTON GARDEN, LONDON, E.C.1

POST-WAR TELEVISION

The advance in Radio Technique offers unlimited opportunities of high pay and secure posts for those Radio Engineers who have had the foresight to become technically qualified. How you can do this quickly and easily in your spare time is fully explained in our unique handbook.

Full details are given of A.M.I.E.E., A.M.Brit.I.R.E. City & Guilds Exams., and particulars of up-to-date courses in Wireless Engineering, Radio Servicing, Short Waves, Television, Mathematics, etc., etc.

We Guarantee "NO PASS—NO FEE"

Prepare for to-morrow's opportunities and post-war competition by sending for your copy of this very informative 112-page guide NOW—FREE.

BRITISH INSTITUTE OF ENGINEERING TECHNOLOGY (Dept. 388)
17, Stratford Place, London, W.1

COVENTRY—RADIO

COMPONENT SPECIALISTS SINCE 1925.

Have you received our 1946 K46 List? The most comprehensive published to-day, examples:—

L.F. CHOKES, 20 H., 80 m/A, 420 ohm.....	6/9
OUTPUT TRANSFORMERS, multi-ratio.....	7/6
ELECTROLYTICS, 9 mfd., 500 volt.....	4/- and 3/3

METERS, 0-1 m/A, M/C, 100 ohm from 40/-

Buy all your radio parts from one firm everything in stock from a washer to a complete receiver. See our List!

NO SURPLUS, ALL NEW STOCK.
PROMPT SERVICE. COMPLETE SATISFACTION

COVENTRY RADIO
191, DUNSTABLE ROAD, LUTON

R.A.F. RADIO!

NEW R.A.F. TRANSMITTERS

Type 1154

Airborne General Purpose Transmitters

Complete with 4 valves. Frequency coverage 500 kc/s, 200 kc/s, 10 mc/s, 3 mc/s, 16.7 mc/s, 2.35 mc/s, 8 mc/s, 2.5 mc/s. Power input 1,200 v., 200 mA A.C. H.T., 5 v. amp. L.T. Chassis size 15in. x 13 1/2in. x 8 1/2in. in strong wood case with metal bound corners and carrying handles, size 22in. x 17in. x 14in. Easily adapted for amateurs. **10 gns.**

R1125B. RECEIVER CHASSIS. 2 7-pin ceramic valveholders, 8 condensers, 3 resistors, 2 transformers, coils, plugs, sockets, etc. All on totally enclosed metal chassis. All to Air Ministry specifications. 12/6.

D.C. MOTOR GENERATOR. 9 v. input, 450 v. output, fitted with cooling fan and switching device; fitted on chassis 12 1/2 x 8 x 2 1/2, weight 17 lb. £3 17s. 6d. Also for 18 v. and 24 v. input.

WIREWOUND VOLUME CONTROLS. 400 ohms, 2/6. **NEW MOVING COIL D.C. VOLTMETERS.** 0-40 v. 2in. flush type, 25/-.

R.A.F. 3-GANG CONDENSERS. Same as used in R1155 chassis. .0005 mfd. 12/6.

R.A.F. MIDGET VOLUME CONTROLS. 100,000 ohms. 1/3 each or 16/- doz.

R.A.F. TWIN VOLUME CONTROLS. 500,000 and 50,000 ohms. 5/6 each.

R.A.F. 2 mfd. CONDENSERS. Mansbridge type, 500 v. wkg. 1/3 each.

R.A.F. TUBULAR CONDENSERS. .1, .15 and .25 mfd., 350 v. wkg. 7/6 doz.

R.A.F. TUBULAR CONDENSERS. Metal-cased. 1.1 + 1 mfd., 500 v. wkg. 2/3 each.

R.A.F. TUBULAR CONDENSERS. .5 and .25 v. 350 v. wkg. with short wire ends. In 25 lots only. 5/6.

R.A.F. 22 MFD. CONDENSERS. 1,000 v. wkg. 7/8-

R.A.F. SELECTOR SWITCHES. Useful for remote control. 21/8.

R.A.F. 10-POINT DEWAR SWITCHES. 2/6.

R.A.F. PARCEL 1. Six each .1, .15, .25 mfd. Tubular Condensers, three 1.1 + 1 mfd. Tubulars, metal-cased, three Midget Volume Controls, 100,000 ohms, two Toggle switches. 20/-.

R.A.F. PARCEL 2. Twelve each .1, .15, .25 mfd. Tubular Condensers, six Midget Volume Controls 100,000 ohms, three Volume Controls, one gross 6 BA Nuts and Bolts, one gross 4 BA screws, one gross Rivets. 30/-.

A New Purchase of

MOVING COIL INSERTS

at an advantageous price enables us to offer these at 5/- each.

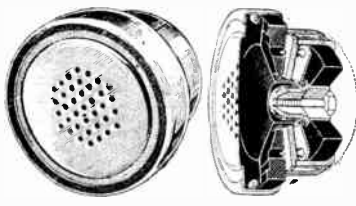

Can be used as Headphones, Midget Speakers (with trans.), Speech Mikes or adapted for Pick-ups.

MULTI-RANGE Moving Coil TEST METERS. New First-grade army type in bakelite case. Ranges: 10, 50, 100 and 500 volts at 1,000 ohms per volt A.C. and D.C. 1, 10, 100 and 500 mA and 0-10,000 ohms. £3 15s. 0d.

NEW 6 and 8in. LOUDSPEAKERS in beautiful polished Plastic and Wood Cabinets: 6in., 30/-; 8in., 35/-.

NEW 0.2 mfd. CONDENSERS, 250 v., 8d. each, 6/8 doz.

SINGLE SCREENED CABLE, 12 yds. 7/6.

EX-GOVERNMENT PLUGS AND JACKS, 5/6.

MAINS DROPPERS, 1,000 ohms, 2 amp., 5/6.

7-PIN PAXOLIN VALVEHOLDERS, 7/8 doz.

INTERNATIONAL AMPHENOL VALVEHOLDERS, 7/8 doz.

CARBON RESISTORS. Assorted values, 22/6 per 100.

LOUDSPEAKERS, less transformers. Rola. 6in., 18/6; 8in., 21/6.

NEW MAINS TRANSFORMERS. Superior quality. 300-0-300 v., 6.3 a., 3 amp., 5 v. 2a. Also 300-0-300 v. 4 v. 3 a., 4 v. 2a. Dim. 2 1/2 x 3 1/2. Weight, 4 1/2 lbs. Blue enamel finish. 24/6 each.

LONDON CENTRAL RADIO STORES

23, LISLE STREET

LONDON Gerrard 2969 W.C.2.

Closed Thurs. 1 p.m. Open all Sat.

SERVICE with a Smile.—Repairers of all types of British and American receivers; coil rewinds; American valves, spares, line cord.—F.R.I., Ltd., 22, Howland St., W.1

TESTGEAR REPAIR SERVICE. specialists in repairs, recalibration, etc., of test equipment of every description for the radio industry.—2, Tower Bridge Rd., London, S.E.1. Tel. Ber. 1669. [4506]

PICK-UPS.—We can now accept orders by post for the rewinding, reconditioning and general overhaul of pick-ups; estimates free.—Pickup Service, 14, Caroline Place, Stonehouse, Plymouth. [4863]

STURDY rewinds, mains transformers, S chokes and fields; we give prompt delivery and guarantee satisfaction 14 years' experience; prices on request.—Sturdy Electric Co., Ltd., Dinton, Newcastle-upon-Tyne. [4316]

TELEVISION and radio service.—Repairs to all makes, British and American; specialists in the repair of pick-ups, mikes, p.a. equipment, and test gear; enquiries invited for trade rates.—Craig Bros., 141, Park Rd., London, N.W.8. [4862]

LOUDSPEAKER repairs and mains transformer rewinds; we can now give prompt service at reasonable prices to dealers and service engineers; send 1d. for our latest list.

A.W.F. Radio Products, Borough Mills, Sharpe St., Bradford. [4495]

REPAIRS to moving coil speaker, cones, R coils fitted, field rewind or altered; speaker transformers, clock coils rewound, guaranteed satisfaction, prompt service.

I.S. REPAIR SERVICE, 49, Trinity Rd., Upper Tooting, London, S.W.17. [4819]

REWINDS, mains transformers, field coils, S chokes, high grade workmanship, 7-day delivery; new transformers constructed to customers' specification, singly or in quantities.—Metropolitan Radio Service Co., 1021, Finchley Rd., N.W.11. Speedwell 3000. [3719]

ALL makes and kinds of electrical and radio instruments repaired by skilled technicians A.I.D. approved; over 60,000 instruments repaired for R.A.F.; all work quoted by return without charge.—C. Gertler, Dept. D, 29-31, Cowcross St., E.C.1. Cle. 6783. [4829]

REWINDS, mains transformers, layer round, wax impregnated, o/p transformers, chokes, field, clock coils, pick-ups, fractional h.p. motor, competitive prices; prompt delivery; guaranteed work.—W. Groves, Manufacturing Electrical Engineer, 154, 16k Field Port Rd., Birmingham, 16. [4547]

TRANSFORMER rewinds and replacement coils, machine layer wound on bakelite former, interleaved, impregnated and clearly marked, rewinds, £1; standard windings to 70watts, coils, 15/6; extra transformers or larger types 10/-; new transformers or chokes to specification, singly or in quantity; trade list on application; delivery by return of post most types; state model and iron sizes when ordering coils, pick-ups, o/p trans., field coils, etc., rewound or replaced; fully guaranteed.—Radio Services, Field St. Works, Blackpool. R.T.R.A. Serv. Members. Tel. 1250-1774.

MISCELLANEOUS

WTD. "W. W." 1935-39, also '45; state price.—91, Granby St., Liverpool, 8.

OFFERS for whole 1945 and 45 "Wireless World" (24).—Spencer, Dunstaffnage, Argyll. [4760]

"WIRELESS Worlds" for sale, offers. [4760]

March, '42-Jan., '46.—78, Brackan Hill, Scarborough, Yorks. [4783]

SIX bound volumes "Wireless World", 1931-1933; offers.—Woodcot, Wilbrough Rd., Birchington, Kent. [4772]

TIME recorders.—Write for particulars.

Gledhill-Brook Time Recorders, Ltd 6419 Empire Works, Huddersfield. [2419]

SPARKS' data sheets. These data sheets provide complete constructional details, together with full-size prints, etc., of tested and guaranteed designs.

ELECTRIC guitar units (3rd edition), 5/-.

ELECTRONIC one-string fiddle, 3/6; 6 Swatt ac/dc amplifier; phase inverter; push-pull output; neg. feedback; portable for use with above or mke, p.u., etc., 3/6.

A.C. two-valve, med. wave, coil details, 2/6; 3 1/2 watt ac amplifier, 2/6.

SPARKS' DATA SHEETS (W.), 9, Pheobeth Rd., Brockley, London, S.E.4. [3622]

NO coupons for part-worn clothing.—Motor trousers, 15/11; black rubber coats, 32/-; paramatta police mcs, 32/-; bus overcoats, 36/-; bus jackets, 26/-; bus suits, 37/6; conductress bus suits, 27/6; conductress overcoats, 30/-; black rubber legslins, 9/11; police paramatta legslins, 9/11; drivers' hats, 4/6; boiler suits, 10/11 and 12/11; bib and brace overalls, 5/11.—R.A.F. helmets, 12/6; garrulet gloves, 4/-; Signal suits, 35/-; crash helmets, 200d contd., 11/6; back packs, 10/6; haver-sacks, 4/11; packing, post ex.—Millets, Cornhill, Lincoln. [4609]

GALPINS

GOV'T. SURPLUS ELECTRICAL STORES

408 High St., Lewisham, London, S.E.13

Telephone: Lee Green 0303. Near Lewisham Hospital

EX GOV'T ROTARY CONVERTERS for car radio, etc., 8 to 9 volts, DC input, 450 volts, 50/80 M/amps, output complete with automatic regulator, smoothing, consisting of condenser, dropping resistances, etc., and a specially designed gearing operating 3 multi-leaf relays, all mounted on chassis, size 12in. x 8in. x 2 1/2in., weight approx. 16 lbs., condition as new, to clear 37/6 each, carriage 2/6. Ditto, same output, but with an input of 12 to 18 volts at 3.3 amps. Price 37/6 each, 2/6 carriage.

EX GOV'T. EIGHT VALVE CHASSIS, size 12in. x 8in. x 2 1/2in., short wave, comprising of 2 highly sensitive multi-contact relays, dropping resistances, approx. 36 fixed condensers ranging from 10 P.F. to 1 N.I.F., also approx. 28, 1 1/2 and 2 watt resistances. To clear, 18/6 each, 1/8 carriage.

STANDARD TELEPHONE, block condensers, 10 mfd. at 550 volt wkg., 7/6 each. T.C.C. 4 mfd. 300 volt AC, wkg. 4/6 each. Ditto, 2 mfd., 2/6 each. T.C.C. 2,000 mfd., dry electrolytic, condensers, 25 volt wkg., 15/-, Ditto, 500 mfd., 50 volt wkg., 12/6 each. All fully guaranteed.

ELECTRIC LIGHT CHECK METERS, by well-known makers, all electrically guaranteed, for AC mains, 200/250 volts, 50 cycles, 1 phase, 5 amp. type, 12/6 each. 10 amp. type, 15/-, 20/25 amps., 17/6 each.

TRANSFORMER CORES, to suit 2 1/2 kW transformer, complete with clamps and bolts, 25/-, Ditto, 100/150 watts, 7/6 each.

ROTARY CONVERTORS, input 220 volts DC at 9 amps., output 88/125 volts, 500 cycles, 1 phase, 1,250 watts, in perfect condition, well-known makers. 11/0.

AUTO-CHANGING TRANSFORMERS, tapped 0, 110, 220, 240, step up or down, 500-watt type, 70/-, Ditto, 1,000 watts, £5 15s.; Ditto, 2,000 watts, £8 15s., extra tappings if required at 10/- per tapping, all fully guaranteed.

SHUNT WOUND DYNAMO, by good maker, 12 volts 10 amps., 1,500 rpm., ball-bearing, condition as new, 90/- each (not car type).

A large stock of Switch-board Motor Starters, and Resistances, are held by us. Please state your requirement.

AUTO-WOUND TRANSFORMER, approx. 5 kilowatt, in new condition. Voltages which can be obtained are 2 up to 18 in steps of 2 volts 80 to 240 in steps of 20 volts, price £15.

EX. G.P.O. HIGHLY SENSITIVE RELAYS, small type, with multi-contacts Q.M.B. action, 5/- each, also same type, new and unused, 10/-, all fully guaranteed.

LARGE PAXOLINE PANELS, size 14in. x 17in. x 1/2in., fitted with switch arm, 12 studs, and contact blade, very smooth action, 5/6 each.

D.C. MOTOR, totally enclosed, shunt wound, 220 volts 1/10 B.H.P., large size, price 37/6.

ROTARY CONVERTOR, input 230 volts at 4 1/2 amps DC, output 80 volts, 1 phase, 2,000 cycles, £5 10s., as new.

"WESTON" MOVING COIL MILLIAMPER METERS, model 505, 2in. dial, flush mounting 0 to 5 m/a., 27/6; 0 to 10, 27/6; 0 to 20, 25/-; 0 to 50, 25/-; 0 to 300, 27/6.

X-RAY TRANSFORMERS, in oil input 100/240 volts 50 cy. 1 phase, output 40,000 volts, £25; 80,000 volts 5 K.V.A., with Coolidge winding, £35; 90,000 volts at 2 1/2 K.V.A., £27 10s., all in perfect condition, fully guaranteed.

FLUORESCENT SCREENS, 15in. x 12in., with lead glass, as new, 75/-, We also have in stock other sizes of screens, and cassettes. Please state your requirements.

BLOCK CONDENSERS, large size, in metal case, 20 mfd. 300 v. AC wkg., 12/6 each. Ditto, 2 mfd., 1,000 volt wkg., 15/- each.

HEAVY DUTY CHOKER, by famous makers, weight 14 lbs., wound 19 gauge wire, two equal coils, 4 terminals, total resistance 10 ohms, 32/6. Ditto, 12 lbs., single winding, 22 gauge, resistance 15 ohms, 30/-, Ditto, 10 lbs., 20 gauge, two coils resistance, 6 ohms, 22/6.

All articles advertised sent on approval against cash. Terms: Cash with order.

Closed Half-day Thursday. Saturdays open from 9 till 6.

RADIO SPARES

MAIN: TRANSFORMERS.		Primaries 200/250 volts.
Secondaries 350-0-350 volts.		
TYPE C.	100 ma. 4 v. 5a., 4 v. 3 a.	34/6
TYPE D.	100 ma. 6.3 v. 5 a., 5 v. 3 a.	24/6
TYPE E.	120 ma. L.T.s as Type C.	37/6
TYPE F.	120 ma. L.T.s as Type D.	37/6
TYPE H.	200 ma. Three L.T.s of 4 v. 6 a. + 4 v.	
3 a. Rectifier		52/-
TYPE I.	200 ma. Three L.T.s of 6.3 v. 6 a. + 5 v.	
3 a. Rectifier		52/-
Secondaries 500-0-500.		
TYPE J.	200 ma. Three L.T.s of 6.3 v. 6 a. + 5 v.	
3 a. Rectifier		56/-
TYPE K.	200 ma. Three L.T.s of 4 v. 6 a. + 4 v.	
3 a. Rectifier		56/-
TYPE L.	250 ma. Three L.T.s of 6.3 v. 6 a. + 5 v.	
3 a. Rectifier		60/-
TYPE M.	250 ma. Three L.T.s of 4 v. 6 a. + 4 v.	
3 a.		60/-
Secondaries 400-0-400.		
TYPE R.	120 ma. 4 v. 5 a., 4 v. 3 a.	40/-
TYPE S.	120 ma. 6.3 v. 5 a., 5 v. 3 a.	40/-

SPECIAL UNITS MANUFACTURED TO FRIENDS' REQUIREMENTS.
 Please note that owing to dimensions and weight of TYPES H to M, kindly add 2 lb for carriage and 1 packing.
HEAVY DUTY MULTI-RATIO OUTPUT TRANSFORMER. 120 ma. 15 watts, tapings for 6L6s in push-pull. PX4s in push-pull, low impedance triode, low impedance pentode, high impedance triode, 27.6; complete instructions with each unit.
OUTPUT TRANSFORMERS. Special offer. Multi Ratio 30 : 1, 45 : 1, 60 : 1, 1.0 : 1, 6 : 1.
SMOOTHING CHOKES. 20 henrys 100 or 120 ma., 10-; 20 henrys 150 ma., 1.2 6; 30, 35 or 40 henrys 200 ma. or 250 ma., 21 6.
LINE CORD. Special offer. .3 amp. 3-way, 180 ohms per yard, 1/9. Best quality.
 Orders accepted by post only. Please help us to eliminate clerical work by sending cash with order. Please include postage with order. **PRICE LIST 1d. stamp.**
H. W. FIELD & SON, Colchester Road, HAROLD PARK, ESSEX
 Telephone: LN3rebourne 2642.

WARD ROTARY CONVERTERS

For Radio, Neon Signs, Television, Fluorescent Lighting, X-ray, Cinema Equipment and innumerable other applications.

We also manufacture:-
 Petrol Electric Generating Plants, H.T. Generators, D.C. Motors, Frequency Changers, etc., up to 25 K.V.A.

CHAS. F. WARD

37, WHITE POST LANE, HACKNEY WICK, E.9
 'Phone: Amherst 1393

AMBASSADOR

TYPE
P.R.
145

SPECIFICATION

20 Watt A.C. Amplifier with built-in Super-het Receiver covering 200-550 M.c. Specially recommended for Schools, Factories, Hospitals, etc. Full specification on request.

INDUSTRIAL
RADIO
AMPLIFIER



R. N. FITTON, LTD.
 HUTCHINSON LANE, BRIGHOUSE. Tel: 283

Scottish Distributors:
 BRITISH ELECTRICAL & MFG. CO. LTD.
 133 West Campbell St., GLASGOW. Tel.: Cen. 3286

£26 10 0
 PLUS TAX 2 2 0

SALE. Terman's "Radio Engineering,"

Henney's "Radio Eng. Handbook," mint cond.; offers.—549, North Rd., Darlington.
"WIRELESS Eng.," 1945 complete; Truman's "Radio Eng." Sturley's "Radio Rec. Design," and many other radio publications; stamp for details.—Box 5568.
COMPLETE stage equipment, comprising 1 footlight 4 circuit batten, 21ft 6in; 2 stage 4 circuit batten, 21ft 6in; 3 2,000 watt dimmers, 1 3,000 watt dimmers for above; 4 500 watt stage floods with screws and stands; all brand new. These were specially procured under 1A priority to be installed in an R.A.P. aerodrome. Best offer over £200 will secure.—Box 5495. [4816]

LIGHTING and charging plants.—Ideal for cottages, farms, etc., ex-R.A.F., reconditioned and guaranteed, compact and portable; J.A.P. 1hp 4-stroke engine (blower cooled), 12.32volts, 9amp, G.E.C. generator, fitted tank, switchboard, ammeter, variable resistance, cut-out, splendid condition, carr. paid £22/10; or J.A.P. engine (without generator) mounted firm base, carr. paid £15/10.—From R. Johnson, 37, St. Leonards Court, East Sbeon, London, S.W.14. [4850]

CONSTRUCTIONAL diagrams.—The most straightforward easy to build circuits yet published; each manuscript contains theoretical and guaranteed, compact and portable; J.A.P. 1hp 4-stroke engine (blower cooled), 12.32volts, 9amp, G.E.C. generator, fitted tank, switchboard, ammeter, variable resistance, cut-out, splendid condition, carr. paid £22/10; or J.A.P. engine (without generator) mounted firm base, carr. paid £15/10.—From R. Johnson, 37, St. Leonards Court, East Sbeon, London, S.W.14. [4850]

WANTED, EXCHANGE, ETC.

AIRMAN requires 25B8GT valve.—Townsend, 28, Waverley Rd., S.E.25. [4798]
JANUARY, 1946, "Wireless World" 1/6 and postage paid.—Box 5171. [4764]
WTD., "Wireless World," 1945, complete.—10, Moor Park Rd., Northwood, Middx.
WTD., Hartley Turner duode and P.M. twin. Siddington Lodge, Cirencester, Glos.
EXCHANGE Universal Avo Minor for decent Plusagram or similar gramo.—Box 5595.
WTD., Tweeter, crystal or moving coil.—53, Huxley Gdns., W. Twyford, N.W.10.
WANTED, Avo or Weston all-wave oscillator or similar, particulars.—Box 5211.
WTD., Goodmans Infinite baby or similar high fidelity speaker, price.—Box 5093.
WANTED, service details Beethoven AD770.—Nickels, Monmouth Hall, Dunball, Som.
WANTED, Service Sheets, all makes; state price and condition.—Nixey-Smith, Netherleigh, Combe Down, Bath. [4794]
WANTED, McMurdo Silver 15-17 chassis and speaker.—Reliance Radio, 97, Lancaster Rd., Enfield, Middx. [4718]
AUTOMATIC record changer required, complete, with or without pick-up; Garrard or similar make.—Box 5254. [4775]
WANTED, duode speaker, Hartley or Magnavox. Price, etc. to Corlette, Castlefield H. tel. High Wycombe, Bucks. [4892]
WANTED, Colvern Ferrocarb coils, G1, G2 and G3; must be in good condition.—R. B. Ransome, Sproughton, near Ipswich.
A DC Garrard record changer late model preferred; must be perfect; state price.—Watt, 5, Battery Terr., Oban, Argyll. [4770]
WE offer cash for good modern communication and all-wave receivers.—A.C.S. Radio, 44, Widmore Rd., Bromley, Kent.
WANTED, Columbia Record LX421, Berlioz Funeral March, Hamlet; good price paid; collection London area.—Box 5019. [4719]
W.W. short-wave, converter, ac, professionally built, as new; wanted, test oscillator.—12, Greenbank Rd., Tunstall, Stoke-on-T.
WE buy for cash, new, used, radio, electrical equipment all types; especially wanted, radios, radiograms, test equipment, motors, chargers, recording gear, etc.—If you want to sell at the maximum price, call, write or phone to University Radio, Ltd., 22, Lisle St., Leicester Square, W.C.2. Ger. 4447.

TUITION

MORSE, private lessons for G2ND, 80, Kictons Rd., London, S.E.16. [4912]
RADIO Engineering, Television and Wireless Telegraphy, comprehensive postal courses of instruction.—Apply British School of Telegraphy, Ltd, 179, Clapham Rd., London, S.W.9 (Estd. 1906). Also instruction at school in wireless for H.M. Merchant Navy and R.A.F.
"ENGINEERING Opportunities."—Free 112-page guide to training for A.M.I.Mech.E., A.M.I.E.E., and all branches of engineering and building; full of advice for expert or novice; write for copy and make your own future secure.—B.I.E.T. (Dept. 387B), 17 Stratford Place, London, W.1. [3837]

CAN YOU—

pass the Morse Code test for a G.P.O. Amateur Wireless Transmitting Licence?

The ability to accurately Send and Receive Morse Code is quickly acquired through the **CANDLER SYSTEM of Morse Code Training**

There are Candler courses for the absolute **Beginner** and for **W/T Operators** who desire to increase their speeds and to improve their technique.

Send for the **Candler "Book of Facts"** It gives full details of all courses. No classes to attend.

Courses supplied on Cash or Monthly payment terms.
THE CANDLER SYSTEM CO.
 (Room 55W) 121 Kingsway, London, W.C.2
 Candler System Co., Denver, Colorado, U.S.A.

THE INFINITE IMPEDANCE ADAPTOR.

An Ultra Modern Servicing Instrument, designed to facilitate simple and positive tests of Oscillator, circuits, detector circuits, A.V.C. components and voltages, etc., etc. With this instrument also many other special operations can be performed: for instance, alignment is possible without a Signal Generator. Price 28/17s. 6d. complete. Instruction manual, which is a text-book in itself, 5s., post free.

V.E.S. (W) RADIO HOUSE, RUISLIP, MIDDLESEX

QUARTZ PLATES

for
Communication
Equipment



Made by
SALFORD ELECTRICAL INSTRUMENTS LTD
 PROPRIETORS: THE GENERAL ELECTRIC Co Ltd. of England

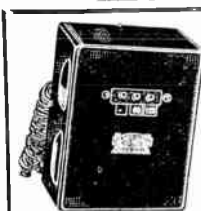

ELIMINATORS. Output 120v. and 60v. on 2 Tappings at 20 ma. Regulated Transformer for A.C. mains. 45/-

BATTERY CHARGERS. "Overnight" Model 6 of 12 volts 1 amp. With ammeter. £4 14s. 6d.; without. £3 19s. 6d.
HOME CHARGER. Input 200-250 volts A.C. Output 6.12 volts 1.0 amp. D.C. £4 10s.

TRIMMER TOOL KITS, a new set of aligning tools, polished ebony, cadmium plated, minimum hand capacity, robust and tough, contains one of each 6 B.A., 5 B.A., 4 B.A., 2 B.A. aligning tools, one each 6 mm. and 8 mm. a.l.t. (for Philips sets), one 8 in. flexible trim screw eliminating hand capacity, one 6 in. and 3 in. trim screw; the whole kit 5/6z. in wallet. 30/-

SOLDERING IRONS, 100/120 v., 200/220 v., 230/250 v. All 60 watts. 13/6. Universal model with Steatit-clad Element, High Bit Temperature 300 deg. C., 50 watts. 22/-

BESTS FOR SOLDERING IRONS, with Special Contactor for Solder, 7/6
SPEAKERS, 8 in. less Tr., 23/-; 6 in. w. Tr., 27/-; 3 in. less Tr., 30/-; 2 in. (Goodmans), 30/-

MULTIMETER, Universal Instrument made by British Physical Laboratories. 1,000 ohms per volt, 1 m.a. full scale deflection, A.C./D.C., 10, 50, 100, 500 volts. M.A. 1, 10, 100, 500 ohms 0-10,000. £8 15s.
MILLIAMMETER, 2 in. Flush, Moving Coil D.C. Range 0-1. 46/9.

VOLTMETER, 2 in. Flush, Moving Iron D.C. Range 0-120. 13/9. 3-range pocket Voltmeter. 36/-
AMMETER, Moving Coil, 30 amps. charge, discharge, as fitted to cars, and suitable when external shunt has been removed, for Circuit Testers, Trickle Chargers, etc. 19/6.

TESTSCOPE, the Vest Pocket Tester, 30 Tests A.C./D.C. 37/6.
DUAL TESTSCOPE, 50 Tests. 47/6.

RAWLING WORKSHOP OUTFIT, over 200 parts in a handy box with eight compartments and 24-page booklet, complete. 15/-

LITERATURE:

Valves Comparative Tables, 1/7. Systematic Radio Servicing, 1/7. Valve Characteristics, 2/7. American Midsets, 2/7. Radio Repair Business, 5/8. Valve Base Cards Index, 6/6. Manual of Radio Circuits, 2/-; Br. & Am. Valve Manual, 3/6. Manual of Direct Disc Recording, 2/-; Amplifier Manual, 2/-; Short Wave Handbook, 2/-; Modern Test Gear Construction, 1/6. Radio Service Manual, 2/6. Radio Reference Handbook, 10/6. Coil and Transformer Manual, 2/-; Cathode Ray Oscilloscope Manual, 2/-; Radio Inside Out, 4/6. Wireless Terms Explained, 3/-; Radio Simplified, 4/6. Problems in Radio Engineering, 5/-; Questions and Answers, Basic Radio, 5/-; Television Terms, 5/-; Short Wave Radio, 10/6. Radio Upkeep and Repairs, 8/-; Service Sheets, 10/6 doz.; Constructional Details and Diagrams for Midset "Victory Four," 5/-; "Occasional Four," 6/-.

VALVES. See list in February issue.

Also enquire for types not listed.

SPARES. We maintain a well-assorted stock of Components of tested quality.

Order C.O.D. under 10/- C.W.O. 2/4. enquiries.

EXPORT ORDERS invited. Forces and Demobilised Special attention.

J. BULL & SONS

(Dept. W.W.)

246, High St., Harlesden, N.W.10

"ENGINEERING OPPORTUNITIES"



This unique handbook shows the easy way to secure A.M.I.Mech.E., A.M.Brit.I.R.E., A.M.I.E.E., City and Guilds, etc.

WE GUARANTEE— "NO PASS—NO FEE."

Details are given of over 150 Diploma Courses in all branches of Civil, Mech. Elec., Motor, Aero., Radio, Television and Production Engineering, Tracing, Building, Govt. Employment, R.A.F. Ma'hs., Matriculation, etc.

Think of the future and send for your copy at once—FREE.

J. E.T., 387, SHAKESPEARE HOUSE, 17, STRATFORD PLACE, LONDON, W.1.

RADIO training.—P.M.G. exams and I.E.E. Diploma; prospectus free.—Technica, College Hill, [0611]
THE Tuition Board of the Institute of Practical Radio Engineers have available home study courses covering elementary, theoretical, mathematical, practical and laboratory tuition in radio and television engineering; the text is suitable coaching matter for I.P.R.E., Service-entry and progressive exams. Tuition fees—at pre-war rates—are moderate.—The Syllabus of Instructional Text may be obtained post free from Secretary, 20 Fairfield Rd., Crouch End, N.8
THE BRITISH NATIONAL RADIO SCHOOL is a long-established and highly successful correspondence school, specialising in transforming operators into engineers, and in this chosen field it stands supreme; during the war years we have been unable to accept students other than radio officers serving in the Merchant Navy; hence we have not advertised, but now we are again free to enrol a limited number of students from "Wireless World" readers seeking personal tuition in preparation for C. & G., Brit. I.R.E. and I.E.E. examinations.—Please write fully to Director of Studies, B.N.R.S., 66, Addiscombe Rd., Croydon. [4792]

TECHNICAL TRAINING

ENGINEERING careers and qualifications.

BOTH Government and industry have announced and emphasised that young men with technical knowledge and qualifications must receive every chance to rise to the highest positions within their capacity, in post-war engineering and allied industry; write to-day for "The Engineer's Guide to Success"—200 courses free—which shows you how you can become A.M.I.E.E., A.M.I.A.E., A.M.I.Mech.E., A.F.R.A.E.S., etc., and covers all branches in radio, automobile, mechanical, electrical, production, aeronautical, etc.
THE Technological Institute of Great Britain, 82, Temple Bar House, London, E.C.4. [4918]

SITUATIONS VACANT

QUALIFIED radio television engineer, knowledge of a r.f. and h.f. heating; London.—Box 2302. [4464]

RADIO service men wanted; 5-day week.—W.1. Mayfair 0947. [4808]

RADIO service engineer for well-equipped retail service dept.—Write, giving fullest particulars, Box 5525. [4829]

REQUIRED for new factory near Aberdare, expert in radio testers and fault finders.—W.1. City, Box 5708. [4856]

RADIO service engineers required immediately; first-class men only need apply, by letter, to Beinn Radio and Electrical Co., Ltd., 122, Hillmorton Rd., Rugby [4720]

OPPORTUNITY for draughtsman with knowledge of radio factory drawing office practice, write stating qualifications, age and salary required.—Box 4634. [4625]

WANTED, designing draughtsman, preferably with knowledge of electronic instruments.—Apply Fuzzehill Laboratories, Ltd., Boreham Wood, Elstree 1137. [4834]

EXPERIENCED radio and television draughtsman required by research television engineers.—Write, stating age, qualifications, salary required, to Box 5418. [4803]

LABORATORY assistant with some knowledge of physics and electrical training required in S.W. London area.—Write, giving details of age, experience, etc., Box 2519. [4913]

TECHNICAL assistants required for development work electrical research laboratory: InterB.Sc. standard or equivalent.—Fuzzehill Labs., Boreham Wood, Elstree 1137. [4829]

ELECTRONICS engineer, with experience of design and operation of television equipment.—Apply, giving full details of academic and practical qualifications to Box 5570. [4829]

RADIO transmitter design engineer, with experience of ultra high frequency wide band width transmitters.—Apply, giving full details of academic and practical qualifications, to Box 5569. [4827]

RADIO service engineer, previous experience in domestic receiver repairs essential.—State age, experience and wages required to Radio Maintenance and Supply Co., Blacklen Rd., Sidecup. [4813]

RADIO testers required for City factory; canteen, 5-day week; opportunity for export Service men with wireless experience.—Write or call, A. J. Balcombe, Ltd., 52-58, Tabernacle St., E.C.2. [4894]

THE Murdoch Group have vacancies at branches in various parts of the country for technical sales and service staff with proved experience, prior to 1939, of handling domestic radio.—Applications in writing, quoting fullest details of experience, age, whether married, home address and salary required to Radio Controller, Murdoch, 21-7, Lamb's Conduit St., W.1. [4916]

ARMSTRONG

RADIO CHASSIS

• **READY SHORTLY** •

Model EXP63

ALL-WAVE 6-VALVE SUPERHET CHASSIS

incorporating wave band expansion on all bands, e.g., the 16-50 metre band covers just over 20 inches on the large illuminated glass scale. Tone and volume controls work on both radio and gram. R.C. coupled, 5 watts output. For 100-250 v. A.C. or D.C. mains.

Provisional price **11 gns.** plus tax.

Model EXP83

ALL-WAVE 8-VALVE SUPERHET CHASSIS

incorporating wave band expansion. Large glass scale. Treble boost control, which together with tone and volume controls work on both radio and gram. High quality push-pull output gives 10 watts audio. For 100-250 v. A.C. mains.

Provisional price **14 gns.** plus tax.

Model EXP43

ALL-WAVE SUPERHET FEEDER UNIT

incorporating wave band expansion, manual I.F. gain control, etc. Fitted in high-grade instrument cabinet, ripple finished with plated hant

Provisional price **14 gns.** plus tax.

The above chassis are of entirely new design and capable of a high performance. Demonstration Sets are now available for interested callers to hear and illustrated technical specifications will be ready soon.

ARMSTRONG METAL WORKING DIVISION

We manufacture high-grade Metal Instrument Cabinets, detachable front and back panels, satin ripple finish, with plated handles. Stock sizes, 15in. long x 8 1/2 in. x 10 in. high and 18 in. long x 8 1/2 in. x 10 in. high. Prices 50/- and 55/-. Special sizes to order.

ARMSTRONG WIRELESS & TELEVISION CO. LTD.

WALTERS ROAD, HOLLOWAY, LONDON, N.7

Phone: NORth 3213

NORTHAMPTON POLYTECHNIC

ST. JOHN STREET, LONDON, E.C.1 (nearest station ANGEL, Underground Mtn. Line)

A Course of Lectures on

ELEMENTS of the DESIGN of AUTOMATIC CONTROL (SERVO) SYSTEMS

will be conducted at the Polytechnic on **TUESDAY EVENINGS at 6 p.m., commencing 5th March, 1946**

LECTURERS:

Dr. A. PORTER, M.Sc., A.M.I.E.E. (Ministry of Supply), from 5th March to 2nd April
Mr. M. L. JOFEL, A.M.I.E.E. (Messrs. A. C. Cossor, Ltd.), from 9th April to 14th May
Prof. K. A. HAYES, O.B.E., B.Sc., M.I.E.E. (Military College of Science), 21st May

Fee for the course: 21/-. Admission by ticket, obtainable from the Secretary, Northampton Polytechnic, St. John Street, London, E.C.1.

THE TOM THUMB



GRAMO AMPLIFIER

The little fellow
with a Loud Voice.

Complete in case 9 x 8 x 6 1/2,
using EL 33's in push-pull 15 w.

Ready to assemble, £8.18.0.
(Carriage and Packing, 2/6.)

ALSO

The A.23 model PUBLIC ADDRESS
AMPLIFIER with high gain pre-amp
stage. Complete in case 14 x 8 x 8 1/2.

Ready to assemble, £14.0.0.
(Carriage and Packing, 3/6.)

OBTAINABLE DIRECT OR THROUGH
YOUR DEALER.

(COMPLETE loose leaf Catalogue and
MONTHLY MAIL SERVICE 1/ per year.)

RADIO INSTRUMENT CO.



Radio Products
294, BROADWAY,
BEXLEYHEATH, KENT
Bexleyheath 3021

MATRICULATION

brings Success & Security

Whatever your age, you can now study for the all-important Matriculation Examination at home on "NO PASS - NO FEE" terms. "MATRIC" is the accepted passport to all careers, and opens up opportunities which would otherwise be completely closed to you. Ensure the success and security of you and yours through post-war difficulties by writing for our valuable "Guide to Matriculation" immediately - FREE.

B.T.I. (Dept. 114)

356, Oxford Street, London, W.1.

THE AURI-PHONE

A miniature Ear-
phone with a high-
fidelity reproduction
of Speech and
Music equal to best
headphones known.
1 1/16 inch diam.;
weight 1/2 oz.; holds in
Ear without headband
or wire loop. Two
interchangeable
nipples, large and
small; two models, 10 ohms. and 1000 ohms.
Operate from prim. or sec. terminals of
Speaker transformer, ideal for pocket radio,
Valve or Crystal set. 5ft. flex cord. Price,
black or flesh-colour enamel, 39s. Reg. Post
free. **NOTE** : We do not make Deaf Aids.



**CEFA INSTRUMENTS, 38a, York Street,
TWICKENHAM, Middx. POPesgrove 6597.**

I NSTRUMENT wiring men required for laboratory work, capable of wiring instruments or building mock-ups from electronic circuit diagrams.—Furzehill Laboratories, Boreham Wood, Ectree 1137. [4776]

L ABORATORY engineer required for development work in radio firm in North London, qualifications and ability essential; salary according to experience.—Write Box No. 240, c/o Streets, 110, Old Broad St., E.C.2.

O PPORTUNITY for laboratory assistant with knowledge of industrial electronics equipment, power oscillators and central circuits, must be practical, write stating qualifications, age and salary required.—Box 4633.

D ESIGNER draughtsman required for S. London by Philips Laboratories, exp. in communications equipment (elect. and mech.)—Apply in writing giving full details to R.T.E. Ltd., 45 Nightingale Lane, S.W.12

D RAUGHTSMAN required by firm making specialised radio equipment; applicants should state qualifications, experience, salary received and salary now required; experience in the drawing of small electrical components essential.—Box 5417. [4802]

R ADIO engineer required for service of prominent manufacturer's sets; good wages and good conditions; knowledge of television essential; apply or write.—London & Provincial Factors, Ltd., 230, Tottenham Court Rd., London, W.1. [4779]

D EVELOPMENT draughtsman, accustomed to work on radio and television transmitters and receivers.—Apply in writing, stating age, qualifications and experience, to Research Laboratories of the General Electric Co., Ltd., Wembley, Middx. [4807]

L ABORATORY assistant required in S.W. London area with knowledge of electrolytic condenser manufacture, able to assist in development and process control; permanency with good prospects for keen person.—Write, giving all essential details, Box 2518.

B USH RADIO, Ltd., have vacancies for engineers with experience in radio, television and radio-location development.—Apply in writing, giving details of qualifications, previous experience and salary required, to the Chief Engineer, Power Rd., Chiswick, W.4.

M ECHANICAL engineer required (in London area) to develop small automatic machines and mechanism for large batch production of components; experience in this class of work essential; applications to state training, experience & salary reqd.—Box 5705.

E LECTRICAL and mechanical engineer for varied and interesting duties in small works; competence and initiative essential, knowledge of electronics desirable; good pay to live man under 40; full or part-time.—Box No. 466, c/o Dawson's, 31, Craven St., London, W.C.2. [4639]

O NE senior radio research engineer and two radio development assistants required to work under chief engineer in laboratory of well known radio manufacturers in Slough district.—Write, stating full particulars of qualifications, experience, age and salary expected, to Box 5628. [4838]

R ADIO manufacturer requires travelling service engineers; good wages, bonus and expenses; van, test gear and tools provided; applications required only from men with good theory, practical experience, clean driving licence and resident in or near York, Brighton and Colchester.—Box 5706. [4854]

E NGINEER required with experience in design of audio-frequency apparatus and able to take design to production prototype, familiarity with midget assemblies and components an asset; responsible position with good prospects; salary £500-£600; apply, stating age and experience.—Box 5760. [4875]

T ELECOMMUNICATIONS engineers, company of repute, London area, requires graduates with several years' experience in development, operating or manufacturing of radio or line communication equipment; applicants should give full details of age, training and experience & state salary required.—Box 5627.

R ESEARCH engineer required for the study of chiefly of problems connected with the suppression of interference with radio reception; must be at least Grad.I.E.E. or equivalent, and experience of the work is desirable; salary according to qualifications, but will not exceed £400 per annum; apply by letter only, stating full details & salary required.—Belling & Lee, Ltd., Cambridge Arterial Rd., Enfield.

E NGINEER required with extensive experience in the design of audio frequency apparatus, and associated components; applicant to have experience of taking design to production prototype standard, and a sound knowledge of the mechanical factors involved; familiarity with the design of midget assemblies and components an asset; responsible position with good prospects; apply, stating age, specific details of past experience; salary £500-£600 according to qualifs.—Box 5541.

VALLANCE'S

PROMPT MAIL ORDER SERVICE
in best quality Radio Components

SPECIAL OFFER.—4 mfd. 500 V.D.C. working 1,000 V.D.C. test block condensers, made by the Stanc Condenser Co. in light grey cans identical with the T.G.C. type 92. New and unused stock; samples tested have stood up to 600 v. AC test without trace of breakdown. Limited supplies, 4/8 each. 1 mfd. 1,000 v. working metal case, 3/6 each. 100 p.f. silver mica ceramic cup condensers, 9d. Erie Resistors, 1 watt, in following values: 220, 1k, 10k, 15k, 20k, 27k, 33k, 40k, 50k, 100k, 250k, 1.1 meg and 1.8 meg, brand-new long wire ends, 4d. each. Erie 1 watt resistors in following values: 5k and 10k, also 50k 1 watt Mullard type, all new, 6d. Erie 2-watt resistors in following values: 600, 25k, and 50k, new, 10d.

TUBULAR CONDENSERS.—0.1 mfd. 1,000 v. working, 11d.; 0.25 750 v. working, 1s.; 0.02 mfd. 750 v. working, 8d.; 0.05 mfd. 1,000 v. working, 11d.; 0.1 mfd. 400 v. working, 8d.; 0.5 mfd. 500 v. working N.I. 1/2; 0.25 mfd. 2,000 v. working, metal case, 4/-; 0.001 mfd. mica condensers, 2,250 v. DC test, 11d.

PUSH-PULL OUTPUT TRANSFORMERS.—Speaker matching from 1-30 ohms, valve loads 1,500 to 16,000 ohms. Will match almost all types of valves, single-ended stages. Push-pull Class A, AB1, AB2 and B, 15 watts 39/9; 30 watts, 49/6. Full instructions with each.

SMOOTHING CONDENSERS.—8 mfd. 500 v., 4/-; 8-8 mfd., 6/-; 8-16 mfd., 6/8; 25 mid. 25 v., 2/3; 50 mfd. 25 v., 2/3; 90 mfd. 50 v., 2/3.

HIGH ACCURACY METERS.—3 1/2 diam. 1 m.a., 52/-; 4 1/2 m.a., 64/-; 500 microamps, 71/8. Weatherhouse meter rectifiers for either type, 15/-, 2-pole 6-way and single pole 12-way meter switches, low resistance contacts, 5/- each.

MULLARD RESISTANCE AND CAPACITY BRIDGES.—Ranges 1 to 10 megohms and 10 mfd. to 10 mfd. power factor measurements, magic eye indicator, 15 s. gns.

PRECISION SHORT-WAVE RADIO COMPONENTS.—From stock—all Raynart and Edystone components available. Coils 4 and 6-pin, ceramic valve-holders Octal, Loctal, acorn, etc. Stand-off insulators, transportation blocks, aerial T pieces, strain insulators, base insulators, feeder spreaders, feed through bushes, tank coil formers, engraved dials, instrument knobs, condensers, receiving transmitting, ultra-short etc. Transmitting racks acorn valves, 6L6G, 807, 6V6, etc., all at list prices.

All enquiries and orders dealt with immediately. Please send cash and postage with order, otherwise C.O.D.

Vallance's, 144, Briggate, Leeds 1

HILL & CHURCHILL
BOOKSELLERS
SWANAGE DORSET
ENGLISH & AMERICAN
BOOKS IN STOCK ON
RADIO AND
TELECOMMUNICATION
CATALOGUE ON APPLICATION

MIDLAND INSTRUMENT CO.

Comprehensive range of Lewcos instrument wires, eureka and nickel chrome res. wires. Flexes and cables, electrical accessories, sleeving. Empire tape, rubber grommets, L.T. rectifiers. Avometers, Weo-Meggers, Ohmmeters, speakers, chassis, dual-range and s.w. coils, var. coards, counters, synchronous motors, microphones, plugs and jacks, etc., etc. New Feb. lists, 1d. s.a.e. Trade lists, 1d. s.a.e.

18, Harborne Park Rd., Birmingham, 17
Tel. HAR. 1308 or 2664.

BATTERY CHARGERS & TRICKLE CHARGERS

Trouble-free Chargers fitted with selenium all-metal rectification. Good allowance on your old Charger. Thirty years experience behind every Runbaken product. Booklet B.15, describing 12 Models, on request.

RUNBAKEN-MANCHESTER

DRAUGHTSMEN and tracers required for S. London, with exp. in prod. of working drawings from data supplied by designers; (1) Mech. draughting; (2) Elect. preferably with exp. on radio comm. equipment; workshop exp. preferred.—Apply in writing, with full details, to R.T.E., Ltd., 45, Nightingale Lane, S.W.12. [4635]

AMPLIVOX, Ltd., thank all those who replied to their advertisement for a service manager's assistant under Box No. 2468; so many letters were received that it has not been possible to reply personally; a suitable man has been chosen and we hope that the unsuccessful applicants will soon be happily settled elsewhere. [4780]

ASISTANT development engineer required by established firm of scientific instrument makers for work on an electrical apparatus; experience of electronics would be useful.—Apply W. G. Pye & Co., Ltd., 80, Newmarket Rd., Cambridge, stating salary required and details of experience. [4789]

PHILIPS Laboratories Communications invite applications from keen technicians to fill posts as laboratory assistant; only applicants to a standard of City & Guilds Grade 3 in radio engineering should apply in writing, with full details, to Personnel Manager, Philips Laboratories, 45, Nightingale Lane, S.W.12. [4758]

RADIO technician required for the manufacture of high grade radio receivers and test equipment in well equipped workshops, excellent opportunity for an energetic and ambitious man to progress with small but rapidly growing concern; ex-serviceman with good radio knowledge and willing to be trained in the work preferred.—Full details to Box 5594.

SERVICE engineer-manager required by radio dealer specialising in first-class repairs to domestic radio and television receivers; only those having technical qualifications, long practical experience and a keen interest in this class of work need apply; good salary, 44-hour week and comfortable conditions, North London district.—Write in first instance, giving fullest particulars, which will be treated in strict confidence, to Box 5323.

LARGE firm with factories in London and Provinces requires an engineer-designer of small mass-produced electro-mechanical precision apparatus, with knowledge of the working properties of metals and insulating materials, must be fully up to date on tool design and methods of parts and assembling small component parts and capable of estimating production costs to close figures; only highly experienced candidates should apply.—Write Box 262, c/o J. C. King & Son, 150, Fleet St., E.C.4. [4825]

RADIO manufacturing company concentrating on development of high quality radio and television receivers has a vacancy for a chief engineer, the position demands a man of wide experience and possessing the highest possible qualifications for which the pay would be commensurate; the location is within 25 miles of London and our own staff is aware of this advertisement; write, giving full particulars of past experience, age, technical qualifications, other relevant details, and salary expected.—Box 5635. [4842]

V.H.F. development work.—Radio manufacturers have vacancies for two high calibre senior engineers, fully experienced in V.H.F. receiver design; good prospects, generous salary and congenial working conditions in well-equipped laboratories are offered; applicants must be capable of originating design and developing apparatus in detail up to the stage of production; must be well acquainted with current services technique, tropicalisation requirements, etc.; must also have had similar experience in a senior capacity either in Government establishment or in commercial development laboratories of first-class firm.—Write, stating in confidence details of pre-war and wartime experience, technical education and qualifications, present salary, age, salary required and date when engagement could start, to Box 5707. [4855]

SITUATIONS WANTED
R.A.F. wireless operator, released, 6 yrs. prior to war 4 yrs.; also experienced in servicing; desires post.—Box 5709. [4857]

C.Q.M.S., 27, foreman of signals, 3 yrs. civilian, 5 yrs. Army radio service experience, seeks situation; released Mar.—Box 5763.

R.E.M.E. 8/Sgt. (Arm. Art. wireless), 31, experienced servicing, receivers, transmitters, electrical instruments, etc.; available early Mar.; London or Home Counties.—Box 5322.

SGT. R.A.F., six years' pre-war experience as radio serviceman, six years as radar mechanic, desires progressive situation in radio industry; available now.—Box 5524. [4822]

RADIO serviceman, demobbed, seeks post, South-west Scotland, North-west England, quick, efficient, experienced.—Box 5710.

EX-R.A.F. Sgt., radar operator, 6 years' experience, desires progressive position in or connection with radar; keen and intelligent worker.—Box 5170. [4767]

B.I.R.E. student, F/S W.E.M., age 24, 3yrs. pre-war PA, and servicing exp., reliable Lam., taking qual. exams, requires post S. Lancs, expects demob. May-June.—Box 5816.

RADIO engineer, demobilised warrant officer, R.E.M.E., Assoc. Brit. I.R.E., C & G. Final, 6 years' experience civilian and service equipment, desires progressive position; Midlands.—Box 5736. [4870]

STAFF Sgt., R.E.M.E., 6 yrs. Radar, wireless, C and G, 2 and 3, 1st cl., and Tech. Elect. 2, desires progressive post radio, electronics, any good opportunity, development preferred.—Box 5817. [4904]

MAJORITY, R.E.M.E., age 30, released, seeks responsible technical or executive position in radio or allied industry; 14 yrs. experience of radio eng. and television (6 yrs. Army radar and wireless)—Box 5298. [4782]

EX-R.A.F. Sgt., wireless mechanic, seeks progressive post; pre-war servicing experience, knowledge and experience of sound reproduction on 35mm and 16mm projectors; further details on request.—Box 5447. [4805]

R.E.M.E. Warrant Officer, 6 yrs. pre-war exp. devel., prod. and service, mnfrs of app., service in tropics, used wkg. own initiative, strict disciplinarian, seeks advancement, willing any part of world if post merits, av. imm.—Box 5780. [4890]

I OFFER the following experience, 6 years' sales office routine, 3 years' departmental manager and buyer, 7 years' retail and manufacturers' sales and service departments, 6 years' R.A.F. in Radar branch; due for demob. shortly, age 37; any proposition with promising prospects considered.—Box 5827.

SGT. (25), A.1 tradesman (Army), seeks progressive post, research or experimental preferred; Sussex or London area; over 5 years' experience major repairs and modifications on radar; keen amateur, very practical; good education, studying for City and Guilds exams; will work hard; avail. Apr.—Box 5733.

COMMUNICATIONS engineer, 25, public school matric., 2 yrs. G.P.O. eng. dept., 6½ years' Army (Foreman of Signals), experienced in radio and telephony equipmt., interested in electronics and nuclear physics, seeks post in London as sales rep., design and development, production or service supervision; Class 1 release, April, approx.; willing to serve probationary period.—Box 5703. [4851]

YOUNG man, good qualifications, soon released from Navy, at present making intensive study, modern public address technique and equipment, requires partnership or business proposition with well-established radio firm or retailers, 50-mile radius London, with a view to starting or taking over the running of a high quality P.A. business, bringing with him capital and very latest in high quality P.A. equipment.—Box 5416. [4801]

SALES manager, 35, well-known radio and electrical component manufacturers (London), seeks similar post with progressive company (not necessarily includes works managers); sound experience includes works management, sales representation and management, technical advertising, export; excellent connection with radio and electrical manufacturing companies and wholesalers.—Write Box A7492, Samson Clarks, 57-61, Mortimer St., W.1. [4844]

WORK WANTED.
AS designers and manufacturers of coils, chokes, transformers, output transformers, wave wound coils, relay coils, fluorescent lighting chokes, etc., of all types, we are able to offer you competitive prices and good deliveries.
SEND your enquiries to Green Electrical Industries, Ltd., 44/45, Tamworth Rd., West Croydon. Tel. Croydon 7417-8. [4399]

PATENTS.
THE proprietor of British Patent No. 549485, entitled Improvements in and relating to electrodes and other metal parts of electron discharge devices, offers same for licence or otherwise to enable its practical working in Great Britain.—Enquiries to Singer, Ehlert, Stern and Carlberg, Chrysler Bldgs., New York 17, N.Y., U.S.A. [4749]

PARTNERSHIP
PARTNER required 250, congenial employment, to work in own residential district; money under own control and at all times fully secured; weekly drawings.—For further particulars apply Box 5497. [4318]

PATENT AGENTS

A. E. HILL, chartered patent agent, 27, Chancery Lane, London, W.C.2. [4368]

AGENCIES

ADVERTISER, 25 years' technical and sales experience, own car, requires agencies radio and electrical; part expenses and commission; pref. Devon and Cornwall.—Box 5490.

ESTABLISHED automobile engineers, covering Lancashire, Cheshire and North Wales, desire distributing, installing and servicing agencies in connection with car radios; director is an ex-radio engineer.—Automart Auto Engineering Co., Hind St., Birkenhead

BUSINESSES FOR SALE OR WANTED

RETAIL wireless and electrical business in heart of West End London, turnover £6,000-£7,000; good lease; price £3,000; s.a.v.—Box 5496. [4817]

RADIO factors and wholesalers, limited company, in Central London, with wide connections, for sale; £1,000, including fixtures and fittings and s.a.v., excellent opportunity; turnover £20,000 p.a.—Write Advertiser, c/o Sidney Gainsley, Harrison and Co., 1, Quality Court, Chancery Lane, W.C.2. [4841]

FREEHOLD shop property investment.—Shortly to be submitted to auction (unless previously sold), including well-fitted shop let to wireless and electrical dealers on short term, the whole producing £270 p.a., exclusive.—Frank Swain, Auctioneer, 170, Notting Hill Gate, W.11. [4795]

COUNTY BOROUGH OF BRIGHTON

Electricity Department

FOR SALE

Offers are invited for the equipment comprising the Local Air Raid Alarm System, including Amplifiers, Control Gear, Diesel-A.C. Generating Set, loudspeakers, connecting cables, fixing and fittings.

A Schedule of the plant and gear may be obtained on application to Mr. H. Pryce-Jones, M.Eng., Engineer and Manager, Brighton Corporation Electricity Department, "Electric House", Castle Square, Brighton, 1.

Tenders (which must be in plain sealed envelopes not bearing any name or mark indicating the sender) endorsed "Tender for Local Air Raid Alarm System" must be delivered to me by noon on the 18th March, 1946.

No Tender will be considered which does not comply with these conditions.

J. G. DREW

Town Clerk

31st January, 1946
Town Hall,
BRIGHTON, 1

THE COIL PICKUP
you have waited for is
NOW READY FOR DELIVERY
WILKINS & WRIGHT LTD.
Holyhead Road, Birmingham, 21

REWINDS
Armatures, Fields, Transformers, Pick-ups, Vacuum Cleaners, Gram. Motors, Speakers Refitted New Cones & Speech Coils.
All Guaranteed and promptly executed. Valves, B.V.A. and American, good stocks. Send stamped addressed envelope for list of Radio Spares, and C.O.D. Service.
A.D.S. Co. ASTON, BIRMINGHAM 6

DENCO COIL TURRETS

We are introducing a new and unique range of coil turrets which constitute complete tuning assemblies for various types of receivers.

Type I, for a 4-wave superhet. receiver with 1.6 I.F., is now available.

High Q permeability tuned coils, Polystyrene insulation, silver plated contacts, and very rugged construction, are some of the outstanding features.

Our new catalogue is now available—send 2½d. stamp.

DENCO (CLACTON) LTD.
Old Road, Clacton-on-Sea, Essex
(Clacton-on-Sea 151).

R&A BRITAIN'S FOREMOST REPRODUCERS

Reproducers and Amplifiers Ltd.
WOLVERHAMPTON,
ENGLAND.

Superspeed
SPECIAL
**CORED
SOLDER**
A.I.D. APPROVED

H. J. ENTHOVEN & SONS LTD.
230 THORNTON ROAD, WEST CROYDON, SURREY
THORNTON HEATH 2462

WALTER SWITCHES
ARE MADE FOR 

WALTER
INSTRUMENTS LTD.

Earls Court Exhibition Buildings, Earls Court, London, S.W.5
FULHAM 6192 GRAMS: WALINST, FULROAD, LONDON

INDISPENSABLE
for Electrical and
Radio
Engineers—



The New
"PYROBIT"
Universal
NEON TESTER 19/T
in a moulded plastic case is
now available for the vest pocket

THE
ACRU ELECTRIC TOOL MFG. CO., LTD.
123, HYDE ROAD, ARDWICK, MANCHESTER, 12 'Phone ARDWick 4284



**W. BRYAN SAVAGE
LTD.**

Expert assistance in the solution of problems relating to

- TRANSFORMERS, CHOKES
- AMPLIFIERS
- POWER UNITS

and Specialised Equipment embodying
ELECTRONIC CONTROL

WESTMORELAND RD., N.W.9
COLINDALE 7131

Printed in England for the Publishers, ILLIFFE AND SONS LTD., Dorset House, Stamford Street, London, S.E.1, by THE CORNWALL PRESS LTD., Fairs Garden, Stamford Street, London, S.E.1. "Wireless World" can be obtained abroad from the following—AUSTRALIA and NEW ZEALAND: Gordon & Gotch, Ltd. INDIA: A. H. Wheeler & Co. CANADA: Imperial News Co.; GORDON & GOTCH, LTD. SOUTH AFRICA: Central News Agency Ltd.; WILLIAM DAWSON & SONS (S.A.), LTD. UNITED STATES: The International News Co.



THE LONDON SYMPHONY ORCHESTRA SWELLS IN . . . AGAIN

SOON the highway and the byways will come to life with cars. Soon the people of this land will want to enjoy the fruits of peace. Soon, thousands of cars, radio equipped, will be tuned in to the London Symphony Orchestra — or Geraldo — or the News . . .

To you who make miniature sets or radio sets for cars, Hunts supply the dual Miniature Electrolytic Capacitor Type I 31A. This is a dual type capacitor of minimum size but possessing the latest technical design improvements, and capable of giving long life and performance under appropriate

voltages and temperatures, with an ability to withstand reasonable ripple current conditions.

This is just one more example of the Hunt ability to supply capacitors for any and every type of radio, based on a sound manufacturing policy of "capacitors only."



A. H. HUNT LTD · LONDON · S.W.18 · ESTABLISHED 1901

GOOD NEWS FOR RADIO MANUFACTURERS & SERVICE ENGINEERS

ERSIN MULTICORE SOLDER

is now available without restriction in

PRE-WAR QUALITY

HIGH TIN CONTENT

ERSIN Multicore Solder in 60/40 tin lead alloy may now be purchased without restriction. For many years 45/55 tin lead alloy has, by Government regulation, been the standard for radio and while it gives excellent results the higher tin content alloy is usually preferred for high quality work. 60/40 has a 37° C lower melting point, it "sets" quicker and the solder joints look brighter. Because there is more tin in 60/40 alloy than 45/55, it costs more. Consequently except for work where the lowest melting point alloy is essential it must be a matter of personal preference which alloy is used.

60/40 alloy Ersin Multicore Solder is available for radio manufacturers in gauges from 10-22 S.W.G. at bulk rates. For service engineers the following standard specification on nominal 1-lb. reels will soon be held in stock by most factors.



CATALOGUE REFERENCE NO.	ALLOY TIN/LEAD	S.W.G.	APPROX. LENGTH PER NOMINAL 1-LB. REEL.	PRICE PER NOMINAL 1-LB. REEL (SUBJECT TO USUAL DISCOUNT)
16014	60 40	14	64 feet	6 -
16018	60 40	13	178 feet	6 9
14513	45 55	13	45 feet	4 10
14516	45 55	16	94 feet	5 3

Labels on 45/55 reels are crimson on buff.
Labels on 60/40 reels are red and white on black.

Manufacturers, Factors and Service Engineers are invited to write for technical information and free sample of Ersin Multicore Solder 60/40 alloy.

MULTICORE SOLDERS LIMITED

MELLIER HOUSE, ALBEMARLE ST., LONDON, W.1. Tel. : (REGENT 1411 P.B.X. 4 lines)