

Wireless World

RADIO and ELECTRONICS



AUG. 1945

1/6

Vol. LI. No. 8

IN THIS
ISSUE :

ARMY "COMMUNICATION" RECEIVER

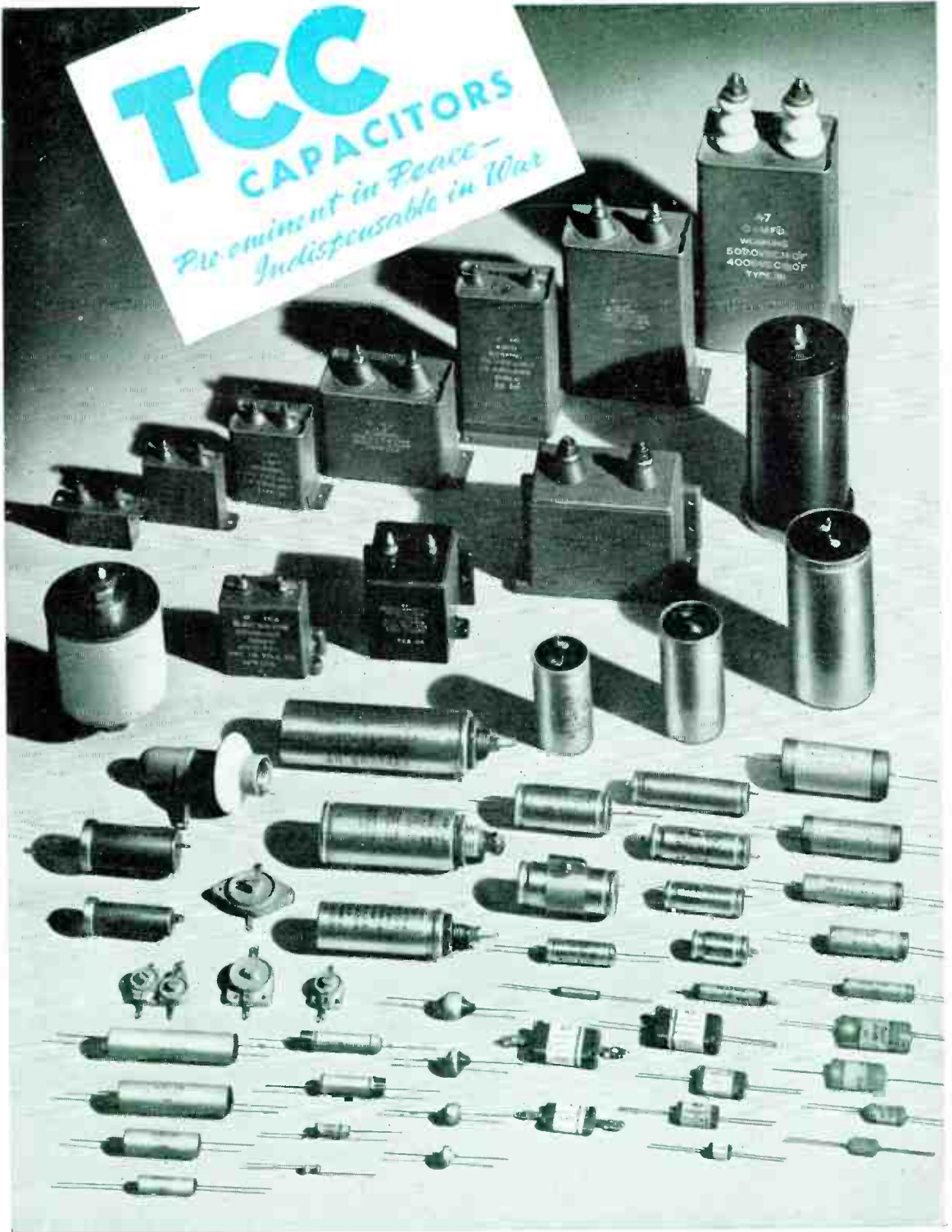

ADVERTISEMENT OF THE TELEGRAPH CONDENSER CO. LTD.

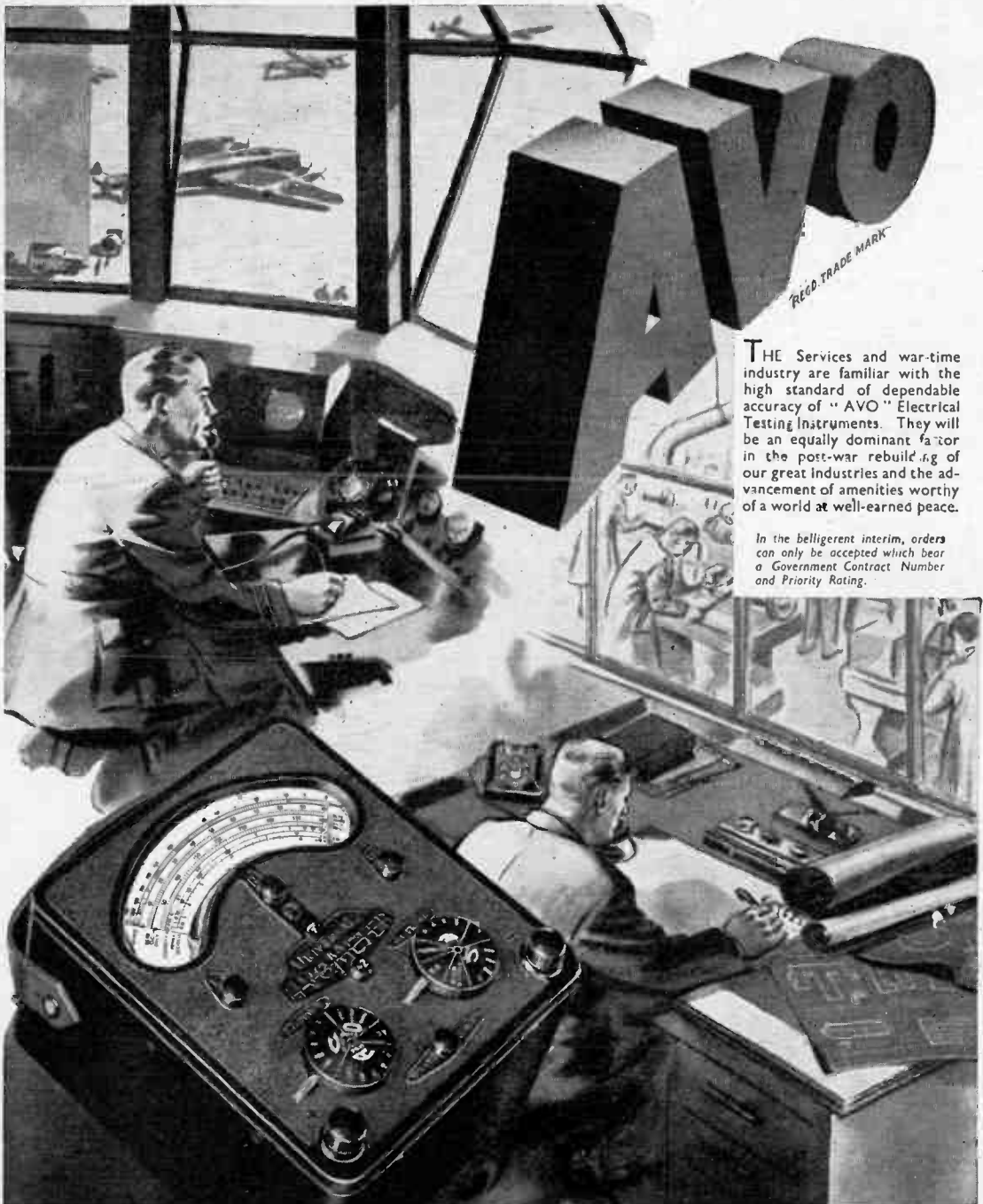

THE Services and war-time industry are familiar with the high standard of dependable accuracy of "AVO" Electrical Testing Instruments. They will be an equally dominant factor in the post-war rebuild of our great industries and the advancement of amenities worthy of a world at well-earned peace.

In the belligerent interim, orders can only be accepted which bear a Government Contract Number and Priority Rating.

Sole Proprietors & Manufacturers:-
THE AUTOMATIC COIL WINDER & ELECTRICAL EQUIPMENT CO. LTD.
 WINDER HOUSE · DOUGLAS STREET · LONDON · S.W.1 TELEPHONE: VICTORIA 3402

Orders bearing Government Contract Numbers and Priority Rating can now be accepted for quick delivery of the following two "AVO" Instruments:-

THE "AVO" TEST BRIDGE

A portable self-contained 50-cycles bridge of exceptional accuracy and utility for direct measurement of all normal values of condensers and resistances. Facilities also provided for condenser power factor measurements and leakage tests by the flashing neon method, resistance, capacity and large inductance measurements against external standards. May also be used as a highly efficient valve voltmeter indicator for measurement of both audio and radio frequency voltages.

THE ALL-WAVE "AVO" OSCILLATOR

An inexpensive, accurate modulated oscillator covering a continuous fundamental frequency band from 95 Kc. to 40 Mc. A harmonic calibration extends the range to 80 Mc. A large clearly marked dial is directly calibrated throughout, accuracy being within 1%. Externally modulated, internally modulated, or R.F. signals obtainable at will. Calibrated double attenuator enables signal to be varied from a few microvolts to 50 millivolts, with a force output of 1 v. Self-contained, fully shielded.

The TAYLOR A.C. BRIDGE

MODEL 110A

These instruments give quick and accurate measurements of Capacity and Resistance. There are six Capacity ranges covering from .00001 to 120 mfd. and the Power factor can also be measured on each range. Six Resistance ranges are available measuring from 1 ohm to 12 megohms. This bridge is A.C. mains operated and a leakage test is also available for detecting leaky paper or mica condensers. Price £14 14s. 0d.
Please write for technical leaflet.

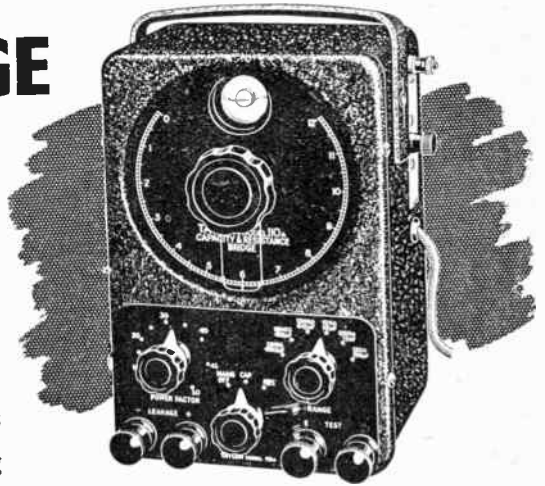

6 RANGES OF CAPACITY
RANGES OF RESISTANCE



Send your enquiries to:—

TAYLOR ELECTRICAL INSTRUMENTS LTD

419-424 MONTROSE AVE., SLOUGH, BUCKS.
Tel: Slough 21381 (4 lines) * Grams: "Taylins", Slough.

Wharfedale

O.P.3

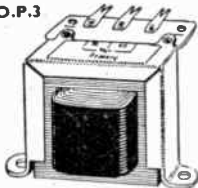

TYPE P

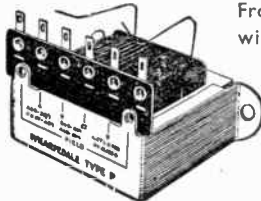

OUTPUT TRANSFORMERS

Production in recent years against Admiralty Contracts has set even higher standards to Wharfedale Components. From this both trade and public will henceforth benefit. The bulk of our production is now on Transformers for Tropical use. We regret that supplies for general sale are still very small.

PRICE LIST

O.P.3	-	3 ratios	-	-	5 6
Type P	-	4 ..	with C.T.	-	6 6
G.P.8	-	8	-	9 6

WHARFEDALE WIRELESS WORKS

HUTCHINSON LANE, BRIGHOUSE, YORKS.

*Phone: Brighouse 50

*Grams: WHARFDEL

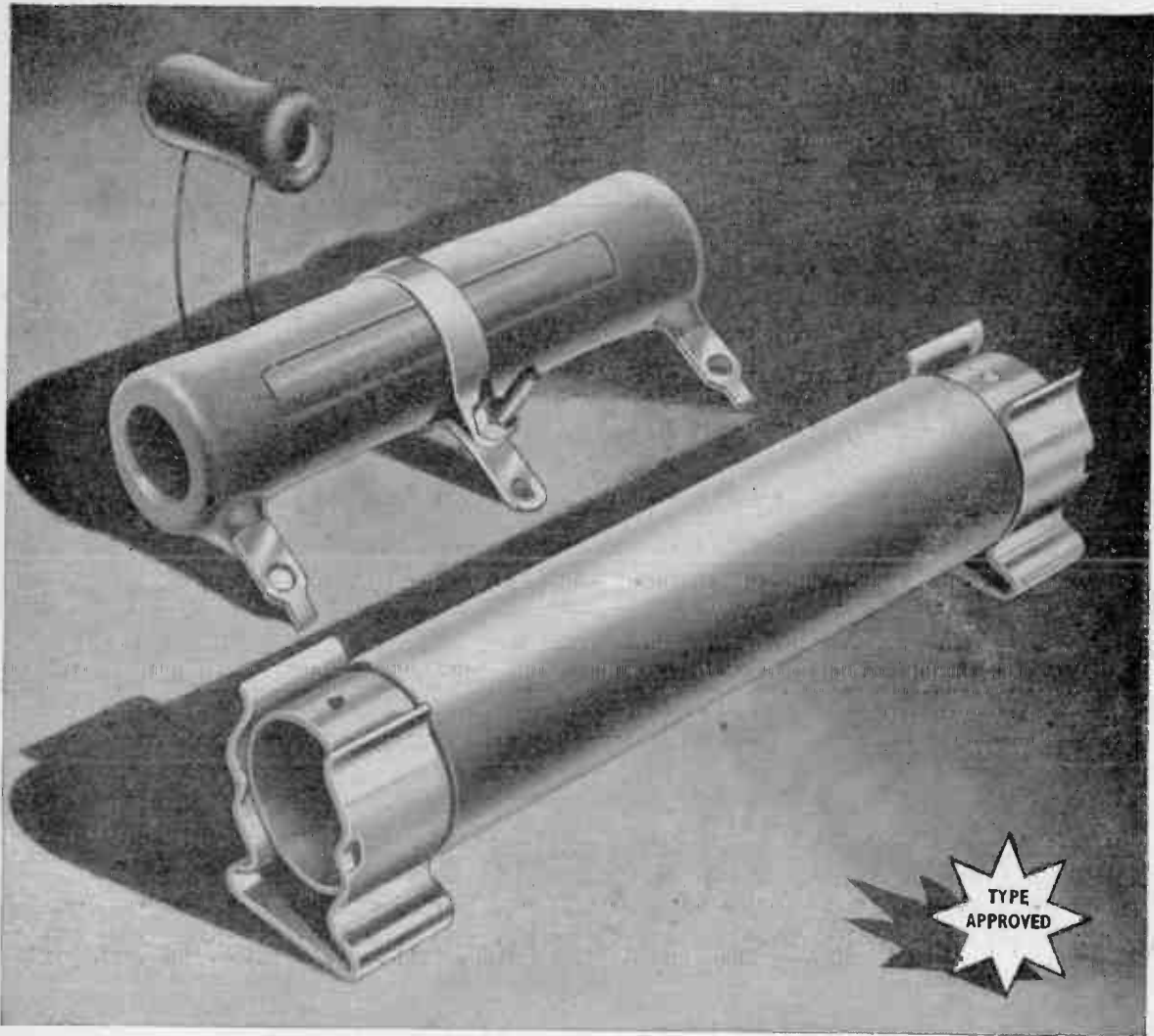

*Fear no more the heat o' the sun,
nor the furious winter's rages . . . Cymbeline.*



WE learned long ago that Power Wire Wound Resistors must be ready to face a hard life. They mustn't lie down or curl up under intense heat; or shiver and go all numb in bitter cold. They must keep on doing their job whatever the conditions. We were the first to give Power Wire Wound Resistors a reliable cement coat to protect them from the climate. Dubilier Resistors can take what's coming—even heavy overloads—and come back for more.

The name is . . . Dubilier

C.R.C.17

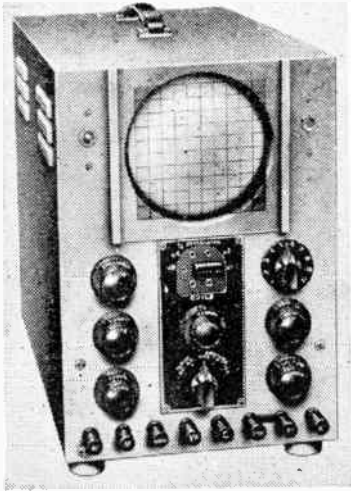

STATIC TWO-DIMENSIONAL visual delineation of any recurrent law.

RELATIVE TIMING OF EVENTS and other comparative measurements with extreme accuracy.

PHOTOGRAPHIC RECORDING of transient phenomena.

SIMULTANEOUS INDICATION of two variables on a common time axis.

INDUSTRIAL INDICATING and TESTING afford increasing scope for the Cathode Ray Tube as the only device with the above inherent features, of which the last is unique in the Cossor DOUBLE BEAM Tube.

The Model 339 Cossor Oscillograph thus equipped is invaluable on all problems of research, production or operational testing, when the effect examined is applied as a voltage. When recurrent the traces are studied visually and when transient are recorded photographically, using Model 427 camera.

A. C. COSSOR LTD.,
INSTRUMENT DEPT.

Cossor House, London, N.5

*Phone: CANbury 1234 (33 lines).
*Grams: Amplifiers Phone London.

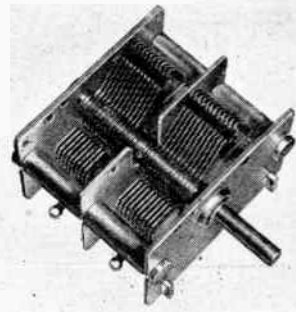
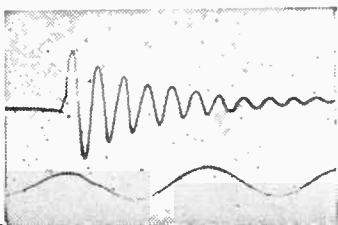

M.G. 1, 2 or 3 GANG CONDENSER

This small size condenser is of rigid construction, and is made in various capacities up to 540mmf. with tropical finish. It can be supplied with trimmers built in if required. The 2 Gang Frame is $2\frac{3}{4} \times 1\frac{3}{8} \times 2\frac{1}{8}$ " over all.



JACKSON
BROS (LONDON) LIMITED
KINGSWAY · WADDON · SURREY
TELEPHONE: CROYDON 2754-5 TELEGRAMS: WALFILCO PHONE, LONDON

M.R. SUPPLIES

have the following superior and brand new RADIO and ELECTRICAL EQUIPMENT in stock and available for immediate despatch or collection. All prices net cash. **VOLTAGE CHANGING TRANSFORMERS**, 200/250 v. to 100/110 v. (and vice-versa). Fully shielded, with countersunk terminal blocks and properly rated. 75 va., 20/6. 120 va., 37/6. Also small supply of 550 va. (suitable for cine, electro-medical, etc.). Double-wound, 230 v. to 100 and 110 v. (and vice-versa), in cast brackets with terminal panels, 26 10s. (owing to heavy weight and packing difficulties we cannot despatch the 550 va. model—we have 75 only).

STEP-DOWN TRANSFORMERS, 200/250 v. Prim. Secs. :—5, 12 and 17 v. at 6 amps., 49/6 (desp. 2/-). Secs. :—7, 11 and 15 v. at 2 amps., 20/- Sec. :—22 v. at 2 amps., 18/6.

BATTERY CHARGERS, for 200/250 v. A.C. Metal rectified. In strong black crystal-line steel cabinet, 9in. x 6in. x 4in. for wall suspension. Screw-in mains selection and radial switch for voltage selection, 2, 6 and 12 v., at full 1 amp., 23 17s. 6d.

S.T.C. METAL RECTIFIERS, D.C. delivery up to 12 v. at 14 amps., 12/6. **SLIDING RESISTANCES**, 100 watts. Fully enclosed, constantly rated. 10 ohms 3 amps., 50 ohms 1.4 amp., 200 ohms 0.7 amp. Any one, 25/- Also 172 ohms (graded). Max. 2 amps.; min. 0.07 amp., 32/6. **STAGE DIMMERS**, controlling stated load from full bright to black-out at 220/240 v., fitted worm drive and handwheel, 1,000 watts, 26 17s. 6d. 1,500 watts, 28 8s. (Carr. either 7/6, plus 20/- for returnable case).

MILLIAMMETERS by first-class makers. High-grade precision m/coil instruments, flush mtg. 071 ma., 2 1/2in., 52/6; 3 1/2in., 37/6.

For 2,000 ohms/volt combined instrument), 3 1/2in., 75/- **COMBINED MEASURING INSTRUMENTS** in crash-proof black bakelite case, 6in. x 4 x 3 1/2in., with carrying handle. 1,000 ohms/volt, universal A.C./D.C. Readings:—M.A., 0/1, 0/10, 0/100, 0/500. Volts, 0/10, 0/50, 0/100, 0/500. Ohms, 0/5,000. Complete with cell, 28 17s. 6d. **VITAVOX HIGH FIDELITY SPEAKERS**, 12in. P.M. (Ticonal), 15 ohms coil, handling 10 watts. Very latest development and best specification. 27 (desp. 5/-). We are obtaining maximum delivery of these, but have to advise very early application.

GOODMAN MINIATURE P.M. M/COIL UNITS, for speaker or microphone. 3 1/2in. overall, fitted high-flux P.M. latest model, 30/-.

GRAMPIAN M/COIL MICROPHONES, suspended in square frame, with plated mounting boss, 15 ohms, 24 4s. Also same make, Senior model for highest quality work, all plated with local on/off sw., 15 ohms, 27 5s. **ROTHERMEL PIEZO-CRYSTAL MICROPHONES**, D.104, all-plated with suspension rings and 5ft. ac. cable, 25 5s. Also sound cell type BR.28 21 0s. Also miniature deaf-aid insert type, 1 1/2in. dia., 29/6. **FLOOE STANDS**, collaps. ext. to 5ft., all chrom., 45/6. Cradles for D.104 only, 8/-.

G.E.C. INDUSTRIAL SPEAKERS, in 12in. drum., handling 8 watts, fitted multi-trans. 65/- (carr. 3/-). **ERICSSON HEADPHONES**, with adjustable headgear, 2,000 ohms, 25/- pair. **PYROBIT ELECTRIC SOLDERING IRONS**, only model that can be held like a pencil, 9in. long, best for elect. work, 220/250 v., 22/- ac. cable, 4/6. **CENTRAL AB VOL. CONTROL**, test switch, 1,000, 3,000, 10,000, 50,000, 100,000 ohms and 1 megohm, any one, 3/11 (45/- doz.). **PYROBIT NEON TESTERS** with screwdriver, 100/750 v., 9/6. **ROTHERMEL CRYSTAL PICKUPS**, senior bakelite model, 78/9. **STROBOSCOPIC SPEED TESTERS** (50 c.), showing 78, 79 and 80 r.p.m. (cardboard only), 1/-.

Please include sufficient for despatch, where not stated.

M.R. SUPPLIES, 68, New Oxford Street, London, W.C.1
(Telephone: MUSeum 2958)

Announcing Glass Seal Terminals

(Process Patent applied for)

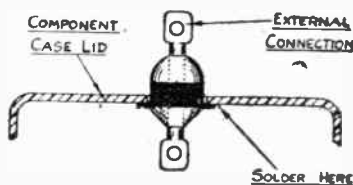

LIST No. 576

750 V. DC. Working at 40,000 feet.
1,500 V. DC. Working at sea level.

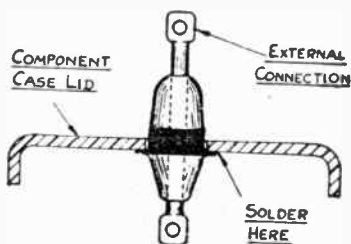

LIST No. 577

1,500 V. DC. Working at 40,000 feet.
3,000 V. DC. Working at sea level.

AFTER rather more difficulties than we expected, we have developed a method of production in our factory at Enfield, where we are able to turn out many thousands per week...*NOW*.

Terminals at present available are illustrated about actual size; other sizes will follow.

They withstand instantaneous and repeated thermal shocks of at least 250°C and will support at least 40 lbs. per square inch air pressure without leakage. These terminals are supplied tin-plated to permit soldering with modern resin covered solders or solder pastes.

Supplied packed in
cartons containing 100.

BELLING & LEE LTD
CAMBRIDGE ARTERIAL ROAD, ENFIELD, MIDDX

GA

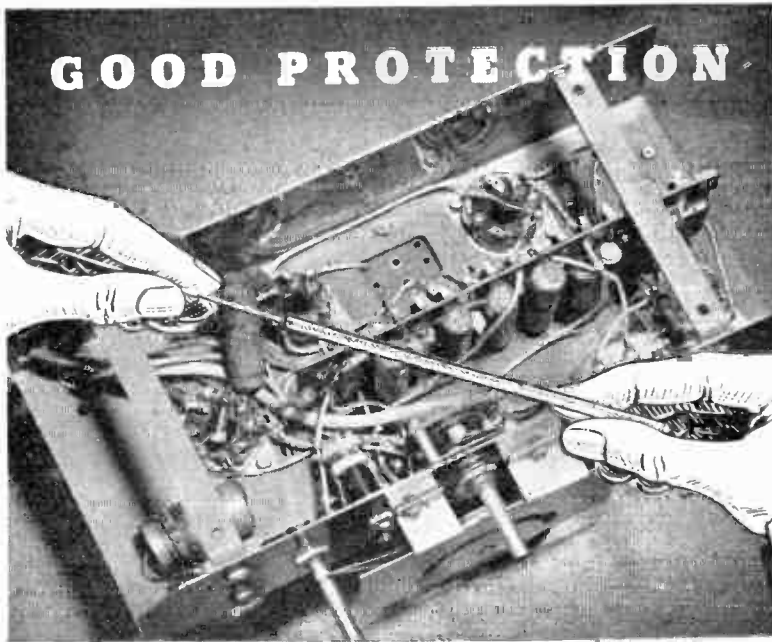

"DELAFLEX" Sleeveings adequately fulfil the vital functions of protection and insulation at every point in the internal wiring of all Radio and Electrical apparatus. "DELAFLEX" is available in i.d. of from 0.5 mm. to 35. mm. in varying types to Specification. The Rolled Silk range is specially made for use in tropical equipment. Fullest details, samples and prices gladly sent on request.

DE LA RUE INSULATION LTD
 IMPERIAL HOUSE · 84 REGENT ST · LONDON · W1 (REGENT 2901)

- ROLLED SILK
- METAL SCREENED
- VARNISHED COTTON
- WOVEN FIBRE GLASS
- VARNISHED ART SILK



SECURITY MEASURES



TIE BOLT

This Bolt was originally turned from Round Bar and Milled, or manufactured as a Hot Brass Stamping. Cold Forging showed an approximate saving of 70% in material.

Specialists in Cold Forging · Roll Threaded Screws; Solid and Tubular Rivets; Nuts and Bolts in all metals; Small Pressings; Auto and Capstan-turned Parts
LINREAD LTD., STERLING WORKS, COX ST. BIRMINGHAM, 3.
 TELEPHONE: N. 1. GEN 3951 PB X
 TELEGRAMS: "LINREAD BIRMINGHAM."
 London Office: Clifton House, Euston Road, London, N.W.1.
 Tele. N. 1. EITR 8291.



Constant Voltage

TRANSFORMERS

LINE VOLTAGE VARIATIONS OF $\pm 15\%$ REDUCED TO $\pm 1\%$

Input Voltage ... 100-260 v. 50 c.p.s.
 Output Voltage ... 230 v. $\pm 1\%$
 Max. load ... 150 watts.
 Input power factor Over 90%
 Prices on application. *Price for details.*

ADVANCE COMPONENTS LTD.

BACK RD., SHERNHALL ST., WALTHAMSTOW, E17. PHONE: WARKSWOOD 43662



ELECTRONICS



One of the OSRAM VALVES specially developed for Radar—an ACT 20 which will find many peace-time applications.

made it
possible !

Hostiles, bearing 194, height 10,000—back went the warning and fighters raced to intercept. From many miles away Radar plotted the enemy's exact position, and brought the defences hurtling into action.

The science of electronics made it possible, for at the heart of every Radar installation lies the valve.

OSRAM VALVES have been in the forefront of electronic development during the war, and will bring to the pursuits of peace many well-tried electronic devices to speed, smooth and make safer our way of life.

Osram

PHOTO CELLS

G.E.C.

CATHODE RAY TUBES

**Osram
Valves**

3 REASONS WHY
you should get your
INSTRUMENT CASES

from **IMHOF'S**

1014

1 CASES SPECIALLY DESIGNED

We will gladly co-operate in designing and producing models exclusive to you.

2 CASES OF STANDARD DESIGN

For the first time you can now buy IMHOF Cases designed to fulfil a specific purpose from stock.

3 CASES TO YOUR SPECIFICATION

Imhof's are fully equipped to build cases of all types to rigid specification and to close limits.

A postcard will reserve for you a copy of our entirely new 16pp. catalogue now in preparation.

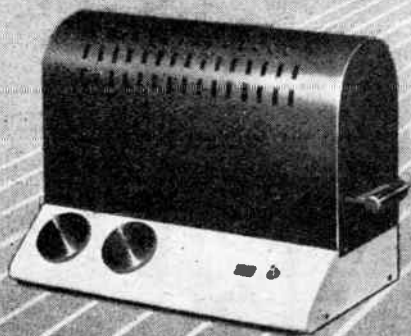

ALFRED IMHOF LTD
 112-116 NEW OXFORD ST
 LONDON W.C.1



-exclusive to the famous

DANK SWITCH

Millions in use

Manufactured by

BRITISH CO., LTD.
KEIGHLEY YORKSHIRE

London Office : 25, MANCHESTER SQUARE, W.1
 *Phone : Welbeck 7941 *Grams : Enesef, London



FOR THE RADIO SERVICEMAN DEALER AND OWNER

The man who enrolls for an I.C.S. Radio Course learns radio thoroughly, completely, practically. When he earns his Diploma, he will KNOW radio. We are not content merely to teach the principles of radio, we want to show our students how to apply that training in practical, every-day radio service work. We train them to be successful!

Special terms for Members of H.M. Forces and discharged disabled members of H.M. Armed Forces

-----You may use this Coupon-----

INTERNATIONAL CORRESPONDENCE SCHOOLS Ltd.

DEPT. 38, INTERNATIONAL BUILDINGS, KINGSWAY, LONDON, W.C.2

Please explain fully about your Instruction in the subject marked X

Complete Radio Engineering. Radio Service Engineers. Elementary Radio.

And the following Radio Examinations :—

- British Institution of Radio Engineers.
- P.M.G. Certificates for Wireless Operators.
- City and Guilds Telecommunications.
- Wireless Operator and Wireless Mechanic, R.A.F.

Name..... Age.....

Address.....

F.W.S.CO.

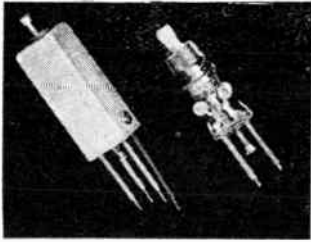

WORLD'S LARGEST RADIO COIL MANUFACTURERS

- RADIO FREQUENCY INDUCTORS
- INTERMEDIATE FREQUENCY TRANSFORMERS
- RADIO FREQUENCY COIL CHOKES
- MICA COMPRESSION CONDENSERS
- AIR DIELECTRIC CONDENSERS
- MICA MOULDED CONDENSERS
- SICKLES SILVER CAP CONDENSERS
- GANGED PERMEABILITY TUNING COMMUNICATIONS EQUIPMENT
- F.M. EQUIPMENT PARTS
- U.H.F. RADIO EQUIPMENT
- SPECIAL ELECTRONIC EQUIPMENT

The F. W. SICKLES Co.
CHICOPEE, MASS., U.S.A.

the Midget of Quality

RAYTHEON "FLAT" HEARING AID TUBES

They fit inside a delicate ring, they are so small; but they are mighty in dependable performance for hearing aid apparatus. Long lived with low battery drain, RAYTHEON Flat hearing aid tubes give quality performance for electronic hearing aids.

RAYTHEON
PRODUCTION CORPORATION
HEARING AID TUBE DIVISION
Newton, Massachusetts.

ARMY-NAVY "E" WITH STARS
Awarded all four Divisions of Raytheon for Continued Excellence in Production.

P. R. MALLORY & CO. INC.
MALLORY VIBRATORS
ARE ALWAYS DEPENDABLE

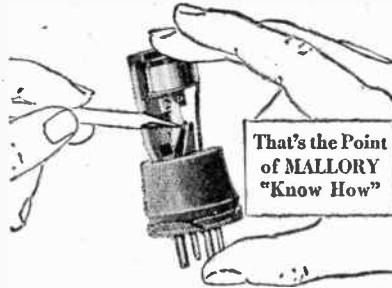

Contacts in a vibrator take a lot of punishment. They must operate under widely varying conditions of temperature and must "make and break" 115 times a second. Small wonder that alert engineers think of contacts first when selecting a vibrator!

For over 20 years, Mallory has been industrial headquarters for every type of electrical contact. It has introduced new contact compositions... evolved better designs... formulated improved surface finishes.

As a result of this wide experience, Mallory equips its vibrators with special grade tungsten contacts which are cut in its own plant from material made to its own specifications. They give longer life, are subject to a minimum of erosion and transfer.

Mallory is ready to apply its special vibrator "know how" to your specific applications.

P. R. MALLORY & CO. INC.
INDIANAPOLIS, INDIANA,
U.S.A.

Radio and Electronics Division

ALSO
"MYKROY" CERAMIC INSULATING MATERIALS
GENERAL ELECTRONIC VACUUM CONDENSERS

FOR THE FUTURE

These Manufacturers will help solve your post-war problems.

Register your name now for full details which will be sent you when supply conditions again permit.

FRANK HEAVER LIMITED
Kingsley Road, BIDEFORD,
N. Devon

G.I.

VICTORY PRODUCTION

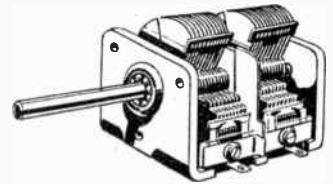

TYPE 2600 MIDGET VARIABLE CONDENSER

WHEN the mission of complete victory is accomplished, General Instrument will help "Win the Peace" by making the best use of still greater knowledge and experience in the manufacture of variable condensers and drives.

THE GENERAL INSTRUMENT CORPORATION
ELIZABETH, N.J., U.S.A.

THE SHAPE OF THINGS TO COME...

TWO-WAY radio communication systems, like the plastic-cased beauty illustrated, are one of the new developments leading industrial designers are thinking of to speed the work of a busy post-war world. Applications of this compact, plastic-cased "walkie-talkie" are almost unlimited. Naturally, this is only one of the usands of uses plastics will be put to after the war, but it will serve to remind you that post-war planning is being done... Kurz-Kasch designers, engineers, tool-makers and moulders... specialists for a generation in plastic planning and moulding will help you with your problems.



KURZ-KASCH INC.
Planners and Moulders for the Age of Plastics
DAYTON · OHIO · U.S.A.



RULE OF THUMB...

In communications, wherever measurement for testing purposes is involved, empiricism can be ruled out. Of no avail without scientific instruments is anything the eye can see, the hand feel or the most observant remember. The radio engineer, therefore, must have test gear on which he can rely and, thanks to the foresight of Marconi Instruments Ltd., has a wide selection from which to choose. And he finds exemplified in these Marconi products the qualities so characteristic of British Engineering craftsmanship—rational design, precise workmanship and technical efficiency.

MARCONI INSTRUMENTS, LTD

ST. ALBANS, HERTFORDSHIRE

Telephone: St. Albans 4323-6

WHAT HAVE YOU?

RAYMART LTD *have management vacancies; how do you measure up?*

- What is your Amateur Radio background?
- What knowledge have you of latest developments and shortwave communication and radiolocation development?
- Can you deal with technical correspondence?
- What selling experience?
- Any manufacturing experience on up-to-date production machinery like B & S Auto Screw Machines, Capstans, Millers etc?
- When are you free and at what salary do you expect to commence?
- Are you interested in a profit-sharing proposition with low salary?
- How have you served your Country in the war?

WHAT WE NEED

We need live radio men with enthusiasm and initiative to work without supervision, feeling that the business is partly their own by virtue of their share in its prosperity.

BILL NIGHTINGALE (G5NI)

will respect all confidences.

48, HOLLOWAY HEAD, BIRMINGHAM, 1

For *Reliability*

Just *TRIX*

Quality **SOUND** Equipment

THERE ARE TRIx AMPLIFIERS FROM 5 to 500 WATTS FOR PRIORITY WORK

THE TRIx ELECTRICAL CO. LTD.
1-5, MAPLE PLACE, TOTTENHAM CT. RD.
LONDON, W. 1.
Tele. MUSEUM: 5817 Grams & Cables, TRIxRADIO, WESDO, LONDON.



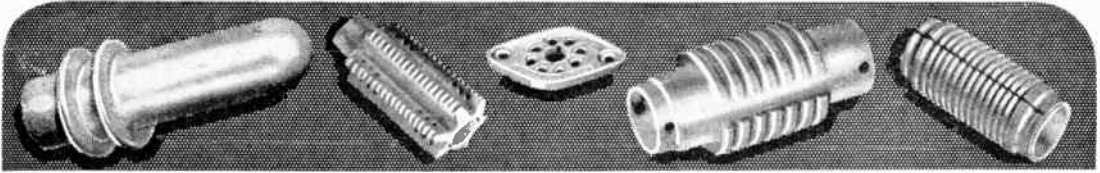

Clear as a Crystal

AND HERE IS THE REASON..

• • • the answer has been found in Bullers Low Loss Ceramics to the problem of Dielectric Loss in High Frequency circuits.

Years of laboratory research and development have brought these materials to a high degree of efficiency. To-day they are in constant use for transmission and reception, and play a vital part in maintaining communications under all conditions.

Made in Three Principal Materials

FREQUELEX—An Insulating material of Low Dielectric Loss, for Coil Formers, Aerial Insulators, Valve Holders, etc.

PERMALEX—A High Permittivity Material. For the construction of Condensers of the smallest possible dimensions.

TEMPLEX—A Condenser material of medium permittivity. For the construction of Condensers having a constant capacity at all temperatures.



Bullers

LOW LOSS CERAMICS

BULLERS, LTD., THE HALL, OATLANDS DRIVE, WEYBRIDGE, SURREY
 Telephone: Walton-on-Thames 2451. Manchester Office: 196, Deansgate, Manchester

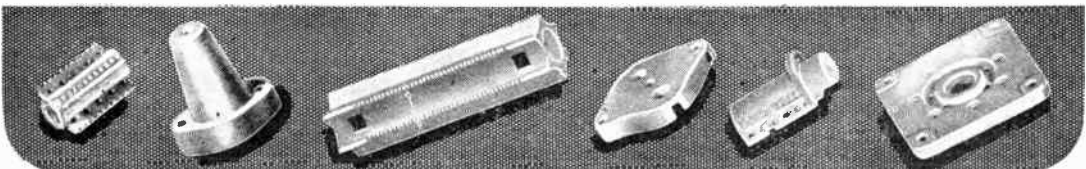

WEBB'S *Radio*

For the laboratory, amateur transmitter, and wherever QUALITY and RELIABILITY are essential, WEBB'S offer unrivalled stocks and service. All apparatus and components are guaranteed—if your needs call for discrimination WEBB'S can help—DON'T come to us if you want obsolete or second-hand material!

Comprehensive stocks enable us to quote for EVERYTHING IN RADIO—our regular adverts, show merely a few interesting lines.

PORTABLE AMPLIFIER CASE, comprising chassis, cover and base plate. Overall size 16"×8"×9" high, chassis depth 2½", removable top cover adequately ventilated top and sides, fitted two carrying handles. Chassis drilled in front for four controls, cut for seven valves, side entries for mains cable and speaker plug. Well finished in black-crackle, this makes an ideal amplifier case. £12 6

Packing and carriage 2/6 extra, with slight delay in despatch owing to shortage of packing. Callers from stock.

MICROPHONES, Etc.

- Rothermel D104 Crystal Microphones £5 5 0
- Rothermel Desk Stand, extends 12" to 24", chrome finished. A
- well-made accessory £1 15 0
- Webb's Floor Stands—collapsible £2 2 0

LOUD SPEAKERS

- Magnavox Mains Energised, 2,200 ohms field, speech coil 2½ ohms, with pentode transformer:
 - 8" type, baffle aperture 7½" £1 10 0
 - 6½" type, baffle aperture 5¾" £1 8 6
- Permanent magnet speakers in variety from 2" miniatures to:
 - Vitavox K12/20 high fidelity 20 watts, overall dia. 12½", baffle aperture 10¾". A heavy duty speaker combining punch, high efficiency and fidelity. Flux density 17,000 lines per sq. cm. £11 0 0

CONDENSERS

- T.C.C. metal cased 4 mfd. 500 v. working..... 10 0
- T.C.C. metal cased 8 mfd. 500 v. working..... 16 0

KEYS

- Webb's operating key, well balanced G.P.O. type bar key, heavy lacquered brass on polished wood base, front and back controls. £1 8 6
- Webb's Amateur Key, similar high-grade lacquered brass, slightly lighter but perfectly balanced, front and back contacts... £1 2 6
- Practice Keys: G.P.O. Bar type on wood base..... 4 0
- U.S.A. type all-metal key 3 6

BOOKS. Technical books a speciality, a few only as shown:

- Introducing Radio Receiver Servicing (Squire) 6/-
- Wireless Amplifier Manual (Bernards) 2/-
- Radio Data Charts (Wireless World)..... 7/6
- Foundations of Wireless (Sowerby) 7/6
- Radio Simplified (Clarricoats) 4/6
- Basic Radio (Berton Hoag) 21/-
- First Course in Wireless (Decibel) 4/6
- Radio Interference Suppression (Ingram) 5/-
- Introduction to Valves (Henderson) 5/-
- Radio Technique (Mills)... 21/-
- Superheterodyne Receiver (Witts)..... 6/-
- Complete Morse Instructor (Tait) 2/-

Prompt attention given to your enquiries and orders whether small or large.

14 Soho Street, Oxford Street,
London, W.1

Telephone: Gerrard 2089

We are available 9 a.m. till 6 p.m. for OFFICIAL business, but please note our SHOP HOURS—10 a.m. to 4 p.m. (Saturdays 10 a.m. to 12 noon.)

LOOKING AHEAD

The day that hostilities cease may be a little late to start deciding who shall supply the Transformers and Chokes for your post-war product.

Why not let us have a rough idea NOW of what you will want, and let us submit suggestions and prototypes?

Just at the moment we are extremely busy making hundreds of thousands of transformers for the battle front, but we are able to devote a certain amount of thought and planning for post-war.

Installed in our newactory is the very latest in Coil Winding Machines, vacuum impregnating plant, test equipment, and everything necessary for the production of the finest transformers that are made.

Drop us a line and let us show you the latest fashions. You are bound to be interested!

WOODEN TRANSFORMER CO. LTD.
MOXLEY ROAD, BILSTON, STAFFS.
Telephone: BILSTON 41959-0



IT'S ALL UPS & DOWNS

Keeping up regular supplies these days is no easy job although we use every endeavour to schedule production evenly. Just now—whilst we are writing this advertisement—for instance, we can give very prompt delivery of that 'truly portable' Portable P.A. Equipment, the "UNIVERSAL FIFTEEN," operating efficiently on all voltages from 200-240 AC or DC. But a week... a month hence? Who knows? So if you are interested in equipment in which more than usual attention is paid to quality, we cannot urge you too strongly to write to us right away.

R.S. Amplifiers

R. S. AMPLIFIERS LTD • 3-4 HIGHFIELD ROAD • SHEPPERTON • MIDDX.
TELEPHONE WALTON - ON THAMES 1019

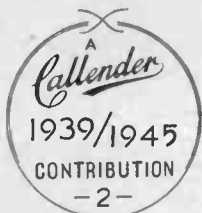
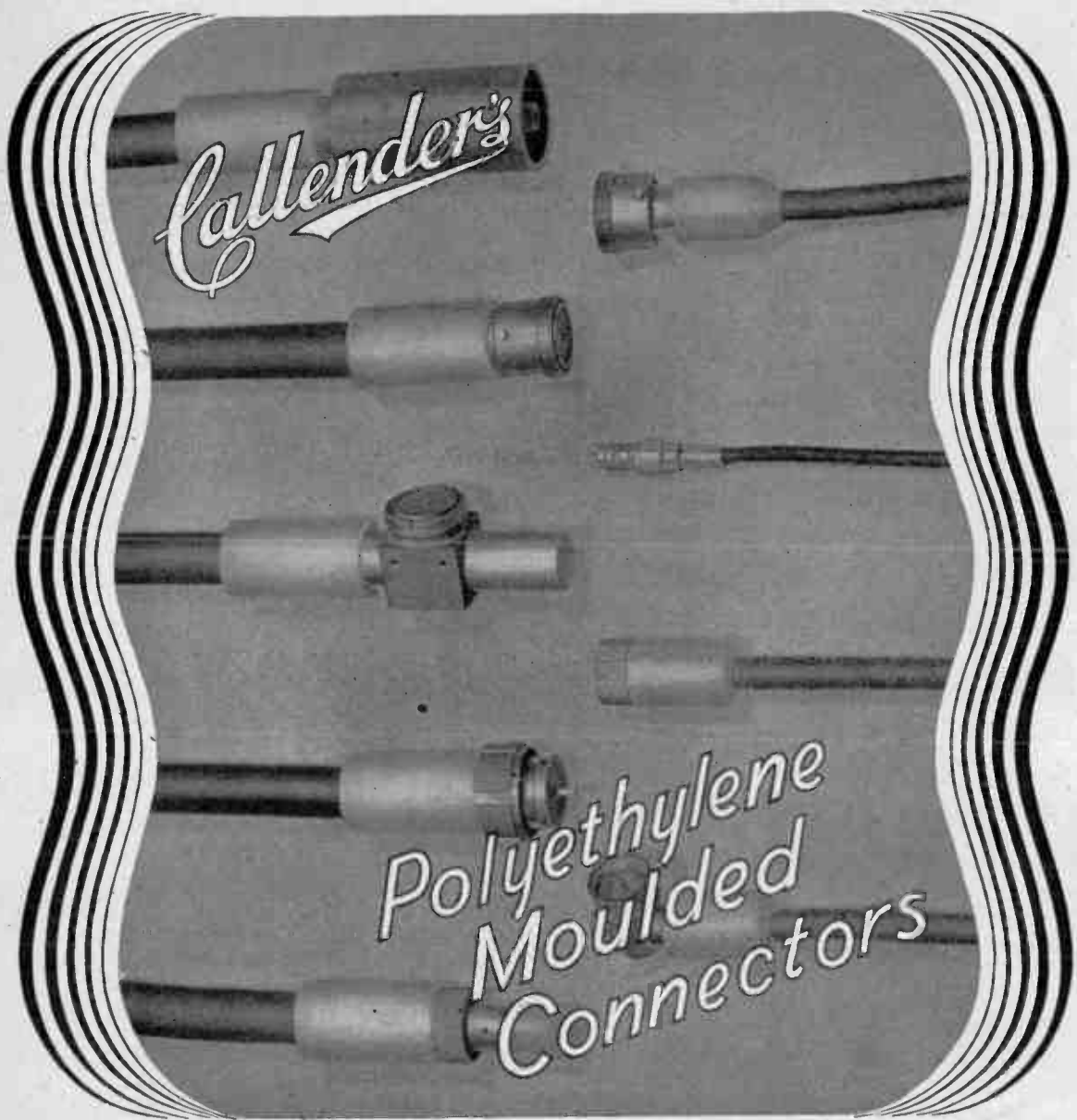

Pressure moulded by a new process that cannot yet be described in detail, these fittings are terminations and connections used in electronic circuits. The production of these polyethylene mouldings in quantity is the result of a new manufacturing technique successfully evolved by Callender's.

BRITISH INSULATED CALLENDER'S CABLES LIMITED

Hamilton House • Victoria Embankment • London, EC4



CERAMIC

High Voltage **CAPACITORS**

Outstanding characteristics of U.I.C. Pot and Plate Capacitors are the high break-down strength, low loss factor, and small dimensions. *Working Voltage:* 10 KV D.C. only or 7.5 KV D.C. Peak + A.C. *Working Load R.F.:* Up to 25 KVA according to type. *Max. Current:* Up to 14 AMP. according to type. *Range of Capacitance:* 5 pF to 1200 pF. Tested to Specification K110. Full details on request.

UNITED INSULATOR CO. LTD. 12-22 LAYSTALL STREET, LONDON, E.C.1

Tel. : TERminus 7383 (5 lines) Grams. : Calanel, Smith, London

THE PIONEERS OF LOW LOSS CERAMICS

From 1939 to 1945

115,000,000
RECTIFIER ELEMENTS,
built into millions of rectifier units

for War Service on land, sea, and in the air—in every theatre of war as well as in every branch of war industry itself—served the needs of war to further the aims of peace.

Most of these have been of new and advanced design and the benefits of this progressive research and development will soon be made available to all.

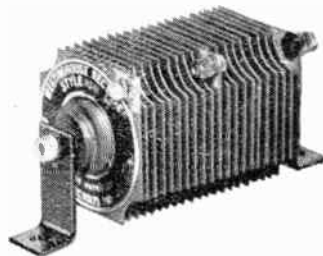

METAL RECTIFIERS

WESTINGHOUSE BRAKE & SIGNAL CO., LTD.,
Pew Hill House, Chippenham, Wilts.

FILM INDUSTRIES LIMITED

pioneers of Public Address Equipment, offer:—



OF COURSE, PRIORITIES HAVE FIRST CONSIDERATION.

F.I. for P.A.
FILM INDUSTRIES LIMITED

60, PADDINGTON STREET, W.1.

'Phone : WELBECK 2385.

LINAGLOW LIMITED

TEST METERS

Finest quality Voltmeters, 2 range pocket type, 0.25 v., 0-250 v. moving iron, **35/-**. Panel mounting moving coil Milliammeters 0-100 m.a., 21m. dial, **57 6/-**; 0-2 m.a., 21m. dial, **45/-**; 0-5 m.a., 21m., 45/-; 0-50 m.a., 3m., dial **45/-**; 0-150 m.a., 21m. dial, **45/-**; 0-11 amp., with shunt, **48 6/-**; 0-50 m.a., 11m. dial, **45/-**.

VARIABLE CONDENSERS. 2-gang, .0005 ceramic with trimmers, 45mg feet, slow-motion drive, dial frame and pointer, **17 9/-**. Midget 2-gang, .00035, **8 6/-**.

TUBULAR PAPER CONDENSERS. 350/500 v., D.C. working. .0001, 3d., .0025, 4d., .01, 8d., .02, 7d., .04, 9d., .08, 9d., .1, 10d., .25, 1-/-, .5, 1 8/-, .05, 9d. each. Parcel of 50 assorted, **27 6/-**.

2-mfd. **TUBULAR CONDENSERS,** 350 v., **2 6/-**.

AERIAL AND OSCILLATOR COILS. Best D.S.C. wire wound, colour coded on bakelite formers. Short, medium and long wave, 16.50 m., 200/550 m., 1,000/2,000 m.; with circuit diagram, **15/-** the set.

I.F. TRANSFORMERS. 465 K.C.'s Iron-cored Litz wound, aluminium can. Limited quantity, **17 6/-** matched pair; **8 6/-** each.

S.M. & L.T.R.F. COILS. Philips; best quality in screened aluminium can; 17-51, 220-585, 725-2,000 metres. (These coils equal to performance of superhet.) Complete with circuit diagram, **9 6/-** the pair.

M. & L.T.R.F. AERIAL COILS. Aluminium screened Philips. 200-585, 725-2,000 metres, complete with circuit diagrams, **2 9 6/-** each.

WAVE CHANGE SWITCH, to suit all above coils, **5 9/-**.

SCREENED INTERLACED FLEXIBLE MICROPHONE CABLE. Twin 6 yards for **6 9/-**; single, 1/- per yard.

VOLUME CONTROLS. 1, 5, 10, 20, 25, 50 and 100 thousand ohms, 4, 1, 1 and 2 meg., without switch, **4 3** each. As above, with switch, **6/-** each; 100,000 ohms, 4 meg., double-pole switch, best American, **6 6** each; 2,000 ohms only, adjustment, **2 6** each; 1,000 ohms only, carbon, screw, adjustment, **1 6** each. Midget 3 meg., with switch, **5 6/-**; less switch, **2 6** each.

MAINS TRANSFORMERS. 350-0-350 4 v. 6 amp. C.T. 4 v. 2 amp., 100 m.a.; heavy laminations; pre-war stock. Bargain, **27 6/-**. 350-0-350, 6.3 v. 3 amp. C.T., 3 v. 2 amp., 100 m.a., **32 6/-**.

L.F. CHOKES. 20 henrys, 150 m.a., **14/-**.

SLOW-MOTION DRIVE. S-1, complete with drum and spindle, **3/-**.

PUSH-BUTTON UNITS. Complete with escutcheon and knobs, 4-way. New, **4 6** each.

WANDER PLUGS. In 2 colours, 2/- per dozen.

LINE CORDS. 3-way, heavy-duty, 3 amp. 360 ohms, **9 6/-**; 480 ohms, **13 6/-**; 600 ohms, **15 9/-**; 2-way, 360 ohms, **5 6/-**; 480 ohms, **7 6/-**; 600 ohms, **13 9/-**.

SPECIAL OFFER BATTERY CHARGERS. 1-amp type, 2, 6, or 12 volt, 200/240 volt input. Finished in black metal cabinet. Small and compact, **£3 19s. 6d.** each.

2 SPECIAL KIT OFFERS

KIT 1.—Tuning heart suitable for 6-valve superhet, comprising variable condenser and slow-motion drive, set of iron-cored I.F.'s 465 K.C.'s Litz wound, aerial coil, R.F. transformer and oscillator coil. All trimmers and padders with wave change switch for 3-wave bands, S.M. and L. Also circuit diagram for complete set, **£3 9s. 6d.**

KIT 2.—Tuning heart for 5-valve superhet, comprising variable condenser and slow-motion drive, set of iron-cored I.F.'s 465 K.C.'s Litz wound, aerial coil and oscillator coil. All trimmers and padders with wave change switch for 3-wave bands, S.M. and L. Also circuit diagram for complete set, **£2 19s. 6d.**

WESTINGHOUSE METAL RECTIFIERS EX-G.P.O.



Suitable for chargers, etc., H wave, H.T. 150/400 v., 50/200 m.a., 15/-.

DE LUXE ALL-WAVE SERVICE SIGNAL GENERATOR

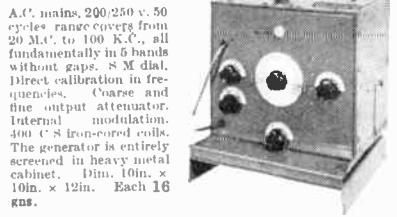

A.C. mains, 200/250 v. 50 cycles, range covers from 20 M.C. to 100 K.C., all fundamentally in 5 bands without gaps. 8 M dial. Direct calibration in frequencies. Coarse and fine output attenuator. Inflection modulation. 400 C 8 Iron-cored coils. The generator is entirely screened in heavy metal cabinet. 10in. 10in. x 10in. x 12in. Each 16 Kbs.

SERVICE KITS

- S5. 1 8-mfd. 500 v.v. Electrolytic, 12 each assorted tubular paper condensers, carbon wire end resistors, 3 yards sleeving, **9 6/-**.
- S5A. 8 x 8-mfd. 500 v.v. Electrolytic, 12 each assorted tubular paper condensers, carbon wire-end resistors, 3 yards sleeving, **10 6/-**.
- S6. 1 8-mfd. 500 v.v., 1 32-mfd. 320 v.v. Electrolytics, 25 each assorted tubular paper condensers, and carbon wire-end resistors, 1 volume control, 3 yards sleeving, **22 6/-**.
- S6A. 1 8 x 8-mfd. 500 v.v., 1 32-mfd. 320 v.v. Electrolytics, 25 assorted tubular paper condensers and carbon wire-end resistors, 1 volume control, 3 yards sleeving, **24 6/-**.
- S7. 2 8-mfd. 500 v.v., 1 4-mfd. 400/500 v.v., 1 32-mfd. 320 v.v. Electrolytics, 18 each assorted tubular paper condensers and carbon wire-end resistors, 2 volume controls, **37 6/-**.
- S7A. 2 8 x 8-mfd. 500 v.v., 1 4-mfd. 400/500 v.v., 1 32-mfd. 320 v.v. Electrolytics, 12 each assorted tubular paper condensers, and carbon wire-end resistors, 2 volume controls, **39 6/-**.
- S8. 3 8-mfd. 500 v.v., 3 32-mfd. 320 v.v., 1 8 x 8-mfd. 500 v.v., 2 4-mfd. 400/500 v.v., 25 each assorted tubular paper condensers and carbon wire-end resistors, 6 yards sleeving, 6 yards P.V.C. cable, 3 tone controls, 6 assorted valveholders, **£4 15s.**
- S8A. 3 8-mfd. 500 v.v., 3 32-mfd. 320 v.v., 3 8 x 8-mfd. 500 v.v., 2 4-mfd. 400/500 v.v., 25 each assorted tubular paper condensers, and carbon wire-end resistors, 6 yards sleeving, 6 yards P.V.C. cable, 3 tone controls, 6 assorted valveholders, **£5 5s.**
- S9. **DE LUXE SERVICE ENGINEER'S KIT.** 6 8 x 8-mfd. 500 v.v., 6 8-mfd. 500 v.v., 6 4-mfd. 500 v.v., 3 32-mfd. 320 v.v., 3 25 x 25-mfd. 500 v.v., 3 50 x 50-mfd. 500 v.v. Electrolytics, 1 pair long-nosed pliers, 3 dozen yards P.V.C. cable, 1 box insulating tape, 1 pair I.F. transformers, 465K.C.'s iron-cored, 1 set aerial and oscillator coils, 162,000 metres, 6 yards sleeving, 6 assorted volume controls, 50 each assorted tubular paper condensers and carbon wire-end resistors, **£12 12s.**

T.R.F. 3-WAVEBAND 4-VALVE CONSTRUCTORS KIT

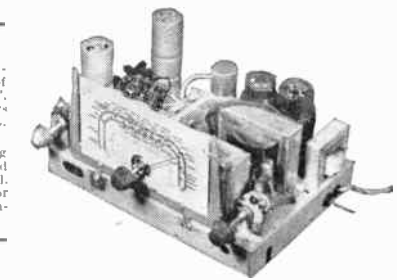

17-2,000 m. Parts, new, ex-television, aluminium screened coils, excellent short-wave reception (the special coils used in this circuit give a performance equal to a superhet), 4 1/2 watts output, complete with loudspeaker, all parts, wiring and theoretical diagram—nothing extra to purchase. Chassis dim. 12in. x 8in. x 6in. to top of dial, 200/250 v. A.C., 1 1/2 gns., including tax. Case and packing, 8s. extra.

ELECTRIC IRONS

Best quality Virens enamel finish. 230/250 v. 450 watt, 5 1/2 lbs., with lead and plug, **38 6/-**.

BREAKFAST COOKERS

Virens enamel finish, hot plate and oven. Dual switches 200,250 v., **57 6/-**.

CAR AERIALS. Telescopic scuttle fixing, extending to 4ft. 6in.; ebonite insulators, nickel-plated, **22 6** each.

VIBRATORS. 4-pln, 6-volt, best quality American, **10 6** each.

MIDGET VANE TYPE. Variable trimmers, 60 mmfd., **3/-** each.

RELAYS. Complete with circuit breaking switch, 200/250 v. A.C., 60 80 v.; D.C. 300 m.a., 15-amp. switch, **7 6** each.

VALVEHOLDERS. Amphetal type. International or English octal chassis mounting, 1/- each; 10 6 per dozen. English wafer type, 4-8 pin, **6** for 2 6.

LOUDSPEAKER TRANSFORMERS. Pentode Output 40:1, 50 m.a., 4/-; Midget multi-ratio 60:1, 80:1, 40 m.a., 7 6; Multi-ratio, 40:1, 60:1, 80:1 and push-pull 80 m.a., 10 6; Pentode Output, 12/15 ohms, 100 m.a., 12 6; Heavy duty, multi-ratio 24:1, 41:1, 48:1, 58:1, 82:1, 116:1 and P.P. 80 m.a., 15 6; 3:1 Inter-valve, 10 6; Push-pull Output, 20-watt, 1,000-0-1,000 Primary, 2.5, 7.5 and 12 15 ohms, secondary, 25/-.

P.M. LOUDSPEAKERS. 3 ohm Voice Coil, Rola, Goodman and Celestion, 6 1/2in., with transformer, **30/-**; 8in., with transformer, **32 6/-**; 2 1/2in., **27 6/-**; 2 1/4in., **30/-**; 5in. 250 ohms, **35/-**; B.T.H. Model, R.K. 10in. Mains energised loudspeakers, 1,000 ohms field, 15 ohms speech, weight, 28 lbs., reconditioned as new, ideal for P.A. work, **£6 6/-**; 10in. Mains energised, 1,140 ohms, with transformer, **45/-**. See transformers above to suit.

VALVES. American types, at B.O.T. controlled retail prices. For replacement purposes only: 6F5, 12F5, 12J5, 12SF5, 1H5, 9 2; 5Y3, 1C5, 11 6; 6Q7, 12Q7, 11 7; 6K6, 6K7, 12J7, 12K7, 6V6G, 12 10; 6A8, 6B8, 68A7, 14/-.

Also British valves at manufacturer's list prices: 6X5, 11 4; 17L6, 11 6; H141DD, TDD4, 11 7; AC/VP2 C14, EF39, KT61, PEN 45, NP41, SP32, T41, VP41, 12 10; D1 Diode lin. Peanut valve with valveholder, 12 10; 6H8, X63, 12Z3, 35Z5, 35Z4, 14 6; AC6/Pen, EL35, PEN 46, T21, 61L6, 18 3. Prices include purchase tax, add 3d. per valve post.

RADIO MECHANIC'S LONG-NOSED PLIERS. Ex-Govt. stock, reconditioned like new, exceptionally cheap, 4/- Extra long-nosed 8 1/2in., 8 6.

HIGH VOLTAGE BRAIDED SLEEVING. 1 and 1 1/4 mm. 2, 3 and 4 mm., first-class quality, 3/6 per dozen yards.

P.V.C. CABLE. 14/36 Red, Green, Blue and Yellow, 2/- per dozen yards.

SPECIAL OFFERS

4-meg. Midget Volume Controls for car radios, etc., 2/6, 5-way Circular Rubber Cable, D.V.14 36, 10d. per yard. 10in Heavy Magnet P.M. Loudspeakers with Pentode output Transformers, **32 6/-**.

Mains Toggle Switches Panel Mounting, 2/- each. DPDT switches, panel mounting, ex-G.P.O., 3/- each. Relays, ex-G.P.O., 300, 500, 1,050, 2,000, 6,500, 8,000, 10,000 ohms, 5/- each.

Wire-wound Carbon Resistors, 1/4, 1/2 and 1 watt. We have practically every size in stock. Send us your requirements.

METAL RECTIFIERS EX-G.P.O.

Suitable for small chargers, relays, etc., 12v. full wave, 100 m.a., 5/-; 6v. H/wave, 50 m.a., 5/-; 4 v. H/wave, 30 m.a., 4/-; 2 v. H/wave, 15 m.a., 4/-; H1, 2 1/2 v., D.C. 10 m.a., 3/6.



LINAGLOW LTD.

Hours of Business: Mon. to Fri. 9 a.m. to 5.30 p.m. Closed 1-2. Nearest Tube—Archway

◆ CALLERS to Show Rooms, 2, HIGHGATE HIGH STREET, N.6

Phone: MOUnview 9431

◆ POST ORDERS to Dept. MO 46, 61, HIGHGATE HIGH ST., N.6

Phone: MOUnview 9432

★ IN THE DEVELOPMENT AND MANUFACTURE OF

Radio Frequency **CABLES**
B.I. HAVE PLAYED A LEADING PART

★ . . . and though supplies are directed to the Services, the experience gained over a considerable manufacturing period is available for the benefit of approved users.

Note.—From fundamental principles, B.I. have made outstanding contributions to design and construction of cables for radio frequency transmission and have perfected production technique.

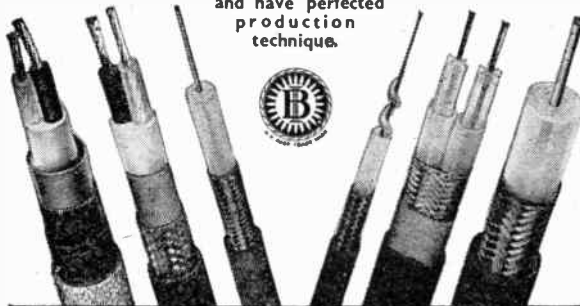

© BRITISH INSULATED CABLES LTD. PRESCOT, LANCs.

Taken over by British Insulated Callender's Cables, Ltd., Regd. Office:—103, Mount Street, London, W.1.



**HEWLETT - PACKARD
LABORATORY
INSTRUMENTS**

FOR SPEED AND ACCURACY

**ELECTRONIC ENGINEERING
SERVICES LIMITED**

24 Stanley Road Heston Moor
Stockport

SOLE BRITISH DISTRIBUTORS

As suppliers of Waxes and Dielectric Compounds to Government specifications to the leaders in the Electrical Industry, we have established a reputation second to none for our

O K E R I N
WAXES

As specialists in the manufacture of Waxes, our Research facilities are at the disposal of those who require a Wax for any technical purpose. Our Waxes are used for Service components.



Consult us —
TE Mple Bar 5927

A.I.D. AND C.I.E.M.E. TYPE APPROVED
for
ARCTIC AND TROPICAL CONDITIONS

**ASTOR BOISSELIER
& LAWRENCE LTD.**
SALES DEPT.

NORFOLK HOUSE, NORFOLK ST., STRAND, LONDON, W.C.2

WHY YOU PREFER ACOUSTICAL—One of a series

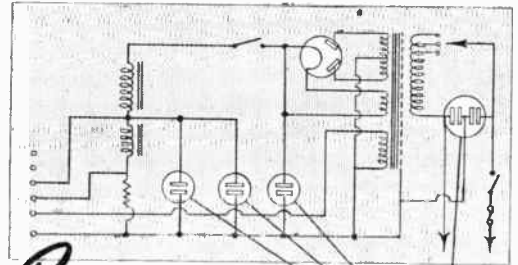

Paper means reliability - plus

In the "U" series Amplifier built by Acoustical, all condensers in the power pack are of the paper type, resulting in the utmost reliability. Just one more reason why you prefer Acoustical.

"Addressing the Public"—a booklet of useful information and diagrams for all those engaged in Public Address work.

1/- post free.



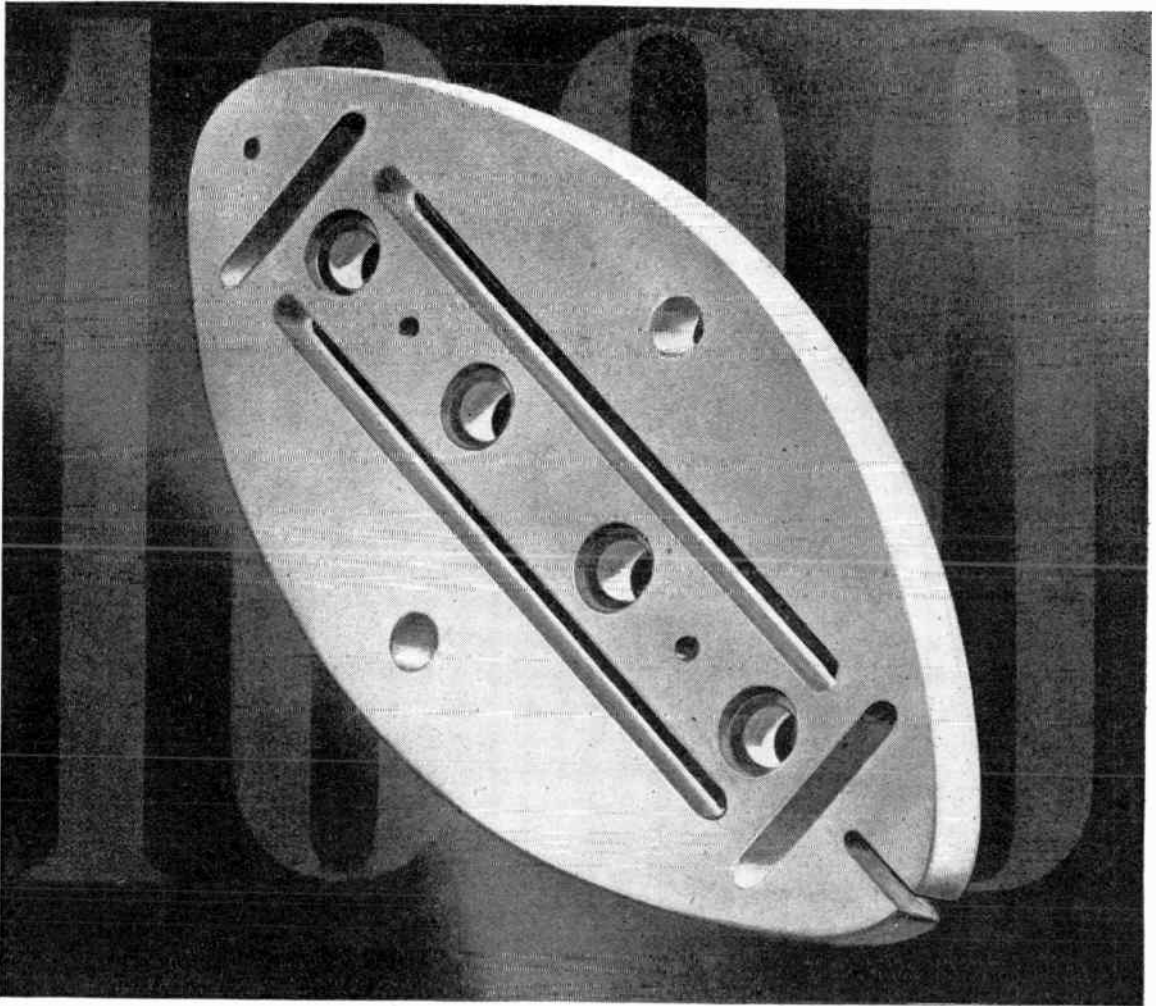

one in a thousand

Ten years ago we introduced the first British-made low-loss ceramic. To-day the range of FREQUENTITE components covers more than a thousand pieces of every shape and size.

With such a store of manufacturing experience we are able to offer advice backed by practical knowledge on your insulation problem. Please consult us before you finalize your design.



STEATITE & PORCELAIN PRODUCTS LTD.

Head Office: Stourport-on-Severn, Worca.

Telephone: Stourport 111.

Telegrams: Steatite, Stourport.

42-5

B

SUPP: 11.

SSW

(11)

PROBLEM

An instrument is out of plane and at an angle with a gearbox to which it must be coupled.

SOLUTION

By using an S.S.W. Co Flexible Drive, Design No. A47, the difficulty can be easily overcome and efficient results obtained.

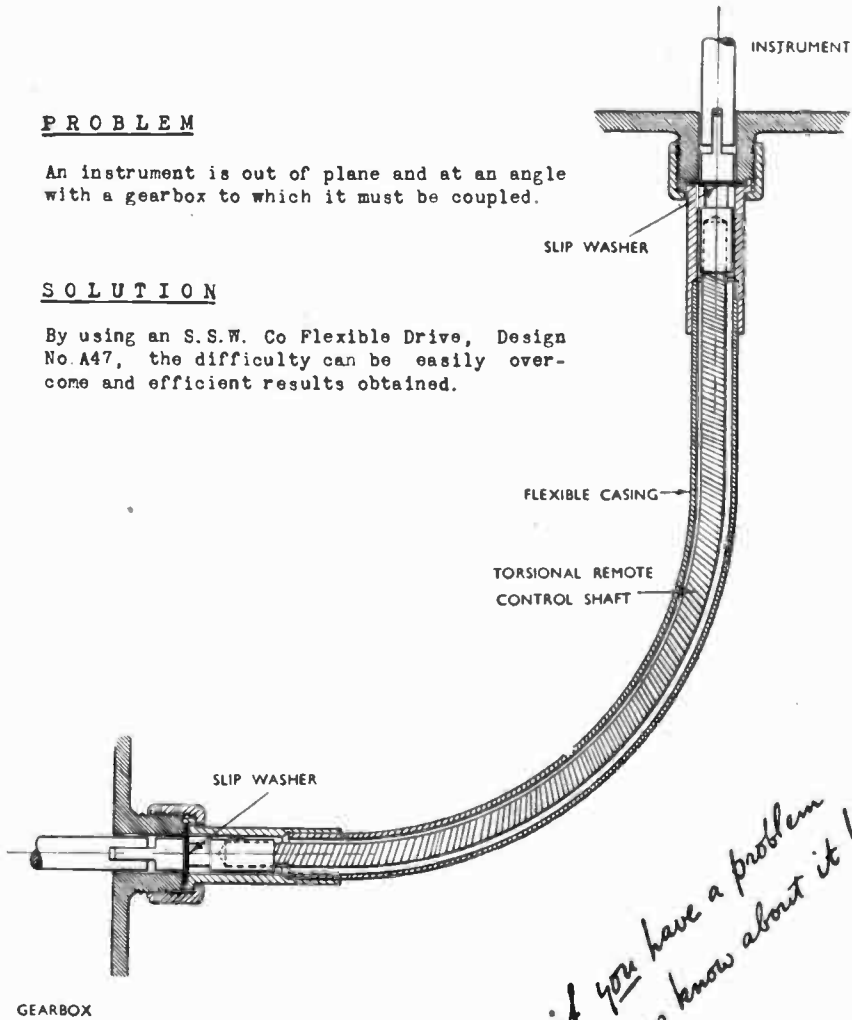

-if you have a problem let us know about it!

Centenary Year

A PAGE FROM THE SUPPLEMENT TO THE TREATISE

This page is for insertion in the loose-leafed TREATISE on FLEXIBLE REMOTE CONTROL. Its position is clearly indicated by the top reference.

If your copy of this addition to the SUPPLEMENT has not yet been received, may we suggest that you cut out this page and place it in the correct position? Better still, of course, send to us for the sheets to the SUPPLEMENT numbered SUPP. 11. (ii) (iii) (iv). These are now in process of being distributed to holders of the TREATISE, a copy of which is still available to those who can put it to good use.

W.T. 22

THE S.S. WHITE COMPANY. LTD., BRITANNIA WORKS, ST. PANCRAS WAY, N.W.1

Wireless World

Proprietors :
ILIFFE & SONS LTD.

Managing Editor :
HUGH S. POCOCK,
M.I.E.E.

Editor :
H. F. SMITH

Editorial, Advertising
and Publishing Offices:

DORSET HOUSE,
STAMFORD STREET,
LONDON, S.E.1.

Telephone :
Waterloo 3333 (35 lines).

Telegrams :
" Ethaworld, Sedist, London."

△

PUBLISHED
MONTHLY

Price : 1/6

(Publication date 26th
of preceding month)

Subscription Rate :
Home and Abroad
20/- per annum.

Radio and Electronics

35th YEAR OF PUBLICATION

AUGUST 1945

MONTHLY COMMENTARY	225
THE " TELEION "	
By J. Reiss	226
RADIO PROSPECTS (concluded)	
By H. A. Hartley	229
VALVES IN THE SERVICES	232
ARMY SET—Type R107	235
DEFINITION IN THE CINEMA	
By H. W. Lee	238
SOLAR ECLIPSE OBSERVATIONS ..	240
CHEAPER HEARING AIDS	
By C. M. R. Balbi	241
WHAT IS QUALITY CONTROL ?	
By Thomas Roddam	243
OPTIMUM VALVE LOAD	
By Dr. Edward Hughes	246
WORLD OF WIRELESS	248
RECORDING LABORATORY	
By Donald W. Aldous	250
LETTERS TO THE EDITOR	252
RANDOM RADIATIONS	
By " Diallist "	254
RECENT INVENTIONS	256

Branch Offices :

COVENTRY :
8-10, Corporation Street,
Telephone : Coventry 5210.

Telegrams :
" Autocar, Coventry."

BIRMINGHAM :
Guildhall Buildings,
Navigation Street, 2.
Telephone :
Midland 2971 (5 lines).
Telegrams :
" Autopress, Birmingham."

MANCHESTER :
260, Deansgate, 3.
Telephone :
Blackfriars 4412 (4 lines).
Telegrams :
" Iliffe, Manchester."

GLAGGOW :
26B, Renfield Street, C.2.
Telephone : Central 4857.
Telegrams : "Iliffe, Glasgow."

△

As many of the circuits and apparatus described in these pages are covered by patents, readers are advised, before making use of them, to satisfy themselves that they would not be infringing patents.

VIBRATORS • TRANSFORMERS • SWITCHES • COILS

MEET A GREAT LITTLE I.F.!

Specially designed to give the maximum gain and selectivity combined with lilliputian dimensions*. Wearite I.F. Transformers are provided with one-hole fixing, the terminal wires being fed through insulated bushings thus preventing movement after mounting. They are available in the following "preferred" frequencies.

M.400.....460 Kc/s M.405.....1.6 Mc/s
M.411.....2.1 Mc/s M.415.....4.86 Mc/s
M.418.....9.72 Mc/s

as well as in frequencies for particular applications.

- Coils enclosed in pot-type iron dust cores
- Tuning by means of adjustable iron dust centre cores
- Fixed tuning condensers contained in screening can

* Dimensions : — 1 1/8" square x 1 1/8" high.

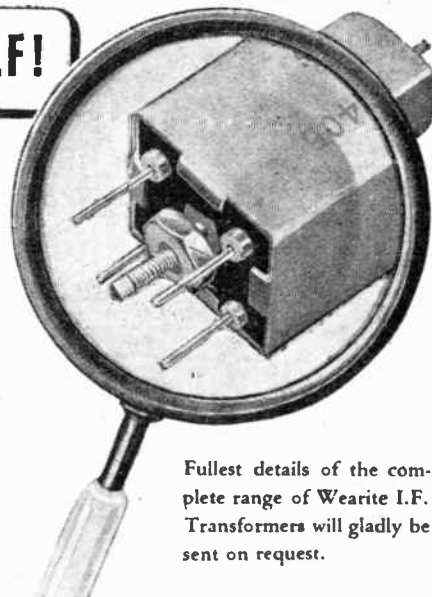

Fullest details of the complete range of Wearite I.F. Transformers will gladly be sent on request.

W R I G H T & W E A I R E L T D

A Name as Old as the Radio Industry

HIGH ROAD TOTTENHAM LONDON N 17 TELEPHONE: TOTTENHAM 3847-9



The letter *Eta*
 (the Greek long e)
 is known by
 engineers as the **symbol**
for Efficiency.

The Philips emblem is
 another **symbol for**
efficiency.



The world-wide
 reputation of Philips
 electrical products is based on the utmost efficiency
 in design, construction and performance.

PHILIPS

**LAMPS • RADIO • X-RAY • COMMUNICATIONS EQUIPMENT
 AND ALLIED ELECTRICAL PRODUCTS**

PHILIPS LAMPS LTD • CENTURY HOUSE • SHAFTESBURY AVENUE • LONDON • W.C.2

(126)

Wireless World

Radio and Electronics

Vol. LI. No. 8

AUGUST 1945

Price 1s. 6d.

Monthly Commentary

Television : Standards of Comparison IT is widely accepted that the cinema provides a convenient and useful standard of comparison when we come to discuss the vexed question of fixing the degree of definition desirable for our post-war television service. In the Television Committee's Report, issued early in the year, such a comparison is constantly made, particularly with regard to big-screen television, and it is categorically stated that the pre-war 405-line system "is not adequate for the large cinema screen, which requires a definition equivalent to a standard of the order of 1,000 lines." Elsewhere in the Report, and without any proviso as to size of screen, the Committee expresses the view that the aim in developing a high-definition system for the future should be "to approach the cinema standard. We think that television definition should eventually be of the order of 1,000 lines. . . ."

Is cinema definition, in fact, equivalent to a 1,000-line television picture, and, as a secondary question, is the cinema an entirely reliable standard of comparison? An answer to the first question is offered in an article appearing elsewhere in this issue, in which the author concludes that, taking into account the conditions under which the final screen image is produced, cinema definition is unlikely to exceed a television equivalent of 400-500 lines in the centre and 300 lines at the edges of the screen.

Questions involving the optical technique of cinematography are rather outside the scope of *Wireless World*, and so we have consulted the Editor of our associated Iliffe journal, *The Amateur Photographer*. In general, he is in broad agreement with the contentions made in the article just quoted, differing only in matters of degree. For instance, he points out that the figures given for the cinema camera lens relate to minimum performance, with the lens wide open. Stopped down, as in bright light, the performance will improve to an extent almost certainly surpassing the limits set by the film. He gives this limit, for film of, say, 55 lines per mm., as about 840 lines per pic-

ture. The projection lens does not lower definition at the centre of the field, though it does so towards the edges. Thus, 840-line television is considered to be the highest standard necessary if equality with the film is the aim. It is also considered that the small angle subtended by the cinema picture as a whole might usefully be stressed. Few people realise that, to an observer situated half-way between projector and screen, the apparent picture size with a 4in. lens is only that of a photo-print 3in. x 4½in. as viewed at 10in. ! With a 7in. lens, size is reduced to 1.7in. x 2.35in.

On the subsidiary question, the Editor of *The Amateur Photographer* offers a word of warning against the blind acceptance of the cinema as an entirely valid standard of comparison. He points out that the home television viewer can approach as closely as he pleases to the screen, and may thus be unwilling to accept a standard of detail-rendering that would satisfy him in the cinema, where he is anchored to his seat. To satisfy the viewer who wants to look at the screen from a distance of 10 inches, 100 lines *per inch of picture* would be needed.

★ ★ ★

Adjusting Ourselves

WE can take encouragement in facing the difficult transition period ahead in the thought that wireless men have not become slaves to conventional ideas to the same extent as practitioners in older arts. So far as receptivity to new technical ideas is concerned, that point is well brought out in a letter from a correspondent, himself an old-timer, published in this issue. But flexibility of mind in technical matters is not enough. The future wireless outlook is potentially fair, but if those potentialities are to be realised quickly and fully, we may be forced to face—or to initiate—drastic changes in the organisational set-up in the industrial and other "political" spheres. It will be the aim of *Wireless World* impartially to present any ideas bearing on these matters that seem likely to bear fruit or to direct thought along profitable channels.

THE "TELEION"

A Versatile Gas Discharge Relay Valve

By J. REISS, B.Sc. (Hons.)

(Romac Radio Corporation, Ltd.)

IN the previous issue of this journal there appeared an article on a high-speed telegraphic system in which one of the essential elements was a gas-filled relay valve of unusual design. It is proposed in this article to give some further details of this valve which has many useful applications in the electronic art.



Fig. 1. Variation in voltage across input electrodes (a) without glow-up electrode; (b) with glow-up electrode.

In the early stages of development of the high-speed telegraph system in 1934 an ordinary two electrode neon valve was at first used as coupling element and later the Pressler neon relay was tried, but because of its sensitiveness to variations in the HT supply and its instability, it proved unsatisfactory. Better results were obtained by using the Pressler tuning indicator with its third electrode which was normally used for suppressing noises. This meant that for the first time it was possible to maintain the glow in the neon device over its whole working range, instead of the usual switching on and off with each impulse as was the case with the two electrode valve. Unfortunately, however, only a very small output voltage was obtainable from this three electrode device as it was not possible to polarise the voltage on the third electrode without interfering with the proper functioning of the other two electrodes.

At this stage the first improvement was made which culminated in the production of the Teleion. A screen was introduced between the first and third electrode so as to prevent the direct influence of one on the other, and so enable the

third electrode to be polarised (i.e. to be held at a voltage more negative than the second electrode with respect to the first electrode).

A scientific controversy arose at the time as to whether it was at all possible to screen one part of a gas-filled valve from the other by means of a metal disc which had to have a hole in the centre to allow for the spreading of the glow along the second electrode. It was maintained that if ionisation took place in one part of the valve it could not be prevented from occurring in the other part of the valve by means of such a screen, and that at best one would still have to contend with the so-called "dark current." However, in the same year, 1934, one such valve was actually made and its effectiveness demonstrated.

In 1935 a fifth electrode was added in order to reduce the time lag normally encountered in gas-filled valves due to ionisation and de-ionisation. This again provoked a rather prolonged scientific controversy, but later on in the same year it was demonstrated on the cathode-ray tube that by the introduction of this fifth electrode—the so-called "glow-

up" electrode—and by maintaining it in an over-saturated condition, the ionisation and de-ionisation times could be reduced to something negligible. In Fig. 1 are shown the type of traces seen on a cathode-ray oscilloscope of the variation of the voltage across the input electrodes of the Teleion when fed from a beat frequency oscillator (through a rectifier). Curve (a) was taken with a Teleion which had no saturated glow-up electrode whilst curve (b) shows the improvement when using an over-saturated glow-up electrode. The humps in curve (a) illustrate the time and energy which is required to produce ionisation and de-ionisation before the valve operates normally and stabilises its own input voltage.

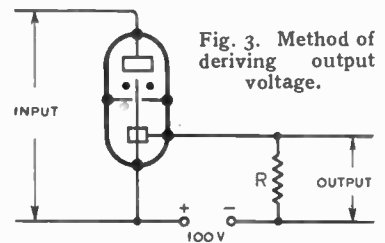

Fig. 3. Method of deriving output voltage.

The addition of this fifth electrode meant, of course, that the range of speeds for which this valve could be used had been greatly increased.

With the help of this five electrode Teleion the first successful high-speed telegraphic arrangement was produced in 1937, this being the forerunner of the arrangement which was used with such remarkable success during this present war.

The Teleion in its present form is a gas-filled valve having five basic electrodes.

1. The positive input electrode, which is a cylinder at the upper end of the valve.
2. The negative input electrode, which is a vertical thin wire in the centre of the valve.
3. The screen, which is a horizontal plate dividing the valve into two parts.

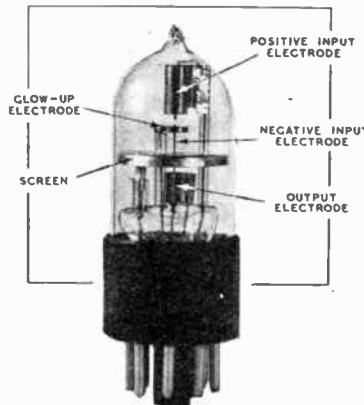

Fig. 2. Principal electrodes in the Teleion valve.

4. The output electrode which is a star-shaped cylinder surrounding the negative input electrode below the screen.

5. The glow-up electrode, which is a ring around the negative

excited by the proximity of the glow. The glow can thus be maintained on the negative input electrode alone or by extending it downwards can be made to touch the output electrode also. This is shown in Fig. 4, where the two conditions for the glow are illustrated.

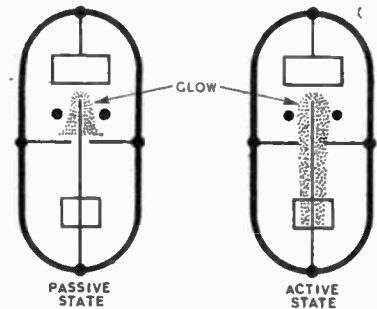

Fig. 4. Extent of glow discharge in the active and passive states.

input electrode between the positive input electrode and the screen.

The input as the name implies is formed by the positive and negative input electrodes. The output is arranged across a suitable resistance which is placed between the output electrode and a potential negative with respect to the negative input electrode. (Fig. 3).

More electrodes are added to fulfil certain requirements. There is an auxiliary positive input electrode, which is a thin wire inside the positive input electrode one end of which approaches very near to the negative input electrode; more output electrodes may be added and placed in a row below the original one.

The propagation of glow along the surface of a cathode with an increase of current in the cathode circuit, is a phenomenon in gas discharge valves. This principle has been incorporated in the Teleion, using the negative input electrode which contains the glow and the output electrode which is

The following are the general characteristics of the Teleion. As the input current increases, there is at first practically no output current at all, then at a predetermined point the full output current is obtained with a very small additional increase in input current. Then with a further increase in input current the output current may be maintained at a constant value. It is important to add that when this process is reversed—that is to say when the input current is decreased again—the new curve obtained almost retraces the curve obtained for an increasing input current as shown in Fig. 5.

Although the change of output voltage across the output resistance is large the input voltage (i.e. the voltage between the positive and negative input electrodes) remains practically constant. This eliminates the Miller effect in the preceding valve more effectively than the screen grid tubes normally employed. The traces

the input electrodes whilst curve (b) shows the output of an amplitude of 100 volts. These curves were taken at a pulsation frequency of 1,000 c/s and illustrate well why the Teleion has proved so successful in high speed telegraphy. The exponential tendencies on one side of the pulses in curve (b) are due to the stray capacities of the leads to the oscilloscope coupled with the one megohm across which the output was taken.

It is of interest to examine

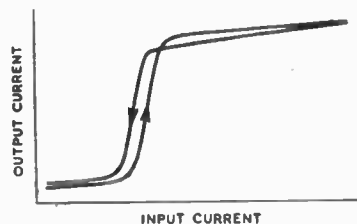

Fig. 5. Input-output characteristic of the Teleion.

more closely why the Teleion gives comparative freedom from Miller effect. One of the chief characteristics of a gas discharge tube is that the current flow may be varied without varying the voltage across the input electrodes. To control this flow of current a variable series resistance is normally employed. In the case of the Teleion, however, the preceding valve is used as the variable resistance, the control of which is maintained by means

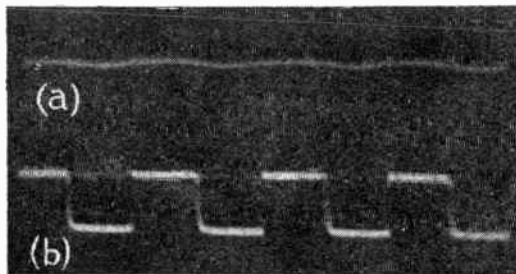

Fig. 6. Oscillograms of input voltage (a) and output voltage (b) at a pulsation frequency of 1000 c/s.

in Fig. 6 were taken on a two beam oscilloscope, curve (a) showing practically no variation across

of the variation in its grid potential. In Fig. 7 is shown the basic circuit for the parallel connection

CHARACTERISTIC DATA FOR THE "TELEION"

Maximum Input Current	Input Voltage	Maximum Output Current	Glow-up Electrode Current	Screen Voltage	Minimum Input Current Variation	
					For DC ampl. 0.6 mA	For relay 0.2 mA
3.5 mA	150-180 V	150 μ A (across 1 M Ω)	3 mA	100-130V		

The "Teleion"—

of the Teleion. It can be seen from the figure that as the supply voltage is constant—particularly as the current withdrawn through resistance R is practically constant and also as the voltage between b and c is constant—the potential

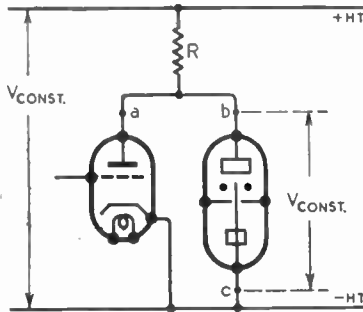

Fig. 7. Basic circuit of Teleion amplifier with parallel connection.

at point a must also be constant irrespective of the variation

of the grid potential. This means that no contra voltage can be reflected back into the input circuit from the anode circuit by means of the inter-electrode capacities, thus eliminating the so-called Miller Effect.

From the characteristics described it will be seen that the Teleion is pre-eminently suitable for the amplification of weak DC pulses such as those derived from the photoelectric cell in a high-speed transmitter or the diode in a receiving circuit. It has also been employed in a sensitive relay circuit of simple design which provides an output of 10 watts for a change of input capacity of one micro-microfarad, and it has also been used to improve the fly-back in time base circuits.

The writer wishes to acknowledge, with thanks, the permission given by M. S. Lalewicz, the inventor of the Teleion, to use certain information incorporated in these notes.

eventually encountered the earth, then, if they travelled at a speed of 1,600 km/sec. they would arrive in about 26 hours.

It was recently announced that spectrograms taken at Mount Wilson in 1944 during magnetic storms showed absorption bands in certain parts of the spectrum, while spectrograms taken during calm magnetic periods showed no such absorption. These absorption bands are attributed to matter travelling from the sun towards the earth, and they indicate maximum velocities of the order of 1,000 km/sec. This is the first direct evidence of the presence in space of calcium ions approaching the earth from the sun at speeds comparable with those previously suggested for the causative agent of magnetic storms.

T. W. B.

IONOSPHERE STORMS

Direct Evidence That They are Caused by Solar Coruscles

WHEN a solar flare is observed on the visible disc of the sun there is very often, at the same time, a sudden ionosphere disturbance, which results in a brief fade-out of short-wave radio signals. That the one is responsible for the other has been well established, the sudden ionosphere disturbance being due to the increased emission of ultra-violet light from the solar flare.

But sometimes there also occurs, about 20–26 hours after the time of the solar flare, a longer period of ionosphere disturbance of a different character from the first—of the type known as an "ionosphere storm." This is the more serious of the two disturbances, so far as its interruptive effects on short-wave communication are concerned, for it lasts a considerable time. Almost always it is accompanied by a disturbance in the earth's magnetic field, and sometimes by auroral displays.

It has for a long time been suspected that a connection exists between the solar flare and the subsequent magnetic and iono-

sphere storms, and that the latter may be due to the arrival in the earth's atmosphere of charged particles of matter which were emitted from the sun at the same time as the visible and ultra-violet radiations. If such particles were ejected from the sun in a direction such that they

ELECTRONIC PROCESS TIMER

DESIGNED for the control of all types of industrial processes and machine tools, including rubber moulding presses, bar twistlers for concrete reinforcing rods, etc., this unit makes use of a single thyratron valve and gives a range of timing intervals from 0 to 25 seconds with an accuracy of 5 per cent. It can be employed also as a time delay switch.

Contactors are fitted to handle up to 5 amps. AC at 230 volts; larger contactors can be fitted to order. The instrument requires a mains input of 200–250 volts, 50 c/s, and is contained in a case measuring 6in. x 6in. x 3in. The makers are G.G.C. Development Co., 109, Belgrave Road, London, S.W.1.

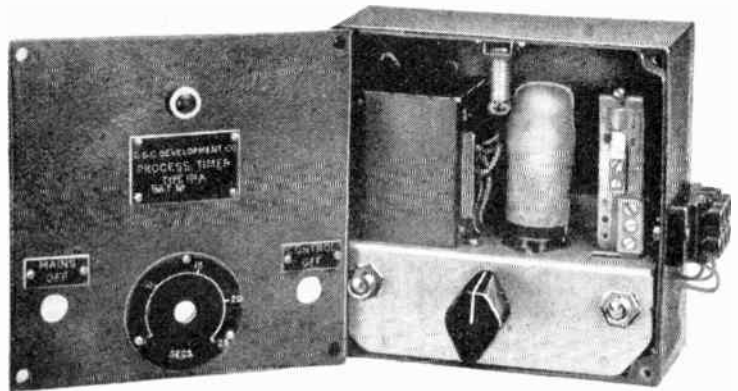

Type P.T.101A electronic process and delay timer.

RADIO PROSPECTS

Suggestions for Re-organisation

By H. A. HARTLEY

(Concluded from page 201, July issue)

THE writer has long believed that technicians should take a political interest in the work they do. This does not mean the sort of politics that the citizen practices when he goes to the poll, but that which is concerned with the way his work is done. The scientist who makes a discovery or the engineer who invents a new machine has a responsibility to society, the responsibility of seeing that the result of his work is used for the good of humanity in general, and not one restricted section of it in particular. A large proportion of the misery that has descended on civilisation has resulted from scientists and engineers taking the view that the exploitation of their work is not their concern. This attitude must be changed, even to the extent of suppressing a new discovery which might be harmful to mankind if improperly used. At the least, steps should be taken to prevent the new knowledge being turned to base ends. This is against the traditional ethic of science; but the time has come when scientific ethic must give way to more important matters, among which is the protection and advancement of civilisation. In all ways the technical worker must take the initiative in the business of developing new methods and apparatus. In our own particular case the plan to be described, if acceptable to technicians, must be sponsored primarily by technicians. It is they who devised broadcasting, and it is they who will improve it. It is their responsibility to ensure that the general public derives the greatest measure of satisfaction and service from their work, for the simple reason that no one else will. In doing so they will also protect their own interests.

In giving the outline of this plan (for considerations of space do not permit of a detailed account) certain premises have to be made. They are:

(a) That commodities have no excuse for existence unless they

are of service or value to the consumer.

(b) That commodities should be designed to give the maximum service to the consumer at the lowest reasonable cost.

(c) That where commodities are of a complex or delicate nature, adequate servicing facilities should exist.

(d) That where the nature of a commodity is such that the consumer is not competent to assess its true worth, the consumer should be protected by a specification for the commodity, as to performance and reliability.

(e) That a manufacturer has no justification for existence as a manufacturer unless his production unit is efficiently run and produces commodities which conform to *a, b, c* and *d* above.

(f) That a manufacturer who produces commodities which do conform to these requirements is entitled to a reasonable profit; and so long as his production unit is efficiently managed, has a right to expect freedom from interference by outside organisations.

(g) That there are three parties to every industrial transaction: the employer, the employee and the consumer. The interests of the first two are safeguarded by employers' federations and trade unions. The interests of the third must be safeguarded by a new sort of organisation.

Backbone of the Industry

We may now consider how to tackle the matter of production for broadcast reception. This aspect of electronics is here considered because of its wide interest, and because it still forms the backbone of the radio industry. Judging from the work done in the U.S.A., it seems that frequency modulation solves the problem of high-fidelity transmission and reception, because it provides a system of short-wave transmission

practically free from interference. The design of FM receivers and transmitters provides technicians with a good opportunity for new work, with plenty of scope for their talents. The problem of who and what is going to provide the FM broadcasting service will be deferred for the time being. For the moment we shall assume that it will exist within a few years of the end of the war.

At the present time there is a serious shortage of radio sets, and most of those now in use are obsolete or working in an unsatisfactory manner. This being so, the time is ripe for tackling the matter of providing the public with good broadcast receivers on new lines. Never, since broadcasting started, has it been so easy, from a "sales resistance" angle, to break away from stereotyped methods, and if FM also arrives, a new sort of set is wanted. It has already been pointed out that the pre-war way of designing and selling sets produced the wrong sort of equipment, so this plan is based on a new conception of how to get sound and vision broadcasting into the homes of the public.

B.B.C. "Network"

Broadcasting is as much a public utility as water or electricity supply, public transport, or garbage collection. In this country we moved ahead of the Americans in unification of the source of programmes. It has taken years of experience of the disadvantages of hundreds of irresponsible broadcasting stations, large and small, to make the Americans realise the advantages of the network system. We have had our own network, in the shape of the B.B.C., longer than any other country. We may complain very bitterly at times about the sort of programmes that are sent out, but at least the B.B.C. system was planned. The receiving of the programmes has never been planned, but it can be.

Ever since the time when the valve manufacturers, unable to

Radio Prospects—

cope with the ever-increasing variety of types of valves called for by set designers, decided to restrict the range, the circuit layout and performance of receivers has tended to become standardised. The valve makers issued to every set maker comprehensive technical reports on the circuit requirements of these standardised valves, and this relieved the set makers from the necessity of having to design receivers from scratch. Certainly, individual set manufacturers introduced novelties of their own which they thought would add refinement to the performance or provide selling points, but basically the various sets had similar sensitivity and selectivity for a given number of valves.

Marked differences existed in the design of appendages like tuning scales, controls and cabinet work, but these differences did not provide alternative service to the user. Only one type of tuning scale is really needed: that which is most easily read and understood. The cabinet work is not a radio problem, and is something which does not properly belong to the radio industry at all.

Receiver Designs

The basis of this new plan is a fully standardised range of receivers of varying performance. The range might include:

- | | |
|--|-----------------------------------|
| A medium-fidelity receiver for B.B.C. programmes. | } of about
4 watts
output. |
| A medium-fidelity all-wave receiver. | |
| A high-fidelity receiver for B.B.C. programmes. | } of about
14 watts
output. |
| A high-fidelity receiver for AM and FM | |
| A small-tube television receiver with medium-fidelity sound. | |
| A large tube television receiver with high-fidelity sound. | |
| Inexpensive gramophone playing desk. | |
| High-fidelity gramophone playing desk. | |

All these chassis would be designed by a central radio research and development establishment, and each type would be covered by a detailed specification of performance, quality and di-

mensions. This central research establishment is very much overdue. It is uneconomical in an industry like radio for each and every manufacturer to have a fully equipped laboratory and staff doing work of an almost exactly similar nature to that done elsewhere. Certain it is that without individual effort in the past many of the advances in technique that have been made would not have materialised; but that initiatory period has passed, and the technique of radio is now fairly well standardised. So much so that for years every broadcast receiver has been made under a common patent pool, and those firms that did the bulk of the original research and development have been handsomely rewarded for their time and trouble. If the industry ever agreed to produce standardised receiver chassis, then it is perfectly obvious that the technique of designing them would also be standardised. The central research institution is the answer.

The cost of maintaining this establishment would, whatever happens, have to be borne by the consumer. Every scrap of radio research must always be paid by the consumer, and it is really a side issue whether it is done by private firms or by the Government. The writer would repeat that he is not here concerned with "isms" of any kind. If Britain became socialistic, then the research centre would be run as a State establishment; if capitalism continues, then the cost would be met by the Radio Industries Council, through the individual members, and ultimately by the people who buy the sets. What is vitally important is the direction of the establishment. Radio must serve the public first, and the manufacturers afterwards. The director would, therefore, be an administrative scientist representing the public and absolutely free from dependence on the industry. He would, in fact, be a State servant.

The designs of the research centre would be made by any manufacturer who wished to make them, and no manufacturer would be allowed to design and produce other equipment unless he also undertook to produce a certain quota of the standardised sets.

The standard chassis would have to conform to the specification laid down for them and they would be sold under the positive guarantee that they did so conform. By this provision the public would be protected from the effects of shoddy material and bad workmanship. It seems logical that the standard chassis should be sold at standard prices, but this system is so liable to abuse, as experience of cartels has shown, that it might be better to retain those features of private enterprise which result in the most efficiently run production unit making commodities at the lowest price, other things being equal.

Advantages

This scheme of a restricted range of standard chassis has many advantages. The cost to the consumer would be enormously reduced by the elimination of wasteful competition; also by the lowering of overhead costs per unit by the larger production of each type consequent on the reduction of number of types. The dealer who has to transfer the set from the manufacturer to the customer would have to carry a very much simpler stock, and his servicing problems would be substantially reduced by having to cater for only a few types instead of many; this would reduce the variety of component parts he has hitherto had to carry in stock. Further, standardised mass-produced test equipment could be produced at a very low figure, so enabling even small-town dealers to install the necessary facilities for carrying out all repairs on their own premises.

The manufacturers would benefit very considerably indeed, for they would at once be relieved from the anxiety of speculative production. Absolved from the necessity of trying to guess what the public will buy, they will have full opportunity for planning their production in the most effective manner; by statistical investigation, the Radio Industries Council could estimate the total number of sets required each year, how the total should be divided up into proportionate parts according to type of chassis, and allocate production of agreed percentages among its members. The factory

workers would benefit by being relieved of the bugbear of seasonal unemployment, a grotesque and inexcusable result of letting things take their own course. After the war labour will have to be directed in very large numbers to such activities as the production of building materials and the erection of homes for the people; it will be necessary for factories in other industries to employ their workers in the most efficient way, and standardised radio production would remove the seasonal demand for sets which were new only in "trimmings," and so enable the factories to work at a constant rate all the year round.

And finally our technicians would benefit. Instead of a mad rush for three months in each year getting something ready for the next Radiolympia, a something which only emerged from the emotional whimsies of the managing director, the indeterminate hunches of the sales department, and such snooping into the activities of other manufacturers as could be achieved, our scientific workers and engineers would be able to evolve a properly planned scheme of broadcast transmission and reception worthy of the century in which we live. They would have security and time to do their work properly. They would not have to make do with ill-equipped laboratories, as so many have had to in the past, but, with the resources of the research and development centre behind them, could do the sort of work they have been able to do during the war, of a class quite beyond the resources of all but a very few private concerns. The semi-skilled technical men would also benefit in a way about to be described.

Radio Cabinets

Thus far we have produced a range of radio and television chassis. This is all that some people want. Architects would like to build in radio as they do central heating and air-conditioning. With these standardised units constructed to a definite specification, they would know exactly where they stand. The private householder might be glad, if he is hard up, to buy the

bare chassis of a radio set; or he might wish to put it into a cabinet of his own design or construction. However, the majority of people seem to consider a radio set as an article of furniture, and in a democratic country all tastes must be considered. The difficulty is surmounted very easily. A panel of designers would be employed to produce a range of cabinet designs for each of the chassis, ranging from a simple box to a fairly elaborate radio-gramophone. These cabinets would also be standardised in construction, dimensions, materials; but they would be supplied by the cabinet-making industry direct to the dealers, thus avoiding a radio manufacturer's overhead charges. The customer would select his chassis and cabinet in the dealer's shop, and there the two would be fitted together.

The Dealer's Part

The dealer must be the essential link between factory and consumer. He must be competent to install and service the equipment, and have financial stability. He will have to employ certified service-men who are paid a salary commensurate with their qualifications. He will have premises situated to meet consumer demand and servicing. This, no doubt, sounds idealistic; but the shopkeeper has a dignified and honourable place in the community. He is not only a servant of the public, but ought also to be their adviser. By lifting the dealer outside the ordinary conception of a parasitic middleman, he acquires new dignity and self-reliance, but he must at the same time give the service which this increased prestige demands. A nation-wide network of radio dealers of this type would provide good employment for thousands of semi-skilled technical men discharged from the armed forces, whose future is otherwise not very promising.

Here, then, is a new plan for the production and marketing of broadcast sound and television receivers. Details cannot be considered here, but should be talked over by radio men in all walks of life. The plan does not depend on

the adoption of any particular form of political economy by the electorate at large, for the ownership of the research centre and the means of production and distribution is a matter of indifference.

But a plan has got to be produced. So far the radio industry has produced nothing beyond a vague statement about increasing production of radio receivers over the pre-war figures, and paying a lot of attention to television. The Bristol Institution of Radio Engineers has issued a report on technical matters and the training and employment of technical workers, which is of great interest to technicians; but it does not deal with the economic and political aspects of the industry. It is not claimed that the present scheme is even approximately perfect, but it is based on a knowledge of what has been or has not been done in the industry in the past, and a shrewd suspicion that unless some positive and progressive plan is put into force, the industry will, after the first few years of meeting normal public demand, finally drift into chaos and bankruptcy.

Neither this nor any other plan will ever make progress or be adopted until organised effort by intelligent people is made. And so the matter is left for the consideration of the technical workers of the industry, who, the writer hopes, will take action on what he has put down in this contribution.

OUR COVER

A SELECTION of Osram high-power valves, ranging from 12-kW to 150-kW anode dissipation, forms the subject of this month's cover illustration. The group includes water-cooled rectifiers with binocular anodes, an air-cooled-anode transmitting triode arranged for either convection or forced air cooling, and an air-cooled-anode mercury rectifier for an output up to 12 amps.

POSTAL TUITION

A SERIES of postal courses has been instituted by the Dundee Wireless College, 7, Airlie Place, Dundee. The courses are planned for those proposing to sit for the P.M.G. 1st and 2nd Class Certificates and for the Civil Air Licence; there is also a course in radio engineering and servicing.

VALVES IN THE SERVICES

Type Designations and Their Commercial Equivalents

(Information supplied by The Inter-Service Technical Valve Committee)

Many readers, both inside and outside the Services, who are concerned with the use of valves marked with Service names, would like to know the commercial types on which the Service types were based. The following tables give this information. The first column shows the Service names, A . . . being an Army type, N . . . a Naval type, V . . . an Air Force type, and CV . . . a common Service type. Since 1941 all valves adopted by the Services have been given "CV" titles, and later all the old A . . ., N . . ., and V . . . valves were brought into this system to eliminate overlapping. However, as large stocks of valves marked with the old Service type designations still exist and numerous equipments are marked with those names, they are made the basis of the arrangement in the first column.

A warning should be given that strict equivalence between the Service type and the given commercial type must not be assumed, as the specification for the Service valve may require selection either for electrical or mechanical requirements or both.

Original Service Name	Current Title	Other Service Names	Commercial Type	Original Service Name	Current Title	Other Service Names	Commercial Type
AD1	CV1314		DLS10	ARTP1	CV1344		TP22
ARDD1	CV1300		10D1	ARTP2	CV1345		TP25
ARDD3	CV1301		D63, 6H6G	AR4	CV1303		HL210A
ARDD5	CV1054	VR54	EB34	AR5	CV1166	NR42	LP2
ARD2	CV1078	VR78	D1	AR6	CV1304		LP2
ARD4	CV1302		D42	AR7	CV1109	NR55, VR109 and A	4D1
ARH1	CV1280	NR67	X64				
ARP1	CV1118	NR39, VR118	PT2, KT2	AR8	CV1306		HL231D1
ARP2	CV1320		SP2	AR9	CV1307		210LF
ARP3	CV1321		9D2	AR10	CV1308		L211D1
ARP4	CV1322		SP210	AR11	CV1309		4019B
ARP5	CV1323		VP2	AR12	CV1310		4020A
ARP6	CV1324		SP4	AR13	CV1311		4022AR
ARP7	CV1325		42MPT	AR14	CV1312		220RC
ARP8	CV1326		AC4/Pen	AR15	CV1313		220LF
ARP9	CV1327		Pen1340	AR16	CV1032	VR32	220B
ARP9A	CV1328		7D8S	AR17	CV1037	NR31, VR37	MH4
ARP10	CV1329		APP4G*	AR20	CV1316		4021B
ARP11	CV1330		TSP4	AR21	CV1055	NR48, VR55	EBC33
ARP12	CV1331		VP23	ATP4	CV1366		V248A
ARP13	CV1332		210VPT, VP21	ATP5	CV1367		V245
ARP14	CV1333		220IPT	ATP7	CV1368		V226
ARP15	CV1195	NR86	KTW63	ATP10	CV1369		4061A
ARP16	CV1074	NR83, VT74	KTZ63	ATP35	CV1370		PV1-35
ARP17	CV1186	NR85	KT63, 6F6G	ATP75	CV1371		PZ1-75, SW75Pen
ARP18	CV1334		KT24				4069A
ARP19	CV1335		SP41	ATP100	CV1372		PY3-600
ARP20	CV1336		SP42	ATP600	CV1373		807
ARP21	CV1192	NR79	Z62	ATS25	CV1374		4282BZ
ARP22	CV1337		116Pen	ATS70	CV1365		SG250
ARP23	CV1124	NR70, VR124	MS/Pen	ATS250	CV1357		LS5
ARP24	CV1338		220VPT	AT15	CV2845		LS5B
ARP25	CV1181	NR59	KT41	AT16	CV2846		MZ05-20
ARP26	CV1340		KT44 (mod)	AT20	CV1361		DET25
ARP33	CV1341		MSP4	AT35	CV1025	VT25	ACT6
ARP34	CV1053	VR53	EF39	AT75	CV1222	NT39	DET16
ARP35	CV1091	VR91	EF50	AT200B	CV1363		FW4-500
ARP36	CV1065	VR65	SP41 (mod)	AU1	CV1264	NU12	RG5-500, 4064A
ARP37	CV1342		QP25	AU2	CV1349		MU12/14, UU5,
ARP38	CV1343		KTZ73 (mod)	AU3A	CV1039	NU17, VU39	IW4, 441U
ARS6	CV1317		S625				U17
ARS7	CV1318		V824, PM12M, S215VM	AU4	CV1113	NU18, VU113	V1907
			V82	AU5	CV1111	VU111	GU50, MU4250,
			ECH35	AU6	CV1072	VU72	RG1/240
ARS8	CV1319						
ARTH2	CV1347						

Original Service Name	Current Title	Other Service Names	Commercial Type	Original Service Name	Current Title	Other Service Names	Commercial Type
AU7	CV1355		ESU300	NR41	CV1083	VR83	210VPT, VP21
AU8	CV1356		U22	NR42	CV1166	AR5	LP2
AU12	CV2853		UI5, RZ1-250	NR43	CV1167		PM24A
AW2	CV1070	VS70	7475	NR44	CV1168		AC044, PX4
AW3	CV1110	VS110	S130	NR45	CV1169		VMP4G
AW4	CV1068	VS68	STV280/40	NR46	CV1170		D41
AW5	CV1359		ME41	NR47	CV1040	VR40	PX25, DO24,
AW6	CV1077	VI77	EM31				PP5/400
CV5	CV5		GU21	NR48	CV1055	AR21, VR55	EBC33
			(special)	NR49	CV1056	VR56	EF36
CV9	CV9		AL60	NR50	CV1171		HA1, AT4, A40
CV18	CV18		RK34	NR51	CV1172		VP4A
CV19	CV19		EHT1	NR52	CV1173		354V
CV24	CV24		HL41	NR53	CV1174		KT42, MP/Pen,
CV25	CV25		4242A				Pen4VA,
CV26	CV26		813				AC/Pen
CV27	CV27		4357A	NR54	CV1175		ZA1, AP4
CV28	CV28		ACT9	NR55	CV1109	AR7, VR109	4D1
CV30	CV30		4270A			and A	
CV31	CV31		U20	NR56	CV1178		DA30, DO30
CV33	CV33		4077A	NR57	CV1179		TT4
CV34	CV34		MR10	NR58	CV1180		V312
CV45	CV45		S130 (mod)	NR59	CV1181		KT41
CV49	CV49		3B/501A	NR60	CV1182		H42
CV65	CV65		Pen25	NR61	CV1183		W42
CV66	CV66		RL37	NR62	CV1184		A373
CV71	CV71		"Osglim"	NR64	CV1281		KTW61
CV75	CV75		4313C	NR65	CV1282		AC/S2Pen,
CV84	CV84		3B/102B				MSP4
CV93	CV93		V625	NR66	CV1187		D41
CV152	CV152		GU21	NR67	CV1280	ARH1	X64
CV173	CV173		DDR2	NR68	CV587		DH63, 6Q7G
CV181	CV181		ECC32	NR69	CV1103	VH103	Y63
CV185	CV185		PM202	NR70	CV1124	ARP23, VR124	MS/Pen
CV187	CV187		U19	NR71	CV1129	VR129	MS/PenT
CV190	CV190		DLS10	NR72	CV1188		N43
CV207	CV207		AC/P4	NR73	CV1285		ECC31
CV216	CV216		VR150/30	NR74	CV1189		AC6Pen
CV225	CV225		ACT17	NR75	CV1190		AC/P4
CV235	CV235		U23	NR76	CV1191		KTZ41
CV242	CV242		GS18, CMG25	NR77	CV1286		EL35
CV243	CV243		4045A	NR78	CV581	6C5G	6C5G
CV244	CV244		4046A	NR79	CV1192	ARP21	Z62
CV245	CV245		4328D	NR81	CV1941	6K7G	6K7G
CV285	CV285		VA35	NR82	CV1193		X65
NGT1	CV1141		GDT4C	NR83	CV1074	ARP16, VT74	KTZ63
NGT2	CV1128	VGT128	GT1C	NR84	CV1194		X41
NGT3	CV1142		MR75	NR85	CV1186	ARP17	KT63, 6F6G
NGT4	CV1143		GT1A	NR86	CV1195	ARP15	KTW63
NGT5	CV1144		BT19	NR87	CV1196		AC5PenD1)
NGT6	CV1145		BT9A	NR88	CV1197		RL18
NGT7	CV1147		BT35	NR94	CV1198		AC/P4
NGT9	CV1149		BT41	NR95	CV1502	VR502	KT32
NR15	CV1151		I410, PM4DX	NS1	CV1069	VS69	STV280/80
NR16	CV1153		PM254	NS3	CV1200		202
NR16A	CV1154		PM254	NS4	CV1201		4317
NR18	CV1156		DEQ	NS5	CV1202		304
NR22	CV1158		S410, PM14	NT13	CV2788		P610
NR23	CV1159		S410, PM14	NT18	CV1206		DO60, DA60
NR26	CV1038	VR38	MHL4	NT20	CV1208		P625, PM256
NR27	CV1160		104V	NT36	CV1219		DA100, MZ1-100
NR28	CV1019	VR19	215P	NT37	CV1220		4033A
NR31	CV1037	AR17, VR37	MH4	NT38	CV1293		SW75Pen,
NR35	CV1163		PM2BA				PZ1-75, PT6
NR37	CV1164		MS4, MSPen	NT39	CV1222	AT75	ACT6
			(mod)	NT40	CV1223		DET5
NR38	CV1165		VMS4, MVSPen	NT58	CV1288		DET12, TY1-50
			(mod)	NT62	CV1237		PM24D
NR39	CV1118	ARPL, VR118	PT2, KT2	NT65A	CV1240		PZ1-35

Original Service Name	Current Title	Other Service Names	Commercial Type	Original Service Name	Current Title	Other Service Names	Commercial Type
NT82	CV1246		P2	VR137	CV1137		RL16
NT87	CV1250		4279A	VR502	CV1502	NR95	KT32
NT92	CV1252		4212E	VR503	CV1503		KT33C
NU5	CV1261		RX3-120	VR505	CV1505		MH41
NU12	CV1264	AU1	FW4-500	VS68	CV1068	AW4	STV280/40
NU13	CV1265		U15, RZ1-250	VS69	CV1069	NS1	STV280/80
NU15	CV1267		U4020	VS70	CV1070	AW2	7475
NU17	CV1039	AU3A, VU39	MU12/14, UU5, IW4, 44IU	VS110	CV1110	AW3	S130
			U17	VT20	CV1020		220P
NU18	CV1113	AU4, VU113	U50	VT23	CV1023		230XP
NU20	CV1268		MU2	VT25	CV1025	AT35	DET25
NU31	CV1279		SU2150A	VT31	CV1031		SG250
NU33	CV1290		HVR2	VT34	CV1034		DET3
NU34	CV1134		T41	VT45	CV1045		X56
VGT121	CV1121		GT1C	VT46	CV1046		PT25H
VGT128	CV1128	NGT2	EM31	VT47	CV1047		TZ05-20,
VI77	CV1077	AW6	Y63	VT50	CV1050		VLS417
VI103	CV1103	NR69	215SG	VT51	CV1051		HL2K
VR18	CV1018		215P	VT52	CV1052		Pen220A
VR19	CV1019	NR28	220PA	VT58	CV1058		EL32
VR22	CV1022		220VSG	VT60	CV1060		E960
VR28	CV1028		220B	VT61	CV1061		807
VR32	CV1032	AR16	QP21	VT61A	CV1573		4074A, DET19,
VR35	CV1035		MH4	VT62	CV1062		RK34
VR37	CV1037	NP31, AR17	MHL4	VT73	CV1073		TVO3-10 (mod)
VR38	CV1038	NR26	PX25, DO24,	VT74	CV1074	NR83, ARP16	DET12, TY1-50
VR40	CV1040	NR47	PP5/400	VT75	CV1075		H63
			PM12M	VT75A	CV1576		KTZ63
VR41	CV1041		210PG	VT75B	CV1577		KT66
VR43	CV1043		210DDT	VT76	CV1076		KT44T
VR44	CV1044		210SPT	VT77	CV1077		KT44
VR49	CV1049		EF39	VT79	CV1079		DA41, TZ40
VR53	CV1053	ARP34	EB34	VT80	CV1080		KT8
VR54	CV1054	ARDD5	EBC33	VT81	CV1081		4307A
VR55	CV1055	NR48, AR21	EF36	VT88	CV1088		4052A
VR56	CV1056	NR49	EK32	VT96	CV1096		832
VR57	CV1057		HA2, 955, 4671	VT104	CV1104		5B/502A
VR59	CV1059		SP41 (mod)	VT105	CV1105		PT15
VR65	CV1065	ARP36	SP41	VT114	CV1114		ML6
VR65A	CV1574		P41 (mod)	VT127	CV1127		E1024
VR66	CV1066		L63	VT506	CV1506		Pen46
VR67	CV1067		D1	VU39	CV1039	NU17, AU3A	5C/450A
VR78	CV1078	ARD2	220TH	VU71	CV1071		MU12/14, UU5,
VR82	CV1082		220VPT, VP21	VU72	CV1072	AU6	IW4, 44IU
VR83	CV1083	NR41	EF50	VU111	CV1111	AU5	U52
VR91	CV1091	ARP35	EA50	VU113	CV1113	NU18, AU4	GU50, RG1-
VR92	CV1092		ZA2, 954, 4672	VU134	CV1134	NU34	240, MU4250
VR95	CV1095		X66	VU504	CV1504		V1907
VR99	CV1099		ECH35, E1341	VU508	CV1508		U17
VR99A	CV1581		KTW62				HVR2
VR100	CV1100		MHLD6				V1901
VR101	CV1101		BL63				V1913
VR102	CV1102		9D2				
VR106	CV1106		15D2				
VR107	CV1107		8D2				
VR108	CV1108		4D1				
VR109	CV1109	NR55, AR7	V872				
VR116	CV1116		41MTL				
VR117	CV1117		1T2, KT2				
VR118	CV1118	NR39, ARP1	DDL4				
VR119	CV1119		41MXP				
VR122	CV1122		MS/Pen				
VR124	CV1124	NR70, ARP23	MS/PenB				
VR125	CV1125		4SH				
VR126	CV1126		MS/PenT				
VR129	CV1129	NR71	HL23				
VR130	CV1130		E1148				
VR135	CV1135		RL7				
VR136	CV1136						

CULTIVATED CRYSTALS

DUE to the present difficulty in obtaining natural quartz in Switzerland, the firm of Brown-Boveri, of Baden, are "growing" artificial piezo-electric crystals. The manufacturing process used was developed by Prof. Scherrer, of the Swiss Federal Institute of Technology. It is stated that the artificial crystals differ only slightly in their properties from those of natural quartz.

Another development of the Swiss firm, described in the *Brown-Boveri Review*, relates to the "Turbator" valve, designed for the generation of centimetre wavelengths. Formerly, the output frequency was fixed solely by the internal valve characteristics, but means have now been devised for introducing variable external tuning by a Lecher wire system.

ARMY SET – Type R107

Communications Receiver, Embodying Variable Selectivity, High Sensitivity and Covering a Wave-band of 1.2 Mc/s to 17.5 Mc/s

ALTHOUGH much Army wireless equipment is of a highly specialised kind, some of the apparatus represents an obvious development from civilian prototypes, and so is of much more general interest. A good example in this category is the Type R107, one of the Army's best communications receivers.

Referring to its circuit diagram reproduced here it will be seen that eight valves are used, they perform the following functions. V1 is a signal-frequency RF amplifier which is coupled to a frequency changing valve V2 by a pair of link-coupled tuned circuits. There is a separate local oscillator valve V3 and then come two IF amplifiers V4 and V5. These are followed by a duo-diode-triode V7, one diode of which functions as a detector with its companion diode pro-

viding delayed AVC and the triode section giving a stage of AF amplification. The valve V6 is a beat-frequency oscillator for CW reception and, finally, there is a low-power triode output stage in the form of the triode section of another duo-diode-triode valve V8. Outside this receiving chain is one other valve V9, a full-wave rectifier for HT supply, which will be found in the power unit.

The first interesting feature one notices is the pair of link coupled tuned RF circuits, which form the coupling between the RF amplifier V1 and the frequency changer V2. Their function is to give good second-channel discriminatory powers to the circuit

as at the higher signal frequencies a total of two tuned circuits only ahead of the frequency changer does not provide a very high ratio of signal to second channel interference, even with an IF of 465 kc/s.

The IF amplifier next claims attention if only for the imposing array of the eight tuned circuits it contains. A single pair couples the frequency changer to the first IF amplifier V4, but two pairs in tandem couple V4 to V5, the second IF amplifier. Coupling between the secondary circuit of one and the primary circuit of the next is, in this case, by means of a 2.2 μ F capacitor C44.

The selectivity provided by this chain of circuits is such that at 3 kc/s off resonance the signal attenuation is about 6 db. This is quite satisfactory for modulated CW morse transmissions and tolerable for R/T where inter-

The front panel of the R107 receiver carries no fewer than fourteen controls. The annotation is the same as used on the circuit diagram.

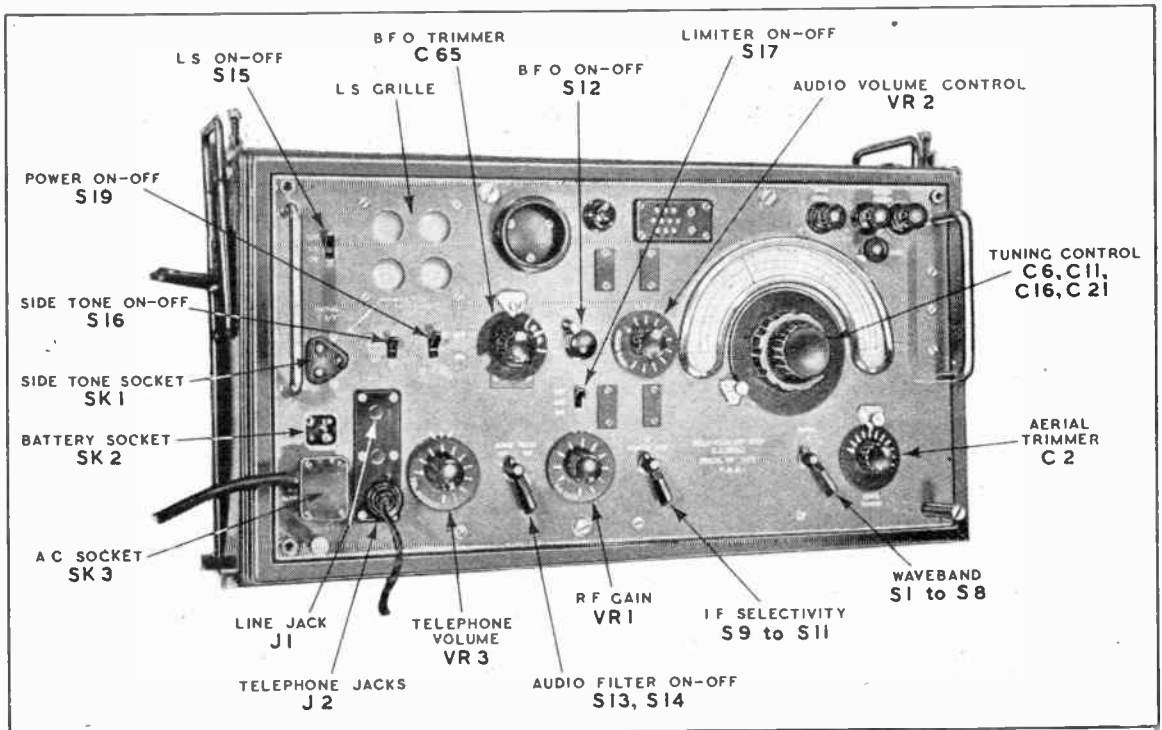

Army Set—Type R107—

ference is very bad, but under less stringent conditions a broadening of the IF response will have its advantages. This also can be done, provision being made for opening out the IF response to a bandwidth of ± 7.5 kc/s.

This variable selectivity feature is obtained by augmenting the normal inductive coupling in the IF transformers by inserting capacity coupling in the low-potential ends of the first three transformers. The capacitors used for this purpose are C31, C42 and C50, each of 0.05 μ F capacity and the necessary circuit rearrangement is effected by the three ganged-switches S9, S10 and S11.

When interference is really bad and still higher selectivity is needed (it can be utilised only for CW transmissions) an audio filter tuned to 900 c/s and having a bandwidth of ± 150 c/s can be inserted between the penultimate and output valves, V7 and V8,

giving a frequency coverage of 1.2 Mc/s to 17.5 Mc/s, which in wavelength is 250 metres to 17 metres approximately. The individual coverages of these ranges are 1.2 to 3 Mc/s, 2.9 to 7.25 Mc/s and 7 to 17.5 Mc/s respectively. Tuning is by a four-gang variable condenser, each section of which has a capacity of 300 μ F, these being marked C6, C11, C16 and C21 in the circuit. The latter is the oscillator tuning section.

Unit Construction

It might be advisable to explain that the circuit diagram given here has been much simplified. In actual fact the receiver is an assembly of three independent units interconnected by twelve-way tag boards and the medley of leads so produced is most confusing when endeavouring to follow a circuit. These interconnections were accordingly omitted, as were two of the three sets of signal frequency coils in the RF intervalve coupling and

appropriate ones are brought into circuit by a three-way waveband-switch which in reality is a ganged assembly consisting of the separate switches S1 to S8 inclusive, plus those for shorting out the idle coils and not included in the diagram.

In the general outline of the function of the various stages in the set V2 was described as the frequency changer. Actually this function is shared by V2 and V3, the former being the mixer, which in the early days of the superheterodyne was often, and with some justification, described as the first detector, while the latter is the local oscillator.

The locally generated oscillations are injected into the suppressor grid of V2 via C20. This grid, being joined to the earth line via the resistor R14, receives a negative bias derived from the flow of cathode current through R12 and R13 in series, whereas the control grid gets its negative bias from the voltage drop across

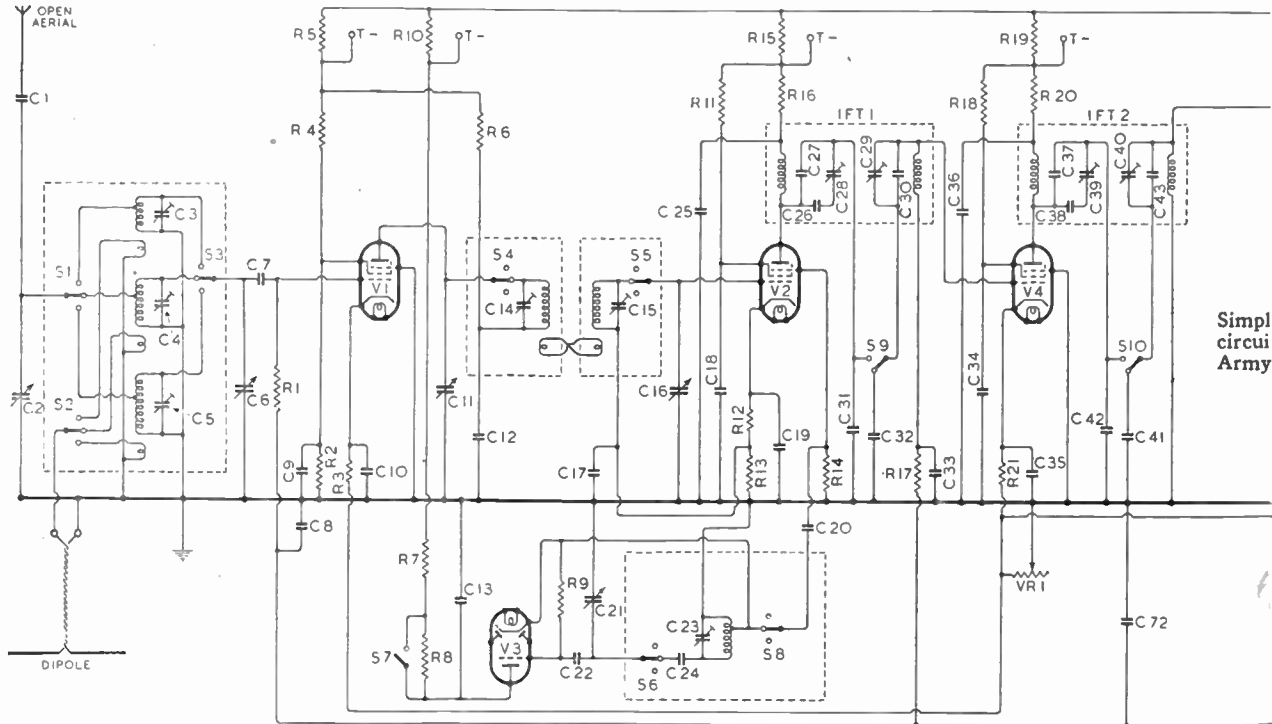

by the linked switches S13 and S14. Reverting now to the input end of the receiver we see that there are three tuning ranges

in the oscillator circuit. All three coils are included, however, in the input circuit in order to emphasise their existence. The

R12 only. In this case the bias on the suppressor grid is about ten times the control grid bias. Switch S7, which is embodied

in the waveband switch, is used to bring an extra anode resistance R8 into circuit, for limiting the amplitude of oscillations on the lowest frequency range.

Although there is a small loudspeaker built into the set its use is generally limited to stand-by occasions, normal traffic working being carried out with headphones. These are plugged into the jack J2—which, incidentally, is in duplicate in the actual receiver.

As the set is primarily designed for headphone reception a signal strength limiter, described as a "crash" limiter, and comprising the two metal rectifiers D1 and D2, is included. Switch S17 brings it into use when needed.

Provision for remote control via the socket SK1 tends to complicate the output end of the receiver, particularly as it also brings "side tone" from the transmitter into the receiver's telephone circuit for the purpose of monitoring the transmission.

COMPONENT VALUES
Circuit Positions

2.2 μF	C44
20 "	C1
25 "	(Pre-set) C3, C4, C5, C14, C15, C23
50 "	(Variable) C2
80 "	C22
100 "	C64, C66, C70
200 "	C7, C20; C61, C62
300 "	(Variable ganged) C6, C11, C10, C21
750 "	C24
0.001 μF	C26, C38, C46, C57, C80, C81
0.005 "	C72, C73
0.01 "	C13, C63, C71, C75, C76, C77, C85
0.05 "	C8, C9, C10, C12, C17, C18, C19, C31, C32, C41, C42, C50, C51
0.1 "	C25, C33, C34, C35, C36, C52, C53, C54, C55, C67, C68, C69, C74
1.0 "	C78, C79, C82
4.0 "	C86
8.0 "	C83, C84
100 ohms	R40
150 "	R42, R43
300 "	R3
400 "	R12
500 "	R21, R23, R38
1,000 "	R31
3,000 "	R5, R10, R15, R19, R25, R32, R33, R39
5,000 "	R6, R13, R20, R26
15,000 "	R41
20,000 "	R2, R34
25,000 "	R4, R7, R16
30,000 "	R30
50,000 "	R9, R14, R29
80,000 "	R8, R11
100,000 "	R18, R24, R37
250,000 "	R1, R17, R22, R28, R36
500,000 "	R27, R35
500 "	VR3
4,000 "	VR1
500,000 "	VR2

output valve grid leak, R37, to earth.

A combined AC/DC power unit embodied in the set supplies all working voltages. DC is derived from a 12-volt accumulator battery and either AC or DC operation is obtainable simply by throwing over the switch S18 to the appropriate position and, of course, connecting up to the right form of supply. No harm can befall the set if the switch is thrown to DC with an AC input and vice versa.

Vibrator HT Supply

Whether battery or AC operated HT for the valves is obtained from an orthodox rectifier circuit fitted with a 6X5G full-wave rectifying valve V9 and the associated transformer windings MT4 and MT5. When battery operated the transformer gets its input via the primary winding MT1 which is energised by the vibrator unit VB. The valves (with the exception of V9) being

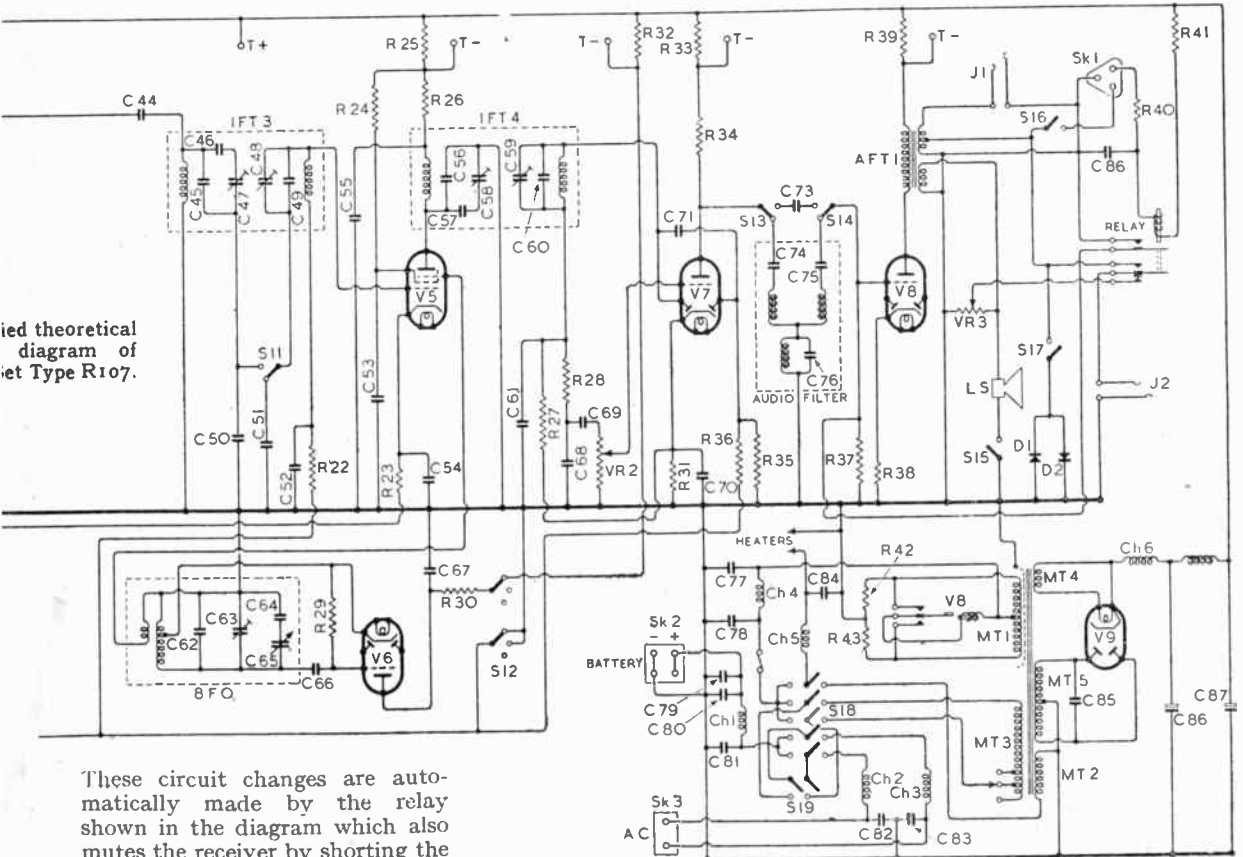

ied theoretical diagram of set Type R107.

These circuit changes are automatically made by the relay shown in the diagram which also mutes the receiver by shorting the

Army Set—Type R107—

connected in a combination of series and parallel, then draw their filament supply from the battery via a "mush" filter consisting of the choke Ch5 and capacitor C84.

With AC operation the filament supply comes from a 12-volt AC winding, MT2, on the transformer, while another winding, namely MT3, now becomes the primary. Under both conditions of operation V9 gets its filament supply from winding the MT4 on the transformer.

The arrangement of the vibrator circuit is of interest as its contacts do not make and break the DC supply, but they merely serve to

short-circuit first one then the other half of the primary winding, both of which are in parallel so far as the DC supply is concerned. As there is no abrupt interruption of relatively heavy currents, which in vibrator circuits produce very high peak voltages in the secondary circuit of the transformer, very simple filtering suffices in this case. The small current needed to energise the operating coil of the vibrator is, of course, rhythmically interrupted, but its magnitude is too small to produce any troublesome surges.

The only filtering required for this unit is provided by the choke Ch4, capacitors C77 and C78 assisted by the suppressors R42

and R43. Any residue that might get into the rectifier circuit is taken care of by Ch6 and C85.

Provision is made for monitoring the various stages in the set by measuring the voltages dropped across resistors R5, R10, R15, etc., to R39, which carry the HT feed currents of the various valves. All these test points, which are marked T in the circuit, are brought out to a small test panel on the front of the set.

As the annotated photograph of the set shows an extraordinary number of controls are assembled on the panel. These include controls for RF and for AF gain, as well as all the switches except S18.

DEFINITION IN THE CINEMA

Assessment of Optical Standards for Television

SINCE the question has recently been raised as to the number of scanning lines required in television to produce a picture having the same standard of definition as the picture projected on the cinema screen it is worth while first to try to assess that standard and express it in terms of lines per picture.

For the purpose of calculation the dimensions of the film picture are taken as 0.600in. \times 0.825in. We have to decide how far definition is affected by (1) the film, (2) the camera, (3) photographic technique, (4) the taking lens, (5) processing, (6) the projector and (7) the projection lens.

(1) **The Film.**—Three films are mentioned in the Kodak Data Book as suitable for cinematography, viz., a normal very high speed emulsion with a resolving power of 30 lines per mm.; i.e., 450 horizontal lines to the picture; a new very high speed emulsion of moderate contrast with a resolution of 45 lines per mm.; i.e., 675 lines per picture; and the normal high-speed emulsion of fairly high contrast which resolves 50 lines per mm., or 750 lines per picture.

By H. W. LEE, B.A., F.Inst.P.

(Scophony Limited)

(2) **The Camera.**—No data are available as to the standard of workmanship. Perforations have a tolerance of 0.0004in. in size and 0.0005in. in pitch. It would thus seem that about 0.001in. error is considered allowable in all, and probably a similar standard is aimed at in manufacture. This demands a precision of a few ten-thousandths of an inch in the individual parts of the film transport mechanism and is attainable in precision engineering. This gives 600 lines per picture.

(3) **Photographic Technique.**—This includes possible blurring of the image through variations in focusing and the requirements of field depth. It will be supposed that a 2in. f/2 lens is used in the camera. Experience shows that it is impossible to be sure of focus closer than 0.002in. even with the refined tools of the opticians testing room. It is unlikely that precision in the studio will be high. An error in focus of 0.002in. is thus possible. At f/2 this produces a blur of 0.001in., which is 1/600 picture height.

A guide to the limit set by depth of focus can be obtained by considering a close-up of a head nearly filling the screen. The reduction will be about 1/20. Now a depth of ± 1 in. on either side of the part upon which attention is focused (usually the eyes) must be allowed without the image becoming perceptibly blurred. Therefore the depth of focus will be $\pm 1/40$ in. at the film; at f/2 a blur of 1/800in. is produced. If this is tolerable, so is a standard of 480 lines.

(4) **The Taking Lens.**—No lens is perfect and generally accepted figures for the usual errors will be quoted for high quality cinema lenses.

(a) *Axial.* The definition can be spoiled by axial chromatic and spherical aberrations; even though these are said to be "corrected" there are always residuals which cannot be entirely removed with the glasses at present available. In a lens for spherical aberration it will be found that if zones are isolated they will each give a slightly different focus. This variation will in a good lens amount to 0.004in. per inch focal length; i.e., it will be 0.008in. in

a 2in. lens $f/2$ and will occur at a zone having a diameter of about $f/3$, so that a point is rendered by this zone as a ring of diameter 0.0027in. if observation is made at the focus for central rays. Now this is the worst zone and the eye in focusing is conscious of the effect of all zones and, so to speak, integrates the effect and chooses not the focus for central rays but one where the total blurring is least. The consequence is that the resulting blur is only half that computed for the worst zone; i.e., will amount to 0.0013in. This divided into 0.6in. gives 450-line definition.

Chromatic aberration is smaller but will add to the size of the blur and so lower the definition slightly from this figure.

(b) *Extra-axial.*—Lenses have likewise residuals of astigmatism and field curvature by which the foci for points off the axis fall outside the plane through the axial focus. A 2in. lens has a field of ± 15 deg. on the film area, and within this angle departure from the focal plane may amount to 0.5 per cent. of the focal length; i.e., to 0.01in. with a 2in. lens. The aperture for oblique pencils is substantially less than for axial pencils, owing to cut off by the rims of the lenses, so that the aperture will be about $f/3$ at the edge of the field; consequently the image of a point will amount to 0.003in. This is 200-line definition, but again it is possible to choose the focal plane so as to give the best results throughout the field and an overall definition of perhaps 400 lines may be looked for.

It may be argued that the focal plane has already been chosen to get the best axial definition and that it is not legitimate to postulate a fresh choice dictated by extra-axial imagery. The answer to this is that the best lenses are so designed that the requirements for best axial and oblique image points are met by the same choice of focus.

(5) *Processing.*—Film shrinkage and the effect of processing have been investigated and certainly may lead to impairment of definition, but these defects can be largely guarded against by careful treatment and storage.

(6) *The Projector.*—What was said about the camera applies equally to the projector, and it is probable that the standard of workmanship aims at a possible 600-line definition.

(7) *The Projection Lens.*—This is of an entirely different type from that of the taking lens and is of greater focal length. A 4in. $f/2$ may be considered typical. Usually the axial definition is better and the oblique definition worse than that of the camera lens. The definition of axial points will therefore not suffer much on projection; the field of this type of lens is, however, far from flat and may have a divergence from flatness of as much as 0.01in. in a good lens, giving an out-of-focus blur which is equivalent to 0.005in. on the film. This is only 120-line definition. Even if central definition is sacrificed somewhat, that at the corners can hardly exceed a 200-line standard. At the side of the picture it may be 50 per cent. better; i.e., 300 line. With a longer focus lens definition will, of course, be somewhat better.

General Considerations.—These standards may seem low, but need not cause surprise. It is generally considered that the eye accepts an image as sharp if the blur does not exceed one minute of arc at the eye. The front of the balcony may be taken as being the best

point of view in the cinema and this may be half way between the projector and screen, consequently the latter subtends twice the angle at the spectator that the film does at the projector. The standard of definition for the projection lens then should be that blur on the film does not exceed half a minute of arc (an angle of 1 in 7,000) and with a 4in. lens blur should then be restricted to $4/7,000$ in. The "line" standard is thus $0.6 \div 4/7,000$; i.e., about 1,000. With a 7in. projection lens a blur of $1/1,000$ could be tolerated, which is 600 lines definition. This physiological tolerance is based on laboratory experiments with a stationary test object of black and white lines. In the cinema the objects on the screen are usually moving, are not geometric in shape and rarely have black and white contrast. Thus a lower standard could be tolerated in the cinema.

Conclusions.—A definition represented by 600 lines is probably the highest the eye could appreciate under the most exacting conditions, and this is probably within the range of resolution of the finest grain film that is used. The conditions under which the final image is produced on the screen do not suggest that definition there ever exceeds a 400- to 500-line standard in the centre and 300 at the edges, and it may at times be lower.

◇

NIGERIAN SERVICE.—The maintenance of the receivers in public buildings and administrative offices in Nigeria is undertaken by the Radio Section of the Public Relations Office. C. A. Huber, a Swiss engineer, who is in charge of the Section, is seen in the workshop in Lagos.

◇



SOLAR ECLIPSE OBSERVATIONS

Effects on the Ionisation of the E and F Layers

DURING the eclipse of the sun on Monday, July 9th last, a series of radio observations that had been in progress for several days reached their zenith. These observations were undertaken by civil and military radio research organisations throughout the British Isles under the direction of the Department of Scientific and Industrial Research.

When the results have been carefully studied and correlated it is hopefully expected that much new knowledge will emerge regarding the composition and characteristics of the E and F ionised layers in the upper atmosphere, which play such a vital part in long-distance radio communication.

Both ordinary transmissions and reflecting systems were employed, the former to study the effects produced at a distance by changes in ionisation and the latter to record and measure changes in density, height and absorption of the respective layers, before, during and after the actual period of the eclipse.

Previous observations had shown that the lower E layer is caused by ultra-violet light emanations, and during previous eclipse

observations radio fadeouts have invariably coincided with the optical eclipse.

A definite pronouncement on the composition of the F layer may be forthcoming when the results of the observations carried out by the ionosphere research section of the Radio Research Board at their Datchet experimental station are analysed and correlated. This entails the careful study of many thousands of measurements and examination of hundreds of feet of photographic record, much of which was taken during the eclipse period.

Investigations of the E layer ionisation were made by one subsection using two pulse transmitters and by observing the nature of the reflected echoes. One transmitter operated on 2 Mc/s, while the other was varied over the range 1.6 to 3.5 Mc/s. These were manually controlled and visual observations made with a large cathode-ray tube. The work was mainly concerned with the absorption effects of the lower strata of this layer.

Investigations of the behaviour of the F layer were made by means of another pulse transmitter automatically sweeping over a fre-

quency range of 0.5 Mc/s to 8 Mc/s and recording on a moving photographic film the echoes reflected from the E and F layers as well as from any patches of high ionisation in or outside the confines of the layers. It is interesting that the paths of meteorites through the ionised layers are clearly discernible.

Elsewhere a continuous record was made on a short-wave signal transmitted from the north of England. The recordings showed a gradual falling-off in signal strength as the eclipse progressed and during the maximum period it was almost inaudible, only to return slowly as the shadow of the moon receded. The radio eclipse did not coincide exactly in time with the optical eclipse, and indeed this was not expected, but the radio fade-out did occur at the anticipated time.

Sun-spot Disturbance

Observations were also made on signals from Canada and other distant countries on, or close to, the path of totality. Direction-finding technique was employed in order to trace the actual path of the signals.

At one period it was feared that sunspot eruptions, which caused some disturbance in the ionised layers, might obscure the effects of the eclipse. Fortunately these fears were not substantiated.

Observations on the F layer are so far not very conclusive as although the critical frequency for the layer fell to a low one and then slowly increased to normal for the time of day and season there was also a change in the critical frequency some little time before the optical eclipse. This could conceivably have been due to a change in the layer's ionisation on the assumption that its composition was due to corpuscular emanations from the sun.

Possibly when all the observations from the many radio bodies engaged have been studied a definite pronouncement might be forthcoming on the actual composition of the F layer.

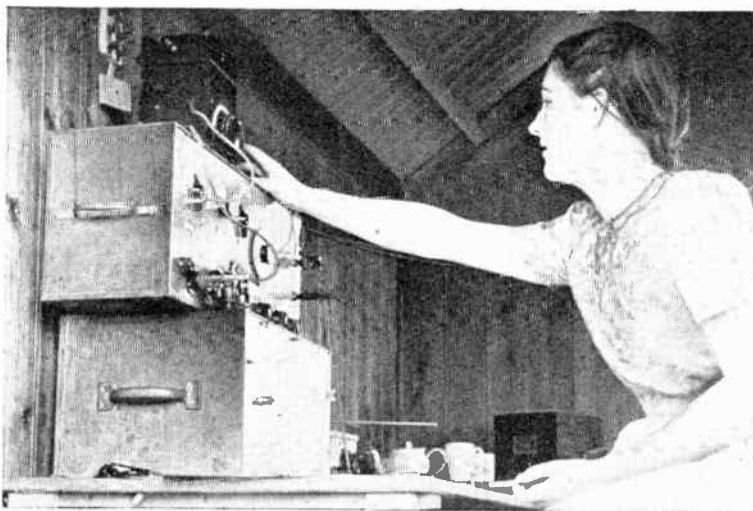

Visual observations on propagation of radio signals on 100 Mc/s were made during the eclipse with this equipment.

Angles on **BRIMAR PRESTIGE**

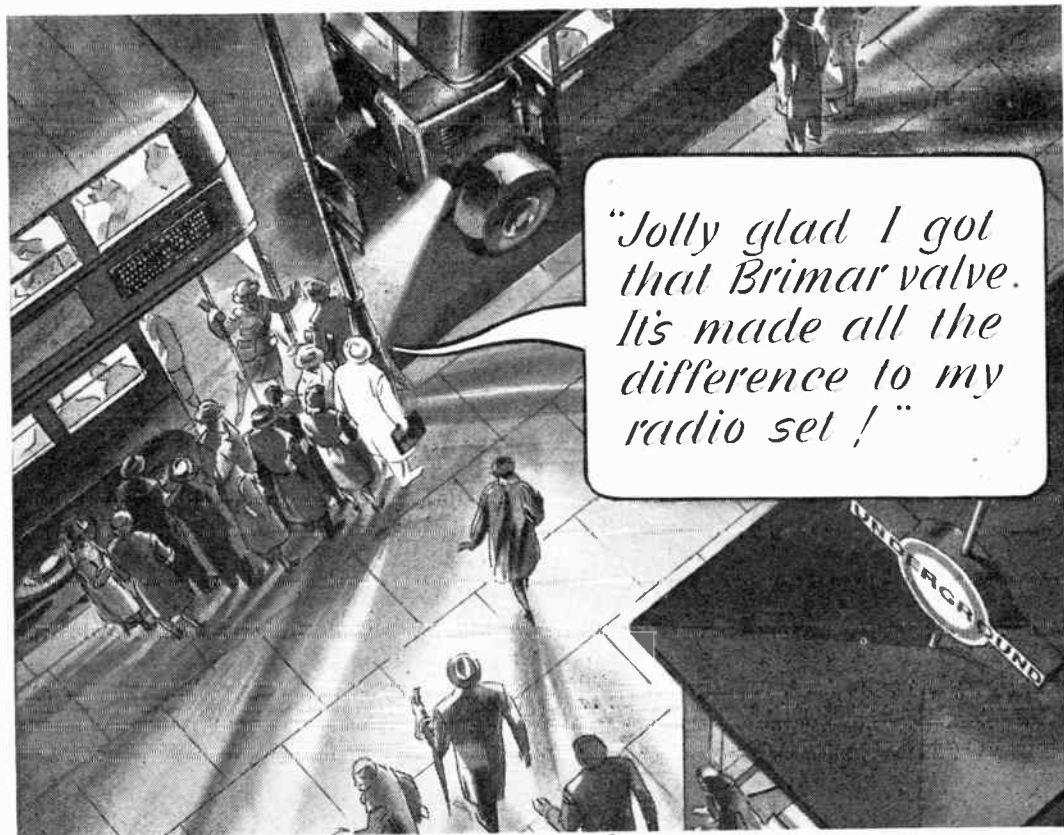

Brimar Valves operate to very close limits with complete reliability. "Peak performance" is an automatic result of their use. Although valves are still in short supply, you may be able to get the Brimar Valve you require.

BRIMAR

(BYA)

VALVES

STANDARD TELEPHONES AND CABLES LIMITED, FOOTSCRAY, SIDCUP, KENT.

The right tool for each job



MORRISFLEX
Equipment includes
Polishing Mops, Felts
and Felt Cones.

Rotary Rasps
for Woodworking.

Mounted Points.

MORREX
Industrial Wire
Brushes.

REX
Rotary Files and
Cutters.

Sanders & Grinders,
etc.

Speed, accuracy and fine finish demand specialised equipment, and in **MORRISFLEX** Flexible Shaft Equipment you have it.

For cutting, filing, grinding and polishing components of aluminium, elektron, non-ferrous alloys and ferrous metals it is unrivalled, ensuring the finest results in the shortest time and at minimum cost. Use **MORRISFLEX** Equipment for scaling, sanding, polishing, tube brushing, removing paint and rust; for rasping woodwork, and many other operations. **MORRISFLEX** Equipment is available in overhead suspension, bench and floor type machines, the two latter being readily portable.

Write for Catalogue

*On Air Ministry,
Admiralty and
War Office Lists*



Morrisflex FLEXIBLE SHAFT EQUIPMENT

Shirley 1237 B. O. MORRIS LTD., SHIRLEY, BIRMINGHAM, 'grams: Morrisflex, B'ham

From MIDGET to GIANT...

Within this Goodmans factory have been designed and produced loudspeakers ranging from the midget for the field set of "the Signals" to the giants used for battle training . . . and in between these extremes a multitude of instruments each built to conform with certain very exacting requirements. In the fulfilling of these urgent needs vital data has been compiled, adding still further to Goodmans' unrivalled knowledge of Sound Reproduction technique. Maybe soon now it may be permitted to devote that experience to the no less insistent calls of Peace. Then, as of yore, Goodmans will be ready to serve. More than ever will it be true to say "If it's a Loudspeaker problem the answer is Goodmans."

GOODMANS *Loudspeakers*

GOODMANS INDUSTRIES LTD · LANCELOT RD · WEMBLEY · MIDDX ·

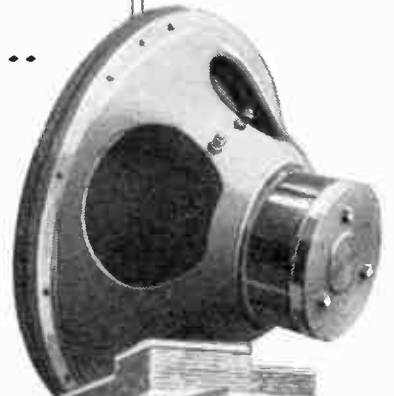

G.D.4.

CHEAPER HEARING AIDS

Should They be Sold by Wireless Dealers?

By C. M. R. BALBI, M.I.E.E.

THERE are indications that before long better and less expensive hearing aids will become available through the radio industry; the problems involved in distributing these instruments to the public are of interest to all concerned.

The question arises whether the wireless retailer should or should not handle these devices. It is obvious that widest scope for distribution is through the radio retail market. This will mean that at last the public will get their instruments and service at rock-bottom prices, but the first thing the public will want to know is, if any harm can come to them by purchasing their instrument from an inexperienced person (I use this term deliberately to distinguish a radio dealer from a hearing aid salesman in a white coat practised in the art of mumbo-jumbo). The answer is given by the National Institute for the Deaf in a statement approved by the Medical Research Council which reads as follows:—

“There appears to be no clinical or experimental evidence that the continued use of a hearing aid causes any increase in existing deafness; nor, except in a few rare cases, does it improve or restore hearing. Nevertheless, the benefits from a satisfactory and appropriate instrument are very definite both to the patient and his friends.”

That is hardly surprising; indeed, if the contrary were true, no person afflicted with deafness should use a telephone or listen to broadcasting without the consent of his medical adviser.

If matters are as simple as this, then why has the retailer not added such a profitable line to his business before? The reason is that the deaf quite naturally want to know what benefit an instru-

ment will give them before purchase. If the retailer was not prepared to give vague promises it meant that the intending purchaser had to be given a week or more home trial. This is expensive because an instrument after a home trial often looks second-hand and the margin of profit does not allow of such a costly procedure.

If, on the other hand, the manufacturer could guarantee that a particular type of instrument would benefit a deaf person to a precisely stated degree, then the cost of selling a hearing aid would immediately be reduced to a level comparable with that of a radio receiver.

To make this possible an instrument has been designed which has been termed a “hearing aid predictor.” The device is a very simple one and consists of a microphone, amplifier (battery or mains driven) and an earpiece so calibrated in db. that it will assess a patient’s intelligibility loss.

The technical aspects involved in the calibration of the predictor can be obtained by reference to the *I.E.E. Journal*, vol. 91, part 3, page 67. In brief, the reproduced sound in the earpiece is such that when the instrument is spoken to at a distance of about

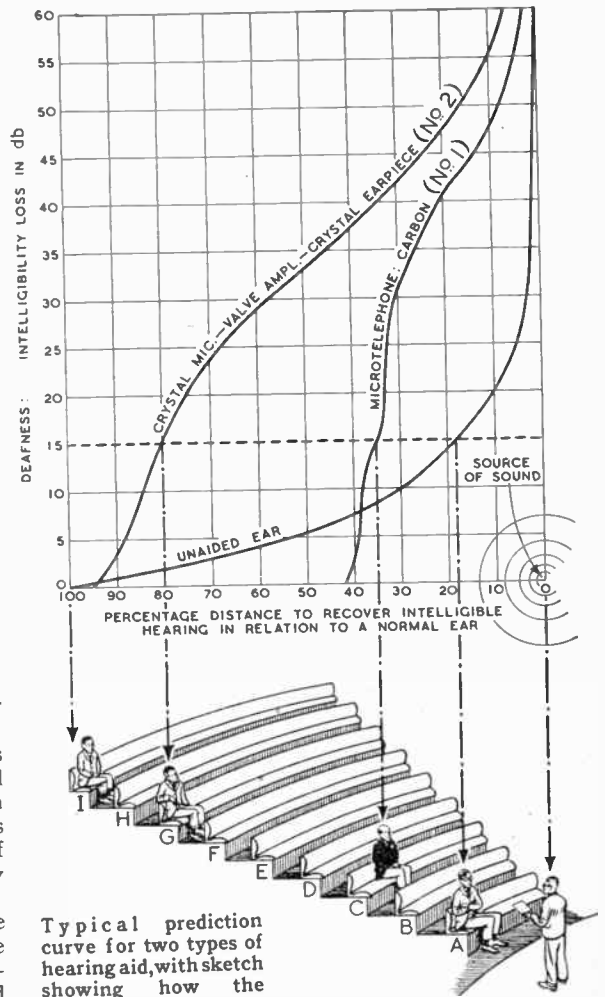

Typical prediction curve for two types of hearing aid, with sketch showing how the benefit derived from them may be simply assessed.

three feet with the pointer at zero the amplification is unity, so that to a person with normal hearing the loudness of reception would appear to be at the same level as if hearing the operator direct.

When a deaf person is being tested the operator would increase the amplification until the patient (also 3ft. from the operator) indicated that the reception was at a comfortable level and appeared normal for the distance which separated them. A tone control is provided with base and top cut which is adjusted to suit the patient.

A short conversation between the operator and the patient quickly determines the degree of deafness concerned, and then the retailer can, by referring to the prediction curves provided and

Cheaper Hearing Aids—

guaranteed by the manufacturer, inform the patient what benefit he can expect from the use of the instrument he intends to purchase.

A typical prediction curve relating to two types of instrument is shown in the figure. If, for example, it was found that the patient's hearing loss was 15 db. then the retailer would be able to assert that he would benefit to the extent of 17 per cent. with instrument No. 1, and 62 per cent. with instrument No. 2. In actual practice it is easier to explain the results by the diagram of an auditorium given below the curves. If the speaker can just be heard intelligibly at the back of the hall by a listener whose hearing is normal, then a deaf person with a 15-db. intelligibility loss can only hear intelligibly with his unaided ear in row A, but with instrument No. 1 he then has the choice of rows A to C, and with instrument No. 2 his choice is extended to rows A to G.

If, on the other hand, a patient was only 5-db. deaf, it can be seen that instrument No. 1 would be of no benefit at all; in fact he would be worse off.

"Difficult" Patients

It is well known that there are certain people, generally of advanced age, who although they can hear sounds easily, cannot distinguish words whatever the intensity level. The predictor, which is founded on an intelligibility basis, would immediately indicate that the patient was unsuitable for any form of hearing aid and thus avoid needless disappointment to the patient and waste of time and expense to the vendor. The operator and the patient therefore know where they stand and the purchase can be made in the confidence that the associated prediction curve provided by the maker will be correct. The integrity or judgment of the vendor is therefore not involved and the system is likely to encourage the manufacturer to improve the performance of his instruments and not let this take second place to appearance, which has generally been regarded as the factor chiefly affecting its commercial success.

BOOK REVIEWS

Radio Service Test Gear. By W. H. Cazaly. Pp. 89; 46 diagrams. Published by Sir Isaac Pitman & Sons, Pitman House, Parker Street, Kingsway, London, W.C.2. Price 6s.

THIS book is mainly a reprint of the eight articles published as a series during 1942 in *Wireless World* under the heading "Instruments." Each of the eight articles in that series constitutes a chapter in the book and they are preceded by an introductory chapter explaining the necessity for more precise information on the performance of a radio receiver than has been customary in the past.

It is quite rightly pointed out that such indefinite expressions as "loud," "powerful," and "mellow tone" possess no real meaning and any interpretation including, or excluding, the right one could be applied to them. But in order to obtain this precise information scientific measurements of performance must be made and to make them suitable apparatus is required. It is a description of this apparatus that fills the remaining eight chapters. The description is theoretical and not the constructional kind, for as the author says in his preface—"Construction involves not only buying and assembling the right components, but adjustment and calibration of the instrument as a whole—and this is usually much more difficult than mere assembly and requires skill and knowledge that cannot be imparted either in a book of this nature or in correspondence." Thus the reader is fully forewarned and in the many circuits of test and measuring apparatus that follow there are few cases

where values have been assigned to the components. But construction of the apparatus would not be unduly difficult, as adequate references are given; moreover, calculating component values for any desired set of operating conditions is always valuable experience.

The book is a guide to the understanding of the basic principles of the design and operation of test gear, and having mastered these facts the reader will be in a far better position to use measuring apparatus intelligently, since knowing its limitations the impossible will not be expected. Moreover, this knowledge will prove invaluable in adapting apparatus for unusual test work, while familiarity with the circuit arrangement enables repairs to be carried out with greater confidence. H. B. D.

Elektrische Schwingtöpfe und ihre Anwerdung in der Ultrakurzwellen-Verstärkertechnik (Klystrons and their use in ultra-short-wave amplification.) By Alfred de Quervain; pp. 88 with 47 figures. A.-G. Gebr. Leemann & Co., Zürich. Price 6 Fr. (Swiss).

This is the result of two years' research at the Zürich Technical College. It goes very fully into the calculation of the losses and thus of the Q-factor of klystrons, also into the temperature coefficient and its compensation in order to keep the resonant frequency constant. The methods of coupling klystrons and matching them to one another and to valves is discussed very fully. The wavelengths considered are usually from 1 to 2 metres. The thesis is well prepared and should appeal to anyone interested in klystrons. G. W. O. H.

Books issued in conjunction with "Wireless World"

	Net Price	By Post
FOUNDATIONS OF WIRELESS. Fourth Edition, by M. G. Scroggle	7/6	7/10
TELEVISION RECEIVING EQUIPMENT, by W. T. Cocking	10/6	10/10
RADIO LABORATORY HANDBOOK, by M. G. Scroggle. Second Edition	12/6	12/11
WIRELESS SERVICING MANUAL, by W. T. Cocking. Sixth Edition	7/6	7/10
HANDBOOK OF TECHNICAL INSTRUCTION FOR WIRELESS TELEGRAPHISTS, by H. M. Dowsett and L. E. Q. Walker. Seventh Edition	30/-	30/7
RADIO DATA CHARTS. Third Edition, Revised by J. McG. Sowerby, B.A., Grad. I.E.E.	7/6	7/10
RADIO INTERFERENCE SUPPRESSION, by G. W. Ingram	5/-	5/4
LEARNING MORSE. 335th thousand	6d.	7½d.
INTRODUCTION TO VALVES, by F. E. Henderson	5/-	5/4
RADIO WAVES AND THE IONOSPHERE, by T. W. Bennington	6/-	6/3

Obtainable from leading booksellers or by post from

ILIFFE & SONS LTD., Dorset House, Stamford Street, London, S.E.1

WHAT IS QUALITY CONTROL ?

Background for Wireless Technicians

WHAT A. P. Herbert calls "witch words" are popular because they relieve both the reader and the writer of the tedious task of trying to understand what is being talked about. In most of the shorter texts on "Quality Control" it is assumed that the reader has some basic knowledge of the subject and merely wants to know the rules and formulæ. In the remainder it is assumed that the reader does not want to know anything about quality control, but needs a sort of drill book which he can use blindly. This article is an attempt to give a background against which the detailed instructions will fall into an ordered scheme. It does not give instructions on how to apply quality control: for those, references 1 and 3 should be consulted. Reference 2, unfortunately, uses a different notation, and may confuse the student. One difficulty which the reader may find troublesome is the fact that almost all the literature is based on machine-shop practice and the application to radio problems is not immediately obvious. This is because the use in machine shops is much easier. There is, however, considerable scope for quality control in radio production, and some uses will be mentioned later.

Modern industry is based on the large-scale production of nominally identical articles. The guiding principle is that a product is not the work of one man, but is an assembly of parts each made by separate men or machines whose sole function is part-making. Indeed, even a single part may be the result of several processes each carried out in separate stages. For this procedure to be successful it is necessary that the parts should be accurately made, so that sets of parts drawn at random from a store should be capable of being assembled without much fitting work.

If parts are to be interchangeable, they must be made to close

By THOMAS RODDAM

tolerances. This means that careful inspection is necessary, and it is when inspection costs start to become a serious part of the whole cost of a part that quality control becomes important. Close tolerances may also mean the risk of a high proportion of scrapped parts, and the inspection process must be quick and efficient so that a machine which is making defective parts is spotted before it has made very many. The most elementary form of inspection involves the checking of every item. Checking may mean merely the use of gauges, or it may involve the measurement of a dimension with a micrometer or some other device which actually determines a value, rather than finding whether the value is within limits or not.

The first step taken by the statistician in simplifying testing procedure is to abandon 100 per cent. inspection and rely on samples.* If we want to know what electrical engineers think about the B.B.C. programmes we do not ask every engineer in the country: we seek out a sample, chosen at random. We might

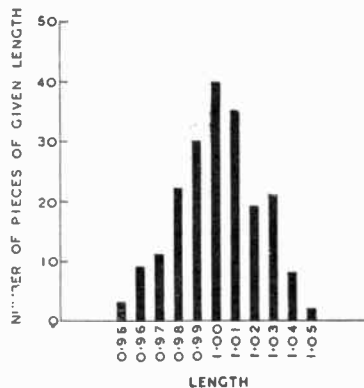

Fig. 1. A typical histogram.

take all members of the I.E.E. whose names begin with the letter R. As their names do not affect their listening habits, this would

give us a reasonable number of views from engineers of all shapes and sizes, and we could predict the general engineer's view from this. Systems of this sort are well known, and their only defect is that the sampling may not be truly random. A poll on the merits of fox hunting taken at a point-to-point race meeting would give very different results from one taken at a performance of "Wozzeck." In sampling parts from a machine we must adopt a lucky-dip procedure. Tables have been published (reference 5) showing the number of items in a sample required to give the information needed about the whole batch. These samples may be quite large and the testing of the samples may still be expensive. Sampling is, however, the only way of dealing with parts which have been shuffled, such as parts made in another factory and delivered as a large batch. Sampling is less efficient than quality control, because one piece of information, the order in which things were made, has been thrown away. The taking of samples for quality control, where the process is being watched in time, should not be random and a sample of successive parts must be taken straight from the machines, to give the latest news. The engineering problem is, as always, that of getting a result which is just good enough with a minimum of effort. To do this in inspection it is imperative that all the information should be obtained from the smallest number of tests. Quality control is a method of squeezing the maximum amount of information out of test results with a minimum of delay.

Let us assume that we are concerned with the problem of parting-off a length of rod on an automatic machine. Ideally our

* "Sample," as used here, is a technical term. It is defined in BS600R: 1942, as "A portion of material or a group of individuals or specimens taken from a large mass or bulk which is used to give information as to the quality of the larger quantity."

machine will cut off standard one-inch lengths, but in practice, when we measure the pieces, we find that some are 1.00in. long, some 1.01in., some 0.99in., and

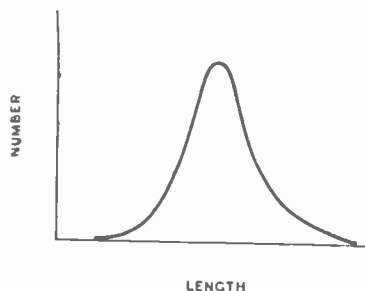

Fig. 2. Example of Gaussian distribution.

so on. If we take a number of pieces and measure them, we can plot the diagram of Fig. 1, which shows how many pieces of each length there are. Note that we only worry about the measurement to 1/100th of an inch. From this we can see that the machine is turning out pieces of length 1 ± 0.05 in., and that of the 200 pieces studied only 25 per cent. lie outside the limits 1.00 ± 0.02 in. This plot is called a "histogram." If more pieces were measured more accurately, the histogram would tend towards the smooth curve of Fig. 2, which is a Gaussian or "normal" curve. This "normal" curve is very important in statistical work, and its properties have been closely studied.

If our machine was not parting off one-inch lengths, but grinding to one-inch diameter from a 1.01-in. bar, we might get the histogram of Fig. 3. This is known as a skew distribution. As this is rather inconvenient, as it does not obey the same laws as a "normal" distribution, something must be done. In Fig. 4, which is taken from BS600R:1942, we see that by plotting the average values of samples of 5 or 10 items we can get our results to "normalise" themselves. A histogram made up from a set of averages is always nearly Gaussian. The engineer making use of general rules for Gaussian distributions should always take the average of a

sample of four or more pieces. The original distribution is not then important.

We have now got some idea of what we are dealing with in our statistics. If our machine is behaving itself, it will go on churning out parts which if measured will simply magnify the histogram without altering its shape or position. We may get different numbers, but the next 200 in Fig. 1 will still have more parts at 1.00in. than anywhere else, and will still have only 2 or 3 per cent.

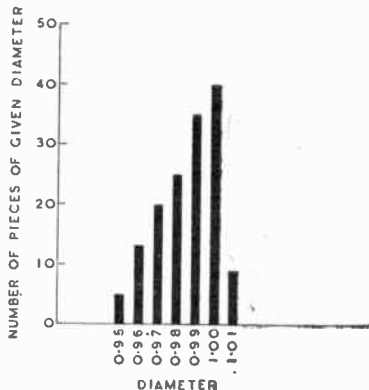

Fig. 3. Histogram showing skew distribution.

as far out as 0.95in. or 1.05in. When a system is behaving like this, it is said to be in "statistical control." Our object is to keep the system in "control." Of course, this is no good if the length should have a tolerance of ± 0.01 in. The controlled level must be good enough for the func-

producing at a controlled average of 0.98in. We shall start to get pieces as short as 0.93in. The appearance of these is an indication that something has gone wrong. If a histogram is drawn it may be found that the shape of the bell-like smooth curve to which it tends is unaltered but that the whole thing has been shifted bodily sideways. The machine is still working as accurately as before, but it is now making the wrong thing and requires to be adjusted to bring the mean length back to its target value. Sometimes the centre of the histogram will not be shifted, but the flare of the bell will be wider. The machine is not working as accurately as it was before. The cure for this condition must be sought. In quality control charts, the first effect is indicated by the "chart for averages" showing loss of control; the second condition is shown by the "chart for range" showing loss of control. The charts give a clue to how the machine has gone wrong.

The detection of a loss of control by the charts and detailed instructions on how to prepare charts are given in references 1 and 3. The procedure is to plot the average value and range of the "quality" of a sample at intervals, and to investigate whenever either of these quantities falls outside lines marked as "Action Limits" on the charts. Just as a modulation control system can be arranged to flash a red light if

AVERAGES OF 200 SAMPLES OF 5

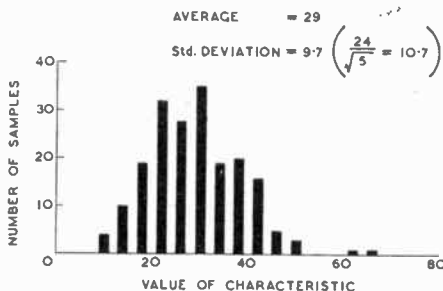

AVERAGES OF 100 SAMPLES OF 10

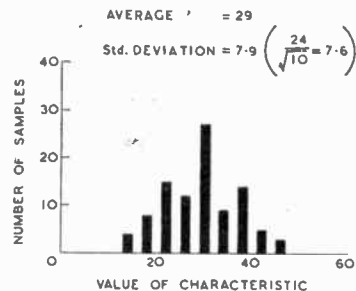

Fig. 4. Sampling from a skew distribution. (From BS600R:1942.)

tion, but our data would be suitable for a spacer designed to have a tolerance of 0.07in. Indeed, our machine is slightly too good!

Suppose now that for some reason the machine changes to

the signal level sent to a transmitter exceeds the prescribed value, so a point beyond the action limits on the control chart is a warning that the machine may be going wrong. The choice

What is Quality Control?—of action limits requires care: I shall attempt an analogy.

If the reader will look at only the left-hand section of the curve of Fig. 2, he will see that this is

We plot the average value of our sample of 4, 5 or 10 parts on a chart, taking samples once every 20 minutes, once an hour or once a day depending on the process. Theoretically 1 reading in 40

More closely to the point in radio work, however, is the inspection and testing of receivers and amplifiers. The gain of an amplifier, or the sensitivity of a receiver, is the average effect of a

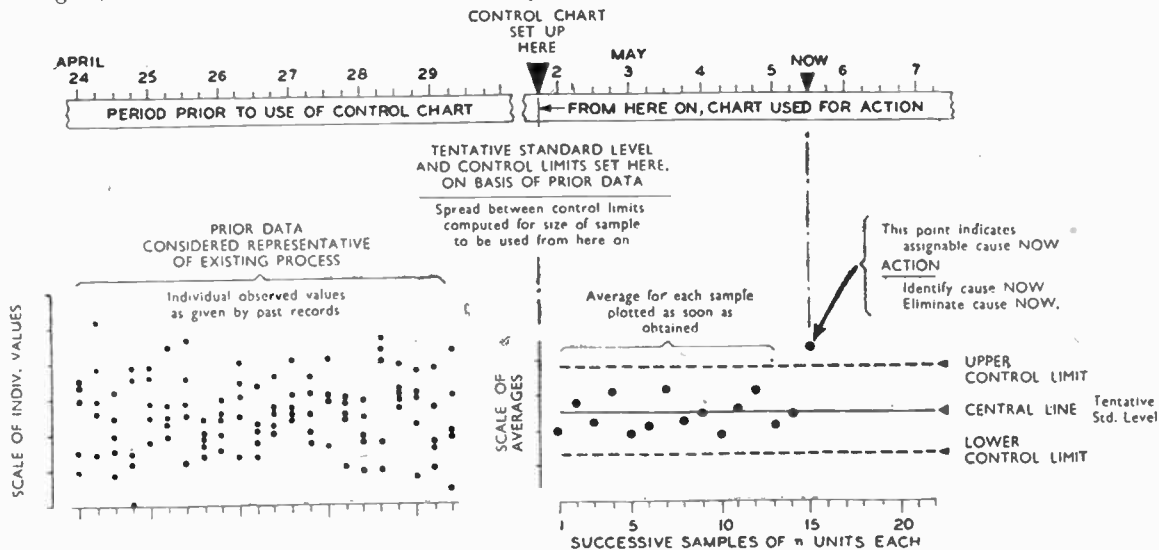

Fig. 5. Features of a control chart for controlling quality during production. (From BS1008:1942.)

very similar to I_a-E_g curve for a valve. If we examine what happens at a given distance from the centre, we are doing something rather like noting the anode current for a given bias.

The action limit on this side of the curve defines the working point and the number of measurements beyond the action limit on the left corresponds to the "red lamp current." Moving the curve means that the working point is altered, and it is known that the greatest sensitivity of anode current to bias will be on the straight part of the slope. In statistical control we usually work near cut-off and the problem is rather like that of detecting a carrier in the presence of noise. The reason why the less sensitive position is chosen is that if we work at the cut-off, we shall not often get any false alarms.

In setting up a quality control system, therefore, we first of all determine the "control characteristic." Then we choose a "cut-off" level, which in the language used is called the 2σ level because it is the (average value) $\pm 2\sigma$ where σ is the "standard deviation," a term which is the measure of the width of the bell.

should be above the upper cut-off and 1 in 40 below the lower cut-off. In practice the extremes of the Gaussian curve do not appear, for obviously there is no chance of our machine making 2-in. pieces or $\frac{1}{2}$ -in. pieces unless it is hopelessly out of order. We can therefore safely regard any point outside the limits quoted as indications that the machine should receive a closer inspection as it is starting to go wrong. Sometimes 3σ limits are used as well. The chance of being outside these is only 1 in 1000, so that a point outside means there is almost certainly that something is wrong.

The detailed procedure is laid down in reference 1 and 2, and a number of other descriptions have been published. It is not intended to go further into the detail here. The sort of record obtained is shown in Fig. 5.

The bell-like normal curve appears in other connections. In reference 4, the results of measurements on radio programme material are discussed. It is found that the instantaneous sound level follows the Gaussian law, so that it would be possible to use the principles of our statistical control to monitor transmission levels.

number of causes. Resistances and valve slopes deviate from their nominal values. In testing an amplifier we require to know whether this deviation is due only to these random causes, or whether there is in addition a true defect. If a control chart is constructed, we can tell whether we should be worried, or whether we are about to go shooting imaginary troubles. Almost all the tests carried out on mass-produced radio equipment could be monitored by quality control methods and there are also possibilities in fields other than production.

Quality control is a method of analysing data which has very wide applications. It is hoped that this article will help to encourage radio men to apply the method to the many radio problems which can be treated by it.

References

- 1 Quality Control Charts. BS600R:1942.
- 2 Quality Control. BS1008:1942. (Contains good bibliography.)
- 3 First Guide on Quality Control for Engineers. Ministry of Supply.
- 4 Le Controle des Phenomenes Transitoires dans les Transmissions Radiophonique. E. Divoire. L'Onde Electrique. Jan., 1936. pp. 40-58.
- 5 Single Sampling and Double Sampling Inspection Tables. Dodge and Romig. Bell System Technical Journal, Jan., 1941; pp. 1-61.

OPTIMUM VALVE LOAD

Unified Treatment for Different Operating Conditions

IT is with some diffidence that one takes up this somewhat hackneyed subject, but the treatments of this problem given in textbooks and some recently-published articles are so involved, and in some cases misleading, that the writer would like to suggest that the various conclusions as to the value of the optimum load resistance can be derived, for different conditions governing the anode voltage, by a single method of solution.

The following treatment utilises the I_a/V_a characteristics together with the load line drawn in the position giving maximum output for zero distortion; and, for simplicity, idealised characteristics are assumed. With the equivalent circuit method, it is impossible to appreciate fully the assumptions involved.

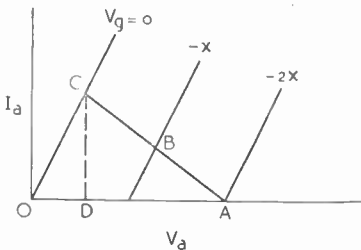

Fig. 1. Idealised valve characteristics for the condition where the HT voltage is fixed and the load resistance is connected directly in the anode circuit.

There are three distinct and clear-cut cases to be considered, namely:

- (1) Where the HT voltage is fixed and the load resistance is in the anode circuit.
- (2) Where the HT voltage is fixed and the load resistance is supplied through a transformer.
- (3) Where the HT voltage is unlimited but where the output power is limited by anode dissipation. In this case, the load resistance may be either in the anode circuit or supplied through a transformer.

Case 1. Suppose the load re-

By EDWARD HUGHES,
D.Sc., M.I.E.E.

sistance R to be in the anode circuit of a triode having a slope resistance R_a and the idealised I_a/V_a characteristics to be as in Fig. 1. Let OA be the HT voltage available; then the maximum grid swing with zero distortion is obtained with a grid bias of $-x$ of such a value that a grid voltage of $-2x$ reduces the anode current to zero.

Let ABC be the load line corresponding to resistance R ; then output power due to the AC components of anode voltage and current is given by

$$\frac{CD \times AD}{8} = \frac{(CD)^2 R}{8}$$

But

$$OA = OD + AD = (CD \times R_a) + (CD \times R) = CD (R_a + R)$$

Hence, AC output power

$$= \left(\frac{OA}{R_a + R} \right)^2 \times \frac{R}{8} = \frac{OA^2 \times R}{8(R_a^2 + 2RR_a + R^2)}$$

To find the value of R that gives the maximum AC power, the simplest procedure is to divide the numerator and denominator of the above expression by R , i.e., AC power

$$= \frac{OA^2}{8(R_a^2/R + 2R_a + R)}$$

This power is a maximum when the denominator is a minimum, namely when

$$\frac{d}{dR}(R_a^2/R + 2R_a + R) = 0$$

$$\text{i.e., } -R_a^2/R^2 + 0 + 1 = 0 \quad \therefore R = R_a$$

Hence the AC output power is a maximum when $R = R_a$.

Case 2. Let OA in Fig. 2 represent the HT voltage available and assume the resistance of the primary of the transformer to be negligible. Draw a line XY such that its slope corresponds to the load resistance R referred to the primary winding, this equivalent resistance being n^2R , where

n = primary turns/secondary turns.

By trial, draw a line EF parallel to XY such that the mid-point H of EF lies on the vertical line drawn at A . If $-y$ be the grid bias corresponding to the I_a/V_a characteristic through H , then y represents the peak value of the maximum alternating grid voltage for zero distortion.

From Fig. 2, AC power

$$= \frac{GF \times GE}{8}$$

$$\text{But } GE/GF = n^2R \text{ and } OA = OG + \frac{1}{2}GE = (GF \times R_a) + (\frac{1}{2}GF \times n^2R) = \frac{1}{2}GF(2R_a + n^2R)$$

$$\therefore \text{AC power} = \frac{GF^2 \times n^2R}{8} = \left(\frac{2OA}{2R_a + n^2R} \right)^2 \times \frac{n^2R}{8} = \frac{OA^2 \times n^2R}{8R_a^2 + 8n^2RR_a + 2n^4R^2} \quad (1)$$

If n be the variable quantity, the condition for maximum AC

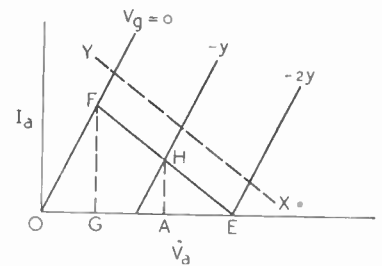

Fig. 2. Fixed HT voltage and load applied through a transformer.

power can be found by first dividing the numerator and denominator of expression (1) by n^2 , giving

$$\text{AC power} = \frac{OA^2 \times R}{8R_a^2/n^2 + 8RR_a + 2n^2R^2}$$

This power is a maximum when the denominator is a minimum, namely when

$$\frac{d}{dn}(8R_a^2/n^2 + 8RR_a + 2n^2R^2) = 0$$

$$\text{i.e., } -16R_a^2/n^3 + 0 + 4nR^2 = 0 \quad \therefore 4n^4R^2 = 16R_a^2$$

$$\text{and } n^2R = 2R_a$$

Similarly, if R be the variable

quantity, divide the numerator and denominator of expression (1) by R, giving

AC power

$$= \frac{OA^2 \times n^2}{8R_a^2/R + 8n^2R_a + 2n^4R}$$

This power is a maximum when

$$\frac{d}{dR}(8R_a^2/R + 8n^2R_a + 2n^4R) = 0$$

$$\text{i.e., } -8R_a^2/R^2 + 2n^4 = 0$$

$$\therefore n^2R = 2R_a$$

Hence, in each case, the AC power is a maximum when the equivalent resistance of the load referred to the primary circuit is twice the slope resistance of the triode.

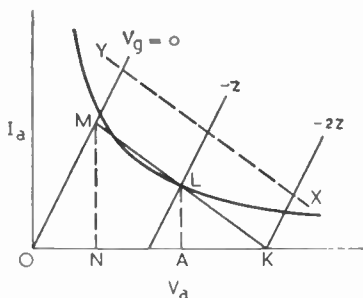

Fig. 3. Unlimited HT voltage, but output power limited by anode dissipation. Load connected direct or through a transformer.

Case 3. Suppose the rectangular hyperbola in Fig. 3 to represent the permissible anode dissipation. Again, draw XY so that its slope represents the load resistance when the latter is in the anode circuit or the equivalent resistance when the load is fed through a transformer.

By trial, draw a line KM parallel to XY such that the point of intersection with the hyperbola at L is midway between K and M . If the I_a/V_a characteristic passing through L corresponds to a grid bias of $-z$, then z represents the peak value of the maximum alternating grid voltage for zero distortion.

With no alternating voltage applied to the grid, the anode dissipation is given by $OA \times AL$. With an alternating voltage applied to the grid and no distortion, the average power from the HT source remains unaltered, and the AC output is equal to the reduction of power dissipated at the anode. A graphical expla-

nation of this was given by the writer in *Wireless World*, October, 1942. Consequently, so long as the frequency is sufficiently high to prevent appreciable variation of the anode temperature, it is immaterial that any part of the load line is above the hyperbola in Fig. 3, i.e., the instantaneous power over a part of the cycle may be allowed to exceed the permissible anode dissipation.

From Fig. 3, AC output power

$$= \frac{MN \times NK}{8} = \frac{LA \times AK}{2}$$

But $LA \times OA =$ a constant, (say, k) for a given triode.

Also,

$$AK/MN = R/2, \text{ and } OA/MN = ON/MN + NA/MN = R_a + R/2$$

$$\therefore \frac{OA}{AK} = \frac{OA}{MN} \times \frac{MN}{AK} = \frac{R_a + R/2}{R/2}$$

$$= 2R_a/R + 1$$

and AC output power

$$= \frac{LA \times OA}{2} \times \frac{AK}{OA}$$

$$= \frac{k}{1 + 2R_a/R}$$

Hence the AC power is a maximum when the denominator is a minimum, namely when R is infinity. Even with $R = 4R_a$, the maximum output is 100 per cent. greater than with $R = R_a$ and 33 per cent. greater than with $R = 2R_a$. Actually, the maximum power is limited partly by the curvature at the lower end of the I_a/V_a characteristics and partly by the highest HT voltage practicable; with the result that in practice R may have to be limited to about 3 or 4 times R_a .

CATALOGUES RECEIVED

BOOKLET describing the "Mastatic" noise-free aerial system and a technical guide on television receiving aerials from Aerialite, Ltd., Castle Works, Stalybridge, Cheshire.

Illustrated leaflet showing typical applications of Oddie fasteners and quick-release pins for instrument panels, from Oddie, Bradbury and Cull, Ltd., Portswood Road, Southampton.

Leaflet describing the "Lens Lite" unit for illuminating and magnifying small instrument parts during manufacture or assembly, from the Electric Depot, Ltd., Pritchett Street, Aston, Birmingham, 6.

GALPINS

ELECTRICAL STORES, 408, HIGH ST., LEWISHAM, LONDON, S.E.13.

TERMS CASH WITH ORDER. No C.O.D. All Prices include Carriage or Postage.

ELECTRIC LIGHT CHECK METERS, first-class condition, electrically guaranteed, for A.C. mains, 200/250 volts 50 cy. 1 phase 5 amp. load, each **12/6**.

AUTO TRANSFORMERS. Step up or down, tapped 0-110-200-220-240; 1,000 watts. **25**.

POWER TRANSFORMER, 4kW, double wound, 400 volts and 220 volts to 110 volts, 50 cycle, single phase. Price **£20**.

AUTO TRANSFORMER, step up or step down, 500 watts, tapped 0-110-200-220-240 volts. **£3 10s**.

1/2 WATT WIRE END RESISTANCES, new and unused, price per doz., 5/6, our assortment.

MOVING COIL AMPMETER by famous maker. 2in. dia., flush mounting, reading 0-10 amps. F.S.D., 20 mA, price **27/6**.

METAL RECTIFIERS, large size, output 50 volts 1 amp., **35/-**.

SMALL MAINS TRANSFORMERS, input 230 volts, output 11 volts 1 amp., **11/-**.

METAL RECTIFIERS, large size, output 12 volts 1 amp., **17/6**.

FIXED RESISTANCES, size 12in. by 1in., fire-proof, resistance 2 ohms to carry 10 amps., 3/- each; set of 16 mounted in steel frame, only **35/-**.

TRANSFORMER CORE for rewinding only, complete with clamps, size approx. 2 1/2 k.w., price **25/-**.

SMALL M.L. ROTARY CONVERTER, in cast all-steel, size 14 x 4 1/2 x 4 1/2 in., permanent magnet fields, converters need attention, not guaranteed. **30/-**.

DYNAMO, slow speed, only 500 r.p.m., output 25v.-10 amps., shunt wound, adjustable brush gear, ball bearing, condition as new, weight 60 lbs., a real high-grade job. Price **£7 10s**.

50 VOLT MOTOR, D.C., input 4 amps., 1/2 h.p., ball bearing, double ended shaft 1/2 in. dia., slow speed, only 500 r.p.m., shunt wound, condition as new, also make good slow speed generator. Price **50/-**.

AUTO TRANSFORMERS, tapped 0-110-200-220-240v., 1 1/2 KW., **£7 10s**; 2 KW., **£10**.

50 VOLT D.C. MOTOR, shunt wound, ball bearing, 1/2 h.p., speed 900 r.p.m., in new condition, make good generator. Price **£7**.

WHAT'S THE WATTAGE ?

Answers!

FLIK-O-DISK

Quick!

The Electrical and Radio Engineers' OHM's Law Calculator

Examples of problems answered in a flash:

- What will be the voltage when current I flows through resistance R ?
- What will be the voltage with watts value W and I current flowing ?
- What is the current flowing where watts value is W and voltage is E ?
- What current will flow through R resistance where voltage is E ?
- What will be the resistance where current I flows at voltage E ?
- What will be the resistance where watts W is at voltage E ?
- What will be the resistance at voltage E through resistance R ?
- What is the wattage of current I through resistance R ?
- What will be the wattage of I current at E voltage ?

The scales read from 1 millivolt to 1,000 volts. From 1 ohm to 1,000,000 ohms. From 1 millamp to 10 amperes. From one-tenth of a milliwatt to 10,000 watts.

The calculator is sold complete and with full instructions at Radio Stores and Stationers. If unable to obtain, write to **IONIC LABORATORIES LTD.**, Dept. W., Cranbourne Terrace, **SALT HILL, SLOUGH, BUCKS.**, for name and address of your nearest stockist.

PRICE

6/6

WORLD OF WIRELESS

U.S. FREQUENCY PROPOSALS

FOLLOWING the recent proposals put forward by the U.S. Federal Communications Commission for the allocation of frequencies above 25 Mc/s, recommendations have now been made for the lower frequencies.

In view of the rumours current some months ago it is interesting to find that some 120 channels have been allocated for international broadcasting. In its finding the F.C.C. states: "Other means of international communication, including the transmission of U.S. broadcasts via point-to-point facilities to foreign countries for re-broadcast there over domestic stations, have a rôle to play; but no such technique can take the place of direct broadcasting from the United States to listeners abroad."

The only changes in the proposed allocations for international broadcasting in this section of the spectrum are: the 15 Mc/s band has been narrowed by 50 kc/s, 100 kc/s have been added to the 17 Mc/s band, and 100 kc/s deleted from the 21 Mc/s band, making each 200 kc/s wide. It will be remembered that the present allocation of 25.6-26.6 Mc/s was omitted from the proposals relating to the higher frequencies as it is useful only

during maximum sunspot activity.

Amateur frequencies below 25 Mc/s remain unaltered in the 3.5, 7 and 14 Mc/s bands, but it is proposed to delete the 300 kc/s band of from 1.75-2.05 Mc/s. In lieu of this the Commission is making provision for an amateur "disaster" network in the 1605-1800 kc/s band. In addition, the 21-21.5 Mc/s band is allocated to amateurs.

The extension of the present broadcast band of 550-1600 kc/s to 535-1605 kc/s is recommended.

There is still considerable controversy on the relative positions of FM and television in the higher frequencies. So much so that in the final allocations between 25-30,000 Mc/s, the 44-108 Mc/s band is not being assigned until the results of FM tests being undertaken during the summer, when sporadic E transmissions are at their maximum, are known. F.C.C. states that space will ultimately be allocated as follows: 36 Mc/s to television, 18 Mc/s to FM, 4 Mc/s to amateurs, 4 Mc/s to non-government fixed and mobile services, and 2 Mc/s to facsimile. The FM alternatives are 50-68, 68-86, or 84-102 Mc/s.

The proposals will be passed to the Federal government preparatory to the holding of an international conference on frequency allocations.

B.B.C. CHANGEOVER

THE first of the B.B.C.'s post-war plans for home listeners is due to come into operation on July 29th, when two programmes, which will be known as the Home Service and the Light Programme, are introduced. They will be followed later by a third programme.

The Home Service will be radiated from 6.30 a.m. until midnight on medium wavelengths by Regional transmitters, which will in most cases operate on the wavelengths used before the war.

The provisional list of the Home Service wavelengths are:—

London Region	342.1	(877 kc/s)
Midland Region	296.2	(1,013 kc/s)
North Region	449.1	(668 kc/s)
	285.7	(1,050 kc/s)
West Region	514.6	(583 kc/s)
	203.5	(1,474 kc/s)
Scotland	391.1	(767 kc/s)
Wales	373.1	(804 kc/s)
Northern Ireland	285.7	(1,050 kc/s)

The Light Programme will be radiated from 9 a.m. until midnight on 1500 metres (200 kc/s), and on 261.1 metres (1145 kc/s) for urban areas where the long-wave transmission is not well received.

U.S.S.R. MORSE BULLETINS

IN response to enquiries from readers we have secured details of the transmission of news in morse from Moscow.

Transmissions are continuous from 0830 to 0430 GMT, but it is impossible to give the exact times for the English transmissions owing to the procedure employed. It is as follows:—Several news items are first transmitted in English and then in French on the Hellschreiber radio-printer; these items are then repeated in the same sequence in English and French morse. After a short interval new items are transmitted in the same order.

The following schedule gives the wavelengths employed throughout the period of transmission:—

0830-1100	25.95, 30.03
1100-1600	20.07, 25.95
1600-1900	36.92, 39.89
1900-2100	54.95
2100-0100	39.89, 54.95
0100-0430	54.95, 65.03

SETS IN THE U.S.

AS a result of a survey of American broadcast receiver manufacturers it is predicted that the industry will require only 83 days after Government restrictions are removed before it starts civilian production. Some five million receivers are expected to come off the production lines in the first six months and a further eight million in the second.

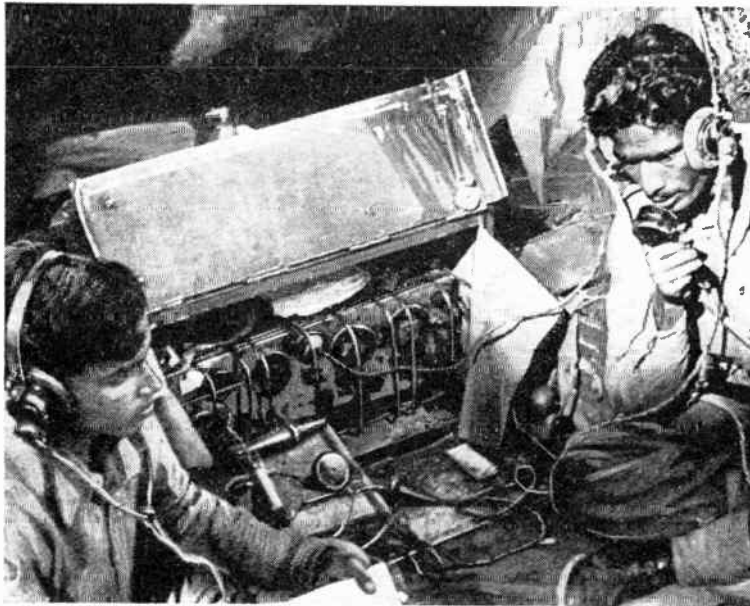

INDIAN SIGNALS. The general-purpose low-power No. 22 transceiver, which has facilities for both 'phone (5W) and CW (15W), in use in the Burma campaign. Men of the Fifth Indian Division are operating the set which has a frequency coverage of from 2-8 Mc/s.

In addition to the broadcast sets some 96,000 television sets are promised.

The majority of the broadcast receivers (65 per cent.) are expected to have seven valves or less.

EDUCATIONAL OPPORTUNITY

WE are informed by the Head of the Department of Electrical Engineering and Physics at the Borough Polytechnic that another intensive full-time course in radio engineering under the Hankey Scheme will commence on October 2nd.

The conditions for entry, which include free tuition and a maintenance grant, are obtainable from the Borough Polytechnic, Borough Road, London, S.E.1.

ABSIE

THE activities of ABSIE (American Broadcasting Station in Europe) ceased on July 4th. With its cessation the two transmitters placed at the disposal of the American Office of War Information by the B.B.C. have been returned.

In addition to being radiated by these two transmitters on 307.1 and 267.4 metres the programmes originating from the London studio of ABSIE have been broadcast on short-waves by American and British stations.

WHAT THEY SAY

A FAULTLESS MONSTER.—Many who attach importance to the fair representation of public opinion regard the B.B.C. as a Frankenstein's monster which is getting out of control. . . . The influence over public opinion of the B.B.C. is already as great as that of all the newspapers put together.—*Somerset de Chair, M.P., writing in "The Times."*

LIBERATION PLEASURES.—I must write to tell you that receiving *Wireless World* was one of the greatest pleasures for me since being liberated. I have already read it completely, but shall go through it several times again.—*A Channel Islands reader.*

SOVEREIGNTY.—One might almost define sovereignty to-day as the possession of a radio station of one's own.—*Walter Elliot in the House of Commons.*

PERSONALITIES

Sir Robert Watson-Watt was present at the opening session of the British Commonwealth Air Transport Council, as advisor on radio and radar.

E. Lloyd Thomas, a contributor to *Wireless World*, has left The Plessey Co., and is now in charge of the electronics section of the Sperry Gyroscope Company.

IN BRIEF

Palestine Broadcasting.—The administration of the Palestine Broadcasting Service has been separated from the General Post Office and a new department of broadcasting has been formed in Jerusalem. The new department has appointed an assistant controller of the English programmes and separate controllers of the Arabic and Hebrew transmissions.

American Radio Conference.—U.S. Government officials, in conjunction with representatives of the American radio industry, are meeting under the chairmanship of Dr. Dellinger preparing for the Third Inter-American Radio Conference, which opens at Rio de Janeiro on September 3rd.

Running Repairs.—The maintenance of the broadcast receivers issued to the Forces presents something of a problem when, as often happens, nobody in the unit knows sufficient about radio to tackle the job of repairing or overhauling a defective set. Middle East Command has now arranged for five radio repair trucks, jointly organised by the Forces Broadcasting Service and R.F.M.E., to tour the Command.

Re-issued.—We have received a copy of the re-issued Bulletin of the British Sound Recording Association. This four-page news sheet gives information on recent developments, equipment and people in the sound recording sphere. Information about the Association's activities is obtainable from the General Secretary, D. W. Aldous, "Strathdee," Studley Road, Torquay, Devon.

Radio v. Cancer.—According to *The Petroleum Times*, radio-frequency energy is being used by Soviet scientists in preparing mineral oil in a finely emulsified state for the treatment of cancer. The emulsion, of which the oil particles must be small enough to pass through very fine capillary vessels, has been successfully used for intravenous injections.

B.L.A.1.—Operated by men of the British Liberation Army, the former German transmitter at Cologne is now broadcasting on 455 metres and is announced as B.L.A.1.

Export Interest.—Industry generally is taking a lively interest in the recently formed British Export Trade Research Organisation (BETRO). The following radio firms are among the ordinary members: The British Thomson-Houston Co., Ltd.; Ultra Electric, Ltd.; Portogram Radio Electrical Industries, Ltd.

New Address.—The address of the Technical and Commercial Radio College, formerly of Ealing, is now North Road, Parkstone, Dorset.

Peacetime Radio.—A Government factory at South Shields has been allocated to Wright and Weaire for civilian radio production.

Cable Merger.—British Insulated Cables, Ltd., and Callender's Cable and Construction Co., Ltd., have amalgamated and will in future be known as British Insulated Callender's Cables, Ltd.

SOON. CRONAME
Designing and Engineering



will again be a factor in the place of far-sighted manufacturers of electronic equipment. From building precision parts for wartime devices the Croname group will turn to the processing of mechanical and decorative items for the electronics industry.

A place in the Crowe schedule has meant attractive, practical, saleable merchandise to many. Our facilities may be valuable to you.

Dial Seals.
 Tuning Mechanisms.
 Pointers. Escutcheons.
 Precision Controls. Knebs.

* Exclusively Represented in Great Britain by

FRANK HEAVER LTD.
 Kingsley Road, Bideford, N. Devon.

Croname Incorporated
 (Croname Parts & Manufacturing Co.)
CHICAGO, ILL. U.S.A.

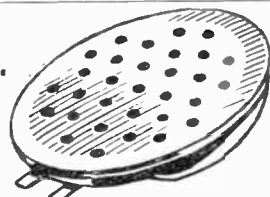

H.A.5 DEAF-AID CRYSTAL MICROPHONE

ASTATIC will be ready to serve you again with high quality piezo-electric devices when the 'All-Clear' of Victory sounds. Astatic deaf-aid microphones can be supplied only if Import Permits are established. Model H.A.5 illustrated is used as standard by America's leading hearing-aid instrument makers.



THE ASTATIC CORPORATION
 CONNEAUT, OHIO, U.S.A.
 and
 TORONTO, CANADA.

— Exclusively Represented by —
Frank Heaver Ltd. Kingsley Road, Bideford, N. Devon

RECORDING LABORATORY

Installation in the Library of Congress, U.S.A.

IT does not appear to be generally known that one of the most modern and elaborate sound recording laboratories in the U.S.A. is installed in the Library of Congress, Music Division, at Washington, D.C., under the direction of the Librarian, Archibald MacLeish.

The need for such a laboratory first expressed itself through the popular demand for duplicates of the recordings in the Library's Archive of American Folk Song. For many years the Library of Congress has sponsored a scheme for recording American folk music in the field from the mouths of contemporary singers. A collection of 10,000 songs on discs, cylinders, etc., has been accumulated under the direction of John A. Lomax, Honorary Curator, to form one of the largest collections of its kind in the world. However, only students who were free to come to the library or enthusiasts who could afford to have expensive copies made were able to use the library's vast collection.

The Carnegie Corporation, in 1940, made a grant of over 41,000 dollars for the installation of a complete laboratory for duplicating gramophone recordings of all types, for making master recordings that can be pressed and distributed, for originating broadcasts and for making transcriptions (16-in. 33 $\frac{1}{3}$ r.p.m. discs) for radio transmissions. In addition, a mobile sound unit and a number of portable recorders were purchased for use in the gathering of "on-the-spot" material and other field recording work.

Through the facilities of the laboratory it is now possible for schools, libraries and individuals to obtain recordings for home study of rare American folk music, poetry, etc., and contemporary U.S. history and culture can be recorded for future generations.

Equipment

The technical equipment of the laboratory includes RCA 88A

By DONALD W. ALDOUS

and MI-3044 microphones, used in the main studio, and in the recording room a large four-panelled rack houses: (1) Hallcrafters SX-28 receiver and Hallcrafters S-31 FM-AM high-fidelity RF tuner (specially chosen for recording radio transmissions with optimum quality and low background noise); (2) 3-channel RCA 85B pre-amplifier, dual-channel line equaliser, patch panel, 40-D amplifier and 94-D monitor; (3) 3-channel pre-amplifier meter panel, patch panel, duplicate RCA 40-D amplifier and 94-D monitor; (4) Presto 55-watt recording amplifier and cutting-head bridging-monitor amplifier. The patching panels permit various possible interconnections of apparatus to be made and allow monitoring at almost any point of the circuits.

Two Scully recording lathes, fitted with RCA MI-4887 heads,

with a pair of Presto 6N recording units, comprise the actual cutting apparatus. These precision Scully machines have an automatic run-out spiralling device and many other useful features, including a special relay-operated change-over circuit to switch the modulation from one cutting-head to the other instantaneously by push-button control.

"Dubbing" Apparatus

As the production of duplicate recordings, up to as many as 200 in one week, from the collection on the shelves of the library is an important part of the work of the laboratory, considerable attention has been paid to the re-recording or "dubbing" apparatus. The main dubbing-table has several pick-ups, including Brush PL-20 and RCA models, each adapted to give the best results with certain types of records. Various cut-off, taper filters and equalisers, mostly used in transcription work, are located on this dubbing-table, to



Interior view of the recording laboratory's sound truck, showing one of the 16-in. recorders, control panels, telephone intercommunication link, recording amplifier, etc.

which also is connected a variable frequency generator that enables old records, originally recorded at speeds other than the normal, to be copied, as the speed of the turntable can be adjusted until the best quality of reproduction is obtained.

Restoring Old Records

An interesting aspect of the work undertaken in this laboratory has been the repair and restoration of old cylinder and disc recordings, of which some specimens are of unique historical value. Many of the cylinders reach the laboratory in dirty and cracked condition covered with mould, and have to be cleaned before being transcribed on to "cellulose" direct playback discs, but the minimum of treatment is applied as the grooves are sometimes damaged by this operation. Another difficult problem is cracked cylinders and discs, but the laboratory technicians are experimenting with a machine to eliminate the worst effects of such cracks and scratches.

The cylinders are copied on a simple rebuilt "Dictaphone" machine with which can be used several specially designed vertical pick-ups, i.e., a photo-electric model made by the Philco company, a lightweight electro-magnetic model, or a special crystal unit. Four feeds, namely, 100, 150, 160 and 200 tracks per inch, have enabled the machine to handle all the cylinders so far encountered, but the transcription turntable has been made continuously variable to cope with rotational speeds varying between 50 and 225 r.p.m.

The sound level on most of the acoustically-recorded cylinders is very low, and the useful frequency range recorded was usually between about 250 and 3,500 c/s, with most of the rumble occurring below 250 c/s and most of the surface noise above 3,500 c/s; hence careful application of equalisers is needed to allow a disc transcription of tolerable quality to be made.

The portable of field recording equipment of the laboratory consists of nine complete portable recorders and a fully-equipped mobile sound truck. All the portable units, comprising small

12-in. and 16-in. slow-speed models, have self-contained power supplies, operated from storage batteries, as well as several with petrol chargers for recharging batteries when commercial power is not available. The sound truck is equipped with two 16-in. Presto turntables, of which one can be seen in the illustration. Telephonic communication is provided between the recording location and the engineers in the truck, and a portable four-channel mixer is available. The apparatus is energised from a self-contained 110-volt 60-c/s. supply, which operates from a 32-volt storage battery system. The batteries can be recharged by a generator driven by the truck engine, or from commercial mains. The frequency of the power supply is regulated by a field control connected to the convertor, and the former, with a frequency-indicating meter, is visible on the control panel next to the turntable in the illustration on the preceding page.

Preserving Recordings

Completed reference transcriptions, recorded on conventional nitro-cellulose direct discs, are stored on racks in closed metal boxes in air-conditioned vaults, as such discs are not stable. Solid-stock pressings are durable, but this process is too slow and costly for most of the records stored in the library's collection, and so research has been commenced to determine the life expectancy and shelf-life, and the best method of preservation, of direct recordings.

In closing this brief survey of the work and equipment of the Library of Congress recording laboratory it should be mentioned that, since 1941, when the United States of America entered the war, the laboratory has been actively engaged in war work, and has devoted a major portion of its time to the Armed Services in the production of master recordings for processing purposes and the rendering of a technical reference service.

The author wishes to express his thanks to Dr. Arthur D. Semmig, Chief Engineer of the laboratory, for information and for permission to reproduce the accompanying illustration.

PREMIER RADIO

(MORRIS AND CO. (RADIO) LTD.)

ALL POST ORDERS TO :

JUBILEE WORKS, 167, LOWER CLAPTON ROAD, LONDON, E.S. (Amberst 4733.)

CALLERS TO :

JUBILEE WORKS or
169, FLEET STREET, E.C.4. (Central 2833.)

1945 LIST NOW AVAILABLE. HUNDREDS OF NEW LINES.

All enquiries must be accompanied by a 2½d. stamp.
ELECTRIC CLOTHES PRESSING IRONS, 8 lb., pre-war quality, with lead, 53/6.

METERS. First grade army type Universal Test Meter in shockproof bakelite cases, ranges 10, 100, 500 volts at 1,000 ohms per volt A/C and D/C, 1, 10, 100, 500 m/a D/C, 0-10,000 ohms, £2 15s.

FIRST GRADE METERS. 3½in. diameter, 1 millamp, £2 12s.; 500 microamps, £2 18s. 6d. 4½in. 1 millamp, £3 5s.; 500 microamps, £3 11s. 6d.; Westinghouse Meter Rectifier for either type, 10/-. Multiple shunts 10, 100, 500 m/a, 10/-. Any value multiplier, 2/6 each.

SUPER QUALITY AMPLIFIERS, 12 watts output high and low gain inputs with mixer, treble and bass controls, two DB 30-11,000 cycles, negative feedback, 2, 4, 8 and 16 ohms output, £14 14s.

INDOOR AMPLIFIERS, 5 watts output, high gain, three-stage, feedback, £8 8s.

BATTERY CHARGERS for 2 v. batt. at 1 a., 25/-; for 2, 4 or 6 v. batt. at 1 a., 45/-; for 6 v. batt. at 1 a., 30/-; for 2, 6 or 12 v. batt. at 1 a., 49/6; for 6 v. batt. at 4 a., £3 10s.; 12 v. 4 amps., £4 10s.

MAINS TRANSFORMERS, 300 + 300 v., 60 ma, three 4 v. 2-3 a. windings, 25/-; 350 + 350 100 m/a, 6 v. 2 a., 6.3 v., 2-3 a., 29/-; 350 + 350 100 m/a, three 4 v. 2-3 a. windings, 29/-; 350 + 350 100 m/a, two 4 v. 2-3 a., two 4 v. 1 a. windings, 35/-; 350 + 350 150 m/a, 5 v. 2 a., 6.3 v. 2 a., 6.3 v. 2 a., 36/-; 500 + 500 250 m/a., 5 v. 3 a. 6.3 v. 2 a., 6.3 v. 4 a., 65/-; 425 + 425 200 m/a. 4 v. 2-3 a., 4 v. 2-3 a., 4 v., 3-6 a., 47/-; 350 + 350 150 m/a, 4 v. 1-2 a., 4 v. 2-3 a., 4 v. 3-4 a., 36/-; 500 + 500 150 m/a, four 4 v., 2-3 a. LT windings, 47/-.

1-VALVE BATTERY S.W. RECEIVER, with 2-volt valve, 4 coils, 12-170 m. bandspread tuning, 55/-, including tax.

STEEL CHASSIS, 10 x 8 x 2½in., 7/-; 16 x 8in., 9/6; 20 x 8in., 10/6; 12 x 9 x 2½in., 7/8.

SECRET-WAVE COILS fit octal sockets, 4-pin aerial coils, 0-15, 12-26, 22-47, 41-94, or 76-170 m., 2/6 each; 150-350 or 255-550 m., 3/-; 490-1,000 or 1,000-2,000 m., 4/-; 6-pin H.F. Trans., 9-15 12-26, 22-47, 41-94 or 76-170 m., 2/6. S.W. chokes, 10-100 m., 1/3; 5-200 m., 2/6.

SECRET-WAVE CONDENSERS easily ganged. 15 mmdfd., 2/11; 25 mmdfd., 3/3, 4/0 gmdfd., 3/3, 100 mmdfd., 3/11, 160 mmdfd., 4/8, 250 mmdfd., 5/8; shaft couplers, 7/1d.; flexible ditto, 1/6. Dual bandspread for use with 2-gang, 6/6.

MIDGET "P" TYPE COILS, 12-35, 16-47, 24-100 91-251, 250-750, 700-2,000, 200-557, available as H.F. trans., aerial, or osc. coils, 2/3 each. Yaxley type wave-change switches, wvery type available; locators, 2/- each; wafers, 1/- each. Small 2-pair condensers: 0.0006, 15/-; Matched pairs iron-cored 465 K.C. I.F. trans., 15/- pair; midget type, 21/- pair. 50 mmdfd. trimmers, 1/-; osc. paddler, 750 mmdfd., 1/9; B.F.O. coil, 2/3.

CONDENSERS. All small tubular type. 25 mf, 35 v.v., 50 mf, 12 v.v., 10 mf, 50 v.v., 1 mf, 500 v.v., or 20 mf, 50 v.v., 2/3 each. 2 mf, 350 v.v., 2/9. 4 mf, 450 v.v., 3/8. 8 mf, 450 v.v., 4/8. 16 mf, 450 v.v., 7/8. 20 mf, 450 v.v., 8/6. 8 + 8 450 v.v., 8/6. 16 + 8 450 v.v., 9/6. 16 mf, 150 v.v., 4/8. 50 mf 50 v.v., 3/6.

CRYSTAL PICKUPS. Cosmocond, £2 11s. Rothermel super, £3 18s. 9d.

AMERICAN VALVES, 4525, 3525, 2525, 128K7, 12877, 2525, 6V6, 6F6, 524, 50, 517, 6K7, 12V6, 1C8, 1E5, 1T5. Many others available.

SUPER GIANT PUSH-PULL INTER-VALVE TRANSFORMERS, 21/-; midget type, 12/6.

MOVING COIL SPEAKERS. Rola 6½in. or 8-in. P.M., no trans., 25/-; Plessey 6-in. P.M. with trans., 29/6. Goodmans 3½in. P.M. with 3 or 15 ohm voice coil, no trans., 30/-; 8in. 1,200 ohm energised speakers, 35/-. Midget standard or P.P. trans. for any above, 10/6. Super quality giant Matchmaker output transformers, match any tube single or P.P. to any voice coil, 7-watt, 22/6; 16-watt, 30/-; 30-watt, 49/6; 60-watt, 59/6.

CHOKES 8H. 300 ohms, 40 m/a, 4/6; 30 H, 400 ohms, 60 m/a, 13/-; 30H, 100 m/a, 4/0 ohms, 19/6; 30H, 185 ohms, 150 m/a, 25/-; 25H, 250 m/a, 120 ohms, 39/6.

SUNDRIES. 2 mm. Systoflex, 2½d. yd.; fusid-cored solder, 6d. per coil or 4/6 per lb.; screened 2-pin. plugs and sockets, 9d.; ditto, 8-pin, 2/-; Octal sockets, 10½d.; ditto, amphenol type, 1/3. Valve screens, 1/2; 6-volt vibrators 4-pin, 12/6. 50ft. Indoor Aerial, 2/6.

Letters to the Editor

Textbook Authors • Students' Troubles • Antiquity of UHF • Tone Control

Radio Textbooks

I READ Thomas Roddam's article in your June issue with interest, as I am the author of an elementary textbook which was reviewed in October, 1944, in *Wireless World*, *Wireless Engineer* (by G. W. O. H.), and in the *Proceedings of the Physical Society*.

Mr. Roddam's suggestions for obtaining authors of good textbooks on radio, presumably those of an advanced nature, are based on the following theme: "There is no time in which the full-time lecturer in radio can keep up to date . . . we cannot see books we want coming from this source. . . . In industry there are potentially better-equipped authors."

Now in my view a good textbook should exhibit these qualities: (i) An ordered assembly of accurate subject-matter to the standard concerned, (ii) clarity of exposition, (iii) a knowledge of the special difficulties of the students for which the book is written.

The possession of a fund of accurate and detailed knowledge of a subject does not automatically carry with it the ability to impart information in a clear and orderly manner by the written (or the spoken) word, and although quality (i) above appears to be well within the powers of men in industry, qualities (ii) and (iii) can only be achieved after experience of active teaching of the subject. Consequently if research workers and others in industry wish to write a good textbook on radio (with the emphasis on the word "good"), they should spend some time in teaching.

On the other hand, as Mr. Roddam has no doubt in mind, there are teachers in the universities, the polytechnics and technical colleges, and the schools who do not take the trouble to keep up with modern developments in their subject. Macaulay wrote: "I hold every man a debtor to his profession," and many teachers,

the true *élite* of the profession, do find time to read regularly journals such as the *Proc. I.E.E.*, *Proc. I.R.E.*, *Wireless Engineer*, *Wireless World*, *Nature*, to quote only a few examples. My suggestions for authors of good advanced textbooks on radio are: Professor G. W. O. Howe of Glasgow University, and J. A. Ratcliffe, C. W. Oatley of Cambridge University.

M. NELKON.
Northampton Polytechnic,
London, E.C.

WITH reference to Thomas Roddam's article, may I suggest that the trouble is in part due to our authors being undecided upon the type of reader to cater for?

This indecision is quite understandable, as the readers of radio textbooks vary between the trained electrical engineer who wishes to specialise in radio and the draper's assistant who is fed up and wishes to "take up something more interesting."

The author, vaguely conscious of this diversity in type of reader, makes an attempt at satisfying all concerned, and inevitably falls between two stools by producing a book which bores to tears the trained engineer, and completely baffles the lay reader who obviously needs a preliminary electrical training before attempting such a highly specialised subject.

So let us take an adequate background knowledge for granted when we write our radio textbooks, and not try to compensate for the lack of such training by using up half or three-quarters of each book with matters which should have been covered by the reader long before he aspired to the study of radio communication.

C. M. LLOYD.
London, N.W.3.

"Value Vectors"

MAY a student chip in to the "Valve Vector" scrimmage? Many of us have dabbled in wireless for years; we haven't got

cathode-ray tubes or valve voltmeters or standard sine-wave sources, so we are not able to check experimentally the dictum of the expert. We have accepted such textbook statements as the "anode current is in phase with the grid input voltage, when the anode load is resistive." We welcomed the appearance of Dr. Sturley's article and spent many hours reading and re-reading it, but we are afraid we must agree with Dr. Parnum at least to this extent, that we were never quite clear what Dr. Sturley meant by "the current I_a produced by the generated voltage μE_g ." Not that Dr. Parnum has cleared matters up; indeed, his criticism and Dr. Sturley's reply have made confusion worse confounded!

Now, Sir, what is the poor student to do? We welcome articles by experts who take pains and trouble to make things clear to avid amateurs, but we like to feel our authority is inviolable. Personally, we confess we are often confronted with an inability to follow an experts' exposition and admit to the human weakness of preferring to remain in happy ignorance rather than lose face by admitting our mental weakness.

But Dr. Sturley will not let us remain in happy ignorance. He has made us so unhappy over this question of anode and grid phase relationship that we hope he will take pity on us and explain a little more fully the problem that disturbs our sleep. The problem is this: does the connection of a reactance in parallel with the resistive anode load affect the phase of the anode voltage, E_a ? So far as our memory serves, we have never seen in any textbook a reference to the effect, if any, of reactance on the anode voltage phase—all references confining themselves to the special case of a resistive load. One infers, of course, that a reactive load will change the phase, but when we, ourselves, put the question to several of our expert friends their

explanations were, to say the least, unsatisfactory.

We applied ourselves vigorously to Dr. Sturley's article feeling that herein lay the solution, but we were not able to expose it—somewhere it lies hidden in E_g , I_a , I_c , I_a , I_c and μE_g . His statement that "the grid input AC voltage and the voltage generated by the generator imagined to exist inside the valve are 180 deg. out of phase; this is true whether the anode load is resistive or reactive," seems incompatible with his conclusion that " E_g lags behind μE_g " in his analysis of the tuned anode oscillator. Our bewilderment is due to our inability to decide which is the source of the AC output, the HT battery or the generator inside the valve? If the valve is an impedance varying inversely with the grid voltage and the anode load is in series with it, then the phase of the voltage at the junction of these two impedances will be determined by their reactances. On the other hand, if the valve is a generator with the anode load strapped across it the reactance of the load will not shift the voltage phase of the generator, but will only affect the phase of the current flowing through it relative to the voltage.

Please, Dr. Sturley, we are grateful for your article; that we do not fully understand it is our lack. Will you help us out?
"STUDENT."

Were Old-timers "Dumb"?

ALTHOUGH I have little fault to find with your contributor "Diallist," I think it is a little unkind to suggest that we old-timers of twenty-five (and more) years ago were "dumb" or conservative enough to scoff at the idea of working on frequencies as high as 25 Mc/s.

In 1917 experiments were being carried out with spark transmitters by the Marconi Company on frequencies lying between 60 and 70 Mc/s., and surely "Diallist" has not forgotten the Inchkeith rotating beam, installed in 1920, operating at 50 Mc/s.

It is doubtful whether the "astonishing developments in wireless technique" seen during the last 25 years would have materialised had not most of those

associated with its development been singularly free from the hide bound limited outlook that one normally associates with followers or practitioners of other professions.

After nearly 30 years' work on frequencies from below 20 kc/s, to something over 6,000 Mc/s., I cannot recall one colleague who ever expressed a doubt regarding the value to the world of development work on frequencies extending in both directions.

I am hoping to live long enough to see the modern physicists turn their attention to the frequencies below 15 kc/s.—possibly for the purpose of erecting a real central heating plant. Then I shall die technically happy.

CHAS. H. WHITE.

Staines, Middx.

"New Versatile Tone Control Circuit"

WITH reference to the letter by D. Winget published in the June *Wireless World*, I should like to make two comments.

His suggestion regarding the alteration of the position of the resistance R_3 (reference his figure) is good, although it cannot be applied to my tone control circuit.

Concerning Mr. Winget's second remarks I entirely disagree. If one takes the meaning of "normal" as being the amplifier without bass boost, then obviously, if one increases the bass, one must also increase the output at the bass compared with normal. Why Mr. Winget refers to correcting the loudspeaker deficiencies as "cooking" and yet does not use this term when it is applied to the correction of deficiencies in other components I cannot see. Surely it is no more cooking to correct for the loss of the low frequencies in the loudspeaker than for the loss of the low frequencies in the pick-up. Usually the loudspeaker is the weakest link in the chain, so why not correct for it? There is another point; assuming the loudspeaker to be perfect, there is greater power associated with the low frequencies than with the higher frequencies, and therefore, if you now put in the low frequencies which were not there in the "normal" amplifier, the output must go up.

G. N. PATCHETT.

Bradford.

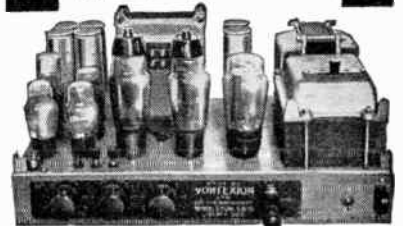

The new Vortexion 50 watt amplifier is the result of over seven years' development with valves of the 6L6 type. Every part of the circuit has been carefully developed, with the result that 50 watts is obtained after the output transformer at approximately 4% total distortion. Some idea of the efficiency of the output valves can be obtained from the fact that they draw only 60 ma. per pair no load, and 160 ma. full load anode current. Separate rectifiers are employed for anode and screen and a Westinghouse for bias.

The response curve is straight from 200 to 15,000 cycles in the standard model. The low frequency response has been purposely reduced to save damage to the speakers with which it may be used, due to excessive movement of the speech coil.

A tone control is fitted, and the large eight section output transformer is available to match, 15-60-125-250 ohms. These output lines can be matched using all sections of windings, and will deliver the full response to the loud speakers with extremely low overall harmonic distortion.

PRICE (with 807, etc., type valves) £18.10.0

Plus 25% War Increase

MANY THOUSANDS ALREADY IN USE

VORTEXION LTD.
257, THE BROADWAY,
WIMBLEDON, S. W. 19.
Phone: LI/Berly 2814

RANDOM RADIATIONS

By "DIALLIST"

Jointing Litzendraht

A BLACKPOOL reader asks if I know any way of making satisfactory soldered joints in "Litz" wire. The ideal method would, I suppose, be to solder and re-insulate each strand separately, but I can hardly imagine any normal human being going to those lengths with, say, 27/44! What I have always done is simply to bare all the strands of both ends, to twist them together, to run in resin-cored solder, and to insulate with a silk binding. It does not take long to do and it seems to work well enough. When making a tapping in a Litz-wound coil, I bare about three-quarters of an inch at the appropriate place in the main wire and about the same amount at the end of the piece that is to form the tap. A standard flex T-joint is then made, soldered and wrapped. The chief snag lies in stripping the insulation from such fine stuff as No. 44 SWG. Scraping is a tedious job and if you attempt to do it you are almost certain to cut or break some of the strands. I have seen it recommended that the insulation should be burnt off with the flame of a match. I wonder if the maker of that suggestion has ever tried it out! Hardly, I think, for if he had he'd have found that the flame burns out not only the insulation, but the wire as well. My own way is to *char* the wrapping by waving a match flame to and fro under it, taking care not to let the silk catch fire. When the insulation has been charred it is easily rubbed off with the fingers. Readers are very likely to know of better methods of dealing with Litz. If they do I should be very glad to have particulars and to publish them for the common good if they will be so kind as to send them along.

□ □ □

Small Tools

ON my return to civil life I was horrified to find how difficult small tools, such as one needs for wireless work, were to obtain and to what prices some of them had risen. My drill canister, when I came to check over its contents, was found to be in need of replenishment. Well, mine proved to have fifteen drills missing or unserviceable (friends and evacuees had done some borrowing in my absence, I suspect) and it wasn't too easy to obtain them. They would have cost about fourpence or fivepence apiece in pre-

war days, but I had to pay an average of just over a shilling a time for them. And such pliers! Can anyone tell me where to buy a good pair of little four-inch bottle-nosed pliers? Mine have mysteriously disappeared, so have flat-nosed pliers of the same size and a much-valued pair of small toggle-action end-cutters.

□ □ □

Good News—If True

KNOWING (a) how many and interests concerned and (b) our national love of compromise, I've always taken rather a gloomy view of the possibility of our getting rid, in any reasonable time, of interference with wireless reception due to man-made causes. I have just heard that a committee is considering the question at the moment and that it is likely to recommend in its report that strong and immediate action should be taken. I hope that this is so and that, when made, its recommendations will be accepted and acted upon at once. What too often occurs is that when a committee of highly qualified and experienced men is constituted to consider this question or that its labours eventually go for little or nothing. Government officials, who must know far less about the subject than they, water down the recommendations until they become more or less ineffective. That's what I'm so afraid of in the case of interference. We are on the verge of producing masses of new motor cars and vast quantities of domestic electrical appliances. Will any Government take the strong line of bringing in immediately legislation making it an offence to sell or use any kind of apparatus which can cause interference with wireless reception? I wish I could think so.

□ □ □

Queer Ideas

A CORRESPONDENT, who endorses my remarks in a recent issue on the folly of leading the man-in-the-street to believe that post-war receiving sets are going to be cheaper, points out also that the lay Press has been guilty—in part at any rate—of starting and fostering some strange ideas. One of these is that radiolocation has led to vast advances in television technique. Quite a lot of people seem to believe that one. Actually it hasn't, for almost the only similarities between the television and radiolocation receivers are that both use cathode-

ray tubes and work on the ultra-short waves. We have probably learnt a good deal about the design and mass production of CRTs, though so far there haven't been many signs that mass production is going to result in any sensational lowering of prices. There have been advances, too, in ultra-short-wave technique in radiolocation and in other branches as well: much work, for instance, has been done on aerial systems and the development of Polythene has solved certain problems. But I don't fancy that any of these things is going to revolutionise television. One weird piece of confused thinking that one comes across is that television and radiolocation are much the same thing. I've heard railway-carriage experts explaining (!) that post-war television will enable those who use it to see distant objects in the dark or even through brick walls. And I wish the lay press would keep radiolocation and ionosphere "sound-ing" separate.

□ □ □

Make It Plain

IT would be no bad idea if radio manufacturers who turn out broadcast sets with magic eyes explained rather more clearly in their books of words how necessary it is to tune correctly if a set is to do itself justice. And would it not be better if the directions told the layman to tune for the smallest spaces between the limbs of the cross rather than for the biggest cross? That is a point that designers of magic-eye tubes might also bear in mind. If the set has no tuning indicator, the handbook should certainly give very plain instructions for finding the optimum setting by ear. With either an indicator-less superhet or a straight receiver I don't think you can beat the bracketing method. Having found the approximate setting, turn clockwise until obvious distortion occurs; then turn anticlockwise until the same thing happens. Make a smaller bracket if need be. The right setting will then be easy to find.

□ □ □

Loudsquawker

SOMETHING has been said recently in *Wireless World* about the fine selection of weird noises that a loudspeaker can emit when there is an electric lamp in the house with a broken filament whose free ends are vibrating and making intermittent contact. I had a

similar experience, but on a grander scale, a few evenings before writing these notes. The loudspeaker began to moan quietly. But the doleful noise didn't remain *piano*; it grew rapidly in volume and ere I could switch off it had become an ear-splitting shriek. When I'd silenced the set I found that the noise was still faintly audible. At first I thought that my ears were still singing, but the sound persisted and I traced its origin to an electric bowl fire, which had been turned on to make flaming June seem a little less like chill December. Switching that off, too, and blessing the ensuing peace and quiet, I waited for it to cool down before making an examination. This bowl fire has a heater element with a screw-in fixing. The screw had worked loose—one of life's deep mysteries is the apparent possession by inanimate screws and nuts of sufficient power of movement to loosen themselves, no matter how firmly they may have been tightened down—and a respectable arc had been taking place between the contacts within the holder. I can assure you that the performance of the wireless set under its stimulus had to be heard to be believed.

Arc Royal

Speaking of arcs reminds me of a spot of bother that we used to have occasionally with what for security reasons I had perhaps better still call radiolocation equipment. The load when one type of transmitter is working is about 16 amps at 230 volts, 50 cycles. The power cable of the transmitter is connected to the generator by means of a hefty plug with good fat pins. Having pushed the plug in you fix it well and truly home by means of a screw-down locking ring. More than once I've known those plugs to be welded solid into the sockets and on one occasion the heat became so intense that the whole lot melted, causing a magnificent short. You might hardly expect arcs to occur in plugs and sockets such as these, or the results to be so devastating with a 16-amp. current. The trouble was invariably due to the carelessness of one "number," who had scamped the work of cleaning the plug points during "care and maintenance." A little dirt on the points was quite sufficient to cause arcing—and there you were. And yet I never remember hearing of similar trouble with 2-kilowatt domestic electric fires, where the load is some 10 amps and the plugs, besides never being cleaned, are often none too good a fit in their sockets.

It's the hidden details that count

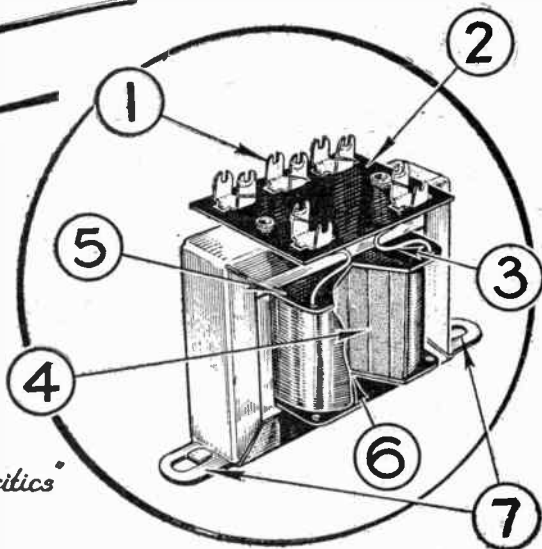

'The choice of Critics'

A.F. Voltage & Small-power Transformers & Chokes for all types of electronic apparatus, in all normal ratings and in a diversity of physical sizes.

- 1 — Heavily silver-plated non-rotatable solder-tags for connexions.
- 2 — Tropic-grade synthetic-resin-bonded tag boards for high insulation resistance under all conditions.
- 3 — Colour-coded leads, welded to instrument wire in bobbin.
- 4 — Layered and sectionalised windings of highest-grade h.c. instrument wire.
- 5 — Synthetic-resin bobbin holding windings in immovable formation.
- 6 — Bobbin & Windings vacuum-impregnated and coated waterproof materials.
- 7 — Core shrouded and tightly clamped with maintained iron-circuit and fixing centres.

Over 100 types to choose from.

Please quote Priority Nos. on orders.



A. F. BULGIN & CO. LTD., BYE PASS RD., BARKING, ESSEX

RIPpleway 3474 (5 lines)

(The name "BULGIN" is a registered Trade Mark)

RECENT INVENTIONS

TELEVISION STUDIOS

TO avoid the unpleasant heating effect of the usual high-powered incandescent lamps, the studio is floodlit by the fluorescent type of lamp.

The increased tendency to "flicker" is offset by enclosing the Iconoscope camera in a light-tight casing, which is fitted with a number of incandescent lamps to provide an adjustable "bias" illumination for the mosaic screen. In addition, an adjustable shutter admits a ray from the studio lamps, which is directed against a photo-sensitive layer on the wall of the tube facing the screen. As the current from the AC lighting mains passes through its zero, the flicker from the biasing lamps will tend to produce a "black" pulse, whilst the ray of light coming from the studio through the shutter simultaneously tends to produce a "white" pulse, due to the electrons released from the sensitised wall of the tube. The two effects are cancelled out in the transmitted picture.

Marconi's Wireless Telegraph Co., Ltd. (assignees of O. H. Schade). Convention date (U.S.A.) July 27th, 1942. No. 566429.

SUPER-REGENERATIVE RECEIVERS

THE theoretical advantage of using a high quenching frequency is partly offset by the fact that the "decay" period becomes too short to allow the amplified signal to fall to its input level before the onset of the next "build-up." To avoid distortion from this cause, it is proposed to accelerate the rate of decay by the periodical application of an out-of-phase voltage.

As shown, incoming signals are applied to the first grid of a pentode through a coil L, which is regeneratively coupled to a coil L1 and de-generatively coupled to a coil L2, the

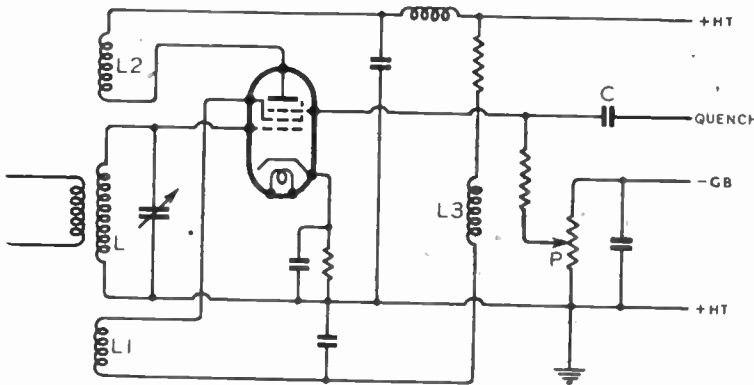

Circuit for high quenching frequencies.

two latter coils being connected to the second grid and anode respectively. Quenching oscillations are fed from a source (not shown) through a condenser C to the third grid, which also takes a variable bias from a potentiometer P. In operation, the bias on the third

A Selection of the More Interesting Radio Developments

grid is adjusted so that at the point of the "quench" when the signal amplification starts to decay, the anode of the valve begins to take current and so feeds back to the first grid an out-of-phase voltage which ceases when that grid regains the level of the input signal. During the ensuing build-up, the anode is again cut off, and the signal is taken wholly by the second grid, the circuit of which includes the positive reaction coil L1 and the output coil L3.

Ferranti, Ltd.; M. K. Taylor; and I. N. Vaughan-Jones. Application date June 1st, 1943. No. 566209.

TUNING INDUCTANCES

A VARIABLE inductance is coiled on a rotatable drum and is engaged by a grooved roller contact, which is spring-pressed on to the wire of the coil and is so moved laterally along it when the coil drum is rotated by the tuning control.

According to the invention, the grooved roller is also constrained to rotate at a speed which is different from that due to a simple rolling movement, in order to ensure a good wiping contact. For this purpose, the contact roller is keyed to a squared shaft which is driven through cord-and-pulley gear from the main tuning shaft, so as to rotate at a lower peripheral speed than the wire of the inductance coil.

Radio Transmission Equipment, Ltd., and C. E. Payne. Application date June 22nd, 1943. No. 567080.

CATHODE-RAY TUBES

A HIGHER voltage must be applied to the deflecting coils to generate a high-speed scanning sweep lasting, say, for 10 microseconds, and repeated every 1,000 microseconds than is re-

quired to give a low-speed sweep lasting for 1,000 microseconds at the same repetition frequency, though the average current taken is larger in the second case. If the supply is taken from a constant-voltage source, it can be shown that a large part of the energy consumed is lost as heat in the power tube. On the other hand, if the anode voltage is made to vary with the velocity of the sweep, much of this waste can be avoided, with a corresponding saving in the size and cost of the equipment.

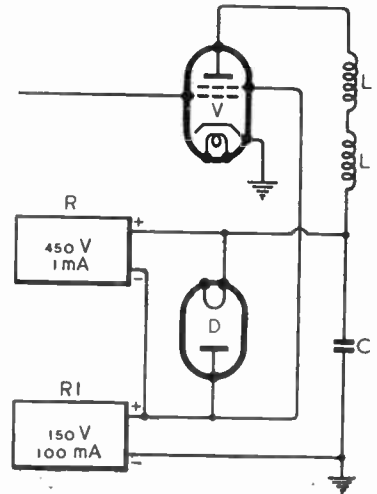

Two-speed sweep circuit.

As shown in the drawing, the power tube V supplying the deflecting coils L is fed from two separate main supply units, arranged in series with a condenser C, one unit being shunted by a diode D. The unit R is a single-diode rectifier in series with a high limiting resistance, and is rated to deliver, say, 1mA at 450 volts. The other unit R1 may be a full-wave rectifier giving an output of 150 mA at 150 volts. For high-speed operation the slope of the saw-toothed oscillation is steep, and the voltage-drop across the coils L will reverse the polarity of the diode D, so that during the idle part of the repetition cycle the applied voltage is reduced to that of the unit R1, with a corresponding saving of energy. For low-speed working the unit R1 supplies the larger current required.

Marconi's Wireless Telegraph Co., Ltd. (assignees of O. H. Schade). Convention date (U.S.A.) May 30th, 1942. No. 566877.

The British abstracts published here are prepared with the permission of the Controller of H.M. Stationery Office, from specifications obtainable at the Patent Office, 25, Southampton Buildings, London, W.C.2, price 1/- each.

The **MULLARD** *all-glass technique*

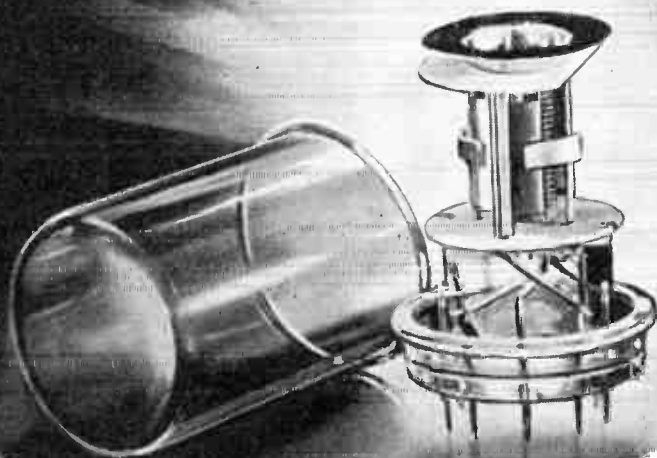

By a complete departure from the conventional form of valve construction, Mullard have effectively reduced the losses due to H.F. resistance, inductance and capacity effects within the valve itself and in the leads coming from the electrodes. The all-glass technique makes use of an almost flat circular glass pressing for the base of the valve, into which short pins are sealed, the electrodes being welded directly to the pins. By thus reducing the length of the lead-out connections, considerably improved efficiency at the higher radio frequencies has been achieved.

A
DEVELOPMENT
OF THE
MULLARD
LABORATORIES

PA
PEOPLE!



**TYPE P.V.H.
NOW AVAILABLE**

**WHERE
NOISE
LEVEL
IS HIGH**

At last you **CAN** do something

The Grampian Type PVH—a velocity loudspeaker—has been in short supply and you haven't been able to deal with "high noise level" workshops. Now the supply situation has eased—type PVH is available for general installation. Go over your P.A. systems and get rid of those irritating "blind spots" which exist where noise level is high or awkward partitioning is interfering.

GRAMPIAN SPEAKER
Projector Type PVH. 10 watts. 15 ohms. Impedance. PRICE
£13.5

GRAMPIAN MICROPHONE
Type M.C.S. Pressure operated. 70-8000 cycles. Impedance 20 ohms. PRICE
£7.5

GRAMPIAN
LOUDSPEAKERS

*Phone: FELTHAM 2657 GRAMPIAN REPRODUCERS Ltd. Hampton Rd., Hanworth, Middx.

All orders dealt with in strict rotation.

Scientific G.A



Sinclair
SPEAKERS
LONDON N.1.

Remember- Walter

J.C.H. LTD

RADIO STAMPINGS

RADIO CHASSIS

RADIO PRESSINGS

FARM LANE, FULHAM, S.W.6. TELEPHONE: FULHAM 5234

C.B.C.

for HIGH • HIGHER and HIGHEST FREQUENCIES!

TENAPLAX Co-axial Cable



SOME TENAPLAX CABLES HAVE **60% AIR INSULATION**
Patented method of construction reduces losses to a minimum.

- Plastic Cover
- Electrical Screening
- Alkathene Sleeve
- Braided Alkathene Filaments
- Conductor

Write for details to

TENAPLAS LTD., 7 PARK LANE, LONDON, W.1

I am the c.g.s. unit of energy—you'll find me in every radio circuit.

HULLO.
-I'M AN
ERG!



ERG

ERG is the trade mark that will identify our products of quality—small parts for big jobs.



ERG RESISTORS LTD.

1021a, FINCHLEY ROAD, LONDON, N.W.11. PHONE: SPEEDWELL 6967

CA

Varley

**TRANSFORMERS
AND CHOKES**

for Reliability

OLIVER PELL CONTROL LTD

CAMBRIDGE ROW • WOOLWICH • S.E.18

TELEPHONE: WOOLWICH • 1422

Rate 6/- for 2 lines or less and 3/- for every additional line or part thereof, average lines 5-6 words. Box Numbers 2 words, plus 1/- Press Day: September 1945 issue, first post Tuesday, August 9th. No responsibility accepted for errors.

NEW RECEIVERS AND AMPLIFIERS
H.P. RADIO SERVICES, Ltd., offer:-

(CIVILIAN radio receivers (splendid performance), ac superhet, £12/3/4; battery superhet, £10/19; 5w ac/dc amplifier, with valves, neat chassis construction, £6/10; Rothermel crystal gramophone pick-ups, 78/9; home ac battery chargers, output 12v lamp, £2/19/6; mains transformers, 80ma, 27/6, 120ma 35/-; stepdown transformers, 230-110v 60w 30/-, 1000v £6/15; Bell trans. 5/11; 1st grade line cord, 0.5amp Score, 60ohms per ft, 2/6 per yd.; volume controls with switch 4/6, without 3/6.

ROLA 8in PM speaker, 19/6; Celestion 8in, fitted with trans., 29/6; Celestion 3½in 29/6; Celestion 8in mains energised, 2,000ohms field, with trans., 36/-; Vitavox 12in PM, £6/18/6; Universal output transformers, 7/6; Meico moving coil microphone, 5gns; Meico floor stands, 42/6; microphone trans., 70/1, 8/6; carbon mikes, 2/6; condensers 500v 2mid 2/6, 4mid 3/9.

CATHODE Ray Tubes—Mullard or Cossor 3in electrostatic with base, £3/6; G11C, Argon rays, 25/-; HivR2A Mullard rectifiers, 20/-; Mullard Universal measuring bridges, 15gns; Mullard B100 cathode ray unit with 3in tube, 12gns.

RADIO Valves.—Very large stock; milliampmeters 0-1ma, highest grade, 3½in 73/6, 4½in 90/-; Midget T.R.F. coils with circuit, 5/- pair; screened 465KC IF transformers, 10/6 pr; 0005 twin gang, 12/6.

ALL new goods. Satisfaction guaranteed. See with enquiries. Postage extra under £4. H. P. RADIO SERVICES, Ltd., 55, County Rd., Liverpool, 4. [3661

COMMUNICATION receivers. — Remember "Dale" after the war.—Dale Electronics, Ltd. 152-6, Gt. Portland St., W.1 Mus 1023

HIGH quality receivers of exceptional performance now being phototyped; two models will be available; deliveries to begin December; limited supplies only; also multi-range ac/dc meter and 1.5-300v valve-voltmeter (ac/dc); eng. invited.—Box 3505. [3641

QUALITY amplifiers, 200-250v ac, 5 watt 8½gns., 12 watt £14; s.a.e. for fully illustrated leaflet and copy of "Design for Quality"; immediate deliveries.—J. H. Briery (Gramophones and Recordings), Ltd., 403, Mill St., Liverpool, 8. Lark Lane 1709. [3796

AMPLIFIERS. — Complete equipment for P.A. industrial, dance and stage installations and portable apparatus from 15 to 150w; early deliveries; illustrations and spec. on request.—Broadcast and Acoustic Equipment Co., Ltd., Broadcast House, Tombland, Norwich, 26970. [2963

BACKERS.—New 7-valve "Wireless World" Quality amplifier with tone control stage, 8 watts push-pull triode output, price includes super Quality triple cone, 12in permanent magnet speaker, with large output transformer and all valves; also as above but with 15 watts tetrode output, ideal for realistic reproduction for public address; limited orders only; 2½d. stamp for particulars, prices, etc.—Bakers Selhurst Radio, Tel. Croydon 4226.

RECEIVERS, AMPLIFIERS—SECOND-HAND

HALLICRAFTER, SX28, as new, 500 kc/s to 43 Mc/s.—Offers to Box 3503. [3636

HALLICRAFTER SX16, 11V Xtal, list £32.—Offers to 45, Westholme Rd., Manchester, 20. [3593

HALLICRAFTERS Super Defiant 5x25 communications receiver; best offer accepted.—Box 3519. [3675

HALLICRAFTERS Skyriider 9-valve communications set, Model 8-22; offers wanted.—Box 3497. [3612

HAYNES 2 h.f. tuner, 14 watt amplifier, speaker, Garrard automatic record changer, £60.—Write 10, Hill Rise, Cuffley. [3600

FOR sale. Eddystone communication receiver, latest model 353A, complete with packs and speaker, new. Offers.—Box 3506.

RADIO sets, amplifiers and radio sundries; list free; state needs.—A.C.S. Radio, 44, Widmore Rd., Bromley, Kent. [3806

SOUND Sales radiogram chassis and Voigt speaker with pack, demonstration, perfect, almost unused.—88, Beaconsfield Rd., Enfield. [3587

NATIONAL H.R.O. Senior model, 7 coils, power pack, rack and panel mtg., recently serviced by Webbs, perfect condition. Offers invited.—2CZII, 140, Seymour Ave., Morden, Surrey. [3525

9-VALVE P.A. p.p. H.M.V. autogram, £10; 3-improved Monodial HF FC, 21F, separate diode 6-valve plus quality PX4 amplifier crystal pick-up walnut console, £70; Universal Minor, £10.—Box 3512. [3667

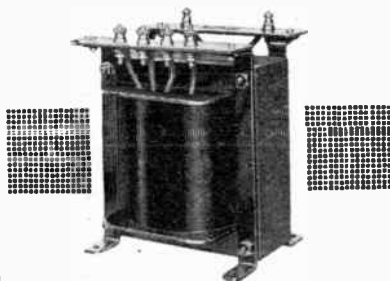

For the past 15 years we have devoted our energies exclusively to the manufacture of Transformers and Chokes. Although we continue to be very active in the field of Research and Development, we are nevertheless giving much of our attention to increasing our range of mounting facilities.

Illustrated above is one of the varied range of styles shown in our Catalogue which is now in preparation. If you would like a copy, please write to us (enclosing 1d. stamp) and we will send you one immediately it is ready.

Telephone: Abbey 2244

PARTRIDGE TRANSFORMERS LTD

76-8, PETTY FRANCE LONDON, S.W.1

ARMSTRONG

ARMSTRONG has always had the name for Quality.

When this war has been brought to a successful conclusion our new range of ARMSTRONG CHASSIS will prove that our reputation was built on a firm foundation.

ARMSTRONG WIRELESS & TELEVISION CO. LTD.
WALTERS ROAD, HOLLOWAY, LONDON, N.7
Phone: NORTH 3213

SUPER-MONODIAL set, complete, loose in 3½x2x1½ oak cabinet with fitted B.T.H.-R.K. M/C Senior; offers.—Rn. 137, Nell Gwynn House, S.W.3. Evenings Ken. 0283. [3609

FDDYSTONE 358X (crystal filter) communication receiver, 200-250v ac, 31,000-90 kc/s, complete with power unit, new cond.; £70.—Filton, 108, Buersall Ave., Rochdale.

AMPLIFIER, 40watt, 4 inputs, separate power pack fully metered on rack, with Garrard autochanger, radio chassis, m. coil mike, 2 speakers, 100yds cable; offers.—Box 3521.

MARCONI CR100 communications receiver, 11 valves, 6 wbdts, 100 cyc, separation crystal gate, service manual, £60; Hallicrafters SX25, 12 valves, var. selectivity, crystal gate, spare valves, instr. manual, £45.—Box 3511. [3666

NEW LOUSPEAKERS

£5/18/6.—New Baker Super Quality 12in Auditorium permanent magnet speaker with triple cone, manufactured by Bakers Selhurst Radio, the pioneer manufacturers of moving coil speakers since 1925, wide frequency range, even response, ideal for quality reproduction, fitted with magnet, having exceptionally high flux density in the air gap, suitable for public address equipment when quality reproduction is first consideration; send 2½d. stamp for leaflet giving details of above and constructional details of a new acoustic chamber designed to extend loud speaker frequency range; also constructional details of an infinite baffle cabinet; every music lover interested in realistic reproduction should write for leaflet.

£8/19/6.—New Baker super power cinema permanent magnet speaker with 18in triple cone of new design, giving wide frequency response free from objectionable resonances; speech is clear and natural and music is reproduced with exceptional realism; fine engineering job, extremely sensitive, ideal for public address equipment when power handling capacity, plus realistic reproduction, is required; present deliveries of speakers three to four weeks.—Bakers Selhurst Radio, 75, Sussex Rd., S. Croydon. Tel. Croydon 6813.

LOUSPEAKERS, SECOND-HAND

MAGNAVOX Duode speaker; offers.—Box 3491 [3945

FERRANTI M.1 P.M. speaker, chassis only; £5 or offer.—Box 3511 [3665

BARKERS 18in pm triple cone, as new; offers. George, 19, Richmond Rd., Reading.

WESTERN Electric 555A L.S. unit, 750Ω, 8-watt field; £10 or nearest.—Box 3507.

CORNER horn cabinet, oak, bass chamber; £12.—42, King Charles Rd., Quinton, Birm. [3639

MAGNAVOX, "66," in large labyrinth; £10.—Ray, 41, Ashridge Way, Morden, Surrey. [3672

MAGNAVOX 66s, 2in 15Ω voice coils, 2,000 field, £4 each; baffle boards in lin timber, 15/-; Goodman's 8in p.m., large magnet for projection horn, 40/-; F.T. p.m. horn unit, £4/10; Truvox horn unit, p.m., £3/10; Vitavox K10, new, £7.—Courtenay Davis, Harpenden. [3688

DYNAMOS, MOTORS, ETC.

METERS.—Large stock of switchboard, volt & amp meters, ac and dc; list available.

MOTOR starters and resistances, several available up to 10hp.

BATTERY chargers; 230v ac to 16v 24amps rotary, £15; 110v ac to 75v Gamps valve, £15; 110v ac to 6v 5amps, metal, £3.

ROTARY converters.—E.D.C. 200 watts, 110v dc to 230v ac, £14; electron vibrator, 300 watts 110v dc to 110v ac, £6; Mackie motor alternator, 500 watts, 110v dc to 110v ac, £12/10; Lang and Squire 24v dc to 230v ac, 60 watts £8/10; Crompton 1,500 watts, 250v dc to 230v ac, £25; Crompton alternator, 5kw, 110v 27amps 60cyc, £17.—H. Harris, Strouds, Bradfield, Berks. [3648

ALL types of rotary converters, electric motors, battery chargers, petrol-electric generator sets, etc., in stock, new and second-hand; supplied against priority orders only.—WARD, 37, White Post Lane, Hackney Wick, E.9. Tel. Amherst 1393. [1988

NEW ac motors, ¼hp, high starting torque, 200-250v, £4/15; ½hp, £5/5; 1hp, £7/5; 1½hp, £9/7/6; all other sizes available; also machinery.—John W. W. Steel, Bingley, Yorks.

GRAMOPHONE AND SOUND EQUIPMENT

PARMEKO recording machine, latest model, very little used, £65; also spare head, unused. £12.—Box 3524. [3687

B.T.H. R.K. Senior with special Duode cone, 1,000Ω field; 20in Enoch 1,000Ω field; 4ft oak faced sand baffle; 30watt amp. PX25AS in push-pull; H.M.V. Hyper Sen. p.n. and trans; offers.—Sargeant, 38, Sussex Sq., Brighton. [3677

MORSE EQUIPMENT

MORSE practice equipment for classroom or individual tuition; keys, audio oscillators for both batt. or main operation.—Webb's Radio, 14, Soho St., W.1. Ger. 2089. [2921

SEXTON'S of
164, Grays Inn Rd., London, W.C.1
for
SALES, SERVICE & SATISFACTION

ELECTRIC SMOOTHING IRONS, weight 5-5½ lbs., for AC or DC mains, strong bakelite handle and thumb rest. Fitted with heavy connector guard and rest. Sole plated specially designed for ironing under buttons, seams and pleats. Complete with two yards of best quality three-core flex and earthed connector. Beautifully finished in highly polished chrome and coloured pastel shades, Blue, Pink, Red, Green, Gold. Price 33/4, inc. of tax of 6/8. Post free.

AMERICAN RADIO VALVES. Types as under at controlled prices. 35Z4GT, 35Z5GT, 45Z5GT, 5Y3G, 1A5GT, 1C5GT, 1Q5GT, at 11/- each. 6J5GT, 6F5GT, 12J5GT, at 9/2 each. 12S17GT, 12SK7GT, 25L6GT, 6K7GT, 6L7GT, 6J7GT, 43G, 1A7GT, 6K6GT, 42G, 6V6G, at 12/10. 6D6, 6C6, at 11/- each. 6Q7GT, 75G, at 11/7 each. 6A7G, 6A8G, 6K8G, at 14/- each. 6U5Z6G5G, Magic eye, 11/- each.

LOUDSPEAKERS. "Goodmans" Midget speaker, 3½" 2-3 ohms voice coil, 30/- each. "Rola" 5", 21/6 each. "Celestion" with transformer size 8" PM, 27/6 each. "Magnavox" 8" with multi-ratio trans. PM, 30/- each. "Celestion" 10" Mains energised, 2,000 ohms field coil, 35/- each. All post paid.

TUNING CONDENSERS. Twin gang .0005 Midget type, 12/- each. Three-gang ditto, 12/6 each.

TUNING COILS. Medium wave only. Aerial and H.F., at 3/9 per pair. Write to-day for latest list of Radio and Electrical accessories. Enclose Id. stamp and stamped addressed envelope.

TERMS: POSTAGE PAID. CASH WITH ORDER ONLY. We regret that owing to shortage of staff we are unable to despatch C.O.D. or send pro-forma invoices.

Telephone: TERMINUS 1304-4842.

INSTRUMENT WIRES, ETC.

Gauge, covering and continuity guaranteed. 14-16-18-20-22-24-26-28-30-32-38 swg. enam. 2/9, 3/4, 3/3, 3/6, 3/9, 4/-, 4/3, 4/6, 4/9, 5/-, 6/- per lb., smaller quantities reels 3d. extra. 1 to 3-lb. reels, 1/- extra. 4 to 8-lb. reels, 2/6 extra. All reels returnable. Also many other interesting Radio and Electronic items. Lists, 1d. S.A.E. Orders over 30/- post free.

MIDLAND INSTRUMENT CO.,
18, HARBORNE PARK RD., BIRMINGHAM, 17.

THESE ARE IN STOCK

RADIO RECEIVER DESIGN (Part I). By K. R. Sturley, Ph.D., B.Sc., M.I.E.E. 28/-, Postage 6d.

WAVEFORM ANALYSIS. A Guide to the Interpretation of Periodic Waves, including Vibration Records. By R. G. Manley, B.Sc. 21/-, Postage 5d.

FOUNDATIONS OF WIRELESS. By M. G. Scroggie, B.Sc., A.M.I.E.E. 17/6, Post 4d.

VALVE REPLACEMENT MANUAL. By A. C. Farnell and A. Wolfenden. 6/-, Postage 3d.

"WIRELESS WORLD" VALVE DATA—Operating conditions and base connections of the principal types and makes. 2/-, Postage 2d.

RADIO SERVICE TEST GEAR. By W. H. Cazaly. 6/-, Postage 3d.

SHORT WAVE RADIO. By J. H. Reyner, B.Sc. (Hons.), A.C.G.I., D.I.C., A.M.I.E.E., M.Inst.R.E. 10/6, Postage 4d.

THE CATHODE TUBE AND ITS APPLICATIONS. By G. Parr, A.M.I.E.E. 13/6, Postage 3d.

WE HAVE THE FINEST STOCK OF RADIO BOOKS IN THE COUNTRY. WRITE OR CALL FOR COMPLETE LIST, 1d.

THE MODERN BOOK CO.
(Dept. W.5), 19-23 PRAED ST., LONDON, W.2

TEST EQUIPMENT

MODEL 40 Avo. all accessories, very good condition. Box 3520. 13676

S.A.L.E. 5in oscilloscope hard valve base; offers—Box 3525. 13652

O 1/2in ma meter, scaled 0-500, FL fitting; 2 1/2in; 30/-; Box 3496. 13607

R.C.A. oscilloscope, lin, timebase, X and Y amplifiers; offers—Box 3488. 13942

UNIVERSAL Avo 40, in perf. wkg. cond.; £17.—53, Waterloo Rd., Leyton, E.10.

FERRANTI m.c. 2 1/2in milliammeter, 0-100 m.a., perf.; £3.—Verney, Highbury, Barn staple. 13650

T O experimenters.—Electrical instruments for sale.—Particulars from 10, Edward Rd., Bromley, Kent. 13625

UNIVERSAL Avomino; Collard ac gram motor.—113, Hazel Rd., Longview, Liverpool. 13679

UNIVERSAL AvoMinor de AvoMinor, also Taylormeter, Series 45, valve tester, all as new; what offers?—J. Little, King St., Cleator, Cumb. 13591

MEGGER tester, Evershed and Vignoles. 200-volt, 2 parts, meter and generator, good condition; £8 or nearest.—Geo. Bailey, 160, Parrock St., Gravesend, Kent. 13594

WESTON Analyzer P772, perfect, as new, in carrying case. 1,000 o.p.v.; £22/- or exch. oscilloscope test gear, etc.—Palmer, Bram Ends, Tregaron Ave., Gosham, Portsmouth.

LATEST model Avo 7, as new, 21gus; 11gus wave Triplett model 1231 battery oscillator, 8gus; brand new full wave metal rectifiers, 12volt 10amp 35/-, 12volt 6amp 27/6, 12volt 3amp £1, 12volt 2amp, 17 6.—Box 3523.

CATHODE ray oscilloscope (3in), Avo Model 7, "W.W." R.C.C., I.F. oscillator, Wobblers, signal generators, hand calibrated capacity and resistance bridges, Universal valve testers, components, etc.—enquiries invited; offers welcomed.—64, Cat Hill, E. Barnet.

HIGH voltage electrostatic test apparatus, tests from 500 to 5,250 volts, with visual and aural indication of test breakdown, complete with special test prods, essential for all manufacturers of electrical apparatus and suitable for M.A.P., A.I.D. and Admiralty tests. Price on application.

KENTISH ELECTRICAL ENGINEERING Co., 5a, Mornington St., London, N.W.1; or sole distributors, Duncan Electrical, 238, Finsbury Rd., N.W.1. 13615

L ABORATORY apparatus, Sullivan 3-dial decade resistance, 1,110ohms, £9; Sullivan Linear frequency condenser, 300pf, £5/10; Weston standard dc millivoltmeter, 15mv, £10/10; Cambridge standard dynamometer, 3-range, £15/10; Cambridge Spot gauge, £8/10; Avomino Universal, unused, £7.—Box 3522.

A.C.D.C. test meter, £8; M/E valve voltmeter, £8; 2 1/2in C.R. tube, 55/-; Acorn rev. (needs attention), £10; photocells, motor tuning unit, 250v power supply, pick-up, H.T.9, Eddystone components, Rich and Bunly 250v mains trans., Stentorian spkr.; details, s.a.e.; state requirements.—Hayles, Welby, Nightingale Lane, Bromley, Kent. 13941

VALVES

ALL B.V.A. valves available, also number of details later.—London Sound Labs., Ltd., or c.o.d.—David Robinson, Ltd., 100, High St., Bedford. 13421

COMPONENTS—SECOND-HAND, SURPLUS VALUE! Matt has it!

LINE CORD—2-way 2/6 per yd., 3-way 3/- per yd. (approx. 60ohms per foot).

SPEAKERS—Celestion P.M. 2 1/2in, less trans. 27/-; 5in P.M. with trans. 27/6; 6 1/2in P.M. (multi-ratio trans), 28/6; Rola 6 1/2in P.M. with trans. 28/6.

TWO gang condensers, 0.0005 with trimmers, 12/6; Midget coils h.f. and aerial, 5/- per pair.

VOLUME controls (all values), 1-switch 3/6, w/switch 4/6, mains transformers 4v and 8v, 7/6; Rothermel (crystal) pick-ups, metal, 8s, £3/13/6; Senior de luxe, £3/18/9; condensers, all types in stock, 2s, 8s, 16s, 20/20, 500w working; 0.1, 0.01, 0.25, 0.05, 25x25, etc. Resistances, 1/2 and 1 watt; all values 1/- each, 10/6 per doz.

LET us quote you for all your requirements. Cash with order, plus postage.

MATT RADIO SERVICE, 152, Richmond Rd., Kingston-on-Thames, Surrey. 13758

INSULATED test prods with removable crocodile attachments, 3/3 complete; speaker gauges, 2/-; many other lines; list 3d., post free.—V. E. S., Radio House, Melthorne Drive, Ruiship. 13936

NEW acorns, 954, 955, 956; linecoril, 60 ohms per foot, 2 core 0.3 amps, 1/-; 3 core 0.3a 1/1; 3 core 0.15a 100ohms, per ft. 1/2.

ELECTRIC soldering irons (state voltage), 13/6; plastic wood, large jar, 3/-; Filiodisk ohms, etc., calculator, 6/6; scratch remover polish, 3/-.

J. BULL and SONS (W.W.), 246, High St., Harlesden, N.W.10. 13623

THE STATIC CONDENSER Co. Ltd.

★ *Manufacturers of*
STATIC CONDENSERS

TOUTLEY WORKS, WOKINGHAM, Berks.

'Phone: WOKINGHAM 708

BATTERY CHARGERS & TRICKLE CHARGERS



Trouble-free Chargers fitted with selenium all-metal rectification. Good allowance on your old charger. Thirty years experience behind every Runbaken product. Booklet R.15, describing 12 Models, on request.

RUNBAKEN-MANCHESTER 1

'SELECTEST'

is Coming

... will interest every Electrical and Radio Engineer.

SALFORD ELECTRICAL INSTRUMENTS LTD. PEEL WORKS SALFORD 3

SOUTHERN RADIOS wireless bargains.

LATEST radio publications.—"Radio Valve Manual," equivalent and alternative American and British types, with all data, 3/6; "Radio Circuits," fully illustrated receivers, power packs, etc., 2/-; "Amplifiers," fully descriptive illustrated manual of circuits, 2/-; "Radio (oil and Transformer Manual), 2/-; "Short Wave Handbook," 2/-; "Manual of Direct Wave Home Recording," 2/-; "Test Gear Construction Manual," 1/6; "Radio Pocket Book," formulas, tables, colour code, etc., 1/-; "International Short-wave Station List," 1/-; "10 Hous for Radio Constructor," 1/-; **SWITCHES**, 3-way 4/-, 8-way 6/- (all complete with knobs); escutcheons for 8-way press button switches, 1/6; knobs, pointer type, black or brown instrument types, 1/4-inch holes, 1/- each; all types of set knobs, black and brown, 1/4-inch holes, 1/- each; resistances, brand new, wire ended, 1/4, 1/2, 1 and 2 watt, assorted value, mainly low, 30/- per 100; heavy duty chokes, 1H, 30 henries, 250 ohms, 120ma, 14/-; 500 ohms 15/-, 1,000 ohms 17/6.

YAXLEY type rotary switches, 11-way, single bank, 6/6; one lb assorted screws, 5/-; assorted soldering tags, including spade ends, 6/- gross; Multicon mica condensers, 28 capacities in one from 0.0001 upwards, 4/-; International octal base valve holders, moulded and paxoline types, 1/- each, 10/6 per dozen; postage stamp trimmers, 30 pf, ceramic and paxoline, 1/- each.

SOUTHERN RADIO SUPPLY CO., 46, Lisle St., London, W.C. Gerrard 6653. [3630

SPECIAL lines (offered with money back guarantee).

M.W. aerial and hf coils with circuit, Litz grid coils, 5/- per pair; if transformers, 1st and 2nd, wound Litz 20/47, iron cores, ceramic trimmers, seamless cans, high q., 465kc, 15/- per pair; hf mains chokes, 2/- each; Paxolin strips with 20 tags, 1/6 each; If chokes, 15h, 240chms, 120ma, first class job, 4/6 each; output transformers, 3 ratio, 60, 90, 120/1, well made, 8/6 each; build your own set, Wizard tri medium wave universal mains receiver circuit and instructions, 5/-; Dorset battery three medium wave ditto, 3 6.—Write Weymouth Radio Accessories, Ltd., 12, Gilbert Rd., Swanage, Dorset. [3625

CHARLES BRITAIN RADIO (K. H. Ede) offers the following bargains:—

SERVICE kits.—No. 1, 1 8mf 450v tub. doz assorted tubulars, 10/-; No. 2, 2 16mf 450v cans, 1 100ma choke, 1 mains dropper, doz assorted resistors, 27/6; No. 3, 2 16mf 450v cans, 2 8mf tubs, 2 4mf cans, 2 2mf 25v cans, 24 asstd. tubular and ceramics, 42/6. **LITZ** wound coils, short and med. wave h.f. and Osc with circuit for superhet, 6/6 ea.; 465kc i.f. trans., 15/- pr.; wavechange switches, 3-pole 4-way, 4-pole 2-way, 3/6 ea.; 2-pole 2-way, 2/9 ea.; 2-gang condensers with trims, 12/9 ea.; 3-gang less trims, 10/- ea.; P type coils, M.W. H.F.A. and Osc, 2/6 ea. **PHILIPS** tubular condensers, 1mf 600v wkg., 10/- doz; 500v, 8/- doz; 400v, 6/6 doz; 01-05, 5/- doz; 00-1005, 3/6 doz; 0001-0005 micas, 3/6 doz; resistors, 1/2 watt, 5/6 doz; 1 watt, 7/- doz; tinned copper wire, all gauges, 2/6 per 1/2 lb reel.

SPEAKERS—4-in Goodmans, with pentode trans., 30/- ea.; 6-in Celestion, with trans., 27/6 ea.; 8-in Celestion, with multi-ratio trans., 32/6 ea.; less trans., 21/- ea. **THIS month's special offers**.—1mf Mnsbridge condensers, ex-G.P.O., 8/6 doz; set of Ekco i.f. transformers and osc. coils, 110k/c, 5/- per set. Send s.a.e. for latest list; terms, cash or c.o.d. over £1.—Charles Britain Radio, (temp. address) "Eureka" Surrey Gardens, Effingham, Surrey. [3654

PARK RADIO SERVICE, 27, Upper St., London, N.1. Tel. Canonbury 1384.

SPEAKERS with output transformers, R. and A., 6 1/2 in, 22/6; Celestion, 6 1/2 in, p.m., 25/-; 8 in, p.m., 27/6; 10 in, p.m., 45/-; R. and A., 6 1/2 in, M.E., 30/-; 10 in, M.E., 45/- each; 1 1/4 in field; less transformer, Goodman 3 1/2 in 30/-, Goodman 12 in 126/-.

LINCOLN, super quality, 60-70 ohms per ft., 2-way 10d ft, 3-way 1/3 ft. **TRANSFORMERS**, mains 200-250 prim., secondaries, 300-0-300, 80 ma, 4v 2 1/2a and 4v 4a or 5v 2a, 6.3v 3a, 32/6; 320-0-320, 120 ma, 4v 3a, 4v 1a, 4v 7a, 38/6; output, multi ratio and centre tap, 8/6.

VALVES, most types in stock (except 0.15 amp series), 1A.30, P.N.25, P.X.4, PEN.B.4, K.T.330, U.R.I.C., PEN.11, 4020, PEN.41.D., 305, 1.N.5, 1.H.5, 1.C.5, 75, 43, 18, 6C, 6B6, 1D6, etc.

CONDENSERS, 10mf, 1,500v, 45/-; 4mf, 1,000v, 15/6; 0.1mf, 1,000 v, 2/-.

SOLDERING irons.—Solon industrial model, 13/-; pencil bit model, 14/3; replacement elements (please state voltage), 4/3.

PARK RADIO SERVICE, 27, Upper St., N.1.



GRAMOPHONE AMPLIFIER CHASSIS 4-VALVE, 4-WATT

Assembled on black Crackle-finished chassis fitted with separate Tone Control, Volume Control with on/off switch, sockets for microphone, gramophone and extension speaker. Hum free, good quality reproduction. A.C. only. Input 200/250 V. Size overall, 8 x 6 1/2 x 7 1/2 in. Ready to play. Price, **10 Gns.** including valves and speaker

4-VALVE, 6-WATT
With PX4 output. Specification as above **12 Gns.**

Theoretical and practical Blue Prints of the above available separately, 3/6 per set.

BLUE PRINTS

of the following circuits. Theoretical and Practical. 3/6 per set of 3 (1 Theo. and 2 Prac.).

No. 1. A.C. T.R.F. 3 valves, Medium Wave only.
No. 2. A.C. T.R.F. 4 valves, Long, Med. & Short.
No. 3. A.C. T.R.F. 4 valves, Short Wave only.
No. 4. A.C. Superhet 4 valves, Short and Med. waves.

No. 5. A.C./D.C. Superhet, 4 valves, Short and Medium Wave.
No. 6. A.C./D.C. Superhet, 4 valves, Long, Medium and Short Wave.
No. 7. Battery T.R.F. 3 valves, Long, Medium and Short Wave.

No. 8. Battery T.R.F. 4 valves, Long, Medium and Short Wave.
No. 9. Battery T.R.F. 3 valves, Short Wave only.
No. 10. Battery T.R.F. 4 valves, Short Wave only.

No. 11. Battery 2 1/2 watt Amplifier, 3 valves, Push-Pull.
No. 12. A.C. Superhet, 5 valves, Ultra Short and Short Waves, 5-100 metres.

No. 13. A.C./D.C. Superhet, 5 Valves Ultra Short and Short Waves, 5-100 metres.
No. 14. A.C. Superhet, 7 Valves, 5-750 metres.
No. 15. A.C./D.C. Superhet 7 Valves 5-750 metres.

Priced list of components sent with each set of Blue Prints.

FOR OVERSEAS READERS 2 New Tropical Circuits

No. 17. Small Communication Type AC and AC/DC Superheterodyne Receivers. Brief specification: 8 Wavebands, 5-2,900 metres, Radio Frequency stage, 7 Valves, Int Octaves, including beat frequency osc. and rectifier, 465 kc/s. Overall measurements: 16 in. x 8 in. x 8 in., in black crackle finish. Shortly available for export.

No. 18. Battery 4-Valve Superhet, 3 Wavebands, 16-50, 200-557, 700-2,900 m. Priced list of components sent with each set of Blue Prints 3/6 per set of 3.

MAINS TRANSFORMERS, to suit all circuits, built to specification. See last month's advertisement for Standard Models.

WESTCOSTS, WX.6, 4/-

ULTRA S.W. COILS (plug-in) air spaced, silver copper wire, R.F., H.P., and Osc., Range 1, 4.5-8 m.; Range 2, 9.5-17 m., 2/3 each; 6/6 set of 3.

3 WAVEBAND COILS, 16-50, 200-550 and 900-2,000 m. (on one former), A. and H.F. also A and Osc., 12/6 pair.

Toggle Switches, miniature, on-off, single pole, 2/6. D.P., D.T., 4/3.

Metal Rectifiers, small, chassis mounting 45 volts, 40 ma., 7/6 each.
Chassis, silver sprayed, undrilled, 10 x 8 x 2 1/2, 7/8. 8 x 6 x 2 1/2, 4/6.

Small 2-gang .0005 Condensers fitted with 4 push button switch. 8/6.

TO OVERSEAS TRADERS! Wholesale and Retail Enquiries are invited.

Orders can be executed for B.L.A., C.M.F. and S.E.A.C. customers.

307 HIGH HOLBORN. LONDON W.C.1. Phone: HOLborn 4631

G. A. RYALL, 36, Huron Rd., London, S.W.17. Mail order only, no c.o.d. under £1 please.

VOLUME controls with switch, 1/2 mg Morganite, perfect job, long spindle, 4/9; twin screened microphone cable, Aerolite, 3yds, 2/9. **CONDENSERS**, tubular, 0.1 350v wkg, reliable make, 7/6 dozen, 0.002 450v wkg, moisture proof, 4/6 dozen.

ERIE 1/2 watt resistances, sizes 330, 450, 10,000, 22,000, 33,000, 220,000, 470,000, 2 mg, insulated type except 33,000, 3/9 dozen. **CELESTION** 10in permanent magnet speakers, very powerful magnet system, really excellent job, 35/- ea.

METER switches, long spindle, 11-way, new, take 1in behind panel, 3/9 each. **SPECIAL** offer connecting wire as push back stranded, cotton and waxed insulation, finished double cotton blue, 12 yards, 1/6, 50yds 5/3, 500 yds coil, 41/-, carr. paid. [3683

RADIO REPAIR SERVICE, 36, Stoneyfields Lane, Edgware, Mdx. Mill Hill 1901. **HIGH-GRADE** components at the lowest prices.—We are able to offer the following new goods:—

P.M. speakers, less transformer, 2 1/2 in 22/-, 3 1/2 in 25/6, 5 in 20/-, 6 1/2 in and 8 in, 19/9; also with transformer, 10 in 32/6, 8 in 22/-; 0.3 amp 3-way line cord, 60-70 ohms per foot, in 10-yd. lengths, 15/- length; auto transformers, 240-110, 75 watts, 18/- each; output transformers, midjet, 5/3; power pentode, 5/3; standard pentode, 5/3; special heavy duty pentode, 6/6; multi ratio type, 7/3; interval transformers, 3-1 and driver class B, 7/- each; l.f. chokes, midjet, 360 ohms, 5/3; 60 m.a. 20 hys, 500 ohms, 6/9; 100 m.a. 32 hys, 1,000 ohms, 13/6; assorted condensers, 0.00008 to 0.15mf, at 8/- dozen; 8+8mf 450v, 5/6 each; limited stock; aerial and h.f. coils, 3/3 per pair; Midjet 2-gang condensers, 9/3; iron-core i.f. coils, 465 ks, in can, 20/- per pair.

GODIS sent only c.o.d., carriage paid for orders £5 and over; under £5, 6d. for postage.

RADIOSALES, BCM/SALES, London, W.C.1., offer 1/- and 1w resistors and tubular paper condensers, usual prices.

BIAS FLEX'S, 50/12v, 25/25v, 10/50v, 2/6 ea.

SPEAKERS, 3 1/2 in p.m., Goodmans, 3 ohm, 31/-.

STANDARD 465 screened i.f.t., 10/-.

SMALL 2-gang, .00005, trim. and feet, 15/-.

VOL. controls, 5/6 with sw., 4/6 less sw. **SPEAKERS**, p.m., 8in Rola or Plessey, 28/6; 6 1/2 in do., 30/-; all with trans.

BOOKS.—Radio Test Gear, 1/6; Radio Pocket Book, 1/-; Radio Valve Manual, 3/6; Radio Circuit Manual, 2/-; Amplifier Manual, 2/-; all useful reference books.

STANDARD electric soldering irons, 60w, 230v, 14/6; solder, tags, crystals, tape, flux, wire, sleeving, all smalls, competitive prices. **EVERYTHING** c.o.d. or c.w.o., post extra; 4-page list 1d.—Radiosales, BCM/SALES, London, W.C.1. [3673

PRICE list id., unequalled range, example P value.—Yaxley 4-bank 6-way switches, 5/6.—Taylor, Macaulay St., Huddersfield. [3595

LOOK out for valves and circuit analyser; details later.—London Sound Labs. Ltd., 40, South Molton Lane, Bond St., London, W.1.

SUPREME RADIO, 746b, Romford Rd., Manor Park, London, E.12, and at 15, Faircross Parade, Barking. Tel. III. 1260. Est. 15 years.

OUR special offer this month.—0.3 amp 3-way line cord, 60 ohms per ft, best quality, 2/- yard; 0.2 mains droppers, 1,000 ohms, 2 sliders, good job, 3/9; 0.2 Pye replacement droppers, 3/6; limited number at these prices; Midjet coils, aerial and h.f., circuit, 8/6 pair, hum, good selectivity, with circuit, 8/6 pair, and less circuit 7/6; job line American m. and l.f. aerial and h.f. coils, 3/6 pair; Midjet m. and l.f. with circuit, 10/6 pair, boxed; Yaxley switch for same, 3/- each; Midjet 2-gang 0.0005, with trimmers, split vanes, fixing brackets, 12/6; dials, 3 1/2 in x 4 in, m.w., 1/9; Midjet speakers, 3 1/2 in, with trans., 30/-, less 25/-; Celestion 6in, with trans., 27/6, less 22/6; Celestion 8in with trans., 26/6, less 21/6; Rola Bin, with trans., 26/6, less £1/1; R. & A.E.M.C., with trans., 1,200 ohms 11/1; 32/6; Midjet chokes, 60 mls, 6/6; 100 mls, 10/6; heavy duty specially wound for good job; trimmers, 35 and 40 p.d.f., 9d. each.

METAL speaker cabinets, 8in fitting, rubber feet, finish old gold, green gaud fitted, to cleat, 17/6; our technical dept. will always help customers in their problems; list available on request for goods not advertised; s.a.e. all enquiries; 6d. extra for postage orders under £5; no c.o.d. [3647

MASTERADIO vibrator pack, 6v, new, 40/-; valves, all new, 1C5GT, 1A7G, 41, 6Q7G, PM22, each 9/-; 1H5G, 6/-; Pathe Kid projector, 40/-.—Carsou, Wimborne, Dumfriess.



'PERFECT' TRIMMER TOOL KIT

Twelve assorted Box Spanners and Screw Drivers, with two extension handles. Indispensable for servicing British and American Receivers. Complete in leatherette wallet. 30/-

VERY finest results guaranteed with "WAVEBAND" COILS, supplied with wiring diagram. TRF Midget medium wave coils, 3/9 pair. TRF medium- and long-wave coils, 7/6 pair. Medium- and long-wave with additional reaction wiring, 8/- pair. Long-, medium- and short-wave coils, 12-49 metres, and m/l, 11/6 pair. "WAVEBAND" canned I.F. coils, 465 kc., very neat construction, 15/6 pair.

HEAVY DUTY Chokes, 30 hen, 120 ma., 200 ohm, 17.6 TRANSFORMERS. 50w O.P. trans for 6L6, 29/6; 6L6 Driver transformers, 17/6 **FIELD COILS**, lin. centre, 1,000, 1,500, 2,000, 2,500, 6,500 ohm, 8/6 each. **MULTI-RATIO**, O.P., 30-1, 60-1, 90-1, 120 1, 3 ohm speech, 7/6 **VOLUME CONTROLS**, with switch; every value, 5/9 each. 1 w. Morganite Carbon Resistors, every value in stock, 8d each, or 90/- per gross. S.P. "On-Off" Toggle Switches, 2/9 D.P. "On-Off," 6/- Push-back wire coils of 36 yds., 4/6 "Servisol" Switch Cleaner, 5/- tin. 12 v. Car Vibrators, 12/6. **RADIO INSIDE OUT** The Serviceman's Manual, 4/9 British Short-Wave League Hand-book, 2/9.

Transmitter Racks, Metal Cabinets, and Chassis, and many "Short Supply" lines shown in our NEW MAIL ORDER LIST, 2d., Post Paid.

EXCLUSIVELY MAIL ORDER.

WAVEBAND RADIO LTD,
63, JERMYN ST., ST JAMES'S, LONDON, S W 1



15, SILVERDALE LONDON, S.E.26

WE LOOK FORWARD To the time when private enterprise is again free to 'lift' life above the utility level.

VOIGT PATENTS LTD.

LATEST ADDITIONS

- Type V74. 350/0/350 v. 75 ma., 4 v. 2 1/2 a., 4 v. 4 a. ct. ... 30/-
- Type V76. As above but 5 v. 2 a., 6.3 v. 4 a., ct. ... 30/-
- Type K450H. 450/0/450 v. 250 ma., 4/5 v. 3 a., and two 6.3 v., 4 a. ct. ... 50/-
- Type OP8. Multi ratio 15 watt output ... 36/-
- " OP12K " 50 ... 52/-
- " K1V3. Sectionalised driver, 3/1... 40/-
- " DV3. Driver trans. 15.20 watt amplifiers ... 15/-

Audio Amplifier Equipments from £12.10.0.

Transformer Catalogue T55, Audio units V65 (2 1/2 d.).

Write for full specifications before designing your own equipment, we also have a blueprint service on many pieces of apparatus. 15 watt, 20 watt, 32 watt, 2/6 ea.

Dealers address your enquiries to "G.L. Dept." for Trade Discounts.

RADIO INSTRUMENT CO.



Radio Products
294, BROADWAY,
BEXLEYHEATH, KENT

POLYTHENE insulated concentric cable 7-strand copper, close woven screen, synthetic covered, ideal down lead and hf conductor, 3/- per yard; 20% discount to trade in 100yd coils; cash with order, carriage fwd. **PURE polythene**, the last word in insulation, requires heat only for application; 4/6 per lb., post pdt; no engineer can afford not to try it.

CHARGING plant, 3-phase input, metal rectifiers, output 45volts 250amps, new and unused, 3 only; £80 each; seen in London.

MOTOR generator, 3-phase motor, direct coupled to 1,050volt, lamp generator with separate 16volt low tension output and 100volt exciter, complete with control panel, mounted above in metal cabinet; best offer secures.

GENERATOR set as above, less control panel. **CONSTANT voltage transformer**, input 160-260v 50cycle, output 220v steady, capacity 3.6kva; £80; new.

FILAMENT transformers, 220v input, output 45v 250amps; £15 each.

WATSON, 69, Lavender Hill, S.W.11. Tel. Bat. 8485. [3620]

CONDENSERS, electrolytic, 16mf 350v working, 6/9; 8mf 150v working, 5/6; Midget medium wave coils, with adjustable iron cores, serial and h.l., 5/6 pair; Bakelite 1am sheet, 7/6in and 4/2in, 3/6 and 7/6 sq ft, cut to any size. -Holland, 12, Blandfield Rd., London, S.W.12. [3613]

HENRY'S offer:—T.R.F. medium and long wave coils with reaction, 8/6 pr with circuit; single pole eleven way, two bank switches, 4/6; 8mf 450v wkg, 4/-; 8mf 350v wkg 2/3; 16x16mf 350v wkg 10/-; line cord 0.3 three way 550hms per ft 3/- per yd; also 0.2 115ohms per ft 3/- per yd; Rola 5in P.M. with transformer, 27/6; Goodmans 5in, less transformer, 21/6; Celestion 8in, less transformer, 21/-; Celestion amphenol valveholders, 4, 5 and 7 pin English, 4, 5, U.X. and int. octal, 9d. each, 1/6 (doz.); medium and short wave coils, aerial and oscillator, 465 K.C. 12/6, with complete ac/dc circuit; i.f. trans., small cans 465 kc. 7/6 each.

HENRY'S, 5, Harrow Rd., Edgware Rd., London, W.2. [3656]

COULPHONE RADIO, Station Rd., New Longton, nr. Preston.—New goods only of the highest quality; all orders attended to same day as received; note price reductions on many lines, and remember that all orders over 5/- are post free; electrolytics, 8x450v 8/9, 8x8 450 12/6, 2x350 3/6, 25x25 and 50x12 2/6, 25x50 3/-. 50x50 3/3; Iola, Plessey, Goodmans and Celestion speakers, p.m. less trans, 3 1/2in 29/-, 5in 21/-, 6 1/2in 21/6, 8in 22/6, 10in 35/-; with transf. 6 1/2in 27/-, 8in 27/6, 10in 42/6; Vitavox super quality 12in p.m. K12/10, £6/13; mains transformers, screened primary, 200-250v, 350-0-350, 100ma, with 4v or 6v l.t.s. 26/6; bobins only, 15/6; 425-0-425, 200ma, 4v 8a, 4v 4a, 4v 4a or 6.3v 4a, 6.3v 4a, 5v 3a, 4v 6a, 20 hy 200ma chokes, heavy duty, 21/-; speaker transformers, push pull universal types, 4watt 3/6, 5w 12/6, 15w 21/-, 30w 37/6; Midget non. 5/-; dropper resistors, 800 Ω 0.3a, with feet and two sliders, 4/6; push-back wire (Henleys), 50ft 2/9, 100ft 4/9; Delaflex 2mm sleeving, 2/- dozen; valveholders, 5, 7, 9 pin English, Mazda octal, 4, 5, 6, 7 pin UX and Int. octal, all types 6d. each; resin-cored solder, 4/- lb.; 3-way cable, 6d. yd. 5-way 10d.; line cord, 60 Ω per foot, super quality, two or three-way, 3/6 per yard; s.a.e. for comprehensive list.

TELE-RADIO (1943), Ltd., for brand new good quality components at manufacturers' list prices. Suppliers to professional constructors and amateurs who want only the best. Weston meters, 250 micro amps, centre zero reading, £3/5; 0-1mA, £2/10; 0-500 micro amps, £3; 0-100 micro amps, £3/15; 0-50 micro amps, £4/10; 1mA instrument rectifiers, 12/6; spot-on wire wound precision resistors, plus or minus 0.05%, 5/6 each (up to 50,000 ohms only); single-pole 12-position switches, 3/6 each; 4-pole 3-way, 3/6 each; cathode ray tubes, G.E.C. 1 1/2in, £2/15; Cossor 23D, 2 1/2in, £3/6; Cossor 26D, 4 1/2in, £6/10; Cossor GDT4B gas-filled triode, 24/4; high-voltage rectifiers and condensers; potentiometers carbon 4/6; with switch, 6/6; wire wound, 6/6, all usual values; crystals, 100 Kcs, 45/- (P.O. permit); Rothermel crystal pick-ups, £3/13/6 and £3/18/9 (high fidelity Red Label 10/- extra); Celestion and Vitavox speakers; 0.0005 2-gang condensers, ceramic insulation, with a.m. drive, 16/6; wave-change switches, variable condensers and trimmers, etc.; comprehensive stocks of British and American valves; steel racks, chassis, panels and cabinets, specific attention (callers only); postal enquiries acknowledged same day; cash orders, if in stock, 24 hours' service; postage and packing extra on all goods.—Tele-Radio (1943), Ltd., 177a, Edgware Rd., London, W.2. Tel. Pad. 6116. [3898]

RADIO SPARES

MAINS TRANSFORMERS.		Primaries 200/250 volts.
Econdaries 350-0-350 volts.		
Type A.	80 ma., 4v. 3a., 4v. 2 1/2a.	32/6
Type B.	80 ma., 6.3v. 5a., 6v. 2 1/2a.	32/6
Type C.	100 ma. Ratings as type A.	34/6
Type D.	100 ma. Ratings as type B.	34/6
Type E.	120 ma. Ratings as type A.	37/6
Type F.	120 ma. Ratings as type B.	37/6
Type H.	200 ma. Three L.T.s. of 4v. and 4v. for rectifier. Ratings as required.	47/6
Type I.	200 ma. Three L.T.s. of 6.3v. and 6v. for rectifier. Ratings as required.	47/6
Econdaries 500-0-500 volts.		
Type J.	200 ma. L.T. windings as type I.	52/-
Type K.	200 ma. L.T. windings as type H.	52/-
Type L.	250 ma. L.T. windings as type I.	56/-
Type M.	250 ma. L.T. windings as type H.	56/-
Econdaries 250-0-250 volts.		
Type N.	200 ma. L.T. windings as type H.	47/6
Type O.	200 ma. L.T. windings as type I.	47/6
Type P.	300 ma. L.T. windings as type H.	60/-
Type Q.	300 ma. L.T. windings as type I.	60/-
Econdaries 400-0-400 volts.		
Type R.	120 ma. 4v. 3a., 4v. 2 1/2a.	40/-
Type S.	120 ma. 6.3v. 5a., 6v. 2 1/2a.	40/-
Type T.	80 ma. L.T. windings as type R.	35/-
Type U.	80 ma. L.T. windings as type S.	35/-
Econdaries 425-0-425 volts.		
Type V.	120 ma. L.T. windings as type R.	39/-
Types H to Q are provided with two L.T. windings, centre tapped.		

Please note that owing to dimensions and weight of types H to Q, kindly add 2/6 for carriage and packing. **MULTI RATIO OUTPUT TRANSFORMER**, 120 ma. 15 watts, tappings for 6L6's in push-pull; FX 4's in push-pull; low impedance triode; low impedance pentode; high impedance triode, 37/8; complete instructions with each unit.

H. W. FIELD & SON
COLCHESTER ROAD, HAROLD PARK, ESSEX

ROMAC RADIO CORPN. LTD
THE HYDE · HENDON · LONDON N.W.9
Designers and Makers of
RADIO & ELECTRONIC DEVICES

WARD ROTARY CONVERTERS

Petrol Electric Generating Plants, H.T. Generators, D.C. Motors, Frequency Changers, etc., up to 25 K.V.A.
CHAS. F. WARD
37, WHITE POST LANE, HACKNEY WICK, E.9
Phone: Amharst 1393

This is a Pressing Subject
We now have power and hand press capacity available in all metals
MODERN PLANT — MODERN METHODS — HEAT TREATMENT
Complete assemblies too, if you prefer
HOWARD CLAYTON-WRIGHT LTD
TIDDINGTON RD., STRATFORD-ON-AVON
PHONE: 3601-2-3. GRAMS: CLAYTONRITE, 5. ON A.

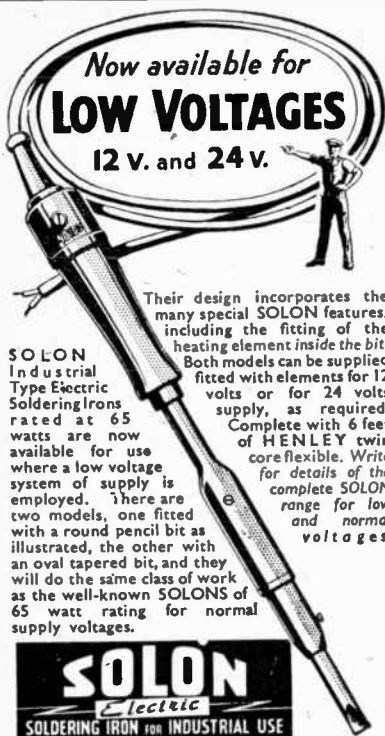

Now available for
LOW VOLTAGES
12 v. and 24 v.

Their design incorporates the many special SOLON features, including the fitting of the heating element inside the bit. Both models can be supplied fitted with elements for 12 volts or for 24 volts, as required. Complete with 6 feet of HENLEY twin core flexible. Write for details of the complete SOLON range for low and normal voltages.

SOLON
Industrial Type Electric Soldering Irons rated at 65 watts are now available for use where a low voltage system of supply is employed. There are two models, one fitted with a round pencil bit as illustrated, the other with an oval tapered bit, and they will do the same class of work as the well-known SOLONS of 65 watt rating for normal supply voltages.



W. T. HENLEY'S TELEGRAPH WORKS COMPANY, LIMITED,
Engineering Dept., Milton Court,
WESTCOTE • DORKING • SURREY

DEFINITELY an Unsolicited Testimonial!

Read this extract from a letter recently received:

"I have been advised by professional operators (radio) to learn the code the 'Candler Way.' I would be grateful if you could send me a copy of the Candler System 'Book of Facts'."

NOTE: The original letter can be inspected at the London Office, and also the original letters of all testimonials quoted in our advertisements.

THERE ARE CANDLER MORSE CODE COURSES FOR BEGINNERS AND OPERATORS.

Would you like a copy of the Candler "Book of Facts"? One will be sent free, on request.

THE CANDLER SYSTEM CO.
(Room 55W), 121, KINGSWAY, LONDON, W.G.2
Candler System Co., Denver, Colorado, U.S.A.

RADIO and electrical engineers.—Ex-Govt. side cutters, 22/6 1/2 doz.; long-nosed insulated pliers, 22/6 1/2 doz., 42/- doz. prs., carriage paid, guaranteed brand new, mains transformers, 4v or 8v, heaters, 80mA, 28/6; 120 mA, 37/6; multi output transformers, standard size, 6/6; carriage paid orders 25; s.a.e. for list radio spares.—A.D.S. Co., 261-3-5, Lichfield Rd., Aston, Birmingham, 6. (3299) **SERVICEMEN**—The following products are well designed and of high quality; volume controls, carbon type, all values, with or less switch, wire-wound resistors, 1 to 60 watts; dropper resistors, 0.2 and 0.3amp; line cords and razor resistors; terms and quotations on req.—Dagole, Ltd., 35, High St., Ruislip, Mdx.

BUY your components direct, and save pounds. Build our M.W. Super Victory Four. Highly satisfied users everywhere: circuit, drilled chassis, brackets, rivets, and everything to build this excellent 4v ac/dc set is supplied for £7/19/6, cabinets; £2/2; detailed circuit separately, 1/6; chassis, 4/6; chassis, valholders, speaker, 2-gang condenser and dial, all assembled, £2/19/6; dial MW/SW; gold/black, punched for dial lamp, 1/-; send 1d. for interesting lists.

BUCLEFUCH RADIO MANUFACTURERS. 1 and 2, Melville Terrace, Edinburgh. **LINECORD**, 0.3amp, 3 way, 3/6 per yd; un-drilled chassis, 8x7x2 1/2, 3/- ea., doz lists at 2/3 ea.; volume controls, 0.25, 0.5, 1.0 ohm, short spindles, no switch, 2/6 ea.; American oct. valve-holders, 7/6 doz; 2mm sleeving, 2/9 doz yds; resin core solder, 4/6 lb; 18G. tnd. cpr. wire, 4/- lb; Midget medium wave coils, 5/- pair; Midget 60ma chokes, 6/6 ea.; Multitap output transformers, 8/6 ea.; 0.2 amp droppers, 5/-; 0.3amp, 5/6 ea.; both with fixing feet; mains transformer replacement bobbins, 4v, or 6.3v heaters, 17/6; electric soldering irons, 12/6; black set knobs, bushed, 7/6 doz; "Meico" moving coil microphones, massive all-chrome quality job, £5/5; solder tags, 2/- gross; etc.; large stocks valves, all service requirements, list 1d.; orders above 10/- post free (mail order only).—A. Huckelbee, "Hazeljohn", Crofton Lane, Orpington.

BATTERY charger kits, rectifiers, mikes, transformers, electrolytics, metal rectifier 2v 0.5 amp type, with transformer, makes ideal trickle charger for 2v wireless cell, with circuit, 13/6, postage 7d.; metal rectifier 12v 2.5a type with transformer and ballast bulb for 2v to 12v charger, needs no ammeter or rheostat, 45/6, post 10d.; metal rectifier 12v 2.5a for battery charger, 22/6, postage 8d.; special charger kit for 6v car battery boosting comprises metal rectifier 6v 2.5a type with transformer and ballast bulb, 39/6, postage 10d., also metal rectifier 6v 1.5a type with transformer and ballast bulb for 2v/6v charger, 32/6, post 10d.; metal rectifier 12v 1.5a type with transformer and ballast bulb for 2v to 12v charger, 32/6, postage 9d., or rectifier alone 8/6, post 5d.; transformer, metal rectifier, ballast bulb to charge three to twenty 2v cells at 1 amp, weight 18lb, ideal for small radio store, £5/10; metal rectifier 12v 3 amp with transformer for 12v charger, 52/6, post 1/-; also heavy duty type transformer with large 12v 5 amp rectifier for 6v/12v charger, £4/10, or with 4 amp rectifier, £2; mains transformers 1t. type, see 2/- tapped at 10v and 14v amp, suit Westinghouse rectifier, 25/-, post 9d. **CHAMPION**, 43, Uplands Way, London, N.21. Tel. Lab. 4457.

THE Simplex Four, complete constructional details of this most successful midget ac/dc receiver (total cost of construction £9) including theoretical and full scale layout wiring diagrams, with instructions, 4/6; Midget high gain t.r.f. m wave coils, 7/6 pair; ditto midget m & l wave coils, 10/- pair, aerial also oscillator coils, all wave, a.m.l., wave, for use with I.F.465 k.c. matched pair, with circuit, 15/- pair; midget I.F. transformers, 465 k.c.s. 17/6 pair; standard size ditto I.F. transformers, 15/- pair; midget 2-gang 0.0005mfd variable condenser, 13/6; Simplex midget chassis for the 4-valve midget, all component fixing holes, 11x4 1/4x2 1/2in, 7/6; midget m wave dials, Ivorine, 4x3 1/2in; 1/6; midget smoothing chokes, 50/60 ma, 6/-; medium chokes, 80 ma, 25 H. 9/-; 120 ma, 25 H. 15/-; midget speaker transformer 6/6; tapped ditto, standard 8/6; Rola p.p. tapped, 12/6; push button 6-way unit, escutcheon, knobs, 5/6; insulated interference suppressor, ac/dc, 2/6; Godmans 12in auditorium P.M.15 ohms speech coil, £6/15; 8in P.M. with tran., 27/6; 6 1/2in ditto, tapped tran., 25/-; M.F. 1,200 ohms, R & A. 8in, 35/-; mains dropper, 0.3 amp, 5/6; ditto droppers the best, 0.3 and 0.2 amp, 7/6; ditto 0.3 amp, 260 ohms, 3/-; comprehensive stocks of all components; lists monthly, 2 1/2d. stamp with enquiries please, postage all orders.—O. Greenlick, 34, Bancroft Rd., Cambridge Heath Rd., London, E.1.

ELECTRADIX OFFERS!

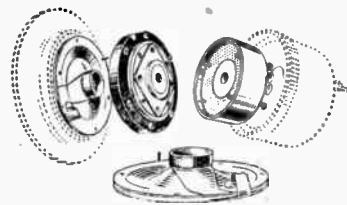

HEADPHONES, MOVING COIL P.M. 45 ohm., 1/2in. coil, 1 1/2in. overall, in bakelite case with 3in. front flange. Coil is energised by the famous ALNI Magnet. These units also make excellent speech mikes, or, with a matching transformer, they can be used as a miniature loud-speaker. No headbands available. Price per pair, 24/-, or 12/6 for one unit. This is one of the finest Electradix Bargains ever offered. Moving coil headphones with Brown type double steel headband and cord, 29/6 per pair.

BELLS. Large Tangent A.C. 230/50 volt ironclad bells, new condition, 6in. gong, 42/-, to Tiny Townsend Buzzers at 10/- each.

BATTERY CHARGERS. "Lesdix" Nitnday models, metal rectification, 2 volts 1/2 amp., for wireless cells, to large chargers for your car accumulator. Send for special Leaflet "W."

LABORATORY AND TEST GEAR **MEGGERS.** Evershed Bridge Meggers with Resistance box, as new, but store-soiled cases, few only.

RADIOGONIOMETER Direction Finders, in polished case, £4 10s.

GALVANOMETERS. Tinsley M.C. Ballistic, Vertical Mirror Reflecting type, 100 ohms., £5 10s. Sullivan Marine Reflecting Galvo., with M.C. Suspension, £9 10s.

RELAYS. Siemens' High-speed Relays in heavy brass case, £3 5s. Telephone type No. 6, 2-coil polarised, S.P.C.O., 6 volts 25 ma., 325 ohms., 8s. 6d. No. 1A. S.P. on-off, 2 volts 40 ma., 5s. Relay movements 1,000 ohms., less blade and contact, 2s. 6d.

METERS. D.C. Moving Coil Milliammeter 0-1 ma., 100 ohms resistance, 2 1/2in. flush panel, bakelite case, £3.

Instrument Rectifier, 1 ma., 10s. 6d. B.S. Sub-Standard M.C. Voltmeter, Sector shape, polished wood base, 5in. scale heavy bakelite terminals, double reading, 0-15 and 0-150 volts. Mirror Scale, Zero adjuster, 6 ma., F.S.D., £5. Portable 3-range D.C. Voltmeter, 4in. x 2in. x 4in., Zero adjuster, 75-150-300 volts, £5.

TRANSFORMERS. 3 kW. Crypto 230 v. to 115 v., shrouded, £12. 3 kW. Metwick, 50 cy. 400 v. to 600 v., £9 10s. 1 kW. Powpuck 50 cy. 250 v. to 50 v., 20 amps., £9. 500 watt Foster 50 cy. 440 v. to 110 v. 5 amps., £4 15s. 150 watt Foster 400 cy. 230 v. to 15 v. 10 amps., £2 15s. 5 watts H.T. test Transformers 110/220 v. to 1,000 v. 5 ma., 10s. Current transformers for meters. Various sizes in stock.

TRANSFORMERS, FOR RE-WIND 3 kW. New type with stampings 4 1/2 x 6 x 7 1/2in., windings damaged by blitz. Can be taken apart to make a number of smaller units. Weight with damaged wire is 65 lbs. Limited number at 45s., carriage extra.

SUPERSEDERS. H.T. Battery Superseders for Radio Receivers. 6 volts input, 110 v. 15 ma. output, 12 volts input, 230 v. 30 ma. output. The Army, the Navy and the Air Force use small Rotary Superseders, a 5 1/2in. midget type taking less space than your old H.T. Battery. Last for ever and cost little more than a few months run on H.T. Battery. Size is only 5 1/2 x 3 1/2 x 3 1/2in., beautifully made, model finish, ball bearings, etc., and takes small current from your accu. Latest model and guaranteed 12 months. Price £3 15s.

HAND MIKES for announcers, broadcasters and recorders, hand type by Tannoy, and Truvox multi-cell carbon type, weatherproof, suitable for hall or outdoor use, with neat switch in handle, 21/-.

Please include postage for mail orders.
ELECTRADIX RADIOS
214, Queenstown Road, Battersea, London, S.W.8
Telephone: MACaulay 2159

LASKY'S RADIO

Are able to supply from stock immediately the following first class and brand new radio and electrical components

SPECIAL KIT OFFER, ONE MONTH ONLY
30 Assorted Condensers, consisting of 3 only 8-mfd. tubular, 600 volt w., One 16-mfd. 450 volt (Vet. can), 2 only 4 mfd. 650 volt w., and 2 mfd. 750 volt w., block paper condensers. 1 mfd. 600 volt w., etc. all new and tested, satisfaction or money back guarantee. £2.15.6. Post free.

SPEAKERS.

Rola 6in. P.M., 21/6; 6in. P.M., 22/6; 8in. P.M., 23/6. Goodman's 3in. P.M., 29/6; 6in. P.M., 21/9; 8in. P.M., 25/6. Goodman's 10in. P.M., £27.6, complete with universal transformer.

LARGER SPEAKERS IN STOCK. PRICES ON APPLICATION.

Volume controls, all values, long spindle, less switch, 3/9, with switch, 5/6.
Mains droppers, .2 and .3 amp., with fixing feet, 1,000 ohms, 5/6.
Lina cord, best quality 2- and 3-way 75 ohms, per foot, 3/3 yard.

MAINS TRANSFORMERS

Primaries, 200/250 v., Secondaries, 350-0-350 v. Type (A) 80 m/a., 4v. 3 amp., 4v. 2 1/2 amp., 29/6, shrouded with fixing feet. (B) 100 m/a., 6.3v. 4 amps. 5v. 2 amp., with feet 32/6. (C) 120 m/a., 4v 4 amp., 4v. 2 1/2 amp., with feet, 35/6. And other types in stock. Price, etc., on application.

TUNING CONDENSERS

.0005 Midget, 2- and 3-gang, less trimmers, 12/6. .0005 Midget 2- and 3-gang, with trimmers, 14/6. .0005 Midget 2-gang condenser with ceramic trimmers and fixing feet, slow motion drive and medium and short wave dial, 18/-.
Toggle switches, from 1/9 each, T.R.F. Coils with circuit medium wave type, 6/8 pair. Very high gain. Medium and Long Wave Coils, with circuit, T.R.F. type, 10/8.
VALVES. We have over 7,000 new American and English mains and battery valves in stock at B.O.T. list prices. Send us your requirements. C.O.D. pro-forma, or cash with order. Send 1d. for our price list of all goods.

LASKY'S RADIO

364, 370, Harrow Road, London, W.9



W. BRYAN SAVAGE LTD.

Expert assistance in the solution of problems relating to

- TRANSFORMERS, CHOKES
- AMPLIFIERS
- POWER UNITS

and Specialised Equipment: embodying

ELECTRONIC CONTROL

WESTMORELAND RD., N.W.9
COLINDALE 7131

LONDEX for RELAYS

for A.C. and D.C.



2VA Coil consumption from 2 to 600 volts and tested to 2,000 volts, Aerial change-over Relays, Mercury Relays, Measuring Relays, and Time Delay Relays.

Midget Relay M.L. (For D.C. only)

Ask for leaflet 205/WFF

LONDEX LTD

MANUFACTURERS OF RELAYS
100, WOODLEY ROAD, LONDON S.E.20

STRONG steel chassis, 6x9x2 1/2, drilled four holes, 1.0. sockets, three control holes, fixing feet, anti-rust finish: 8/- each, post paid; s.a.e. for quotation other sizes.—Noller, Aldeburgh, Suffolk.

RUSSELLS RADIO offer 11. transformers. 465, K.C.S., iron cored, 16/- pair; aerial and h.f., 5/- pair; new type suppressor, 6/-; O.P. transformer, 8/6; all goods guaranteed; add 9/- for postage.—Russells, 22a, Palmerston Rd., Hovecombe, Hants. [3860]

CONDENSERS, electrolytic, 4mfd Micro-packs, 425v. 6/-; 8mfd carboard, 8/3 each; ditto tubular, 7 6; 8x16, with clip, 10/6; 8mfd paper metal can, ideal for amplifiers, 15 6; all 500 volts working; ECR30 C/R tubes, 3in. 63 - each; Philips 3-wave A. and h.f. coils, 7 6 pair, still available B.V.A. valves; send 1d stamp for list of surplus radio and P.A. equipment.—Gregory, Union St., Cheddar. [3643]

COTTON-COVERED copper instrument wire, 1 lb reels, 18, 20, 22, 24 gauges, 1/6; 26, 28 gauges, 1/9; 30, 32, 2/-; 34g 2/3; silk covered ditto, 2oz reels, 24, 26, 28g, 1/16; 30, 32, 34, 36g, 1/9; 42g, 2/-; 16g double silk, 1lb, 5/-; B.A. thread screws, 1 gross useful sizes, 2/6; ditto, nuts, 2/6 gross; assorted gross screws and nuts, 2/6; ditto, brass washers, 1/6 gross; fibre washers, 1/6 gr; assorted solder tags, 2/- gr; assorted small eyelets and rivets, 1/3 gr; rubber-covered stranded copper wire, 1d yard; heavier quality, 1 1/2d. yd; very heavy quality, 2 1/2d. yd; ideal for aerials, earths, etc.; tinned copper connecting wire, 20ft coil, 6d.; ditto, rubber covered, 10ft 6d.; finest quality, push-back wire, 12 yards, 2/3; single cotton-covered tinned copper wire, 25g, 12 yards, 9d.; 50 yds, 3/-; twin bell wire, 12 yds, 1/9; heavier quality, 12 yds, 2/3; flat rubber-covered ditto, 3d. yard; twin flat braided electric cable, 6d. yard; all postage extra.—Post Radio Supplies, 33, Bourne Gardens, London, E.4. [3593]

WANTED, EXCHANGE, ETC.

WTD., cone unused Mazda ac/SP1.—Meeson, The Corner House, Ullesthorpe, Rugby.
WTD., folded exponential horn, 1in throat, in cabinet preferred.—Box 3489. [3943]
WTD., quality tuner unit for use with W.W.Q.A.—29, Warwick Ave., Crosby.
NEOON transformer wanted, 6-10,000v.—Details to Vane, 23, Cres., Ilminster, Som.
WTD., rotary converter, 230 dc to ac, out put abt. 250 mA.—Warner, 15, Cobble Cres., Crawley. [3949]

WANTED, 20w amplifier, ac mains, complete with loud speakers and microphone.—Write Box 3514. [3669]
WTD., new 70L7GT (GT only); also Feb. 45. "W.W." good cond.—R. V. Goode, 4, Clifton, York. [3659]

WTD., S-22 Hallcrafters rec., good price paid.—Williams, Birchington Hall, Kilburn, Tel. Mai. 1164. [3809]
WANTED, h.c. mains sets and valves.—Details and price to N. Reider, 49, Chisburn Rd., Bow, London, E.3. [3642]

RADIOGRAM cabinet, modern style, prof. walnut, speaker opening not necessary; good price for right article.—Box 3504. [3637]
HARTLEY-TURNER p.m. speaker, in good condition, Duode preferred.—Shilson, 143, Jayshaw Av., Great Barr, B'ham, 22a. [3680]

WANTED, coil winding machines, automatic paper interleaving type preferred.—Write, giving full particulars, to 2, Cottesloe Rd., Norton-on-Tees. [3946]

WE buy for cash, new, used, radio, electrical equipment all types; especially wanted, radios, radiograms, test equipment, motors, chargers, recording gear, etc.—If you want to sell at the maximum price, call, write or phone to University Radio, Ltd., 22, Lisle St., Leicester Square, W.C.2. Ger. 4447.

REPAIRS AND SERVICE

BEST quality rewind in 24 hrs.; guaranteed; competitive.—Radiowinds, Brundall, Nfk.
REWINDS and conversions to mains and output transformers, fields, etc., from 4/6.—N.L. Rewinds, 4, Brecknock Rd., N.7. [3915]
METROPOLITAN RADIO SERVICE CO. for guaranteed repairs to British and American receivers of all types.—(Service Dept.), 1021, Finchley Rd., N.W.11. [3886]
RADIO repairs can now be undertaken by first-class radio department equipped with modern laboratory.—Sinclair Speakers, 12, Pembroke St., London, N.1. [3616]

RADIO repairs quickly executed to all makes, English or American; lowest possible prices.—The Music Box, 89, London Rd., London, S.E.1. (Tel. Waterloo 4460 and 6766.)

MAINS transformers rewound and constructed to any specification; prompt delivery.—Brown, 3, Bede Burn Rd., Jarrow. [3460]
AL types of radio receivers serviced; Mullard and Pilot specialist; valves in stock; sound repairs for 13 years.—T. E. Fevyer, F.I.P.R.E., 50, Vine St., Uxbridge.

PHOTO-ELECTRIC CELLS

Se Te on gold-alloy, super-sensitive to light, gas-filled, permanent, operate relay direct or with Valve Amplifier, perfect reproduction of Speech and Music from sound track of films; large tube 3 1/2in. from glass top to valve pin base, 1in. diam., 38 -; same type, 2 1/2in. long, 35 -; small tube 2in. from top to terminal base, 2in. diam., 30 -; fminature cell, glass top to cap base, 1in. overall, 1in. diam., thin flex leads, 28 -; all cells operate on 40-100 volts. Connections diagrams free.

PRECISION OPTICAL SYSTEM, producing fine knife edge line of light from any car headlight bulb, for scanning film sound track direct into Photo-cell, metal tube 2in. long, 3/4in. diam., 1/2in. focus, 52.-. Instructions free. Goods by return.

CEFA INSTRUMENTS, 38a, York Street, TWICKENHAM, Middx. POPesgrave 6597

For **UTMOST PRECISION** always use **Silyam** ELECTRICAL INSTRUMENT COMPANY LIMITED TORQUAY DEVON

SOUND SALES

TRANSFORMERS-QUALITY RADIO & AMPLIFIERS
WEST ST. FARNHAM, SURREY.

ROTHERMEL CORPORATION LTD

are now able to supply their well-known Piezo Crystal Productions, including:—

- PICK-UPS, MICROPHONES, HEADPHONES, NEEDLE PRESSURE UNITS.

Descriptive leaflets and prices on application.

ROTHERMEL HOUSE, CANTERBURY ROAD, LONDON, N.W.6.

Radio Servicemen

How would you like: (a) to receive a monthly ration of 12 electrolytics? (b) to be able to borrow receiver service sheets? (c) to be able to get practically any valve or spare? (d) to receive an interesting bulletin fortnightly? All these and other advantages you get only 7/6 yearly. One condition only: you must be running a regular spare or full-time radio repair service. Write enclosing 7/6 requesting to be made a member of V.E.S.

V. E. S. (W), Radio House, Ruislip, Middx

SOUND EQUIPMENT

real Sales with Service

Personal consultation and advice is freely given on the combination of equipment best suited to your particular need. Any make demonstrated without obligation.

Stockists of VITAVOX High Quality Equipment.

R. G. JONES OF MORDEN

MORDEN PARK SOUND STUDIOS
London Road • Morden • Surrey
Phone: MITcham 3668

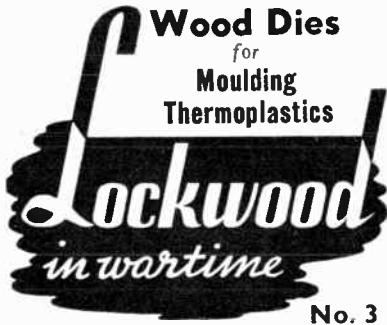

Wood Dies
for
Moulding
Thermoplastics

No. 3

Now it can be told

During the last six years "Lockwood" craftsmanship has been devoted to the design and manufacture of many hundreds of intricate wood dies used in the pressing of Thermoplastic (Perspex), Cupolas, Fairings, Turrets, etc., for Aircraft.

☞ Weighing up to $\frac{1}{4}$ of a ton and hand worked to very fine limits, the knowledge and experience gained by us in this field will benefit you when once again we can manufacture Furniture and Cabinet-work for your peacetime requirements.

☞ In No. 4 of this series we shall give the names of famous Aircraft for which we have executed this type of work.

LOCKWOOD & COMPANY
HARROW, MIDDX. BYRON 3704

Just Out!

AN EXPERIMENTAL COURSE IN THE FUNDAMENTAL PRINCIPLES OF RADIO

By R. H. Humphry, M.Sc., F.Inst.P.

A laboratory course designed for those who have little or no knowledge of electricity and magnetism. The fundamental principles of the subject are dealt with, and a statement of the theory underlying each experiment, or group of experiments, is given in a concise form. 12s. 6d. net

CATHODE RAY OSCILLOGRAPHS

By J. H. Reyner, B.Sc.(Hons.),
A.C.G.I., A.M.I.E.E., etc.

An easily understood guide to the practical application of Cathode Ray Tubes to numerous purposes, including the examination of oscillations, or wave forms. Second edition. 8s. 6d. net

PITMAN

PITMAN HOUSE, PARKER ST., KINGSWAY, W.C.2

MAINS transformers service, repairs, re-winds, or construction to specification of any type, competitive prices and prompt service.—Sturdy Electric Co., Ltd., Dipton, Newcastle-upon-Tyne. [3084]

"SERVICE with a Smile."—Repairers of all types of British and American receivers; coil rewinds; American valves, spares, line cord.—F.R.I., Ltd., 22, Howland St., W.1. Museum 5675. [1575]

TRANSFORMER rewinds, special designs manufactured, all types fields, chokes, outputs, etc., rewound; moderate charges, quick delivery, guaranteed high-class work; trade only.—H. W. Forrest, 67, Burnham Rd., Shirley, Birmingham. Sli. 2483. Est. 1922. [3652]

24-HOUR service, 6 months' guarantee, any transformer rewind, mains, outputs and i.f.s., etc. all types of new equipment supplied to specification; business heading or service card for trade prices.—Majestic Winding Co., 180, Windham Rd., Bournemouth. [3592]

REWINDS, mains transformers, field coils, chokes, high-grade workmanship, 7-day delivery; new transformers constructed to customers' specification, singly or in quantities.—Metropolitan Radio Service Co., 1021, Finchley Rd., N.W.11. Speedwell 3000. [3719]

REWINDS, mains transformers, layer wound, wax impregnated, chokes, O/P transformers, clock coils, field coils, pick-ups, complete repairs, competitive prices, prompt service, 12 months' guarantee; trade enquiries invited.—W. Groves, Manufacturing Electrical Engineers, 154, Icknield Port Rd., Birmingham, 16.

TO radio dealers and service engineers only.—Loudspeakers repaired quickly, or materials supplied; also big stocks of all components; send your trade card or billhead and 1d. stamp for our current lists.—A.W.F. Radio Products, Borough Mills, Sharpe St., Bradford, Yorks. [3410]

DE GALLIER'S, Ltd. — "Service with a guarantee." If you cannot get your receiver serviced, let American specialists do the job; first-class workmanship only; specialising in Air-King, Belmont, Challenger, Detroit, deWald, Emerson, Ferguson, Garod, Hallicrafter, Hammerlund, McMurdo, Medwest Majestic, Pilot, Philco, Spartan, etc., also any British set. Remember, for 15 years we have handled as distributors American receivers s.a.e. with all enquiries.—Degallier's, Ltd., 9, Westbourne Court, London, W.2.

MISCELLANEOUS

TIME recorders.—Write for particulars.—Gledhill-Brook Time Recorders, Ltd., 84, Empire Works, Huddersfield. [2419]

BUSINESS for sale, radio, elec., etc., Surrey; profits £12 p.w.; £750 s.a.v.—Business Brokers, 46, St. James's Pl., S.W.1. [3601]

EXPERIENCED amateur with capital wishes to actively join with proprietor of an existing radio business.—Box 3494. [3600]

SPARKS' data sheets.—These data sheets provide complete constructional details together with full-size prints, etc., of tested and guaranteed designs.
MIDGET two-valve, all dry batteries, 9 volt ht. med. wave, powerful 'phone sigs., size $5\frac{1}{2} \times 5\frac{1}{2} \times 3\frac{1}{2}$ in, ideal set, travellers, etc., 2/6; AC ht charger, 2 or 6 volt, 2/6; dc ht charger, 2/-; transverse current microphone, 2/6; pa amplifiers and other designs in hand.
SPARKS' DATA SHEETS (W.), 9, Pheobeth Rd., Brockley, London, S.E.4. [3622]

G. L. BROWN, Eng. Designer.—Design, development and construction of electro-mechanical apparatus and small mechanisms.—6, Glenby Ave., Gt. Crosby, Liverpool, 25.

CHASSIS, brackets, clamps, shrouds, etc., made quickly accurately with professional finish in A.A. benders, used by large radio mfrs, invaluable to experimental engineers.—Full details free from A. A. Tools, 197a, Whiteacre Rd., Ashton-u-Lyne. [3770]

FOR sale.—Bucks, 1 hr. Baker St.; freehold detached house, 2 shops, one radio, electrical, cycles, toys, the other ladies' hair-dressing saloon (lock-up); licence held for all electrical installations in district; garden, garage, telephone; disposal through illness; all at £3,000.—Box 3502. [3634]

SITUATIONS VACANT

A WELL-KNOWN and long-established manufacturer of radio components requires a chief mechanical engineer; excellent opportunity for a man with good qualifications and experience in mechanical design; appointment when present restrictions of employment are withdrawn.—Box 3485. [3933]

DRAGHTSMAN (junior) required by progressive radio and electrical manufacturers; opportunity afforded to introduce originality in design; appointment when restrictions of employment are withdrawn; excellent prospects for young man.—Full particulars, age and salary to Box 3492. [3598]

LONDON CENTRAL RADIO STORES

WIREWOUND POTENTIOMETERS. 4,000 ohms. Open type on porcelain formers, 9 1/2 spindle, 2 1/2 in. 12/6. 25,000 ohms. Tropical type enclosed in bakelite moulding, 1/2 in. spindle, 1 1/2 in. 4/6.

SPEAKERS. Goodmans 3 1/2 in. P.M. 3/2 ohms speech coil, less transformer. 27/6. Goodmans 12 in. P.M. 15 ohm V. coil. £3 15s. Carr., etc., 4/6 extra. P. & A. 8 in. mains energized with Pentode output transformer, 1,200 ohm field. 37/6. Celestion 10 in. P.M. with transformer. 45/-. Celestion 6 in. P.M. with transformer. 27/6.

EXTENSION SPEAKERS, in Rexine covered Cabinets—6 in. Rola. 32/6.

SLIDING RESISTANCES. 1,100 ohms 0.4 amp. wirewound on twin porcelain formers. A first-class engineering job. 32/6.

D.C. MOVING COIL MILLIAMMETERS with 2 in. clear reading dial, flush mounting. 0-1 mA. Full scale deflection. 47/6. 0-25 mA. 2 in. dial. Flush mounting, bakelite case. Made by Ernest Turner Electrical Instruments Ltd., 50/-, 6-6 mA. 2 in. dial. Flush mounting, bakelite case. Extra scales for conversion, voltmeter and ohmmeter. Internal resistance, 250 ohms, 50/-.

MICROAMMETER, 0-500, 2 in. dial. Flush mounting, bakelite case, £4 10s.

1 mfd. TUBULAR CONDENSERS 5,000v. DC wkg 5/6

TWO-RANGE D.C. VOLTMETERS. Moving coil 0-300, 0-600 v. Complete with shunt. 2 in. clear reading dial. Flush mounting. Made by Ernest Turner Electrical Insts. Ltd. £3 17s. 6d.

TWIN CARBON POTENTIOMETERS, 0.5 megohm-5/6.

MAINS TRANSFORMERS. Newly manufactured. 250-0-250 v. 80 mA. 4 v. 3 a., 4 v. 3 a. 28/6. 300-0-300 v. 75 mA. 6.3 v. and 5 v. 28/6.

4 mfd. CONDENSERS, 250 v. D.C. wkg., size 2 1/2 x 2 x 2. 5/6.

MIDGET POT' METERS. Wirewound, 8 ohms. 4/6. CONDENSERS. Metal case. 0.1 mfd. 1,000 v. D.C.W. Insulated terminals. 2 1/2 x 2 1/2 in. 3/6.

TUBULAR CONDENSERS. 0.1 mfd., 350 v. D.C.W. Bakelite with metal ends. Tag terminals. 1/6.

YAXLEY TYPE METER SWITCH. Single pole. 11-way. 6/6.

"MUTER" PUSE-BUTTON UNITS. 8-way, with mains switch rated 125 v. at 0.3 amp. and 250 v. at 1 amp. 3/6.

EX-G.P.O. ELECTRO-MAGNETIC COUNTERS. 25-50 v. D.C. Counting to 9,999. 6/-.

PLATINUM CONTACTS. Double spring, mounted on ebonite. 1/6.

MULLARD EA50 VALVES. 10/6.

CHASSIS 11 x 9 1/2 x 2 1/2 in. 3/6.

A PARCEL OF CONDENSERS containing 4 each Tubular .1, .01, .001, .005, .0003, .0055, .0064, .004, .0025, .002 mfd. 1 each Electrolytic 8 mfd., 8 x 8 mfd., 16 mfd. 450 v. wkg. .1 + .1 + .1 mfd. 350 v. wkg. All new. The lot, 45/-.

Closed Thursdays, 1 p.m.
Open all day Saturdays

23, LISLE STREET
LONDON GERard 2969 W.C.2.

ENGINEERING OPPORTUNITIES



This unique handbook shows the easy way to secure A.M.I.Mech.E., A.M.Brit.I.R.E., A.M.I.E.E., City and Guilds, etc.

WE GUARANTEE—
"NO PASS—NO FEE."

Details are given of over 150 Diploma Courses in all branches of Civil, Mech., Elec., Motor, Aero., Radio, Television and Production Engineering, Tracing, Building, Govt. Employment, R.A.F. Maths., Matriculation, etc.

Think of the future and send for your copy at once—FREE.

B.I.E.T., 387, SHAKESPEARE HOUSE,
17, STRATFORD PLACE, LONDON, W.1.

RADIO laboratory engineer, with practical experience of radio and also electrical measurements, offered permanent post, with good prospects; over 51 or Class A ex-Serviceman.—Box 3516. [3671]

CHARGE hands required for radio and/or electrical instrument servicing; class A Servicemen men over 51; must be experienced, not afraid of work, conversant with modern methods; good wages and permanency.—Box 3500. [3629]

ACTIVE partnership, with option of eventual purchase, offered in small, old-established firm (measuring instruments); about £1,000; offers interesting work and secure future to keen technician; banker's reference.—Box 3508. [3663]

LIVE radio service engineers wanted immediately, accustomed to fault finding, checking, testing, etc.; good wages; Slough district; permanent post of suitable men, over 51 or Class A ex-Servicemen; unless fully qualified do not write.—Box 3515. [3670]

SALES representative required to call upon manufacturers of radio receiving and transmitting apparatus and electronic equipment throughout the country; applications invited from class A Servicemen; salary according to age and experience.—Apply to Personnel Officer, Box 3501. [3662]

BERRY'S (SHORT WAVE), Ltd., [3633] have vacancies for men experienced in (a) communication receivers, (b) transmitters, (c) transmitting valves; applications invited from class A Servicemen and men over 51.—Full details of experience and past positions to 25, High Holborn, London, W.C.1. [3628]

ASSISTANT required in Central London to undertake full-time instruction work in tele-communications, principally broadcasting and radio-telephony; previous teaching experience not essential.—Write, stating age, experience, and salary required, to Box M.453, Willings 362, Gray's Inn Rd., W.C.1. [3644]

RADIO engineer required for development work by small established manufacturers; good theoretical knowledge more essential than wide experience; permanent progressive post for young man (25-35) with initiative and adaptability; appointment when relevant restrictions on employment are withdrawn.—Full particulars, age and salary to Box 3493. [3644]

OVERSEAS employment.—Broadcast officer required by the Gold Coast Government Broadcasting Department for one tour of 12 to 24 months, with possible permanency; salary £450, rising to £720 a year, plus local allowance of £48 and separation allowance for married men between £84 and £204, according to number of children; outfit allowance £60; free passages and quarters; candidates should be of good education and have had a thorough training in the theory and operation of wireless broadcast transmitters and in studio technique; should understand thoroughly the system of distributing radio programmes by wire, and have a knowledge of modern superheterodyne short-wave receivers; a knowledge of gramophone disc recording is desirable. [3597]

APPLICATIONS, which must be in writing, stating date of birth, full details of qualifications and experience, including present employment; also identity and National Service or other registration particulars, and quoting Reference No. O.S. 875, should be addressed to the Ministry of Labour and National Service, Appointments Department, Sardinia St., Kingsway, London, W.C.2. [3597]

SITUATIONS WANTED
SERVICE engineer, 39, seek position as outside representative; 20 years' experience; good references; car available.—Box 3517. [3671]

RADIO engineer, 10 years' civilian experience, desires partnership or position in radio business; small capital; any area considered; driver, release group 19.—Box 3513. [3671]

TX, RX, and plastics.—Test engineer, age 40, 3 years present laboratory, previously in charge wiring and assembly depts., thoroughly practical and used to all modern test gear.—Box 3518. [3674]

RADIO engineer, over 20 years' exp., development, experimental and service work, requires progressive and remunerative position.—Offers to Box 3499. [3619]

R.A.F. officer, 26, adaptable, hard worker, bomber pilot with experience on single-, twin- and four-engined aircraft, now studying radio engineering, desires post-war situation, either air or ground, preferably with firm engaged on radio and radar design and research.—Box 3495. [3602]

TUITION
RADIO training.—P.M.G. exams, and I.E.E. Diploma; prospectus free.—Technical College, Hull. [0611]

HILL & CHURCHILL
BOOKSELLERS
SWANAGE DORSET
ENGLISH & AMERICAN
BOOKS IN STOCK ON
RADIO AND
TELECOMMUNICATION
CATALOGUE ON APPLICATION

REWINDS
Armatures, Fields, Transformers, Pick-ups, Fractional H.P. Motors, Speakers Refitted New Cones & Speech Coils.
All Guaranteed and promptly executed.
Valves, B.V.A. and American, good stocks. Send stamped addressed envelope for list of Radio Spares, and C.O.D. Services.
A.D.S. Co. 261-3-6, Lichfield Road, Aston, BIRMINGHAM, 6

Improved
Terminal CLIPS
Well made of steel, double ridged for strength. Teeth on three sides of lower jaw and special design of upper jaw ensure firm grip and good contact.
Wingard
CHURCH ROAD · HENDON · LONDON · N.W.4

TRANSFORMERS & COILS
TO SPECIFICATION.
MANUFACTURED or REWOUND.
STANLEY OATTELL LTD.,
9-11, East Street, TORQUAY, Devon.
Phone: Torquay 9192.

COVENTRY RADIO
Component Specialists since 1925
"NAPP" MAINS TRANSFORMERS, Pri.200/250v., Secondary 350-0-350 volt, 80 ma., 6.3v. 3s. 5v. 2½s., or with 4v. 4s., 4v. 2½s. 26/6
"WAPP" OUTPUT TRANSFORMERS, 70 ma. 4/9
Multi-Ratio, 8/9, Tapped Power/Fenode 4/9
VOLUME CONTROLS, with S.P. switch, 1st Grade, sizes from 1,000 ohm to 2 megohm 12/6
2-GANG CONDENSERS, .0005 mfd., best quality, with 1½inx feet, 3½inx spindle 12/6
M.E. SPEAKERS, Celestion, 8in., 2,000 ohm field, with standard transformer 36/6
Latest 1d. list includes 3½in. to 12in. Speakers, Yaxley Switches, I.F. Transformers, Condensers, Resistors, Coils and Dozens of other Components.
PROMPT SERVICE, COMPLETE SATISFACTION
NOTE.—We close from August 5th to 10th.
THE COVENTRY CO.
191, DUNSTABLE ROAD, LUTON.

MATHEMATICS.—Expert personal post- tuition; Matric. Inter, radio maths.—Prospectus and advice free, from S.P.T.C., 8, Ascupthorpe House, Portswold, Southampton.
"ENGINEERING Opportunities." free "E 112" page guide to training for A.M.I.Mech.E., A.M.I.E.E., and all branches of engineering and building; full of advice for expert or novice; write for free copy and make your peacetime future secure.—B.I.E.T. (Dept. 387B), 17, Stratford Place, London, W.1.

TECHNICAL TRAINING
A.M.I.E.E., City and Guilds, etc., on "No pass—no fee" terms; over 90% successes. For full details of modern courses in all branches of electrical technology send for our 112-page handbook, free, post free.—B.I.E.T. (Dept. 388A), 17, Stratford Place, W.1.

GREAT possibilities exist for technically qualified engineers, key men in wartime and afterwards. Through the home-study courses of The T.I.G.B. take a recognised engineering qualification, such as A.M.I.Mech.E., A.M.I.E.E., A.F.R.Ae.S., A.M.I.Chem.E. C. and G., etc., in which examinations the T.I.G.B. students have passed 25 FIRST PLACES and hundreds of passes. Write today for "The Engineer's Guide to Success"—free—containing the world's widest choice of engineering courses covering all branches, including aeronautical, mechanical, electrical, wireless, chemical, etc.
THE TECHNOLOGICAL INSTITUTE OF G.T. BRITAIN, 82, Temple Bar House, E.C.4.

PATENT NOTICES
RADIO-electric patents.—Well-known London radio component manufacturers are open to consider patents or designs for post-war period.—Write Progress, c/o Alfred Bates & Son, Ltd., 130, Fleet St., London, E.C.4.

THE proprietors of British Patent No. 505632, entitled Improvements in and relating to cathode-ray tubes, offer same for licence or otherwise to ensure its practical working in Great Britain.—Inquiries to Singer, Ehlert, Stern and Carberg, Chrysler Building, New York City, 17, N.Y., U.S.A. [3596]

THE proprietors of British Patent No. 504934, entitled Improvements in Circuits for Evacuated Envelopes and Method of Manufacturing the Same, offers same for licence or otherwise to ensure its practical working in Great Britain.—Inquiries to Singer, Ehlert, Stern and Carberg, Chrysler Building, New York City 17, N.Y., U.S.A. [3887]

THE proprietors of British Patent No. 537689, entitled Improvements in wave signalling systems, particularly applicable to facsimile telegraphy, and No. 537699, entitled Improvements in frequency modulation systems, offer same for licence or otherwise to ensure their practical working in Great Britain.—Inquiries to Singer, Ehlert, Stern and Carberg, Chrysler Building, New York City, 17, N.Y., U.S.A. [3627]

WORK WANTED.
DESIGN and development.

WE have facilities particularly suited to this class of work; A.I.D. approved; enquiries to:—**GREEN ELECTRICAL INDUSTRIES, Ltd.**, 44-45, Tamworth Rd., Croxson, Tel. 7417-8.

Coil winding, vacuum-pressure impregnation.—**Godfrey Industries, Ltd.**, Brundall, Norfolk. Tel. 90. [3604]

SHET metal and engineering Co. in London area have immediate capacity for all classes light sheet metal work; high standard of workmanship guaranteed.—Apply Box 3498.

CAPACITY available for complete manufacture of all types of radio and electrical equipment; wave winding, coil and transformer work, with vacuum impregnation; highly super optical standards; A.I.D. approved.
GREEN ELECTRICAL INDUSTRIES, Ltd., 44-45, Tamworth Rd. Tel. Croxson 7417-8.

THETA RADIO and TELEVISION Co., Ltd., 233-235, Lewisham High St., London, S.E.13, wish to supplement present production by the manufacture of new types of radio or other domestic electrical products; capacity is also available for coil and transformer winding to specification; the repair of all types of British and American receiving equipment can be undertaken on behalf of the trade; high grade workmanship and quick delivery guaranteed. [3631]

BOOKS, INSTRUCTIONS, ETC.
COPIES "Modern Wireless," Feb., '41, to date inclusive; offers.—Box 3509. [3664]
"WIRELESS World," 1929 to 1936, except 18/9/29 and 12/11/30; "Wireless Engineer," 1932-35.—BM/MB6F, London, W.C.1.
"WIRELESS World," 1933-35, 270 issues, unbound; 1940-44, 5 vols, complete, bound; offers.—Martin, 3, Cliff Av., Loughborough, Leics. [3678]

Printed in England for the Publishers, LIFFE and SONS LTD., Dorset House, Stamford Street, London, S.E.1, by THE CORNWALL PRESS LTD., Paris Garden, Stamford Street, London, S.E.1. "Wireless World" can be obtained abroad from the following—AUSTRALIA and NEW ZEALAND: Gordon & Gotch, Ltd. INDIA: A. H. Wheeler & Co. CANADA: Imperial News Co.; GORDON & GOTCH, LTD. SOUTH AFRICA: Central News Agency, Ltd.; WILLIAM DAWSON & SONS (S.A.), LTD. UNITED STATES: The International News Co.

**FOR WAR SERVICE AND
POST-WAR PLEASURE**

The most famous set makers fit

MAZDA
RADIO
VALVES



THE EDISON SWAN ELECTRIC CO. LTD., 155 CHARING CROSS ROAD, LONDON, W.C.2

ADVERTISING Ersin Multicore ON THE OTHER SIDE OF THE ATLANTIC

 **FOR THOSE WHO SEEK**
The Finest
Cored Solder in the World



W in the near future, to sending once more supplies of Ersin Multicore Solder to our friends in the U.S.A. and elsewhere overseas. Ersin Multicore contains 3 cores of non-corrosive Ersin Flux and provides just that extra rapidity of fluxing action which ensures a precision standard of consistently reliable solder joints. Only a solder wire having 3 independent cores of flux, evenly distributed across the cross-section of the solder wire, can give this extra efficiency. If you make high quality electronic equipment you will wish to learn more about Ersin—the flux contained in the 3 cores. It possesses all the non-corrosive properties of best grade Rosin but is specially activated to remove surface oxides and prevent them forming during soldering processes. It operates with a speed and certainty which previously has never been thought possible with a non-corrosive flux. Whether you buy solder by the 1-lb. or 10,000-lb. it would give us much pleasure to send you technical literature and samples of Ersin Multicore 3 Core Solder. Just send us your name and address.



FLUXING BY FLUX provide just the correct proportion of flux to solder. NO extra flux is required. The flux does not tend to run out of the cores: so there is always a supply available for the next joint. The utmost economy of flux and solder is achieved.

Five standard antimony free alloys are available. Ersin Multicore Solder is supplied in bulk quantities in any other tin-lead alloy to special order. Recently 45 tin and 55 lead alloy has been in most demand for electronic equipment. Colour coding of reels and packages makes different alloys instantly recognisable.

GAUGES	WEIGHTS
10 S.W.G.	22 S.W.G.
13 S.W.G.	16 S.W.G.



Ersin Multicore Solder is made in a wide range of gauges. Standard gauges supplied are from 10 S.W.G. - 22 S.W.G. (120" - .020") (3.251 - .7109mm) 13 S.W.G. (.092" - 2.336mm) and 16 S.W.G. (.064" - 1.625mm) are the most widely used sizes for the production of electronic equipment.

ERSIN which is contained in the 3 cores of Multicore Solder is a pure high grade rosin which has been subjected to a complex chemical process to increase its fluxing action to the highest possible degree without impairing in any way the well-known non-corrosive and protective properties of the original rosin. In effect, rosin as a flux suffices only as an agent to avoid oxidation during soldering, whereas Ersin will not only remove surface oxides, but also prevent their formation during the soldering operation.

**ERSIN
ACTIVE
NON-CORROSIVE
FLUX**

ERSIN MULTICORE
 THE SOLDER WIRE CONTAINING
3 Cores OF NON-CORROSIVE ERSIN FLUX

MULTICORE SOLDERS LTD.
 SUITE 5, COMMONWEALTH HOUSE, NEW OXFORD STREET, LONDON, W.C.1, ENGLAND
 Telephone: CHANCERY 5177 2. Cable: DUSTICROM, WESTCENT, LONDON.

U.S.A. DISTRIBUTORS:
 BRITISH INDUSTRIES SALES CORPORATION
 401 BROADWAY, NEW YORK, N.Y. 11

CANADIAN DISTRIBUTORS:
 SNI-DOR RADIOELECTRIC LTD.,
 455 CECIL ST. WEST, MONTREAL

Above is a reproduction of a double page colour advertisement now appearing overseas in such journals as the U.S.A. "Electronics." That there is a demand for Ersin Multicore in U.S.A. is particularly interesting because the production of cored solder in North America probably exceeds that made in all other countries of the world combined. Many U.S.A. and other overseas manufacturers of high quality radio

equipment find it worthwhile to import British made Ersin Multicore Solder although freight and often duty has to be paid. Most British radio manufacturers know also that the superiority of Ersin Multicore makes it more economical to use than any other form of solder. If you are not already enjoying the advantages of Multicore, please let us know.

Wireless World