

Wireless World

RADIO • ELECTRONICS • ELECTRO-ACOUSTICS



APRIL 1944

1/6

VOL. L. No. 4

IN THIS ISSUE : STANDARDS FOR TELEVISION



Over to you - OVER!

Today the output of Osram Valves is devoted to the war effort of the United Nations. Important contributions have been made in research, experiment and development by scientists and technical experts, in collaboration with the war services. But Osram Valves for maintenance of existing equipments are available. Consult your usual supplier.



When priority of production is no longer essential Osram Valves, incorporating many striking developments in scientific research, will once more be freely available. Then it will be over to you — over!

Osram Valves

MADE IN ENGLAND

Advt. of The General Electric Co. Ltd., Magnet House, Kingsway, London, W.C. 2



Regd. Trade Mark

PRECISION

TESTING INSTRUMENTS

HIGH accuracy, simplicity, exceptional versatility and proven reliability have won for "AVO" Instruments a world-wide reputation for supremacy wherever rapid precision test work is demanded. There is an "AVO" Instrument for every essential electrical test.

Orders can now only be accepted which bear a Government Contract Number and Priority Rating.

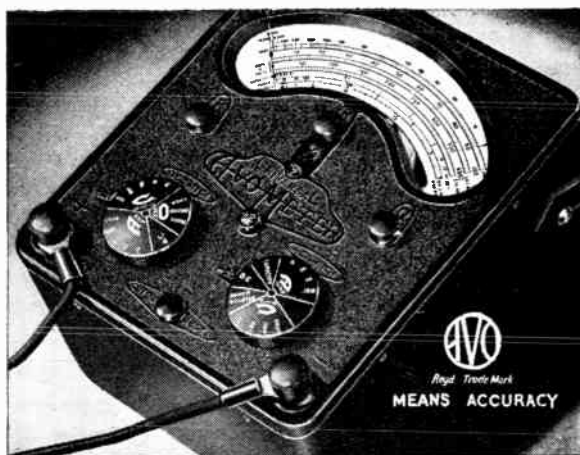

The MODEL 7 50-Range Universal
AVOMETER

Electrical Measuring Instrument

A self-contained, precision moving-coil instrument, conforming to B.S. 1st Grade accuracy requirements. Has 50 ranges, providing for measuring A.C. & D.C. volts, A.C. & D.C. amperes, resistance, capacity, audio-frequency power output and decibels. Direct readings. No external shunts or series resistances. Provided with automatic compensation for errors arising from variations in temperature, and is protected by an automatic cut-out against damage through overload.

Sole Proprietors and Manufacturers

THE AUTOMATIC COIL WINDER & ELECTRICAL EQUIPMENT CO. LTD., Winder House, Douglas Street, London, S.W.1.

'Phone: VICTORIA 3404-1



The outstanding characteristics of U.I.C. Ceramic Pot Condensers are their high break-down strength, low loss factor, and small dimensions. *Test Voltage* up to 15 KV D.C. or 10 KV R.M.S. *Working Voltage* up to 7.5 KVD.C. or 5 KVR.M.S. *Radio Frequency Working Load* from 2.5 to 15 KVA according to type. *Capacity Range* 20pF to 1250pF. Made to Specification K. 110. Full details on request.

UNITED INSULATOR CO. LTD.
12-22, LAYSTALL STREET, LONDON, E.C.1

Tel.: TERminus 7383 (5 lines) Grams.: Calanel, Smith, London

THE PIONEERS OF LOW LOSS CERAMICS



Moisture-proof . . .

“Stability in Insulation” and how it is achieved . . .

This enlightening little work — “STABILITY IN INSULATION” — is the last word on the subject of modern insulation. It is full of facts worth noting.

Did you know, for example, that HY-MEG ensures electrical performance above reproach — even in tropical heat and after prolonged heavy duty — conditions, which are normally so harmful to ordinary impregnating varnishes? It tells also how HY-MEG’s efficiency is unimpaired by damp or the deteriorating action of oils, acids and alkalis; such faults as softening of wire enamel and wire breakage are prevented by the use of HY-MEG.

Evidence of the superiority of HY-MEG is abundantly contained in the booklet, a copy of which will gladly be sent to you. Please apply on Business Heading or Card, enclosing 2d. to comply with the Control of Paper (No. 48) Order 1942.



‘HY-MEG’ IMPREGNATING VARNISH

V. 6934. Made specially for enamelled wire windings; but is equally suitable for Rayon and Glass-covered wire.

LEAVE IT TO OUR ‘BRAINS TRUST’

Have you a special problem? If so, let the experts, whose research work produced ‘HY-MEG’ solve it. Their long and varied experience in overcoming insulation difficulties is at your disposal.



SEND FOR
YOUR COPY
TODAY

LEWIS BERGER & SONS LTD., (Established 1760) LONDON E.9 'Phone: AMHerst 3321

MANUFACTURERS OF INSULATING VARNISHES AND ENAMELS



German war industry pounded again

The raid is on industrial Germany, many miles away. Timed to perfection, groups of bombers from different bases converge on the target. Radio and radio-devices play an all-important part in these missions. Yet, despite priority requirements, good supplies of Mazda Valves are being made available to the listening public. Ask your Dealer for details of types available.

MAZDA

RADIO VALVES

THE EDISON SWAN ELECTRIC CO. LTD.,  155, CHARING CROSS RD., LONDON, W.C.2.
(R.M. 16)

'DIAMOND H'

Multi-circuit

SWITCHES

APPROVED BY SERVICE DEPTS.

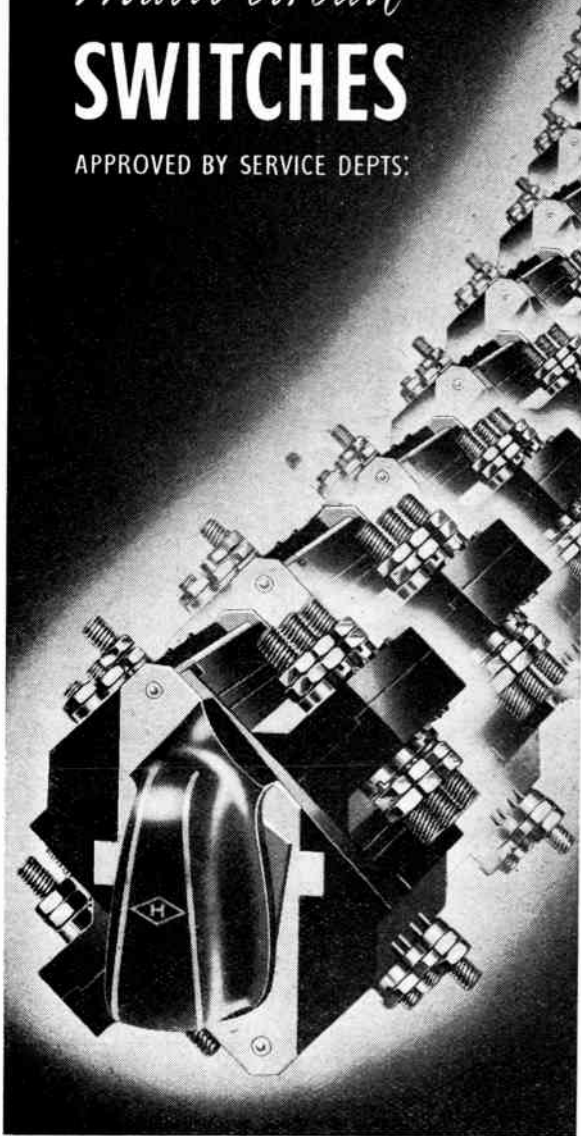

DESCRIPTIVE LIST NO. 76.
ON APPLICATION

'DIAMOND H' SWITCHES, LIMITED
LONDON. W. 4.

WHARFEDALE

MIDGET 3½-inch UNIT

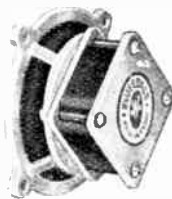

ALCOMAX MAGNET

Flux Density 8,000 lines.

Speech Coil 15 ohms or 2/3 ohms.
The first Wharfedale Unit using
the new ALCOMAX magnet
steel which gives extremely high
flux density with small size.
Designed for use as Microphone
or Midget Speaker. Very sensitive.

Supplies are available for
PRIORITY ORDERS ONLY

PRICE

28'6

(list)

WHARFEDALE WIRELESS WORKS

(SOLE PROPRIETOR: D. E. BRIGGS)

HUTCHINSON LANE • BRIGHOUSE • YORKS

PHONE: BRIGHOUSE 50

'GRAMS: "WHARFEDALE"

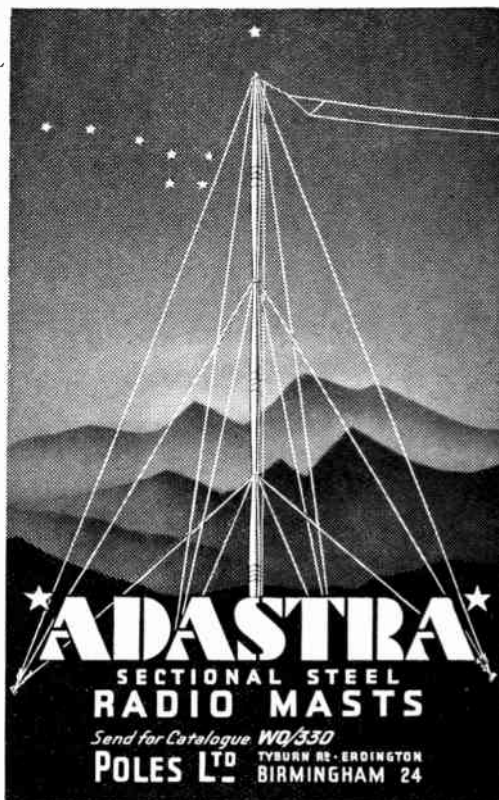

ADASTRA
SECTIONAL STEEL
RADIO MASTS

Send for Catalogue *WQ/330*

POLES LTD TYBURN RD - ERDINGTON
BIRMINGHAM 24

As like as

PEAS IN A POD

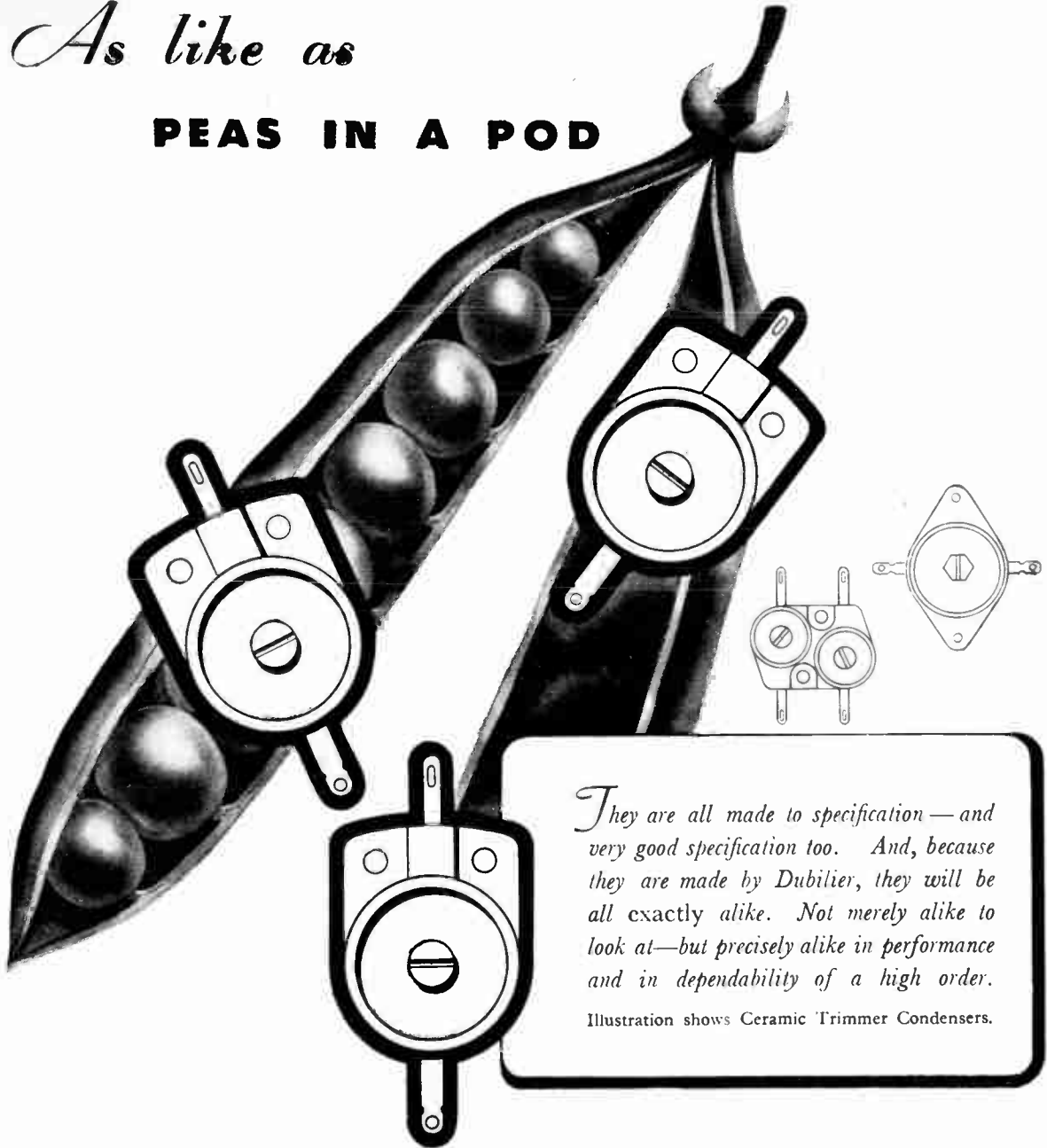

They are all made to specification — and very good specification too. And, because they are made by Dubilier, they will be all exactly alike. Not merely alike to look at—but precisely alike in performance and in dependability of a high order.

Illustration shows Ceramic Trimmer Condensers.

DUBILIER

CONDENSER CO. (1925) LTD.

CONSISTENTLY GOOD



C. R. Casson

TAYLOR VALVE TESTER

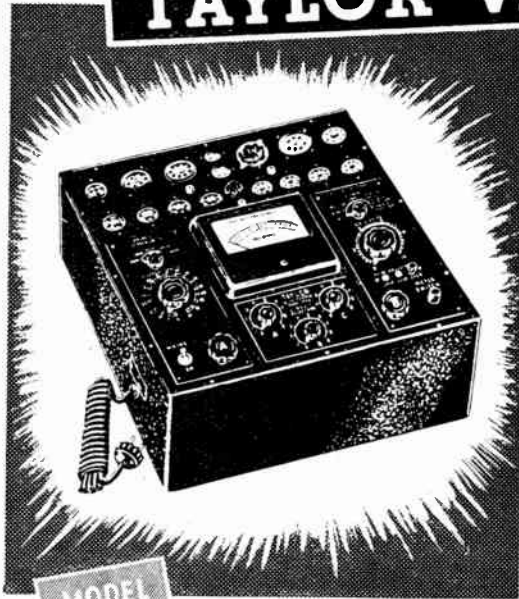

MODEL
45A

Please write for
technical brochure.

Send your enquiries to:

TAYLOR ELECTRICAL INSTRUMENTS LTD.,
419-424 Montrose Avenue, Slough, Bucks.
Telephone: Slough 21381 (4 lines)
Grams: "Tayfins, Slough"

This new and improved Taylor Valve tester measures the Mutual Conductance of all types of amplifying valves and also checks the emission of Diodes and Rectifying valves

Two ranges of Mutual Conductance measurement are available being 3 mA/V full scale and 15 mA/V respectively. Anode and Screen Volts can be adjusted to suit the valve under test and a variable supply of Grid Volts is also available. A switch gives a choice of 17 different filament Volts covering from 1.1 Volts to 117 Volts

Sixteen valve holders are provided to cover all the popular British, American and Continental types. Separate tests are available for checking Continuity, Element Shorts and Heater to Cathode Leakage. The three selector switches ensure that the correct voltage is applied to every pin of the valve under test.

A comprehensive book of instructions is issued with each instrument, complete with a valve chart giving settings for over 2,000 valves of all makes

The instrument is operated from A.C. Mains and a mains adjustment is provided covering from 200-250 Volts at 40-100 cycles

Model 45A/S Price £15 . 15 0

Taylor
electrical instruments Ltd.

WAXES OKERIN

AND
DIELECTRIC MATERIALS

Cable, Condenser, Coil, Transformer and Resistance
Impregnating, dipping, sealing, filling and finishing.

A.I.D. and C.I.E.M.E. TYPE AP-
PROVED WAXES to meet both
ARCTIC and TROPICAL conditions.

TELEPHONE: WEST DRAYTON 2189

**ASTOR BOISSELIER
& LAWRENCE LTD**

MIDDLESEX OIL & CHEMICAL WORKS

WEST DRAYTON, MIDDLESEX

The
LOUDSPEAKER
YOU KNOW BY EAR
now making
EVERY WAR EFFORT

BRITISH **Rola** LIMITED
DEVIZES · LONDON · BIDEFORD
ENGLAND

F.W.S.CO.
TRADE MARK

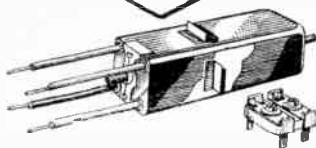

Sickles Midget Transformer and Trimmer.

OUR greatly increased manufacturing facilities in the War effort, coupled with our added production knowledge, will materially benefit you 'when Victory is won.' Quality has always been the dominant consideration in the design—in the choice of materials and in the method of manufacture of our products; and we look forward with confidence to the day when we shall once again continue our relationship with the Radio Industry of Great Britain with greater cordiality than ever before.

**I.F. TRANSFORMERS
AERIAL AND OSCILLATOR COILS
TRIMMER AND PADDER CONDENSERS
COIL FORMS, etc.**



**The F. W. SICKLES Co.
CHICOPEE, MASS., U.S.A.**

RAYTHEON - PROGRESS -

OVER 12,000 highly skilled Raytheon employees are producing for the military... when we again return to peacetime pursuit of normal business, the Raytheon dealers and servicemen will have the additional advantage of all of Raytheon's wartime engineering development and production of electronic tubes for the enormous number of new applications.

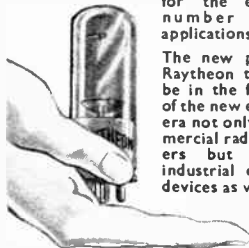

The new peacetime Raytheon tubes will be in the front line of the new electronic era not only in commercial radio receivers but the new industrial electronic devices as well.

**WORLD'S LARGEST
EXCLUSIVE
TUBE MANUFACTURERS**



**RAYTHEON
PRODUCTION CORPORATION
NEWTON, MASS., U.S.A.**

P. R. MALLORY & CO. Inc.

MALLORY VIBRATORS



IDEAS WILL POP FOR YOU

IN the crucible that is war production, ideas pop into reality in bewildering numbers. Co-operative progress in techniques in chemical, metallurgical and electrical applications of materials, has contributed astounding gains to man's control over Nature's resources. Comparatively few can have more than a vague notion of industrial accomplishment for the war effort. But the discoveries that have mechanised warfare and conquered the air, that have developed transportation and supplies to marvellous wartime results, represent ideas that will pop into an amazing variety of commercial contributions to post-war living standards.

**P. R. MALLORY & CO. INC.
INDIANAPOLIS, INDIANA,
U.S.A.**

Radio and Electronics Division

ALSO

"MYKROY" CERAMIC INSULATING MATERIALS

"IDEAL" RECHARGEABLE CELLS AND CHARGERS

GENERAL ELECTRONIC VACUUM CONDENSERS

FOR THE FUTURE

These Manufacturers will help solve your post-war problems. Register your name now for full details which will be sent you when supply conditions again permit.

FRANK HEAVER LIMITED

**Kingsley Road, BIDEFORD,
N. Devon**

G. I.

VICTORY PRODUCTION

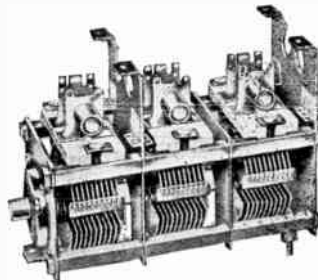

WHEN the mission of complete victory is accomplished, General Instrument will help "Win the Peace" by making the best use of still greater knowledge and experience in the manufacture of variable condensers and drives.

**THE GENERAL INSTRUMENT
CORPORATION
ELIZABETH, N.J., U.S.A.**



TWO-WAY radio communication systems, like the plastic-cased beauty illustrated, are one of the new developments leading industrial designers are thinking of to speed the work of a busy post-war world. Applications of this compact, plastic-cased 'walkie-talkie' are almost unlimited. Naturally, this is only one of thousands of uses plastics will be put to after the war, but it will serve to remind you that post-war planning is being done... Kurz-Kasch designers, engineers, tool-makers and moulders... specialists for a generation in plastic planning and moulding will help you with your problems.



KURZ-KASCH INC.
Planners and Moulders for the Age of Plastics
DAYTON • OHIO • U.S.A.



GOODMANS
New **T 2-12"**
LOUDSPEAKER

for the SERVICES
and all PUBLIC ADDRESS PURPOSES
including FACTORIES, WORKSHOPS,
CANTEENS, ETC.

Goodmans
LOUDSPEAKER & TELEPHONE ENGINEERS

INDUSTRIES, LTD.
WEMBLEY, MDX.

M.R. SUPPLIES

Maintaining their reputation for instant delivery and dependable quality, offer the following brand new RADIO, ELECTRICAL and INDUSTRIAL EQUIPMENT. All prices nett cash.

MAINS TRANSFORMERS, special heavy duty, high spec. prim. 230 v. secs. :- 500-0-500 v. 250 m.a. (tolerant to 350 m.a.) and sep. wdg. 250-0-250 v. 50 m.a. (tol. to 75 m.a.), 4 v. 4 a., 4 v. 4 a., 6.3 v. 4 a., 10 v. 5 a., all C.T., finished brackets and terminal board, weight 23 lbs., £7.10.0 (carr. 2/6); also prim 230 v. secs. :- 1700-0-1700 v. 400 m.a. and 6.3 v. 5 a. with high insulation, weight 55 lbs., £13.10.0 (pkg./carr. 6/-). Very limited number of both of these items.

G.E.C. CURRENT FED MICROPHONES. Require no amplifier—work directly from 12-volt accumulator (current drain when in use 14 amps.). Supplied with appropriate transformer for matching to 15-ohms coil. The microphone has a return switch at convenient point above handle to be pressed only while speaking, thus conserving battery consumption. Complete, £9.17.6. NOTE :- Any 15-ohms speaker will suit, but we can supply from stock the most efficient type with P.M. Projector Unit (15 ohms) and 30in. Dispersive Horn, price £8.17.6. The complete system as above supplied for £18.10.0 (carr. 7/6). Very few left.

G.E.C. PUBLIC ADDRESS SPEAKERS. Latest P.M. M/Coil Projector Units (15 ohms), with built-in multi-line transf. and 42-inch round all-metal Horn, complete. With "B" Unit, 10 watts, £10.5.0. With "A" Unit, 12 watts, £12.10.0 (carr. either 7/6). Also new **SENIOR INDUSTRIAL SPEAKERS** in 10½-in. Metal Drum with front and rear grille, fitted fine 10-in. P.M. Unit with multi-line Transformer. 75/- (carr. 2/6). **CENTRALAB SOUND PROJECTION CONTROLS** (suitable for other uses). **STRAIGHT FADERS** for two pickups, or mike/pickup, each side 100,000 or 50,000 ohms (two models), 26/6. **GAIN CONTROLS**, 1 megohm with screw-driver, 100/500 volts A.C./D.C., 50 ohms only, 26/6. "T" **PAD FADERS** for 500, 200 and 50 ohms lines (three models) controlling three channels (pre-war list £4). Limited number at only 42/6 each. Instructions with each. **LONDEX BELAYS** with 230 v. A.C. Coil and 3-pole C.O., 6-amp. H.T. switching, 42/6. Also with 6 v. D.C. Coil and 2-pole break 3 amp., 230 v. switching, 7/6.

SLIDING RESISTANCES. 100 watts, fully enclosed, 6½ins. long with bushed cable entries. Following range in stock: 4 ohms 5 amps., 50 ohms 1.4 amp., 100 ohms 1 amp., 200 ohms 0.7 amp. and 400 ohms 0.5 amp. Any one 25/-.

"**PYROBIT**" **ELECTRIC SOLDERING IRONS**. The popular "Instrument" model for small electrical work—can be held like a pencil. Only 9½ins. long with efficient radiation for hand comfort. 230/250 v., 45 watts (bit temperature over 300 deg. C.); with pointed pencil bit, 21/-. **RESIN-CORED SOLDER** (S.T.C.) 40 per cent. tin, on 1 lb. reels, 4/8. **PYROBIT**, **NEON TESTERS** (New Safety Model) with screw-driver, 100/500 volts A.C./D.C., 9/6. **TRANSFORMER BOBBINS**, solving the re-wind problem. Standard for many sets, H.M.V., Marconi, Eye, Lissen, etc. Prim. tapped 200/250 v. Secs. :- 350-0-350 v. 75 m.a., 4 v. 3 a., 4 v. 4 a., core opening 1½in. sq. and 1½in. through, 18/6. Also with 6.3 v. 4 a., 5 v. 3 a., same price.

ROTHEMEL-BRUSH PIEZO-CRYSTAL MICROPHONES. We regret that owing to enemy action there is a delay in the satisfaction of orders for the 42/- model recently advertised. We have in stock a few of the special D.104 model, with knuckle-joint, angle adjustment, at 75/- each. Floor Stands, chrom., collapsible, 46/8. Chrom. ext. Table Stands, 25/-.

SCREENED FLEX, multi-strand, best quality single-pole, six-yard lengths, 4/8. **CABINET M/COIL SPEAKERS** (by prominent maker). 10-inch 10-watt P.M. Unit in massive polished oak cabinet, fitted multi-transformer. Cabinet size—16in. by 14½in. by 9in., £8.10.0 (we cannot despatch).

TOGGLE PRESSSES, **FUZZY WIRE JOINTERS** in stock—See previous adverts. Please include sufficient for packing/postage.

M.R. SUPPLIES, 68, New Oxford Street, London, W.O.1
(Telephone: MUSEUM 2958)

Remember-Walter

LTD.

RADIO STAMPINGS • RADIO CHASSIS • RADIO PRESSINGS

FARM LANE, FULHAM, S.W.6. TELEPHONE: FULHAM 5234

C.R.C.1

"The Voice of the Service"

SIGNALLING EQUIPMENT

LTD.

Manufacturers of

Small Transformers, Heavy Duty Resistances, Plugs and Sockets, Fuse Holders, Electric Bells, Buzzers, and Switches. Also Plastic Mouldings, Coil Windings, Light Pressings, Turned Parts, and other components and accessories for the Wireless and Electrical Trades

Merit House, Southgate Road, Potters Bar
Phone: Potters Bar 3133. Telegrams & Cables: Sel, Potters Bar



GR ADVERTISEMENT OF THE TELEGRAPH CONDENSER CO., LTD.

WEBB'S *Radio*

SHORT WAVE CONDENSERS

Wavemaster Ceramic Insulation Tuning Condenser, .0001, .00016 - - - -	5/-
Wavemaster Ceramic Insulation Reaction Condenser - - - - -	5/-
Eddystone Cat. No. 1068 Ultra H.F. Split Stator Condenser Capacity as Series gap : Minimum 3 m.mfd., maximum 20 m.mfd. Each section Minimum 5 m.mfd., maximum 40 m.mfd. - - - - -	7/6

MORSE PRACTICE

Metal U.S.A. Pattern Speed Key - - -	4/6
G.P.O. Bar type on Wooden Base - - -	8/6
G.P.O. Heavy duty operating type, polished brass lacquered, very fine balance -	£1/8/6

DIALS

Telsen Slow Motion Dial, Panel Mounting, escutcheon type - - - - -	2/-
Johnson Handle Indicator, complete handle and scale, suitable for instrument or transmitter use—	
4in. type - - - - -	4/-
6in. type - - - - -	5/6

CERAMICS

We carry comprehensive stocks of ceramic material.

Formers from 1in. long by $\frac{1}{2}$ in. diameter, in varied sizes and types up to 12in. by 3in. diameter.

Stand-off Insulators from $\frac{3}{4}$ in. height up to 5in. height.

Aerial Feeder Spreaders, 4in. and 6in.

Lead Through Insulators, from $1\frac{1}{2}$ in. to 3in.

Aerial Insulators, 3in. and 6in.

14 Soho Street, Oxford Street,
London, W.1

Telephone: Gerrard 2089

We are available 9 a.m. till 6 p.m. for OFFICIAL business, but please note our SHOP HOURS—10 a.m. to 4 p.m. (Saturdays 10 a.m. to 12 noon.)

Listen to this...



The Egyptian Pan—a simple enough instrument to look at, but in the hands of an expert produces really "hot" music working listeners into a frenzy... here, Benny Goodman's counterpart looks as if he is trying!

AND ON THE FACTORY FRONT

Trix
TRIX
Quality SOUND Equipment

AVAILABLE FOR PRIORITY ORDERS. SEND FOR DETAILS

The TRIX ELECTRICAL CO., LTD. New Address:
1-3, MAPLE PLACE, TOTTENHAM CT. RD., LONDON, W.1.
Tel: MUSEum 5817. *Grams & Cables: TRIXADIO, WESDO, LONDON.

SIMPLIFIED DIODES

SMALL IN SIZE, BUT OF GREAT
MECHANICAL STRENGTH AND HIGH
EFFICIENCY



WESTINGHOUSE

WESTECTORS

are miniature Westinghouse Metal Rectifiers suitable for use up to 1500 kC. They possess all the inherent advantages of the larger types and require very simple circuits as they have no heater, cathode or anode.

WESTINGHOUSE BRAKE & SIGNAL CO. LTD.
Pew Hill House, Chippenham, Wilts.

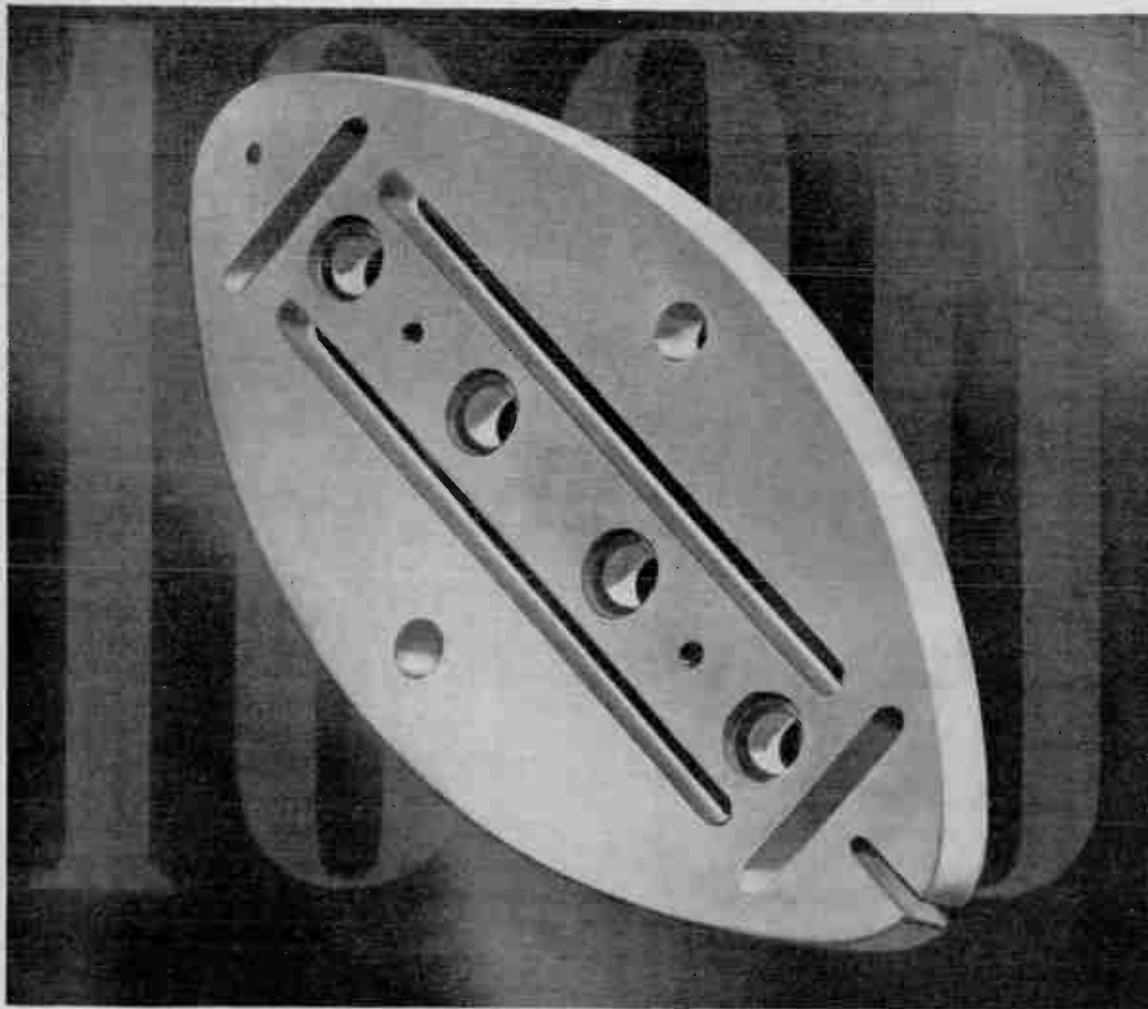

one in a thousand

Ten years ago we introduced the first British-made low-loss ceramic. To-day the range of FREQUENTITE components covers more than a thousand pieces of every shape and size.

With such a store of manufacturing experience we are able to offer advice backed by practical knowledge on your insulation problem. Please consult us before you finalize your design.



STEATITE & PORCELAIN PRODUCTS LTD.

Head Office: Stourport-on-Severn, Worcs.

Telephone: Stourport 111.

Telegrams: Steatain, Stourport.

SP.26

The story behind the scale

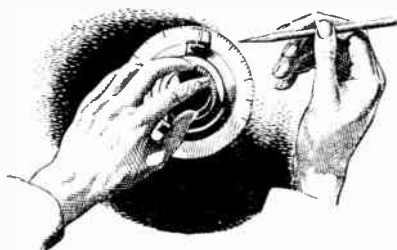

★ How precise itself must be the means of measuring precision! In Radio the means implies Marconi instruments, of many types specifically designed to measure precise performance in communication equipments.

The last graduation on a calibrated dial is the finishing touch to a Marconi instrument; a meticulous operation, but not more so than the many preceding it. For behind this work—back to the very birth of wireless communication—is a tradition of skill and workmanship.

The complete answers to questions of measurement are found entirely within the Marconi organisation. That is why such a diversity of instruments is produced to meet many and increasing requirements. Our activities are centred around this specialised work—perhaps already we have anticipated *your* particular problem.

MARCONI Instruments Ltd

ELECTRA HOUSE, VICTORIA EMBANKMENT, LONDON, W.C.2

*Audio Amplifiers
and Sub-assemblies
to critical standards*



In addition to Standard Amplifiers the activities of Acoustical include Special Amplifiers for Industrial Applications, Microphones, Transformers, Coil Winding, Sheet Metal Work, Stampings, Switch Assemblies, etc.



ACOUSTICAL
MANUFACTURING Co. LTD.
HUNTINGDON - TEL: 361

ROGERS

Postwar industry will be making wider use of industrial electronic technique developed during recent years. In this work Rogers Radio Tubes—the tubes which opened the way to all-mains wireless—have played and will play a recognised part. Rogers with an established reputation for quality, produce all standard types of radio receiving tubes, power tubes for radio transmission, audio frequency amplification and industrial electronic applications generally. At present engaged solely on official work, they look forward to future co-operation over a wide field of industry.

ROGERS RADIO TUBES LTD.

TORONTO (ONTARIO) CANADA

A subsidiary of BROADCAST RELAY SERVICE LIMITED.
VICTORIA STATION HOUSE, VICTORIA ST, LONDON, S.W.1

Callenders

RADIO FREQUENCY CABLES

one of our aids to
Victory



We are specialists in the design, production and testing of all types of low loss and low capacity cables for use at high frequencies. We shall be pleased to make available the accumulated experience of our research and technical organizations in connection with special radio frequency cable problems directly related to the national effort.

CALLENDER'S CABLE & CONSTRUCTION CO. LTD., HAMILTON HOUSE, VICTORIA EMBANKMENT, LONDON, E.C.4

All over the World

SERVICE ENGINEERS REPAIRING DOMESTIC RADIO

may now use **ERSIN MULTICORE**

THE SOLDER WIRE WITH 3 CORES
OF NON-CORROSIVE ERSIN FLUX

● Ersin Multicore — the A.I.D. approved solder wire containing three cores of active non-corrosive Ersin flux—has been adopted by the leading makers of radio and electrical apparatus in preference to other forms of solder because it provides speedy and efficient soldering with complete immunity from corrosive or dry joints.

● Service engineers can now enjoy the advantages of Ersin Multicore Solder. Supplies are obtainable from leading radio and electrical factors.

● Insist on Multicore, and if you do not receive supplies promptly write to Multicore Solders Ltd., giving name and address of usual factor. Firms engaged upon Government Contracts are invited to write for free technical information and samples.



MULTICORE SOLDERS LTD. COMMONWEALTH HOUSE NEW OXFORD ST. LONDON, W.C.1. Tel: CHAncery 5171/2

SPRAGUE

TYPE PX-25, "VITAMIN Q"



HIGH VOLTAGE PAPER CONDENSERS

to Stand 5,000 to 15,000 Volts at 110° C.

Typical of other Sprague Condensers now setting new standards on war jobs, these Type PX-25 units, with exclusive "Vitamin Q" impregnant, have proved their dependability under the most rigorous conditions. Voltages run from 5,000 to 15,000 volts and ambient temperatures are on the order of 110° C. Used at low and ordinary temperatures, these Sprague Condensers give a greatly increased margin over ordinary commercial types.

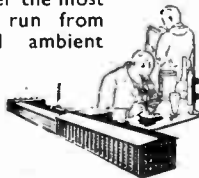

*TRADE MARK REGISTERED

SPRAGUE SPECIALTIES COMPANY

North Adams, Mass., U.S.A.
103, Grove End Gardens, London, N.W.8.

BASICALLY BETTER...



Air-Insulation ...

is the basic principle of
CO-AX LOW LOSS CABLES
Unequalled H.F. Properties

There is a CO-AX Cable for every H.F. Purpose

TRANSRADIO LTD. Inc. TELE-EQUIPMENT 0-16 HIGHWAY BEACONSFIELD

P.A. AMPLIFIERS

LIMITED QUANTITY ONLY.

Output 15 watts, 6 valves, 200-250 A.C. Pre-Amplifier for microphone, gramophone and radio terminals. Multi-range output, 2.5 ohms to 15 ohms. Fitted two volume controls and tone control. In metal cabinet as illustrated.

Price **£18.10.0** Carr. paid

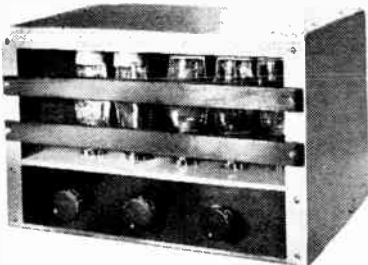

POLARISED DOUBLE-ACTING RELAYS

These are telephone type Relays with polarised differential movement. Two 500-ohm windings. Large diameter contacts. A typical example of first-class workmanship. As illustrated **17/6**

ELECTRO-MAGNETIC RELAYS. Brand new surplus stock, make and break units to operate on 1½ v. at 15 m.a.; to clear stock **5/9**

OAK SWITCHES

2½in. spindle, complete with knob. 4-way, 2-bank with connecting block, **4/-**
4-way, 2-bk., **3/3**



For Yaxley type wave-change and other switches, see March advt.

EXTENSION SPEAKERS. Brand new, first-class P.M., in beautifully polished cabinets, 52/6. In Rexine covered cabinets, 50/-.

PLATINUM CONTACTS

Double Spring, mounted on ebonite, **1/6**



LOUDSPEAKERS. Rola 10in. P.M., 35/-; Celestion 8in., with transformer, 29/6. Goodmans P.M. without transformers: 5in., 21/-; 8in., 30/-; 10in., 47/6. Post & pack, 1/6 each extra.

MAINS TRANSFORMERS
A special line of newly manufactured British transformers. 300.0-300 v. at 80 m.a., 6.3 v. 2a., 5v. 2a size **37/6**



Post & pack, 1/3 extra.

MANSBRIDGE Type Metal-Cased CONDENSERS 350V. WORKING

2 mfd., 4 × 1½ × 2in. **4/6**
2 mfd., 4 × 1 × 1½in. **2/6**
2 mfd., 2½ × 1 × 1½in. **2/6**
.02 mfd. Size 4½ × ½ × 1½in. **1/6**
.2 + .2 mfd. Size 2½ × ½ × 2in. **2/6**
Also 250 mfd., 25 v., in Bakelite case **2/6**
500-v. wkg. 2 mfd., 2½ × 2 × ½in. **5/6**

PENTODE OUTPUT TRANSFORMERS

Well-made and efficient. Suitable for Small Speakers.

7/-

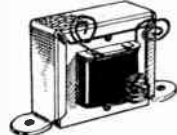

MANUFACTURERS' STOCK :

HEAVY DUTY MAINS TRANSFORMERS
Input 200-250 v. A.C., 350-0-350 v. 120 m.a., 4 v. 2 a., 4 v. 3 a., 6.3 v. 4a. **33/6**
Weight 11 lbs.

★ We regret slight delay in dispatch of goods owing to staff shortage.

LONDON CENTRAL RADIO STORES

23, LISLE STREET, 'Phone: GERrard 2969 LONDON, W.C.2

LONDON CENTRAL RADIO

Miscellaneous Offers!

CHASSIS drilled for 4 valves only. 10½ × 7½ × 3in. (ends and sides). Grey finish, 5/-.

CONDENSERS. First-class 0.1 mfd., oil-filled, 5,000 v., working, only 11/6 each.

TWIN SCREENED PICK-UP LEADS, fitted 2 plugs, 8ft. 6in. long, 2/8.

ELECTRO-MAGNETIC COUNTERS. Ex-G.P.O. every one perfect, electro-magnetic, 500 ohm coil, counting to 9,999, operated from 25 v.-50 v. D.C., many industrial and domestic applications, 0/-.

SCANNING AND DEFLECTOR COILS. Ex-television receivers, assembled complete in metal frame, 7/6.

ELECTRIC SOLDERING IRONS. 200-250 v., 65/75 w., 12/6.

2-GANG SUPERHET VARIABLE CONDENSERS, 0.005 mfd., with trimmers, 10/6.

BRASS ROD. Screwed brass rod, 2 B.A., 4 B.A., and 6 B.A., 12in. lengths, useful for many purposes, 5/6 doz. lengths.

VALVE-HOLDERS, all brand new, Mazda octal, 1/-.

VALVE-HOLDERS. Paxolin, 7- and 9-pin, 7d. each, 6/- doz.

VITREOUS ENAMELLED RESISTANCES, 10,000 ohm, 10 w., 3/6.

ELECTRIC RAZOR RESISTANCES, universal input, in strong metal case, 10/- each.

REACTION CONDENSERS. Fine quality job, 0.0003 mfd., to clear at 2/3 each.

TUBULARS. Wire-end tubular condensers, 0.1 and 0.01 mfd., 400 v. working, 1/-.

COSSOR 0.025 CONDENSERS, 8,000 v., 7/6.

METAL-CASED CONDENSERS, 0.03 mfd., 500 v., 1/3.

T.C.C. TUBULAR CONDENSERS, 0.1 mfd., 6,000 v. D.C. test, 8/9; 0.04 mfd., 350 v., 2/-.

T.C.C. CONDENSERS in metal cases, special offer, much reduced to clear, 4 × 4 mfd., 70 v. working, 2/6 each.

EX-GOVT. PLUGS AND JACKS, as previously advertised, 5/9.

EX-G.P.O. PLUGS, 1/9.

METAL SCREENED ANODE VALVE-CAPS, with short screened lead, 9d.

RED BAKELITE ANODE CAPS, 1/-.

HEAVY METAL SCREENED CABLE. Single, 1/-.

Twin, 1/6 per yd.

TRIMMERS. Postage stamp 40 PF., 6d. Twin 40 + 40 PF., 1/-.

PHILIPS POTENTIOMETERS. 100,000 ohm. With switch, 4/6.

CARBON POTENTIOMETERS, 50,000 ohm, 5/6.

DIAL LAMPS. Philips' screw type dial lamps for dial illumination, 15 watt, 1/9 each.

SPEECH COIL RIBBON WIRE, enamelled copper, gauge approx. 20 thou. by 5½ thou., 3/3 per lb. reel; also 23 s.w.g. d.c.c. wire, 100 yd. coils, 5/6.

FLEXIBLE DRIVES. Ideal for remote control in radiograms, etc., approx. 2ft. lengths, 4/3.

VALVES. EA50, Mullards, to clear, 10/6 each.

PUSH-BUTTON UNITS. 8-switch unit (no coils), 4/6 each; 12-switch unit (no coils or switches), 2/6 each.

CERAMIC VALVE-HOLDERS, brand new, low loss, 7-pin, 1/5 each.



GRAMPIAN

'SOUND IN SOUND'

- ★ SPEAKERS
- ★ AMPLIFIERS
- ★ MICROPHONES

• WHEN HAPPY DAYS ARE HERE AGAIN



GRAMPIAN REPRODUCERS LTD. HAMPTON ROAD, HANWORTH, MIDDLESEX.

Telephone: FELtham 2657-3

Ensure the most successful results



● USE ●

B.I.
CONDENSERS

BRITISH INSULATED CABLES LTD.
Head Office: PRESCOT, LANC'S Telephone: PRESCOT 451.

Miniature BRUSH
Crystal
PRODUCTS *Earphones*

TYPE DJE

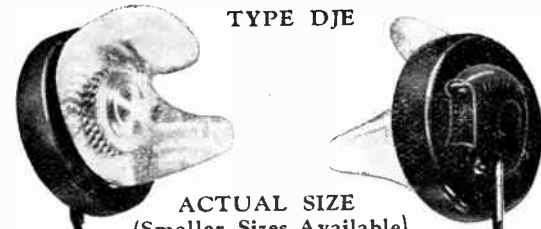

ACTUAL SIZE
(Smaller Sizes Available)

PHENOMENAL POWER SENSITIVITY
● 1 dyne per sq. cm. per 1 micro volt amp.

WEIGHS ONLY 7 GRAMMES
● Range of standard detachable mouldings

FITS INTO EAR CANAL
● Eliminates interfering sounds

EXCEPTIONALLY SMALL SIZE
● Inconspicuous and easy to wear

IDEAL FOR PORTABLE RADIO SETS

Sole Manufacturers
THE BRUSH DEVELOPMENT COMPANY
CLEVELAND, OHIO
PROMPT DELIVERIES AGAINST GOOD PRIORITIES
write for details to
ELECTRONIC ENGINEERING SERVICES LTD.
BRITISH DISTRIBUTORS

24, STANLEY ROAD, HEATON MOOR
STOCKPORT
TELEPHONE: HEATONMOOR 3107

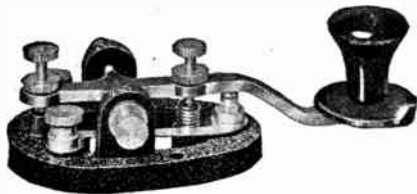

"RIGHT ON TOP"

With this Raymart "Speed" Key which combines all that is best in British and American key design, you can, because of its extreme lightness of action and rigidity of construction, keep "right on top" of your transmitting. The key is fitted with heavy silver contacts.

The Wireless World test report confirms that it is "suitable for serious work."

Price
Post
Paid **8/6**

A good companion for Morse practice, is the Raymart High Note Buzzer. Price 2/- (Postage 3d.). For further details see our advertisement on Page 10 of the March issue.

RAYMART
CRAFT A CREED

48, HOLLOWAY HEAD,
BIRMINGHAM, I.

Telephone: Midland 3254



is sure to be tough going —but the result will be decisive — we've prepared for it right down to the last detail. Masteradio electrical equipment will be in it on land, sea and air operations



Masteradio
VIBRATORPACKS

As supplied to the WAR OFFICE, AIR MINISTRY,
POST OFFICE and other GOVERNMENT DEPARTMENTS

MASTERADIO LTD · VIBRANT WORKS · WATFORD HERTS

LINAGLOW LIMITED

RADIO CHASSIS. 18-gauge steel, cellulosed grey, fitted 4 octal valve holders, grommets, with 20 colour coded resistors. Dimensions: 11 x 7 1/2 x 1 1/2. Also similar but fitted mains socket and three 4-pin valveholders, grommets, drilled ready to take transformers, chokes, etc. Dimensions: 14 x 10 1/2 x 1 1/2.

VALVE HOLDERS—AMPHENOL TYPE. International or Mazda Octal, chassis mounting, 1/-.

TUBULAR STEEL FRAMES. Cadmium plated for radio chassis mounting and many other purposes, drilled ready for use—18in. high x 14in. wide, very useful for swivel frame in Radio Laboratory, 7/6 the pair.

SUPERIOR QUALITY KNOBS, ex television, suitable for radio. For 1/4 in. spindles with grub screw. 1 1/2in., 1/9; 1in., 1/3; 3/4in., 9d.

TUBULAR PAPER CONDENSERS. 350-500 v., D.C. working, .0001, .0003 mfd., 4/- doz.; .001, .004 mfd., 8/- doz.; .01 mfd., 7/- doz.; .05 mfd., 9/- doz.; 1 mfd., 12/- doz.; 2 1/2, 3 mfd., 15/- doz.; or assorted parcel of 50 for 27/6. Minimum orders, 1 doz. any type.

SILVER MICA CONDENSERS. Flat wire-end. Assorted values, 17/6 per 100.

UNIVERSAL RAZOR RESISTANCE. Suitable for practically every type of electric Razor, drops voltage from 200/250 to 100 110 v. Supplied in safety metal cage with asbestos lining. Specification: 1,500 ohms with adjustable slider, 10/6.

LINE CORDS. 2-way 360 ohms, 8/6; 480 ohms, 11/-; 600 ohms, 13/9; 3-way heavy duty 3 amp., 360 ohms, 13/6; 480 ohms, 17/6; 600 ohms, 21/-.

3 1/2in. GOODMAN P.M. LOUDSPEAKER. Extra heavy magnet for Midgets and communication sets, 30/-.

VOLUME CONTROLS. 1,000, 5,000, 10,000, 20,000, 25,000, 50,000, 100,000-ohm; 1/2, 1 and 2 megohm, without switch, 4/9 each. As above, with switch, 6/9. 1/2 megohm Double Pole Switch, Best American, 7/6. **WIRE WOUND,** Best American, New ex television, 2,000 and 10,000 ohms, 5/- each.

WIRE END CARBON RESISTORS. New, ex television chassis, 1/2, 1 and 2-watt. Assorted parcel of 100, 35/-.

CABINET STAYS SELF-LOCKING, best Bronze finish, 5/- each.

3-gang .0003 VARIABLE CONDENSERS, with geared slow-motion ball drive, pointer and dial frame. Ceramic insulation, 14/6.

12in. AUDITORIUM P.M. LOUDSPEAKER CHASSIS. Ticonal magnet, 10 ohms, 12/15 watts. Exceptionally sturdy construction, 27.15.6 each.

P.A. AMPLIFIERS

Suitable for Factory Installation

— Immediate Delivery —

30-WATT P.A. AMPLIFIER. A high quality Amplifier, using finest components and Red "E" Valves. Circuit: High Resistance input feed through separate input sockets or through pre-amplifier socket into two series connected valves with tone and volume control followed by twin valve acting as Amplifier and Phase Inverter, feeding into two High Wattage Output Pentodes connected in negative feed back. Class A B Circuit: 200/240 volts A.C. Chassis, finished in dark grey. 16-gauge steel. Brand new pre-war manufacture. Amplifier is fitted with Multi-Ratio output Transformer to take from one to forty-four 5,000 ohm speakers, also 15 ohm speaker and 600 ohm line. Separate Standby Switch. Amplifier with valves suitable for gram. **£35 10 0** microphone and radio inputs. Price

PORTABLE P.A. AMPLIFIER. Specification: 4-valve Amplifier Unit in metal cage, microphone, one speaker, all cables, contained all in one cabinet and collapsible type tripod floor stand, AC/DC 200/250 v. 5 watt maximum, suitable for hall averaging 600 people. Input jack provided, transverse current carbon type microphone, separate volume controls for microphone and gramophone input. Variable tone control. **29 Gns.**

PORTABLE P.A. AMPLIFIER. Specification: 5-valve Amplifier Unit, 2 speakers, microphone, all cables, all in one cabinet and collapsible type tripod floor stand, AC/DC 200/250 v., 8/10 watts, suitable for hall averaging 600 people. Input jack provided, ribbon type microphone chromium plated, separate volume controls for microphone, gramophone input. Variable tone control. **39 Gns.**

MICROPHONES. De Luxe Piezo Crystal microphones in chromium case. Specification: 60 D.B. below 1 volt. Frequency response 30/8,000 C.P.S. **6 Gns.**
As above—Standard model in bakelite case **3 Gns.**
2-tier Stands for above, 25/-.

SCREENED INTERLACED FLEXIBLE MICROPHONE CABLE. Single. Special Offer, 9d. per yd. Twin 1/3 per yd.

SCREENED MICROPHONE LEAD, fitted four Wander Plugs, 3/6.

VALVES

AMERICAN TYPES AT B.O.T. CONTROLLED RETAIL PRICES. FOR REPLACEMENT PURPOSES ONLY.
1H5, 12B7, 12B7B, 9/2; 1A5, 1C5, 5Y3, 25Z6, 35Z4, 11/-; 6Q7, 12Q7, 11/7; 6F5, 6K7, 128K7, 25L6, 12J7, 35L6, 12/10; 6A8, 6B8, 6K8, 6SA7, 12SA7, 14/-; 70L7, 83, 15/3.

Also British Valves at Manufacturers' List Prices. AC/ME, 10/6; UU4, UG, UU7, 11/-; HL41DD, TD14, 11/7; AC/VP2, CL4, EP39, KTW61, Pen 45, SP41, SP42, T41, VP41, 12/10; D1 Diode lin. Penaut Valve with valve holder, 12/10; ECH3, FC13, X63, 14/-; AC6Pen* EL35, Pen 46* U21, 18/3.

* Post Office Permit necessary.

All prices include Purchase Tax. Add 3d. per valve postage.

6 ASSORTED VOLUME AND TONE CONTROLS, with and without switch, 19/6.

L.F. SMOOTHING CHOKES. Finest quality, 20, 40 and 60 henrys, 150 m.a., 18/9 each.

SWITCHES. DPDT panel mounting. P.O. type, 2/6. D.P. 4-point push-pull, 9d.

SPECIAL HEAVY DUTY RESISTORS. 5-watt for bias etc., all values from 25 to 2,000 ohm, 1/9 each. Similar to above, but 10-watt, 2/3.

50-OHM CENTRE-TAPPED RESISTOR, tapped at 25 ohm, for pilot lamps, 2/-.

SPECIAL MULTI-LINE CORD RESISTOR. 5 tappings 50 ohm, 1 tapping 750 ohm, with slider, .2 amp., 8/6. 950 ohm .2 amp., Chassis mounting, heavy duty on porcelain former, 2 adjustable tappings, 8/6 each.

ALUMINIUM VALVE CAPS. Special price 6d.

HUMDINGERS. 25,000 and 50,000 ohms, 6d. each.

MULLARD & MAZDA CATHODE RAY TUBES

- 7 in. **£3 10 0** 9 in. **£4 18 0**
- HOLDER,** for above, complete with mounting base, scanning and focussing unit with coil **47/6**
- HIGH VOLTAGE TRANSFORMER,** for above, 200,250 v., 4,000 v., 2 v. 2 amp. **47/6**
- Line Scanning Output Transformer** **12/6**
- 0.1 T.C.C. 4,000 v.w. Condensers for above, Braud new. **8/6**
- RECTIFIERS FOR ABOVE,** UU4 at 11/-; U21 at 15/3
- Plywood Frame and Rubber Mount for Cathode Ray Tube,** also suitable for loudspeaker baffle, 7in. hole **7/6**

LOUDSPEAKER TRANSFORMERS. Push-Pull output tapped Primary and Secondary, 120 m.a., ratios 10:1, 5:1 and 3.5:1, 15/-; Multi-Ratio and Push-Pull transformer, ratios 30:1, 45:1, 60:1, 90:1 and P.P. class b, 75 m.a., 12/6. Heavy duty multi-ratio transformer, ratios 24:1, 41:1, 48:1, 55:1, 82:1, 116:1, 80 m.a., 15/6. Class "B" and Q.P.P., 75 m.a., 12/6.

MAINS TRANSFORMERS. 200/250, 350-0-350, 6.3 v. 3 amp., 5 v. 2 amp., 120 m.a. shrouded, 42/6; 300-0-300, 4 v. 2 amp., 4 v. 2 amp., 150 m.a., 42/-; 325-0-325, 4 v. 6 amp., 4 v. 2 amp., 2 v. 1.5 amp., 150 m.a., 45/-.

AUTO TRANSFORMERS. Step up or down 110/220/240 v., 100-watt, 35/-.

LOUDSPEAKERS. P.M. 3-ohm voice coil without transformer, 6in., 21/-; 8in., 25/6; 10in., 28/6. 10in. Mains Energised M.C. Speaker, 2,000 ohms field, 2.5 ohm speech coil, 32/6.

UNIVERSAL RESISTOR. Suitable for practically every type of American and British AC/DC Receiver. Supplied in safety cage with asbestos lining. Specification: 750 ohms, 3 amp., with four sliders for adjustable tappings, 12/6.

★ Send for details of AMERICAN MIDGET and CAR RADIO. ★

◆ **CALLERS** to Show Rooms, **61 HIGHGATE HIGH ST., N.6.**
Phone: MOUview 9432.

LINAGLOW LIMITED
HOURS OF BUSINESS 9 a.m. to 5.30 p.m.
Saturday, 9.30 a.m. to 12.30 p.m.

◆ **POST ORDERS** to Dept. M.O.14
3 HAMPSTEAD LANE, N.6.
CASH WITH ORDER ONLY.

WALTER SWITCHES ARE MADE FOR



WALTER INSTRUMENTS LTD.

Earls Court Exhibition Buildings, Earls Court, London, S.W.5
FULHAM 6192

C. R. Casson 7

It isn't . . . isn't what? Isn't a watt!

It's the c.g.s. unit of energy.

WHAT'S "ERG"?

ERG is the trade mark identifying a line of products that will be available when we've finished the biggest job of all.

ERG RESISTORS LTD.
1021a, FINCHLEY ROAD, LONDON, N.W.11
PHONE: SPEEDWELL 6967



B



JUST TO BE DIFFERENT

Every so often somebody sits on a pole for a fortnight. Or uses his nose to push a peanut up Pike's Peak. He hopes that novelty will bring him fame and fortune. What he gets is a brief and cheap notoriety: his 'stunt' is without purpose or value.

But, says someone, how about yourselves? Isn't a great part of Simmonds' success due to novelty? Simmonds Stop Nuts, Fram Filters, Simmonds Instruments and Controls— isn't each of them an example of industrial novelty? Don't Simmonds encourage and seek for industrial novelty?

The answer to all these questions is "Yes." If you think you have a novel idea for industrial use you'll find us ready listeners. But we shan't listen long if novelty is *all* you have to offer. To hold our interest, your idea must pass a simple but searching test: "Is a job done better, or more quickly, or more cheaply?" In short, the important thing about any Simmonds product is not that it is novel, but that it is *better*.



SIMMONDS DEVELOPMENT CORPORATION LIMITED

2-3 · NORFOLK STREET · LONDON · W.C.2

A COMPANY OF THE SIMMONDS GROUP

Finding
NEW and **BETTER**
ways

S I M M O N D S

LONDON · MELBOURNE · MONTREAL · PARIS · NEW YORK · LOS ANGELES

Wireless World

Radio • Electronics • Electro-Acoustics

34th YEAR OF PUBLICATION

APRIL 1944

Proprietors :
ILIFFE & SONS LTD.

Managing Editor :
HUGH S. POCOCK,
M.I.E.E.

Editor :
H. F. SMITH.

Editorial, Advertising
and Publishing Offices:

DORSET HOUSE,
STAMFORD STREET,
LONDON, S.E.1.

Telephone :
Waterloo 3333 (35 lines).
Telegrams :
"Ethaworld, Sedist, London."



PUBLISHED
MONTHLY

Price : 1/6

(Publication date 25th
of preceding month)

Subscription Rate :
Home and Abroad
20/- per annum.

COMMENTS OF THE MONTH	97
FREQUENCIES FOR TELEVISION	98
MORSE BY PULSES.	
By R. C. Whitehead	102
ARMY'S MOBILE STATION	106
CATHODE FOLLOWER OUTPUT STAGE.	
By C. J. Mitchell, A.M.I.E.E.	108
RADIO HEATING EQUIPMENT.	
By L. L. Langton, A.M.I.E.E.	111
FUTURE OF SOUND RECORDING	114
MORE TELEVISION PROPOSALS	116
LETTERS TO THE EDITOR	118
WORLD OF WIRELESS	120
NEWS IN ENGLISH FROM ABROAD	122
RANDOM RADIATIONS. By "Diallist" ..	123
BOOK REVIEWS	124
RECENT INVENTIONS	126
UNBIASED. By Free Grid	128

Branch Offices :

COVENTRY :
8-10, Corporation Street,
Telephone : Coventry 5210.
Telegrams :
"Autocar, Coventry."

BIRMINGHAM :
Guildhall Buildings,
Navigation Street, 2.
Telephone :
Midland 2971 (5 lines).
Telegrams :
"Autopress, Birmingham."

MANCHESTER :
260, Deansgate, 3.
Telephone :
Blackfriars 4412 (4 lines).
Telegrams :
"Iliffe, Manchester."

GLASGOW :
26B, Renfield Street, C.2.
Telephone : Central 4857.
Telegrams : "Iliffe, Glasgow."



As many of the circuits and apparatus described in these pages are covered by patents, readers are advised, before making use of them, to satisfy themselves that they would not be infringing patents.

Miniature I.F. Transformers

DESIGNED FOR MAXIMUM
GAIN AND SELECTIVITY IN
THE SMALLEST DIMENSIONS

The coils are contained in enclosed pot-type iron dust cores, tuning adjustments being obtained by means of adjustable iron dust centre cores.

Fixed tuning condensers are contained inside the screening can.

The following frequencies are preferred standards but others are available for particular applications :—

M.400 - - 460 Kc/s. M.405 - - 1.6 Mc/s.
M.411 - - 2.1 Mc/s. M.415 - - 4.86 Mc/s.
 M.418 - - 9.72 Mc/s.

Wartime restrictions prevent our accepting orders other than those covered by priority numbers.

The illustration shows the actual size of the Unit which is provided with one hole fixing, the terminal wires being fed through insulated bushings which, in turn, prevent movement of the transformer when mounted in position.

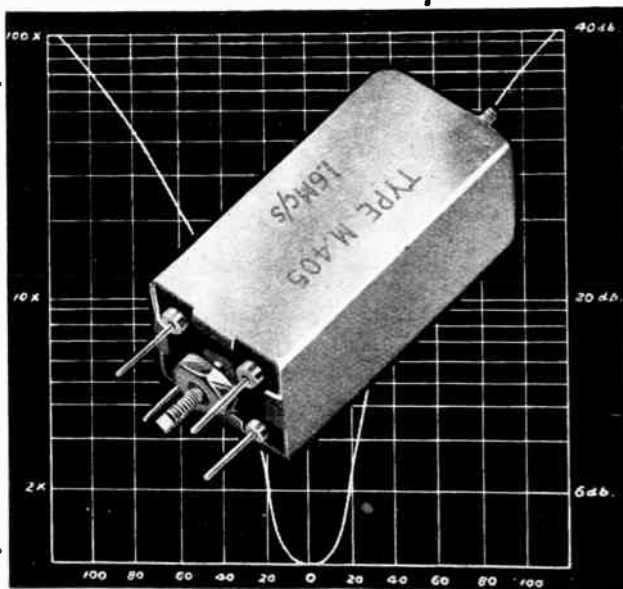

WRIGHT & WEAIRE LTD.

HIGH ROAD, TOTTENHAM, N.17.

Telephone : TOTtenham 3847-8-9.

*Over twenty years of
experience and research
are behind the advanced
technique of today...*



MULLARD
THE MASTER VALVE
A Valve for Every Purpose

DOMESTIC · COMMERCIAL · INDUSTRIAL · SCIENTIFIC · MEDICAL · EXPERIMENTAL

THE MULLARD WIRELESS SERVICE CO. LTD., CENTURY HOUSE, SHAFTESBURY AVENUE, LONDON, W.C.2. (77 rev.)

Wireless World

Radio • Electronics • Electro-Acoustics

Vol. L. No. 4

APRIL 1944

Price 1s. 6d

Comments of the Month

The Television Standards Controversy

IT is almost unanimously agreed in wireless circles that a special effort should be made to restart television with the least possible delay when the war ends. The subject has aroused widespread interest, but so far there is nothing approaching agreement as to the standards of definition that should be adopted for the service. Broadly speaking, there are three schools of thought on this problem. First, we have those who maintain that the surest way of avoiding delay is to revert to the well-tried standards of 1939. Secondly, there are those who advocate an appreciable but not drastic increase in definition—generally with the proviso that it should be sufficiently high to make the line structure of the picture invisible at optimum viewing distance. Lastly come the advocates of a “final” system of extremely high definition, with colour reproduction, if not an immediate target, as a development of the very near future.

If the only way to avoid a long and indefinite delay was to return to the pre-war system, we should still regard that as the best plan. But those who advocate the middle course, with definitions of something in the order of 600 lines, put forward very attractive arguments as to why their proposals should involve no great delays. Though there is not complete agreement as to the precise standard, it is contended that a virtually “line-free” picture can be obtained with a system that does not involve radical departures from well-tried technique either in transmission or—equally important—in the manufacture of receivers.

Very high definitions or colour systems involve so many uncertain factors that their development into a practical service is likely to need much time, even if no unexpected difficulties are encountered. Such systems would involve much higher carrier frequencies, which, as pointed out elsewhere in this issue, are likely to introduce reflection troubles. That particular problem could only be investigated fully by large-scale “field” tests carried out under practical conditions. Another argument put forward against systems involving very high carrier frequencies is that the receivers would be more

costly and thus the spread of television would be to some extent restricted and retarded.

Radio Heating.—This application of transmitter practice may well become one of the major offshoots of wireless, and while it is still in its development stage it would be well to consider the question of interference. It has been said that some suggested designs of RF heating generators might have been evolved with no other object than to interfere with wireless reception!

The problem is by no means simple, and it seems unlikely that it can be satisfactorily solved by the straightforward expedient of allocating bands of frequencies for radio heating. Probably no one yet knows exactly what frequencies are best suited to the various operations, but it is highly improbable that all desirable frequencies will be available. Even if they were, the frequency “drift” of a typical equipment during certain heating operations is so considerable that an impossibly wide band would be required. Failing exclusive operating frequencies, the only alternative is thorough screening of the generator and the “work.”

All those who undertake the design, installation and operation of radio heating gear will, we hope, realise their responsibility for taking all precautions against causing interference. Unless they do so, vexatious and hampering—perhaps crippling—legislation is likely to be introduced.

Public Relations.—The future of wireless in all its branches must ultimately depend in some measure on the extent to which the general public is interested in, and informed on, its applications and developments. Fortunately, wireless is always “news” to Fleet Street, but the industry as a body has been surprisingly backward in taking advantage of this fact. We know that the lay Press finds great difficulty in gathering authoritative information even on purely commercial radio matters, and are glad to hear that the Public Relations Committee of the R.M.A. has now begun to remedy this deficiency.

FREQUENCIES FOR TELEVISION

Factors Affecting the Choice of Carrier

IN recent issues of *Wireless World* there has been some discussion concerning the re-establishment of a television service in this country after the war, and this matter has lately been the subject of debate in other quarters as well. A very important point is the choice of a frequency, or range of frequencies, upon which the television service is to be operated. This involves some consideration of the factors affecting wave propagation at different frequencies; as this is a subject not without interest to the radio student we may, while avoiding the deeper and more mathematical side of the problem, go into it in some detail. Of course, when it comes to the actual allocation of frequencies for the television service there may be many matters—political, economic, even of expediency—that may well outweigh the technical considerations, but we shall, in this article, resolutely refrain from any discussion of them.

Long- or Short-Range Television?—In the first place, because of the large band-width required by a television transmitter, and the impossibility of finding room for it on the lower frequencies, there would seem to be no question—even if there were no other reasons—that the right place for such a transmitter to work is on the ultra-high frequencies. Years ago this appeared to be a regrettable fact, because it was then generally supposed that the range of such a transmitter would be limited to the optical horizon. But it was soon shown that the effects of diffraction and of tropospheric (not ionospheric) refraction were such as to extend the service area of an ultra-high-frequency transmitter to quite economic limits. But precisely where, in the range of ultra high frequencies, should the television service be operated?

We had better pause, before going any farther, to decide what sort of a service—in point of range—our projected television stations should give. To consider the ques-

tion broadly—do we visualise a *long-distance* television service, using the ionosphere as a transmission medium, or do we rule this out and consider the service area of a station to be relatively “local”? We must decide upon the latter alternative, not because a long-distance service will necessarily always be an impossibility, but because, owing to the relative instability of the ionosphere as a transmission medium, present-day technique would not suffice to overcome the resulting distortion to the received picture. Past experiments have shown that selective fading such as is produced by the ionosphere causes the contrast of the received picture to change very markedly, while the existence of a number of different ionospheric paths for the different rays comprising the received signal results in repetition, not only of the subject matter of the picture, but also of the synchronising pulses, so that it is impossible to obtain a steady picture.

So we shall, in this article, discard altogether the idea of using the ionosphere for the propagation of the television waves, and visualise only “local service” transmitters. In other words, the service area of a station will be fed only by waves which reach the receivers *directly*—allowing for the effects of diffraction and of refraction in the troposphere. We will return to this subject later.

First Considerations. — If we wish to confine the service area of our television transmitter to a “local” region it is important that we work on frequencies which are above the MUF of the regular ionosphere layers at every season and time of day, and at every epoch of the sunspot cycle. It might seem that we could suppress the upward-going radiation and send our wave out only along the earth’s surface, but we must remember that a wave taking off at a very small angle to the horizontal can reach the ionosphere and be returned to earth at a distant point. If we attempted to

avoid this we should probably ruin reception within the true service area. If, however, we work only on frequencies which will always be too high to be refracted by the ionosphere layers, we shall avoid the possibility of our signals reaching to long distances and giving rise to interference with distant local transmissions of television on the same channel. The frequencies in use for the pre-war British television service were not, it seems, quite high enough to do this, for during the winters of 1936-37, 1937-38 and 1938-39, the signals were received fairly consistently at Riverhead, N.J., and at several other places in the U.S.A. And it is pretty certain that they got there by being refracted in the regular F_2 ionosphere layer—travelling across the Atlantic in two hops. The years in question were, it is true, near the time of maximum sunspot activity, and such high frequencies would not be refracted in the F_2 layer now. But we may expect another sunspot maximum in about five or six years’ time, and, in planning for television services on an international basis one must look ahead for more than six years.

It was not, as a matter of fact, a very regrettable occurrence that the television signals reached the U.S.A. as they did—it made a very interesting and informative experiment, and one from which we should now learn. But the situation is likely to be different in the post-war years. Great Britain will not then be the only country to have a television service in regular operation, as she was before the war, and we ourselves shall presumably not confine ourselves to transmissions from a single television transmitter. The ultra-high frequencies will be put to use by a large number of television stations—and also by other services—in a large number of different countries, so it will be essential to arrange that the frequencies used are such as will confine the radiated signals strictly to the service area of each station, so far as this is regularly possible.

What, then, are the highest frequencies likely to be subject to ionospheric refraction at any time during the sunspot cycle? If we know this we shall have made the first step towards the location of the ideal frequency bands for television. Well, they will obviously vary greatly with latitude, because the ionisation of the upper air is not uniform over the earth's surface, but increases towards the low latitudes, where the sun is more directly overhead. But let us make the assumption that the highest frequencies capable of being refracted at a middle latitude in the Northern Hemisphere will indicate roughly the low limit to the television frequency bands suitable for use in the whole of Europe and in the greater part of North America and Northern Asia. This assumption will not be very far wrong. There is one other point to be borne in mind. We cannot be sure that coming sunspot maxima will produce the same ionisation levels as prevailed at the last one. But, as we have no radio data available for earlier sunspot cycles, a study of that obtained at the last one will have to suffice.

Experimental Evidence. —

Firstly we have the experimental evidence already referred to, i.e., the reception of the London television signals at Riverhead, N.J. An examination of the Riverhead records shows that during the years when the observations were made reception was only obtained during the winter periods, i.e., between September and March. It will be remembered that it is during winter that the daytime ionisation is highest, and the conclusion is that during the summer months the ionisation of the refracting layers was never high enough to support propagation on these frequencies. So far as the sound channel on 41.5 Mc/s is concerned, during the winter of 1937-38 reception was obtained fairly consistently from the middle of September to the middle of March, though there were many days, and sometimes, periods of several days when the signals went unheard. During the next winter—that of 1938-39—no good reception was obtained till nearly the middle of October, and it ceased early in February, so that the period of consistent reception

was considerably less than during the previous year. This was no doubt due to the fall in ionisation resulting from the progress of the sunspot cycle, which was, from 1937, proceeding towards a minimum. The vision channel on 45 Mc/s was much less consistently well received than was the 41.5 Mc/s channel, and reception started later and finished earlier each winter on this higher frequency, while the periods of no reception during the winter frequently ran into many days. In fact, after December, 1938, hardly any reception was obtained on this channel at all.

These results appear to indicate that 41.5 Mc/s would only be likely to be propagated by the ionosphere during the winter of years near the sunspot maximum, and that 45 Mc/s would be very near the extreme high limit for such propagation even at that time.

Ionosphere Measurements.—Let us now briefly examine some ionosphere data to see how this checks up with the experimental evidence obtained at Riverhead. The ionosphere records made at Washington are the most suitable for our

purpose, since these were made in a latitude towards the southern boundary of that part of the Northern Hemisphere which we are considering. The highest ionisation of the last sunspot maximum seems to have prevailed there in November and December of 1937, when the measured noon critical frequencies were higher than at any time during the sunspot cycle. Taking the monthly average value of the critical frequency of the F_2 layer at noon, and calculating from it the MUF for a distance of 3,500 kilometres—representing approximately the highest frequency usable for long-distance transmission—we find that the average MUF for these two months was about 43 Mc/s. If the average noon MUF for a month at the maximum of the sunspot cycle were 43 Mc/s we should expect the MUF on particular days to vary up and down from this value by about 15 per cent., i.e., from about 36.6 Mc/s to about 49.4 Mc/s. That gives us about 50 Mc/s as a fairly safe frequency to use in order to avoid ionospheric refraction in winter daytime at the maximum of the sunspot cycle. This appears to check quite well with the Riverhead results; 41.5 Mc/s was received fairly consistently during the winter but not during the summer, while 45 Mc/s was much less consistently received, being quite strong on some days, but obviously above the MUF on many days. The evidence, therefore, appears to indicate that frequencies from 50 Mc/s upwards would not be propagated by the ionosphere even during winter daytime at the sunspot maximum, and to show that 50 Mc/s would be a fairly safe low limit to the frequency band suitable for television.

Sporadic E.—By avoiding frequencies lower than 50 Mc/s, then, we could hope to avoid propagation to long distances by any of the *regular* ionosphere layers at any time. But there remains the phenomenon of sporadic E to be considered. Sporadic E is the name given to the thin, highly ionised patches which sometimes appear within the E layer. They are of fairly frequent occurrence in summer but are infrequent in winter, whilst they are unpredictable in nature and do not occur

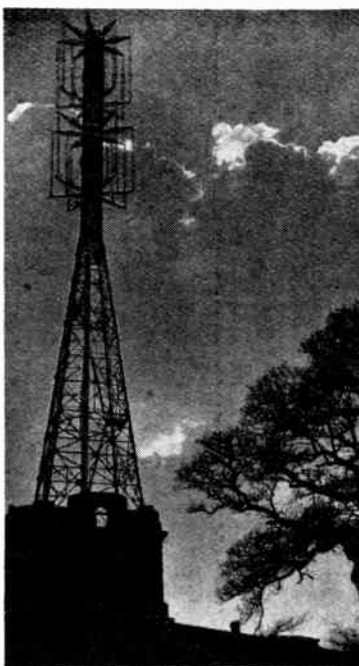

Pre-war television was radiated from Alexandra Palace on 45 Mc/s (vision) and 41.5 Mc/s (sound).

Frequencies for Television—over a very wide area. But these highly ionised patches can, because of the relatively small height at which they lie, return waves to earth of frequency sometimes as high as 75 Mc/s, and these waves may be returned at distances up to 2,000 kilometres with a single reflection.

An examination of some sporadic E critical frequency data indicates, however, that a frequency of 50 Mc/s is high enough to escape reflection by sporadic E on all but rare occasions, for even when it is particularly prevalent the highest frequency it will reflect is most often lower than this. For example, on a number of summer days when sporadic E was particularly in evidence it appears that its ionisation was such as to reflect frequencies up to 30 Mc/s often, frequencies between 30 and 45 Mc/s occasionally and frequencies above 45 Mc/s only very rarely. Furthermore, although occasional propagation out to 2,000 kilometres would thus occur by way of this medium, it is unlikely that the sporadic E would be so widely distributed as to render possible a second hop. So that the chances of interfering with other television services beyond 2,000 kilometres distant on a frequency of 50 Mc/s appear to be extremely remote. The evidence, therefore, indicates that, if the operating frequency for the television service is not less than 50 Mc/s we can afford to ignore the effects of sporadic E.

Refraction of the Space Wave.

—We may now examine another interesting matter in connection with the propagation of the ultra-

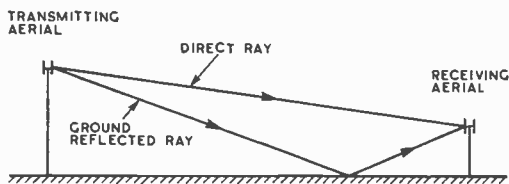

Fig. 1. Showing the two components of the space wave.

high frequencies, which will be of some importance in television. It has already been said that the range of a television station is not limited to the optical horizon, but, due to the effects of diffraction and of tropospheric refraction, is

extended considerably farther. Diffraction, it will be remembered, is the phenomenon which enables a wave to bend slightly round an intervening object, such as the bulge of the earth's surface. But it has been found that the field strength beyond the optical horizon is greater than can be attributed to the effects of diffraction alone, and furthermore, that the signals at these distances are subject to fading. This points to the presence of a refracted component in the received field, and this is indeed the case. This refraction is not, however, due to any ionisation of the air such as

accounts for the refraction of the lower short-wave frequencies. It occurs in the troposphere, and the air here is of such very high density—compared to that in the ionosphere—and the recombination rate is consequently so high, that free electrons could not exist for any length of time. There are two distinct cases in which we may have the radiated energy returned from within the troposphere—one of which we may call a normal, and the other an abnormal condition.

To take the first case first. It should be appreciated that on ultra-high frequencies the actual "surface" wave—the wave that travels along the ground itself—is not of much importance. It does not contribute much to the received field unless the receiving aerial is near to the ground itself; i.e., not more than 2 or 3 wavelengths above it. What produces most of the received field is that part of the ground wave known as the "space" wave. This consists of two components—a directly received ray and a ray received by reflection from the ground. This is illustrated in Fig. 1, for the case of a receiver situated relatively near to the transmitting station. The most important component in the received field is the directly received ray, and in

Fig. 1 this is shown as travelling in a straight line between transmitting and receiving aerial. Under such conditions it will, of course, soon be intercepted by the bulge in the earth's surface due to its curvature, and it will, therefore, not affect any receiving aerial which is beyond the optical horizon. But such receiving aerials do pick up energy from the

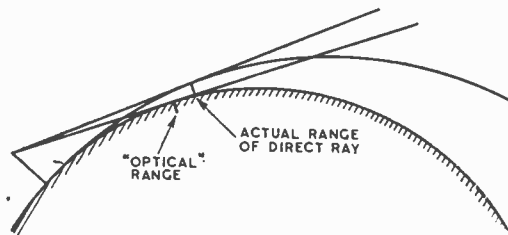

Fig. 2. Effect of apparent increase in earth's radius on range of direct ray.

direct ray, and they are enabled to do so because the ray can travel, not in a straight line, but in a continuously curving path. This is brought about by the fact that the refractive index of the troposphere is not constant, but decreases with increasing height, because with increasing height the dielectric constant of the atmosphere decreases. This is due to the normal decrease of atmospheric pressure, of temperature and of water vapour content with height—all of which quantities will affect the dielectric constant. So the rays which leave the transmitting aerial at small angles to the horizontal are subject to constant refraction and thus travel in the form of an arc, so that they can reach the earth again at points beyond the line of sight. The situation that arises is as if the earth's radius had been increased—by about 1.33 times under normal atmospheric conditions—leading to a decreased curvature of its circumference. Fig. 2 is illustrative of this and compares the range of the direct ray under actual conditions with its range if there were no refraction. But perhaps Fig. 3 better illustrates the sort of conditions under which the direct ray may travel, and shows how it can actuate a receiver which is located well below the line of sight.

The top of the trajectory made by such a ray may vary between a few hundreds and a few thousands of feet, depending on

the distance from the transmitter at which it returns to earth, but it would appear that in the stratosphere (33,000ft.) such refraction would be insufficient to return the ray to earth.

The extension of the range of a station by these effects is fortunate; it leads to more economical operation of the service, provided that it does not introduce any ill effects as well. The evidence gained from the published results of past experiments shows that on frequencies of 50 Mc/s—or even on 40 Mc/s—a considerable amount of refraction of the direct ray does take place, leading to the good reception of signals up to about $1\frac{1}{2}$ times the optical range.

As to any disadvantages which may arise, it will be appreciated that the pressure, temperature and water vapour content of the atmosphere do not always vary at the same rate with height, but undergo slow but constant changes. This leads to a variation in the refractive index and consequently to fading of the received signal. But this fading is of a very slow, shallow type and is not particularly selective in character; generally speaking, it is quite tolerable on a television signal.

Atmospheric Discontinuities.—

The second case of the return of energy from the troposphere—that which we ascribed to an abnormal condition—is brought about by the presence of atmo-

sudden changes in the region of such discontinuities. Furthermore, the rate of its change may vary rapidly both in respect of time and of height. Such discontinuities give rise to reflection of waves of ultra-high frequency, and rays which leave the aerial at relatively large angles to the horizontal may be returned to earth by this means. The discontinuities occur only within the troposphere and generally in the lower part of it; i.e., at small heights above the ground. Thus the rays may reach the ground both within and also far beyond the optical path, and, because of the varying nature of the reflections, fast and severe fading may result. This is usually worst beyond the optical horizon and may be sufficiently selective to introduce bad distortion into the received picture. This type of fading will not, however, be a normal feature of reception beyond the optical horizon, since the atmospheric discontinuities only occur from time to time. Their incidence depends upon the meteorological conditions, and a study of the air mass conditions prevailing in fronts and occlusions would seem to indicate that there is a likelihood of their occurring in the vicinity of such air mass boundaries. Further experimental data relevant to this phenomenon is required before it can be regarded as being fully understood.

Conclusions.—It would seem, then, that frequencies from 50

Mc/s upwards would be the most suitable for the television services of all countries in the middle latitudes of the Northern Hemisphere, and that stations operating on these frequencies could provide a service reasonably free from interference and fading to

points very considerably beyond the optical range, the actual range depending on the nature of the terrain.

What would be the upper limit of the desirable frequency band? One can but speculate as to the full requirements of a television service, but it may be that not more than six, and possibly only three, complete channels would be required. Starting with a lower

limit of 50 Mc/s, and allowing a band-width of 6 Mc/s for each complete channel (vision and sound) would mean an extreme upper limit of 86 Mc/s, and perhaps no higher than 68 Mc/s. It seems that the production and operation of transmitters and receivers at frequencies of that order would be well within the bounds of post-war possibility.

Of course, the upper limit suggested would be greatly exceeded if it were decided to use a system of transmission requiring a very much wider frequency band than that of the pre-war standard; indeed, the limit might be prescribed by the increasing difficulties of equipment design consequent on increase of frequency.

Finally, the upper limit would probably also be affected by another consideration—the reflection of waves from large buildings and hills. In built-up areas waves may be reflected from large buildings so as to produce a number of different paths between transmitter and receiver. Energy arriving by the various paths may be additive at some frequencies and subtractive at others, thus introducing distortion into the signal. This kind of distortion is likely to increase with frequency, because, the shorter the wavelength, the smaller is the surface that acts as an efficient reflector.

STANDARD-FREQUENCY TRANSMISSIONS

TWO changes in the standard-frequency broadcast service radiated by the U.S. National Bureau of Standards station WWV, near Washington, D.C., have recently been introduced.

The first of these is the addition of a new radio frequency, that of 2.5 Mc/s. The standard musical pitch, 440 c/s—corresponding to A above middle C—is broadcast on this frequency from 2300 to 1300 GMT.

The other change is the omission of the pulse on the 59th second of every minute. This pulse of 0.005-second duration, which consists of 5 c/s each of 0.001-second duration and is heard as a faint tick, is transmitted at intervals of 1 second.

Full details of the other transmissions from the 10-kW station were given in our February issue.

Information on how to receive and utilise the service is given in a pamphlet obtainable on application to the National Bureau of Standards, Washington, D.C., America.

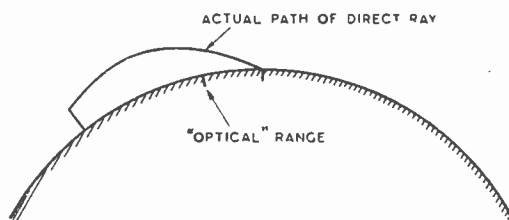

Fig. 3. Showing how the direct ray may be received beyond the "optical" range.

spheric discontinuities. There may arise the situation where, due to peculiarities in the formation of the boundaries between air masses coming from differently heated zones, the temperature, which normally decreases steadily with height, remains constant or even shows a rise with height. What is even more important, the water vapour content of the atmosphere may undergo very

MORSE BY PULSES

A "Double Current" System of Radio Telegraphy

IF one considers the waveform of the signals radiated by a transmitter sending morse by conventional methods, it will be seen that it is possible to effect a considerable saving in radiated energy. In conventional morse communication, energy is radiated by the transmitter during the *whole* of the time that the morse key is depressed. In the system to be described energy is radiated only for very brief periods, when the key is first pressed and again when it is released. In between these two brief bursts of radiated energy a signal is provided to the phones of the receiver by an audio-frequency oscillator located at the *receiver*. The function of the first burst of energy is to switch this oscillator on and the function of the second is to switch it off again. These bursts will be referred to as "marking" and "spacing" pulses in accordance with telegraphic nomenclature for "double current" working.

It will be seen that at the receiver there is required a special form of relay which will remain "closed" indefinitely on the receipt of a marking pulse and which will remain "open" indefinitely on receipt of a spacing pulse.

We will now consider some of the ways in which the marking and spacing pulses can be made to differ from each other.

(a) They may consist of short pulses of radiated carrier modulated by different audio frequencies, and at the receiver these pulses may be separated after detection by filters tuned to these audio frequencies.

(b) The marking and spacing pulses may consist of short-period radiations of plain carrier but at *slightly* different frequencies. At the receiver these may be heterodyned by an RF oscillator to produce after detection two different audio frequencies which may

By R. C. WHITEHEAD

then be directed via tuned AF circuits to the marking and spacing circuits of the special relay.

(c) Pulses of different durations may be radiated. This is the writer's method, and it will now be explained in greater detail.

Transmitter

This consists of a conventional master oscillator circuit driving one or more Class "C" amplifiers in cascade which deliver power to the aerial. One of these amplifiers is provided with a steady negative grid bias so high in value that, with only the RF voltage and the bias supplied to its grid circuit, the valve does not become conductive during any part of the RF cycle. In order to make this valve conductive and thus allow energy to be radiated, brief positive pulses are delivered to the grid. These may be provided by a pulse generator controlled by the morse key as shown in Fig. 1. Three resistances are joined in series across the HT to form a

will discharge through R_g and R_{ds} . Apart from the discharge of C_s being accomplished this has no material effect upon the system. When the key reaches the marking contact, C_m will be charged from the HT system *via* R_g . The flow of this charging current through R_g causes a positive potential to be applied to the grid of the valve *via* one winding of the transformer and the resistance R_s , and thus anode current now flows.

The lower dotted waveform in Fig. 2 (A) shows the potential which is developed across R_g . The potential of the grid is prevented from rising any higher than that of the cathode by the flow of grid current through R_g . The valve is thus allowed to become conductive during a portion of the time when C_m is being charged. When the condition of C_m approaches that of full charge the charging current will fall to a low value so that the potential of the grid will commence to fall below that of the cathode. The anode current of the valve will now commence to fall and as it does so there will be induced into the grid winding from the anode winding a voltage in opposition to that across R_g . This causes the valve to become suddenly non-conductive and a signal as shown in Fig. 2 (B, lower) is delivered from the pulse generator to the overbiased Class "C" amplifier mentioned above, and a signal as shown in Fig. 2 (C, lower) will be radiated. This will be a mark signal and will cause the special relay at the receiver to close and remain closed until a spacing signal is radiated.

When the key is released, C_m will discharge *via* R_{dm} and R_g , and except for the discharge of C_m being accomplished, this will have no effect upon the circuit. When the key reaches the spacing contact, C_s will become charged *via* R_g and for a brief period the pulse generator valve and the overbiased Class "C" amplifier will again become conductive, but because C_s has a smaller capacity than C_m its charging current will fall to the critical value in a shorter period so that

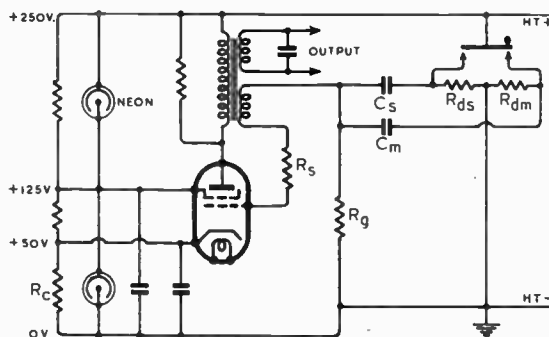

Fig. 1. Circuit diagram of proposed pulse generator.

potentiometer, and the potential drop across one of them (R_c) raises the cathode potential of the valve to a point where the latter becomes non-conductive.

Suppose that the morse key be in the up or space position, the condenser C_s will be charged and C_m will be uncharged. When the morse key is pressed, during the time that it takes to travel from the space to the mark position C_s

the valves will be conductive for a shorter period and a narrow or spacing pulse will be radiated.

The Receiver

Fig. 2 (C) shows the received signals representing a broad or mark pulse and a narrow or space pulse. The signals must now be detected as usual and then separated and led by different paths to the marking and spacing circuits of the relay.

Fig. 3 shows the basic circuit of the receiver. V_1 is operated as a grid detector and the level of the

from V_1 are independent of input levels within the working range of the system. V_1 also acts as a phase splitter so that a supply of positive pulses is available from the anode and a supply of negative pulses is available from the cathode.

The signals are now led to the special relay via two separate paths, one admitting the broad pulses only and the other the narrow pulses only.

Fig. 2 (E) shows what happens to the anode potential of V_1 under the influence of broad and

MR, and Fig. 2 (K) shows the variations in potential to be expected at A. It will be noted that the steep wavefronts of the pulses have been considerably modified because the condenser of the integrating circuit is acquiring its additional charge through the resistance.

Prior to the commencement of any pulse, the condensers of the integrating circuit is charged to the potential of the anode of V_1 , say, 150 volts, and under the influence of any pulse the potential to which the condenser is charged will rise.

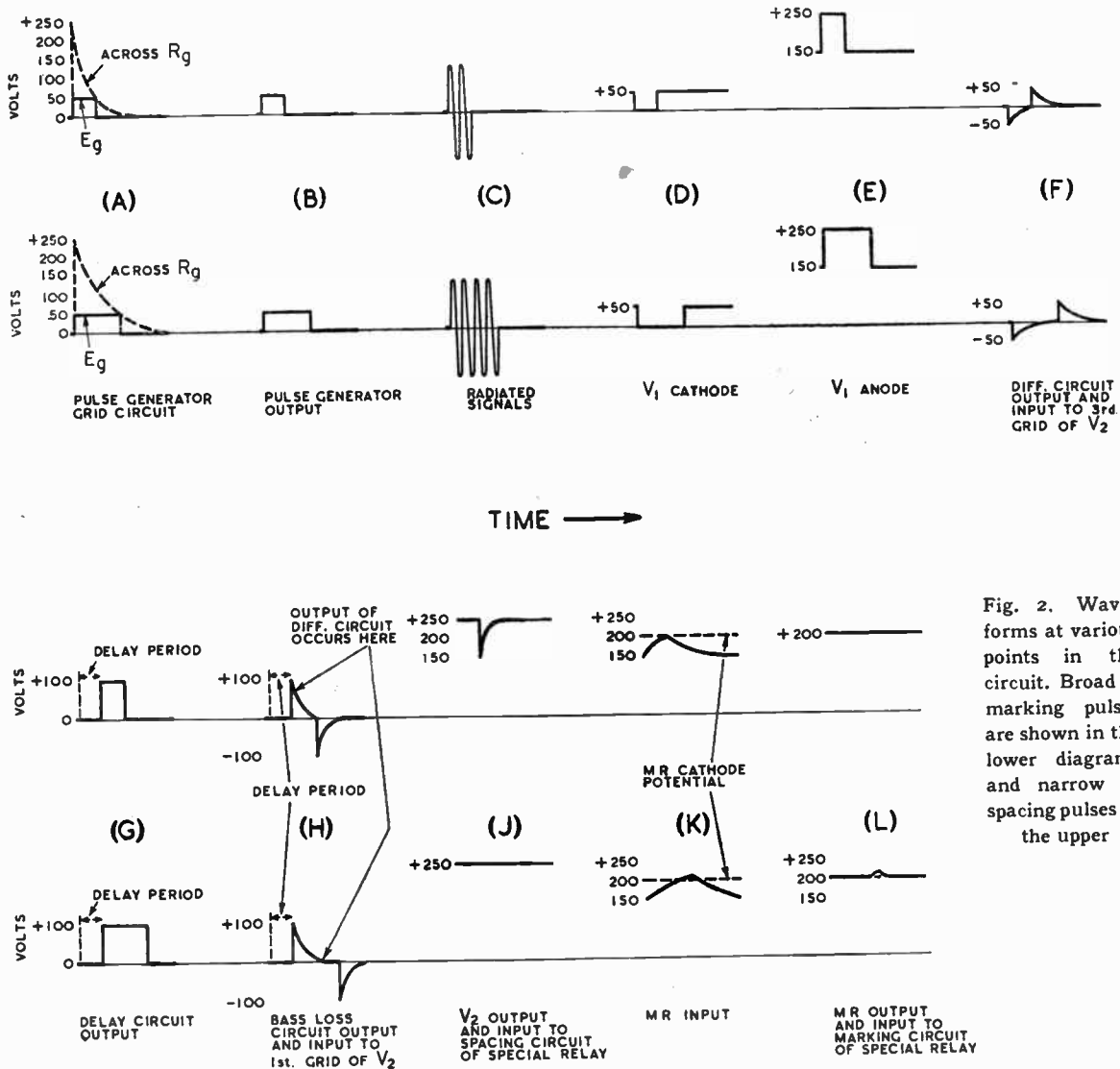

Fig. 2. Waveforms at various points in the circuit. Broad or marking pulses are shown in the lower diagrams and narrow or spacing pulses in the upper

input signal is made to have a value high enough to cause "limiting" to take place so that the levels of the output signals

narrow pulses respectively. Pulses from the anode of V_1 are led via the integrating circuit to the "anode" A of the metal rectifier

Now the "cathode" C of MR is joined to a potentiometer across the HT system and the two resistances of this potentiometer

act also in parallel as the load of MR. Let C be at a potential of, say, 200 volts, MR will therefore only become conductive when the potential of A rises above 200 volts.

It will be seen from the upper curve of Fig. 2 (K) that during a

its first and third grids. Under all other conditions V_2 is non-conductive. The inputs to the two grids of V_2 are arranged in such a manner that this condition can only be secured under the influence of a narrow pulse.

and (H) represent the two inputs to V_2 . Consider first the lower curve in each diagram. When the positive pulse of Fig. 2 (F) arrives the positive pulse of Fig. 2 (H) has collapsed almost to zero and the result of this is that under

Fig. 3. Basic circuit of receiver for converting pulse telegraphy to conventional morse signals.

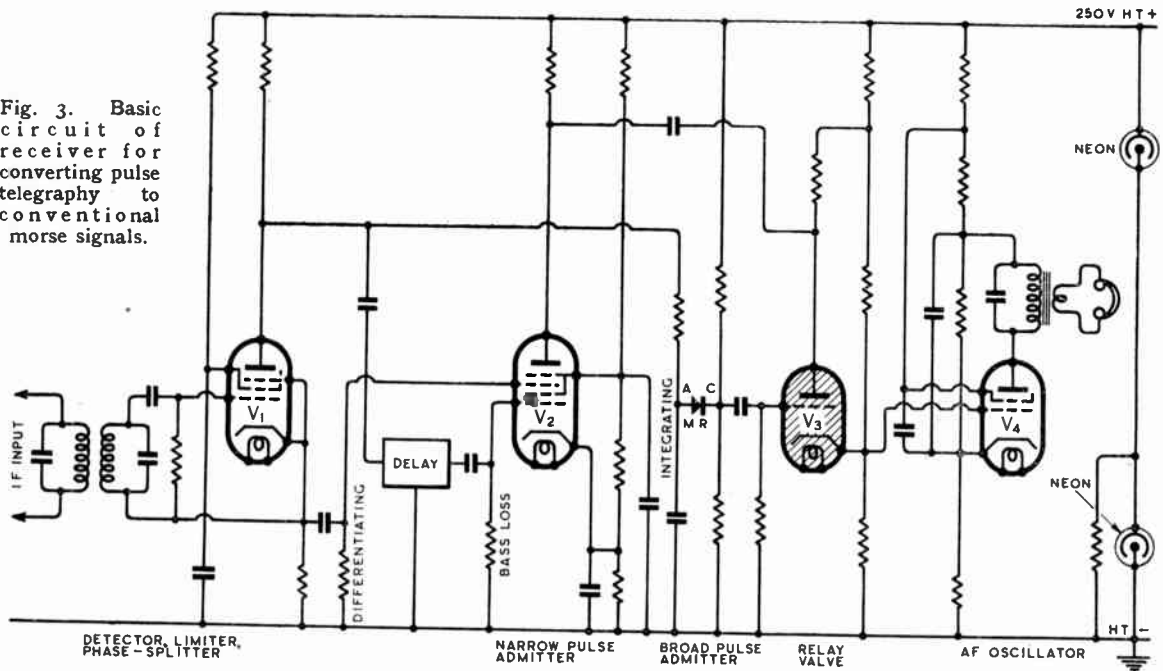

narrow pulse there is insufficient time for the potential of A to rise higher than the potential of C, so that no signal passes through MR during a narrow pulse. On the other hand, as shown in Fig. 2 (K, lower), during a broad pulse there is time for the potential of A to rise above 200 volts and thereby make MR conductive. Fig. 2 (L) shows the variations in potential to be expected at C under the influence of broad and narrow pulses. The output of MR is now taken to the marking side of the special relay.

The narrow-pulse admmitter circuit consists of a differentiating circuit, a delay circuit, a bass-loss circuit and a hexode mixing valve V_2 . For the operation of this admmitter, supplies of negative and positive pulses are required, and these are obtained respectively from the cathode and anode of V_1 , and are shown in Figs. 2 (D) and (E).

The basic principle of operation of the narrow pulse admmitter is that V_2 is allowed to become conductive only when it receives positive pulses *simultaneously* on

Fig. 2 (I) shows the outputs of the differentiating circuit with broad and narrow pulses, and it will be seen that due to the small time constant of the differentiating circuit, a positive pulse is secured on the trailing edge of *any* input pulse. Thus if either a broad or a narrow pulse be delivered to the differentiating circuit then the output of the latter will consist of a negative pulse coinciding with the leading edge of the input pulse and a positive pulse coinciding with the trailing edge of the input pulse. These pulses are now delivered to the third grid of V_2 .

At the same time as this is happening positive pulses as shown in Fig. 2 (E) are obtained from the anode of V_1 . These are passed through a delay circuit, the output of which is shown in Fig. 2 (G). These are then passed through the bass-loss circuit to the first grid of V_2 .

The effect of the bass-loss circuit is shown in Fig. 2 (H). The influence of this circuit on a pulse is the same as that of the differentiating circuit, but it is put to a different use. Now Figs. 2 (F)

these conditions (i.e., that of a broad or marking pulse) V_2 does *not* become conductive. Now consider the upper curves of Figs. 2 (I) and (H). When the positive pulse of Fig. 2 (I) is delivered to the third grid of V_2 , the positive pulse of Fig. 2 (H), on the first grid of V_2 , is still almost at its full value and under these conditions (i.e., that of a narrow or spacing pulse) V_2 becomes conductive and delivers a *very* narrow pulse as shown in Fig. 2 (J, upper) to the spacing circuit of the special relay.

Up to the present we have separated our pulses according to their widths and delivered them *via* separate paths to the marking and the spacing circuits of the special relay. It now remains to be considered what form this relay must take. The energy available so far is insufficient to actuate an ordinary electromagnetic type relay. This is due in part to the very short *time* occupied by the pulses. It is possible to amplify those two signals separately and apply them to a conventional relay, but such amplification

would be uneconomical, and it is possible to secure directly the required effect by the employment of the gas-filled relay valve V_3 .

When this valve receives at its grid a positive pulse corresponding to a broad or marking pulse it becomes conductive and remains so indefinitely until it receives on its anode a negative pulse corresponding to a narrow or spacing pulse. It thus acts in the same manner as an ordinary line telegraph relay operated in the "unbiased" condition for "double current" working. The output from V_3 is taken from its cathode. When the transmitter key is in the space position the cathode of V_3 is nearly at earth potential because V_3 is non-conductive, but when the transmitter key is held in the mark position the cathode of V_3 is at a higher potential because this valve is then conductive.

We have secured at the receiver a signal of waveform such as may be found in a conventional morse system, and this signal may now be used to control the final recording or indicating device. In Fig. 3 a dynatron audio-frequency oscillator is suggested. V_4 is normally held non-conductive by virtue of the fall of potential across its cathode resistance. When the potential of the cathode of V_3 rises, V_4 is allowed to become conductive. In its anode circuit the primary of the transformer shunted by the condenser forms a tuned circuit which controls the frequency of this oscillator and this frequency may be adjusted to suit individual tastes. The secondary winding on the transformer is used to feed the phones.

Conclusion

The economy which can be effected by the employment of this system is dependent upon the bandwidth which may be allotted to the communication channel. Whilst no tests or detailed calculations have been made, it is estimated that if a bandwidth of 20 kc/s is allowed, the narrow pulse may be approximately half a millisecond. A system which achieves economy of energy at the transmitter appears to be particularly suitable for mobile or distress communication. In the latter case or if ultra-short-waves be employed then, it is permissible for a higher

bandwidth to be used. In this case the duration of the pulses may be shortened and a greater degree of economy secured. When pulses of very short duration are employed it is advisable to extinguish V_3 of the receiver with a "broad" pulse. In this case each of the pulses must be given an additional phase reversal in the receiver and used for purposes opposite to those already suggested. This is because valves of the gas-filled relay type require pulses of longer duration to "extinguish" them than to "strike" them. Alternatively a "pulse-widening" circuit can be connected between the anodes of V_2 and V_3 .

The relative durations of narrow and broad pulses are governed by the degree to which voltages are stabilised in the transmitter pulse generator and in the receiver, and also the degree to which components in these circuits will remain stable. It is estimated that with standard components and one adjustable component in the receiver and one in the transmitter the broad pulse may be reduced in duration to twice that of the narrow pulse. Obviously the shorter the period of the broad pulse the greater will be the degree of economy secured, but the conditions of operation become too critical if a ratio closer than two to one be employed for the pulse width durations.

Let us now estimate the economy of energy which may be secured. Suppose that the narrow and broad pulse widths be respectively half and one millisecond as suggested above.

When the word "RADIO" is sent by this system at any speed, 13 mark and 13 space signals will be transmitted. This is equivalent to a radiated time of 19½ milliseconds only. At 24 words per minute a dot occupies approximately 50 milliseconds and a dash occupies 150 milliseconds. If the same word "RADIO" is sent by a conventional morse system the transmitter will be radiating for 1,300 milliseconds. The consumption of energy in those parts of the circuit which are affected is therefore reduced to 1/66. Overall economy is, of course, not as great as this. When comparing transmissions at lower speeds however the saving will be greater.

TECHNICAL GLOSSARY

A NEW and enlarged "Glossary of Terms used in Telecommunications" has recently been issued by the British Standards Institution. Many new definitions have been added and many others have been revised to keep pace with recent developments. Well over half the terms are current in wireless, though there are sections for land-line telephony and telegraphy. The purely wireless sections are headed Radio-communication, Television and Radio Direction Finding. Among new terms defined is radiolocation: "Determination of the position of a distant object or reflecting surface by a method involving the use of reflected radio waves."

What seems to be one of the less happy innovations is the word "omni-aerial" as a preferred alternative to "omni-directional aerial." The extension of the term "radio broadcasting" to cover sound, vision or facsimile transmission for general reception, though logical enough, runs contrary to accepted usage and seems likely to make for confusion. On the other hand, everyone will approve the complete omission of "static"—a quite incorrect but still popular designation of interference. "Anti-static aerial" is given, but its use is deprecated. The same applies to "demodulation" as a synonym for "detection." One could wish that the unnecessary "video-frequency," given as a second-choice synonym for "vision frequency," was also deprecated.

Perhaps the most drastic substitution is "sender" as a preferred alternative for "transmitter." We know that the word is used in the Services, but except for purely official purposes, it does not seem to have made much headway. But one feels that we ought to like the shorter word "sender"; most authorities urge that an English word is always more natural and forceful than a Latin derivative.

Though prepared primarily as a guide for the standardisation and co-ordination of technical terms, the Glossary should interest a much wider readership than most publications of its kind. Issued as B.S.204:1943 by the British Standards Institution, 28, Victoria Street, London, S.W.1, it costs 3s. 6d., postage included.

WIRELESS TRAINING PLANE

OUR cover illustration this month shows the new Proctor IV aircraft designed as a wireless training plane for the R.A.F. and Naval Air Arm. It is fitted with the 200lb. of equipment necessary for training the wireless operators of our big bombers.

Army's Highest Powered MOBILE STATION

*Designed for Direct Working
Between All Theatres of War*

WITH a power of at least 3 kW in the aerial this mobile Army transmitter is comparable with a medium-powered broadcast station and has, potentially, a world-wide range. Yet it can be erected and be sending high-speed morse within three or four hours of arrival at any selected site.

The station is a self-contained unit of five vehicles and two trailers, the crew consisting of an officer of the Royal Signals, 22 operators, instrument mechanics, electricians and drivers of the Royal Signals, and one cook of the Army Catering Corps. In view of the importance of the work—direct communication between Army H.Q. and G.H.Q. and between G.H.Q. and the United Kingdom—special care is taken in the selection of members of crews. Men who show outstanding ability during their preliminary training in Royal Signals are earmarked for a special course in the handling of high-speed morse apparatus and are trained in all the duties of operation and instrument maintenance so that they can take over any task in the receiving vehicle, which is

Receiving vehicle and 70ft. aerial masts are shown on the right.

(Below) Interior of receiving vehicle. The signalman nearest the camera is supervising the operation of the Wheatstone transmitter, the next man is examining tape coming off the receiver undulator and two men operate keyboard perforators. The message clerk is accepting a dispatch for transmission.

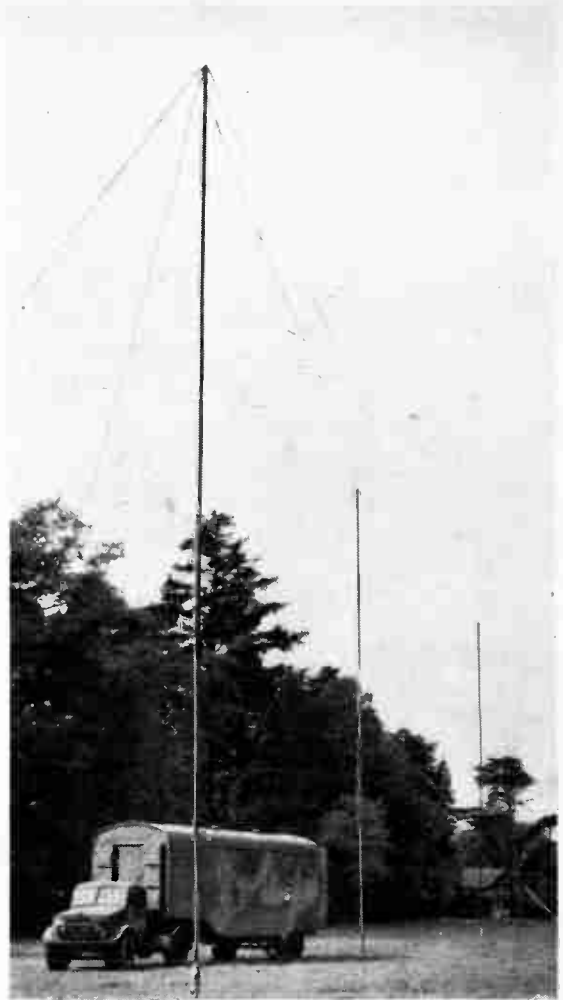

the nerve centre of the station.

This vehicle, which consists of a long van body on a semi-articulated chassis, has an operating bench running the whole length of the off side. Cupboards for the instrument mechanics' tools, a desk for the message clerk adjacent to a small "letter box" for dispatches, and a power switchboard occupy the near side, and there is a bench for typewriters at the front end of the vehicle. The long bench carries two keyboard perforators for punching the transmitting tape, a receiving undulator (and spare), and a hand operating key. Two high-grade receivers of the communication type and their associated recording bridges for producing DC impulses are mounted on shelves at a convenient height above the undulators.

The "transmitting head," which

is connected by cable to the transmitter, and the receiver undulator operate at speeds up to 150 words per minute. The undulator tape is passed to the receiving operators and is drawn across the front of a typewriter by a small electric motor and transcribed by eye at a speed of about 30 to 35 words per minute. This method has several important advantages over completely automatic working and is capable of handling an average of 30,000 words per day. Separate dipole transmitting and receiving aerials are erected at a suitable distance apart on 70ft. collapsible masts and simultaneous two-way working is normal.

To ensure efficient operation of the high-speed telegraph instruments in all climates, the air in the receiving van is filtered, dried and temperature controlled by an air-conditioning plant at the forward end of the vehicle. As a consequence the crew work under conditions which are the envy of their Army colleagues.

The transmitter is housed in a similar type of vehicle which may be parked 600 yards away. There is telephone communication between the vehicles so that instructions for changing frequency, etc., may be passed expeditiously.

The transmitter and the HT supply equipment occupy separate cubicles and are accessible on all sides. Wave changing is effected by interchangeable tank circuit coils, spare coils being stored in a rack against the near-side wall. The power amplifier valves are cooled by air blast and spare valves are carried in resilient mountings behind the power supply cubicle. Two aerials are used, one for day (high frequency) and the other for night (low frequency) operation. When on the road, the mast sections are slung in racks below the chassis of the vehicle.

Power from local supply mains can be used if available, but the unit is naturally not dependent on external power and has its own

diesel generator sets delivering 27 KVA three-phase at 400-230 volts. The generator is mounted on a trailer and is towed by a four-wheel drive lorry which carries part of the crew and their kit when the station takes the road. There are two of these generator units in order that adjustment and overhaul can be carried out

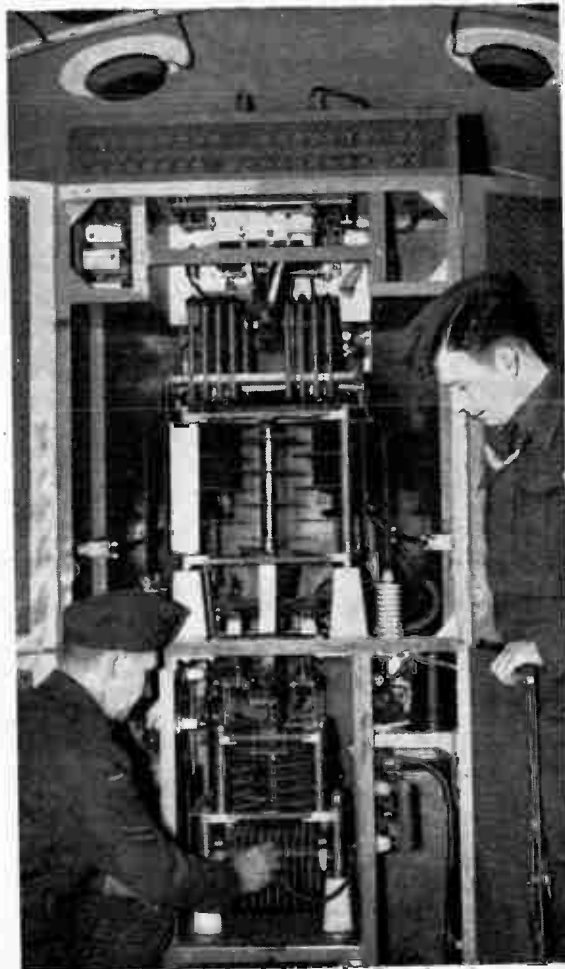
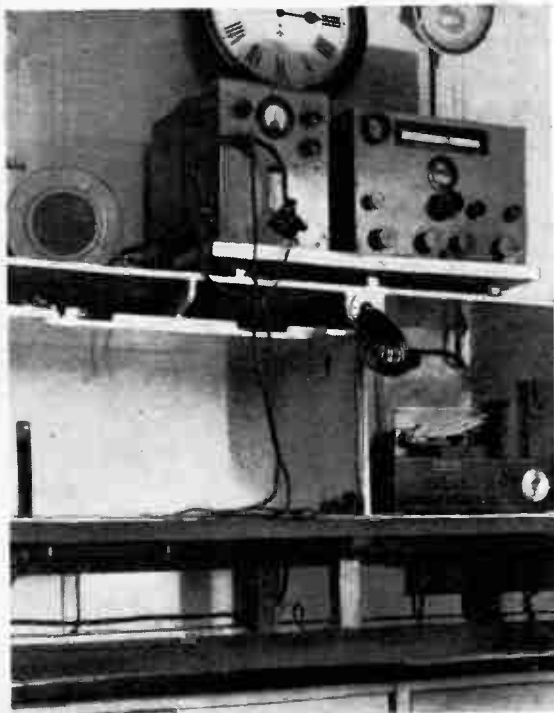

Interior of transmitter cubicle (above).

Receiving position showing recording bridge and receiver on shelf above undulator. A duplicate receiving position is used as a standby and for monitoring the transmitter

without interrupting the service. The station, with its long, train-like vehicles, is called the "Golden Arrow" after the famous London-Paris boat train, and several have been allotted for future operations on the Continent. The equipment has already proved its efficiency in places as far apart as Italy and Bengal. In Sicily a "Golden Arrow" went ashore from landing craft late one evening and by 9 o'clock the following morning was hard at work with the War Office 1,200 miles away.

CATHODE FOLLOWER OUTPUT STAGE

Loudspeaker Damping Improved by Low Output Impedance

THE cathode follower is finding many applications in modern radio technique, and has been described in some detail in previous issues of this journal.¹ The basic circuit is shown in Fig. 1, where it is seen that the device is a single-stage amplifier with its load connected in the cathode lead instead of the anode lead, while the output is taken from the cathode instead of the anode. The effect of such an arrangement is to reduce the stage gain to a value slightly less than unity, for the

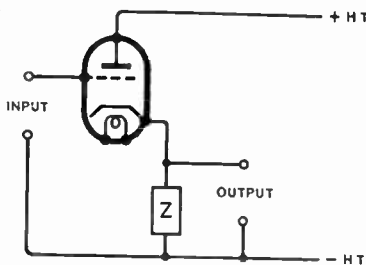

Fig. 1. Basic circuit of the cathode follower.

total output voltage appears on the cathode and therefore is opposing the input voltage, but the salient features of the device are a high input impedance and a low output impedance, which render the stage suitable for interposing between a signal source and an amplifier with a low input impedance.

It is not intended to derive complete expressions for the characteristics of the cathode follower, and the following brief survey of the nature of the circuit will suffice.

In the first place, the stage gain can be calculated from the well-known feedback formula:

$$A = \frac{A_o}{1 - \beta A_o} \quad \dots \quad (1)$$

where A = the gain of the amplifier with a fraction β of the output fed back into input terminals

¹ *Wireless World*, July 1941, p. 176.; July 1942, p. 164.

By C. J. MITCHELL, A.M.I.E.E

A_o = the gain of the amplifier without feedback.

Since β is negative, and in this case equal to unity, the expression becomes:

$$A = \frac{A_o}{1 + A_o} \quad \dots \quad (2)$$

$$\text{or, } A = \frac{\mu Z}{R_a + (\mu + 1)Z} \quad \dots \quad (3)$$

(since $A_o = \frac{\mu Z}{R_a + Z}$, where R_a is

the valve AC resistance, μ the amplification factor and Z the load impedance) A_o is always large compared with unity, so the gain is always slightly less than unity.

The effects of inter-electrode capacitances in a valve are in proportion to the voltages developed across them. From Fig. 2 it is seen that the grid-to-anode capacitance is virtually in parallel with the signal source; therefore one of the components of the input capacitance is the grid-to-anode capacitance (C_{ga}). The grid-to-cathode capacitance, however, has but little effect on the input capacitance, for the potential difference developed across it is very small, namely, the difference between the signal voltage and the

equal to the reciprocal of the mutual conductance (in amperes per volt) of the valve employed in the circuit. By considering the basic circuit in Fig. 1, it can be seen that the effect of drawing a current from the output terminals will be to reduce the cathode potential. This will enable the valve to pass more current, and the extra current passed by the valve will tend to restore the cathode potential to its original value.

The principal application of the cathode follower is that of an impedance-matching device (or "buffer" stage), but the circuit can be readily adapted for operation as an output stage, where the low output impedance will provide excellent damping for the loudspeaker, while the large negative feedback will render the stage practically distortionless.

The circuit recommended is shown in Fig. 3. The output valve is a Mazda AC2/pen. connected as a triode. The potential divider connected across the HT supply provides the grid with a positive bias in order to offset the excessive positive cathode bias produced by the DC resistance of the output transformer primary wind-

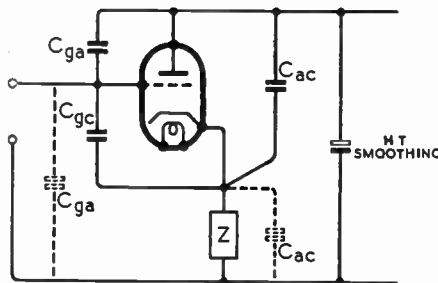

Fig. 2. The inter-electrode capacitances are represented as condensers connected externally to the valve. Since the HT+ line is bypassed to earth by the smoothing condenser in the power pack C_{ga} and C_{ac} are virtually in the positions indicated by the broken lines.

output voltage. For most practical purposes the input capacitance may be considered to be equal to the grid-to-anode capacitance.

The output impedance of the cathode follower is almost independent of the value of the load impedance, and is approximately

ing. In some cases, it will be found possible to dispense with this biasing arrangement and to connect the earthy end of the coupling transformer secondary directly to the chassis. This can be done when the DC resistance of the output transformer primary is from 100-150 ohms; if it is lower

than about 80 ohms, it may be necessary to apply *negative* bias to the grid of the valve. The best procedure to adopt is to connect a milliammeter in the HT lead and adjust the bias until the correct value of current is flowing, not forgetting that the meter is indicating both anode and screen

output from a generator, the load impedance must be equal to the output impedance of the generator, so it would appear that the correct value of cathode load impedance would be of the order of 200 ohms. This argument does not apply to the cathode follower, however, and we must not over-

It can be argued, of course, that if the wrong value of load impedance is employed, the input will automatically adjust itself and so offset to a large extent the effects of incorrect matching. While this is perfectly true, there is no point in deliberately mismatching the load to the valve, and the following example will demonstrate the effects of incorrect values of load impedance.

In the circuit under discussion, the valve passes a steady current of 40mA, and if a load impedance of 5,000 ohms is employed, the AC power in the load will be $5,000 \cdot I^2$ (since $W = I^2 Z$). If the power is 3 watts, then $I^2 = \frac{1}{5,000}$,

and $I = 24.5 \text{ mA (RMS)}$. The peak value of this current will be 34.5mA, so the HT current fluctuations will be from 5.5mA to 74.5mA—it will be possible for the current to swing about its mean value of 40mA without the valve running into the cut-off or saturation region of its characteristic. The anode voltage swing can be calculated in a similar manner. $W = 3 \text{ watts} = V^2 / Z = V^2 / 5,000 \therefore V = \sqrt{15,000} = 122 \text{ V (RMS)} = 173 \text{ V (peak)}$. If the HT voltage is 250, the maximum theoretical voltage swing of the cathode will be 500 V, and the peak-to-peak cathode voltage swing (346 V) can occur without the valve cutting off.

Now consider the effect of matching the load to the output

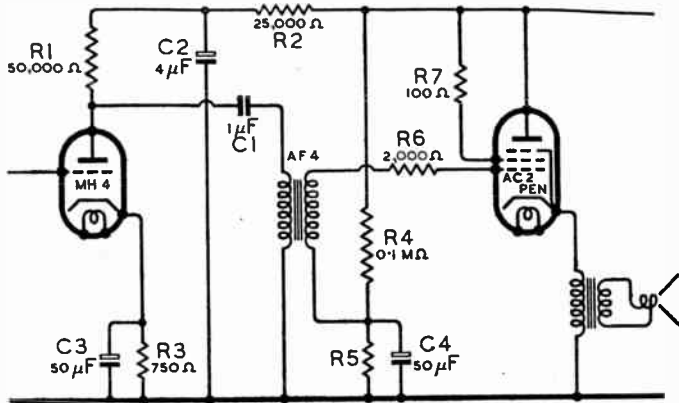

Fig. 3. Circuit of output stage and pre-amplifier. The biasing potential divider R4, R5 consists of a 100,000 ohm resistor in series with R5. The value of the latter depends on the DC resistance of the output transformer primary.

current. This should be 40 mA. The bias is by no means critical, and the valve will deliver a reasonably large undistorted output when the grid is overbiased. In general, it is better to overbias than to underbias the grid.

Matching Loudspeaker to Valve

When employed as a triode the AC2/Pen has a mutual conductance of 0.01 ampere per volt and an AC resistance of 2,500 ohms. In a normal amplifier with a *resistance* in the anode the maximum power will be delivered to the load when its resistance is equal to the AC resistance of the valve, but if the load is a resistive impedance (a transformer-coupled loudspeaker, for instance), it can be shown that the maximum undistorted power output will be obtained when the load impedance is equal to *twice* the AC resistance of the valve. A suitable value of load impedance will therefore be 5,000 ohms.

In deciding on a suitable value of cathode load impedance, it should be borne in mind that the cathode impedance must be matched to the AC resistance of the valve, and not to the output impedance of the circuit. This may seem a little confusing, for, in order to obtain the maximum

look the fact that, although the circuit characteristics are changed by the negative feedback, the *valve characteristics* are entirely unchanged. The feedback simply modifies the input between the grid and cathode of the valve, and this attenuated input is subjected to the full amplification of the valve, just as it would be in a normal amplifier. The apparently low output impedance is

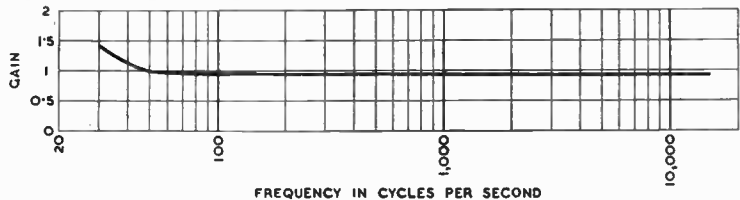

Fig. 4. Frequency characteristic of output stage. The increase in gain at the lower frequencies is due to phase shift.

due to the fact that a decrease of output resulting from the application of a load of low impedance to the output terminals results in a reduction of the opposing signal fed back, which, in turn, results in a larger input appearing between the grid and cathode of the valve. When viewed from this angle it is seen that the valve still requires the same load impedance as it does when functioning without negative feedback.

impedance. If the load impedance is 200 ohms, then $W = 200 \cdot I^2$. If the no-signal current through the valve is 40 mA, the maximum peak-to-peak current swing will be from zero to 80 mA, so the peak AC component will be 40 mA = 28.3 mA (RMS); the power will be $(0.0283)^2 \times 200 = 0.16 \text{ watt!}$ If the input voltage were increased to bring the output up to 3 watts as before, then the peak-to-peak current swing would be 346 mA. Since the cur-

rent cannot fall below zero, this means that the current would have to swing from zero to 346 mA; the negative half-cycles would have an amplitude 40 mA and the positive half-cycles an amplitude of 306 mA. The dis-

Fig. 3 is a Ferranti AF4, the frequency characteristic of which is shown in Fig. 5.

When the amplifier was tested on a radio programme, the reproduction was remarkably good. Speech was reproduced with as

put impedance of the circuit. Distortion could not be detected until the valve was delivering its full output of 3½ watts, after which further increases of input resulted in a marked increase in distortion. One remarkable feature of the circuit is the unusually large output which can still be obtained when the valve is over-biased. Quite a good undistorted output can be obtained when the cathode current is reduced to half its normal value; this is due to the fact that distortion produced in the valve is reduced in the same proportions as the gain, and when operating with a 5,000-ohm load this reduction is 18 to 1.

It is not essential to use a pentode or tetrode in this circuit, and

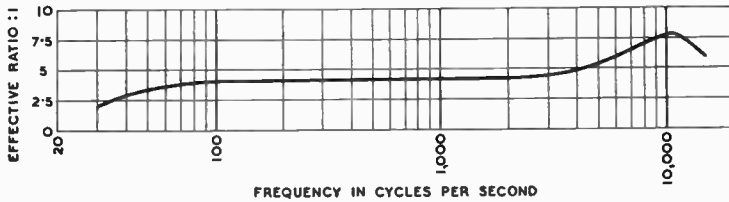
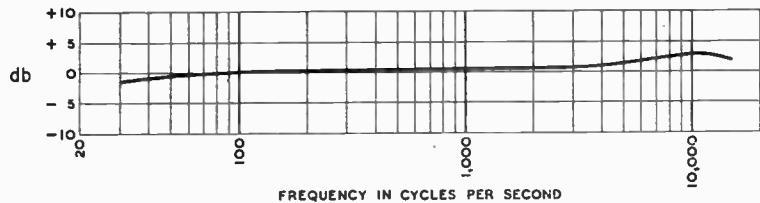

Fig. 5 (above). Frequency characteristic of intervalve transformer.

Fig. 6 (below). Overall response of the two-stage amplifier. Zero db corresponds to a "gain" of 0.95.



tortion introduced would be nearly 50 per cent. without taking into account distortion of the positive half-cycles due to saturation. This distortion would be reduced by the negative feedback, but with a load of 200 ohms the internal gain of the circuit would be only 1.9, and, therefore, the distortion would be reduced to just less than 17 per cent.

With the higher load impedance, the internal gain of the circuit would be approximately 17 and the distortion introduced would be reduced to 1/18 of its original value, so even 50 per cent. distortion introduced by overloading the valve would be reduced to less than 3 per cent.

The "gain" of the stage (without the intervalve transformer) remains level at about 0.95 from 100 c/s to 15 kc/s, above which frequency the circuit could not be tested owing to the lack of a suitable oscillator. Below 30 c/s there is a considerable increase in gain, and this is due to phase shift which reduces the effective value of the negative feedback, but over the rest of the frequency range phase shift is negligible.

It may surprise the reader to notice that an intervalve transformer is used instead of resistance-capacitance coupling between the output valve and its pre-amplifier, but unless there is a very large high-tension voltage available it will not be possible to provide a sufficiently large voltage swing to drive the output valve; the input voltage is larger than the output voltage, and is, in fact, the normal input voltage plus the output voltage. A good intervalve transformer parallel fed should not introduce appreciable distortion. The transformer employed in the circuit shown in

good fidelity as the narrow band of transmitted frequencies permit, and consonants such as "t" and "k" were clear and distinct; the absence of bass resonance tended to give the impression that orchestral items would lack bass, but this impression was false, for in musical items the bass was well maintained, although not exaggerated by mechanical resonances. These improvements are due to the large negative feedback and to the exceptionally heavy damping of the loud speaker by the low effective out-

put impedance of the circuit. Distortion could not be detected until the valve was delivering its full output of 3½ watts, after which further increases of input resulted in a marked increase in distortion. One remarkable feature of the circuit is the unusually large output which can still be obtained when the valve is over-biased. Quite a good undistorted output can be obtained when the cathode current is reduced to half its normal value; this is due to the fact that distortion produced in the valve is reduced in the same proportions as the gain, and when operating with a 5,000-ohm load this reduction is 18 to 1.

Books issued in conjunction with "Wireless World"

	Net Price	By Post
FOUNDATIONS OF WIRELESS. Fourth Edition, by M. G. Scroggie, in preparation	7/6	7/10.
TELEVISION RECEIVING EQUIPMENT, by W. T. Cocking	10/6	10/10
RADIO LABORATORY HANDBOOK, by M. G. Scroggie. Second Edition	12/6	12/11
WIRELESS SERVICING MANUAL, by W. T. Cocking. Sixth Edition	7/6	7/10
HANDBOOK OF TECHNICAL INSTRUCTION FOR WIRELESS TELEGRAPHISTS, by H. M. Dowsett and L. E. Q. Walker. Seventh Edition	30/-	30/7
WIRELESS DIRECTION FINDING, by R. Keen. Third Edition	30/-	30/7
RADIO DATA CHARTS. Third Edition, Revised by J. McG. Sowerby, B.A., Grad. I.E.E.	7/6	7/10
RADIO INTERFERENCE SUPPRESSION, by G. W. Ingram	5/-	5/4
LEARNING MORSE. 335th thousand	6d.	7½d.
INTRODUCTION TO VALVES, by F. E. Henderson	5/-	5/4
VALVE REPLACEMENT MANUAL, by A. C. Farnell and A. Woffenden	6/-	6/2

Obtainable from leading booksellers or by post from
ILIFFE & SONS LTD., Dorset House, Stamford Street, London, S.E.1.

Angles on **BRIMAR PRESTIGE**

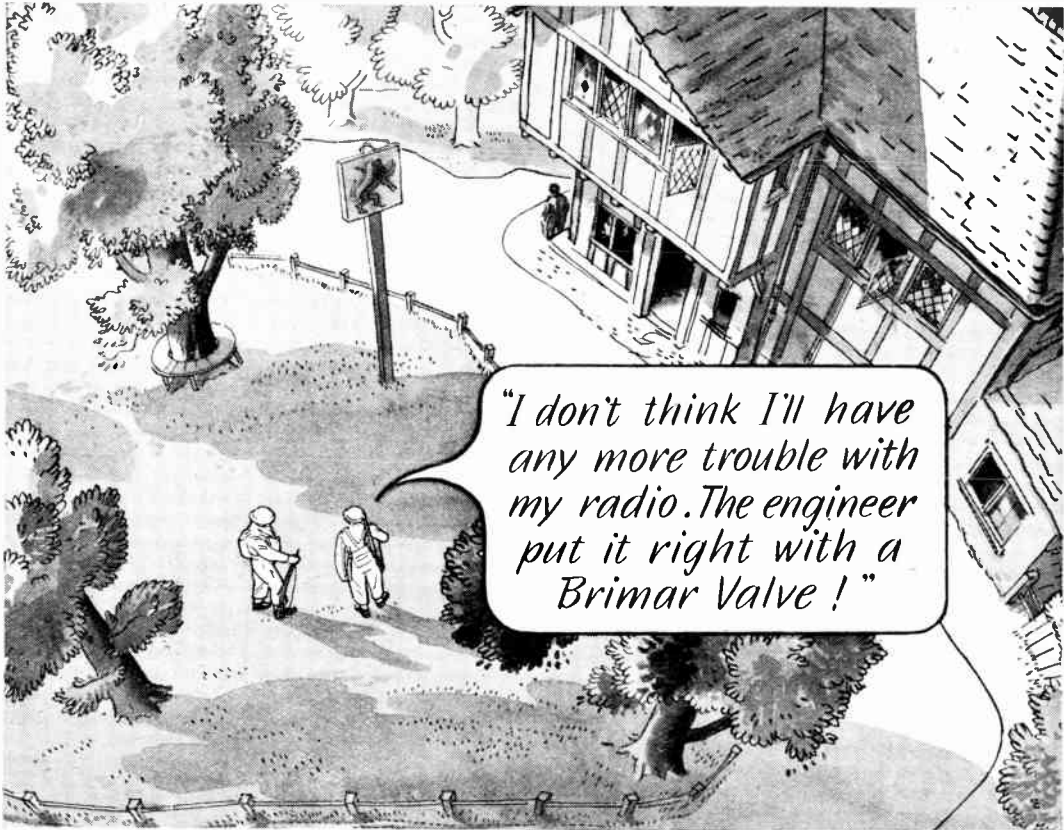

All Radio and Service Engineers have a high opinion of Brimar Valves. They know that they can be relied upon to give a first-class performance.

BRIMAR

BYA

VALVES

STANDARD TELEPHONES AND CABLES LIMITED, FOOTSCRAY, SIDCUP, KENT.

"to Insulate"

INSULATE: To separate or isolate by a non-conducting substance

Webster's Dictionary

Practically all waxes are used to "separate or isolate," but the degree of insulation provided by the different types of waxes varies enormously.

There is obviously no higher degree of insulation required than that of electrical components and apparatus in intense electrical fields, especially in the extremes of conditions to which they are subjected to-day.

We specialise in the supply of
WAXES *for all*
purposes—under all conditions

Our technical advice is at your disposal.

If you have any problem of

IMPREGNATING—DIPPING—FILLING

we, as consultants to the Industry, shall be glad to offer you a solution.

CLAUD CAMPBELL & CO. LTD.

4, LLOYDS AVENUE—LONDON—E.C.3

Telephone Nos. :—ROYAL 5403/4/5.

Rotary Cutting, Filing, Grinding and Polishing - *Economy and Accuracy*



Use MORRISFLEX Flexible Shaft Equipment, and REX Rotary Files and Cutters for cutting, filing, grinding and polishing components of aluminium, Elektron, non-ferrous alloys and ferrous metals. For metal buffing and cleaning we supply MORREX Rotary Wire Brushes, and MORRISFLEX Rotary Polishing Mops and Felts, also Felt Cones. MORRISFLEX Rotary Rasps are ideal for woodworking, and attachments for MORRISFLEX machines include Sanders and Grinders.

MORRISFLEX machines are available in overhead suspension, bench and floor types. Their use ensures speed with accuracy, and a high degree of finish. Write for Lists.

B. O. MORRIS LTD.

SHIRLEY,
 BIRMINGHAM.

Shirley 1237.

*Grams :

Morrisflex, Birmingham.



MORRISFLEX

FLEXIBLE SHAFT EQUIPMENT

RADIO HEATING EQUIPMENT

Designing a Class "C" Push-Pull RF Generator

By

L. L. LANGTON,

A.M.I.E.E.

THE heart of any radio-heating equipment is, of course, the generator of RF power, and as it is, together with its power supply, a fairly expensive piece of gear, its economics require some study by anyone who is contemplating the construction of a radio heater.

Two main types of generator may be used, the master oscillator-power amplifier and the self-excited power oscillator. The use of the former is not to be recommended, as the frequency of the tuned amplifier is modified by the inclusion of "work" in the circuit, while the self-excited oscillator automatically adjusts itself for load conditions and so forms a better industrial tool. If a large mass of "work" loads a generator, the frequency may be pulled as much as 20 per cent. It is, of course, possible to tune the amplifier circuit to compensate for the "work," but tuning components in circuits of such power are both large and expensive. The master oscillator being of low power may be easily tuned to suit load conditions by normal receiver-tuning components, but it is now no longer a master oscillator in the accepted sense of the term and in any case forms an extra unwanted control.

Whenever RF power is required for purposes such as industrial heating, electro-medical diathermy, etc., Class "C" operation must be employed for reasons of valve economy. This type of operation gives a pulse of power to the tank circuit during part of half a cycle, the high "Q" of the tank circuit maintaining power during the following half-cycle. However, since the "Q" of the tank circuit is not very high when loaded with "work," the push-pull Class "C" type of circuit giving power during part of each half-cycle is advantageous.

A Class "C" operated valve is biased to approximately twice cut-off and large RF existing voltages are imposed to push the grid positive during part of each cycle. The anode current will be a maximum when the grid is at

maximum positive potential (E_g max.) and the anode potential will be a minimum (E_a min.) owing to the voltage drop across the tank circuit. The grid and anode voltage and current respectively are shown in Fig. 1. The grid will take current during its positive pulse, and E_g max. must not exceed E_a min., as the grid would then take such a large current that the valve would be injured.

The total emission of which the filament is capable must be drawn by the grid and anode when the potentials are E_g max. and E_a min. respectively. From a complete set of characteristics of the valve, E_g max. and E_a min. are chosen, so that they are separated by a

temperature of the valve, so that it is essential to operate the valve at precisely the filament voltage prescribed by the manufacturers.

If the valve is overrun and the rated total emission current exceeded, the life of the valve will be considerably shortened. No attempt should ever be made to measure total emission current under static conditions by applying a steady positive potential to the grid and anode and adding the respective currents. Should this be attempted the large standing currents would ensure the very rapid destruction of the valve. Manufacturers assess the total emission of which a filament is capable from the nature of the material used, the physical shape and working temperature of the filament.

The part of the half-cycle during which the grid runs positive and the valve gives power depends upon the value of grid bias and

RF exciting voltage applied.

For cut-off bias it would be a full half-cycle or 180 deg. The arc which is normally used for Class "C" operation is from 120 to 150 deg. It will be noted that, at the moment of maximum power in the tank circuit, the anode current is a maximum and the anode voltage a minimum, and, under these conditions, the AC resistance of the valve will be a minimum. The lower the valve AC resistance

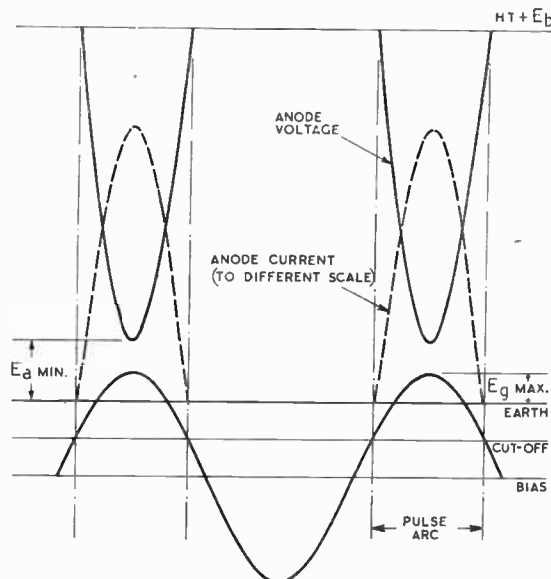

Fig. 1. Voltage and current relations in an oscillator operating under Class "C" conditions.

voltage equivalent to 2 to 5 per cent. of the HT voltage of the valve, and at the same time draw the total emission current. This current varies steeply with the filament

the greater the plate efficiency, because more volts will be dropped across the tank circuit and be available for useful "work."

If the grid pulse were greatly

Radio Heating Equipment—shortened, keeping E_g max. the same, the plate efficiency during the pulse would be improved and, in practice, plate efficiencies approaching 100 per cent. may be achieved. Plate efficiency is not to be confused with power efficiency, for the former refers to conditions existing during the period of the pulse only, while power efficiency refers to conditions existing over the whole cycle. A valve capable of 500 watts output with an arc of 140 deg. would give less than 250 watts if the arc were shortened to 80 deg.

The normal operating arc, 120 to 150 deg., gives plate efficiencies of approximately 80 and 60 per cent. respectively, and the value of grid bias required for a definite arc is given by the expression:—

$$E_{gb} = \frac{E_b}{\mu} + \left(E_g \text{ max} + \frac{E_a \text{ min}}{\mu} \right) \frac{\cos\left(\frac{\theta}{2}\right)}{1 - \cos\left(\frac{\theta}{2}\right)} \quad \dots \dots (1)$$

where θ = angle of arc
 E_{gb} = bias-voltage
 E_b = HT voltage
 μ = μ plification
 or.

The anode current will consist of two components, the DC current I_{dc} and the alternating current I_{ac} which is the oscillatory current supplying power to the tank circuit. I_{ac} will consist of fundamental and harmonic frequency components, but the latter will be small and may be neglected in approximate design. For a tank circuit "Q" of 10 the second harmonic power will be 6.6 per cent. and the third harmonic power 3.6 per cent. of the fundamental. For higher values of "Q" the harmonic content will be less. The ratio of I_{dc} and I_{ac} to total emission current I_t is tabulated below for the useful arc of positive grid voltage, 120 to 150 deg.

Angle θ (degrees)	$\frac{I_{dc}}{I_t}$	$\frac{I_{ac}}{I_t}$
120	0.195	0.350
125	0.201	0.360
130	0.208	0.370
135	0.214	0.380
140	0.220	0.390
145	0.227	0.400
150	0.234	0.410

The power input to the oscillator is the product of HT voltage and DC anode current.

$$\text{Power input} = E_b \times I_{dc} \quad (2)$$

The power output is given by half the product of AC anode current and the difference between HT voltage and E_a min.

$$\text{Power output} = \frac{E_b - E_a \text{ min.} \times I_{ac}}{2} \quad \dots \dots (3)$$

The statement that this is the power output is not quite correct, for, being a self-excited oscillator, a small part of the power is used in driving the grid circuit. This power is the product of peak RF drive voltage and DC grid current.

The difference between power input and power output represents the anode dissipation of the valve and, with the average Class "C"

circuit, a power efficiency of 66 per cent. should easily be achieved and may often be exceeded. It can be taken as a rough guide that a valve which will dissipate say 500 watts at its anode will be capable of delivering 1 kW. of power under Class "C" conditions. Similarly, two such valves, used in push-pull, would give 2 kW.

Grid bias is obtained by grid leak and condenser, the value of the leak being determined to a first approximation by the grid current (as indicated on a moving coil meter) and the bias voltage required, it being simply $R = \frac{E}{I}$.

The capacitance of the grid condenser should be such that with the grid resistor the time constant of the RC circuit is not so low that the condenser becomes appreciably discharged during one cycle, nor so large that intermittent interruption of oscillation occurs. An approximate method of determining this capacitance is given later in this article.

As the oscillator is loaded plate current will increase and grid current decrease, which causes the value of the bias to decrease under load conditions. This is dangerous, for with certain valves the bias may not be sufficiently great to

prevent E_g max. exceeding E_a min. It may be necessary to adjust the grid resistor under load conditions to prevent the bias voltage becoming too low, and this may be done automatically by including a relay in the HT supply lead to operate at a predetermined current, the relay contacts being connected across a portion of the grid resistor.

Bias may also be obtained by the use of a cathode resistor, but by this method the bias will increase as the anode current rises and, if an optimum resistor for load conditions is chosen, the standing unloaded anode current would be unnecessarily large. With cathode resistor biasing, should the generator cease to oscillate, there will be some bias applied to the grid of the valve, due to the DC drop across the resistor. With grid-leak bias, however, biasing voltage will disappear when oscillation stops. A combination of both types of bias is sometimes used as a measure of protection. On larger generators bias is often provided by a separate power pack and in this case oscillation failure has no harmful effect.

Tank Circuit

The "Q" of the tank circuit unloaded should be as high as possible, and when fully loaded "Q" should not fall below 10-12. The harmonic content of the output of an oscillator rises as "Q" is reduced, and below the values stated, a large portion of the power delivered to the load would be at harmonic frequencies. Also, since a tank circuit may be regarded as a resistance equivalent to its dynamic resistance, the power factor it presents to the valve is unity. With very low "Q" values, the tuning frequency which gives maximum voltage across the tank circuit will not be that which gives unity power factor. This will tend to reduce the overall efficiency of the generator and the effect is again due to the large harmonic content.

If, in the absence of a load, the tank circuit has a "Q" of 100, and when loaded a "Q" of 10, the tank circuit efficiency will be $\frac{100 - 10}{100} = 0.9$. This is the proportion of the total power delivered to the tank circuit by the

valve, which may be transferred to the load, assuming there are no losses in the transfer.

The peak alternating voltage across the tank circuit will be $E_b - E_a$ min., and, when considering the power in the circuit, the RMS voltage $E_b - E_a$ min./ $\sqrt{2}$ is involved. The resistance across which this voltage is developed is equivalent to the dynamic resistance of the circuit $\frac{L}{CR}$ ohms, where

R is the effective series resistance of the coil. This resistance is better expressed in this case as $Q\omega L$. The proof of this statement is as follows:—

$$Q\omega L = \frac{\omega L}{R} \times \omega L$$

but at resonance $\omega L = \frac{1}{\omega C}$

$$\therefore Q\omega L = \frac{\omega L}{R} \times \frac{1}{\omega C} = \frac{L}{CR} \quad \dots \quad (4)$$

Since $\frac{E^2}{R}$ represents the power in the circuit,

$$P = \left(\frac{E_b - E_a}{\sqrt{2}} \right)^2 \div Q\omega L$$

from which

$$\omega L = \left(\frac{E_b - E_a}{\sqrt{2}} \right)^2 \div PQ \quad (5)$$

This expression gives the value of inductive reactance for optimum power conditions in a circuit of given "Q." The value of "Q" is chosen to lie between 10 and 12, so that the tank circuit efficiency is as high as possible. From a knowledge of the value of ωL the inductance and hence capacitance to tune to the required frequency are found.

In designing push-pull Class "C" circuits, each valve is considered individually with regard to its operating conditions, but the peak alternating voltage developed across the tank circuit will be $2(E_b - E_a$ min.) or twice that for a single-ended oscillator. When the optimum value of ωL is found by application of equation (5), it must be remembered that the power is doubled in the case of push-pull operation and ωL will have twice the value it would for a single-ended oscillator. This agrees with the well-known fact that the optimum equivalent load resistance for a push-pull circuit should be twice that for a single-ended circuit.

A circuit diagram for a push-pull oscillator is given in Fig. 2.

Grid leak bias is employed and is developed across the common resistor R_1 for both valves. This enables one meter to indicate grid current. The RF chokes CH_1 and CH_2 in the grid circuit are to prevent the grid leak and condenser forming a shunt path for RF grid drive energy. A meter is included in the cathode lead of each valve and will indicate the sum of grid and anode currents.

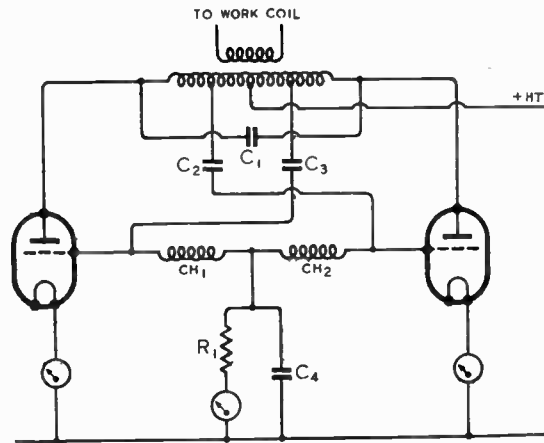

Fig. 2. Basic circuit of push-pull oscillator suitable for radio heating.

As an example of Class "C" push-pull power oscillator design, a heater employing two Osram A.C.T.9 valves will be considered. The valve data given by the manufacturers includes:—

- Total emission current—2 amps.
- High tension voltage—10,000.
- Anode dissipation—800 watts (Free air circulation).
- Anode dissipation—1,100 watts (Forced air circulation).
- Amplification factor—40.
- Max. positive grid volts—500.

As the anode dissipation is 1,100 watts with forced air circulation, one may reasonably expect an output of at least four times this power with two valves in Class "C" push-pull. Taking as a reasonable compromise between plate and power efficiency, an angle of flow of 140 deg,

$$\frac{I_{dc}}{I_t} = 0.22 \text{ and } \frac{I_{ac}}{I_t} = 0.39$$

and for 2 amps. total emission this gives a DC current of 440 mA. and a peak alternating current of 780 mA. The maximum grid current for the average valve is

approximately 15 per cent. of the total DC current or 66 mA in this case. The peak RF current flowing in the grid circuit under the conditions of Class "C" operation will be twice this value or 132 mA. This leaves a DC anode current of $440 - 66 = 374$ mA. and a peak RF anode current of $780 - 132 = 648$ mA. The value of E_a min. will lie between 10 and 15 per cent. of the HT voltage. Assume 12 per cent. or 1,200 volts, $E_b - E_a$ min. = 8,800 volts and power

$$\text{output for one valve will be } \frac{8,800}{2} \times 0.648 =$$

2.85 kW. The input power will be $10,000 \times 0.374 = 3.74$ kW., leaving an anode dissipation of $3.74 - 2.85 = 0.89$ kW. The power output from two valves will be 5.7 kW. and, assuming a tank circuit "Q" of 10 for load conditions, $\omega L =$

$$\left(\frac{2 \times 8,800^2}{\sqrt{2}} \right) \div (5,700 \times 10)$$

= 2,700 ohms. The RF voltage drop across the tank circuit dynamic resistance at resonance ($Q\omega L$) is $2,700 \times 0.648 = 17,600$ approx. or $2(E_b - E_a$ min.).

E_a max. must be less than E_a min. and lies between 4 and 8 per cent. of the HT voltage, according to the mutual conductance of the valve. For the A.C.T.9 valve, the manufacturer's value for E_a max. is 500 volts or 5 per cent. of the HT voltage. From equation (1) the value of grid bias is found to be 524 volts, so the value of grid resistor will be $\frac{524}{0.132} = 3,969$ ohms.

The size of grid condenser C_4 will depend upon the frequency of oscillations, and it can be taken that its reactance should be between 2 and 5 per cent. of the value of the grid resistor. Peak RF grid drive voltage will be $500 + 524 = 1,024$ volts and, as the peak RF voltage across half the tank circuit will be 8,800, the grid condenser tap will be positioned at $\frac{1,024}{8,800} \cdot \frac{T}{2}$ turns from the centre of

Radio Heating Equipment—

the coil where $T =$ number of turns on coil. The coupling condensers feeding energy to the grid from the tank circuit should have a capacitance such that their reactance is negligible compared with the impedance of RF grid chokes, and hence their value is elastic.

This example of design gives a power efficiency approaching 75

per cent., but it must be remembered that the valve is pushed to its limit as all the filament emission has been utilised. It is not customary to push valves quite so hard, and values of E_g max. and E_g min. are normally chosen which do not fully utilise the total filament emission, and power efficiencies of 66 per cent. are more often aimed at, so that replace-

ment costs can be minimised.

The present article has covered the major points of power oscillator design procedure, and these could be applied to oscillators, no matter how small or large the output required. The same procedure is applicable to Class "C" amplifiers, the difference being that no account need be taken of grid excitation power.

FUTURE OF SOUND RECORDING

Possibilities of Improvement in Post-war Gramophones

THE discussion on the subject "Recording and Reproduction of Sound," held by the Wireless Section of the Institution of Electrical Engineers on February 15th, aroused such interest that extra seats had to be brought into lecture theatre; the proceedings lasted for over three hours.

Dr. G. F. Dutton, in his introduction, stated that when industry can turn back after the war to the development and manufacture of gramophones, it would be useful to have a settled line of attack. It was the purpose of this discussion to exchange views regarding the various systems available for the recording and reproduction of sound, bringing out their comparative merits and demerits.

The disc system, in spite of its age, offered a great many facilities for home use and for broadcasting. It was relatively easy to handle, it provided a self-contained and compact unit, processing was relatively cheap, short numbers could be catered for, and the record was accessible for extracting short portions for programmes or educational use.

The development of the cellulose recording disc had given the recording companies a new tool. We were now able to assess the quality of the recording and reproducer by direct playback, without the doubtful intermediary stage of processing as was necessary when wax discs had to be used.

The relative merits of the lateral-cut and the hill-and-dale systems were very close. The hill-and-dale system was the older and had now been largely replaced by lateral cut.

The chief improvements required for the disc system were: signal to-noise ratio, intensity range, frequency range, freedom from non-linear distortion, constancy of results and life, storage and playing time.

Wider Frequency Response

The frequency range on the average pre-war record was limited at the high end to 6,000 c/s. Very few gramophones could utilise even this limited range because of the response characteristics of the pick-ups and the surface noise of the records. The recording range could be taken up to 12,000 c/s, and this range could be preserved without appreciable loss during the factory processing, provided certain precautions were taken. The desirability of an extended range had been a debatable point, and the issue has always been clouded by the intervention of noise. With the direct cellulose playback, we could now better appreciate the advantages of extending the frequency range.

Before an extended frequency range could be utilised, attention had to be paid to the record processing, record material, needle point, and the pick-up system. The size and shape of record grooves and of the needle point must receive special attention. Only by use of the correctly shaped needle tip could quiet surface records be used. Broadly speaking, the record disc consisted of a mixture of thermoplastic resins in suitable proportions to give strength, good plastic flow in the press and ultimate stability. Whether or not a mineral filler was to be added depended on the type

of needle to be used in the pick-up and the pressure of the needle point when playing. The optimum shape of needle had a hemispherical end of 0.0025in. radius when working with the accepted standard shape of groove. Ordinary commercial needles departed from this ideal shape, many presenting extremely sharp points which exert such a pressure on the record that the surface was broken. In the past, therefore, a record filler had to be used to grind these sharp points to a reasonable bearing surface within a few inches of travel. A practically noiseless record without a filler was possible, and any introduction of filler increased noise in proportion to the amount and to the particle size. The wear on the needle also depended on the filler used. The war had seen the development of a number of plastics which were extremely interesting from a record-manufacturing point of view, and no doubt these would be tried when they became available for this type of work after the war.

With regard to film or strip recording, the introduction of ultra-violet recordings had increased the resolution to such an extent that the film may be taken with little or no loss up to 12,000 c/s, using the standard film speed of 90ft./min. Intermodulation, which was at one time a common type of distortion, was now reduced to a small value. The use of normal silver photographic emulsions for printing copies was expensive for domestic gramophones. There were, however, several diazo-dye printing processes which were a great deal

cheaper. It was also well known that film could be arranged with two tracks working in opposite directions, so that one track could be used when unwinding, and the other track for rewinding the spool. The future of the strip or film reproduction depended on the processing costs.

Binaural Effects

On the question of stereophonic recording and reproduction, it was admitted that no sound-recording system could claim to have high fidelity unless it recorded and reproduced the direction of the original sounds. But at least two channels were necessary and the expense was considerable. The lack of binaural effect in single-channel normal recording had been corrected to a large extent by positioning the microphone and by special acoustic conditions of the studio.

Demonstrations were given from recordings of the disc type and also of the film type.

Two speakers later emphasised the great interest of sound recording to the B.B.C., especially for repeat programmes, an interest which has been greatly increased under war conditions. At the moment discs play a large part in the B.B.C. recordings, but some are of larger diameter than the normal 10in. or 12in. record and revolve at a lower speed to secure a longer playing time.

A special feature in this connection was the design of portable apparatus for securing material which could not be brought to the studio. On the general question of high-grade recording, the comment was made that the B.B.C. was unable to purchase in this country equipment which would fill their requirements, and they are now using their own design of equipment which will take 17in. discs having 150 grooves per inch. 10,000 c/s has been adopted as the upper limit of frequency.

More than one speaker saw in the discussion an excellent opportunity of taking stock of the present position of the art and assessing the prospects for the future. The importance of the co-ordination of electro-acoustic research work was stressed, there being various lines of development under investigation at the present time. A published list of standards was necessary, but

nothing authoritative had yet been done in this country. The warning was given that this question would have to be faced very soon. The demand was made for standards of speeds, dimensions of grooves, etc.

The weight of pick-ups received considerable attention, and the hope was expressed that there would be no more 120 gm. pick-ups and no more motors of uncertain speed. Pick-ups of not more than 40 gm. were recommended. The 120-gm. pick-up was said to give a pressure of some 20 tons to the sq. inch on the needle point.

For home use, at least for a long time, it was felt that the disc must predominate over the film owing to the higher cost of film apparatus and the greater expense of processing and—although this was not accepted by Dr. Dutton—owing to the capital value represented by the world-wide currency and interchangeability of the present familiar discs.

The possibility of film recording apparatus becoming available which would enable a private individual to take recordings of B.B.C. programmes, and so build up a private library, was mentioned and caused some amusement. Possibilities of after-war developments in film reproduction of sound with new emulsions having improved resolution were indicated as being on the way. A frequency range even exceeding 15,000 or 16,000 cycles was mentioned in this connection. Although some people doubted the necessity of raising the frequency range to 12,000 cycles, the opposite view prevailed that it is essential to take the frequency range as high as possible for an adequate reproduction of music, particularly "attack."

The discussion made it clear that important developments are pending and that major improvements in sound recording for all purposes lie ahead.

DIRECT RECORDING ON FILM

ONE of the principal objections levelled against recording on film—the need for development and drying—is overcome in the

pick-up are mounted on a rocker arm, and either may be brought into operation by movement of the lever seen projecting to the left of the coil of film. An essential feature of the mechanism is a resilient bed of felt

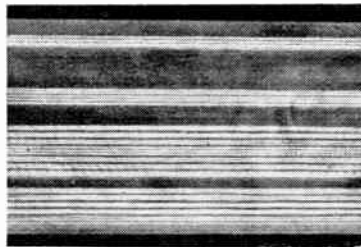

Fonda sound recorder and a specimen of the film.

system evolved by the Fonda Corp. of New York by embossing a track with a needle on plain cellophane strip. The machine illustrated makes use of a 320ft. endless loop just over an inch in width and is capable of taking 60 parallel grooves. With a film speed of 40ft. per minute a playing time of 8 hours is obtained at a cost of about 50 cents per hour.

The recording head and play-back

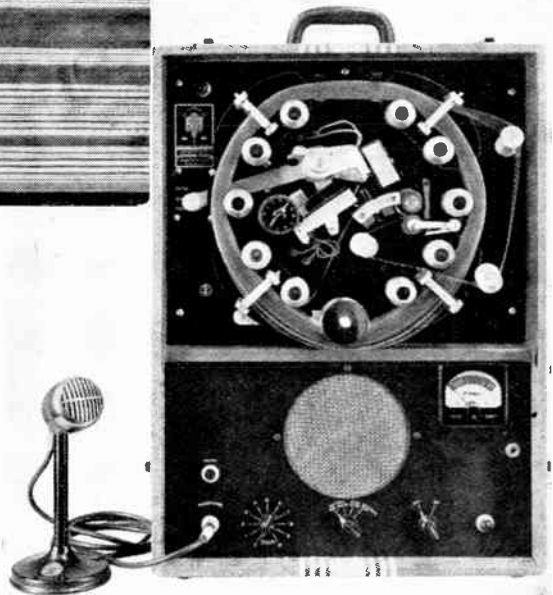

under the recording needle which ensures a well-formed track without the risk of cutting through the film.

The apparatus is already in use by American Airlines for recording ground-air conversations.

MORE TELEVISION PROPOSALS

Definition Standards for Our Post-war Service

IN the course of a recent discussion meeting of the British Institution of Radio Engineers on television standards, opened by W. A. Beatty and L. H. Bedford, the latter examined the essential parameters of a plane monochromatic television system with a view to deciding what might be changed in the post-war British television system. He said that there were three schools of thought on post-war television, of which the two extremes were those who wished to reopen after the war on 405 lines and those who were willing to postpone reopening of the service indefinitely until some drastically improved system had been developed; in contrast to these extremes there was the school which aimed at the earliest possible reopening on standards consistent with present technico-economic limits and the extension of television to a nation-wide service, together with a nation-wide UHF sound broadcasting system. The proposal to reopen on 405 lines and change fairly soon to a fundamentally different system would be impracticable, and it should be assumed in discussion that the standard adopted for reopening would be the permanent standard.

For either 405 lines or development within present limits the following parameters could remain unchanged: twofold interlaced scanning, a picture aspect ratio of 5 to 4, the present synchronising signals and mask times, and the use of positive modulation. Negative modulation has its advantages, including the possibility of obtaining automatic gain control from the synchronising pulses, but positive modulation has the overwhelming merit of freedom from false synchronising by noise peaks; reliability of synchronisation is of paramount importance to the non-technical user, to whom the complete break-up of the picture is far more distressing than the appearance of interfering signals on it.

The carrier frequency previously used has been well tried and proved satisfactory; any change

to a very much higher and untested frequency would risk troubles, and although the first experiment had succeeded, it would be unwise to submit the public to another experimental period by choosing a carrier frequency whose suitability is not fully proved. The sound transmission should use frequency modulation, and the vision signal should be transmitted on the vestigial side-band system. Besides the American experience with the latter, we have practical evidence of its advantages from pre-war receivers, in which it was found preferable to adjust the somewhat limited pass-band of the receiver so that the carrier frequency fell near one side of the band instead of at the centre.

The classic formula relating the required frequency band to the picture definition is $f = \frac{1}{2}(1/T)Rn^2$, where n is the number of lines and T the scanning time of the picture, both net (i.e. excluding masking) and R the picture aspect ratio. If the picture definition is unsaturated (i.e. if the line structure of the picture is perceptible) there is no upper limit to the useful frequency band for a given number

may be attributed to stroboscopic effects, and which modifies the formula to $f_i = (1/3)(1/T)Rn_i^2$; this means that with a given bandwidth the optimum number of lines is 50 per cent. greater for interlaced than for sequential scanning.

To determine how many lines are necessary for the picture to be saturated at a given viewing angle, it is necessary to know the "acuity of vision." But in television it is the sharpness of edges of comparatively large masses which controls the apparent sharpness of image, not the resolution of fine detail on which "acuity of vision" is normally based, and Mr. Bedford had carried out experiments to determine the acuity of vision in this television context. Using special test charts, he had found that a square-wave black and white pattern (i.e. a strip made up of alternate black and white sections) is distinguishable from a uniform grey when the angle subtended by a unit of the pattern is 1 in 2,000; but by taking instead the possibility of distinguishing between a square-wave distribution of illumination and a sine-wave distribution of

PICTURE CHARACTERISTICS

Vertical Viewing Angle	n	R	N	T	f	Remarks
1/6	450 (s)	5 : 4	254,000	16 ms	7.94 Mc/s	sat.
1/6	675 (i)	5 : 4	254,000	32 ms	5.95 Mc/s	sat.
1/10.5 (sat.)...	385 (i)	5 : 4	82,000	32 ms	1.92 Mc/s	B.B.C. service
1/8.1 (sat.) ...	500 (i)	5 : 4	139,000	32 ms	3.26 Mc/s	
1/4	675 (s)	4 : 3	600,000		14.0 Mc/s	Cinema
	1,000 (i)					

Abbreviations: sat., saturation; n , nett no. of lines; R, picture ratio; N, number of picture points; T, picture scanning time; f , frequency band required; s, sequential; i, interlaced.

of lines, because the definition along the length of the lines increases with the band-width; the equation should therefore be used only in the opposite sense, that for a given band-width there is an optimum number of lines. If the scanning is interlaced, there is an additional factor of 2/3 which

the same period, and as a further stage using a light distribution made up of sine wave and third harmonic, he had arrived at an angle of 1 in 1,350 or about 2½ minutes of angle as the appropriate acuity of vision. On this basis he showed the accompanying table giving figures for

viewing angle, net number of lines, picture ratio, number of "picture points," picture scanning time and frequency band for various types of picture. For example, the Alexandra Palace transmissions had 385 lines net with interlaced scanning, and would appear saturated (i.e. free from line structure) if viewed from a distance of 10.5 times the picture height. To obtain saturation at a viewing angle of 1 in 6, which is believed to be optimum for television, would require 450 lines sequential scanning or 675 lines interlaced; the latter is the optimum number of lines for a band-width of 5.95 Mc/s. As a standard of comparison, a cinema picture has a definition equivalent to 675 lines sequential or approx., 1,000 lines interlaced scanning, which would correspond to a band-width of 14 Mc/s. The viewing angle from the best seats in a cinema is about 1 in 4.

At the close of the discussion, the Chairman announced that the Institution was collecting information for a statement to be submitted to the Television Committee.

Another Scheme

General problems involved in re-starting the British television service after the war were reviewed by B. J. Edwards, of Pye, Ltd., in a paper read before the Institution of Electrical Engineers on February 23rd. Mr. Edwards considered that the factors influencing the expansion of television were economic rather than technical, and he surveyed the possibilities of obtaining the necessary revenue for the service by means of sponsored programmes, licensing, and some degree of Government support. Fortunately, much of the best programme material would come from transmission of topical events which would involve little cost.

Radio links on centimetre waves were advocated for distribution throughout the country; a proposed basic scheme is shown in the accompanying map. The cost of cables for distribution would retard development, and it was thought that in any case no cable system yet exists that is capable of transmitting the wide vision band envisaged as desirable.

After reviewing the admitted advantages of re-starting on the

pre-war definition standards, Mr. Edwards concluded that this procedure would have a retarding effect on research and development, and advocated a change to an improved system with definition of the order of 800 lines with a vision bandwidth of 20 Mc/s, which would imply a carrier frequency running into hundreds of megacycles. Colour television was regarded as a desirable development, but one for the future rather than the present. It was possible, however, that, by choice of a suitable line structure and frame reproduction rate, colour could eventually be introduced without rendering monochromatic receivers obsolete.

One of the greatest difficulties likely to be encountered with a high-definition system was interference with the main picture by

reflections of the signal from buildings, etc., which give rise to secondary images laterally displaced a short distance from the main image. One method of minimising the effect of these unwanted signals is to increase the directional properties of the receiving aerial by some form of reflector. From considerations of wind pressure and cost it would seem desirable to operate on such a frequency that a paraboloid reflector not greater than 2 ft. or, better, 18 in. in diameter, could be used.

The advantages of interlaced scanning were considered far to outweigh its disadvantages. Although it did not bring about any great saving in band-width—certainly not 2 : 1 for good picture resolution—the author thought that there are unexplained differ-

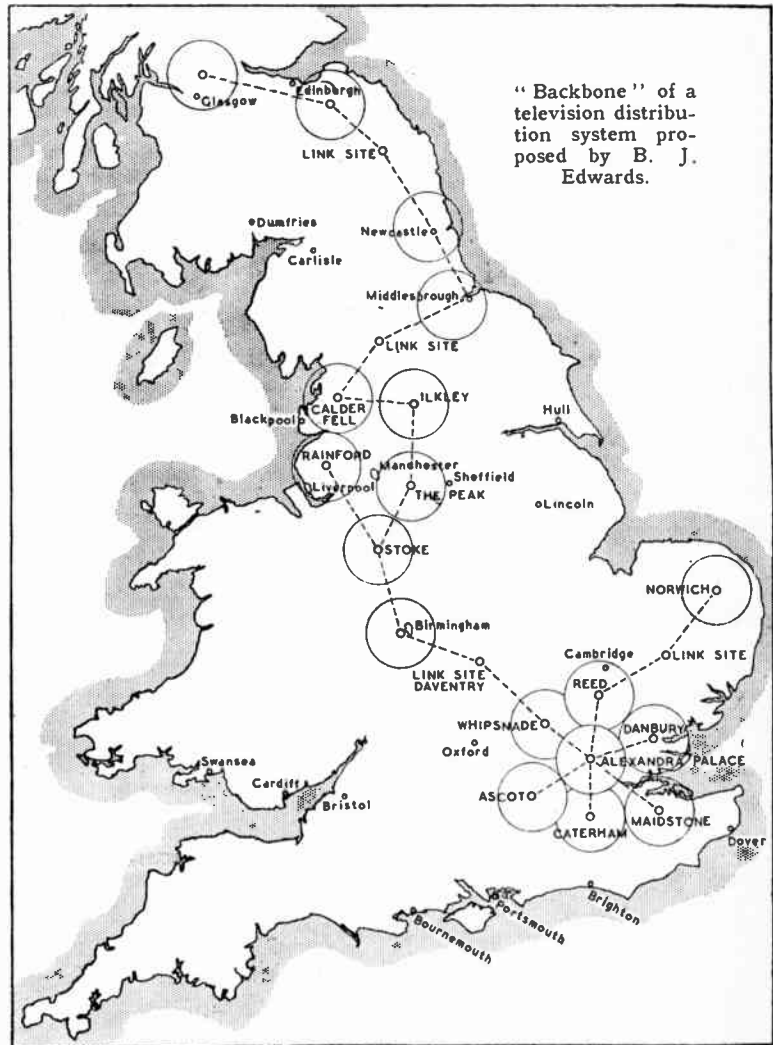

More Television Proposals—

ences in the definition obtainable with interlaced and sequential scanning for a given band-width. The rate of 25 frames per second was considered reasonable.

After considering other secondary details of transmitter and receiver design Mr. Edwards came to the conclusion that to re-start on the old standards was undesirable, although he considered the possibility of operating the old system for a period of, say, 5 years while a new system was being developed. He thought that the foundations of a progressive and successful television industry could best be laid by beginning experimental transmissions on an improved system as soon as possible. It was not unreasonable to suppose that, thanks to the increased

tempo of radio development, it would be possible to start such transmissions within a year.

In the discussion that followed doubt was widely expressed whether an improved system—especially one with such a radically increased definition as that proposed—could in fact be developed so quickly as the author suggested. As a natural corollary, there was a marked tendency to advocate re-starting on 1939 standards, with parallel development of a system of higher definition. Arguments against adopting a great increase in definition were mainly concerned with the time necessary for evolving a technique differing radically from known practice, with the higher cost of receivers, and with the problem of reflection interference.

not in some cases reduce the effect of interference injected into the mains. The fact that some of this interference is re-radiated by the house wiring and picked up by the aerial is, of course, a reason why a transformer screen cannot in such circumstances be fully effective in eliminating it.

An elaborate series of tests, with interference of different kinds injected at distant and nearby points, and with various types of receiver in use, would provide interesting and useful data, and perhaps someone with suitable facilities will investigate this subject further.

T. A. LEDWARD.

Huyton, Nr. Liverpool.

Why "I" for Current ?

IN the March issue of *Wireless World* Mr. Ghery states that he has been puzzled for many years over the choice of the letter "I" for current. I have, with the kind assistance of the Librarian of the Institution of Electrical Engineers, looked up this question with the following rather interesting results.

A copy of Munro and Jamieson's pocket-book, 17th edition, issued in 1904, gives the following information:—

R Resistance	A Amperes
C Current	K Capacity
V Volts	I Current (AC only)
E EMF	L Inductance

It is very interesting to note that the main difference is the rather extraordinary one of using "I" to indicate alternating current only. The other differences are, of course, the use of "C" for current and "K" for capacity.

I believe, but I had not the necessary time to verify it, that the present symbols "I" for current (both AC and DC) and "C" for capacity were introduced in the year 1915.

I was also interested to note in a "Report of the Committee on Electrical Standards," published at Cambridge and covering the years 1862 to 1912 inclusive, that, at the 22nd meeting of the Committee held at Ipswich in 1895, Sir Oliver Lodge describes a unit which he calls total inductance and to which the symbol "N" is applied. Lodge states that $N = LC$.

At the same meeting a Mr. Everitt describes another quantity which he calls "differential

Letters to the Editor**Reducing Mains-borne Interference •
Origins of Symbols****"Transformer Screening"**

MAY I comment on T. A. Ledward's article in your January issue? While I think that his suggestions for improvement in this direction are admirable and call for little criticism, I would like to point out that his tests with a vacuum-cleaner, receiver and screened transformer do not tell us much. This is because, apparently, little account was taken of the radiation of interference by the house wiring being picked up by the aerial.

From the tests quoted one would interpret that, as in 1 (a) and 1 (b) no difference was observed, in 1 (c) the drop in interference output reading was due to out-phasing of the interference arriving at the receiver from (i) the aerial, (ii) the mains via the transformer screen. The differences observed between tests 1, 2 and 3 were surely due to the different relative amplitudes arriving at the receiver via the two paths and their difference in phase. These would naturally change when the positions of the source of interference were changed.

I would suggest that if Mr. Ledward had disconnected the aerial completely from the receiver he

would, in reducing to a minimum the number of variables in his given set of conditions, have obtained more valuable results in estimating the effectiveness of his transformer screening.

J. WEAVER.

Stafford.

Author's Reply

I QUITE agree with Mr. Weaver's interpretation of my interference tests on a receiver with a screened transformer. These tests were only included in the article as being of some general interest, but were not by any means exhaustive. Mains-borne interference was not, of course, the principal subject matter of the article.

The tests did, however, give the actual results obtained under certain practical, though limited, *working conditions*, which would not have been the case had I disconnected the aerial completely, as suggested by Mr. Weaver.

I find it rather difficult to appreciate the real point in his criticism, but I think he has misunderstood my purpose. I was not, in this case, comparing the effectiveness of different forms of screening, but showing that an earthed transformer screen would

inductance," which has the value dN/dC .

I have not seen either of these terms before, and I should be interested to know if other readers make use of them.

As to the reason for the choice of the letter "I" to indicate current, it is presumably taken as the initial letter of the word *Intensity*. I regret this is not a complete answer to Mr. Ghery's letter but it may prove of interest.

O. S. PUCKLE.

Edgware, Middx.

THE answer to the question put by Mr. G. Ghery, "Why 'I' for Current?" is that "I" is the initial letter of *Intensité*. As French is the predominating language in international electro-technical literature, the symbol "I" has been generally adopted.

C. W. MARSHALL.

East Horsley, Surrey.

Non-interfering Domestic Devices

I WAS interested in "Diallist's" remarks in your March issue about future domestic electrification. As he rightly points out, a lot of interference trouble would never occur if manufacturers made more use of the induction type of motor. I have, however, been a little more fortunate than "Diallist." When, some time ago, one of my manufacturer friends told me he was proposing to make and market an electric hair-dryer, I immediately suggested he used an induction-type motor. Objections were raised on the grounds of cost—he apparently already had a fairly cheap little commutator-type motor. I replied the AC type should cost less, besides being much more reliable, etc. Then the question of speed came up. It was agreed that he should check speeds, experiment, etc., and, to cut the story short, that manufacturer went into production with a hair-dryer having an induction motor which was non-interfering, quiet running, virtually trouble-free, and—important from his viewpoint—cheap to make.

The egg-whisk, drink-mixer, mincing-machine, etc., can readily have induction-type motors. The real problem comes with vacuum-cleaners and sewing-machines. However, I feel there is still hope even here.

Let us all put in a word for the

induction motor wherever we can and, sooner or later, it will bear fruit.

T. L. FRANKLIN.

Broxbourne, Herts.

Servicemen's Organisation

WITH reference to the letter appearing in the March issue of *Wireless World* regarding a servicemen's organisation, may I say that active steps are now being taken to endeavour to form one?

It is hoped shortly to hold a meeting at which preliminary arrangements for the organisation can be made and it is hoped that, for the benefit of those interested, you will be able to publish further details in due course.

J. H. CORBETT.

High Wycombe. Bucks.

THE WIRELESS INDUSTRY

AN up-to-date catalogue of the measuring instruments made by Taylor Electrical Instruments, Ltd., 419/422, Montrose Avenue, Slough, Bucks, is now available and will be sent free on request to firms who are interested.

The accurate measurement of time intervals ranging from 1 millisecond to 1 second is made possible by an instrument known as the "Microtimer" which is made by R. K. Dundas, Ltd., The Airport, Portsmouth. The principle involves the charging of a condenser through a constant current circuit, the resultant voltage being measured by a DC valve voltmeter. Instruments for AC or battery operation are available.

A comprehensive illustrated catalogue of T.C.C. condensers for receivers and transmitters has been prepared and is available to responsible executives in firms engaged on essential work, Government supply departments, etc., on application to the Telegraph Condenser Co., Ltd., Wales Farm Road, London, W.3. The matter is exceptionally well arranged and there is much useful advice on the selection of suitable types for all purposes.

Since the notice in our December, 1943, issue of the acquisition of Hammans Industries, Ltd., by De La Rue Plastics, Ltd., it has been announced that a new company, De La Rue Insulation, Ltd., has been formed to manufacture the laminated plastics, insulated sleeveings and insulated wires formerly made by both companies. The offices of the new company are at Brighton Road, Sutton, Surrey, and there are showrooms at "Imperial House," Regent Street, London, W.1.

Until further notice, all correspondence for Norman Rose (Electrical), Ltd., and for the subsidiary firm, Waveband Radio, Ltd., should be addressed to 26, Elvaston Mews, Kensington, S.W.5.

GALPINS

ELECTRICAL STORES

"FAIRVIEW,"
LONDON ROAD, WROTHAM,
KENT.

TERMS: Cash with Order. No C.O.D.
All prices include carriage or postage.

MOTOR-DRIVEN PUMP, for oil or water, motor 220v. D.C., 1 amp., 1,250 r.p.m., maker Keith Blackman. £6 10s.

MASSIVE GUNMETAL WINCH, complete with long handle, for use with $\frac{1}{2}$ in. dia. wire cable, weight 50 lbs., condition as new. £3.

ELECTRIC LIGHT CHECK METERS, well-known makers, first-class condition, electrically guaranteed, for A.C. mains, 200/250 volts 50 cy. 1 phase 5 amp. load, 11/- each; 10 amp. load, 13/6.

SOLID BRASS LAMPS (wing type), one hole mounting, fitted double contact, S.B.C. holder, and 12 volt 16 watt bulb. 3/6 each, or 30/- per doz.

TUNGSTEN CONTACTS, $\frac{3}{8}$ in. dia., a pair mounted on spring blades, also two high quality pure silver contacts, $\frac{3}{8}$ in. dia., also on spring blades, fit for heavy duty, new and unused. There is enough base to remove for other work. Set of four contacts, 5/-.

ROTARY CONVERTER, D.C. to A.C. Input 22 volts D.C. (twenty-two). Output 100 volts at 140 M/A, 50 cycle, single phase, ball bearing, in first-class condition, no smoothing. £3.

RESISTANCE UNITS, fireproof, size 10x1in. wound chrome nickel wire, resistance 2 ohms to carry 10 amps. 2s. 6d. each.

AMP METER, switchboard type, 6in. dia., for AC/DC, one reading 0-300 amps., one reading 0-100 amps., either meter, 50/-.

TRANSFORMER, input 230 volts, output 2,000, 1,000-0-1,000, 2,000 v. at $\frac{1}{2}$ amp. £9.

3-PHASE TRANSFORMER, 410v. to 240v. at 2kW, size of core 14in. by 11in. by 5 square inch section. £10.

ROTARY CONVERTER, input 220 volts D.C.; output 18 volts at 28 amps. £7 10s.

TAPE MACHINE, fitted Klaxon 220v. D.C. motor geared drive, rheostat control, 18 ohm relay, complete with tape reel and tape. £10.

TRANSFORMER cores will rewind for a 1 kW auto, present windings not guaranteed. 22/6.

BLOCK CONDENSERS, 4 M.F., 2,500v. working, size 6in. x 5in. x 3in. 30/-.

TRANSFORMER, input 200/250 volts; output 500, 450, 400-0-400, 450, 500 volts at 250 M/A, also 5v. 4a. C.T. twice, size 6x7x5in. 70/-.

VOLTMETER, 9in. dia., switchboard type, for A.C. or D.C., range 0-700 volts, clear scale 100 to 700 volts, very even reading. £3.

AIR PRESSURE GAUGE by famous maker. 10in. dia., reading 0-4,000 lb. per square inch, as new, in case. £7 10s.

SWITCH FUSE in wrought iron case, 3-way, for 400 volts at 40 amp. 45/-.

BUZZER WAVEMETER, complete in teak case, range 10 to 5,000 metres, condition as new. 30/-.

WANTED

If any reader has Price Lists or Catalogues of Radio and Electrical Goods I would greatly appreciate them to replace those lost in removal. Postage or cost willingly refunded.

WORLD OF WIRELESS

AMERICAN BROADCAST SETS

AN authoritative statement on the supply of imported receivers was issued by the Radio Manufacturers' Association on March 6th. It states that it is expected the work of testing the first 10,000 imported receivers and of making them suitable for the British market will shortly be completed, and so permit their distribution to the trade during March.

It is announced a further 20,000 sets will become available probably during the following three months.

These imported receivers will, it is understood, be followed later by the "standard" British-made set.

The imported sets, all of which are superhets, are of many types but, for the purpose of price regulation, have been classified into four groups by the Board of Trade.

Those in Group I are medium-wave five-valve sets (including rectifier) in bakelite cases and will cost £11 14s. 2d.

Sets in Group II are similar to those in Group I but generally in wooden cabinets. A few sets in this group cover the medium- and short-wave bands. Price £13 10s.

Group III includes six-valve medium-wave sets for AC/DC/battery operation and receivers similar to those in the first two groups but in superior cabinets. Price £15 5s. 10d.

Group IV comprises AC/DC/battery six-valve sets covering the medium- and short-wave bands. Some have push-button tuning. Price £17 1s. 8d.

The majority of the sets for short-wave operation cover 16 to 50 metres, but a few 16 to 25 metres only.

The prices given include Purchase Tax.

SERVICING EXAMINATION

THE first Radio Servicing Certificate Examination to be held under the auspices of the Radio Trades Examination Board will take place on Saturday, May 13th. It is understood the closing date for entries, which should be addressed to the Secretary to the Board, 9, Bedford Square, London, W.C.1, is March 31st.

RADIO AND CIVIL AVIATION

NO details are available of the discussions which have recently taken place between technical and operational experts at a British Commonwealth and Empire Conference held to study wartime advances in radio development in the light of its bearing on post-war civil aviation. It is understood only technical aspects were examined

and the delegates have to report the recommendations to their respective Governments.

Sir Stafford Cripps, the Minister of Aircraft Production, who is Chairman of the Radio Board, presided at the conference.

COMPONENT MAKERS' REPORT

IN the recently presented Annual Report for 1943 of the Radio Component Manufacturers' Federation it is stated that the year's work has been principally directed towards assisting the war effort by promoting a vastly augmented output and improving the technical standards of components. There has been expansion of the Technical Panels and the Technical Coordinating Committee under the Inter-Service Component Manufacturers' Council; many inter-service draft specifications have been published. Miniature components have in many cases needed an entirely new manufacturing technique. A private exhibition of components held last month proved a great success, 77 firms showing apparatus.

Member firms of the new R.C.M.F. Council are: Belling and Lee, A. F. Bulgin and Co., Plessey Co., Reliance Manufacturing Co., Standard Telephones and Cables, Steatite and Porcelain Products, Telegraph Condenser Co., Westinghouse Brake and Signal Co., and Wingrove and Rogers.

Sir Percy Greenaway was re-elected as President, and the officers for 1944 are: Chairman, P. A. Sporing; Vice-Chairman, E. M. Lee; Treasurer, A. J. Dobie; Vice-Presidents, Major Peter, A. F. Bulgin, J. R. Spink.

BRAVERY AT SEA

THE latest list of awards of "Lloyd's War Medal for Bravery at Sea," which is given to officers and men of the Merchant Navy and Fishing Fleets for exceptional gallantry at sea during the war, contains the names of two radio officers: 1st R.O. Frederick R. Clark (deceased) and 3rd R.O. Neil M. Coleman.

When their ship, sailing alone, was torpedoed and set ablaze 1st R.O. Clark sacrificed his life by his devotion to duty, remaining on board to transmit messages which brought a ship to the rescue of the survivors. 3rd R.O. Coleman also displayed great courage and a high sense of duty. While the distress messages were being transmitted he held a broken connection in position and would not leave until the flames forced him to do so.

FM PROBLEMS IN THE STATES

SOME of the problems associated with the development of frequency modulation were discussed at a recent convention of FM Broadcasters, Inc., in New York. The convention was told that the Radio Technical Planning Board "place FM problems near the top of its agenda" for post-war development.

One of the biggest problems facing FM planners is that of accommodating an adequate number of stations in the larger metropolitan areas in the existing FM frequency band. This band, extending from 42 to 50 Mc/s, accommodates forty FM channels with a maximum of 17 stations in the same metropolitan area.

The hope is entertained by interested parties that an adjacent portion of the spectrum now allotted to television may be made available for FM. Commenting on this point our Washington contemporary, *Broadcasting*, says "television proponents are resisting this move."

FERRY-SERVICE RADIO

SIX long-wave wireless stations, linking the United States, Newfoundland, Labrador, Greenland, Iceland and Great Britain, have been erected by the U.S. Army and are "greatly expediting" the ferrying of aircraft across the North Atlantic.

The United States War Department announces that the new long-wave network ensures a 24-hour radio-telegraph and radio-teletype service uninterrupted by atmospheric disturbances and magnetic storms which so frequently interfere with short-wave communications in the far North.

WHAT THEY SAY

TO-DAY . . . there has spread throughout the country [U.S.A.] the understanding that FM means not only technical improvement, but a renaissance of the broadcast structure. . . . The broadcasting and manufacturing industries now have at hand a vast post-war development which will furnish improvement and utilise manufacturing plant capacity on a scale never approached in pre-war days. It is the only development the radio art has that will do this for many years to come.—*Dr. Edwin H. Armstrong, at the fifth annual convention of FM Broadcasters, Inc., in New York.*

It will be the concern of the B.B.C. to work in closest co-operation with all those industries in the

chain of bringing the output of the B.B.C. to the consumer.—*Robt. Foot, B.B.C. Director-General, at the Radio Industries Club luncheon.*

The [American] wife is steadily corrupted and eventually poisoned by the most fiendish advertising ever to be inflicted on mankind—the advertising of the radio. . . . She turns on the radio and gets what are known as “soap operas” or “washboard weepers.” . . . The terrible fact is that millions of women listen to the most demoralising slush with such attention that, in fact, it becomes their real world. This is something to consider when advertising interests raise the question of commercial radio in Britain.—*William Brown, writing in “Reynolds News” on David Cohn’s book “Love in America.”*

CAR RADIO AGAIN

THE ban imposed by the Postmaster-General in June, 1940, on the carrying of sets in road vehicles has been lifted. It is estimated that some 50,000 sets were removed from cars when the ban was imposed.

Owners of sets which were impounded should apply to the police of the district in which they were impounded for their return.

DISINTERESTED ?

WHEN asked in the House of Commons whether he would appoint an additional member to the Government Television Committee to represent the interests of the user, the Lord-President of the Council said: “This Committee is primarily concerned with technical matters; it would not be appropriate nor necessary at this stage to add representatives of outside interests.”

IN BRIEF

I.E.E. Award.—Harold Page, M.Sc., has been awarded the Coopers Hill War Memorial Prize and Medal by the Council of the I.E.E. for his paper on “The Measured Performance of Horizontal Dipole Transmitting Arrays.” The award is triennial and fell in 1943 to the I.E.E.

Radio Corsica.—A new broadcasting station built since the liberation of the island can now be heard on short waves in the 29-metre band and on 355 metres. It relays programmes from Algiers Radio at 0600, 1130, 1730, and 1900 (GMT).

Forces Radio in Italy.—Sir James Grigg, Secretary of State for War, replying to a question, said: “A considerable number of wireless sets [for the Forces] were already in Italy. Additional sets would reach Italy from the Middle East and this country shortly, and further supplies would follow.”

Congratulations.—We join in the congratulations offered by the wireless industry to our contemporary *The Wireless and Electrical Trader*, which celebrated its “coming of age” in March.

Sylvan Ginsbury, who was one of the first to introduce American components to this country, went over to the Australian War Supplies Procurement Board in Washington when the firms he represented turned from export to war work. Mr. Ginsbury has now relinquished this full-time post, but still acts as consultant for the Australian department in Washington.

Relay Statistics.—The radio relay statistics to the end of September, 1943, show an increase of 17,692 subscribers, although the number of exchanges has been reduced by one to 275.

Prisoners of War.—Marconi radio officers who are prisoners of war have been receiving monthly parcels of cigarettes, tobacco, books, etc., as a result of a Fund inaugurated at Marconi’s, which has collected £5,400 in 32 months for this purpose.

Aid to China.—A cheque for £115 has been sent to the United Aid to China Fund, the proceeds of a dance given by Masteradio Sports and Social Club.

Waste paper plays its part in the manufacture of mobile wireless stations now used by the R.A.F. These travelling transmitters, which can be brought into action in the early stages of a campaign before landlines can operate, provide communications and are also used in conjunction with radio-location stations. For sound and thermal insulation the walls are lined with building board containing a substantial percentage of salvaged paper. Paper is also needed to equip the stations with instruction manuals, reports and plotting charts.

MEETINGS

Institution of Electrical Engineers

Wireless Section.—The subject of the paper to be given by Dr. D. Gabor on April 5th will be “Energy Conversion in Electron Valves.” Dr. G. L. Sutherland will open a discussion on “Metals and their Finishes in Radio Construction” on April 18th. Both meetings commence at 5.30 and will be held at the I.E.E., Savoy Place, Victoria Embankment, London, W.C.2.

Cambridge and District Wireless Group.—A meeting will be held at the University Engineering Department, Trumpington Street, Cambridge, at 8.15 on March 30th, when R. H. Angus, M.A., will give a lecture, illustrated by a cinematograph film, on the subject of “Transients on Transmission Lines.” B. J. Edwards will give a “Survey of the Problems of Post-war Television” at a meeting to be held at 5.30 on April 17th at the Cambridgeshire Technical School, Collier Road, Cambridge.

London Students’ Section.—J. W. Bayliss will give a paper on “Industrial Heating at Radio Frequencies” at the Institution at 7 p.m. on April 26th.

Institution of Electronics

A joint meeting of the North Western Branch of the Institution of Electronics and the Manchester and District Branch

OF OUR ABILITIES AND FACILITIES WE GIVE GLADLY



PARAMOUNT above all else is the necessity of meeting urgent and immediate demands for the protection of cherished liberty.

Astatic’s engineering and manufacturing facilities are therefore first at the disposal of Allied Governments.

Astatic will be ready to serve you again with high quality plezo-electric devices when the “All Clear” of Victory sounds.

Register your name with our Representative for your future benefit.



THE ASTATIC CORPORATION
YOUNGSTOWN, OHIO, U.S.A.
TORONTO, CANADA.

Exclusively Represented by
Frank Heaver Ltd. Kingsley Road, Bidaford, N. Devon

HOME SAFELY— THANKS TO RADIO



THE far reaching achievements of the electronics industry are being made available to the Armed Forces in ever increasing quantities.

Crowe is proud of its proven ability to produce precisely made electronic control mechanisms in large numbers.

★
Exclusively Represented by
Frank Heaver Ltd.
Kingsley Road, Bidaford, N. Devon.

CRONAME RADIO COMPONENTS

CROWE NAME PLATE AND MANUFACTURING CO.
CHICAGO, ILL. U.S.A.

World of Wireless—

of the Institute of Physics will be held at 7 o'clock on April 14th at Reynolds Hall, College of Technology, Manchester, when Dr. D. Gabor will give a paper on "Electron Beams."

Brit.I.R.E.

London Section.—"Development of Wired Broadcasting" is the subject

of a paper to be given by T. Adorjan at a meeting to be held at the Institution of Structural Engineers, 11, Upper Belgrave Street, London, S.W.1, at 6.30 on April 27th.

Midlands and North Eastern Sections.—F. E. Lane's paper on "Special Electron Tubes" will be given before the Midlands Section on March 31st at the University of Birmingham (Mathematics Theatre), Edmund

Street, Birmingham, and at the North Eastern Section meeting at Neville Hall, Newcastle-on-Tyne, on April 26th. An ordinary meeting of the Midlands Section will also be held at the University of Birmingham on April 19th, when a paper will be given by C. E. Tibbs entitled "A Review of Wide-Band Frequency Modulation Technique." All these meetings commence at 6.30.

NEWS IN ENGLISH FROM ABROAD

Country : Station	Mc/s	Metres	Daily Bulletins (BST)	Country : Station	Mc/s	Metres	Daily Bulletins (BST)
Algeria				French Equatorial Africa			
Algiers	8.965	33.46	1600, 1700, 1800, 1900, 2100, 2200	FZI (Brazzaville) ..	11.970	25.06	1945, 2145
	12.110	24.77	1700, 1800, 1900, 2100	India			
America				VUD3 (Delhi) ..	7.290	41.15	0530, 0900, 1400, 1650
WRUW (Boston) ..	6.040	49.67	0800	VUD4	11.790	25.45	0530
WLWK (Cincinnati)	6.080	49.34	0600, 0700, 0800, 0900,	VUD3	11.870	25.27	0530, 0900, 1400
WKRD (New York)	6.100	49.18	0000, 0100, 0200, 0500, 0600, 0700	Iran			
WOOC (Wayne) ...	6.120	49.03	0100, 0200, 0300, 0400, 0500	EQB (Teheran) ..	6.155	48.74	2225
WBOS (Boston) ..	6.140	48.86	0900, 1000	Mozambique			
WCBX (Brentwood)	6.170	48.62	0500, 0700	CR7BE (Lourenco Marques) ..	9.830	30.52	2050
WGEO (Schenectady)	6.190	48.47	0615, 0810	Newfoundland			
WKTM (New York)	6.370	47.10	0000, 0100, 0200, 0300, 0400, 0500, 0800, 0900, 2300	VONH (St. John's) ..	5.970	50.25	2315
WKLJ (New York)	7.565	39.66	0200, 0300, 0400, 0500, 0700, 0900	Palestine			
WLWO (Cincinnati)	7.575	39.61	0600, 0700	Jerusalem	11.750	25.53	1615
WKRD (New York)	7.820	38.36	0800, 0900†	Portugal			
WGEO (Schenectady)	9.530	31.48	1000, 2100	CSW6 (Lisbon) ..	11.040	27.17	2000
WCDA (New York) ..	9.590	31.28	1200	Spain			
WCRC (New York) ..	9.590	31.28	1100	EAQ (Aranjuez) ..	9.860	30.43	2050†
WKRD (New York)	9.897	30.31	1000, 1100	Sweden			
WLWO (Cincinnati)	11.710	25.62	1200, 2000, 2100, 2200	SBU (Motala) ..	9.535	31.46	2220†
WRUW (Boston) ..	11.730	25.57	1300, 1400	SBP	11.705	25.63	1700
WCRC (Brentwood)	11.830	25.36	1530, 1630, 1900, 2045	Switzerland			
WGEO (Schenectady)	11.847	25.32	1300, 1400, 1500, 1600, 1700	HER3 (Schwarzenburg)	6.345	47.28	2150
WOOW (Wayne) ..	11.870	25.27	1200, 1300	HER4	9.535	31.46	2150
WBOS (Boston) ..	11.870	25.27	1100, 2100	Syria			
WRUS (Boston) ..	15.130	19.83	1300, 1400, 1500, 1600, 1700, 1800	FXE (Beirut) ..	8.035	37.34	1735
WOOC (Wayne) ..	15.190	19.75	1200, 1300	Turkey			
WBOS (Boston) ..	15.210	19.72	1200, 1400, 1530, 1800	TAP (Ankara) ..	9.465	31.70	1800
WLWK (Cincinnati)	15.250	19.67	1400, 1500, 1600, 1700, 1800, 1900, 2000, 2100, 2200	U.S.S.R.			
WCBX (Brentwood)	15.270	19.65	1530, 1630, 1900, 2045	Moscow	5.890	50.93	2300
WGEO (Schenectady)	15.330	19.57	1200, 1300, 1700†		7.300	41.10	1800, 2000, 2100, 2200, 2300, 2347
WRUW (Boston) ..	17.750	16.90	1600, 1700		7.332	40.92	2000, 2100, 2200, 2300
WLWO (Cincinnati)	17.800	16.85	1400, 1500, 1600, 1700, 1800, 1900		9.545	31.43	1240, 1515
WCDA (New York) ..	17.830	16.83	1530, 1630		10.445	28.72	1240
Australia					11.830	25.36	1600
VLI4 (Sydney) ..	7.240	41.45	1515		11.940	25.13	0100, 2347
VLG (Melbourne) ..	9.580	31.32	1515		15.230	19.70	1240, 1515
Belgian Congo					15.750	19.05	1240, 1320
Leopoldville ..	15.520	19.33	1200	Vatican City			
Brazil				HVJ	5.970	50.25	2015
PRL8 (Rio de Janeiro)	11.715	25.61	2030†				
China							
XGOY (Chungking)	9.635	31.14	1500, 1700, 2130				
Ecuador							
HCBJ (Quito) ..	12.455	24.09	0000, 2030				
Egypt							
Cairo	7.510	39.94	1845, 2100				

It should be noted that during the currency of this issue Double Summer Time will be introduced, and it will, therefore, be necessary to add one hour to the times given above on, and after, April 2nd. †Sundays excepted.

RANDOM RADIATIONS

By "DIALLIST"

A Change of Heart?

FROM the earliest days of broadcasting until the outbreak of the war it was notorious that the first question put by the prospective buyer of a wireless set to the shopman was: "How many foreign stations will it get?" Probably nine-tenths of the receivers sold to the public were chosen by the simple method of turning the tuning pointer slowly through the medium-wave band and noticing the number of transmissions that were heard in the process. Any set which produced something like the proverbial "station at every division of the dial" was a sure seller. And this despite the fact that few domestic receivers were used after perhaps the first fortnight of their working lives for bringing in anything but one or other of the local alternatives, the Regional and National programmes. There might be Sunday afternoon excursions to Luxembourg or Radio Normandie; but that was about the extent of the subsequent use of the set for reception at ranges over 50 miles or so. Will this curious craving for sensitivity of which little or no use is made return and persist in the coming days of peace? We had a discussion on the point in the Mess the other day. I set the ball rolling by suggesting that as practically no foreign listening had been done by the average man and woman during the war, the wireless set had come to be regarded more and more as a means of obtaining entertainment when required from the most easily tapped sources: after all these years of home listening the urge to indulge in trips abroad would have disappeared amongst ordinary listeners, who would demand quality of reproduction rather than sensitivity. Many were disposed to agree; but there were others who felt that there would be a sudden big increase in foreign listening, once things had settled down to normal.

"Background Music"

In my heart of hearts I rather fancy that those who took this line are right. Much as I would like to see the public hanker more after quality of reproduction and less after sensitivity and selectivity, I sadly fear that the number to whom quality means anything has diminished greatly during the war. There has been such a development of the curious use of the receiver to provide what is called "background

music"; that is music to which no one listens with any attention. The set "whoomphs" away quietly in the corner whilst everyone talks or reads or plays bridge. If the intending purchaser feels that a more constant supply of background music is to be obtained from the sensitive set capable of bringing in many foreign stations, he'll choose it and will not heed talk about superior quality. Radio manufacturers will have to decide soon—if they haven't decided already—which line they are going to take in their post-war models. As long ranges are so much easier and cheaper to achieve than good quality of reproduction, it may well be that they will choose to return to the old path of the days before the war.

□ □ □

A Problem

MY friend Henry Watte-Knowse decided the other day that he was urgently in need of an ammeter with a 0-10 scale. He had a great deal of trouble in finding one, but eventually came across a second-hand moving-iron instrument, which he was assured was of good quality and accurate. Taking it home he devised some simple tests of a rough and ready kind. He rigged up first of all a 12-volt battery and a 36-watt head-lamp bulb and placing the instrument in series, obtaining a reading of 3 amps. That seemed satisfactory so far as it went; but, recalling that meters of the moving-iron type will also measure AC., he tried it on a 1-kilowatt electric radiator connected to his 200-volt AC mains. The reading was as near 5 amps as makes no matter. Fired now with the spirit of adventure, he next passed the DC and the AC through the instrument together. We will take it for the purposes of the problem that he devised means of keeping the 200-volt AC out of his lamp circuit and the 12-volt DC out of the radiator. Here, then, was the instrument passing a DC already measured as 3 amps and an AC already measured as 5 amps. "Good thing I made the experiment," he told me afterwards. "It showed that though the wretched thing might be pretty good on the lower half of its scale, it was hopeless on the other half." Henry Watte-Knowse took the instrument back to the shop where he had bought it and demanded the return of his money. After protesting that the meter was a good one and that it wasn't fair to expect it to deal



THE "FLUXITE QUINS" AT WORK

"What! Digging at this time o' night?
Are you certain you're feeling all right?"
"It's this 'Earth'" hollered Oi!
"When we fixed it, old boy,
We buried our tin of FLUXITE."

See that FLUXITE is always by you — in the house — garage — workshop — wherever speedy soldering is needed. Used for over 30 years in Government works and by leading engineers and manufacturers. Of all Ironmongers—in tins, 8d., 1/4 & 2/8.

Ask to see the FLUXITE SMALL-SPACE SOLDERING SET—compact but substantial—complete with full instructions, 7/6.

TO CYCLISTS! Your wheels will NOT keep round and true unless the spokes are tied with fine wire at the crossings AND SOLDERED. This makes a much stronger wheel. It's simple—with FLUXITE—but IMPORTANT.

The FLUXITE GUN puts FLUXITE where you want it by a simple pressure. Price 1/6, or filled, 2/6.



ALL MECHANICS WILL HAVE

FLUXITE

IT SIMPLIFIES ALL SOLDERING

Write for Book on the ART OF "SOFT" SOLDERING and for Leaflets on CASE-HARDENING STEEL and TEMPERING TOOLS with FLUXITE. Price 1d. each.

FLUXITE LTD.

(Dept. W.W.), Bermondsey Street, S.E.1

Random Radiations—

with more than one type of current at once, the vendor, acting on the principle that the customer must always be right, handed over the cash and took back the instrument. Later on, when he'd had time to think the matter over, he decided that he had been a fool to do so. Was he right or wrong? Taking it that the currents were exactly 3 amps and 5 amps, and that the meter was dead accurate, what should it have read when dealing simultaneously with both?

□ □ □

"I" for Current

IN the last issue of *Wireless World* a correspondent asked the interesting question: "Why was the symbol 'I' chosen to represent current in equations and formulæ?" I have often wondered if there was any rhyme or reason behind the choice, but the only answer I can find is that "I" was adopted quite arbitrarily as a replacement of the original "C" (no longer suitable because it was needed as the symbol for capacity) for the simple reason that it was one of the few letters without a special mathematical significance at the time. In the same way the hitherto idle "X" was given a whole-time job to represent reactance, and "Z," likewise out of work, was harnessed as the symbol of impedance. Many of the symbols that we now use in wireless and kindred formulæ are of very recent adoption. For instance, I find in Capt. H. J. Round's monograph on the "Shielded Four-electrode Valve" (the screened-grid), published in 1927, "K" used to represent mutual conductance, and "M" to represent amplification factor. "K" obviously would not do, for its recognised task is to signify dielectric constant, and "M" had already staked out its claim to stand for mutual inductance. Nowadays "gm" seems to have secured general recognition as the symbol for mutual conductance—though one sometimes finds it written *Gm*. "μ" is firmly established as representing amplification factor. But there are still a few symbols which vary from textbook to textbook, and these variations are a nuisance. Worst of all are the symbols which stand for one thing in one formula and for another thing in another in the same work. One of the most annoying of these to me is "π," which may mean (in round figures) 3.14—or 180 degrees. Mathematicians assure me that the meaning is so obvious that there is no need to indicate whatever "π" stands for the ratio of the circumference to the diameter of a circle or for this number of radians. As

one who has been bitten by struggling with what happened to be the wrong meaning of "π" in endeavouring to follow a mathematical argument, I'm still not convinced.

□ □ □

Phonetic Alphabets

THE worst of the phonetic alphabets that we use for spelling out words over the telephone line or in radio transmission is that there is no universally accepted version. In the Services we have abandoned "Ack" in favour of "Abel," and "Baker" has ousted "Beer"; but the G.P.O. operators still seem to have alphabets of their own. "A," I think, is "Apple" to them, and the "N" that used to be "Nuts"

to us, but is now "Nan," remains "No one" to some, at any rate, of them. A broadcasting entertainer, whose name is so familiar that for the moment it escapes me, produced a glorious alphabet that began "Ay for 'Osses," and continued through "Effervescence" and "Ell for leather." And in this queerly spelt and queerly pronounced language of ours there are wondrous opportunities. Have you ever thought of what could be done in the way of a spoof phonetic alphabet—phony alphabet would perhaps be a better term—full of entirely misleading guide-words? A for Aye, S for Sea, W for Wye, Y for You, E for Eh, J for Jee may suffice to set you devising others.

BOOK REVIEWS

The Cathode Ray Oscillograph in Industry, by W. Wilson, D.Sc., M.I.E.E. Pp. 148, 156 figs. Published by Chapman and Hall, 11, Henrietta Street, London, W.C.2. Price 12s. 6d.

THE use of the cathode ray oscillograph, first limited to the delineation of electrical waveforms and certain radio and electrical measurements has, in the last decade, been extended to many branches of industry and, of course, to weapons of war. This book naturally concerns itself only with industrial applications and opens with a chapter on general principles, and then proceeds to a detailed description of two main types of oscillograph, the glass tube type and the metal tube (continuously evacuated) type. This is followed by a chapter giving a brief treatment of accessory circuits, such as power supplies and amplifiers.

A series of chapters on the various applications of the oscillograph follow, commencing with single deflection readings, where the instrument is used as an electronic voltmeter or ammeter, and continuing through differential tests (double deflection), repeating time-base tests, single sweep time-base tests, tests involving independent bases other than time, ending with the recording of mechanical pressures, where the oscillograph is used as an engine indicator.

Next comes a chapter on the electron microscope, an application which is destined to be of considerable assistance not only to industry, but possibly to the future welfare of mankind.

The last chapter, on construction, operation and maintenance is sketchy in the extreme. The author in his preface says, "There is a close resemblance between the glass

tube 'set' and the wireless receiver, and it is all to the good that the class of experimenter who enjoys making up the latter shall be encouraged to do the same with the oscillograph." Up to a point, this may be reasonable, but it is not likely that amateur constructors will wish, or be able, to make industrial oscillographs. In any case, this chapter of the book will not help them.

An appendix giving four pages on the characteristics of thermionic valves and less than six pages on photo-cells, oscillators, and piezo-crystals does not appear to serve any very useful purpose in a book which will presumably be read by engineers who have a reasonable knowledge of electronic work.

The book is well illustrated and contains a good deal of information on the commoner uses of the oscillograph in industry, but as new uses occur so rapidly, it cannot be said to be complete. W. E. M.

Electricity and Radio Transmission.

By Sir John Townsend, M.A., F.R.S. Pp. 183; 126 figures. Published by Warren and Son, High Street, Winchester. Price 8s. 6d.

THIS book combines an unconventional choice of subject matter with a somewhat unusual treatment. The physical disposition of the material itself is equally unconventional, for the list of contents at the beginning does not give page references but lists the various sections of the chapters. These are numbered, and the book contains a total of 136 of these sections. This, combined with the absence of an index, makes the search for a particular subject longer than it need be. In his preface the author states that the aim

of the book is to explain how electromagnetic waves are related to other electrical phenomena without using such complexities as the *j*-notation and Gauss' theorem. This does not mean, however, that the calculus has been rigorously excluded; on the contrary, it is used at many points, and quite a number of elementary differential equations are encountered in the final chapter.

Chapter I defines the unit of capacitance and contains many references to the quadrant electrometer. Chapter II continues laying foundations by defining the units of current and resistance but also introduces magnetic moments, primary and secondary cells, electrolysis and photo-electricity. Moving coil meters, the cathode-ray oscilloscope and thermo-electricity are next met, and after a fourth chapter on solenoids and the determination of inductance, the book goes on to discuss high-frequency AC and radio transmission. Chapter VI is devoted to electromagnetic induction and its practical applications. After a chapter on resonance, coupled circuits and electromagnetic waves on parallel wires, the valve is introduced in the eighth and final chapter, which discusses the diode as a rectifier and the triode as amplifier and oscillator.

Most of the diagrams give the impression of being reproductions of the author's own freehand sketches, but perhaps a more serious criticism is to say that this book could equally well have been written 12 years ago. One searches in vain for a reference to FM or pentodes, and tetrodes are dismissed in less than half a page.

Students with adequate mathematical aptitude and background who are seeking an introduction to radio will find the book useful. It fulfills the purpose of introducing the reader to the method of solving radio problems by mathematical analysis.

S. W. A.

Wave Filters, by L. C. Jackson. Pp. 107 + vii; 64 figures. Methuen & Company, 36, Essex Street, London, W.C.2. Price 4s. 6d.

THIS book has recently been added to the well-known series of physical monographs, and the author has "... aimed at providing an account of the properties of electrical wave filters adequate for the needs of students of physics and radio."

It starts with a brief description of the applications of wave filters, followed by two chapters on constant-*k*, and *m*-derived and composite filters. Succeeding chapters cover "further types"—including crystal band pass and coaxial filters

—the effect of losses in components, and mechanical and acoustical applications of filter theory.

Two minor criticisms of the first chapter may be made. First, smoothing filters should have their cut-off well below the *fundamental ripple* frequency, and not as stated below the *mains* frequency. One of the advantages of 3- and 6-phase rectification is the raising of the ripple frequency with consequent economy in filter components. Secondly, the surface noise from a gramophone record does not all lie above 4,000 c/s. Actually it covers almost the whole audible spectrum, but it is aurally most objectionable above 4,000 c/s.

The second and third chapters set forth the fundamentals of filter theory lucidly and concisely; they are the best in the book, and care has obviously been taken to avoid ambiguities. The casual reader might perhaps be puzzled by the explanation of the terms mid-shunt and mid-series iterative impedance (p. 27), until it is realised that the dotted lines AA' and BB' of Fig. 1 (incidentally the dashes are missing) are intended to divide the filter so that Z_1 is halved and Z_2 doubled.

The effects of resistive losses in filter components is well, but rather briefly, treated; a larger and more accurate version of Fig. 46 would have been welcome so that it could more readily have been applied to practical design problems, on which there are some notes.

The sections concerning crystal and coaxial (for UHF) filters give some idea of what has been achieved and how, and form but an introduction. The same remark applies to the mechanical and acoustical applications section, but the outline of the method is here rather more detailed. Misprints are few, but several figures do not correspond exactly to the text. The discrepancies are slight and obvious, however.

To those to whom wave filters are at present a closed book, this monograph will serve as a very welcome introduction to the more recondite texts. It will also serve well as a survey for those whose interests are more general, and the low price should assure its popularity. The author is to be congratulated on his clear exposition of the fundamentals.

J. McG. S.

BACK NUMBERS

A READER has for disposal unbound copies of *Wireless World*, covering the period 1921 to 1934, which he will be glad to give to any institution, society or group which can make use of them. The donor asks that the cost of carriage be paid by the recipient. Requests should be sent to H. Palmer, c/o *Wireless World*.

The Improved
VORTEXION
50 WATT
AMPLIFIER CHASSIS

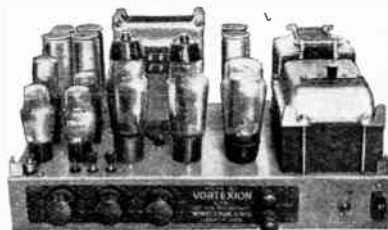

The new Vortexion 50 watt amplifier is the result of over seven years' development with valves of the 6L6 type. Every part of the circuit has been carefully developed, with the result that 50 watts is obtained after the output transformer at approximately 4% total distortion. Some idea of the efficiency of the output valves can be obtained from the fact that they draw only 60 ma. per pair no load, and 160 ma. full load anode current. Separate rectifiers are employed for anode and screen and a Westinghouse for bias.

The response curve is straight from 200 to 15,000 cycles in the standard model. The low frequency response has been purposely reduced to save damage to the speakers with which it may be used, due to excessive movement of the speech coil. Non-standard models should not be obtained unless used with special speakers loaded to three or four watts each.

A tone control is fitted, and the large eight-section output transformer is available to match, 15-60-125-250 ohms. These output lines can be matched using all sections of windings, and will deliver the full response to the loud speakers with extremely low overall harmonic distortion.

PRICE (with 807 etc. type valves) **£18.10.0**

Plus 25% War Increase

MANY HUNDREDS ALREADY IN USE

Supplied only against Government Contracts

VORTEXION LTD.

257, The Broadway, Wimbledon, S.W.19

'Phone: L1Berty 2814

RECENT INVENTIONS

MULTIVIBRATORS

THE figure shows a cross-coupled pair of valves for generating square-shaped impulses. The circuit is distinguished from others of the same general type by the provision of a resistance RC which is inserted in the common HT lead and is supplementary

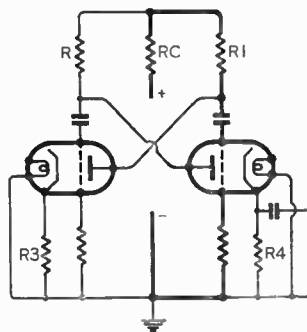

Modified multivibrator.

to the usual anode resistances R and R₁. This enables the circuit to generate a periodic "square" wave which has a perfectly flat top with no upward or downward "tilt." Variation of the value of the resistance RC also serves, within limits, to control the operating frequency.

It will be observed that the cathode of each valve is connected to earth through resistances R₃, R₄, respectively. For satisfactory operation, these resistances should have a value not more than half that of the usual anode resistances, whilst the value of the common resistance RC should not be less than double that of the usual anode resistances. The output may be taken off from either of the cathode resistances.

H. W. Platley. Application date May 13th, 1942. No. 555078.

PERMEABILITY TUNING

THE waveband coverage of a permeability-tuned set, particularly when coupled to a small frame aerial, is increased by the use of a single sliding core, which is made for one half of its length of powdered magnetic material, the other half-length being a copper tube. In operation the effective inductance of the tuning coil is increased as usual when threaded by the powdered material, but is reduced below normal by the "spade tuning" action of the copper tube.

In a specific example a 7½ in. square frame aerial is coupled to a tuning coil 1½ in. in length wound on a hollow former of 0.22 in. outer diameter. The sliding core is 3 in. long, one half being of powdered iron-tin alloy, and the other half a copper tube with an outer diameter of 0.2 in. and an inner diameter of 0.165 in.

This gave a tuning range of 540 to 1,560 kc/s, with a substantially constant signal voltage input throughout.

Johnson Laboratories, Inc. (assignees of W. A. Schaper). Convention date (U.S.A.) March 8th, 1941. No. 555735.

A Selection of the More Interesting Radio Developments

ADAPTERS FOR FM SIGNALS

A PENTAGRID converter valve is arranged to convert frequency- or phase-modulated waves into amplitude-modulated waves of a different frequency, the device being used as an adapter to enable a standard superhet set to receive FM signals.

As shown, incoming signals are fed from the aerial through a tuned circuit FC to the third grid of the converter valve V, the anode of the valve being connected to an output circuit M which is tuned to the fixed intermediate frequency of an ordinary superhet set S. The cathode and the first and second grids are back-coupled in the usual way to generate local oscillations on a circuit FC₀; this serves to beat down the datum frequency of the incoming signal to the fixed frequency of the output circuit M. The positive screen of the third grid is connected to a circuit FC₁, which is also tuned to the centre or datum frequency of the received signals.

The circuits FC and FC₁ are coupled together through the space charge inside the mixing valve. The coupling introduces a phase shift of 90 deg. between the two equal frequencies, and so serves to convert the original FM

given band of wavelengths. When a signal is picked up, it is fed to a pair of frequency-discriminating diodes, which are coupled to the last IF amplifier and are tuned respectively above and below the fixed intermediate frequency. The voltages thus developed are applied through a balanced relay to the motor, so that the latter first brings the input circuit accurately into step, and then locks it to the signal.

The control will also serve to compensate for any "drift" in the carrier-frequency of the transmitted signal. As soon as the signal ceases, the balanced relay is automatically opened, and the tuning-control motor again starts to hunt.

E. K. Cole, Ltd., and A. W. Martin. Application date July 30th, 1942. No. 557147.

S O S ALARMS

ALTHOUGH the automatic S O S alarm may be duly switched into circuit when the ship's operator goes off duty, it may happen that he will forget to see that the aerial switches are left in correct position, so that even if the receiver proper is in good order an S O S signal may be missed.

To prevent such a contingency the usual testing buzzer is provided with a relay which automatically changes over the aerial contact from the receiver input to an auxiliary inductance. The latter is thus placed across the aerial capacity to form a circuit tuned to the S O S wavelength. During test the receiver is thus momentarily disconnected from the aerial, whilst the buzzer energises the auxiliary circuit. This can then radiate sufficient energy to operate the S O S alarm only (a) if the aerial input switch was originally in its correct position, (b) if there is no aerial "fault" to upset the predetermined tuning of the auxiliary circuit, and (c) if the circuits of the receiver proper are in good order.

Standard Telephones and Cables, Ltd., and J. D. Holland. Application date March 27th, 1942. No. 556319.

Standard Telephones and Cables, Ltd., and J. D. Holland. Application date March 27th, 1942. No. 556319.

FREQUENCY-CHANGING VALVES

THE electrodes in a "mixer" valve of the pentagrid-converter type are arranged in two groups, which are symmetrical about two axial planes set at an angle to each other. As shown in cross-section, the cathode K and first control grid G form one group, the other consisting of the first screen grid S, the second control grid G₁, the

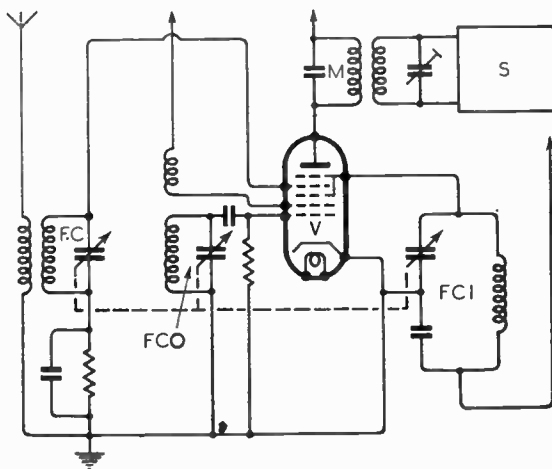

FM-AM converter.

signal into an amplitude-modulated carrier which can be handled by the ordinary type of receiver.

Marconi's Wireless Telegraph Co., Ltd. (assignees of S. Hunt). Convention date (U.S.A.) May 15th, 1941. No. 555857.

AUTOMATIC TUNING CONTROL

IN the absence of any signal, a motor under the control of a self-reversing switch constantly alters the tuning of the input circuit of a superhet set, so that it "searches" or sweeps over a

second screen grid S1 and the anode A. The longitudinal axis of symmetry of each of the groups coincides with the main axis of the bulb. In this way the first screen grid is brought nearer to the second control grid, and the screening between the two control grids G and G1 is made sufficient to prevent any electronic coupling caused

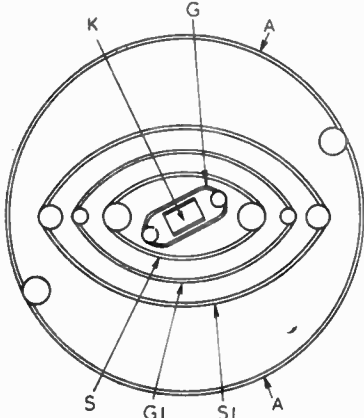

Improved pentagrid electrode arrangement.

by the space charge which forms the "virtual cathode" of the outer group. The backward drift of slow-moving electrons is intercepted, whilst other inductive effects due to the virtual cathode are minimised.

Philips Lamps, Ltd. (communicated by N. V. Philips' Gloeilampenfabrieken). Application date January 28th, 1942. No. 556461.

BLIND-LANDING BEACONS

AN earthed screen of predetermined size is inserted between and at right angles to the two limbs of a vertical dipole aerial for radiating blind-landing signals. Radio-frequency energy is supplied across the gap between the lower aerial and the screen, the latter being connected to the upper aerial through an impedance, which is shorted by a keying switch in the usual E-T or A-N morse sequence.

The effect of the screen, whilst not preventing capacity coupling between the two aerial elements, distorts the normal directional symmetry of the arrangement about the horizontal plane, so that the resultant lobe of radiation is tilted upwards on one side of the switch (say during a dash) as compared with its direction on the other side of the switch (when a dot is being transmitted). The two lobes will therefore intersect to mark out an inclined or gliding path, of equi-signal strength, to an approaching pilot. The angle of descent can be varied by suitably adjusting the size of the screen and the value of the keying impedance.

Aga-Baltic Akt. (formerly Aga-Baltic Radio Akt.). Convention date (Sweden) January 13th, 1941. No. 556899.

The British abstracts published here are prepared with the permission of the Controller of H.M. Stationery Office, from specifications obtainable at the Patent Office, 25, Southampton Buildings, London, W.C.2, price 1/- each.

Forward

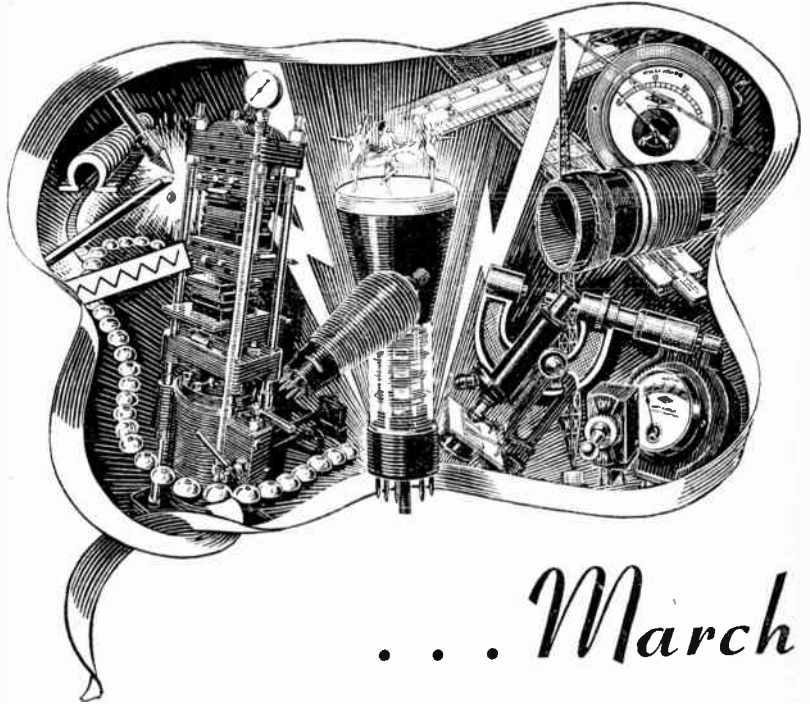

. . . March

THE science of Electronics moves apace in present time of War, but the future holds promise of great achievements. At present, we may only see "as in a glass" the fashion of things to come. In all phases and in all applications, **BULGIN RADIO PRODUCTS** will make their contribution; until then, we ask your kind indulgence. Please quote priority and Contract Nos.

"The Choice of Critics"



Registered Trade Mark

A. F. BULGIN & CO. LTD., BYE PASS RD., BARKING, ESSEX
 Radio and Electrical Component Manufacturers.
 TEL. : RIPPLEWAY 3474 (4 lines).

Felis Sapiens

AMONG certain classes of listener who lack the necessary education and experience of life to appraise the babblings of the Brains Trust at their true worth, Commander Campbell has come to be regarded as a modern Munchausen or a dished-up de Rougemont, due to the great variety of his experiences in many parts of the world. Even his fellow Brains Trustees, and sometimes the Question Master also, are apt to lend countenance to this entirely erroneous view, as was evinced the other day when the Commander related his remarkable story of the rats, who with uncanny prescience deserted a ship at a certain port a few days before she was lost at sea.

It is fortunate that I can, in this instance, come to the Commander's aid, as it so happened that I was on board the ship in question and had only just time to do a backwards pierhead jump when I learned of the rats' strange behaviour. It *must* have been the same ship, as it would be stretching a long arm of coincidence too far to suppose that there were two such ships.

I was, however, startled to hear another member of the Brains Trust point out that cats, too, have this remarkable gift of prescience developed to an even higher degree, and that several instances are on record of their having hastily left a building due to be destroyed by a bomb several hours later.



"Friends in the neighbourhood."

I need hardly tell you that I have lost no time in harnessing the resources of modern science to this apparently supernatural feline gift. Following Dr. Johnson's notable example, I have had special exit holes for the cat cut in the doors of my residence, but have gone a stage further by fitting metal plates on

By

FREE GRID



each side of every hole, these forming a condenser connected in a delicately balanced oscillator circuit.

The specific inductivity of a cat is, of course, greater than that of air, and consequently when she passes out, the capacity of the condenser is changed, the circuit balance upset and a relay-operated alarm is sounded. The only difficulty I am having at present is to devise some method of distinguishing between the cat's normal exits and her "bomb-prescience" exits, and this is where you may be able to help me. At present matters are in hopeless confusion, as the cat seems to have an unusually large number of friends in the neighbourhood, and the alarm is in almost constant operation.

Certain carping critics may possibly write to point out that, barring the difficulty I have already mentioned, I could achieve my aim in a far simpler manner by using a photocell and a lamp on either side of the exit holes and making the cat cut the ray, instead of going to the expense and complication of rigging up an oscillator circuit. My answer to this is that, quite apart from technical difficulties such as having to see that the lamp did not infringe the black-out regulations and to see that daylight did not operate the photocell, I should be disgracing my profession if I failed to use a strictly radio method to achieve any object where radio can possibly be used. I should, in fact, be stooping to the level of certain dishonourable members of the gas engineering profession whom one sees walking about shamelessly in the black-out with electric torches; as I told one of them only the other night, he could at least have the decency to use an acetylene lamp.

"Give Us Back Our Eleven Days"

I WAS a little surprised at being taken to task in a recent issue of *Electrical Review* about my complaint (*Wireless World*, February issue) that the fitting of electric points in the skirting board of a room necessitates a constant lumbago-producing jack-in-the-box bobbing up and down to switch on and off. The writer in *Electrical Re-*

view agrees with me that my suggested waist-level position would be more convenient, but raises the objection that it would make the electric fixtures rather obvious.

This reminds me of a period in the development of the wireless industry when radio manufacturers suffered from such a sense of shame for their own products that they foolishly attempted to disguise them as pictures or rose bowls, and even to build them into so-called Elizabethan cabinets. The piano industry, so I am told, suffered from the same sort of inferiority complex in its early days. Nowadays pianos



"Every picture tells a story."

and radio sets are made to look and to sound beautiful, and proudly display themselves for what they are. Cannot electric fixtures be likewise imbued with pride of function and harmony of design?

In any case, are not ordinary electric lighting switches fixed at wrist level? In fact, now I come to think of it, in the very sanctum of the Editor of *Electrical Review* himself is a plug point fitted at wrist level. Possibly, however, I am wrong and it was a gas point that I once noticed there. The true explanation of this astounding attack on me seems to be that the writer who penned it is "agin this 'ere progress," and had he lived in September, 1752, he would have been vociferous in his demand for the return of the eleven days.

No doubt, after the war he will be found marching to Downing Street in the ranks of the retrophiles (horrible hybrid) with the rallying cry of "Give us back our black-out!" in an endeavour to ruin that impudent fellow Mr. Therm, who, not content with getting his "Foot" in at Broadcasting House, has installed high-pressure gas-lighting outside the very portals of the temple of Electrical and Wireless progress in Stamford Street in readiness for the brave new world of health, wealth and happiness after the war.



Porcelain

His day's work done, he becomes one with the crowd on its homeward way, and there is nothing to distinguish him from his accustomed background. But we know him as a highly skilled craftsman who controls a white-hot furnace which is baking porcelain. Not the kind that will ever grace a tea-table, but a high grade of ceramic material with special electrical properties used in the manufacture of resistances, valves and many other components vital to

radio communications.

Much depends on their unfailing reliability—and so Philips, whose manufacturing resources extend from raw material to finished product, make their own porcelain to their own exacting standards.

He is one of the thousands of workers who gave you, before the war, the Philips products you knew and trusted so well. *His skill is a vital asset to the nation today.*

PHILIPS



RADIO ★ LAMPS

AND ALLIED ELECTRICAL PRODUCTS

PHILIPS LAMPS LTD., CENTURY HOUSE, SHAFTESBURY AVENUE, W.C.2 (411)



WE'RE WAITING FOR THE TIME, TOO . . .

. . . when R-S Sound Equipment will be freely available to the many instead of the 'few.' But the 'few' to-day are the most important. They are the ones on whom depends how soon R-S will again be able to supply all you demand. And the 'few' are just one of the reasons why we cannot make for general use all the Sound Equipment we should like. There is, however, a small—very small—range that is sometimes at your customers' disposal, and if you think they would like to know more about it we'll gladly send you a catalogue if you'll send us a penny stamp.



AMPLIFIERS

R.S. Amplifiers, Ltd., 3-4, Highfield Road, Shepperton, Middx
Tel.: Walton-on-Thames 1019.

RELIABILITY



WODEN TRANSFORMERS

VACUUM IMPREGNATION
FINEST MATERIALS
CRAFTSMANSHIP
RIGOROUS INSPECTION
ensure
RELIABILITY

WODEN

Transformer Co. Ltd.

Thornley St., Wolverhampton

Tel.: Wolverhampton 22829

MAKERS OF TRANSFORMERS, POWER PACKS,
& SPECIAL RECEIVING & TRANSMITTING APPARATUS



FOR THE RADIO SERVICEMAN DEALER AND OWNER

The man who enrolls for an I.C.S. Radio Course learns radio thoroughly, completely, practically. When he earns his Diploma, he will KNOW radio. We are not content merely to teach the principles of radio, we want to show our students how to apply that training in practical, every-day radio service work. We train them to be *successful!*

Special terms for members of H.M. Forces.

-----You may use this Coupon-----

INTERNATIONAL CORRESPONDENCE SCHOOLS Ltd.

DEPT. 38, INTERNATIONAL BUILDINGS, KINGSWAY, LONDON, W.C.2

Please explain fully about your instruction in the subject marked X

Complete Radio Engineering. Radio Service Engineers.
Elementary Radio. Television.

And the following Radio Examinations:—
British Institution of Radio Engineers.
P.M.G. Certificates for Wireless Operators.
Provisional Certificate in Radio Telephony and Telegraphy for Aircraft.
City and Guilds Telecommunications.
Wireless Operator and Wireless Mechanic, R.A.F.

Name..... Age.....

Address.....

HIVAC
THE SCIENTIFIC
VALVE
BRITISH MADE

Specialists in
MIDGET VALVES

HIVAC LIMITED
Greenhill Crescent,
Harrow on the Hill, Middx.

Telephone: Harrow O895

CLASSIFIED ADVERTISEMENTS. Rate 6/- for 2 lines or less and 3/- for every additional line or part thereof, average lines 5-6 words. Each paragraph charged separately. **Free Day:** May issue, first post Thursday, April 6th, one day earlier at branch offices. **Box Numbers** 2 words, plus 1/-. **Deposit System:** particulars on request. No responsibility accepted for errors.

Ode

Partridge

No. 30

£ s. d.

Umpteen million pounds a day
We spend to fight the war,
The miner gets a fiver
And then he strikes for more.

Of course the factory worker
Can knock up quids and quids,
Then toddles home when finished
To see his wife and kids.

I wonder how they'd like this:
For bed, a muddy hole,
The only fire to greet them,
Hot shells, instead of coal.

So what about us soldiers
Who've got the hardest job.
I reckon we're entitled
To more than eighteen bob.

Oh yes, I get my clothing,
A bit for kids and wife,
But don't forget, to save you
I risk my blinkin' life.

N. Partridge

Transformer Manufacturers,
76-78, PETTY FRANCE, LONDON,
S.W.1. Telephone: ABBey 2244.

ARMSTRONG SERVICE

Man proposes but war disposes!
That is why there has been some
delay in our Service Department,
which we greatly regret.

Happily, however, we have caught
up with arrears and can now
service receivers and return most
of them in seven days.

Whilst this position lasts we can
also undertake the repair and
overhaul of receivers other than
our own make including American
types.

All enquiries should be addressed
to

ARMSTRONG (Radio Service Dept.)
WALTERS ROAD, HOLLOWAY, LONDON, N.7
Phone: NORth 3213

NEW RECEIVERS AND AMPLIFIERS
30-WATT ac amplifiers, precision built instruments, input and output channels to requirements; early deliveries.—Below.
150-WATT racks, comprising 5 amplifiers as above intercoupled, fitted for remote control for industrial installations; send for full details and illustrations; complete equipment, including speakers and microphones, etc., available.—Below.

18-WATT ac/dc amplifiers, mixing input channels, bass and treble controls, input and output transformers: 18gs.—Below.

DANCE and stage transportable equipment, comprising 18-watt amplifier as above, m/c mike, adj. stand, 2 speakers, cables; 36gs.—Broadcast & Acoustic Equipment Co., Ltd., Broadcast House, Tombland, Norwich. [2024

NEW new AC 4 1/2-watt quality amplifiers. 8gs., complete, s.a.e. particulars.—John Brierley, 1, St. Paul's Ave., Lytham St. Annes.

£24 World "quality amplifier with tone control stage, 8 watts push-pull triode output, price includes super quality triple cone, 12in permanent magnet speaker with large matched output transformer and all valves; as above but with 15-watt tetrode output £25/10; ideal for realistic reproduction for public address, limited number available.—Bakers Selhurst Radio, 75, Sussex Rd., S. Croydon. Tel. Croydon 4226 for demonstration.

RECEIVERS, AMPLIFIERS—SECOND-HAND
A LBA radiogram for sale.—84, The Drive N.W.11. [2571

FOR sale, 230volt ac National H.R.O. Senior, with 9 coils.—Apply Box 3048. [2426

TROPHY 8, 1942, perfect; Rola G12; best offer.—58, Hillside, Horsham, Sussex.

COMMUNICATION rec., 5-200 metres, Kyri-zone tuner, sep. spkr.; £25.—Box 3092.

W.W. amplifier, 1 h.f. tuner and Epoch Domino speaker (Bournemouth).—Box 3090. [2597

QUANTITY amplifier, 15 watt, ac. £15.—Graham Newbery, Melody House, Axminster. [2523

SIX receiver, perfect condition; offers.—58, Nunsfield Rd., Fairfield, Buxton, Derby. [2525

HALLICRAFTERS SX25 with speaker and 'phones, used few hours only, in maker's packing; best offer?—Fenton, Derbyhaven, 15c of Man. [2546

THREE radiograms, McMichael, Ekco, Marconi, also American Freud Hissman mid-get set, perfect, take £20 for Marconigram.—Ring Bays, 0363. [2461

RECEIVERS.—One or two nearly complete 4v super-hets (plus rect.), pentode output, on grey cellulosed welded steel chassis, with 5 valves, £9-£11; first class components, all beautiful condition.—Box 3071. [2519

32-WATT P.P. amplifier, 230 ac (amateur built), 6L6's, with separate h.t. supply to screens, high and low gain inputs, paper smoothing condensers, needs overhauling, but valves perfect, £9, or best offer; 10-watt P.P. amplifier, 230 ac, 2 high-gain inputs, multi radio output transformer, with plug and cable for operation off 12-volt l.t. and vibrator h.t. supply; in first-class condition, £15, or best offer.—Box 3085. [2581

Wanted
ADVERTISER, private, will pay good price for all-dry wireless set.—Box 3073. [2528

TRIODE output amplifier, up to 8 watts; also circuit for Q.A. super tuner (W.W., Feb., 1936).—55, Brownlow St., York. [2567

WANTED, wireless receivers, any quantity, going or otherwise!—Cathodic Radio Services, 134a, South Ealing Rd., W.5. Tel. Eal. 1368. [2425

WE offer cash for good modern communication and all-wave receivers.—A.C.S. Radio, 44, Widmore Rd., Bromley. [1541

HALLICRAFTERS SX28, SX32, SX25, SX23, National 100X, or NC200, for work national importance.—Fullst details, price, condition, Box 3076. [2542

HAYNES 14-watt amplifier, or similar, with or without valves, or S.S. Tri-channel equipment, latest model, without speakers. Particulars to T. D. Hill, 22, Newport Rd., Middlesbrough. [2577

WE buy at your price, used radiograms, radios, amplifiers, converters, test meters, motors, pick-ups, all radio and electrical accessories, etc.; we call and pay spot cash.—Tel. Eust. 1966, or Ger. 4447. University Radio, Ltd., 238, Euston Rd., N.W.1 [2536

LONDON CENTRAL RADIO STORES will pay good prices for receivers, radiograms, amplifiers, dynamos, converters, test equipment, electric gramophone motors, and all radio and electrical accessories.—London Central Radio Stores, 23, Lisle St., London, W.C.2. Gerrard 2969. [9836

Advertisers and buyers are reminded that under Defence Regulations 1939, Statutory Rules and Orders 1940, Number 1689, a permit (T 99 G) must be obtained before sale or purchase of certain electrical and wireless apparatus, particularly such valves and apparatus as are applicable to wireless transmission.

IT'S WORTH—

5 Minutes' trouble, to save hours and £'s.

A WONDERFUL RANGE OF TECHNICAL BOOKS NOW AVAILABLE.

RV 30. RADIO VALVE MANUAL. 66 pages; British and American Equivalents, Curves, etc. ... 3/9

RC/22. RADIO CIRCUITS. Diagrams for making Receivers, Transmitters, Test Gear, etc. ... 2/3

OP/01. RADIO OPERATORS' MANUAL. Formula, Codes, etc. ... 1/3

"RADIO INSIDE OUT." The Trade's Best Seller for years. Every possible hint for the Serviceman ... 4/9

MANUAL OF SCIENCE ... 2/3

ENGINEERING PRACTICE ... 2/3

ENGINEERS AND ELECTRICIANS HANDBOOK ... 1/3

SERVICE SIGNALLING MANUAL ... 1/3

Special Offer: One each of above 8 Books for 17/6, post paid.

NEW TRIMMING TOOL OUTFIT. 14 assorted box spanners and screwdrivers; polished ebonite, complete in carrying case, 30/-.
EMI. Type Mains Trans. Bobbins, 4v. and 6v., 18/6.

12 assorted Silver Mica Conds., 7/6. Volume Control, less switch, every value, ONLY 3/6.

750 ohm 3a Resistor in cage, 10/-. 1000 ohm 2 amp. replacement dropper, for every set, 5/-.
SPECIAL KIT OF PARTS FOR THE HOME REPAIRER: Comprising electrolytics, resistors, controls; advertising offer, very limited quantity available, 60/- post paid. "Servisol," Switch-cleaning, 8-oz. tin 5/-. Pen. O.P. Trans., 8/6. 10 w. Auto-Trans., 27/6. VC Knobs, 8d.

Service Books on Crossley, Belmont, Spartron, Emerson, each 12/6. Complete set, 37/6. New List, 2/6.

EXCLUSIVELY MAIL ORDER HOUSE.
WAVEBAND RADIO LTD.
30, Queensgate, London, S.W.5

L.R.S. STUART PUMPS

As supplied to Govt. Depts. & County Councils



Prompt Delivery

These Centrifugal Pumps are ideal for Machine Tool Cooling and all pumping purposes—hot or cold water. Supplied complete with foot-valve, strainer and hose union. Suitable rubber hose available from stock.

- No. 10. 100 gals. per hour. Carr. 2/- extra. 25 2 6
- No. 11. 280 gals. per hour. Carr. 2/- extra. 28 6 0
- No. 12. 560 gals. per hour. Carr. 3/- extra. 27 12 0

Please send 2/4. stamp for specification.
State purpose for which pump is required.

AVOMINOR AC/DC and DC METERS
Prompt delivery. Priority Orders only.

LONDON RADIO SUPPLY CO.
Estab. 1925,
Ardingly Road, Balcobme, Sussex



With the Solon there's no waste heat—the heating element is inside the copper bit itself! All the heat is at the point—where you want it. The terminals are at the other end, safely housed away from the heat and easy to get at. Every Solon is supplied complete with 6ft. of Henley 3-core flexible. Made for the following standard voltages:—100/110, 200/220, 230/250. Supplies are, of course, only available for essential war work. Order well in advance as demands are heavy. Made in England

Illustration shows a standard 65 watt model; other types and sizes available.



W. T. HENLEY'S TELEGRAPH WORKS CO. LTD. Engineering Dept., Milton Court, Westcott, Dorking, Surrey

LASKY'S RADIO 370 HARROW RD. PADDINGTON, W.9

(Op. Padd. Hospital). Phone: Cunningham 1979
Offer for Sale the following components:—

- CONDENSERS**
2 mfd. 600 v. Block Paper Cond. 2/6 each.
TUBULAR .02 mfd. 2,000 v., 1/-, .25 mfd. 2,000 v., 1/6 each. .25 mfd. 350 v., 1/3 each. .05 mfd. 500 v., 1/- each. .01 mfd., 500 v., 9d. each. 50 mfd. 12 v., 1/4 each. 10 mfd. 25 v., 1/6 each. 1 mfd. 350 v., 6d. each. 2 and .3 amp. Mains Droppers, tapped, 7/6.

SPECIAL BARGAINS FOR SET BUILDERS
Grey cellulosed steel radio chassis complete with IF and aerial coils, trimmers, condensers, A and Earth sockets, 8-valve holders, resistors, 8 mfd. 500 v. wkg. Condenser, and many various components, etc., etc. Size 8in.x12in. x1 1/2in. Special offer 27/6. Post Free.

- U.S.A. Octal Valve Holders ... 7/6 doz.
Vol. Cont. 1/2, 1 and 1 meg., less switch, 2/9.
Ditto with switch, 5/9.
Midget v.c. 1/2 meg, less switch ... 3/9 each
.3 amp 3-way, line Cord, 70 ohms, per foot ... at 5/9 yard

VALVES! VALVES! VALVES!
We have over 5,000 new and boxed English and U.S.A. Mains and Battery Valves in stock, including KT33C, 6AB, 25Z4, 75, 5Z4, U50, 35Z5, 35L6, 6F6, FC13c, VP2, 5P4, PX4, PENAA, TDD4, UU5, 6K7, 6K8, 1W4 350, U12, 12AB, 12Q7, PEN36c, PENDD4020, etc. Rola P.M. less Transformers, 5in. at 19/6, 6 1/2in., 21 - 8in. at 23/6.

Goodman's 3 1/2in. 12 ohms V coil at 27/6, 5in. 21/6. 10in. £2 5s., less Trans.
Mains Transformers, 350-0-350, 4 v. heaters, 36 - 6.3 v. and 5 v. heaters, 37/6.
Universal 5 speaker Transformers ... 7/6 each
Pentode ... 6/6 each
Pentode Midget 5prk. Trans. shrouded 5/9 each

Send us your requirements. C.O.D. BUT CASH WITH ORDER PREFERRED.
Send 1d. stamp for latest list.
See our Classified Advert. under Valves, p. 30.

NEW LOUDSPEAKERS
NEW Broadcast P.M. loud-speakers, 3 models: 12in 12watt 15,500 lines, 1 1/2in dia, voice coil; 12in 25watt 18,000 lines, 1 1/2in dia, voice coil; 15in 40watt 18,000 lines, 2 1/2in dia, voice coil; machined and precision built instruments, Wiconal magnets, detachable diaphragms, die-cast chassis, uniform response, superior standards in fidelity, sensitivity, accuracy, tonal quality, appearance and finish; prompt deliveries; specifications and illustrations upon request.—Broadcast & Acoustic Equipment Co., Ltd., Broadcast House, Tombland, Norwich. [2537]

£5/15 only.—Brand new super quality 12in Auditorium permanent magnet speaker with triple cone, manufactured by Bakers Selhurst Radio, the pioneer manufacturers of moving coil speakers since 1925, wide frequency range, even response, ideal for quality reproduction, fitted with 1 1/2in speech coil and magnet having exceptionally high flux density in the air gap, suitable for public address equipment when quality reproduction is first consideration; send 2/6d, stamp for leaflet giving details of above and constructional details of a new acoustic chamber designed to extend loud speaker frequency range; also constructional details of an infinite baffle cabinet; every music lover interested in realistic reproduction should write for leaflet.

£8/15 only.—Brand new Super Power 18in Cinema permanent magnet speaker with 18in triple cone; will handle 20 watts U.D.O. ideal for quality public address equipment when power handling capacity plus realistic reproduction is required.—Bakers Selhurst Radio, 75, Sussex Rd., South Croydon, Tel. Croydon 4226 for demonstration. [2573]

LOUDSPEAKERS SECONDHAND
ROLA G12 and Goodman's 10in., both unused; offer.—58, Hillside, Hoarham, Sussex.
10-INCH G.E.C. speaker, with self-contained energising unit (200.250 ac). £5, or best offer; P.P. output transformer for above, 15/-; Parmeco 12in permanent magnet speaker, 15 ohms, £5, or best offer.—Box 3086.

- Wanted**
WANTED, RK 12in and G.12 speakers.—Box 3082. [2565]
WANTED, Voigt unit, with twin cone or cone only.—Box 3070. [2518]
WANTED, Hartley-Turner duode speaker.—1, Chapel St., Rishton, Lancs. [2568]
WANTED, 12in speaker, energised or p.m.; send details.—Higgins, "Southdene," Thiristane Rd., Malvern, Wores. [2547]
TWO semi-projector type p.m. spkrs., 7 or 15 ohms, s/coil, 10 to 20w, suitable P.A., also Epoch "Domino," 7 or 15 ohms, s/coil or sim.—Particulars, Worton, 5, Brookhill St., Stapleford, Notts. [2551]

DYNAMOS, MOTORS, ETC.
ALL types of rotary converters, electric motors, battery chargers, petrol-electric generator sets, etc., in stock, new and second-hand; supplied against priority orders only.
WARD, 37, White Post Lane, Hackney Wick, E.9. Tel. Amherst 1393. [1988]

L.T. dynamos for charging in stock; it 12 and 17lb. ditto, 27/6; all carr. paid England and Wales.—Electradix, 214, Queenstown Rd., Battersea, S.W.8. [2604]

RELIABLE multi vibrator unit, input 50v dc, output 230v ac, 50 cycles, capable of delivering approx. 100w; shielded cabinet and full interference suppression, vibrator sprung mounted; 15gns.—Chapman, Grove Farm, Roydon, Diss. [2531]
E.D.C. 12-volt dc to 230 ac, 50 cycles 90 watt; Wattes 50-volt dc to 230 ac, 50 cycles 100 watt, in silencing cabinet, with filters; E.D.C. 220 dc to 230 ac, 50 cycles 90 watt, in silencing cabinet and with filters; all three in excellent condition and to be sold to best offer, separate or together.—Box 3087.

Wanted
WANTED, rotary converter, any size.—Hull. 221, City Rd., London, E.C.1. [2428]

TEST EQUIPMENT
E.M.T. Oscilloscope, model Q2497; offers.—Rosen, 24, Park Hill Court, Croydon.

UNIVERSAL Avo Minor, new condition, in exchange for high res. dc Avo Minor.—Bird, 111, Cecil Rd., Norwich. [2575]

TESTOSCOPE used everywhere by radio service engineers, makes 20 important tests; send for interesting leaflet "R.I."—Runbaken, Manchester, 1. [1074]

TAYLOR Oscillator, model 65A, £18/18; also Avo Minor Universal in carrying case, £10; all as new.—Tregelles, 13, Quantock Rd., Weston-super-Mare, Somerset. [2555]

TAYLOR model 301 meter, 0-0.8 ma. 2 1/2in dial, new, £4; wanted, precision 5- or 6-gang condenser, 300-500 mmfd sections.—Lewis, 138, Maidstone Rd., Rochester, Kent.

W. BRYAN SAVAGE LTD.
Expert assistance in the solution of problems relating to
● TRANSFORMERS, CHOKES
● AMPLIFIERS
● POWER UNITS
and Specialised Equipment embodying
ELECTRONIC CONTROL
WESTMORELAND RD., N.W.9
COLINDALE 7131

Yours to a tenth of a thou!
Delivery promises are often like pie crust—made to be broken. Microscopical tolerances in light Engineering Products are routine with us, but our delivery dates have a tolerance of 3/1000 of a year.
Wingard MA LTD.
Precision Engineers
EUGENE WORKS, EDGWARE ROAD, HENDON, N.W.9

WARD ROTARY CONVERTERS
Petrol Electric Generating Plants, H.T. Generators, D.C. Motors, Frequency Changers, etc., up to 25 K.V.A.
CHAS. F. WARD
37, WHITE POST LANE, HACKNEY WICK, E.9
Phone: Amherst 1393

SALFORD Selenium PHOTO-ELECTRIC CELLS
ENLIGHTENMENT ON LIGHT
A Range of Standard sizes available—mounted or unmounted. Special sizes to order.
Please address enquiries to:—
SALFORD ELECTRICAL INSTRUMENTS LTD.
PEEL WORKS, SALFORD, 3
Telephone: BLAUBORNS 2488 (4 lines) Telegrams: SALSAL, SALSAL, MANCHESTER
PROPRIETORS: THE GENERAL ELECTRIC CO. LTD., OF ENGLAND

AUSTERITY RADIO LIMITED

CONSTRUCTORS' KITS

3-v.

T.R.F.

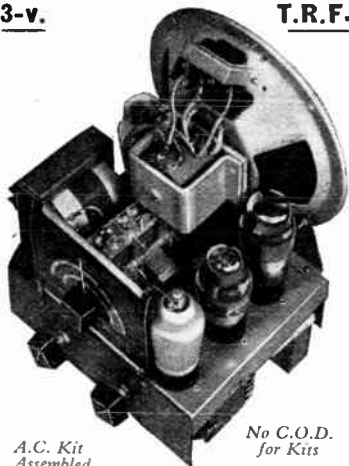

A.C. Kit
Assembled.

No C.O.D.
for Kits

Delivery approximately One Month.

New Litz-wound coils are now supplied with these Kits which give good quality reception of B.B.C. programmes. Complete with chassis 8in. x 6 1/2in. x 2 1/2in., Valves, M.C. Speaker and wiring diagram. (Regret, no cabinets.) 3 controls.

A.C. 3-V. (+ RECTIFIER) KIT. V.M.H.F. Pen., Triode, L.F. Pen., Rectifier, M.C. Speaker. Price 11 gs. Post 1/1, plus 3/6 packing (returnable).

BATTERY 3-V. KIT. V.M.H.F. Pen., Triode Detector and Output Tetraode, P.M. Speaker. Price 27. Post 1/1, plus 3/6 packing (returnable).

COMPLETE 5-WAVEBAND COIL UNITS. R.F. stage, Frequency Changer and Oscillator. Iron cored Midget Coils and Trimmers, all associated condensers and resistors, 3-gang tuning condenser and switch with circuit diagram blue print, colour coded. £3-10-0.

3-GANG CONDENSERS, ceramic insulation, .00025, 8/6; also STANDARD .0005 ceramic insul. 12/6.

SHORT-WAVE COILS. 3 bands covering 12-50 metres. Aerial and H.F. mounted on screened switch. Wired up to terminal output connections. All numbered. 11" spindle. Complete with circuit. 20/-.

A. & H.F. TRANSFORMERS with reaction colour coded. 10/6 a pair.

465 KCS. I.F. TRANSFORMERS. Air-cored, screened, with trimmers. 15/- a pair. Iron-cored, unscreened, small. 15/-.

UNIVERSAL MAINS TRANSFORMERS. A.C. input, 230 v. output, 300-0-300, 6.3 v., 4 amp., 5 v., 2 amp., 4 v., 2 amp., 4 v., 4 amp., 80 m.a. Screened primary colour coded—a good replacement transformer, especially for sets using mixed valves, 32/6 each.

STANDARD REPLACEMENT MAINS TRANSFORMERS, input 200,250 A.C., output 350-0-350, 150 m.a., 6.3 v., 5 amp., 5 v., 2 amp., 35/- each.

MAINS VOLT DROPPING RESISTORS, 2 amp., 1,000 ohms, 2 variable sliders, 6/-; 3 amp., 750 ohms, 2 variable sliders, 7/-.

10-WATT WIRE-WOUND RESISTORS, 2,000, 1,000, 500 and 150 ohm, 2/6 each.

VOLUME CONTROLS, 1, 1 and 2 meg., with switch, 6/6 each. 5,000, 10,000, 25,000 and 50,000 ohms, less switch, 4/- each.

CHASSIS. Un drilled steel, painted, new, 10 1/2 x 8 1/2 in., 7/6; 8 x 6 x 2 1/2 in., 4/6 each.

★ Please add postage for enquiries and orders, C.O.D. orders accepted.

Postal Permit to export to Northern Ireland and Eire. Owing to present circumstances, prices are subject to increase without notice.

307, HIGH HOLBORN,
LONDON W.C.1. Phone: HOLborn 4631

VALVE voltmeter, 6 range 0-60v, in steel case, incl. neon stab, PEN 45, SP41, TV4, diode probe, 1mA Weston, 50 mA Sifam meters.—Offers to Sim, 53, Mungallhead Rd., Falkirk. [2516]

JUST released, 45-range ac/dc kit, complete with B.S. 1st grade meter (3 1/4 in. diam.), 1,000 opv volts to 5,000, current (including ac) to 10 amps, ohms, decibels, etc.; 7gns; limited number only.

7-PAGE list describes above and many other test equipment kits (s.a.e.).—MacLachlan and Co., Strathroy. [2566]

PHILCO all-purpose tester model 048 (signal generator and test meter combined), £15; Ferranti test meter, ac/dc, £6; Avo Minor, dc, £3.—Mason, Ardsley House, East Ardsley, nr. Wakefield. [2527]

FERRANTI moving coil meters, one each, 0-500 m/a, 0-15 m/a, 0-150 m/a, 0-300v at 40/-; one 0-300v face slightly marked but O.K., 30/-; one 0-600v electrostatic, 45/-; one each 0-100v, 0-7v, ac-dc, 11.1 (Ferranti), 35/-; all flush mounting except 7/-; also ht transformers and high voltage condensers, Ferranti trans.; send s.a.e.—Box 3078. [2552]

Wanted

SECOND-HAND double beam Oscillograph required.—Box 3080. [2559]

WANTED, good all-wave ac oscillator.—Davies, 2a, Russell St., Bedford. [2576]

AVOMETER or Avominor, in order, cash.—Sharpe, Heath Rd., Exworth, Suffolk.

WANTED, mains or batt. signal gen.—Lowland, Mavista, North St., Nazeing.

EXPERIMENTER wants to exchange: Gent's 3-speed cycle (nearly new), gent's wrist watch, car radio, Avo signal generator (battery), dynamometer valve tester, 2 eliminators and quantity of radio parts; for Taylor valve tester, Taylor sig. generator, res. cap. bridge (Hunts or similar)—Box 3089. [2596]

NEW MAINS EQUIPMENT

VORTEXION mains transformers, chokes, etc., are supplied to G.P.O., B.B.C., L.P.T.B.; why not you? Limited but unqualified; orders can only be accepted against Government contracts.

VORTEXION, Ltd., 257, The Broadway, Wimbledon, London, S.W.19. Lib. 2814.

RADIOLAB valve and set tester, £11; Crypton 2-circuit charger, spare valve, max. rat. 30v 6a, crate returnable, £12; Tunar Home charger, max. rat. 12v 5a, £6/17/6; 2 Eko mains units, type A.C.V., incorporating ht, gb and a.c.t., each £3; Columbia mains unit, type 305C, incorporating ht, ac and dc lt, £4; carriage free on above goods.—T. G. R. Dowsett, 48, Grove Rd., Eastbourne. [2569]

MORSE EQUIPMENT

MORSE practice equipment for class-room or individual tuition; keys, audio oscillators for both battery or main operation.—Webb's Radio, 14, Soho St., London, W.1. Tel. Gerrard 2089. [2291]

GRAMOPHONE AND SOUND EQUIPMENT S.A.L.E. B.T.H. induction gram. motor, type YG, and 10in turntable; also B.T.H. M.I. cinema pick-up.—Offers to Box 3085. [2579]

GRAMOPHONE springs, Emco, all sizes and types in stock; usual prices; immediate delivery; c.o.d.—Napiers, Woodfield House, Ave. [2520]

COILS for filters, tone controls, etc., all types of transformers for "V.W." circuits.—R. Clark, 30, Langland Crescent, South Stanmore, Middx. [2570]

DIAMOND reproducing needles; will fit standard pick-ups, and are virtually everlasting; limited number only; £1/2/6; cash with order.—S. Smith, 4, Norfolk House, Queen's Drive, W.3. [2564]

RECORDING engineer offers consulting service for disc-film-tape, etc.; advice, diagrams; tests and reports; general design and information all aspects of sound recording.—S.a.e. with enquiries BM/DFAD, London, W.C.1.

SURPLUS to requirements.—Amplifiers by G.E.C., all brand new, 30watt BC82330/1/3 with AGC, £51; 30watt mobile BC82211/12, incl. mic., use with 12v battery, £35; 60watt BC82350/2, £56; microphones, BC82265 m/c, 110/-; BC82274 carbons, 70/-; crystals, 90/-; quantity metal industrial speakers, 75/-; in cabinets with transformer, 44/-; vol. cons. to suit, 3/3 each; BC83174R 1/s chassis with trans., 52/-; junction boxes fitted bakelite, 11/6 and 15/- doz.—N.E. (Sales), Ltd., 48, Prestongate, Hessele, Yorks.

Wanted

H.M. ship requires I.P.6 pick-up for ship's Stromberg-Carlson radiogram. — Write Box 3075. [2535]

WANTED urgently, power transformer for E.M.I. gram-playing desk, Model No. 610, any condition.—Box 3068. [2514]

ELECTRADIX

DYNAMOS—MOTORS—ROTARIES.



For essential and experimental work, permit free. Fine modern quarter-horse D.C. motors, 200 to 250 volts, enclosed, drip-proof silent bearings, flange or base fixing, double end shaft, 1/2 in. dia., 1,450 revs.; size 7 1/2 in. x 7 in., weight 35 lbs. Compound. We fully guarantee. 1/5th H.P., £3/10/-; 1 H.P., £4. Larger powers in stock.

LAST POWER TRANSFORMERS. 100 watt G.P. Co., 50 cycles, 230 volts to 22 volts, 3-4 amps., 40/-; 150 watt Foster, 400 cycles, 230 volts to 15 volts C.T., 10 amps., £3. 250 watt Foster, 50 cycles, 110 volts to 10,000 volts, 25 m.a., £4. 500 watt Foster, 440 volts, 50 cycles to 110 volts, 5 amps., £4/15/-. 1 kW Powquip, 250 volts, 50 cycles to 50 volts, 20 amps., £9. 1 1/2 kW Zenith, 100 volts, 50 cycles to 6,000 volts, 25 m.a., £8. 2 kW Foster, 200/230 volts, 50 cycles to 4,000 volts, £9/10/-. 3 kW Metwick, 400 volts, 50 cycles to 600 volts, oil, £9/10/-. 4.3 kW Foster, 400 volts, 50 cycles to 60 volts to 72 amps., £17.

TRANSFORMER PARTS. We offer a few shrouded carcasses ready for rewinding. 250 watt size, 27/6. First class make. If you can cut your own lams, out of 6in. Stalloy sheet, we can supply in 38in. lengths at 1/3 each.

SMALL SWITCHGEAR. Automatic Circuit Breakers, 10 amps. upwards, open or ironclad, triple pole, thermal trip, from 25/-; Battery cut-outs and Remote control D.C. contactors 6/12 volts 8 amps, type L, 10/6. 10 volts, 240 volts and 230 volts, 10 to 40 amps., 35/-. Rotary Instrument Switches, 7-way by R.I., ebonite panel, 7 studs on teak box, 7/6 only. Low voltage Switchgear, Lucas 8-way Aero enclosed, change-over and fuses, R.A.F. surplus, 3/6. 6-way R.A.F. push-button, 2/9. G.P.O. single c/o, 7/6. 3-way rocker switches, 3/6.

We can supply 100 ohm and 10,000 ohm Wheatstone Bridges. G.P.O. dial switch rheostats, 4,000 ohms and 8,000 ohms. Sullivan and Tinsley Mirror Galvos, Meggers, Avos, Siemens high speed Relays, 10,000 ohms Raycraft Relays. Incomplete ex-Govt. Wheatstone Bridges, less coils, 45/-; G.P.O. vertical Galvos, 35/-.

METAL CABINETS AND COVERS. Die cast aluminium boxes with hinged lid; inside 8 1/2 x 4 1/2 x 5 1/2 in., for oscillators, etc., 10/-. Covers. Light metal, ventilated special arch shape to contain 6 1/2 x 5 in. with terminal cover extension, 3/6.

RHEOSTAT Panel one-hole ETNA 0 to 1 ohm 3 amps., with pilot bulb, 3/-. Pilkon circular lab., 8in. mahog. base, glass front, 50 ohms 2 amps., 35/-. Sliders, protected mains type, 1/2 amp. 750 ohms, 17/6.

RECORDING OF MORSE SIGNALS. Ex G.P.O. Morse Inkers, record on paper tape, clockwork drive, fine workmanship; Siemens make in first class order, £12/10. Special field H.Q. Morse Inker, Key and Indicator, £15.

FIXED CONDENSERS. 2 mf., 250 volt smoothers, metal case, G.P.O., 2/6. Dubilier & T.C.C. .25 mf., 230 volt, 2/-. H.T. Mica 4,000 volts, 25 mf., 10/-. 2,000 volts, 1 mf., 10/6. B.I. oil-filled, 6,000 volts, 1 mf., 35/-. 4,000 volts, 2 mf., 45/-.

CONDENSERS. Ultra Short Wave variable air condensers, 16 m.mfd. Trolit insulation ball-bearings. Surplus to a Govt. contract and new, 5/-

MAGNETS. We have a large range of permanent magnets all sizes from 2 ozs. to 4 lbs., of fixed or permanent magnets for 12 volts D.C. with 2in. free plunger 1/2 in. dia., compound wound, 6/6.

Please send stamped envelope for answer to enquiries and include postage for mail orders.

ELECTRADIX RADIOS

214, Queenstown Road, Battersea, London, S.W.8

Telephone MACaulay 2159.

**Calling "C" for Charlie!
Calling "C" for Charlie!
Calling "C" for Charlie!**

Are you receiving me ?

O.K. "S" for Sugar.
Receiving you perfectly.

Can you like a book, thanks to the way I have improved through studying the

CANDLER SYSTEM OF MORSE CODE TRAINING

whenever I have had a little time to spare. I took it up because several of my friends in the Services who are highly efficient W/T Operators, advised me to train the way they did.

IRREFUTABLE EVIDENCE

of the soundness of Candler training is given in the "24 extracts from students letters" sent to all who write for the Candler

"BOOK OF FACTS"

which gives full details of the Courses for Beginners and for Operators who wish to improve their speeds and technique.

Write to:—

THE CANDLER SYSTEM CO.
(Room 55W), 121, Kingsway, London, W.C.2
Candler System Co., Denver, Colorado, U.S.A.

PITMAN ★ BOOKS

RADIO UPKEEP AND REPAIRS

By Alfred T. Witts, A.M.I.E.E. Keep your set up to "concert pitch" in these days of shortages. This book enables the average radio owner to diagnose the ordinary troubles of his wireless set and to remedy them himself. Sixth Edition. 7s. 6d. net.

PROBLEMS IN RADIO ENGINEERING

By E. T. A. Rapson, A.C.G.I., D.I.C. A classified collection of examination questions in Radio Communication, together with some useful notes, and formulae and answers to those questions. Designed particularly to meet the need of National Certificate students in Radio Communication. Fifth Edition. 5s. net.

BASIC CALCULATIONS FOR RADIO, WIRELESS & ELECTRICAL TRADES

By A. E. Druett, B.Sc. (Eng.) Lond., A.M.I.Mech.E. Applies to R.D.F. and Wireless Mechanics. Wireless Operators, and Electricians, Groups I and II. The syllabus for the proficiency examination is adequately covered, and fully worked solutions are included. 3s. 6d. net.

RADIO SIMPLIFIED.

By John Clarricoats. Provides a useful background of fundamental radio knowledge. The minimum of space has been devoted to theoretical considerations consistent with a sound basis of knowledge. Second Edition. 4s. 6d. net.

Some of the books advertised may be temporarily out of stock when you place an order. If you have any difficulty in obtaining copies of Pitman Books through your bookseller, write to Enquiry Department, Pitman House, Kingsway, London, W.C.2
Please do not send money when making enquiries

39, PARKER STREET, KINGSWAY

WANTED, universal mains auto-changer; will exchange ac model with cash adjustment.—Box 5072. [2524]

LARGE modern good quality radioram cabinet, in good condition; state measurements and price.—Phipps, 73, Willington Rd., Wood Green, N.22. [2578]

QUALITY m/c or crystal pick-up, also quality speaker; two Reslo S.U.7 units and 4ft 6in horns for sale, as new, £17.—Dixcove, Gillscliff Rd., Ventnor. [2533]

RECORDING equipment complete or component parts, professional or semi-professional, urgently required.—Akroyd, Albany Rd., Victoria Park, Manchester, 14. [2595]

GRAMOPHONE motor in first-rate condition. 230v a.c.; also T.M.G. gramophone pick-up, R.I. Varley pick-up arm.—Dr. Fothergill, Ingleside, Trinity Rd., Darlington.

COMPONENTS—SECOND-HAND, SURPLUS L.E.D.'S Service kits. Kit No. 1, one 8mfd 450v tubular, 2 each 0.05, 0.001, and 6 resistances, 11/6 kit.

KIT 2.—Two 8mfd 450v tubulars, one 0.3 mains dropper, 2 var. taps; one 60ma choke and 6 resistances, 30/6 kit.

TUBULAR wire end condensers, 1,000v test, 0.1, 3/- doz; 0.05, 0.01, 7 6 doz; 0.004, 0.002, 0.001, 5/6 doz; mica condensers, H.M.V. asstd. values, 5 6 doz; Dubilier 0.0001, 4/6 doz.

MAINS droppers, 1,000 ohm, 0.2amp, two var. taps, 4 6 each; Little Maestro type, 0.3amp, 5/6 each.

WAVECHANGE switches, 2pt, 3-way, 4pt 2-way, 3 9 each; 4pt 3-way, 4/6 each.

GOODMAN P.M. speakers, 10in, with multi- ratio trans., will handle 6w. £2/11/6.

MAINS transformers, 350 0-350, 4v 4a, 100ma, usual primaries, 29/6 each.

VOLUME controls, less switch, long spindles, all values from 5,000 to 2meg, 3/4 each; spindle extenders, 6d. each.

VALVEHOLDERS.—Octal Brit. and Int., 8/6 doz. Slewing, 3d. per yard, or 1 doz 2/6; grid caps, Oct. and Brit., 1/- doz.

SUPERHET kits.—Band-pass A coil, osc. coil, two i.f. trans., 110ks. 3-gang tuning condenser, ex Ekco, with v.t., £1.

SPEAKER transformers, standard pentode, 8/- each.

L.E.D.'S special offer.—Rothermel "Electrad" var. resistances, 5w, 15,000, 50,000 and 1meg, with knob, panel mounting, boxed, complete with instructions; (list 8/-) to clear 4/- each. Terms: c.w.o. or c.o.d. £1 or over.—K. H. Ede, "Eureka," Surrey Gardens, Effingham, Surrey. [2584]

EDISON steel batteries, 2 banks of 5, 1.2 volts 60 amps per cell (max.); £35/10.—R. H. Bury, 58, Whitworth Rd., Rochdale, LONDON CENTRAL RADIO STORES.—See our displayed advert, page 15, this issue.—London Central Radio Stores, 23, Lisle St., London, W.C.2. Ger. 2969. [2359]

ALL radio enthusiasts will find much to interest them; send 1d. stamp for latest list, or call at Berry's (Short Wave) Ltd., 25, High Holborn, W.C.1 (Tel. Holborn 6231).

IT would be an exaggeration to say we have everything in radio, but we have nearly every valve, resistance, condenser, etc.; pay us a visit, it will save you a lot of time.—Berry's (Musical), Ltd., 10, London Rd., Camberley, Surrey. [2522]

RADIOSALES offer: All popular valves, re- sistances, 1/6w, 4d.; 1/6w, 6d.; 1w, 9d.; most values tubulars, 0.0001 to 0.005, 9d.; 0.01 to 0.05, 1/-; 0.1 (special), 6d.; Paxolin valveholders: octal, 7- and 9-pin, 9d.; 4- and 5-pin, 6d.; enquiries others, s.a.e., post extra.—RCM/SALES 9, London, W.C.1. [2553]

LIMITED number all-wave push-button tuners, consisting all necessary coils, trimmers, switches for long, med. to s.w. bands plus 8 pretuned stations, 39/6 ea. (no c.o.d.); suitable gang cond., 12 6; pair 405, 11.5. 18/-; chassis, other comps. avail; stamp enquiries.—Richard, 56, Clayhall Ave., Ilford.

ELECTRIC soldering irons, pencil bit, 12/6; resin cored solder, 1lb 4/6; 18g tinned copper wire, 1/2lb, 2/-; 2mm sleeving, 2/9 doz yds; pushback wire, 1/9 doz yds; heavy twin mains flex, 7/6 doz yds; rubber-covered 3mm flex, 1/9 doz yds; 50mfd 12v electrolytics, 1/6; 10mfd 50v can type, 2/9; 0.2 amp 1,000 ohm droppers, adjustable, 4/-; 0.3 amp 750 ohm, adjustable, 5/6; American octal valveholders, 8d.; British 7-pin, 8d.; 0.1mfd 350v condensers, 6/6 doz; black set knobs, 7/- doz; solder tags, 2/- gross; "Clix" 2-pin plugs, 5 amp, 1/-; 3-pin 5 amp, 1/3; 3-pin 15 amp plugs, 2/6; BC adaptors, 1/3; volume controls, long spindles, all usual values, 3/6; with switch, 4/6; top cap connectors, 1/- doz; screened type, 8d. ea.; octal or standard; insulation tape, 1/2lb 1/-; large stocks American valves, etc.; orders above 10/- post free; mail order only.—"A. H." Hazeljohn, Crofton Lane, Orpington. [2438]

"UNIVERSAL CIRCUITS"

by R. S. Roberts, M.Brit.I.R.E., A.M.I.R.E.

Three folders and a thirty-six page booklet, presenting the main principles of radio circuit operation in a concise and convenient form for the pocket.

- I. The Transmitter.
- II. The T.R.F. Receiver.
- III. The Superheterodyne Receiver.

By means of hinged flaps, the charts give a large number of recognised alternatives for each stage. To assist the student in memorising and understanding these, a logical five-colour scheme has been adopted throughout.

"Grid Leak" says: "The Charts and Notes are really intended for students and teachers of radio, but are extremely useful to every radio engineer."

Price complete 6/3 post free, from

The Bookstall
NORTHERN POLYTECHNIC
HOLLOWAY, LONDON, N.7

RELAYS TYPE LF WORK IN ANY POSITION



Specified by many Government Departments

Ask for leaflet SPN'WW

LONDEX LTD
MANUFACTURERS OF RELAYS
ANERLEY 207 ANERLEY ROAD LONDON S.E.20 PHONE SYSTEM 8234

SPEAKER REPAIRS by Specialists

Any make, British or American Best Service

TRADE ONLY Moderate Charges
Also Components for Service Men at keenest prices. List 1d. Holders of Export Licence for Northern Ireland.

A. W. F. RADIO PRODUCTS 'Phone: 11926
Borough Mills, Sharpe Street, Bradford, Yorks.

"SYSTEMATIC RADIO SERVICING"

A method for organising the repair-shop, devised and employed by J. Bull. Also a catalogue of many Radio Service Aids including "History of Faults," "Job Cards," which almost repair the sets, "Valve Base Data Cards," and perhaps most important, a Rectifier which will replace any of the popular Universal valves such as 12Z3, 2Z5, 1D5, U30, 40SUA, etc. Price 1/7 p.f.

V.E.S.,

(W) Radio House, Moithorne Drive, Rutlip, Mdx.

"ENGINEERING OPPORTUNITIES"

This unique handbook shows the easy way to secure A.M.I.Mech.E., A.M.Brit.I.R.E., A.M.I.R.E.E., City and Guilds, etc.

WE GUARANTEE—

"NO PASS—NO FEE."

Details are given of over 150 Diploma Courses in all branches of Civil, Mech., Elec., Motor, Aero, Radio, Television and Production Engineering, Tracing, Building, Govt. Employment, R.A.F. Maths, Matriculation, etc.

Think of the future and send for your copy at once—FREE.

B.I.E.T., 387, SHAKESPEARE HOUSE
17, STRATFORD PLACE, LONDON, W.1.

VALVES

This is part of our current stock of valves and if all their equivalents were mentioned it would be found that we can supply either the exact valve or a suitable replacement for almost any type. Wherever possible please order C.O.D. Stamp with enquiries, please.

PRICES STRICTLY B.O.T. RETAIL

BATTERY. 21 OH1L, LD210, 5 10; P220, PM2A, 7 4; 210DDT, HD24, TD12A, 9 2; 210SP7, 210VFA, 210VPT, 215SG, 220HPT, 220 OT, HP210, KP2, KT24, PM12M, PM22A, SP2, S215VM, VP2, VP210, VP2B, W21, Z21, Z22, 11; PC2, FC2A, X24, 12 10.
A.C. TYPES.—21DA, 6 9; 35 4V, AC2HL, MH4, AH14, 9 2; AZ1, ZH, DW2, DW4-500, 1W4-550, MU14, U10, 11; AC044, MH41, PX4, TDD4, 11 7; 42MP Pen, AC VP1, AC/VP2, AC/Pen, AC2Pen, AC5Pen, KT268, MVS Pen, MVS PenB, PenA4, PenVA, SP4, VP4, VP4B, VPT4, 12 10; AC/TH1, AC/TP, FC4, MK40, TH4, TX41, VHT4, 41MPG, 14; KT32, KT33C, PenB4, 14 8; MP Pen, 16 6; FW4-500, KT66, 18 3; PX25, VPT400, 24 4; Pen428, 30 5.
UNIVERSAL.—2D13A, 9 2; CV1, U31, URIC, UR3C, U4020, 11; 11D3, TD1D3C, 11 7; 8D2, 9D2, 13SP4, CL4, CL33, Pen9C, SP13, SP1320, VP13A, VP13C, 12 10; CBL1, Pen1D4020, TH21C, 15 3.
MAZDA.—H123, 5 10; Pen25, UV5, UV6, UV7, U4020, VP23, 11; HL41DD, HL133DD, 11 7; Pen45, SP41, TP23, TP26, VP41, 12 10; AC/TP, TH41, TH233, 14; QP25, PenD4020, 15 3.
E TYPES.—EM4, 11; EB2, EB33, 11 7; CL4, CL33, EFS, EFS, EL33, 12 10; CL135, ECH2, ECH3, ECH35, EFS, EFG, EK2, EL2, 14; EBL1, EBL31, 15 3; EL5, 16 6; EL33, 18 3.
AMERICAN.—OZ4, 1A5, 1B5, 1H5, 2A6, 2A7, 2B7, 5Y3, 5Y3, 5Z1, 6A3, 6A4, 6A6, 6A6G, 6A7 conversion, 6C3, 6D6, 6C8, 6E6, 6F5, 6P6, 6R8, 6I16, 6I18, 6J7, 6K6, 6K7, 6K8, 6L6, 6L7, 6P5, 6Q7, 6A7, 6S47, 6S47, 6S47, 6V6, 6X5, 6Z6, 10, 12A5, 12Q7, 17, 12AF5, 12Z5, 19, 24, 25, 26D8, 28Y5, conversion, 25Z5 conversion, 25Z6, 32, 33, 34, 35, 37, 38, 42, 46, 48, 50, 53, 57, 71A, 75, 76, 78, 79, 80, 81, 85, 89, 1851R (Ballast) K53B and C (Ballast).

VALVES & ADAPTORS

In the cases where we cannot supply the exact valve or equivalent, we can get your set going with a valve and an adaptor, the additional cost being 4/6.

SPARES

KIT OF 12 TRIMMER TOOLS in American cloth folder. Very handy. 30/-
32 B. LINE COIL.—3 amp, 3 core 50 ohms per ft., extremely good quality. 6/9 per yd.
CELULOSE CEMENT for speaker valve and most other repairs. 5/- large tin. **SERVISOL**, more than a switch cleaner, 7/- tin. **MAINS TRANSFORMER** 350-0-350 4-volt heaters. 29/6
VOLUME CONTROLS with switch, 5/-
6 V. VALVE EQUIV. CHARTS 1/7, post free. **BOOKLET ON AMERICAN MIDGETS**, 2/7.

J. BULL & SONS

(Dept. W.W.)

246, HIGH ST., HARLESDEN, N.W.10.

R. K. Dundas

LIMITED

Experimental and Aeronautical Engineers and Scientific Instrument Makers. Manufacturers of Precision Mechanical, Electro-Mechanical and Thermionic Instruments. Electro-Medical and Industrial Apparatus, Time Interval Measurement and Counters, DC Amplifiers and Recorders. Specialised Design Enquiries Welcomed

THE AIRPORT, PORTSMOUTH

Telephone : 74874.

G. A. RYALL, 69, Wharfedale Gdns., Thorn-ton Heath, Surrey.—Please note new temporary address; mail order only; no c.o.d. under 20/- please.

T.C.C. 0.1 nonduct. tubul. cond., in Pax-tubes, type 330, 350v wks., 7/6 doz.

SLOW motion (epicyclic) drives, in well-finished brass, ratio 8-1, shaft 1 1/4 in. long, 1/4 in dia., drilled to take pointer, 1/3 each.

PAXOLIN strip, 2 1/4 in wide, 12 in lengths, 3 1/6 and 100 25/-; short lengths cut ground board size, 6/1 3.

THIMBLE top caps, 24 1/3; insulating tape, black, 1/3 lb.; Wearite switches, ebonite with silver-plated contacts, for 2hf and hand pass, with dial lights, 1/6 each.

5-PIN plugs and sockets, complete with metal insulated cap, 2 for 1/6.

TWO-WAY screened flexible, good quality, 1/3 yard, three yards 2/9; twin screened, high insulation and cotton outer cover 1/9 yard, 4-day 2/3 yard.

TEN-WAY cable, good conductors, 1/3 yard, three yards 2/9; ten-way cable, including three 5 amp conductors for low tension circuits, 2/- yard, three yards 4/9.

OCTAL 8-pin plugs with base, complete with insul. metal cap, 1/3 each, three for 2/9; twin rubber cable, tough flexible 1/3 yard.

MORGANITE long spindle 10,000 volume controls less switch 3/9, 50,000 ohms medium spindle 3/6, 1 meg long spindles 3/9.

DIAL plates, oblong, 5/2x2 1/2 approx., Burnpet, Varley, Vidor, with station names; 4 assorted for 1/6.

BURNPET portable set dial, 4 1/2 in x 2 in approx., two types, 2 1/3; Burnpet 4-band, 8x5 1/2, s.w. on lower half dial, 1/6 each; Vidor 3-band, 6 1/2 x 5 1/2, 1/6 each.

COILS, iron core midget, Litz wound, medium wave tapped, no reaction, 2/3 each; push-back wire stranded, cotton covered, 3 colours, 12 yards, 2/5.

MICROPHONE capsules by Standard Tele-phones, 3/9 ea.; Centralabvc, less switch, long spindles, 5,000 ohms, 1 meg, 3 9 ea.

INPUT strips, 2 in x 3 in, 2-way, 2/9 dozen; with terminal screws, 3/9 dozen; anchor or mounting strips, 2/3 dozen, 5-way.

SPECIAL offer T.C.C. double mica cond., 0.0001 x 0.0001 five (ten condensers) for 1/3; Hunts 0.01 mica cond., 1/- ea.; hf chokes on ebonite bobbins, 5,000 ohms, 1/3 ea.

ERIE colour coded resistances, 2-watt type, 680, 6,800, 140,000, 150,000, 220,000, 470,000, 820,000, 2 1/3; Erie 3-watt, 680, 6,800, 1/3 each.

YAXLEY type low loss switches, single pole dt, 2 bank, 2/9, single bank 2/3.

CLYDON and Plessey trimmers, 70mm, 2, 1/6; 1,000 and 2,000mm, 2, 1/-; low value oddments, 2, 1/-.

HENRY'S offer Ferranti AF5C's P.P. trans., 30/-; T.C.C. 2mf 1000v wkg., 7/6; small 3-gang, 0.0005 with trim., 10/-; short-wave hf chokes, 2/-; midget T.R.F. coils with reac., 10/- pr.; 5in Plessey p.m. with trans., 28/6; Goodman's 3in p.m., 27/6; midget chokes and sp. trans., 6/6; 0.2 line cord, 750 and 900 lengths, 2-way, 10/-; slow motion epicyclic drives, 2/-; car radio suppressors, 18/6 set of 6.—Henry's, 5, Harrow Rd., Paldington, W.2. Pad. 2194. [2554]

SOUTHERN RADIO'S wireless bargains: Screws and nuts, assorted gross of each (2 gross in all), 10/-; soldering tags, including spade ends, 6/- gross; Philco 3-point car aerials, excellent for short-wave and home aerials, 7/6; Limit tone arms, universal fixing for all types of sound boxes and pick-up heads, 10/-; Ace "P.O." microphones, complete with transformer, ready for use with any receiver, 7/-; circular magnets, very powerful, 1 1/4 in diameter, by 3/4 in thick, 1/6 each, 15/- per doz.; Erie resistances, brand new, wire ends, all low value from 0.8 ohms upwards, a few higher value are included in each parcel, 1/4, 1/2, 1 and 2 watt, 100 resistances for 3/-; Multicon Master mica condensers, 28 capacities in one from 0.0001, etc., etc., 4/- each; special assorted parcel for service men, 100 Erie resistances (description above), 24 assorted tubular condensers, 6 reaction condensers, 0.0001, 12 lengths insulated (leaving, 75ft. push-back connecting wire, soldering tags, screws, wire, etc., 65/-, all brand new; crystals (Dr. Cecil), 6d., with cats-whisker, 9d.; complete crystal detectors, 2/6; 5ft. wire for aerials, etc., 2/6; 25yds push-back wire, 5/-; Telsen reaction condensers, 2,0001, 1/9 each; Telsen large disc drives, complete with knob, etc. (box), type W 184, 2/6 each; insulated sleeving, assorted yard lengths, 3/6 doz.; single screened wire, doz. yards, 10/-; loud speaker units, unshrouded, midget type, 4/-; metal case condensers, 0.1 0.1+0.1, 2/6; rheostats, power type, 30 ohm, 4/6; pointer knobs, black and brown, 1/4 in, 1/-.—Southern Radio Supply Co., 46, Lisle St., London, W.C. Gerrard 6653. [2152]

PREMIER RADIO

Premier 1-Valve de Luxe Battery Model S.W. Receiver, complete with 2-volt valve, 4 coils covering 12-170 metres. Built on steel chassis and panel. Bandspread tuning, 55/-, including tax.

PREMIER MICROPHONES

Transverse Current Mike. High-grade large output unit. Response 45-7,500 cycles. Low hiss level, 23/-.

Premier Super-Moving Coil Mike. Permanent Magnet model requiring no energizing. Sensitivity 56db. Impedance 25 ohms. Excellent reproduction of speech and music, 25/5-.

Microphone Transformers, 10/6 each.

Crystal Mike. Response is flat from 50-5,000 cycles with a slightly rising characteristic to 8,000 cycles. Output level is minus 60db. Price 39/6.

Chromium Collapsible Type Microphone Stand, 52/6.

CHASSIS

Lead coated steel, undrilled.
 10 x 8 x 2 1/2 price 7/- each.
 16 x 8 x 2 1/2 price 8/6 each
 20 x 8 x 2 1/2 price 10/6 each

I.F. TRANSFORMERS, IRON CORED

4- and 6-pin types, now have octal pin spacing and will fit International Octal valve holders.

NEW PREMIER S.W. COILS

450-470 kc., plain and with flying lead, 7/6 each.

4-PIN TYPE **6-PIN TYPE**

Type	Range	Price	Type	Range	Price
04	9-15 m.	2/6	06	9-15 m.	2/6
04A	12-25 m.	2/6	06A	12-25 m.	2/6
04B	22-47 m.	2/6	06B	22-47 m.	2/6
04C	41-94 m.	2/6	06C	41-94 m.	2/6
04D	76-170 m.	2/6	06D	76-170 m.	2/6
04E	150-350 m.	3/-			
04F	285-550 m.	3/-			
04G	490-1,000 m.	4/-			
04H	1,000-2,000 m.	4/-			

New Premier 3-Band S.W. Coil, 11-25, 25-38, 38-86 m., 4/9.

Bakelite Dielectric Reaction Condensers.

0001 inf. 1/3, 0003 inf. 2/6, 0005 mf. 2/9 each

0003 inf. Differential 2/11 each

H.F. CHOKES

S.W. H.F. Choke, 10-100 m. 1/3

Binocular H.F. Choke 1/6

Brass Shaft Couplers, 1/4 in. bore 7 1/2 each

Flexible Couplers, 1/4 in. bore 1/6 each

7-pin Ceramic Chassis mtg. English fitting Valve Holders, 1/6 each

Amphenol Octal Chassis mounting Valve Holders, International type, 1/3 each; English type Octal, 1/3 each.

RESISTANCES

Mains Resistances, 660 ohms, 3A Tapped, 360 x 180 x 60 x 60 ohms, 5/6 each.

1,000 ohms, 2A Tapped 900, 800, 700, 600, 500 ohms, 5/6 each.

SWITCHES

QMB, panel mounting, split knob type, 2 point on/off, 2/- each. Double pole on/off, 3/6 each.

VOLUME CONTROLS

Carbon type, 20,000 and 2 meg., 3/9 each.

5,000 and 10,000, 4/6 each.

Wire Wound Type, 5,000 and 10,000 ohms, 5/6 each.

Valve Screens for International and U.S.A. types, 1/2 each.

Resin-Cored Solder, 7 1/2 lb. per coil

Push-Back Connecting Wire, 2 1/2 lb. per doz.

Syaloflex Sleeving, 2 mm., 2/6 per doz. yards.

Screened Braided Cable, Single, 1/3 per yard.

Twin, 1/6 per yard.

MOVING COIL SPEAKERS

Goodmans 3 1/2 in. P.M. Speaker, 15 ohms voice coil, 30/-.

Rola 6 1/2 in. P.M. Speaker, 3 ohms voice coil, 25/-.

Rola 8 in. P.M. Speaker, 3 ohms voice coil, 25/-.

Above speakers are less output transformer.

7-pin Output Transformers, 3 1/2 watts, price 10/6 each.

Celestion or Plessey 8 in. P.M. Speaker, 29/6.

Celestion 10 in. P.M. Speaker, 49/6.

The above speakers are fitted with output transformers.

Morse.—The Premier Oscillator supplied complete with valve, on steel chassis, price 27/6. Practice key 3/3, TX key 5/10, Super key 11/6. 3-Henry Chokes (as used in Oscillator), 10/-.

High pitched Buzzer, adjustable note, 1/11 each.

Send for details of other Accessories available.

ALL ENQUIRIES MUST BE ACCOMPANIED BY A 2/- STAMP.

PREMIER RADIO CO.

ALL POST ORDERS TO :

JUBILEE WORKS, 167, LOWER CLAPTON ROAD, LONDON, E.5. (Amberst 4723.)

CALLERS TO :

JUBILEE WORKS or 169, FLEET STREET, E.C.4. (Central 2833.)

THE RADIO INSTRUMENT CO.
AGAIN AVAILABLE!!!

We have pleasure in announcing that all types of transformers (including OP12) are now in production, and will shortly be available to all "Wireless World" readers.

NEW DESIGNS.

Restrictions on laminations and stamping problems have been overcome by an alteration in structural design which in no way affects the performance or dependability.

MAINS TRANSFORMERS.

Type	GT350 0.350 v. 120 m.a. 4 v. 2 a. and 4 v. 2 a. and 4 v. 2 a. and 4 v. 4 a. CT ...	35-
	GX 350 0.350 v. 120 m.a. 4 v. 2 1/2 a. and 4 v. 6 a. CT ...	37 6
	GY 350 0.350 v. 120 m.a. 5 v. 2 1/2 a. and 6.3 v. 6 a. CT ...	37 6
	GW 425 0.425 v. 120 m.a. 4 v. 2 1/2 a. and 4 v. 2 1/2 a. and 4 v. 6 a. CT ...	45-
	GZ 500 0.500 v. 150 m.a. 4 v. 3 a. and 4 v. 7 a. CT ...	45-
	GAZ 500 0.500 v. 150 m.a. 5 v. 3 a. and 6.3 v. 6 a. CT ...	45-

The above types are for "upright" mounting. A full-size print and technical specification sent upon request.

OPI2G OUTPUT TRANSFORMER

Electrically equivalent to the original OP12, but in the new upright construction. 50-watt multi-ratio ... 42/6

The prefix "G" added to our list code letters denotes THE NEW UPRIGHT CONSTRUCTION available for GENERAL DISTRIBUTION.

All inquiries to:—DEPT. 'G.'

THE RADIO INSTRUMENT CO.
294, BROADWAY, BEXLEYHEATH KENT

'Phone: Bexleyheath 3021

FLIK-O-DISK
Answers!
Quick!

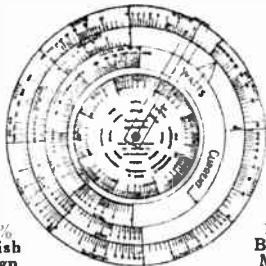

100% British Design

100% British Made

Answers all OHM'S LAW problems—for example:

- What will be the voltage when current I flows through resistance R?
 - What will be the voltage with watts value W and I current flowing?
 - What is the current flowing where watts value is W and voltage is E?
 - What current will flow through R resistance where voltage is E?
 - What will be the resistance where current I flows at voltage E?
 - What will be the resistance where watts W is at voltage E?
 - What will be the resistance where watts W at current I?
 - What is the wattage at voltage E through resistance R?
 - What is the wattage of current I through resistance R?
 - What will be the wattage of I current at E voltage?
- The scales read from 1 millivolt to 1,000 volts. From 1 ohm to 1,000,000 ohms. From 1 milliamper to 10 amperes. From one-tenth of a milliwatt to 10,000 watts.

FULL INSTRUCTIONS WITH EACH INSTRUMENT.

PRICE 4/6 Postage 3d.

Order at once whilst deliveries are good
IONIC LABORATORIES LTD.
8 Cranbourne Terrace, Salt Hill, SLOUGH, BUCKS, ENG.

15 amp plugs, 2-pin, 15/6 doz; wander plugs, 1/6 doz; suspension springs for aerials with 2 insulators, 1/- each; earth rods, 12in, 1/-; copper wire, 100ft 3/6, 75ft 2/3, 50ft 1/9; 5 m/m wire, 25/- 100 yds; electric soldering irons, 15/9 each, 230-50 volts; cycle valve tubing, 1/- per yard.—Larg's, Whitehall St., Dundee. [2549]

COULPHONE RADIO, New Longton, nr. Preston.—New goods only; Tunggram and B.V.A. valves; mains transis., 350v 100ma. 4v 6a, 4v 2.5a, or 6.3v 3a, 5v 3a, 33/6; mains transf. bobbins, windings as above, 17/6; p.m. speakers, less transf., Rola 5in 21/6, 6 1/2in 22/6, 8in 24/-, Plessey 10in, powerful magnet, 35/-, Celestion, with pen. transf., 8in 30/-, 10in, heavy duty magnet, 45/-; power-pen. output transf, 7/6; push-pull Universal, 15/6; Parafect I.I. transis., 4:1, 6/6; Bell transis., 6/6; line cord rep. resistors, 100ft 5/6; carbon resistors, 1/4w 4d., 1/2w 6d., 1w 9d.; switch cleaner, 2/6 bott.; cellulose cement, 4/- 1/2pt; cored solder, 4/6lb tin; cop. wire, 2/3 1/2lb; sleeving, 2mm, 3d. yd; condensers, 50mfd 12v, 25mfd 25v, 2/-; 25mfd 50v, 2/9; 50mfd 50v, 3/3; tubular and silver mica, all sizes; valve holders, 1d. per pin; vol. controls, with sw., 5/9; less sw, 4/9; electro-micro, soldering irons, 60w, 12/6; smoothing iron elements, 450w, 2/3; fire spirals, 750w, 2/-; 1,000w 2/6; s.a.e. for stock list. [2544]

VALVES

2000 VALVES, British and American; send stamped addressed envelope for list.—Napiers, 127, Prestwick Rd., Ayr.

5000 valves, all types, including output, rectifiers, etc.; also a few tax-free ones left; s.a.e.—Davies, 28, Mount Vernon Crescent, Barnsley. [2406]

BERRY'S (SHORT WAVE), Ltd., 25, 11gh Holborn, W.C.1, have a large stock of English and U.S.A. valves; 1d. stamp s.a.e. for list.—(Tel. Holborn 6231.) [2562]

OUR adaptors will help in replacing unobtainable valves; send 7d. for interesting booklet on valve replacements; trade enquiries invited.—V.E.S., Radio House, Ruislip. [1885]

COULPHONE RADIO, New Longton, nr. Preston.—Tunggram and B.V.A. valves, hundreds in stock; post and packing free; rectifiers 5Y3G, 5Z4G, 80, equiv. U12, U14, etc., 10/-; really prompt service; s.a.e. for list and enquiries. [2545]

VALVES.—We have over 5,000 new and boxed English and U.S.A. mains and battery valves in stock, including 6A7, 6A8, 25Z4, 75, 5Z4, U50, 35Z5, 50L6, 35L6, 6F6, 6C13c, VP2, SP4, PNA, PENA4, 125Q7, TDD4, U15, 6K7, 117Z6, 6Q7, 6K8, 6X5, 6B8, 1W4350, U12, 12A8, 12Q7, 6SA7, 6SK7, PEN36c, etc., etc.; send 1d. stamp for latest list.—Lasky's Radio, 370, Harrow Rd., Paddington, W.9 (opposite Paddington Hospital).

1000 valves in stock.—CX1C, 11/-; UR3C, 11/-; U10, 11/-; VP23, 11/-; AC2/PenDD, 15/3; AC5/PenDD, 15/3; Pen DD-4020, 15/3; VP13C, 12/10; SP13, 12/10; Pen A4, 12/10; 80, 11/-; 78, 12/10; 45, 11/7; 42, 12/10; UU5, 11/-; U31, 11/-; 1W4/350, 11/-; HL23, 5/10; AC/TH1, 14/-; SP41, 12/10; EM3, 10/5; AZ1, 11/-; 36, 12/10; 6C6, 12/10; IC5GT, 11/-; IH5GT, 9/2; 35Z4GT, 11/-; send s.a.e. for valve and wireless parts lists, 2d.—Ransom, 9 and 34, Bond St., Brighton. Retailers not supplied. [2397]

VALVES, British and American, many types in stock; Midget aerial and h.f. medium wave, t.r.f. high gain coils, ideal for t.r.f. receivers, 9/- pair; Midget receiver chassis, drilled for 4 valves, 10 1/2 x 6 x 2in, grey, first class, heavy quality, 9/6; superior quality smoothing chokes, heavy duty, 120ma, 200ohms, 15/-; 80ma, 500ohms, 12/6; Midget chokes, 50-60ma, 7/6; Midget highly polished black and standard knobs, 9d., 8/1 doz.; replacement field coils, for standard 8in speakers, 400ohms, 5/-, 48/- doz.; 2-way screened leads, braided, terminating 4 wander plugs, fully finished, 54in long, 3/-; line cord, 500ohms per foot, 0.3amp, 3-way, 6/- yard; universal mains droppers for all receivers, 1,000ohms, 0.2amp, fitted 2 variable taps, 4/6; 750ohms, 0.3amp, do. taps, 5/6; superior quality job, with fixing feet, etc., 0.2 and 0.3amp, 7/6; dials, 3 waveband, station names, etc., coloured, ivory, 7 x 3 1/2in, 1/6; Midget speaker transformers (pen), 7/6; wire wound potentiometers, 2,000ohms, 6/6; valveholders, paxolin, English and American, 9d., 8/- doz.; nuts, screws, 4BA, round heads, brass, 6/- gross; 6BA cheese heads, sheradised, 5/- gross; full range speakers, etc., lists available; postage on all orders.—O. Greenlick, 34, Bancroft Rd., Cambridge Heath Rd., London, E.1. Steppay Green 1334. [2602]

Wanted

WANTED: up to 4 corn pentodes, 4-volt B.L. prof. AP4, also 8 holders for same. —Box 3077. [2543]

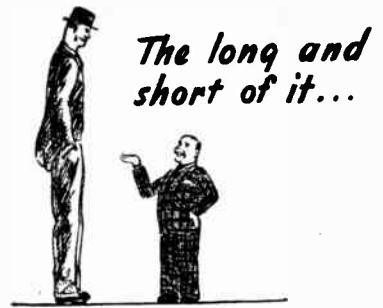

The long and short of it...

... is that there is a long list of orders and supplies are short—very short—of Gardiner Transformers, especially in the Small Power class up to 1 Kva. We are doing our utmost to catch up, but when you are kept waiting we know you will understand. Maybe we are partly to blame for making such a good job!

GARDNERS
RADIO LIMITED
Manufacturers of
Very Good Transformers
SOMERFORD · CHRISTCHURCH · HANTS

HILL & CHURCHILL
BOOKSELLERS
SWANAGE DORSET
·
ENGLISH & AMERICAN
BOOKS IN STOCK ON
RADIO AND
TELECOMMUNICATION
·
CATALOGUE ON APPLICATION

Cabinets?

Increased production facilities enable us to give immediate attention to orders for urgent requirements and we are now in a position to accept further contracts or sub-contracts for Government work.

We specialise in **AMPLIFIER and EXTENSION SPEAKER CABINETS.**

All enquiries should be accompanied by Priority No.

HIRSH & HYAMS, LTD.
Cabinet Manufacturers,
93, Hackney Road, London, E.2. Bish. 4012.

URGENTLY, two radio valves, type 3Q5GT; good price.—Box 3081. [2561]
NEW boxed valves wanted, any quantity, dealers' and service men's complete stocks bought.—J. Bull and Sons, 246, High St., Harlesden, N.W.10. [2155]

REPAIRS AND SERVICE

MIDWEST, McMurdo, Belmont, Crosley, Ferguson, etc., valves; the American experts.—Bennett's, 4, Humberstone Drive, Leicester. [2478]

LOUDSPEAKER repairs, British, American, any make; moderate prices.—Sinclair Speakers, 170, Copenhagen St., London, N.1. Terminus 4355. [2415]

ALL types of radio receivers serviced; Murphy and Pilot specialist; valves in stock; sound repairs for 13 years.—T. E. Fevyer, F.P.R.E., 50, Vine St., Uxbridge. [2561]

"SERVICE with a Smile"—Repairers of all types of British and American receivers; coil rewinds; American valves, spares, line cords.—F.R.I., Ltd., 22, Howland St., W.1. Museum 5675. [1575]

MAINS transformers service, repairs, rewinds, or construction to specification of any type, competitive prices and prompt service.—Sturdy Electric Co., Ltd., Dipton, Newcastle-upon-Tyne. [9651]

REWINDS mains transformers, field coils and chokes, high grade workmanship, seven to ten days' delivery; new transformers manufactured against Government contracts.—Metropolitan Radio Service, 1021, Finchley Rd., Golders Green, London, N.W.11. [2603]

ROGERS—Majestic Radios.—All service enquiries in relation to these receivers should be made to G. H. Bradbury, 48, The Broadway, Stoneleigh, Surrey. Tel. Ewell 3252. Rogers-Majestic service specialist, Late Chief Engineer, R. M. Electric, Ltd. [2599]

DEGALLIER'S, Ltd.—"Service with a guarantee." If you cannot get your receiver serviced, let American specialists do the job; first-class workmanship only; specialising in Air-King, Belmont, Challenger, Delco, Detroit, deWald, Emerson, Ferguson, Garod, Halli-crafter, Hammerlund, Lafayette, Meisner, McMurdo, Midwest, Majestic, Pilot, Philco, Player, Sparton, Stronberg-Carlson, Wells-Gardner, etc., also any British set; remember, for 14 years we have handled as distributors American receivers; this is self-explanatory; s.a.e. with all enquiries. Technical advice on all radio and electronic problems; Due to large number of applications for technical advice received, technical queries answered 3/6 each; this does not apply to the supply of circuits.—Degallier's, Ltd., 9, Westbourne Court, London, W.2. [2560]

MISCELLANEOUS

PHOTO-ELECTRIC cells, 90 volts, 21/ each.—Universal Electrical Co., 221, City Rd., London, E.C.1. [2429]

TIME recorders.—Write for particulars.—Gledhill-Brook Time Recorders, Ltd., 84, Empire Works, Huddersfield. [2419]

WANTED to purchase, small electrical or engineering company or title only.—Write with full particulars to Box 3091. [2598]

EXPERIMENTAL models—Capacity wanted for the rapid and accurate manufacture of various models to our designs.—Apply Box 3069. [2517]

2-VOLT midget accumulators, ebonite containers, suitable for flash lamps, deal aids, etc., new, 4/6 post free.—Warren, 88, Wellington St., Luton, Beds. [2526]

RUBBER stamps made up to your special requirements, and design, typical example, stamp showing name, address and profession; 9/6 post free.—V.E.S., Radio House, Ruislip. [1884]

CHASSIS transformer shrouds, clips and many other fittings quickly made on A.A. benders; accurate and inexpensive.—Details from A.A. Tools, 197w, Whiteacre Road, Ashton-under-Lyne. [2558]

SYNCHRONOUS motors, "Sangamo" 200-250 volts ac, 50c, self-starting, field reduction gears and extra gears, ideal movements for time switches, electric clocks, etc., rotor speed 200 rpm, consumption 2½ watts; 22/6 the set. [2586]

MERCURY break trip switches, 15-20 amps, enclosed bakelite on metal saddles 2 1/10 x 7/10, terminal block, etc.; 6/6 each. Electromagnets, 200-250 volts ac, resistance 320 ohms, 1½x1½, 3/6 each. [2586]

CINE lenses, 1-inch focus, 3.5 and 1.9, combined taking and projecting, fitted iris diaphragm, nickel-plated mounts, ideal for soundheads; 8/6 each; terms cash with order.—H. Franks, Scientific Stores, 53, New Oxford St., W.C.1. Tel. Museum 9594. Callers only.—Large selection of differential reduction gears, meters, relays, etc. [2586]

SITUATIONS VACANT

ELECTRONIC laboratory requires experienced scientific glassblower for research work.—Write, with full particulars, to Box 3079.

SEXTON'S for

SALES, SERVICE, SATISFACTION

ELECTRIC IRONS for 200/220 volt, 230/250 volt AC/DC mains, 5-5½ lbs. weight, strong wooden handle with plated dome, connector guard and thumb rest, polished sole plate, complete with 6ft. flex at 32 1/6 each.

AMERICAN RADIO VALVES. Most popular types available at Board of Trade controlled prices.

BRIVARON Radio valves, British made types as follows:—RF.120, equivalent to Marconi U.12. 80, equivalent to American 80, 5Y3, equivalent to American 5Y3, 5Y4, equivalent to American 5Y4. RF.40, equivalent to 1D5 or URIC, at 11/- each. Post 4d.

LINE CORDS. Three-way, best quality: 360 ohms, at 8/6 each. 480 ohms, at 10/6 each. 600 ohms, at 13/6 each.

EXTENSION LOUD SPEAKERS. "Rola" 3-ohm voice coil, less trans., size 5in., at 21/6; with trans., 29/6. "Rola" 3-ohm voice coil, less trans., size 8in., at 24/- each. "Celestion" 8in. with trans., at 29/6 each. "Goodmans" 3½in. 12-ohm voice coil, ideal for microphones, communication sets, etc., at 30/- each.

SPANNERS. Wooden handled box type, invaluable for service work, 2, 3, 4, 6BA, at 3/4 each. Sets of 2, 4, 6BA, box spanners with tommy bar, at 3/6 per set.

ELECTRIC IRON ELEMENTS. Universal voltage, 200/250 volt for AC/DC mains, at 2/6 each.

TERMS : Cash with Order only.

Send 1d. stamp and S.A.E. for latest list of electrical appliances and radio components available from stock.

J. E. SEXTON & CO. LTD.

164, Gray's Inn Road, London, W.C.1.

Tel. : Terminus 1304 & 4842.

YOU can become a first-class RADIO ENGINEER

We are specialists in Home-Study Tuition in Radio, Television and Mathematics. Post coupon now for free booklet and learn how you can qualify for well-paid employment or profitable spare-time work.

T. & C. RADIO COLLEGE
 2 The Mall, Ealing, W.5

(Post in unsealed envelope, 1d. stamp.)

Please send me free details of your Home-Study Mathematics and Radio Courses.

NAME

ADDRESS

W.W.27

BERRY'S (SHORT WAVE), Ltd., 25, High Holborn, W.C.1, have vacancies for asst. manager and asst. sales; permanency and good prospects.—Write first to 10, London Rd., Camberley, giving full details of experience, age, salary reqd., etc. [2563]

WANTED, instructor, capable of lecturing to students up to P.M.G. first-class certificate standard; good position with post-war prospects.—State age, experience, and salary required to Northern Counties Wireless School, 57, Guildhall Street, Preston. [2588]

WINDING head foreman (radio) required in small radio instrument factory, with manufacturing experience of H.S., L.F., and mains transformers, etc., and impregnation; applicant must be able to teach and control operatives in this work and be capable of building up this production section; scope exists for the right man; give experience, age, salary expected and date free.—Box 3088. [2592]

PATENTS agents.—Urgently required for fully qualified agents specialising in electronics or agents in private practice willing to devote whole time for duration of war to this work on agreed remuneration basis; also experienced patents record clerk with knowledge of recording and clerical duties connected with patent agents' work.—Write, giving full particulars of salary required and experience, to Box 3074. [2534]

LONDON County Council.—Electro-medical technician (part-time) required for two sessions a week (each session of 2½ hours day-time) at Lambeth Hospital, Brook Drive, S.E.11; rate of pay 12s. 6d. a session, together with a cost-of-living addition of 1s. 9d. a session at present; applicants must have had experience in adjusting and repairing wireless instruments and accessories.—Apply for application form to Medical Officer of Health (S.D.3), The County Hall, Westminster Bridge, S.E.1. [2529]

SITUATIONS WANTED

RADIO engineer desires change; 7 years' exp. cathode ray gear, experimental and production; exempt.—Box 3084. [2580]

TECHNICAL TRAINING

A.M.I.E.E., City and Guilds, etc., on "No pass—no fee" terms; over 95% successes. For full details of modern courses in all branches of electrical technology send for our 112-page handbook, free and post free.—B.I.E.T. (Dept. 388A), 17, Stratford Place, London, W.1. [2432]

GREAT possibilities exist for technically qualified engineers, key men in wartime and afterwards. Through the home-study courses of The T.I.G.B. take a recognised engineering qualification, such as A.M.I.Mech.E., A.M.T.E.E., A.F.R.Ae.S., A.M.I.Chem.E., C. and C., etc., in which examinations the T.I.G.B. students have passed 25 FIRST PLACES and hundreds of passes. Write today for "The Engineer's Guide to Success"—free—containing the world's widest choice of engineering courses covering all branches including aeronautical, mechanical, electrical, wireless, chemical, etc.

THE TECHNOLOGICAL INSTITUTE OF GREAT BRITAIN, 82, Temple Bar House, London, E.C.4. [1403]

TUITION

LEARN Morse code the Candler way.—See advertisement on page 28. [1292]

RADIO training.—P.M.G. exams. and I.R.E. Diploma; prospectus free.—Technical College, Hull. [0611]

RADIO Engineering.—Television and Wireless Telegraphy, comprehensive postal courses of instruction. Apply British School of Telegraphy, Ltd., 179, Clapham Rd., London, S.W.9 (Estd. 1906). Also instruction at school in wireless for I.L.M. Merchant Navy and R.A.F. [9249]

A POSTAL training in electrical engineering—power or radio; individual correspondence tuition by highly qualified engineers with wide teaching and technical experience. Elementary or advanced courses. Preparation for recognised examinations. Pre-service training specially arranged.—G. B., 18, Springfield Mount, Kingsbury, N.W.9. [1731]

THE Tuitionary Board of the Institute of Practical Radio Engineers have available home study courses covering elementary, theoretical, mathematical, practical, and laboratory tuition in radio and television engineering; the text is suitable coaching matter for I.P.T.E. Service-entry and progressive exams; tuitionary fees—at pre-war rates—are moderate.—The Syllabus of Instructional Text may be obtained post free from the Secretary, Bush House, Walton Avenue, Henley-on-Thames, Oxon. [1462]

COACHING for P.M.G. examinations; 150 typical 1st and 2nd class technical questions, price by post 5/-.—The North Eastern School of Wireless, 69, Osborne Rd., Newcastle-upon-Tyne, 2. (2081)

ENGINEERING Opportunities, free 112-page guide to training for A.M.I.—Mech.E., A.M.I.E.E., and all branches of engineering and building; full of advice for expert or novice; write for free copy, and make your peacetime future secure.—B.I.E.T., (Dept. 567B), 17, Stratford Place, London, W.1.

PATENT NOTICES

RADIO electric patents.—Well-known London radio component manufacturers are open to consider patents or designs for post-war period. Write Progress, c/o Alfred Bates and Son, Ltd., 130, Fleet St., London, E.C.4.

THE proprietors of British Patents Nos. 516110, 516111, 516167, 516168, entitled Improvements in Electron Discharge Tubes, and No. 516169, entitled Improvements in Bases or Caps for Electron Discharge Tubes, offer same for license or otherwise to ensure their practical working in Great Britain.—Inquiries to Singer, Ehlert, Stern and Carlberg, Chrysler Bldg., New York City, 17, N.Y. U.S.A. [2498]



For high quality loud speakers when the good times come again.

The Courts, Silverdale, London

REWINDS

MAINS & OUTPUT TRANSFORMERS, FIELD COILS, PICK-UP COILS, ARMATURES PROMPTLY EXECUTED

Philips and Ekco D.C. Converters bought, sold and exchanged. Valves, B.V.A. and American, good stock. Send stamped addressed envelope for price list

A.D.S. Co. 261-3-5, Lichfield Road, ASTON, BIRMINGHAM, 6

BOOKS, INSTRUCTIONS, ETC.
WEBB'S radio map of the world locates any station heard, size 40x30in, 4/6. post 6d., on linen, 10/6, post free.—Webb's Radio, 14, Soho St., London, W.1. Tel. Gerard 2089. [9947]

Wanted
W.T.D., May, 1940, "W.W." servicing sheets, —Lautgass, 40, Leckhampton Rd., Blackpool. [2557]

WANTED, Theorie et Pratique des Circuits Fondamentaux de la T.S.F., par J. Quinet-Struys (PAOA.), c/o Radio Holland, Lennox House, Norfolk St., W.C.2. [2550]

WANTED, "Wireless World," vols. 16-44 inclusive; state price.—Cadet (E) M. T. Usher, R.N., Royal Naval Engineering College, "Manadon," Crownhill, Plymouth. [2530]

CLASSIFIED ADVERTISEMENTS intended for the MAY issue can be accepted up to First Post Thursday, APRIL 6th.

COVENTRY RADIO

COMPONENT SPECIALISTS SINCE 1925.

Coil Formers, Paxolin, 1/2 x 2in., 1 1/2 x 3in., 3d.; L.F. Chokes, 200 ohms, 60 m.a., screened, 10/-; Trimmer, 3,30 pf. postage stamp type, 6d.; Switches, oak, 2 wafers, 4 position, 4/6; Switches, Q.M.B. toggle N.F., on-off, 2/9; Resistors, 10 watt wire wound, 50 to 2,000 ohms, 2/-; Resistors, Eric, Dabiller, 1/2, 1, 2 and 3 watt, 20 assorted sizes, new stock, 12/6; Condensers, T.C.C., etc., 25 pf. to 25 mfd., 350 450 volt wkg., 20 assorted sizes, 12/6; Wiring Kit, contains 1lb. solder, 1lb. T. copper wire, push-back, sleeving, flex, tags, spades, etc. Serviceman's Kit, 12/6.

Instrument Wires, Enamelled Copper, sizes 16 to 42 s.w.g., also D.C.C. and Tinned on 1lb. reels.

5,000 B.V.A. Valves always in stock.

Latest List of 1st Grade Components sent on receipt of 1d. stamped envelope.

THE COVENTRY CO.
191, DUNSTABLE ROAD, LUTON

BATTERY CHARGERS & TRICKLE CHARGERS

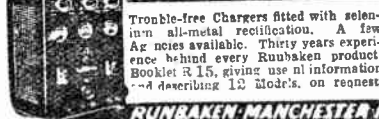

Trouble-free Chargers fitted with selenium all-metal rectification. A few Ag news available. Thirty years experience behind every Runbaken product. Booklet R 15, giving use n information and describing 12 models, on request.

RUNBAKEN-MANCHESTER LTD

CERAMIC PARTS METALLISED AND TINNED

E. & M. DEVELOPMENTS LTD.
492, IPSWICH ROAD, SLOUGH, BUCKS.
Tel: SLOUGH 21435.

PHILCO CAR AERIALS

Complete in original boxes, brand new, with wire, screened cable, brackets, etc., 12/6 (Pre-war and full instructions at..... Price.)

Philco tone controls, 2/6. Philco 2-band RF coils, and 451 oscillator coils with self-contained trimmers, 5/- each. Philco slow-motion drives, 5/-.

Assorted 1-watt resistors, 7/- dozen. Assorted 2, 3, and 5 watt resistors, 12/- dozen. Assorted Components, valve-holders, resistors, condensers, terminals, wire, tags, coils, bulb-holders, switches, hooks and various other radio components and electrical £1 per parcel fittings, journals and service sheets

Satisfaction guaranteed. Posting and Packing extra. Cash with order.

E. H. ROBINS TRADING CO., LTD.
44, Kyle Crescent South, WHITCHURCH, Glam.



TRANSFORMERS and CHOKES
For RELIABILITY
SEND US YOUR ENQUIRIES

OLIVER PELL CONTROL LTD
CAMBRIDGE ROW, BURRAGE ROAD, WOOLWICH, LONDON, S.E.

RADIO SPARES

MAINS TRANSFORMERS. Primaries 200 250 v. Secondaries, 350-0-350 v. Type 80, 80 ma., 4 v. 5a., 4 v. 2 1/2 a., 32 B. Type 1C, 100 ma., 4 v. 5a., C.T. 4 v. 2 1/2 a., 33 B. Type 4B, 120 ma., 4 v. 5a., 4 v. 2 1/2 a., 37 B. Type G3, 120 ma., 6.3 v. 5 a., 5 v. 2 1/2 a., 37 B. Type 106, 100 ma., 6.3 v. 5a., 5 v. 2 1/2 a., 35/-.

TRANSFORMER BOBBINS. H.M.V., Marconi, Philco, Ekco, Murphy, Bush, Ultra, 24/-. Please state model number.

OUTPUT TRANSFORMERS. Power, Pentode, Class B & Q.P.P., 11/-.

Class B & Q.P.P., 9/-. Power, Pentode, 25/30 ma. Midset, 9/6. Power, Pentode, 12 ma. Midset, 6/9. Heavy Duty Pentode, 100 ma., 13/6.

CHOKES, SMOOTHING. 20 henries 100 ma., 12/6. 11 henries 70 ma., 9/6.

MAINS DROPPING RESISTORS. .2 amp. 950 ohms, 6/9; .3 amp. 600 ohms, 6/-.

Fitted with sliding clip and provided with feet for chassis mounting.

LINE CORD. 3-way .3 amp. approx. 185 ohms, per yard 7/-; 2-way .2 amp. approx. 145 ohms, per yard 5/3.

FIELD COILS. Heavy duty, 1,500, 2,000, 2,500, 6,500 ohms, 12/-.

SPEAKERS. Celestion Sin. P.M. with transformer, 27/6.

SPECIAL OFFER. SYSTOFLEX. 1 1/2 mm., 2 mm., 3 mm., 4 mm., 5 mm., 6 mm., doz. yards, 2/9; 30/- per gross yards.

PLEASE NOTE. Delay in delivery may arise owing to demand, but every effort will be made to despatch with the least possible delay.

Orders accepted by post only, and those of 10/- or less should be accompanied by cash. Please include postage with order. Orders over 10/- can be sent C.O.D.

PRICE LIST, 2 1/2 stamp.

Licences for Export to N. Ireland and Eire.

H. W. FIELD & SON, COLCHESTER RD., HAROLD PARK, ESSEX



INVENTORS

The world-wide Simmonds Organisation has established new methods and new products in many industries with great success. Simmonds Development Corporation seeks new ideas and inventions of brilliance and ingenuity to be developed by the technical resources and marketing knowledge of the Simmonds Group.

ALL COMMUNICATIONS MUST BE IN WRITING IN FIRST INSTANCE TO—

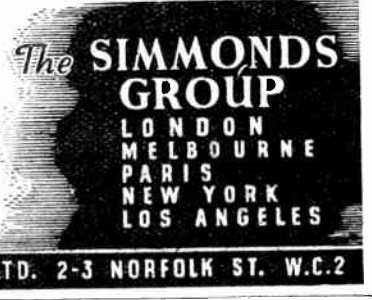

SIMMONDS DEVELOPMENT CORPORATION LTD. 2-3 NORFOLK ST. W.C.2

Printed in England for the Publishers, LIEFFERS AND SONS LTD., Dorset House, Stamford Street, London, S.E.1., by THE CORNWALL PRESS LTD., Paris Garden, Stamford Street, London, S.E.1. "Wireless World" can be obtained abroad from the following—AUSTRALIA and NEW ZEALAND: Gordon & Gotch, Ltd. INDIA: A. H. Wheeler & Co. CANADA: Imperial News Co.; GORDON & GOTCH, LTD. SOUTH AFRICA: Central News Agency, Ltd.; WILLIAM DAWSON & SONS (S.A.), LTD. UNITED STATES: The International News Co.

THE S. WHITE COMPANY · BRITANNIA WORKS · ST. PANCRAS WAY · CAMDEN TOWN · LONDON N.W.1.
Cable Address : WHICODENTA, WESDO, PHONE, LONDON Telephone : EUSTON 4758-4759

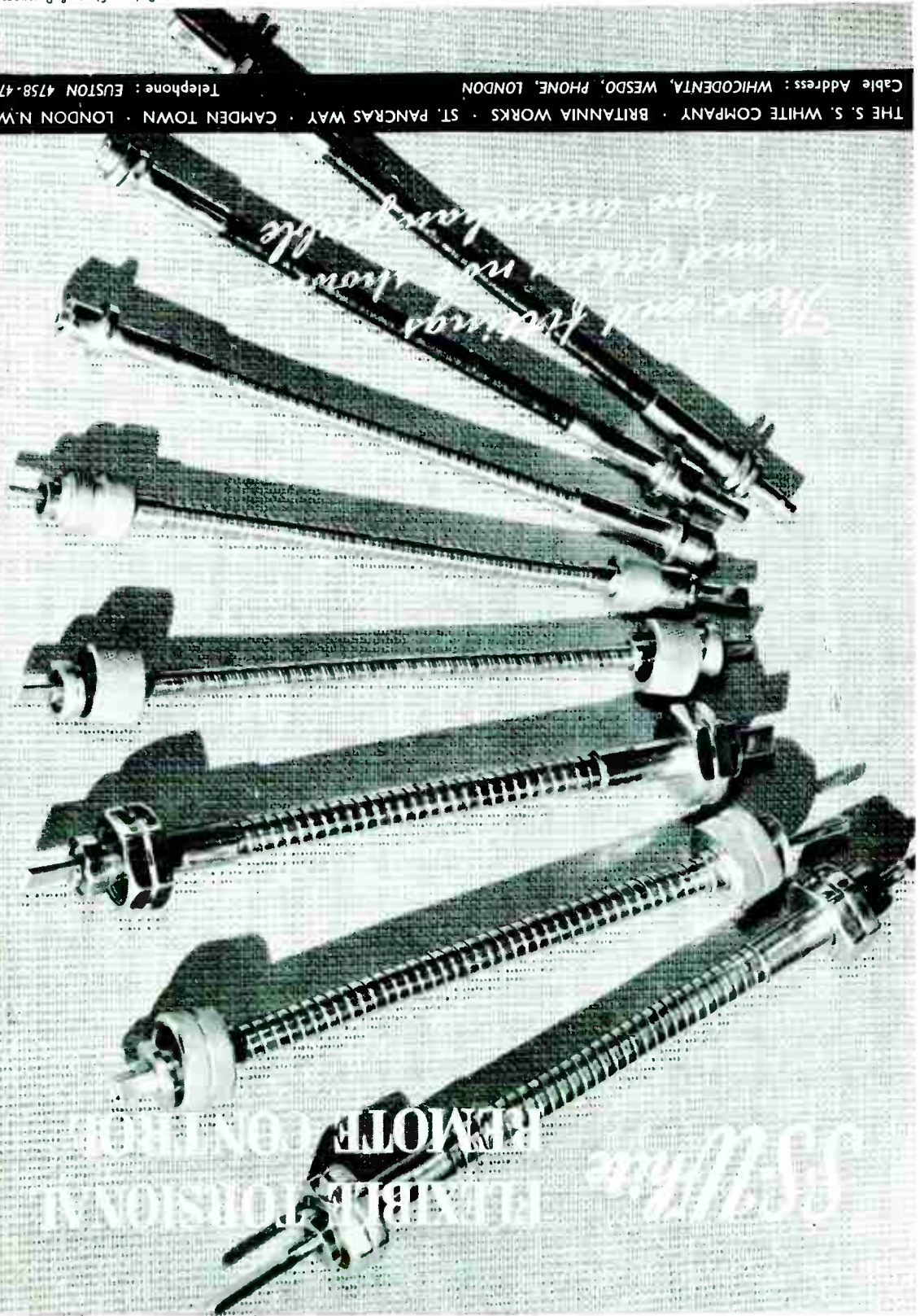

*How much Kitching you know
will show in your Kitching*

ST. WHITE
ELECTRICAL DIVISION AT
TEMPLE ENGINEERS

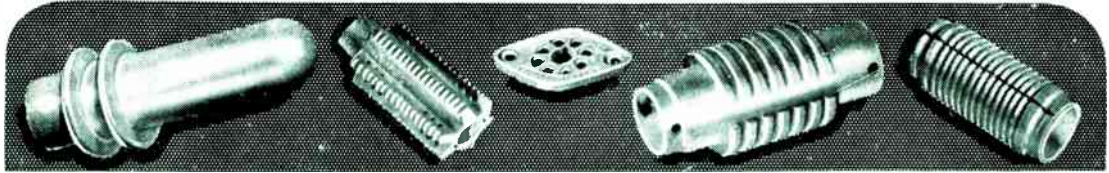

Clear as a Crystal

AND HERE IS THE REASON..

• • • the answer has been found in Bullers Low Loss Ceramics to the problem of Dielectric Loss in High Frequency circuits.

Years of laboratory research and deve'opment have brought these materials to a high degree of efficiency. To-day they are in constant use for transmission and reception, and play a vital part in maintaining communications under all conditions.

Made in Three Principal Materials

FREQUELEX—An Insulating material of Low Dielectric Loss, for Coil Formers, Aerial Insulators, Valve Holders, etc.

PERMALEX—A High Permittivity Material. For the construction of Condensers of the smallest possible dimensions.

TEMPLEX—A Condenser material of medium permittivity. For the construction of Condensers having a constant capacity at all temperatures.



Bullers

LOW LOSS CERAMICS

BULLERS, LTD., THE HALL, OATLANDS DRIVE, WEYBRIDGE, SURREY
 Telephone : Walton-on-Thames 2451. Manchester Office : 196, Deansgate, Manchester

