

Wireless World

RADIO • ELECTRONICS • ELECTRO-ACOUSTICS

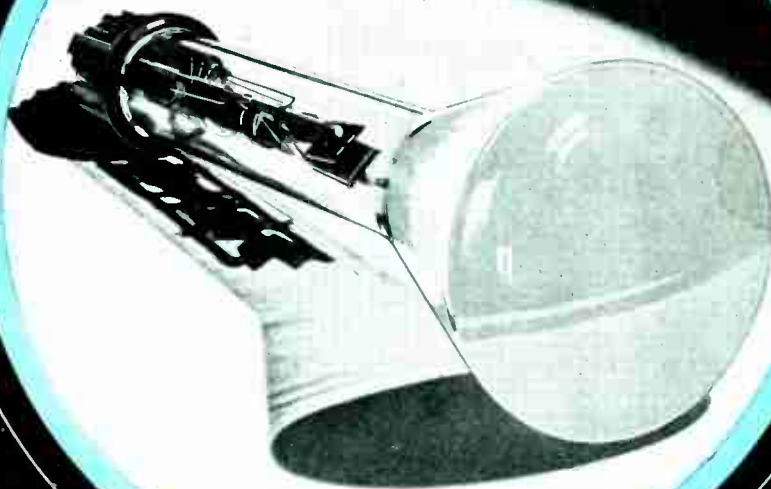

JAN. 1944

1/6

Vol. L. No. 1

IN THIS
ISSUE :

PROBLEMS OF MATCHING : NEW SERIES

Exide

BATTERIES

FOR RADIO

are playing their part in the great national effort. They are as indispensable to the purposes of war as to those of peace

THE CHLORIDE ELECTRICAL STORAGE COMPANY LIMITED
Grosvenor Gardens House, Grosvenor Gardens,
London, S.W.1

w.r. 8B/43



MODEL 7
UNIVERSAL
AVOMETER

AVO

REGD. TRADE MARK

On Active Service



“AVO” Electrical Testing Instruments are maintaining on active service and in industry the “AVO” reputation for precision and reliability. Orders can only be accepted which bear a Government Contract Number and Priority Rating.



Regd. Trade Mark

MEANS
ACCURACY

Sole Proprietors and Manufacturers:

THE AUTOMATIC COIL WINDER & ELECTRICAL EQUIPMENT CO., LTD., Winder House, Douglas St., London, S.W.1

Telephone: Victoria 3404/7

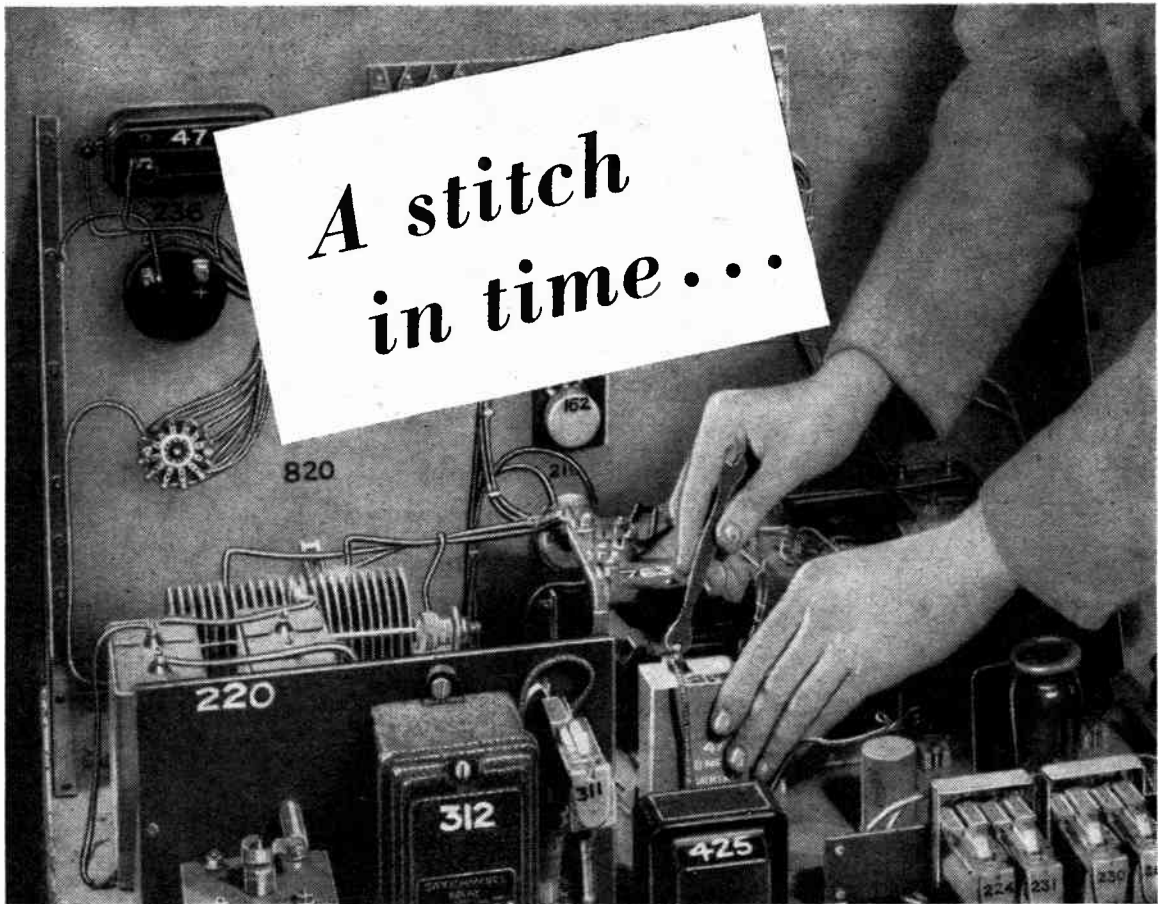

Everyone knows that Redifon radio transmitters, receivers, amplifiers and other equipment are thoroughly reliable. That's particularly reassuring just now, when our production effort is extended on the most essential work. You can add to this safety factor by a little extra care in maintenance. For instance,

- 1 Make sure that all voltages and currents are correctly adjusted, that the relays act properly, and that the specified fuses are fitted.
- 2 Keep everything clean, free from dust and moisture, well ventilated.
- 3 Carry out any minor repairs to wiring; keep all screws and nuts tight; watch for oil leaks; and have a regular inspection schedule.
- 4 Handle the controls with reasonable care.

REDIFFUSION LTD

**Designers and manufacturers
of Radio Communication and
Industrial Electronic Equipment**

R E D I F O N

A SUBSIDIARY OF BROADCAST RELAY SERVICE LIMITED
VICTORIA STATION HOUSE • VICTORIA STREET • LONDON • S.W.1 (PHONE VICTORIA 8831)



Complete High Power Radio Transmitter and receiver, mounted in light army truck. These transmitters are in service in all theaters of war and in most all branches of the army.

The radio amateur is fighting this war, too

satisfy his progressive demands. Many of the world's leading electronic engineers are radio amateurs and much of the equipment in use today by the armed services is a product of the great amateur testing grounds. Two outstanding examples are: the SCR-299 Transmitter and Eimac valves.

The SCR-299 transmitter, designed by Hallcrafters, is an adaptation of the model HT-4 which is a 450 watt rig designed primarily for amateur use. Its characteristics and performance capabilities were such that it was easily adapted to military use and it is today seeing service throughout the world in all branches of the army. It is significant to note that Eimac valves... created to satisfy the demands of the amateur... occupy the key sockets of the SCR-299. Yes, and Eimac Vacuum Tank Condensers, too, are in this now famous transmitter.

The SCR-299 offers a striking confirmation of the fact that Eimac valves are first in the important new developments in radio... first choice of the leading engineers throughout the world.

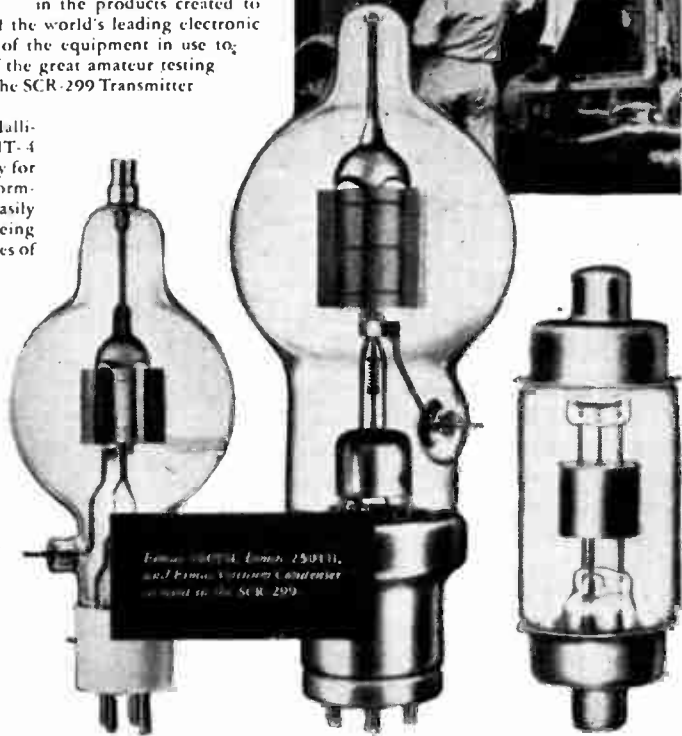

Eimac 250E11, Eimac 250E11, and Eimac Vacuum Tank Condenser mounted in the SCR-299

Follow the leaders to



EITEL-McCULLOUGH, Inc., SAN BRUNO, CALIF.
 Plants at Salt Lake City, Utah and San Bruno, California
 Export Agents: FRAZAR & HANSEN, 301 Clay Street,
 San Francisco, California, U.S.A.

Service Engineers

repairing domestic radio may now use

ERSIN MULTICORE SOLDER

THE SOLDER WIRE WITH 3 CORES OF NON-CORROSIVE ERSIN FLUX

Ersin Multicore — the A.I.D. approved solder wire containing three cores of active non-corrosive Ersin flux, has been adopted by the leading makers of radio and electrical appar-

atus in preference to other forms of solder because it provides speedy and efficient soldering with complete immunity from corrosive or dry joints.

Because of the economy of metals effected in using Ersin Multicore and the fact that the repair of domestic radio is now rated as an "Essential Home Civil Requirement," Service Engineers, too, can now enjoy the advantages of the finest cored solder in the world.

Stocked by the leading radio and electric factors. There may be slight delays in delivery, but insist on Multicore, and you will receive your share in turn. In case of extreme difficulty write to Multicore Solders Ltd., giving name and address of usual factor. Firms engaged upon Government Contracts are invited to write for free technical information and samples.

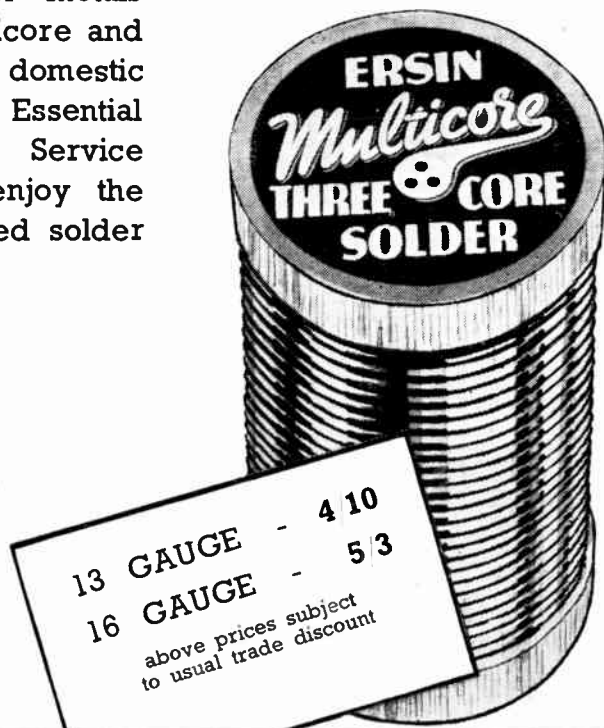

MULTICORE SOLDERS LTD. COMMONWEALTH HOUSE, NEW OXFORD ST., LONDON, W.C.1. Tel. CHAncery 5171/2



**T H E R E I S N O S U B S T I T U T E
F O R
E N G I N E E R I N G , E X P E R I E N C E**



And this is obviously a matter of extent, intensity and time.

Take Electrical condensers for instance—simple in conception maybe—but demanding infinite experience and skill, to satisfy the exacting operating conditions of modern requirements. The fulfilment of these has meant the whole time occupation of highly skilled specialists, working at high pressure, in this way to earn, along with their countrymen in other spheres, the right of survival.

What a wealth of experience and technical excellence will be available to all, when happier times arrive ; and nowhere more than in Dubilier Condensers.

DUBILIER
CONDENSER CO. (1925) LTD.



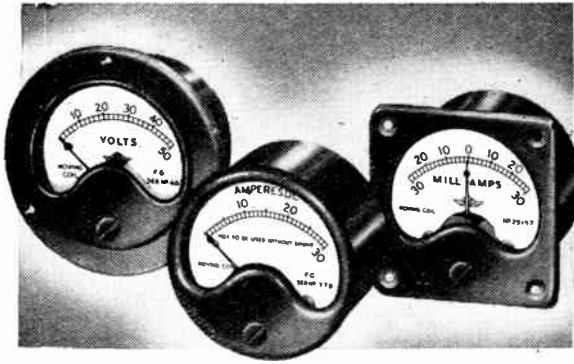

The illustration shows 2" moving coil instruments for flush and projection mounting.

SERVICEABILITY



Electrical Measuring Instruments

Must Function
Under All Conditions

Atmospheric disturbances, climatic changes, extremes of heat and cold can all affect the efficiency of instruments. By installing M.I.P. Instruments, you can be sure that every provision has been made to counteract the hazards set by Nature. Research, excellence of design, and the use of the best materials makes possible a degree of serviceability which is as complete as human ingenuity can devise.



Can we help you with your War-time problems? Write to us to-day.

MEASURING INSTRUMENTS
(PULLIN) LTD.
ELECTRIN WORKS, WINCHESTER ST., ACTON, W.3

WHARFEDALE

GOLDEN CHASSIS

Basically unchanged since 1935 . . . and still in the forefront to-day!

The Response Curve here shown was taken nearly 7 years ago and it has been found impossible to improve on it by any change in the Cone. Improvements to the suspension have brought the Cone Resonance down to below 75 C.P.S. Used by B.B.C., G.P.O., etc.

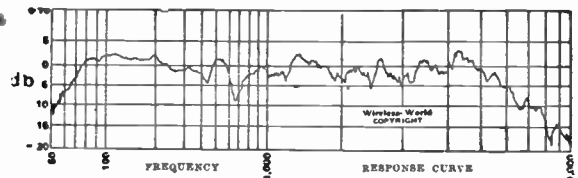
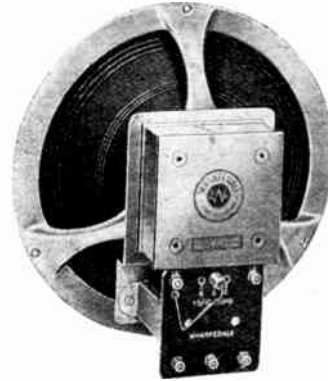

PRICE 70/- (without Transformer). PRIORITY ORDERS ONLY

WHARFEDALE WIRELESS WORKS
HUTCHINSON LANE, BRIGHOUSE, YORKS.

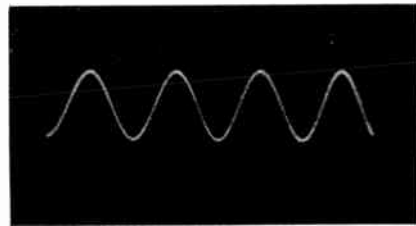

B.S.R. STANDARD SINE WAVE SOURCES

TYPE LO.800A. OSCILLATOR

—an actual oscillogram of output voltage is illustrated—gives good waveform even below 10 c.p.s. This necessitates a minimum "pull-in" between the two H.F. oscillators. Superlative design results in an almost perfect waveform from the lowest to highest frequencies. The output voltage is constant to within a few per cent. over the frequency range. This Model is chosen as a Standard by most Departments. Stable, reliable. Indispensable to all serious workers.

Output up to 5 watts. Three range output voltmeter incorporated—0-250, 0-50, 0-10. Four output impedances, 5000, 1000, 600 and 15 ohms. Frequency ranges (3 models), 0-15000, 0-25000 and 0-50000 c.p.s.



BIRMINGHAM SOUND REPRODUCERS LTD.,
Claremont Works, Old Hill, Staffs.
Cradley Heath 6212/3. Grams: Electronic, Old Hill

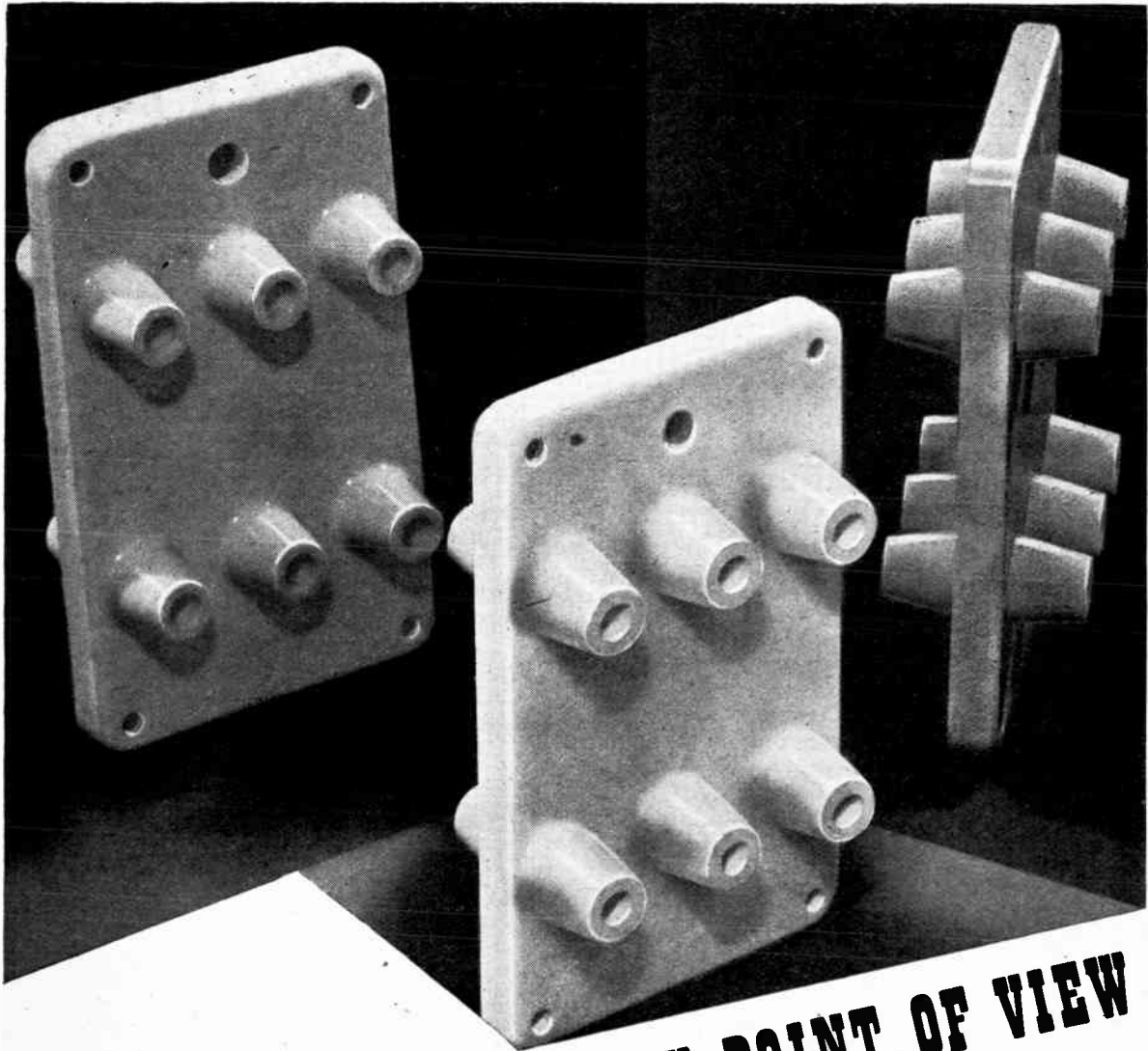

FROM EVERY POINT OF VIEW

Frequentite is the most suitable material for all high frequency applications. Ten years ago we introduced the first British-made low loss ceramic, and consultation with us before finalising the design of new components is a wise precaution.



STEATITE & PORCELAIN PRODUCTS LTD.

Head Office: Stourport-on-Severn, Worcester.

Telephone: Stourport 111.

Telegrams: Steatain, Stourport.

SP30

Lister Electronic Products Co.

CLEVELAND,

OHIO

SPECIALISTS IN UHF EQUIPMENT

MULTI-CHANNEL
FREQUENCY MODULATED KEYING LINKS

MULTIPLE CRYSTAL HOLDERS
FOR UP TO 100 CRYSTALS

TEST GEAR :—HF AND UHF OSCILLATORS,
CRYSTAL CONTROLLED MULTIVIBRATORS

AUTOMATIC ALARM SYSTEMS

INDUCTION HEATING FURNACES

PRIORITIES ONLY

For details write to:—

Electronic Engineering Services, Ltd.

SOLE BRITISH DISTRIBUTORS



24 STANLEY ROAD, HEATON MOOR, STOCKPORT

Talking About DELIVERIES

An Explanation . . .

The demand for BRIMAIN Power Units for extra-essential purposes is now so heavy that we must, very reluctantly, hold over further deliveries of these A.C. Generators for approximately three months. In consequence there may also be a corresponding delay in giving fullest information in response to enquiries.

. . . and a Request

Will you, therefore, bear with us during this difficult period should there appear to be undue delay in dealing with your enquiries as fully as we should wish?

BRIMAIN

Power Units

BRITISH FILMS LTD., 199, Piccadilly, London, W.1. Tel. :
REGent 12828. Works 4 260, High Road, Balham, London,
S.W.12. Tel. : BATtersea 8506.

HIVAC
THE SCIENTIFIC
VALVE
BRITISH MADE

Specialists in
**MIDGET
VALVES**

HIVAC LIMITED
Greenhill Crescent,
Harrow on the Hill, Middx.
Telephone: Harrow 0895

ROLA

LOUD
SPEAKERS
THE WORLD'S FINEST REPRODUCERS

TRANSFORMER
LAMINATIONS
Core Widths $\frac{1}{8}$ " to $\frac{1}{2}$ " (E's and I's.)
EIGHT STOCK SIZES

A Comprehensive Bulletin together with details of Associated Covers
and Clamps with design data will be sent to manufacturers on request.

BRITISH ROLA LIMITED
MINERVA ROAD · PARK ROYAL · N.W.10 · WILlesden 4322

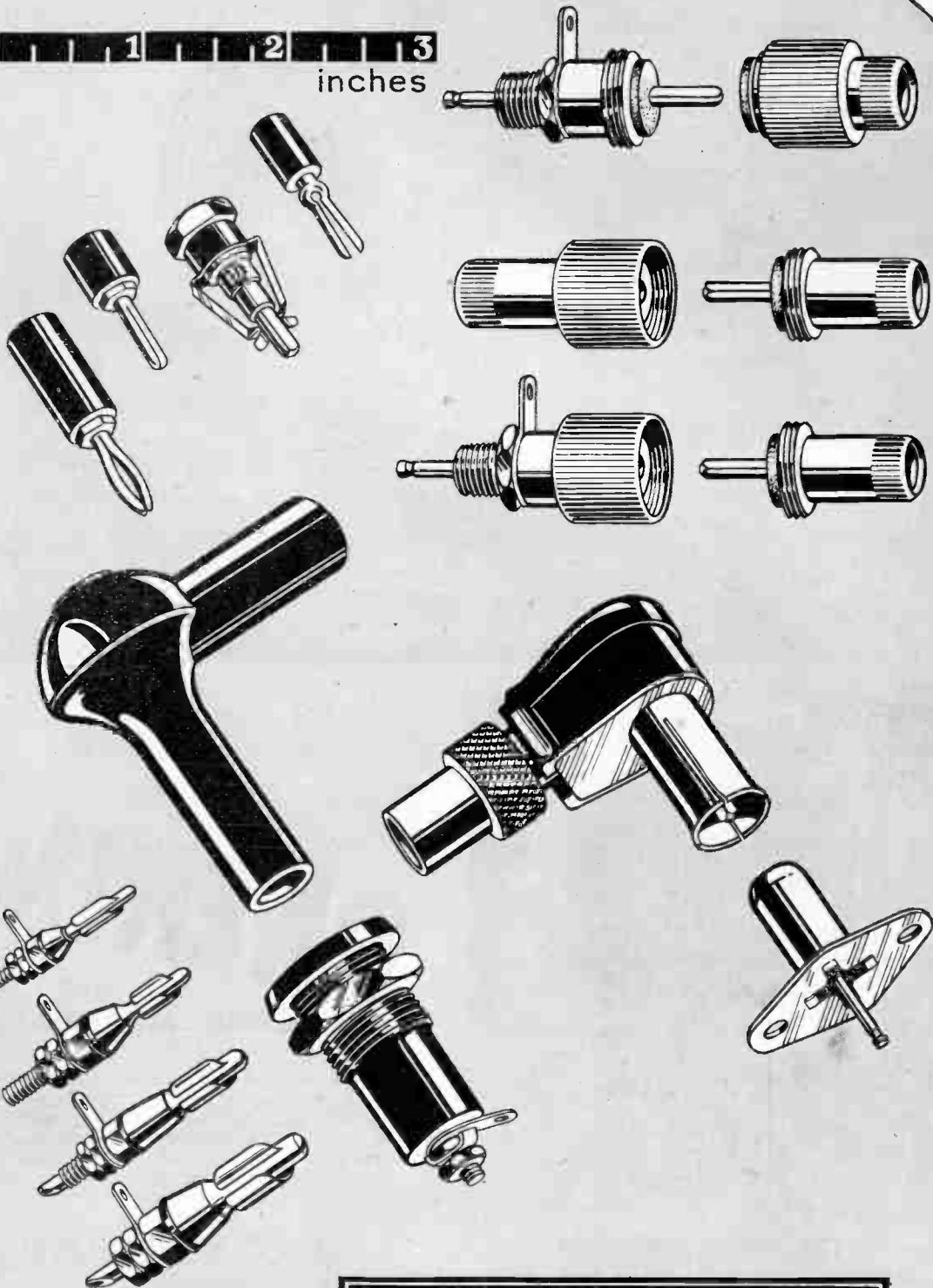

BELLING & LEE LTD
CAMBRIDGE ARTERIAL ROAD, ENFIELD, MIDDX

6A

*British Aircraft
Use*



**FOR QUICKER, EASIER,
CABLE & PIPE LINE MARKING**

**DURABLE - LEGIBLE - INDELIBLY PRINTED IN ANY COLOUR
CAN BE USED WITHOUT TOOLS - RESISTANT TO FLUIDS AND HEAT**

HERTS PHARMACEUTICALS LTD. WELWYN GARDEN CITY

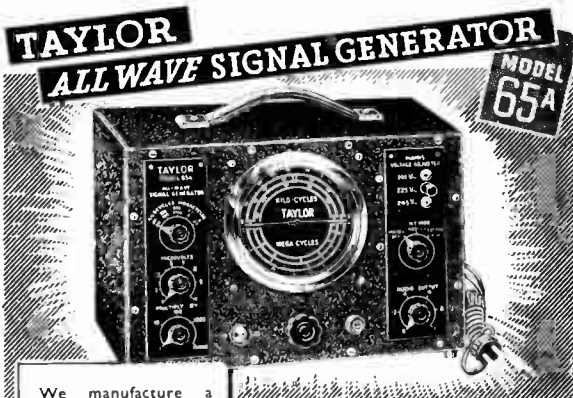

We manufacture a complete range of measuring instruments and Radio Test equipment. Model 83a is a 74 Range measuring instrument. 4,000 ohms per volt A.C. and D.C. Measures up to 5,000 v. and 10 amps A.C. and D.C. and to 10 Megohms with internal batteries.

Price £15 15s. 0d.

This new, improved generator operates from A.C. Mains and covers a range from 100 Kilocycles to 46 Megacycles in 6 wavebands, the dial being directly calibrated in frequency. Output smoothly variable up to approximately 100,000 Microvolts. Either external or internal modulation at 400 Cycles can be used. Iron cored coils used on all bands. The instrument is thoroughly screened, and mains filter is fitted, reducing radiation to minimum. Screened output lead and book of instructions supplied.

Price £14 14s. 0d. complete.

Write for technical brochure

Taylor
electrical instruments Ltd

TAYLOR ELECTRICAL INSTRUMENTS LTD.
419-424, Montrose Avenue, Slough, Bucks. 'Phone: Slough 21381

**WAXES
OKERIN**

**AND
DIELECTRIC MATERIALS**

Cable, Condenser, Coil, Transformer and Resistance Impregnating, dipping, sealing, filling and finishing.

A.I.D. and C.I.E.M.E. TYPE APPROVED WAXES to meet both ARCTIC and TROPICAL conditions.

TELEPHONE: WEST DRAYTON 2189

ASTOR BOISSELIER & LAWRENCE LTD

MIDDLESEX OIL & CHEMICAL WORKS

WEST DRAYTON, MIDDLESEX

◆ LINAGLOW LIMITED ◆

ANNOUNCE the purchase of a well-known British Manufacturer's pre-war stock of RADIO COMPONENTS, CABINETS, etc.

All in perfect condition, brand new, finest quality. Many items considerably below pre-war prices. Quantities are limited—DO NOT MISS THIS OPPORTUNITY.

MULLARD & MAZDA
CATHODE RAY TUBES
 7 in. **£3 10 0** 9 in. **£4 18 0**
HOLDER, for above, complete with mounting base, scanning and focussing unit with coil **47/6**
HIGH VOLTAGE TRANSFORMER, for above, 200/250 v., 4,000 v., 2 v. 2 amp. **47/6**
 Line scanning output transformer **12/6**
 Plywood frame and rubber mount for Cathode Ray Tube, also suitable for loudspeaker baffle, 7in. hole **7/6**

VOLTAGE DROPPING AND LINE CORD REPLACEMENT RESISTORS

.3 amp. 600 ohm **LINE CORD RESISTOR** chassis mounting, with adjustable slider, 6/6. As above, .2 amp., 5/6.
SPECIAL HEAVY DUTY RESISTORS, 5-watt for bias, etc., all values from 25 to 2,000 ohm, with copper clips, 1/6 each. Similar to above but 10-watt, 2/8.
 50-ohm centre-tapped Resistor, tapped at 25 ohm, for pilot lamps, 2/-.

SPECIAL MULTI-LINE CORD RESISTOR, 5 tappings 50 ohm, 1 tapping 750 ohm, with slider, .2 amp., 8/6. 950 ohm .2 amp., Chassis mounting, heavy duty on porcelain former, 2 adjustable tappings, 8/6 each.

UNIVERSAL RESISTOR. Suitable for practically every type of American and British AC/DC Receiver, supplied in safety metal cage with asbestos lining. Specification: 750 ohms, .3 amp., with four sliders for adjustable tappings, 12/6.

UNIVERSAL RAZOR RESISTANCE. Suitable for practically every type of electric Razor, drops voltage from 200/250 to 100/110 v. Supplied in safety metal cage with asbestos lining. Specification: 1,500 ohms with adjustable slider, 10/6.

LINE CORDS. 2-way, 360 ohms, 8/6; 480 ohms, 11/-; 600 ohms, 13/6. 3-way heavy duty 3 amp., 360 ohms, 13/6; 480 ohms, 17/6; 600 ohms, 21/-.

3in GOODMAN P.M. LOUDSPEAKER. Extra heavy magnet for Midgets and communication sets, 30/-.

VOLUME CONTROLS. 1,000, 5,000, 10,000, 20,000, 25,000, 50,000, 100,000-ohm; 1/2, 1 and 2 megohm, without switch, 4/6 each. As above, with switch, 6/8.

L.F. SMOOTHING CHOKES. Finest quality, 20, 40 and 60 henries 150 m.a., 16/9 each.

SWITCHES. DPDT panel mounting, P.O. type, 2/8. D.P. 4-point push-pull, 8d.

VALVE HOLDERS AMPHENOL TYPE. International or Mazda Octal, chassis mounting, 1/-.

RADIO CHASSIS
 No. 1. 18 gauge steel, cellulosed grey, fitted 4 octal valve holders, grommetta, with 20 colour coded resistors. Dimensions: 11 x 7 1/2 x 1 1/2 **17/6**
 No. 2. 18 gauge steel, cellulosed grey, fitted mains socket and three 4-pin valve holders, grommetta, drilled ready to take transformers, chokes, etc. Dimensions: 14 x 10 1/2 x 1 1/2 **18/6**
 No. 3. 8-valve 18-gauge steel, cellulosed grey, fitted with octal valve holders, 7 l.f. and aerial transformer cans fitted with odd coils and trimmers, volume control, aerial and earth sockets, mains plug and socket, 24 assorted colour coded resistors, 24 T.C.C. condensers, various trimmers. Dimensions: 8 x 12 x 1 1/2 **30/-**

HUMDINGERS. 25,000 and 50,000 ohms, 6d. each.
SCREENED INTERLACED FLEXIBLE MICROPHONE CABLE. Single. Special Offer, 6d. per yd. Pre-war Super Quality, 1/3 per yd. Twin, 1/8 per yd.

.003 VARIABLE CONDENSERS WITH TRIMMERS. 3-gang, completely screened. Ideal for short-wave work. 3-hole chassis mounting. Bargain, 4/6.

P.A. AMPLIFIERS

Suitable for Factory Installation
 — Immediate Delivery —

30-WATT P.A. AMPLIFIER. A high quality Amplifier, using finest components and Red "E" Valves. Circuit: High Resistance input feed through two separate input sockets or through pre-amplifier socket into two series connected valves with tone and volume control followed by twin valve acting as Amplifier and Phase Inverter, feeding into two High Wattage Output Pentodes connected in negative feed back. Class A B Circuit: 200/240 volts A.C. Chassis, finished in dark grey. 16-gauge steel. Brand new pre-war manufacture. Amplifier is fitted with Multi-Ratio output Transformer to take from one to forty four 5,000 ohm speakers, also 15 ohm speaker and 600 ohm line. Separate Standby Switch.
 Amplifier with valves suitable for gram. microphone and radio inputs. Price **£35 10 0**

PORTABLE P.A. AMPLIFIER. Specification: 4-valve Amplifier Unit in metal cage, microphone, one speaker all cables, contained all in one cabinet and collapsible type tripod floor stand, AC/DC 200/250 v. 5 watt maximum, suitable for hall averaging 600 people. Input jack provided, transverse current carbon type microphone, separate volume controls for microphone and gramophone input. Variable tone control **29 Gns.**

PORTABLE P.A. AMPLIFIER. Specification: 5-valve Amplifier Unit, 2 speakers, microphone, all cables, all in one cabinet and collapsible type tripod floor stand, AC/DC 200/250 v., 8/10 watts, suitable for hall averaging 800 people. Input jack provided, ribbon type microphone chromium plated, separate volume controls for microphone, gramophone input. Variable tone control **39 Gns.**

MICROPHONES. De Luxe Piezo Crystal microphones in chromium case. Specification: 60 D.B. below 1 volt. Frequency response 30*8,000 C.P.S. **6 Gns.**
 As above—Standard model in bakelite case **3 Gns.**

L.F. TRANSFORMERS 465KCs. Aluminium can with flying lead, 7/6.
ALUMINIUM VALVE CAPS. Special price 6d.
3-CORE MAINS LEAD with Iron connector fitted, 5/-.
SCREENED MICROPHONE LEAD, fitted four Wander Plugs, 3/6.
6 ASSORTED VOLUME AND TONE CONTROLS with and without switch, 19/6.

CABINETS
 No. 1. Exceptionally well-made pre-war radio cabinets, figured and inlaid walnut, large enough for radio chassis, loudspeaker and power pack. Dimensions: 20in. x 17in x 16in. **4 Gns.**
 No. 2. As above—dimensions: 22in. x 17in. x 16in. **£4 12 6**
 No. 3. DE LUXE Console model—specification as above. Dimensions: 38in. x 19in. x 16in. **8 Gns.**
 Packing case for all above, 10/- extra

J.T.C.C. 4,000 v.w. CONDENSERS. Brand new, 8/6.

TUBULAR STEEL FRAMES. Cadmium plated for radio chassis mounting and many other purposes, drilled ready for use—18in. high x 14in. wide—very useful for swivel frame in Radio Laboratory, 7/6 the pair.

SUPERIOR QUALITY STREAMLINE RADIO KNOBS. For 1/2in. spindles with grub screw. 2in, 1 1/2; 1in., 1 1/2; 3/4in., 9d.

TUBULAR PAPER CONDENSERS. 350-500 v., D.C. working, .001, .003 mfd., 4/- doz.; .001, .004, 8/- doz.; .01, 7/- doz.; .05 mfd., 9/- doz.; .1 mfd., 12/- doz.; .2, .5 mfd., 15/6 doz. or assorted parcel of 50 for 27/6. Minimum orders, 1 doz. any type.

SILVER MICA CONDENSERS. Flat wire-end. Assorted values, 17/6 per 100 (not more than 5 alike).

LOUDSPEAKER TRANSFORMERS. Tapped Power Pentode Output, 75 m.a. ratios 42:1 and 55:1, 10/6. Pentode output 75 m.a. ratio 35:1, 9/6; Push-Pull output tapped Primary and Secondary, 120 m.a. ratios 10:1, 5:1 and 3.5:1, 15/-; Multi Ratio and Push-Pull Transformer, ratios 30:1, 45:1, 60:1, 90:1, and P.P. class B, 75 m.a., 12/8. Heavy duty multi-ratio transformer, ratios 24:1, 41:1, 48:1, 58:1, 82:1, 116:1, 80 m.a., 15/8.

MAINS TRANSFORMERS. 200/250, 350-0-350, 4 v. 6 amp., 4 v., 3 amp., 120 m.a. or 6.3 v., 3 amp., 5 v., 2 amp., 37/6. 4 v., 4 amp., 4 v., 4 amp., 100 m.a., 30/-; 300-0-300 4 v., 6 amp., 4 v., 2 amp., 150 m.a., 42/-; 325-0-325, 4 v., 6 amp., 4 v., 2 amp., 2 v., 1.5 amp., 150 m.a., 45/-.

AUTO TRANSFORMERS. Step up or down 110/210/220/240 v., 100-watt, 35/-; 110/240 v. 75 watt, 27/6.

LOUDSPEAKERS. P.M. 3 ohm voice coil without transformer, 5in., 21/-; 6 1/2in., 22/6; 8in., 25/6; 10in., 28/6. 10in. R.G.D. energised M.C. Speaker, 250, 500 and 1,200 ohm field, 2.5 ohm speech coil, 30/- . Any of the above can be supplied with pentode output transformer, 10/8 extra. With multi-ratio, 15/- extra.

VALVES
AMERICAN TYPES AT B.O.T. CONTROLLED RETAIL PRICES. FOR REPLACEMENT PURPOSES ONLY.
 1H5, 12F6, 12SF6, 9/2; 1A5, 1C5, 1N5, 5Y3, 6X5, 6Z5, 6S4, 6S5 1 1/2; 6A7, 12Q7, 12SQ7, 11/7; 6F8, 6K7, 12J7, 12K7, 12SK7, 25L6, 35L6, 36, 42, 78, 50L6, 12L10; 6A8, 6B8, 6K8, 6A7, 12A8, 12S7, 14/-; 7017, 33, 15/3.
 Also British Valves at Manufacturers' List Prices: H14DD, 9/2; ACME, 10/6; 7U4, UUG, UU7, 11/-; TDD4, 11/7; AC/VP, CL4, EF89, KT61, Pen 45; 8F41, 8F42, VP41, 12/10; D1 Diode 1in. Peanut Valve with valve holder, 12/10; AC/TP, ECH3, PC13, X63, X65, 14/-; AC6Pen* KL35, Pen 46, T41, U21, 18/8.
 * Post Office Permit necessary.
 All prices include Purchase Tax. Add 3d. per valve postage.

◆ **CALLERS to Show Rooms, 61 HIGHGATE HIGH ST., N.6.**
 Phone: MOUview 9432.

LINAGLOW LIMITED
HOURS OF BUSINESS 9 a.m. to 5.30 p.m.
 Saturday, 9.30 a.m. to 12.30 p.m.

◆ **POST ORDERS to Dept. M.O.8, 3 HAMPSTEAD LANE, N.6.**
CASH WITH ORDER ONLY.

ANNOUNCEMENT

WE regret that owing to pressure of Service requirements, orders for Loudspeakers and Microphones can only be accepted when accompanied by Government Contract Numbers.

A comprehensive range of Instruments is being manufactured, including Loudspeaker Units from 2½" diameter to 12" diameter; Special High Power Loudspeakers in Cabinets suitable for Tropical conditions; Hand Microphones, also Special High Sensitivity Compact Light-weight Microphones for field use; Telephone Receivers, Moving Coil Headphones, etc.

GOODMANS

INDUSTRIES LIMITED

WEMBLEY, MIDDLESEX.

LOUDSPEAKER & TELEPHONE ENGINEERS

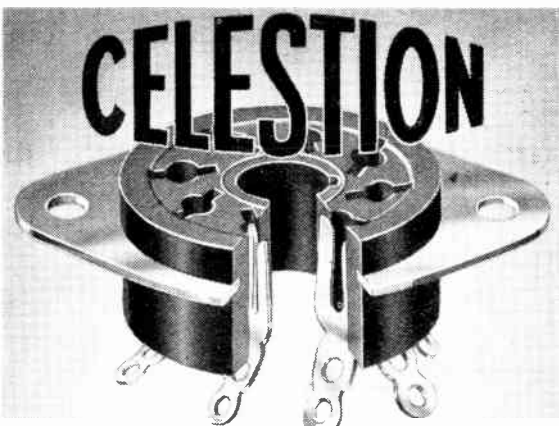

VALVEHOLDERS

Manufactured under "Amphenol" Licence.

The name "Celestion" is a guarantee of quality & service.

List of British and American types will be sent on request.

At present we can only supply against Priority Orders.

CELESTION LTD.

Engineers
KINGSTON-UPON-THAMES, SURREY.
Telephone: KINGSTON 3656-7-8



*Audio Amplifiers
and Sub-assemblies
to critical standards*

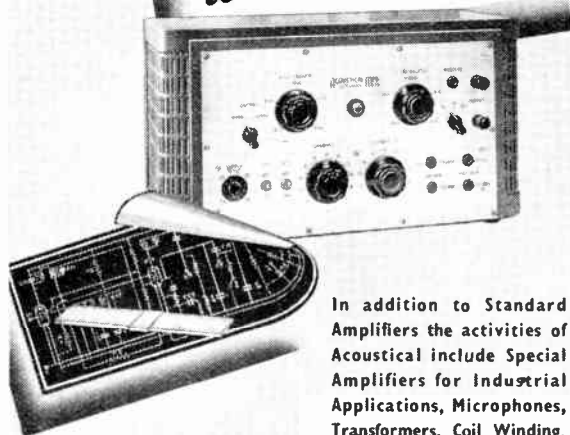

In addition to Standard Amplifiers the activities of Acoustical include Special Amplifiers for Industrial Applications, Microphones, Transformers, Coil Winding, Sheet Metal Work, Stampings, Switch Assemblies, etc.



ACOUSTICAL
MANUFACTURING Co. Ltd.
HUNTINGDON - TEL: 361

TOWERS OF STRENGTH

for use with
high voltages



The outstanding characteristics of U.I.C. Ceramic Pot Condensers are their high break-down strength, low loss factor, and small dimensions.

Test Voltage up to 15 KV D.C. or 10 KV R.M.S.

Working Voltage up to 7.5 KV D.C. or 5 KV R.M.S.

Radio Frequency Working Load from 2.5 to 15 KVA according to type. *Capacity Range* 20pF to 1250pF.

Made to Specification K.110. Full details on request.

UNITED INSULATOR CO. LTD.

12-22, LAYSTALL STREET, LONDON, E.C.1

Tel: TERminus 7383 (5 lines)

Grams: Calanel, Smith, London



THE PIONEERS OF LOW LOSS CERAMICS

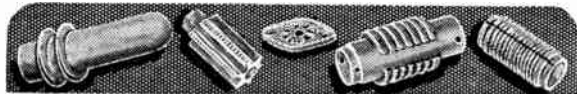

*Clear as a
Crystal*

AND HERE IS THE REASON . .

. . . the answer has been found in Bullers Low Loss Ceramics to the problem of Dielectric Loss in High Frequency circuits.

Years of Laboratory research and development have brought these materials to a high degree of efficiency. To-day they are in constant use for transmission and reception, and play a vital part in maintaining communications under all conditions.



**Made in
Three
Principal
Materials**

FREQUELEX

An Insulating material of Low Dielectric Loss, for Coil Formers, Aerial Insulators, Valve Holders, etc.

PERMALEX

A High Permittivity Material. For the construction of Condensers of the smallest possible dimensions.

TEMPLEX

A Condenser material of medium permittivity. For the construction of Condensers having a constant capacity at all temperatures.

BULLERS, LTD.
THE HALL,
OATLANDS DRIVE,
WEYBRIDGE, SURREY
Telephone:
Walton-on-Thames 2451
Manchester Office:
196 Deansgate, Manchester.

Bullers

LOW LOSS CERAMICS



*The shape of
things to come*

H.T. and L.T. units in "Westalite" (the new selenium compound) giving improved performance.

"Westectors" sealed against ingress of moisture and suitable for use in any climate.

**WESTINGHOUSE
metal rectifiers**

at present available against priority orders only, but will be generally released as soon as possible.

WESTINGHOUSE BRAKE & SIGNAL CO., LTD.,
Pew Hill House, Chippenham, Wilts.



ONE CHANCE IN 254

The mathematicians haven't yet calculated your probability of selecting the best Sound Equipment when you judge by eye alone. But the odds against you are heavy—probably more than your chances of being dealt a "straight" in a game of poker. Performance is the only dependable guide. Just another reason why the resources of R.S. are principally in demand in sterner fields these days. If, however, you have customers who would like to know just what limited range we are still able to supply, we'll gladly send you our most recent catalogue if you'll send a penny stamp.

R.S.

AMPLIFIERS

R.S. Amplifiers Ltd., 3-4, Highfield Road, Shepperton, Middlesex.
Tel.: Walton-on-Thames 1019.

F.W.S.CO.

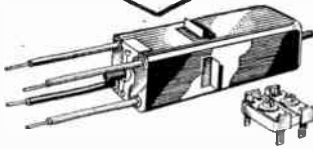

Sickles Midget Transformer and Trimmer.

OUR greatly increased manufacturing facilities in the War effort, coupled with our added production knowledge, will materially benefit you 'when Victory is won.' Quality has always been the dominant consideration in the design—in the choice of materials and in the method of manufacture of our products; and we look forward with confidence to the day when we shall once again continue our relationship with the Radio Industry of Great Britain with greater cordiality than ever before.

**I.F. TRANSFORMERS
AERIAL AND OSCILLATOR COILS
TRIMMER AND PADDER CONDENSERS
COIL FORMS, etc.**



**The F. W. SICKLES Co.
CHICOPEE, MASS., U.S.A.**

**RAYTHEON
- PROGRESS -**



It is typically American to accomplish yesterday's impossibilities today. Raytheon research laboratory to-day and every day is delving into seemingly impossible Radio Electronic Tube problems...and solving them in an incredible space of time.

This unending scientific research carried on at Raytheon to aid the armed forces during the present conflict will, when we are once more on a peacetime basis, give Raytheon tubes the advantage of these newly-developed electronic principles. Your new Raytheons will be the product of the latest scientific research.

**WORLD'S LARGEST
EXCLUSIVE
TUBE MANUFACTURERS**



**RAYTHEON
PRODUCTION CORPORATION
NEWTON, MASS., U.S.A.**

P. R. MALLORY & CO. Inc.
**MALLORY
VIBRATORS**

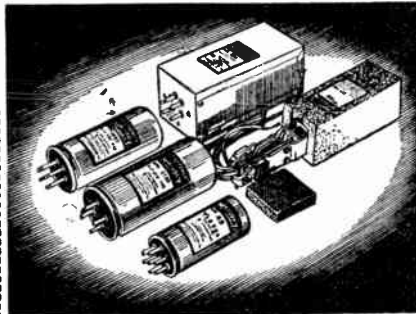

IDEAS WILL POP FOR YOU

IN the crucible that is war production, ideas pop into reality in bewildering numbers. Co-operative progress in techniques in chemical, metallurgical and electrical applications of materials, has contributed astounding gains to man's control over Nature's resources. Comparatively few can have more than a vague notion of industrial accomplishment for the war effort. But the discoveries that have mechanised warfare and conquered the air, that have developed transportation and supplies to marvellous wartime results, represent ideas that will pop into an amazing variety of commercial contributions to post-war living standards.

**P. R. MALLORY & CO. INC.
INDIANAPOLIS, INDIANA,
U.S.A.**

Radio and Electronics Division

**ALSO
"MYKROY" CERAMIC INSULATING MATERIALS
"IDEAL" RECHARGEABLE CELLS AND CHARGERS
GENERAL ELECTRONIC VACUUM CONDENSERS**

FOR THE FUTURE

These Manufacturers will help solve your post-war problems. Register your name now for full details which will be sent you when supply conditions again permit.

**FRANK
HEAVER**

LIMITED

**Kingsley Road, BIDEFORD,
N. Devon**

G.I.

**VICTORY
PRODUCTION**

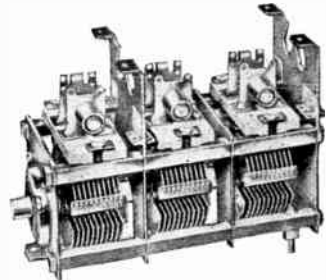

WHEN the mission of complete victory is accomplished, General Instrument will help "Win the Peace" by making the best use of still greater knowledge and experience in the manufacture of variable condensers and drives.

**THE GENERAL INSTRUMENT
CORPORATION
ELIZABETH, N.J., U.S.A.**

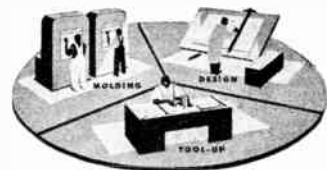

WHEN you think of plastic mouldings for post-war products we suggest you consult the Kurz-Kasch "Plastic Round Table"—a group of specialists in design, materials, tool-up and moulding. Kurz-Kasch can give you complete service under one roof, one responsibility.



KURZ-KASCH INC.
Moulders of Plastics,
**DAYTON - OHIO
U.S.A.**

Listen to this...



The Bosun's Call—Hundreds of orders are preceded by the piping of this traditional little instrument . . . 10-day relayed throughout a ship by P.A. Equipment . . .

AND ON THE FACTORY FRONT

trust
TRIX
Quality SOUND Equipment

AVAILABLE FOR PRIORITY ORDERS. SEND FOR DETAILS

THE TRIX ELECTRICAL CO. LTD. 65, BOLSOVER STREET, LONDON, W. 1

Phone: BISTON 5471/2 Church & Conner, TRI-RADIO, WESDO, LONDON.

Instrument Cases

If you are on Priority Work, IMHOF's Engineering Division can place a well-equipped modern plant and a wide experience at your disposal for the building of high-grade Instrument Cases, Chassis, etc., in metal.

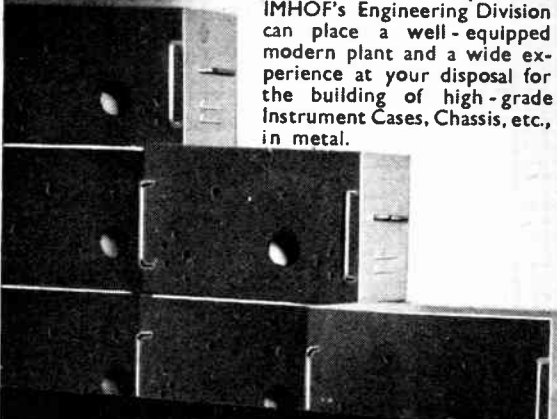

IMHOF'S

CONTRACTORS TO THE ADMIRALTY,
AIR MINISTRY, MoS and G.P.O.

ALFRED IMHOF, LTD., 112-114, NEW OXFORD STREET, LONDON, W.C.1. MUSEUM 5944

M.R. SUPPLIES

Immediate delivery from stock of the following brand new RADIO, ELECTRICAL and INDUSTRIAL EQUIPMENT. All goods offered are of our usual highly dependable quality. All prices nett cash.

ELECTRODE WIRE JOINTERS ("Fuzt" by S.T.C.). A new and important development for the Electrical Industry. We have first supplies now available. Dispenses entirely with soldering jointed wires. Merely twist ends together—copper-copper, copper-resistance or resistance-resistance—place in jaws of tool and press and release trigger—job done, with many important advantages over the old method. Suitable for all SWG from 80 to 30. (Other models shortly available.) Complete with Portable Transformer (230/250v.), Jointing Tool and Leads, ready for use, £5 nett. Packing/carriage, 3/6.

TOGGLE PRESSES (by S.T.C.). Senior and new Minor models here in stock. Double-acting, precise tool, suitable for all small pressing operations in many trades. Senior, pressure 1½ tons, weight 150 lb., £30 nett. Minor, pressure ¼ ton, weight 80 lb., £23 nett. Price, ex this address.

ROTHERMEL-BRUSH PIEZO-CRYSTAL MICROPHONES. Exceptional new offer of 500 only. Neatly housed in black bakelite, 2½in. dia. and 2½ long, with plated mounting boss tapped standard ¼in. (26). Fine level response and high output, suitable for all microphone uses and fully recommended by us as piezo-crystal specialists. With about 6ft. screened lead attached, only 42/-. This is undoubtedly the greatest opportunity for a good crystal microphone we have presented, now or pre-war. Suitable Floor Stands, all chromium, collapsible, portable, ext. to 5ft. 6in., 42/-.

MINIATURE P.M. M/COIL MICROPHONE/SPEAKER UNITS (Goodman). Only 3in. dia., fitted weighty alnico magnet. Imp. 12-ohms. For use either as speaker or microphone and therefore ideal for intercom. systems, 30/-.

A.C. MAINS BELLS (Siemens). Operating direct from 200/250 v. A.C. mains. Well made on bakelite base, 3in. dia., with plated gong and adjustable note, 5/6. Suited for office, factory, laboratory, etc.

LONDEX RELAYS. 200/250 v. A.C. 2-watt coil, with triple-pole change-over 6-amp. high-tension switching, 42/6. Also same make, with 6-volt D.C. coil and breaker 2-pole (up to 3 amps. at 250 v.) when coil is energised. Miniature model, approx. 2in. by 1½in. by ½in. Tropical spec. and high insulation, 7/6. (Can also be used as first-rate buzzer).

LABORATORY SWITCHES on mahogany base, 4in. dia. Switch arm and six terminals (lacquered brass) above and 2-pole change over, self-cleaning, low capacity switch below. Instrument finish, ex Govt., new, 10/6.

SLIDING RESISTANCES. 100 watts, fully enclosed housing, 6½ins. long, with bushed cable entries. Following range: 4 ohms 5 amps., 10 ohms 3 amps., 50 ohms 1.4 amp. and 170 ohm 0.7 amp. Any one, 25/-.

ERICSSON HEADPHONES. New, in makers' boxes, with headbands, 2,000 ohms, 25/- pair. Also same make, second-hand, 2,000 ohms, 3/9 each single phone.

TRANSFORMER BOBBINS. Solving the re-wind problem. Standard for many sets, including Marconi, Pye, Lissen, etc. Prim. tapped 200/250 v., Secs. 350/0/350 75 m.a., 4 v. 3 a., and 4 v. 4 a., core opening 1½ sq., by 1½ through, 18/6.

THERMO-COUPLE AMMETERS (M/Coil) by Weston, Ferranti, Turner, etc., housed in black bakelite, with 2½in. sq. flange, flush panel, requiring 2in. mounting hole. Reading 0/2½ amps. any frequency A.C. or D.C. (Deshunted def. 1½ to 3 ma. D.C.), 37/6. Ex Govt., excellent condition.

Please include sufficient for packing, postage; excess refunded. Staff shortage—no C.O.D. or lists.

M.R. SUPPLIES, 68, New Oxford Street, London, W.C.1.

(Telephone: MUSEum 2958)

When they have
finished their
vital war service



DAGENITE

AND

PERTRIX

—the dependable BATTERIES
will again be available
to all

FOR RADIO, CARS, MOTOR

CYCLES, COMMERCIAL VEHICLES, AIRCRAFT, ETC

Sales Concessionaires: **HOLSUN BATTERIES LTD.**

137 Victoria Street, London, S.W.1.

D10b.

EDDYSTONE

558x

SOME INDIVIDUAL FEATURES CONTRIBUTING TO AN OUTSTANDING PERFORMANCE

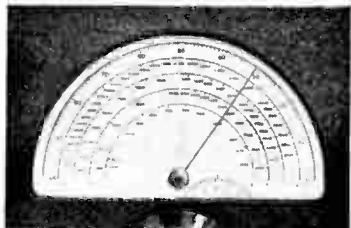

DIAL CALIBRATION.

The above photograph gives a clear idea of the manner in which the dial is marked. Four coils have direct calibration and the remainder are referred by graphs to the outer scale. The small Logging Scale is gear driven from the Drive Mechanism and, therefore, positive in action. By quick reference to the outer scale and the pointer reading thereon, and the reading of the Logging Scale, it is possible to return to any given point at any time quickly and accurately; further, any number of stations working on fixed wavelengths can be logged and returned to for operational purposes.

COIL UNITS.

High - efficiency coils mounted in die-cast screening containers. Tuning ranges:

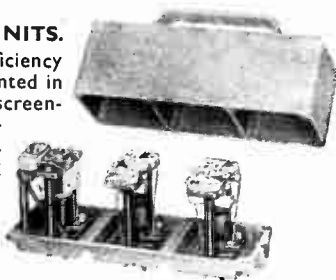

Range	Kc/s.	Range	Kc/s.
A	22,000—31,000	F	600—1,250
B	9,000—22,000	G	300—600
C	4,500—9,000	H	150—300
D	2,100—4,500	I	90—150
E	1,250—2,100	J	40—90

TUNING DIAL DRIVE MECHANISM.

Utilises a flywheel drive and spring loaded Tufnol gearing, giving a ratio of approximately 70-1. The gearing is driven through a friction disc and so arranged that when the pointer, which is attached to the shaft driving the gang condenser, is either at zero or 100 terminating point of travel, the small stop-pin prevents further movement of this shaft and the friction drive acts as shock absorber, removing strain from the Tufnol gears themselves.



I.F. TRANSFORMERS.

Air - trimmed, high signal/noise ratio and stability.

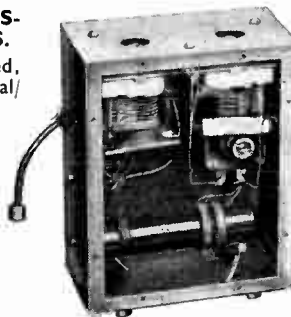

REASONABLE DELIVERIES CAN BE QUOTED FOR PRIORITY REQUISITIONS.

Full circuit details available in 30-page instructional booklet, price 2/6 post free.

WEBB'S

Radio

★ 14, SOHO STREET, LONDON, W. 1.

Telephone GERRARD 3089

OPEN 9 a.m.—4 p.m. SATURDAYS TILL 12 NOON

★ IN THE DEVELOPMENT AND MANUFACTURE OF

Radio Frequency CABLES

B.I. HAVE PLAYED A LEADING PART

★ . . . and though supplies are directed to the Services, the experience gained over a considerable manufacturing period is available for the benefit of approved users.

Note.—From fundamental principles, B.I. have made outstanding contributions to design and construction of cables for radio frequency transmission and have perfected production technique.

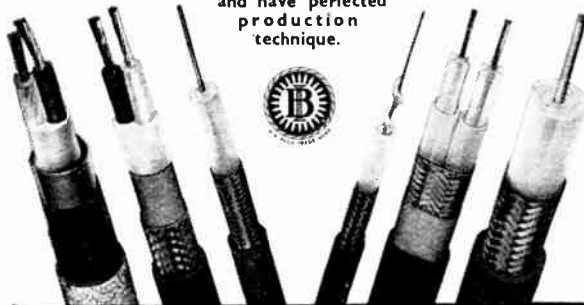

© BRITISH INSULATED CABLES LTD. PRESCOT, LANCS.

RAYMART

CRAFT A CREED

The illustration below will give you some idea of the varied and extensive range of Raymart Ceramic goods and Insulators.

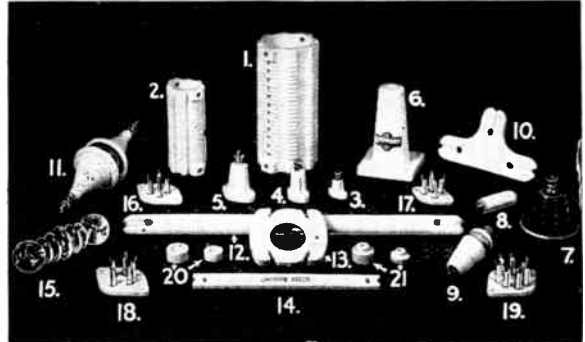

When sending your enquiries, state your requirements as we have many other lines which are not included in the above illustration.

RAYMART Enquiries invited from Government Departments, Traders and Servicemen.
 48, HOLLOWAY HEAD, BIRMINGHAM, 1
 Cables : Raymart, Birmingham. Telephone : Midland 3254

MARTIN'S HAVE IT—IN STOCK ;

Mains Transformers. Well made Standard Replacements, 4-v. and 6.3-v., 37 6 each.
 .01 and .03 Tubular Fixed Condensers, 1,500 V.D.C., 9d. each.
 .05 Tubular Fixed Condensers, 1,500 V.D.C., 1/3 each.
 .0001 Reaction Condensers, 2/- each. Boxed
 Varley Type Switches, 4 way, 1-bank, 2-pole, 3/6 each.
 Resistors, 1 watt, 100 ohms to 2 meg., mixed, 72/- gross.
 Resistors, 1/2 watt, 100 ohms to 2 meg., mixed, 63/- gross.
 Dropper Resistors, wire wound 1,000 ohms, variable superior type, fitted 2-hole fixing lug, 5/9 each.
 10-watt Resistors, 500 ohms, wire wound, 2/6 each.
 2-Gang Condensers, .0005, with slow motion drive. Brand new. Boxed, 9/- each.
 3-Gang Condensers, .0005, new, 7/- each.
 Volume Controls and Tone Controls, all values, with switch, 6/6 each; without switch, 4/6 each.
 Valve Holders, 7-pin British, 8d. each.
 Replacement Valves for American Midgets, and British receivers, nearly all types in stock—all at controlled prices.

MARTIN'S (Edmonton) LTD.
 3/4 The Broadway, Edmonton, London, N.9. TOTtenham 4188

WALTER SWITCHES

ARE MADE FOR



WALTER
 INSTRUMENTS. LTD.

Earls Court Exhibition Buildings, Earls Court, London, S.W. 5
 FULHAM 6192

C. R. Casson 7

Varley

TRANSFORMERS and CHOKES
 For RELIABILITY
 SEND US YOUR ENQUIRIES

OLIVER PELL CONTROL LTD.
 CAMBRIDGE ROAD, BURRAGE ROAD, WOOLWICH, LONDON SE

BASICALLY BETTER...

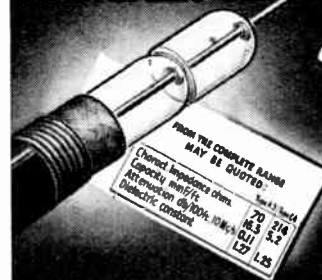

Air Insulation is the basic principle of

CO-AX
 LOW LOSS CABLES
 Unequaled
 H.F. PROPERTIES

TRANSRADIO LTD. Inc. TELEQUIPMENT CO. 16 HIGHWAY, BEACONSFIELD.

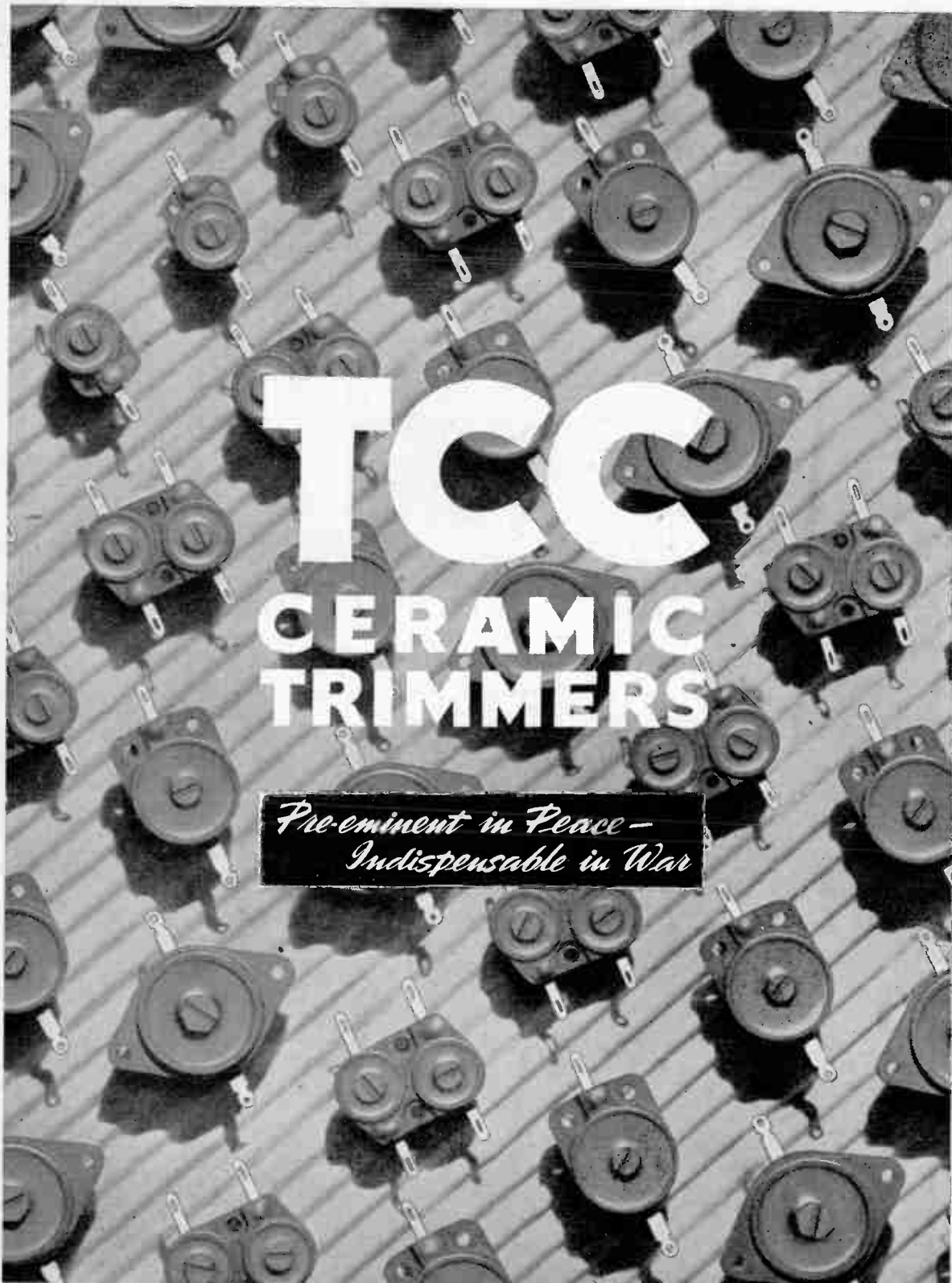

TCC CERAMIC TRIMMERS

*Pre-eminent in Peace -
Indispensable in War*

ADVERTISEMENT OF THE TELEGRAPH CONDENSER CO., LTD.



Accessory after the fact

WHEN Balzac designed his house, with artistic eccentricity he made no provision for the staircase. It had to be built on outside.

Simmonds AEROCESSORIES are not accessories after the fact. Whether they lengthen the life of a power unit, as in the case of the Fram Oil and Engine Cleaner, or whether, like the Simmonds Nut or the Spire Nut, they save time, materials and labour, they are designed to be an integral part of the whole.

Designed after a specialised diagnosis of a given problem, Simmonds products anticipate the needs of the planner. They are AEROCESSORIES before the fact.

S I M M O N D S

In high service to
AERONAUTICAL, INDUSTRIAL & MARINE
Construction

THE SIMMONDS NUT · PINNACLE NUT · SPIRE NUT · SIMMONDS INSTRUMENTS,
CONTROLS AND ELECTRONIC PRODUCTS · FRAM OIL AND ENGINE CLEANER

SIMMONDS AEROCESSORIES LTD.
GREAT WEST ROAD, LONDON
A COMPANY OF THE SIMMONDS GROUP

LONDON MELBOURNE MONTREAL PARIS NEW YORK

Wireless World

Radio • Electronics • Electro-Acoustics

33rd YEAR OF PUBLICATION

JANUARY 1944

Proprietors :
ILIFFE & SONS LTD.

Managing Editor :
HUGH S. POCKOCK,
M.I.E.E.

Editor :
H. F. SMITH.

Editorial, Advertising
and Publishing Offices:

DORSET HOUSE,
STAMFORD STREET,
LONDON, S.E.1.

Telephone :
Waterloo 3333 (35 lines).

Telegrams :
"Ethaworld, Sedist, London."



PUBLISHED
MONTHLY

Price : 1/6

(Publication date 25th
of preceding month)

Subscription Rate :
Home and Abroad
20/- per annum.

EDITORIAL. Standards for Television	1
AUDIO-FREQUENCY GENERATOR. By S. K. Lewer, B.Sc.	2
MATCHING—I : Maximum Power and Minimum Distortion at Audio Frequencies. By S. W. Amos, B.Sc. (Hons.)	6
" WIRELESS WORLD " BRAINS TRUST	8
RADIO DATA CHARTS—No. 13 : Inductance, Capacity and Frequency : Medium Wave. By J. McG. Sowerby, B.A., Grad.I.E.E... ..	10
CARBON RESISTORS. By R. H. W. Burkett, B.Sc.	12
TRANSFORMER SCREENING. By T. A. Ledward, A.M.I.E.E.	15
SHORT-WAVE MARINE UNIT	19
BOOK REVIEWS	20
WORLD OF WIRELESS	21
NEWS IN ENGLISH FROM ABROAD	22
" SUPERHET-STRAIGHT " SWITCHING. By P. A. Shears	24
LETTERS TO THE EDITOR	26
RECENT INVENTIONS	28
RANDOM RADIATIONS. By " Diallist "	30
UNBIASED. By Free Grid	32

Branch Offices :

COVENTRY :
8-10, Corporation Street.
Telephone : Coventry 5210.

Telegrams :
" Autocar, Coventry."

BIRMINGHAM :
Guildhall Buildings,
Navigation Street, 2.
Telephone :
Midland 2971 (5 lines).
Telegrams :
" Autopress, Birmingham."

MANCHESTER :
260, Deansgate, 3.
Telephone :
Blackfriars 4412 (4 lines).
Telegrams :
" Iliffe, Manchester."

GLASGOW :
26B, Renfield Street, C.2.
Telephone : Central 4857.
Telegrams : " Iliffe, Glasgow."



As many of the circuits and
apparatus described in these
pages are covered by patents,
readers are advised, before
making use of them, to satisfy
themselves that they would
not be infringing patents.

Miniature I.F. Transformers

DESIGNED FOR MAXIMUM
GAIN AND SELECTIVITY IN
THE SMALLEST DIMENSIONS

The coils are contained in enclosed pot-type iron dust cores, tuning adjustments being obtained by means of adjustable iron dust centre cores.

Fixed tuning condensers are contained inside the screening can.

Units are made with a number of variations in windings and coupling coefficients for certain circuit conditions, but five Standard types are recommended for general use.

War-time restrictions prevent our accepting orders other than those covered by priority numbers.

The illustration shows the actual size of the Unit which is provided with one hole fixing, the terminal wires being fed through insulated bushings which, in turn, prevent movement of the transformer when mounted in position.

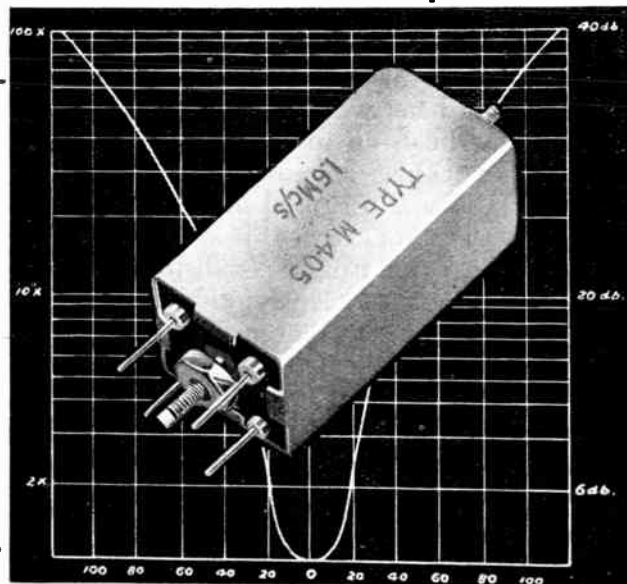

WRIGHT & WEAIRE LTD.

HIGH ROAD, TOTTENHAM, N.17.

Telephone : TOTtenham 3847-8-9.



Magnets

He earns no medals; his name will never make headlines; his way of life is modest and his work unexciting.

But to us he is an individual, a personality; not just a number on the time clock. He is a skilled man — and more, because for years his skill has been allied to the Philips tradition of doing things more efficiently; of making things just that much better.

He melts metals—very special metals which are used for making 'Ticonal'* permanent magnets of unusual power and unique properties; an outstanding Philips' invention. He is one of the thousands of Philips workpeople who gave you, before the war, the Philips products you knew and trusted so well. His skill is a vital asset to the nation today.

* Registered Trade Mark.

PHILIPS



RADIO ★ LAMPS

AND ALLIED ELECTRICAL PRODUCTS

PHILIPS LAMPS LTD., CENTURY HOUSE, SHAFTESBURY AVENUE, W.C.2 (24F)

Wireless World

Radio • Electronics • Electro-Acoustics

Vol. L. No. 1

JANUARY 1944

Price 1s. 6d.

Standards for Television

Ensuring an Early Post-war Start

IN last month's issue we examined two proposals for the drastic reorganisation of British broadcasting after the war. One of these, put forward by members of the Cossor research staff, dealt in considerable detail with the use of ultra-short waves as a supplement to our existing broadcasting service. Television was included as an integral part of this short-wave service; indeed, the whole scheme amounted to a complete "Plan for Post-war Broadcasting," so far as technical organisation is concerned. In discussing the plan last month, we confined our comments to its more general aspects; we will now consider the proposals for television.

As will be remembered, the Cossor scheme provided for transmissions with a definition of 525 lines, and 50 frames per second, interlaced. Carrier frequencies for the nation-wide distribution system envisaged would be in the band 49.5-64.5 Mc/s. A single-sideband system, as proposed, would enable each channel, with its accompanying frequency-modulated sound transmission, to be kept within a 5-Mc/s band. The 15-Mc/s band demanded for television would thus be divided into three such channels, which would be shared among the 12 stations considered to be necessary for covering all the more populous areas of Great Britain and Northern Ireland. As compared with the pre-war standards, the proposals imply a rather higher standard of definition (525 against 405) and a rather higher carrier frequency.

The plan was presented in its entirety before a meeting of the Institution of Electrical Engineers, and during the discussion that followed it was the television proposals—as opposed to those for sound broadcasting—that evoked most of the comments. Many speakers contended that an increase of 525 lines over the pre-war standard of 405 was not sufficient to warrant a change; it would be better to make the earliest possible start and leave high definition until later. Others maintained, taking the analogy of the cinema, that colour transmission was highly desirable. Almost all considered that the promise of continuity of whatever service was decided upon was essential and that the public would never give

full support to the service if there were constant threats that receivers would soon become obsolete.

It was particularly gratifying to us that everyone supported the view that, whatever standards may be adopted, nothing should be done that might hinder the re-establishment of the television service when the war ends. Writing in our November issue, we urged that it was better, if we must accept the principle that any change would involve delay, to restart with pre-war standards for the London area adopting new standards if necessary, for the provincial stations. But if, as we are now assured, the new standards could be put into operation virtually as soon as the old, there seems little point in temporarily reviving a system of transmission that will generally be regarded as obsolete. If, as is argued, the proposed 525-line transmission can be developed into something that is virtually perfect, there is a very strong argument for adopting it as the "final" system.

Compensating Pre-war Set Owners?

If a change is to be made there is the question of compensation for those who already have 405-line receivers, bought with the understanding that they would not become obsolete during a period of years that had not expired when war broke out. Though we should deplore any attempt to shirk obligations towards these set-owners on a legalistic quibble, it is felt that the existence of the pre-war receivers should not be allowed to stand in the way of establishing post-war television on the soundest possible lines.

An advantage of the Cossor scheme is that it would employ what is virtually established present-day technique, both in transmission and reception, and no method of manufacture inherently different from what has already been practised on a fairly large scale would be involved in the production of receivers. Indeed, it seems to be a good working principle, when planning post-war television standards, that the system to be adopted should go as far towards perfection as is possible within the framework of existing technique and reasonably well-tried practice.

AUDIO-FREQUENCY GENERATOR

Resistance-Capacity Tuning with Wien Bridge

UNTIL recently, practically all audio-frequency oscillators were either of the beat-frequency type or of the simple regenerative type having an inductively coupled feedback circuit as its resonant element. The disadvantages of these types have been recognised and considerable efforts have been made to overcome them. The major difficulties were associated with the production of a pure sinusoidal waveform, the maintenance of frequency calibration and the uniformity of voltage output over the full range of frequency. The application of the principles of the Wien bridge has led in recent years to the development of a new type of resistance-capacity tuned oscillator of relatively simple design in which these difficulties are very easily overcome.

This new type of oscillator, which has sometimes been described as the phase-shift oscillator or negative-feedback oscillator, appears to be due to H. H. Scott^{1,2}, and has been put into production by certain manufacturers. Its chief features are stability of frequency and amplitude, simplicity in circuit design and construction, immunity from the effects of variations in supply voltage and valve characteristics, quick warming-up, low cost, and with the commonly available com-

Feedback Circuit

By

S. K. LEWER,
B.Sc.

ponents, an improved graduation of the tuning scale.

In principle, the resistance-capacity tuned oscillator consists of a resistance-coupled amplifier back-coupled through a Wien bridge. The form of bridge which is most convenient for this purpose is shown in Fig. 1. The feedback voltage is applied to the terminals A and B, and the output from the terminals is taken to the input of the amplifier. Both positive and negative feedbacks are obtained by connecting X to the grid of the first valve and Y to the cathode, B being earthed, so that the arm R_4 actually comprises the cathode bias resistance of this valve. The terminal A is connected through a blocking condenser to the anode of the second amplifier valve. It will be shown later that the bridge is balanced only at one frequency dependent on the values of resistance and capacity in two arms of the bridge (AX and XB). Except at the frequency for which the bridge is balanced, the negative feedback exceeds the positive feedback, and by increasing the positive feedback slightly the circuit can be made to generate oscillations. This oscillation cannot occur at any frequency

other than the balance frequency.

Fig. 2 shows the manner in which the two-stage amplifier is coupled to the bridge. Voltage obtained from the anode of V_2 supplies negative feedback at the point Y through the voltage-divider R_3R_4 , and positive feedback at the point X through the resistance-capacity network $R_1C_1R_2C_2$. The phase at Y will be the same as that at A, and the voltage across YB will obviously depend on the ratio R_3R_4 . The phase and voltage amplitude at X,

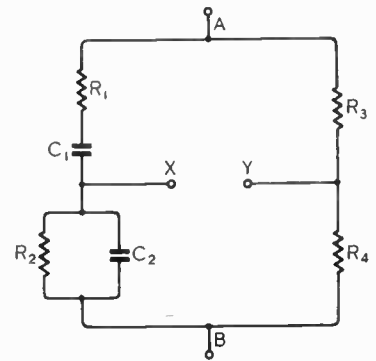

Fig. 1. Form of Wien bridge used in the resistance-capacity tuned oscillator.

however, requires more detailed study. For the bridge to be balanced, there should be zero phase difference and zero voltage between X and Y.

First consider the phase shifts due to AX and XB respectively. At any frequency $f = \omega/2\pi$ the current in the series arm AX leads the voltage across it by an angle whose tangent is $1/\omega R_1 C_1$, while the corresponding phase-shift in the parallel arm XB is $\omega R_2 C_2$. The resultant phase-shift at X will be zero when $1/\omega R_1 C_1 = \omega R_2 C_2$, i.e. when $\omega^2 = 1/R_1 R_2 C_1 C_2$ or

$$f = 1/2\pi \sqrt{R_1 R_2 C_1 C_2}$$

For practical reasons, it is convenient to make $R_1 = R_2$ and $C_1 = C_2$, so that the frequency at which there is zero phase-shift becomes $f = 1/2\pi R_1 C_1$.

At this frequency it is essential that the voltage amplitudes at X and Y should be balanced (except for the slight excess of

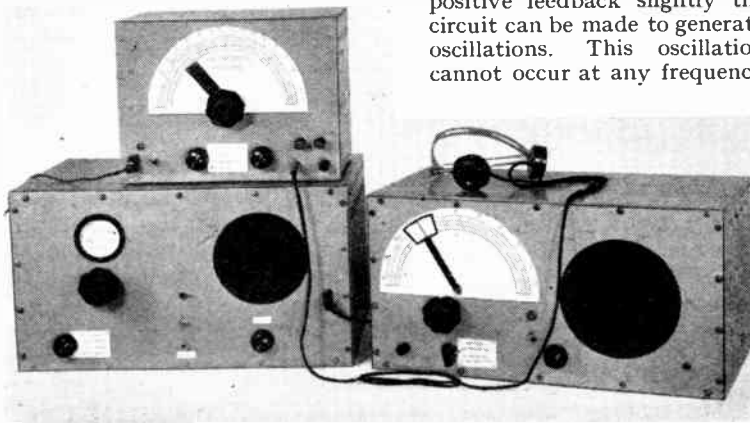

Three different examples of structural design for the audio-frequency generator. The circuit used in each case is that shown in Fig. 3 except that the smaller instrument is not provided with a built-in speaker.

positive feedback necessary to maintain oscillation). This condition may be expressed as $Z_{AX}/Z_{BX} = R_3 R_4$. Substituting the respective values for the impedances,

$$\begin{aligned} Z_{AX}/Z_{BX} &= \sqrt{R_1^2 + I/\omega^2 C_1^2} / \sqrt{I/R_2^2 + \omega^2 C_2^2} \\ &= \sqrt{R_1^2 + I/\omega^2 C_1^2} \sqrt{I/R_1^2 + \omega^2 C_2^2} \\ &= \sqrt{I/\omega^2 C_1^2 R_1^2 + \omega^2 R_1^2 C_1^2} + 2. \end{aligned}$$

At the balance frequency, as shown above, $f = I/2\pi R_1 C_1$ or $\omega R_1 C_1 = I$, so that $Z_{AX}/Z_{BX} = 2$; hence $R_3 = 2R_4$.

It should be noted that the frequency of oscillation will be inversely proportional to the capacity. In other types of oscillator where the resonant circuit comprises inductance and capacity, the frequency is inversely proportional to the square root of the capacity. The R-C type of oscillator therefore has a more convenient tuning scale, better suited to most purposes.

The frequency would be affected to some extent by a dependence of the phase-shift on the supply voltage to the feedback amplifier, but in the conventional type of amplifier this condition is usually absent, and by including automatic control of the amplitude of oscillation, a very high order of frequency stability is easily obtained.

Automatic amplitude control is essential if good waveform and frequency stability are to be achieved. It may conveniently be incorporated by choosing a diode-triode valve as V_2 and coupling the rectified output back to the grid of V_1 in a manner similar to customary practice in radio receivers.

Construction

Several different oscillators were built on these basic principles, and except for quite unimportant modifications the same circuit arrangement was successfully used in all cases. Fig. 3 shows a practical circuit diagram for an oscillator having four overlapping tuning ranges: 30-220 c/s, 150-1,100 c/s, 450-3,000 c/s, 2,000-14,000 c/s. The lowest frequency is dependent on the internal gain characteristic of the oscillator

and on the maintenance of good insulation in relation to the high-value frequency determining resistances. The upper frequency limit is determined by the shunting effect of stray capacities across the resistances in the bridge circuit and in the feedback amplifier. Oscillators have been built, using the same principle, for frequencies up to about 4 Mc/s.³ The coverage of each range and the amount of overlap are capable of easy adjustment to suit particular needs.

The output from the oscillator section is not adequate for most purposes and therefore an amplifier is added and a built-in speaker is provided. In the first experimental assembly, it was evident that serious disturbance of the waveform and frequency arose from varying conditions in the

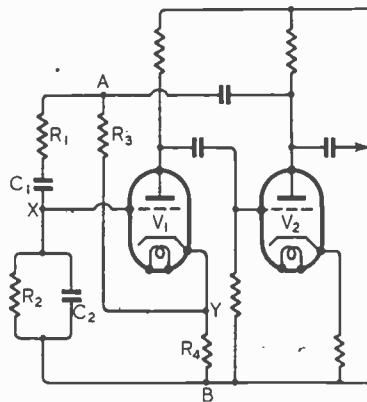

Fig. 2. Two-stage amplifier circuit showing method of connecting bridge.

output stage as the gain control was adjusted. The troublesome effects were traced to capacity coupling between the first grid circuit of the oscillator section and the anode circuit of the output stage of the amplifier, and to a minor degree there was some disturbance of frequency stability due to acoustic feedback from the loudspeaker, presumably arising from vibration of the variable-condenser vanes. The disturbing effects of electrostatic coupling were readily overcome by providing very thorough screening around the oscillator section, and inserting a buffer stage between the oscillator section and the output amplifier section. The dotted line in Fig. 3 indicates where the screening should be arranged.

The acoustic feedback effect disappeared when the final model was completed (the loudspeaker being mounted in the same cabinet as the oscillator-amplifier), but it is a point to be watched in any design where the frequency-determining condenser is liable to be affected by vibration from the loudspeaker. The effect is negligible, of course, if the loudspeaker is located separately from the oscillator unit.

The necessity of avoiding electrostatic feedback in the circuit arrangement means that certain obvious precautions must be taken in the placing of the components and the wiring, but there are some other considerations which determine at least partly the layout of the components. The feedback potentiometer R_5 which provides a variable control of the feedback, must be accessible during testing but must not be so placed as to invite variation of its setting by the user after the oscillator has been calibrated. The best arrangement is perhaps a recessed mounting so that the necessary adjustment can be made with a screw-driver operating in an end-slot in the potentiometer spindle through a suitable aperture in the panel or screening box.

Further, the trimmers belonging to the variable condenser must be readily accessible for setting-up purposes, although if necessary they could be mounted separately from the variable condenser assembly in some more convenient position.

The frequency-determining resistances (R_1 to R_4 in Fig. 3) must be chosen so that the several ranges have a suitable overlap at each end of the condenser scale, and it is very desirable, therefore, that they should be capable of easy replacement during the initial adjustments.

It is also convenient to be able to replace R_{26} and C_{12} , the automatic gain control time-delay components, since the satisfactory operation of the oscillator may be found to depend on the value of the time-constant. Similarly, the cathode-bias and feedback resistance R_6 should be accessible in order to ensure that the optimum value is being used. These components can only be selected by trial-and-error, and by bearing this in mind while the wiring-up is being carried out, the subsequent

testing and adjustment are greatly simplified. All the other components function in the usual way and do not call for any special consideration.

It is important to note that the frame of the variable condenser (which is usually connected to the rotor assembly) is at grid potential, the resistance to earth being of the order of megohms. This calls for a mounting of very high resistance, so that the calibration may not be affected by any subsequent change in the leakage resistance of this mounting, and similarly an insulated coupling must be used between the condenser spindle and the control knob. It is not necessary to place a screen around the condenser assembly itself, as it is sufficient (and probably preferable) to arrange the screen to protect all the circuit elements belonging to the first two valves. Since the frame of the variable condenser is at AF potential, it is necessary to balance this comparatively large capacity by connecting a condenser of 50–100 $\mu\mu\text{F}$ across the upper section (C_2 in Fig. 3). The effective frequency-determining series and parallel

capacities may then be made approximately equal over the working range by suitable adjustment of this balancing condenser.

The choice of valves need not present any difficulty, as the required characteristics are not at all critical. For the oscillator section a variable- μ pentode and a diode triode are essential, while on the amplifier side the buffer may be a triode or any kind of tetrode or pentode, and the characteristics of the output valve are obviously determined by the magnitude of the power output required.

All the intervalve couplings must be capable of passing frequencies extending to the upper and lower limits of the required range without appreciable attenuation, which in effect means that the coupling condensers should be of ample capacity. Extra filtering in the HT supply to the first two valves is incorporated by means of $R_{25}C_{13}$, partly to minimise hum from the rectified AC source and partly to decouple the oscillator and amplifier sections in the interests of frequency stability and waveform.

Provided that the pairs of resistances R_1 to R_4 have been fairly accurately matched, it should be sufficient to adjust the respective trimmer capacities across the variable condenser until the waveform and amplitude remain satisfactory over the full sweep of the tuning control. A trial-and-error process will be necessary, since the setting of the feedback potentiometer R_3 is rather critical, and at any setting which is not the optimum it will be found that the waveform and the amplitude vary throughout the tuning range.

If the capacity of the variable condenser to earth is known, the balancing condenser C_2 can be adjusted to have a similar value. Otherwise, it could be set at various values while the other adjustments are being made until the performance on all ranges is found to be satisfactory.

To achieve satisfactory operation it is practically essential to use a cathode-ray oscillograph for making the initial adjustments, but if this is not available, it should be possible to arrive at a reasonably satisfactory condition

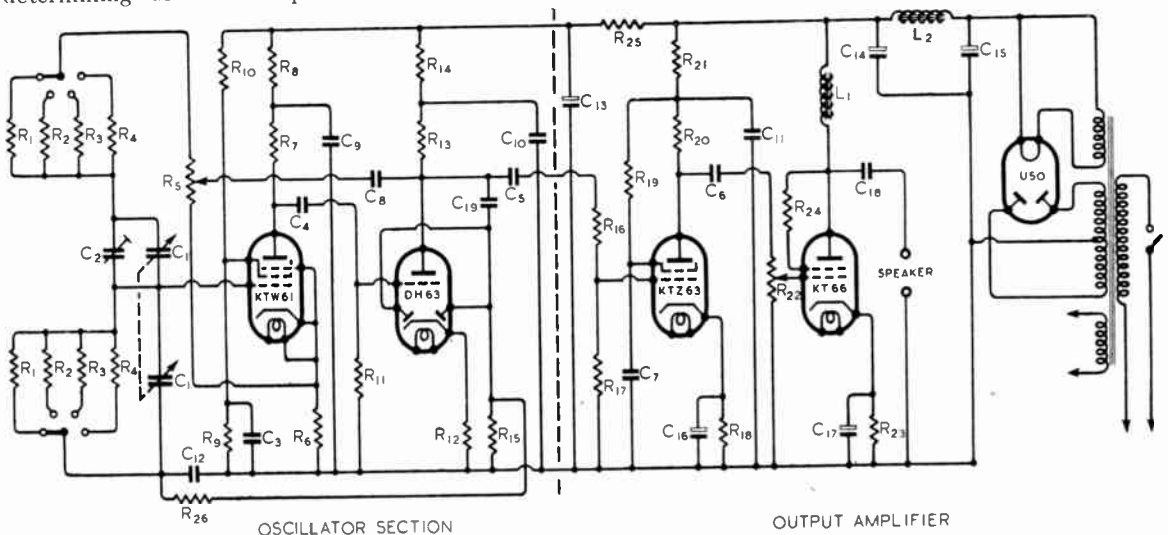

Fig. 3. Practical circuit of resistance-tuned oscillator having four tuning ranges : 30–220 c/s, 150–1,100 c/s, 450–3,000 c/s, 2,000–14,000 c/s.

R_1 5 M Ω ,	$\frac{1}{2}$ watt	R_7 30,000 Ω ,	1 watt	R_{14} 50,000 Ω ,	$\frac{1}{2}$ watt	R_{21} 50,000 Ω ,	$\frac{1}{2}$ watt
R_2 1.03 M Ω ,	$\frac{1}{2}$ "	R_8 30,000 Ω ,	1 "	R_{15} 100,000 Ω ,	$\frac{1}{2}$ "	R_{22} 0.5 M Ω	
R_3 375,000 Ω ,	$\frac{1}{2}$ "	R_9 50,000 Ω ,	1 "	R_{16} 0.5 M Ω ,	$\frac{1}{2}$ "	R_{23} 333 Ω ,	2 "
R_4 130,000 Ω ,	$\frac{1}{2}$ "	R_{10} 30,000 Ω ,	1 "	R_{17} 100,000 Ω ,	$\frac{1}{2}$ "	R_{24} 100 Ω ,	$\frac{1}{2}$ "
R_5 10,000 Ω ,	$\frac{1}{2}$ "	R_{11} 0.5 M Ω ,	$\frac{1}{2}$ "	R_{18} 600 Ω ,	$\frac{1}{2}$ "	R_{25} 20,000 Ω ,	3 "
R_6 2,000 Ω ,	$\frac{1}{2}$ "	R_{12} 1,000 Ω ,	$\frac{1}{2}$ "	R_{19} 0.5 M Ω ,	$\frac{1}{2}$ "	R_{26} 1 M Ω ,	$\frac{1}{2}$ "
		R_{13} 15,000 Ω ,	$\frac{1}{2}$ "	R_{20} 20,000 Ω ,	$\frac{1}{2}$ "		
C_1	0.0005 + 0.0005 μF	C_8 to C_{12}	1 μF , 400 V wkg.	C_{18}	4 μF , 500V wkg.		
C_2	100 $\mu\mu\text{F}$, air trimmer	C_{13} to C_{15}	8 μF , 600V peak	C_{19}	0.05 μF , 400V wkg.		
C_3 to C_7	0.1 μF , 400V wkg.	C_{16} and C_{17}	50 μF , 50V peak	L_1 and L_2	20 H, 75 mA.		

by using a valve voltmeter to measure the amplitude and by relying on the ear for the purity of tone.

The frequency stability of the oscillator is practically unaffected by all normal mains voltage fluctuations. A variation of supply voltage between 260 and 160 V. was found to result in less than 0.1 per cent. variation in the

acoustic scale. In one model, which was not especially good in respect of uniformity of output voltage, the deviation from average level exceeded 2 db only when the frequency was above 11,000 c/s. The output characteristics of the four ranges of this particular instrument are shown in Fig. 4.

The question of calibration is

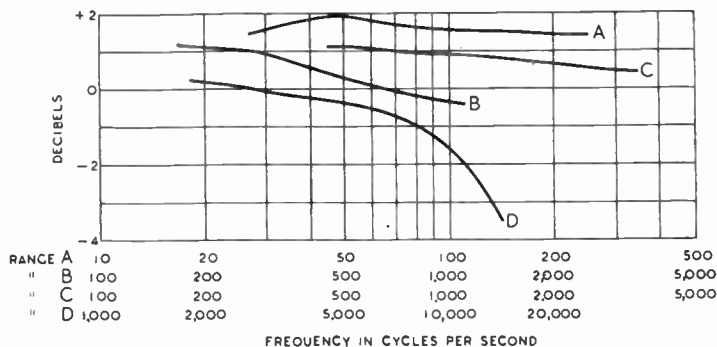

Fig. 4. Output voltage variation for four frequency ranges. The output corresponding to 0 db is 30V RMS across 100,000 ohms.

generated frequency. Stability of this order is reached within about 30 seconds after switching on from a cold start. The long-term stability of the frequency calibration depends chiefly on the constancy which can be achieved in the values of the resistances forming the tuning network. Ageing and humidity may prove to be the most serious disturbing factors, and for high precision work only the very best resistances should be used. The commonly available resistances, however, appear to give a frequency stability of better than 0.5 per cent. over a period of several months, with a day-to-day stability 10 to 100 times better than this.

The waveform, as measured at the anode of the output valve, is practically sinusoidal at all frequencies except the very lowest, i.e. below about 60 c/s, where the distortion becomes quite apparent on an oscillograph. The acoustic output is also dependent, of course, on the characteristics of the speaker and cabinet design.

In the various models which have been constructed, no great importance was attached to the maintenance of constant voltage output throughout the frequency ranges, but it was observed that appreciable deviations from the average level occurred only at the extreme top and bottom of the

regarded as being outside the scope of this article. No new technique is involved, and any of the usual methods may be employed. The choice will, of course, depend on the degree of accuracy required and the apparatus available. It may, however, be added that it has been found to be quite practicable to calibrate the frequency scale in steps of 10 c/s as high as 5,000 c/s and in steps of 1 c/s below 200 c/s.

In conclusion, the author wishes to express his thanks to Mr. J. M. W. McBride and to Mr. L. Stenning for the assistance derived from discussions with them on this subject.

REFERENCES

- ¹ H. H. Scott, "A Low Distortion Oscillator," *G.R. Experimenter*, April 1939, p. 1.
- ² H. H. Scott, "A New Type of Selective Circuit and Some Applications," *Proc. I.R.E.*, Feb. 1938, p. 226.
- ³ C.-K. Chang, "A Frequency-modulated Resistance-capacity Tuned Oscillator," *Proc. I.R.E.*, Jan. 1943, p. 22.
- ⁴ F. E. Terman, R. R. Buss, W. R. Hewlett and F. C. Cahill, "Some Applications of Negative Feedback with Particular Reference to Laboratory Equipment," *Proc. I.R.E.*, Oct. 1939, p. 649.
- ⁵ E. L. Ginzton and L. M. Hollingsworth, "Phase-shift Oscillators," *Proc. I.R.E.*, Feb. 1941, p. 43.
- ⁶ W. B. Nottingham, "R-C Oscillator Analysis," *Electronics*, July 1942, p. 109.
- ⁷ R. C. Whitehead, "Designing a Resistance-capacity Oscillator," *Wireless World*, Dec. 1942, p. 278.
- ⁸ W. N. Tuttle, "Bridge-T and Parallel-T Null Circuits for Measurements at RF," *Proc. I.R.E.*, Jan 1940, p. 23.
- ⁹ R. L. Dawley, "The Improved Wide-range Audio Oscillator," *Radio*, Dec. 1940, p. 16; also June 1940, p. 17.

REVIVING OLD IDEAS

(From "Radio," New York)

A WELL-KNOWN engineer said that, should he have a hand in the development of post-war radio-electronic products, he would set a group of men to digging in the dust of the past in search of new ideas.

What he means, of course, is that many ideas have been born much before their time, and are, therefore, worth reviewing in the light of more recent developments. A scheme that proved a washout in its time may now prove to be the answer to a trying riddle.

A case in point is the original R.C.A. loop-operated receiver employing the Type 199 tubes. In a sense this receiver represented brilliant engineering, but the use of a loop antenna at a time when gain was both expensive and difficult to obtain was definitely a *faux pas*. But some years later, when gain became cheap and relatively easy to obtain, the loop was resurrected and to very good advantage. Yet, not until someone put two and two together to make a very profitable four for the entire radio field.

It is also interesting to observe that a condenser phonograph pick-up was developed—and a few manufactured—around 1924 or so. It was designed for use in conjunction with an RF oscillator and some form of detector, and had no advantages over other types of pick-up that we can recall. But there are indications now that the capacity pick-up, used in conjunction with a small FM unit, may find widespread use in the post-war period.

Loudspeakers are another case in point. Small speakers with rather good efficiency and frequency response can be developed if the cone has sufficient rigidity and at the same time a rather large excursion. The answer to this problem may well rest in the use of a single-turn voice coil. If that is the case, it will be found that a single-turn voice coil was first used in a dynamic speaker about 1924.

The future is always indebted to the past in some manner, and it is good engineering practice to constantly revalue old ideas in the light of new developments.

MATCHING

I.—Maximum Power and Minimum Distortion at Audio Frequencies

By S. W. AMOS,

B.Sc. (Hons.)

POSSIBLY the simplest form of matching circuit is that illustrated in Fig. 1, which shows a source of power (a dynamo, for example) connected to a load (a lamp is shown in the illustration). The problem is to get maximum power (illumination) into the load, which has a resistance of R_l ohms, the dynamo being assumed to have a resistance of R_i ohms, and to be running at a constant speed thus giving a constant output of E volts. From Ohm's law we have that the current in amps. in the circuit is given by—

$$i = \frac{E}{R_i + R_l}$$

Thus the power, P , in the load is given by—

$$P = i^2 R_l = \frac{E^2 R_l}{(R_i + R_l)^2}$$

We can find out when this power

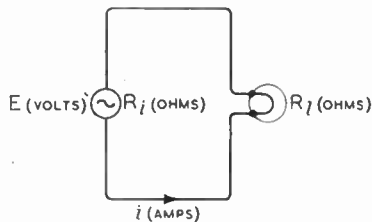

Fig. 1. Circuit illustrating simplest form of matching.

is a maximum by considering a numerical example. Suppose $E = 6$ volts and $R_i = 5$ ohms. By giving R_l various values and evaluating the power from the above expression for each value we obtain the curve shown in Fig. 2 (a), which shows that maximum power is given when the load has a resistance of 5 ohms, which is the resistance of the generator. This is an important conclusion and one of very general application. We will call it the first law of matching thus—For maximum power in the load—

$$R_l = R_i \quad \dots \quad (1)$$

Suppose we desire the condition for maximum voltage developed across the load. From the circuit of Fig. 1 the voltage across R_l is given by—

$$E_l = i R_l = \frac{E R_l}{R_i + R_l}$$

It is not generally appreciated that all the coupling circuits used in radio, whether AF, RF or IF, are examples of matching, either for maximum power transfer, maximum voltage transfer or optimum performance in some other quality. It is the purpose of these articles to discuss the laws of matching with particular reference to some of the types of AF and RF circuits used in receivers and transmitters and the conditions for optimum performance will be given.

The value of this expression has been plotted in Fig. 2 (b) for various values of R_l . From this curve we can see that E_l tends to the value E and the greater R_l is compared with R_i the nearer does E_l approach E . In radio when we say that one resistance has to be great compared with another we make the first ten times the other whenever possible. We can therefore state the second law of matching thus—For maximum voltage across the load—

$$R_l = 10 R_i \quad \dots \quad (2)$$

We have so far assumed R_i constant and R_l variable, the reverse sometimes occurs, i.e., R_l is fixed and R_i is controllable. In this case maximum power is dissipated in the load when

Fig. 2. Curves illustrating dependence of (a) power and (b) voltage across R_l on the value of R_l . Both curves apply to the circuit of Fig. 1, where $E = 6$ volts and $R_i = 5$ ohms.

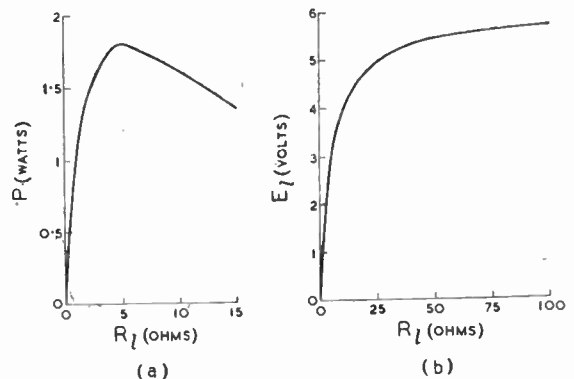

maximum voltage is generated across it and this occurs when R_l is small compared with R_i , say, one-tenth of R_i .

Now a valve is a generator of alternating potential. Consider

Fig. 3 (a) which represents a triode of internal resistance (anode impedance) R_a feeding into a load R_l , the alternating input to the grid being E_g volts. Fig. 3 (b) is the electrical equivalent of the circuit in which the valve is shown as a generator of internal resistance R_a delivering μE_g volts, where μ is the amplification factor of the triode. Fig. 3 (b) compares directly with Fig. 1 and we have therefore the immediate results that, for maximum power in the load, R_l must equal R_a and for maximum alternating voltage across the load, R_l should be great compared with R_a . The practical significance of these results is clear. If a triode valve is to be used for power output purposes with a loudspeaker approximating to a pure resistance connected directly in its anode circuit as in Fig. 3 (a) then we shall get maximum power into the speaker by making its resistance equal to the internal resistance or impedance of the valve. When the triode is used as a voltage amplifier to realise the full amplification factor of the valve the load resistance should be very much greater than the anode impedance. In practice R_l rarely exceeds three times R_a (in which case the stage gain equals $\frac{3}{4}\mu$) because the signal handling capa-

city of the valve is severely curtailed by the use of loads of value greater than this.

The matching condition for greatest power output used up to now, namely $R_l = R_a$, does not

hold when the loudspeaker is fed by means of a transformer from the anode circuit as shown in Fig. 4. A complete explanation of why this is so is beyond the scope of this article: it is sufficient to say that it is because the anode potential of the valve can, when a

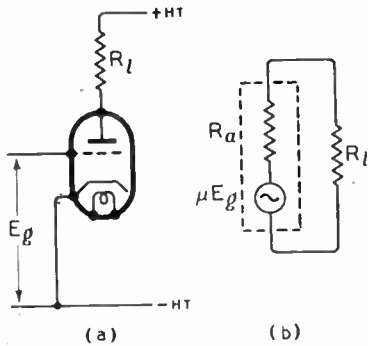

Fig. 3. A triode amplifying stage (a) and its equivalent circuit (b). The latter compares directly with Fig. 1.

transformer is used, swing from zero to twice the value of HT used, whereas in the other circuit the positive potential peak was limited to the value of the HT volts. For the transformer coupled loudspeaker the condition for maximum power transfer is $R_1 = 2R_a$ where R_1 is the value of the loudspeaker resistance reflected into the primary of the output transformer. If the turns ratio of the latter is $n : 1$ and the speech coil resistance is R , then the condition for maximum power transfer may be written—

$$\frac{R_1}{R} = \frac{1}{k^2} \cdot \frac{L_P}{L_S}$$

or in general terms—

$$\frac{R_1}{R_2} = \frac{1}{k^2} \cdot \frac{L_1}{L_2} \quad \dots (3)$$

In this L_P and L_S are the primary and secondary inductances respectively and k is the coefficient of coupling between them. Now in audio-frequency amplification in which iron-cored transformers are used k is very nearly equal to unity (not quite unity, of course, otherwise there would be no leakage inductance), and, moreover, the inductances are proportional to the squares of the numbers of turns. Consequently law (3) can be reduced to the simple form—

$$R_1 = n^2 R$$

in which form the majority of readers will recognise it. The

author prefers version (3), however, for it applies equally to RF circuits in which coupling coefficients are often far from equal to unity and inductances are just as often not proportional to the second or any other power of the number of turns.

This method of matching two resistances by means of a transformer is one extensively used in radio. To get maximum power from R_1 to R_2 if these are connected by a transformer the ratio is given by the expression—

$$\sqrt{\frac{R_2}{R_1}} : 1$$

As just explained when this expression is applied to a triode output valve, R_2 , the optimum load is given by $2R_a$, R_1 being the speech-coil resistance. To quote a numerical example, typical values for R_2 and R_1 are 3,000 and 2 ohms respectively, giving the output transformer ratio as

$$\sqrt{1,500} : 1 = 39 : 1$$

In order to transmit speech and music satisfactorily over a land-line it is necessary that the line be terminated at each end in a resistance equal to its characteristic impedance. This characteristic impedance depends on the dimensions of the land line but an average figure is 600 ohms. If,

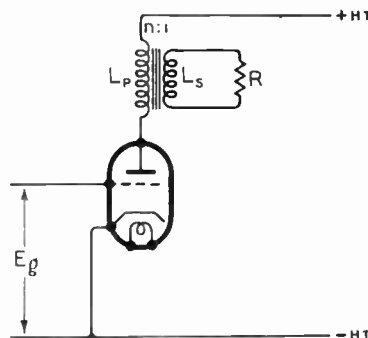

Fig. 4. A triode amplifying stage with transformer-coupled load. The matching condition for this differs from that for Fig. 3 (a).

therefore, the output of a receiver is required to be fed to a line an output transformer should be used, such that its ratio gives a good match between the optimum load of the output valve and 600 ohms. If the optimum load is 10,000 ohms then the ratio to use is—

$$\sqrt{\frac{10,000}{600}} : 1 = 4 : 1$$

For a triode, as we have seen $R_1 = 2R_a$ for maximum power output but for pentode and tetrode output valves this relationship is far from true. Such valves have very high values of internal resistance (50,000 ohms is a

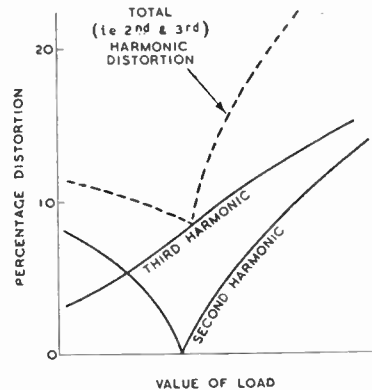

Fig. 5. Dependence of load resistance of distortion given by pentode output valve.

common value) and work most satisfactorily into loads with a resistance generally between one-sixth and one-third of their impedance. Now such output valves can give a rather high distortion unless considerable care is taken to match them carefully to the loudspeaker. Fig. 5 shows how the distortion given by a pentode valve depends on the value of the load it "looks" into. Curves are given for second, third and total distortion and it is immediately clear that it is possible to choose a value of load which will give the greatest freedom from distortion; in other words it is possible to match the valve to the load for minimum distortion. It is almost certain, however, that the value of load which gives minimum distortion will not give the greatest output power.

We will now consider intervalve transformers and see how they satisfy the matching laws. The basic circuit for two transformer-coupled valves is given in Fig. 6. This is another example of matching two resistances by means of a transformer, the resistances being the anode impedance of V_1 and the input impedance of V_2 . Now the anode impedance of V_1 , if this is a triode, may be between 10,000 and 50,000 ohms but the input of V_2 depends on quite a number of factors. If V_2 is operating in Class A condi-

tions, i.e., with no grid current flowing, then its input resistance will depend chiefly on the frequency and the nature and magnitude of its anode load. At 1,000 c/s and for a resistive load we can take this input resistance as being about 10 megohms. For a numerical example we will consider the value 8 megohms and we will let the impedance of V_1 be 50,000 ohms. As no grid current flows this is a case of matching for greatest voltage transfer so that, from matching expression (2) the reflected resistance across the transformer secondary should be one-tenth the input resistance of V_2 . This gives the transformer ratio as—

$$\sqrt{\frac{800,000}{50,000}} : 1 = 4 : 1 \text{ step-}$$

up which agrees well with the values used in practice.

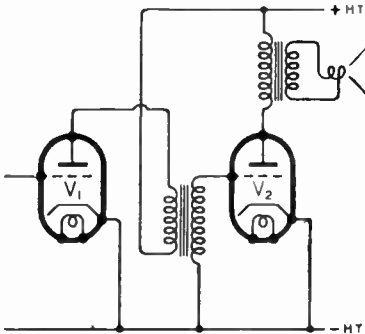

Fig. 6. Basic circuit of transformer-coupled AF amplifier.

Suppose that V_2 is a Class B amplifier, or rather one half of a Class B output stage. Two differences are now noticeable. First, grid current now flows in V_2 and so its input resistance is low, about 5,000 ohms say. Second, the power associated with this flow of current has to be supplied by V_1 , which makes this example one of matching for greatest power transfer. Using expression (3) we have that the ratio of the transformer is given by—

$$\sqrt{\frac{20,000}{5,000}} : 1 = 2 : 1 \text{ step-}$$

down in which R_a of V_1 has been taken as 20,000 ohms. Incidentally, the secondary resistance should be as small as possible to avoid waveform distortion due to the voltage drop when the grid current flows through the transformer secondary.

Wireless World Brains Trust

Future of the Disc

MORE VIEWS ON QUESTION No. 16. (Is the disc record due for supersession, and, if so, what system of sound recording for domestic reproduction should take its place?)

DR. L. E. C. HUGHES considers that we are committed to the disc, but that there is room for the parallel development of a system giving a much longer period of uninterrupted reproduction. He writes:—

WHILE I would subscribe to nearly all the contentions of Stuart Black (*Wireless World*, December, 1943) respecting the disadvantages of the disc (and, historically speaking, the advantages of the cylinder) as the geometric form of the medium for carrying recorded sound, may I emphasise the fact that the material of the recording medium is the controlling factor? We can always get adequate frequency response by adopting a sufficiently high speed of medium, i.e., resolution of the wave-form; the limiting factor is the ground-noise. This is virtually eliminated in sound-film, e.g., "Fantasia," but at what a price! I recollect that A. G. D. West estimated (in a lecture before the Royal Society of Arts) that the optimum design of sound-film for the home would have to sell at five times the cost of discs for material alone.

We are committed to discs; on occasion the quality can be extremely good. The major defect is only the limitation of playing-time. The difficulty of the varying track-speed only shows up in the varying quality towards the centre when the needle is wearing. The needle must wear, otherwise the material of the record would wear to a greater extent and reduce its own life. A distinct improvement would be to play the disc outwards instead of inwards. This method was adopted in the earliest sound-film, when Vitaphone utilised the synchronised disc as a quick answer to the pressing demand for adding sound to scene. Unfortunately, the method was not adopted when records (slow-speed, with special acoustic re-

producers) were used for talking books for the blind.

We are committed to discs commercially because of the immense capital locked up, not so much in the technical equipment for their production, but in the costs of the artists. Any new system which purports to compete with discs in the ordinary market must start from scratch with no titles in its catalogue. As the great majority of artists and most large orchestras are under contract to the principal recording companies, one cannot imagine where recording material saleable on a new type of machine, not interchangeable with discs and competing with them, is to come from. Even if an *élite* market could be found for a system markedly superior to the disc system, the same difficulty of titles arises.

We have, therefore, to find a new source of high-grade sound for recording purposes. It exists only in broadcasting, and, having paid one's licence for the service of broadcasting, I see no legal hindrance to recording it for one's private interest, providing the record is not made for public sale or usage. The way out of the *impasse* lies in the production of a recording system which, while robust, simple in operation, and cheap both in first cost and running costs, would enable a domestic user to get quality which is at least as good as, if not better than, existing discs.

We are again back to the material. The major demand is for non-interruption, which is impossible on a rigid material. The only alternative is a filmic material of sufficient area to take the longest uninterrupted musical or dramatic works. This medium must be used in such a way that the ground noise is at least as low in relation to the recorded sounds as the best records or modern sound-film. With such a recording system and abundant supplies of cheap film, the enthusiast can record to his heart's content what he likes of what is broadcast, or what he likes to create in his own surroundings.

He makes his own recorded library and becomes independent of the existing vested interests. Such a system has, of course, not yet appeared, but it seems to me that these are the lines on which a new system must be introduced.

There is one possible improvement to the disc system which Mr. Black did not mention: the standardisation of the exact dimensions of the cutting stylus among the recording companies throughout the world. I am aware that a leading company has tried to give a lead in this matter, but nothing came of it. A bad fit of the reproducing needle in the groove leads, I am sure, to unnecessary wear of the record. If the two could be fitted together, and this could be done only by international agreement, I feel that records would not wear so quickly.

Likewise, mechanical tracking of the pick-up is not possible until there is international agreement on the spacing of grooves. The latter are sometimes varied to accommodate high-amplitude recording. The customer also likes to feel that the surface is fully used, forgetting that this is linked to the time of playing.

The Edison cylinder is, for artistic purposes, dead, as Mr. Black says. In the form of the Dictaphone and the Ediphone it is, however, still doing an enormous job in commerce and also helping the B.B.C. in its vast war-time job of monitoring. The apparent low ground noise arises from the restricted reproduced frequency band. Some tests with the modern electrical pick-up on a cylinder would be illuminating.

DONALD W. ALDOUS, *Technical Secretary of the British Sound Recording Association, surveys suggested improvements to disc recording and discusses possible alternative systems.*

THE question "Is disc recording obsolete?" has long been debated among recordists and others interested in the subject. Briefly, the answer generally agreed upon at these discussions is "No; the disc recording system will continue to be of great use for domestic record reproduction purposes, but numerous improvements are urgently needed." It is on the question of the desired

improvements that no final agreement could be reached! (I shall confine my remarks to recordings, on any system, but produced in quantity chiefly for domestic reproduction, as the direct play-back disc system will continue for a long time to find many applications by both professional and amateur recordists, which I have covered elsewhere.)

Among the suggested improvements and modifications are the use of (a) the vertical or hill-and-dale cut, (b) constant amplitude recording, (c) constant groove-speed recording, (d) variable groove-pitch recording, (e) pressings in a "scratch-free" plastic, and such refinements as (f) standardisation of groove size, shape and pitch, (g) markings on record labels to show frequency characteristic used, and (h) the coefficient of compression, to permit the correct volume expansion coefficient to be used in reproduction, and, lately, (i) the use of an FM pick-up.

In view of my friend Stuart Black's comments, he will no doubt be interested to learn that a method of embossing or burnishing disc recording, in which no "thread" is removed, used in combination with constant groove-speed recording, has recently been revived in America. It makes possible 30 minutes' music or 45 minutes' speech recording on one side of a 12in. disc.² A polished round stylus is used for recording and play-back. The constant groove-speed method was also

¹ "Manual of Direct Disc Recording," (Bernards, Ltd.)

² "Embossing at Constant Groove-Speed," *Electronics*, July, 1940.

employed in the "Longnote" record, marketed by Filmophone Flexible Records, Ltd., in this country in the early 1930's.³

Regarding film recordings for home use, one can recall the technically successful Duo-Trac method.⁴ An excellent survey of the question whether sound-on-film can supplant the disc record, by Mr. R. H. Cricks,⁵ indicates that the electrical and acoustical parts of such a design present no difficulties, but long and costly experimental work to solve the following problems would be necessary: (1) the discovery of some less costly film base than cellulose-acetate, (2) the computation of optical components capable of the necessary standard of definition, (3) the perfection of mechanical devices for the recording, printing and reproduction of the film, as well as the snag of the complicated patent situation regarding the commercial use of certain types of film drive, use of ultra-violet light for recording/printing, and certain noise-reduction, volume-expansion devices, etc. Also the questions of a simple portable apparatus and a design for locations where no electric power supply is available must be taken into account.

I have refrained from giving a final personal opinion, as I think it would be prudent to wait until the latest views of fellow-technicians have been expressed before passing final judgment. Then perhaps someone will attempt a summing-up.

³ *Wireless World*, p. 286, March 16th, 1932.

⁴ *Wireless World*, p. 277, March 19th, 1937.

⁵ *Electronic Engineering*, April, 1942.

SUSPENSION OF TECHNICAL INFORMATION SERVICE

A Reminder to Readers

SHORTLY after the outbreak of war, it was decided to suspend the service formerly conducted by the "Wireless World" Technical Information Bureau.

This decision, arrived at with regret, was brought about by shortage of technical staff due to the demands of the Services. It was felt that the energies of those who remained could most usefully be employed in the production of the journal, and not in dealing with individual queries, either by letter or telephone.

Readers are reminded that this suspension is still in force, and must remain so until the end of the war.

RADIO DATA CHARTS—13

Inductance, Capacity and Frequency : Medium Wave

LAST month we dealt with the theory of the series tuned circuit. Continuing the discussion let us now turn to the more commonly used parallel tuned circuit shown in the figure, in which all the resistance is supposed to be in the inductive arm, approximating closely to practical conditions.

Parallel resonant circuit.

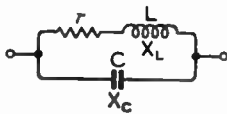

It will be remembered that at resonance the impedance of the series circuit was a pure resistance equal to the resistance of the inductance. At the same time the impedance was at a minimum. In the parallel case it turns out that the impedance is high at resonance and is largely resistive. In our working we may therefore assume the criterion of resonance in the circuit as (1) presenting a pure resistance (2) presenting the maximum impedance. The first case will be chosen here as it is rather simpler to work out and since the results obtained by adopting either criterion or resonance are exactly the same.

The impedance of the parallel circuit is clearly the impedance of the two arms in parallel with one another, and so

$$Z = \frac{(r + jX_L)(-jX_C)}{(r + jX_L) + (-jX_C)}$$

This may be rearranged in the form $(A + jB)$ and when this is done it turns out that

$$Z = \frac{rX_C^2}{r^2 + (X_L - X_C)^2} + j \frac{(X_C^2 X_L - X_C X_L^2 - r^2 X_C)}{r^2 + (X_L - X_C)^2} \quad \dots \quad (1)$$

For the impedance to be purely resistive the imaginary term to the right of this equation must be zero, hence the numerator must be zero, and so

$$X_C^2 X_L - X_C X_L^2 - r^2 X_C = 0 \quad \dots \quad (2)$$

from which

$$\omega^2 = 1/LC - r^2/L^2$$

By

J. MCG. SOWERBY,

B.A., Grad.I.E.E.

(By permission of the Ministry of Supply)

or

$$f = \frac{1}{2\pi} \sqrt{\frac{1}{LC} - \frac{r^2}{L^2}} \quad \dots \quad (3)$$

It was shown in the notes concerning the dynamic resistance of a parallel tuned circuit (*Wireless World*, July 1943, p. 194) that the magnitude of this pure resistance is approximately

$$R_D = L/r \quad \dots \quad (4)$$

and it is called the dynamic resistance of the tuned circuit. Equation (3) gives us the frequency of resonance of the circuit but in practice it may be further reduced to

$$f = \frac{1}{2\pi\sqrt{LC}} \quad \dots \quad (5)$$

since the term r^2/L^2 of equation (3) is small compared to the $1/LC$ term when the Q of the circuit is reasonably high. In fact the frequency given by (5) will differ from the frequency as given by (3) by 1 per cent. when the Q of the coil is about 7. When the Q is 50 (which is a more practical value) the two formulae differ by only two parts in 10,000 (or 200 c/s in 1 Mc/s). Hence the simple formula (5) is quite accurate enough for all practical purposes except when special conditions obtain.

In addition to the above mentioned two criteria of resonance there is another—this being the frequency of the damped oscillations produced by a transient in the circuit. This is known as the *natural* frequency and it turns out that this frequency is given by the equation

$$f = \frac{1}{2\pi} \sqrt{\frac{1}{LC} - \frac{r^2}{4L^2}} \quad \dots \quad (6)$$

The right hand term under the square root sign is even less here than in (3) and consequently equation (6) differs from (5) by even less than (3) so that once again the approximate formula is justified as being quite sufficiently accurate for the vast major-

ity of calculations. However, if the Q is less than 7 the exact formulae should be remembered.

It will be of interest now to calculate the currents in the two arms of the parallel circuit. If E is the applied voltage then the current through L is

$$I_L = \frac{E}{\sqrt{r^2 + \omega^2 L^2}} \div \frac{E}{\omega L} \quad \dots \quad (7)$$

and through C it is

$$I_C = E\omega C \quad \dots \quad (8)$$

The current through the whole circuit is

$$I = E/R_D = EC/r/L \quad \dots \quad (9)$$

The ratio of the currents in the condenser (or, to a close approximation, the coil and the whole circuit is thus from equations (8) and (9)

$$\frac{I_C}{I} = E\omega C \cdot \frac{L}{ECr} = \frac{\omega L}{r} = Q \quad \dots \quad (10)$$

The current through the condenser or coil is therefore Q times the current passed through the whole circuit, but as the currents in the coil and condenser are nearly out of phase only a small current as given by (9) is drawn from the source of supply. In the last RF (or IF) stage of a receiver it would not be unusual to have a voltage across the tuned circuit of 30 volts. If the dynamic resistance were 90,000 ohms (a reasonable figure) the total current would be 1/3 mA. If the Q of the coil were 180 then the current through the coil would be 60 mA—quite a high current. Hence in designing coils it should not be forgotten that they may be called upon to carry currents of this order and appropriate precautions should be taken.

The Chart.—As before the chart is based upon the simplified formula (5). It is only necessary, in use, to connect two of the quantities L , C , and f together with a ruler when the third will appear opposite the ruler on the appropriate scale.

Example.—What is the resonant frequency of a parallel circuit of 100 μ H and 200 μ F?

Ans. 1.125 Mc/s (1,125 kc/s of a wavelength of 266.57 metres).

ABAC No. 13
[Third Series]

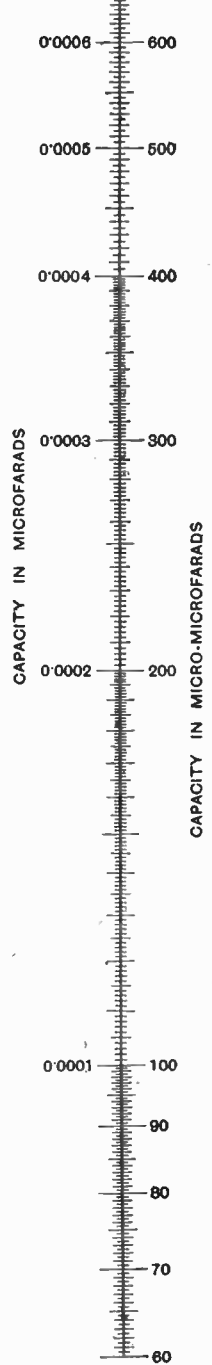
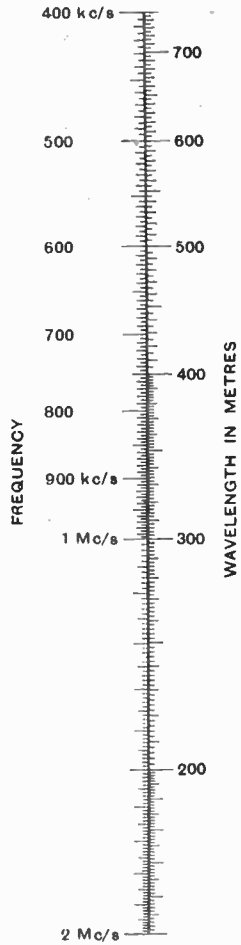

INDUCTANCE, CAPACITY AND FREQUENCY
MEDIUM WAVE

Wireless World
COPYRIGHT

CARBON RESISTORS

Properties of the Various Types

IT is well known that most of the resistors at present used in radio equipment are of the carbon type and have the fundamental properties of carbon modified to a greater or less degree by reason of the peculiarities of construction. The types at present in use in the order of output are: (1) composition rod; (2) composition film; (3) cracked carbon film.

The composition rod resistor comprises a cylinder of material consisting of a mixture of carbon, either graphite or carbon black, or both together with silica or other refractory material and a cement or binder such as a thermoplastic resin. The materials are blended in the proportions required to give the desired resistance, moulded into shape and then fired. The resistors are then selected for value, provided with leads and painted. There are types, however, which are insulated, and these may be provided with an outer insulating ceramic tube or covered with a synthetic resin surface layer.

The composition film type of resistor comprises a film formed by applying a paste containing carbon to a former, which may be a ceramic rod or glass tube, and then baking. This film may be spiralled to increase the resistance, and that formed on a ceramic rod is then painted with a protecting lacquer. The type produced on the glass tube is encased in moulding material without spiralling.

"Cracked" Carbon

The carbon film type is becoming increasingly popular in this country and has superior properties to the two previous types. This resistor comprises a film of pure carbon, probably graphite, deposited on ceramic rods or tubes by passing them through an atmosphere containing organic vapours at high temperatures. This process is known as "cracking," and the resistors produced in this way are frequently referred to as cracked carbon resistors. The deposit of carbon is of low resistivity and the effective resist-

By R. H. W. BURKETT, B.Sc.

ance of the component may be increased by reducing the thickness of the film by a polishing process or by spiralling the film by means of diamond or carborundum cutters. End caps and leads are provided and the whole resistor given some measure of protection by a lacquer or sleeving of insulating material.

Apart from the cracked carbon and one make of composition film resistors, which types have their final resistance value determined by spiralling, the resistance value is controlled by the composition of the initial mixture from which the components are made. Due, however, to the inherent variations in the materials and to slight differences in manufacture there is a scattering effect about the target value. It will thus be seen that while a large number of the final resistors will be at or near the target value, a proportion will be wide of the mark.

If the resistors are being selected to within ± 5 per cent. of the nominal value, the number of rejects will be higher than if the selection is to ± 20 per cent. The recently adopted "Preferred Values" have been designed to overcome this wastage of material. Each preferred value together with its maximum possible positive tolerance coincides with the next highest preferred value having the maximum negative tolerance. It will thus be seen that no matter what degree of scattering is obtained the product can be sorted into one or another preferred value.

The final resistance value can be controlled to a certain extent in the case of carbon rod resistors by spraying a ring of copper of suitable width on the component before it is painted or otherwise protected. The result is to short out a certain proportion of the resistor and thus adjust its value to the desired extent.

It is generally recognised that the resistance of a carbon resistor will vary with external conditions but the nature and extent of these

variations are not so widely known. The chief causes of change of resistance are:—(1) Passage of time; (2) Loading; (3) Moisture; (4) Temperature; (5) Voltage.

The accompanying table gives a picture of the magnitude of these changes and a brief discussion of these variations will not be unprofitable.

There is sometimes a very rapid change of resistance after manufacture, but this change levels out to a slow drift for the whole life of the resistor. The change is probably due to a packing effect as the carbon particles settle into permanent positions to ease strains caused in manufacture. Usually, except when exceptional supply difficulties make it impossible, the initial large change is allowed to take place in storage or the factory and after this "ageing" or settling-down process the resistor is sorted and marked with its nominal value.

Ageing

The resistance value of a resistor changes during the load, and, as with the time effect mentioned above, the change is rapid at first and decreases in magnitude in a short time. This steady drift then continues throughout the life of the resistor and if anything tends to increase slightly as the resistor nears the end of its useful life. The change is generally greater in the case of the composition film and least for the cracked carbon types. The change for composition film resistors should not exceed five per cent. for the first twenty-four hours of loading and after that should be of the order of a few per cent. per month. If, however, resistors are not allowed to age for a short while after manufacture the initial change is likely to be large and variations up to ten per cent. may be obtained. Some of the change may be due merely to the drying out of moisture and so will be an adjustment of a previous variation rather than a permanent alteration of resistance. The composition rod type will also change to a very similar extent, but cracked carbon resistors should be

stable to half per cent. and over a period of several months' continuous loading; one or two per cent. should represent the maximum drift.

This load drift will, as has been pointed out, continue, and it is apparent that the time may come when the resistor is outside the permitted tolerance limit. It is then clear that the resistor has completed its useful life. This is one way of determining the rating of the resistor, for it will be that rating at which the resistor will remain just within defined limits for its expected life.

Rating Systems

The problem of rating is, however, more complex than this, since, defined in this manner, rating would need amendment every time a change in production methods altered the load stability of the resistor. Other drawbacks of the method are that it is long and laborious, and unless much time is spent on it the results are hit or miss.

Further, considering the demands of standardisation, such a method may produce a number of resistors of one rating but of various sizes and this may be of great disadvantage when replacements are required.

An alternative method is to base the rating on the surface temperature rise of the resistor. This has some basis in fact since the operating temperature is very largely causative of resistance changes. The difficulties of measuring such a surface temperature have been largely surmounted and this new system of rating is supported by the Services. These ratings do not differ materially from those adopted by manufacturers except that the larger resistors tend to have their ratings reduced while the smaller units have been up-rated. This latter fact may be explained by the fact that a considerable quantity of heat is lost *via* the leads.

The work carried out on the rating of resistors tends to show that the temperature gradient from the centre to the outside of a resistor is not more than a few degrees. The temperature distribution along the resistor is, however, greater, and the temperature rise of the ends of the resistor is generally 30 per cent. less than that at the centre.

The highest temperature of the air in which a resistor can be expected to operate is about 60°C. and if a surface temperature rise of 45°C. is adopted as the normal full load working condition, this will yield a surface temperature of 105°C. which figure is generally accepted as the highest temperature that carbon resistors will withstand for a period without marked deterioration. It is for this reason that 45°C. has been adopted as the standard figure for temperature rise.

The subject of rating is not exhausted, and a system based upon the maximum permissible change due to temperature coefficient has been proposed. Such a method has had little support but its nature will be apparent when the question of temperature coefficient is discussed below.

One of the most serious causes of variation is that due to moisture. Carbon has a great susceptibility to the action of moisture and will absorb it from the air, which always contains a certain proportion. The effect is small in normal atmospheric conditions in this country, but in tropical conditions, where the air is frequently saturated and components may be expected to operate with a film

of moisture on the surface, the resulting change of resistance may be intolerable.

Composition resistors, both solid and film, may vary up to 20 per cent. from initial value when subjected to cycles of high humidity. As would be expected by reason of the smaller bulk of the resistor element, the composition film will react to changes of humidity more readily even if the ultimate change is no greater. The carbon film resistor is also very susceptible to humidity, and, due to the greater delicacy of the resistance element, the resistor can easily become open-circuited.

To inhibit this effect, manufacturers protect the resistors by various methods. Composition rod resistors are sometimes covered with a ceramic tube or outer envelope of thermoplastic material. In all cases they are impregnated with wax and painted. The other types are usually lacquered with special water-resisting paints, but in one case the composition film is embedded in a moulded case. Certain cracked carbon resistors are protected by a sleeving of polyvinyl chloride slipped on the unit. This method is not too satisfactory and is regarded as a tem-

VARIATIONS OF RESISTANCE VALUE FOR CARBON TYPE RESISTORS.

	Carbon Composition rod	Carbon Composition film	Cracked Carbon film
Ageing ..	± 5 per cent. ..	± 5 per cent. ..	± 1 per cent.
Loading ..	± 2 per cent. ..	± 5 per cent. ..	± ½ per cent.
Moisture ..	+5 per cent. normally, +10 per cent. for extreme tropical conditions	+5 per cent. normally, +10 per cent. for extreme tropical conditions	1-2 per cent. but, with new finishes now available, this will fall to 1 per cent. max.
Temperature Coefficient in per cent. per deg. C.	-0.03 for low resistance values rising to -0.2 for the higher values of resistance	-0.03 for low resistance values rising to -0.3 for the higher values of resistance	Usually consistent at -0.02 to -0.03 with occasional batches up to -0.08 for higher values
Voltage coefficient in per cent. per volt DC applied	Rising from -0.01 for low resistance values up to -0.025 for the higher values. Resistors having a large bulk tend to have a lower coefficient	Rising from -0.01 for low resistance values up to -0.025 for the higher values	Less than -0.01 per cent.
Noise in microvolts per volt DC	Rising to 2 for higher resistance values	Rising to 2 for higher resistance values	Normally negligible

Note :—The figures given for ageing represent the extreme changes likely to be encountered and should be halved for the variation over a period of six months.

porary expedient only. Much work is being done on the question of protective lacquers, and the problem will probably be solved in the near future.

The amount of protection is such that a variation less than 5 per cent. for solid composition, 10 per cent. for composition film, and 1 per cent. for cracked carbon resistors should be expected under adverse conditions of humidity.

Temperature Coefficients

The effect of temperature is almost as serious as that of humidity and in certain cases can be more important. Resistors have a temperature coefficient which is expressed as a percentage change per degree centigrade rise. This is not properly a coefficient in the case of composition resistors since the curve of resistance with temperature often displays regressions explicable only by assuming differential coefficient of linear expansion of the materials. Over a small temperature range the change is approximately linear and it is therefore the practice to regard the phenomenon as a temperature coefficient. In nearly all cases a rise of temperature will produce a reduction in resistance and the amount may vary from 0.025 up to 0.3 per cent. per degree centigrade. The table gives a rough indication of the amount of variation.

The importance of temperature coefficient can be assessed by consideration of the total temperature change likely to be encountered by radio equipment in normal use. The maximum temperature range for home use is from approx. $-10^{\circ}\text{C}.$ to $+40^{\circ}\text{C}.$ The temperature rise inside an enclosed set may be a further $30^{\circ}\text{C}.$ and also there is the $45^{\circ}\text{C}.$ rise likely to be encountered when a resistor is running at full load. All these effects are additive and it will be seen that in normal home use a range of $-10^{\circ}\text{C}.$ to $+105^{\circ}\text{C}.$, i.e., $115^{\circ}\text{C}.$ may be encountered. With a co-efficient of 0.3 per cent. which can often be met, a change of 34 per cent. will be produced. Such a change may easily be tolerated in many radio circuits without serious loss of efficiency. Should, however, a circuit such as a time-base, attenuator, filter or oscillator which is set up more precisely be affected in this man-

ner the result may be completely intolerable. In such cases cracked carbon resistors with their low and consistent temperature coefficient must be used. The above outline shows the importance of this factor, but when Service apparatus is involved which must operate equally well at high altitude, in arctic regions and also after prolonged exposure to the sun's rays in some tropical desert situation, a range of approx. $-70^{\circ}\text{C}.$ to $+100^{\circ}\text{C}.$, the effect can be seen to be even more important.

In order to mitigate the effect of high temperatures when it is known that they will work under these conditions, it is usual to de-rate resistors and so reduce the temperature rise, but such conditions cannot always be foreseen, and a loss of efficiency in ordinary use is apparent.

A less well-known phenomenon is the change due to the application of voltage to the resistors. This is normally masked by the change due to the heating effects of the current passed and is only apparent when measurements of resistance are made by the application of very short pulses of current on a suitable bridge. The standard method is a pulse of a half-second duration with 5 seconds interval between the pulses.

The coefficient is expressed as a percentage change per volt DC applied, and will vary from 0.001 up to 0.025 per cent. This figure is always negative. The smaller figure, as will be expected, is usual for the cracked carbon resistor while the larger figure will be encountered with the composition type. These figures appear to be very small, but a resistor may have up to 1,000 volts applied and a composition resistor may have consequent variations up to 25 per cent.

One of the most elusive phenomena in resistors is that of noise. On passing a current through the component an increase of background noise or hiss is apparent. This does not appear to have a frequency characteristic and is uniformly distributed over the band used for the tests. Associated with this thermal noise is an effect due to transient peaks which is apparently quite independent of the previous noise. The peaks are irregular and occur

at irregular intervals. The amplitude of noise is a function of the voltage applied and is apparently associated with the dimensions of the resistor as well as being dependent on its life history and composition.

With full load applied to the component the resulting noise may vary from a few microvolts for the cracked carbon types up to a millivolt or so for very high values of the composition resistors. Such an effect must obviously be borne in mind when the first stages of high-gain amplifiers are designed.

From a superficial consideration of the above one might infer that the carbon group of resistors is totally unstable, but such a conclusion would be completely erroneous. The wide variations described will only be encountered in extreme conditions and a good designer will be able to allow for these or take care that his components are properly protected and selected to meet the conditions under which they will work.

It is, however, very apparent that detailed knowledge of these variations is necessary to designers since, armed with knowledge of the physical characteristics of the components, allowance can be made where necessary and compensating means employed if required.

Carbon resistors are produced by the million, and, when doing the type of work for which they are fitted, are extremely reliable in service. They are robust, accepting prolonged overload without marked change, and seldom break down. The components are economical in raw materials and man-power and doubtless through research now in progress they will eventually become even more reliable and consistent.

Chirardi Books

BOOKS by Alfred Ghirardi on radio theory, maintenance and repair, formerly issued by Radio and Technical Publishing Company, of New York, will in future be published by the Radio and Technical Division of Murray Hill Books, Inc., of 232, Madison Avenue, New York 16, N.Y., U.S.A. By disposing of his publishing business to this company, Mr. Ghirardi will be able to devote more of his time to the writing of books on radio and electronic subjects; he will also act as Editorial Consultant to Farrar and Rinehart, Inc., the proprietors of Murray Hill books.

TRANSFORMER SCREENING

Suggestions for Improvement

By

T. A. LEDWARD,

A.M.I.E.E.

EVERY piece of electrical apparatus has its defects. There is no such thing in practice as a pure inductance, a pure capacitance or a pure resistance; the best are only near enough for practical purposes. To mention only some of the features of a perfect transformer, the coils would possess neither resistance nor capacitance, the magnetic field would wholly link all the coils and the coils would not be coupled by any electric field. (The term *electric* is used here in preference to *electrostatic*, as the latter term is open to criticism when applied to A.C.)

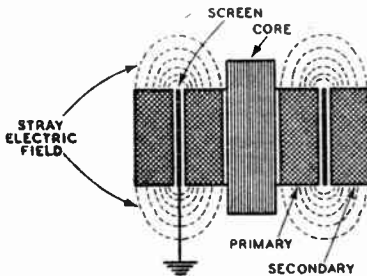

Fig. 1. Why the conventional transformer screen may be ineffective.

A practical transformer does not attain perfection in any of these particulars, and the importance of any of them depends upon the purpose for which the transformer is to be used, but it is the last named, i.e., absence of electric coupling, that usually receives the least attention. In many cases the electric coupling is of no importance and where screens are fitted between primary and secondary windings they are often intended as a safety device which, when earthed, will prevent a high primary voltage from contacting the secondary winding in the event of insulation failure.

But there are many instances where a transformer is used for operating test apparatus from the mains when it is highly desirable, and in some cases essential, that there should be no stray electric field between windings. This is especially the case where thermionic amplifying apparatus is used in conjunction with measuring

instruments. In some cases totally different readings may result from merely reversing the connections to the supply mains.

The writer has so frequently encountered defeats of this nature that he has gone to some trouble to investigate the effectiveness of different forms of screening. He has found that the usual form of screen, comprising a sheet of metal foil placed over the primary winding and having an insulated overlap to avoid circulating currents, while being very useful and effective for many purposes, falls far short of perfection and can be greatly improved upon.

The ineffectiveness of the conventional screen is due to the spreading of the electric field around the ends of the windings, as shown in the diagram of Fig. 1. It is clear that, to be fully effective, the screen should completely enclose one of the windings. It is necessary, of course, that no part of a screen should form a short-circuited turn, so that insulated overlaps must always be provided.

In some cases it is desirable to screen each winding separately and bring out separate connections to the screens. This may be neces-

sary where there are several windings on one core and each must be screened from the rest. In some cases, certain screens must not be earthed, but must be connected to some other part of the circuit. The cases that arise are so numerous and varied in character that it is not proposed to consider them in great detail in the present article, the purpose being rather to indicate how to achieve good screening, and how to test the effectiveness of a screen. It may be remarked, however, that trouble due to insufficient screening is most likely to arise when it is not possible, owing to the nature of the test circuit, to earth directly one end of the secondary winding.

As a simple illustration, consider Fig. 2 in which the transformer T feeds three impedances Z_1 , Z_2 and Z_3 in series. The impedances may be plain resistances, inductive or capacitive reactances, or any combination. It is required to measure the volts drop across Z_2 with a mains-driven valve-operated millivoltmeter. This instrument requires an earth connection at E, so that neither end of the secondary of transformer T can be directly earthed. The primary is earthed by the supply company's neutral at N. Any leakage capacitance current must flow through the impedance Z_1 , Z_2 and Z_3 , the direction of flow being as shown by the arrows.

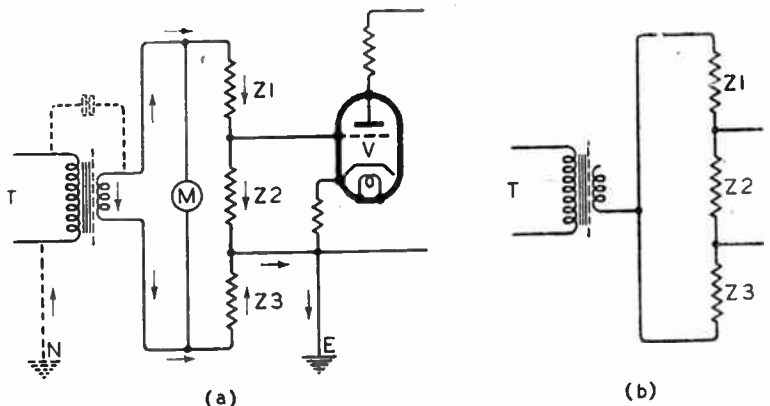

Fig. 2. Showing how trouble may be brought about by inadequate screening.

Transformer Screening—

It is seen that Z_1 and Z_2 are in parallel with Z_3 , so far as capacitance current is concerned, so that if Z_3 were zero, no capacitance current would flow through Z_1 and Z_2 . The amount of capacitance current which flows through Z_2 , and so affects the voltage applied to V , thus depends upon the value of Z_3 . This current may either oppose or assist the current due to the transformer secondary voltage as indicated on M , the

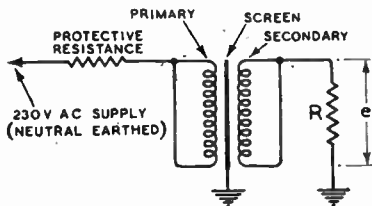

Fig. 3. Method of applying voltage for test purposes.

reading of which is unaffected by the leakage capacitance. Whether the leakage current is added or subtracted from the transformer secondary current depends upon which way the primary connecting plug is placed in the socket. This also affects the amount of capacitance current, because if the secondary is near the high voltage end of the primary when the plug is inserted one way, it will be near the low voltage, or earthed, end if the plug is reversed. In either case, the valve-operated voltmeter will give a false reading, as it will not indicate the voltage that will exist across Z_2 when the measuring apparatus is disconnected.

Suppose we attempt to put matters right by transferring the earth from E to one end of the secondary winding of T . Then the transformer that provides mains current for the millivoltmeter unit, unless this transformer is efficiently screened, will cause the same trouble as before, owing to the impedance Z_3 being then interposed between that transformer and earth. If the earth connection is removed altogether, a slight improvement may be obtained, but the result will still be inaccurate.

This illustration serves to show the desirability of properly screening all instrument and testing transformers, as, although either the valve-voltmeter or the apparatus fed by transformer T may be perfectly sound considered separ-

ately, they are unsatisfactory in combination, unless at least one screen is used.

In order to demonstrate that an appreciable error can be incurred with quite ordinary impedance values, a circuit was set up as in Fig. 2, in which plain resistances were used. These resistances were accurately measured by DC and had the following values: Z_1 —71,900 ohms; Z_2 —592 ohms; Z_3 —105,300 ohms. These values can be assumed to be substantially the same on 50-c/s AC.

The transformer T was made as described later in this article and had an ordinary screen S_1 and a special screen S_2 provided (see Fig. 4). The voltmeter M indicated 6 volts, so that the voltage across B should be $592 \times 6 / (71,900 + 592 + 105,300) = 0.02$ volt or 20 millivolts.

The actual readings obtained are shown in Table 1. The mains

TABLE 1.

	Millivolts across Z_2 .	
	Plug normal.	Plug reversed.
Core only earthed	18.2	21.5
Core and S_1 earthed	19.7	21.2
Core, S_1 and S_2 earthed...	20	20

plug was reversible and under "Normal" are shown the readings with the plug in one position and under "Reversed" with the plug reversed. It will be seen from this table that the only accurate results were obtained with the special screen, S_2 , in use and they were independent of the way in which the plug was connected. In any case of doubt it is always advisable to try reversing the plug, when the reading should not alter.

Another test with the same circuit, which showed the defect even better, was made by reducing the voltage applied to Z_1 , Z_2 , Z_3 to zero by connecting both ends to one terminal of the open-circuited transformer secondary as in Fig. 2 (b). The results of this test are shown in Table 2. The reading should, of course, be zero—as it is with full screening.

If the transformer T were feeding a bridge in which a valve amplifier and voltmeter were used to indicate balance, it is clear that

the same trouble would arise. Another case is where, in certain magnetic tests, T might feed a push-pull amplifier, when screening of T would again be important. Whenever the transformer secondary cannot be directly earthed a screen should be provided.

In view of the value of a really good screen, it is of interest to consider a simple method of testing the degree of screening obtained in any particular transformer.

The principle involved in the tests to be described is that any electric field coupling primary and secondary can be considered as a leakage capacitance which will be zero for a perfect screen. If an AC voltage be applied across primary and screen, any leakage capacitance to secondary will produce a voltage between secondary and screen. It is better not to energise the primary in the ordinary way for these tests, as the electromagnetically induced voltage in the secondary is not required and would be troublesome.

In applying a voltage across primary and screen, the simplest method is to earth the screen, short-circuit the primary winding, and connect it, via a safety resistance, to the live side of the 230V AC mains, as shown in Fig. 3. The mains neutral is, of course, assumed to be earthed by the supply company, so that a voltage of 230 now exists between primary and screen. The secondary should then be short-circuited and earthed through a resistance R ; then any voltage drop e across this resistance, if it is not too high,

TABLE 2.

	Millivolts across Z_2 .	
	Plug normal.	Plug reversed.
Core only earthed	1.21	1.92
Core and S_1 earthed	0.15	1.06
Core, S_1 and S_2 earthed...	0	0

will be almost directly proportional to the leakage capacitance. In making a number of comparative tests, the best procedure is to vary R to give the same value of e for each test, so far as this is practicable. Then R will be inversely proportional to the leakage capacitance. In all cases a low-reading

valve-operated AC millivoltmeter is the most satisfactory measuring instrument.

After making a number of tests on a variety of transformers with and without screens, a special transformer was made up with windings and screens arranged, as shown in section in Fig. 4. The connections for test are also shown in this figure. In order to simplify the diagram, only one connection is shown to each winding, but the two ends of each winding should be connected together. Tests were made of leakage capacitance from primary winding A to secondaries B and D in turn, firstly with no earths, secondly with core only earthed, thirdly

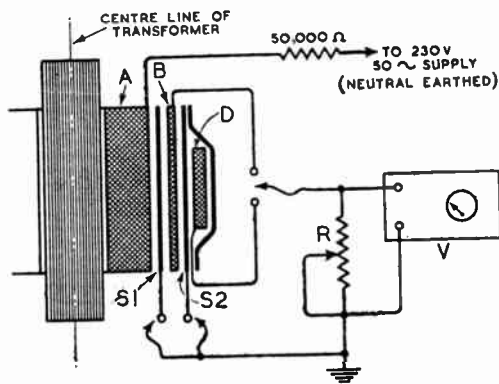

Fig. 4. Experimental transformer with extra screening; test connections are shown.

with core and screen S1 earthed, and fourthly with core and screens S1 and S2 earthed. The transformer was a small 25-watt size with 230-volt primary and two 4-volt secondaries. The core was the usual form made from T and U stampings. Screen S1 was of the kind most generally fitted, namely, a strip of foil with insulated overlap covering the outer layer of the primary. Winding B was wound over this screen. Screen S2 completely enclosed winding D, and comprised two foils similar to S1, but with the outer one formed over the sides of winding D as shown, and bound to the inner one. Thus no part of winding D was unscreened, except the connecting leads. The screens were, of course, only effective when earthed. R was adjusted to give a 20-mV reading for each test.

Let e = volts across R
 E = applied voltage
 C = leakage capacitance

Then volts across leakage capacitance = $\sqrt{E^2 - e^2}$, but as e is negligible compared with E , the voltage across C may be considered as equal to E . The capacitance between secondary windings and screens is, in effect, in parallel with R , but, for the conditions of these tests, it may be neglected. The reactance of C will be E/I and $I = e/R$.

$$\begin{aligned} \therefore \text{Reactance} &= ER/e \\ \text{and } C &= e/2\pi fER \text{ farads.} \\ \text{Now } e &= 0.02V \\ E &= 230V \\ \text{and } f &= 50 \text{ c/s.} \\ \therefore C &= 0.02 \times 10^{12}/314.16 \times \\ &= 230R \mu\mu F. \\ &= 277 \times 10^3/R \mu\mu F. \end{aligned}$$

R is the only variable throughout the tests so that calculation of C becomes very simple.

Table 3 shows comparative tests of different screening for the transformer of Fig. 4. It will be seen that while the normal form of screen has reduced the leakage capacitance between A and B to about 1/18th of the value with no screen, the complete enclosure of winding D (except for leads) has reduced the value between A and D to about 1/150th of the unscreened value. The table also shows corresponding reactance values of the leakages for 50 c/s. The figure for winding D should be satisfactory for most

way is to former-wind the coil and, after taping with suitable insulating tape, add a covering of narrow metal tape, the finishing end of which must be insulated where it overlaps the start. Other methods may occur to the reader. So long as the winding to be screened is enclosed in a conducting covering which does not form a short-circuited turn, that is all that is required.

Where an experimenter already possesses several pieces of apparatus with unscreened, or insufficiently screened, transformers and it is desired to extend their usefulness by the provision of good screening, an economical alternative to screening each transformer separately—which in some cases is impracticable—is to provide a single 1/1 ratio screened transformer which may be interposed between the mains and any piece of apparatus in use.

This article has been concerned with the desirability of good screens on instrument or testing transformers when connected to the supply mains, but while on the subject of screening, it is only natural that many other cases may suggest themselves to the reader in which a screen may be useful. A question most likely to arise is whether mains-borne interference in a radio receiver can be reduced by a screen between windings of the mains transformer.

This is a more difficult problem, and is beyond the scope of the present article to deal with fully. It may be of interest, however, to set down briefly the results of

TABLE 3.

	A to B		A to D	
	Capacitance ($\mu\mu F$)	Reactance at 50 c/s. (megohms)	Capacitance ($\mu\mu F$)	Reactance at 50 c/s. (megohms)
No earths	198	16.1	111	28.8
Core earthed	185	17.3	103	31.1
Core and S1 earthed ...	11.1	288	9.24	345
Core, S1 and S2 earthed	3.08	1035	0.74	4320

purposes, but could be further improved if necessary by enclosing the primary also in a separate screen.

The method described for enclosing winding D is clearly only applicable to a winding of very little depth. Other methods must be used for deep windings. One

some simple tests made by the writer.

The receiver used had an unscreened mains transformer and, for the purpose of the tests, a 1/1 230-volt transformer was constructed with a screened primary. Primary and secondary were separately former-wound and the

primary was screened by taping with tinfoil strip. This transformer was then interposed between the supply mains and the receiver.

The location was a particularly quiet one, where mains-borne interference is not often experienced. Interference was, there-

ception of the screen to the aerial did not interfere at all with normal reception.

Here, then, is a case where a transformer screen, when connected to the *aerial*, can be extremely effective in reducing mains-borne interference.

Unfortunately, however, the complete cure of mains-borne interference is not quite so simple as that, as these further tests demonstrate.

Test No. 2.—(a) The vacuum cleaner was plugged in at point F on the first floor and the reading on M with the screen open was now only 1.0.

(b) M was readjusted to give a reading of 2.0 as before. The screen was then connected to the

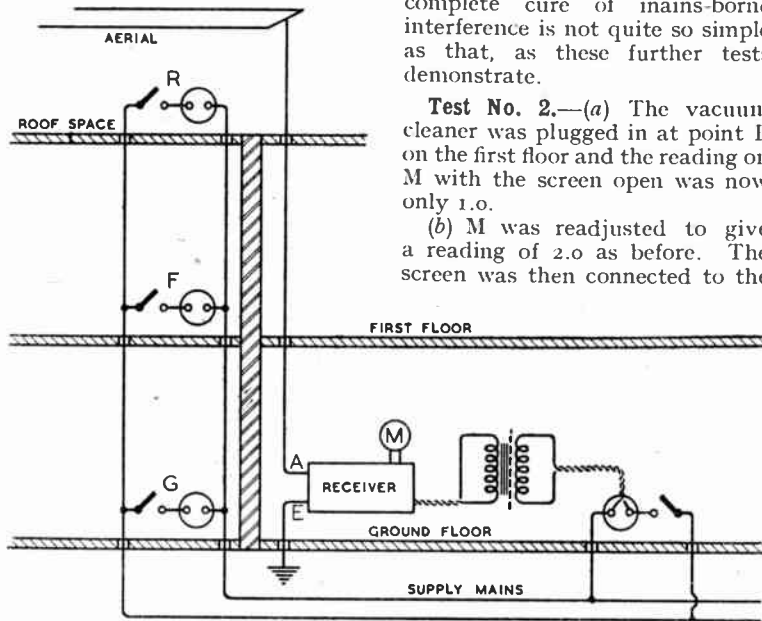

Fig. 5. Set-up for investigating the effect of transformer screening in reducing mains-borne interference.

fore, specially produced by running a vacuum cleaner in other rooms. The aerial was an indoor one, just under the roof. Roughly, the disposition of plug points, etc., was as shown in Fig. 5.

Test No. 1.—(a) With the vacuum cleaner plugged in at G on the ground floor the interference was severe and practically obliterated normal reception. Under these conditions, the rectifier voltmeter M was adjusted to give a reading of 2.0. (This is only a relative value for comparison and was obtained across a tapping on a multi-ratio speaker transformer with the set de-tuned and the screen disconnected.)

(b) The screen was then connected to the earth terminal of the set, but no difference was observed in the interference.

(c) The screen was then connected to the *aerial* terminal of the set and the interference almost disappeared. The reading on M dropped from 2.0 to 0.1. When a station was tuned in, the con-

aerial terminal and the reading on M fell from 2.0 to 1.1.

The normal level of interference was thus less when the cleaner was plugged in at this point, but the screen was less effective in reducing it.

Test No. 3.—Point R on the top floor, just under the aerial, was then tried and, with the cleaner plugged in at this point, the interference was almost negligible with the screen disconnected. The reading on M was approximately 0.1. Connecting the screen to either aerial or earth slightly *increased* the interference, the reading on M being 0.2 to 0.4.

To attempt to give a detailed explanation of the reasons for the foregoing results would require a good deal of space, but it is clear that one cannot simply fit a screen and say that all mains-borne interference will be reduced. Some of it may, in fact, be increased. Some further experimental work in this connection would seem to be justified.

EUROPE'S 213,000,000 LISTENERS

Comparative Figures of Radio Density

A SYNOPTIC table compiled by the International Broadcasting Office of the Union Internationale de Radiodiffusion, Geneva, shows the increase in the number of listeners in the European Zone during 1942. It should, perhaps, be pointed out that the European Zone is bounded on the north and west by the natural limits of Europe, on the east by the meridian 40 deg. E., and on the south by the parallel 30 deg. N. One section of the graph shows the number of listeners and the other the radio density.

Sweden retains first place so far as radio density is concerned with 254.13 receivers per 1,000 inhabitants. Second place is retained by Denmark with 243.1 per 1,000. Their respective figures at the end of 1941 were 243.4 and 233.9.

Great Britain again holds third place with a density of 197.76 as compared with 186.7 the previous year. In 1941 fourth place was held by Germany, which is now relegated to the sixth with Iceland and Switzerland in the fourth and fifth places, having 184.78 and 170.95 per 1,000 respectively. In both these countries there has been an increase—14 and 11 per 1,000 respectively.

Germany's figure shows a decrease from 177.48 to 164.95 per 1,000. This is not, sad to relate, necessarily due to fewer Germans wishing to listen to Goebbels' outpourings, but to the fact that this year's figure includes the low-density areas in Bohemia-Moravia and the occupied territories of Poland and the U.S.S.R.

In the section of the graph showing the number of receivers in each country, Germany, with which is included the territories mentioned above, leads with a total of 16,113,466. Figures not being available for the U.S.S.R., Britain holds second place with 9,139,426, and France third with 5,404,600.

The total number of receivers in Europe at the end of 1942, allowing the 1941 figures for the U.S.S.R., Norway and Egypt, for which later figures are not available, is estimated at 53,238,000, an increase of nearly 1,500,000 on the previous year's figure. Allowing for an average of four listeners to each receiver Europe had nearly 213,000,000 listeners in 1942.

GOODS FOR EXPORT

The fact that goods made of raw materials in short supply owing to war conditions are advertised in this journal should not be taken as an indication that they are necessarily available for export.

SHORT-WAVE MARINE UNIT

"Plug-in" Equipment for Ships

AS a result of the vastly accelerated rate of building merchant ships in U.S.A., there is a tendency to construct wireless equipment for them in single-unit form, so that it may be installed in minimum time. Such equipment, for operation on medium waves, was described in *Wireless World* of July, 1942; the set required nothing more in the way of installation than the erection of an aerial and an electrical connection to the ship's mains supply.

A companion unit for operation on short waves has now been produced by the Federal Telephone and Radio Corporation, and is described in a recent issue of *Electrical Communication*. The HF Marine Unit, as it is called, is equally self-contained, comprising transmitter, receiver and power equipment in a single housing, with a projecting operating table. It has a continuously variable frequency range of from 2 to 24 Mc/s, and, if required, may be installed side by side with the medium-wave outfit, from the generator of which it may if necessary obtain its power. In such cases the keying relays of both transmitters are wired together so that the short-wave unit may be keyed from the operating

table of the medium-wave set.

The SW unit is shown in the accompanying photographs. The transmitter gear occupies the upper section of the cabinet, while the receiver is below it, and immediately above the operating table. In the bottom compartment is a motor generator supplying high-voltage DC and low-voltage AC, the latter providing heating current for the valve filaments through a transformer.

For operation under war conditions, an interesting feature of the set is that, thanks to continuously variable tuning, the transmitter may quickly be adjusted to function on frequencies not usually included in commercial ship bands; thus the detection of signals by an enemy station is made more difficult. In a similar way, by making frequent predetermined changes of transmitting frequency a safeguard is provided against the location of the ship by enemy direction-finders. There are 40 crystal-controlled frequencies provided by 10 crystals. It is stated that frequency stability with crystal control is better than 0.02 per cent.; at other wavelengths, with the self-excited oscillator, it exceeds 0.05 per cent.

A minimum of 200 watts is provided on the 2-16 Mc/s range by a pair of Type 813 beam tetrodes in parallel in the power output stage when feeding into a normal ship's aerial. Between 16 and 24 Mc/s output drops to 150 watts. Special short-wave aeri- als are not required to achieve these

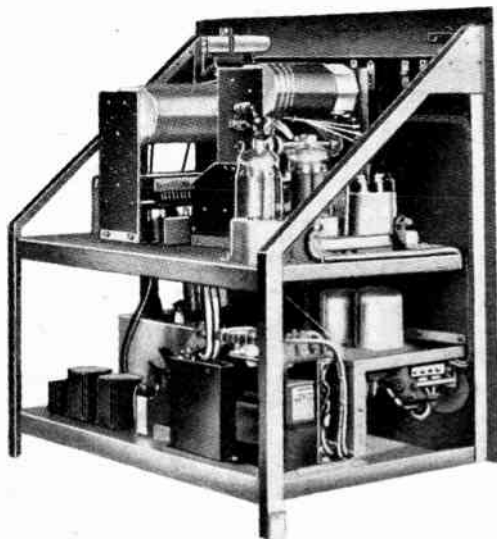

The transmitter unit, which is hinged to swing forward for inspection.



The complete ship's short-wave transmitter and receiver.

outputs, as a matching network is used for aerial tuning, thus allowing operation at any frequency with a wide variety of radiating systems. In practice, it seems that the ship's normal medium-wave aerial is generally used with the SW equipment.

The motor generator of the unit may be operated from ship's mains of either 110 or 230 volts DC. When modulated CW, as well as pure CW is required, a special generator provides, in addition to the normal anode current at 1,750 volts DC and filament current at 78 volts AC, an output at 200 volts, 700 c/s, for modulation. To prevent the application of an excessive load on the ship's mains by an over-hasty operator, the motor starter is of the escapement type. In addition, the starter is equipped with a pair of auxiliary contacts which provide a time delay of about 15 seconds and prevent keying until the heaters of the driver valves have attained their working temperature.

Although the unit is so compact, the question of accessibility of components for maintenance has not been ignored. The whole transmitter panel is hinged at its base, and can be swung forward so as to give easy access to both valves and components.

BOOK REVIEWS

Worked Radio Examples. By A. T. Witts, A.M.I.E.E. Pp. 126; 60 figures. Published by Sir Isaac Pitman and Sons, Ltd., Parker St., Kingsway, London, W.C.2. Price 6s. 6d.

THE author has produced in this book an excellent little volume to accompany a standard text-book. It is intended to help those wireless operators, service-men or students of radio (and they are many) who find difficulty in memorising and using formulæ to solve the problems they are likely to encounter. To this end the book contains no text in the usual sense, but consists of a total of 302 numerical problems on radio matters, each very carefully worked out, the various steps in each calculation being given in full. The problems, which are supplemented by occasional notes to explain subtle points or indicate alternative methods of procedure, all depend for their solution on well-known formulæ, and several problems are devoted to each, so that every formula is encountered in several of the possible forms in which it can be applied in practice.

The first chapter is devoted to Ohm's law, the problems being concerned with series and parallel resistances, meter shunts and power in DC circuits. The internal resistance of coils, series and parallel arrangements and the capacity and charging of accumulators are dealt with in the second chapter, and in the next the problems are on electromagnetism, the calculation of inductance and transformers. Chapter IV is concerned with condensers and capacitance; the problems here are mainly on series and parallel connections and the calculation of capacitance and leakage current in electrolytic condensers.

In his next chapter on the calculation of inductive and capacitive reactance and resonant frequencies the author quite rightly avoids the j -notation and calculates the answers directly from the Pythagorean relationship. Similarly in the next chapter, on AC and impedance, omegas are omitted and the general expression used for an alternating current is $i = I_{\max} \sin 2\pi ft$. Chapter VII deals with the graphical determination of and the relationship between the impedance, amplification factor and mutual conductance of a valve and also the method of calculating the power output and harmonic distortion content, while the final chapter discusses the calculation of stage gain and output valve matching.

The book should serve its purpose well and can be confidently recommended. S. W. A.

Basic Calculations for R.A.F. Ground Duties, by A. E. Druett, B.Sc., A.M.I.Mech.E. Pp. 80. Published by Sir Isaac Pitman and Sons, Ltd., Parker St., Kingsway, London, W.C.2. Price 3s. 6d.

THE war has produced a large crop of small books of the "cram" variety, all at popular prices and designed to present the man in the Services with an easily understood exposition of his subject, thus enabling him to learn with the least effort and to pass his examinations in the minimum time. This book is of this type.

Beginning with the most elementary processes, such as the addition, subtraction and multiplication of fractions and decimals, this little book gives a brief account of the fundamentals of arithmetic, mensuration and graphical representation in so far as they are involved in the work of airmen engaged in the Radio, Wireless and Electrical trades of the RAF and Cadets training for ground duties, for whose benefit the book has been prepared.

Fractions and their addition and subtraction are dealt with in Chapter I, decimal notation in Chapter II and indices in Chapter III. Further arithmetical subjects such as the relationship between British and Metric units, ratio and proportion, and averages and percentages are next encountered, and algebra is introduced in the seventh chapter on formulæ and equations. The remaining four chapters deal respectively with the measurement of

angles, mensuration of the circle, right-angled triangles and graphs.

Each chapter concludes with a set of examples, all of which are of an essentially practical nature. Solutions worked out in full are given.

The short instructional sections which begin each chapter are, in view of the brevity of the book as a whole, necessarily somewhat condensed, but there is no doubt that the most attractive feature of the volume is to be found in the many numerical problems it contains and in the full solutions to them given at the end. S. W. A.

MUSEUM PIECE

AN accompanying illustration shows a rather unusual demonstration wireless receiver used by the late Richard Kerr, lecturer on experimental physics, *circa* 1900. It has now been presented to the Science Museum, South Kensington, by his daughter, Mrs. Christmas, who assisted him in his lectures. Mrs. Christmas believed that this set had been made for her father by the Marconi Company, but the design, and particularly the ebonite coherer cup which contains a few fine nickel filings, when compared with a contemporary photograph, suggests that it was made by Leslie Miller, manufacturing electrician, who took out a number of patents between 1897 and 1915. These included a description in 1897 of an ebonite box coherer, similar to that shown in this photograph. If Marconi's had supplied the instrument, it would almost certainly have included the Marconi glass tube coherer.

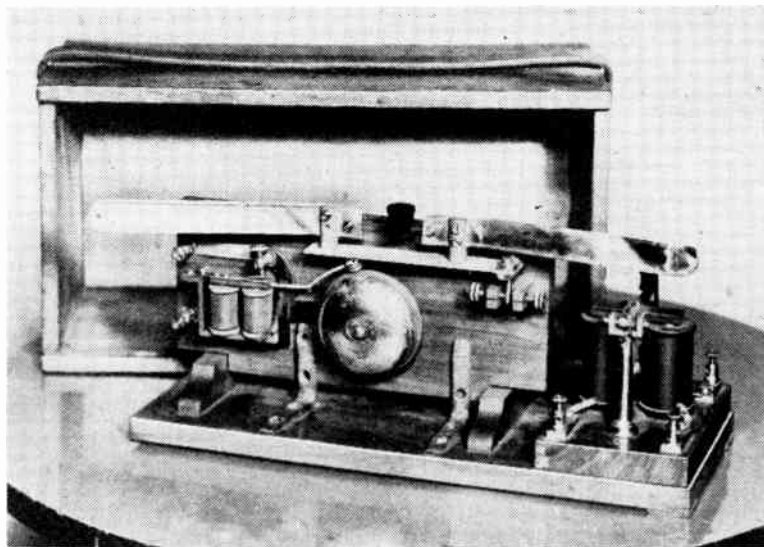

LAST-CENTURY WIRELESS. This coherer detector unit, believed to have been made in about 1899, has recently been presented to the Science Museum, South Kensington.

WORLD OF WIRELESS

UNIVERSITY RADIO

CONCLUDING his recent review of the progress of broadcasting during the life of the B.B.C., Stuart Hibberd made a plea for a post-war University of the Air. "As I see it," he said, "there will be a huge demand for courses and training in all sorts and kinds of subjects by men who have been, and are about to be, demobilised, all of them about to return to civil life, many of them about to start in a profession or trade, and we know already that there will be an acute shortage of teachers and lecturers. Such a situation will surely be a great opportunity for broadcasting—we should go ahead now with plans to help the nation to meet this need.

"Broadcasting can place would-be students in touch with the greatest authorities on their subjects in the land." He pointed out the main essential would be the setting aside of one wavelength, which could be heard throughout the country, for educational purposes.

"MUCH ADO . . ."

THE lay Press recently carried banner headlines such as "90,000 utility sets for Christmas," "85,000 new sets soon." On enquiry it is learned that, whilst there is no justification for undue optimism on the part of besieged dealers and would-be purchasers, there is a movement afoot to expedite the production of the 75,000 unfinished receivers in the possession of manufacturers at the end of September. These have to be completed before "standard" sets are put into production. Moreover, the 10,000 American sets which recently arrived under Lend-lease arrangements have yet to be released.

It has been stated by the R.M.A. that "standard" receivers will be produced by various manufacturers, but will *not* be sold under trade names. Substantial quantities are not expected to be available until June.

The sets, which will be for AC and battery operation, will be distributed through the normal trade channels, preference being given to those areas most urgently in need of them.

COMPETITIVE BROADCASTING

IT was encouraging to hear from the Minister of Information at the B.B.C.'s twenty-first birthday luncheon that he approved of the introduction of competitive broadcasting in this country.

His idea, however, of granting "a measure of broadcasting Home

Rule" to the regional stations, whereby the B.B.C. would become "the mother of a number of really healthy competitive enterprises and get rid of some of the stain of monopoly" hardly meets the case. One might ask: "What use will a competing programme in London be to a listener in Glasgow with a local-station quality receiver?"

The criticism of the regional scheme of competitive broadcasting is that it savours of parochialism and runs counter to the true spirit of broadcasting, which is not the proper medium for serving local audi-

HIGH-POWERED ARMY RADIO.

A section of the new transmitter for high-speed working with the various theatres of war. The station, which is voice-frequency operated over land lines from London, is maintained by Royal Signals.

ences or sectional interests. Some drastic proposals for putting into practice the competitive principle in British broadcasting were considered Editorially in *Wireless World* last month.

WIRELESS COLLEGES

AS the result of a recent meeting of the principals of the privately owned British wireless schools, "The National Association of Wireless Colleges" has been formed. The chairman is B. G. Moran, of the Manchester Wireless College, while Gordon S. Whale, of The Wireless College, Colwyn Bay, N. Wales, is honorary secretary.

As regular readers know, many questions relating to the post-war qualifications and training of Merchant Navy radio officers have recently come up for discussion. It is now understood that the authorities concerned wish the training schools, as well as other interested bodies, to be represented at any future meetings in connection with these matters. As reported in our last issue, plans are already on foot for setting up a Radio Officers' Training Board.

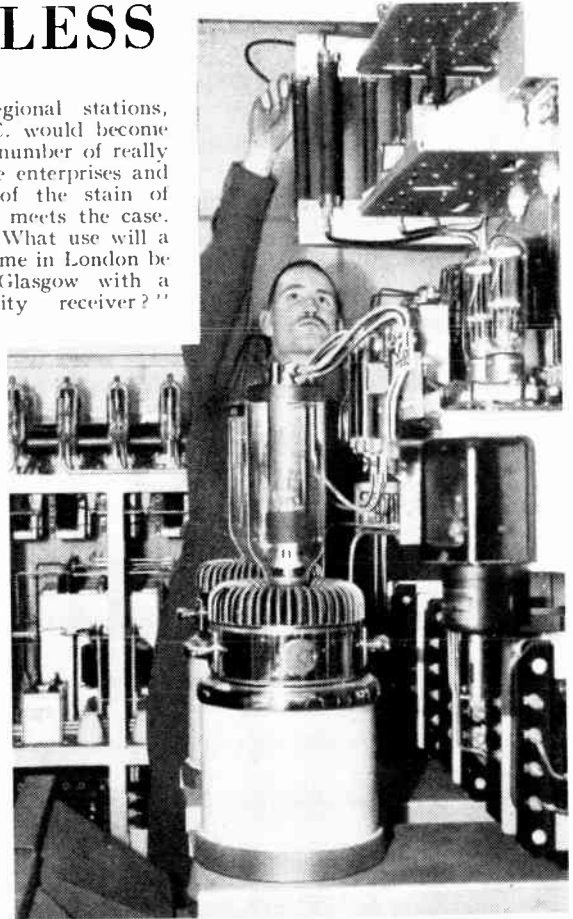

U.S. "FREEDOM" STATION

IT can now be stated that the landing of Allied Forces on the North coast of Africa was materially helped by the broadcasts to the inhabitants of Morocco from a transmitter on an American warship.

The broadcasts, appealing to the people to lay down their arms and help the liberators, came from a 5-kW transmitter which was originally destined for a broadcasting station in New Jersey.

The story behind these broadcasts is perhaps of interest. It started about six weeks before the invasion when the U.S. Amphibian Command ordered from Western Electric (on "Triple A" priority) a 5-kW medium-wave transmitter. Owing to the suspension of the manufacture of transmitters except under Government contract, the company had not the apparatus in stock and there was not sufficient time in which to construct it. It was therefore decided to ask for the return of a transmitter which had been delivered to station WHOM, New Jersey, but had not yet been installed. This was procured and the transmitter installed in a battleship

World of Wireless—

in time to take part in the successful landings.

RADIO ENGINEERING COURSE

A FULL-TIME course in radio engineering, conducted under the Hankey Scheme and lasting six months, is to start at the Borough Polytechnic (Borough Road, London, S.E.1) early in the New Year.

Students should possess qualifications equivalent to the ordinary

national certificate in radio or electrical engineering, and in any case must have some knowledge of radio communications. Would-be entrants will be considered on their merits. At the end of the course students will sit for the higher national certificate in radio engineering.

Tuition is free and a maintenance allowance is paid to students, who are "reserved" from call-up during training. Prospective students must obtain a release from their employ-

ment; it is hoped that wireless firms will support the scheme, which gives a good opportunity for increasing the technical knowledge, usefulness and status of their staffs.

WHAT THEY SAY

WE [Sperry Gyroscope Co.] never entered the electronic business as a distinct field. Electronics, on the other hand, entered our business, and our products have

NEWS IN ENGLISH FROM ABROAD

Country : Station	Mc/s	Metres	Daily Bulletins (BST)	Country : Station	Mc/s	Metres	Daily Bulletins (BST)
Algeria				French Equatorial Africa			
Algiers	8.965	33.46	1600, 1700, 1800, 1900, 2100, 2200	FZI (Brazzaville) ..	11.970	25.06	1945, 2145
	12.110	24.77	1700, 1800, 1900, 2100				
America				India			
WRUW (Boston) ..	6.040	49.67	0800	VUD3 (Delhi) ..	7.290	41.15	0800, 1300, 1550
WLWK (Cincinnati)	6.080	49.34	0600, 0700, 0800, 0900	VUD4	9.590	31.28	0800, 1300, 1550
WCRC (Brentwood) ..	6.120	49.03	0600	VUD3	15.290	19.62	0800, 1300
WKTS (New York) ..	6.120	49.03	0100, 0200, 0300, 0400, 0900	Mozambique			
WBOS (Boston) ..	6.140	48.86	0900, 1000	CR7BE (Lourenco Marques)	9.830	30.52	1155, 1712, 1915
WCBX (Brentwood)	6.170	48.62	0500	Newfoundland			
WGEO (Schenectady)	6.190	48.47	0615, 0815	VONH (St. John's) ..	5.970	50.25	2315
WKTM (New York) ..	6.370	47.10	0100, 0200, 0300, 0400, 0500, 0800, 2300	Palestine			
WLWO (Cincinnati) ..	7.575	39.61	0600, 0700	Jerusalem	11.750	25.53	1615
WKRD (New York)	7.820	38.36	0100, 0200, 0300, 0400, 0500, 0700, 0800, 0900, 2200	Portugal			
WGEO (Schenectady)	9.530	31.48	1000, 2100	CSW6 (Lisbon) ..	11.040	27.17	2000
WCDA (New York) ..	9.590	31.28	1100, 1200	Spain			
WKRD (New York) ..	9.897	30.31	1000, 1100	EAQ (Aranjuez) ..	9.860	30.43	1915‡
WLWO (Cincinnati) ..	11.710	25.62	1200, 1300, 2000, 2100, 2200	Sweden			
WRUW (Boston) ..	11.730	25.57	1300, 1400	SBU (Motala) ..	9.535	31.46	2220‡
WCRC (Brentwood) ..	11.830	25.36	1530, 1630, 2045	SBP	11.705	25.63	1700
WGEO (Schenectady)	11.847	25.32	1300, 1400, 1500, 1600, 1700	Switzerland			
WBOS (Boston) ..	11.870	25.27	1100	HER3 (Schwarzenburg)	6.165	48.66	2150
WBOS (Boston) ..	15.210	19.75	1400	HER4	9.535	31.46	2150
WLWK (Cincinnati) ..	15.250	19.67	1400, 1500, 1600, 1700, 1800, 1900, 2000, 2100, 2200	Syria			
WCBX (Brentwood) ..	15.270	19.65	1530, 1630, 2045	Beirut	8.035	37.34	1820
WGEO (Schenectady)	15.330	19.57	1200, 1300, 1400, 1700	Turkey			
WRUL (Boston) ..	15.350	19.54	1500, 1700	TAP (Ankara) ..	9.465	31.70	1800
WRUW (Boston) ..	17.750	16.90	1600, 1700	U.S.S.R.			
WLWO (Cincinnati) ..	17.800	16.85	1500, 1600, 1700, 1800, 1900	Moscow	5.890	50.93	2200, 2300
WCDA (New York) ..	17.830	16.83	1530, 1630		6.980	42.98	1700, 2100
Australia					7.300	41.10	1100, 1700, 1800, 2000, 2100, 2200, 2300, 2347
VLI10 (Sydney) ..	9.580	31.32	1515		7.332	40.92	2000, 2100, 2200, 2300
VLG3 (Melbourne) ..	11.710	25.62	0800		7.560	39.68	1100
VLI2 (Sydney) ..	11.872	25.27	0800		9.545	31.43	1240
VLG9 (Melbourne) ..	11.900	25.21	1515		10.445	28.72	1240
VLI3 (Sydney) ..	15.320	19.58	1030		11.830	25.36	1600
Brazil					15.230	19.70	1240, 1320, 2200, 2300,
PRL8 (Rio de Janeiro)	11.715	25.61	2030‡		15.750	19.05	2347
China				Vatican City			
XGOY (Chungking) ..	9.635	31.14	1500, 1700, 2130	HVJ	5.970	50.25	2015
Ecuador				Algers			
HCBJ (Quito) ..	12.455	24.09	0000, 2030		1176	255	0100, 1400, 1800, 1900, 2000, 2200
Egypt				Athlone			
Cairo	7.510	39.94	1840, 2100		565	531	1340‡, 1845, 2210
				Tunis			
					868	345.6	0000, 0100, 1900, 2000, 2100, 2200, 2300

It should be noted that the times are BST—one hour ahead of GMT.

‡ Sundays excepted.

Wireless World

been vastly improved by its applications. We see no end in sight of utilising more and more applications of this new tool, and our research laboratory is now well equipped for electronics research, as it has been for gyroscopics, hydraulics, and many other older fields.—*R. E. Gillmor, President of Sperry Gyroscopic Co., in "Electronics."*

Withing five years after peace FM stations will supplant all local, most of the regional, and some of the high-power standard broadcast stations [in the U.S.].—*W. T. David, of the General Electric Company of America.*

FM makes a fair signal perfect, a poor signal good, and a useless signal inaudible.—*K. I. Jones, at the I.E.E.*

FM CALL SIGNS

SOME months ago a system of allocating call signs to FM broadcasting stations based on their location and the frequency employed was introduced in the United States. It has now been foreseen that the post-war growth of FM will necessitate a change in the system of allocation, and it has, therefore, been decided to use standard four-letter calls as for all other transmitters. The exception to this new ruling is that owners of medium-wave

stations who also operate FM transmitters may add the suffix "FM" to the call sign for the medium-wave stations.

According to the latest figures there are 45 licensed FM transmitters in the States.

DEATH RAY AGAIN

THE "death ray" became headline news again a few weeks ago when two men were accused and fined £50 each at Lancaster for unlawfully possessing a wireless transmitter designed to be used as a navigational beacon, and other apparatus capable of being assembled into a transmitter.

The accused stated that they had the backing of the War Cabinet Scientific Committee for the apparatus with which, it was claimed, they had destroyed electric apparatus at Horsham, Sussex, 230 miles away.

LONDON RADIO SOCIETY

THE St. Pancras Radio Society has recently been formed; meetings and classes will be held at the L.C.C. Men's Institute, Holmes Road, Kentish Town. A course in wireless servicing is proposed. The secretary is G. F. Kittson, 111, Messina Avenue, West Hampstead, London, N.W.6.

IN BRIEF

Radar in the Navy.—A recent Fleet Order announces the formation of a Radar Branch in the Royal Navy. It also states that there will be increases of pay for radar ratings ranging from 2s. a day for instructors to 3d. a day for new ratings. It is understood it is not intended to issue special badges to officers and ratings in the new branch.

Marconi's Yacht.—According to broadcasts from Paris, all the apparatus has been removed from Marconi's famous yacht, *Eletra*, and the vessel taken to a place of safety. It will be remembered that it was on this yacht that Marconi carried out some of his most useful experiments in the realm of ultra-short waves.

Maj. Gladstone Murray, until recently general manager of the Canadian Broadcasting Corporation, has stated that during the week which elapsed between Britain's declaration of war and the entry of Canada into the war he was asked by "a group of left-wing politicians" to give, in the interests of neutrality, equal prominence to news bulletins from Britain and Germany. His resistance to these efforts is stated to have contributed largely to the defeat of the attempt to keep Canada neutral.

Radio Eireann.—The Minister for Posts and Telegraphs, speaking in the Dáil recently, stated that the number of licence holders in Eire for the past year had decreased by about four per cent. At March 31st this year there were 167,671 licences—nearly 7,000 fewer than the year previous.

Radio at War.—Approximately 90 per cent. of the U.S. Army Signal Corps' allocation of \$5,000,000,000 for communication equipment for the year is to be spent on radio apparatus.

Berlin's Broadcasting House.—It is reported that the Funkhaus, Germany's Broadcasting House, was destroyed in a recent R.A.F. raid on Berlin.

Institution of Electrical Engineers.—A Wireless Section Meeting will be held at the I.E.E., Savoy Place, Victoria Embankment, W.C.2, at 5.30 p.m. on Tuesday, January 18th, when J. A. Smale, B.Sc., will open a discussion on "Comparative Merits of Different Types of Directive Aerials for Communications."

"Vibrations and Waves" is the subject of a series of six lectures to be given by Prof. E. N. da C. Andrade, D.Sc., F.R.S., at the Royal Institution, 21, Albemarle Street, London, W.1, during the Christmas vacation. The lectures, which are adapted to a juvenile audience, will be given at 2.30 p.m. on December 28th, 30th, January 1st, 4th, 6th and 8th, when the subjects will be Vibrations, Wave Properties in General, Sound Waves, Visible Light, Short Electromagnetic Waves and Long Electromagnetic Waves, respectively. The subscription is 10s. 6d. for juveniles aged 10-17 and £1 is. for adult non-members.

Institute of Physics, Electronics Group.—A discussion on "Space-Charge and Noise in Radio Valves" will be opened by Drs. P. B. Moon and R. R. Nimmo at a meeting of the Institute of Physics to be held at 2.30 p.m. on January 22nd at the University, Edmund Street, Birmingham.

GALPINS

ELECTRICAL STORES

"FAIRVIEW,"
LONDON ROAD, WROTHAM,
KENT.

TERMS: Cash with Order. No C.O.D.

Regret Orders from Eire and Northern Ireland cannot be accepted.

SUPER SENSITIVE RELAYS, multi leaf, P.O. type, very low M/A working, as new. Price 15/- each, post free.

AUTO-TRANSFORMER, 2,000 watts, tapped 0-110-200-220-240 volts, as new. Price **£8.10.0**, carriage paid.

RESISTANCE MATS, size 8in. by 6in., set of four, 80, 80, 150 and 600 ohms, carry 1/2 to 1 amp. Price, set of four, 5/-, post free.

RECORDING AMPMETER, in ironclad case, meter movement wants repair, no pen, clock perfect, range 0-3 amps. Price **£5**, carr. paid.

MOTOR-DRIVEN PUMP, for oil or water, motor 220v. D.C., 1 amp., 1,250 r.p.m., maker Keith Blackman. Price **£6 10s.**, carr. paid.

200 AMP. CABLE, V.I.R., as new, rubber cover perfect, size 37/13, lengths 30 to 40 yds. Price in lengths, 5/- per yard, carr. paid.

MASSIVE GUNMETAL WINCH, complete with long handle, for use with 1/2 in. dia. wire cable, weight 50 lbs., condition as new. Price **£3**, carriage paid.

ELECTRIC LIGHT CHECK METERS, well-known makers, first-class condition, electrically guaranteed, for A.C. mains, 200/250 volts 50 cy. 1 phase 5 amp. load, 10/- each; 10 amp. load, 12/6, carriage 1/-.

1/2-WATT WIRE-END RESISTANCES, new and unused, assorted sizes (our assortment). 6/- per doz., post free.

SOLID BRASS LAMPS (wing type), one hole mounting, fitted double contact, S.B.C. holder, and 12 volt 16 watt bulb. Price 3/6 each, post free, or 30/- per doz., carriage paid.

TUNGSTEN CONTACTS, 3/8 in. dia., a pair mounted on spring blades, also two high quality pure silver contacts, 3/8 in. dia., also on spring blades, fit for heavy duty, new and unused. There is enough base to remove for other work. Price, the set of four contacts, 5/-, post free.

ROTARY CONVERTER, D.C. to A.C. Input 22 volts D.C. (twenty-two). Output 100 volts at 140 M/A, 50 cycle, single phase, ball bearing, in first-class condition, no smoothing. Price **£3**, carriage paid.

MOVING COIL AMPMETERS, 2 1/2 in. dia., panel mounting, modern type by famous makers, range 0-1/2 amp. (F.S.D. 10 M/A), price 25/-; range 0-20 amp. (F.S.D. 20 M/A), price 30/-.

MILLIAMMETERS, 2 1/2 in. dia., flush mounting, moving coil, range 0-100 M/A (F.S.D. 5 M/A). Price 45/-.

METER MOVEMENTS, moving coil, for recalibration, large size, 4 to 6 in. scale, deflection average 30 M/A. Price 15/-, post free.

ROTARY CONVERTER, D.C. to D.C., input 24 volts D.C., output 1,000 volts 250 M/A, choke and condenser smoothing fitted to both input and output, condition as new, weight 80 lbs. Price **£10**, carr. paid.

DYNAMO, shunt wound, output 50 volts 6 amps., speed 1,000 r.p.m., ring oiler bearings. **£5**, carr. paid.

RESISTANCE UNITS, fireproof, size 10 x 1 1/2 in., wound chrome nickel wire, resistance 2 ohms to carry 10 amps. Price 2s. 6d. each, post free.

EPOCH SPEAKER, Super Cinema model, 20 watts output, 15 in. Cone, 15 ohm Coil, 6 volt field, no energising. Price **£7 10s.**, carriage paid.

"SUPERHET-STRAIGHT" SWITCHING

Cathode Follower Method Calling for Few Circuit Alterations

By P. A. SHEARS

HIGH-QUALITY reproduction from a receiver demands among other things, low distortion and a wide frequency range. The music-lover will of necessity employ a superheterodyne in order to be able to take advantage of the many excellent concerts from abroad, and, with variable selectivity, he will be able to obtain in most cases quite good results from astonishing distances. When, however, he moves to the Home programme he is apt to feel that there is room for improvement. Those who have space and means will employ a separate straight receiver for local reception, but by a little judicious switching a superhet with an RF stage can give excellent results as a straight set with "cathode follower" or negative feedback detector, no extra valves being required, and—

an important point—no switching in RF leads.

The method will be clear from the diagram, which shows the circuit applied to the writer's receiver. The frequency changer operates as the cathode follower detector with the oscillator anode feed disconnected; the audio section is switched through to the frequency-changer cathode.

Looking at the frequency changer in a little more detail, it will be seen that the amount of switching required is very small. The control grid is already connected and the anode circuit can be regarded as a short circuit to frequencies in the broadcast band; in any case, the screen will act as an anode for the purposes of cathode follower detection. The

oscillator grid may be left connected.

The current in the cathode load resistor is straight from the HT line and many contain hum frequencies and necessitate some extra filtering in the anode and screen feeds to the valve. This filtering may be left permanently in circuit.

The variable-mu characteristic of the frequency changer does not appear to have any deleterious effect on the performance as cathode follower detector. Operation will be in the region of cut-off as in all cathode follower detectors, the 100 per cent. negative feedback causing cancellation of distortion.

There are, therefore, only three circuits to be switched (a) oscillator anode, (b) cathode from bias circuit to a suitable load resistor

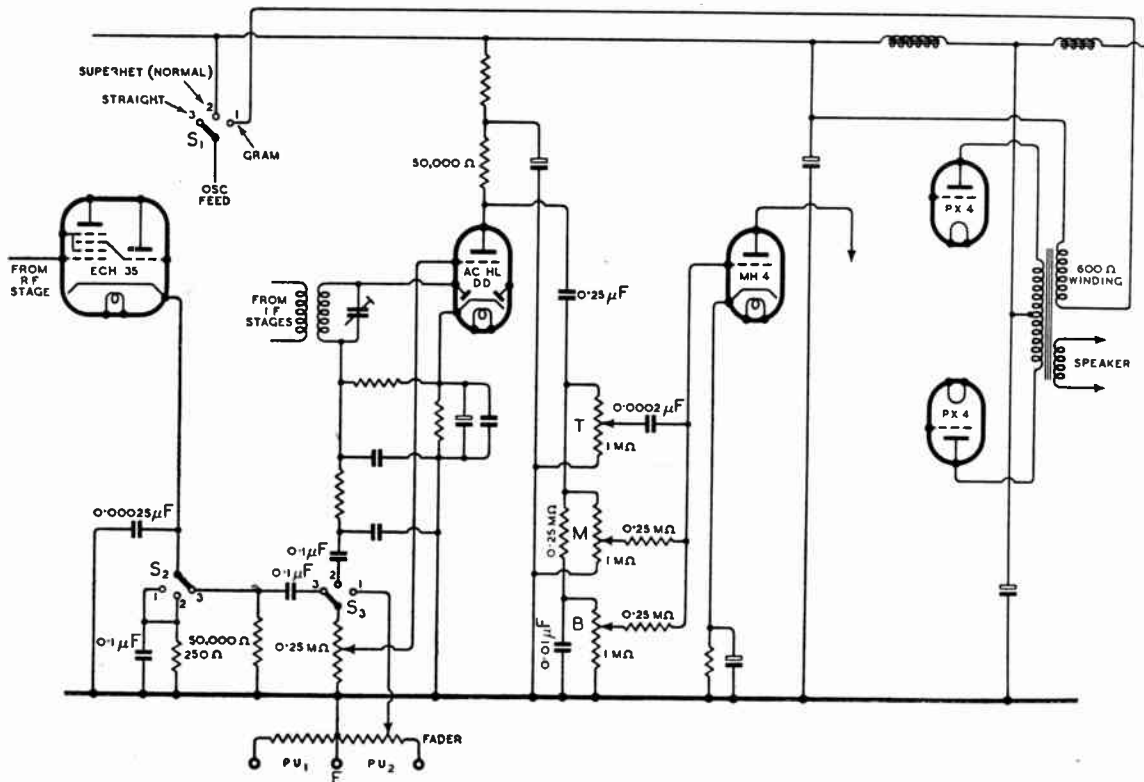

Skeleton diagram showing alterations required in a superheterodyne to convert it to a straight receiver with cathode follower detector. A tone control system favoured by the author is also shown.

(c) audio section from diode detector to cathode follower detector load resistor. In the writer's case a 3-pole, 3-position midget Yaxley type switch was available, and one of the positions was utilised instead of the existing Gram/Radio switch, so that the three positions of the new switch became "Gram"-" Superhet " "Straight."

Demands from the household for a system whereby gramophone concerts could be relayed to other receivers suggested a use for the blank contact, on which the oscillator anode feed wiper rested in the "Gram" position of the switch. Those who have operated several superhets on one aerial system will appreciate that sufficient of the oscillator voltage finds its way along the aerial to give quite a substantial signal strength on another receiver. Thus by modulating the oscillator output, programmes can be easily conveyed, hum free, throughout the building. This is a superior method to that of long screened leads; it employs no more radiated power than when the set is operating as a receiver and thus cannot infringe transmitting regulations.

A point arises regarding the depth of modulation of the oscillator output. It will be advantageous to keep the depth of modulation low—say below 50 per cent. on the average—in order (a) to keep the total distortion as low as possible, (b) to minimise frequency modulation, which is bound to occur to some extent with a modulated oscillator, (c) to leave ample margin for handling peaks when using volume expansion.

The oscillator anode voltage in a superhet is usually of the order of 150 v.; thus 75 V peak audio, or about 50 V RMS, will give 50 per cent. modulation. This may be obtained from the output stage or from the driver of a push-pull stage. In any case, the exact arrangement will depend on the output required from the set for monitoring the transmission. If the full output of several watts is required, the RMS anode voltage will be far too great and will over-modulate the oscillator. The power dissipated in the load on the

output valve is $\frac{E^2}{Z}$ where Z is the load impedance and E the voltage across it. Thus it will be seen that

for a typical pentode with load impedance 5000Ω the power corresponding to 50 V is $50^2/5000 = 0.5$ watt. Thus in most cases, unless it is permissible to operate at this low level, it will be necessary to employ another transformer of ratio approx. 4:1 step-down in parallel with the speaker transformer. A better arrangement would be to find two tappings on the primary of a multi-ratio output transformer between which the requisite voltage is developed. At any rate, the matter is not critical and trial and error cannot fail to yield the desired result.

In the author's own arrangement a "600-ohm" winding was available on the output transformer; with 6 watts output, 60 volts are developed.

Improved Tone Control

Often when listening to a programme the critical listener feels that the reproduction could do with "just a little more bass" or "a bit more extreme treble," and he may wish for separate volume controls for treble, middle and bass. The arrangement used by the writer is shown on the circuit diagram. The treble is separated out by a 0.0002μF condenser in the slider of the treble control, and the bass filter consists of a 0.25MΩ resistor and 0.01μF condenser.

Resistors of 0.25MΩ are incorporated in series with the sliders of the middle and bass controls to prevent mutual short-circuiting.

To obtain a satisfactory boost of either end of the frequency spectrum a considerable reserve of gain is required. Two triodes feeding transformer coupled PX4's are just sufficient. With a pentode or tetrode output stage and two triodes in the earlier stages, as shown, there would be ample reserve.

THE WIRELESS INDUSTRY

THE firm of Vacuum Science Products has now changed its name to Radio-Electronics, Limited. (Address: Merton Road, Norwood Junction, London, S.E.25.) This concern is at the moment devoting itself chiefly to the manufacture of photocells and various types of caesium and rubidium photo-electric multipliers.

The temporary head office of the British Aluminium Co., Ltd., is now at Salisbury House, London Wall, London, E.C.2. Tel.: Clerkenwell 3494.

CRONAME RADIO COMPONENTS



MILITARY demands on the electronics industry require large quantities of material made to precision standards never before approached by quantity production methods. Crowe has had signal success in solving problems of rapid production of precise electronics control mechanisms. This experienced ability will be an important factor in the post-war programmes of many firms.

Exclusively Represented in Great Britain by
FRANK HEAVER LTD.
Kingsley Road, Bideford, N. Devon.

CROWE NAME PLATE AND
MANUFACTURING CO.
CHICAGO, ILL. U.S.A.

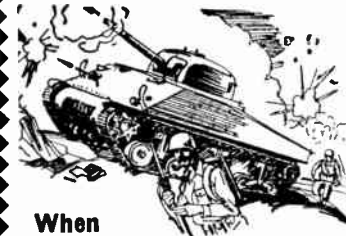

When

Every **SECOND** counts

ASTATIC Multi-contact Plugs and Sockets and Co-axial Connectors not only speed up the operation of connecting and disconnecting electrical circuits for military radio equipment but, what is more important, they guarantee positive circuit contacts for uninterrupted radio communications. Government approved Astatic Plugs, Sockets and Connectors are highly praised by radio manufacturers for uniform quality & expert workmanship.

ASTATIC

THE ASTATIC CORPORATION
YOUNGSTOWN, OHIO, U.S.A.
TORONTO, CANADA.

Exclusively Represented by
Frank Heaver Ltd. Kingsley Road
Bideford, N. Devon

Synchronising Electric Clocks : Synthetic Sound : Pick-up "Arms"

Time Signals

I AGREE with Evan W. Davies, who writes in your December issue, that it would be convenient if it could be known in advance when "mains time" would be in agreement with Greenwich time, but the very existence of fluctuations (not so wide, perhaps, as those he implies) suggests that the regulation would not be equal to the task of holding the clocks in step if there were an unexpected change of load just before the pre-arranged time signal.

It is a case of Mahomet and the mountain, and, fortunately, there is quite a simple method of getting on to "mean mains time" without calling for extra exertions on the part of the "grid." By keeping one's own clock under observation for, say, a week or ten days and plotting the error at each B.B.C. time signal in the form of a graph, it is possible to strike an average (dotted line in the accompanying example) which will show how much the mains had drifted from their own datum line when the clock was first started. It is then possible at any time, with the aid of a watch with seconds hand to stop

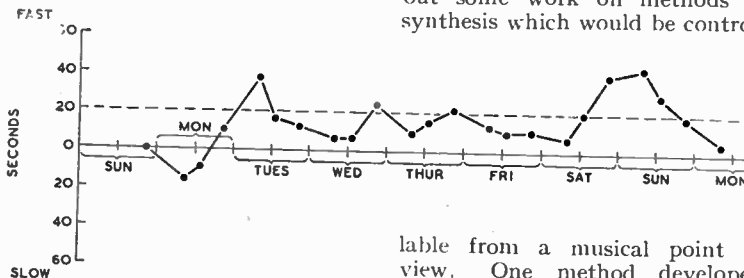

the clock for long enough to remove this standing error. If the local clock is slow on "mean mains time" by, say, 20 seconds, all that is necessary is to advance the hands by one minute and stop the clock for $60 - 20 = 40$ seconds. The error will now coincide with that shown on the master clock at the grid control system.

H. MORGAN.

London, S.E.

Synthetic Sound

YOUR contributor, Free Grid, in his paragraph, "Ersatz Run Riot," has, with his usual blend of fact and fancy, touched on a subject which should be of some interest to musically minded technicians, since it offers a wide field for experiment.

The idea of synthetic sound is not particularly new, the idea having occurred to physicists of the last century, but one of the first suggestions that a new musical technique might be evolved thereby came from the Hungarian artist, Moholy-Nagy, in about 1924; his idea was that a record might be made using some sort of engraving machine, but it was not found possible to put this into practice. Since then, as is fairly well known, quite a number of film technicians have produced sound tracks from drawings, but the chief difficulty seems to be that unless there is some relatively simple method of producing and combining any required waveforms, however complex, the whole thing becomes too laborious and cumbersome to have much practical use. Some years prior to the war I carried out some work on methods of synthesis which would be control-

lable from a musical point of view. One method developed (the subject of British Patent No. 527818) has given promising results; disc records only have been made, although the system can be applied to any type of sound track.

Although it is possible to produce, as well as many other effects, the exaggerated vocal imitations apparently suffered by your contributor, I believe the chief importance of synthetic music is the fact that it will offer

the composer the means of creating his work in pure sound, without reference to existing instrumental limitations, and of presenting it to his audience without the intervention of any interpreting artists. It is obvious that before many composers are going to venture into this new medium they will have to be convinced that electrical reproduction of music can practically equal an original performance; how long this will take may depend on the activities of some of the high-fidelity enthusiasts among your readers. In addition, there seems a possibility that the production of special synthetic records, for example, for concert hall reproduction, may give the opportunity to introduce new and improved recording and reproducing techniques which may give the impetus needed to break away from the limitations imposed by present-day standard methods.

C. C. BUCKLE.

Winterbourne Monkton,
Wilts.

Pick-up "Arms"

I SHOULD like to add my remarks to those of your other correspondents regarding the correct term to use when referring to "that which carries the pick-up."

Of the two suggestions made, tracking arm by Mr. Robb; carrying arm by Mr. Aldous; I much prefer the former, as it is surely the arm which assists the pick-up to track the record.

However, I am not at all certain that either expression is necessary, or even desirable; both are unwieldy when used with the word "Pick-up" in front, as they must be to give the complete meaning.

I would suggest the term "pick-up arm," which is short, complete, and conveys immediately what one means. It does not suggest recording, as Mr. Aldous fears "tracking arm" might, although I would say here that the word "arm" in connection with a cutter head for recording is rather out of place with modern equipment where the cutter is mounted on a carriage, which is part of the traverse mechanism, thus doing away with the older type of long counterbalanced arm which was never really a satisfactory method of mounting.

I quite agree with Mr. Aldous's desire to cut out that awful misnomer "tone arm," and also that it is desirable to standardise terms used in recording, particularly when one considers its rapid advancement during the last few years, and the great strides forward which have been made since the start of the war, particularly in this country, which has been very slow in the past.

R. W. LOWDEN.

Camberley, Surrey.

Musical Taste

I WAS very interested in "Diallist's" reply (your December issue) to my challenge on the subject of top cutting, and would like to make some further comments.

In the first place, I agree that valve hiss can hardly be a problem in a crowded and presumably fairly noisy mess, but it was not my intention to imply that all three of my suggested reasons for top cutting were necessarily applicable to any one case. In the average home, I think that they do all apply, but in a mess one of them predominates; namely, the fact that music is being used as a background, and is anything but really listened to.

Secondly, I must confess that my letter was not entirely concerned with the technical problem. My musical taste appears to be similar to "Diallist's," except that I happen to like jazz. There is so little real jazz to be heard to-day that I was prepared to forgive him for confusing it with dance music, but I did feel that

he was allowing musical questions to confuse the issue. I agree that there is a connection between popular taste in music and in reproduction, but I do not think that it is as simple as "Diallist" suggests. For if dance music and jazz are really intended to be heard only in a "topless" condition, why is it that people will go to great trouble to hear their favourite bands in the flesh? It seems to me that the connection between popular music and "mellow tone" is that both are intended to be half-listened to by people who have never made the effort necessary to obtain real musical experience.

Finally, I would like to say that I do, in fact, both tolerate and like jazz without top cut, and from a reasonably high-quality receiver, though whether I should do so if my receiver were an "ordinary domestic set" is, perhaps, another matter.

P. B. FELLGETT.

Cambridge.

A VALUABLE INDEX

SOME 300 abstracts from, and references to, recently published articles in the world's technical press are included in each issue of our sister journal, *Wireless Engineer*.

The subject and author indexes to the abstracts and references published during 1943 will be issued as a separate publication early in the New Year. Our Publishers inform us that, as supplies will be limited, readers requiring copies should make early application. The charge for the index, which will occupy some forty pages, will be 2s. 8d., including postage.

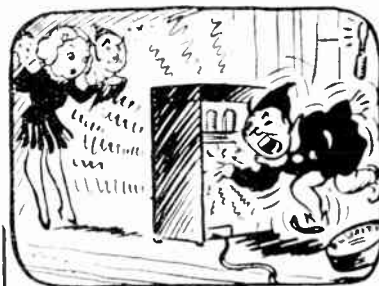

THE "FLUXITE QUINS" AT WORK

"What's wrong with our wireless today? It's never behaved in that way!"
(When FLUXITING, you see,
Our bright lad, you'll agree,
Should have switched off the juice, the young jay.)

See that FLUXITE is always by you — in the house — garage — workshop — wherever speedy soldering is needed. Used for over 30 years in Government works and by leading engineers and manufacturers. Of all Ironmongers—in tins, 8d., 1/4 and 2/8.

Ask to see the FLUXITE SMALL-SPACE SOLDERING SET—compact but substantial—complete with full instructions, 7/6.

TO CYCLISTS! Your wheels will NOT keep round and true unless the spokes are tied with fine wire at the crossings AND SOLDERED. This makes a much stronger wheel. It's simple—with FLUXITE—but IMPORTANT.

The FLUXITE GUN puts FLUXITE where you want it by a simple pressure. Price 1/6, or filled, 2/6.



ALL MECHANICS WILL HAVE

FLUXITE

IT SIMPLIFIES ALL SOLDERING

Write for Book on the ART OF "SOFT" SOLDERING and for Leaflets on CASE-HARDENING STEEL and TEMPERING TOOLS with FLUXITE. Price 1d. each.

FLUXITE LTD.
(Dept. W.W.), Bermondsey Street, S.E.1.

Books issued in conjunction with "Wireless World"

	Net Price	By Post
FOUNDATIONS OF WIRELESS. Fourth Edition, by M. G. Scroggie, in preparation	7/6	7/10
TELEVISION RECEIVING EQUIPMENT, by W. T. Cocking	10/6	10/10
RADIO LABORATORY HANDBOOK, by M. G. Scroggie. Second Edition	12/6	12/11
WIRELESS SERVICING MANUAL, by W. T. Cocking. Sixth Edition	7/6	7/10
HANDBOOK OF TECHNICAL INSTRUCTION FOR WIRELESS TELEGRAPHISTS, by H. M. Dowsett and L. E. Q. Walker. Seventh Edition	30/-	30/7
WIRELESS DIRECTION FINDING, by R. Keen. Third Edition	30/-	30/7
RADIO INTERFERENCE SUPPRESSION, by G. W. Ingram	5/-	5/4
LEARNING MORSE. 335th thousand	6d.	7½d.
INTRODUCTION TO VALVES, by F. E. Henderson	5/-	5/4
VALVE REPLACEMENT MANUAL, by A. C. Farnell and A. Woffenden	6/-	6/2

Obtainable from leading booksellers or by post from

ILIFFE & SONS LTD., Dorset House, Stamford Street, London, S.E.1

RADIO NAVIGATION

IN the diagram (a) is a vertical cross-section through an underground aerial-and-reflector system, which is intended to radiate an approach path, say for an aircraft, without offering any dangerous obstacle to the craft when landing. Energy from the dipole D is focused by an elliptical reflector E, so that it appears to originate from a point P on the surface of the ground. From P the radiation spreads uniformly over an horizontal angle of 180 deg., and vertically through an angle GPK which is determined by the constants of the reflector E. A spherical reflector S serves to reinforce the aerial energy received by the reflector E. The underground installation can be protected, if necessary, by a coverplate M with a portion N which is transparent to the radiated waves.

By arranging two such installations in close proximity, the two radiated fields can be separately modulated and made to provide a narrow overlapping sector of equi-signal strength, forming an approach path of known type, as

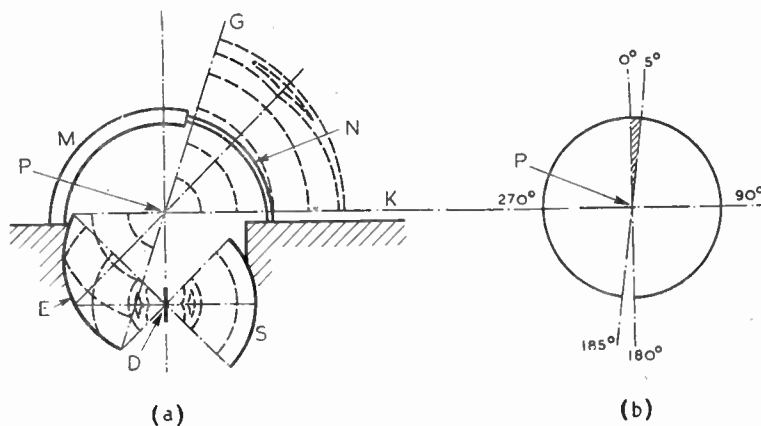

(a) Underground beam approach aerial system.

shown by the shaded part of diagram (b), yet distinguished by the fact that the diametrically opposite sector carries no signal, thus removing the usual 180 deg. ambiguity in direction.

H. M. Dowsett. Application date April 7th, 1942. No. 553424.

AUTOMATIC SELECTIVITY CONTROL

THE selectivity of a receiver for ultra-short waves is kept broad during the operation of searching, but is automatically sharpened as the circuits are brought into tune with a desired station. This result is secured by deriving a control voltage the value of which varies with the deviation of the circuits from resonance.

The radio-frequency stage of the receiver includes a circuit with a comparatively wide bandpass characteristic, whilst the IF stage includes a bandpass circuit of adjustable width. When a signal is tuned in close enough to fall within the first bandpass, a voltage is produced in the IF stage and is fed to an associated frequency dis-

A Selection of the More Interesting Radio Developments

criminating circuit to shift the frequency of the local oscillator, so that the resulting frequency is brought to the centre of the second bandpass. This, in turn, causes the AVC unit to apply a negative bias to a valve which serves, in known manner, to reduce the effective width of the second bandpass as the incoming signal increases in strength, i.e., as the point of resonance is approached. The arrangement described is preferably combined with the known type of control which serves automatically to sharpen the selectivity of the set in the presence of an interfering signal.

Hazeltine Corporation (assignees of H. A. Wheeler and R. L. Freeman). Convention date (U.S.A.) January 23rd, 1941. No. 554668.

magnetic control field then causes each electron to travel in a spiral path through that device, whereupon a second deflecting electrode restores the straight-line path through the "drift space." Similar deflectors are mounted at each end of the "collectors" or output electrode. The net effect is to intensify the degree of modulation, thus increasing the efficiency of the arrangement as a generator or amplifier at ultra-high frequencies.

Philips Lamps, Ltd. (communicated by N. V. Philips Gloeilampenfabrieken). Application date December 18th, 1941. No. 554202.

RADIO COMPASSES

RELATES to direction finders of the kind in which the direction of signals received on a constantly rotating aerial system is indicated on the screen of a cathode-ray tube by an electron beam which is rotated synchronously with the aeriels. The aerial system is driven by a motor, which is also geared to a two-phase generator for imparting the required circular movement to the electron beam.

As the aerial rotates, the signal strength will vary from maximum to minimum in accordance with the well-known directional effect. This low-frequency voltage can be applied to control the cathode-ray indicator in various ways. It may, for instance, produce a single bright spot at the appropriate point on the periphery of the fluorescent screen; or it may create a dark gap in a brightly illuminated circular trace; alternatively, the rotating beam may be deflected radially so as to produce an elliptical trace or "finger" pointing in the required direction.

In all cases, the clearness of the indication given will depend upon the effective intensity-control exerted by the low-frequency aerial voltage upon the electron beam.

The invention describes various arrangements for increasing the sensitivity of the device in this respect, more particularly by using a cathode-ray tube in which two controlling anodes are inserted in the path of the beam between the gun and the ordinary deflecting plates.

Standard Telephones and Cables, Ltd. (communicated by International Standard Electric Corporation). Application date January 6th, 1942. No. 554251.

PERMEABILITY TUNING

A CONSTANT frequency-difference is maintained between the incoming signal and the local oscillator, in a superhet receiver with permeability tuning, by making the oscillator core and coils longer than the core and coils of the signal circuits, and by initially setting the oscillator core so that it enters its coil before the others.

It is usually easy to gang the moving cores to give the required beat frequency at the beginning and end of the tuning range, but it is a more difficult matter to maintain the difference

MODULATING AN ELECTRON STREAM

THE electrons flowing through a discharge tube of the cathode-ray type are passed, under the control of an axial magnetic field, through a pair of semi-cylindrical electrodes carrying an alternating voltage. This imposes different velocities upon the electrons, which next pass through a hollow metal cylinder or "drift space," where they "sort themselves out" into a spaced series of bunches. The stream is then said to be velocity-modulated, and in this form will deliver energy to a second pair of semi-cylindrical electrodes similar to the first. In this type of modulating tube the electrons usually travel in a straight line from the cathode through the various control electrodes.

In order to prolong the period of time during which the electrons are subjected to the modulating action, an auxiliary electrode is arranged to deflect the stream so that it enters the "bunching" device at an angle to the main axis of the tube. The

frequency constant at all the intermediate settings on the scale.

The inventors have plotted the frequency (1) of the signal circuits and (2) of the local oscillator circuit, against the different positions of their respective cores, and have discovered that the slopes of these two curves begin to develop a marked difference at a certain point. The object of the arrangement described above is to throw this point beyond the limits of the tuning range without restricting the band-width to be covered.

Philips Lamps, Ltd. (Communicated by N. V. Philips' Gloeilampen-fabrieken.) Application date January 30th, 1942. No. 555150.

RADIO BEACONS

WHEN the vertical dipoles of a radio-beam transmitter are mounted on the top of a building or motor vehicle, a certain amount of horizontally polarised energy is liable to be reradiated from the screening-mesh that is laid below the aerials. Such secondary radiation is objectionable, because its polar diagram does not coincide with that of the primary overlapping beams, and may therefore cause the navigator, say of an aircraft, to get false guiding signals when his machine is banking and the receiving aerials are inclined to the vertical.

By way of remedy an auxiliary screen or network is mounted horizontally above the point on the transmitting dipoles at which the aerial current reverses. The secondary currents induced in this screen are therefore in phase-opposition with those flowing in the lower screen. The upper screen is also so arranged that both the currents are of equal magnitude, whereby undesired radiation from them is substantially neutralised.

Standard Telephones and Cables, Ltd., and A. J. Maddock. Application date December 9th, 1941. No. 553970.

FREQUENCY MODULATION

THE frequency of the carrier wave is made to respond flexibly to the applied signal, without having to use any special correcting circuits to stabilise the transmitter about the mean or unmodulated frequency.

For this purpose a quarter-wave

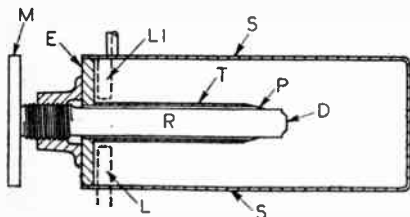

(a)

As shown enlarged at (b), the inner end of the rod is fitted with a flexible diaphragm D. This is driven by a moving-coil system C, to which signal currents are applied by leads passing through a central aperture. The resulting piston-like vibrations of the diaphragm vary the effective length of the rod R, and therefore the instantaneous frequency of the resonator.

(Oscillations at carrier frequency are fed to the resonator by a loop L, and the modulated output is coupled by a second loop L1 to the transmitting aerial. The outer conductor or screen S is connected to the rod R by a metal sleeve T, which makes sliding contact at the point P where the current density is less than it is near the end-plate E.

A. D. Blumlein. Application date November 16th, 1939. No. 554715.

SHORT-WAVE TUNING DEVICES

A SECTION of concentric transmission line, short-circuited at one end, forms an inductance which can be tuned by a variable condenser branched across the other ends of the inner and outer conductors. If, however, such a device is used to effect a frequency change greater than three to one, it is found that the "Q" of the circuit falls off rapidly towards the lower end of the scale. This can be overcome by using two separate sections of transmission line in series, one section covering the higher part of the tuning range and the second the lower, with the necessary "overlap" required to give a continuous variation over the entire range.

The invention provides means for switching the two sections in and out of circuit with each other, utilising the fact that at the "shorted" end of each section the current flows from the inner to the outer conductor of the line through multiple paths which are radial. The switch consists of a rotatable disc or plate, which in one position connects the two sections in series, and in another position short-circuits the inner and outer conductors of one of the sections.

Marconi's Wireless Telegraph Co., Ltd. (assignees of W. H. Conron and B. W. Suchle). Convention date (U.S.A.) March 1st, 1941. No. 554350.

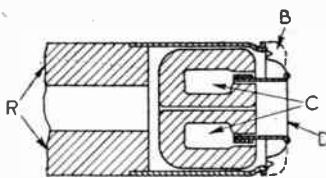

(b)

Concentric-line frequency modulator.

resonator of the concentric-line type serves as the main oscillator, and the desired signal variations are secured by varying the effective length of the centre core or "stub."

As shown at (a) in the diagram, a quarter-wave rod R is mounted inside a closed screen S to form a resonant system which is tuned to the carrier frequency by adjusting the length of the rod through a micrometer screw M.

The British abstracts published here are prepared with the permission of the Controller of H.M. Stationery Office, from specifications obtainable at the Patent Office, 25, Southampton Buildings, London, W.C.2, price 1/- each.

The Improved
VORTEXION
50 WATT
AMPLIFIER CHASSIS



The new Vortexion 50 watt amplifier is the result of over seven years' development with valves of the 6L6 type. Every part of the circuit has been carefully developed, with the result that 50 watts is obtained after the output transformer at approximately 4% total distortion. Some idea of the efficiency of the output valves can be obtained from the fact that they draw only 60 ma. per pair no load, and 160 ma. full load anode current. Separate rectifiers are employed for anode and screen and a Westinghouse for bias.

The response curve is straight from 200 to 15,000 cycles. In the standard model the low frequency response has been purposely reduced to save damage to the speakers with which it may be used, due to excessive movement of the speech coil. Non-standard models should not be obtained unless used with special speakers loaded to three or four watts each.

A tone control is fitted, and the large eight-section output transformer is available to match, 15-60-125-250 ohms. These output lines can be matched using all sections of windings, and will deliver the full response to the loud speakers with extremely low overall harmonic distortion.

PRICE (with 807 etc. type valves) £18.10.0
Plus 25% War Increase

MANY HUNDREDS ALREADY IN USE
Supplied only against Government Contracts

VORTEXION LTD.

257, The Broadway, Wimbledon, S.W.19

Phone: LIBerty 2814

RANDOM RADIATIONS

By "DIALLIST"

Interference

SEVERAL letters from readers on the subject of interference with short-wave reception have reached me; and doubtless others will eventually catch me up. I mean that I have been out on a tour of inspection; letters follow from address to address. One such reached me recently after an adventurous journey in the course of which it had been re-addressed no fewer than five times. On short-wave interference the general consensus of opinion is much what I expected: trouble from motor car ignition systems has decreased, since there are fewer motor cars on the roads; that from domestic appliances has lessened somewhat owing to the casualties amongst them and the impossibility of obtaining replacements. But interference from commercial electrical machinery has become a great deal worse than it was, for much more of such machinery is in use now than was the case in 1939. No steps seem to have been taken to compel those who install electrical appliances to render them non-radiating. That is a thousand pities, for much of the machinery now in service will remain in use when the war is over, though employed on different tasks. And its owners will be able to put up pleas for leniency; no doubt they'll ask and obtain leave to use the offending appliances till they wear out. Hence if we ever do get effective legislation against the radiation of interference with wireless reception it is likely to be years before it comes properly into force.

Do It Now!

One thing that we could do without hurting anybody is to prohibit right away the manufacture or sale of any kind of domestic electrical appliances that cause interference. Practically none are being made now, so far as I know, and an immediate enactment on the lines suggested would give manufacturers plenty of time to put their houses in order. To give one example: certain electric shavers are amongst the worst of offenders, interference from them extending over a surprisingly large area. None, I believe, are being made now either here or in the United States. The proposed regulations would ensure that, when production restarts, fresh designs or modifications of those existing would render all electric razors offered for sale here innocuous, so far as radiated interference is concerned. It would be sheer folly to allow manufacture and sales to continue

on the old unrestricted lines—but I sadly fear that that is exactly what will happen.

Not Sauce for the Gander

One correspondent puts up a very reasonable grouse. He installed a short-wave transmitter, not just for the fun of the thing, but because certain of the powers that be had intimated that he could give valuable voluntary help in certain ways. It was found to cause interference with the reception of his neighbours. Complaints were made and he had what was necessary done at his own expense. But when he complained mildly that his work was being hampered by interference with his reception from the said neighbour's vacuum cleaners and so on he was told that nothing could be done about it. That's a bit hard, when you come to think of it. What's sauce for the goose should be sauce for the gander, too.

□ □ □

Post-war Television

IN one or other of the lay papers I came across a scare headline the other day: "Present Television Sets No Use After the War," or something of that kind. First of all I don't believe that that will be so; but would it matter very much if it was? Most of the television receivers sold were combination instruments, capable of being used for the reception of sound only on the medium-wave band. Doubtless sets of that kind have been thoroughly used for broadcast reception during the war. They have given their owners their money's worth in that way alone. Very few receivers can have been laid up, so to speak in lavender and not used at all. It wouldn't, then, be any great hardship if, after the war, the authorities decided to scrap right away the present transmitting installation at Alexandra Palace and to make a fresh start with apparatus incorporating all the improvements made in the intervening years. But, as I've suggested, I don't think that that will happen. The "Ally Pally" plant served only Greater London and its environs; hence it's only in that area that pre-war television receivers in private ownership are to be found. Very well; let the Alexandra Palace outfit continue for the time being to serve this area and give those living in it full opportunities for making use of their existing receivers. Meantime develop television broadcasting further afield

by installing, as was suggested in the *Wireless World* Editorial last month, transmitting plants that are bang up to date to serve the most thickly populated parts of the Provinces. London's modern plant can compete either with the others or a little later; but the old one should in either event be kept at work for some little time, so that there may be no recriminations about a breach of faith.

□ □ □

Locating a Break

WHAT at first appeared to be rather a tricky problem cropped up the other day. Two of the many insulated leads in a stout multi-cored cable some 200 yards in length were found to be broken, and the problem was to make a repair as soon as might be, destroying as little as possible of the expensive cable in the process. No cable-testing instruments were available; in fact, we weren't too well off for instruments generally, having none by us but an Avo and an accurate wavemeter. Strenuous efforts to locate the break by feeling for it as the cable was moved gently to and fro or to detect the grating of broken ends by ear did not appear to promise results, so we sought to improvise some kind of testing device. An idea that seemed to have possibilities was to measure the capacity of an unbroken pair, then to measure that of the broken pair. By comparing the two capacities we might be able to calculate the approximate position of the break. As we had inductances of known value, the suggestion was to rig up an oscillator, using first an unbroken pair and then the broken pair as the tuning condenser; we could then measure the frequency and obtain the capacity from a *Wireless World* Abac. But we did not try the experiment after all, for a radio mechanic was lucky enough, on making a last attempt, to spot the place of the breakage by feel. I wonder if it would have worked out. Perhaps some reader can suggest a simpler and better method, bearing in mind the limited instrument equipment that we had at hand.

□ □ □

Certificated Service-men

THE idea behind the proposed examination by the Radio Trades Examination Board for wireless service-men is a good one, provided that the examinations themselves are of the right kind. By that I mean that I hope they won't counterbalance inability to use a soldering iron as it should be used. And theoretical knowledge won't help in the tracing out of faults unless it's backed up by a good ration of common sense. The first test that I would give a budding service-man

would be aimed at discovering whether he could use simple tools properly—it's surprising to find how large a proportion of mankind can't use a screwdriver! They may be able to worry screws in and out somehow, but look at the blades of their screwdrivers when they have been in use for a little time—and at the slots of the screws with which they have dealt. My view, for what it is worth, is that there should be practical tests with examinations in elementary theory for newcomers to the ranks of service-men. More difficult tests in both practice and theory should be available to those who had gained experience, and there should be every opportunity for the really good practical man to qualify himself as time goes on in the more advanced aspects of theory.

CATHODE-RAY PHOTOGRAPHY

TWO interesting papers dealing with the problems of photographing cathode-ray oscillograph traces were read by W. Nethercot (Electrical Research Association) and N. Hendry (Rotax, Ltd.) at the November meeting of the Association for Scientific Photography.

The recording of single transients with traverse times of less than a microsecond was discussed by Mr. Nethercot, who pointed out that achromatic lenses in the camera are unnecessary, since with the usual blue screen the light emitted is confined to a comparatively narrow band in the blue-violet region. Neither is it necessary to use a high-grade corrected lens for oscillograph recording at a fixed distance. The difficulties usually met with in making lenses of large aperture do not therefore arise, and negatives of useful dimensions have been obtained from a 5½ in. tube using a 2¼ in. focus lens with an aperture of f/1. Best results were obtained with ortho emulsions such as the Kodak R.55 or Ilford 5.G.91, using the Kodak D.19b or Ilford I.D.2 developers. Panchromatic film is frequently fogged by the glow from the tube cathode.

Mr. Hendry pointed out that small changes in the setting of the brilliancy control made large differences in the apparent recording sensitivity due to changes in the spectral emissivity of the screen. Except for the highest speeds, recording paper was as satisfactory as film and more economical. He had found that the usual mercuric iodide intensifier gave good results, and also the uranium nitrate silver intensifier, recently described in the British Journal of Photography, which gave a fivefold increase in density. Extreme cleanliness and the use of distilled water is, however, necessary if staining is to be avoided.

COMMUNICATIONS DEPEND...

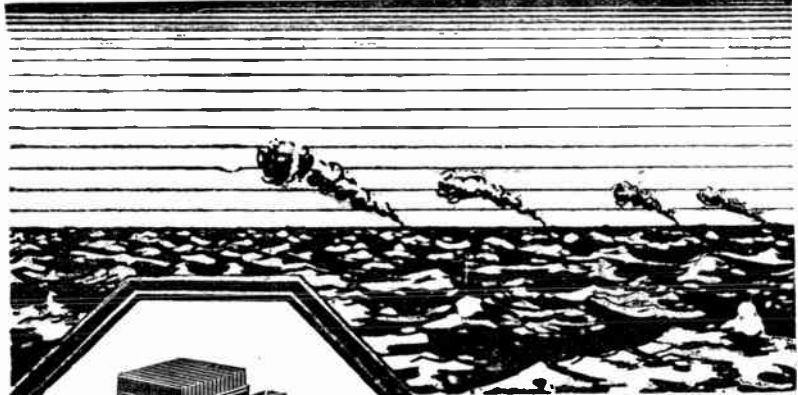

ON SMALL PARTS...

IN countless instances quite intricate pieces of apparatus are wholly dependent on the proved reputation and reliability of their component parts.

All products from the House of Bulgin are pre-eminent for superior design and workmanship and every article bearing our Trade Mark has to pass exacting and exhaustive tests during the course of its production.

We ask the kind indulgence of the Trade on delivery until peaceful conditions return.

Please quote priority and contract No.

The Choice of Critics

BULGIN FOR SWITCHES

The best Radio and small Electrical Switches in the world. Every one is the finest of its class, and the best for any job. Snap-action, low and constant contact resistance, reliable performance for tens of thousands of operations: all these are permanent characteristics.

"The Choice of Critics"

BULGIN

REGISTERED • TRADE • MARK

A. F. BULGIN & CO. LTD., BYE PASS RD., BARKING,

TEL.: RIPPLEWAY 3474 (4 lines).

ESSEX

UNBIASED

Black-out Blues— and the Cure

NOW that signposts have again appeared on our roads and there is a certain measure of relaxation of other stringent measures which circumstances forced us to accept in 1940, it would not be out of place, I think, if the Government were to make a further gesture in this direction by allowing us to have a little further information about the precise *modus operandi* of radiolocation. So far we have only been told rather vaguely that it operates on the principle of waves being reflected from the object it is desired to locate. I am, of course, perfectly well aware that to people whose basic technical knowledge is sound and whose powers of reasoning are above the average, like readers of *Wireless World*, this tiny scrap of information is more than enough to enable them to figure out precisely how it works.

I am, therefore, addressing this appeal to the Government to relax the regulations to a sufficient degree to enable the ordinary man in the



Radio can stop this.

street not only to be informed how it works, but even to be given permission to construct simple locators for himself. My reasons for so doing are that in this final winter of the black-out (*vide* Old Moore) a golden opportunity presents itself for the radio industry to get the great British public really interested in the technical side of radio to the extent that they were in the nineteen-twenties.

As is well known, in 1922 and onwards the home constructor of sets was "motivated" (what a word!) mainly by the fact that he was unable to hear the then new-fangled

By
**FREE
GRID**

broadcasting unless he built his own set, and the act of building the set led to the coming into being of a great deal of technical interest in radio.

Anybody who has followed me thus far and has not turned for light relief to the Editorial or to the Recent Inventions pages will be wondering what on earth I am driving at and why anybody should want to build a radiocator even if permission were given. Anybody whose torso is so covered with black-out blues and other forms of contusion as my own, due to constantly colliding with street lamps and outsize females during these days of renewed No. 8 battery famine, will know the answer to that question. My firm belief is that if permission were given to build and use a low-power radiocator, the battery-starved public would leap at it.

There is, in other words, as vital a need for building one as there was to build a wireless receiver in 1922. The demand is already there. It only needs Government permission for the idea to come into effect. As a result there would be created such a renewed interest by the masses in radio technology as we have not seen since 1922, and the ground would be all prepared for the radio industry to have a flying start when peace returns. But it must not be forgotten that this is the last winter when it can be done, and there is therefore need of a swift decision, and I trust that the Government will appoint a commission to sit on my idea without further delay.

Fröhliche Weihnacht

I NOTICE that the Nazi propaganda service has been busy of late trying to make our flesh creep by telling us how occupied their laboratories have been in perfecting the radio-controlled torpedo bomb by which we are all to be wiped off the face of the earth. This new engine of destruction is apparently a sort of flying torpedo which,

Santa Claus up to date.



according to the usual inspired "neutral" sources, can be guided to its ultimate destination by its parent plane up in the stratosphere, with such a degree of accuracy that it can be caused to proceed down a chimney, if need be, like Father Christmas, about whom many of us are thinking at this time of the year.

No doubt the Germans themselves have not forgotten the season of the year, and are planning to give the bombs a delayed-action mechanism and paint them to represent Father Christmas so that they can be successfully "planted" in the nursery on Christmas Eve and joyfully welcomed by the unsuspecting British child. I cannot think, in fact, why this thought did not occur to the writer of the item in the particular London newspaper which I have before me at the moment; he seems to have thought of almost everything else in what amounts to a blood-curdling eulogy of German ingenuity. It would appear that this writer imagines that radio control of any form of aircraft or air-borne device is something entirely new, and I hardly like to disillusion him by referring to our own pre-war "Queen Bees" and other things.

I must do so, however, but will not deal with anything so recent as "Queen Bees," but will take him back over thirty years to the issue of this journal for September, 1913, where he will find mention of miniature radio-controlled aircraft attacking a target with bombs which were themselves released by radio control. No doubt the German research workers have not been idling away their time, but their latest achievements, if indeed they exist, will probably be short-circuited at the source by an R.A.F. raid.

It is time that the venerable antiquity of wireless was better realised. Few people know that next year we celebrate the jubilee of Marconi's arrival in England in 1895, that in 1898 Queen Victoria had the Royal yacht fitted with wireless, and in 1899 wireless was used in the Boer War.



Valves and Speed

Speed is more important to-day than ever before in the world's history. Its accurate measurement — from the speed of light down to the relatively slow speed of a racehorse — can be more easily and positively achieved by electronic means than in any other way.

And so the thermionic valve can serve the community with equal facility in the social as

well as the industrial sphere. For example, when associated with photo-electric cells in a suitable apparatus, it will time with absolute accuracy the contestants in a race, be they horses, motor-cars or aeroplanes; and it will also photograph them automatically at the precise instant they pass the winning post.

MULLARD

THE MASTER VALVE

A Valve for Every Purpose

DOMESTIC · COMMERCIAL · INDUSTRIAL · SCIENTIFIC · MEDICAL · EXPERIMENTAL

THE MULLARD WIRELESS SERVICE CO. LTD., CENTURY HOUSE, SHAFTESBURY AVENUE, LONDON, W.C.2. (67)



SIGNALLING EQUIPMENT LTD.

Manufacturers of

Small Transformers, Heavy Duty Resistances, Plugs and Sockets, Fuse Holders, Electric Bells, Buzzers, and Switches. Also Plastic Mouldings, Coil Windings, Light Pressings, Turned Parts, and other components and accessories for the Wireless and Electrical Trades

Merit House, Southgate Road, Potters Bar
 Phone : Potters Bar 3133. Telegrams & Cables : Sel, Potters Bar

ERG
 ON ALL GOVERNMENT LISTS

Resistors

MANUFACTURED BY

ERG RESISTORS LIMITED
 1021a, FINCHLEY ROAD, LONDON, N.W.11

Technical Books

Splendid new series, all post paid.

- Ref. RV/30. **RADIO VALVE MANUAL.** A 66-page handbook dealing with American and British valves, Characteristics, Curves, Equivalents, Alternatives, Data, etc. 3/9
- Ref. RC/22. **RADIO CIRCUITS.** A Pocket Handbook giving theoretical diagrams and fullest instructions for making Receivers, Transmitters, Test Gear, etc. A very ambitious book 2/3
- Ref. EH/1. **ENGINEERS' AND ELECTRICIANS' HANDBOOK.** Tables, Data, Charts, Cables, A.C. and D.C. Motors. Indispensable to every Electrician's equipment 1/3
- Ref. MS/11. **MANUAL OF SCIENCE.** Prepared for the use of all Service and Civilian Technical Personnel on Heat, Light, Sound, Magnetism, Formula, Data, Tables, etc. 2/3
- Ref. EP/12. **ENGINEERING PRACTICE.** A fully illustrated handbook for Workshop, Drawing Office, Stores, etc. All Machine parts, Tools, Equipment, Instruments, etc., identified at sight. 2/3
- Ref. OP/01. **RADIO OPERATORS' MANUAL.** Formulas, Codes, Data. Very useful to new members of the Forces 1/3
- Ref. SS/M.1. **SERVICE SIGNALLING MANUAL.** Semaphore, Heliograph, Morse Code, etc., etc., for R.A.F. and Naval use 1/3
- RADIO INSIDE OUT.** Thousands of these standard Radio Handbooks in daily use. Hosts of useful information, actual replacement parts specified for all popular Receivers 4/9
- SPECIAL PRICE OFFER**—one each of all the above eight books will be sent post paid for 17/6
- New Series of three books on American Radio Servicing.** CROSSLEY, BELMONT, SPARTAN. Schematic drawings and fullest information. The set 37/6

EXCLUSIVELY MAIL ORDER.

WAVEBAND RADIO LTD.
 4/5, Pall Mall Place, Pall Mall, London, S.W.1

The **"PYROBIT"** New

SOLDERING IRON

for Precision Instrument Work

Can be operated like a pencil

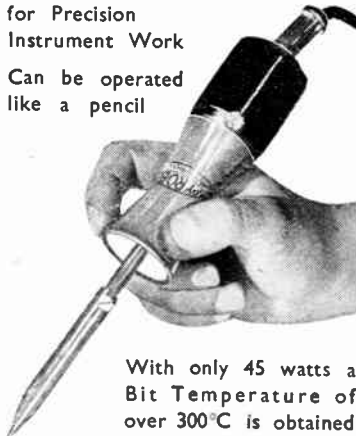

With only 45 watts a Bit Temperature of over 300°C is obtained

For all Voltages from 6—250 volts.

The ACRU ELECTRIC TOOL MFG. CO. LTD.
 123 HYDE ROAD
 ARDWICK, MANCHESTER, 12
 Telephone: ARDWICK 4284



FOR THE RADIO SERVICE MAN, DEALER AND OWNER

The man who enrolls for an I.C.S. Radio Course learns radio thoroughly, completely, practically. When he earns his diploma, he will **KNOW** radio. We are not content merely to teach the principles of radio, we want to show our students how to apply that training in practical, every-day, radio service work. We train them to be **successful!**

INTERNATIONAL CORRESPONDENCE SCHOOL

Dept. 38, International Buildings, Kingsway, London, W.C.2
 Please explain fully about your instruction in the subject marked X.

- Complete Radio Engineering
- Radio Service Engineering
- Elementary Radio Television
- And the following Radio examinations:
- British Institution of Radio Engineers
- P.M.G. Certificate for Wireless Operators
- Provisional Certificate in Radio Telephony and Telegraphy for Aircraft
- City and Guilds Telecommunications
- Wireless Operator & Wireless Mechanic, R.A.F.

Name..... Age.....
 Address

MELTON METALLURGICAL LABORATORIES LTD

Liquid Silver, Platinum and Gold
 for metallising CERAMIC, MICA, QUARTZ or GLASS.

Low melting-point **SOLDER** from 70°C.

Non-corrosive Liquid **FLUX** for all electrical purposes. A.I.D. Approved.

Agents for Australia: A. S. HARRISON & CO. PTY. LTD.
 85, CLARENCE STREET, SYDNEY.

IPSWICH RD., TRADING ESTATE, SLOUGH, BUCKS. Phone: Slough 20992

Superspeed

CORED SOLDER

A.I.D. APPROVED

H. J. ENTHOVEN & SONS LTD.
 230 THORNTON ROAD, WEST CROYDON, SURREY
 THORNTON Heath 2462

CLASSIFIED ADVERTISEMENTS. Rate 6/- for 2 lines or less and 3/- for every additional line or part thereof, average lines 5-6 words. Each paragraph charged separately. Press Day: February issue, first post Tuesday, January 11th, one day earlier at branch offices. Box Numbers 2 words, plus 1-. Deposit System: particulars on request. No responsibility accepted for errors.

Ode
Partridge
No. 28
Greetings

Peace and Goodwill. To talk of these
Seems strange in midst of war
Yet in our hearts we feel convinced
'Twill come, in 'forty-four.

Such thoughts, p'raps fathered by the
wish,
Somehow seem justified
When one surveys the mighty force
Of Allies, unified.

So why not just anticipate,
Turn war clouds inside out
And glimpse the silver lining.
Then, Hearty Greetings shout.

'Tis good! We'll take our own advice.
To friends, both far and near,
As whisky's scarce and champagne's
"off."
We drink your health—in beer.

N. Partridge

Transformer Manufacturers,
76-78, PETTY FRANCE, LONDON,
S.W.1. Telephone: ABBey 2244.

**ARMSTRONG
SERVICE**

OUR SERVICE
DEPARTMENT
IS STILL
AT YOUR SERVICE

ARMSTRONG MANUFACTURING CO.
WARLTERS ROAD, HOLLOWAY, LONDON, N.7
Phone: NORTH 3213

NEW RECEIVERS AND AMPLIFIERS

30-WATT ac amplifiers, precision built instruments, input and output channels to requirements; early deliveries.—Below.

150-WATT racks, comprising 5 amplifiers as above intercoupled, fitted for remote control for industrial installations; send for full details and illustrations; complete equipment, including speakers and microphones, etc., available.—Below.

18-WATT ac/dc amplifiers, mixing input channels, bass and treble controls, input and output transformers; 18gns.—Below.

DANCE and stage transportable equipment, comprising 18-watt amplifier as above.

m/c mike, adj. stand, 2 speakers, cables; 36gns.—Broadcast & Acoustic Equipment Co., Ltd., Broadcast House, Tombland, Norwich. 26970.

only.—New 7-valve "Wireless £24 World" quality amplifier with tone control stage, 8 watts push-pull triode output, price includes super quality triple cone, 12in permanent magnet speaker with large matched output transformer and all valves; as above but with 15-watt tetrode output, £25, ideal for realistic reproduction for public address; limited number available.—Bakers Selhurst Radio, 75, Sussex Rd., S. Croydon.

RECEIVERS, AMPLIFIERS—SECOND-HAND

TROPHY 8, 1942, with 10in Goodmans speaker; best offer.—18, Orchard Estate, Ely. [2250]

EDDYSTONE communication receiver, 10-valve, with speaker; £45.—37, Cranborne Rd., Putters Bar, Dorset. [2305]

EDDYSTONE All-World Eight, battery operated, 6 spare valves, 2 short, 1 medium wave coils, excellent condition.—Box 2996. [2244]

SCOTT Imperial chassis, 27 valves, super speaker, outstanding performance; £125.—A.C.S. Radio, 44, Widmore Rd., Bromley. [2251]

PHILCO car radio, 7 valves, very compact, suitable house, excellent performance, new 12v battery and charger; £20.—Box 2994. [2539]

B.T.H. cinema rack amplifier (less valves), 55 watts class A output, or splendid basis transmitter; £35 or offer; cost £200.—Cinema, Bishops Castle. [2310]

"W.W." Q.A. Super, £10; H.M.V. automatic record changer, d.c., with pick-up, in cabinet; Philips 4-valve a.c. 3-wave model 2013; Ferranti A.F.6C.; coupling unit for 12 watt P.P. amplifier; Hartley-Turner speaker, 2,500 ohms; B.T.H. universal gram motor; offers.—Box 2992. [2234]

BRITISH Instructional Films talkie outfit, new and unused, 16 millimetres, complete in two carrying cases as supplied, would cost to-day, if obtainable, approx. £300, all gear drive built similar to picture house machines; offers invited for same; applicants must make definite offers, and enclose stamped addressed envelope, otherwise will not be replied to.—Capper, Gorse Bank Lane, Baslow, Derbyshire. [2290]

Wanted

WANTED, Hammarlund Super Pro; letters only.—F. Smith, 36, Haldon Rd., S.W.18. [2297]

WE offer cash for good modern communication and all-wave receivers.—A.C.S. Radio, 44, Widmore Rd., Bromley. [1541]

HALLICRAFTERS SX25 or SX28 receiver urgently required, with matched speaker; high price given for perfect instrument.—Box 2998. [2247]

WANTED (either) Hallicrafter S.32, S.X.28 or National H.R.O., with matched speaker, good condition; state price; no dealers.—R. Barrott, 11, Kinross Rd., Lillington, Leamington Spa, Warwick. [2281]

LONDON CENTRAL RADIO STORES will pay good prices for receivers, radiograms, amplifiers, dynamos, converters, test equipment, electric gramophone motors, and all radio and electrical accessories.—London Central Radio Stores, 23, Lisie St., London, W.C.2. Gerrard 2969. [9836]

HIGH price will be paid for modern high-performance communications receiver incorporating 2 R.F. stages and "R" (db) meter, with full band spread, coverage, complete with matched speaker, servicing manual, etc., all in perfect working order and condition; internally lighted dials preferred.—Box 2999. [2248]

NEW LOUDSPEAKERS

BROADCAST 12in p.m. loud speakers, precision built instruments to lab. standards and micrometer accuracy, Ticonall magnets, demountable diaphragm and magnet assemblies, perfect and permanent alignment, extended frequency range, uniform response, superior acoustical characteristics, maximum sensitivity, highest efficiency.—Broadcast & Acoustic Equipment Co., Ltd., Tombland, Norwich. 26970. [2025]

Advertisers and buyers are reminded that under Defence Regulations 1939, Statutory Rules and Orders 1940, Number 1689, a permit (T 99 G) must be obtained before sale or purchase of certain electrical and wireless apparatus, particularly such valves and apparatus as are applicable to wireless transmission.

"The Colonel's Lady — and Judy O'Grady"

These two charming persons may have been "sisters under the skin"; but whilst the more deadly are possibly all soul-mates it would not be wise to take it for granted that this generalisation applies equally to—transformers, for instance. Undoubtedly many of them superficially look equal to a Gardner, but beneath their metal 'skin' they are worlds apart. This 'class distinction' is noticeably marked in the case of Gardners' Small Power Transformers up to 4 kva. May we ask you then to consult with us when next you need this type of component and the specification stresses "The Colonel's Lady" aspect?

We regret that at present Small Power Transformers are available for highest priority orders only.



GARDNERS RADIO LIMITED
SOMERFORD · CHRISTCHURCH · HANTS

L.R.S.

STUART PUMPS

As supplied to Govt. Depts. & County Councils.



These Centrifugal Pumps are ideal for Machine Tool Cooling and all pumping purposes—hot or cold water. Supplied complete with foot-valve, strainer and hose union. Suitable rubber hose available from stock.

No. 10, 100 gals. per hour. Carr. 2/- extra. £5 2 6
No. 11, 280 gals. per hour. Carr. 2/- extra. £6 6 0
No. 12, 560 gals. per hour. Carr. 3/- extra. £7 12 0

Please send 2d. stamp for specification. State purpose for which pump is required.

The **STUART AUTOMATIC FLOAT SWITCH** is the best method of controlling water—Post paid level. Price complete with all fittings.... £2 6 0

LONDON RADIO SUPPLY CO.
Estab. 1925
Ardingly Road, Balcombe, Sussex

LASKY'S RADIO 370 HARROW RD. PADDINGTON, W.9

(Opp. Paidd. Hospital). Phone: Cunningham 1979

Offer for sale the following components:—

CONDENSERS

- 2 mfd. 600 v. Block Paper Cond. ... 2/6 each
- 2+1 mfd. 500 v. Block Paper Cond. 5/- each
- 2+1 mfd. 500 v. Block Paper Cond. 3/6 each
- .02 mfd. 2,000 v. Tubular ... 1/- each
- .25 " 2,000 v. " " " " " " 1/6 each
- .25 " 350 v. " " " " " " 1/3 each
- .05 " 500 v. " " " " " " 1/- each
- .01 " 500 v. " " " " " " 9d. each
- 50 " 12 v. " " " " " " 1/4 each
- 10 " 25 v. " " " " " " 1/6 each
- 25 " 25 v. " " " " " " 1/9 each
- .1 " 350 v. " " " " " " 6d. each
- .1 " 350 v. " " " " " " 7/6 each
- 3 amp Mains Droppers Tapped ... 7/6 doz.
- U.S.A. Octal Valve Holders ... 2/9 each
- Assorted Volume Cont. less switch
- Assorted Volume Cont. 1/2, 1/3 and 1 meg with switch ... 5/9 each
- Midget volume controls 1/2 meg. less switch ... 3/9 each
- 3 amp 3-way line, Cord, 70 ohms, per foot ... at 5/9 yard.

VALVES! VALVES! VALVES!

We have over 5,000 new and boxed English and U.S.A. Mains and Battery Valves in stock, including 6A7, 6AB, 25Z4, 75, SZ4, U50, 35Z5, 50L6, 35L6, 6F6, FC13c, VP2, SP4, PX4, PENA4, AC2PENNDD, TDD4, UUS, 6K7, 6K8, 1W4/350, U12, 12A8, 12Q7, PEN36c, etc., etc.

SPEAKERS

- Rola P.M. less Transformers, 5in, at 19/6
 - 6jin. 21/-, 8in. at 23/6
 - Goodman's 3 1/2in. 12 ohms V/coil at 27/6
 - 5in. 21/6
 - Special offer: Goodman's 10in. £2 5s, less Transformer.
 - Universal Speaker Transformers ... 7/6 each
 - Pentode " " " " " " 6/6 each
 - 4v. + 4v. Commercial Mains Transformers, H.T., 350—0—350, Shrouded, at 35/- each.
 - English-type Valve Holders ... 8/6 doz.
 - Systoflex Assorted ... 2/6 doz.
 - Toggle Switches ... 3/- each
- Send us your requirements. C.O.D. BUT CASH WITH ORDER PREFERRED.

DIRECTIONAL HORN LOUDSPEAKERS

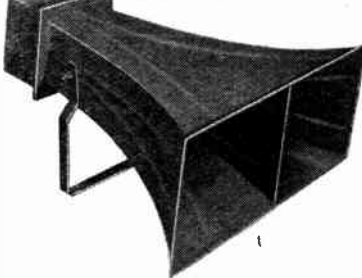

Designed and specially treated to avoid unwanted resonances.
Length 39", flare opening 26" x 12".
15 ohms, handles 10 watts.
Price £8.18.6

AMPLIFIERS AND COMPLETE FACTORY INSTALLATIONS

INDUSTRIAL AMPLIFIER & TELEPHONE CO.

Tower Works, Old Town, Clapham, S.W.4. TEL. No.: MACaulay 3200

£4/15 only.—Brand new super quality triple cone permanent magnet speaker made by Bakers Selhurst Radio, the pioneer manufacturers of moving coil speakers since 1925, wide frequency range, even response, ideal for qual. reproduction, fitted with 1 1/2-inch speech coil and magnet having exceptionally high flux density in the air gap, suitable for public address equipment when quality reproduction is first consideration; send 2d. stamp for leaflet giving details of above and constructional details of infinite baffle cabinet; every music lover interested in realistic reproduction should write for leaflet.

£8/15 only.—Brand new super power cinema permanent magnet speaker with 18-inch triple cone, will handle 20 watts U.D.O., ideal for quality public address equipment.—Bakers Selhurst Radio, 75, Sussex Rd., South Croydun. [2318]

LOUDSPEAKERS SECONDHAND

- VOIGT, with new twin cone, 3ft. horn; s.a.e.; offer.—Box 3015. [2311]
- FERRANTI M1 P.M.; nearest £5.—10, Avenue, Poulton-le-Fylde. [2246]
- EPOCH 14in. £9; W.B. 10in. £6.—Brook Dor-Ed, Nth. Lopham, Diss. [2234]
- WHARFEBLAI. Golden chassis speaker, less transformer; 50/-.—Box 3006. [2293]
- TWO Parneko 13 inch cone permanent magnet P.A. speakers, £6 each.—Box 3010.
- 3000 olms B.T.H. Senior R.K. dc speaker, with trans; £5/17/6.—Box 3011.
- ROLA G.12 and Vitavox K.12/10. 12in P.M. speakers, both 15 ohms; £8 each.—Scroggs, 32, King's End, Ruislip. [2288]
- ROLA G.12, Epoch 99K. Marconi, B.T.H. R.K.; several a.f. and o.p. trans.—Hardwicke, 29, Warwick Ave., Crosby, Lancs. [2279]

Wanted

B.T.H. 10 inch diaphragm, preferably leather surround, 100 or 230 volt field, with or without field exciter unit.—Box 3014.
HARTLEY-TURNER speakers, good condition, per. mag. preferred; also Voigt corner horn, with or without unit; state prices.—Box 3002. [2268]

DYNAMOS, MOTORS, ETC.

- PHILIPS converter unit (Code 28.891.460), 110-245v d.c. to 230v a.c., with service manual.—Box 3003. [2270]
- ALL types of rotary converters, electric motors, battery chargers, petro-electric generator sets, etc., in stock, new and second-hand; supplied against priority orders only.
- WARD, 37, White Post Lane, Hackney Wick, E.9. Tel. Amherst 1393. [1988]
- L.T. dynamos for charging, Lucas-Rotax, 6-12v 8 amps dc, 3rd brush, weight 11lb, size 8in x 4 1/2in, unused ex W.D., cost £10, to clear 17/6 each; ht and lt G.E.C. double-current 6v and 600v, 17lb ditto, 27/6; all carr. paid England and Wales.—Electradix, 214, Queenstown Rd., Battersea, S.W.8. [1748]

Wanted

WANTED urgently, two or three rotary converters, E.I.C.C. preferred, to operate from 230v DC supply and provide from 180w to 1/2Kw at 230v AC, with AC voltmeter and control preferred, smoothed for work on ultra short waves, must be quite modern and little used.—Write Box 3017. [2313]

TEST EQUIPMENT

- AVOMETER, latest model 40, brand new; best offer secures.—Box 3008. [2298]
- FOR sale, laboratory impedance bridge. General Radio Corp. type 650A, complete, as new, very little used; best offer secures.—Box 3000. [2256]
- METERS, Ferranti, 15mA 50/-; Victoria, 10mA 40/-; Turner, 250 uA 60/-; Acorn triodes, 30/-; Magnavox 66, with field supply; offers.—Box 3020. [2323]
- TESTSCOPE, used everywhere by radio service engineers, makes 20 important tests; send for interesting leaflet "R.1."—Runbaken, Manchester, 1. [1074]
- MANUFACTURER has for disposal quantity of instrument wire, including 300lb 39swg d.s.c. copper wire, 10/6 per lb., and 60lb 31tz 10/47, 30/- per lb; willing to split quantities.—Box 2991. [2233]
- SERVICING equipment, comprising multi-meter, analyser, zero current voltmeter, signal generator, audio-frequency oscillator, frequency modulated oscillator and three-range output meter, all in two cases; s.a.e. for details.—Box 3005, c/o Wireless World. [2289]
- C.O.D. only.—We have a few only Avometer a.c./d.c. and d.c. meters in stock; £8/10 and £3/10; send no cash in case sold; c.o.d. and post charges, 1/6 extra; preference to priority orders.—London Radio Supply Co., Ardingley Rd., Balcombe, Sussex. [2263]
- NEW 6-page lists give advance particulars of valvetesters, signal tracers, oscilloscopes, etc., as well as details of our standard, easily assembled test equipment kits (multi-meters, oscillators, bridges, V.V. meters, etc.); also miniature mains transformers, including bridge and valvetester types.—S.a.e., stating requirements, to MacLachlan & Co., Strathyre.



for INDUSTRIAL CANTEENS, AIR FORCE, ARMY and NAVY CAMPS, SCHOOLS, etc.

Special units with built-in Radio can be delivered in 14 days.

Catalogue on application.

Scottish Distributors: British Electrical & Manfg. Co., Ltd. 133, West Campbell Street, Glasgow. Telephone: Central 3286.



SPEAKER REPAIRS by Specialists

Any make, British or American Best Service Moderate Charges
TRADE ONLY Also Components for Service Men at keenest prices. List 1d. Holders of Export Licence for Northern Ireland.
A. W. F. RADIO PRODUCTS 'Phone: 11926
13, Lilycroft Road, Bradford, Yorks.



For high quality loud speakers when the good times come again.

The Courts, Silverdale, London S.E.28. 'Phone: SYD 6666.

SALFORD Selenium PHOTO-ELECTRIC GELLS

ENLIGHTENMENT ON LIGHT

- A Range of Standard sizes available — mounted or unmounted.
- Special sizes to order.

Please address enquiries to: SALFORD ELECTRICAL INSTRUMENTS LTD. PEEL WORKS, SALFORD, J. PARRELL, MANCHESTER. PROPRIETORS: THE GENERAL ELECTRIC CO. LTD., OF ENGLAND.

—THE RADIO INSTRUMENT CO.—

MAINS TRANSFORMERS.—We manufacture a range of T.E.N. standardised types of power units. Domestic receiver replacements, 350 volt 100 ma. secondaries, 26/6.
For large receivers and radiograms, 350 v. 120 ma. secondaries, 37/6.
For Sound Equipment and Industrial use, 500 v. 150 ma. secondaries, 41/6.
Any transformer can be supplied with BVA 4-volt heaters, or 5-volt and 6.3-volt for USA heaters. Prices are net cash to the trade, priority contracts taking precedence in delivery.
Full specifications will be found in previous issues of "W.W."
Technical data on these and all our winding products are detailed in our Components Catalogue (2d.) sent on application.
"WE THREE IN HARMONY"
(Apologies to Happidrome.)
The Mains transformer.
The Output transformer. The I.V.3.
Three transformers, around which almost any type of amplifier can be built, from 6 watts to 60.
THE MAINS TRANSFORMER. Types Z or AZ, for BVA or 6-volt valves, supplies 500 volts at 150 ma, with total 9 amps. L.Ts.
THE OUTPUT TRANSFORMER (OP12) A multi-ratio unit with a primary inductance of 120 mh, multiple secondaries, tapped primary, for triode or pentode in any "Class" of push-pull.
THE INTERVALVE TRANSFORMER, a new innovation for coupling the phase splitting valve or valves to the output. Ratio 1/3, tapped secondary for enabling separate bias to each output valve.
SPEAKERS.
Industrial 8in. P.M.s. 5 watt, in metal drum cabinets of pleasing appearance, supplied without transformer, 47/6.
A limited number of 8in. P.M.s., with pentode trans, 29/6.
Just arrived: Some 8in. P.M.s., less trans. 21/-.
Cable, Single, screened microphone cable, 7/6 per dozen yards.
Pointer knobs, we are again able to repeat this popular line, black instrument pointer knobs, 1/4in. bore, 7/6 per dozen.
For twin flex, cables, condensers, solder, etc., write or phone your enquiries. We endeavour to manufacture or distribute all requirements for the Radio Repair Depot.
THE RADIO INSTRUMENT CO.
294, BROADWAY, BEXLEYHEATH, KENT.
Phone: Bexleyheath 8021.

The Season's Greetings —

to all Candler students who are readers of the "Wireless World."

H. Freeman

(London Manager)

THE CANDLER SYSTEM COY.

IN reviewing the results of the Candler system of Morse Code training for the year 1943, we feel justifiable pride in the fact that a very large proportion of Candler trained operators are now serving in the Army, Navy and Air Force; others are acting as W/T instructors, or carrying out W/T work of national importance.

If any readers of the Wireless World resolve that in 1944 they will become proficient W/T operators, or improve their present efficiency in Morse Code work, they are invited to make application for the Candler "Book of Facts." It gives full details of the Candler courses for **Beginners and Operators.**

Candler Code Courses are supplied on Cash or monthly payment terms.

THE CANDLER SYSTEM COMPANY
(55.W.) 121 Kingsway, London, W.C.2.

The Candler System Co. Denver, Colorado, U.S.A. (144).

LONDON CENTRAL RADIO STORES.—Manufacturers' surplus components collected from all over the country; real bargains for discriminating radio enthusiasts; no extra charges for postage, packing, etc.; this avoids confusion.
CONNEXIONS, 14x8 1/2 x 3in, drilled for 11 valves and transformer, 6/6.
STEP-UP, step-down transformers, 100-240v. 60w; 30/6.
3-GANG superhet variable condensers, 0.0005 mfd, with trimmers; 10/6.
YAXLEY type wave-change switches, 4-way, 3-bank, with shielded oscillator section, length from stop plate approx. 5in, spindle 2in, 6/3; 5-way, 6-bank, with 3 screened sections, adaptable to many uses, length from stop plate approx. 6 1/2in, spindle 2in, 7/3; 3-way, 3 double banks, without shields, 2in spindle, length 6 1/2in, 6/3.
YAXLEY pattern switches, 5-way, single-bank, on-off mains switch, carrying 1 amp at 250v, 2in spindle with knob, 6/-; 3-way, single-bank, 1in spindle, with knob, 3/3.
OAK switches, 2 1/2in spindle, complete with knob, 4-way, 2-bank, with connecting block, 5/-; 4-way, 2-bank, 4/3.
SPEECH transis, brand new, ex well-known speaker maker, ratio 30:1, a fine job; 6/9.
RELAYS.—Brand new, surplus stock, electromagnetic make and break units to operate on 1 1/2 volts at 15mA; to clear stock, 5/9 each.
MOTOR tuning.—Fine brand new 3-gang 0.0005mfd condenser, no trimmers, designed for motor drive, large diameter driving disc and reduction gear for slow motion manual drive; 13/6 each.
BRASS rod.—Screwed brass rod, 2B.A., 4B.A. and 6B.A. 12-inch lengths, useful for many purposes; 5/6 doz lengths.
VALVEHOLDERS, all brand new, Ciestion Amphenol, Mazda and Inter. octal; 1/-.
CONDENSERS, tubular wire end, made by Plessey, 25mfd, 25 volt working, 50mfd, 12 volt working; 1/9 each.
RESISTANCES.—Assorted wire-end resistances by best makers, ideal for servicemen and experimenters; to clear, 3/6 doz, 13/3 for 50, 23/6 for 100.
CERAMIC valveholders, brand new, low loss, 7 pin; 1/5 each.
CONDENSERS.—First class 0.1mfd. oil-filled 5,000 volt workings only 11/6 each.
T.C.C. tubular condensers—0.1mfd, 6,000 volt d.c. test, 8/9 each; also 2mfd tubulars, 300 volt working, 2/6 each.
T.C.C. condensers in metal cases, special offer, much reduced to clear, 4x4mfd, 70 volt working; 2/6 each.
VIBRATORS.—Brand new American synchronous self-rectifying vibrator units, 12 volt input, 280 volt output, 65mA, fitted with 7-pin American base; 16/- each.
COUNTERS.—Ex. G.P.O., every one perfect, electro-magnetic, 500 ohm coil, counting to 9,999, operated from 25v-50v dc, many industrial and domestic applications; 6/-.
VALVEHOLDERS.—Paxolin, 7 and 9 pin; 7d. each, 6/- doz.
DRIPPING resistances.—To replace 2- and 3-way line cords, with diagram showing connections, 0.3 amp, in strong metal case, 13/- each; without case, 10/- each.
VITREOUS enamelled resistances, 10,000 ohm, 10w, 3/6.
ELEC. razor resistances, universal input, in strong metal case, 10/- each.
REACTION condensers.—Fine quality job, 0.0003 mfd; to clear at 2/3 each.
TUBULARS.—Wire-end tubular condensers, 0.1 and 0.01mfd, 400v working; 1/-.
VALVEHOLDERS.—Side contact, 8-pin type, in bakelite, 1/9 each; anode bakelite valve caps, 8d.; anode valve caps with screened lead, 1/3.
DIAL lamps.—Philips' screw type dial lamps for dial illumination, 15 watt; 1/9 each.
SPEECH coil ribbon wire, enamelled copper, gauge approx. 20 thou, by 5 1/2 thou.; 3/3 per lb. reel; also 23 s.w.g. d.c.c. wire, 100 yd. coils, 5/6.
EXTENSION speakers.—Brand new, first-class p.m. loud speakers, in beautifully polished cabinets, 61/6; rexine covered, 57/6.
FLEXIBLE drives.—Ideal for remote control in radiograms, etc., approx. 3ft. lgth.; 4/3.
VALVES.—EA50, Mullards; to clear, 10/6 each.
PLUGS and jacks.—Ex-Govt., powerful phosphor-bronze springs, ensuring perfect contact, overall lgth., incl. 1/2in threaded shank, 3 1/2in, supplied with nut for panel mtg.; complete with best quality plug, 5/9.
SCANNING and deflector coils, ex television receivers, comp. in metal frame; 8/6 ea.
PUSH button units.—Permeability iron cored coil units, 6 spring loaded switches, 16/- each, 8 switch unit (no coils), 4/6 each; 12 switch unit (no coils or switches), 2/6 each.
(Continued on p. 29.)

HARRISFLEX
CONTROLLED FLEXIBLE BEARINGS
AND
ANTI-VIBRATION
OR
INSTRUMENT MOUNTINGS



Insulating delicate Instrument Panels against vibration and shock. Types and sizes available to carry varying loads (Rubber to Metal Bonded).



Type I is a popular and simple Instrument Mounting used extensively on aircraft, etc. Two Studs Rubber Bonded. Designed to carry substantial loads for its size.

HARRISFLEX BEARINGS LIMITED
TIDDINGTON ROAD · STRATFORD-ON-AVON

Battery Charging CLIPS

Well made of steel, double ridged for strength. Teeth on three sides of lower jaw give firm grip and good contact. Opens 1 1/4".

Wingard
Precision Engineers
EUGENE WORKS, EDGWARE ROAD, HENDON, N.W.9

W. BRYAN SAVAGE LTD.

Expert assistance in the solution of problems relating to

- TRANSFORMERS, CHOKES
- AMPLIFIERS
- POWER UNITS

and Specialised Equipment embodying

ELECTRONIC CONTROL

WESTMORELAND RD., N.W.9
COLINDALE 7131

BATTERY CHARGERS & TRICKLE CHARGERS

for all purposes
"QUICK-CHARGE" CHARGERS
well known for reliability
Booklet R.18, giving useful information and describing 13 Models, on request

RUNBAKEN-MANCHESTER



Designed by engineers for engineers, the Solon Electric Soldering Iron gives neater, cleaner, more efficient work in less time. The heating element is right inside the bit, giving constant heat at the point—where you want it. All internal connections housed at end of handle—away from heat and easy to get at. Complete with 6ft. of Henley 3-core flexible. Made for the following standard voltages:—100/110, 200 220, 230 250. Supplies are, of course, only available for essential war work. Early ordering is advisable as the demand is heavy.

Made in England

Model shown is a standard 195 watt round pencil bit Solon. Other sizes and types available.



W. T. HENLEY'S TELEGRAPH WORKS CO. LTD.
Engineering Dept., Milton Court, Westcott, Dorking, Surrey

(Continued from p. 28.)
POTENTIOMETERS.—Wire wound, ex-Govt., 50,000 ohms, 5/6; also carbon potentiometers, 50,000 ohms, 5/6.
ELECTRIC soldering irons, 200-250v 75w, 12/6.
SEE also our display advt. on this page.

LONDON CENTRAL RADIO STORES. 23, Lisle St., London, W.C.2. [2284]
IDEAL for pocket receivers, etc.—Hivac midjet valve units, comprising XL and XD valves, in holder, 2v fl., 15/-, complete; further available: (350) American Morganite Stackpole submidjet, 1/2meg controls, (700) TCC 0.01 condensers Type 43 (800) small 2,000, 3,000, 2meg resistors.—P. West, c/o 13, Lower Park, Putney Hill, S.W.15. S.a.e. No callers.
ELECTROLYTIC condensers, 16-8mfd 550v 9/-, 15mfd 15v 2/-, 25mfd 25v 2/3, 25mfd 12v 2/3, 25mfd 15v 2/7½, 8-8 450v 8/3, 24-16mfd 15/2; sent c.o.d.—Lars's Whitehall St., Dunlee. [2237]

LASKY'S RADIO, 370, Harrow Rd., Paddington, W.9, offer for sale the following components: 0.02mfd 2,000v at 1/- each; 0.25mfd 2,000v, 1/6 each; 0.05mfd 500v at 1/- each; 2mfd 600 v block at 2/6 each; 50mfd 12v at 1/4; 10mfd 25v at 1/6 each; 0.1mfd 350v at 6d. each; speakers, Rola p.m., 5in. at 19/6; 6½in at 21/-; 8in at 23/6; all less transformer; Goodman's, 3½in at 27/6, 5in at 21/6; special offer, 10in at £2/5, post extra; send us your requirements. [2283]

COLUPHONE, Radio, New London, nr. Preston.—New goods only. Tungstran valves, English and Amer. rectifiers, 10/6; mains transf., 350v 100mA, 4v 6A, 4v 2½A, 32/6; 350v 120mA, 6.3v 3A, 5v 3A, 33/6; mains trans, bobbins, std rep Eng. and Amer., 18/6; Rola p.m., less transf., 5in 20/-, 6½in 22/-, 8in 24/-, 10in 29/6; Celestion 8in p.m. with trans. 30/-; cored solder, 4/6 lb; tin. cop. wire, 2/3 1½lb.; 2mm Systoflex, 3d. yd.; Barr, resist., 6/-; line cord replace, resist., 800 ohm, 2 adj. taps, 6/9; Paraflex I.I. transf., 4:1, 5/-; 50mfd 12v 2/-, 25mfd 25v 2/-; Eric resist., 1w 9d., ½w 6d., ¼w 4d.; pushback wire, 100ft 6/-; switch cleaner, 2/3 bott.; power-pentode out. trans., 7/6; bell transf., 6/6; valveholders, 1d. per pin; Stanelco el. solder, irons, 21/-; tub. and mica cond., V cont., with sw. 5/9, less sw. 4/9; 450w. iron elements, 2/3; s.a.c. or stock list. [2261]

RECTIFIERS.—"Trickle charger rectifiers, 2v. half amp, with transformer, make up a splendid trickle charger for 2v wireless cell, full instructions, 13/6, postage 7d.; instrument type rectifiers for meters, bridge type, bakelite, very good make, new goods, 1 ma, 18/6. 5 ma, 10 ma, 50 ma 15/6, postage 3d.; electrolytic condensers, T.C.C., cardboard type, 24 mfd 250v working, also 40 mfd 250v working, 15/4 the two, post free, not sold separately. Microphones.—Rothermel "Bullet" microphones, still the best value in crystal mikes, black crackle finish, headlamp shape, £3; Rothermel D.104 crystal mikes, a superior finish microphone at a moderate figure 95/-, stands available; also well-made moving coil microphones, very massive construction, fine response, 95/-; miniature crystal deaf aid mikes, with clip for lapel, 42/6; Rothermel Senior bakelite crystal pick-ups 78/6.—Champion, 42, Howitt Rd., London, N.W.3.

SOUTHERN RADIO'S wireless bargains: Screws and nuts, assorted gross of each (2 gross in all), 10/-; soldering tags, including spade ends, 6/- gross; Philco 3-point car aerials, excellent for short-wave and home aerials, 7/6; Limit tone arms, universal fixing for all types of sound boxes and pick-up heads, 10/-; Ace "P.O." microphones, complete with transformer, ready for use with any receiver, 7/-; circular magnets, very powerful, 1½in diameter, by ½in thick, 1/6 each, 15/- per doz.; Eric resistances, brand new, wire ends, all low value from 0.8 ohms upwards, a few higher value are included in each parcel, 1, ½, 1 and 2 watt, 100 resistances for 30/-; Multicon Master mica condensers, 28 capacities in one from 0.0001, etc., etc., 4/- each; special assorted parcel for service men, 100 Eric resistances (description above), 24 assorted tubular condensers, 6 reaction condensers, 0.0001, 12 lengths insulated sleeving, 75ft. push-back connecting wire, soldering tags, screws, wire, etc., 65/-, all brand new; crystals (Dr. Cecil), 6d., with cats-whisker, 9d.; complete crystal detectors, 2/6; 75ft. wire for aerials, etc., 2/6; 25yds push-back wire, 5/-; Telsen reaction condensers, 0.0001, 1/9 each; Telsen large disc drives, complete with knob, etc. (boxed), type W 184, 2/6 each; insulated sleeving, assorted yard lengths, 3/6 doz.; single screened wire, doz. yards, 10/-; loud speaker units, unshrouded, midjet type, 4/-; metal case condensers, 0.1 -0.1+0.1, 2/6; rheostats, power type, 30 ohm, 4/6; pointer knobs, black and brown, ½in, 1/-.—Southern Radio Supply Co., 46, Lisle St., London, W.C. Gerrard 6653. [2152]

Polarised Relays



Air Ministry type, high speed (V.F.) Relay A modern instrument in cast alloy case, 2½in. dia. x 4½in. high. The Relay is mounted on high-grade Paxolin base, 2½in. x 2½in. x ½in. with 8 pins for connecting. It is polarised by a 3in. horseshoe magnet. Separate adjustments are provided for magnetic bias on armature. Large size operating coil with double windings 24 ohms and 13,500 ohms; alloy armature carries double contacts providing single-pole change-over switching with large adjustable fixed contacts. All contacts are of platinum and will carry 60-watts non-inductance load.

All contacts, windings and metal case are insulated from each other and brought out to pins on Paxolin base. The actuating current is 8 volts at 0.6 ma.
Speed approx. 100 c.p.s. Price **£3.5.0**

Special Offer

METAL CASED CONDENSERS

Approx. 350 volts

4 mfd. 4 × 1½ × 2in.	... 6/6
2 mfd. 4 × 1½ × 1½in.	... 4/6
2 mfd. 4 × 1 × 1½in.	... 2/6
2 mfd. 2½ × 1 × 1½in.	... 2/6
Also 250 mfd. 25 v. in bakelite case	... 2/6

GOODMANS P.M. SPEAKERS, without transformers 5in., 21/-, 8in., 30/-, 10in., 47/6. Post and packing, 1/6 each extra.

MAINS TRANSFORMERS

Input 200/250 v. AC, 350-0-350 v. 120 m.a., 4 v. 2 a., 4 v. 3 a., 6.3 v. 4 a. Weight 11 lbs., 42/6.

H.M.V. TRANSFORMERS. 5,000 v., 26 v. tapping, 12/6.

TWIN SCREENED PICK-UP LEADS, fitted 2 plugs, 8ft. 6in. long, 2/9.
See our classified Advt. on p. 28.

LONDON CENTRAL RADIO STORES

23, LISLE STREET, LONDON, W.C.2
GERrad 2969

SEXTON'S for RADIO SERVICE

ELECTRIC SMOOTHING IRONS, for 100/110 volt, 200 220 volt, 230/250 volt AC/DC mains, 3-3½lb. weight, strong wooden handle, with plated thumb rest, dome, connector guard and rest, ground and polished sole plate, complete with 6ft. 3 core flex at 28/6 each, including Purchase Tax and postage. Please state voltage when ordering. Limited quantity available.

WHY NOT BUILD YOUR OWN RADIO RECEIVER: A Four-Valve Universal Mains Medium Wave radio can be easily constructed at home from many of the odd components that you as a radio enthusiast will undoubtedly have, or which are readily obtainable from practically any radio dealer. We offer to you comprehensive instructions at 5/- per set, which contains theoretical circuit, point to point wiring diagram, component layout and list of the components with the correct specified values that are necessary to build "The VICTORY UNIVERSAL FOUR." Frankly you will be amazed at the performance of this midjet radio when comparing with the high price sets at present on the market.

BRIVARON BRITISH MADE VALVES. American types: 80, 5Y3, 5Y4, 5 volt rectifiers, RF.120 4 volt rectifier, type RF.30 equivalent to 1D5, URIC at 11/- each.

HAND CRYSTAL MICROPHONES, with 7ft. screened cable, manufactured by Brush Crystal Co., Ltd., at £3.3s. each.

GOODMAN'S 3½IN. P.M. SPEAKERS, 12 ohms voice coil, ideal for microphones, communication sets at 30/- each.

TERMS: Cash with Order only. Send 1d. stamp and S.A.E. for list of appliances, valves, etc.

J. E. SEXTON & CO. LTD.
164, Gray's Inn Road, London, W.C.1.
Tel: Terminus 1304 & 4842.

"UNIVERSAL CIRCUITS"

by R. S. Roberts, M.Brit.I.R.E., A.M.I.R.E.

Three folders and a thirty-six page booklet, presenting the main principles of radio circuit operation in a concise and convenient form for the pocket.

- I. The Transmitter.
- II. The T.R.F. Receiver.
- III. The Superheterodyne Receiver

By means of hinged flaps, the charts give a large number of recognised alternatives for each stage. To assist the student in memorising and understanding these, a logical five-colour scheme has been adopted throughout.

"Grid Leak" says: "The Charts and Notes are really intended for students and teachers of radio, but are extremely useful to every radio engineer."

Price complete 6/3 post free, from

The Bookstall
NORTHERN POLYTECHNIC
HOLLOWAY, LONDON, N.7

COVENTRY—
RADIO

COMPONENT SPECIALISTS SINCE 1925.

- COIL FORMERS, 6 asst. small sizes 1/6
 - P. TYPE COILS, S, M, or L Wave, Aerial or Oac. 2/6
 - SWITCHES, 4-pole, 3-way, suitable for P. coils 4/3
 - SWITCHES, Q.M.B. Toggle. D.P., 3/9. S.P. 2/9
 - I.F. TRANSFORMERS, 465 kc., screened, 1st grade. 7/6
 - CONDENSERS, 20 asst., 25 pf. to 25 mid., T.C.C., etc. 12/6
 - RESISTORS, 20 asst., 1/4, 1 and 2 watt, Eric, etc. 12/6
 - L.S. TRANSFORMERS, 80 m/a., power-pentode. 10/-
 - VOLUME CONTROLS, less Switch 3/9 and 4/9
 - METAL RECTIFIERS. Combined HT/LT 20/-
 - BOLA P.M. SPEAKERS, 5in., 6 1/2in., 8in. from 2/-
- LATEST LIST of Components, including Mains Transformers, Gang Condensers, Trimmers, Slewings, Instrument Wire, Resistors, Flex. Condensers, Pilot Lamps, etc., sent on receipt of I.D. stamped envelope.
5,000 B.V.A. VALVES always in stock.
Terms: CASH WITH ORDER. Post paid over £2.

THE COVENTRY CO.,
191, DUNSTABLE ROAD, LUTON.

Radio Service

REWINDS. Mains from 25/-. Output from 6/-, Field Coils, 9/-, PROMPT DELIVERY.
VALVES (B.V.A.). Send for list—good selec.
PHILIPS D.C. CONVERTERS—Bought—Sold—and Exchanged.
S.A.E. to—

A.D.S. Co., 261/3/5, Lichfield Road,
BIRMINGHAM, 6.

VALVES, ETC.

Tungram Valves
DDT13 (equiv. to Mullard TD13C) and DDT13S (equiv. to Mullard TD13), 9 G. Tunggram P215 (equiv. to Mullard PM2) and SP22 (equiv. to Mullard PM20), 6/-, Philo types 1A3E and 1B4E (battery screened grid valves), 9/-. Fixed Condensers, wire-end, 6/- doz.; tag or terminal type, 4/- doz. Resistors, 1/2-watt, 4/- doz.; 1 watt, 6/- doz. assorted. British Glass Barretters, exact equiv. to Philips CIC, Marconi 202 and Tunggram BR201, 9/-. Parcels of Assorted Components, approx. weight 10-12 lb., £1.
Satisfaction Guaranteed. Post and packing extra, stamp with enquiries please. **E. H. ROBINS TRADING CO., LTD.**
44 Kyle Crescent South, Whitchurch, Glam.

WARD ROTARY
CONVERTERS

Petrol Electric Generating Plants, H.T. Generators, D.C. Motors, Frequency Changers, etc., up to 25 K.V.A.

CHAS. F. WARD

37, WHITE POST LANE, HACKNEY WICK, E.9
Phone: Amherst 1393

"SYSTEMATIC RADIO SERVICING"

A method for organising the repair-shop, devised and employed by J. Bull. Also a catalogue of many Radio Service Aids including "History of Faults," "Job Cards," which almost repair the sets, "Valve Base Data Cards," and perhaps most important, a Rectifier which will replace any of the popular Universal valves such as 12Z3, 25Z5, 1D5, U30, 40SUA, etc. Price 1/7 p.f.

V.E.S.,

(W) Radio House, Melthorne Drive, Ruislip, Mdx.

G. A. RYALL, 69, Wharfedale Gardens, Thornton Heath, Surrey.—Please note new temporary address; mail order only; no c.o.d. under 20/- please.

ERIE resistances.—1/2W, 680 ohms, 3/4 doz.
T.C.C. 0.1 non-induct. tubul. condensers, in wax tubes, type 330, 350v wks., 7/6 doz.
SLOW motion (epicycle) drives, in well-finished brass, ratio 8-1, shaft 1 1/2 in long, 1/4 in dia., drilled to take pointer, 1/3 each.
PAXOLIN strip, 2 1/2 in wide, 12 in lengths. 3 1/6 and 400 25/-; short lengths cut group board size, 6 1/3.

THIMBLE top caps, 24 1/3; insulating tape, black, 1 1/3 lb; Weaire switches, ebonite with silver-plated contacts, for 2H and band pass with dial lights, 1/6 each.
YAXLEY switch screens, size approx. 4in x 3 1/2 in, drilled mtg. flange, 3 for 1/3.
5-PIN plugs and sockets, complete with metal insulated cap, 2 for 1/6.
DIAL plates, oblong, 5 1/2 x 2 1/4 approx., Burndept. Varley, Vidor, with station names, 4 assorted for 1 6.

BURNDIPT portable set dials, 4 1/2 in x 2 1/2 in approx., two types, 2, 1/3; Burndept 4-band, 8x5 1/2, s.w. on lower half dial, 1/6 each; Vidor 3-band, 6 1/4 x 5 1/2, 1/6 each.

COILS, iron core midget, Litz wound, medium wire tapped, no reaction, 2/3 each; push-back wire stranded, cotton covered, 3 colours, 12 yards, 2/3.

T.C.C. double 0.001 x 0.0001 mica condensers, 3, 1/3; Hunt's 0.01 mica, 1/- each; twin rubber flexible, one cover, for essential replacements, 5 yards, 7/6.
MICROPHONE capsules by Standard Telephones, 3/9 each; Centralab volume controls, less switch, long spindles, 5,000 ohms, 1/2 meg, 1/2 meg, 3/9 each; unused 10-way flexible stranded wire, 2/- yard.

CENTRALAB volume controls, short spindle, 1/2 meg, less switch, unused, 2/10 each; twin screened, flexible, 1/3 yard; ditto, high insulation and cotton outer cover, 1/9 yard; ditto, 4-way, 2/3 yard.
ERIE colour coded resistances, 2-watt type, 680, 6,800, 140,000, 150,000, 220,000, 470,000, 820,000, 2, 1/6; Erie 3-watt, 680, 6,800, 1/3 each; wound ebon. bobbins, 5,000 ohms, slotted to take Hiflux iron, 100v, 1/3 ea.

AUSTERITY RADIO, Ltd. (formerly F. II. Wilson), new address, 307, High Holborn, W.C.1.

CONDENSERS, tubular, 0.0005 in fd to 0.005, 6d. each; 0.02 to 0.01, 9d. each; silver mica, 0.00015, 0.0002, 0.0005, 0.00005 in fd., 9d.

VALVE holders, 4-, 5-, 6-, 7-pin Paxolin, 6d.; International Octal, 9d.; Octal cable plug and socket, 2/-; 5-pin cable plug (to fit standard 5-pin English valve holder) with 5 coloured leads, 2/-.

PAXOLIN, polished, flat, strong, 18 x 2 1/4 x 3/32nds approx., 1/6; soldering tags, 3d. dozen; terminal strips, from 3d. to 9d.; eyelets, 1/2 to 1/6 gross; resistors, 1/2w, 6d.; 1w, 1/- each, most values available; Spiro clips, 2 a 1d.; flexible coupling joints, large, 1/-; dial lamp holders, 6d.; Systoflex, coloured, plain and striped, 4d. per yd lgth.

See also our display advt. on p. 31.
AUSTERITY RADIO, Ltd., note new address, 307, High Holborn, W.C.1. Holborn 4631. [2292]

Wanted
WANTED, Marconi push pull input transformer, 292.—Box 2993. [2236]

URGENTLY required, quantity Colvern screened adjustable i.f. transformers, construction two bakelite bobbins, sliding and clamping by rotation on ribbed pillar; type and condition of windings immaterial.—Box 3004, c/o Wireless World. [2280]

VALVES
5000 valves, all types, including output, rectifiers, etc., s.a.e.—Davies, 28, Mount Vernon Crescent, Barnsley. [1848]
2000 valves, British and American; send stamped, addressed envelope for list.—Napiers, 127, Prestwick Rd., Ayr. [2258]
400 new boxed valves for sale, preferably in one lot; over 80 types of well-chosen stock; list if required; list price, less 30%, plus tax.—Box 3009. [2303]

OUR adaptors will help in replacing un-obtainable valves; send 7d. for interesting booklet on valve replacements; trade enquiries invited.—V.E.S., Radio House, Ruislip. [1885]

SPECIAL offer.—Aorns, 954, 955, 956, at 50/- each; also 1852 (6AB7), 1853 (6AC7) at 21/- each; order c.o.d. immediately; stock limited.—J. Bull and Sons, 246, High St., Harlesden, N.W.10. [2315]

ENGINEERING OPPORTUNITIES



This unique handbook shows the easy way to secure A.M.I.Mech.E., A.M.Brit.I.R.E., A.M.I.E.E., City and Guilds, etc.

WE GUARANTEE—
"NO PASS—NO FEE."
Details are given of over 160 Diploma Courses in all branches of Civil, Mech., Elec., Motor, Aero, Radio-Televison and Production Engineering, Tracing, Building, Govt. Employment, R.A.F. Maths, Matric., etc.

Think of the future and send for your copy at once—FREE
B.I.E.T., 387, SHAKESPEARE HOUSE
17, STRATFORD PLACE, LONDON, W.1.

LOW VOLTAGE BULBS

FOR ALL PURPOSES

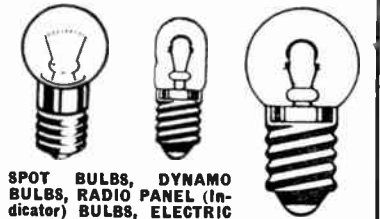

SPOT BULBS, DYNAMO BULBS, RADIO PANEL (Indicator) BULBS, ELECTRIC LAMPS, TORCH CASES, BATTERIES.

SUPEX LAMPS LTD.
Appointed B. O. T. IMPORTER SELLING AGENTS
50, GRAY'S INN ROAD, LONDON, W.C.1.
Tel.: HOLBORN 0225

HILL & CHURCHILL
BOOKSELLERS

SWANAGE DORSET

ENGLISH & AMERICAN
BOOKS IN STOCK ON
RADIO AND
TELECOMMUNICATION
CATALOGUE ON APPLICATION

The Season's Compliments
to users of the
COIL PICK-UP
at home and overseas.
H. H. JONES, 62, Worcester St.,
STOURBRIDGE.

TESTOSCOPE



Makes 30 important tests A3/DO. Used everywhere by Electricians, Wireless and Service Engineers. Interesting booklet "E14" on testing, free. From all Wholesalers or direct.
RUNBAKEN -- MANCHESTER -- I

10/- ea.—Clearing stock h.f. pens., freq. changers, P.D.T.s, etc., FC13, FC4, MX40, VMP4G, VP4B, DLI, 6A7, AC/VPI, etc.; triodes, MH4, AC/HIL, etc., 7/6; c.o.d. 6d. extra; no recs. or output pens.—65, Carlton Mansions, Randolph Ave., London, W.9. [2276]

VALVES—Mullard AZ1, DW4/500, EBL1, FC4, IW4/500, PenA4, PM2BA, TDD4, VP4B, FCH35, EF39; Brimar 6A7, 6A8GT, 6F6G, 6K7G, 6Q7G, 9D2, 25A6G, 25Z4G; Marconi D63, KT33C, KTW63, MH41, MHL4, X41; Mazda AC/HLLD, AC/VPI, HL2, HL23, HL22, HLI320, 8215VM, Pen45DJ, SP25, VPI320, TH41, TP26, UUS, VP24, VP210, VPI322; sent c.o.d.—Larg's, 24, Whitehall St., Dundee, Angus. [2238]

VALVES—We have over 5,000 new and boxed English and U.S.A. mains and battery valves in stock, including 6A7, 6A8, 25Z4, 75, 5Z4, U50, 35Z5, 50L6, 35L6, 6F6, FC13c, VP2, 8P4, PX4, PENAA, AC2PENID, TDD4, UUS, 6K7, 11Z76, 6Q7, 6K8, 6X5, 6B8, IW4, 350, U12, 12A8, 12Q7, 6SA7, 6SK7, PEN36c, etc., etc.; send us your requirements.—Lasky's Radio, 370, Harrow Rd., Paddington, W.9 (opposite Paddington Hospital). [2282]

1000 valves in stock.—PM22A, 11/-; Pen A4, 12/10; Pen 4DD, 15/3; 2D4B, 6/9; TH2321, 14/-; AC5/PenDD, 15/3; FC13, 14/-; SP13C, 12/10; AC/TP, 14/-; UUS, 11/-; 431U, 11/-; IC5GT, 11/-; IHS6T, 11/-; DLI, 11/-; 80, 11/-; 45, 11/-; CL33, 12/10; CL4, 12/10; CBL1, 15/3; U50, 11/-; DC2/Pen, 30/5; 35Z4G, 11/-; 25Z4G, 11/-; 12J5GT, 9/2; 6Q7GT, 11/7; 128Q7GT, 11/7; send s.a.e. for valve and wireless parts lists. 2d.—Ransom, 9 and 34, Road St., Brighton. Retailers not supplied.

VALVE, British and American, many types in stock; Midget aerial and h.f. coils, medium and long waves, ideal for midget t.r.f. receivers, 11/- per pair; Midget 2-gang 0.0005mfid variable condensers, fitted slow motion drive, 12/6; Midget receiver chassis, drilled for four valves, 10 1/2 x 6 x 2 1/2 in., grey, first class, heavy quality, 9/6; superior quality smoothing chokes, heavy duty, 120 m.a., 200 ohms, 15/-; 80 m.a., 500 ohms, 12/6; midget, 270 ohms, 50-60 m.a., 8/6; midget knobs, highly polished black, and standard knobs, 9d., 8/- doz.; 2-way screened leads, braided insulation, 54in., fully finished, terminating four plugs, for mike, gram., amplifiers, etc., 3/-; wire-wound potentiometers, 2,000 ohms, 6/6; condensers tubular wire ends, 350v working, 0.1 and 0.01mfid, 7/6 doz; screws and nuts, 4BA, round, 3/6 gross; superior quality line cord, 50 ohms per foot, 0.3 amp, 3-way 6/- yard, 2-way ditto 5/- yard; universal mains droppers, for all receivers; 1,000 ohms, 0.2 amp., fitted two variable taps, 4/6; 750 ohms, 0.3 amp., do. taps, 5/6; dials, three wavebands, station names, etc., coloured, 7 x 3 1/2 in., 1/6; a few electrolytic condensers still available; full range speakers, sleeving, etc., etc.; licence to export to N. Ireland; lists available; stamped and addressed envelope with all enquiries, please, postage on all orders.—O. Greenlick, 34, Bancroft Rd., Cambridge Heath Rd., London, E.1. Steney Green 1334.

Wanted

WANTED urgently, 1G4, 1G6, driver and class B tubes.—Wybridge 2332. [2267]

NEW boxed valves wanted, any quantity, dealers' and service men's complete stocks sought.—J. Bull and Sons, 246, High St., Harlesden, N.W.10. [2155]

REPAIRS AND SERVICE

REPAIRS to the trade, own transport needed.—Cathodine Radio Service, 134A, South Ealing Parade, W.5. Tel. 1368. [2157]

MIDWEST, McMurdo, Belmont, Crosley, Ferguson, etc., valves; the American exnerts.—Bennett's, 4, Humberstone Drive, Leicester. [2302]

METROPOLITAN RADIO SERVICE Co. guaranteed repairs to American and British receivers.—1021, Finchley Rd., N.W.11. Spe. 3000. [9641]

All types of radio receivers serviced, Murphy and Pilot specialist, valves in stock, sound repairs for 13 years.—T. E. Feyver, F.I.P.R.E., 50, Vine St., Uxbridge. [2253]

RADIO repairs, amplifiers, mikes, l.s. meters, etc., workmanship guaranteed; send by rail, pack safely; for public and special prices to trade.—L. E. Healey, 125, Old Rd., Clapton, Tel. 105. [2272]

SERVICE with a Smile.—Repairers of all types of British and American receivers; coil rewinds; American valves, spares, line cords.—F.R.L., Ltd., 22, Howland St., W.15. Museum 5675.

MAJESTIC diagrams and service details of most popular 1930 to 1940 models, supplied exclusively to radio service engineers; price £2/2 post paid.—(Dept. W.) International Majestic Radio Corporation, Ltd., 6, Angel House, Angel, London, N.1. [2211]

AUSTERITY RADIO LIMITED

Formerly F. H. Wilson
CONSTRUCTORS' KITS

3-v. T.R.F.

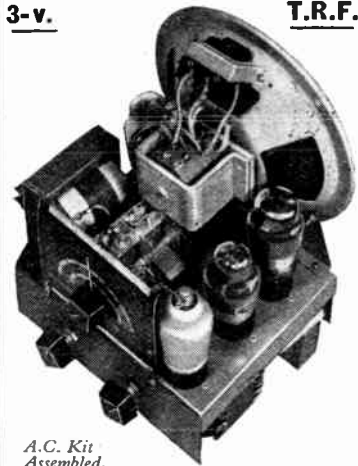

A.C. Kit Assembled.

When assembled these Kits give excellent reproduction on Medium and Long Waves. Supplied complete with chassis 9in. x 6 1/2 in. x 2 1/2 in., Valves, M.C. Speaker and wiring diagram. (Regret, no cabinets.) 3 controls, A.C. 3-V. (+ RECTIFIER) KIT. V.M.H.F. Pen., Triode, L.F. Pen., Rectifier, M.C. Speaker. Price 10 gns. Post 1/1, plus 3/6 packing (returnable).

BATTERY 3-V. KIT. V.M.H.F. Pen., Triode Detector and Output Tetraode, P.M. Speaker. Price 27. Post 1/1, plus 3/6 packing (returnable).

3-GANG CONDENSERS, ceramic insulation, .00025, 7/6; .0005, with trimmers, 10/6.

AERIAL AND H.F. TRANSFORMERS with reaction medium and long waves. Iron cored on medium waves loading coil on long waves. 10/- per pair.

A. & H.F. TRANSFORMERS with reaction colour coded. 10/6 a pair.

SCREENED DUAL RANGE COILS, Louk and Medium. Aerial and H.F. Transformers with reaction. Size 2 1/2 dia. x 3 1/2 in. Iron-cored on medium wave only. With circuit blue print. 12/6 a pair.

465 KCS. I.F. TRANSFORMERS. Air-cored, screened, with trimmers. 15/- a pair. 465 KCS permeability tuned. Iron-cored, screened. 15/- a pair.

UNIVERSAL MAINS TRANSFORMERS, A.C. input, 230 v. output, 300-0-300, 6.3 v., 4 amp., 5 v., 2 amp., 4 v., 2 amp., 4 v., 4 amp., 80 m.a. Screened primary colour coded—a good replacement transformer, especially for sets using inlaid valves, 32/6 each.

STANDARD REPLACEMENT MAINS TRANSFORMERS, input 200/250 A.C., output 350-0-350, 80 m.a., 4 v., 4 amp., 4 v., 2 amp. Screened primary, 30/- each.

STANDARD MAINS TRANSFORMERS, input 200/250 A.C., output 350-0-350, 160 m.a., 6.3 v., 5 amp., 5 v., 2 amp., 35/- each.

10-WATT WIRE-WOUND RESISTORS, 2,000, 1,000, 500 and 150 ohm, 2/6 each.

PADDERS, Twin ceramic .0005 infd. and .001 infd. (max.), 2/6 each.

VOLUME CONTROLS, 1 meg., with switch, 6/6 each. 25,000 and 50,000 ohms, less switch, 4/- each.

COMBINED VOLUME CONTROL, 100,000 ohms and Reaction Condenser, 6/6.

CHASSIS, Undrilled steel, painted, new, 10 1/2 x 8 x 2 1/2 in.; 7/6; 8 x 6 x 2 1/2 in., 4/6 each.

Please add postage for enquiries and orders. C.O.D. orders accepted.

Licence to export to Northern Ireland and Eire (owing to present circumstances, prices are subject to increase without notice. See our Classified Advt. on page 30).

307, HIGH HOLBORN, LONDON W.C.1. Phone: HOLborn 4631

MAINS transformers service, repairs, re-winds, or construction to specification of any type, competitive prices and prompt service.—Sturdy Electric Co., Ltd., Dipton, Newcastle-upon-Tyne. [9651]

DEGALLIER'S Ltd.—"Service with a guarantee." If you cannot get your receiver serviced, let American specialists do the job; first-class workmanship only; specialising in Air-King, Belmont, Challenger, Delco, Detroit, deWald, Emerson, Ferguson, Garod, Halli-crafter, Hammerlund, Lafayette, Meisner, McMurdo, Midwest, Majestic, Pilot, Philco, Player, Sparton, Stronberg-Carlson, Wells-Gardner, etc., also any British set; remember, for 14 years we have handled all distributors American receivers; this is self-explanatory; s.a.e. with all enquiries.—Degallier's, Ltd., 9, Westbourne Court, London, W.2.

MISCELLANEOUS

WANTED, Synchronic Master, seconds pendulum; state condition and price.—BM/FAM3, W.C.1. [2242]

WANTED, amateur type Iconoscope or Monoscope; state price.—Patchett, 1, Leafhill Grove, Eccleshill, Bradford. [2278]

RUBBER stamps made up to your special requirements, and design, typical example, stamp showing name, address and profession; 9/6 post free.—V.E.S., Radio House, Huislip. [1884]

BUILD your own wind charger; compact, balanced turntables (with adjustable "strap" to take any car dynamo), tail post, etc., on hefty mast bearings, limited number only, 18/6; post and box 1/6.—Barham, Hill-ton, Bradmore Green, Coulsdon, Surrey. [2252]

NIFE nickel cadmium alkaline batteries.—Quantity alkaline cells, 70 ah to 300 ah capacity, types L, 8 and T, suitable for lighting plants, traction, starter batteries, etc.; also 1,500 yards multi circuit cable, consisting of 14 separate rubber insulated t.c. conductors, each 1/0.036in., whole compounded, t.r. insulated and braided; write for list; trade supplied.—Mathew Bros., 25, Sandy Lane North, Wallington, Tel. 4050. [2319]

SITUATIONS WANTED

ENGINEER—Transmitters, com. receivers, facsimile, teleprinter, all intricate electro-mechanical apparatus; highest ref.—Box 3018. [2320]

SERVICE engineer-manager, exempt military service, at present employed provinces, seeks post London area; highest references.—Box 2995. [2243]

ADVERTISER, ex War Office technical instructor, seeks engagement, experienced electrical, mechanical repairs, also sound film apparatus, P/A equip., tele., radio, etc., initiative, controlling staff, excel. driver.—Box 3016.

TECHNICAL TRAINING

A.M.I.E.E., City and Guilds, etc., on "No pass—no fee" terms; over 95% successes. For full details of modern courses in all branches of electrical technology send for our 112-page handbook, free and post free.—B.I.E.T. (Dept. 388A), 17, Stratford Place, London, W.1. [2265]

GREAT possibilities exist for technically qualified engineers, key men in wartime and afterwards. Through the home-study courses of the T.I.G.B. take a recognised engineering qualification, such as A.M.I.Mech.E., A.M.I.E.E., A.F.R.Ae.S., A.M.I.Chem.E., C. and G., etc., in which examinations the T.I.G.B. students have gained 25 FIRST PLACES and hundreds of passes. Write today for "The Engineer's Guide to Success"—free—containing the world's widest choice of engineering courses covering all branches, including aeronautical, mechanical, electrical, wireless, chemical, etc.

THE TECHNOLOGICAL INSTITUTE OF GREAT BRITAIN, 82, Temple Bar House, London, E.C.4. [1403]

PATENT NOTICES

THE proprietor of the patent No. 512141 for improvements in or relating to radio receiving sets is desirous of entering into arrangements by way of licence and otherwise on reasonable terms for the purpose of exploiting the same and ensuring its full development in this country.—All communications should be addressed in the first instance to Haseltine, Lake and Co., 28, Southampton Buildings, Chancery Lane, London, W.C.2. [2232]

THE proprietor of the Patent No. 525135 for improvements in or relating to combined article of furniture and radio receiving set is desirous of entering into arrangements by way of licence and otherwise on reasonable terms for the purpose of exploiting the same and ensuring its full development and practical working in this country.—All communications should be addressed in the first instance to Haseltine, Lake and Co., 28, Southampton Buildings, Chancery Lane, London, E.C.2.

TUITION

LEARN Morse code the Candler way.—See advertisement on page 28. [1292]

RADIO training.—P.M.G. exams. and I.E.E. Diploma; prospectus free.—Technical College, Hull. [0611]

COACHING for P.M.G. examinations; 150 typical 1st and 2nd class technical questions, price by post 5/-.—The North Eastern School of Wireless, 69, Osborne Rd., Newcastle-upon-Tyne, 2. [2081]

RADIO Engineering.—Television and Wireless Telegraphy, comprehensive postal courses of instruction. Apply British School of Telegraphy, Ltd., 179, Clapham Rd., London, S.W.9 (Estd. 1906). Also instruction at school in wireless for H.M. Merchant Navy and R.A.F. [9249]

ENGINEERING Opportunities.—Free 112-page guide to training for A.M.I.Mech.E., A.M.I.E.E., and all branches of engineering and building; full of advice for expert or novice; write for free copy and make your peacetime future secure.—B.I.E.T. (Dept. 387B), 17, Stratford Place, London, W.1.

THE Tuitionary Board of the Institute of Practical Radio Engineers have available home study courses covering elementary, theoretical, mathematical, practical, and laboratory tuition in radio and television engineering; the text is suitable coaching matter for I.P.R.E. Service-entry and progressive exams; tuitionary fees—at pre-war rates—are moderate.—The Syllabus of Instructional Text may be obtained post free from the Secretary, Bush House, Walton Avenue Henley-on-Thames, Oxon. [1462]

RADIO SPARES

MAINS TRANSFORMERS. Primaries, 200/250v. Secondaries, 350-0-350v.	
Type 1C. 100 ma., 4v. 6a., CT, 4v. 2ja.	31/-
Type 46. 120 ma., 4v. 6a., 4v. 2ja.	35/-
Type 63. 120 ma., 6.3v. 5a., 5v. 2ja.	35/-
Type 106. 100 ma., 6.3v. 4a., 5v. 2ja.	34/-
Type 180. 180 ma., 4v. 4a., 4v. 6a. CT.	39/6
AUTO TRANSFORMERS. 110/200-250v. 100 watts	30/-
OUTPUT TRANSFORMERS.	
Heavy Duty Pentode, 100 ma.	13/6
25/30 ma., Midget	9/6
Battery	6/6
CHOKEES. Smoothing.	
20 Henries, 100 ma.	12/6
RESIN CORED SOLDER. Per lb. reel	5/6
MAINS DROPPING RESISTORS.	
2a. 950 ohms, 60; 3a. 900 ohms.	6/9
Fitted with sliding clip and provided with feet for chassis mounting.	
LINE CORD.	
3 way 3a. per yard	7/-
2 way 2a. per yard	5/3
FIELD COILS, HEAVY DUTY, 1,500 ohms.	
2,000 ohms, 2,500 ohms, 6,500 ohms.	12/-
Delay in delivery may arise owing to demand, but every effort will be made to despatch as soon as possible.	
PLEASE NOTE. —Orders accepted by post only, and those of 10/- or less should be accompanied by cash. Please include postage with order. Orders over 10/- in value can be sent C.O.D.	

H. W. FIELD & SON
14, Colchester Road, Harold Park, Essex.

VALVES

This is part of our current stock of valves and if all their equivalents were mentioned it would be found that we can supply either the exact valve or a suitable replacement for almost any type. Wherever possible please order C.O.D. Stamp with enquiries, please.

PRICES STRICTLY S.O.T. RETAIL.

2 VOLT BATTERY RANGE.—LD210, 5 10; PM2A, 7 4; FC2A, 12 10; SG215, SP2, VP2, VP2B, 11/- each; Q122B conversion, 19 9; PM22A, PM22M, 11/-.

4 VOLT A.C. RANGE.—2D4A, 6 9; 904V, MH4, 9 2; AZ1, MU14, U10, U31, 11/-; PX4, TDD4, 11 7; MKT4, MVS PenB, ACVP1, PenA4, SP4, VP4, VPB, 12 10; AC7P, AC7H1, 14/-; FC4, TH4, 14/-; PenH4, 14/8; MPT4, 15/-; 84VB, VMS4 conversion, 17 6; AC2PenDD conversion, 19 9.

UNIVERSAL AC/DC.—2D13A, 9 2; URIC, 11/-; TDD13C, 11 7; 8P2, SP13, SP13C, VP13A, 12 10; FC13, 14/-; Pen36C conversion, 17 6.

MAZDA OCTALS.—H123, 5 10; Pen25, VF23, 11 7; H1DD, H133D, 11 7; Pen45, SP41, VP41, 12 10; TH41, 14/-; Q125, 15/3.

MULLARD E TYPES.—EM4, 11/-; EBC3, EBC33, 11 7; EFS, EFP, EFB, EL3, EL33, 12 10; ECH2, ECH35, EFS, EFG, EK2, EL2, EL32, 14/-; EBLL, EBL31, 15 3; EL35, 18 3.

1A4, 15 3; 1A5, 11/-; 1A7, 12 10; 1B5, 15/-; 1C8, 12 10; 1B7, 18 3; 1H5, 9 2; 1H4, 9 2; 1N5, 11/-; 5Y3, 11/-; 5Z4, 11/-; 6A3, 18 3; 6A8, 14/-; 6B8, 15 3; 6C8, 17 6; 6F6, 12 10; 6F7, 14/-; 6F8, 18 3; 6H6, 6 10; 6K7, 12 10; 6L7, 12 10; 6K8, 14/-; 6L8, 18 3; 6L7, 12 10; 6N6, 18 3; 6P6, 15/-; 8Q7, 11 7; 8SC7, 18 3; 8SQ7, 11 7; 8X5, 11/-; 8Z5, 12 5; 11/-; 8D2, 12 10; 10, 18 3; 19Q7, 11 7; 12SF5, 9 2; 12SA7, 14/-; 24, 15/-; 38, 14 9; 37, 15/-; 38, 17 6; 42, 12 10; 46, 15/-; 53, 16 6; 56, 15/-; 57, 14/-; 80, 11/-; 85, 11 7; U52, 18 3.

VALVES & ADAPTORS

In the few cases where we cannot supply the exact valve or equivalent we can get your set going with a valve and an adaptor, the additional cost being 4/6.

SPARES

LINE CORD.—3 amp, 3 core 60 ohms per ft., extremely good quality, 6 9 per yd. **CELLULOSE CEMENT** for speaker, valve and most other repairs, 5/- large tin. **"SERVISOL"** more than a switch cleaner, 5/- tin. **MAINS TRANSFORMERS, 350-0-350 4 volt heaters, 29 3. VOLUME CONTROLS** with switch 7/6. **VALVE EQUIVALENTS CHARTS, 1/7, post free.**

J. BULL & SONS
246, HIGH ST., HARLESDEN, N.W.10.

SHORT postal course for 1st or 2nd class P.M.G. certificates, with occasional optional attendances; Nth. London, 2 mins. station.—BCM/Radiocerts (2), W.C.1. [2240]

A POSTAL training in electrical engineering—power or radio; individual correspondence tuition by highly qualified engineers with wide teaching and technical experience. Elementary or advanced courses. Preparation for recognised examinations. Pre-service training specially arranged.—G. B., 18, Springfield Mount, Kingsbury, N.W.9. [1731]

BOOKS, INSTRUCTIONS, ETC.
WANTED. "W.W." 21st July, 1933, QST Jan. 1930 Oct. 1933.—O'Hefferman, Annesley Hotel, Norwich. [2296]

WANTED. P. R. Coursey's "Electrical Condensers," good price; urgent.—Holden and Hunt, Cox's Lane Wks., Old Hill, Staffs.

WANTED. "W.W." May, Aug. and Dec. 1940, March to Oct. 1941, Jan. to Oct. 1943.—Edwards, 16, Stackpool Rd., Southville, Bristol. [2262]

WEBB'S radio map of the world locates any station heard, size 40x30in., 4/6, post 6d., on linen, 10/6, post free.—Webb's Radio, 14, Soho St., London, W.1. Tel. Gerrard 2089. [9947]

VALVES FOR ALL BATTERY CHARGERS



A limited number of valves available. Please state type required. Also send for list of Battery Chargers and Conversions to Metal Rectification.

Runbaken
MANCHESTER 1

Telephone—ARDwick 2507

AFTER THE WAR!

The advance in Radio Technique after the war will offer unlimited opportunities of high pay and secure posts for those Radio Engineers who have had the foresight to become technically qualified. How you can do this quickly and easily in your spare time is fully explained in our unique handbook.

Full details are given of A.M.I.E.E., A.M.Brit.I.E.E., City & Guilds Exams., and particulars of up-to-date courses in Wireless Engineering, Radio Servicing, Short Wave, Television, Mathematics, etc., etc.

We Guarantee "NO PASS—NO FEE"

Prepare for to-morrow's opportunities and post-war competition by sending for your copy of this very informative 112-page guide NOW—FREE.

BRITISH INSTITUTE OF ENGINEERING TECHNOLOGY (Dept. 388)
Stratford Place, London, W.1

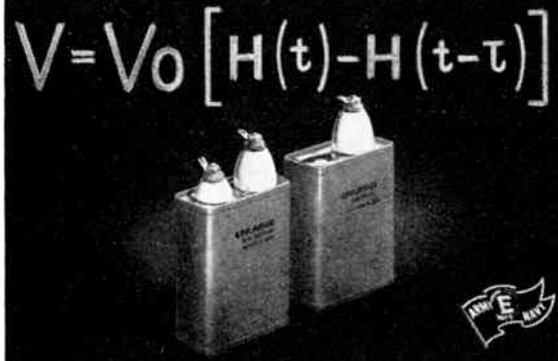

. . and Vo is Anything Upwards of 1 Kv!

If you're dealing with voltages of a kind indicated by the accompanying formula, we don't have to tell you that the job of finding suitable components is difficult, especially if these V's are working into low Z's. More often than not, however, Sprague has been able to meet the need. Typical are the Sprague Type Px-25 "Vitamin Q" Paper Condensers which read "off scale" on megohm bridges at more than 200,000 megohms.

Let us know your Condenser problems. We'll make our recommendations accordingly, telling you frankly and honestly just what you can expect.

* REGISTERED TRADE MARK

SPRAGUE CONDENSERS

Sprague Specialties Co., North Adams, Mass., U.S.A.
103 Grove End Gardens, London, N.W.8

NUMBER
RE SERIES

PRIMER of RUBBER BONDING

1

AN ELEMENTARY EXAMPLE TO PROVE A POINT

OUT-OF-DATE METHOD
of LOCKING rubber

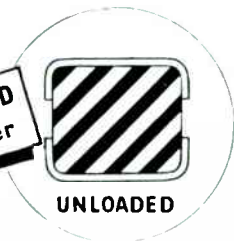

Large rubber volume; no bond between rubber and metal; metal cupped pressings to contain rubber.



Small part of total rubber in work; severe stresses at metal edges; high friction and abrasion potential.



High stress concentration at metal edges; limited "compression" movement.

TO-DAYS METHOD of
BONDING rubber



High duty bond between metal and rubber; stress reducing "pips" at metal edges; precision-moulded with rubber and metal.



Reduced rubber volume; freedom for shear movement within controlled limits; no stress or abrasion concentration.



All rubber in work; freedom from abrasion; controlled deflection; cheap metal parts.

This series, in the form of a PRIMER should be of value to engineers and designers when they are exploring the possibility of embodying rubber as an integral part of engineering systems. We need hardly say that *individual* problems of vibration will receive full consideration if sent to us at Dunstable.



This is an example



RB.18



RUBBER BONDERS' LTD

Engineers in Rubber bonded to metal

FLEXILANT WORKS - DUNSTABLE - BEDS.

Value proved by long service

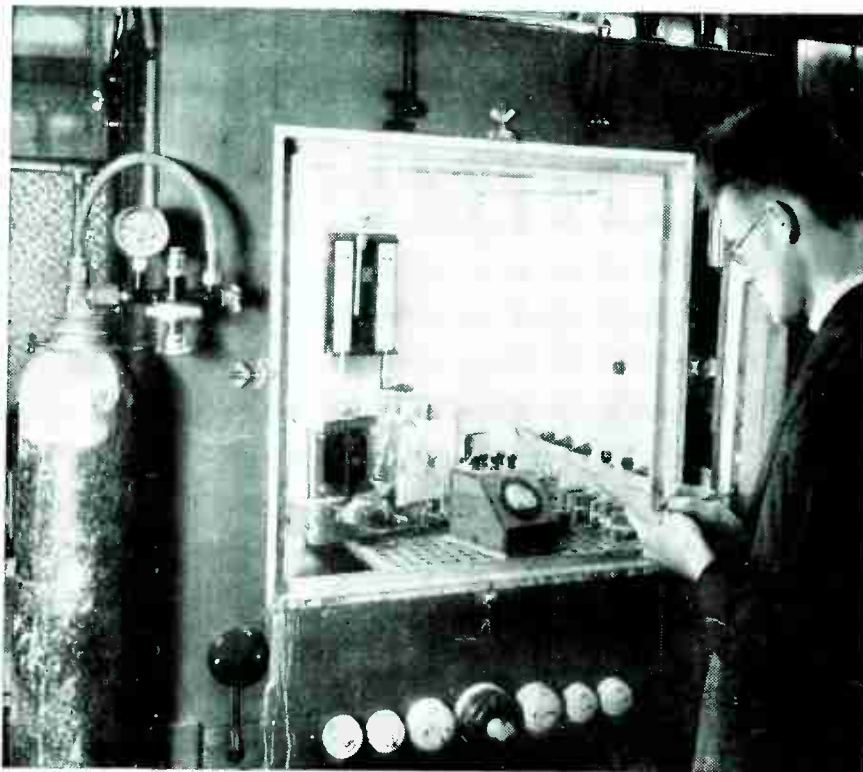

Osram Valves

MADE IN
ENGLAND

Ever since the advent of radio Osram Valves have been closely connected with all the progressive stages of development in radio science. Intensive research still goes on, and improvements in design and technique to keep pace with the advancing times will ultimately be of benefit to all.

Advt. of The General Electric Co. Ltd., Magnet House, Kingsway, London. W.C.2