

SUPERHETERODYNE DESIGN

*Rev Robertson*

The  
**Wireless  
World**

MONTHLY  
ONE SHILLING

**COVERING  
EVERY WIRELESS INTEREST**

SEPTEMBER 1941



THE WIRELESS INDUSTRY'S WAR EFFORT



## CERAMIC TRIMMER CONDENSERS

*for Service & the Services*

Special features include :

- Simple design and small size. Low power factor.
- Perfect mechanical and electrical stability.
- Negligible or negative temperature co-efficient.
- Unaffected by humidity. Linear capacity law.
- Capable of fine adjustment.

Send for interesting Technical Brochure.

CONTRACTORS TO GOVERNMENT DEPARTMENTS  
On A.I.D. APPROVED LIST



# UNITED INSULATOR CO LTD

*The Pioneers of Low Loss Ceramics*

12-16 LAYSTALL STREET, LONDON, E.C.1

Tel: TERMINUS 4118-9

Grams: CALANEL, SMITH, LONDON



*Meters that Matter*

BRITISH MADE

FROM years of intensive research in the design and manufacture of electrical testing equipment has grown the range of world-famous "AVO" Instruments. To-day, wherever rapid precision testing is demanded, there will be found the meters that matter—"AVO" Meters.

46-range Model 7  
Universal AvoMeter

40-range Model 40  
Universal AvoMeter

"Avo" Valve Tester with Universal Panel

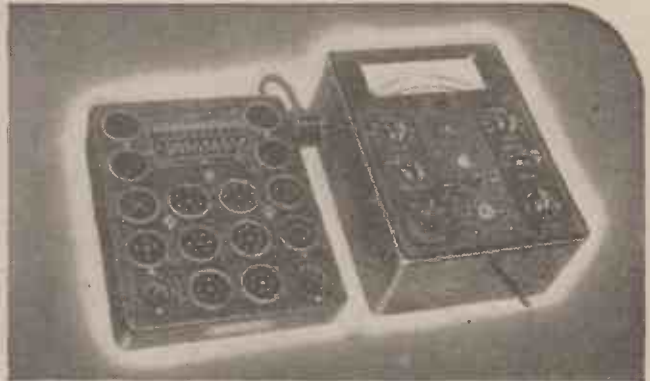
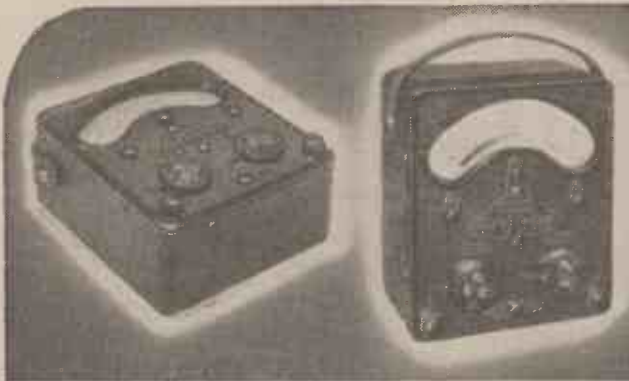

All-Wave "Avo" Oscillator

"Avo" Test Bridge

Universal AvoMinor

D.C. AvoMinor

**OTHER "AVO" INSTRUMENTS  
(Not Illustrated)**

- "Avo" Bonding Meter.
- "Avo" Milliohmmeter.

*Write for literature fully descriptive of any "Avo" Instrument in which you are interested.*

In spite of greatly increased production, most of our output of "AVO" Instruments is being taken by the Services. Delay in delivery of Trade orders is consequently inevitable, but we shall continue to do our best to fulfil your requirements as promptly as possible.

Sole Proprietors and Manufacturers:  
**THE AUTOMATIC COIL WINDER & ELECTRICAL EQUIPMENT Co. Ltd.**  
Winder House, Douglas Street, London, S.W.1. Phone: VICTORIA 3404-7.



# Masteradio

VIBRATORPACKS  
BRITISH EQUIVALENTS OF  
AMERICAN TYPES

A SELECTION FROM THE FULL RANGE OF STANDARD VIBRATORPACKS

TYPE	OPERATING VOLTS	CONSUMPTION AMPS.	OUTPUT VOLTS D.C. UNSMOOTHED	OUTPUT M.A.	TYPE OF RECTIFIER
6A300	6	7	300	100	Sync. Vibrator
6B300	6	7	300	100	OZ 4 Valve
12A300	12	3.5	300	100	Sync. Vibrator
12B300	12	3.5	300	100	OZ 4 Valve
VP554	6	6/7	300-275-250-225	100	OZ 4 Valve
VP552	6	6/7	do.	100	Sync. Vibrator
VPG554	12	3/3.5	do.	100	OZ 4 Valve
VPG552	12	3/3.5	do.	100	Sync. Vibrator
VP553	6	4/5	200-175-150-125	100	OZ 4 Valve
VPG553	12	2/2.5	do.	100	OZ 4 Valve

THE PORTABLE POWER SUPPLY FOR RADIO TRANSMITTERS & RECEIVERS.

PUBLIC ADDRESS SYSTEMS.

SCIENTIFIC APPARATUS.

EMERGENCY POWER SUPPLY SYSTEMS.

Used by:  
The WAR OFFICE  
The AIR MINISTRY  
The POST OFFICE  
and POLICE FORCES.

Proven for long life and reliability under war conditions (in all services, on land, sea and in the air).

Efficiency as high as 70% including rectification.

Size only 5 3/8" x 4 1/2" x 5 3/8" high and weighing only 6 lbs. approx.

Outputs of up to 30 watts from 6 or 12 volts Battery. (Special Vibratorpacks up to 60 watts.)

Write for details :- **MASTERADIO LTD.** VIBRANT WORKS, WATFORD, Herts.  
Grams: MASTIOLA. Phone: WATFORD 9885/9890.

## COSSOR CATHODE RAY APPARATUS

THE DEMAND HAS BEEN SO GREAT for this equipment that all separate components have been sold. We can still offer, however, the apparatus complete with C.R. Tube, in Cabinets as mentioned below. It can be adapted to a variety of purposes, including Oscilloscopes, and those interested in Research and Development should not miss this opportunity, as such apparatus is no longer obtainable through normal channels.

Equipment as illustrated, with C.R. Tube type 3244, diameter approx. 6", complete in Walnut Table Cabinet (12"x21"x16 1/2"). Carr. fwd., plus 2/6 packing ... **£17**

As above, but with C.R. Tube type 3221, diameter approx. 7 1/2", complete in Walnut Pedestal Cabinet (15"x20"x36"). Carr. fwd., plus 2/6 packing ... **£18.50**



Further exceptional offers of Cathode Ray and Radio Equipment.

**POWER PACK AND AMPLIFIER CHASSIS.** Includes heavy mains transformer 350-0-350, 120 m.a. w/4 tappings. High voltage transformer for supplying C.R. Tube. Various condensers including 16 x 16 mfd. 550 v. working, 1-16 mfd. 450 v. working, 50 x 50 x 2 mfd. B.I. Electrolytics, etc. Pentode output transformer; chokes; resistors; trimmers; bias electrolytics; mica and tubular condensers; short-wave coils, etc. The quality of the workmanship and components is of the highest class. **67/6**  
Valve diagram free ...  
Carr. fwd. Add 2/6 for packing.

**TIME BASE CHASSIS.** For 8in. Cathode Ray Tube. Well-made cadmium-plated chassis, size 17in. x 14 1/2in. x 2in., containing approximately thirteen fixed resistors ranging from 15,000 ohms to 1 megohm, five variable resistors, 2,000 to 20,000 ohms, approximately 14 various tubular and electrolytic condensers, also sundry focus and scanning coils and chokes. (Complete circuit and service manual available, price 6d. each.) **30/-**  
Carr. fwd. Add 2/6 for packing.

**CATHODE RAY TUBES (MAGNETIC TYPE).** Not available through ordinary channels. 10in. £5, 12in. £6, 15in. £8. All tubes must be collected by buyer.

**EA50 TELEVISION DIODES.** 6.3 v., 0.15 amp. Limits: Vd. max. 50 v., Id. max. 5.0 m.a., Vd. max. (Id. = plus 0.3 µa) — 1.3 v., Vfk. max. 50 v., Rfk. max. 20,000 ohms ... **10/6**

**VISION UNITS.** To fit on Time Base. Consists of 3 Mullard T.S.E.4 and 1 Mazda D1 Valves. Approximately 25 resistors ranging from 75-75,000 ohms, about 30 condensers of various values, together with Rejector, Grid and various Band Pass Coils, also approximately 10 chokes of various descriptions and W6 Westector. Completely wired and screened. (Complete circuit and service manual available, price 6d. each.) **40/-**  
Post and packing 1/6 ...

**MAINS TRANSFORMERS.** Originally made for Television Power Packs where accuracy and robustness are essential. Weight 12lb., size 5 1/2in. x 4 1/2in. overall. 350-0-350 v. 120 m.a. Tapped. 4 v. 2 a.; 4 v. 8 a.; 3 v. 3 a.; 20 v. 1 a. Diagram free. Post and packing 1/6 ... **25/-**

**HEAVY DUTY MAINS TRANSFORMER.** Input 240 v. A.C. One tapping at 5,000 v. max. 20 amp., and one for supplying filament of Mullard HVR 2 (6.3 v. at .65 amp.) Shrouded in metal box, carr. fwd. **10/6**

**B.I. CONDENSERS.** .1 x .1 mfd. 7,000 volt d.c. test with porcelain insulators ... **20/-**

**4-VALVE 5-WATT AMPLIFIER CHASSIS** for 220-250 A.C. Shock-proof chassis, 2 triodes output stage with super 10in. energised M/C speaker, special output transformer and volume control. Complete. Carr. and packing 2/6 extra **6GNS.**

See our Miscellaneous Advertisement (page 14) for other interesting items.

### LONDON CENTRAL RADIO STORES

23, LISLE STREET, LONDON, W.C.2.

Phone: GERrard 2969



# Leadership

won in the face of extreme odds

From an infant beginning facing giant competition... these tubes have paved the way for many of the great improvements in radio... gained the confidence of the leading engineers through their superior performance capabilities, their in-built stability and stamina, their dependability and economy in operation... today they occupy an important niche in the industry. The only tube unconditionally guaranteed against premature failures caused by gas released internally.

Once you put Eimac tubes to work you'll see why they are first choice for the important jobs in radio communications... why the world's leading engineers... amateur, commercial and military... use and recommend them wholeheartedly.

*Follow the leaders to*

Illustrated:  
Eimac 35TG, 75T, 100T and 250T tubes

**Eimac**  
TUBES

Export Agent

**FRAZAR & CO. LTD.**

301 CLAY STREET

SAN FRANCISCO, CALIFORNIA, U. S. A.

# PREMIER RADIO

Bakelite Dielectric Variable Condensers. .0005 mfd. Suitable Tuning or Reaction. 1/6 each; .0001 and .00075, 6d. each.  
 Short-Wave H.F. Chokes. 10-100 m., 10jd. each.  
 Pye Louden Type. 15-200 metres, 2/-.  
 Lissen Dual Range Screened Coils. Medium and Long Waves, 2/9 each.  
 Small 2 Gang, .0005 with Trimmers, 3/6; ditto 3 Gang fully screened, 5/-.  
 2,000 ohm 25 watt Res with 5 Tapping Clips, 1/6.

SHORT-WAVE CONDENSERS			
Trolitul insulation. Certified superior to ceramic.			
Alli-brass construction.		Easily ganged.	
15 m.mfd.	2/4	100 m.mfd.	3/-
25 m.mfd.	2/6	160 m.mfd.	3/7
40 m.mfd.	2/6	250 m.mfd.	4/-

**ELECTROLYTIC CONDENSERS**  
 Cardboard cases. 4+4+1, 500 volt, 3/9; 25 mfd. 25 volt, 1/6; 50 mfd. 12 volt, 1/6; 15 mfd. 100 volt, 1/3; 2 mfd. 250 volt, 1/9; 8 mfd. 125 volt tubular, 1/6.

LOUD SPEAKERS	
Rota 6" P.M. with O.P. Trans.	15/-
" 10" "	22/6
Goodmans 8" "	20/-
Plessey 175 ohm Field	7/6
" 2000 "	15/-

**PREMIER MICROPHONES**  
 Transverse-Current Mike. High grade large output unit. Response 45-7,500 cycles. Low hiss level, 23/-.  
 Moving Coil Mike. Permanent magnet model requiring no energising. Response 90-5,200 cycles. Output .25 volt average. Excellent reproduction of speech and music. 49/-.  
 Microphono Transformers. Suitable for all mikes. Tapped primaries. A, 20 and 40 : 1; B, 30 and 60 : 1; C, 50 and 100 : 1, 6/6 each.

Please Note.—All Short-wave Kits include Purchase Tax.

**NEW PREMIER S.W. A.C. RECEIVER**  
 In response to many requests we have now produced an A.C. version of the popular Premier Short Wave SG3 Kit. Circuit: Pentode H.F. Stage, Pentode Detector, Pentode Output, and F.W. Rectifier. 200-250 v. A.C. Operation. Built-in Power Pack. Hum-free operation. For use with Phones or P.M. Speaker.

Complete Kit of Parts with drilled chassis, all components, Plug-in Coils covering 13-170 metres, 4 valves and full instructions **£6.14.6** and circuits

Battery Version also available Kit £4/15/4.

★ "The Wireless World" said they were "very much impressed..." ★  
 See full Test Report, pp. 492-3, December issue. Send for details.

**"LEARNING MORSE."**

Premier Practice Oscillator. Strictly follows the circuit described in the above W.W. publication. Mounted on steel chassis, wired, tested and complete with valve, 27/6. Morse Keys, 3/3, TX Keys, 5/9.

**PREMIER BATTERY CHARGERS FOR A.C. MAINS.**

Westinghouse Rectification complete and ready for use. To charge: 6 volts at 1 amp... 26/-  
 2 volts at 1/2 amp... 13/4 12 volts at 1 amp... 28/-  
 6 volts at 1/2 amp... 22/- 6 volts at 2 amp... 43/6

**ALL ENQUIRIES MUST BE ACCOMPANIED BY 2d. STAMP.**  
**ALL ORDERS LESS THAN 5/- 6d. POST EXTRA.**

**PREMIER 1941 HIGH FIDELITY AMPLIFIERS**

Each Amplifier is individually tested and supplied with specially matched valves.

4-watt A.C. Amplifier	£3 11 0
6-watt A.C. Amplifier	£7 13 6
8-10-watt A.C./D.C. Amplifier	£7 9 0
15-watt A.C. Amplifier	£9 8 0

**MAINS TRANSFORMERS**

Wire-ends. All L.T. Windings Centre Tapped.		
SP. 250	250-0-250 v. 60 m.a. 4 v. 1-2 a., 4 v. 2-3 a., 4 v. 2-3 a.	13/4
SP. 300	300-0-300 v. 60 m.a., 4 v. 2-3 a., 4 v. 2-3 a., 4 v. 2-3 a.	13/4
SP. 301	300-300 v. 150 m.a. 4 v. 2-3 a., 4 v. 2-3 a., 4 v. 1 a., 4 v. 1 a.	17/4
SP. 350A	350-350 v. 100 m.a. 5 v. 2 a. (not C.T.), 6.3 v. 2-3 a.	16/-
SP. 350B	350-350 v. 100 m.a. 4 v. 2-3 a., 4 v. 2-3 a., 4 v. 2-3 a.	18/-
SP. 351	350-350 v. 150 m.a. 4 v. 1-2 a., 4 v. 2-3 a., 4 v. 3-4 a.	17/4
SP. 351A	350-350-150 m.a. 4 v. 3 a., 4 v. 2-3 a., 4 v. 1 a., 4 v. 1 a.	22/-
SP. 352	350-350 v. 150 m.a., 5 v. 2 a., 6.3 v. 2 a., 6.3 v. 2 a.	18/-
SP. 811	300-300 60 m.a. 4 v. 1 a., 4 v. 5 a.	8/11
Auto Transformers. Step up or down. 100-125 v. to 200, 230 or 250 v. A.C., 60 watts, 11/4; 125 watts, 15/-; 200 watts, 22/-.		
Push-Pull Driver Transformers, 3-1 Ratio		
Class B Driver, 1-1 Ratio		8/6
Universal Output Transformers, 11 Ratios. Single or Push Pull		
C.T. Output Transformers, 50-1		4/8
Heavy Duty Type for G 12's, etc.		
		8/8

**MATCHMAKER UNIVERSAL OUTPUT TRANSFORMERS**

Will match any output valves to any speaker impedance, 11 ratios from 13 : 1 to 80 : 1 5-7 watts, 16/10. 10-15 watts, 21/10. 20-30 watts, 36/10. 60 watts, 49/6.

## PREMIER RADIO CO.

ALL POST ORDERS to: **JUBILEE WORKS, 167, LOWER CLAPTON ROAD, LONDON, E.5. (Amherst 4723.)**  
 CALLERS to: Jubilee Works, or 169, Fleet Street, E.C.4 (Central 2833), or 50, High Street, Clapham, S.W.4. (Macaulay 2381.)

**REJUVENATE YOUR RADIO this INEXPENSIVE WAY**



Cast your mind back to the time when you had just bought your present radio. You got a kick out of listening then that you don't get now—a thrill which the passage of time and gradual wear and tear has blunted. You can recapture that thrill NOW—by adding an inexpensive Stentorian Extension speaker to your present set. Quite apart from the convenience of being able to listen in any room you desire, the improvement in reproduction will surprise you



Cabinet Models from 21/6

Ask your dealer for a demonstration.



# Stentorian

THE PERFECT EXTRA SPEAKER FOR ANY SET

WHITELEY ELECTRICAL RADIO CO. LTD., MANSFIELD, NOTTS.

**OVERALLS**  
 PURCHASE DIRECT FROM THE MANUFACTURER  
 for WOMEN all WORKERS

The ideal protective garment for female workers, a smart practical bib and brace overall in heavy drill. Strong and durable, with adjustable straps and useful pockets. Stocked in all sizes in shades of Khaki, Bottle, Brown and Navy.

This and several other types can be seen at our Showrooms, 39, Cheapside, E.C.2.

Strong, peaked caps as worn by model (centre) give full protection to hair and thus conform with B.O.T. regulations. On left is shown similar peaked cap fitted with net top, cool and comfortable but controlling all strands of hair. (Above) Mob cap or beret style, fitted elastic band, giving sense of security and comfort.

**E. SHUTTLE & Co. Ltd.**  
**Ashley Works, ASH ROAD, STRATFORD, 15**



**"Everything  
O.K. Sir !"**

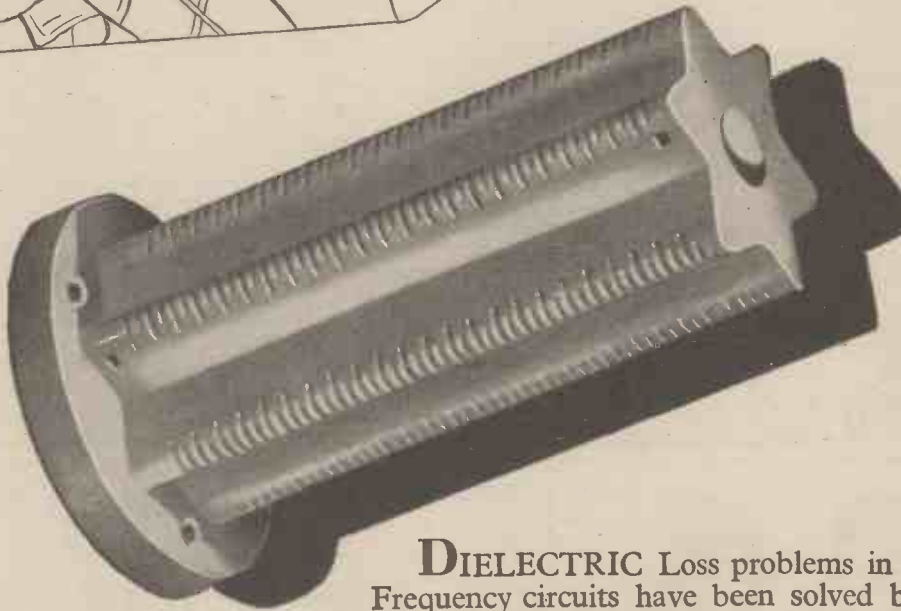

**Made in Three  
Principal Materials:**

**FREQUELEX.** An Insulating material of Low Dielectric Loss. For Coil Formers, Aerial Insulators, Valve Holders, etc.

**PERMALEX.** A High Permittivity Material. For the construction of Condensers of the smallest possible dimensions.

**TEMPALEX.** A Condenser material of medium permittivity. For the construction of Condensers having a constant capacity at all temperatures.

**DIELECTRIC** Loss problems in High Frequency circuits have been solved by the use of Bullers Radio-Frequency Ceramics.

Many years of research and development in our Laboratories have brought these materials to a high degree of efficiency.

They are in constant use for transmission and reception and play an important part in maintaining communication under all conditions.

# Bullers

## LOW LOSS CERAMICS

BULLERS, LTD., THE HALL, OATLANDS DRIVE, WEYBRIDGE, SURREY  
Telephone: Walton-on-Thames 2451  
Manchester Office: 196 Deansgate, Manchester



# A NEW HIGH NOTE BUZZER AND A NEW 6-PIN CERAMIC COIL HOLDER BY—

# RAYMART

CRAFT A CREED

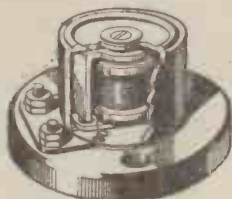

Polished Bakelite Case.  
Size: 1 1/2" dia., by 1" high. Two fixing holes.

PRICE  
ONLY

**2/-**

(Postage 3d.)

This new Raymart product is an Ideal British Made High Note Buzzer for Morse practice.

It is well designed and constructed, is very robust, has exceptionally heavy coin silver contacts, is totally enclosed, therefore dust-proof, works off 3 to 4 1/2 volt dry battery, and, we repeat—it is a High Note Buzzer at a highly competitive price. Only 2/-.

Orders over 5/-, of course, post free.

Pioneers of quality short-wave materials at sane prices, we have pioneered many innovations amongst which are Microvariable Condensers with RMX Ceramic endplates, Electrically shorted ball races in Condensers, increased range of Insulators, parasitic filters, improved Coils on thin formers raising "Q" of Coils by removing insulation from field, etc., etc., and now we are pleased to give you details of the two latest additions to the Raymart range.

Here is a new Raymart RMX Ceramic Coil Holder to fit your 6-pin Coils. Note the plan drawing of it. Try your Coils on it and then scrap your high-loss Holders. The price? only 1/6 with sterling silver-plated sockets, probably less than you paid for your bakelite one, and, delivery at the moment—Ex Stock.

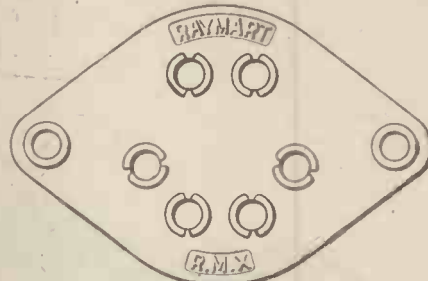

PRICE ONLY

**1/6**

(Postage 2 1/2d.)

# RAYMART

CRAFT A CREED

We also manufacture the most comprehensive range of Communication Equipment, Components for Transmitters, Receivers, Oscilloscopes, etc., etc.

44 & 48 HOLLOWAY HEAD, BIRMINGHAM, 1. Phone: Midland 3254

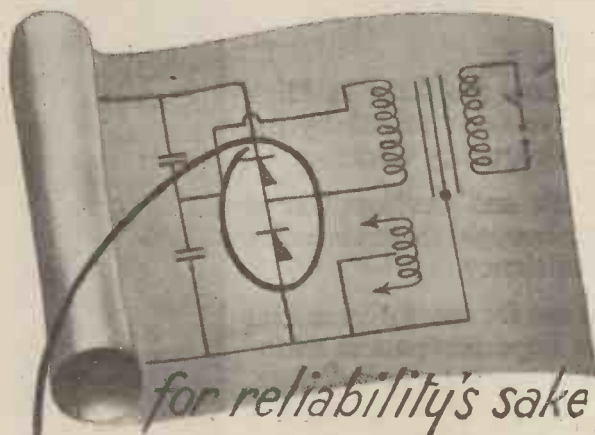

*for reliability's sake*

## PUT IT THERE

A Westinghouse Metal Rectifier as the power behind your mains receiver, means a constant H.T. supply without any rectifier renewals. Just instal it... then ignore it... it will last for years.

# WESTINGHOUSE NEEDS NO RENEWALS.

Send 3d. to Dept. W.W. for a copy of "The All Metal Way."

WESTINGHOUSE BRAKE & SIGNAL Co. Ltd., Pow Hill House, Chippenham, Wilts.

## RADIO DESIGNER'S HANDBOOK

**A Comprehensive Manual  
for Radio Engineers and  
Experimenters**

Edited by F. Langford Smith, B.Sc., A.M.I.E.E.

This handbook is a complete collection of all the principal formulae involved in the design of receivers and components. The eight sections of the book deal with Audio Frequencies; Radio Frequencies; Rectification; Filtering and Hum; Receiver Components; Tests and Measurements; Valve Characteristics; General Theory; Sundry Data.

Full explanations are given of the way the principles are applied and each chapter gives a list of works dealing with the particular subject.

Size 8 1/2 x 5 1/2 inches, 352 pages with numerous diagrams and charts. Cloth boards

Price 8/6 net. By post 9/1

ILIFFE & SONS LTD.

Dorset House, Stamford Street, London, S.E.1





# Exide BATTERIES

*'Still keep going when the rest have stopped'*

THE CHLORIDE ELECTRICAL STORAGE COMPANY LTD.

(Exide and Drydex Batteries) Grosvenor Gardens House, Grosvenor Gardens, London, S.W.1

Telephone : VICTORIA 2299.      Telegrams : Chloridic, Sowest, London.



USED  
WHEREVER DEPENDABILITY  
IS VITAL

**DAGENITE**

and

**PERTRIX**

FOR RADIO, CARS,  
MOTOR CYCLES AND COMMERCIAL VEHICLES

YOU, TOO, SHOULD USE  
DAGENITE AND PERTRIX—  
THE DEPENDABLE BATTERIES

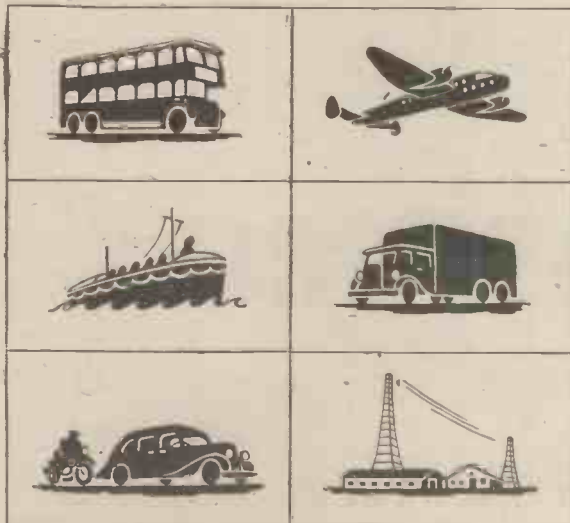

OBTAINABLE FROM HOLSUN SERVICE STATIONS  
AND USUAL DEALERS.

Sales Concessionaires:

**HOLSUN BATTERIES LIMITED**  
137, Victoria Street, London, S.W.1

DI/41



SUSPENSION FOR  
DIRECTING SOUND  
DOWNWARDS—



—TO THE  
LEFT—



—OR TO THE  
RIGHT.



ADDRESS  
YOUR STAFF  
THROUGH A  
**CELESTION  
LOUDSPEAKER**

with a volume sufficient to  
overcome local noise

The same speaker will  
carry music to your staff—  
true music, not just a  
volume of sound

The Celestion method of  
suspension enables the  
sound to be directed  
wherever you want it

Standard Model, 6 watts input. Cad-  
mium plated and sprayed battleship grey

**CELESTION LTD**

Kingston - upon - Thames, Surrey

Telephone: KINGston 5656-7-8

**MELTON METALLURGICAL LABORATORIES LTD**

**LIQUID SILVER**

for metallising CERAMIC, MICA,  
QUARTZ or GLASS.

Low melting-point **SOLDER** from 70°C. or to specifica-  
tion. Non-corrosive Liquid **FLUX** for all electrical or  
Radio purposes.

*Pre-War deliveries. Overseas enquiries invited.*

IPSWICH RD., TRADING ESTATE,  
SLOUGH, BUCKS. Phone: Slough 20992



**DO YOUR MAINS VARY?**

USE A VOLTAGE REGULATOR AND  
CONTROL THE A.C. WITHOUT  
INTRODUCING SERIES RESISTANCE.

Operate your laboratory apparatus  
exactly as intended.

The knob below the meter gives manual  
adjustment while on load in small steps  
over a range of 40 volts.

Input 80 to 300 volts. Output adjustable 200 to  
240 volts. Rating 150 to 200 watts and, being a  
transformer, it can of course be reversed.

PRICE **£6** EACH.

Designed by Mr. Volgt  
for Edison Bell

Supplies now limited

**VOIGT PATENTS LTD,**

THE COURTS, SILVERDALE, LONDON, S.E.26  
Telephone: Sydenham 6666.

# F R E Q U E N T I T E

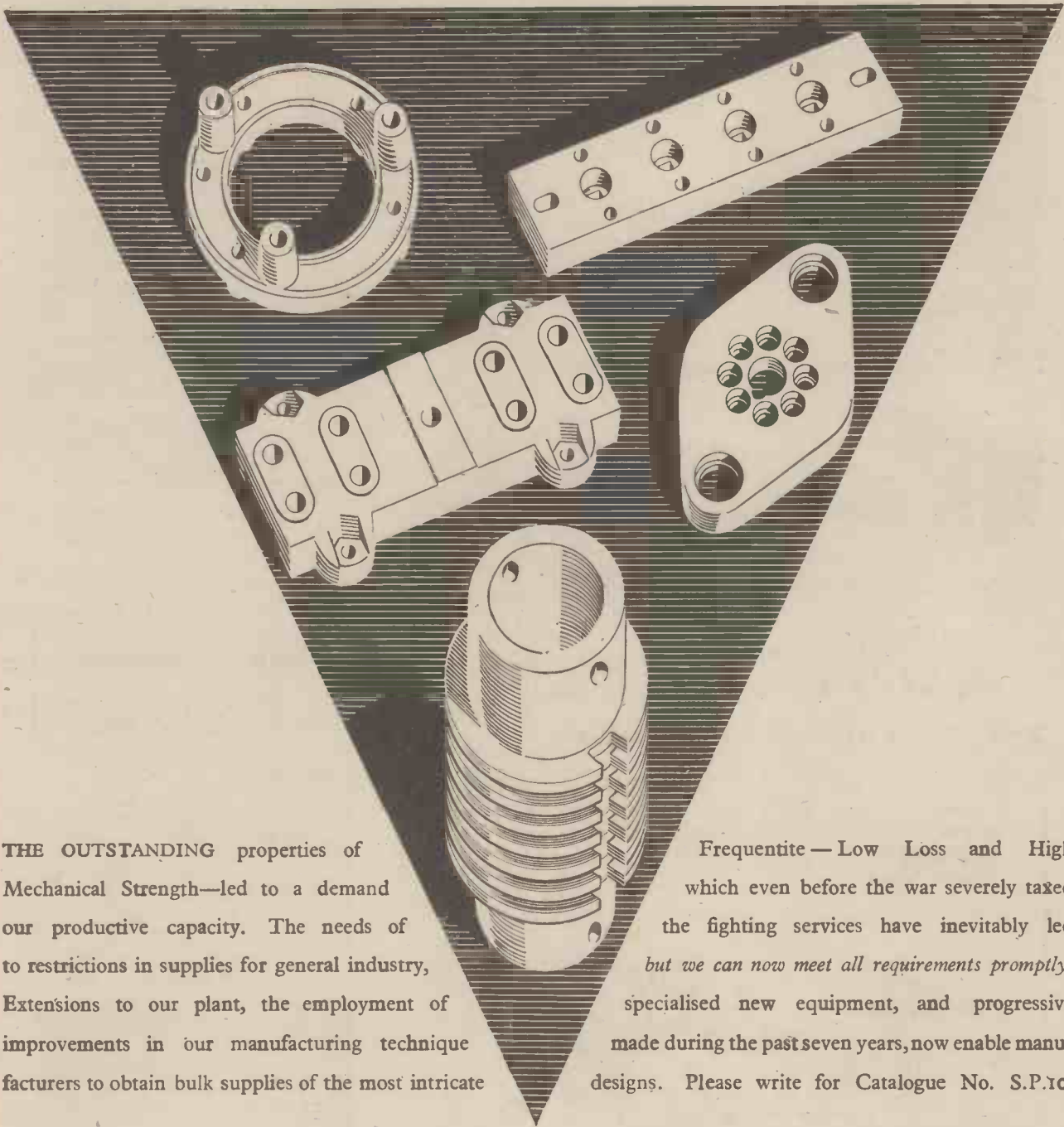

THE OUTSTANDING properties of Mechanical Strength—led to a demand our productive capacity. The needs of to restrictions in supplies for general industry, Extensions to our plant, the employment of improvements in our manufacturing technique factories to obtain bulk supplies of the most intricate

Frequentite — Low Loss and High which even before the war severely taxed the fighting services have inevitably led but we can now meet all requirements promptly. specialised new equipment, and progressive made during the past seven years, now enable manu- designs. Please write for Catalogue No. S.P.10.

*The Pioneer British-Made Low Loss Ceramic*  
**STEATITE & PORCELAIN PRODUCTS LTD.**

Head Office and Works :  
STOURPORT - ON - SEVERN, WORCS.

Telephone: Stourport 111.

Telegrams: Steatoin, Stourport.

SP.3









# ADAPTABILITY

The amazing adaptability of Simmonds Speed Nuts enables manufacturers to speed up production on practically every type of assembly. From our range of over 600 types of Speed Nuts there are probably several which can simplify your production operations and accelerate output. Study the selection shown on this page in the light of your present assembly procedure.

If you have an assembly problem where the time taken is hampering output, we will be very glad to co-operate with a view to effecting economies in time and cost.

*Simmonds*  
*Speed Nuts*  
(PATENTS APPLIED FOR)

 <p><b>SPEED CLIP</b> For fastening inaccessible studs or rivets.</p>	 <p><b>SPEED NUT</b> Eliminating a stamping, nut and lock-washer in holding wires and conduits.</p>
 <p><b>SPEED NUT</b> Designed for assembly from the nut side.</p>	 <p><b>SPEED FIX</b> For radio assembly.</p>
 <p><b>SPEED FIX</b> Used in conjunction with any unthreaded member.</p>	 <p><b>SPEED CLIP</b> Holds cable or wire, replacing four separate parts.</p>



**SIMMONDS AEROCESSORIES LTD**

GREAT WEST ROAD, LONDON.



# The Wireless World

31st Year of Publication

Covering Every Wireless Interest

## SEPTEMBER 1941

Proprietors :  
ILIFFE & SONS LTD.

Editor :  
HUGH S. POCOCK.

Editorial, Advertising  
and Publishing Offices :  
DORSET HOUSE,  
STAMFORD STREET,  
LONDON, S.E.1.

Telephone:  
Waterloo 3333 (35 lines).

Telegrams:  
"Ethaworld, Sedist, London."



**PUBLISHED  
MONTHLY**

**Price: One Shilling**

(Publication date 20th  
of preceding month)

Subscription Rates  
Home and Abroad.  
14/- per annum

EDITORIAL .. .. .	223
DESIGNING A MODERN SUPERHETERODYNE. By R. G. D. Holmes, A.M.I.E.E. .. .. .	224
RANGE OF ULTRA-SHORT WAVES. By T. W. Bennington .. .. .	228
ELECTROSURGERY. By A. W. Lay, F.Inst. P. .. .. .	231
UNBIASED. By Free Grid .. .. .	234
THE WORLD OF WIRELESS .. .. .	235
NEWS IN ENGLISH FROM ABROAD .. .. .	237
SERVICING EQUIPMENT AND ITS USES, Part III. By "Service" .. .. .	238
LETTERS TO THE EDITOR .. .. .	242
RANDOM RADIATIONS. By "Diallist" .. .. .	244
RECENT INVENTIONS .. .. .	246

### Branch Offices :

COVENTRY:  
8-10, Corporation Street.  
Telephone : Coventry 5210.  
Telegrams : "Autocar, Coventry"

BIRMINGHAM:  
Guildhall Buildings,  
Navigation Street, 2.  
Telephone:  
Midland 2971 (5 lines).  
Telegrams:  
"Autopress, Birmingham."

MANCHESTER:  
260, Deansgate, 3.  
Telephone:  
Blackfriars 4412 (4 lines).  
Telegrams:  
"Iliffe, Manchester."

GLASGOW:  
26B, Renfield Street, C.2.  
Telephone: Central 4857.  
Telegrams: "Iliffe, Glasgow."



*As many of the circuits and apparatus described in these pages are covered by patents, readers are advised, before making use of them, to satisfy themselves that they would not be infringing patents.*

## Quicker and Better than a Re-wind



All this is prompted by the desire to help dealers, by ensuring that every Unit is as reliable as human skill, and experience can make it. A component which enables you adequately to cope with the multiplicity of Valve Types in use today.

Here is a pedigree component which is available at less than re-wind cost. 6/- each. Conveniently packed. Display box of 6 from all Factors and Wholesalers.

The new Grampian All-ratio Output Transformer provides 8 Ratios to suit any standard speech coil impedance. Tapped primary and secondary ensure more exact matching than any other similar model. Primary is tapped for Triode, Battery, Pentode. Mains Pentode and Push-pull Output. Secondary is tapped for 2 ohms and 9 ohms speech coil. Universal fixing plate.

**GRAMPIAN REPRODUCERS LIMITED**  
KEW GARDENS, SURREY ————— 'Phone: RICHMOND 1175/6/7

# RADIOLOCATION!

The word has come to represent to the man in the street the latest developments in radio technique in its application to the location of hostile aircraft. The word could also have been appropriately used in describing the new EDDYSTONE 358 Communication Receiver.

For "Radiolocation" of those long distance "Difficult-to-Receive" Short Wave Stations for the reception of which precision instruments only are of use, the Eddystone "358," like the famous lighthouse, represent a landmark in Communication Receiver design. It is ruggedly built, British to the core, and our engineers have incorporated every advanced detail to assure that performance shall be equal to present-day tasks.

### Outstanding Features.

32 M/cs. to 120 K/cs.  
Accurate calibration.  
High sensitivity. Very high signal-to-noise.  
Logging scale. All-circuit meter. Separate power pack.



EDDYSTONE components and Receivers have for some time been difficult to obtain. The demand is still colossal, but we have overcome most of our wartime set-backs and have now in ENERGETIC PRODUCTION a range of components to meet most requirements. This range is being added to quickly. The "358" and its counterpart medium frequency model "400" with or without band-pass crystal filters are available

## WEBB'S RADIO

14, SOHO STREET, OXFORD STREET, LONDON, W.1  
OPEN 9 a.m. to 6 p.m. ; SATS. 1 o'clock.

'PHONE : GERRARD 2089

# The Wireless World

COVERING EVERY  
WIRELESS INTEREST

ESTABLISHED  
1911

Vol. XLVII. No. 1071

SEPTEMBER, 1941

Price One Shilling

## Broadcasting as a Weapon

*Need for "Fierce and Stubborn Resistance"*

**B**BROADCASTING was described as "the only brand-new weapon in this war" in a recent speech in the House of Commons by Captain L. F. Plugge, M.P., who spoke at length on the subject of our war needs in the field of broadcasting.

Captain Plugge is competent to express an opinion on these matters. He will be well known to our readers as a past contributor and as being responsible for programmes formerly broadcast from Radio Normandie and other Continental stations. These transmissions, sponsored from this country, cut across the B.B.C. monopoly; and at various times have been violently opposed. We mention this fact because we wish to anticipate the possibility that the Government may seek technical advice on Captain Plugge's proposals from persons who, by reason of his past activities, may be prejudiced against him. We would urge that these suggestions, clearly put forward in the National interest, should be examined with an open mind.

The main proposal is that we should lose no time in trying to recapture ground in the field of broadcasting (which means propaganda) which we have steadily been losing to Axis powers ever since the war began. Even at the outbreak of hostilities our position was very weak, so far as broadcasting to the peoples of Europe was concerned. Our authorities scrupulously observed the spirit of the various pre-war international broadcasting agreements, and even some of our home broadcasting stations have been deliberately redesigned as regards their aerial systems with the express purpose of concentrating radiation locally and avoiding interference with Continental transmissions. As a result the reception of British broadcasting on the types of sets in general use on the Continent is extremely difficult; and when we add to this the penalties attaching to listening to us it is not difficult to realise that our Continental audience must be relatively small.

We believe that the majority of people in this country, our politicians included, enjoy the confidence of ignorance in thinking that all our talks to the Continent are being consistently received and are influencing public opinion. Captain Plugge shattered this dream, asserting

as an example that when, on December 25th, our Prime Minister broadcast a personal message to the Italian people, it was as if he were using a telephone which was not connected.

While we have been allowing this state of affairs to continue, Germany, on the other hand, has strengthened her broadcasting grip of the whole Continent. Not only the stations of Germany, but now the stations of nearly every country in Europe are there to do her bidding and poison the minds of the peoples of Europe with her propaganda. It is no use to assume that the hatred of Germany is so great that her propaganda will have no effect. Its persistence and ubiquity will eventually achieve the results desired by Germany unless successful steps are taken to counteract it. The evil effects of Nazi propaganda will tend to persist in the minds of most European peoples, who will be in no fit state for the reception of those ideas which will bring about the restoration of good will and ultimate reconstruction.

### *Constructive Suggestions*

What, then, has to be done? Captain Plugge's proposals are constructive as well as critical. We need around Europe a ring of broadcasting stations of such power that they are capable of being heard wherever Nazi propaganda penetrates, and on the same sets.

Gibraltar, Malta and Cyprus are suggested as sites for stations to reach southern Europe. Some of our own stations could be strengthened in power and their efficiency in radiation to the Continent increased.

Captain Plugge showed himself to be aware of the defence considerations which resulted in the curtailment of our own broadcasting distribution methods, thus handicapping the B.B.C. from the start, but these defence measures are now due for reconsideration in the light of past events, and we would suggest that a broadcasting station is no longer so valuable a directional guide to enemy aircraft as was at first considered, if only for the reason that other methods of guidance are now so efficient that objectives can be reached equally well in the absence of such a guide.





Analysing the above the writer came to the conclusion that the sensitivity and the AVC characteristics of the latter circuit plus, if possible, the added advantage of "forward" control giving a flat AVC curve are desired. This directed thought to the possibility of reflexing. IF signals, after amplification by a suitable pentode and demodulation by a diode, could be transferred back to the IF amplifier for amplification at audio-frequencies, providing suitable loads are inserted. This circuit has not been popular in the past because of the many difficulties encountered such as modulation distortion, rectification, etc. However, with modern RF pentodes, and some experimental work, the writer was able to overcome these difficulties one by one and to produce a receiver with the desired results at little additional cost.

Using the Mullard range of "E" Series valves for their low heater consumption, we have chosen for the frequency changer the triode-hexode ECH<sub>3</sub> with a conversion conductance of 0.65 mA/V and a triode slope of 3.8 mA/V. For an intermediate frequency amplifier, as this valve is controlled by AVC, and is used for amplifying also audio-frequencies, it is important that the variable-mu characteristic follows as closely as possible to a logarithmic law since an appreciable amplitude distortion at audio-frequencies would be undesirable. The EF9 was therefore chosen.

The double-diode output pentode is the EBL1. The circuit of the final reflex receiver is shown in Fig. 1 and the gain expected at 1,000 kc/s was computed as follows.

The EBL1 requires 0.43 volt RMS grid swing to produce an output of 50 milliwatts into the speech coil. The audio stage gain of the EF9 with a working slope of 2 mA/V and an anode load of 10,000 ohms is 20. The audio input required to the EF9 is therefore  $\frac{0.43}{20} = 0.0215$  V RMS. The

RF input to the diode to give 0.0215 V audio output at 30 per cent. modulation is 0.18 V RMS (this was found by measurement).

The intermediate frequency stage gain is given by Slope  $\times Z_p$ , where  $Z_p = \frac{1}{2} \sqrt{Z_1 Z_2}$  (see Fig. 2).

The IF transformer is adjusted to critical coupling ( $\omega M = \sqrt{r_3 \cdot r_4}$ ), where  $r_3$  and  $r_4$  are the total series resistances of the loaded primary and secondary circuits. The slope of the EF9 = 2 mA/V.

The diode dampings  $R_2$  and  $R_3$  are computed from the following facts.

In a modern high-gain receiver

where an audio-frequency stage is used before the output valve the standard output of 50 milliwatts is obtained with signals of the order of 0.1 volt on the diode. Linear detection may only be assumed when the input signal to the diode is 1 volt or greater; therefore smaller signals are considered to produce quadratic rectification. The change from quadratic to linear rectification is gradual, and therefore the calculation of the load

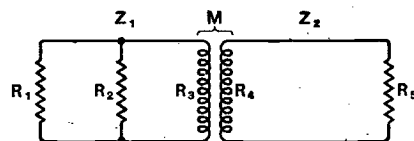

Fig. 2.—Equivalent circuit of IF stage.  $R_1$  = output impedance (EF9 = 0.9 megohms);  $R_2$  = AVC diode load damping;  $R_3, R_4$  = dynamic resistance of tuned circuits;  $R_5$  = speech diode damping.

$R_5$  introduced by the speech diode is rather complex.

When there is no signal the diode damping is equal to  $\frac{V_t}{i}$  where  $V_t$  = the "temperature voltage," a factor depending upon the temperature of the cathode and the material of which this is made, for oxide-coated diodes this value is given as 0.1, and  $i$  = momentary value of diode current, which is given as 1 micro-amp. (it is found by experience that the diode adjusts itself to a negative potential of 0.5 volt when 0.5 megohm is used).

Therefore  $\frac{V_t}{i} = \frac{0.1}{1} \times 10^6 = 100,000$  ohms. This value holds good for signals up to 0.1 volt.

From 0.1 volt to 1 volt, the diode damping is equal to  $\frac{1}{2} R \frac{V_m}{V}$  where  $V_m$  = amplitude of RF signal,  $V$  = DC voltage on diode, and  $R$  = diode load resistance. The damping in this case is between 100,000 and 250,000 ohms. For input voltages greater than 1 volt, the damping can be taken as  $\frac{1}{2} R$ .

Since the AVC diode receives a delay voltage, the damping effect of this diode will depend on signal strength. In our case the signal voltage is much less than the delay voltage, and the damping will be equal to the load and decoupling resistances in parallel. Therefore in our case we can take the speech diode damping  $R$  as being approximately 100,000 ohms and the AVC diode damping as 300,000 ohms.

The "Q" of each tuned circuit in the IF transformer was measured when completely shielded, the primary was found to be  $Q = 93$ , and the

secondary  $Q = 132$ . (The primary coil is situated nearest to the chassis.)

The dynamic resistance can now be calculated from  $R = Q\omega L$  or  $\frac{Q}{\omega C}$ .  $R_3$  primary = 187,000 ohms,  $R_4$  secondary = 265,000 ohms,  $Z_1 = 900,000$ , 300,000 and 187,000 ohms in parallel = 102,000 ohms,  $Z_2 = 265,000$  and 100,000 ohms in parallel = 72,500 ohms,  $Z_p = \frac{1}{2} \sqrt{102,000 \times 72,500} = 43,000$  ohms, stage gain =  $2 \times 43 = 86$ . Therefore, volts required on grid of EF9 =  $\frac{0.18}{86} = 2,090$  microvolts.

Next we come to the gain to be expected from the frequency changer. The conversion slope of the ECH<sub>3</sub> is 0.65 mA/V and  $Z_p$  must be calculated from the circuit of Fig. 3.

As in the case of the IF stage, critical coupling is assumed and the dynamic resistances are again primary = 187,000 ohms and secondary = 265,000 ohms.

Therefore,  $Z_1 = 900,000$  and 187,000 ohms in parallel = 155,000 ohms,  $Z_2 = 265,000$  and 500,000 ohms in parallel = 173,000 ohms,  $Z_p = \frac{1}{2} \sqrt{155,000 \times 173,000} = 81,750$  ohms, Stage gain =  $0.65 \times 81.75 = 53$  approximately. Hence the voltage swing required on grid of ECH<sub>3</sub> =  $\frac{2090}{53} = 39.4$  microvolts.

At 1,000 kc/s the step-up in the aerial coil = 10. Therefore, gain of receiver =  $\frac{39.4}{10} = 3.94$  microvolts absolute.

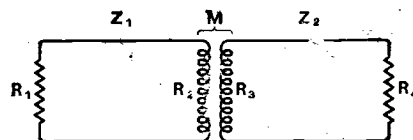

Fig. 3.—Equivalent output circuit of frequency changer stage.  $R_1$  = output impedance of ECH<sub>3</sub> = 0.9 megohms;  $R_2, R_3$  = dynamic resistance of tuned circuits;  $R_4$  = grid leak (0.5 megohm).

A receiver was made up to this specification, and after alignment a sensitivity check was made at 1,000 kc/s and found to be 9.5 microvolts. This is not in very close agreement with the calculated figure of 3.94 microvolts, and the difference was found to be due to degeneration in the cathode circuit of the output valve.

An analysis of the circuit shows that the cathode resistance and bypass condenser of the output valve is also common to the grid circuit of the driver valve. In the experimental chassis a by-pass condenser of 50 mfd.

**Designing a Modern Superheterodyne—** was used, and this can cause an attenuation of 2.65 times at 400 cycles (the modulation frequency of a standard signal generator) as shown by calculation from the circuit of Fig. 4.

It can be seen that the input to  $V_1 = e_a = e_b - e_c$  and that the input to  $V_2 = e_a - e_c$ . But  $e_a = 20 \times e_c$ , therefore the input to  $V_2 = (e_c \times 20) - e_c = (e_b - e_c) 20 - e_c = 20e_b = 21e_c$ .

The reactance of a 50 mfd. condenser at 400 c/s is 8 ohms. Being an electrolytic type with a power factor of 10 per cent. its effective resistance was 8.8 ohms. The bias resistance of 150 ohms is in parallel and this brings the total effective resistance down to 8.3 ohms.

To give 50 milliwatts output, 0.43 volt input to  $V_2$  is required. The slope of  $V_2 = 9.5 \text{ mA/V}$ , therefore  $e_a - e_c = 0.43 \text{ V}$ .  $e_c = \frac{8.3 \times 9.5}{1000} \times 0.43 = 0.0339 \text{ V}$ .  $e_a = 0.43 + 0.0339 = 0.4639 \text{ V}$ .  $e_a = \frac{0.4639}{20}$  (stage gain  $V_1 = 20$ )  $= 0.02319 \text{ V}$ .  $e_b = 0.02319 + 0.0339 = 0.0571 \text{ volt}$ .

Without this degeneration  $e_b = \frac{0.43}{20} = 0.0215 \text{ volt}$  [when  $e_c = 0$  and  $e_b = e_a$ ]. Therefore AF attenuation  $= \frac{0.0571}{0.0215}$  or 2.65 times.

A test was then made to prove the theory, the cathode of the output

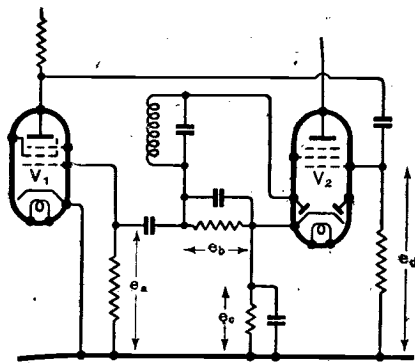

Fig. 4.—Illustrating the cause of degeneration in the AF stages.

valve  $V_2$  was earthed and the valve was biased via its grid leak by a battery.

The sensitivity was then measured again at 1,000 kc/s and found to be 4.75 microvolts, which shows a total degeneration of 2 times. The difference between 2.65 and 2 times could be accounted for by the fact that the diode was working on a different part of its curve, which shows that for 0.0215 volt AF, 0.18 volt RF is required on diode and for 0.0571 volt

AF, 0.35 volt RF is required on diode to give these ratios.

It can now be seen therefore that the total impedance of the cathode circuit of the output valve to AF requires to be as near zero as possible and it is extremely important in a

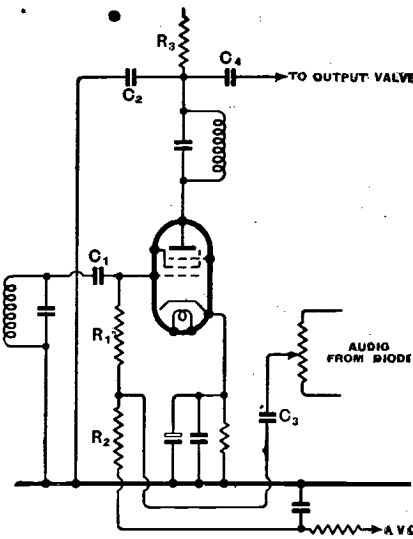

Fig. 5.—Basic circuit of the reflexed (IF-AF) stage.

circuit of this kind. The maximum capacity electrolytic condenser that can be purchased to-day in a reasonably small and cheap tubular form is 500 mfd. The total impedance of the cathode circuit using this is 0.8 ohm and  $e_b$  was calculated to be 0.0249 volt (approx.), giving an attenuation

$$= \frac{0.0249}{0.0215} = 1.16 \text{ times.}$$

The following sensitivity figures were now obtained.

	Short	Medium	Long
Wavelength in metres ...	13.5 50	200 550	1,000 2,000
Sensitivity in microvolts ...	5.0 22	2.5 19	20 12

The sensitivity at 1,000 kc/s was found to be 5.5 microvolts as against the calculated value of 3.94, which can now be seen to be in quite reasonable agreement with the calculations. Measurements were then taken of each individual stage and slight progressive departures from the calculated values were noticed. These were due mainly to:—(1) Feedback in wiring. (2) Exact optimum coupling in the IF transformers not obtained. (3) Attenuation of IF at EF9 grid owing to circuit arrangement as explained later.

After much experimental work the circuit shown in Fig. 5 was developed around the EF9 valve.

A certain amount of compromise has to be made in the choice of  $C_1$  and  $R_1$ . The IF feed condenser  $C_1$  has to be small from the point of view of audio-frequencies, for together with the valve input capacity it forms the lower arm of a potentiometer. At IF, however, it is the upper arm and should therefore be made large.

At IF this is equivalent to the circuit in Fig. 6 (a).  $R = R_1$  plus that portion of volume control in circuit and as it is high compared with the reactance of  $C_g$  it can be neglected, and the IF signal on the grid is equal to

$$\frac{X(C_g)}{X(C_g) + X(C_1)} e \text{ in our case } C_1 = 40 \mu\mu\text{F and } C_g = 5.5 \mu\mu\text{F. The intermediate frequency is 473 kc/s and hence } X(C_1) = 8,400 \text{ ohms. } X(C_g) = 61,000 \text{ ohms. Therefore IF signal at grid } \frac{61}{61 + 8.4} = \frac{61}{69.4}$$

of its original value. This explains 12.2 per cent. of the loss between calculations and measurements.

The equivalent circuit at audio-frequencies is shown in Fig. 6 (b). At 5,000 c/s  $X(C_1 + C_g) = 0.7 \text{ megohm. } R_1 = 0.5 \text{ megohm. Audio at grid } = \frac{X}{\sqrt{R^2 + X^2}} = \frac{0.7}{\sqrt{0.5^2 + 0.7^2}} \approx 83.6 \text{ per cent. or a loss of 4 db. at 5,000 c/s.}$

Reducing  $R_1$  would reduce the top cut but increase the damping on the IF transformer secondary.

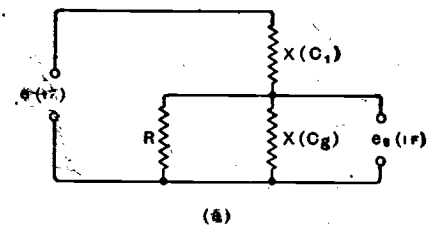

(a)

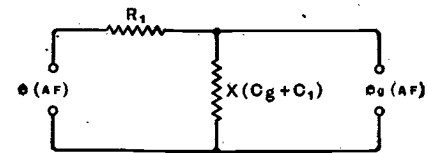

(b)

Fig. 6.—Equivalent input circuits of reflexed stage (a) at intermediate frequencies, (b) at audio frequencies.

IF and AF anode loads are placed in series and the reactance of the IF decoupling condenser  $C_2$  should be sufficiently low to by-pass IF to earth, but as it is in parallel with the AF load of 10,000 ohms its reactance at 5 kc/s should be large compared with 10,000 ohms.

A 1,000  $\mu\mu\text{F}$  condenser was found sufficiently large to by-pass 473 kc/s to earth and the new anode load at 5,000 c/s will be equal to  $\frac{R}{\sqrt{1 + \omega^2 C^2 R^2}} = \frac{10,000}{1.1} = 9,100$  ohms or a loss of 2db which is negligible.

However, since the attenuation of this frequency, due to the number of

such as (1) Grid current, (2) Maximum permissible anode voltage swing (due to the inclusion of an impedance in the anode circuit), and (3) Modulation distortion.

Considering 0.5 volt as being the maximum aerial signal, the AVC voltages developed at the grids of the mixer and IF amplifier valves were

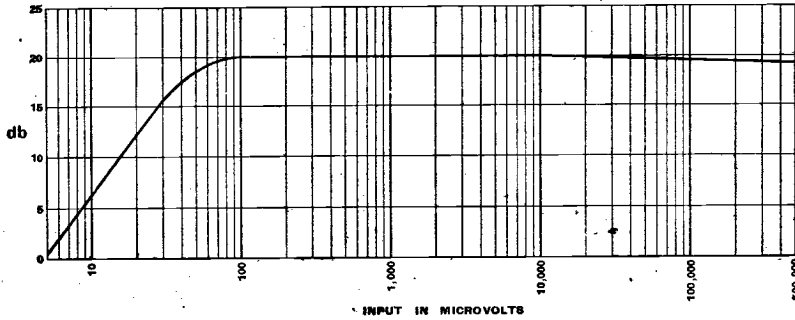

Fig. 7.—AVC characteristic of the receiver measured at 1,000 kc/s. Volume control adjusted to give 1 watt maximum output. Reference level 0db = 1 milliwatt.

tuned circuits in a superhet of this description, far exceeds this amount, this additional loss will not be noticed.

AVC is delayed and comes into operation after maximum output is obtained at 30 per cent. modulation. Full AVC is applied to the mixer and only a portion to the IF valve. This latter was adjusted until the power output level remained substantially constant for all aerial inputs exceeding the threshold value, and was found to be approximately 0.5.

The AVC characteristic is shown in Fig. 7, from which it can be seen that AVC commences at 30 microvolts and for all inputs exceeding 100 microvolts the output remains constant.

As the reflexed valve has to handle the largest IF signal it is in the greatest

measured and found to be 19.5 and 10 volts respectively.

The voltages appearing at the grids and anodes were calculated at 1,000 kc/s and the results tabulated as below:—

Aerial Input	Aerial Coil Gain	HF Volts on Mixer Grid	AVC Volts on Mixer	Conversion Slope	Conversion Gain	HF Volts on IF Grid	AVC Volts on IF	IF Slope	IF Gain	IF Anode Volts (EF)	Peak Volts	Less Delay	Measured
0.5	10	5	19.5	0.00245	0.2	1	10	0.44	19	19	27	20	19.5

(1) Grid current should be avoided, (a) because it causes damping on the connected circuits, (b) because it flattens the tops of the modulation envelope and introduces serious distortion, rendering the computed modu-

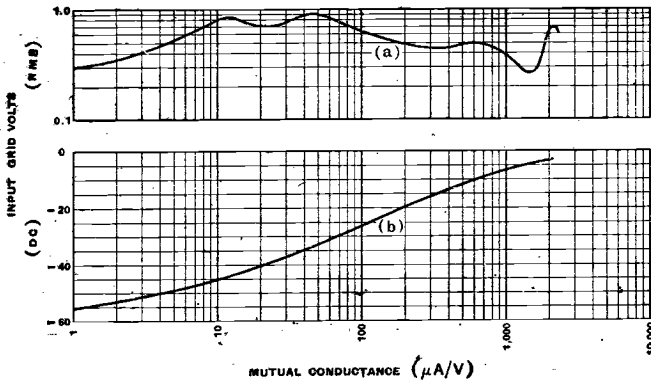

Fig. 8.—Curve (a), input volts plotted against mutual conductance for constant cross-modulation, K = 1 per cent. Curve (b), mutual conductance as a function of grid bias.

danger of being overloaded, and therefore it is chiefly from this consideration that the amount of control to this valve will be governed.

The largest signal this valve can accept is subject to certain limitations

lation distortion under (3) invalid. As a negative grid voltage of 1.3 volts can be taken as the starting point of grid current, the maximum permissible RMS value of grid signal for a modulation depth of 100 per cent.

will be  $V_{eff} = \frac{V - 1.3}{2\sqrt{2}}$  where  $V_{gr} =$  negative grid bias derived from the AVC plus cathode circuit. For 0.5V input to aerial  $V_{gr} = 10 + 1 = 11$ , making  $V_{eff} = \frac{11 - 1.3}{2\sqrt{2}} = 3.4V$

Actual the input to the grid of the IF valve = 1 volt which is well inside the limit.

(2) Permissible anode voltage swing for DC plate volts of 180v = 140v. For a modulation depth of 100 per cent. the peak value of the maximum permissible carrier wave will be 70v.

Therefore with an IF gain of 19 maximum grid signal to prevent anode distortion =  $\frac{70}{19\sqrt{2}} = 2.6$  volts RMS.

The 1-volt IF signal is again well inside the limit.

(3) The amount of modulation distortion introduced by a valve is dependent upon many factors and is very tedious and difficult to obtain outside the valve manufacturers' laboratories. Published data on the subject was therefore consulted in order to obtain this information.

In Fig. 8 curve (a) shows input

voltage against slope for constant cross modulation "K" of 1 per cent.

From this modulation distortion can be calculated from the formula  $D = \left(\frac{E_1}{E_2}\right)^2 \times \frac{3}{8} m$ , where  $E_1 =$  RF signal voltage RMS,  $m =$  modulation depth, and  $E_2 =$  the voltage shown plotted against slope on the K = 1 per cent. curve, the slope being calculated from the working grid bias (curve (b), Fig. 8).

In our case, under the worst conditions, i.e. with a large aerial input signal of 0.5 volt at 1,000 kc/s and 100 per cent. modulation, the IF input voltage on the EF9 grid = 1 volt RMS and the total bias = 11 volts. The slope of the EF9 at this point is 600 microamps/V. Referring to the curve (a) 0.5 volt is shown against this slope and  $m = 1$ , therefore modu-

lation distortion  $D = \left(\frac{1}{0.5}\right)^2 \times \frac{3}{8} m = 1.5$  per cent.

This distortion is shown for the worst case, and as it falls off directly as the square of the input signal this value is reasonable.

(To be concluded.)

# Range of Ultra Short Waves

By T. W. BENNINGTON

THE mechanism of the propagation of short waves up to a frequency of about 40 Mc/s is now fairly well understood. When we come to waves having a higher frequency than this—generally considered as “ultra-short” waves—though a great deal of work has been done and a considerable amount of information obtained, the subject should still be thought of as “under investigation.”

That there are differences in the behaviour of ultra-short waves as compared with that of the ordinary short waves is readily apparent. Needless to say, the ultra-shorts obey the same general laws which are applicable to the propagation of all electro-magnetic waves. The differences in their behaviour are due to the fact that phenomena which are of great significance in normal short-wave propagation have a reduced or negligible effect when the frequency is increased beyond a certain value, while other phenomena assume a significance at the increased frequency which is absent when lower frequencies are considered. There is, of course, no sharp dividing line between the frequencies which behave in one way and those which behave in the other, the limit being a variable factor, depending, as would be expected, on the time of day, season of the year, and epoch of the sunspot cycle.

## The General Picture

Let us, therefore, briefly consider the whole range of the short wave frequencies with a view to clarifying our ideas as to the mechanism of their propagation in the light of the latest information available.

We will start with the range of frequencies extending upwards to a variable value from about 3 Mc/s. These we may call the short waves proper, and their general behaviour conforms to the variations of the regular ionosphere layers.

There is, of course, a ground wave which travels over the surface of the earth and will provide a useful signal up to distances of about 30 miles or more from the transmitter, the range depending on the frequency and the nature of the intervening terrain. But, as these frequencies depend for their usefulness upon the particular properties of their “sky” waves, the “ground” waves are little used in

practice. In fact, the “ground” wave has few advantages not possessed by lower frequencies and has several disadvantages when compared with them. The aerial systems of these short-wave stations are almost always designed so as to throw the majority of the radiated wave in an upward direction, so that the “ground” wave can be regarded as being merely incidental.

Coming to the upward-going waves—or “sky” waves—we find that, during the greater part of the year they penetrate the E and F<sub>1</sub> layers—where the ionic density is not great enough to refract them—and are returned to earth at great distances by refraction at the F layer during the night and at the F<sub>2</sub> layer during the day. For a short time during the summer day the E or F<sub>1</sub> layer can take the place of the F<sub>2</sub> as far as refraction of the short waves is concerned, for their ionic density is then at its highest, and they are able to refract these waves. We will, however, consider the F or F<sub>2</sub> layers to be the refracting media.

## Exploring the Layers

A regular check is kept on the ionic density of these layers by means of exploring waves which are sent vertically upwards and, on reaching the layers, are returned to earth. By this means records are obtained of the virtual heights and critical frequencies of the layers for each hour of the day and season of the year. The critical frequency is the highest frequency which is returned for a wave sent vertically upwards. These records have been regularly compiled for many years, so that we have information available showing the variation which occurs owing to the effect of the sunspot cycle.

We will not go farther into the details of this matter here. It is sufficient to say that when a wave is sent out obliquely—as it is for practical communication—so as to strike the layer at an angle, then a higher frequency is returned than for a wave sent vertically upwards. The greater the degree of obliquity the higher is the frequency returned, until eventually we come to the position when we are transmitting almost horizontally—or at least at a very small angle to

## Conditions for Propagation Over Exceptionally Long Distances

the ground. Under these conditions the highest possible frequency is returned by the layer and the greatest possible distance covered in one hop. The highest frequency which the layer will return so as to come down at any particular distance is called the “maximum usable frequency” for that distance. The maximum usable frequency is related to the critical frequency by a known law, so that, by studying the critical frequency records we can find the maximum usable frequency at any time.

Let us examine some of this data and find what some of the most significant maximum usable frequencies actually are, for this will show us what range of frequencies we may expect to be propagated by the regular ionosphere layers. It will also indicate what limits may be set to the frequencies which conform to ordinary short-wave technique and which frequencies must be considered as coming within the designation of “ultra-short” waves.

## Long “Hops” on USW

We find that in the autumn of 1937—when solar activity, and hence the layer ionisation was at a maximum—the maximum usable frequency for a wave leaving at a small angle to the ground became as high as 47 Mc/s during the day. Such a wave would return to earth at a distance of about 2,200 miles from the transmitter, which is about the maximum distance possible for one hop. The figure of 47 Mc/s is taken from the *average* values for that time of year, and it is probable that on certain days the ionisation so far exceeded its average value that a frequency as high as 54 Mc/s might have been returned. This latter figure may be taken as roughly representing the highest frequency likely to be refracted by the F<sub>2</sub> layer at any time. During the

night and a great part of the day the highest frequency refracted would, of course, be considerably lower. Since 1937 the ionisation of the layers has fallen considerably owing to the effect of the sunspot cycle, and during the spring of 1941 the highest frequency likely to be regularly usable was about 28 Mc/s, while a frequency of about 32 Mc/s might have been usable on certain days.

We may take these values—54 Mc/s in 1937 and 32 Mc/s in 1941—as representing the highest frequencies we should expect to be propagated by way of the regular F2 layer over one hop. For multiple hop transmission we should not expect such high frequencies to be usable, because, owing to the time differences at different refraction points, peak ionisation conditions would be unlikely to occur at more than one of them. The maximum usable frequency for the whole transmission path would, therefore, almost always be lower than that for the refraction point where peak ionisation conditions prevailed. Nevertheless, for transmission to parts of the U.S.A.—by two hops—the maximum usable frequency during the afternoon might be as high as 51 Mc/s in 1937 and 29 Mc/s in 1941.

## Reasons for Long Ranges

It appears, therefore, that in extreme cases communication to countries as close to England as Russia, Turkey or North Africa would be possible on some days on the frequencies given above by way of the regular layers, the transmission being by one hop. Transmission to countries lying nearer than these would have to be on somewhat lower frequencies. Two-hop transmission to parts of the U.S.A. would appear to be possible on some days on the frequencies given. This would account for some of the results which we observe in practice. For example, the U.S.A. 26-Mc/s broadcast stations were regularly receivable during the equinoxes and winter for some years past, but are less frequently heard this year. The London television channels of 41.5 and 45 Mc/s were fairly regularly received during certain months of the year in the U.S.A. from 1937 to 1939. It is significant that the periods during which these stations were received decreased each year from 1937 to 1939, being, for 41.5 Mc/s, up to the end of March in 1937, from the end of September to mid-March in the winter of 1937-38, and from early October to mid-February in the winter of 1938-39. This is because the maximum usable frequencies would not be

so high during the summer period and would decrease each year owing to the effect of the sunspot cycle. The period during which 45 Mc/s was received was less than that for 41.5 Mc/s. All this points to the fact that the transmissions were received by way of the regular F2 layer, and that they were near the limit for reception by way of that layer. It is possible also that the few occasions on which 56 Mc/s bridged the Atlantic were occasions of *exceptionally* high ionisation in the F2 layer.

So much for propagation by way of the regular ionosphere layers. We may now turn our attention to frequencies higher than those with which we have just dealt, remembering that upward-going waves on the frequencies we are now to consider will not be turned back by the regular layers, but will penetrate them and pass out into space.

On these frequencies there will, first of all, be the directly received wave, extending out to distances limited by the length of the optical path, i.e., to distances such that a straight line joining transmitter and receiver will pass clear of the earth's surface and will not encounter any obstructions such as mountains or hills. Naturally, the higher the location of the transmitter and receiver aerials the greater will be the length of the optical path.

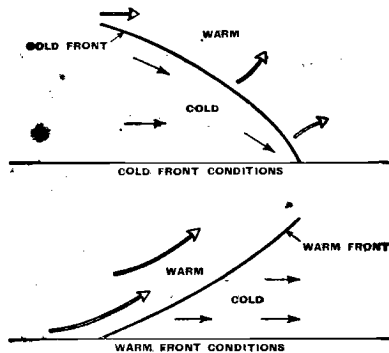

Ultra short waves may be refracted at the boundaries of air masses of different densities. This diagram illustrates suitable meteorological conditions for refraction that often exist.

Beyond the horizon there is still a field of considerable strength, due to the presence of a diffracted wave. By the process of diffraction the wave is bent round an intervening obstacle—such as the earth's surface—and thus reaches to distances which would otherwise be impossible. The field due to the diffraction wave—like that due to the directly received wave—is a steady one, and, as the path lengths do not vary, it is not subject to fading.

But an ultra-short wave transmission may be received at considerable distances beyond the optical range, and the field at these distances is found to be subject to considerable variations, both of a short-period and long-period character. This points to the presence of a refracted component in the received field. As has been pointed out, the frequencies are too high for the wave to undergo refraction at the ionosphere layers, so we must look for some other agent. The long-period variations in the received field have been correlated—to some extent—with meteorological conditions, and here we have a clue as to the nature of the refractive process.

It is, in fact, almost certain that the waves are refracted, at least partly, at the boundaries of air masses of different densities. The presence of such different air masses usually occurs in connection with the formation and movement of atmospheric "depressions."

## Meteorological Effects

The diagram illustrates conditions which often occur. In the case of the cold front there is an advancing mass of cold air which is pushing forward into the warm air and forcing it upwards, while in the warm front the warm air is overtaking a mass of cold air and flowing upwards over it. In both cases there is a discontinuity at the boundary of the two air masses; and a temperature inversion may occur there. That is to say, as we go vertically upwards from the ground, the temperature may suddenly cease to fall with increasing height (as it normally does) and may actually show a rise with height for a short distance. The two air masses will be of a different density, and the density gradient will be steep where there is a temperature inversion. Under these conditions refraction of the ultra-short waves can occur.

The boundary of the air masses will lie at a height from the ground extending up to perhaps about 6½ miles, the height of the tropopause, which marks the lower edge of the stratosphere. So the height at which the wave undergoes refraction may vary between about half a mile and 6½ miles. Thus we may get a refracted wave coming down even within the optical distance, or the wave may be refracted so as to return to earth at distances up to about 200 miles. There is also a possibility that some refraction may always occur at the tropopause, because here there is always a cessation of the fall of temperature with height. It would appear also

## Range of Ultra Short Waves—

that at night temperature inversions can occur even without the cold or warm front conditions. All these phenomena have been and are being correlated with variations in reception on the ultra-short waves, and good agreement has been found.

Refraction at the boundaries of differing air masses would appear to account, for example, for the reception on 56 Mc/s over distances corresponding to those to France, Belgium and Holland. It could also account for long-distance reception of the London television station in those countries. A station operating on 60 Mc/s in the U.S.A. was regularly heard over a non-optical path up to 100 miles, though there was a marked dependence on meteorological conditions. The signals from these stations at these distances are usually weak, which might indicate that they are being received by multiple refraction from atmospheric discontinuities situated not far above the ground. When meteorological conditions are favourable, however, the signals become very strong, which would indicate that reception is by a single hop from a discontinuity higher in the atmosphere, such as might occur with a cold or warm front. Experiments on 75 and 150 Mc/s in the U.S.A. showed that variations are present in the wave received over an optical path, indicating the presence of a refracted component.

We may perhaps conclude that it is possible to receive signals from distances within the optical range to distances up to about 200 miles, and on frequencies up to perhaps 100 Mc/s, because of refraction which occurs at air mass boundaries from half a mile to 6½ miles above the ground. The signals will generally be weak, but when conditions are favourable, may be quite strong.

## At Greater Ranges

Signals are often heard at good strength on frequencies as high, at least as 56 Mc/s over distances greater than those just given. An example is the reception obtained on 56 Mc/s from stations in Germany, Sweden and Italy before the war.

This must be accounted for in a different way. It is, undoubtedly, due to the presence of what is known as the Sporadic E layer. Reflections from waves sent up vertically are often obtained from heights corresponding to that of the E layer, but on frequencies very much higher than the critical frequency of that layer. These are thought to come from

“patches” in the E layer where there is a very sharp gradient in the ionisation, i.e., where the ionisation increases very rapidly with height. This is called the Sporadic E, and, as its name implies, is an erratic occurrence in that layer. Sporadic E does, however, occur pretty often, particularly in the summer and in the evening, though it may occur at any time.

## “Sporadic E” Reflections

A study of the records of the upper limit of frequencies for reflections from the Sporadic E at vertical incidence indicates that frequencies of 10 Mc/s are commonly reflected, frequencies of 12 Mc/s fairly commonly, and there is one record of a reflection at 15 Mc/s. Because of the relatively low height of the Sporadic E as compared with that of the F layer, this will lead to relatively higher frequencies for long-distance transmission. For example, the figures given above indicate that 50 Mc/s, 60 Mc/s, and on one occasion 75 Mc/s would be refracted with the most obliquely incident waves. These waves would return to earth at a distance of about 1,100 miles, and waves coming down from this medium at somewhat shorter distances could be of only slightly lower frequency. It is to be noted that such transmissions would not be in any way reliable, because of the erratic and unpredictable nature of the medium. Such transmissions as have been reported over the distances mentioned on the ultra-short waves conform to just these very characteristics. They are erratic as to time of occurrence and duration, and they occur most frequently in the summer and in the evening. It is unlikely that multiple-hop transmission would occur in this way because of the improbability of finding the Sporadic E at two successive points of refraction.

It would appear that we may sum up the whole matter by saying that short-wave propagation takes place as follows:—

(a) By a direct wave over the optical path, of which the length varies according to the nature of the terrain and the height of the aeri-als.

(b) By a diffracted wave from the limit of the optical path and up to an uncertain distance—uncertain, because beyond the optical path it is very difficult to separate the diffracted from the refracted component.

(c) By refraction at the regular F, F<sub>2</sub>, F<sub>1</sub> or E layers to great distances. The upper limit of frequency for this type of transmission will depend on the length of the transmission path and on the virtual height and ionic

density of the refracting layer. The extreme limit was probably about 54 Mc/s in 1937 and 32 Mc/s in 1941. Apart from occasions when ionosphere storms or sudden ionosphere disturbances are in progress, the transmissions will be reliable. The received signal will be subject to fading, due to varying path lengths. There will be a skip area between the outer limit of the direct wave and the inner limit of the indirect wave. Within this area weak and unreliable signals will be receivable by “scattering” from points in the lower layers of the ionosphere.

(d) On frequencies above those for (c) and up to about 75 Mc/s, by refraction at the Sporadic E. This type of transmission might provide reception from about 300 miles or less to about 1,100 miles. There will be a skip area as for (c). The signals may be strong, but the transmissions will be erratic as to time and frequency. They will occur most frequently in the summer and in the evening. It is unlikely, therefore, that they will ever be of use for regular communications.

(e) On frequencies above those for (c) and up to, perhaps, 100 Mc/s by refraction at atmospheric discontinuities. This type of transmission might provide reception from the limit of the optical path to about 200 miles. The signals will normally be weak, but with favourable meteorological conditions may be strong. They will be subject to fading due to the varying path lengths. There will be no skip area. Because of certain advantages which go with the use of these waves it is likely that they will be widely used for certain services over distances considerably in excess of that of the optical path. It is unlikely that they will ever be used for working to distances near the limit because of the marked dependence of the waves on meteorological conditions.

## BOOK RECEIVED

**The Cathode-Ray Oscilloscope.** Second edition. By W. E. Miller, B.A. (Editor of *The Wireless and Electrical Trader*).—Although this book was primarily written for wireless service engineers, it has since been found of value in Service training schools and technical institutions. No previous knowledge of the subject is assumed, and in addition to the elementary theory of the tube a number of applications of the oscilloscope are treated. The book is illustrated by numerous diagrams and photographs of traces. Pp. 48; 34 figures. Published by *The Wireless Trader*, Dorset House, Stamford Street, London, S.E.1. Price 2s.; by post 2s. 2d.

# Electrosurgery

## Radio Technique in the Operating Theatre

Several months ago we published an article explaining how the use of radio principles helps the physician. Now, an engineer who has had considerable experience in collaborating with the medical profession deals with the subject from the point of view of the surgeon, explaining how wireless technique is used to replace the knife, and to some extent also the ligature.

By A. W. LAY, F.Inst.P.

**B**EFORE proceeding to consider the *modus operandi* of electro-surgery, in which high-frequency currents in the range of from 1 to 5 megacycles (60 to 300 metres) are employed, it may be as well to draw the attention of the general reader to a fact already well known in medical circles. This is that at high frequencies currents of high density can be tolerated by the human system without pain or harmful effects to the tissues; whereas if currents of the same density were applied at low frequencies, or DC, the effects would be harmful or even fatal.

In considering the application of high-frequency currents to the human body the difference between metallic conductors and those rich in ions should be borne in mind; but to give an adequate explanation of the behaviour of high-frequency currents on the cells of which the tissues are composed would necessitate going rather more fully into bio-physics and bio-chemistry than an article in a wireless journal warrants. It must suffice, therefore, to explain that, owing to the rapidly fluctuating magnetic fields associated with high-frequency currents, these currents are forced to the surface of any metal conductors which they are traversing.

This fact has led to the growth of the popular belief that the human body is immune from injurious effects when high-frequency currents traverse it, because, according to this conception, these currents travel immediately under the skin, and by so doing avoid passing through the vital organs. This conception is erroneous; the truth may best be revealed by stating that DC, and also AC of relatively low frequency, cause harmful effects because, by electrolytic action, they disturb the

natural pattern of the molecular structure of certain vital body fluids.

The extent of the harm done by this process is approximately proportional to the product of the current density and the time during which the current flows. But when high-frequency currents of upwards of one million cycles per second are applied to the tissues, these harmful effects are nullified by virtue of the rapid reversal of the polarisation of the electric field, which would otherwise cause the electrolytic decomposition of the body fluids. Furthermore, at these high frequencies the polarisation in one direction does not persist long enough for pain to be felt. It is for these reasons that very high current densities at high frequency can be tolerated without harmful effects or discomfort.

Put in another way, in the case of high-frequency current the product of current density and the time during which it flows in one direction is reduced to a tolerable value as the time

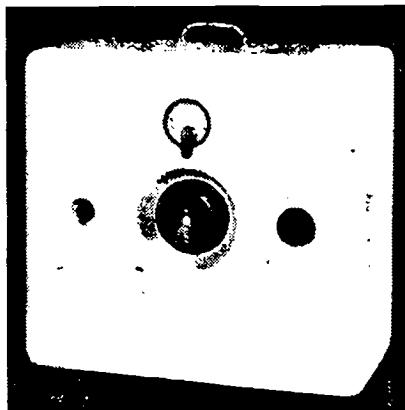

The Marconi-Ekco Spark Generator. It can be used either for diathermy or surgery.

factor is so small, and, therefore, the current factor may be large.

As examples of convenient demonstrations of the toleration by the human system of high current densities at 1,000,000 c/s, it may be stated from actual experience that a current of 800 milliamps may be passed from hand to hand for a period of 15 minutes without harmful effects occurring in the case of a person in normal health; similarly, a current of about 2 amperes at the same frequency may be passed through the thorax by using 12 x 20 centimetre plates as electrodes.

### Electrosection

We can now proceed to deal with the first branch of electro-surgery, namely, electrosection, which means that an electric arc is used for the purpose of excising, or cutting, and cauterising tissue simultaneously.

This cutting arc is produced when the current breaks down and ionises the air gap between the active electrode and the tissue to be cut. In most surgical applications of high-frequency currents those of undamped wave-form produce far better effects than when a train of damped waves is applied to the tissues, the only exception being for coagulation, or blood clotting for the purpose of the stopping of bleeding, when better results appear to be obtained from a slightly damped wave.

At present valve and spark types of generators are in use to provide high-frequency current for the medical profession, but the obvious advantages offered by the valve type of apparatus are gaining the favour of surgeons, as this type can be designed to provide either form of wave, whereas it is not possible to design spark generators to give an undamped output. However, spark apparatus is relatively cheap, and very robust, and if well designed and manufactured it can give useful service in general surgical work.

Recently the Marconi-Ekco Company has developed a greatly improved spark type of combined apparatus for electro-surgery, and diathermy in close collaboration with the medical profession. This unit is known as the Therator Spark Type MME10. It has been fully approved by the surgeons who use it regularly, and it has

## Electrosurgery—

been supplied to Army mobile units.

The apparatus provides 400 watts of energy at 1111 kc/s (270 metres), which is adequate for all surgical purposes, and sufficient to give diathermy treatment to two patients simultaneously. By means of a single control adequate

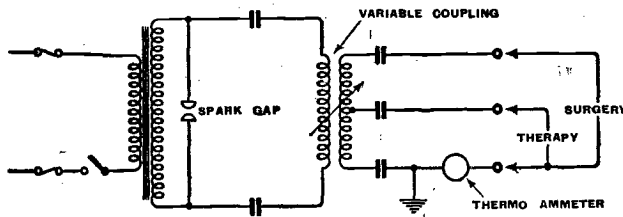

Fig. 1. The circuit diagram of the Marconi-Ekco Spark Generator. It provides an output of 400 watts at 1111 kc/s, and is largely used in major operations. Its great advantage is low cost and robustness.

flexibility is provided so that the output from the unit may be set at a low value suitable for surgical work on delicate tissues, or set to give sufficient current for extensive coagulation. The output is continuously variable from the minimum to the maximum output, and a graduated dial enables the operator to pre-set the output according to the surgeon's requirements. An outstanding feature of the high-frequency system is the novel type of spark discharger which has been developed specially to render the output consistent and trouble-free.

The mechanical design makes the unit very compact, portable, and strong. The chassis and case are both of aluminium, thus providing the maximum screening and giving very little interference when properly installed in accordance with the G.P.O. recommendations. Fig. 1 gives an idea of the high-frequency system of the MME10 apparatus, the outward appearance of which can be seen in an accompanying photograph.

Passing now to the actual use of high-frequency currents in surgery, it

must be emphasised that we are concerned here only with the physics of the subject, and mainly with the application of Joule's Law, which, as is well known, states that the heat produced in calories =  $0.24I^2Rt$ , where  $I$  is the working component of the current,  $R$  the resistance through which

$I$  passes, and  $t$  the time in seconds during which the current flows.

Firstly, it should be mentioned that raising the temperature of the blood to about 40 deg. C. accelerates its coagulation and so checks bleeding. When a cutting operation is performed

by high-frequency current, specially shaped electrodes are used instead of the surgeon's orthodox scalpel or knife. These electrodes take the form of a straight wire, a loop, or a small blunt blade, as shown in accompanying photographs.

None of these electrodes cut the tissue mechanically as the surgeon's knife does. The cutting effect depends upon the intense concentration of heat in a minute arc, which is struck and maintained at a point of the operating electrode during the course of the cutting stroke, which is controlled by the surgeon. Further research is necessary to determine the exact process by which the heat disintegrates the molecular structure of the tissue, but it can be safely stated that, if current of suitable value and characteristics is applied, a very clean cut is obtained, and that healing compares very well with the effects following the use of the surgeon's knife.

In order that these successful re-

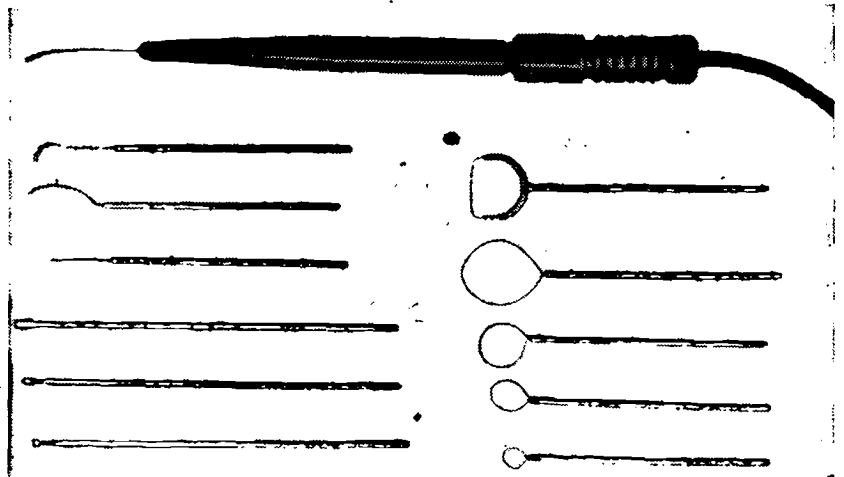

(From "Electrosurgery," by Kelly and Ward. By courtesy of the W. B. Saunders Co.)

Some of the cutting electrodes used in various types of operation. They are held in a small chuck attached to a handle about the size of a fountain pen. The mushroom-shaped electrode is used for causing extensive blood clotting.

sults may be achieved, however, it is of paramount importance that the intensity of the current shall not be too high, and that the active electrode shall not be allowed to dwell at any point in the course of the cut, otherwise the resultant clotting is too deep, and the tissue becomes charred. The effect of this is that healing will not then take place, or, at best, will be seriously delayed.

The successful operation depends upon the use of the correct current

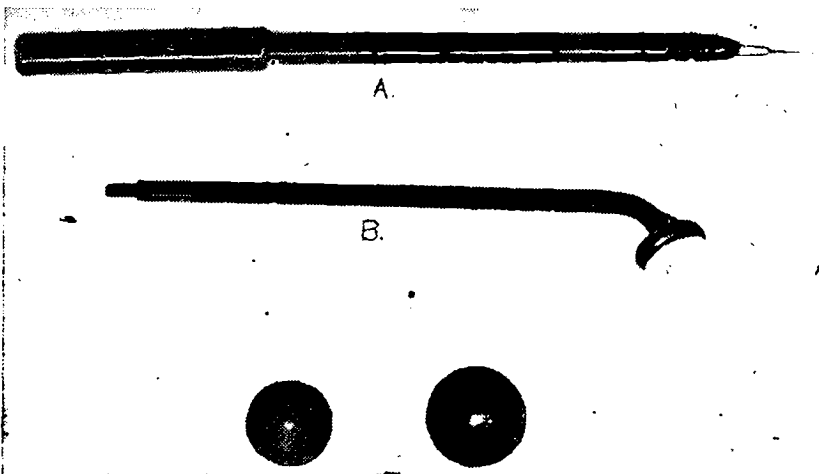



value and speed of cutting to produce a white film of clotting on each side of the cut, which is just sufficient to seal up the blood vessels as the tissue is severed. This process demands a high degree of skill from the surgeon, who usually tests out new equipment on animal tissue before using the current for operations on human beings.

## Stopping Bleeding

It often happens that the electrode unavoidably severs a large blood vessel, and as it is not allowed to dwell in its course, for reasons already stated, the flow of blood from this vessel may not be completely stopped. When this occurs the surgeon gathers the end of the blood vessel in a pair of special forceps and applies a more intense current through the actual forceps in the manner indicated in Fig. 2, and is thus able to stop the bleeding.

In any case the number of ligatures, or tying-off of severed blood vessels, as the result of practising electrosurgery is only about one-third of the number required by the more orthodox methods. Many surgeons who have practised electrosurgery state that far less pain, shock and physical injury follow the operation than when the ordinary surgeon's knife is used.

The current is collected from the patient's body by a special electrode consisting of a large plate, several square centimetres in area. This is connected to a good earthing system, thus forming a sink for the current from the body of the patient, if this were not done the body would be at a dangerous potential, and an arc would be drawn from the patient to any near point at earth potential, or from the operating surgeon or his assistants with injurious effects in the nature of a burn.

This earthing plate, generally termed the "indifferent" plate by the medical profession, is usually covered with lint which has been soaked in a ten per cent. saline solution, although specially prepared contact creams are now in use. The plate is then bandaged to a convenient part of the body, such as an arm or leg, or under the patient's back. Great care is taken to ensure uniform pressure over the area of plate contact with the body, thus avoiding hot-spots which would be caused by high density of current at any point.

A few of the forms of electrodes used in cutting operations are shown in accompanying photographs. It will be seen that these instruments are held by a small chuck which is attached to

a neat operating handle about the size of a fountain pen. The cable carrying the current from the high-frequency generator is passed through this handle to the chuck.

In some designs of operating handle a small switch is incorporated which

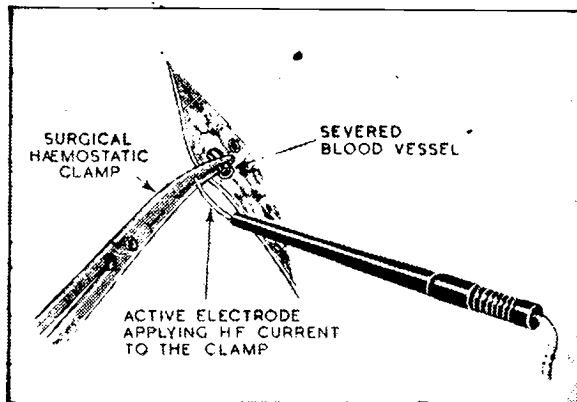

Fig. 2. When a large blood vessel is severed, the surgeon grips it in a special pair of forceps and applies an intense HF current to the wound by placing the cutting electrode in contact with the forceps. This causes clotting and so stops bleeding.

enables the surgeon to switch the current at will, but this means breaking the high-frequency circuit, and usually a convenient foot switch wired in the low-frequency circuit and placed in a handy position under the operating table is considered to be a better method of control. The hands of the surgeon are then free of this switching operation, which may be done by his foot, or by that of his assistant.

It will be understood that all the operating equipment, including the cables, must be suitable for sterilising

be quick as time is of paramount importance in work of this nature.

The high-frequency energy required for cutting operations in general surgery varies from about 30 to 80 watts—depending upon the work in hand. In an air medium the critical cutting voltage is about 220 to 230 volts RMS; at voltages above 250 the arc is too fierce and then there is a tendency for the divided tissue to become charred; this effect must be avoided.

(To be concluded.)

## The "Acoustic Envelope"

### New Development to Aid Voice Production

A METHOD for providing a singer, actor or solo musician with an acoustic effect around him similar to what he experiences when performing in a small, reverberant room or enclosure has been devised by Mr. H. Burriss-Meyer, of the Stevens Institute of Technology, Hoboken, New Jersey, U.S.A. The "envelope" of sound is made audible to the artist only and not to the audience.

This "acoustic envelope" was specifically developed for Paul Robeson, with the object of producing on the concert platform a zone in which the acoustic conditions would approximate those of a small, highly reverberant studio. Such conditions are very desirable as in them the artist hears himself easily and makes no unusual effort to project his voice. The lack of adequate side-tone to judge one's audibility, etc., due to concert hall acoustics, may lead to

tension and technical faults in voice production.

The technique of Mr. Burriss-Meyer consists of reproducing in the restricted zone the significant harmonics of the voice or instrument. The area within which the sounds are audible must be limited since, for concert use, it is generally essential that the audience hear nothing emanating from an electro-acoustic device. The method has been employed by Mr. Robeson in his recent concert tour in America in halls of widely varying acoustic characteristics.

It has also been used experimentally with (a) full orchestra and settings on the stage of the Metropolitan Opera House, New York; (b) violin soloist with piano accompaniment; and (c) choruses of more than 100 voices. The method can be used without affecting microphone pick-up for broadcasting purposes.

D. W. A.

# UNBIASED

By FREE GRID

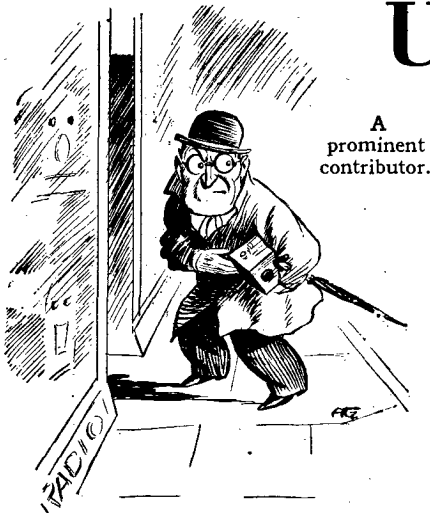

A prominent contributor.

## Radiolocation

NO doubt many of you will be wondering what, if anything, has been my part in the development of radiolocation. I cannot, of course, say very much about it as the very word makes Editors and other censors shy like startled horses.

The truth of the matter is that although the basic idea of radiolocation was undoubtedly mine, I seem to have missed the bus badly by using the idea for an entirely different purpose to that of locating aircraft. The reason for this lapse on my part is due, I suppose, to the fact that there is a great gulf fixed between mathematical genius and practical ability, a fact which was strongly exemplified recently when a certain very prominent contributor to *The Wireless Engineer* was seen slinking into the local wireless dealer's with his crystal set after a vain struggle to get it to work.

I seem not only to have missed a great opportunity of making my name more famous than it is, but to have run the very grave risk of making it infamous by unwittingly disclosing information to a certain foreign Power.

It so happened that many years ago I was called into consultation by this particular government to solve a traffic signal problem which was worrying them. In that country, just as over here, they are troubled by motorists trying to slip past the traffic lights when they are red. They are, however, a bit more up to date than we are, for they have a photocell arrangement fitted up so that an invisible beam is put across the road when the red shows.

Any motorist attempting to cross cuts this and actuates a flash light and miniature camera fitted at the top of one of the posts, and the local police-

man calls round every morning to collect the evidence of the night's dirty work recorded on the film. Actually an invisible (infra-red) flash light is used in conjunction with a spool of infra-red film, so that the offending motorists do not know that their offences have been recorded.

It was found impossible to put the ray-generator and photocell at the top of the traffic light supports with the camera as the ray then passed above the tops of cars. They had to be put halfway down their respective posts well within the zone of small-boy interference, and therein laid the snag.

It was this point upon which I was called in to advise, and I promptly solved the problem by substituting modern radio technique for their archaic photocell methods. I mounted a transmitter-receiver at the top of the post out of harm's way. The transmitter was automatically switched on when the traffic lights went red and its waves were promptly reflected back to the receiver by the top of any car trying to run the gauntlet. When no car intervened the waves continued on and struck the road, and although they were, of course, reflected, the time period was too great to operate the receiver, which was synchronised with the transmitter.

As I have already said, if I had only had a little more imagination I might have made myself famous by offering my idea to the R.A.F. for sterner purposes than catching traffic light beaters. Moreover, I feel very uneasy lest the foreign government for whom I evolved this radio traffic control scheme may have been base enough to put it to a use I never intended.

## A Delicate Task

SINCE the war began we seem to have had quite a spate of articles, books, gramophone records and all manner of other devices designed to enable people to learn the morse code. *The Wireless World* excelled itself by publishing an article complete with diagrams of the ulna, the humerus and other medical unmentionabilities which are used in manipulating a morse key, and is now celebrating Samuel Morse's 150th birthday by producing yet another edition, the eighth, of its "Learning Morse" booklet, of which 175,000 or some such Goebbels-like figure have already

been disposed of, as the house agents euphemistically put it. But what has astonished me more than anything is that not one of the experts who have written these learned theses on the subject has bothered to give any hints on how to learn to manipulate a typewriter or even to tell us that nobody can acquire any real speed at morse unless he can also type. Anybody who doubts this latter point can settle it by writing for one minute at topmost speed a portion of some well-remembered ditty like "Who's Your Lady Friend?"

From the foregoing test it will be found that thirty words a minute or thereabouts is the utmost speed at which anything can be written down legibly. Morse can be received at a far greater rate, however, 73 words per minute being the speed attained by McElroy, the world's champion, while quite ordinary operators can read at well over forty words per minute. Shorthand, owing to its phonetic nature, will not help us, and so a typewriter becomes essential.

I have, therefore, been trying to remedy this defect by preparing an article in which due attention is paid to attaining a high manipulative speed on the typewriter as well as on the morse key. I am, however, up against an unexpected snag, as, if I am to do the job thoroughly with pictures of ulnae and humeri in the manner of morse articles already published in *The Wireless World*, I have got to get hold of an expert typist to see which



An old-fashioned typist.

particular arm joints and muscles she uses when typing.

Unfortunately, Mrs. Free Grid cannot type, and we happen to be living temporarily in a remote part of the country where fashions move slowly and typists still wear long sleeves and other things, and I scarcely like to broach the subject to them. I wonder, therefore, whether any of you who work in the more sophisticated atmosphere of a London office would care to help me by making the necessary observations.

# THE WORLD OF WIRELESS

## AMERICAN TELEVISION

### R.C.A. and N.B.C. Plans

RECOGNISING the contributions which purchasers of early television receivers have made toward the development of the American television service, the R.C.A. Manufacturing Company has announced that it will adjust free of charge all R.C.A. television sets in the New York area to conform with the new standards which came into operation on July 1st.

The N.B.C.'s New York station W2XBS, in the Empire State Building, which has been transmitting experimentally since June, 1936, is now in service on a commercial basis at various times between 2 and 11 p.m. on six days a week.

It is expected that the installation of the N.B.C.'s second transmitter, W3XNB, at Washington, D.C., will be completed by November, but it will not be ready for commercial service until next March.

The site has been selected in Philadelphia for the third N.B.C. television station, and application has been made to the Federal Communications Commission for permission to proceed with the erection.

In a letter accompanying the N.B.C.'s application to the F.C.C. attention was called to the fact that National Defence is the industry's primary concern at the present time. Therefore, the service and construction applied for will be carried out subject to the demands of the Government. The letter concluded: "R.C.A. recognises, however, that civilian pursuits must continue and be curtailed completely only in extreme emergency. We believe, as always, in the future of television, and are confident that in it is the future method of mass communication which will carry radio broadcasting far beyond its present state of development."

## CONDENSERS IN WARTIME

TWO R.M.A. specifications, one dealing with the rating and dimensions of paper and electrolytic condensers and the other with colour coding of condensers, have now been combined into a single War Emergency British Standard (BS271-1941). The restricted range of values, etc., covered by the Specification will, it is considered, meet the normal requirements of the industry under wartime conditions, so far as fixed condensers for receivers are concerned.

## RADIO-FREQUENCY PROBE

### For Detecting Metallic Foreign Bodies

RECENTLY a speaker on the German radio described a new device by which, he claimed, bullets, shell splinters, and other metal objects in the body can be readily located.

This metal-finder, developed by Siemens and their medical advisers, depends on the use of a high-frequency oscillator of low power. The tuning coil is fitted into a sterilisable porcelain probe, 10 cm. long and 10 mm. in diameter. If this coil approaches

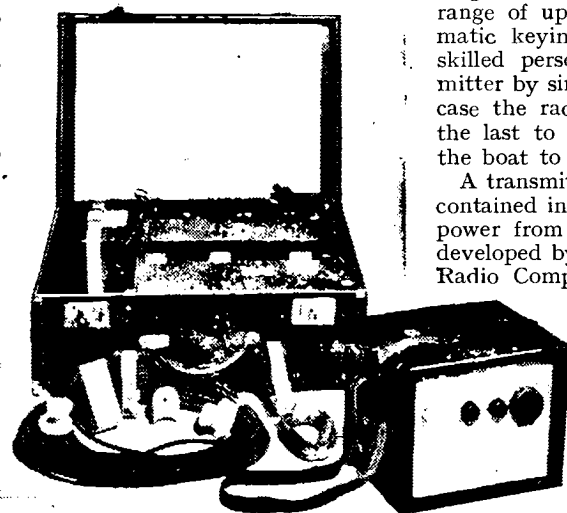

a metallic substance, such as a splinter in the operation area, the inductance of the coil will change, and hence so will the frequency of the transmitter. The change of frequency, which may be very minute, can be made audible by combining these oscillations with those of a second short-wave generator oscillating at a slightly different frequency, and so obtaining oscillations at the beat frequency, amplifying them and passing them to a loud-speaker.

The apparatus has an equally good reaction to all metals, including the large group of light metals now being increasingly used which cannot be located by magnetism. Tests carried out during more than a hundred operations have proved its worth, and so far it has never failed.

The apparatus is extremely sensitive and can trace the minutest particles, but all metal instruments within a 10 cm. radius must be removed while the probe is in use.—  
From *The Lancet*.

## LIFEBOAT WIRELESS

### Automatic SOS Transmitter

IN order to ensure as speedy a rescue as possible of men of the Merchant Navy who have had the misfortune to suffer shipwreck, the Ministry of War Transport has arranged for at least one lifeboat on all merchant vessels to be equipped with a new lightweight portable transmitter.

Circuit details have not been disclosed, but the following facts may prove of interest. The single-valve transmitter, which employs a valve little larger than that in the output stage of a receiver, is stated to have a range of up to 200 miles. An automatic keying device enables an unskilled person to operate the transmitter by simply pressing a button, in case the radio officer (always among the last to leave the ship) is not in the boat to use the key.

A transmitter, which is entirely self-contained in a suitcase and derives its power from a dry battery, has been developed by the International Marine Radio Company.

Lifeboat transmitter and receiver. The transmitter and accessories are housed in a watertight suitcase. The phones for the receiver are stowed in the back of the set.

To enable those in the lifeboat to receive messages from rescue ships a very light portable receiver, which tunes to the 600-metre band, is supplied with the transmitter.

## NEWS IN MORSE

A NEW schedule of the transmission of official British news bulletins in Morse from the Post Office stations was introduced in July. The call signs and the wavelengths employed for these transmissions, which are intended for overseas, are:—

GIA 15.27 m.	GIH 28.17 m.
GAD 15.40 m.	GAY 33.67 m.
GBL 20.47 m.	GBR 18,750 m.
GID 22.13 m.	

The times (GMT) of the transmissions and the transmitters used are:—

2330	GBR, GAY, GIH.
0930	GBR, GIA, GID, GIH.
1200	GBR, GAD, GIA, GID.
1600	GBR, GAD, GIA, GID.
1930	GBR, GAY, GBL, GID.

For the transmissions at 1200 and 1600 the transmitter GIA has its aerial directed to South America. The aerial used by GBL for the 1930 transmission is also directed to South

## Wireless World

### The World of Wireless—

America, but this transmitter closes down at 2000, and the transmission is continued by GBR, GAY and GID.

These Post Office transmissions will be found to offer good practice at reading by those learning Morse.

### \$40,000 FOR WORLD BROADCASTING

#### U.S. Government Counter-propaganda?

THE Reconstruction Finance Corporation, an American Government-controlled organisation, has authorised a grant of \$40,000 to the World-Wide Broadcasting Foundation, operators of short-wave stations WRUL and WRUW, Boston.

Broadcasting, Washington, commenting on the grant, which is the first made to a comparable non-commercial organisation, suggests it indicates concrete Government interest in a counter-propaganda campaign.

### WIRELESS EDUCATION FOR THE FORCES

#### An Appeal for Help

MANY members of the Forces wishing to use the limited spare time that they have at their disposal to the best advantage have applied to the London Regional Committee for Education among H.M. Forces for assistance, under the Committee's Directed Reading Service, in the study of wireless and kindred subjects.

The officers of the Committee are experiencing some difficulty in finding tutors willing to correspond with these men. They would, therefore, welcome any assistance that readers of *The Wireless World* may be able to give. They should send their names and addresses to the above Committee, c/o The London School of Hygiene and Tropical Medicine, Keppel Street, W.C.1.

to December 31st, 1941. Competitors must forward their proofs of claim between October 1st and December 31st to the secretary, John Adam Street, Adelphi, London, W.C.2.

### FROM ALL QUARTERS

#### BST

THE British Summer Time given in this and subsequent issues of *The Wireless World* is one hour only ahead of GMT.

#### B.B.C. News on Short Waves

THE wavelengths which are now in use in the B.B.C. European and World Services for the transmission of news in English and the times (BST—1 hour ahead of GMT) at which they are radiated, are:—

0100, 0145 and 0530: 31.32, 31.25, 25.53.  
0715: 42.46, 31.55, 31.25, 25.53, 19.82, 19.66.  
0900: 49.59\*, 41.49\*, 31.55, 25.53, 25.38\*, 25.29\*  
19.82, 19.66, 19.60.  
1200: 31.25, 25.53, 19.82, 16.84, 16.77, 16.64, 13.97.  
1400: 19.82, 16.84, 16.77, 16.64, 13.97.  
1430: 49.59\*, 41.49\*, 25.38\*, 25.20\*.  
1700: 31.75; 25.53, 19.82, 16.84, 16.77, 13.92.  
1900: 31.25, 25.53, 24.02, 19.82, 19.66, 16.84.  
2145: 31.25, 25.53, 19.82, 19.60.  
2300: 49.59\*, 41.49\*, 30.96\*.  
2345: 31.32, 31.25, 25.53.

Wavelengths marked with an asterisk are used in the European Service.

#### Canadian Short Waves

THE new 7.5-kW short-wave station of the Canadian Broadcasting Corporation at Vercheres, Quebec, has recently been working experimentally. Its allocated call signs and frequencies are: CBFW, 6.160 Mc/s; CBFX, 9.630 Mc/s; CBFY, 11.705 Mc/s; and CBFZ, 15.190 Mc/s. It will be remembered that this station was erected to serve the French-speaking communities in areas of Western Canada which are outside the service area of the Corporation's existing network of medium-wave stations.

#### Civilian Technical Corps

THE Civilian Technical Corps, which, as announced in last month's issue, gives Americans the opportunity of working on radiolocation for Britain, has gratefully accepted the offer of the Radio-marine Corporation of America and R.C.A. Institutes to make their technical facilities in twenty cities of the United States available to the Corps for examination of volunteers.

#### G.E.C. General Managers

DR. A. H. RAILING and Mr. Leslie Gamage have been appointed general managers of the General Electric Company. Each has been a director for many years; the former has devoted his attentions chiefly to the engineering and manufacturing sides of the company, while the latter, in addition to occupying the position of Secretary, has been director in charge of the overseas business.

#### R.S.G.B. Convention

ALTHOUGH the apparatus shown by the dozen or more exhibitors at the R.S.G.B. Convention held at the I.E.E. on August 9th was not for sale, con-



THE BATTLE OF THE ATLANTIC. One of many such wireless rooms at various points along our coasts where communication with convoy escorts is maintained. Each telegraphist is operating a transmitter and receiver of which there are several at each station. The transmitters, some of which are of considerable power, have a very wide range.

#### BOUND BROOK AERIALS

A SITE of seventy acres is devoted exclusively to the transmitting aerials of the N.B.C.'s two 50-kW stations WRCA and WNBI.

The Bound Brook site is rectangular in shape, with the long dimension facing in the general direction of Latin America. This is important, the engineers explain, because a considerable number of aerials are necessary to properly serve the various sectors within the arc of 100 degrees between Pernambuco and Mexico City. The short dimension of the site faces Europe, for which a smaller number of aerials are necessary to serve the sector between Moscow and Madrid, which is only 30 degrees.

#### PRIZE INVENTIONS

LAST year's winner of the £50 prize offered by the Royal Society of Arts under the Thomas Gray Memorial Trust for an invention for the improvement and encouragement of navigation was Mr. H. C. Walker, of Cheam, Surrey. Twenty-four entries were submitted. Mr. Walker's entry was a self-contained automatic SOS transmitter for use in lifeboats.

A similar prize is again offered by the Council of the R.S.A. for an invention, publication or diagram which, in the opinion of the judges, is considered to be an advancement in the science or practice of navigation, proposed or invented by the entrant in the period January, 1936,

## Wireless World

siderable interest was displayed by the many who attended the function. The Services were well represented among those who attended and the opportunity of informal discussions was appreciated.

### Amateur Recording

A NEW type of stylus for record cutting has recently been introduced in the U.S.A. Made of so-called "Permo metal," an alloy of metals of the platinum group, it is claimed to give results comparable with a sapphire stylus, and to have valuable self-lubricating properties. The "life" is stated to be sufficient for the cutting of 200 10-in. discs. Long-life play-back needles of the same metal are also produced.

### Aerial Regulations

A DECREE regulating the use of outside aeriels in Switzerland was recently made by the State Council of the Canton of Geneva. It stipulates that all aeriels must conform to one of the approved models, so far as public safety and their aesthetic aspect are concerned. The regulation provides for a communal aerial for all blocks of more than four flats.

### Without Comment!

"NORTHERN winds sweeping over Europe from Russia have always enabled the Soviet, even in the worst weather, to broadcast with greater audibility and less kilowatt power than any other State. This natural advantage . . ."—*News Review*.

### WCBX-WCRC

BEFORE installing the thirteen directional aeriels at Brentwood, Long Island, New York, the new site of the twin 50-kW C.B.S. international short-wave stations WCBX and WCRC, models of the arrays, built to a scale of 1 in 7, were used by the engineers to check their anticipated performance. Eight of the thirteen arrays will be directed towards Latin America.

### 65 w.p.m.

THE Marconi Memorial award of the American Veteran Wireless Operators' Association for the Morse proficiency tests, in which 800 amateurs took part, was awarded to W. B. Hollis, who operates W5FDR, of Houston, Texas. To qualify for this award Mr. Hollis attained a speed of 65 w.p.m. Perfect copy for one minute was necessary.

### V in H.M.V.

A BADGE embodying the letter V was issued by H.M.V. last autumn to those of the staff who volunteered to continue working during air-raid alerts. This badge has, as the result of the V campaign, now come to signify "working for victory." H.M.V. Savings Groups have subscribed over £45,000 in the National Savings Campaign and they now aim to raise £10,000 for two Spitfires this month.

### Cossor's Contributions

IN the last twelve months employees of A. C. Cossor, Ltd., have contributed over £1,000 in pennies to the Red Cross Penny-a-Week Fund.

## The Wireless Industry

ELECTRADIX RADIOS and Leshe Dixon and Co. have moved to 19, Broughton Street, Queenstown Road, Battersea, London, S.W.8. (Address for both correspondence and callers.) Station: Queen's Road, Battersea (S.R.). Telephone: Macaulay 2159.

The Micanite and Insulators Co., Ltd., ask that wherever possible orders for Paxolin sheet and tube should be confined to the natural colour. The black material often asked for is in no way superior from the electrical or mechanical point of view.

### Aircraft Identification Charts

NEARLY half a million of the aircraft identification charts issued by our associated journal *Flight* have been purchased by the armed forces and the public. The following types are available from our publishers, Iliffe and Sons Ltd., Dorset House, Stamford Street, London S.E.1:—

British Aircraft: on card; 1s.; by post 1s. 6d. Pocket transparent chart, 1s. 6d. post free. American aircraft used by R.A.F. and Fleet Air Arm: on card; 1s. 3d., by post 1s. 9d. German aircraft: on card; 1s. 3d., by post 1s. 9d. Pocket transparent chart, 1s. 6d., post free. Troop carriers: on card; folded for pocket; 6d., post free. Italian aircraft: 6d., by post 7½d.

## NEWS IN ENGLISH FROM ABROAD

### REGULAR SHORT-WAVE TRANSMISSIONS

Country : Station	Mc/s	Metres	Daily Bulletins (BST)	Country : Station	Mc/s	Metres	Daily Bulletins (BST)
<b>America</b>				<b>Iran</b>			
WXB1 (Bound Brook)	11.890	25.23	5.0.	EQB (Teheran)	6.155	48.74	7.30.
WRCA (Bound Brook)	17.780	16.87	3.0, 5.0.	<b>Japan</b>			
WGEO (Schenectady)	9.530	31.48	9.0†.	JZJ (Tokio)	11.800	25.42	10.30.
WGEA (Schenectady)	15.330	19.57	6.45‡, 9.55‡.	<b>Manchukuo</b>			
WBOS (Boston)	11.876	25.26	9.0.	MTCY (Hsinking)	11.775	25.48	8.0 a.m., 10.5.
WCAB (Philadelphia)	6.060	49.50	12.30 a.m.†, 5.55 a.m.†, 11.30‡.	<b>Sweden</b>			
WCBX (Wayne)	9.650	31.09	9.0‡, 10.45‡.	SBO (Motala)	6.065	49.46	10.20.
WCBX	11.830	25.36	6.30‡.	<b>Thailand</b>			
WCBX	15.270	19.65	1.0†, 2.0†, 4.0*, 4.45‡.	HSP5 (Bangkok)	11.715	25.61	12.45.
WRUL (Boston)	6.040	49.67	11.30‡.	HS6PJ	19.020	15.77	12.45.
WRUL	11.730	25.58	11.30‡.	<b>Turkey</b>			
WRUL	11.790	25.45	8.30‡.	TAP (Ankara)	9.465	31.70	7.15.
WRUL	15.350	19.54	4.0*, 5.0‡, 8.30‡.	TAQ	15.195	19.74	12.15.
WRUL	17.750	16.90	4.0*, 5.0‡.	<b>U.S.S.R. (Moscow)</b>			
WLWO (Cincinnati)	15.250	19.67	5.0.	31-metre band	—	—	7.0, 8.0, 9.0, 10.15.
<b>Australia</b>				<b>Vatican City</b>			
VLR3 (Melbourne)	11.850	25.32	5.20.	HVJ	6.190	48.47	8.15.
<b>Egypt</b>				<b>MEDIUM-WAVE TRANSMISSIONS</b>			
SUX (Cairo)	7.860	38.14	6.50, 10.10.	kc/s      Metres			
<b>French Equatorial Africa</b>				<b>Ireland</b>			
Brazzaville	11.970	25.06	8.45.	Radio-Eireann	565	531	1.40‡, 6.45‡, 6.50‡, 10.9.
<b>India</b>							
VUD2/3 (Delhi)	9.590	31.28	1.30, 4.50.				
VUD4	11.830	25.36	9.0 a.m., 1.30, 4.50, 6.15.				
VUD3	15.290	19.62	9.0 a.m.				

It should be noted that the times are BST—**one hour** ahead of GMT—and are p.m. unless otherwise stated. The times of the transmission of news in English in the B.B.C. Short-wave Service are given on the preceding page.

\* Saturdays only.    ‡ Saturdays excepted.    † Sundays only.    ‡ Sundays excepted.

# Servicing Equipment and Its Uses

## Part III.—Miscellaneous Apparatus

By "SERVICE"

**H**AVING reviewed the major items of servicing equipment with which the beginner will come in contact we will next turn to other apparatus which although, perhaps, not absolutely necessary for the servicing of the majority of receivers, will help a great deal in speeding up service repairs and enabling quick diagnosis to be made.

The most important of these subsidiary pieces of equipment is the Capacity Tester, providing that it is one that will test condensers under actual working conditions in addition to giving a capacity reading.

As a large number of condensers used in modern radio receivers operate with a potential of two or three hundred volts across them, it is essential that for worth-while tests the capacity tester should be mains driven so that by means of a transformer and rectifying valve or metal rectifier quite high voltages are available for insulation tests. In order to cater for condensers which are used to decouple biasing resistors and others which are used in low-voltage positions various insulation test voltages should be available. A range such as 10, 25, 50, 250, 400 and 500 volts will suit most requirements.

The Sullivan "Capacitester," a self-contained measuring instrument used for routine production tests as well as for service purposes.

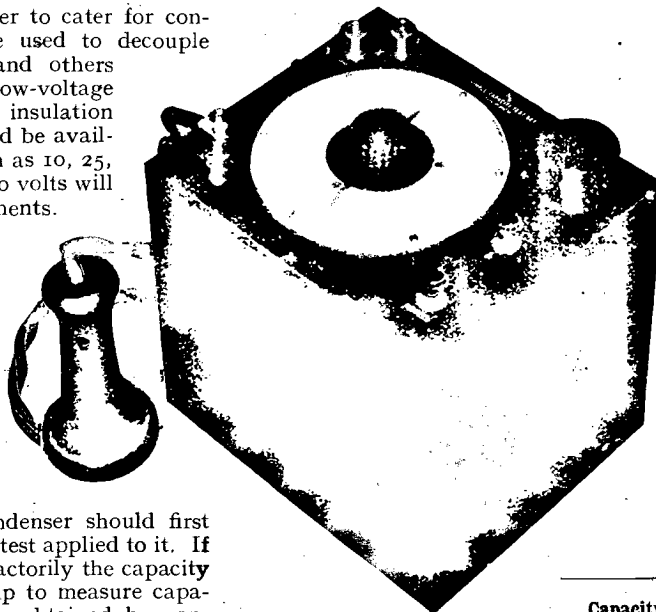

A suspected condenser should first have an insulation test applied to it. If it passes this satisfactorily the capacity tester can be set up to measure capacity and a reading obtained by connecting the suspected condenser to the appropriate leads.

A point to keep in mind is that good condensers hold their charge for quite a long time, and the risk of shock should be guarded against. Some capacity testers have an arrangement of switching whereby when the range

switch is turned to the "off" position before the condenser is disconnected from the tester, a short circuit is automatically applied to the test leads so that the condenser is discharged.

In order to test the capacity and insulation of all types of condensers, many modern capacity testers have facilities for checking the leakage current of electrolytic condensers. The test gives a good indication of the efficiency of the condenser, as if the leakage current is fairly normal the capacity can be assumed to be within the limits required for the work for which the condenser was designed. Electrolytic condensers are only made for fairly high capacities and, therefore, their actual value is not so important as are the values of the small condensers used in RF circuits.

An important feature in these tests is that it is desirable to allow the test

Leakage current is generally referred to in terms of milliamps per microfarad, and an average maximum figure is about 0.5mA per mfd.

Never apply AC to electrolytic condensers. The reverse voltages due to the negative half-cycles will cause heavy current to flow through the condenser which may be seriously damaged, although a direct current with a small superimposed ripple is not harmful to electrolytic condensers. A certain value of polarising voltage is applied to them before their capacity can be measured, and when this DC potential is applied and a comparatively small AC potential is superimposed for operating the bridge circuits of the capacity tester, no harm will be done to the condensers.

This point is mentioned as some analysers which are termed "universal" testers have methods of measuring the capacity of a condenser by applying an AC voltage with an AC voltmeter in series with the condenser to be tested. The method is quite satisfactory for condensers having paper or mica dielectrics. The condenser will act as a resistance so that the voltmeter will read something less than the full voltage being applied to the circuit, and the resistance effect due to the condenser will be directly proportional to its capacity.

The smaller the capacity the higher will be the resistance, or, as we should term it, the impedance to the AC current, and a lower voltage will be shown on the AC voltmeter.

The method depends upon the frequency of the mains supply—generally 50 cycles is taken as standard—and for any particular frequency the voltmeter scale can be marked to indicate the capacity at the various voltage positions on the scale. The inexperienced should be warned against using

to be carried out over a short period so that the condenser is being tested under normal working conditions, and the figures given in the table are representative of most types of electrolytics.

Capacity	Test Voltage DC	Total Leakage Current
2 mfd.	350 V	0.45 mA after 10 min.
4 "	225 V	0.8 " " " "
8 "	350 V	1.0 " " " "
10 "	350 V	2.0 " " " "
16 "	350 V	3.2 " " " "
25 "	25 V	150 $\mu$ A " 5 "
50 "	10 V	150 " " " "

this method of capacity testing for electrolytic condensers.

An important consideration which must be kept in mind when dealing with capacity testers concerns the leads to which the condensers are connected. The test leads supplied with the instrument should be used, or, if they have to be replaced, the new leads should be of similar length and type of wire. They should not be lengthened as the instrument has probably been calibrated with the test leads in circuit so that their capacity may be taken into account. The use of longer leads may upset the calibration, especially on very low capacity ranges.

Many capacity testers have ranges which go down to 0.0001 mfd. from a maximum capacity of 80 mfd., and at the minimum range the capacity of quite a short length of additional lead will seriously upset calibration.

Most types of capacity testers operate by a bridge circuit which balances the capacity of the condenser undergoing test against a standard condenser incorporated in the instrument.

Only a comparatively low voltage is employed in these types of capacity testers which are not mains-driven, while in others no voltage at all is applied to the condenser, the required signal energy being derived from a sound source such as an oscillating valve or buzzer. Before a condenser is passed as being O.K. after its capacity has been checked on such testers, it must be subjected to a voltage test to see whether its insulation is satisfactory under working conditions. For this purpose a small insulation tester is very useful.

### Testing Insulation Resistance

Insulation Testers are small editions of the well-known Megger type of instrument. They operate by means of a hand-driven generator which applies a potential of about 250V, and any current passing through the circuit is indicated by means of a needle which traverses a scale calibrated in megohms.

The voltage applied by an insulation tester cannot be varied, and, therefore, condensers which under normal working conditions are subjected only to low voltages should not be tested in this way, otherwise they may be destroyed by the test.

Insulation testers are, of course, very useful for many other investigations. Mains transformers may be checked by applying the test leads between each winding on the transformer, and also between the windings

and the laminations. As in the case of condensers, transformers can break down in a way which is only observable when a fairly high voltage is applied to them, and a dry-cell type of ohm-meter may not always show up the trouble. Tests between aerial and earth may be made.

One of those pieces of apparatus about which the newcomer need not worry unduly concerning his ability to appreciate its uses is the Audio-frequency Oscillator, but it will prove

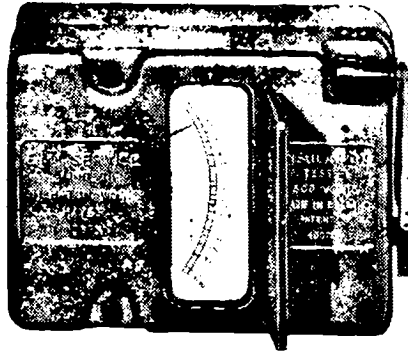

*Courtesy E.M.I. Service.*

The insulation tester is a simplified form of megger.

of great value to him as he becomes more experienced.

As its name implies, the audio-frequency oscillator is to AF circuits what the service oscillator is to RF and IF circuits. By its aid AF signals may be injected into the input of an amplifier or into any part of the amplifier, or into the pick-up sockets of a radio receiver chassis and applied to loudspeakers undergoing test.

It is not necessary to go deeply into the theory or design of audio-frequency oscillators. It will be sufficient to state that the arrangement in most of them comprises two valves oscillating at a high frequency with the output of the two valves mixed as in a superhet. circuit so as to produce a beat. Such an effect is produced when a station is tuned in on an oscillating receiver; the oscillations in the receiver beat with the oscillations of the incoming signal to produce a third oscillation whose value is the difference between the values of the two primary oscillations.

When the frequency of the two signals differs by 10,000 cycles per second, then a note of 10,000 c/s, which is very high, is heard from the receiver. As the station is more accurately tuned in, the difference between the two oscillations will decrease so that a lower note is produced, until, finally, when the station is dead in



It's the attention to detail that makes R.S.A. Equipment just that much better . . . just that much more reliable . . . just that much more efficient. But not that much more expensive.

Whether your interest in purchasing Sound Equipment is private, industrial or associated with the present National Emergency, you will find an investigation of the **R.S. AMPLIFIERS** range well placed and well repaid.

The items listed below are representative of our apparatus and full details will be sent on request. Let us know your special needs and we'll be happy to co-operate.

### AMPLIFIERS

"M.M. Twin."—Double speaker equipment giving 12 watts output. Five valves, AC/DC 190-260 volts. Complete with "mike," stand and cables.

"Universal Fifteen."—15 watts output. Two speakers. AC/DC 190-260 volts. High and Low impedance input. Complete with "mike," stand and cables.

"Porta Thirty."—30 watts output. Two speakers (this equipment can accommodate up to fifteen speakers!), AC 200-250 volts. Complete with "mike," C.P. stand and cables. The acme of perfection in portable amplification.

### CHASSIS

Five types of chassis are available 50 watt, 30 watt, 15 watt, 12 watt and a 12-watt Battery Unit.

### ACCESSORIES

Crystal Microphones and Stands. Speaker Units (Exponential Horns), 11 watts and 13 watts capacity.

**R·S AMPLIFIERS Ltd.**  
3-4, HIGHFIELD ROAD,  
SHEPPERTON · · · MIDDX.

Phone 1 Walton-on-Thames 1019

### Servicing Equipment—

tune, there is no difference between the two oscillations, and nothing is heard. This effect is made use of in the audio-frequency oscillator.

One of the oscillating circuits of the AFO is permanently set with regard to its frequency, while the second oscillating circuit is set very near this

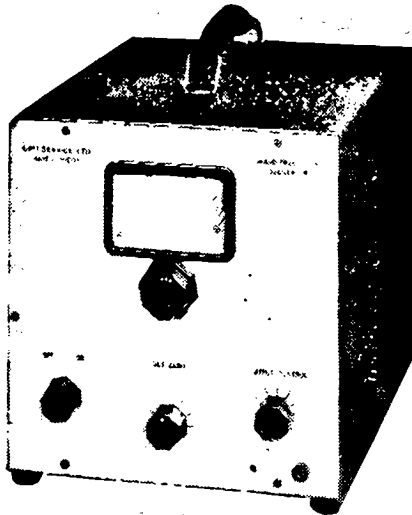

This E.M.I. Service audio oscillator provides signals for injection into any part of the AF section of a receiver.

frequency but has a variable condenser incorporated which allows the frequency to be either exactly equal to the first circuit or to be different from it by a definite amount which is marked on the scale of the variable condenser.

Most oscillators are very simple to operate. The controls comprise an on/off switch, a tuning control and an attenuator control which enables the strength of the output from the oscillator to be adjusted as desired.

With regard to the application of the AFO, a few typical examples will illustrate the use of the instrument and show its time-saving capabilities.

Often a rattle from the loudspeaker will be observed when a certain type of music is reproduced. By connecting the audio frequency oscillator to the AF stages in the receiver, a signal may be injected which is reproduced in the loudspeaker. The frequency of the signal may then be varied, and the output from the oscillator increased, when it will be found that the rattle complained of can generally be caused at a certain frequency and a certain strength of signal.

The characteristics of the rattle are then noted as to whether, for example, it is metallic, such as may be due to loose nuts and other metal work, or

"papery," such as can be caused by speech coil leads fouling the speech coil or cone. With the help of a steady signal, the speaker unit may then be visually examined for these faults and the trouble cleared.

Another fault which is easy to diagnose with the help of an AFO is microphony. This complaint can be caused by valves, ganged condensers, stiff, short wave wiring, etc., vibrating under the influence of sound waves from the loudspeaker. Often the howl is only produced at certain frequencies, and strength of signal and investigation is difficult unless the signal can be maintained. The AFO will provide a suitable type of input to the receiver to enable investigations to be carried out to eradicate the trouble.

The fidelity characteristics of the AF stages of amplifiers or receivers may be obtained and many other investigations carried out to discover the capabilities of a receiver or to compare it with one of a different make, but these applications do not really concern us here, so we will not enlarge upon them.

### The Valve Tester

A Valve Tester, which enables a good idea of the efficiency of suspected valves to be ascertained, is an important item of service workshop equipment. There are too many types of valve testers to enable a comprehensive description of this class of instrument to be given in this article, but one or two points of a general nature which apply to them may be of value to readers.

One of these concerns oscillator valves or "mixers." Quite a common fault in this type of valve is its inability to oscillate over certain parts of the wavelength covered by the receiver. For example, a receiver may operate quite satisfactorily on long and medium waves but give erratic results on short waves. On checking the valves in a tester as a preliminary test, they may all appear to be perfectly satisfactory, but with the type of fault with which we are concerned the oscillator valve should be suspected, and, where possible, a new one tried. Failure to oscillate on short waves is a test that cannot be very satisfactorily covered by static tests on the majority of valve testers.

Another form of valve fault is the trouble which occurs with certain types of output valves which give rise to distortion after, perhaps, a quarter of an hour or so of operation. The cause of the distortion is often due to the valve, which becomes slightly

"soft" when it has thoroughly warmed up in the receiver, but when it is in the valve tester it may exhibit all the characteristics of a good valve unless it is allowed to remain on the tester for at least the length of time required for the fault to show up in the receiver.

The valve tester is hardly an essential item of equipment. As a matter of fact, the majority of experienced service engineers, both in the field and in the workshop, generally go back to their analysers for checking valves. Even in congested modern chassis it is generally possible to find parts of the circuit in which the analyser may be connected for measuring anode currents and in the cases of super-sensitive meters grid bias and grid currents, all of which tests will enable a diagnosis of the valves and their circuits to be made.

If it is desired to test valves outside the receiver it is an easy matter to rig up a valve holder with leads from it to HT, GB and LT, the sources of which may be varied in voltage to suit the type of valve being tested. The analyser can then be applied to the various valve circuits and a full diagnosis obtained which may be compared with the maker's specification.

Another point which presents a problem to valve tester designers is how bad must a valve be to be regarded as unserviceable.

### Manufacturing Tolerances

It will not be disclosing any vital trade secrets to say that manufacturers have to set certain minimum and maximum limits for their valves to pass mass-production inspection tests. The wide limits set for some valves make it very difficult for the valve testers to be designed to give a universally satisfactory "up-to-standard" reading when the valve is being tested. If the valve tester is made too critical, then the user would reject many valves and return them to the manufacturer for replacement, while on the manufacturer's test board the valves would be shown up as quite O.K.

Another consideration is that in many of the "de luxe" types of receivers certain valves operate in very critical circuits and the circuit ceases to function correctly when the valve deteriorates slightly from its maximum efficiency. In such cases both the service valve tester and the manufacturer's inspection would indicate that the valve is "up to standard." The only sure test in these cases is examination of the characteristics of the valve by means of measurements



of its anode current under certain voltage conditions or a trial replacement of the valve which is suspected.

If its shortcomings are appreciated the valve tester can be very useful for

the routine checking of valves from a receiver and as an indication that the valves are satisfactory before proceeding to make a more thorough investigation of the chassis.

## Electrical Communication

A Review of the Past Year

**W**HILE the vital importance of wireless telegraphic and telephonic communication is enhanced by the stress of war, details of developments and operations disclosed for publication are comparatively few. However, the International Standard Electric Corporation of New York, as is its practice, reviews the last year (1940) from an international viewpoint in the latest issue of its journal, *Electrical Communication* (Volume 19, No. 3).

It seems certain, says the writer, that following the cessation of hostilities, many current communication developments will be adapted to the pursuits of peace, and the tendency to co-ordinate or unify communication services, such as wire and radio, will increase because of inherent advantages and the pressure of economic conditions.

A decided advance in the application of ultra-high frequency technique to air navigation was marked by the ordering of "Indianapolis" landing apparatus from Civil Aeronautics Administration for installation at the airports of six cities in the United States. The Indianapolis landing system provides the pilot with complete guidance to the airport runway. Instruments on the dashboard provide the pilot not only with the exact line of approach laterally to the runway, but also with the exact line of descent. Furthermore, two marker beacons along the line of approach indicate distances from the runway.

Following an extensive and successful trial in the New York area, the Western Union Telegraph Company is installing automatic facsimile transmitters and facsimile transmitter-recorders in many of the larger cities in the United States for use in receiving telegrams from agencies and small branch offices and for picking up and delivering telegrams for private individuals. From the results so far obtained it is evident that facsimile provides a very convenient service.

The facsimile duplicator, which is an offshoot of facsimile transmitters and recorders, is finding extended application as a commercial duplicating machine. It is capable of copying material with an area of approximately

11in. by 16in., and in general it will reproduce printed matter in which the type is not smaller than that in which this line is printed.

In electrical communications in general, the tendency has been towards the postponement of less urgent, even though fundamentally important, activities because of prevailing conditions. A conspicuous exception is, of course, the expansion of broadcasting both nationally and internationally.

## Wireless World Valve Data

Reprints Available

**A**LTHOUGH the last Valve Data Number of *The Wireless World* (May, 1940) is now out of print, copies of a complete reprint of the data section are available from our publishers at a cost of 1s. 7½d., postage included. The reprint gives operating conditions and base connections of the principal types and makes of valves, and includes a chart of graphical symbols.

## Abstracts and References

**S**OME readers of *The Wireless Engineer* feel that the publication of abstracts from, and references to, articles which have appeared in foreign journals which are not obtainable in this country is unsatisfactory, in that it creates an intellectual thirst which cannot be satisfied. This, however, does not represent the consensus of opinion regarding this monthly feature of our sister journal, which in any case serves to show the directions in which development work in other countries is proceeding. Moreover, abstracts from journals that are difficult to obtain here are, where necessary, written at such a length as to constitute in themselves a valuable and even detailed source of information.

In addition to nearly 300 abstracts and references, the August issue contains an article on some of the effects of secondary emission on deflector-plate characteristics of CR tubes, and another on the influence of stray capacities on the effective inductance of a screened coil.

*The Wireless Engineer*, which is published on the first of the month, is obtainable to order through newsagents or direct from our publishers at Dorset House, Stamford Street, London, S.E.1, at 2s. 8d., including postage.

## The "Fluxite Quins" at work

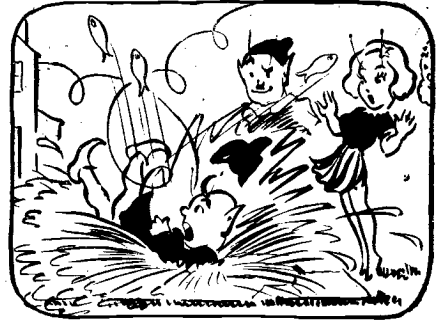

When the aerial wire broke loose

Ol cried "FLUXITE, quick! What the deuce!"

Yelled OH "Look out mate!

You'll come down, sure as fate!"

And he did—in the pond—what a goose!

See that FLUXITE is always by you—in the house—garage—workshop—wherever speedy soldering is needed. Used for 30 years in Government works and by leading engineers and manufacturers. Of Ironmongers—in tins, 4d., 8d., 1/4 and 2/8.

Ask to see the FLUXITE SMALL-SPACE SOLDERING SET—compact but substantial—complete with full instructions, 7/6.

Write for Free Book on the art of "soft" soldering and ask for Leaflet on CASE-HARDENING STEEL and TEMPERING TOOLS with FLUXITE.

**TO CYCLISTS!** Your wheels will NOT keep round and true unless the spokes are tied with fine wire at the crossings AND SOLDERED. This makes a much stronger wheel. It's simple—with FLUXITE—but IMPORTANT.

## THE FLUXITE GUN

is always ready to put Fluxite on the soldering job instantly. A little pressure places the right quantity on the right spot and one charging lasts for ages. Price 1/6, or filled 2/6.

FLUXITE LTD.  
(Dept. W.W.)  
BERMONDSEY  
STREET, S.E.1

ALL MECHANICS WILL HAVE

# FLUXITE

IT SIMPLIFIES ALL SOLDERING

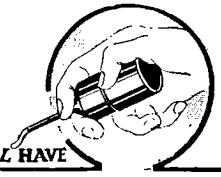

# LETTERS to the EDITOR

## The Editor Does Not Necessarily Endorse the Opinions of His Correspondents

### Receiver Servicing

AS one who has been engaged in the servicing of radio receivers for nearly 20 years, I should be glad if you would allow me to reply to your correspondent "Radio Man in Uniform," whose letter appears in the August issue of *The Wireless World*.

In the first place, the replacement of a valve is no longer the straightforward act of removing the old and plugging in the new it used to be. Many types are now unobtainable, and alternatives which the dealer may have in stock may be disinclined to function without considerable modification of the circuit, as can be gathered from one of the timely and excellent articles on the subject in the August number.

I have just completed a job involving the substitution of a triode-hexode type of frequency changer for a triode-pentode type, in which four resistances and two condensers had to be changed, a 9-pin holder removed and a 7-pin one fitted in its place, and complete realigning and reganging carried out. Does your correspondent suggest that the profit on the sale of the valve should recompense the dealer for the cost of these components, plus the time involved in fitting them? Furthermore, the sudden demise of a rectifier valve is frequently due to a short-circuited smoothing condenser. If the owner of the receiver were to purchase a replacement and put it into service without first having the set examined, the new one would promptly go the way of its predecessor, so that a small service charge could hardly be called unjustified. Other similar instances could be cited.

The remarks regarding technical information and service data are also difficult to understand. If your correspondent was engaged in the radio trade in civilian life, he should know that such information is supplied by the manufacturer for the exclusive use of its appointed agents and is usually marked "Private and Confidential." He would also know that a charge is made for service manuals, and more than one manufacturer stipulates that the information contained therein shall not be communicated to the public. The dealer is not in a position to verify the *bona fides*, or other-

wise, of seekers after information. To conclude a letter which I am afraid is already over-long, I suggest that if there is really any disrepute and suspicion attached to the servicing side of the radio industry, it is principally due to unfounded, unjustified and uninformed statements similar to those made by your contributor, and to the unwillingness of the public to pay a fair charge for time and experience.

S. W. HOSKING,  
Service Manager, Bourne Radio  
and Electric, Ltd.  
Bournemouth.

I CANNOT allow the unwarranted attack on the servicing industry by "Radio Man in Uniform" to pass unchallenged. Eleven of our radio men are now in uniform themselves, and I can assure your correspondent that, far from looking for a service job, we try to avoid it where possible. We prefer to pass a valve over the counter rather than spending time fitting and checking.

Technical data, makers' service sheets, reference books, volumes of *The Wireless World*, etc., are on file for the perusal of callers such as "R. M. I. U." Only one rule has to be made; anything may be copied but the originals must not be taken away. Those I have questioned among the 80 traders whose service work we handle all endorse my view that ready help should be available to any *bona fide* service man in the Forces.

Finally, I must state that I agree with every word written by your correspondent, W. H. Cazaly, in the same issue. At the risk of being thought nasty, I would point out that the fact of a radio man being in uniform is no criterion of his capability in the commercial radio world.

So that no one will consider this letter cheap advertising, I sign myself—  
P. Q. (A.M.I.P.R.E.).

Reading.

### Should Amateurs Know Morse?

I HAVE been interested in the correspondence that you have received on post-war amateur transmission.

There is one thing that I would unhesitatingly advocate, and that is the total abolition of morse as a condition to the granting of a transmitting licence. This absurd condition often

prevented well-qualified and scientific workers from obtaining a transmitting licence, as they found themselves forced to go back to school to learn the tick-tack-toe business.

In my experience I never found morse of the slightest use in my experiments. I would even go so far as to abolish the use of morse entirely for all amateur transmitters, as a nuisance on the air.

The real qualification for a licence should be the past training and present knowledge of the applicant, who should have been well grounded in the principles of magnetism and electricity, and the elementary knowledge of radio as a means of communication.

In conclusion I hope that both the R.S.G.B. and yourselves will urge that morse as a *sine qua non* to the issue of amateur radio licences should be abolished.

HERBERT W. HAYDON (ex G2ZL)  
Weston-super-Mare.

### Re-coating Recording Blanks

WITH reference to the letter from Mr. Aldous (in the August issue) asking for information about recording blanks, I made some blanks a few months ago which I found very successful. The process I used is as follows:—

Soak 500 grams good quality gelatine in cold water for 30 mins. In this time it takes up sufficient water for subsequent manipulation. Pour off excess water and heat the swollen gelatine on a water bath or in a porringer until melted. Do not overheat at any stage in this preparation. Add 50 c.c. of sulphonated castor-oil (also known as Turkey Red Oil) and 25 c.c. glycerin or glycol. Allow to cool to 45 deg. C. and keep covered to prevent surface skin forming. If required some water-soluble Nigrosine or aniline black dye may be added.

The coating operation requires some practice and I carried this out as follows:—

A tin-plate bath measuring 10½ in. long by 7 in. deep and only ¾ in. wide is filled almost full with the coating mixture. The blank disc is impaled on a ¼ in. piece of dowel rod. Immerse the blank in the solution kept at 45 deg. C. and rotate slowly by means of the wooden "axle," for which bearings are provided by filing semi-circular depressions in the sides of the bath. Lift out from the solution slowly, still rotating the blank. Revolve the blank in the air so that the coating will run evenly. In a few seconds it will have set. Put aside in a dust-free atmosphere to dry; this takes about 24 hours. The finished coating is easily

## Wireless World

cut and the swarf is continuous. The finished record can be hardened with the following solution:—

Meth. spirits .. .. 1 oz.  
Formalin .. .. ½ „  
Water .. .. 1 „

With regard to the removal of existing coatings, if they are of the gelatine type try leaving them in the following bath at 37 deg. C. (blood heat) for 10 hours or so. This should digest the gelatine completely.

Pepsin .. .. 1 gram  
Hydrochloric acid .. 5 c.c.  
Water .. .. 1,000 „

I shall be pleased to supply any further details on this subject. I should point out that some of the formulae and processes I have given here are possibly covered by patents.

W. H. PIERCE.

London, S.E.1.

### “Designing Small Portables”

I CANNOT agree with the statement in the above article (your August issue) that an improvement of gain of the order of 25 times of 28db can be obtained by increasing the inductance 5 times.

It is very unfair to state that: “Fortunately, however, we can easily eliminate the effects of an increase in  $r$  by the use of reaction”; surely this applies to the smaller inductance too.

To make a more exact comparison it would be better to show the improvement of gain obtained for the same band width,  $Q$  being the determining factor.

$$\text{As } Q = \frac{R}{\omega L} \text{ and } R = \frac{L}{Cr}$$

if we increase the inductance  $L$  5 times, for the same wavelength  $C$  must be reduced 5 times ( $\lambda = 1885\sqrt{LC}$ ). Therefore, as Mr. Amos states, when reaction is applied and the larger inductance is reduced to the same  $RF$  resistance as the smaller inductance,

i.e.,  $r = 3$  ohms, the dynamic resistance  $L/Cr$  would be 25 times greater, but  $\omega L$  has also increased 5 times, and, therefore,  $Q$  is only 5 times greater. Therefore for the same band width the improvement of gain would be only 5 times, or 14 db.

R. G. D. HOLMES, A.M.I.E.E.  
Cosham, Portsmouth.

[The author writes: Mr. Holmes has missed my point in his second paragraph. If the HF resistance of a  $157\mu H$  coil is 3 ohms, reaction could be used to reduce it effectively to, say, 1 ohm. In the same way, if the HF resistance of the  $800\mu H$  inductance is 16 ohms, use of reaction will reduce this also to 1 ohm, and the comparison of the performances of the coils is made on the assumption that their HF resistances have been so reduced to the same amount.

I must admit that Mr. Holmes is right in his third paragraph. A gain of 28 db is only possible when the high inductance circuit is used in conjunction with a constant current generator, e.g., in the anode circuit of an RF pentode or frequency changer, the gain of such a circuit being given by  $\mu L/CR$  where  $\mu$  is the mutual or conversion conductance of the valve. Used in conjunction with an aerial the coil will permit an improvement of gain of 14 db. Even this, however, represents a considerable improvement in performance over conventional circuits, and is, hence, well worth attempting.—ED.]

### Morse Practice Oscillator

BASED on the design for a valve oscillator given in *The Wireless World* booklet, “Learning Morse,” this unit, made by the Premier Radio Co., 167, Lower Clapton Road, London, E.5, costs 27s. 6d. It is mounted on a steel chassis provided with sockets at each end for the connection of a key and headphones, and is normally finished in black enamel.

The model tested gave a clear note of about 900 cycles per sec. and operated steadily with an HT of  $16\frac{1}{2}$  volts. A resistance is included in the filament circuit which is designed to run off a 3-volt flashlight battery. The set includes a volume control and on-off switch, but not a pilot light.

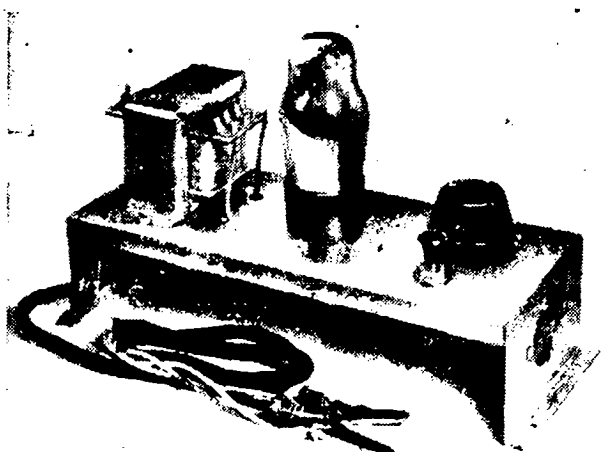

# VORTEXION

## 50w. AMPLIFIER CHASSIS

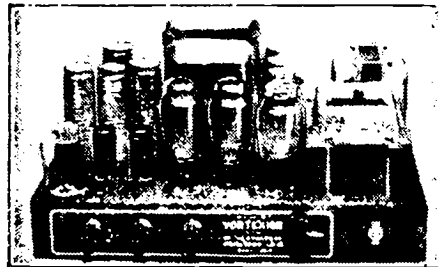

A pair of matched 6L6's with 10 per cent. negative feed-back is fitted in the output stage, and the separate HF supplies to the anode and screen have better than 4 per cent. regulation, while a separate rectifier provides bias.

The 6L6's are driven by a 6F6 triode connected through a driver transformer incorporating feed-back. This is preceded by a 6N7 electronic mixing for pick-up and microphone. The additional 6F5 operating as first stage on microphone only is suitable for any microphone. A tone control is fitted and the large eight-section output transformer is available in three types:—2-8-15-30 ohms; 4-15-30-60 ohms or 15-60-125-250 ohms. These output lines can be matched using all sections of windings and will deliver the full response (40-15,000 c/s) to the loud speakers with extremely low over-harmonic distortion.

CHASSIS with valves and plugs ..... £17 10 0

Goodmans P.A. Speakers in stock.

Paper Mache Horn Speakers..... £6 6 0

Moving Coil Microphones..... £5 5 0

Chromium Microphone Stands from..... 15 0

Many hundreds already in use for  
A.R.P. & GOVERNMENT purposes

### 15w. AC & 12-VOLT DC AMPLIFIER

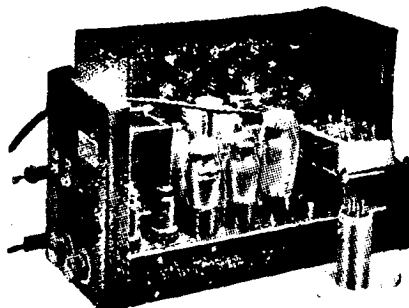

TYPE CP20

This small Portable Amplifier operating either from AC mains or 12-volt battery, was tested by “THE WIRELESS WORLD,” October 1st, 1937, and has proved so popular that at Customers' demand it remains unaltered except that the output has been increased to 17.2 watts and the battery consumption lowered to 6 amperes. Read what “The Wireless World” said:—

“During tests an output of 14.7 watts was obtained without any trace of distortion so that the rating of 15 watts is quite justified. The measured response shows an upper limit of 18,000 c/s and a lower of 30 c/s. Its performance is exceptionally good. Another outstanding feature is its exceptionally low hum level when AC operated even without an earth connection. In order to obtain the maximum undistorted output, an input to the microphone jack of 0.037 volt was required. The two independent volume controls enable one to adjust the gain of the amplifier for the same power output from both sources, as well as superimpose one on the other or fade out one and bring the other up to full volume. The secondary of the output transformer is tapped for loud speaker or line impedances of 4, 7.5 and 15 ohms.” Prices

AC and 12-volt CHASSIS with valves, etc. .... £12 12 0

AC only CHASSIS with va. ves, etc. .... £8 18 6

Gauze Case for either chassis, 12/6 extra.

Plus 20% War Increase.

Delivery. Prompt delivery on “Priority 1A” orders.

**Vortexion Ltd., 257, The Broadway,  
Wimbledon, S.W.19. Phone: LIBerty 2814**

# RANDOM RADIATIONS

## The Anniversary

UNLIKE the "radiations" of many months past, this is written at my own home, where I am enjoying—and enjoying is no mere figure of speech—seven days' leave. It's but the fourth I've had since August, 1939, when so many of us laid aside the thrills of peacetime radio for the far greater thrills to be found in the life of the bloodthirsty and licentious soldiery! I'm writing this paragraph on the 27th anniversary of the outbreak of the last war, and the day brings back a radio memory. At the beginning of August, '14, I had gone in quest of sea trout to an island in the Outer Hebrides. We had little news of the crisis that preceded the Hun march into Belgium, for such newspapers as did reach us were generally at least two days old. Therefore, we knew nothing of the events of the opening days of August, by which this country was drawn into the war. We were sitting—half a dozen or so keen fishermen on holiday—round the fire called for by the chilly, damp night of those islands, when, shortly after midnight, the operator of the nearby Service radio station burst excitedly into our midst with the news that England was at war with Germany. Every one of us was a soldier or sailor of sorts—regular, reservist or territorial—and we began straightway to make plans for getting back in the quickest possible time to the mainland. It was days before we managed it. In the years that passed I saw name after name of those good fellows in the casualty lists, and I believe that I am the only one of that little company of anglers to be serving in the still greater war of to-day.

## A Wire Curiosity

JUST before I came on leave we burnt out a very important wireless transformer. There was a mechanic available to rewind it and he had the apparatus called for; but he hadn't and we couldn't get the necessary wire. "Never mind," sez I, "I've lashings of all gauges of wire at home. What size d'you need?" We hadn't a wire gauge; but he produced a sample from the burnt-out winding and guessed it as No. 32. I thought it was finer and put it at No. 34. When I got home I put the sample through the gauge and found

By "DIALLIST"

that it wasn't either. It was actually No. 33 SWG. At first that seemed a bit curious, for our manufacturers don't as a rule use the odd sizes. Then the solution of the puzzle dawned on me. The wrecked transformer was of American make. I looked up a table of U.S.A. wire sizes and found that their No. 30 is exactly the same as our No. 33, both having a diameter of 0.0100 in. I don't think I'd realised previously how greatly the American wire gauge differs from the British SWG. It seems rather a pity that the two great countries that don't use the metric system but are so closely linked in radio matters can't adopt a common standard of wire gauges, to say nothing of screw threads. We've taken the American Morse drill sizes to our bosoms. Can't they meet us over SWG wires and BA threads? The British Standard Wire Gauge is a good deal more finely graduated than the American, and for small screws I doubt if there's any series in the world so good as that of the British Association.

## Beginning at Home

But before we ask our friends across the Atlantic to come into line with us in these radio matters it might be as well for us to begin by setting our own house in order. There's one glaring example of a perfectly gratuitous refusal by one of the Fighting Services to adopt not just the national, but the international standards of measurement. Doubtless you know at any rate the older edition of the Admiralty Handbook of Wireless. It's a splendid and most comprehensive work; but it's disfigured by the retention of an out-of-date standard of capacity. For years all radio folk have been accustomed to rating condensers in microfarads or micro-microfarads. Not so the Navy. For them the old-fashioned jar is still the unit of capacity. The jar, I take it, dates from the days of the Leyden Jar and is as much out of date as the idea that a condenser condenses.

## U.S.A. Television

NOW that television has got its second wind in the United States it is going, or just about to go, with a swing, so far as the suppliers of vision programmes are concerned.

I've just had a letter from the American G.E.C. telling me about their new programme. Till now their transmitter in the Helderberg Mountains, a little to the South of Schenectady, has been working with a 3 kW for sound and 10 kW for vision. Soon—possibly by the time that this is in print, for the letter is dated July 6th—the sound transmitter will have gone up to 20 kilowatts and the vision to 40. When this has happened it will, I fancy, be the most powerful sound-cum-vision transmitting station in the world. Our own A.P. station was rated at 5 kW for sound and 15-18 for vision. Doubtless it would have reached higher levels had we remained at peace, but war put an end to its activities and to its expansion. It is interesting to note that the Federal Communications Commission has raised the television standard of definition. Previously this stood at 441 lines, 50 frames per second. Now it is to be 525 lines. The American G.E.C. further tell me that the F.C.C. also favours the use of frequency modulation rather than amplitude modulation for the sound portion of the transmissions. Though the power used is high, it seems most unlikely that these broadcasts will be able to make their way, except during "peak" conditions, across the Atlantic to this country. There must also be few British DX enthusiasts who have USW receivers adapted for frequency modulation. Still, the unexpected proverbially happens in long-distance wireless, and if any readers do pick up the Helderberg transmitter, "I'd be greatly obliged if they'd send me a line."

## The Useful "Log."

FUNNY how many people can't or won't use the simple and handy logarithms—an ever-present aid to the working out of otherwise laborious calculations. The other day I found a brother officer tearing his hair over a longish series of calculations which involved multiplying the square roots of certain numbers by one set of figures and dividing the results by another set. He was making very heavy weather of it, finding the square roots by "longhand" methods and divisions on the same lines. "Why on earth don't you use logs?" I asked. It turned out that he couldn't—thought that logs were something so frightfully complicated that only the initiated could use them. I gave him a little instruction and a log table book. When I left he was turning out the many answers needed at a totally unexpected rate of knots.

## Simple, Believe Me

Heaps of radio men have the same idea. If logs didn't come their way at school they think that it's quite impossible to master them now. Believe me, it isn't, really. There's nothing in the least formidable about logs, and even if you don't know the first thing about them at this moment, you can be using them in a matter of hours to your ease and profit for the solution of radio formulae if you'll either get a friend to show you the ropes or read up the few pages devoted to the subject in one of the many excellent little books on mathematics that are available to-day. Years ago when I voiced these sentiments to a friend he said: "Oh yes, it's all right for you; you're good at figures." To which I replied that it was just because I wasn't good at figures and loathed the drudgery of long multiplication and division sums (in which I invariably made mistakes) that I used logs. Small books of log tables, by the way, run as a rule to only four figures, which is hardly sufficient for reasonable accuracy in radio calculations. I've found recently an eightpenny book of five-figure log tables which is remarkably comprehensive. If any reader wants particulars, I'll be glad to send them.

## Unrationed Jam

THOUGH civilians and soldiery alike have seen woeful cuts made in their jam allowance, the same does not apply to the radio stations which use the medium and the short wavelengths for their transmissions. At the moment of writing it's not a case of jam yesterday or jam to-morrow, such as Alice found when she ventured through the Looking Glass. It's jam to-day with a vengeance. Jerry has more or less played at jamming for many moons now. It was the Russians who showed how to do it in good earnest when he launched his campaign against them. On some nights in June it was almost impossible to find any German station clear of a Russian *obligato*. Jerry retaliated, though not always effectively. Until the raids on Moscow began you could generally pick up the news in English from Russia. It's not always so easy now. It would be funny, if it wasn't so pathetic.

## "MINIMISING SELECTIVE FADING"

*A Correction*

IN the article under the above heading in our August issue the reference to Fig. 7 on page 202, column 2, printed as AE=4CD, should have read EC=4CD.

## COMMUNICATIONS DEPEND....

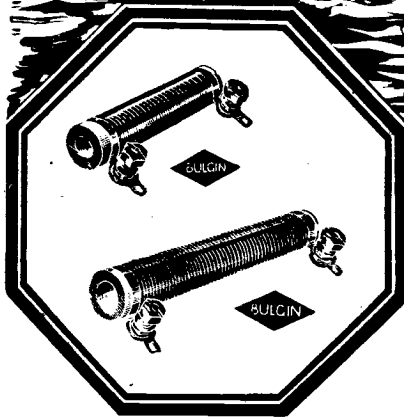

## ON SMALL PARTS....

IN countless instances quite intricate pieces of apparatus are wholly dependent on the proved reputation and reliability of their component parts.

All products from the House of Bulgin are pre-eminent for superior design and workmanship, and every article bearing our Trade Mark has to pass exacting and exhaustive tests during the course of its production.

That is why every manufacture of national importance incorporates Bulgin Components.

*The Choice  
of Critics*

## BULGIN FOR RESISTORS

The largest and most comprehensive range of Resistors. Values from 0.10 to 150,000Ω in wire-wound types, ratings of from 2 to 100W. Solenoidal-wound and double-spiral models available. Special accuracies of  $\pm 1$  per cent. to order, at special prices. Only the finest materials are used throughout.

*Let us send you*

Our new 128 pp. Catalogue No. 164WW, fully illustrated and with technical and dimensional data. A valuable and comprehensive reference list. Price 9d. post free.

ALWAYS DEPEND ON

# BULGIN

REGISTERED • TRADE • MARK

A. F. BULGIN & CO. LTD., BY-PASS RD., BARKING, ESSEX.

Telephone: RIPPLEWAY 3474 (4 lines).

# RECENT INVENTIONS

*A Monthly Selection of the More Interesting Radio Developments*

## RADIO NAVIGATION BEACONS

THE usual pair of overlapping-beams, for guiding a pilot down a course marked out by the reception of signals of equal strength from each beam, are replaced by the arrangement shown in the drawing. This consists of three beams, the centre one K being modulated by a single continuous note, and the two outer ones being keyed by the morse signals A and N respectively.

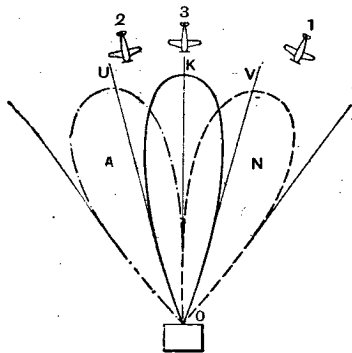

Improved "homing" system for aircraft.

One advantage is that the pilot of the No. 1 machine will hear only the morse signal N. This not only tells him he is off-course, but also informs him roughly to what extent, because he knows he must be outside the angle KOV, otherwise he would also pick-up the continuous note from the beam K. The pilot of the machine No. 2 will hear both the morse signal A and also the continuous note from the centre beam K, and knows accordingly that he is flying inside the sector KOV; but the pilot of machine No. 3, who hears only a continuous note, knows that he is on his proper course. A further advantage is that any variation in the power radiated by the beacons will not distort the course indications.

*Standard Telephones and Cables, Ltd. (Assignees of F. A. Kolster). Convention date (U.S.A.), May 25th, 1938. No. 528874.*

## CUTTING OUT INTERFERENCE

ONE known method of reducing the effect of interference is to apply a cut-off potential to one or more of the valve amplifiers so that they are blocked or paralysed during the short period of time during which the impulsive disturbance persists. This, of course, prevents the passage of both the signal and the interference, but the period of interruption is so short that it does not affect the apparent continuity of the signal. A disadvantage of the method, however,

lies in the fact that it also cuts out too per cent. carrier-wave modulation, and so, in effect, prevents the receiver from following the true percentage modulation of the signal as transmitted.

It is possible to use this method of suppressing interference, and, at the same time, to keep the percentage modulation, as reproduced, accurately in step with the signal as transmitted, if the suppression-control bias is taken from the audio-frequency side of the receiver.

According to the invention, a more satisfactory solution is found by deriving the control or "blocking" bias in part from the radio-frequency side of the receiver so that it is proportional to the mean amplitude of the received carrier wave, and in part from the audio-frequency side so that it follows the fluctuations of the "modulation envelope" or rectified wave.

*Magyar Wolframlampa. Convention date (Hungary) May 6th, 1938. No. 528484.*

## RADIO ALTIMETERS

IT is possible for the pilot of an aeroplane to measure his height above ground by transmitting signals from the machine towards the earth and receiving back the reflected waves. The frequency of the outgoing wave is regularly varied

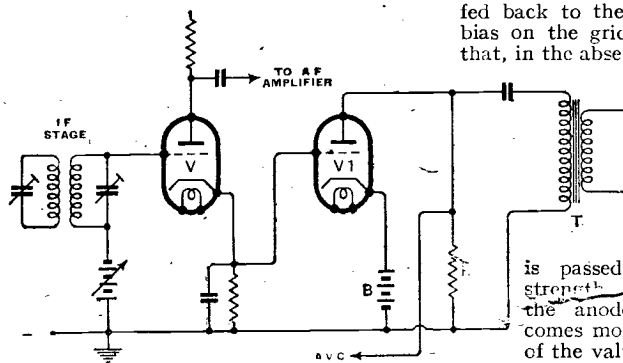

Improving AVC on strong signals.

is passed. However, as signal strength increases, the cathode of the anode-bend detector V becomes more positive, and the grid of the valve V1 follows suit, until, at a level of strength determined

by the fixed bias B, an increasing AVC voltage is delivered to the preceding amplifiers. Means are provided to eliminate mains "hum" from the derived AVC voltage.

*A. H. Cooper and A. D. Blumlein. Application dates May 19th, 1939, and March 15th, 1940. No. 529590.*

The British abstracts published here are prepared with the permission of the Controller of H.M. Stationery Office, from specifications obtainable at the Patent Office, 25 Southampton Buildings, London, W.C.2, price 1/- each.

CLASSIFIED ADVERTISEMENTS. The charge is 6/- for each paragraph of 2 lines or less, and 3/- for every additional line or part thereof, average 7 words to a line. Each paragraph is charged separately. ADVERTISEMENTS for the October issue are accepted to First Post on Wednesday, September 10th, at the Head Office, Dorset House, Stamford Street, London, S.E.1, or one day earlier at provincial Offices.

THE PROPRIETORS retain the right to refuse or withdraw advertisements at their discretion. They are not responsible for clerical or printers' errors although every care is taken to avoid mistakes. Cheques and postal orders should be made payable to Iliffe & Sons Ltd. and crossed. Notes are legal tender and cannot be traced if lost in transit.

ADVERTISERS may have letters, other than circulars, addressed to numbers at this office. The words Box 000, c/o "WIRELESS WORLD" must be paid for and a further 1/- added for registration and forwarding replies. DEPOSIT SYSTEM. Full particulars upon application to the Deposit Dept., "Wireless World," Dorset House, Stamford Street, London, S.E.1.

Ode  
**Partridge**  
No. 8

"THE BUSY VEE"

How doth the little busy V  
Delight to irritate  
Both Hermann and wee Doctor G.  
And H. the Prince of Hate.

It gets about on silent wings,  
It sticks on door and wall,  
It's tapped on glass and metal things,  
'Tis Freedom's clarion call.

Dit Dit Dit Dah—Dit Dit Dit Dah—  
It travels far through space  
And Doctor G. broadcasts much biah  
To save his country's face.

But though he may do so for years,  
This sign and rhythmic sound  
Will sting their eyes and burn their ears  
And bring them to the ground.

Then to this simple little V,  
With grateful, happy sigh,  
We'll carve on stone for all to see,  
"VENI, VIDI, VICI."

**N. Partridge**

B.Sc., A.M.I.E.E.  
King's Bldgs., Dean Stanley St.,  
LONDON S.W.1

Telephone: VICTORIA 5035

NEW RECEIVERS AND AMPLIFIERS

**£18/10** Only, usual price £22.—*Wireless World* 2 R.F. Receiver, with push-pull quality amplifier, chassis, 10 valves, including tone control stage, 8 watts triode output, ideal for quality reproduction from radio and gramophone; limited number. —Bakers Selhurst Radio, 75, Sussex Rd., South Croydon. [9519]

RECEIVERS & AMPLIFIERS—SECONDHAND, ETC. **HALLICRAFTERS** 8X17, and Speaker, unused 18 months, perm. required; guaranteed; owner called up—2, Church St. Evesham. [9672]

**MURPHY** B5 Battery Superhet, 5-valve, completely overhauled and revalved; 14 gns. new, take £11 or nearest.—P. C. Shenton (ex 2DSL), c/o Mrs. Lewis, Yelling, St. Neots, Hunts. [6677]

**MICHAEL** 381 Receiver, used 18 months, £12; W.W. 2RF receiver, with W.W. 3½-watt Quality Amplifier, walnut cabinet, built Sound Sales, used 13 months.—Rev. Blood, Mill Rd., Metheringham, Lincoln. [6678]

**MURPHY** A76 A.C. 6V, with SP41, long, medium, handsread 16-50, no second channels, £15; Ekco AW108 A.C., 5V, 9-stage superhet, tuning eye, 3 bands, var. sel., 8 watts, dipole, pickup, speaker sockets; £12.—H., 2, Dunstable Mews, London, W.1. [6679]

**MUSIC** While You Work.—180w. Output Rack Type Amplifier, incorporating two sets which feed into four MZ100 output valves, input for Mike and Gram. Turntable. In perfect working order. Suitable for large factory or relay service. Complete with valves, £150. Arrange own transport.—Relay Service, Tarring Rd., Worthing. [9665]

**MCCLURE** A.C.F.5, 5-waveband feeder unit, 4 red E valves and magic eye, £10; McClure A.C.16, 16-watt amplifier, £10; McClure twin matched 10in. speakers, £5 pair; Garrard R64 mixed autochanger, £10; McMurdo silver solid walnut console cabinet, £10; Kester Hacker Anson autoradiogram, purchased new 1939, turns 20 mixed records, cost £287, best offer over half; all above items are in perfect condition.—Carswell, White Gables, Mearnskirck. [6680]

Wanted

**HALLICRAFTER** with R.F. and Xtal. super-silver or similar.—45, Westholme Rd. Manchester 20. **WANTED**, 1936 "Mono-dial," Radio portion only. Wignall, 9, Bond Terrace, Walmer Bridge, nr. Preston. [9659]

**WANTED**, good mains communication receiver, 10-550 m.; also components.—Baylis, 105, Appledore Ave., Barmehurst, Kent. [6673]

**PRESET** Receiver and Amplifier (W.W. Aug. 1939), also Sound Sales tri-channel amplifier and speakers, also crystal speaker and tweeter only—The Jolly Gardener, Maiden's Green, Bracknell, Berks. [9661]

**WANTED** for Cash, second-hand battery sets, condition immaterial but must include valves.—Details to F. T. Martin, Osterley Hotel, Osterley, Middlesex. [9649]

NEW MAINS EQUIPMENT

**VORTEXION** Mains Transformers, chokes, etc., are supplied to G.P.O., B.B.C., L.P.T.B.; why not you? Imitated, but unequalled. **VORTEXION, Ltd.**, 257, The Broadway, Wimbledon, London, S.W.19. 'Phone: Lib. 2814. [9571]

SHORT-WAVE EQUIPMENT

**RADIOMART**, largest distributors communication equipment. National distributors.—48, Holloway Head, Birmingham. [9555]

NEW LOUDSPEAKERS

**BAKERS** Brand New Surplus Speaker Bargains. **EVERY** Music Lover Interested in Realistic Reproduction should write for free descriptive leaflet now.

**£5/10**: usual price £10.—Brand new permanent magnet infinite baffle speaker, complete with beautifully finished cabinet in polished walnut.

**£2/10**: usual price £5.—Brand new super magnet model; exceptional bargain; limited number. **SECURE** One of These Exceptional Bargains Now.

**BAKERS** Triple Cone Conversions Will Immensely Improve Reproduction of Your Present Speaker. ("For a few shillings you have converted a speaker scheduled for the scrap heap into one worth pounds.—W. E. Darby, Grad.I.E.E."). Write for details.

**BAKERS SELHURST RADIO**, 75, Sussex Rd., 8th. Croydon. [9423]

**PAMPHONIC**—Auditorium, 16in. latest twin diaphragm, weight 44lbs., 17,000 lines in gap, 2in. coil, handle 25 watts, brand new, in original case, pre-war list 12 gns., exceptional opportunity; 6 gns.—249, Gristhorpe Rd., Selly Oak, Birmingham. [9663]

SECOND-HAND LOUDSPEAKERS

**SINGLE** Cone Voigt Speaker, little used; nearest £11.—Box 2590, c/o The Wireless World. [9668]

CABINETS

**WE** Regret That, owing to all our employees having joined H.M. Forces, we are unable to accept orders for cabinets except to callers. Limited stock only. We have a large stock of radio components.—H. L. Smith and Co. Ltd., 289, Edgware Rd., London, W.2. Tel.: Pad. 5891. [6683]

ESTD. **L.R.S.** 1925

KEEP YOUR SHELTER DRY!  
We can supply from stock if you order at once.

The 'Stuart' Centrifugal Electric SHELTER PUMP



Quickly clears water from shelters. Ideal for many other A.R.P. uses. A sound job built for continuous running.

Fan-cooled ball bearing motor, A.C. or D.C., any voltage. Low current consumption. May be plugged into lighting circuit. Connections for rubber hose. All parts non-rusting. Please state exact mains voltage required.

These pumps (as supplied to Government Depts., Railway Cos. and County Councils) may also be used for garden fountains.

Fountain Jets 4/- extra.

No. 10.	100 gals. per hour	£5 2 6
No. 11.	280 gals. per hour	£6 6 0
No. 12.	560 gals. per hour	£7 14 0

Prices include foot valve and strainer. Pump is ready for immediate use. Carriage and packing 2/- extra.

AVOMINOR A.C./D.C. TEST METERS

We have a limited number of these well-known meters in stock. Order now. Price £6.10.0, postage 6d. extra.

We still have a few of the following items available—

- Morphy-Richards Electric Fans.
- Morphy-Richards Electric Irons.
- Mullard Battery Receivers.
- Davenset 12-volt Battery Charger (one only).

Send 2d. stamp for illustrated price lists of any item. Terms: Cash with order or C.O.D.

LONDON RADIO SUPPLY CO.

(Proprs.: The L.R. Supply Co. Ltd.)  
All communications to evacuation address—  
"WINDEN," ARDINGLY RD., BALCOMBE, SUSSEX

**ARMSTRONG**

REGRETS

In our July and August advertisements we offered complete Coil and IF assemblies as fitted to our RF22P and AW3P chassis.

All these assemblies have now been sold. Orders were dealt with in strict rotation and many remittances had to be refunded as demand greatly exceeded supply. To those readers we can only say "We're awfully sorry!"

ATONEMENT

Endeavouring to do our best in these days of restricted supplies, we are pleased to be able to offer to our friends who contemplate building a Modern Super-heterodyne Short-Wave Receiver or who are converting a Broadcast Bands Receiver for All-wave reception, a very limited number of the following equipment.

Brief Description:

HF, Aerial and Oscillator Coils, covering 2 bands, 13-35 and 30-100 m., together with two 465kc. litz wire wound IF Transformers. All in aluminium cans with self-contained trimmers. The Coils and IFs are supplied complete with factory blue print, giving a modern 8-valve circuit and values of various components. Price **20/-**

We have many other high-grade components suitable for the Constructor, such as Ganged Condensers with drive and scale, Ganged Switches, Drilled Metal Chassis, Mains Transformers, High-class Speakers, etc. Send us your requirements enclosing stamped envelope.

**ARMSTRONG MANUFACTURING CO.**  
WALTERS ROAD, HOLLOWAY, LONDON, N.7

'Phone: NORTH 3213

**RELAYS** for A.C. and D.C.



**SILENT & RELIABLE**  
2 VA coil consumption, from 2-800 volts, tested to 2,000 volts. Unmounted and in cast iron casing. Also Time Lag Relays. High Sensitive Relays, complete control plants.

Midget Relay type ML (for D.C. only) Apply for leaflet SPN/WW

**LONDEX LTD.**

Electrical Remote Control Engineers and Manufacturers  
Anerley Works, 207, Anerley Road, London, S.E.20  
Tele.: SYDENHAM 6258/6259.

# More OPINIONS from Students taking Candler Code Courses

"As a student of the Candler System I would like to say how pleased I am that, thanks to the excellent training I have received, I now hold the PMG Certificate In Wireless Telegraphy." Ref. 1412. A.W.G., Glasgow.

"And may I say how pleased I am at my progress. At first I could send and read 0 w.p.m. Now I am doing 15 w.p.m. easily." Ref. 2674. J.L., Atherton, Lancs.

"Since enrolling for the Candler Advanced Code Course my speeds are as follows:—Sending 21 w.p.m., Receiving 23 w.p.m. Ref. 1883. P.T.W.C., London, S.E.10.

"In conclusion I should like to inform you that the course is proving beneficial to me, and I no longer have to consciously "think" about signals. My receiving speed is now around 20-21 w.p.m. for plain language." Ref. 3069. J.H.C., Morden, Surrey.

"I have just completed the third lesson of your Junior Code Course. Starting from 0 w.p.m., I can now send 12 w.p.m. and receive 10 w.p.m. comfortably. Besides teaching me the necessary fundamentals of learning code, it has made my learning interesting and given me great confidence in myself." Ref. 4278. V.G.V., Wembley, Middx.

All original letters can be inspected.

There are complete Candler Code Courses for beginners and for Operators who desire to improve their speeds and technique.

Courses supplied on Cash or Monthly Payment terms.

## COUPON

Please send me Free and without obligation a copy of the Candler "Book of Facts."

NAME.....

ADDRESS.....

Post coupon in 1d. unsealed envelope to London Manager Room (55W) 121, KINGSWAY, LONDON, W.C.2

**CANDLER SYSTEM CO.**

Candler System Co., Asheville, North Carolina, U.S.A.

941



# FOR THE RADIO SERVICE MAN, DEALER AND OWNER

The man who enrolls for an I. C. S. Radio Course learns radio thoroughly, completely, practically. When he earns his diploma, he will KNOW radio. We are not content merely to teach the principles of radio, we want to show our students how to apply that training in practical, every-day, radio service work. We train them to be successful!

## INTERNATIONAL CORRESPONDENCE SCHOOLS

Dept. 38, International Buildings, Kingsway, London, W.C.2.

Please explain fully about your Instruction in the subject marked X.

Complete Radio Engineering  
Radio Service Engineers

Elementary Radio

Television

If you wish to pass a Radio examination, indicate it below.

Inst. of Wireless Technology

P.M.G. Certificate for Wireless Operators

Provisional Certificate in Radio Telephony and

Telegraphy for Aircraft

City and Guilds Telecommunications

Name..... Age.....

Address.....

(Use penny stamp on unsealed envelope)

**DYNAMUS, MOTORS, ETC.**  
ALL Types of Rotary Converters, electric motors, battery chargers, petrol-electric generator sets, etc., in stock, new and second-hand.  
**WARD, 46, Farringdon St., London, E.C.4. Tel.: Holborn 9703. [0518]**

**Wanted**  
**ROTARY Converter, 220 D.C. to 230 A.C., 100 watts.—Box 2587, c/o The Wireless World, [9643]**

**GRAMOPHONE EQUIPMENT**  
**TABLE Type (Metal) Twin Turntable, M/I Pick-ups Garrard Universal motors (special control resistance), £15.—The Courts, Silverdale, S.E.26. [9664]**

**Wanted**  
**TWO Telefunken TO.1001 Pickups, good condition essential.—State price to Box 2589, c/o The Wireless World. [9650]**

**VALVES**  
**Wanted**  
**HIVAC Midget Valves, XD, XL and XP, unused; state price, other deal and types considered.—Hamilton, 65, Mossiel Rd., Glasgow. [9652]**

**VALVES** Wanted, any quantity from one upwards; test equipment service sheets and spares also wanted.—J. Bull, 4, Melthorne Drive, Ruislip. [6686]  
**WANTED.—Ostar-Ganz valves, NG100 rectifiers and G.5 frequency-changers in working order, 200-250 volt, 7-pin bases; state price.—Lindsay, 47, Queen's Rd., Bradford, Yorks. [9616]**

**TEST EQUIPMENT**  
**USED But Perfect Universal Avo Minor Meter, prompt; quote lowest price.—Box 2588, c/o The Wireless World. [9648]**

**TAX Free, one doz. only, type 954 acorn pentodes, ideal for valve voltmeters; £2 each; hundreds of other valves always in stock.—J. Bull, 4, Melthorne Drive, Ruislip. [6685]**

**Wanted**  
**WANTED, 40 or 46 Range Avometer.—Hall, 14, Wellgate, Grimsby. [6684]**  
**UNIVERSAL Avometer, new condition.—Harris, 79, Western Av., Acton, London, W.3. [9655]**  
**COSSOR Oscilloscope for Cash or Exch, new De Luxe 7 v. A.W. sets.—Tate, Church St., Romsey, Hants. [9653]**

**MORSE EQUIPMENT**  
**FULL Range of Transmitting Keys, practice sets and equipment for Morse training.—Webb's Radio, 14, Soho St., London, W.1. 'Phone: Gerrard 2089. [9553]**

**COMPONENTS—SECONDHAND, SURPLUS, ETC.**  
**SOUTHERN RADIO'S Wireless Bargains.**

**ALL Goods Previously Advertised Still Available.**  
**SOUTHERN RADIO, 46, Lisle St., London, W.C. Gerrard 8653. [9238]**

**LONDON CENTRAL RADIO STORES Offer Finest Bargains in Radio and Electrical Gear.**

**CONDENSERS.—Special offer of metal cased paper condensers, 300 v. working. Made by well known Government contractors. All brand new and unused. 2 mfd., 1/8; 1 mfd. x1 mfd., 1/9; 1 mfd., 1/-; 0.5, 0.25 and 0.1 mfd., 8d. Tubular, paper type 186. 0.5 mfd. 450 v. D.C. working, to clear, 5/6 doz.**

**RESISTORS, 10 watt, 100 ohm vitreous enamelled, 20 mains resistors 1/3 each.**

**FLEXIBLE Drives.—Well made shielded cable drives for remote control. Ideal for radiogramophones. Approx. 2ft. long. To clear 4/- each.**

**ELECTRO-MAGNETIC Counters.—Resistance 500 ohms. Counting from 1-12,999. Size 4 1/2 in. x 2 in. x 1 1/2 in. Ex-G.P.O. Invaluable for countless purposes, 9/6 each. A smaller type, 1-1,999, size 4 1/2 in. x 1 1/2 in. x 1 1/4 in., 5/6. Cannot be repeated, and doubtful if they can be purchased brand new to-day.**

**SMALL Reversible A.C. Motors (as used for motor tuning).—25-50 volts A.C. Built-in reduction gear spindle. Speed about 50 r.p.m. A first-class job with hundreds of applications, 9/6.**

**AUDAK Pick-up Heads.—High resistance coil, made by the famous Audak Company of New York. Extensively used in sound recording and laboratories. Ideal for grammo turn-table amplifiers, 6/6 each.**

**AUDAK Cutting Heads.—Heavy duty type. 3.5 ohm coil. A really high-class instrument, 17/6.**  
**AXLEY Type Switches, 2-way, 1/-; 2 bank 4-way, 2/3.**

**SINGLE Earpieces.—Good line for experimenters. Flexible metal sheathing, chrome plated, 2/6.**

**OUTPUT Transformers.—Primary 300 ohms D.C. Secondary 0.5 ohm D.C. Brand new, mfrs. type, 4/6. Also new chokes, 3 henry, 150 ohms, 3/-.**

**TAPPED Mains Resistances for 0.2 amp. valves. Tapped at 200, 250 and 250 v. To clear, 4/- ea.**

**WESTINGHOUSE Rectifiers.—The popular type H.T.8 Slightly used, but guaranteed in good condition and working order. Only 8/6 each.**

**B.I. Condensers.—Block type oil filled in metal cases with terminals. High quality components. 4 mfd. 450 v. d.c. test, 3/6. Also 0.1 mfd., 1,000 v. d.c. test, 2/6; and 0.25 mfd., 1,000 v. d.c. test, 2/6.**

**RELAYS.—Small relays for operation on 2 v. D.C. with 6-way make and break switches. Brand new, many useful applications, 5/- each.**

**SEE Our Display Advt. on Page 2. Sufficient postage must be included with order.**

**LONDON CENTRAL RADIO STORES, 23, Lisle St., London, W.C.2. 'Phone: Gerrard 2969. [9658]**

**G. A. RYALL, Arnhem, Marsh Lane, Taplow, Bucks.—Goods advertised April issue still available, except Amplifiers, Speakers and Transformers [9644]**

**A.C.-D.C. Converter, Rola auditorium speaker, wired up chassis without valve, including Tobe American all-wave tuners; offered to best bidder.—E. J. Forbat, 8, Charing Cross Rd. [6681]**

# WARD

## AC/DC ROTARY CONVERTERS

for operating P.A. Amplifiers, Radio Receivers, etc.

**WE ALSO MANUFACTURE**  
DC/DC ROTARY TRANSFORMERS, SMALL ALTERNATORS, SMALL DC MOTORS, H.T. GENERATORS, MAINS TRANSFORMERS up to 10 k.v.a. PETROL ELECTRIC generator sets up to 50 k.v.a. BATTERY CHARGERS for private and industrial use, and are fully equipped for general small engineering work. Full details of any of the above upon request. Export enquiries invited.

**CHAS. F. WARD**  
Office and Works:  
37, White Post Lane, HACKNEY WICK, E.9  
Telephone: Amherst 1393.

**THE SUPERHETERODYNE RECEIVER by Alfred T. Witts.**

A reliable and comprehensive guide to the superheterodyne receiver, incorporating all recent developments. It provides the essential working knowledge required by every keen amateur, radio mechanic and service engineer. Recognised everywhere as the standard work. "Gives all the information necessary for a complete understanding of the Superheterodyne Receiver," says PRACTICAL WIRELESS. Fifth Edition 5/- net (by post 5/5). Pitman's, Parker Street, W.C.2.

# RADIOLOCATION!

Are you going to help?

R.A.F. Radio Mechanics and everybody who knows about radio will tell you that these books are the best books to give you up-to-date radio knowledge. Thousands of men are studying them to-day and equipping themselves for useful radio work immediately.

First Course in Wireless (Gives the beginner a good groundwork) 8/- net.  
Wireless Terms Explained (Everybody's book explaining radio jargon) 2/6 net.  
Introducing Radio Receiver Servicing (No frills; good sound book about first principles and practice) 6/- net.  
Superheterodyne Receiver (R.A.F. men must know about superhets) 4/8 net.  
Radio Upkeep and Repairs for Amateurs (New revised edition of this most popular book ready shortly) about 6/- net.  
Definitions and Formulae—Radio (Speaks for itself. Slips into the pocket) 6d.  
Radio Books List (30 books) FREE.

RADIO BOOKS YOU'LL NEED

*From bookellers or Pitman's, Parker St., W.C.2*

**SHORT WAVE RADIO by J. H. Reyner**

A comprehensive, practical survey of modern developments in the use of short, ultra short and micro-waves by a foremost expert. It provides a great deal of valuable data concerning the practical methods of their use in radio transmission. Extremely important to-day! "One of the finest treatises available."—Journal of the Institution of Electrical Engineers. 10/6 net (by post 11/-). Pitman's, Parker Street, W.C.2.



# GALPINS

## ELECTRICAL STORES

21 WILLIAM ST., SLOUGH, BUCKS

Phone: SLOUGH 20855

Terms: Cash with Order.

**ELECTRIC LIGHT CHECK METERS**, small, late type, well-known makers, in first-class condition, electrically guaranteed, for A.C. Mains 200/250 volts 50 cy. 1 phase, 5 amp. load, 10/- each; 10 amp. load, 12/6; 20 amp. load, 15/-; all carriage paid.

**D.C. ELECTRIC LIGHT CHECK METERS**, 200/250 volts, 5 and 10 amps., in new condition and electrically perfect; 7/6, post free.

**ELECTRIC LIGHT CHECK METERS**, small, late type, well-known makers, in good condition, electrically guaranteed for 200/250 volts 50 cy. 1 phase A.C. mains. 5 amp. type, 6/-; 10 amp., 7/6; 20 amp., 9/- each. Post 1/- on all types.

**D.C. ELECTRIC LIGHT CHECK METERS**, 200/250 volts, 5 and 10 amps., 4/6 each, post 1/- (in new condition).

**EX R.A.F. SWITCH PANEL**, with case (new), fitted 6 small knife switches, leads, cords and cleats, complete in wood case, 2/6 each, post 6d.

**VOLTAGE CHANGING TRANSFORMERS** (Auto Wound), 100/110 to 200/240 v., or vice versa, fully guaranteed, 1,000 watts, 60/-.

**DUG-OUT LAMPS**, Ex R.A.F., solid brass construction, glass dome, complete with 12-volt bulb (any bulb can be fitted), wall fitting, 3/- each, post 6d.; Ditto, wing type, as new, 2/6, post 6d.

**DUG-OUT LAMPS**, Ex R.A.F., porthole type, or can be bracket fitted, glass dome, three colour fitting, white, red or green, solid brass construction, 6in. dia., complete with bulb; any size bulb can be fitted. Price 5/-, post 6d.

**EX R.A.F. AUTOMATIC CHARGING CUT OUTS AND VOLTAGE REGULATORS**, to suit any dynamo up to 20 volts at 15 amps., fully adjustable, wiring instructions, complete in metal case. Price 3/6, post 6d.

**110-VOLT D.C. MOTOR**, totally enclosed, rated at 8 amps., ball bearing, in new condition, make good slow-speed dynamo, £2/5/-, carriage forward.

**GUNMETAL PULLEYS**, 7in. diameter, to take lin. dia. rope, complete with rope guard and hook, 7/6 each, post free. 1/2 H.P. 110 v. D.C. MOTOR, in good working order, 25/-, carriage forward.

**FLOODLIGHTS**, 12in. dia., multi mirror type with 5in. dia. margin spot centre, any bulb can be fitted, 15/-, carriage paid.

**BELL PUSHES**, Ex G.P.O., solid ebonite, two silver contacts, as new, 1/6, post free.

**TUNGSTEN CONTACTS**, new, one fitted screw and one fitted blade; 1/9 the pair, post free.

**SALVAGE CHASSIS**, all damaged, offered for value of components, guaranteed value. Price 7/6 or 12/6 each, post free.

**UNIVERSAL CHASSIS** (no transformer), not guaranteed to work, but worth three times the value asked for the component value alone. Midget chassis only, 12/6 each, post free.

**ASSORTED WIRE END tubular condensers and resistances**, all round. Price 2/6 per doz., post free.

**X-RAY TABLE**, complete with shield and tube stand, fully adjustable in every way, hand control, in first-class condition. £25, carriage forward.

**EPOCH SUPER CINEMA LOUD SPEAKERS**, 25 watt model, 6 volt 2 amp. field energised (no energising) in first-class condition. Price £3/10/-, carriage forward.

**LARGE TRANSFORMER**, windings, etc., perfect, size approx. 5,000 watts, core and wire perfect, material alone worth the money. Price £5.

**FRACTIONAL H.P. D.C. MOTORS**, 110 v. or 220 v., direct current, all in perfect working order, from 1/2 h.p. to 1/2 h.p. Price 10/- each, post free.

### RADIO CLEARANCE, Ltd.

**LOW-LOSS Ceramic Valve Holders**, Lissen Hi-Q, baseboard and chassis, 7-pin, 1/- each.

**LOW-LOSS Short-wave Condensers**, variable Ceramic insulation, brass vanes, Lissen Hi-Q minimum capacity 20 mfd. List, 5/6 each; our price, 2/6 each.

**PUSH-PULL Switches**, Lissen 2-point; 4d. each.

**YAXLEY Type Switches**, 6-bank, 3/- each, 9-bank, 3/6 each.

**MIDGET Speakers**, Goodmans Energised, 600 ohms field, including transformer, new, boxed; 10/6 each.

**STRAIGHT Line 3 wave-band Dials**; 1/11 each.

**PHILIPS All-Wave Coils and IF Transformers**, 3/- each; complete unit, 15/-.

**MAINS Transformers**, 300-0-300v. 100 m.a. 5v. 2 1/2 amps., 6.3 5 amps, drop-through chassis type; 12/6 each.

**MAINS Transformers**, 250-0-250v., 80 m.a. 4v. 1 1/2 amp., 4v. 4 amp., 200-250 mains, new, boxed; 12/6 each.

**MAINS Transformers**, 350-0-350v. 4v. 5 amps., 12/6 each; 500-0-500 4v. 1 amp., 6.3v. 4v. 2 amp., £1 each.

**CHASSIS Mounting Valve Holders**, English type, 4-5-7 pin; 3d. each.

**CENTRALAB Volume Controls**, midget type, 2,000, 5,000, 25,000, 50,000, 100,000 ohms, less switch; 2/9 each.

**4-WAY Pushbutton Switches**; 1/3 each.

**DROPPING Resistances**, for all purposes, total resistance 535 ohms. 5 taps in steps of 50 ohms, standard for Pye, Lissen, Ever-Ready, etc.; 3/6 each.

**10 FT. Coils Connecting Wire**; 4d. each, galvanized, red or white.

**BRAIDED Screened Cable**, single and twin; 9d. per yard.

**PUSH-ON Pilot Lamp Holders**; 3d. each.

**PLESSEY Single Gang 0.0005 Variable Condensers**, 1/11 each; 2-gang 0.0005 variable condensers, with vernier control, 1/11 each.

**SOLID Dielectric Condensers**, by well-known maker, 0.0005 tuning and 0.0003 reaction differential; 6d. each.

**B.I. Wire-end Bias Electrolytics**, 50 mfd., 12v.; 1/6 each.

**TUBULARS**, wire-end non-inductive paper condensers, all sizes up to 0.01, 5d. each; 0.1, 7d. each.

**T.C.C. 2 mfd. Electrolytic Condensers**, 200v. working; 1/3 each.

**CONDENSERS**, 0.0005 triple; 2/6 each.

**DOUBLE Fuse Holders**, complete with two 1 amp. fuses; 1/6 each.

**GOOD Assortment of Mains and Filament Transformers**, L.F. chokes and alum. chassis, etc.

**MAINS Energised Speakers**, by well-known makers, 1,500 and 1,000 ohms; 12/6 each, complete with transformer.

**ALL Orders must include Sufficient Postage to Cover. Hours of Business: Week-days 9-4.30, Saturdays 9-1 p.m. Please write your name and address in block letters; we cannot undertake to answer enquiries unless postage is included (24d.).**

**RADIO CLEARANCE, Ltd.**, 95, High Holborn, London, W.C.1. Telephone: Holborn 4631. [9669]

**H.T. Battery Famine**—For immediate use, 12 sets of 120-volt Hart and Exide wet H.T.'s in 60-volt crates; 10/- per crate, or offer for lot considered.—Fryer and Hartley, Ltd., Rochdale. [9647]

**L.T. Metal Rectifier**, 12v. 1 amp., with transformer and ballast lamp, charges two volts to twelve volts, the kit 22/9, postage 1/-. Instrument type Rectifiers for meters, 8/6. Crystal Mikes, famous maker, 52/6.—Champion, 42, Howitt Rd., London, N.W.3. [9570]

**COULPHONE RADIO**, New Longton, Preston.—Tungram and Amer. Valves. Latest type P.M. speakers with trans, 8in. Goodmans, 18/6. 10in. Rola, 22/6. Electrolytics, 500v. 8 mfd., 2/9; 8+8 mfd. (4 leads), 4/9; 16+8 mfd., 6/3. 50 mfd. 50v., 2/9. Pick-ups with vol. control, 17/6. Eric and Bromber 1 w. resistors, 6/6 doz. Vol. Controls, with switch, 4/3. Tubulars, valve holders, etc. S.A.E. new list. [9660]

**Wanted**  
**Q.P.P. Transformer**, Bulgin L.F.45 or similar, new if possible.—48, Irving Rd., Coventry. [9671]

**GAMBRELL "Novotone"** Wanted for Radiogram, new or second-hand.—Details Cooper, c/o Post-box 4, Norwich. [9653]

**WE Buy New or Used Radios, amplifiers, meters, converters, radio and electrical accessories, etc.**—Phone: Ger. 4447. [9603]

### REPAIRS AND SERVICE

**L.T.P. Repair All Mains Transformers and Chokes.** Prompt delivery.

**LONDON TRANSFORMER PRODUCTS, Ltd.**, Willesden, N.W.10. Wll. 6486 (3 lines). [9552]

**SPECIALISTS in Multi-valve Radio Service**, 10 to 40 valve receivers, high quality amplifiers.—Harris, 37, Edgeworth Crescent, N.W.4. Telephone: Hendon 7153. [9656]

**"SERVICE with a Smile"**—Repairers of all types of British and American receivers; coil rewinds; American valves, spares, line cords.—F.R.I., Ltd., 22, Howland St., W.1. Museum 5675. [9834]

**MAINS Transformer Service**, repairs, rewinds, or construction to specification of any type, competitive prices and prompt service.—Sturdy Electric Co., Ltd., Dipton, Newcastle-on-Tyne. [9651]

# ELECTRADIX

**ENGINE SETS.** 500 watt single cylinder 2-stroke, water-cooled self-oiling Pelapone Engine, mag. ign., coupled to 50/70 volts 10 amps, shunt dynamo, 1,000 r.p.m., £17/10/-.

**Horizontal Twin Petrol A.B.C. Engine**, fan-cooled, coupled 1 1/2 kW. D.C., dynamo 50/70 volts 25 amps., mag. ignition. Cost £190. Sale, £25. Austin 4-cyl. water-cooled Engine, mag. ignition and 110 volt dynamo, 3 1/2 kW. £48. 2 1/2 H.P. Twin Douglas Petrol Engines, £10/5/-.

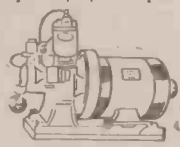

**SIGNAL GEAR.** Buzzers. Bakelite cased practice Buzzers, 3/6. Neat brass cased Buzzer, 4/6. Heavy type, Bakelite cased, 5/6. D.3 Buzzers, multiple windings, no contacts, 5/-.



**Cambridge-Townsend, High Note model, "T" diaphragm blade, platinum contacts, smallest Buzzer made, 10/-.**  
**Morse Keys.** Type B.1, a strong key, 5/-.

**TELEPHONES.** Modern bakelite handcoms, G.P.O. type in brown at 27/6, resting cradle stand 3/6. Midget L.R. Impedances, iron core, 2-coil phone type, 2/3.

**MIKES.** Metal-clad Mikes, can be used as they are, or in any case, 5/-.

**RELAYS.** Single Pole No. 4A on-off, 2 volts, phone type, 5/-.

**VALVES.** "WECO" Peanuts midget, 4 pin. 1 volt triodes, new, 3/6.

**DYNAMO BARGAINS.** D.C. ball-bearing semi-enclosed, 1,850 revs., 15 lb., 6in. x 5in., cheap, carriage paid; 200 volts 1/2 amp., 21/-; 200 volts 1 1/4 amp., 36/-.

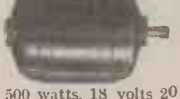

500 watts, 18 volts 20 amps. and 400 volts 200 m.a., £5.

**MOTORS.** Micro Motors. A.C. split phase synchronous motors, squirrel cage rotor, 3in. dia. Dog clutch drive to reduction gear from 2,000 revs. to 58 r.p.m. Voltage 15 to 20 volts, 50 cycles, reversible, double shaft, enclosed, laminated, new. Suit model drive. Remote control switching, tuning drive, etc., 8/-, post free.

**PLEASE NOTE NEW ADDRESS**  
**ELECTRADIX RADIOS**  
**19, BROUGHTON STREET, S.W.8**  
Our new offices adjoin our works at Battersea, 19, Broughton Street, Queenstown Road, S.W.8, on No. 137 bus route. Nearest Rly. Sta., Queen's Rd., Battersea (S.R.).  
Telephone: Macculay 2150.

# CASES AND PARTS

FOR

Radio and Radio Instruments in wood or metals and in any quantity.

Anything in wood from a packing case to precision work.

Cases, racks and panels, etc., in metal.

Please send full details or drawings with enquiries.

Metal parts can only be manufactured for essential work or agains: Contract No.

**LOCKWOOD & CO.** PHONE: BYRON 3704  
LOWLANDS ROAD, HARROW, MIDD.

**EPOCH**—Genuine hand-made diaphragms, all models. —“R.E.C.S.” Crown St., Reading. Phone: 2796.  
**METROPOLITAN RADIO SERVICE Co.** Guarantee Repairs to American and British Receivers. Linecord resistances, condensers, and vol. controls. Trade supplied.—1,021, Finchley Rd., N.W.11. Spc. 3000. [9641]

**BUSINESSES FOR SALE OR WANTED**  
**“THE Wireless and Electrical Trader”** is an essential part of the equipment of every Wireless Trader, its pages reflect the very latest turn of trade events, and it is read by all the leading dealers and manufacturers, for particulars of businesses offered or wanted. By subscription, to the trade only, 17/6 per annum, post free.—Send your trade card for specimen copy to Dorset House, Stamford St., London, S.E.1. [0614]

**TECHNICAL TRAINING**  
**GREAT Possibilities Exist for Technically Qualified Engineers, key men in wartime and afterwards.** Through the home-study courses of The T.I.G.B. take a recognised engineering qualification such as A.M.I.Mech.E., A.M.I.E.E., A.M.I.R.E., A.F.R.Ac.S., A.M.I.Chem.E., C. and G., etc., in which examinations the T.I.G.B. students have gained 25 **FIRST PLACES** and Hundreds of Passes. Write to-day for “The Engineer’s Guide to Success.”—Free—containing the world’s widest choice of engineering courses covering all branches, including Aeronautical, Mechanical, Electrical, Wireless, Chemical, etc.  
**THE TECHNOLOGICAL INSTITUTE OF GREAT BRITAIN, 82, Temple Bar House, London, E.C.4.** [9335]

**TUITION**  
**RADIO Training.**—P.M.G. exams. and I.E.E. Diploma, prospectus free.—Technical College, Hull. [0611]

**PRACTICAL Radio Postal Courses, coaching for I.P.R.E. R.A.F., A.I.D. exams; booklet free.—Secretary, I.P.R.E., Bush House, Walton Avenue, Henley-on-Thames. [9547]**

**RADIO Engineering, Television and Wireless Telegraphy; comprehensive postal courses of instruction.—Apply British School of Telegraphy, Ltd., 179, Clapham Rd., London, S.W.9 (Estd. 1906). Also instruction at school in wireless for H.M. Merchant Navy and R.A.F. [9249]**

**THE NORTHERN POLYTECHNIC, HOLLOWAY ROAD, N.7.**

Department of Musical Instrument and Radio Technology.

Head of Department S. A. Hurren, M.C., F.Brit.I.R.E.

Full-time Day Courses in **RADIO SERVICING** in preparation for all recognised qualifications in these subjects. Practical laboratory and workshop experience provided.

Prospectus free on application to Secretary. New Term begins September 8th.

**TRIX SOUND EQUIPMENT**  
**RELIABLE AMPLIFICATION**  
 The TRIX ELECTRICAL COMPANY LTD.  
 65, Bolsover St., London, W.1. Euston 5471

**SITUATIONS VACANT**  
**WIRELESS Technical Instructors Required in Army Units.**  
**EMOLUMENTS.**—Pay 8/9 per day (7 days a week); clothing, rations and accommodation, or if this cannot be provided allowances at authorised rates; if married and otherwise eligible, family allowance payable in respect of wife and children, subject to allotment from pay.  
**CANDIDATES** Should Preferably be under 35 and over 24, and  
**(A)** Hold one of the following qualifications:—

Graduateship of the Institution of Electrical Engineers.  
 Final (Grade III) Certificate of City and Guilds of London Institute Examination in Radio Communication.  
 Higher National Certificate in Electrical Engineering.  
 Certificate of City and Guilds of London Institute in Radio service work.

**(B)** Be able to pass an examination on the following syllabus:—  
 Simple algebra, including quadratic equations; simple trigonometrical ratios and identities; Properties of electrical currents; heating of conductors; magnetic fields; unit of current; Ohm’s Law; resistance in series and parallel; potentiometers.  
 Magnetic effect of current fields due to parallel wires; field due to a solenoid; electro-magnets. Meters.  
 Induction; effect of rotating a coil in a magnetic field.  
 Mutual and self induction and inductance; effect of inductance on growth and delay of current.  
 Capacity; charging storage and discharge of condensers; through resistance and inductance.  
 Alternating currents; vector diagrams; effect of resistance variation; effects of L and C in A.C. circuit; phase difference of currents; resonance in a series circuit; parallel circuit of L and C; Q factor; Elementary knowledge of valves; simple theory of amplifiers, oscillators and detectors; general principles of radio practice.

**SUITABLE Candidates** will be interviewed at Local Centres, and, if successful, will be enlisted and appointed Acting Sergeant Tradesman. For those who are on the Schedule of Reserved Occupations, special arrangements will be made to enable them to be enlisted. In the event of any applicant found to be reserved under Schedule of Reserved Occupations special application will be made for relaxation of the Schedule. No guarantee can be given that this application will be successful.  
**APPLICATION Forms** may be Obtained by Postcard from the Under-Secretary of State, The War Office (A.G.6c). Whitehall, S.W.1. [9520]  
**COMPETENT Radio Engineer, part or full time, good remuneration.**—Harris, 37, Edgeworth Crescent, Hendon 7155. [9657]  
**SERVICE Engineer for Valve Deal Aids, reserved occupation, permanency for man with ability on miniature amplifiers and of good address.**—Write age, experience and salary required, Amphivox, Ltd., 2, Bentinck St., W.1. [9667]

**WANTED, for Radio Valve Factory in S.W. London, Physicists and Electrical Engineers with a few years’ factory experience (not necessarily in radio); age about 25-30; good post-war prospects.—Apply Box 206, L.P.E., 110, St. Martin’s Lane, W.C.2. (14)**

**PATENT NOTICES**  
**IT Is Desired to Secure the Full Commercial Development in the United Kingdom of British Patents Nos. 379,299 and 588,462, which relate to “Improvements in and relating to Electrolytic Cells,” either by way of sale or the grant of licences on reasonable terms.—For particulars apply Phillips’, Bank Chambers, 329, High Holborn, London, W.C.1. [9654]**

**THE Owners of British Patent No. 465,747 Relating to “Improvements in or Relating to Variable Inductance and Resistance Coils” are desirous of entering into negotiations with one or more firms in Great Britain for the purpose of exploiting the invention either by the sale of the Patent Rights or by the grant of Licences on reasonable terms.—Interested parties who desire further particulars should apply to Albert L. Mond & Thiemann, of 14-18, Holborn, London, E.C.1. [6682]**

**VACUUM CLEANERS**  
**HOOVER Minor, complete with accessories, £7/7; brand new Protos, £6/19/6 (no tax); Hoover bags, belts, brushes, spares for all cleaners, repairs.—“R. E. C. S.” Crown St., Reading. Phone: 2796. [6675]**

**Wanted**  
**HOOVER or Good Cleaner Wanted; also floor polisher.—R. E. C. S., Crown St., Reading. [6676]**

**BOOKS, INSTRUCTIONS, ETC.**  
**WEBB’S Radio Map of the World Locates any Station Heard. Size 40x30in. 4/6, post 6d. On linen, 10/6, post 6d. Webb’s Radio Globe, 12in. model. Radio prefixes, zones, etc. 27/6.—Webb’s Radio, 14, Soho St., London, W.1. Phone: Gerrard 2089. [9554]**

**EVERY Radio Dealer Who is Not a Regular Reader of “The Wireless and Electrical Trader” should send his trade card at once for a specimen copy and full details of the “Trader” Services. “The Wireless and Electrical Trader” has the widest influence, and is read by all the leading manufacturers and traders. Trade only, 17/6 per annum, post free. Published at Dorset House, Stamford St., London, S.E.1. [0615]**

**ENGINEERING OPPORTUNITIES**  
 This unique Handbook shows the easy way to secure A. M. I. C. E., A. M. I. Mech. E., A.M.I.E.E., A.M.I.A.E., A.M.I.R.E., and similar qualifications. WE **GUARANTEE—“NO PASS—NO FEE.”** Details are given of over 150 Diploma Courses in all branches of Civil, Mech., Elec., Motor, Aero, Radio and Production Engineering, Draughtsmanship, Tracing, Inspection, Government Employment, **BUILDING** (the great after-war career), R.A.F. **MATHS**, etc. Write for this enlightening Handbook to-day. **FREE** and post free. Men with Radio knowledge can obtain attractive posts in the Services.  
**BRITISH INSTITUTE OF ENGINEERING TECHNOLOGY, 387 Shakespeare House, 17, 18, 19 Stratford Place, London, W.1**

*This space reserved for*  
**W. BRYAN SAVAGE LTD.**

**CLASSIFIED ADVERTISEMENTS** intended for the **OCTOBER ISSUE** can be accepted up to **Wednesday, Sept. 10th.**

**THE BEST WAY to LEARN MORSE**  
**“MASTERS” INSTRUCTIONAL RECORDS**  
 Prepared by an ex-Royal Corps of Signals Instructor, these records contain messages at a speed up to 20 words per minute. Private Tuition given. Details on request.  
 Price 4/- each or Complete Set of Three 10/-  
**C. E. MASTERS,**  
 43, GROVE PARK ROAD, CHISWICK, W.4

**THE SIMMONDS GROUP**  
**INVENTORS**  
 We continually seek new inventions and products in all branches of industry for development and production by the manufacturing Companies of the Simmonds Group throughout the world.  
**SIMMONDS DEVELOPMENT CORPORATION LTD.**  
**BUSH HOUSE, W.G.2.**



# Solder THE MODERN AND SPEEDY WAY

USE  
**ERSIN  
MULTICORE**  
THE SOLDER WIRE WITH 3  
CORES OF NON-CORROSIVE  
ERSINE FLUX



Photo.  
Courtesy H.M.V.



- Avoids Dry Joints
- Increases Electrical Efficiency of Joints
- Speedily makes Sound Joints on Dirty or Oxidised Surfaces
- Always Correct Proportions of Flux and Solder
- No additional Flux Required
- Low Melting Point (190° C. for 60/40 alloy)
- Approved by Air Ministry & G.P.O.
- All-British and acknowledged by the Leading Manufacturers to be the finest Cored Solder in the world

**FREE** Two informative publications on Soldering have been issued by Multicore Solders Ltd. Executives are invited to send for copies and a free sample of Multicore solder.

MULTICORE SOLDERS LTD., BUSH HOUSE, LONDON, W.C.2  
Tel. TEMple Bar 5583/4

# B.I. COPPER EARTHING RODS

for  
WIRELESS  
APPARATUS

## 100% MORE SURFACE AREA



Designed to give a low resistance earth contact. Made from solid drawn H.C. copper. The multiple fins ensure larger surface area and better contact with the earth than any dry-lying earth of similar diameter and weight at present on the market; giving nearly 50 per cent. more contact area than a circular rod of equal diameter, or 100 per cent. more than a solid rod of equal weight. About 1 1/4" of the rod is left exposed and the earth lead is simply clamped against the rod by means of the copper clamp ring and screw. No sweating or soldering is required. Supplied in two standard sizes, 18" and 24". Longer rods of similar type can be supplied, if desired, to meet special requirements.



U.K. Regd. Trade Mark.

**BRITISH INSULATED CABLES LTD.,**  
CABLE MAKERS AND ELECTRICAL ENGINEERS,  
Head Office: PRESCOT, LANCS.  
Telephone No.: PRESCOT 6571.

# ROLA

**LOUD  
SPEAKERS**  
THE WORLD'S FINEST REPRODUCERS

---

**TRANSFORMER  
LAMINATIONS**

Core Width 1/8" to 1 1/2" (E's & I's)

**EIGHT STOCK SIZES**

▲ Comprehensive Bulletin together with details of Associated Covers and Clamps with design data will be sent to manufacturers on request.

---

**BRITISH ROLA LIMITED**  
MINERVA RD., PARK ROYAL, N.W.10. WILlesden 4322

# WHARFEDALE GOLDEN CHASSIS

As supplied to the  
**B.B.C.**

Supplies of this first-class  
Loud Speaker are still  
available.  
Delivery 2/3 weeks.

**PRICES:**

	Less Trans.	With Trans.
Chassis only	60/-	75 -
Cabinet Model	97/6	112/6

**RESPONSE CURVE**

**WHARFEDALE WIRELESS WORKS**  
SOLE PROPRIETOR: D. E. BRIGGS,  
HUTCHINSON LANE, BRIGHOUSE, YORKS.  
PHONE: BRIGHOUSE 50. 'GRAMS: "WHARFDEL."



# A 4 POINT PLAN TO INCREASE WAR PRODUCTION

## A MESSAGE TO MANAGEMENT.

In a recent broadcast speech, Mr. Ernest Bevin, Minister of Labour and National Service, showed how urgent was the need for more workers—especially women—in Great Britain's War Industries. Employers who are playing *their part* in the drive for greater and still greater war production will find this 4-point plan a sure guide.

### HERE ARE THE FOUR VITAL POINTS LAID DOWN BY THE MINISTRY OF LABOUR.

- 1 Skilled men are needed for the really skilled jobs. Be sure that each of your men is employed up to the very limit of his skill. Combat skilled labour shortage by breaking down processes wherever you can, and by training up your workpeople, men and women, to jobs of greater skill.
- 2 Training Schemes must be developed to the greatest possible extent. Take in more new workers for training on the job in your own works. Remember that the Government will help you with semi-skilled men and women trained under official schemes.
- 3 Prepare, now, to employ more and more women. Look constantly to women for your new recruits: they are excellently suited to many types of semi-skilled work. Hundreds of thousands must enter war production this year and every factory must play its part.
- 4 Efficient personnel management is essential. Remember that you must secure the whole-hearted co-operation of your workpeople. Look closely to their welfare. Many of them may be new to industry: be patient and help them all you can during the first difficult weeks. A little foresight will reduce your labour turnover.

**THE MINISTRY OF LABOUR AND NATIONAL SERVICE HAS DISTRIBUTED A GUIDE TO THE EMPLOYMENT AND WELFARE OF WOMEN WORKERS. EVERY RESPONSIBLE EXECUTIVE—WHETHER HE BE EMPLOYER OR MANAGER—MUST INSIST ON SEEING IT.**

You should make a special point of reading the new booklet "THE EMPLOYMENT OF WOMEN... SUGGESTIONS TO EMPLOYERS." Problems created by the increasing influx of new women workers into war factories are dealt with clearly... concisely; and the suggestions contained in the booklet will be of interest and great value to YOU! If you have not yet received your copy, instruct your secretary to write for one TO-DAY, to the local Employment Exchange, asking for pamphlet P.L. 87/1941

### These are the contents in the Booklet:

- |   |                                     |
|---|-------------------------------------|
| 1 Appointment of a Woman Personnel Officer.               | 4 Interviewing of Candidates.       |
| 2 Functions of a Woman Personnel Officer.                 | 5 On engagement.                    |
| 3 Consultations preparatory to the introduction of Women. | 6 On reporting for duty.            |
|   | 7 During first month of employment. |
|   | 8 Working hours.                    |

# MOBILISE FOR

