

BAIRD COLOUR TELEVISION

MONTHLY
ONE SHILLING

The
**Wireless
World**

*COVERING
EVERY WIRELESS INTEREST*

FEBRUARY, 1941

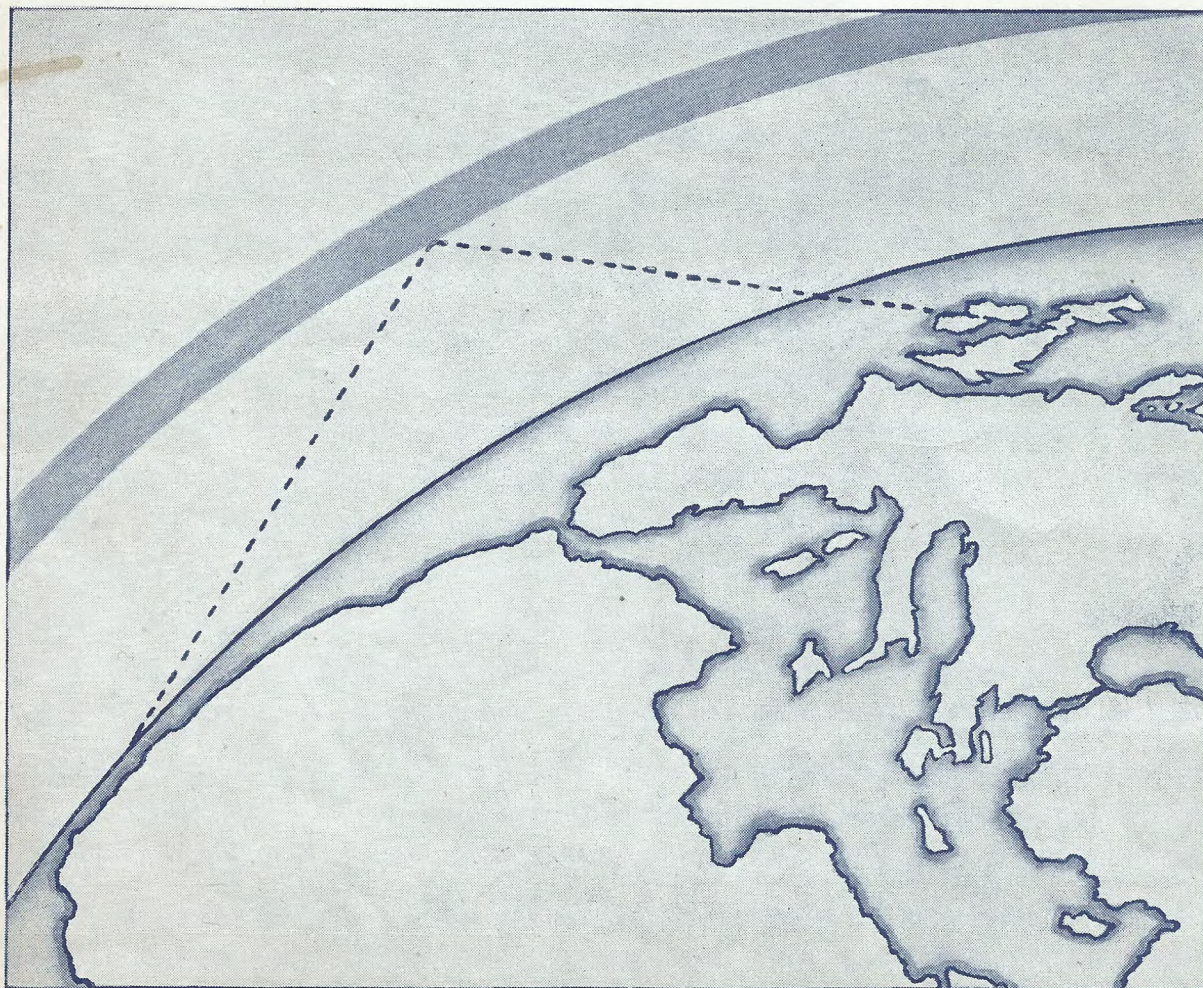

CHARACTERISTICS OF SHORT WAVES



SILVERED MICA FIXED CONDENSERS



SUPREME FOR RADIO RECEPTION AND TRANSMISSION AND CARRIER WAVE TELEPHONY

Specified for important Government contracts, U.I.C. Silvered Mica Fixed Condensers are guaranteed to give high efficiency and performance under the most exacting conditions.

Made in our own London factory from the finest materials obtainable, they are available at short notice in capacities from 7.5 up to 12,000 pF.

Write for full details and brochure.

ON A.I.D. APPROVED LIST.

UNITED INSULATOR CO LTD

The Pioneers of Low Loss Ceramics

12-16 LAYSTALL STREET
LONDON. E.C.1

Tel: TERMINUS 4118-9

Grams: CALANEL, SMITH, LONDON

SIMPLIFIED SERVICING MAINTENANCE & FAULT FINDING

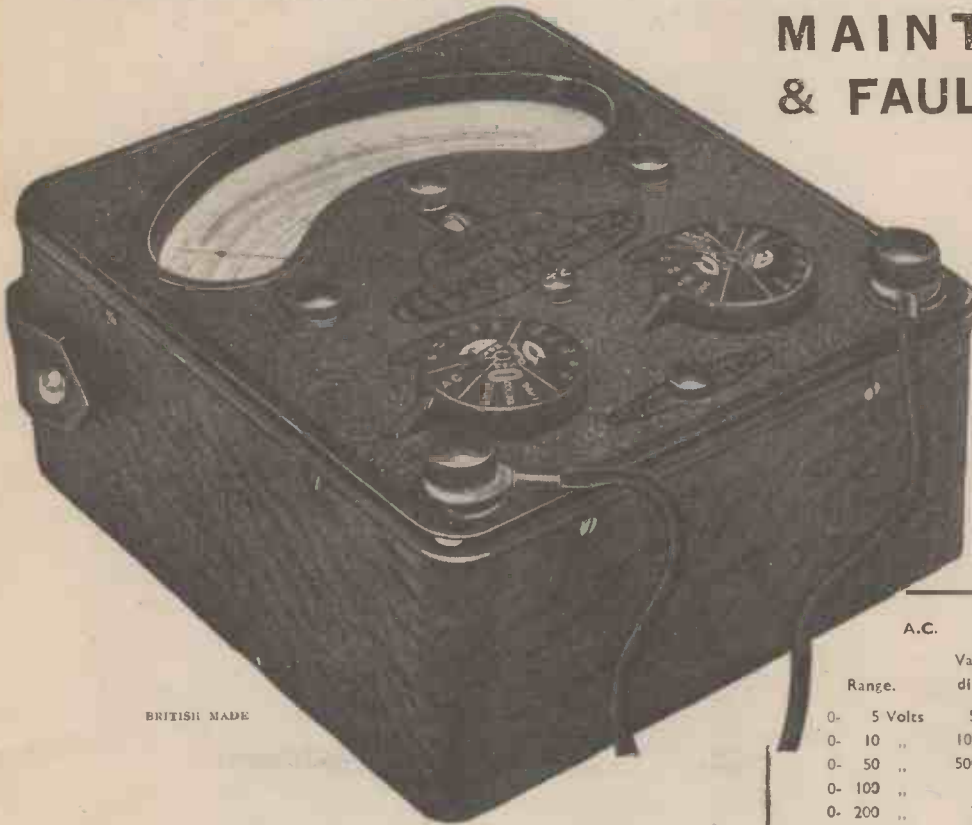

BRITISH MADE

46 Ranges
of
Direct
Readings

DESIGNED by technicians who have made a special study of the service and maintenance engineers' problems, the Model 7 Universal AvoMeter is acknowledged throughout the world as the one indispensable combination testing instrument. A single meter, yet at the touch of two simple switches it provides for any one of the 46 ranges of measurements for testing and tracing all electrical faults.

Entirely self-contained, the Model 7 Universal AvoMeter is essentially portable and, above all, simple to use. It is dead-beat in action, has a 5-inch hand-calibrated scale with anti-parallax mirror, and conforms to B.S. 1st Grade accuracy requirements. It is fully protected by an automatic cut-out against damage through overload.

Also available:

Model 7 Resistance range Extension Unit, (for measurements down to 1/100th ohm).

40-range Universal AvoMeter.

• Write for fully descriptive pamphlet.

Sole Proprietors and Manufacturers:

The Automatic Coil Winder & Electrical Equipment Co., Ltd.,
Winder House, Douglas Street, London, S.W.1. Telephone: Victoria 3404/7

VOLTAGE			
A.C.		D.C.	
Range.	Value per division	Range.	Value per division
0- 5 Volts	50 mV.	0- 50 mV (1 mA range)	0.5 mV.
0- 10 "	100 "	0- 100 mV (2 mA range)	1 "
0- 50 "	500 "	0- 500 mV	5 "
0- 100 "	1 Volt	0- 1 Volt	10 "
0- 200 "	2 "	0- 5 "	50 "
0- 400 "	4 "	0- 10 "	100 "
0- 500 "	5 "	0- 50 "	500 "
0-1,000 "	10 "	0- 100 "	1 Volt
		0- 200 "	2 "
		0- 400 "	4 "
		0- 500 "	5 "
		0-1,000 "	10 "

CURRENT			
A.C.		D.C.	
Range.	Value per division	Range.	Value per division
0- 5 mA	50 μ A	0- 1 mA	10 μ A
0- 10 "	100 "	0- 2 "	20 "
0- 50 "	500 "	0- 5 "	50 "
0-100 "	1 mA	0- 10 "	100 "
0-500 "	5 "	0- 50 "	500 "
0- 1 Amp.	10 "	0-100 "	1 mA
0- 5 "	50 "	0-500 "	5 "
0- 10 "	100 "	0- 1 Amp.	10 "
		0- 5 "	50 "
		0- 10 "	100 "

RESISTANCE	
Range.	First indication.
0-10,000 ohms	0.5 ohms
0-100,000 "	5 "
0- 1 megohm	50 "
0-10 " 500 "	500 "
0-40 " 2,000 "	2,000 "

using internal 1½-volt cell.
using internal 9-volt battery.
using external source of A.C. or D.C. voltage.

CAPACITY	POWER	DECIBELS
0 to 20 mFd.	in 4,000 Ω	reference level 50 mW
First indication 0.01 mFd.	Internal resistance	
	0 to 4 watts	-10 Db. to +15 Db.
	First indication 1 mW	

The 46-RANGE UNIVERSAL

AVOMETER

Regd. Trade Mark

Electrical Measuring Instrument

Model 7

*Serving
the
National
Interest-*



**G.E.C.
Radio**

Advt. of The General Electric Co. Ltd., Magnet House, Kingsway, London, W.C.2.

Raymart Insulators and Ceramic Goods

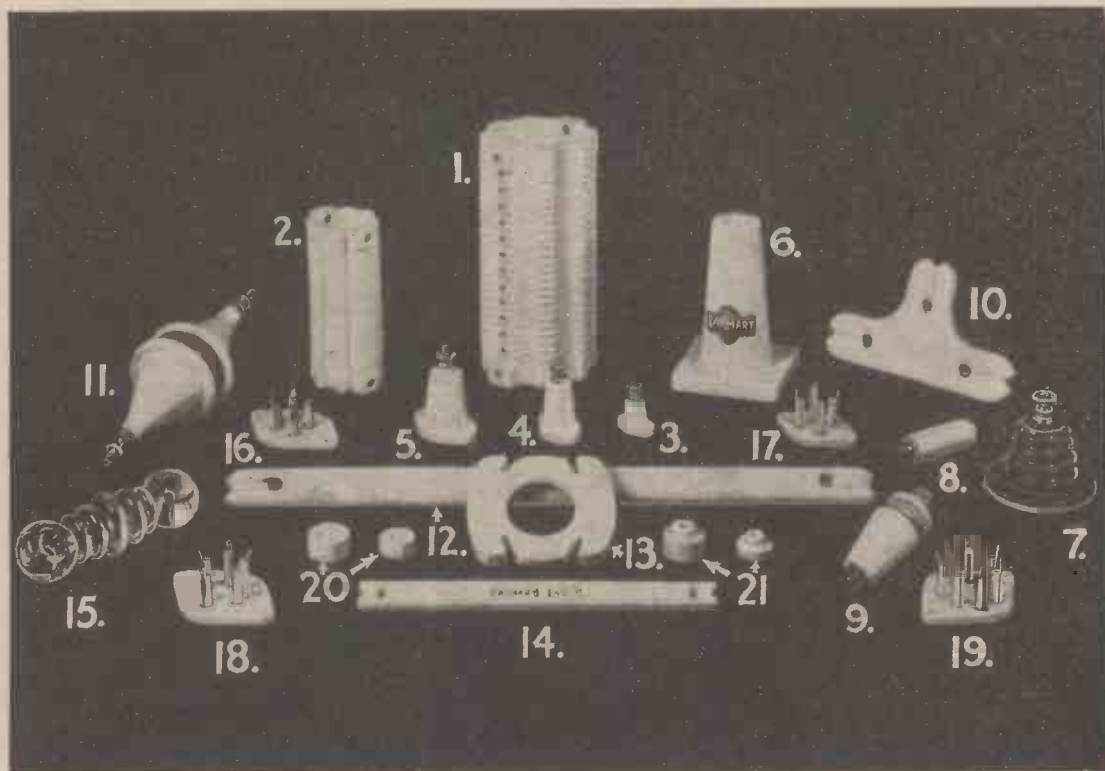

OUR ILLUSTRATION GIVES BUT A SMALL INDICATION OF THE WIDE VARIETY OF INSULATORS AND CERAMIC GOODS AVAILABLE FROM RAYMART, WHO CARRY THE LARGEST RANGE OF THESE PRODUCTS IN THE COUNTRY. THERE ARE MANY OTHER RAYMART LINES APPROVED AND USED BY H.M. SERVICES. MICRO-VARIABLE CONDENSERS—PRECISION DIALS AND A LARGE SELECTION OF SPECIALITIES FOR SHORT-WAVE WORK.

Here are the details of the 21 lines illustrated above:

1. Type TFX.—Coil Form, grooved and ribbed, 2½" dia., 5" of winding space with mounting holes and provision for link or inductive coupling.
2. Type BTX.—A similar coil form, 1½" dia. x 3½" long.
3. Type ST.—White glazed vitreous porcelain stand-off insulator, fitted with nickel-plated terminals; height excluding terminals 1".
4. Type SS.—Similar in all respects; height excluding terminals 1".
5. Type SM.—The largest of this type of stand-off insulators, 1½" excluding terminals.
6. Type SX.—Heavy stand-off insulator, 3½" high, four-hole fixing, no terminal supplied, but we have sockets specially made to fit.
7. Types SG and SL.—Standard beehive insulators; two versions are available—(a) Brown glazed (SG); (b) Unglazed (SL)
8. Type SP.—A special low-loss pillar insulator, produced primarily for ultra-high frequency use, the lowest loss insulator ever offered of this type. 1½" long x ½" dia. and internally threaded at both ends 2BA; supplied with screws and cork washers.
9. Type FTI.—Double-cone feed-through Insulator for feeding H.T. or R.F. through baseboard of chassis, mounting coils, etc. Height above chassis 1½"; below chassis ½". Full insulation provided on chassis up to ½" thick. Supplied with two cork washers and 2BA all-thread with nuts.
10. Type AT.—Aerial T piece, designed to facilitate erection of transposed or zeppelin type aerials.
11. Type SCL.—Lead-in insulator or H.F. bushing, provides maximum surface leakage path, highly glazed. Rubber ring washers ensure absolute weather-proof qualities. For especially exposed positions our Type DCL Insulator is identical with the SCL, but has at one end an overlapping double cone, so ensuring that no moisture shall form a path on the insulator.
12. Type AX.—12" glazed porcelain insulator with an exceptionally long leakage path and negligible capacity effect, used extensively for transmitting or where aerial loss must be kept to a minimum.
13. Type TB.—Transposition Block, an extremely light ceramic block for transposed feed lines. These will not slip out and are suitable for continuous exposure as supplied to the Cunard White Star Liner "Queen Mary."
14. Type FS.—Highly-glazed feeder-spreader giving a 600 ohm line. Light in weight and free from appreciable loss when exposed to atmospherical influences.
15. Type AG.—Flint-glass aerial insulator, with an excellent high frequency characteristic and long leakage path.
- 16 & 17. English Ceramic Valveholders with silver-plated contacts, both four- and five-pin.
- 18 & 19. Ceramic Sockets with silver-plated contacts for American valves.
- 20 & 21. Type FTL and FTS.—Feed-through bushes in ceramic. Type FTL passing a 2BA screw; Type FTS a 4BA screw. Extremely useful for carrying high voltage or R.F. through metal panels

Government departments—Manufacturers—Servicemen, etc., are invited to send us their inquiries.

RAYMART LTD. 44 & 48 HOLLOWAY HEAD, BIRMINGHAM, I
Cables: Raymart, Birmingham. Telephone: Midland 3254

FREQUENTITE

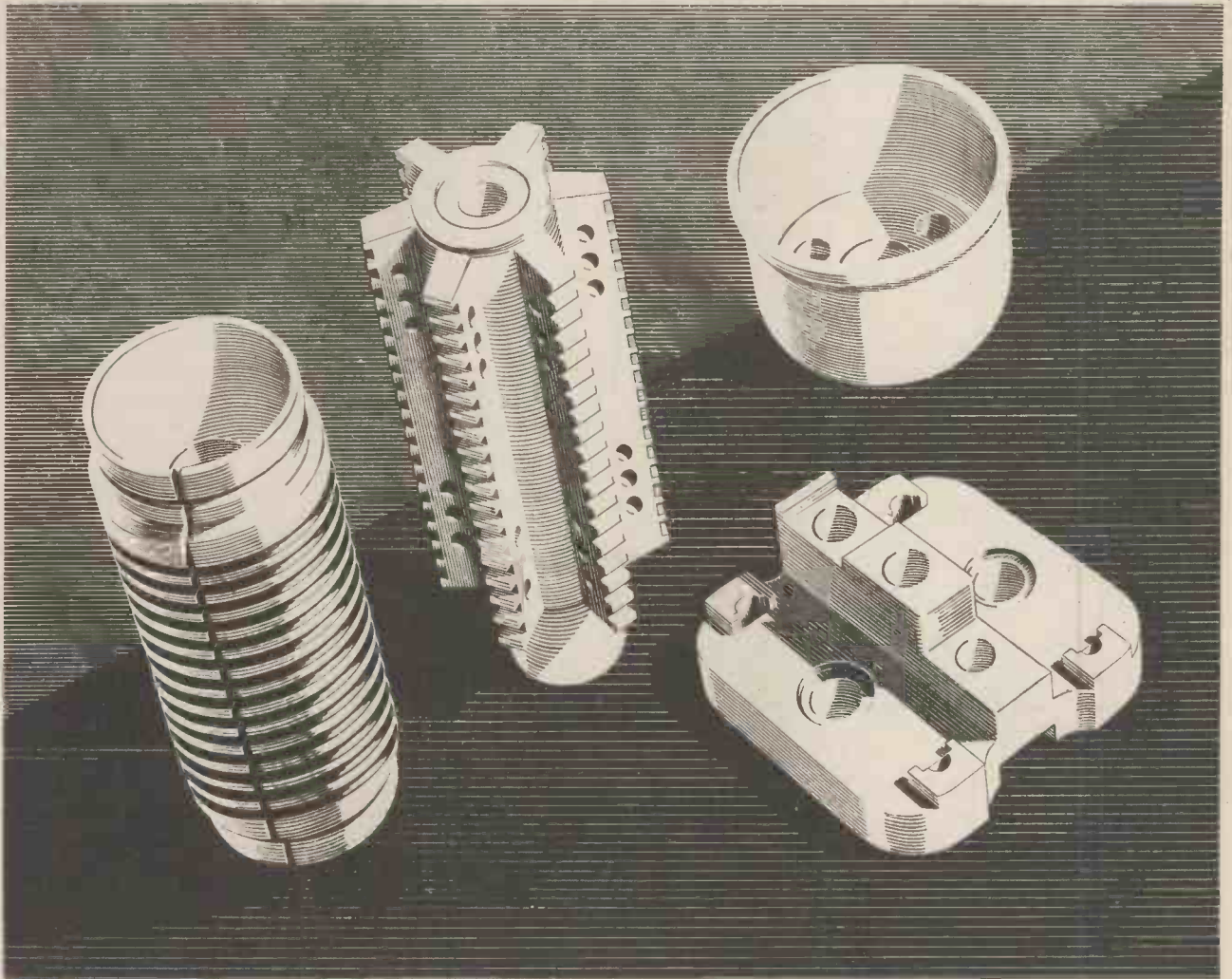

LOW LOSS • HIGH SURFACE RESISTIVITY
• COMPLETE STABILITY • These outstanding properties of Frequentite have led to its adoption by all leading radio manufacturers. Frequentite is suitable for every type of component however intricate the design. Full details will be sent on application—ask for Catalogue S.P. 10.

STEATITE & PORCELAIN PRODUCTS LTD.

Head Office and Works :

Telephone : STOURPORT 111.

STOURPORT-ON-SEVERN, WORCS.

Telegrams : STEATAIN, STOURPORT.

PREMIER RADIO

PREMIER SMOOTHING CHOKES

Type	Current	Henrys	Res	Prices
C 40/500	40 MA	20-34 H	500 ohms	5/3
C 60/180	60 MA	8 H	180 ohms	5/3
C 60/400	60 MA	25-34 H	400 ohms	7/6
C 60/500	60 MA	18-30 H	500 ohms	5/3
C 100/400	100 MA	20-34 H	400 ohms	9/6
C 150/185	150 MA	20-34 H	185 ohms	13/6
C 200/145	200 MA	20-34 H	145 ohms	15/9
C 250/120	250 MA	25 H	120 ohms	17/6
C 60/2500	60 Speaker Field		2500 ohms	7/6

Replacement

PREMIER PICK-UPS

Heads (will fit any tone-arm) ... 7/6
 Premier Pick-up with Volume Control
 2,000 ohms 12/6
 Premier de Luxe, 6,000 ohms ... 17/6

ANOTHER SPECIAL OFFER

Rothermel Brush Piezo Crystal Pick-ups.
 New Junior P.U. with arm, 24/6. Standard,
 S.8 Model with arm, 34/9. P.U. head only,
 De Luxe Model, 24/6.

PREMIER 1941 HIGH FIDELITY AMPLIFIER KITS

Each Kit is complete with ready drilled chassis, selected components, specially matched valves and full diagrams and instructions.

	Kit of Parts with Valves	Completely Wired and Tested
4-watt A.C. Amplifier	£2 14 0	£3 11 6
4-watt A.C./D.C.	3 0 0	3 17 6
6-watt A.C.	6 16 6	7 13 6
8-10 watt A.C./D.C.	6 11 6	7 9 0
15-watt A.C.	7 18 9	9 8 0

Black Crackle Steel Cabinet, 17/6 extra.

MAINS TRANSFORMERS

Wire-ends. All L.T. Windings Centre-Tapped

SP 250	250-0-250 v. 60 ma., 4 v. 1-2 a., 4 v. 2-3 a., 4 v. 2-3 a.	11/9
SP 300	300-0-300 v. 60 ma., 4 v. 2-3 a., 4 v. 2-3 a., 4 v. 2-3 a.	11/9
SP 301	300-300 v. 150 ma., 4 v. 2-3 a., 4 v. 2-3 a., 4 v. 1 a., 4 v. 1 a.	15/-
SP 350A	350-350 v. 100 ma., 5 v. 2 a. (not C.T.), 6.3 v. 2-3 a.	14/-
SP 350B	350-350 v. 100 ma., 4 v. 2-3 a., 4 v. 2-3 a., 4 v. 2-3 a.	14/-
SP 351	350-350 v. 150 ma., 4 v. 1-2 a., 4 v. 2-3 a., 4 v. 3-4 a.	15/-
SP 352	350-350 v. 150 ma., 5 v. 2 a., 6.3 v. 2 a., 6.3 v. 2 a.	15/9

Auto Transformers. Step up or down. 100-125 v. to 200, 230 or 250 v. A.C., 60 watts, 9/11; 125 watts, 13/6; 250 watts, 18/6.

L.T. Transformers, all C.T.
 4 v. 2-3 a. ... 9/11 6.3 v. 2-3 a. ... 9/11
 2.5 v. 5 a. ... 9/11 7.5 v. 3 a. ... 9/11
 5 v. 2-3 a. ... 9/11 12 v. 3-4 a. ... 15/-

Push-Pull Driver Transformers, 3:1 ... 6/6

Universal Output Transformers, 11 Ratios. Single or Push-pull ... 6/6

Bell Transformers, 3-5-8 volts ... 5/6

MATCHMAKER UNIVERSAL OUTPUT TRANSFORMERS

Will match any output valves to any speaker impedance.

11 ratios from 13:1 to 80:1, 5-7 watts, 15/9. 10-15 watts, 20/6. 20-30 watts, 35/-.

Potentiometers, all resistances, 2/4 each; with switch, 3/3.

Ceramic Valve Holders, chassis mounting, 4 or 5 pin, 7d. each. 7 pin, 11d. each.

Valve Screens, for American type valves. Small size, 1/2. Medium size, 1/2.

"LEARNING MORSE"

Premier Morse Key, Bakelite Base and Brass Movement ... 3/3
 General Purpose Morse Key ... 5/10
 Heavy Duty TX Key on Cast Base ... 10/-
 Bakelite Buzzers ... 2/-
 3 Henry Chokes ... 7/6
 Complete Kit of Parts for Valve Oscillator as described in W.W. "Learning Morse" ... 25/-

PREMIER SHORT-WAVE KITS

for OVERSEAS NEWS

Incorporating the Premier 3-Band S.W. Coil, 11-86 Metres without coil changing. Each Kit is complete with all components, diagrams and 2-volt valves. 3-Band S.W. 1 Valve Kit, 14/9. 3-Band S.W. 2 Valve Kit, 22/6.

DE LUXE S.W. KITS

Complete Kit, including all Valves, coils, wiring diagrams and lucid instructions for building and working. Each Kit supplied with a steel Chassis, Panel and plug-in coils to tune from 13 to 170 metres.

1-V. S.W. Receiver or Adaptor Kit ... 20/-
 1-V. S.W. Superhet Converter Kit ... 23/-
 1-V. S.W. A.C. Superhet Converter Kit 26/3
 2-V. S.W. Receiver Kit ... 29/-

SHORT-WAVE GEAR

Short-Wave Coils, 4- and 6-pin types, 13-26, 22-47, 41-94, 78-170 metres, 2/- each, with circuit.

Premier 3-Band S.W. Coil, 11-25, 19-43, 38-86 metres. Suitable any type circuit, 2/11. 4-pin or 6-pin Coil Formers. Plain or Threaded, 1/2 each.

Utility Micro Cursor Dials, Direct and 100:1 Ratios, 4/3.

Bakelite Dielectric Variable Condensers. .0005 mf. Suitable Tuning or Reaction, 1/6 each.

Short-Wave H.F. Chokes. 10-100 m., 10jd. each. High grade Pie-Wound U.S.A. type, 1/9 each.

Lissen Dual Range Screened Coils. Medium and Long Waves, 2/9 each.

SHORT-WAVE CONDENSERS

Trolital insulation. Certified superior to ceramic. All-brass construction. Easily ganged.

15 m.mfd. ... 1/9 100 m.mfd. ... 2/3
 25 m.mfd. ... 2/- 160 m.mfd. ... 2/6
 40 m.mfd. ... 2/- 250 m.mfd. ... 2/11

PREMIER MICROPHONES

Transverse Current Mike, High grade large output unit. Response 45-7,500 cycles. Low hiss level, 23/-.

Moving Coil Mike. Permanent magnet model requiring no energising. Response 90-5,200 cycles. Output .25 volt average. Excellent reproduction of speech and music, 49/-.

Microphone Transformers. Suitable for all mikes. Tapped secondaries, A, 20 and 40:1; B, 30 and 60:1; C, 50 and 100:1, 6/6 each.

Microphone Stands. Bakelite table stand, 9 in. ring, 7/6 each. Adjustable Floor Stand, 8 in. ring, Chrome finish, 26/6.

REPLACEMENT VALVES

for ALL SETS

Europa Mains Valves. 4 v. A.C. Types, A.C./H.L., A.C./L., A.C./S.G., A.C./V.M.S.G., A.C./H.P., A.C./V.H.P., A.C.P., all 5/6 each. A.C./H.P., A.C./V.H.P., 7-pin, 8/6. A.C./Pens. I.H., 10/6; A.C./P.X.4, 9/-; Oct. Freq. Changers, 9/6; Double Diode Triodes, 9/9; 3½-watt D.H. Triode, 12/-; 350 v. F.W. Rect., 6/6; 500 v., 8/9. 13 v. .2 amp. Gen. Purpose Triodes, 5/6; H.F. Pens. and Var.-Mu H.F. Pen., Double Diode Triodes, Oct. Freq. Changers, 8/6 each. Full and Half wave Rectifiers, 6/6 each. D.D. Pens., 10/3.

Write for latest lists.

Cardboard Electrolytic Conds. 4 MFD, 8 MFD, 1/9; 8x8, 3/6; 4x4, 2/8; 8x4, 3/3; 4x4x1, 3/9; 4x4x4, 4/3; 16x8, 4/-; 16x16, 5/-.

NEW PREMIER S.W. A.C. RECEIVER

In response to many requests we have now produced an A.C. version of the popular Premier Short Wave SG3 Kit. Circuit: Pentode H.F. Stage, Pentode Detector, Beam Power Output, and F.W. Rectifier. 200-250 v. A.C. Operation. Built-in Power Pack. Hum-free operation. For use with Phones or P.M. Speaker.

Complete Kit of Parts with drilled chassis, all components. Plug-in Coils covering 13-170 metres, 4 valves and full instructions and circuits

£4-10-0



BATTERY VERSION also available. KIT £3 8 0
 COMPLETE CHASSIS wired and Tested £3 18 6
 EXTRA COILS 9-15, 200-2000m. also supplied

"The Wireless World" said they were
 "very much impressed"

See full Test Report pp. 492-3 December issue
 Send for full details

PREMIER BATTERY CHARGERS

for A.C. MAINS

Westinghouse Rectification complete and ready for use

To Charge: 6 volts at 1 amp. 22/6
 2 volts at ½ amp. 11/9 12 volts at 1 amp. 24/6
 6 volts at ½ amp. 19/- 6 volts at 2 amps. 37/6

MOVING COIL SPEAKERS

All complete with transformer. Rola 6½ in., 15/-; 8 in. P.M.s, 17/6; 10 in. P.M.s, 22/6.

ENERGISED MODELS

Plessey 8in., 175 ohm field, 7/6; G.12 energised, or 2,500 field, 63/-; 10 in. B.T.H. 1,600 ohm field, less transformer, 11/6. Magnavox 154, 2,000 ohms Universal transformer, 15/-.

ALL ENQUIRIES MUST BE ACCOMPANIED BY 2½d. STAMP

ALL POST ORDERS to:

JUBILEE WORKS, 167, LOWER CLAPTON ROAD, LONDON, E.5 (Amherst 4723).

PREMIER RADIO CO.

CALLERS to:

Jubilee Works, or 169, Fleet Street, E.C.4 (Central 2833), or 50, High Street, Clapham, S.W.4 (Macaulay 2381).

B.I.

RADIO MATERIALS

We have had a long experience in the manufacture of all kinds of Cables and Wires, Aluminium Sheets and Strips, Static Condensers, Insulators and Iron Work, Telephone Cords and Copper Earthing Rods, for Radio use.



Regd. Trade Mark.

BRITISH INSULATED CABLES LTD
CABLE MAKERS AND ELECTRICAL ENGINEERS
Head Office:
PRESCOT, LANCS. Tel. No. PRESCOT 6571

The greatest value in Radio today!



**AMBASSADOR
NEW SERIES U.3540**

- 5 valve Superhet with Mazda valves (Export Model with Mullard type).
- 3 Wave Bands.
- 7 Energised Speaker.
- A.C./D.C. Mains.
- Australian Walnut Cabinet.
- Price £8.15.0
tax £1.17.5.

FOR no other set gives so much in return for so little cost. It has all the finer points of a radio to ensure complete reliability, first-rate reception and natural tone—and a fine handsome appearance—all at a price which is truly reasonable. Yet nothing in the set is cheap and nothing has been omitted to make the price.

Ambassador

OUT VALUES THEM ALL

★ Illustrated is the New Ambassador Table Model. Cabinet in Medium or Light Oak.

Write for details to the Manufacturers: R. N. FITTON LIMITED, BRIGHOUSE, YORKS, ENGLAND. Cable Export Enquiries to Ambassador, Brighouse, England. Enquiries for Scotland to: B.E.M. CO., LTD., 187, ST. VINCENT STREET, GLASGOW C.A.

M.R. SUPPLIES

continue to offer from stock the following **FIRST-CLASS BARGAINS IN NEW RADIO AND ELECTRO-TECHNICAL GEAR.** All items actually in stock at time of going to press. Will Government Contractors please quote Priority where available.

ROTHERMEL-BRUSH D.104 PIEZO-CRYSTAL MICROPHONE INSETS. The heart of the famous Rotermel D.104 Microphone, only require housing but can be used just as supplied. Hundreds in use. Final opportunity, 25/-.

BRUSH PIEZO-CRYSTAL ELEMENTS, 2in. dia., fitted stylus. For successful construction of microphone, cardiophone, tweeter, piano-repeater. Many in use as Vibration Pickups for testing bearings, etc., water leak detection, location of noise or vibration in machinery, etc. Very many applications and wonderful opportunity, 6/11.

ROTHERMEL PIEZO-CRYSTAL PICKUPS, the last of the famous Standard model, complete on arm, at 37/6.

PHOTO-ELECTRIC CELLS. Brand new, fully guaranteed. Cetron C.E.1 professional cells. 100 micro-amps per lumen, standard UX base (holder supplied). Suitable for cinemas, laboratories, etc. (These would now cost over 60/- each to import.) Last few at 39/6 each.

SYNCHRONOUS TIME SWITCHES (200/250 v. 50 c.). Breaking up to 10-amps. and providing two on-off periods per 24-hours. For controlling any electrical device, radio, domestic appliances, factory coolers, "music-while-you-work," etc. Precision made, half usual price, 69/6. Also model with good 5-day spring movement, same duties, 49/6.

ELECTRO-MAGNETIC COUNTERS.—Coil resistance 500 ohms or 3 ohms, counting up to 9,999. Many domestic and industrial applications, checking production quantities rates of production, rejections, percentages, use in inspection departments, checking telephone calls, etc., 5/6. In dozen lots, 4/10 each.

GEARED HIGH TORQUE MOTORS. Operation 15/30 volts A.C. Spindle speed 60 r.p.m. Made for radio tuning but can be applied to many other purposes. Reversible, with automatic 2-pole make switch. Synchronous at 50 c., making them suitable for Recording Instruments, etc. Finest model imported from U.S.A., 8/6 each.

LOW TENSION RECTIFIERS. Great News. Supplies again in stock! Permanent metal type by large British manufacturer. D.C. delivery 12/14 v. at 1.5 amp., 10/9. Also Heavy Duty Model, D.C. delivery 12/14 v. at 5 to 6 amps., 32/6. See below.

STEP-DOWN TRANSFORMERS, suitable for above rectifiers and for low-voltage shelter lighting, etc. All prim. 200/250 v., secondary 7/11/15 v. at 2 amp., 10/11. Also sec. 23 v. 2 amp., 12/- Also 10 v. 7.5 amp., 18/6. Also special new model, constructed in brackets, with terminals, D.C. delivery in conjunction with 32/6 rectifier, 12/14 v. 5/6 amps., 32/6.

MINIATURE P.M. M/C/OIL UNITS. For use as either Microphone or speaker, 12-ohms impedance. Ideal for shelter or for inter-com. Fine frequency response, high flux alni magnet, 13/6.

MULTI-RATIO TRANSFORMERS. Suitable either as output or microphone input for above units. Tapped primary and secondary and giving 8 ratios, 5/6.

RADIO INTERFERENCE SUPPRESSORS. Post Office pattern. Completely eliminating all interference from mains-borne sources. Kit supplied with diagram, 3/6.

TRANSVERSE CURRENT MICROPHONES. The original and most satisfactory type is still available for the discriminate buyer. Model MR/224, in black bakelite casing, 29/6. The original MR/204 (which set the standard), 57/6. Microphone Floor Stands, in best quality chromium plate, 27/6. Or massive claw-foot model, extending 4ft. to 6ft., with 8in. or 9in. ring (please state which required), 38/6. Our stands are undoubtedly the finest value prevailing in these difficult times.

3-GANG .0005 VARIABLE CONDENSERS. With 50/1 slow motion drive and ball-bearings, these are a remarkable opportunity at 3/6.

We still have some **COMPLETE AMPLIFYING EQUIPMENTS** to offer. Please enquire.

Get it now from—

M. R. SUPPLIES, 68, New Oxford St., London, W.C.1
Telephone: MUSeum 2958

TAYLOR

for Accurate
TESTING



VALVE TESTER

MODEL 45

Note these important features:

MUTUAL CONDUCTANCE TESTS. Over 1,000 types of British, American and Continental valves can be put through highly accurate tests.

17 VALVE HOLDERS. There are 17 different types of valve-holders fitted, including the new American Bantam, Loktal, Mazda Octal and Midget Deaf-Aid types. **EVERY VALVE** tested under correct working conditions.

ADAPTORS. No external adaptors are required.

"GOOD," "7," "REPLACE." The Taylor 4 1/2 in. square type moving coil meter has a scale for indicating the slope of valves.

CATHODE LEAKAGE. A specially calibrated scale shows a leakage as high as 10 megohms.

FILAMENT CONTINUITY AND SHORTS. These are indicated by a lamp mounted on the panel.

VALVE TESTER MODEL 45

is supplied complete with a grid connecting lead—comprehensive book of instructions and an up-to-date Valve Chart Manual.

A fully descriptive Brochure is available free on request.

BRITISH MADE.

GUARANTEED SIX MONTHS.

Portable Model at £14/19/0.

Standard Bench Model
£14 - 3 - 6
No purchase tax payable.

TAYLOR ELECTRICAL INSTRUMENTS LTD.
419-422, Montrose Avenue, SLOUGH, Bucks.
Phone: Slough 20061

THIRTY-FIVE YEARS'

SPECIALISED EXPERIENCE

T.C.C.

T.C.C.

Condensers

Another famous firm specifies

Simmonds Speed Nuts

(PATENTS APPLIED FOR)



Leading Manufacturers are proving the amazing efficiency and adaptability of Simmonds Speed Nuts.

In the Automobile, Electrical, Radio, Plastic, Cooker and Refrigerator Industries, to mention only a few, this modern fastening method is accelerating assembly, halving handling time and effecting considerable savings in costs and material.

There is no limit to the applications of Simmonds Speed Nuts apart from the many standard types. The unique flexibility of the Speed Nut System makes it possible for special types to be created to meet particular assembly problems. Our Engineers are constantly evolving Speed Nut designs to cope with such problems as blind locations, difficult spacing jobs, tricky Knob-to-shaft assemblies and many others which have hitherto baffled designers.

Investigate the Speed Nut System NOW. Our Development Department will be pleased to collaborate and submit suitable designs to meet your individual needs.

Illustration shows a Simmonds Speed Nut application on a Commer nameplate. Below are a few of the thousands of successful Speed Nut applications:

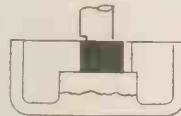

SPEED CLIP CA 728
For moulded knobs of the thermo-setting type. This Spring Collar simplifies fastening and replacement. The knob is moulded with a "D" shaped hole to prevent turning, and the spring SPEED CLIP engages frictionally with the shaft. Eliminates the difficulties of internal springs and grub screws.



SPEED NUT NR 404
Designed for assemblies which require tightening from the nut side. It has two holes for use with a two-prong key. For rapid assembly, nut is zipped down over threads and given a turn to tighten.



SPEED NUT NS 1037

These Speed Nuts, which in each case eliminate a stamping, a nut and a lock washer, solve the problem of holding wires, conduits and coils securely in place. The flexibility of the Speed Nut enables it to be used with conduits of different diameters.

ly in place. The flexibility of the Speed Nut enables it to be used with conduits of different diameters.

SIMMONDS AEROCESSORIES LTD

GREAT WEST ROAD, LONDON.

The Wireless World

COVERING EVERY WIRELESS INTEREST

30th Year of Publication

Proprietors : ILIFFE & SONS LTD.

Editor :
HUGH S. POCOCK.

Editorial,
Advertising and Publishing Offices :
DORSET HOUSE, STAMFORD STREET,
LONDON, S.E.1.

Telephone : Waterloo 3333 (35 lines).
Telegrams : "Ethaworld, Sedist, London."

COVENTRY : 8-10, Corporation Street.
Telegrams : "Autocar, Coventry." Telephone : 5210 Coventry.

BIRMINGHAM :
Guildhall Buildings, Navigation Street, 2.
Telegrams : "Autopress, Birmingham." Telephone : 2971 Midland (5 lines).

MANCHESTER : 260, Deansgate, 3.
Telegrams : "Iliffe, Manchester." Telephone : Blackfriars 4412 (4 lines).

GLASGOW : 26B, Renfield Street, C.2.
Telegrams : "Iliffe, Glasgow." Telephone : Central 4857.

PUBLISHED MONTHLY.
Price : One Shilling
(Publication date 20th of preceding month.)

Subscription Rates :
Home and Abroad, 14/- per annum.

As many of the circuits and apparatus described in these pages are covered by patents, readers are advised, before making use of them, to satisfy themselves that they would not be infringing patents.

No. 1064

Vol. XLVII. No. 2

FEBRUARY, 1941

Contents

EDITORIAL	31
NOISE IN FM TRANSMISSIONS	32
PROPAGATION OF SHORT WAVES. By D. W. Heightman	36
THE FUTURE OF AMATEUR RADIO. By "Navigator" ..	40
BAIRD COLOUR TELEVISION	43
MOTOR CAR IGNITION INTERFERENCE	45
CURRENT TOPICS	46
NEWS IN ENGLISH FROM ABROAD	48
SHORT-WAVE PORTABLE. By W. H. Cazaly	49
SHORT-WAVE RECEIVING CONDITIONS	50
SPY'S TRANSMITTER	51
RANDOM RADIATIONS. By "Diallist"	52
COSSOR MODEL 75A: Test Report	54
RESISTANCE-TUNED OSCILLATOR	56
UNBIASED. By Free Grid	58
RECENT INVENTIONS	59

WORLD CONTACT WITH A TROPHY

IN THESE HISTORIC TIMES WORLD LISTENING PROVIDES A NEVER ENDING SOURCE OF INTEREST AND ENTERTAINMENT.



THE TROPHY IS SPECIALLY DESIGNED FOR ALL-WORLD RECEPTION

TROPHY 6 Valve incorporating all latest improvements, 10 to 545 metres. Built-in Speaker, A.C.
£11.11.0 or £4.14.8 deposit and 34/6 monthly.
 Purchase Tax, £2.9.8.



TROPHY 8 Valve A.C. A super communication receiver with amazing range. 7 to 550 metres.
£14.19.6 or £6.4.5 deposit and 44/- monthly.
 Purchase Tax, £3.4.5.

PETO SCOTT CO. LTD. Showrooms at 77, CITY ROAD, E.C.1. SEND FOR FULL SPECIFICATION

How much wood...?



TWO years ago it was the standard practice to make Radio cabinets from Beech plywood. Cabinets built from plywood may be made with large surfaces, with curves, or with rounded corners, which cannot easily be imitated in solid board; and they may be finished with veneers of Mahogany, Rosewood, Walnut, Bubinga or any of a great variety of other woods capable of taking a high polish.

When the War began it was immediately clear that plywood could no longer be easily imported from Sweden, Poland, Finland and Russia, and that some changes in cabinet technique would be necessary if we were to have any chance of keeping up a reasonably steady supply of radio cabinets. It was with this in mind that the cabinet used for our A.90 and D.90 Table models was designed.

This cabinet is a simple design built up from a rectangular frame work, with four flat sides of solid board, stained and polished, and an inset front covered with fabric. A moulded bakelite panel surrounds the grouped controls and scale in the lower part of the front, and provides a background for the knobs which is not easily scratched or dirtied.

The plain polished sides may be made from any of a number of woods: Beech, Pine, Obechi, Mahogany, Oak and Teak have all been used as one or other became available. The fabric covering enables us to make the front itself from grades of plywood which are still obtainable, but which are not suitable for polishing or veneering. In periods of extreme shortage of wood it has been found possible to make the bottom and front of the cabinet from a very hard pressboard and tests

carried out in a warm and humid atmosphere show that this has no ill effects on the strength, durability and appearance of the receiver.

As another method of saving wood we have used a moulded bakelite cabinet for the AD.94 receiver. We don't regard bakelite and the other plastics as "substitutes" for wood—materials to be finished a mottled brown and made to look vaguely like wood. They never do look like wood, and there seems to be no very good reason for trying to make them do so.

Plastics have possibilities of their own, and a bakelite cabinet should be designed to suit the material. The "94" itself is a case in point, since its shape, interesting enough and easily handled as a moulding job, is quite unsuited to wood-working technique.

It will be seen that we have met the wood shortage in two ways—by designing for one receiver a cabinet which uses the wood that is available and by using a bakelite cabinet for a second model. These changes, coupled with those in other parts of the receivers, have enabled us to make at least some of the radio sets the public needs, at a time when raw materials are very difficult to obtain.



Wartime cabinet design has been adapted in the case of the "90" Table Models (left) to the available supplies of wood. Economy in timber is also achieved by using bakelite for a second receiver (right).

All Murphy Sets, exclusive of valves and batteries, guaranteed for a year.

MURPHY

Murphy Radio Limited, Welwyn Garden City, Herts.

C.R. Casson 968

The Wireless World

COVERING EVERY
WIRELESS INTEREST

ESTABLISHED
1911

No. 1064. Vol. XLVII. No. 2.

FEBRUARY, 1941

Price One Shilling

Editorial Comment

Planning for Peacetime

A GOOD number of our readers will demand that the post-war world shall provide them, among other desirable things, with facilities for taking part in what is surely the finest of all hobbies—amateur wireless transmitting. Writing with a lively recollection of the difficulties experienced by the amateur in regaining his privileges after the end of the last war, we feel that it is not too early to begin making plans now for organising the whole matter on a satisfactory basis. One reason for doing so is that there is bound to be an enormous number of would-be recruits to the amateur movement from the ranks of Service wireless personnel.

We will not argue that, because amateur transmission has proved such a valuable training ground for entrants to the wireless branches of the fighting services, everything possible should be done to encourage it in preparations for future wars. That would seem like a distressingly cynical counsel of despair. Rather would we urge that the post-war amateur will help to forge a link in the chain of international co-operation and mutual understanding that will be so urgently needed.

It is for these reasons that we tender no apology for publishing at the present time an article, appearing elsewhere in this issue, which offers some constructive suggestions as to the conditions under which amateur licences should be granted in the future.

It is evident that on one point at least our contributor takes much the same attitude as expressed in this journal in 1938, when we urged the abandonment of the condition (which had even then become farcical) that applicants for licences should prove that they had serious scientific experimental work in view. A genuine interest in wireless and the

attainment of a reasonable standard of proficiency should be enough.

There must be no misunderstanding about one important matter. No reasonable person knowing anything about the subject would suggest that the ether should be thrown open to any incompetent and irresponsible applicant for a transmitting licence. In pleading for some relaxation of the official attitude we have always maintained that proof of a reasonably high standard of operating ability should be required before the granting of a full licence. If the amateur movement grows, a technical examination may also be necessary. An incompetent operator has enormous potentialities for disorganising wireless communications, and proper safeguards are essential.

Saturation Point?

It has been suggested that there is not room for many more amateur transmitters, but, given proper organisation of their activities, that attitude seems to be quite untenable. As we pointed out in 1938, some 40,000 amateurs in the U.S.A. then seemed to accommodate themselves fairly comfortably within the confines of waveband allocations very little more generous than those occupied by a mere 7,000 in the whole of Europe. In any case, the question of saturation, so far as the band of wavelengths with world-wide range is concerned, should really be considered on a world basis, and not from a local or national point of view.

The advantages of having a cut-and-dried scheme, ready for submission to the Post Office immediately war ends, is obvious, and it is hoped that readers who have alternatives to "Navigator's" suggestions will not hesitate to put them forward.

Noise in FM Transmissions

FIELD TESTS CONFIRM ADVANTAGES OVER AMPLITUDE MODULATED SYSTEMS

In view of the importance of possible future developments in frequency-modulated broadcasting, extensive calculations and experiments have been made in America to determine quantitatively the improvements which are to be expected in the service range of FM stations. This article summarises the results obtained, which show close agreement between theory and practice

IN the matter of signal-noise ratio, the superiority of frequency-modulated broadcast systems over those with amplitude modulation is not solely due to the action of the limiter stage¹ of the receiver in "ironing out" amplitude variations. There are fundamental differences in the way in which noise voltages combine with the carrier in FM and AM receivers, and in nearly all circumstances the resultant effect is to the advantage of FM.

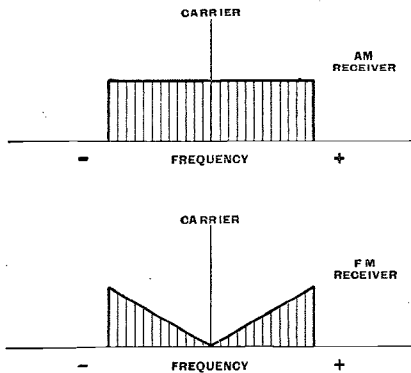

Fig. 1.—The frequency spectrum resulting from the combination of noise with a carrier is rectangular in the case of amplitude modulation and triangular with frequency modulation receivers.

Random noise such as that arising from valve hiss comprises a continuous spectrum of frequencies ranging from zero upwards in which the components approximate to a constant amplitude. Mathematical analysis² has shown that when the

¹ "Receivers for FM Transmissions," *The Wireless World*, December, 1940.

² "Frequency Modulation Noise Characteristics," M. G. Crosby, *Proc. I.R.E.*, April, 1937.

noise is combined with a carrier the resultant spectrum in a receiver for amplitude modulation is rectangular, whereas in an FM receiver it is triangular. (See Fig. 1.) Put in another way, the audio noise at the output terminals of an AM receiver is constant at all frequencies, but in FM reception it increases proportionally to the frequency of each component of the noise. Experimental proof is furnished by the cathode-ray oscillograms of Fig. 2, obtained by swinging a heterodyne oscillator across the carrier to which the receiver was tuned.

When amplitude and frequency modulation are competing on equal terms, i.e., with 100 per cent. modulation in the case of AM, and a deviation ratio of unity in the case of FM (frequency departure equal to upper audio limit), the signal-noise ratio can be shown² to be $\sqrt{3}$ or 1.73 times better in FM than in AM reception. This is an initial gain for FM of 4.75 db.

But the deviation ratio is rarely as low as unity, and in practice is usually about 5:1 (75 kc/s frequency deviation for an upper audio limit of 15 kc/s). From Fig. 3 it

Fig. 2.—Oscillograms from amplitude (top) and frequency modulation receivers obtained by tuning the set to a carrier and swinging a heterodyne across the carrier to simulate noise. The nick in the AM oscillogram is due to "pulling" near zero beat.



will be seen that the FM noise spectrum reaches its maximum at 75 kc/s, whereas the 15 kc/s audio cut-off in the receiver or loud speaker rejects the greater part of the triangle and passes the small darkly shaded area which is only one-fifth of the whole. Thus there is in this case a gain in signal-noise ratio of 1.73×5 or 18.75 db.

Still further improvement is obtained by the "pre-emphasis" of

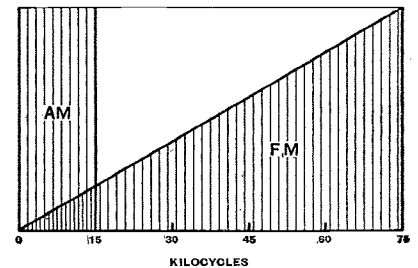

Fig. 3.—With an upper audio-frequency limit of 15 kc/s, the noise in the output of a 75 kc/s FM receiver is limited to the area shown by the small triangle.

high frequencies in the transmitter and a converse "de-emphasis" in the receiver. The R.M.A. and F.C.C. have standardised this practice in America for television and UHF transmissions in accordance with the impedance-frequency characteristics of a series inductance-resistance network having a time constant of 100 micro-seconds, and when the curves are analysed to find the RMS signal-noise improvement a further gain of 7.35 db. is found, giving a total of 26 db. over amplitude modulation.

All the foregoing considerations are based on the assumption of a reasonably large carrier-noise ratio, i.e., greater than unity. Below a carrier-noise ratio of unity, the signal-noise ratio at the output of the receiver ceases to be proportional to the input carrier-noise ratio. The reasons for this effect have been worked out in theory³, and the curves of Fig. 4 show the calculated

Noise in FM Transmissions— magnitude of the effect. The physical process by which the signal is depressed below the "improvement threshold" or limiting carrier-noise ratio is somewhat involved and the waveform of the noise is an important factor.

Fluctuation noise due to valve and circuit hiss, which in spite of its name is of comparatively steady average amplitude, produces a greater depression than impulse noise such as that due to car ignition systems. In the latter type of noise the peaks are not only limited by the frequency characteristics of the system, but they also depress the signal and punch holes in it in a similar manner to certain noise suppression circuits which have been developed for amplitude modulation receivers. Another important point is that receivers designed for a high deviation ratio should require a higher

be working above and the other below its threshold.

All these theoretical predictions have been confirmed by laboratory experiments, and more recently³ by field tests undertaken by the National Broadcasting Company in America. These tests were of an exceptionally

General view of the transmitter at station W₂XWG. The change over from amplitude to frequency modulation is effected by relays. An accurate check of the transmission line voltage was obtained by the GR multi-range valve voltmeter seen on the stool in the foreground.

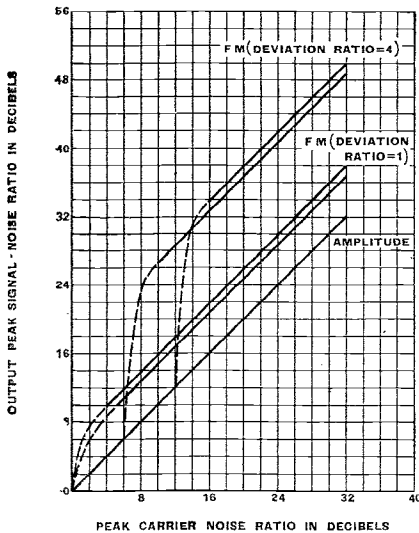
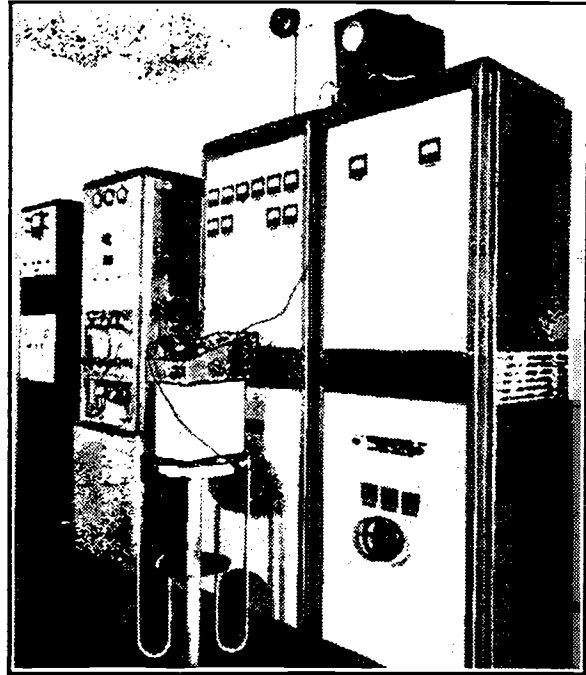

Fig. 4.—Calculated signal-noise ratio characteristics of frequency and amplitude modulation. In each pair of curves the higher is for impulse noise and the lower for fluctuation noise.

carrier input to reach the "improvement threshold" than low deviation receivers, the reason being that the wider IF band width of the high deviation receiver accepts more noise. At certain carrier levels near the fringe of the service area of a FM station the low deviation receiver may be expected to give a better signal-noise ratio than the high deviation receiver, because one will

thorough and painstaking character and were designed to settle once and for all the rival claims of amplitude and frequency modulation and of the relative merits of different deviation ratios in the latter system. As far as quality of reproduction was concerned it was regarded as axiomatic that there was nothing to choose between FM and AM and that the governing factors were the use of an ultra-short wavelength for transmission which permitted an extension of the 10 kc/s band width permitted on normal broadcast bands. The tests were

³ "NBC Frequency-Modulation Field Test," by R. F. Guy and R. M. Morris, *R.C.A. Review*, October, 1940.

therefore directed primarily to the evaluation of the frequency-modulated system in terms of the suppression of noise and interference, using the amplitude-modulated system as a reference standard.

To eliminate every possible disturbing factor it was decided from the start to use the same transmitter, receiver, aerial systems and measuring equipment for each system of modulation.

The transmitter was a 1 kW RCA unit designed originally for amplitude modulation and modified for alternative frequency modulation, the circuit changes being effected by a number of relays. A reactance control in the primary circuit of the

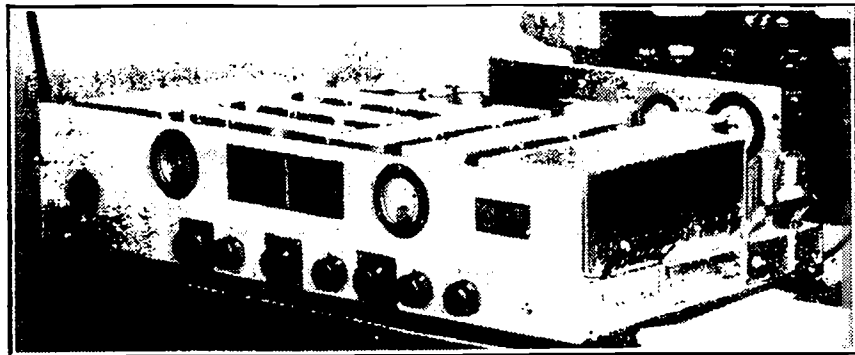

R.C.A. special field test receiver for frequency and amplitude modulation. The sensitivity is of the order of 1 microvolt.

Noise in FM Transmissions—

main rectifier gave a continuously variable control of power from 1,000 watts to less than 0.1 watt during transmission with frequency modu-

sured to make them as nearly ideal and alike as possible. RF frequency changer and output stages were made common to both systems of reception, and the change-over

pole, a broadcast loop aerial, a vernier speedometer and distance recorder, and a magnetic compass.

After a preliminary survey of the field intensity contours of the trans-

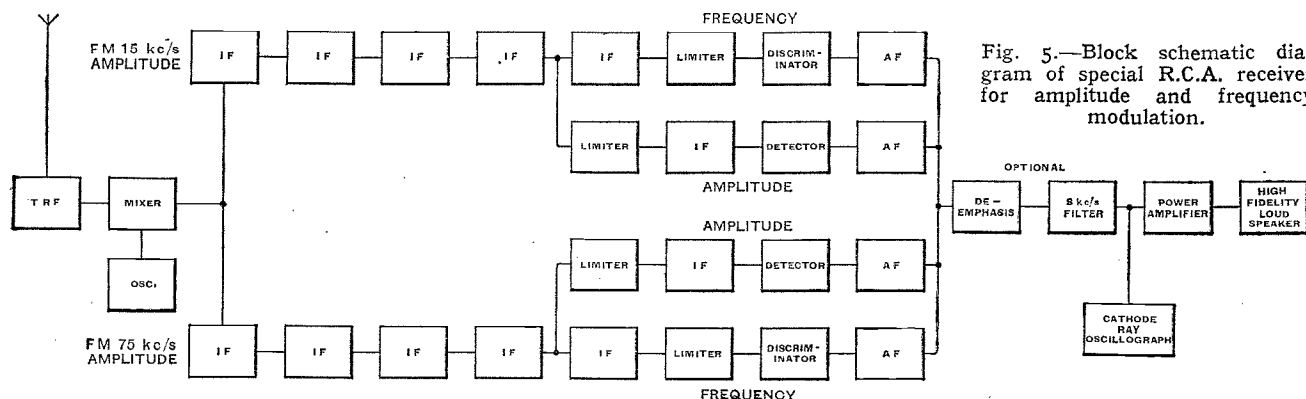

Fig. 5.—Block schematic diagram of special R.C.A. receiver for amplitude and frequency modulation.

lation. The power delivered to the aerial was accurately measured by a GR valve voltmeter across the aerial transmission line. Modulation was effected by the reactance valve method and a crystal-controlled oscillator in conjunction with a discriminator circuit was used to keep the average carrier frequency stable.

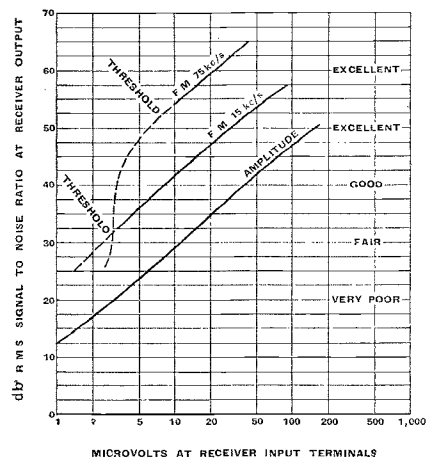

Fig. 6.—Signal-noise performance with valve and circuit noise only.

The aerial system normally used was the television aerial on the top of the Empire State Building, New York, but an auxiliary folded dipole was available for periods when the main antenna was occupied for television. The station was given authority to transmit either FM or AM on 42.6 Mc/s and was licensed as W2XWG.

Four receivers were built specially for the tests, and no expense was

was effected only in the IF and detector or discriminator sections of the chain. Parts of the same IF system were used for AM and 15 kc/s FM, but a separate IF amplifier was used for 75 kc/s FM. A single switch selected the type of modulation required.

A shielded mutual inductance type attenuator was used between the aerial and the receiver. By using this in conjunction with control of the transmitter power and of the power radiated from artificial noise sources, any combination of carrier and noise voltages could be produced. The transmitter and receiver were equipped with "pre-emphasis" and "de-emphasis" filters.

Auxiliary apparatus at the permanent receiving stations included cathode ray oscillographs, noise and distortion meters, a harmonic analyser, disc recording equipment, noise producing devices such as diathermy machines, automobile ignition systems, etc.

The two permanent stations were situated in the NBC laboratory at a distance of one mile, and at Bellmore, Long Island, 23 miles away. Observations were also made at nine temporary stations up to distances of nearly 90 miles. The equipment of the temporary stations was built into two cars, one of which is shown on the next page. This vehicle was equipped with field intensity measuring sets mounted in aviation shock absorbers, a universally mounted di-

mitter, investigations were made to determine the minimum field intensity which would provide a good service. The curve in Fig. 6 shows the results which were obtained with a signal generator feeding directly into the input terminals of the receiver. Under these conditions there was no external noise interference, and receiver hiss was the limiting factor. Measuring along the 10 microvolt vertical ordinate, it will be seen that the difference in signal-noise ratio between amplitude modulation and 75 kc/s frequency modulation is 26 db, so that the full theoretical advantage is realised.

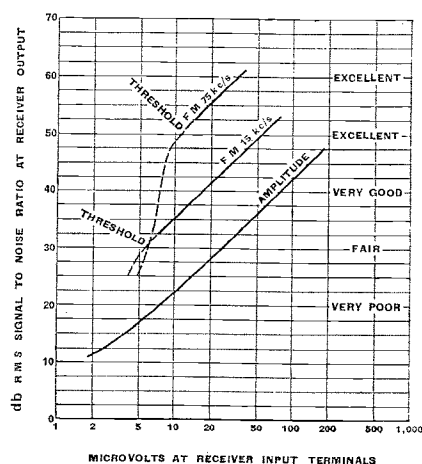

Fig. 7.—Performance with circuit hiss and miscellaneous quiet neighbourhood noise. Transmitter W2XWG, New York City and receiver R.C.A. special receiver at Bellmore, Long Island.

Noise in FM Transmissions—

The curves of Fig. 7 were taken at Bellmore under representative receiving conditions, and show the

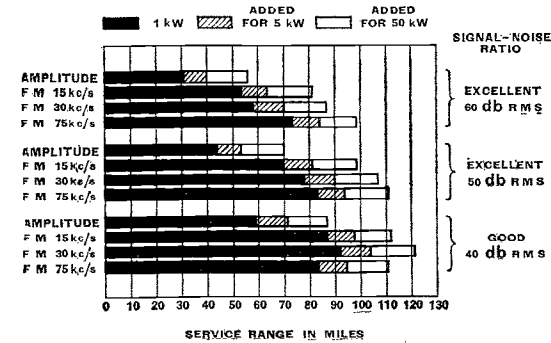

Fig. 8.—Bar chart of estimated average service ranges of various transmission systems. Calculations are based on noise levels in the Bellmore neighbourhood and the assumption of an aerial height of 1,000ft. and receiver height of 30ft.

results which were obtained with a combination of circuit hiss and quiet neighbourhood noise. Noisier conditions would shift all three curves to the right without altering the vertical distances between points on the curves.

The data obtained in these tests were plotted in the form of a bar chart (Fig. 8), showing the calculated service ranges for 30 kc/s deviation and for higher transmitter powers. An interesting point is that a 30 kc/s deviation with a signal-noise ratio of 40 db, which may be regarded as a satisfactory minimum for good service, has a better range than the 75 kc/s deviation, owing to the greater limitation imposed by the

“improvement threshold” which occurs at a signal-noise ratio of 60 db, but for practical purposes does not become severe until about 53 db for the higher deviation. Above this value 75 kc/s deviation is definitely better than 30 kc/s, but for maximum coverage the lat-

N.B.C. Radio Facilities engineering car equipped with field intensity measuring sets, vernier speedometer and distance recorder, compass, etc.



ter would seem to be the optimum frequency deviation.

With regard to simultaneous operation of two FM stations on the same channel, it was found that interference and cross talk were unnoticeable when the carrier voltage of the desired station was 20 db

greater than the undesired station. The opinion is expressed that with a reduction of this difference to 12 db the service would be still tolerable. With amplitude modulation, on the other hand, a minimum power difference of 40 db is essential.

On adjacent channels with 200 kc/s separation, tests showed that the undesired carrier should not exceed the desired carrier by more than 10 db. This was the average value obtained with two commercial FM receivers. With the R.C.A. special receiver, on the other hand, a difference of 17 db could be tolerated.

Tests for the signal-noise levels at which the “improvement threshold”

begins gave levels of 60 db for 75 kc/s and 35 db for 15 kc/s.

In all the foregoing experiments the noise was predominantly of the continuous hiss type. Tests with ignition interference confirmed that for similar subjective estimates of service quality a signal-noise ratio (peak in this case) 10 db less than hiss gave equivalent results.

Diathermy interference was largely dependent on the type of HT supply ;

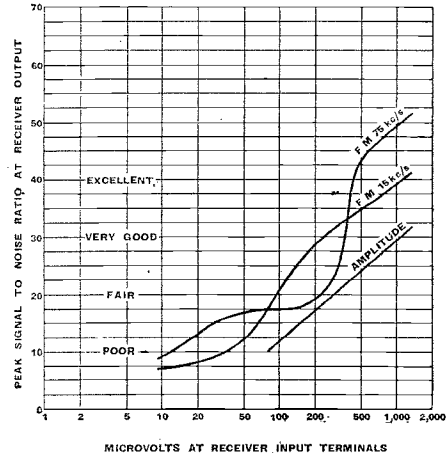

Fig. 9.—Signal-noise curves for peak ignition noise (56 uV/metre) from car roof. distant travelling at 30 m.p.h. Modulation was simulated by detuning the 15 kc/s system by 6 kc/s and the 75 kc/s system by 24 kc/s.

machines with raw AC were characterised by a transmission band about 15 kc/s in width. Observations made with a machine of this type with fairly weak interference centred exactly on the desired carrier showed a superiority of FM over AM of 20 to 25 db for 75 kc/s, and 10 to 12 db for 15 kc/s deviation. With the interference off the carrier frequency, conditions were quite altered, and at 5 kc/s off tune, AM was approximately equal to 15 kc/s FM, and was in some cases actually superior to 75 kc/s FM. When the diathermy interference was centred at the edge of the 15 kc/s FM and AM pass-band, the interference was highly attenuated, but with 75 kc/s FM it was extremely severe, as the interference products were well within the pass-band of the latter system. It would seem that a locality with strong diathermy interference calls for narrow band receiving systems, but the wide band is superior when interference is weak.

Propagation of Short Waves

HOW THEY TRAVEL THROUGH SPACE

This simplified explanation of the way in which short-wave signals travel over vast distances through space is published for the benefit of the large numbers of readers who, since the war, have turned to short-wave broadcasting for information and interest.

By D. W. HEIGHTMAN

THE newcomer to short-wave reception soon finds that a knowledge of fundamental matters concerning the propagation of such waves is of considerable assistance in obtaining best results with a minimum waste of time. It is our purpose here to go into such matters in a simple manner, taking little previous knowledge of the subject for granted.

We are chiefly concerned with frequencies between 5 and 30 megacycles, or wavelengths of 10 to 60 metres. Compared with long and medium waves, where the "ground wave" is of most importance, short-wave signals are received over long distances by virtue of the "sky wave." The terms ground wave and sky wave are probably self-descriptive enough, but it might be mentioned that the ground wave is propagated along the surface of the earth without any form of reflection between transmitter and receiver. On long and medium waves the ground wave is attenuated to a far less extent than on short waves, consequently the lower frequencies are more suitable for ordinary broadcasting, providing reliable signals up to a hundred miles or so. Unless the aerials are erected abnormally high (as in the case of television) the ground wave in the case of short waves is of little use over 30 miles or so. To cover long distances on the short waves we rely on the sky wave, which leaves the transmitter, travels upwards for a hundred miles or so until it reaches the ionosphere, where it is then reflected (more correctly refracted or bent) back to the receiver many miles away.

The ionosphere is that part of

the earth's atmosphere, extending mainly between 25 and 250 miles above the surface of the earth, which is ionised by the sun's rays. By ionisation we infer the splitting of a gas, generally rarefied, into charged particles known as ions, by the passage of a radiation or stream of electrons through the gas. Electrons are, as it were, knocked off from their atoms or become attached to

WRUL, Boston, is one of the most consistently well received of American broadcasters, as the 19- and 25-metre bands, used simultaneously for transmissions beamed on Europe during the early evening, are generally suitable for propagation conditions then existing. At about midsummer and midwinter, however, waves respectively shorter and longer than either of those used would often provide better signals. The photo shows one of WRUL's curtain beam aerials at Scituate, near Boston.

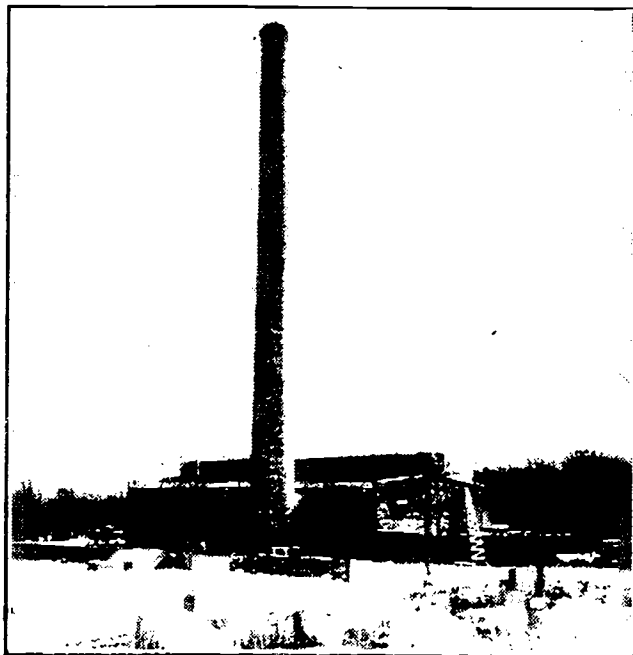

other atoms, by the radiation. Unless the gas is rarefied the free electrons soon recombine with the ions and the gas is no longer ionised. Such an ionised gas has the property of bending waves of radio frequency on the passage of such waves through the gas. The amount of bending depends on the ionisation density

and the frequency of the wave. The higher the frequency of the wave the less it is bent, and also the higher the density of ionisation the higher the frequency of the wave that can be refracted. In the present instance, of course, the outer atmosphere of the earth is the rarefied gas and the ultra-violet radiation from the sun the main ionising agent.

While there is still much for the scientist to find out about the ionosphere, in recent years much data has been obtained, and the following is a brief picture of it as we understand it to-day. The ionisation is not evenly distributed with height, and at certain heights is considerably more intense. Thus we speak of the various layers of the ionosphere. It must be remembered, however, that

the layers can be as much as one hundred miles thick and seldom exist as thin reflecting surfaces, the inner and outer boundaries of the layers being quite indefinite. There are two layers of the ionosphere which chiefly affect radio signals. These are known as the E and F layers. Their heights above the earth's surface and

Wireless World

Propagation of Short Waves—

their ionisation density depend on several variables, some known and others unknown. During daytime from about March to October, and particularly in midsummer, the F layer splits into two layers, called the F₁ and F₂ layers, which recombine at dusk to form the single night-time F layer. The effect is seldom observed in winter when there is only one F layer. The E layer, which generally has a less ionisation density than the F layers, exists at an average height of 110 km. (70 miles), while the night-time F layer is at an average height of 300 km., dropping to some 200 km. during daylight in winter. When it exists the F₂ layer is subject to considerable variation in height, reaching its maximum height in the middle of the summer day, around 400 km., and dropping back to the night-time F layer height as the day proceeds. The F₁ layer does not vary in height to the same extent as F₂ and averages about 200 km.

Short-wave Paths

From the foregoing we arrive at the simple diagram of Fig. 1 which demonstrates the fundamentals of short-wave propagation. It should be remembered that the lines in this figure only represent the points of greatest ionisation in layers of considerable thickness. The distribution of ionisation with height would be somewhat as represented by the shaded area on the extreme right of the diagram. Obviously from Fig. 1 the factors controlling the distance covered by the short-wave signal will be (1) the transmitter frequency, (2) the angle at which the main radiation leaves the earth, (3) the layer heights, (4) the ionisation density of the layers. In practice we have to adjust (1) and (2) to suit existing conditions of (3) and (4). While this sounds simple enough, matters are considerably complicated by the fact that the ionosphere is subject to many irregularities, and also that the distribution of daylight over the path of the signal is often very uneven, especially over long distances east or west.

The line *a* in Fig. 1 represents the path of a low-frequency signal leaving the transmitter at a high angle.

Since the ionisation of the lower layer is sufficient to reflect a signal of low frequency, such as *a*, this signal returns to earth at a comparatively short distance. Path *c*, however, is that of a signal of considerably higher frequency which leaves the transmitter at the same angle as *a*, but which passes through the first layer, where the ionisation is insufficient to return it to earth, and is reflected by the higher layer of greater ionisation, thus arriving at a point considerably farther away than *a*.

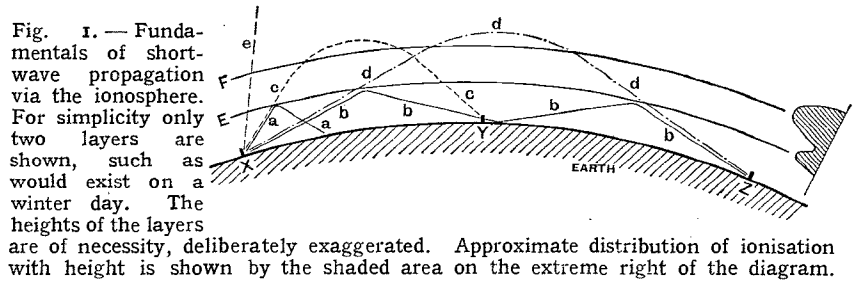

Fig. 1. — Fundamentals of short-wave propagation via the ionosphere. For simplicity only two layers are shown, such as would exist on a winter day. The heights of the layers are of necessity, deliberately exaggerated. Approximate distribution of ionisation with height is shown by the shaded area on the extreme right of the diagram.

The signal *e* of the same frequency as *c*, but leaving at a high angle, passes through both layers, and is not returned to earth. In this instance, signals leaving at a higher angle than *c* will not be returned to earth, so that the distance X—Y represents the shortest distance that can be covered by a signal of the higher frequency *c*. Between X and Y no signals will be receivable (except over a few miles close to the transmitter due to the ground wave and at intermediate distances due to other secondary effects producing very weak signals) and the distance XY is known as the skip distance for waves of a given frequency. It should be realised that the skip distance will vary with frequency, and will not be constant for any particular frequency, since it depends on existing conditions in the ionosphere. Alternatively, the longest distance that can be covered in a single hop will be that of a signal which leaves the transmitter at a very low angle such as *d*. The actual distance covered will depend on the layer heights and distribution of ionisation over the signal path, and can be anything from 3,000 to 6,000 miles or so.

Signals leaving at intermediate angles between *d* and *c* will be receivable at any point between Y and Z. The distance X—Z could be

covered by a lower frequency signal, taking path *b*, in two or more hops and relying on reflection from the ground (or water) at intermediate points. For a given power radiated by the transmitter, however, it would be found that the lower frequency signal would be weaker than the single-hop high-frequency signal; this is due to the attenuation which occurs in the multiple reflection in the ionosphere and in the imperfect reflection from the ground. A low-frequency signal is also subject to

greater attenuation on its passage through the ionosphere. Therefore, for any signal route, strongest signals are obtained using a frequency near the highest usable frequency under any given conditions.

“Critical Frequencies”

In order to be able to forecast radio conditions and also to keep a record of them for future reference, various scientific bodies in different parts of the world carry out daily observations, by means of special apparatus, on the heights and “critical frequencies” of the various layers. Briefly, a transmitter is arranged to send waves vertically upward in a series of very short impulses. These signals, reflected by the ionosphere, are picked up on a nearby receiver, the output of which is connected to a cathode-ray tube. On the cathode-ray tube is seen a large deflection due to the impulse received direct from the transmitter and smaller deflection due to the reflected impulse. From the distance between these two impulses on the tube screen it is possible to determine the time taken by the signal to go up to the layer and back. Knowing the speed of radio waves (186,000 miles per second), it is then a fairly simple matter to arrive at the dis-

Propagation of Short Waves—

tance travelled by the signal, half the distance in this case being the approximate height of the ionised layer. Thus it is possible to measure what is known as the "virtual height" of the various layers. The virtual height obtained in this way will be somewhat greater than the actual height to which the signal travels, since the signal is slowed down somewhat during its passage in and out of the layer.

As the frequency of the above-mentioned impulse transmitter is gradually increased, say, from 2 megacycles, it will be found that the virtual height of the layer also increases slightly and then suddenly, as the frequency reaches, say, between 3 and 4 megacycles, the virtual height jumps up to something like double the original value. This indicates that the signal of increased frequency is passing through the first or E layer, and is now being reflected by the F layer. The highest frequency of waves transmitted vertically upward and returned to earth is known as the critical frequency of the particular layer in question.

As the frequency of the transmitter is increased from, say, 4 megacycles, again there is a gradual increase of indicated virtual height until a point is reached, say 12 Mc/s, where no further reflections are indicated. This shows that the waves are now passing into outer space, and in this instance 12 Mc/s would be the critical frequency of the F layer. Fig. 2 gives typical records of virtual heights and critical frequencies for various seasons, etc.

Low-angle Transmissions

Signals of considerably higher frequency than the critical frequency will be returned to earth by the various layers if these signals are transmitted at low angles to the earth (instead of vertically upward as in the case of the critical frequency) for then a signal so transmitted will arrive at the layer at an oblique angle and its passage through the layer will be longer, also it will not require the same amount of bending to return it to earth. Generally the highest frequency of a low-angle signal which will be returned to earth (often termed upper frequency limit)

is approximately three times the critical frequency in the case of the F layer and three to five times in the case of the E layer.

Unfortunately in many respects, since the ionisation in the atmosphere is caused by the sun's radiation it is obvious that the ionisation density of the layers will vary almost continually with the earth's rotation, both hourly from day to night and with the various seasons of the year. In addition the sun's radiation is far from constant, being subject to various fluctuations and irregularities. The presence of spots on the

net result is that the average ionisation in the atmosphere is greatest in sunspot maximum years and follows the sunspot cycle of eleven years average between peaks. Hence, as the sunspots reach their maximum years, the maximum usable radio frequencies are highest, being almost double those usable at the sunspot minimum. The last sunspot maximum was 1937, and since that year conditions on the higher radio frequencies have gradually fallen off.¹

The critical frequencies of the E and F layers vary as shown in Fig. 2 (b) during each 24 hours. It will

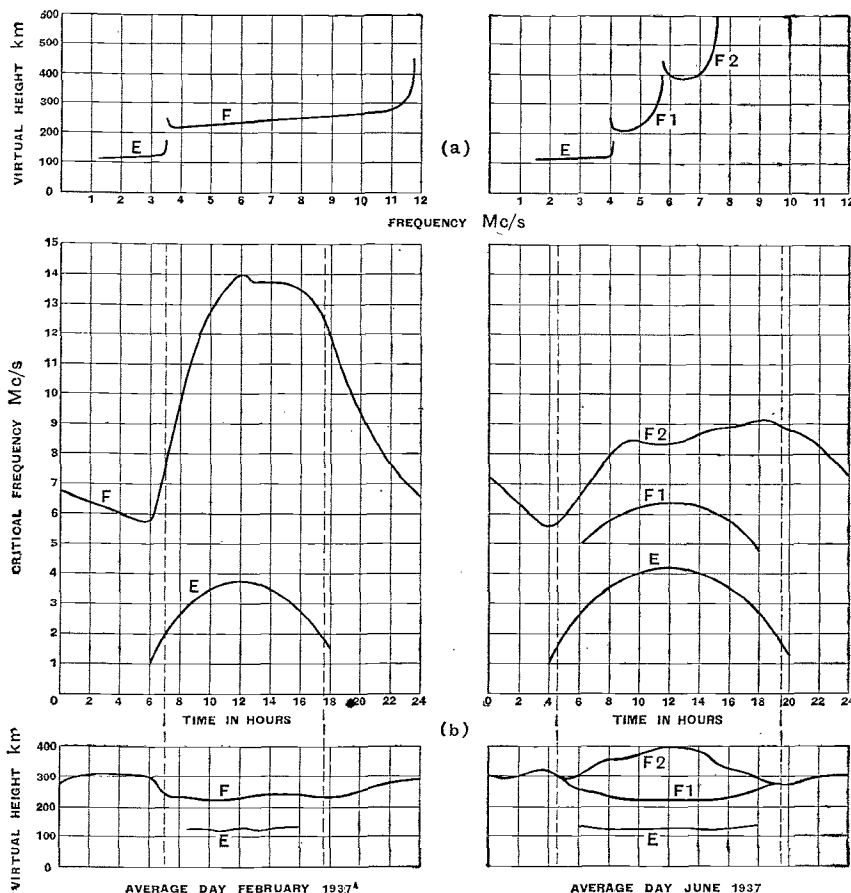

Fig. 2.—(a) Variation of virtual height with increase of frequency for a winter and summer day. (b) Comparing virtual heights and critical frequencies for winter and summer throughout the 24 hours for average days in February and June, 1937 (sunspot maximum). (After data contained in Sept., 1937, report of Nat. Bureau of Standards, Washington.)

sun affect its radiation and, therefore, the ionosphere, considerably. Generally the effect is to increase the ionising radiation and thus the critical frequencies, but the improvement is at times followed by short periods of disturbed conditions. The

be observed that the E layer reaches its maximum ionisation around mid-day, and so also does the F layer in winter, but in summer months the latter layer generally reaches higher

¹ "Collecting Short Wave Data," *The Wireless World*, August, 1940.

Propagation of Short Waves—

critical frequencies later in the day, an hour or two before sunset. The F layer ionisation is greatest at the end of February and the end of October, reaching a minimum in midsummer and slightly falling off in midwinter. Thus, during the winter months the upper frequency limit for long-distance transmission during daylight is considerably higher than in summer and also a much wider band of frequencies can be used without undue attenuation towards the lower frequencies. In the summer daytime, when the E layer critical frequency is at a maximum and is much nearer the values of the F layers, only a comparatively narrow band of frequencies are suitable for daytime long-distance transmission *via* the F layers, because the higher ionisation in the E layer reflects most frequencies back to earth at short distances.

During the summer months, and occasionally at other times, there occurs what is known as "sporadic E" or "intense E" layer ionisation during which the ionisation in the E layer is greatly increased and is thought to be more stratified. Signals of 60 Mc/s or more are reflected under such conditions. Sporadic E conditions do not, however, last for more than an hour or two and are of a comparatively local nature.

At night-time, both in winter and summer, transmission on frequencies over 1-2 Mc/s takes place *via* the F layer. The summer night-time F layer critical frequencies are generally higher than those in winter when the lowest values for the layer are recorded.

Occasionally conditions in the ionosphere occur which cause complete or partial fade-outs of signals from certain directions. The first type of fade-out is characterised by a sudden disappearance of signals for short periods of a few minutes to an hour or two, only during daylight, with a rapid return to normal conditions. This sudden or short-period fade-out is said to be due to chromospheric eruptions on the sun, causing suddenly greatly increased ionisation below the E layer, which results in great attenuation of short-wave signals. The effect of this type of fade-out is greatest where the sun's radiation is

perpendicular, i.e., in southerly directions from this country. The lower frequencies down to 2 Mc/s or so are more affected by the short period fade-out than are the higher frequencies.

The second type of fade-out, which is of a more serious nature, occurs when what is known as an ionosphere storm takes place. During such a storm the ionisation in the F layer is considerably reduced and the virtual height is subject to considerable variation, particularly over parts of the world near the polar regions. Signal routes in southerly directions are seldom affected; at any rate, never so seriously as routes north of east or west. The ionosphere storm is thought to be caused by the arrival of charged particles from the sun, chiefly at the polar regions of the earth. It is accompanied by a "magnetic storm" (when the earth's magnetic field suffers considerable variation) and also often by the Aurora Borealis. The onset of the ionosphere storm is generally slow, taking several hours to reach a maximum and the fade-out lasts with diminishing intensity for two or three days, conditions gradually returning to normal. The higher frequencies are most badly affected by the long-period type of fade-out, the deterioration in conditions becoming less the lower the frequency. In this country we notice the effect of ionosphere storms mostly on signals from North America, since the signal paths pass near to the north pole. Many signals which do not completely fade-out during an ionosphere storm are subject to extremely rapid "flutter" fading.

In a subsequent article we will consider, in relation to everyday short-wave reception, the more practical aspects of the phenomena that have been discussed.

In What Direction?

CORRECTED RULES FOR USING THE WEIR NOMOGRAM

IT is regretted that the rules for applying the Weir Nomogram, as given in the article in the January, 1941, issue of *The Wireless World* were incorrect on account of the scales being interchanged. The scale COC' is actually the

(distant) station latitude scale and the latitude curves E represent the observer's latitude. The amended rules are:—

1. Find X, the point on the latitude scale corresponding to the station latitude.

2. Find Y, the point of intersection of the observer's latitude curve and the longitude difference curve.

3. Join XY and through O, the centre of the circular scale, draw a line OZ meeting the scale at Z where the angle θ may be read off (the parallel lines may be drawn by the aid of a ruler and set square).

4. If the longitude difference is greater than 90 degrees use the intersection point in the opposite quadrant.

5. The scale reading θ gives the bearing East or West of North.

Example 1: The point X on the nomogram is the 40-degree division on the North Lat. scale. The point Y, since, $120 > 90$, will be in the opposite (South) quadrant (Rule 4) and is at the intersection of the 120-degree Long. Diff. curve and the 53-degree latitude curve (found by interpolation). A line OZ is now drawn through O parallel to XY and cuts the circular scale at the 44-degree graduation. Hence the bearing is 44 degrees West of North.

Example 2: The point X on the nomogram is the 30-degree division on the S. Lat. scale. The point Y is the intersection of the 150-degree Long. Diff. curve with the 53-degree Latitude curve, and since $150 \text{ degrees} > 90$ degrees it will (Rule 4) be in the North quadrant. OZ is drawn through O parallel to XY and the circular scale reading is 55.5 degrees. The bearing is thus 55.5 degrees East of North.

From the World's Journals

THE January issue of our sister journal, *The Wireless Engineer*, includes nearly 300 abstracts from, and references to, articles on wireless and allied subjects recently published in the technical journals of America, Russia, Germany, India, Japan, Canada, Italy and Great Britain. The abstracts and references section is a regular monthly feature of *The Wireless Engineer*, which is published on the first of the month, and is obtainable to order through newsagents or direct from our Publishers at Dorset House, Stamford Street, London, S.E.1, at 2s. 8d. post free.

The application of the locked-in oscillator to automatic tuning and modulation is dealt with in an article in the same issue. Another article deals with the question of interference in relation to amplitude, phase and frequency modulated systems.

An index to the 4,500 abstracts published during 1940 was included in the December issue of *The Wireless Engineer*.

The Future of Amateur Radio

PLANNING FOR THE POST-WAR TRANSMITTING BOOM

NOW that, after a period of more than fifteen hectic years, all British amateurs are silent once again, it would appear to be a suitable time to review the past and to prepare plans for the future. That the "amateur spirit" in this country did not die on the outbreak of war is shown in many different ways, not the least important of which is the interest apparent amongst service operators. It may well be that, if the authorities accede to the demand that will certainly arise at the conclusion of the war, the number of transmitting licences will reach a figure undreamt of in September, 1939. It is with these considerations in mind that the writer, an ex-amateur, will attempt to point out how beneficial modifications could be introduced into the licensing regulations. It must be obvious to all who came into contact with conditions as they existed during the last few years that, unless some alterations are made, amateur radio will probably cease to be of use to anyone, and will certainly

By "NAVIGATOR"

wave communication is generally recognised. That this work, however, was not confined to the early twenties is sometimes forgotten, and it may not be out of place to recall one or two matters which apply particularly to the last few years. Outstanding has been the use made of 28 Mc/s, the result not of mere chance, but of organised and persistent effort by a small but skilled band of experimenters who were rewarded by seeing the time come when transatlantic amateur signals were being received in this country far louder than those of the high-power broadcasting stations. Again, much of the UHF equipment used by the Services of the belligerent nations is closely related to the portable amateur stations which were in vogue some time before the war. Although many other similar instances could be quoted, the writer will be content to mention only one further point; the extensive "amateur market" has been an important fac-

none too high, a fact that may lead to unpleasant consequences later. The chief reason for this was probably the state of the 7-Mc/s band, which was made hideous by a small minority of amateur telephony stations vying with each other in the use of redundant Americanisms and "baby-broadcaster" procedure. Another aspect which must be viewed with alarm by all who hope for an early resumption of activity is the suspicion with which all matters concerning amateur transmitting is viewed by the public, the Press, and possibly the authorities. The closing down of stations in a country at war is understandable, but we have now come to the stage when a country nominally at peace, the United States, has forbidden its amateurs to communicate with foreign countries. The continued operation of certain German "amateurs" must have made many persons wonder whether their peacetime activities were quite so innocuous as they sounded.

Before putting forward any suggestions, it is necessary briefly to review the regulations as they existed prior to September, 1939, and to consider the questions that arise from them. To facilitate this, the main problems have been classified under



Courtesy T. C. R. Bulletin

KEEPING THE AMATEUR SPIRIT ALIVE. — Although there is no non-professional transmission nowadays, amateur radio is very much alive, and its adherents are actively engaged in planning their doings for after the war. Here is a group of amateurs, in and out of the fighting services and including many Canadians, who met at Farnborough to renew old friendships.

lose those features which made it unique amongst hobbies.

The valuable nature of the part which amateurs have played in the development of world-wide short-

tor in the improvement and cheapening of commercial apparatus.

Despite the work done by amateurs, their status in this country immediately preceding the war was

five main heads. They are: (1) Licences and Examinations, (2) Frequencies, (3) Power, (4) Telephony, and (5) Traffic Handling.

Two types of licences were issued:

Wireless World

The Future of Amateur Radio—

(a) The non-radiating artificial aerial licence, and (b) the full radiating licence. The AA licence, known only in this country, was, in effect, practically issued upon application, since, apart from references and a birth certificate, it was only necessary to state that some scientific object was in mind. This last point was often overcome by enlisting the aid of another amateur! Despite this, most amateurs will agree that the scheme was excellent in many ways. Its detractors made much of an occasional case of "pirating" by AA holders; but the writer is of the opinion that the AA licence did much to lessen this curse, because many who, if they had had no licence at all, would have been tempted to transmit, were restrained from so doing by the fear that they would lose what privileges they had, and they would render impossible the achievement of their ambition, a "full ticket." The obtaining of this was circumscribed by the morse test of 12 wpm; it is interesting to note that the corresponding speeds in U.S.A. and Canada were 13 wpm and 10 wpm respectively.

Deterring the Dabblers

Thus the number of amateurs was limited, since, while anyone sufficiently interested could soon reach this speed, the faint-hearted often fell by the way. The position, however, at the end of the war will be very different, as there will be hundreds of thousands of men more or less expert at morse. While many of these will, given the chance, no doubt become first-class amateurs, it will be necessary, in order to prevent overcrowding of the bands, either to raise the speed or to introduce a theoretical radio test. This second method could easily be adopted, and, in fact, has for a long time been in force in many countries. In the U.S.A., for example, an examination set by the F.C.C. must be taken. This includes transmitter theory, amateur regulations, and elementary operating procedure.

The second point that will need considerable attention before licences are reissued is the thorny problem of frequencies. No one could dispute the statement that before the war the

most crowded portions of the ether were the 7-Mc/s and 14-Mc/s bands, which, although used regularly by at least 25,000 amateur stations, together covered a frequency range of only 700 kc/s. Of these 700 kc/s, 100 kc/s (7,200/7,300 kc/s) were rapidly being rendered unusable by the 7-Mc/s broadcasting stations, whose numbers have greatly increased since the outbreak of war.

Knowing how in the past the broadcasting stations, once they have established a "bridgehead,"

OTHERWISE ENGAGED—Many hundreds of British amateurs are doing wireless work in the services, and particularly in the R.A.F. They are getting experience of apparatus of a vastly different type from that to which they have been accustomed; here, for example, is the relatively high-powered installation of a Sunderland flying boat.



soon infiltrate over a wide area, the outlook as regards this band is none too bright. As regards the other bands, the position was much better; 1.7 Mc/s, although shared with other services, was, on the whole, a very useful frequency, and the surprising lack of interest shown in it was no fault of the G.P.O., which was always ready to allow its use; 3.5 Mc/s was also shared, and in this case use of it was reserved to a selected few. This was a great pity, as it led to the overcrowding of 7 Mc/s for semi-local contacts more suited to the 3.5-Mc/s band. If, as is the case in the States, telephony was generally allowed on 3.5 and not 7 Mc/s, one of the abuses that might be at least checked is that of the "baby broadcasters," who relied on the large number of all-wave sets which seldom cover 3.5 Mc/s.

A few years ago considerable interest was aroused by the suggestion that transmission on 112 Mc/s and above should be thrown open to all

bona-fide experimenters without all the "red-tape" connected with the ordinary licence. While this is in many ways an excellent plan which might do much to develop UHF communication, the following difficulties appear to be almost insurmountable. First, it is doubtful whether any remarkable results could be achieved by experimenters who had little experience of low-fre-

quency transmitters, especially in view of the trend towards crystal control on the UHF. Secondly, it is extremely doubtful whether the G.P.O. would ever consider allowing anyone to possess transmitting equipment without the formalities connected with the ordinary licences when it is remembered that the G.P.O. would be unable to monitor these transmissions effectively.

More Power?

Another question which is always of importance to amateurs is that of licence power. Many regarded the regulations in this country, limiting the beginner's power to ten watts, as unreasonably severe when compared with other countries. It should be pointed out, however, that there are many dangers in the immediate granting of permits for, say, 100 watts, and it is felt that, in principle at least, the G.P.O. was wise in keeping power strictly in check.

The writer hesitates before plung-

The Future of Amateur Radio—

ing into the bitter controversy as to the merits of telephony versus telegraphy which arouses more bad feeling than any other subject. The fact remains that, while both systems are equally indispensable in their own spheres; a telephony station in the hands of a poor operator is of far more danger to the status of the amateurs than a badly operated CW station.

"Traffic Handling" is another question which, while arousing interest, is never likely to be translated into fact in this country where all third party communication is a monopoly of the G.P.O. The main advantage of allowing traffic handling is that it raises the standard of telegraph operating as can be seen in the difference between the standard in this country compared to that existing in the United States. As opposed to this the danger of attracting persons not interested in the radio side of their hobby must be considered; another factor is that in a small country such as Great Britain its use would be very limited.

Post-war Plan

The writer having reviewed the regulations as they were, now ventures to give a skeleton outline of those alterations which will be necessary to meet the changed situation which will exist after the war.

(1) There should be three types of licence: (a) Artificial Aerial, (b) Intermediate, and (c) Full. The issue of AA licences to be much the same as in pre-war days. A simple theoretical and procedure examination and Morse test of 12 wpm to be held before the issue of the Intermediate licence. A test of 15 wpm, more advanced procedure examination and at least six months holding of the Intermediate licence to be required for obtaining a Full licence.

(2) The Intermediate licence to be for telegraphy only and with a power not exceeding 15 watts on the 1.7, 3.5, 7, 14 and 56-Mc/s bands.

(3) The Full licence to include 28 Mc/s and 112 Mc/s, a power of 50 watts with higher power only in special cases and the use of telephony on 1.7, and 3.5 Mc/s and 14,100-14,250 kc/s and on all bands above this.

(4) The system of Post Office inspectors to be regularised so that at a minimum there should be one visit a year.

In conclusion, it is suggested that, as soon as possible after the cessation of hostilities, a committee, including some pre-war active amateurs, should be set up and should be given full powers to advise the G.P.O. Such a committee might come to occupy a permanent place in the amateur sphere and could do much to prevent those abuses already mentioned. This would be in accordance with the British idea of a New Order; we all know only too well what Hitler would like to do to us and we have not forgotten the disappearance of first the Austrian and then Czechoslovakian amateur transmitters

Correspondence

High-quality German Recordings—and an Opportunity

AS I had the pleasure of originating the correspondence on high-quality commercial recordings (*The Wireless World*, February 17th, 1938) may I offer a few comments on the present revival of interest in the topic?

At the risk of being suspected as a fifth columnist I suggest that the criterion for high-quality recording is the German Telefunken series, formerly available in this country. For consistently smooth recording with apparent auditory perspective, especially in orchestral recordings (*e.g.*, Telefunken E.2686, an Overture by Auber, Berlin Philharmonic Orchestra), I have found none superior. The use of adequate reverberation contributes largely to the natural "atmosphere" of these recordings. I am glad to be able to say that a number of English records (*e.g.*, Columbia LX.880, Rhapsody "España," by Chabrier, London Philharmonic Orchestra) equals the best Telefunken, but they have to be carefully selected. In my opinion, the order in technical quality for the major record-producing countries of the world is (1) German, (2) English and (3) American.

At one time the Germans were leading the world in such fields as the manufacture of glass for lenses, certain branches of chemical science, and in night photography, but now British technology has supplanted them.

Can't we do likewise with gramophone recording?

In this connection it is pertinent to quote a few lines from a recently published statement of Mr. W. S. Purser, Technical Recording Manager, E.M.I., who said, "... the technical side of recording is not standing still; on the contrary, the research, development and trial of new ideas and improvements are continually going on, and have never been relaxed even to-day. The improvements which are wanted in recording are well known and appreciated by the technical staff, while the commercial and other limitations to their achievement, although known also, are no deterrent to our research. One of the limitations, of course, is the price at which a reproducing instrument can be sold." Mr. Purser also mentioned that "no reproducing machine has yet been made which gives all there is on the record."

Lastly, I add my quota of records of outstanding quality:

"Horn Concerto" (Mozart); B.B.C. Symphony Orchestra. H.M.V. DB3973-4.

"Capriccio Italien" (Tchaikovsky); B.B.C. Symphony Orchestra. H.M.V. DB3956-7.

"Swan of Tuonela" (Sibelius); Stokowski and Philadelphia Orchestra. H.M.V. DR997.

"Largo al Factotum" (Rossini); Lawrence Tibbett (baritone). H.M.V. DB1478.

"Lost Chord" (Sullivan); Webster Booth (tenor). Organ accompaniment. H.M.V. C3130.

Guitar Solos by Vincente Gomez. Brunswick 02820.

"Zigeunerweisen" (Sarasate); Ida Haendel (Violin). Decca K940.

Tango tunes. Mantovani's Orchestra. Decca F7571.

DONALD W. ALDOUS.
Torquay, Devon.

The Wireless Industry

STANDARD TELEPHONES AND CABLES, LTD., announce the temporary withdrawal of the Brimar 25Z6G rectifier valve. To facilitate replacements in AC/DC receivers using this valve a new type 25Z4G has been introduced. The latter is a single diode rectifier, and to ensure that it will function satisfactorily in receivers with parallel anode resistors, pins 3 and 5 in the octal base have been connected internally.

A revised price list has just been issued by Taylor Electrical Instruments, Ltd., 419/422, Montrose Avenue, Slough, Bucks. The increases take effect from January 1st, 1941.

W. Edwards and Co., Southwell Road, Loughborough Junction, London, S.E.5, have just introduced a modified McLeod vacuum gauge to take the place of inexpensive imported types. The new gauge, which will be known as the "Vacustat," covers the range from 10 to 0.01 mm/Hg.

Baird Colour Television

DEVELOPMENT PROCEEDS IN SPITE OF WAR

AT his laboratories in Sydenham, Mr. Baird demonstrated on December 20th, 1940, his latest contribution to the television art. He used a large-screen receiver of a type suitable for the home, capable of providing a super high-definition picture in full natural colours as well as reproducing the pre-war standard television transmission as radiated by the B.B.C. In addition to these features, the outfit also functions as an all-wave radio receiver and an automatic record-changing radiogram, all the apparatus being housed in one cabinet. Each portion of the four-in-one receiver is switched into operation by means of a push-button control.

Explaining to a *Wireless World* representative his reasons for continuing development work, Mr. Baird expressed the view that the television industry ought to be in a position to absorb thousands of workers at the end of the war. This would do much to tide us over the critical period that would coincide with the cessation of hostilities. A practical television service was first achieved in Britain, and, continued Mr. Baird, it is in the

national interest that this leadership should be maintained. We must not come back to television only to find, like Rip van Winkle, a world that has advanced beyond our ken.

Mr. Baird's first demonstration of television in colour was in 1928 before the British Association. This was followed, after ten years of successes and setbacks, by an 8-foot by 12-foot colour television picture being shown at the Dominion Theatre, London, to an audience of 3,000 people. The transmission was by means of wireless over a distance of eight miles, from the Crystal Palace studio. Both of the above-mentioned results were achieved with the use of all-mechanical methods of scanning at both the transmitting and receiving ends of the links employed. In 1939 a demonstration was given of a 120-line colour picture, using the same type of scanner at the transmitter as that employed at the Dominion Theatre, but making use, at the receiving end, of a cathode-ray tube in conjunction with a rotating colour filter disc. This was the forerunner of the present receiver.

Before describing the transmitter and receiver which were used in the



View of the cathode-ray flying spot scanner, with a lay figure in position for scanning.

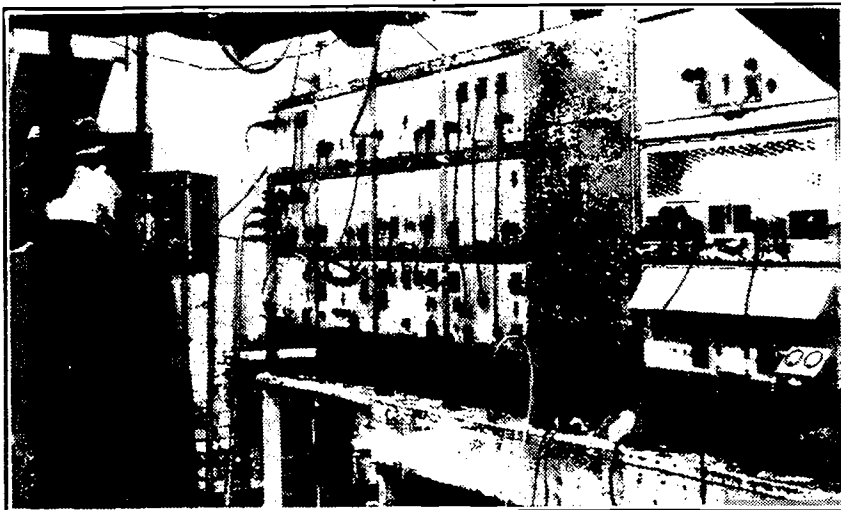

The transmitter control and power rack. At the centre can be seen the screen of the monitor receiver, upon which the engineer may observe a full colour picture.

demonstration, a short account will be given, for the benefit of readers not familiar with the three-colour process, of the principle governing the reproduction of natural colour prints. All colours are produced by mixing the three primary colours, red, green and blue, in the correct proportions. Blue and red mixed results in purple, red plus green gives us yellow, and so forth throughout the whole range of colours. In colour printing this principle is used in the following manner: three pictures are made of the coloured subject, one showing the red component of the subject, one the green component and the other the blue. Upon these three prints being superimposed, a print is obtained which has in its composi-

Baird Colour Television —

tion the complete colour range of the subject, so providing a reproduction in natural colours.

Mr. Baird makes use of this principle by providing colour filters to his transmitter and receiver scanners, but uses only two colours, red and blue-green, since he has discovered that this combination gives,

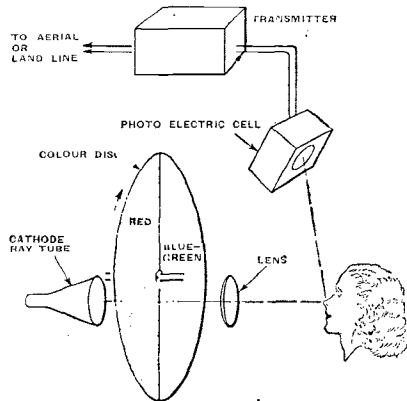

Fig. 1.—Simplified diagram showing the layout of the transmitting scanning system.

with the type of photo-electric cell used, the same results as would be obtained with the three separate filters. This results in a considerable simplification of the scanning mechanism.

Mr. Baird's original system of flying-spot scanning is employed.* That is to say, the subject is scanned by a moving spot of light which, in the case of colour television, is projected through a disc fitted with the blue-green and red colour filters so that the scene or person being televised is scanned by blue-green and red spots in rapid succession. The standard of scanning with this system is 600 lines per picture, which it should be noted is 50 per cent. greater than the B.B.C. standard.

In the flying spot system of scanning, the moving light spot is not obtained by mechanical means such as scanning discs or mirror drums as in the past, but from the exceedingly bright spot that may be obtained on the screen of a projection cathode-ray tube. The tube used is of the "teapot" type, so named by reason

* See *The Wireless World*, August 17th, 1939.

of its shape, operating at a voltage in the region of thirty thousand. The spot is moved in the required scanning motion over the screen by magnetic deflector coils operated from circuits normally associated with such high-voltage tubes. Mounted in front of the tube and driven by a motor is the disc upon which are mounted the colour filters mentioned before. In front of the disc is a lens system which serves to transmit the scanning spot, after it has passed through the filter, to the subject or scene being televised, which is therefore scanned first by a blue-green and then by a red spot, the filter disc being run at the correct speed to allow full coverage for each filter colour. The light from the coloured spots covering the scene is reflected on to three large colour sensitive photoelectric cells, the current from these being amplified and passed to radio or line circuits for transmission to the receiver. In the photograph can be seen the scanning lens in the centre and one of the photoelectric cells. Fig. 1 shows in simplified diagrammatic form the layout of

the scanning elements of the transmitter. Another photograph gives a view of the transmitter control and power racks, with a small monitor receiver at the centre, upon which a full colour picture is obtained. This is of use to the engineer for control purposes, and also as a guide to a person being televised, for by a glance at the monitor, he is able to maintain his correct position.

It should be pointed out that the apparatus, although it is, through restrictions of space, at the present moment set up for televising only one or two people at a time, may be readily adapted for large scenes.

All external features of the receiver may be observed in the third photograph. The screen, the largest yet produced in a home receiver, is 2ft. 6in. by 2ft.

The method of reproducing the picture in colour follows the principles of colour printing already explained. The transmitted pictures corresponding to the colours described are superimposed to form the complete television picture in natural colours. The manner in

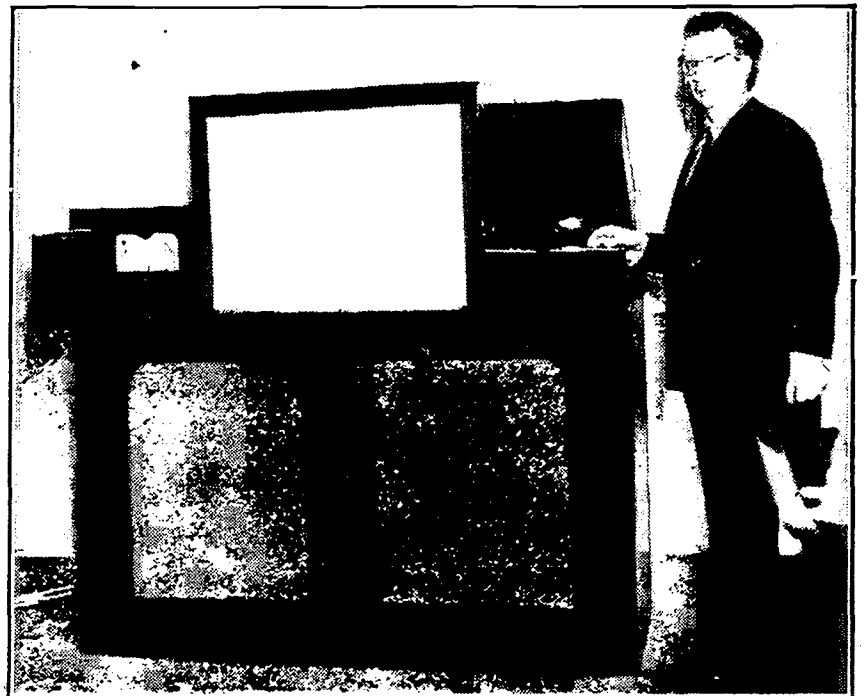

A view of the receiver, with Mr. Baird standing at the side. To the left of the screen will be seen the all-wave radio receiver, while to the right is the automatic record-changing radiogram. The four control knobs of the television receiver are to the left and right of the central upright upon which are mounted the four push buttons which switch on the radio receiver, the radiogram, the B.B.C. standard television reception circuit, or the Baird natural colour 600-line circuit.

Baird Colour Television—

which this is carried out is the converse of the scanning system at the transmitter, the picture being first produced in black and white on the screen of the cathode-ray tube, in front of which is rotated a filter disc identical with that at the transmitter. By means of impulses transmitted with the picture signal, the disc is kept absolutely in step with its counterpart at the transmitter.

The black and white pictures passing through the filters are coloured blue-green and red and then

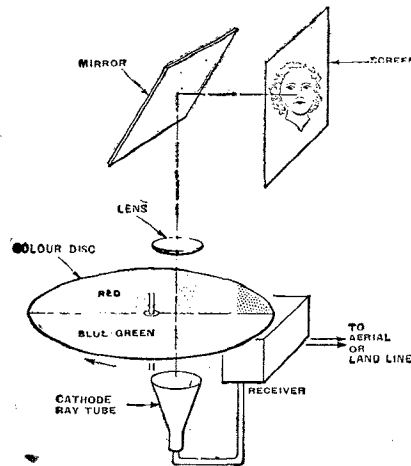

Fig. 2.—A simplified diagrammatic explanation of how the black-and-white picture on the cathode ray tube is converted into a coloured reproduction on the screen.

projected on the screen by means of an efficient optical system, at such speed that the eye sees them there together. The result of this is the same as that achieved in colour printing, namely, they blend to form a picture in natural colours. The projection cathode-ray tube in the receiver is situated at the bottom, throwing the picture upwards on to a mirror and thence to the ground glass screen. The only controls consist of the four knobs under the screen, not counting the push-button switches. For producing a black and white picture the filter disc is simply not used. This, together with the change in scanning circuit necessary to receive the different standard of transmission, is controlled by the one push-button.

The demonstration can only be described as a very considerable

success. The colour picture was of more than adequate brilliance, being also both pleasing and restful to watch. The various tone values were produced with a degree of truth comparable with the "Technicolour" films which we are now used to seeing at the cinema. A notable point in connection with viewing the colour picture is an apparent stereoscopic effect which makes the picture stand out to a

remarkable degree. This effect was quite apparent when still pictures were used as the subject, but became even more so when their place was taken by a girl with red hair, the tones and sheen of which were reproduced perfectly.

Mr. Baird is now working on a receiver of small cost, which will give a picture in full colours on a normal home-receiver tube, and be within the reach of the average pocket.

Motor Car Ignition Interference

RESULTS OF FIELD STRENGTH MEASUREMENTS AT HIGH FREQUENCIES

THE development of the ultra-short wavelengths for television and other services has given prominence to the interference produced by motor car ignition systems. One of the first essentials for a successful attack on this problem at the receiving end is a knowledge of the nature and magnitude of the energy radiated.

To this end observations have been made in America¹ to determine the average field strength, polarisation and frequency of the interference from traffic on a standard two-lane highway near Riverhead, Long Island.

The dipole receiving aerial was erected 100ft. from the road at a height of 35ft., and was connected to a double superheterodyne with IF amplifiers operating at 40 and 4.1 Mc/s. The latter was equipped with a relatively strong beat frequency oscillator, and the audio output was passed through a 5 kc/s low pass filter in order to limit the band width (10 kc/s) associated with the peak measurements. The peak indicator circuits consisted of a resistance-capacity time circuit in which the charging time was 15 micro-seconds to over 90 per cent. of the peak voltage of the impulse, and the decay time was 1 second, sufficient to take a reading on a damped meter.

The results of observations of general traffic on 40, 60, 100, 140, 180, 240 and 450 Mc/s are shown in the accompanying curves. There is no very great difference between the horizontal and vertical polarisation, and there is little doubt that the polarisation can be of all kinds.

The radiation from the ignition

system is modified by the body of the car, and may vary between cars of identical design. The strength of the radiation at 450 Mc/s is understandable when it is realised that the ignition leads and parts of the car which act as radiators are more comparable with the short wavelengths, and their efficiency compensates for any falling off in the power generated at the higher frequencies. Also, the propagation conditions are improved,

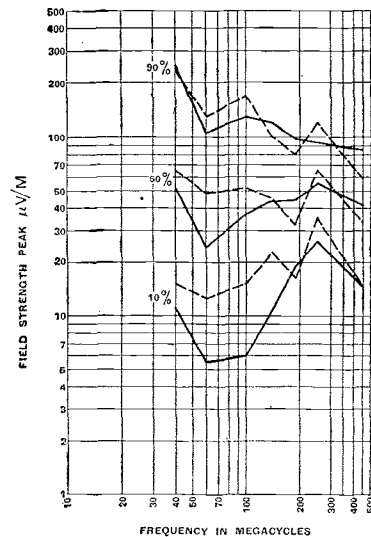

Peak field strength of motor car ignition radiation, with an aerial 35 ft. high and 100 ft. from the road. The dotted curves are for vertical and the full-line for horizontal polarisation. Ninety, fifty and ten per cent. of all cars and lorries produced less than the field strength indicated by the curves.

except at short distances, due to the increased phase difference between the direct and ground-reflected waves at a given point.

¹ "Field Strength of Motor Car Ignition Between 40 and 450 Mc/s," by R. W. George, *Proc. I.R.E.*, September, 1940.

Current Topics

RECENT EVENTS IN THE WORLD OF WIRELESS

BROADCASTING STATIONS OF THE WORLD

Some Interesting Facts

DETAILS have recently been published by the Union Internationale de Radiodiffusion of the number of long-, medium-, and short-wave stations of the world, and the total power output of each country and continent at the end of 1939.

The total number of stations for the world is 2,509, which have an aggregate power of 19,623 kW. The average power is therefore 7.8 kW.

We tabulate below the total number of stations operating in each continent, and the aggregate power. The average power per station is also given.

	Stations	Power (kW) Aggregate	Average
Africa	63	249	2.95
Central America... ..	195	243	1.24
North	1,058	4,732	4.44
South	396	1,382	3.50
Asia (excluding U.S.S.R.)	170	861	5.05
Europe (including U.S.S.R.)	463	11,751	25.40
Oceania	164	406	2.48

In 1926, when the Geneva Plan was brought into operation, there were 123 stations in Europe with an aggregate power of 116 kW, which corresponds roughly to an average of 1 kW per station. In the fourteen years which have elapsed, the number of transmitters has increased to 463, which is barely four-fold, whereas

the aggregate power, which is now 11,751 kW, is a hundred-fold increase. The average power is now approximately 25 kW as compared with 1 kW.

The number of transmitters in the United States is 839, which is approximately the same as in 1926. The number had, however, exceeded 1,100 a year or two before. The average power in 1926 was very low, for the total power of America's 800-odd stations was roughly the same as that of Europe's 123 stations. The average power of the United States transmitters is now 4.45 kW, compared with Europe's 25.4 kW.

A tremendous increase in the aggregate power of the world's transmitters is noticeable in the past 14 years. In the United States it is in the ratio of 37 to 1, and in Europe, where approximately 60 per cent. of the world's total power output is concentrated, it is 100 to 1.

It is very noticeable from the figures given by the U.I.R. that in countries where broadcasting is State-controlled, and where a system of receiving licences is in force, the number of transmitters is relatively small, but their individual power is very high.

NEW YEAR HONOURS

Scientific Services Rewarded

THE New Year Honours list contained a number of names well known in the world of wireless.

Dr. E. V. Appleton, LL.D., F.R.S., who is Secretary to the Committee of the Privy Council for Scientific and Industrial Research, and was recently appointed to the Government's Scientific Advisory Committee, has been created a Knight Commander of the Order of the Bath (K.C.B.).

Mr R. A. Watson Watt, who was until 1936 Superintendent of the Radio Department of the National Physical Laboratory and is at present Scientific Adviser on Telecommunications at the Ministry of Aircraft Production, is made a Companion of the Order of the Bath (C.B.).

The India Office list includes the name of Mr. Lionel Fielden, who was the first Controller of Broadcasting, Government of India. He has been made a Companion of the Order of

the Indian Empire (C.I.E.). In 1940 he relinquished his post in India, and has since taken charge of the B.B.C.'s programmes destined for Indian listeners.

R.S.G.B. RECORD YEAR

IN spite of prevailing conditions, the report of the Honorary Treasurer of the Radio Society of Great Britain shows that the year's income exceeded expenditure by £345—a record in the Society's history. This very satisfactory state of affairs is attributed, first, to the effectiveness of the economies introduced at the outbreak of war, and, secondly, to the splendid support given by members to the appeal to carry on the work of the Society.

The report was presented at the annual general meeting, following which Mr. A. D. Gay delivered his presidential address.

R.A.F. OPPORTUNITIES

Need for Signals Officers

VACANCIES still exist in the Royal Air Force for technical officers for signals duties. Commissions in the R.A.F.V.R. will be granted for the duration of hostilities to suitable applicants between the ages of 21 and 50 years.

Applications are invited from holders of electrical engineering or science degrees with experience of wireless, and from holders of technical college or approved institution diplomas with two years' experience in telecommunications engineering (preferably on the radio side).

A number of posts is also available for candidates possessing a sound theoretical knowledge of elementary electricity and magnetism, of the principles of wireless telegraphy and telephony, and of transmitting and receiving circuits and HF measuring apparatus. Some practical experience is also desirable.

Candidates should apply at once in writing to the Air Ministry S.7 (e) 1, Adastral House, Kingsway, W.C.2, giving full particulars of their qualifications, training and experience. Those who are engaged on important National Work should not submit applications without first consulting their employers as to the possibility of their being spared for R.A.F. duty.

Candidates who have previously applied are requested not to renew their applications.

BROADCASTING HOUSE

IN last month's Editorial, tribute was paid to the B.B.C., which had maintained its service, sometimes under "front-line" conditions, throughout the year. The recent announcement officially making known that Broadcasting House has twice been hit during air raids and seriously damaged shows that the commendation was more than justified. On both occasions the attacks were made during peak hours, but the transmissions in the Home, Forces, European and Overseas services were continued without interruption.

It was learned with regret that a number of the B.B.C. staff were killed and others wounded, most of the casualties being among members of the monitoring staff.

Wireless World

SHORT WAVES

THE Rangoon firm of Misquith, Ltd., writing on the subject of broadcast receivers for the Burmese market, suggests that the most suitable set would cover, in addition to the normal short wavebands, wavelengths of 60-62 and 86 metres, on which the local Rangoon station and the Indian stations are operating. Long and medium waves are not required.

AC is available in the larger towns of Burma, but there is scope for AC/DC models, also for battery-operated receivers up-country and in the jungle.

B.B.C. SHORT-WAVE NEWS

ALTHOUGH there are few changes in the schedule of news bulletins broadcast in the B.B.C.'s short-wave European service, we give below the details for the convenience of readers.

The call signs and frequencies to be used during this month are:—

GSA, 6.050 Mc/s (49.59 m); GSB, 9.510 Mc/s (31.55 m); GRX, 9.690 Mc/s (30.96 m); GSN, 11.820 Mc/s (25.38 m); GSE, 11.860 Mc/s (25.29 m); and GSO, 15.180 Mc/s (19.76 m).

The times (B.S.T.) of the transmission of news and the calls used are:—

0030 GSA
0900 GSA
1245 GSA, GSN, GSE
1415 GSA, GSN, GSE, GSO
1700 GSA, GSN, GSE
2345 GSA, GSB, GRX

CANADIAN NEWS

THE Canadian Broadcasting Corporation's new 7.5-kW short-wave station, recently completed at Vercheres, Quebec, at a cost of approximately £15,000, is intended to serve the French-speaking communities in remote areas of the Quebec Province which are outside the service area of the existing network of medium-wave stations. This station is not intended, as had previously been stated, as an international station.

Licence fees provided \$2,906,605 of the C.B.C.'s total income of \$3,752,061 for 1939-40. Commercial broadcasting accounted for \$700,867.

FROM ALL QUARTERS

Fault Finders' Reserved Age

SINCE January 8th the reservation age from service in their trade capacity for fault finders and testers in wireless engineering has been raised from 30 to 35.

Subtle Propaganda

THE ends to which Nazi agents have gone to sway American public opinion is revealed by the publication of the Report by the Dies Committee. It discloses that desperate efforts were made to enlist the services of commentators on the networks and that steps were taken to colour and control broadcast news through the German-owned Transocean news service.

O.B.E. for W/O

IN recognition of his devotion to duty when his ship was attacked by an armed raider, Mr. George W. Hackston, wireless operator of s.s. *Harby*, has been appointed an Officer of the Order of the British Empire (O.B.E.). He sent out the position of the vessel and remained at his post in the wireless room throughout the attack until it was set on fire.

Standard Frequency Station Burned

A TEMPORARY 1-kW transmitter is being used by the National Bureau of Standards following the destruction of its standard frequency station WWV at Washington in November. The station transmits a frequency of 5,000 kc/s from 10.0 a.m. to midnight daily except Sunday. The temporary service is CW with announcements in morse.

N.B.C.'s European Manager

MR. FRED BATE, the European manager of the National Broadcasting Company of America, was recently injured when the N.B.C.'s temporary offices close to Broadcasting House, London, were damaged. He had sufficiently recovered from his injuries to sail for the States on January 8th on leave.

French Stations

IT is learned from the U.I.R. that consequent upon the reorganisation of the French broadcasting system the names of the stations have been altered. The name of the town will in future be suffixed by "National" instead of "P.T.T.", etc.—i.e., Lyon-National, Toulouse-National, etc., instead of Lyon P.T.T. and Toulouse-Pyrénées.

Brit. I.R.E. North Western Section

IN accordance with a resolution of the Council of the British Institution of Radio Engineers, a meeting was recently arranged in Manchester for the purpose of forming a North Western Section of the Institution. At this meeting it was proposed to call an inaugural meeting in March.

American Amateurs

SEVEN members of the American Radio Relay League have been appointed to the Amateur Radio Committee of the U.S. Defence Communications Board. The committee is to consider all questions relating to amateur radio and its place in the national defence programme.

British Insulated Cables

COLONEL J. TENNANT, D.S.O., D.L., M.I.Mech.E., retired from his position of works manager of the Prescott works of British Insulated Cables, Ltd., on December 31st. Mr. D. W. Aldridge has been appointed in his place.

Scott Receivers

AT the annual general meeting of E. H. Scott Radio Laboratories it was stated that, through restrictions in the supply of materials, present and future production of receivers must be greatly curtailed. A large percentage of the existing stock of component parts must

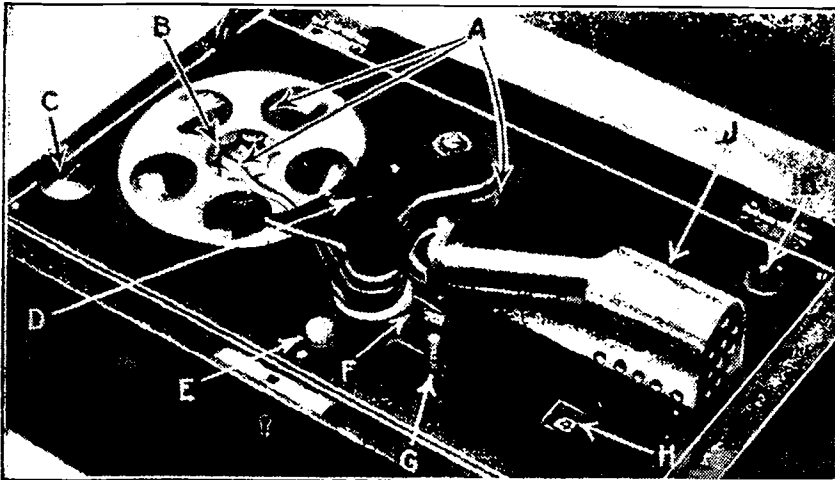

A NEW FILM-GRAMOPHONE, designed by Mr. E. J. Wender, of the Electro-Physical Laboratories, London. Ninety minutes' playing from four sound-tracks on one film is possible with this instrument, which is contained in a box 14in. by 9in. by 7in. Novel features are the endless strip film, i.e., the film feeds from its centre and rewinds round the periphery of the spool simultaneously, thus obviating rewinding after reproduction; also the use of separate small barrier-layer type photo-cells, made by E.P.L., for each track. The change-over of tracks is therefore entirely electrical and no change in position of either film or cells is necessary. Key: A, film (travels anti-clockwise); B, locating pins; C, light intensity control resistance; D, track aligning screw; E, F, automatic track changer and push-button control; G, lever to open gate for threading film; H, automatic track number indicator; J, lamp housing; K, mains switch.

Wireless World

Current Topics—

be reserved for replacement purposes. If frequency modulation comes after the war, the company will be able to embark at once on the manufacture of suitable receivers and adaptor units.

New M.W.T. Chairman

ADMIRAL H. W. GRANT, who is a director of Cable and Wireless, has been appointed chairman and managing director of Marconi's Wireless Telegraph Company.

Wireless for the Blind

IN response to Mr. Ernest Bevin's Christmas Day broadcast appeal more than £8,320 has been given by some 18,000 donors to the British Wireless for the Blind Fund.

NEWS IN ENGLISH FROM ABROAD

REGULAR SHORT-WAVE TRANSMISSIONS

Country : Station	Mc/s	Metres	Daily Bulletins (B.S.T.)	Country : Station	Mc/s	Metres	Daily Bulletins (B.S.T.)
America				Manchukuo			
WNBI (Bound Brook)	17.780	16.87	4.0‡, 6.0.	MTCY (Hsinking)	11.775	25.48	8.0 a.m., 10.5.
WCAB (Philadelphia)	6.060	49.50	} 12.45 a.m.‡, 1.0 a.m.†.	Nova Scotia			
WCAB	9.590	31.28		CHNX (Halifax) 6.130 48.94 10.45.			
WBOS (Millis)	9.570	31.35	11.45.	Newfoundland			
WCBX (Wayne)	11.830	25.36	8.30†.	VONG (St. John's)	5.970	50.25	11.15.
WCBX	17.830	16.83	2.0, 3.0†, 4.0†, 4.15§‡, 5.0*†.	Rumania			
WGEO (Schenectady)	9.530	31.48	7.0.	Bucharest	9.280	32.33	10.40‡.
WGEA (Schenectady)	15.330	19.57	8.30†, 9.55§‡, 11.25‡.	Spain			
WPIT (Pittsburgh)	15.210	19.72	1.0, 2.0‡, 6.0, 7.45, 9.55§‡.	FET1 (Valladolid)	7.070	42.43	8.50.
WRUL (Boston)	11.790	25.45	6.0.	EAJ7 (Madrid)	9.860	30.43	12.30 a.m.
WRUL	15.350	19.55	} 8.15§‡, 9.30 †.	Sweden			
Australia				SBO (Motala)	6.065	49.46	10.20.
VLQ (Sydney)	9.615	31.20	8.0 a.m., 8.0.	Thailand			
VLQ5	9.680	30.99	1.30, 4.30, 10.30.	HSP6 (Bangkok)	11.715	25.61	2.45.
VLQ2	11.870	25.27	6.0.	Turkey			
VLQ7	11.880	25.25	8.0 a.m., 3.0, 8.0, 11.0.	TAP (Ankara)	9.465	31.70	7.15.
VLQ8	17.800	16.85	7.0 a.m.	TAQ	15.195	19.74	12.15.
China				U.S.S.R.			
XGOY (Chungking)	11.900	25.21	11.30 a.m., 12.10, 9.30, 10.30.	— (Moscow)	7.545	39.76	10.30, 11.30.
Finland				RW96	9.520	31.51	7.30, 9.0, 10.30, 11.30.
OFD (Lahti)	6.120	49.02	} 8.55 a.m., 7.15, 10.15, 11.15.	RAL	9.600	31.25	1.0 a.m.
OFD	9.500	31.58		—	10.724	29.59	11.30.
OFE	11.730	25.47		—	11.499	26.09	12.0 noon.
OIE	15.190	19.75		—	11.710	25.62	10.30.
Greece				—	11.830	25.36	7.33 a.m., 7.30, 11.30.
Athens	7.075	42.39	11.0	—	12.000	25.00	1.0 a.m., 9.0†, 10.30.
Hungary				RNE	14.720	20.38	12.0 noon, 5.0.
HAT4 (Budapest)	9.125	32.88	1.30 a.m.	—	15.040	19.95	1.0 a.m.
India				RKI	15.180	19.76	1.0 a.m., 7.33 a.m., 9.0, 10.30.
VUD2/3 (Delhi)	9.590	31.28	9.0 a.m., 1.30, 4.50.	—	15.715	19.09	12.0 noon.
VUD4	11.830	25.36	9.0 a.m., 1.30, 4.50, 6.15.	—	18.540	16.18	12.0 noon.
VUD3	15.290	19.62	9.0 a.m.	Vatican City			
Iran				HVJ	6.190	48.47	8.15.
EQB (Teheran)	6.155	48.74	7.30.	Yugoslavia			
Japan				YUA (Belgrade)	6.100	49.18	10.25.
JZJ (Tokio)	11.800	25.42	9.5.				
JZK	15.160	19.79	9.5.				

It should be noted that at this time of the year changes of wavelength are frequently made and readers are, therefore, advised to try alternative wavelengths. The times of the transmission of news in English in the B.B.C. Short-wave European Service are given on page 47.

REGULAR LONG- AND MEDIUM-WAVE TRANSMISSIONS

Country : Station	kc/s	Metres	Daily Bulletins (B.S.T.)	Country : Station	kc/s	Metres	Daily Bulletins (B.S.T.)
Bulgaria				Rumania			
Soha	850	352.9	9.55 (Th. and Sat.).	Radio-Romania	160	1,875	10.40‡.
Hungary				Bucharest	823	364.5	10.40‡.
Budapest	546	549.5	11.10.	Spain			
Ireland				Radio-Coruna	968	309.9	1.10 a.m.
Radio-Eireann	565	531	6.45‡, 10.5†, 10.10‡.	Sweden			
Latvia				Motala	216	1,389	} 10.20.
Madona	583	514.6	10.0 (Tu. and Fri.).	Stockholm	704	426.1	
Kuldiga	1,104	271.7	10.0 (Tu. and Fri.).	Goteborg	941	318.8	
				Falun	1,086	276.2	
				U.S.S.R.			
				Moscow I	172	1,744	11.30.

All times are p.m. unless otherwise stated. * Saturdays only. § Saturdays excepted. † Sundays only. ‡ Sundays excepted.

Short-Wave Portable

LIGHTWEIGHT HEADPHONE SET FOR PRESENT CONDITIONS

By W. H. CAZALY

Most of the lightweight portable sets produced for wartime conditions have been designed to cover the medium broadcast band. Here is a simple set for short waves only. It will operate with a short extemporised aerial.

THE receiver to be described can be contained, together with a 45-V HT battery, a 3-V dry cell LT battery, a couple of plug-in coils and a pair of headphones, in a fibre case of the kind used to carry civilian respirators. From 4 to 14 Mc/s (about 21 to 75 metres) can be covered with suitably wound coils. Consumption is at the rate of about 4mA for HT and 0.1A for LT.

Construction is particularly easy, as the components are mounted on a piece of stout tin-plate which fits in the top of the fibre case and is held by angle brackets bolted to the sides. Care should be taken to leave as

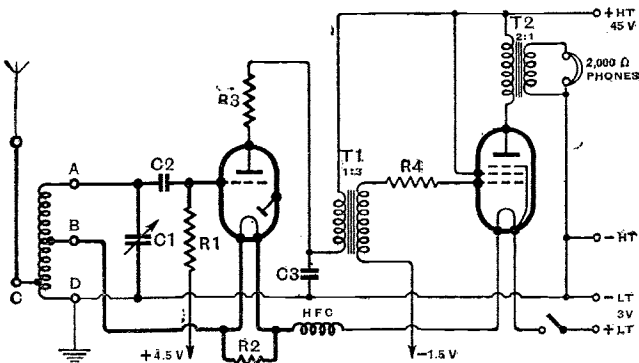

Fig. 1.—Complete circuit diagram; components and wiring shown in heavy lines should be well isolated. Values of components: C1, C2, 0.0001 μ F; C3, 0.0005 μ F; R1, 2-3 M Ω ; R2, 28 Ω ; R3, 10,000 Ω ; R4, 0.25 M Ω .

much clear space as possible round those parts of the circuit (see Fig. 1) drawn in thick lines; for this reason it is not advisable to enclose the whole receiver in a metal container. The filament choke consists of a glass tube 2in. long by $\frac{1}{2}$ in. external diameter wound with No. 34 SWG enamelled wire. The 28-ohm resistance in parallel with the 0.05-amp. filament of the triode detector is a tiny home-made job consisting of No. 38 SWG resistance wire (insulated) pile-wound on a $\frac{1}{2}$ in. piece of match stick.

The circuit is obviously a modification of the familiar Hartley reacting detector, followed by a transformer coupled pentode output stage. One unusual feature is the use of quite a large positive bias on the triode grid.

This serves to decrease the AC resistance of the valve sufficiently for it to develop enough power in the reaction circuit to bring about oscillation at the high-frequency end of the band covered. Rectification appears to take place fairly efficiently, though distortion is inevitably present; the only noticeable departure from normality is the increase of the anode current from less than 0.1mA

Fig. 2.—To avoid the use of batteries for grid bias, the additional circuits above can be used. If positive bias for the detector is thus obtained, a double-pole on-off switch must be added as shown inside the dotted lines.

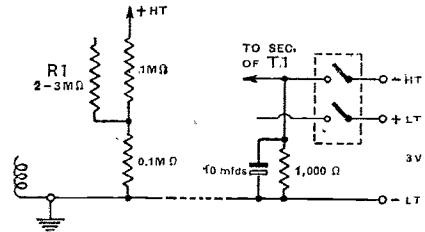

to nearly 1mA. In the circuit diagram of Fig. 1 the bias of both detector and output stages is shown as being obtained from batteries, which need be only very small ones; but it may be obtained in each case by resistance networks, as shown in Fig. 2. Reaction is controlled by the 10,000-ohm variable resistance R3, and this component *must* have low self-capacity.

The circuit as given has been found to operate satisfactorily over the frequency band mentioned with 45V HT.

The frequency of 14 Mc/s is given as the highest handled by this receiver, because above that frequency oscillation is not readily obtained. By taking more than ordinary care about layout and the efficiency of the components involved in the RF portions of the circuit, however, useful reception can be obtained in the 15 Mc/s band and even higher. Stray reactances must be kept down to a minimum; the tuning condenser should be a good SW low-loss type; the valve may be "de-capped" (i.e., have the composition base removed and the elec-

COIL TURNS, SPACED 14 TURNS PER INCH.
1½in. diameter ribbed former, 4-pin.

	Freq. in Mc/s. (approx.)	A-B Turns	B-C Turns	C-D Turns	Wire (SWG)
C	4-5.5 (55-73m)	11	6	6	24
	5.5-9.5 (32-55m)	6	4½	1½	24
	9.5-14 (21-32m)	4	3	1	20

Fig. 3.—Coil winding data, subject to alteration through such varying factors as stray capacities, component losses, etc. Average stray capacities acting in parallel with C1 will be about 50 μ F.

trode leads soldered directly in circuit); the grid may stand a little more positive bias; the optimum taps on the coil for filament and aerial may be found by experi-

Short-wave Portable—

ment. By close attention to such details, oscillation can be obtained at higher frequencies with a coil having, say, only 7 or 6 turns altogether.

The output transformer *can* be dispensed with. Owing to the serious mis-matching of the output pentode with its high AC resistance to even the best of phones, however, a considerable loss of power must be expected. If used without a transformer, the headphones should be of the high-impedance type; 4,000 ohms is preferable to the more usual and less expensive 2,000-ohm type. An almost ideal arrangement would be a choke-capacity

output coupling feeding a pair of piezo-electric ear-pieces; but these are very expensive and difficult to obtain nowadays. For an output transformer the author made successful use of a small 1:6 ratio intervalve AF transformer, connecting it "the wrong way round," i.e., with the secondary in the anode circuit and the primary feeding the phones. Similar types of conveniently small size are listed in the catalogues of such firms as Bulgin and Premier. The "midget" type of transformer is not to be recommended, as the core is usually of high-permeability alloy, and performance is very seriously affected by passing DC through the windings.

Short-wave Receiving Conditions

PROSPECTS FOR FEBRUARY

(COMMUNICATED BY THE ENGINEERING DEPARTMENT OF CABLE AND WIRELESS, LTD.)

THERE were no prolonged periods of "peak" conditions during December, short-wave reception being frequently subnormal, particularly on the 2nd, 20th to 23rd (inclusive) and 28th to 31st (inclusive) when ionosphere storm effects were reported.

The average Disturbance Factor (on a zero=negligible, and 9=extremely great, basis) was for the period 12th to 31st (inclusive) approximately 33 per cent. in excess of that for the first eleven days of the month. In connection with the above in the December issue of this journal, published on November 20th (see page 484) a reference was made to the probability in December of relatively disturbed conditions during the middle and latter part of that month.

There was no definite evidence of any sudden disturbance of the "Dellinger" type during December. Reception was seldom impaired by atmospherics; the general level of which was, however, appreciably above normal during the afternoon of the 10th, when thunderstorms were reported in certain parts of the country.

In high northerly latitudes such storms, whilst of much less frequent occurrence in winter than in summer, are not uncommon in North-West Europe.

Particulars of the broadcast bands which, it is considered, should prove most reliable during February under normal conditions of propagation at the times stated for five selected routes are given below; these may serve as a guide when considering the possibilities of reception from places not too remote from those specified.

Attention is drawn to the fact that a number of factors, for example (a) transmitter power, (b) efficiency of aeri-als at both the transmitting and receiving end, and (c) ionosphere abnormalities, may often result in better reception being obtained on wavebands other than those quoted. (The times given in this report are GMT.)

Montreal: Midt, 31, 41 or 49 m; 0300, 41 or 49 m; 0600, 49 m; 0900, 25 or 31 m; 1100, 19 or 25 m; 1400, 16 or 19 m; 1800, 19 or 25 m; 2100, 25 or 31 m.

Difficulties may be experienced on occasions between 0700 and 1000 and at other times should ionospheric conditions be disturbed. "Echo" signals are not unusual at this season during the period from 1300 to 1600.

Buenos Aires: Midt, 31 or 41 m; 0300, 31, 41 or 49 m; 0600, 41 or 49 m; 0900, 19 or 25 m; 1200, 16 m; 1500, 13 or 16 m; 1800, 16 or 19 m; 2100, 25 or 31 m.

Reception may prove to be difficult for a period of one or two hours centred on 0830 and 1930; with the approach of the Vernal Equinox the duration of the former will tend to increase and that of the latter to decrease.

Nairobi: Midt, 31 or 41 m; 0300, 41 or 49 m; 0700, 25 or 31 m; 0900, 16 or 19 m; 1100, 16 m; 1400, 16 or 19 m; 1800, 19 or 25 m; 2100, 25 or 31 m.

Apart from the period from 0400 to 0700, when fading may be present, reception should be possible throughout the twenty-four hours.

Cairo: Midt, 41 or 49 m; 0300, 49 m; 0600, 25 or 31 m; 0900, 19 or 25 m; 1200, 19 m; 1500, 19 or 25 m; 1800, 25 or 31 m; 2100, 31 or 41 m.

In general, no difficulty should be encountered on this route except possibly between 0330 and 0600.

Tokio: 0700, 19 or 25 m; 0900, 16 or 19 m; 1100, 19 or 25 m; 1300, 25 or 31 m; 1800, 31 or 41 m; 2300, 41 or 49 m.

Short wave reception over this route is expected to be extremely unreliable during the period midt.-0600.

At the time of writing this report the trend of conditions suggests that the average disturbance factor for the period February 12th to 23rd (inclusive) may prove to be higher than that for the remaining days of the month.

1940-1941 Amplifier Handbook and Public Address Guide.

By Moe Asch. Pp. 80. Radcraft Publications, Inc., 20, Vesey Street, New York City, U.S.A. Price (in U.S.A.) 25 cents.

TO provide practical everyday information for the sound specialist is the object of this publication, states the author in his foreword. For this reason explanation of fundamentals and the theory of circuit applications have been reduced to a minimum and, bearing this in mind, it can be said that this is an interesting and useful book.

The five sections of the book are as follows: (1) Source (all types of microphone and pick-up); (2) Amplifiers (voltage amplification, power stage, power supplies and design considerations); (3) Distribution (loudspeakers, speaker baffles and housings); (4) Co-ordination (input impedance matching, phasing speakers, etc.); and (5) Public Address Data and Information (the A.B.C. of db., VU, Mu, Gm and Sm, and db. data, etc.).

Loudspeaker matching technique is clearly and fully expounded. Inverse feedback and tone compensation are briefly covered and an explanation of the Volume Unit (VU), a new standard of reference level, which is a steady state of 1 milliwatt across a 600-ohm line, recently introduced by the Bell Telephone Laboratories, is included.

D. W. A.

Spy's Transmitter

IT was recently disclosed that three enemy agents, convicted of spying, had been executed in London. Among other things found in their possession was a complete portable short-wave transmitter, and *The Wireless World* has been given facilities by the authorities to prepare a detailed description of the apparatus.

Some mild disappointment will be felt that the transmitter is not of especial technical interest, either mechanically or with regard to its circuit arrangement. The circuit is, indeed, except for the use of a quartz crystal and a pentode valve, almost exactly the same as that used by a member of the staff of this journal in 1924, when everything to do with the short waves was brand new, and we were all eager to get some first-hand experience of their behaviour. In the matter of mechanical layout the set seems distinctly unhandy, at any rate if, as the fiction writers would have us believe, the enemy agent is always compelled to work his gear under the most difficult of conditions. A rather more finished job might have been expected from the best German technicians, and one is inclined to wonder whether the

DETAILS OF THE GEAR USED BY ENEMY AGENTS

former owners of the set were, figuratively speaking, free lances, responsible for their own equipment, and merely paid by results.



The transmitter unit, batteries, aerials and accessories are distributed between two leather carrying cases.



comparable power output and wave-range coverage) ranges of several hundred miles were often worked. It

must also be remembered that in those days receivers were much less sensitive.

The complete equipment is contained in two black leather carrying cases with shoulder straps. In the first case, measuring 8½ in. by 7¾ in. by 4 in. and weighing 4 lb., are the transmitter unit, a spare valve, morse key and aerial equipment. The second case, which measures 11 in. by 6 in. by 3¾ in. and weighs 7 lb., contains three 90-volt (nominal) HT batteries and two 4.5-volt dry-cell LT batteries, with their connecting leads. It should be observed that, before the gear can be put into operation, it must be removed from the carrying cases.

A metal box, measuring 5½ in. by 4½ in. by 3 in., houses the transmitter

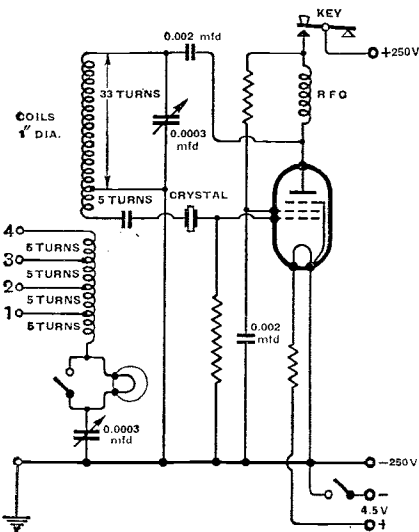

Complete circuit diagram of the transmitter with details of the coils. Taps are provided for aerial circuit adjustment, which is carried out with the help of an indicator lamp.

Spy's Transmitter—

unit, which weighs about 1 lb. On the top panel are mounted an on-off filament switch, sealed plug-in crystal holder, key sockets, two tuning condenser dials, and aerial taps for adjustment. There is also a small lamp, with short-circuiting switch, to act as an indicator of current in the aerial circuit. Connections for the batteries and aerial and earth complete the external attachments. The key is provided with a 4-foot wandering lead.

Two sets of aeriels are provided, and it appears that the usual practice is to use aerial and counterpoise, for which arrangement the circuit is

suitable. One aerial measures 11.6 metres and the other 11.45 metres; each has a lead-in connection 1.62 metres long. Over the frequency range covered by the transmitter these aeriels would work reasonably efficiently as quarter-wave current-fed radiating systems.

When crystal controlled, the set gives a pure CW note. By removing the crystal and short-circuiting the plug sockets, the transmitter may be operated without frequency control. Under these conditions stability is still of a high order, and the note, as heard on a suitable receiver with BFO, is still pure over the useful part of the tuning range.

best of all hobbies? Don't we think over ways of improving the results that we obtained in the past and promise ourselves the joys of putting them to the test when the time comes? Aren't we thinking out the experiments that we'll try once we have the opportunity? We are. And when peace returns we'll get down to it with a will. Meantime, all honour to those, debarred from serving by age or other disability, who are keeping the experimenters' flag flying. They're seeing to it that wireless does not stand still. We've been able to read accounts of some of their good work, and so to keep ourselves abreast of the times. But a vast amount of what has been done can't be revealed till the war is over. And those revelations will provide huge new fields for experimental work.

Random Radiations

By "DIALLIST"

The Radio Missing Link

FOR a long time I've been pressing for ultra-short-wave radio to supplement one short but very vulnerable part of the communications of my particular bit of the war. I think I'll get it pretty soon now, but there have been many obstacles to break down. One brass-hatted bloke told me that he might do the transmitter, but didn't think he could lay his hands on a suitable receiver. I said that I thought that that left no real difficulties. "What about the receiver?" sez 'ee; "you can't do without that. What do you suggest?" "Make it," I made bold to reply. "Make it? Oh, but you couldn't do that. A most expert job." He was astonished to hear that I'd made and designed scores and scores of receivers of all kinds, and that, given a pound or two to spend on parts, I could guarantee results. Eventually it turned out that receivers were available after all, and that there'd be no need for me to return to my pre-war constructional activities. My missing ultra-short-wave link is promised any day now, and you can imagine how happy I'll be to have it

servicing wireless men who have seen anything of the radio equipment of the Services have similar beautiful dreams now. What lovely things there will be to buy for a song when we've straightened out the present complications and returned to normal ways of life once more! Some of you will remember how we revelled in Government surplus after the last war. Wave-meters and other measuring instruments, transmitting and receiving sets—or the parts to make them with—come our way at undreamed-of prices. And the effect of amateur experimental work was just marvellous. Your brilliant man is often hampered by lack of cash to buy the expensive gear that he needs to further his work. One of the few good results of a modern war is that its aftermath may place such things within his grasp. And once he has got them he can forge ahead like the proverbial express train. There is sure to be a similar selling-off of surplus apparatus when this war has come to its end, and I can foresee that its effects will be to produce just such another forward march by amateur experimenters and research devotees as happened in the years following 1918.

Blast and Loudspeakers

IT was interesting to read in a recent issue of *The Wireless World* that the most common form of damage to wireless receivers subjected to the effects of blast was the destruction of the loud-speaker cone. Did you know that the waveform of a bomb-blast pressure wave was almost exactly like that of one of the most unpleasant kinds of atmospheric in shape. It rises almost vertically to its peak, then falls almost equally steeply until the "zero" line is reached. That is the "positive" or pressure part of it. Then comes the "negative" pull or suck. This takes the form of a long, shallow curve below the zero line. The effect of blast on a building—or a loud-speaker cone—is much the same as that of an atmospheric on an aerial; vibration at the natural frequency is set up. As a rule the final damage to a building is done, not by the violent looking "positive" half of the blast wave, but by the suck of its "negative" portion. That's why the glass from windows and the bricks from walls fall outwards rather than inwards. I haven't examined any loud-speaker cones that have fallen victims to bomb blast, but I'm open to wager that most of them have been pulled rather than pushed out of shape. Any experiences from readers would be welcome.

"Après la Guerre Fini"

SOLDIER, sailor and airman used to promise themselves all kinds of delightful things in the last war when the desirable, if ungrammatical, state of affairs described in the heading came to pass. And I suppose that all

The Stimulus

It's only natural that something of the kind should take place. Here we are now, called from our labs, and our radio dens to do willingly our jobs in the Navy, the Army, or the Air Force. But aren't we all longing for the day when we can settle down again to the

Not So Easy

ALWAYS up to date, *The Wireless Trader* produced in its Christmas number one of those "Do You Know?" features that are so popular nowadays. One of the teasers propounded interested me greatly—and

Wireless World

Random Radiations—

made me think a bit. It consisted of reproductions of the symbols used in circuit diagrams of valves and other "vacuum tubes" that aren't really valves. There were 33 of them in all, and you were invited to give each its correct name. Easy enough, you say? So did I, till I tried! I got most of them right after puzzling out the electrode arrangements. But with some of the more complicated ones puzzling out was the operative word. What a difference from the valves of 20 years ago when no symbol contained more than a filament, a single grid and a single plate—not even the grid in the case of the diode! Even when the tetrode and the pentode came along, it was pretty plain sailing. But now that you've got things like the octode and the triode-heptode a little thinking *plus* a counting of grids has to be done ere you feel prepared to give a name to some complicated symbol. Could you draw, right off the reel, the conventional symbol for a triode-heptode? You can? Well, now try drawing, without reference to any book, of course, a diagram of its pins and their connections.

Colour Television

TELEVISION, somehow, seems little more nowadays than one of those pleasant memories of the past. It's just about a year and a half—and what a year and a half!—since I saw images on the screen of a television receiver, and a little less since the Alexandra Palace transmitter closed down "for the duration." Hence it's refreshing to find that, despite the

war, development work on television still goes forward. Mr. Baird has produced, I read, some quite noteworthy advances in colour television, and progress in this direction is being made also on the far side of the Atlantic. I've no doubt at all that television in natural colours will come, and a welcome improvement it will be. But what I most want to see, both in the cinema and in television, is stereoscopic projection. That, too, is only a matter of time. Much progress has been made by the movie experts; I believe that stereoscopic films have been projected experimentally with no small success. When we have television and ciné pictures projected both in colour and stereoscopically each of these forms of entertainment will become inestimably more attractive. It will be an even bigger jump forward than that from the silent film to the talkie or that from sound only to sound-cum-vision by wireless. That's my view, anyhow.

Club News

British Short-wave Correspondence Club

Hon. Sec.: Mr. A. Richardson, The Watering, Parham, Woodbridge, Suffolk.

Members are asked to note that the above club has now been divided into zones for reasons of closer control. These zones are as follows, managed by the members named:—

Scottish Zone: T. Jack, "Loanhead," Greengairs, Airdrie, Lanarkshire.

Northern Zone: T. Knight, 37, Hartington Street, Barrow-in-Furness, Lancashire.

Southern Zone: R. Nugent, Field House, Windmill Hill, Nr. Hailsham, Sussex.

Eastern Zone: D. G. Garrard, 135, Hervey Street, Ipswich, Suffolk.

Western Zone: P. Griffiths, 14, Winch Crescent, Haverfordwest, Pembrokeshire.

All overseas members should still address all communications regarding the club to H.Q.

BOOKS ON WIRELESS

issued in conjunction with "The Wireless World"

	Net Price	By Post
"FOUNDATIONS OF WIRELESS," by A. L. M. Sowerby. Second Edition	5/-	5/6
"RADIO LABORATORY HANDBOOK," by M. G. Scroggie	8/6	9/1
"WIRELESS SERVICING MANUAL," by W. T. Cocking. Fifth Edition	5/-	5/6
"HANDBOOK OF TECHNICAL INSTRUCTION FOR WIRELESS TELEGRAPHISTS," by H. M. Dowsett. Sixth Edition	21/-	21/9
"WIRELESS DIRECTION FINDING," by R. Keen. Third Edition	25/-	25/9
"RADIO DATA CHARTS," by R. T. Beatty. Second Edition	4/6	4/11
"TELEVISION RECEIVING EQUIPMENT," by W. T. Cocking	7/6	8/-
"RADIO INTERFERENCE SUPPRESSION," by Gordon W. Ingram	5/-	5/4
"LEARNING MORSE." Fourth Edition	6d.	7½d.
"RADIO DESIGNER'S HANDBOOK," Edited by F. Langford Smith	7/6	8/1
"THE WIRELESS WORLD DIARY AND REFERENCE BOOK FOR 1941"	2/5½	2/7

Obtainable from Leading Booksellers and Railway Bookstalls or by post (remittance with order) from

LILFE & SONS LTD., Dorset House, Stamford Street, London, S.E.1

The "Fluxite Quins" at work

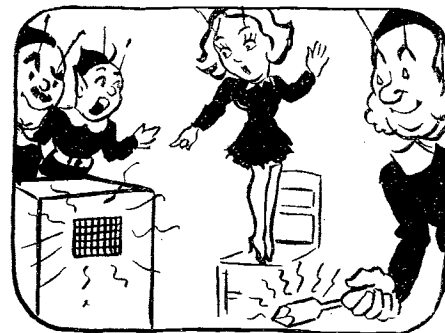

"There's a mouse in the wireless," OO pleaded;
"It's squealing!"—to her aid the lads speeded.

"That noise, I deduce,
Is a wire broken loose,"

Explained OH, "and it's FLUXITE that's needed."

See that FLUXITE is always by you—in the house—garage—workshop—wherever speedy soldering is needed. Used for 30 years in Government works and by leading engineers and manufacturers. Of Ironmongers—in tins, 4d., 8d., 1/4 and 2/8.

Ask to see the FLUXITE SMALL-SPACE SOLDERING SET—compact but substantial—complete with full instructions, 7/6.

Write for Free Book on the art of "soft" soldering and ask for Leaflet on CASE-HARDENING STEEL and TEMPERING TOOLS with FLUXITE.

TO CYCLISTS! Your wheels will NOT keep round and true unless the spokes are tied with fine wire at the crossings AND SOLDERED. This makes a much stronger wheel. It's simple—with FLUXITE—but IMPORTANT.

THE FLUXITE GUN

is always ready to put Fluxite on the soldering job instantly. A little pressure places the right quantity on the right spot and one charging lasts for ages. Price 1/6, or filled 2/6.

FLUXITE LTD.
(Dept. W.W.),
BERMONDSEY
STREET, S.E.1

ALL MECHANICS WILL HAVE

FLUXITE

IT SIMPLIFIES ALL SOLDERING

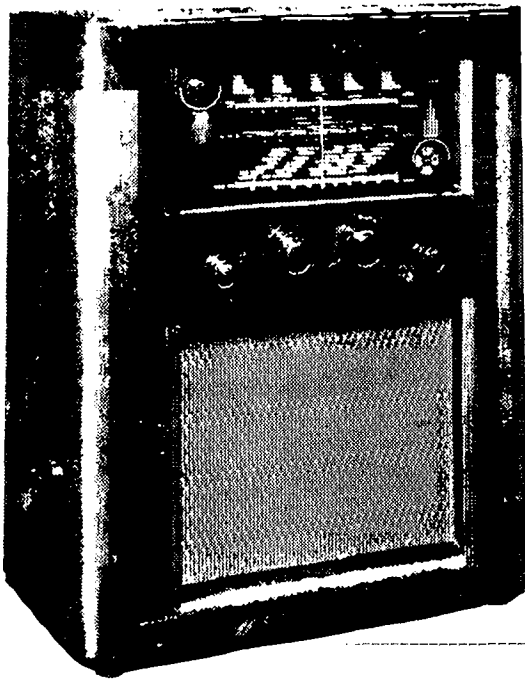

Test Report

Cossor Model 74A

TABLE MODEL SUPERHET FOR AC MAINS
(5-VALVE+RECTIFIER AND TUNING INDICATOR)

WAVERANGES

Short ... 16- 52.5 metres

Medium 195- 560 metres

Long ... 810-2,085 metres

Price : £14 14s. +
£3 3s. 3d. Purchase Tax.

FEW firms provide a wider choice of broadcast receivers in the medium- and low-priced categories than A. C. Cossor, Ltd. These are known and appreciated by a large section of the listening public. Not so many people realise that the Cossor range includes a number of receivers of more comprehensive specification for the discriminating listener who is prepared to pay a little more for a performance which will distinguish his set from the average.

The Model 74A is in every way a

big set. It is fitted with an RF stage, and has a large triode output valve feeding a 10-inch loud speaker. The cabinet measures $22 \times 17\frac{1}{2} \times 10$ inches, and the performance is in every way commensurate with its appearance.

Circuit.—The aerial is transformer-coupled to the pentode RF amplifier, the long-wave coupling being provided with damping. On gramophone the input grid is earthed.

The coupling between the RF stage and the triode-hexode fre-

quency changer is by means of transformers with tuned secondaries. Tuned-grid oscillator coils are used, and the output of the frequency changer is passed to a single variable-mu pentode IF amplifier.

Both IF transformers are permeability tuned, and the input transformer has a third winding which is always in circuit. It is centre-tapped to earth, and the selectivity switch reverses the sense of the coupling, thus changing the inductance of the primary and increasing the band width.

The output IF transformer is tapped down for both signal and AVC diodes. AVC is delayed, and the cathode ray tuning indicator takes its control from the signal rectifier circuits.

Resistance-capacity coupling is used between the triode amplifying portion of the second detector and the output stage.

The output valve is of the directly heated type, and the power rectifier is indirectly heated so that the smoothing condensers are adequately protected. The loud speaker field is

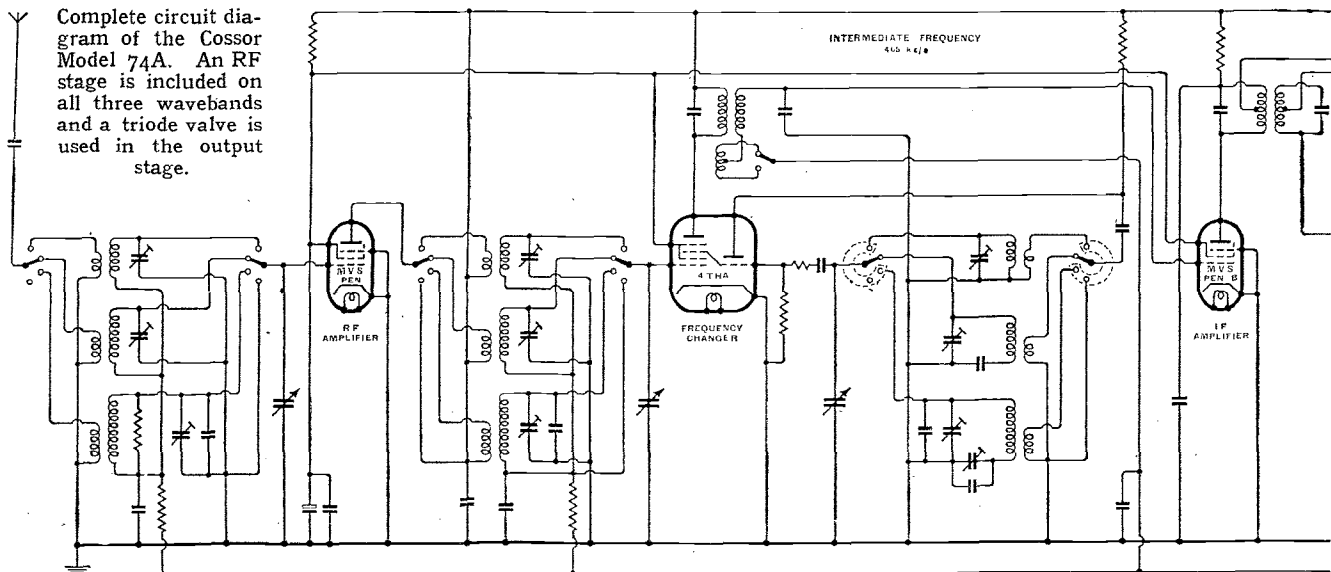

Cossor Model 74A—

connected in the negative HT lead.

Performance.—On the radio frequency side the performance is everything one would expect from a receiver incorporating an RF stage. Sensitivity and image rejection on short waves are both good.

Selectivity on all three wave ranges is well up to the work in hand, and the extra band-width made available by the switch makes just that little difference between good and exceptionally good quality on the local station.

It is the quality of reproduction which is the outstanding feature of this set. The efficient loud speaker, in conjunction with the considerable baffle area provided by the cabinet, combine to give "console" volume in the bass. This is well able to carry the excellent high note response, and as far as frequency range is concerned the Model 74A is well in advance of most commercial receivers. The harmonic distortion is also extremely low, and the volume control can be tuned up to the maximum on any station without any apparent signs of overloading.

Another aspect of the quality which is worthy of note, and which is all too rare these days, is the wide-angle dispersion of the sound from the front of the set. There is less impression of the sound emanating from a "point source," and a greater feeling of expansiveness which greatly enhances the reproduction of

orchestral items. With AVC applied in three stages the control is very effective, and the only fault we had to find with the performance as a whole was a slight tendency to pulling in the oscillator near the bottom of the short-wave range, under the influence of wide variations of signal strength.

Constructional Features.—The chassis is divided into two parts, the output stage and power pack being fitted on the floor of the cabinet. The main chassis, which is open at the bottom, is mounted above the loud speaker and access is readily obtained to the trimmers without dismantling the set. A really substantial stiffening bar prevents flexing of the sides of the cabinet, and also serves as a support for the back of the main receiver chassis.

The controls are five in number, the main on-off switch being mounted separately in a recess at the left-hand side of the cabinet, and the remaining four—Tuning, Volume, Waverange and Combined Selectivity and Tone—are situated just below the large rectangular tuning scale. Station names are shown on all three wavebands, and the short-wave range is calibrated in megacycles as well as metres. The scale is indirectly illuminated, and a maltese cross waverange indicator matches the magic eye.

Makers.—A. C. Cossor, Ltd., Highbury Grove, London, N.5.

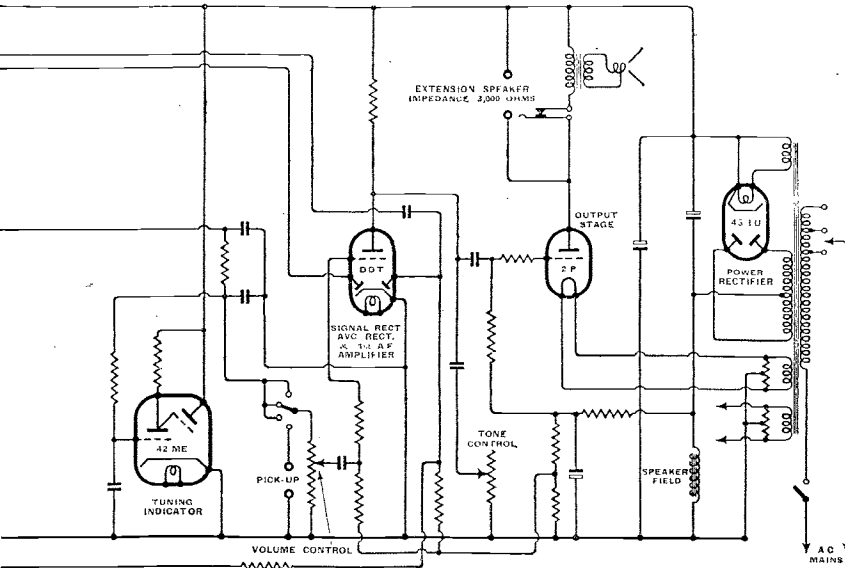

BULGIN

for
SWITCHES

THE BULGIN RANGE OF SWITCHES is the largest and best in the British Isles. These All-British types meet every Radio Switching Requirement, and—made by experts, designed by experts—do so in the best way possible. The Best is always the Cheapest.

NATIONAL EFFORT

IN these times, in many directions, needless to say, we are directing our main efforts and supplies towards the requirements of the Government Services.

However, some supplies of components are still available for Radio Servicing, but should delays occur we know our friends will appreciate the difficulties which at present arise from day to day. We would point out that delays can be minimised and often avoided if alternatives are, wherever possible, specified when ordering.

Prices are being kept as low as possible despite increased costs in every direction. Meanwhile you still have the best and largest range of radio products in the United Kingdom to choose from.

THANK YOU!

A SELECTION OF SWITCHES

List No.	Max. V.	Max. A.	Price Ea.
S.180	250	4	2/-
S.81T	250	2	1/9
S.114*	250	2	3/-
S.205**	250	0.1	5/6
S.89	250	3	3/6
S.188*	250	4	3/3
S.88*	250	3	3/-
S.45	32	1	6d.
M.P.1	100	0.1	1/3

(* = d.p. ** = 18-way selector.)

War Increase + 16 2/3%

FOR ALL RADIO COMPONENTS

Advt. of A. F. BULGIN & CO., LTD.,
BYE PASS ROAD, BARKING, ESSEX.
Tel.: RIPpleway 3474 (4 lines).

Resistance-tuned Oscillator

ITS APPLICATION TO AUTOMATIC FREQUENCY CONTROL

IN *The Wireless Engineer* for September, 1937, there was described a practical form of resistance-tuned oscillator. In this type of oscillator, instead of the tuning of the circuit being achieved by varying a capacity or inductance as in ordinary oscillatory circuits, the tuning is carried out by means of a variable resistance. Such an oscillator has particular advantages when used as the local oscillator of a radio receiver. For example, in push-button receivers it is difficult to secure a stable adjustable capacity, and it is costly to secure a stable oscillator circuit by a multiplicity of adjustable inductances where the station selection is by the switching of pre-set tuned circuits. Stable adjustable resistances are, however, procurable. The resistance-tuned oscillator is also easily adapted to use in automatic frequency correction circuits as additional components are not required as in the more usual arrangements.

The following is a description of a suitable oscillator circuit as devised by D. E. Foster, an R.C.A. engineer.

In the accompanying drawing there is shown a superheterodyne receiver system of a generally conventional type, except for the arrangement of the local oscillator network. The receiver comprises the usual signal collector, adapted to collect signals in the broadcast band of 550 to 1,500 kc/s, which feeds a tunable radio-frequency amplifier (not shown). The first detector and IF amplifier are conventional. The amplified IF energy may then be impressed upon a combined second detector-frequency discriminator network.

Briefly, it may be stated that the function of the second detector-discriminator network is to derive audio energy and a frequency-dependent direct current voltage from the IF energy. The discriminator network can be entirely independent of the second detector

circuit. The direct current voltage output of the discriminator varies in polarity and magnitude with the sense and amount respectively of frequency departure of the IF energy from the assigned IF value. The variable direct current voltage, or AFC bias, is passed from the discriminator to the local oscillator V.

The local oscillator comprises the valve V, which includes at least a cathode, a control grid and anode. The anode is regeneratively coupled to the grid by means of inductive coupling between the anode coil L and the grid coil L₁. Direct current voltage of the proper positive value is applied to the anode through L, whereas L₁ is connected between the earthed cathode and the direct current blocking condenser C. The anode is further connected to earth through a path which includes a frequency-dependent impedance network C₁, R, a condenser C₂ and any one of a plurality of resistors R₁, R₂, R₃. The function of the

resistor may be selected by means of a push-button switch.

The local oscillation energy is impressed on the first detector network. Of course, the frequency of the local oscillations will differ from the signal frequency impressed on the first detector by the frequency value of the IF energy. It should be understood that the tunable circuits of the radio frequency and first detector may also include push-button switches, mechanically coupled to those of the local oscillator circuit, so as simultaneously to vary the signal circuits to different frequencies, so that at different adjustments of the oscillator and signal circuits the IF energy will have substantially the assigned IF value. The function of the AFC circuit is to correct for any deviation from the assigned IF value, should the oscillator or signal circuits shift in frequency. In place of the group of resistors R₁, R₂, R₃ there may be employed a single adjustable resistor.

The AFC bias is applied to the grid of V through the grid leak resistor R₄. The variation in bias of this grid is converted into a

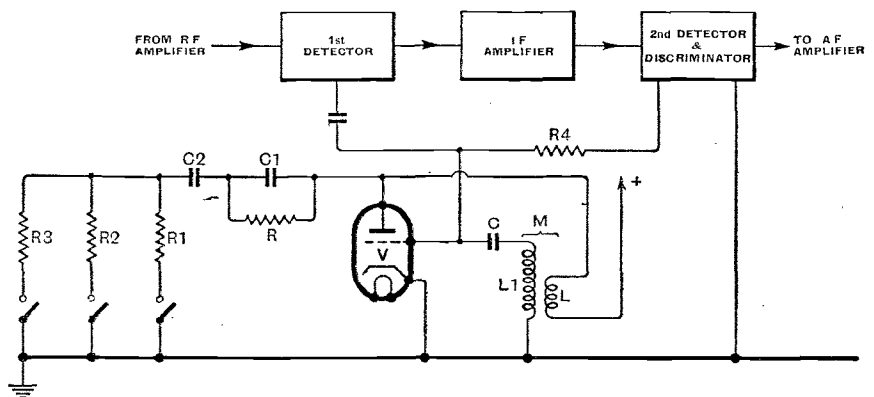

Block diagram of a superheterodyne receiver, and, in detail, the circuit of a resistance-tuned local oscillator.

impedance network R, C₁, will be explained later. The resistors R₁, R₂, R₃ function as the main tuning means for the local oscillator network. Each of these resistors has a magnitude such that when in circuit with the network R, C₁, the local oscillator is tuned to a desired local oscillation frequency. Any tuning

change in gain of V; the change in gain, in turn, is translated into a frequency shift of the oscillator network. The polarity of the AFC bias determines the direction in which the oscillator frequency is varied to compensate for the IF energy frequency departure. The direct current voltage output of the

Resistance-tuned Oscillator—

discriminator rectifiers arranged in opposition will be positive or negative with respect to earth depending upon whether the IF energy has shifted to one side or the other of the assigned IF carrier value.

The local oscillator network functioning will now be described. The regeneratively coupled valve V provides negative resistance; the tuning resistor R₁-R₃ provides positive resistance whose magnitude is adjusted to vary the oscillation frequency. By varying the gain of V the value of negative resistance can be adjusted. Hence, at selected values of positive resistance, the AFC bias can be used to secure small frequency adjustments in order accurately to tune the oscillator to that frequency which will cause the proper IF value to be produced. The grid of V has a normal negative value by virtue of grid current flow, as the valve is in an oscillator circuit. It is desirable to maintain the grid at such a bias value as to cause the frequency shift to be substantially symmetrical with variations in applied discriminator potential about a mean value.

The Resistance Oscillator

The following detailed considerations of the functioning of the oscillator network will make the operation clearer. In a circuit consisting of a pure negative resistance which is a function of frequency, and a positive resistance in series therewith, oscillation will occur when the net resistance around the circuit is zero. The frequency of oscillation is that frequency which will make the negative resistance component equal the positive resistance component. Therefore, changing the positive resistance component will change the oscillation frequency. Now the required negative resistance which is a function of frequency can be secured by connecting across a negative resistance which is independent of frequency a reactance, and in series with that combination a reactance of opposite sign shunted by a resistance of approximately the same magnitude as the negative resistance. Therefore, small changes of the magnitude of the negative resistance will affect the oscillation frequency.

In the circuit shown inductance L is coupled to L₁ and through blocking condenser C to the grid of V. The output of V is joined to L so that an oscillation circuit is formed. The anode-cathode impedance of V forms a negative resistance in shunt with L. In series with this combination is condenser C₁ and positive resistance R in shunt therewith, approximately equal to a negative valve resistance. This combination L-V-R-C₁ forms a negative resistance which is a function of frequency, as resistance R and the negative resistance of V are approximately equal and each is approximately equal to $\sqrt{L/C}$ where L is the inductance of coil L and C is the capacity of condenser C₂.

Now if the tuning resistance R₁-R₃ is zero, the frequency is that normal to an oscillatory circuit composed of inductance L and capacity C₁. If resistance R₁-R₃ equals resistance R, the oscillation frequency is theoretically infinite, but is actually limited to some finite value by distributed capacity of coils. Decreasing the negative resistance a small amount so that the relationship, that negative resistance is equal to resistance R and to $\sqrt{L/C}$ still holds approximately, will likewise cause frequency increase. If the AFC bias is applied to the grid of V, through a DC amplifier if necessary to obtain a low impedance source since V, being an oscillator, will draw some grid current, it will change the operating trans-conductance of V, and hence the magnitude of negative resistance between plate and cathode. If the grid of V is made more negative its trans-conductance will decrease, and the negative resistance will increase, thereby resulting in a decrease of oscillation frequency and vice versa.

Identifying German Aircraft

NEW types of German aircraft are included in the new identification chart which has been prepared by *Flight*. Improvements introduced as a result of the use of many thousands of earlier editions are incorporated in the new chart which is printed on a card measuring 22in. by 14½in. Published by the Flight Publishing Company, Dorset House, Stamford Street, London, S.E.1, the chart costs 1s., plus 6d. postage. The postage on up to six copies is 8d. and on twelve copies 11d.

VORTEXION
50w. AMPLIFIER CHASSIS

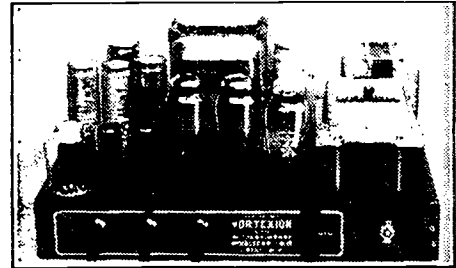

A pair of matched 6L6's with 10 per cent. negative feedback is fitted in the output stage, and the separate HT supplies to the anode and screen have better than 4 per cent. regulation, while a separate rectifier provides bias.

The 6L6's are driven by a 6F6 triode connected through a driver transformer incorporating feedback. This is preceded by a 6N7, electronic mixing for pick-up and microphone. The additional 6F5 operating as first stage on microphone only is suitable for any microphone. A tone control is fitted, and the large eight-section output transformer is available in three types—2.5-8.15-30 ohms; 4-15-30-60 ohms or 15-60-125-250 ohms. These output lines can be matched using all sections of windings and will deliver the full response (40-18,000 c/s) to the loud speakers with extremely low overall harmonic distortion.

CHASSIS with valves and plugs..... £17 10 0
Or complete in black leatherette cabinet with Collaro turntable, Piezo P.U. and shielded Mike Transformer..... £22 10 0
Plus 10% War Increase on above prices.
Goodmans B.A. Speakers in stock.

Paper M. ché Horn Speakers..... £6 6 0
Moving Coil Microphones..... £5 5 0
Chromium Microphone Stands from..... 10 6

Many hundreds already in use for
A.R.P. & GOVERNMENT purposes

15w. AC & 12-VOLT DC AMPLIFIER

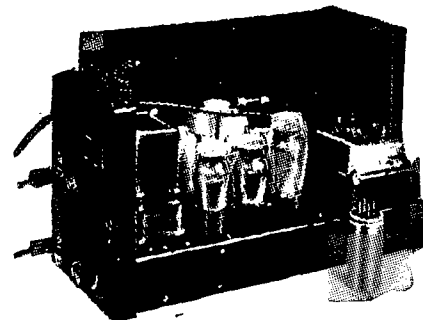

TYPE CP20

This small Portable Amplifier operating either from AC mains or 12-volt battery, was tested by "THE WIRELESS WORLD," October 1st, 1937, and has proved so popular that at Customers' demand it remains unaltered except that the output has been increased to 17.2 watts and the battery consumption lowered to 6 amperes. Read what "The Wireless World" said:—

"During tests an output of 14.7 watts was obtained without any trace of distortion so that the rating of 15 watts is quite justified. The measured response shows an upper limit of 18,000 c/s and a lower of 30 c/s. Its performance is exceptionally good. Another outstanding feature is its exceptionally low hum level when AC operated even without an earth connection. In order to obtain the maximum undistorted output, an input to the microphone jack of 0.037 volt was required. The two independent volume controls enable one to adjust the gain of the amplifier for the same power output from both sources, as well as superimpose one on the other, or fade out one and bring the other up to full volume. The secondary of the output transformer is tapped for loud speakers of line impedances of 4, 7.5 and 15 ohms." Prices: Plus 10% War Increase.

AC and 12-volt CHASSIS with valves, etc. £12 12 0

Or in Rexine Case with Collaro Motor, Piezo P.U. and Mike Transformer..... £17 17 0

AC only CHASSIS with valves, etc. £8 18 6

Or in Rexine Case with Collaro Motor, Piezo P.U. and Mike Transformer..... £14 0 0

Gauze Case for either chassis 15/6 extra.

Write for Illustrated Catalogue.

Vortexion Ltd., 257, The Broadway,
Wimbledon, S.W.19. Phone: LIBerty 2814

Unbiased

Helping the Enemy

I LITTLE thought that I should raise such a hornets' nest about my ears when I mentioned last month that it was so difficult nowadays to distinguish between the whistle of a falling bomb and the whistle from the loud speaker due to oscillation from a neighbouring set that I frequently found myself dragging Mrs. Free Grid under the table with me when a particularly realistic howl came from the horn of the "old faithful" I am using in my refuge room.

Howls of protest have come from hordes of these oscillators who go completely beyond the bounds of decency by suggesting that I am in the pay of the wireless manufacturers and trying to help them line their pockets by compelling people to invest in new receivers of the non-radiating type. To these latter I can only say that no wireless manufacturer has yet made it worth my while to betray my trust.

There are quite a number of readers, however, who agree with me, and go even further and demand that a watch be kept not only on wireless whistlers but on all users of domestic electrical apparatus of the interference-producing kind, since it cannot be doubted that aircraft flying over a town pass through a veritable cloud of interference which readily tells them that they are no longer over the empty countryside. Personally speaking, I think that it would be a good opportunity

By FREE GRID

lines, and not only was he able to distinguish between town and countryside, but could even tell one district from another in certain cases. Over DC districts, for instance, the interference is much more pronounced owing to the use, among other things, of commutator motors, while an arc-rectified AC/DC district is readily distinguishable on a receiver equipped with a cathode-ray tube owing to the peculiar waveform emitted.

I must, however, part company with him when he suggests that, prior to the outbreak of war, German agents disguised as G.P.O. interference trackers made elaborate radio-interference charts of the whole country. Probably they were only American salesmen planning a sales campaign of suppression devices and getting the necessary data concerning the most profitable territory to operate in.

An Iron Constitution

I WAS extraordinarily interested in the report published in several newspapers about a new and homely method adopted by surgeons for finding small and elusive fragments of bombs in people's anatomy, but I must protest strongly against the suggestion that there is any novelty in it, as I used it myself many years ago soon after de Forest put the grid in Fleming's diode and made thermionic amplification possible. Actually it was not bomb fragments in my case, but shrapnel which I had picked up in the siege of Mafeking, way back in '99. I well recollect that I had so many small fragments in me that the captain of the ship on which I was returning home was compelled to request me not to visit him on the bridge as I upset the ship's compass.

It was not until many years afterwards that the final pieces of shrapnel

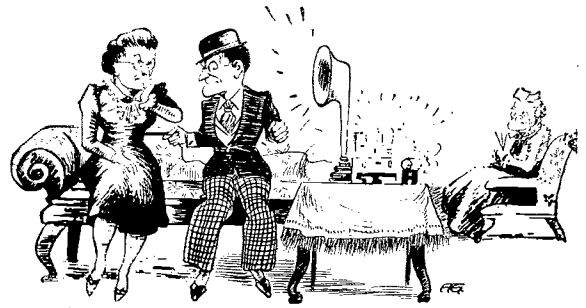

Playful prods.

were removed with the aid of a metal prodder attached to the aerial terminal of a home-constructed wireless set. The whole affair remains very vividly in my memory owing to a nasty passage of arms I had with Mrs. Free Grid's mother when, through my callow ignorance of women's attire, I foolishly imagined that I had discovered metal fragments in her daughter's anatomy. Mrs. Free Grid was, of course, much younger then, and, being still single, was not averse to my playful prods with a metal searching rod. What was started in fun continued in deadly earnest, however, as the loud speaker protested volubly every time I penetrated her defences. It was quite a long time before I discovered that the noise was due to her metal defences which were in those days just giving place to whalebone.

I suppose that I ought to have known better, but, after all, we are only young once, and I used my influence to get the aforementioned defences removed in order to continue my investigations further. I was considerably astonished to find that the loud speaker still indicated the presence of metal. It only shows how careful we scientists have to be not to allow ourselves to be led away into drawing false conclusions. For a long time I was seriously puzzled, and entertained all kinds of wild and far-fetched theories to account for the presence of metal in her body, only to discover in the end that it was all due to an iron tonic she was taking.

Incidentally, I may say that I have since discovered that this arrangement is an excellent test for the efficacy or otherwise of certain iron tonic patent medicines, and if any of you who have been taking any of these concoctions find on trying out this test that it fails to ring the bell, or, in other words, to make sounds from the loud speaker, you are justified in asking for your money back. No doubt before very long the vendors of some of these ferrous nostrums will include successful tests with this apparatus in some of their published testimonials.

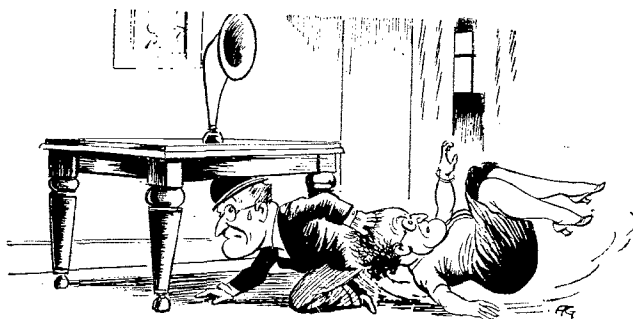

Taking cover.

to make the ether safe for post war listeners by putting pressure on manufacturers of interference-producing electrical devices to fit suppressors now.

One correspondent claims that in pre-war days when he was an active member of a flying club he carried out a large number of experiments on these

Recent Inventions

Brief descriptions of the more interesting radio devices and developments disclosed in Patent Specifications will be included in these columns

TONE CONTROL

A COMBINATION of positive and negative feed-back is utilised to improve the tone of a low-frequency amplifier. In a two-stage amplifier, voltage from the output transformer of the second stage is fed back through a condenser to the grid of the first stage. This applies reverse reaction, the discrimination of the condenser in favour of the higher frequencies giving the effect of a low-frequency boost.

A tapping is also taken from a resistance in the same feed-back circuit to the grid of the same second stage. This gives positive reaction, and a shunt condenser is provided to by-pass the higher frequencies so that the lower tones are again favoured. Any desired range of frequencies can similarly be boosted by inserting suitable impedances in the feed-back circuit.

E. K. Cole, Ltd., and A. W. Martin.
Application date October 19th, 1938.
No. 520350.

PUSH-BUTTON TUNING

EACH button on a switch-tuned set is given a multiple duty so that it can be made to select a given station on each of, say, four available wavebands without the necessity of having to operate any separate switch. As shown, the shaft of the push button P is made in two parts, which are flexibly jointed at J. The outer part of the shaft is enclosed in a washer W of spongy rubber or similar yielding material, where it projects through the cabinet casing, so that, in addition to the usual direct or plunger motion, the button P can be moved slightly upwards or downwards, as indicated by the arrows A, B. It has also a similar slight freedom of movement to right or left of its centre position.

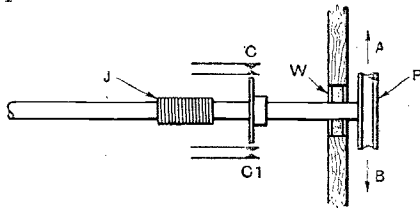

Multiple-duty push-button system.

An upward movement closes the pair of contacts C and so changes the waveband switch to a given position, whilst a downward movement will bring another waveband range into operation through the contacts C1. Other waveband changes can be effected by moving the push button against similar contacts arranged at right angles to C and C1.

Kolster-Brandes, Ltd., and W. A. Beatty. Application date November 11th, 1938. No. 521209.

INTERFERENCE FROM THE MAINS

IN addition to the usual mains "hum," a further interference is sometimes caused by the production of "harmonics" of the supply frequency in the rectifier unit. Another source of trouble, particularly in a superhet. receiver using a high intermediate frequency, is due to higher harmonics of the IF, which get through by capacity coupling into the heater circuits of the amplifying valves, and so back through the primary winding of the supply transformer into the input of the receiver. If any of these harmonics happens to lie near to the signal frequency, it will be considerably amplified.

All such types of disturbance are eliminated, according to the invention, by electrostatically screening from one another not only the primary winding and the secondary winding supplying the anode voltage, but also the secondary winding connected to the heating circuits of the amplifiers, and the primary supply winding. This prevents the transfer by capacity coupling of any of the parasitic-frequencies in question.

Philips Lamps, Ltd. Convention date (Germany) June 3rd, 1938. No. 520622.

"QUIET" TUNING

THERE is a certain amount of difficulty in applying a clear-cut muting action to a receiver which is fitted with automatic tuning as well as automatic volume control. The object of the invention is to ensure "quiet" tuning, in such a case, when changing-over from one programme to another, even when frequency separation is small.

For this purpose the normal muting bias is arranged to be opposed by a second bias, which is set up across an impedance in series with a glow-discharge tube, both these being included in the anode circuit of a control valve. The valve is subjected to a triggering voltage from one of the IF stages—so that the voltage varies in accordance with the incoming signal strength. The voltage in question passes through a highly selective piezo-electric filter so that it has a clear-cut action in removing the muting bias whenever tuning is changed from one station to another.

Marconi's Wireless Telegraph Co., Ltd., and O. E. Keall. Application date 12th January, 1939. No. 523697.

"BEAM" VALVES

THE invention relates to valves of the kind in which the electron stream is first formed into a definite beam, more or less as in a cathode-ray tube, and is then controlled by deflecting it to one side or other. The object is to produce a tube capable of handling a stream, say, of the order of 400 milliamps at from

1,000 to 2,000 volts, and to control it by comparatively small deflecting fields.

A feature of the invention is the use of a single electron lens both for producing and deflecting the stream, this being contrasted with the ordinary cathode-ray tube practice of using one electrode system for producing the beam, and a different electrode system for deflecting it. Also, according to the invention, the deflecting fields are applied to the electrons before they reach the beam-forming unit, this again being in contrast with ordinary CR tube practice.

J. H. O. Harries. Application dates November 9th and December 1st, 1938. No. 521199.

FILAMENT SWITCHING ARRANGEMENTS

RELATES to means for bringing the cathode of a valve more quickly than usual to the temperature at which it emits a full stream of electrons. The same idea can also be used to maintain a valve relay of the kind employed for intermittent or "watchdog" duty at a "threshold" temperature so that it can be brought into action with the least possible delay.

If the switch S is moved in an anti-clockwise direction, it first makes a momentary contact at 1 and so "flicks" the full voltage of the battery A across the filament. This rapidly heats it up, but, because the contact is only momentary, no harm is done. The switch then passes on to the contact 2, where the low-voltage battery B is brought permanently into circuit.

By using a circular group of contacts, across which the switch is constantly driven by a clockwork or other motor D.

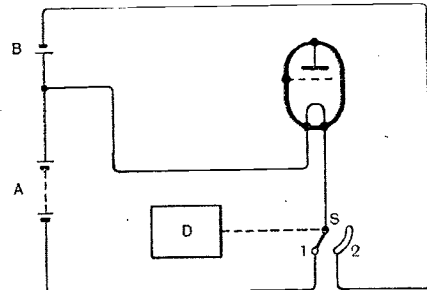

Circuit for quick filament heating.

it is possible to maintain the filament normally at a point just below the temperature of full emission, and to bring it up to full activity only once per revolution. This economises battery consumption in the case of a valve relay which is only intended to keep watch for a possible emergency or "calling" signal. At the same time the relay is kept ready to respond promptly, and

Recent Inventions—

without any time-lag, when such a signal arrives.

A. A. Thornton (communicated by Philco Radio and Television Corporation). Application date August 26th, 1938. No. 521912.

o o o o

PA LOUDSPEAKERS

IN order to protect the loudspeakers, used in out-of-doors public-address systems, from the effects of bad weather, the sound-reproducing box is arranged above, and substantially at right-angles to, the tapering neck of the horn, the latter being mounted horizontally. A curved tube connects the reproducer box to the throat of the horn, and is fitted with a drainage plug. The arrangement is designed to prevent rain from driving in along the horn and so damaging the delicate diaphragm of the sound-reproducing unit.

Standard Telephones and Cables, Ltd., and J. C. Curry. Application date November 15th, 1938. No. 521408.

o o o o

SYNCHRONISING IN TELEVISION

THE line and frame scanning impulses used in television are separated by passing them through a differentiating circuit which imposes a phase difference of 180 degrees between the two sets of signals. The synchronising signals are radiated in the form shown at A, where L represents the short line-impulses and F the longer frame-impulses.

Both are applied to a condenser C in series with a diode D, the input to the latter being shunted by a resistance R.

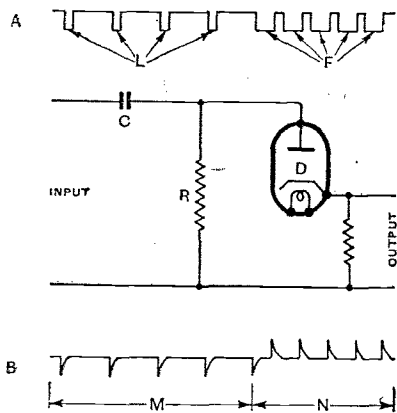

Separating line and frame impulses.

The discharge period of the condenser C is such that it reaches a steady state corresponding to the curve M in the lower line B of the figure until the frame impulses reach it, whereupon the wave front "reverses" to give out-of-phase impulses of the form shown at N. The frame pulses can now be easily separated from the line impulses by the rectifying action of the diode D, which passes them on to the time-base circuit.

W. Jones and Pye, Ltd. Application date January 25th, 1939. No. 524286.

TUNING ADJUSTMENTS

IF it is desired to alter the semi-fixed tuning elements associated with one of the push-buttons on a set which, in addition to being switch-tuned, is also fitted with automatic frequency control, a certain difficulty arises. This is due to the fact that so long as the AFC is operative it tends to obscure the accuracy or otherwise of the new adjustment, since no matter what alteration is effected, it will appear to be correct. No calculated allowance can be made, since the "pull" of the AFC is variable and only ceases to act when the true adjustment has actually been made.

Such adjustments are not often necessary, and, in practice, one usually has to remove the escutcheon plate from the set in order to get access to the components concerned.

It is now arranged that the screws which fix the escutcheon plate in position normally complete the circuit of the automatic frequency control. When they are withdrawn the AFC circuit is automatically broken, and the required adjustment can then be made accurately and without trouble.

G. D. Barraclough. Application date December 22nd, 1938. No. 522975.

o o o o

GENERATING MICRO-WAVES

CENTIMETRE waves are generated in a magnetron valve which is stabilised by means of a Lecher-wire "resonator." The resonator consists of two strips which run the length of the tube, inside the glass bulb, and may be bent over to form a short-circuited "loop" at one end, the HT supply then being tapped to the midpoint of the loop.

Four anodes, arranged in two pairs, are set at right-angles to the resonator, one pair being welded to the upper strip, and the other pair to the lower strip, a gap being left at the opposite end of the welding point in both cases. The cathode is arranged in the centre of the anode system, along the line where the two pairs of anodes would normally intersect each other.

The electron-discharge path is from the cathode towards the rear edges of the four anodes. Under the influence of the applied magnetic field, oscillations build up along the Lecher-wire resonator. For a discharge path of 0.5 millimetres, the tube will generate waves from 4 to 5 centimetres long.

Telefunken Ges. für Drahtlose Telegraphie m.b.h. Convention date (Germany) December 20th, 1937. No. 522905.

o o o o

SHORT-WAVE MODULATION

THE figure shows a valve, of the magnetron type, for signalling on ultra-short waves so that the output is a pure amplitude-modulated carrier, free from any superposed frequency modulation. The underlying principle is to separate the oscillation-generator stage electrically from the modulating stage, so that any interaction between the two is avoided.

The cathode C is surrounded by two anode segments A and A₁, with apertures O, O₁, from which some of the oscillating electrons in the anode-cathode space pass, through positively biased ring electrodes R, R₁, into the modulating space containing signal grids G, G₁ and anodes A₂, A₃. The whole arrangement

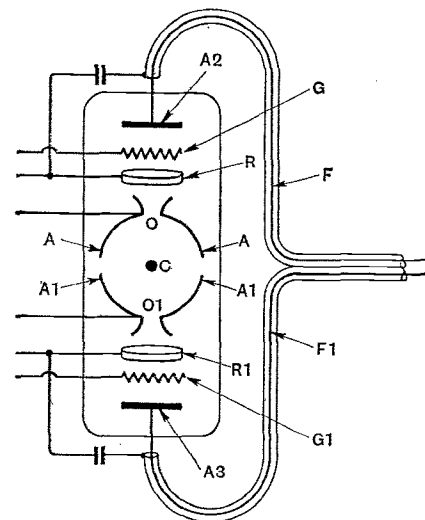

Design of magnetron for pure amplitude modulation.

forms a push-pull system, the modulated output being taken off by co-axial feeders F, F₁ from the anodes A₂, A₃. The method of the invention is comparable with the known system of using a space-charge grid to modulate a constant electron current from a virtual cathode.

Telefunken Ges. für drahtlose Telegraphie m.b.h. Convention date (Germany) February 11th, 1938. No. 525022.

o o o o

SCREENING

A NUMBER of insulated wires, forming, say, the RF leads or conductors of a wireless receiver, are threaded through the meshes of a wire-gauze sheet. They are thus held in any desired "run" or position, and at the same time are effectively screened from each other by the wire-gauze foundation, which can be earthed.

The combination can conveniently be used as a wiring sheet or panel for the chassis of a wireless set, or as a method of carrying and screening the RF cables used for remote control.

Marconi's Wireless Telegraph Co., Ltd., and J. S. Swift. Application date January 6th, 1939. No. 523484.

The British abstracts published here are prepared with the permission of the Controller of H.M. Stationery Office, from specifications obtainable at the Patent Office, 25, Southampton Buildings, London, W.C.2, price 1/- each.

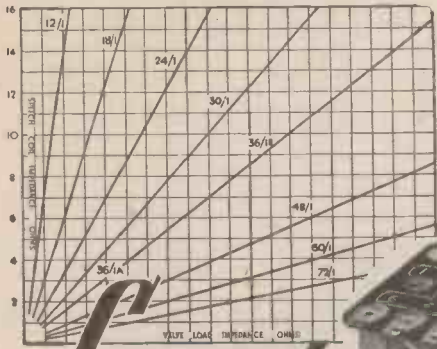

*This Chart makes matching with ONE transformer simplicity itself. Send for details including this chart.

Correct MATCHING with ONE Transformer

All output valves from 2,000 to 20,000 ohms (including Q.P.P., Class B, and P.P.) and speech coils of 1 to 16 ohms can be accurately matched with this ONE transformer. Due to a unique system of winding, high efficiency is attained on all ratios. Careful selection of insulation material assures exceptional freedom from breakdown.



RATIOS	LIST PRICE
12:1 18:1 24:1 30:1	6/3
36:1* 48:1* 60:1 72:1	
(*Centre tapped)	

Delivery from stock. Write for full description and data chart with tapping instructions.

GOODMANS INDUSTRIES LTD., Lancelot Rd., Wembley, Middx. Phone: Wembley 4001 (5 lines)

GOODMANS 101 MULTI-RANGE REPLACEMENT OUTPUT TRANSFORMER

Winter Boom in Extension Speaker Listening . . .



Cabinet Models from 21/6 This winter is introducing a rapidly increasing number of listeners to a new radio pleasure: "music where they want it"! Free from the restrictions of one-room radio, they are enjoying their favourite programmes in the Shelter, whilst working in the kitchen, or wherever it is convenient to listen; and all by the simple connection of a Stentorian Extension speaker to their existing radio. What's more, these handsome but moderately priced speakers offer an appreciable improvement in reproduction over most built-in speakers. Why not make full use of your radio this winter by installing a Stentorian?

Illustrated literature on request

MUSIC WHILE THEY WORK & SHELTER

WB Stentorian
THE PERFECT EXTRA SPEAKER FOR ANY SET
WHITELEY ELECTRICAL RADIO CO. LTD., MANSFIELD, NOTTS

HOW TO MAKE an A.C.-D.C. TEST SET

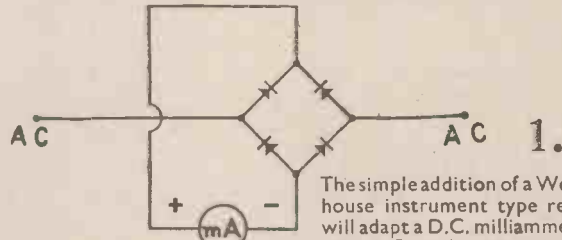

The simple addition of a Westinghouse instrument type rectifier will adapt a D.C. milliammeter to read A.C. milliamps with 11 per cent. higher full scale range.

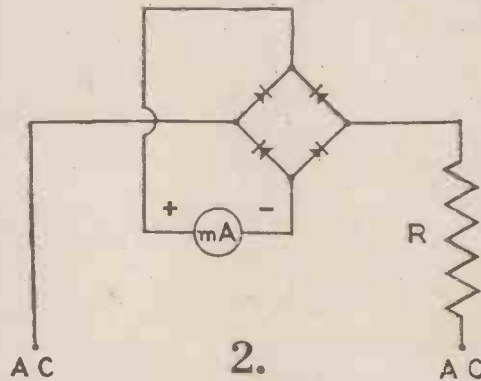

By adding a series resistance "R" the A.C. milliammeter is easily converted into an A.C. voltmeter. The value of "R" depends on the full scale reading required.

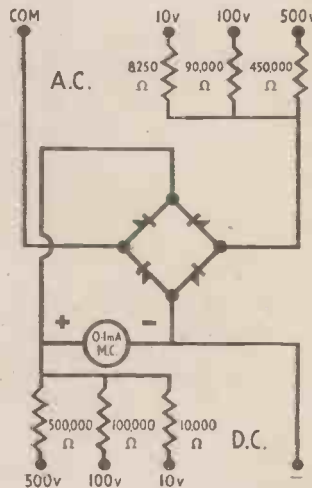

3. Descriptive pamphlet No. 11-B contains full details for the construction of a simple and robust A.C.-D.C. test set, suitable for reading D.C. and A.C. volts, and for measuring L.F. voltages in radio receivers. It also describes how the meter may be calibrated to read watts or decibels and also deals with the design of current transformers to enable high ranges of alternating current to be measured. Use the coupon and get your copy now.

Westinghouse
WESTINGHOUSE BRAKE & SIGNAL CO., LTD.,
Pew Hill House, Chippenham, Wilts.
enclose 3d. in stamps. Please send me descriptive pamphlet No. 11-B.

Name

Address

W.W.241

NO INCREASE IN PRICES

ELECTRADIX BARGAINS

NO INCREASE IN PRICES

AUTOMATIC CIRCUIT BREAKERS

Magnetically tripped switches that operate instantaneously. We offer, at a reduced price, Circuit Breakers of first-class make. In place of fuses on power circuits. Operate instantly on an overload or short, and can be switched on again at once. The operating coils can easily be arranged for remote control. With horn arc arrester in astatite, magnetic blow-out field, and solenoid current trip. Fireproof construction and bakelite or metal cover. Made in single, double, and triple pole. Prices are very low, and type marked with a star have thermal trip delay. Illustration shows S.P. with cover removed.



SINGLE POLE, HEAVY IRON CASE 250/400 Volt		
Rating 6 amps.	Type	Price
4	S 11/1G	11/6
10	S 11/1Z	13/6
16	S 11/1G	16/-
15	S 11/1Z	18/-

4in. x 5 1/2in. DOUBLE POLE, IRON CASED 300/500 Volt					
Rating 1 amp.	Type	Price	Rating 5 amps.	Type	Price
11	S 11/2Z	18/6	5	S 11/2Z	25/6
15	S 11/2Z	19/-	6	S 11/2Z	26/-
20	S 11/2Z	20/-	10	S 11/2Z	23/-
25	S 11/2Z	21/-	16	S 11/2Z	32/-
30	S 11/2Z	22/-	10	S 11/2Z	30/-
40	S 11/2Z	22/-	12	S 11/2Z	35/-
45	S 11/2Z	25/-	15	S 11/2Z	34/-

22 TRIPLE POLE, 3 TRIPS Light Iron Case 300/500 Volt			TRIPLE POLE, 3 TRIPS Heavy Iron Case 300/500 Volt		
Rating 800 m/a.	Type	Price	Rating 600 m/a.	Type	Price
3	S 11/3Z	25/-	800	S 11/3Z	27/-
3	S 11/3Z	24/-	1 amp.	S 11/3Z	24/-
4	S 11/3	21/-	2	S 11/3Z	22/-
6	S 11/3	32/-	3	S 11/3Z	26/-
10	S 11/3	38/-	4	S 11/3Z	28/-
15	S 11/3Z	45/-	4	S 11/3	23/-
			4	S 11/3Z	30/-
			6	S 11/3	36/-

ROTARY SWITCHES

Instrument type Rotary Back-panel Voltage Switches, with 40 sector contacts. Ideal for home-made multi-range meter sets, multi-tap chokes, power potentiometers or faders. Brand new, limited number, surplus on a contract. Finely made with front panel plate and knob. Type L40- Pre-tax Sale Price 7/6.

CURRENT ROTARY SWITCHES. 20 contacts, carry up to 10 amps., multi-blade brush. Back of panel type, as above. Type 11. Few only at 8/- each.

TYPE "S" SELECTOR RELAY SWITCHES.—8 arms of 25 ways each. Relay solenoid operated for distant control. As used in Tote and Auto phone exchange, 20/-.

SINGLE BLADE RELAYS.—No. 1 type 80D 1,000 ohms "on-off", s.p. 6 volts, 8 m.a. No. 2 type 82Z s.p. 2,000 ohms "on" only, 10 volts 5 m.a. 8/-.

OTHER SWITCHES

Small 7-stud on ebonite with plug, 1/8 Yaxley, wave-change, 2-gang with knob, one hole, 1/2. Keyrole Power Plug, 15 amps., shrouded panel wall, two pairs on box, unused, 10/- 8NAP Indicating on-off and change-over switches, carry 250 volts, 5 amps., 1/2; 10 amps., 1/6. Single-pole Change-over 10 amp. Switches, porcelain, 1/6. Double-pole, ditto, 3/6 R.A.F. 80B Series Parallel Barrel Switches, 5 amps., 2/-.

CHANGE-OVER. Send-Receive Switches on Ebonite. 2/- Unmounted Knife Switches, S.P., 10 amp., 4/6. D.P. C.O. 25 amp., 14/- Triple-pole Change-over, 30 amp., 22/6. D.P. Linked, 10 amp. G.E.C. Tumbler, in iron box, 2/6. G.P.O. Tumbler D.P. C.O., on mahog. base, 1/6.

A SPECIAL DESIGN IN AUTO-SWITCHES with time-lag tripping on 2 to 3 amps. Safety thermo switch with quick-break auto overload trip, for back of panel with front indicating knob, compact, 4in. x 2in. x 1/2in. deep. Any voltage up to 1,000 v. (as illus.) Only 5/6. Worth a Guinea.

SWEET AIR IN YOUR SHELTER, with a Lesdix Neron Ozonizer, cost almost nothing to run on A.C. mains and can be hung on the wall; 10 watts, 17/6; 25 watts, 25/-.

RADIO ROTARY CONVERTERS. For D.C. mains to 230 v. A.C. output. In silence cabinet, with filter. All sizes in stock, from 15 watts upwards, 30, 50, 100, 200, 400 and 800 watts, etc. Also 50-watt size 12 volts and 60 volts input. T.V.T. Sets, 6 volts to A.C., 25/-.

MOTORS. We still have a stock of fractional H.P. motors, A.C. and D.C., as well as large machines of all sizes and types.

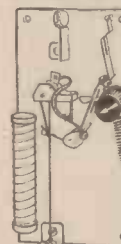

A SELECTION OF RELAYS

2 m.a. Table Relay. For Radio Work. Compact vertical type, enclosed. Screened 3,000 ohm coil, platinum contacts, single-pole change-over, 4 amp. contacts, wood base, metal case, size 2 1/2in. diam., 3 1/2in. high. Price only 8/-, G.P.O. glass top B. Relays are larger, twice the size, have massive platinum contacts, 15/-, some chipped, 10/-, a few without contacts, 5/-, 6d. postage.

TELEPHONE TYPE RELAYS. SINGLE BLADE RELAYS. No. 1a is a new special high resistance, 42,000 ohm, works on 1 m.a. Price 12/6.

No. 11 type 80D, 1,000 ohms, "on-off", s.p. 6 volts, 8 m.a., 7/- No. 2 type 82Z s.p., 2,000 ohms, "on" only, 10 volts 5 m.a., 8/- L.R. SERIES RELAYS. No. 13 type L.A., 1 ohm, 2 on 1 off, 12/6. No. 14 type L.B., ditto, 10 ohms, 12/6.

STAYPUT RELAYS. No. 15 type 1,950 ohm, 1,300 ohms, trip contacts "on" hand reset, 12/- No. 16, ditto, but reverse, contact set "on" by hand, trip-off coil, 1,500 ohms, 14 volts, 10 m.a., 12/-.

SUPERSENSITIVE MOVING COIL RELAYS. Work on tiny currents from photo-cells, etc. (1) The famous Weston Relay, open type, Model 30, 50/-, List price, 50 dollars. Mounted in mahogany case with glass top, 60/-, For panel, the 2in. meter type W1 works on 50 microvolts, with 150 mils. on main contact, 63/-

ELECTRO-MAGNETS for 250 volts 30 m.a., holds 14 ozs., 2/6. SOLENOIDS for remote work or relay, 4 and 6 volts, 1in. stroke and 1 oz. pull, silk-covered coil, metal frame, 3/6. Magnetic key, 10 amp. contacts, 6 volt, coil, 15/- Auto Cut-out and Cut-in Battery Switches, 15/-.

LIGHT AND BAY CELLS. Selenium, 10/6. Electro-cell, Self-generating, 25/- Raycraft outfit with relay and amplifier, 55/- Photo-Cells for sound on Film, Television and Ray work, R.C.A., 25/- Beck, Angle Prismas, mounted in carrier, 5/6.

VOICE RECORDING

VOICE-RECORDING MACHINE. Illuminated pedestal type, fitted automatic motor, disc recording gear and amplifier, by the Amusement Equipment Co., Ltd. Put 6d. in the slot and 125 words are recorded on tin disc, plays back to earphones. For voice letters to friends and relations, an acquisition to a canteen or entertainment depot; earns good fun fair money, only £22. Cost £90.

TWO DOMESTIC BARGAINS

AERIFRIGE DOMESTIC REFRIGERATOR. Cabinet size, 46in. high x 22in. x 20in., 31 cu. ft. capacity, white enamelled, New condition, £14.

UNIVOLT ELECTRIC DOMESTIC WASH MACHINE. 230 volt A.C./D.C. mains, 16in. dia., 23in. high, 9/8 gal., £4/10/-.

WORKS EQUIPMENT

230 Volts A.C. 2 1/2 kW. RECTIFIER EQUIPMENT, with 5 kW. transformer and Phillips valve, D.C. output, 230 volts 10 amps., £15.

TEST PANEL, with 4 meters for full-range works testing. Ranges 5 m.a. to 12 amps. D.C. or A.C., with rectifier and transformer, 5 volts to 500 volts, 7in. dial meter on steel panel, 27in. x 30in., £12.

4-RANGE A.C. WORKS AMMETER SWITCH, by Elliott, for 5, 25, 100 and 400 amps., with selector knife, £8/10/-.

DISTRIBUTION BOARDS. Polished Hardwood, glass door, clip fused, D.P., four of 12-way, one 8-way, two 6-way, six 5-way, all at 2/- per way.

ELECTRIC ENGRAVER AND TATTOO MACHINES. A.C. mains, 75/-.

VACUUM CLEANERS. "Pulvis" Large Hall Cabinet Type on wheels, fitted 1 h.p. motor exhaustor, 200 v. or 100 v. Cost £22. Set, £5.

ZET OZONIZERS for air purification. 1 Tube Units, 10/6. Complete in white enam. wall case, 9in. x 3in. x 3in., with flex and plug, 12/6; 2 Tube Units, 15/-.

WAX HEATERS. Electric Automatic Wax Sealers, all brand new and copper clad, 7/6.

ELECTRIC CLOCK. Movements 230 volts A.C., less hands, 10/-

ELECTRO-MAGNETS. Powerful 20 model, 18 gauge bobbin 110 v., lift 7 lbs., 3/6; 220 v. D.C. lift 12 lbs., on A.C. 14 lbs., 3/6. 1 h.p. Morse Chain and Wheels, 5/- set. Skewgear Boxes, 1 h.p., 10/- Gear Boxes, 2-1 for 1 h.p., 4/6. Electric Governors, 7/6. Bowden R.A.F. Remote Controls, 18 points, 7/6.

ELECTRIC DRILL STANDS. Massive Wolf rib and fall with counterweight; suitable large or small machines, 10/6, carriage forward.

LENS GRINDING MACHINE. Oscillating movement for motor drive, £3/10/-.

200 TRUE-TWIN CAMERASCOPES, 2 lens viewers, 1/- post free.

COMPRESSORS Only for Refrigerators or Tyre Pumping, £3. Brass Unions, 1/- Stop Valves for refrigerators, 2/6.

ELECTRIC GOVERNORS. Centrifugal control, 1,500 r.p.m. contacts, brushes, slip rings for auto speed regulation, 7/6.

PUMP FLOAT SWITCH, 45/- Double-pole, 55/- Foot Valves, 1in., 2/6. Welded Steel 1 pint H.P. Containers or Surge Pots, 2/6.

TRAINING AIDS FOR NAVY, ARMY AND R.A.F.

L.P. SOLO PHONES. For buzzer Morse. Single Earpiece, 40 ohms, with cord, 1/3. Ditto, D.3, 60 ohms, with cord, 1/6. W.E., 1,000 ohms, with cord, 2/- 2,000 ohms Earpiece, with cord, 2/6.



L.R. DOUBLE HEADPHONES. Pilot Signalers 120 ohms Phones All leather headbands with slide adjustment chin strap and 4in. cord, 3/6. Sullivan 120 ohms. Aluminium Headbands, 3/8.

RADIO PHONES. Brown, A Read Phone, aluminium headband, 4,000ohms, 35/6. 1,500 ohms 21/6. 120 ohms 17/6. Cords, 1/6. Various Makes. Sec'd hand Headphones in good order, 2,000 ohms and 4,000 ohms, 4/6 and 6/6, with cords. Western Electric, 2,000 ohms, 4/6.

TAPPER KEYS for Morse Signal Transmission. Service 81ent Practice Keys, 3/- T.X. Practice Key, front contact, on black moulded base, a good small key, 3/6. Long bar Type Practice Key, T.X.2, with cranked bar, 5/6. Superior Model B2, with key on polished wood base, 7/6. Operators P.F. plated pivot bar and terminals, mahogany base, 9/6. Type I.V. Superior ditto, nickel-plated pivot bar and fittings, on polished base, 10/6. Panel Keys to fold up flat, 6/6. Fullerphone double acting Morse Key, solid brass on heavy base, 7/6. Three-colour light Switch Box, with Morse key for code signals, 4/6. S.G. Brown totally enclosed type, 42/-.

LEARNERS' MORSE PRACTICE SET. Special Duplex with Key Buzzer and Lamp for sound and visual, 10/- Heliographs and tripods.

BUZZERS, small type, with cover, 1/6. Power Buzzers, with screw contact and adjustable armature, 2/6. Heavy Buzzers, in Bakelite case, 3/6. Siemens Morse Line Transmitters, with key and brass-cased Power Buzzer, 17/6. Magneto Exploders, 25/-.

PORTABLE FIELD PHONES FOR LISTENING POSTS AND A.E.P. Leather case W.D. Type 135. Service Field Phones are difficult to get at the present time. Solid but serviceable. Cases, Morse keys, mike and phone.

EXCHANGES, Plug type, 5-line and 20-line. Wire and cables cheap.

TELEPHONES for all purposes. House Shelter and Office.

COMPASSES. W.D. Marching Compass, jewelled, course setter, etc., mahogany case, 5in. x 3in. x 1in., 10/- W.D. Prismatic Watch type, brass case, 800ing card-folding prism, 35/- Mariner's Bin. Binnacle Boat Compass, portable, gimbal bases, etc., 45/- Kelvin Ship Compass, pattern 14, liquid type, Mahogany case, 10in. x 10 1/2in. x 7 1/2in., 60/- Plain lin. Pocket Compass, 1/-.

MORSE RECORDERS. Ex W.D. Standard G.P.O. Paper Tape lickers record Morse signals automatically. Work direct on line or through relay on radio, mahogany base drawer contains reel. All are in good order, £7. Super Type, £8.

H.T. BATTERY SUPERSEDERs. £ 85 v. at 6 m.a. for H.T. from your 2-volt battery, no H.T. batteries, 7in. x 4in. x 3in. Bakelite finish, Vibrator and Metal Rectifier, by S. G. Brown. Sale 37/6. Full guarantee. Type S, for larger sets. Can be supplied for either 5-volt, 4-volt or 6-volt battery. Model 10, output D.C. 120 volt, 10 m.a., 2 taps, 65/- Model 20, output D.C. 135 volt, 20 m.a., 3 taps, 70/- VIBRATORS, G/12 volt car type, 4 amp., 10/-.

PETROL ELECTRIC GENERATING SETS for Lighting and Charging. Half h.p. DIRECT COUPLED, 150 watts D.C., 1,300 r.p.m., 2-stroke water-cooled 1-cyl. Engine, magneto ignition. On bedplate with 30 volts 5 amps. Dynamo, £12. 75 Larger size, 1 kW. Petrol Electric Sets, 500 watts, 2-stroke water-cooled 1-cyl. Engine, magneto ignition, fuel and oil tank, £16

COMPASSES. W.D. Marching Compass, jewelled, course setter, etc., mahogany case, 5in. x 3in. x 1in., 10/- W.D. Prismatic Watch type, brass case, 800ing card-folding prism, 35/- Mariner's Bin. Binnacle Boat Compass, portable, gimbal bases, etc., 45/- Kelvin Ship Compass, pattern 14, liquid type, Mahogany case, 10in. x 10 1/2in. x 7 1/2in., 60/- Plain lin. Pocket Compass, 1/-.

MORSE RECORDERS. Ex W.D. Standard G.P.O. Paper Tape lickers record Morse signals automatically. Work direct on line or through relay on radio, mahogany base drawer contains reel. All are in good order, £7. Super Type, £8.

H.T. BATTERY SUPERSEDERs. £ 85 v. at 6 m.a. for H.T. from your 2-volt battery, no H.T. batteries, 7in. x 4in. x 3in. Bakelite finish, Vibrator and Metal Rectifier, by S. G. Brown. Sale 37/6. Full guarantee. Type S, for larger sets. Can be supplied for either 5-volt, 4-volt or 6-volt battery. Model 10, output D.C. 120 volt, 10 m.a., 2 taps, 65/- Model 20, output D.C. 135 volt, 20 m.a., 3 taps, 70/- VIBRATORS, G/12 volt car type, 4 amp., 10/-.

PETROL ELECTRIC GENERATING SETS for Lighting and Charging. Half h.p. DIRECT COUPLED, 150 watts D.C., 1,300 r.p.m., 2-stroke water-cooled 1-cyl. Engine, magneto ignition. On bedplate with 30 volts 5 amps. Dynamo, £12. 75 Larger size, 1 kW. Petrol Electric Sets, 500 watts, 2-stroke water-cooled 1-cyl. Engine, magneto ignition, fuel and oil tank, £16

COMPASSES. W.D. Marching Compass, jewelled, course setter, etc., mahogany case, 5in. x 3in. x 1in., 10/- W.D. Prismatic Watch type, brass case, 800ing card-folding prism, 35/- Mariner's Bin. Binnacle Boat Compass, portable, gimbal bases, etc., 45/- Kelvin Ship Compass, pattern 14, liquid type, Mahogany case, 10in. x 10 1/2in. x 7 1/2in., 60/- Plain lin. Pocket Compass, 1/-.

MORSE RECORDERS. Ex W.D. Standard G.P.O. Paper Tape lickers record Morse signals automatically. Work direct on line or through relay on radio, mahogany base drawer contains reel. All are in good order, £7. Super Type, £8.

H.T. BATTERY SUPERSEDERs. £ 85 v. at 6 m.a. for H.T. from your 2-volt battery, no H.T. batteries, 7in. x 4in. x 3in. Bakelite finish, Vibrator and Metal Rectifier, by S. G. Brown. Sale 37/6. Full guarantee. Type S, for larger sets. Can be supplied for either 5-volt, 4-volt or 6-volt battery. Model 10, output D.C. 120 volt, 10 m.a., 2 taps, 65/- Model 20, output D.C. 135 volt, 20 m.a., 3 taps, 70/- VIBRATORS, G/12 volt car type, 4 amp., 10/-.

PETROL ELECTRIC GENERATING SETS for Lighting and Charging. Half h.p. DIRECT COUPLED, 150 watts D.C., 1,300 r.p.m., 2-stroke water-cooled 1-cyl. Engine, magneto ignition. On bedplate with 30 volts 5 amps. Dynamo, £12. 75 Larger size, 1 kW. Petrol Electric Sets, 500 watts, 2-stroke water-cooled 1-cyl. Engine, magneto ignition, fuel and oil tank, £16



Stamped envelope must be enclosed for Free Bargain List "W" or for replies to enquiries.

ELECTRADIX RADIOS

LONDON'S LARGEST SUPPLIERS OF BARGAINS IN RADIO, ELECTRICAL, MECHANICAL AND SCIENTIFIC INSTRUMENTS, 218, UPPER THAMES ST. LONDON, E.C.4. Telephone: Central 4611

**Wireless
World**

CLASSIFIED ADVERTISEMENTS

THE CHARGE FOR ADVERTISEMENTS in these columns is

12 words or less, 3/- and 3d. for every additional word.

Each paragraph is charged separately and name and address must be counted.

SERIES DISCOUNTS are allowed to Trade Advertisers as follows on orders for consecutive insertions, provided a contract is placed in advance, and in the absence of fresh instructions the entire "copy" is repeated from the previous issue: 3 consecutive insertions, 5 per cent.; 6 consecutive, 10 per cent.; 12 consecutive, 15 per cent.

ADVERTISEMENTS for the March issue are accepted up to First Post on Monday, February 10th, at the Head Offices of "The Wireless World," Dorset House, Stamford Street, London, S.E.1. (or one day earlier at the Branch Offices, 8-10, Corporation Street, Coventry; Guildhall Buildings, Navigation Street, Birmingham, 2; 260, Deansgate, Manchester, 3; 26a, Renfield Street, Glasgow, C.2.

Advertisements that arrive too late for a particular issue will automatically be inserted in the following issue unless accompanied by instructions to the contrary. All advertisements in this section are subject to prepayment.

Cheques and Postal Orders sent in payment for advertisements or deposits should be made payable to **ILIFFE & SONS Ltd.**, and crossed. Notes cannot be traced if lost in transit. They must therefore be regarded as being despatched at sender's risk. Alternatively, they may be sent per registered post.

All letters relating to advertisements should quote the number printed at the end of each advertisement and the date of the issue in which it appeared.

The proprietors are not responsible for clerical or printers' errors, although every care is taken to avoid mistakes. They also retain the right to refuse or withdraw advertisements at their discretion.

NEW RECEIVERS AND AMPLIFIERS

A NEW 200-watt A.C. Amplifier, with provision for gramophone and microphone input, 2 Tungram P.100/1,000 valves; bargain.—Box 2562, c/o *The Wireless World*. [9380]

£13/10 Only, usual price £22.—*Wireless World* 2 R.F. Receiver with push-pull quality amplifier, 10 valves, including tone control stage, 8 watts triode output, ideal for quality reproduction from radio and gramophone; limited number.—Bakers Selhurst Radio, 75, Sussex Rd., South Croydon. [9344]

RECEIVERS AND AMPLIFIERS SECOND-HAND. CLEARANCE. SURPLUS, ETC

PETO Scott Preselector, little used, offers; 23- or 27-valve Scott chassis and speaker wanted.—Box 2561, c/o *The Wireless World*. [9379]

EDDYSTONE E.O.R. Communication Receiver, nearly new; £35.—Cooknell, 38, Prior Deram Walk, Canley, Coventry. Tel.: 60512 Cov. [9395]

W.W. Type Quality Amplifier, Vortexion 500-500 transformer, S.S. chokes, new valves, 2 P.X.4s, 2 M.H.4s, M.H.4, M.U.12-14, Magnavox L.S. £3; radiogram cabinet, walnut, 30/-—101, The Avenue, Pinner 5101. [9398]

BANKRUPT Bargains.—Genuine offer; brand new 1939-40 fully guaranteed models, makers' sealed cartons, at 25 to 40% off present prices; also portables, midgets; send 1/6d. stamp lists.—Radio Bargains, Dept. W.W., 261-3, Lichfield Rd., Aston, Birmingham, 6. [9362]

Wanted

R.M.E.69 and **D.B.20**; cash.—Tregunna, High Cross St., St. Austell, Cornwall. [9375]

WANTED, pre-tuned Quality Receiver or similar Quality Receiver, prefer less amplifier.—3, Kirby Rd., Blackpool. [9392]

SOUND SALES Tri-channel Amp. (1939 or later), excluding 346 amplifier and speaker; also wanted Voigt corner horn (not home constructed), excluding speaker unit.—Write 113, Kingsfield Ave., Harrow, Middx. [9399]

AMPLIIFIER, 200 volts, 50 cycles, output about 10 watts, gram. and microphone switching; state price.—Box 2559, c/o *The Wireless World*. [9376]

WANTED, first class R.F. unit with short waves, to plug into W.W. 12-watt quality amplifier.—J. D. Davies, Lyth Hill, near Shrewsbury. [9369]

ARMSTRONG STRIVING

We are still striving to give our customers every satisfaction with regard to delivery and service. Actually the endeavour is greater than ever because the difficulties are greater than ever.

We know our old friends will realise that, through no fault of our own, lack of supplies have prevented us from accepting many of the orders received for various models of Armstrong Chassis.

As mentioned last month our Service Dept. is in full operation. This affords an opportunity for customers' old type chassis to be brought up to their original efficiency.

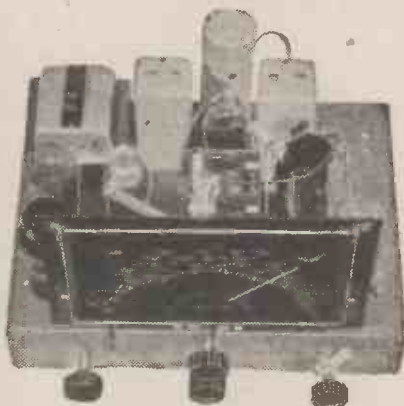

To readers who have a real need of a new wireless set, we have a few of our latest EXP48 Chassis so favourably reviewed in the October issue of "The Wireless World." Briefly, the specification is —

SPECIAL OVERSEAS MODEL EXP48
8-v. 4-BAND ALL-WAVE SUPERHET CHASSIS
(13-160m. continuous & normal Broadcast bands)
6 Watts Push-Pull Output.

Send for Illustrated Specification which fully describes this chassis with prices, etc.

ARMSTRONG MANUFACTURING CO.
WALTERS RD., HOLLOWAY, LONDON, N.7, ENGLAND
*Phone: NORth 3213

ACOUSTICAL MANFG CO.

SPECIALISTS IN

**Amplifiers, Transformers,
and all Sound Equipment**

have (owing to enemy
action) removed to:

**138-140, WARDOUR STREET,
LONDON, W.1,**

where our full services are available.

For the convenience of private advertisers, letters, other than circulars, etc., may be addressed to numbers at "The Wireless World" Office. When this is desired, the sum of 1/- to defray the cost of registration and to cover postage on replies must be added to the advertisement charge, which must include the words Box 000, c/o "The Wireless World." All replies should be addressed to the Box number shown in the advertisement, c/o "The Wireless World," Dorset House, Stamford Street, London, S.E.1. Remittances should not be sent through the post to Box Numbers.

DEPOSIT SYSTEM

Readers who hesitate to send money to advertisers in these columns may deal in perfect safety by availing themselves of our Deposit System. If the money be deposited with "The Wireless World," both parties are advised of its receipt. Notes and Money Orders save time. Cheques should be made payable to Iliffe & Sons Ltd., and are acknowledged to seller when "cleared."

The time allowed for decision is three days, counting from receipt of goods, after which period, if buyer decides not to retain goods, they must be returned to sender. If a sale is effected, buyer instructs us to remit amount to seller, but if not, seller instructs us to return amount to depositor. Carriage is paid by the buyer, but in the event of no sale, and subject to there being no different arrangement between buyer and seller, each pays carriage one way. The seller takes the risk of loss or damage in transit, for which we take no responsibility. Details of any arrangement made between parties which does not concur with any of the above conditions must be advised to us when the deposit is made. For all transactions whether a sale is effected or not a commission of 1 per cent. is charged on and deducted from the amount deposited (minimum charge 2/-). All deposit matters are dealt with by Iliffe & Sons Ltd., Dorset House, Stamford Street, London, S.E.1.

RECEIVERS AND AMPLIFIERS SECOND-HAND, CLEARANCE, SURPLUS, ETC

Wanted

WANTED Immediately, new and used sets, radio-grams, record players, automatic record changers, electric gramophone motors, etc.; quote make, model, type or catalogue number (see rear), and whether working or not; definitely best prices paid.—Snell, Arcade, Swansea. [9383]

PUBLIC ADDRESS

VORTEXION P.A. Equipment.
IMITATED, but unequalled.

WE Invite You to a Demonstration.

A.C.20 15-20-watt Amplifier, 38-18,000 cycles, independent mike and gram., inputs and controls, 0.037 volts required to full load, output for 4, 7.5, and 15 ohms speakers, or to specification, inaudible hum level, ready for use; 8½ gns. complete.

C.P.20 12-volt Battery and A.C. Mains Model, as used by R.A.F., output as above; 12 gns.

A.C.20, in portable case, with Collard motor, Piezo pick-up, etc., £14; C.P.20 ditto, £17/17.

50-WATT Output 6L6s, under 60 watt conditions, with negative feed back, separate rectifiers for anode screen and bias, with better than 4% regulation level response, 20-25,000 cycles, excellent driver, driver transformer, and output transformer matching 2-30 ohms impedance electronic mixing for mike and pick-up, with tone control, complete with valve and plugs; £17/10.

COMPLETE in Case, with turntable, B.T.H. Piezo pick-up and shielded microphone transformer; £22/10.

80-WATT Model, with negative feed back; £25, complete.

120-WATT Model, with negative feed back; £40, complete.

250-VOLT 250 m.a. Full Wave Speaker, field supply unit; 25/-, with valve.

WE are Compelled Through Rising Costs to Increase our Prices by 10%.

ALL P.A. Accessories in Stock; trade supplied.

SEE Our Display Advertisement on page 57 (Edit.).

VORTEXION Ltd., 257, The Broadway, Wimbledon, S.W.19. *Phone: Lib. 2814. [9232]



You just plug in with Solon Electric Soldering

With the Solon you can work wherever there's a lamp holder—and do better work! Solon Electric Soldering is easy, neat, strong and clean. No stopping to heat up—constant heat maintained at point. 15 hours soldering uses only 1 unit.



Made for following standard voltages:—200/220, 230/250.



Handyman model supplied complete with Resin-Cored Solder, Flex and Lamp Adaptor **9/4**

Solon Resin-Core Solder **6D.** per reel.

W. T. HENLEY'S TELEGRAPH WORKS CO. LTD.
(Dept. 23/E), Engineering Sales Dept., Milton Court, Westcott, Dorking, Surrey.

WORK OF NATIONAL IMPORTANCE

Skilled W/T Operators are required in practically every branch of the Services—Navy, Army, Air Force as well as for the Mercantile Marine, Commercial Companies and other work of National Importance.

Many who would like to become W/T Operators are located too far away from the few schools which they might attend, whilst others cannot spare the time taken, or are too tired after a day at business to travel to and from classes

THE CANDLER SYSTEM OF CODE TRAINING IS CARRIED OUT IN YOUR OWN HOME

The excellence of Candler Code Courses has accounted for the success of many thousands of present-day operators. Many readers of "The Wireless World" are taking Candler Courses. There are courses for the absolute beginner, and for those who want to improve their technique or bring up their w.p.m. speeds.

If you will fill in the Coupon below and post it in an unsealed envelope (postage 1d.) I will at once send you a copy of the "Book of Facts" and other essential information.

Courses supplied on Cash or Monthly Payment terms.

COUPON

Please send me a Free Copy of Candler "Book of Facts."

NAME

ADDRESS

Post Coupon in 1d. unsealed envelope to London Manager
CANDLER SYSTEM CO. (Room 55.W.),
121, Kingsway, London, W.C.2.

Candler System Co., Asheville, North Carolina, U.S.A.

NEW MAINS EQUIPMENT

VORTEXION Mains Transformers, chokes, etc., are supplied to G.P.O., B.E.C., L.P.T.B.; why not you?

WE are Compelled Through Rising Costs to Increase our Prices by 10%.

VORTEXION, Ltd., 257, The Broadway, Wimbledan, London, S.W.19. Phone: Lib. 2814. [9233]

NEW LOUD-SPEAKERS

BAKERS Brand New Surplus Speaker Bargains.

EVERY Music Lover Interested in Realistic Reproduction should write for free descriptive leaflet now.

£5; usual price £10.—Brand new permanent magnet infinite baffle speaker, complete with beautifully finished cabinet in polished walnut.

£2/10; usual price £5.—Brand new super quality triple cone speaker, permanent magnet model; exceptional bargain; limited number.

£1/12/6; usual price £3/5.—Brand new permanent magnet infinite baffle extension speaker, in rexine covered cabinet, the ideal extension speaker.

SECURE One of These Exceptional Bargains Now.

BAKERS Triple Cone Conversions Will Immensely Improve Reproduction of Your Present Speaker. ("For a few shillings you have converted a speaker scheduled for the scrap heap into one worth pounds.—W. E. Darby, Grad I.E.E.") Write for details.

BAKERS SELHURST RADIO, 75, Sussex Rd., 8th. Croydon. [9345]

SECOND-HAND LOUD-SPEAKERS

ROLA G.12, 2,500 ohms field; £2; wanted P.M. model.—Dawson, Jeweller, Halesworth. [9385]

SHORT-WAVE EQUIPMENT

G5N1 for Short Wave Equipment; largest stocks in the country; communication receivers; National agents; American and British Valves, etc. See advertisement on page 3.—44, Holloway Head, Birmingham. [0531]

"H.A.C." Short-wave Receivers, famous for over eight years; latest model one-valve now available; complete kit of precision components, accessories, full instructions, requiring no soldering; only 16/-, postage 6d.; illustrated catalogue free.—A. L. Bacchus, 109, Hartington Rd., S.W.8. [9322]

CABINETS

A CABINET for Every Radio Purpose.

SURPLUS Cabinets (Undrilled) from Noted Make.

WE Have Hundreds in Stock (no Catalogues); send measurements of chassis, etc., and say what kind of cabinet required; stamp for reply.

INSPECTION Invited.

H. L. SMITH and Co., Ltd., 289, Edgware Rd., W.2. Tel.: Pad. 5891. [9331]

DYNAMOS, MOTORS, ETC.

ALL Types of Rotary Converters, electric motors, battery chargers, petrol-electric generator sets, etc., in stock, new and second-hand.

A.C. D.C. Conversion Units for Operating D.C. Receivers from A.C. Mains. 100 watts output. £2/10; 150 watts output, £3/10.

WARD, 46, Farringdon St., London, E.C.4. Tel.: Holborn 9703. [0518]

BARGAIN.—110 volt, 0.8 amp. D.C. semi-enclosed, ball bearings, 1,850 revs., weight 15lb., size 6in.x5in.; no tax; cheap, 10/6, carriage forward.—L. Dixon, 218, Upper Thames St., E.C.4. [9400]

VALVES Wanted

25 B8GT Valve.—Lee, Wireless Depot, Pocklington, York. 9397

TAX-FREE STOCKS HAVE ALMOST GONE
New supplies will be 25% higher.

ORDER FREE OF TAX NOW!
L.R.S. EASY TERMS ON REQUEST.

RADIO RECEIVERS, &c.

VIDOR all-dry ARP receiver 320	£ 7 7 0
EVER READY all-dry Superhet	£ 10 0 0
ULTRA Model 70	£ 8 10 0

Part carr. 2/- extra on receivers.
HEAYBERD MODEL A 0-5 Battery Charger, Westinghouse 2-12 v. at 2 a.
AVO Universal AC/DC Test Meter 5 0 0
AVOMINOR Test Meter 8 10 0
VORTEXION AMPLIFIERS (see advt. page 57. Edit.). Now available from us on Easy Terms.

Write for quotation!
W.S. LOUDSPEAKER UNITS (Junior) 1 15 6

DOMESTIC ELECTRICAL GOODS

MORPHY RICHARDS IRONS, Auto-control Safety Model, post 1/- 1 5 0
MORPHY RICHARDS FIRES—
Tubular Major, 1 kW 1 7 6
Tubular Twin Beam, 1 or 2 kW 1 16 0
Cray Twin Beam, 1 or 1½ kW 1 1 0
Senior Twin Beam, 1 or 2 kW 1 7 6
ORMOND HAIR DRYER 1 12 6

State voltage and include 1/- carr. with order.
STUART-TURNER AC/DC CENTRIFUGAL PUMPS—
No. 10, 100 gals. per hour 4 10 0
No. 11, Pumps 250 gals. per hour 5 12 0
Foot valve and strainer 12/8 and 15/- extra (when water has to be lifted over 15ft.).

First-class construction. Ideal for A.R.P. Shelters.
LIONEL ELECTRIC TRAIN SETS. High-grade Goods of Passenger sets 4 4 0

CLOCKS, WATCHES, &c.

WESTMINSTER CHIMES CLOCKS—
With high-grade movements, 8-day, guaranteed Walnut cases 3 0 0
TRIPLE CHIMES CLOCKS—A few only available at 3 12 6
Postage 1/- extra.

GENTS' HIGH-GRADE 15-JEWEL Chrome WATCHES, RECTANGULAR MODEL, Swiss movement (wrist) . . . 2 2 0

REJUVENATE YOUR SHAVEMASTER by fitting a new 475 Comb and Cutter. Post free, 9/6 per set

Send 2d. stamp for illustrated price lists of any item. Terms: Cash with order or O.O.D.

LONDON RADIO SUPPLY CO.

Established 1925
All communications to evacuation address—
"WINDEN," ARDINGLY RD., BALCOMBE, SUSSEX

Masteradio
—MALLORY

VIBRAPACKS

PERFECT PORTABLE POWER

British-made Vibrator Power Supply Units employing the **WORLD-FAMOUS "MALLORY" VIBRATORS**

OUTPUTS of up to 30 watts from either 6 volt or 12 volt battery supply.

EFFICIENCY as high as 70% including rectification.

LIFE. Masteradio-Mallory Vibrators mean longer life. Longer life means **LOWEST COST PER HOUR ACTUAL USE**.

DEPENDABILITY. In Masteradio-Mallory Vibrapacks the Vibrator is working under ideal conditions, thus ensuring utmost dependability.

Used by the War Office, Air Ministry, G.P.O.

Let our Technical Dept. solve your portable power problems. Write for details:

MASTERADIO Ltd.

(Dept. W. W.) Vibrant Works,
RICKMANSWORTH ROAD,
WATFORD, HERTS.

'Grams: Mastialo, Watford. 'Phone: Watford 9885.

Ode
Partridge
No. 4

A SONG

Two little peasants, Hit and Muss,
Thought they'd like to run the bus;
Ranting much, and raising hands,
Caused revolutions in their lands.

Other folk looked on with smiles,
Ignorant of Dictators' wiles,
Till peaceful countries they o'erran
And Hitler was the "king-pin man."

Success is easy, thought this Hun,
When he got France on the run.
"Britain can't fight me alone,"
He sneered to Muss on the 'phone.

Musso thought he'd try his luck,
Went for Greece, got badly stuck.
Adolf sought to smash our nerve,
But found it on the upward curve.

What has this to do, you ask,
With Radio, our especial task?
We reply in tones sonorous:
The answer's in this little chorus:

Work a little longer,
Work a little more,
Then we shall be stronger
To get rid of this boor.
Sacrifice our hobbies,
Save all the cash we can,
Because it's hotter in the fire
Than in the frying pan.

Partridge and Staff, still battling on,
Join in the chorus of this song.
Though working harder than before,
Like Oliver Twist, can tackle more.

In 1940 much was done,
But what of 1941?
Truly shall we show the knaves
That Britons-NEVER shall be slaves.

N. Partridge
d.Sc., A.M.I.E.E.

King's Bldgs., Dean Stanley St.,
LONDON S.W.1

Telephone VICTORIA 5035.

WARD WE MANUFACTURE:
ROTARY CONVERTERS
DC/AC for operating P.A.
amplifiers, Radio Re-
ceivers, etc.
DC/DC ROTARY TRANS-
FORMERS, SMALL ALTERNATORS, SMALL
DC MOTORS, H.T. GENERATORS, MAINS
TRANSFORMERS up to 10 k.v.a. PETROL
ELECTRIC generator sets up to 50 k.v.a.
BATTERY CHARGERs for private and industrial use
We can also handle general
small engineering work.
Full details of any of the above upon request
CHAS. F. WARD
46, FARRINGTON ST., LONDON, E.O.4
Telephone: Holborn 9703.
Works: Bow, E.

COMPONENTS

SECOND-HAND CLEARANCE, SURPLUS, ETC.,

G. A. RYALL, "Arnehurst," Marsh Lane, Taplow,
G. Bucks (late Ryalls Radio of London), offers radio
goods, all new, unless otherwise stated. Post free.
Minimum orders 1/3, please.

ROLA 10in. 2,000 ohm Energised Speakers, pentode
transformers, with over 11 yards 3-way rubber
cable with 5-pin plug, with 4-prong winder, in portable
rexine carrying case, leather handle, brown finish,
nickel plated corners. Note, speaker aperture is 8in.
only; made for Pathe cine outfit, in original wrap-
pings, size 16½in. square, 7½in. deep; .17/9 each.

SPEAKER Only, as above, 9/6; cable and plug only,
as above, 2/9; case with cable holder, as above,
7/9.

SPEAKERS as Above, in portable cases, slightly
soiled or marked, 10/9 each, less cable; amplifier
carrying cases, 20in. x 12in., 4/9.

AMPLIFIER Chassis Complete, ex the Patescope
cine outfit, contains the two mains transformers
as below, two Hunts 8 mf. 500v. Mansbridge 2x1 mf.,
pair low voltage cathode condensers, group board with
resistances as below, toggle switch, T.C.C. 0.01, two
Erie resistances, 5-pin socket for speaker, fully wired,
with mains leads and double adaptor, flat pancake-type
chassis (SG as LF valve, pentode output, rectifier),
gramophone input socket, three valve holders, less
valves; 18/6 the lot, carriage paid.

MAINS Transformers, made by Standard Telephones
for Pathe amplifier, input 110-250v. A.C., out-
puts 350.0-350v. 120 ma., 4v. 2½ amp., 4v. 4-5a.,
special heavy primary, used as 250v. Auto trans. for
other items below; can be used as 300w. auto trans-
former, drop through type, size 5½x4½x2in. deep;
10/9 each, used, as new.

A.C. Induction Motors, fitted with fan cooling, 1.500
revs, one-tenth horse power, 110v., for use with
above transformer, supplied 8 mf. paper block con-
denser, as used motors, fitted 4-pin plug; 14/9, used,
as new.

A.C. Transformer, input 110v., for use with above
transformer, secondaries 10v. and 20v. at 5 amps
and 8 amps; 4/9.

CELESTION Ring Cone 10in. Speakers, medium
pots, 1,000 ohms, less transformers, 8/9 each;
white finish. Celestion speakers, 10½in., brown
finish, less transformers, 600 ohm and 1,400 ohm,
robust magnets, 8/9 each. Celestion 9in. 2,000 ohm,
with pentode transformers, 8/9 each. Magnavox 152
type heavy magnets, with pentode transformers, 1.650
ohms, 10/6. Few only.

CELESTION 10in. Speakers, less transformers, with
4-pin Octal plug, fields 1,500 ohms, special curved
(exponential type) cones, good bass response; 7/9 each;
all have normal speech coils, about 2 ohms.

NOTE.—All above speakers are energised types, and
not permanent magnet, of which we have none
to offer at present, and are not suitable for use as
extension speakers unless suitably energised.

BLOCKS Containing Two Large Capacity Mans-
bridge Condensers, low voltage, for cathode by-
pass, inverted chassis type; 1/6 each.

AMERICAN Valves, sets three, 2-volt American
bases, 1A4 VM/HFP, 1B4 HFP, 2101 ½-watt
output Pentode; 6/6 the set of three; suit. Philco sets.

R.C.C. Units on Small Paxolin Panel, comprise
T.C.C. 0.01 mica condenser, 0.15 non-inductive
tubular, 2 meg. and 4 meg. ½-watt resistances; two
for 1/6.

SPECIAL Note.—We are now confining our business
to mail orders, and shall be able to give prompt
attention from a quiet situation.—G. A. Ryall, "Ar-
nehurst," Marsh Lane, Taplow, Bucks. [9402

PREMIER RADIO.

PLEASE See Our Displayed Advertisement on
page 5. [0488

SOUTHERN RADIO'S Wireless Bargains.

ALL Goods Previously Advertised Still Available.

SOUTHERN RADIO, 46, Lisle St., London, W.C.
Gerrard 6653. [9338

VAUXHALL—Rola 8in. P.M. speakers, with trans-
former, 14/9; volume controls, 2/3, with switch
3/-.

VAUXHALL—Electrolytic condensers, 8 mfd., 500v.,
2/3; 8+8 mfd., 500v.; 3/6; 3-gang bandpass-
H.F. iron-cored tuning coils, 19/6.

VAUXHALL UTILITIES, 163a, Strand, London,
W.C.2. Postage extra orders under 3/-; 1d.
stamp for list. [9372

L.T. Metal Rectifiers, 12v. 1 amp. 4/6; Instrument
type rectifiers for meters, 8/6; crystal micro-
phones, famous maker, 52/6.—Champion, 42, Howitt
Rd., London, N.W.3. [9387

COULPHONE Radio, New Longton, Preston.—
Prompt personal service. Tungram valves; guar-
anteed American valves, 5/9 to 6/9, including Octal.
Dubilier and Erie 1-watt resistors, 4/3 doz.; Cosmo-
cord Series III crystal pickups, 23/6; Rola G12
speakers 2,500 field, 57/6; Rola 8in. P.M., 15/6;
Rola 10in. P.M., 22/6; all with transformers; service
accessories; lowest prices; stamp for list. [9381

AN EXCELLENT OPPORTUNITY!

For Gramophone or Microphone use
in the Home, Office or Factory,
This Modern 5-watt, 4-Valve 220-volt
A.C. AMPLIFIER CHASSIS
is an outstanding bargain.



Two Triodes in output stage. HI-GAIN Screened
Grid I.F. stage. Designed for energised M.C. Speaker
may be adapted for P.M. Speaker by using field
replacement choke. Limited supplies only of this
repeatably offer. Price, including valves and
Output Transformer **£3 . 5 . 0**
Energised Speaker to suit, 15/-.

MICROPHONES Heavy
duty, double button type.
Chromium-plated case. Gold-
plated electrodes. High out-
put. Good Quality. With
mounting clips and springs,
£1.15.0.



TRANSFORMERS for above
microphone, 7/6.



AUDAK PICK-UP HEADS.
High resistance coll, 6/6.

AUDAK CUTTING HEADS
(Heavy duty). 3-5 ohm coll. High
quality instrument, 17/6.

**B.T.H. CAPACITOR
GRAMOPHONE MOTORS**,
with 5-Inch Turntable, 100-250
volts, 22/6; an unusual Bargain!

SINGLE EARPIECES, with flexible metal
sheathing, chrome plated, 2/6.

**ELECTRO-MAGNETIC COUN-
TERS**, Resistance 500 ohms, counting
from 1 to 12,999, 9/6.

Smaller Type, 1 to 1,000, 5/6.

Useful for innumerable purposes.
TELEPHONE HAND SETS. Second-
hand, in good order. Ideal for A.R.P.,
etc., 6/6.



WESTINGHOUSE RECTIFIERS.
Type H.T.8, slightly used. Guaranteed
O.K., 8/6.

**COMPLETE MOTOR-DRIVE TUNING
ASSEMBLY**. Including 2-gang .0005 condenser,
tuning motor with muting switch and homing
commutator and station selector. With 8-Button
push-button switch, 25/- Full details supplied.



**B.T.H. HEAVY
DUTY RECORDING
MOTORS**.
79 r.p.m. capacitor
type, 220 volts A.C.
50 cycles, baseboard
or under-baseboard
mounting. Weight
7lbs. Without Turn-
table, but including
Capacitor, £2.2.0.

SMALL REVERSIBLE A.C. MOTORS (as used
for motor tuning). 25-30 volts A.C. Built-in
reduction gear spindle. Speed about 60 r.p.m. A
first-class job with hundreds of applications, 8/6.

TAPPED MAINS RESISTANCES for .2 amp.
valves tapped 200, 230-250, 4/-.

RAYTHEON VALVES. Types 24, 3/6; 45, 3/6;
80 Rectifier, 5/3.

SATOR .5 meg. Volume Control and switch, 1'
spindle, 1/9.

LONDON CENTRAL RADIO STORES
23, LISLE STREET, LONDON, W.C.2
'Phone: GERard 2969.

ELECTRICAL AND WIRELESS EQUIPMENT OF AIRCRAFT

Including Repair, Overhaul and Testing of Magnets
By S. G. Wybrow. The primary object of this book is to indicate to ground engineers, in broad outline, the basic principles of design, together with notes on the care and maintenance of equipment, fault realisation and repair. A volume in the Aeronautical Engineering Series—Ground Engineers.
Fourth Edition. 5s. net.

SHORT WAVE RADIO

By J. H. Reyner, B.Sc. (Hons.). An essential handbook for those wishing to become thoroughly familiar with the subject, whether from the Services' point of view, or for experimental reasons. Covers every phase of the subject, with useful references to up-to-date books and articles on specialised branches.
Second Edition. 10s. 6d. net.

THE SUPERHETERODYNE RECEIVER

Its Development, Theory and Modern Practice
By Alfred T. Wits, A.M.I.E.E. A well-known book which the R.A.F. candidate in particular will find invaluable. Makes every detail of the subject understandable and provides essential working knowledge required by every keen amateur, radio student and service engineer.
Fourth Edition. 4s. 6d. net.



PITMAN BOOKS



FOR THE RADIO SERVICE MAN, DEALER AND OWNER

The man who enrolls for an I. C. S. Radio Course learns radio thoroughly, completely, practically. When he earns his diploma, he will KNOW radio. We are not content merely to teach the principles of radio, we want to show our students how to apply that training in practical, every-day, radio service work. We train them to be successful!

INTERNATIONAL CORRESPONDENCE SCHOOLS

Dept. 38, International Buildings, Kingsway, London, W.C.2.
Please explain fully about your instruction in the subject marked X.

Complete Radio Engineering
Radio Service Engineers

Elementary Radio Television

If you wish to pass a Radio examination, indicate it below.

Inst. of Wireless Technology
P.M.Q. Certificate for Wireless Operators
Provisional Certificate in Radio Telephony and Telegraphy for Aircraft
City and Guilds Telecommunications

Name..... Age.....
Address

(Use penny stamp on unsealed envelope.)

COMPONENTS—SECOND-HAND, CLEARANCE, SURPLUS, ETC.

RADIO CLEARANCE, Ltd.

PLESSEY 4-waveband Coil Units with Switching, fully screened, pre-H.F. stage, 465 k/c oscillator, 13 metres-2,000 metres, 21/-; I.F. trans., 2/6 each extra.

2-VOLT Output Pentode Valves, 5-pin, unboxed; 2/11 each.

LISSEN 2-volt Battery Pentodes, 4-pin, side terminals, P.T.2A.; 4/11 each.

LISSEN Rectifier Valve, U650; 2/11 each.

LOW-LOSS Ceramic Valve Holders, Lissen Hi-Q baseboard and chassis, 7-pin; 1/- each.

MANSBRIDGE Type Condensers, Lissen Hi-Q 250 D.C. working, moulded cast with feet, 1 mid.; 6d. each.

LOW-LOSS Short Wave Variable Condensers, ceramic insulation, brass vanes, Lissen Hi-Q, minimum capacity 5 microfarads, two types, boxed, with knobs, 160 mid., list 7/6 each, our price 3/- each; 20 mid., list 5/6 each, our price 2/6 each.

ROTARY Coil Units, Lissen Hi-Q, 4-band from 4.8-9.1 metres, can be selected by turn of knob, with circuit, boxed, list 15/6; our price 6/11 each.

PUSH/PULL Switches, Lissen 2-point, 4d. each; 3-point, 6d. each.

YAXLEY Type Switches, 4-pole, 3-way, 9d. each; Yaxley switches, 4-bank, 2-pole, 4-way, 2/6 each; Yaxley switches, 6-bank, 3/- each; Yaxley switches, 9-bank, 3/6 each.

AMERICAN Line Cords, with fittings, 3/6 each; 3-way American line cords, 450 ohms resistance, 3/6 each.

ROLA P.M. Speakers, latest model, 7/8in. cone, with power and pentode transformer; boxed, 15/- each.

MAGNAVOX 10in. Energised Speaker, field resistance 3,000 ohms; 12/6 each.

CLOCK-FACED Dials, 5in.x5in., with printed scale, 3-wave; 2/6 each.

STRAIGHT-LINE 3-waveband Dials; 1/11 each.

MAINS Transformers, G.E.O. American windings, 350-0-350v. 65m.a., 6.3v. 2.5 amps., suitable for replacements in G.E.C. models; 6/6 each.

MAINS Transformers.

WEARITE R.C.1 250-0-250v. 80 m.a., 4v. 2.5 amps., 9/11 each; R.C.2 350-0-350v. 120 m.a., 4v. 2.5 amp., 4v. 4 amps., 12/6 each; R.C.3, 350-0-350v. 150 m.a., 4v. 2.5 amps., 4v. 2 amps., 4v. 5 amps., 15/- each; R.C.4 500-0-500v. 150 m.a., 4v. 2 amps., 4v. 2 amps., 4v. 2.5 amps., 4v. 5.6 amps., 21/- each; R.C.5, 100-watt auto transformer, 100-110v., 200-250v., reversible, 14/11 each; all above transformers 200-250v. tapped primaries; R.C.D. drop-through type capped, 350-0-350v. 100 m.a., 5v. 2 amps., 6.3v. 5 amps., 10/6 each.

CHASSIS Mounting Valve Holders, American, 4-5-6 pin, 4d. each; Octals, 6d. each; Loctal, 10d. each.

CHASSIS Mounting Valve Holders, English Cliz type, 4-5-7-pin, 3d. each; valve-holders, Celestion 5- and 7-pin, chassis type, 4d. each; baseboard type, 5-pin, 2d. each.

VOLUME Controls, Centralab, spindles length 2 1/2in., with switch, 100,000, 250,000, 500,000 and 1 meg., 2/11 each; Centralab 1 meg. volume controls, with switch, 1 1/2in. spindle, 2/- each.

CENTRALAB Midget Volume Controls, 2,000, 5,000, 25,000, 50,000, 100,000, 500,000 ohms, less switch, 2/9 each; 1,000, 25,000, 50,000, with switch, 3/6 each.

SPEAKER Transformers, pentode output, 3/6 each.

PRESS-BUTTON Units, size of unit 6in. x 6in. x 2in., complete with 6 press buttons and capacitors, 4/11 each.

12-WAY Push Button Switches, 1/6 each; 11-way ditto, 1/6 each; 6-way ditto, 1/- each; 7-way ditto, 1/- each.

SPEAKER Cabinets, suitable for 8in. speaker; 4/6 each.

DRIPPING Resistances, for all purposes, total resistance 535 ohms., 5 taps in steps of 50 ohms., standard for Pye, Lissen, Ever-Ready, etc.; 3/- each.

PUSH Back Connecting Wire; 1d. per yard.

10 FT. Coils Connecting Wire, glazed; 4d. each.

DUAL Capacitors, 300x600; 4d. each.

I.F. Transformers, 465 k/c, in 1 1/2in. cans; 2/6 each.

COIL Kit, for superhet circuit, including 2-gang straight condenser, aerial coil assembly, oscillator coil assembly, and 2,465 k/c I.F. transformers; with circuit diagram, 8/11 each.

(This advertisement continued on next page.)

ENGINEERING OPPORTUNITIES

This unique Handbook shows the easy way to secure A. M. I. C. E., A. M. I. Mech. E., A.M.I.E.E., A.M.I.A.E., A. M. I. W. T., A.M.I.R.E., and similar qualifications. WE GUARANTEE—NO PASS—NO FEE. Details are given of over 150 Diploma Courses in all branches of Civil, Mech., Elec., Motor, Aero, Radio and Production Engineering, Draughtsmanship, Training, Inspection, Government Employment, BUILDING (the great after-war career), R.A.F. MATHE., etc. Write for this enlightening Handbook to-day. FREE and post free. Men with Radio knowledge can obtain attractive posts in the Services.

BRITISH INSTITUTE OF ENGINEERING TECHNOLOGY, 387 Shakespeare House, 17, 18, 19 Stratford Place, London, W.1

FREE 208 PAGES

CABINETS

for
RADIO AND RADIO INSTRUMENTS

In Wood, Metal, Rexine, etc.

Details of Radio Cases for the Home will be forwarded on receipt of 2½d. in stamps.

LOCKWOOD & CO. (Dept. W.)
65, LOWLANDS ROAD, HARROW,
MIDDLESEX
Phone: BYRON 1818

MAINS TRANSFORMERS

Mains Transformers to customers' own specifications, or in accordance with our standard list—of which we would be glad to send you a copy.

Westmoreland Road, London, N.W.9
Telephone: Colindale 7131.

W. BRYAN SAVAGE LTD

THE INSTITUTE OF WIRELESS TECHNOLOGY
(Founded in 1925. Incorporated 1932)

PROFESSIONAL MEMBERSHIP

The advantages of professional membership are open to all qualified wireless engineers.

Full information, with syllabus, may be obtained from the Assistant Secretary, Institute of Wireless Technology, 25, Firs Drive, Palmers Green, London, N.13.
Phone: PALMERS GREEN 2413

VALVES—American and British types—large stocks carried.

Send Trade-card (and 2½d. stamp) for Price-Lists and Comparative Charts, to:

LEONARD HEYS, 36, Henry Street, Blackpool, Lancs. (Established 1922.)

TRIX **SOUND EQUIPMENT**

RELIABLE AMPLIFICATION
The TRIX ELECTRICAL COMPANY LTD.
65, Bolsover St., London, W.1, Euston 5471

**COMPONENTS—SECOND-HAND,
CLEARANCE, SURPLUS, ETC.**

(This advertisement continued from previous page.)

- P**HOT Lamps, 6.3 0.3 amps.; 6d. each.
- P**LESSEY Single Gang 0.0005 Variable Condensers; 1/6 each.
- T**.C.C. 8 Mfd. Tubulars Electrolytics; 1/6 each; 150v.
- B**.I. Wire-end Bias Electrolytics, 50 mfd., 12v.; 1/6 each.
- T**UBULARS, wire-end, non-inductive paper condensers, all sizes up 0.01, 5d. each; 0.1, 7d. each.
- B**.I. 4 Mfd. Tubulars, 1/9 each; ditto, 2 mfd. tubulars, 1/3 each; B.I. 8 mfd. cartons, 2/11 each.
- C**ONDENSERS, 0.0005 twin, 1/3 each; triple, 1/9 each.
- L**ISSEN Mica Condensers, our assortment; 2/- dozen.
- R**AYTHEON Valves, first grade; largest stockists; all types stocked, including glass series, glass octal series, metal series, bantam series, single-ended metal series and resistance tubes.
- A**LL at Most Competitive Prices; send for lists.

ALL Orders Must Include Sufficient Postage to Cover. Hours of business: Week-days, 9-4. Saturdays 9-1 p.m. Please write your name in block letters. We cannot undertake to answer enquiries unless full postage included (2½d.).

RADIO CLEARANCE, Ltd., 95, High Holborn, London, W.C.1. [9404]

Wanted

- C**ONTRAST Expansion Unit (W.W., Dec. 9th, 1937).—Widdup, Reedham, Poynton Park, Poynton, Cheshire. [9391]
- W**ANTED, Telefunken pick-up T0.1001, preferably with tone control; state condition, price.—Box 2564, c/o *The Wireless World*. [9396]
- F**ERRANTI Transformers, A.F.9, A.F.7C.S. or A.F.7, Ferranti speaker M.I.+Colpak for Straight III.—Price and details to Blair, 4, Hillend Rd., Glasgow, N.W. [9403]

GRAMOPHONE MOTORS

Wanted

- L**IGHT Weight Quality Pick-up, turntable (induction motor preferred), full details.—Goodchild, Bulsham St., Chelmsford. [9386]
- F**ULL Price Paid for Electric Gramophone Units and Record Changers, 500 wanted immediately, cash waiting.—Adogram, 27, Worcester St., Wolverhampton. [9405]
- W**ANTED Immediately for Spct. Cash, all types A.C. and A.C./D.C. Electric Gramophone Motors, preferably, but not essentially, complete with Pick-ups and Auto-stops; all Automatic Record Changers, new or second-hand; state exact types, condition and price required.—Box 2563, c/o *The Wireless World*. [9390]

METERS, ETC.

D.C. Centre Zero 15-0.15 amps., reads from ½ amp., Weston 2in. flush type; 9/6, postage 6d.—L. Dixon, 218, Upper Thames St., E.C.4. [9401]

TEST EQUIPMENT

- O**NE Cossor Oscilloscope, Model 3332, with F.M. ganging oscillator, model 3343, complete with manuals, new condition, £30; Hunt capacity bridge, perfect, £6.—Foard, Hereford Cottage, Upper Hale, Farnham. [9374]
- W**anted
- V**ALVE Tester, 3in. Oscilloscope, Mains Signal Generator.—26, Bramdean Crescent, Lee, S.E.12. [9394]
- W**ANTED, reliable make A.C. or D.C. All Wave Oscillator.—Matheson, Fishmarket, Aberdeen. [9384]

TUITION

- R**ADIO Training.—P.M.G. exams and I.E.E. Diploma; prospectus free.—Technical College, Hull. [0611]
- M**ORSE Code Courses.—"Book of Facts." free.—Candler System Co. (Room 55 WO), 121, Kingsway, London, W.C.2. [9074]
- W**IRELESS Officers.—Short courses of training for young men for marine and air services.—Matlne School, South Shields. [9166]
- P**RACTICAL Postal Courses, radio television, test equipment design, trade-test coaching for R.A.F. post, I.P.R.E. and I.W.T. exams; booklet free.—Secretary, I.P.R.E., Bush House, Walton Av., Henley-on-Thames. [9328]
- R**ADIO Engineering, Television and Wireless Telegraphy; comprehensive postal courses of instruction.—Appl. British School of Telegraphy, Ltd., 179, Clapham Rd., London, S.W.9 (Estd. 1906). Also instruction at school in wireless for H.M. Merchant Navy and R.A.F. [9249]

**GALPINS
ELECTRICAL STORES**

Owing to War Conditions this business is now transferred to:—
21, WILLIAM ST., SLOUGH, BUCKS.

Terms: Cash with Order

ELECTRIC LIGHT CHECK METERS, small, late type, well-known makers, in good condition, electrically guaranteed for 200/250 volts 50 cy. 1 phase A.C. mains. 5 amp. type, 6/-; 10 amp., 7/6; 20 amp., 9/- each. Post 1/- on all types.

D.C. ELECTRIC LIGHT CHECK METERS, 200/250 volts 5 and 10 amps., 4/6 each, post 1/- (in new condition).

PHILIPS HIGH VOLTAGE CONDENSERS. Infd. at 4,000 volt working, 5/6 each, carriage 1/0.

REGULATORS, STARTERS AND LARGE DIMMER RESISTANCES. Stud Switch-arm type. State wants. **SWITCHBOARD VOLT AND AMPMETERS MOVING COIL AND MOVING IRON**. All first-class makers. Please state requirements.

TEN LINE CORDLESS TELEPHONE PORTABLE EXCHANGE BOARD, complete with calling generator in new condition, £6/10/-, carriage forward.

EX R.A.F. GLASS ACCUMULATOR TANKS, 5 x 5 x 5in., new and unused, 3/6 each, post 1/-.

EX R.A.F. SWITCH PANEL, with case (new), fitted 6 small knife switches, leads, cords and cleats, complete in wood case, 2/6 each, post 6d.

SMALL ELECTRIC ROTARY CONVERTOR, 110 volts D.C. input, 10 volts at 30 amps. output. Useful for garage charging, 55/-, carriage forward.

D.C. MOTOR BLOWERS, 2in. inlet and outlet. Aluminium body, laminated field, ideal for dug-out ventilation. 100 volt, 25/-.

HIGH-VOLTAGE TRANSFORMERS, useful for all test work or television. Input 200/240 volts, output 5,000 and 7,000 volts, 6/6 each, post 1/-.

VOLTAGE CHANGING TRANSFORMERS (Auto Wound), 100/110 to 200/240 v., or vice versa, fully guaranteed, 1,000 watts, 60/-; 2,500 watts, 110/-.

DUG-OUT LAMPS, Ex R.A.F., solid brass construction, glass dome, complete with 12-volt bulb (any bulb can be fitted), wall fitting, 3/- each, post 6d.; Ditto, wing type, as new, 2/6, post 6d.

DUG-OUT LAMPS, Ex R.A.F., porthole type, or can be bracket fitted, glass dome, three colour fitting, white, red or green, solid brass construction, 6in. dia., complete with bulb; any size bulb can be fitted. Price 5/-, post 6d.

1 kW. TRANSFORMER, 100 v. input at 100 cycles, output 10,000 volts centre tapped, price 30/-, carriage forward.

EX R.A.F. AUTOMATIC CHARGING CUT OUTS AND VOLTAGE REGULATORS, to suit any dynamo up to 20 volts at 15 amps., fully adjustable, wiring instructions, complete in metal case. Price 3/6, post 6d.

B.T.H. LIGHTWEIGHT HEADPHONES, 4,000 ohms, headbands damaged, phones guaranteed, 5/- per pair Post free.

DYNAMOS, all shunt wound and fully guaranteed, 50/75 v.—15 a., £6/10/-; 50/75 v.—25 a., £8/10/-; 50-volt—30 a., £8/10/- All carriage forward.

SWITCHBOARD, lightweight, suitable for portable set, fitted a pair of meters, Everett Edgecumbe, flush fitting, 3½in. dia., reading 0-150 v. and 0-50 a., moving coil, 5 double-pole knife switches, etc., £5, carriage forward.

25-VOLT D.C. MOTOR, maker "Crompton," ½ h.p., ball bearing, in perfect order, £3, carriage forward.

DITTO, on iron bedplate, but fitted with large reduction gear and rope drum, £5, carriage forward.

110-VOLT D.C. MOTOR, totally enclosed, rated at 8 amps., ball bearing, in new condition, make good slow-speed dynamo, £2/5/-, carriage forward.

MANGIN REFLECTING MIRRORS for spotlight work, price 5/-, post 6d.

GUNMETAL PULLEYS, 7in. diameter, to take lin. dia. rope, complete with rope guard and hook, 7/6 each, post 1/-.

PHILLIPS TRANSFORMERS, 220 v. input, output 2,000-0-2,000 volts, 200 m/a and 2 L.T.s., 50/-, carriage forward.

MILLIAMMETERS by famous makers, 2½in. dia., flush fitting, 0-3 m/a, 50/-; 0-50 m/a, 40/-; 0-200 m/a, 35/-.

2 kW TRANSFORMER CORES for rewinding, sound windings but rating unknown, 20/- each, carriage forward.

STEEL CABINETS, suitable for large amplifiers, etc., size 42in. by 24in. by 16in. Price 35/-, carriage forward.

½ HP 110 v. D.C. MOTOR, in good working order, 25/-, carriage forward.

4 M.F. T.C.C. CONDENSERS, 3,000 v. working, 20/- each, carriage, pass. train, 1/6.

SLIDER RESISTANCE, 2,500 ohms at 200 m/a, worm and wheel control, 25/-, post free.

REPAIRS AND SERVICE

GUARANTEED Repairs, any transformers, choke, motor armature, converter, dynamo, etc.; keenest prices, immediate quotation, prompt, dependable service.—See below.

L.T.P. (LONDON TRANSFORMER PRODUCTS, Ltd.), Willesden, N.W.10. Willesden 6486 (3 lines). [9221]

EPOCH—Genuine replacement diaphragms for Domino, 66/99, Supercinema, etc.—"R.E.C.S." Crown St., Reading. Phone 2796. Day or night. [9388]

MAINS Transformer Service, repairs, rewinds, or construction to specification of any type, competitive prices and prompt service.—Sturdy Electric Co., Dipton, Newcastle-on-Tyne. [0516]

"**SERVICE with a Smile**."—Repairs of all types of British and American receivers; coil rewinds; American valves, spares, line cords.—F.R.I., Ltd., 22, Howland St., W.1. Museum 5675. [8934]

METROPOLITAN RADIO SERVICE—Guaranteed repairs to American and British receivers; American valves, condensers, volume controls, linecord resistances, Majestic I.F. transformers, and rewinds, trade supplied.—1021, Finchley Rd., N.W.11. Speedwell 3000. [0435]

PATENTS FOR SALE

THE Owner of British Patent No. 380,876, relating to "Improvements on or relating to Signalling Systems," is desirous of entering into negotiations with one or more firms in Great Britain for the purpose of exploiting the invention either by sale of the patent rights or by the grant of licences on reasonable terms.—Interested parties who desire further particulars should apply to Albert L. Mond and Thiemann, 14 to 18, Holborn, London, E.C.1. [9370]

SITUATIONS VACANT

WANTED, by old-established Central London firm, a first-class service engineer; must be thoroughly conversant with all makes and preferably able to repair spring motors.—Box 2549, c/o *The Wireless World*. [9334]

WANTED, Physical Laboratory Assistant, temporary, may become permanent post.—Applications, stating age, experience, salary, whether liable military service, to Laboratories, Stowe School, Buckingham. [9393]

WANTED.—Civilian Morse and Procedure Instructors (male) at R.A.F. Signals Schools. £4/12/6 weekly, rising annually by 2/6 to £5/2/6. Ability to send and receive morse at 25 w.p.m. essential. Experience of teaching and lecturing an advantage. Minimum age 30

APPLY, in writing, Air Ministry (S.5D.), W.C.2, with particulars of experience, age, etc. Third class fares repaid to candidates required to attend Selection Boards. [9348]

MAN Required, to test micro telephone and valve type apparatus, works in safe area; hostel accommodation available; good pay and prospects to a man able to up-grade production.—Call or write, 309, Oxford St., W.1. [9371]

BRITISH OVERSEAS AIRWAYS CORPORATION has vacancies for Ground Radio Operators for universal service. Candidates must be British subjects by birth, fit and in possession of a 1st or 2nd class P.M.G.'s Marine Certificate. Preference will be given to men with five or more years' recent seagoing experience. The above posts are permanent and opportunity will exist for promotion to flying rank.

LETTERS of Application, stating age, experience, whether married or single, licence number and military commitments (if any) should be addressed to the General Establishment Officer, Wellington House, Canynge Rd., Bristol, 8. Please mark envelopes GEO/JWW/31. [9382]

WANTED.—Civilian Wireless Instructors (male) at R.A.F. Signals Schools. £5/2/6 weekly, rising annually by 2/6 to £5/10. Sound knowledge of electrical principles and their application to radio and low power electrical engineering essential. Test for candidates will include giving lecture on any subject they choose involving principles of modern radio. Lecturing sequence and style most important. Minimum age 30.

APPLY, in writing, Air Ministry (S.5D.), W.C.2, with particulars of experience, age, etc. Third class fares repaid to candidates required to attend Selection Boards. [9349]

TECHNICAL TRAINING

GREAT Possibilities Exist for Technically Qualified Engineers, key men in wartime and afterwards. Through the home-study courses of The T.I.G.B. take a recognised engineering qualification such as A.M.I.Mech.E., A.M.I.E.E., A.M.I.R.E., A.F.R.Ae.S., A.M.I.Chem.E., C. and G., etc., in which examinations the T.I.G.B. students have gained 25 FIRST PLACES and Hundreds of Passes. Write to-day for "The Engineer's Guide to Success"—Free—containing the world's widest choice of engineering courses covering all branches, including Aeronautical, Mechanical, Electrical, Wireless, Chemical, etc.

THE TECHNOLOGICAL INSTITUTE OF GREAT BRITAIN, 82, Temple Bar House, London, E.C.4. [9335]

MORSE EQUIPMENT

FULL Range of Transmitting Keys, practice sets and other equipment for Morse training.—Webb's Radio, 14, Soho St., London, W.1. 'Phone: Gerrard 2089. [9350]

PATENT AND TRADE MARK AGENTS

GEE and Co. (H. T. P. Gee, Mem. R.S.G.B., etc.), 51-52, Chancery Lane, London, W.C.2. Holborn 4547-8. Handbook free. [0001]

BUSINESSES AND PROPERTY FOR SALE, TO BE LET, OR WANTED

"THE Wireless and Electrical Trader" is an essential part of the equipment of every Wireless Trader; its pages reflect the very latest turn of trade events, and it is read by all the leading dealers and manufacturers, for particulars of businesses offered or wanted. By subscription, to the trade only, 17/6 per annum, post free.—Send your trade card for specimen copy to Dorset House, Stamford St., London, S.E.1. [0614]

MISCELLANEOUS

WANTED, in good condition, coil winder, suitable speech coils and small transformers.—Lensesre, 11, Buckingham Gate, S.W.1. [9377]

FOR SHORT-WAVE COMPONENTS

Communication Receivers for work of National importance; and all accessories for short-wave work and experiments. Call or write to

WEBB'S RADIO

14 SOHO ST., OXFORD ST., LONDON, W.1

ELECTRIC SHAVERS

WANTED, Shavemaster electric shavers, must be in good working order and condition.—Box 2558, c/o The Wireless World. [9373]

VACUUM CLEANERS

REBUILT, guaranteed Hoovers, Hotpoints, Goblins, Electrolux, Sunbeams, etc., from £2/2.—"R.E.C.S." Crown St., Reading. 'Phone 2796. This month's Bargain: "£15/15 Tellus," complete, £5/5, perfect. We Buy Hoovers. Exchanges. Repairs. [9389]

BOOKS, INSTRUCTIONS, ETC.

WEBB'S Radio Map of the World Enables You to Locate Any Station Heard. Size 40in. by 30in. 2-colour heavy art paper, 4/6, post 6d. Limited supply on linen, 10/6, post 6d. Webb's Radio Globe, superb 12in. full-colour model. Radio prefixes, zones, etc. Heavy oxidised mount. Post paid, 27/6.—Webb's Radio, 14, Soho St., London, W.1. 'Phone: Gerrard 2089. [8767]

"WIRELESS Direction Finding." By R. Keen, B.Eng. (Hons.), Sheffield, A.M.I.E.E. Third Edition. Covers the latest developments, including medium- and short-wave Adcock systems and deals with Beacon Transmitters, Aircraft Approach and Blind Landing processes. There are also detailed descriptions of Commercial Shore, Ship and Aircraft Installation. Price 25/- net. By post 25/9, from Iliffe and Sons Ltd., Dorset House, Stamford Street, London, S.E.1.

"ELEMENTARY Principles of Wireless Telegraphy and Telephony." By R. D. Bagnauy. Revised by O. F. Brown, B.Sc. Third edition (1930). The standard textbook for wireless students and beginners. Deals with the whole subject of wireless telegraphy and telephony, avoiding too technical a treatment of the problems involved. Well illustrated. Price 7/6 net. By post 8/1, from Iliffe and Sons Ltd., Dorset House, Stamford Street, London, S.E.1.

BOOKS, INSTRUCTIONS, ETC.

"TELEVISION Receiving Equipment." By W. T. Cocking, A.M.I.E.E. A new handbook containing information for everyone interested in cathode-ray receiving equipment. The complete vision and sound receiver is described and the treatment throughout is substantially non-mathematical. Price 7/6 net. By post 8/-, from Iliffe and Sons Ltd., Dorset House, Stamford Street, London, S.E.1.

"RADIO Data Charts." By R. T. Beatty, M.A., B.E., D.Sc. Second edition. A series of Abacs providing most of the essential data required in receiver design and enabling problems to be solved without having recourse to complicated mathematical formulae. Price 4/6 net. By post 4/11, from Iliffe and Sons Ltd., Dorset House, Stamford St., London, S.E.1.

"WIRELESS Servicing Manual." By W. T. Cocking, A.M.I.E.E. Fifth Edition. Deals with the principles and practice of the repair and adjustment of wireless receivers, and contains appendix of detailed information. Price 5/- net. By post 5/6, from Iliffe and Sons Ltd. Dorset House, Stamford Street, London, S.E.1.

CLASSIFIED ADVERTISEMENTS

intended for the MARCH ISSUE can be accepted up to Monday, February 10th

INDEX TO ADVERTISEMENTS

Aconstical Mfg. Co.	Page 13
Armstrong Manufacturing Co.	13
Automatic Coil Winder & Electrical Equipment Co., Ltd.	1
Bakers Selhurst Radio	Classified p. 14
Birmingham Radiomart GEN	3
British Institute of Engineering Technology	16
British Insulated Cables, Ltd.	6
British Rola, Ltd.	Inside Back Cover
Bulgin, A. F., & Co., Ltd.	Edit. p. 55
Candler System Co.	14
Electradix Radios, Ltd.	12
Eric Resistor, Ltd.	Inside Back Cover
Fitton, R. N., Ltd.	6
Fluxite, Ltd.	Edit. p. 53
Galpin's Electrical Stores	17
General Electric Co., Ltd.	2
Goodman's Industries, Ltd.	11
Henley's, W. T., Telegraph Works Co., Ltd.	14
Heys, Leonard	16
Institute of Wireless Technology	16
International Correspondence Schools	16
Lockwood & Co.	16
London Central Radio Stores	15
London Radio Supply Co.	14
Marconi's Wireless Telegraph Co., Ltd.	Back Cover
Masteradio, Ltd.	14
McClure, John, Ltd.	18
M.E. Supplies	6
Murphy Radio, Ltd.	10
Partridge, N.	15
Peto-Scott Co., Ltd.	9
Pitman, Sir Isaac, & Sons, Ltd.	16
Players Cigarettes	Inside Back Cover
Premier Radio Co.	5
Radio Clearance, Ltd.	Classified p. 16
Ryall, G. A.	Classified p. 15
Savage, W. Bryan, Ltd.	16
Simmonds Aerocessories, Ltd.	8
Steatite & Porcelain Products, Ltd.	4
Taylor Elecl. Instruments, Ltd.	6
Telegraph Condenser Co., Ltd.	7
Trix Electrical Co., Ltd. (The)	16
United Insulator Co., Ltd.	Inside Front Cover
Voigt Patents, Ltd.	Inside Back Cover
Vortexion, Ltd.	Edit. p. 57 & Classified Ad. p. 15
Ward, C. F.	13
Webb's Radio	18
Westinghouse Brake & Signal Co., Ltd.	11
Whiteley Electrical Radio Co., Ltd.	11

IMPORTANT

Owing to shortage of the necessary type of 4-valve valves we are at present unable to supply our A.C range of chassis complete with valves.

For those who can make use of their own valves or can obtain local supplies, we continue to offer these units, less valves, making a reduction in price accordingly.

The units are still aligned and tested on standard set of valves before despatch.

Chassis complete with American type Octal Valves (6-3 v.) are still available. Filament transformers to supply 6-3 v. are available at small cost.

* * * * *

We are in a position to undertake all classes of Tool making, Sheet Metal work, Instrument and Radio production and particularly invite Government contracts and sub-contracts.

JOHN McCLURE, LTD.
CROXSONS' WORKS, HIGH WYCOMBE, BUCKS

Telephone High Wycombe 1290-1

ERIE Standard CARBON RESISTORS



(10Ω to 9.5 megΩ. Tolerance ± 10%. Wired Ends)
 Type No. 4, ½ watt - 6d. Type No. 3, ½ watt - 6d.
 Type No. 2, 1 watt - 1/- Type No. 1, 2 watt - 1/6
 Type No. 0, 3-5 watt - 2/6

The ERIE S.R. 48 RESISTOR KIT

If you wish to secure the S.R.48 Resistor Kit in its original form, as illustrated, we cannot urge you too strongly to order now. It may be necessary for us at any time to substitute a cardboard carton for the pressed steel box which we are at present supplying free of charge. Remember, the S.R.48 Resistor Kit offers you the right replacement in a form equally handy for toolbox, workshop or counter display.

Remember, too, that ERIE ½ watt and 1 watt standard carbon resistors will carry a load of 1 watt and 2 watts respectively, allowing for a 50% overload, and in consequence this kit will cover all your requirements over the ½ watt to 2 watt range. The ERIE S.R.48 Resistor Kit contains 48 standard carbon resistors, 24 each ½ watt, and 1 watt in an assortment 36/- of most used values. List Price

ERIE REPLACEMENT VOLUME CONTROLS

Erie Replacement Volume Controls are the only fitting companions for Erie Resistors.

STANDARD CONTROLS.

Without Switch - 2/6 With S.P. Switch - 3/-
 With D.P. Switch - 3/6

Non-standard Spindles 2/- per control extra.

Centre tap controls, dual and gang controls have been withdrawn temporarily.

ALSO Vitreous Wirewound Power Resistors.

Send for complete Price List.

ERIE RESISTOR LTD.

Carlisle Road, The Hyde,
 Hendon, N.W.9.
 Telephone :—Colindale 8011.

**-Enjoy the long evenings-
 WITH**

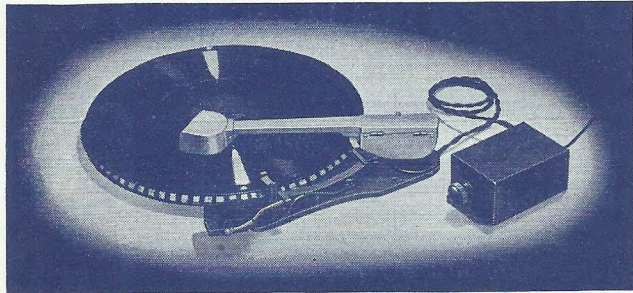

The VOIGT MOVING COIL PICK-UP
 Output 50 m.v. Price 26. VOIGT PATENTS LTD. Phone: SYDenham 6666
 Delivery ... 8-10 weeks. The Courts, Silverdale, S.E.26. Reg. Off.: 22 Castle St., E.C.1

The Wireless World DIARY

& Reference Book for 1941

A pocket compendium for the wireless enthusiast

Price 2/- net

By post, including Purchase Tax, 2/7

ILIFFE & SONS, LTD.,
 Dorset House, Stamford Street, London, S.E.1

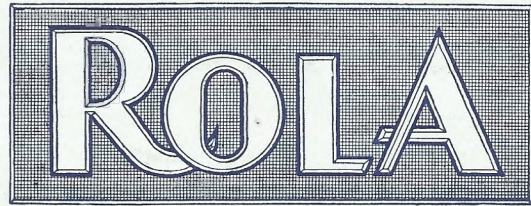

TRANSFORMER

LAMINATIONS

EIGHT STANDARD SIZES

CORE WIDTHS 1/8" to 1 1/2" (E's and 1's)

AVAILABLE FROM STOCK

A Comprehensive Bulletin together with details of Associated Covers and Clamps with design data will be sent to manufacturers on request.

BRITISH ROLA LIMITED
 MINERVA ROAD, PARK ROYAL, N.W.10
 WILLESDEN 4322



Cheerfulness

When cheerfulness is in danger of disturbance, light a 'Player,' and with a few 'puffs,' put trouble in its proper place. The friendly Sailor, as always, stands for cheery contentment and a guarantee that quality and purity remain unchanged.

KEEP THAT HAPPY EXPRESSION

Player's Please



marconi's make it.

★ *If it is a matter of wireless apparatus for broadcasting or television; for naval or military purposes; for marine or air communications; for mobile or fixed aids to navigation; for any application whatever to practical requirements . . . ask Marconi's.*

Because now, as in the earliest days of wireless experiment, Marconi's are pioneers in design and leaders in technical efficiency.

For full particulars of all types of wireless apparatus, apply to Marconi's Wireless Telegraph Co., Ltd., Electra House, Temple Place, London, W.C.2.