

RECEIVERS FOR FREQUENCY MODULATION

The

MONTHLY
ONE SHILLING

Wireless World

*COVERING
EVERY WIRELESS INTEREST*

DECEMBER, 1940



WIRELESS EXPORT DRIVE: BRITAIN DELIVERS THE GOODS



CERAMIC COIL FORMERS

...FOR GREATER
RADIO EFFICIENCY

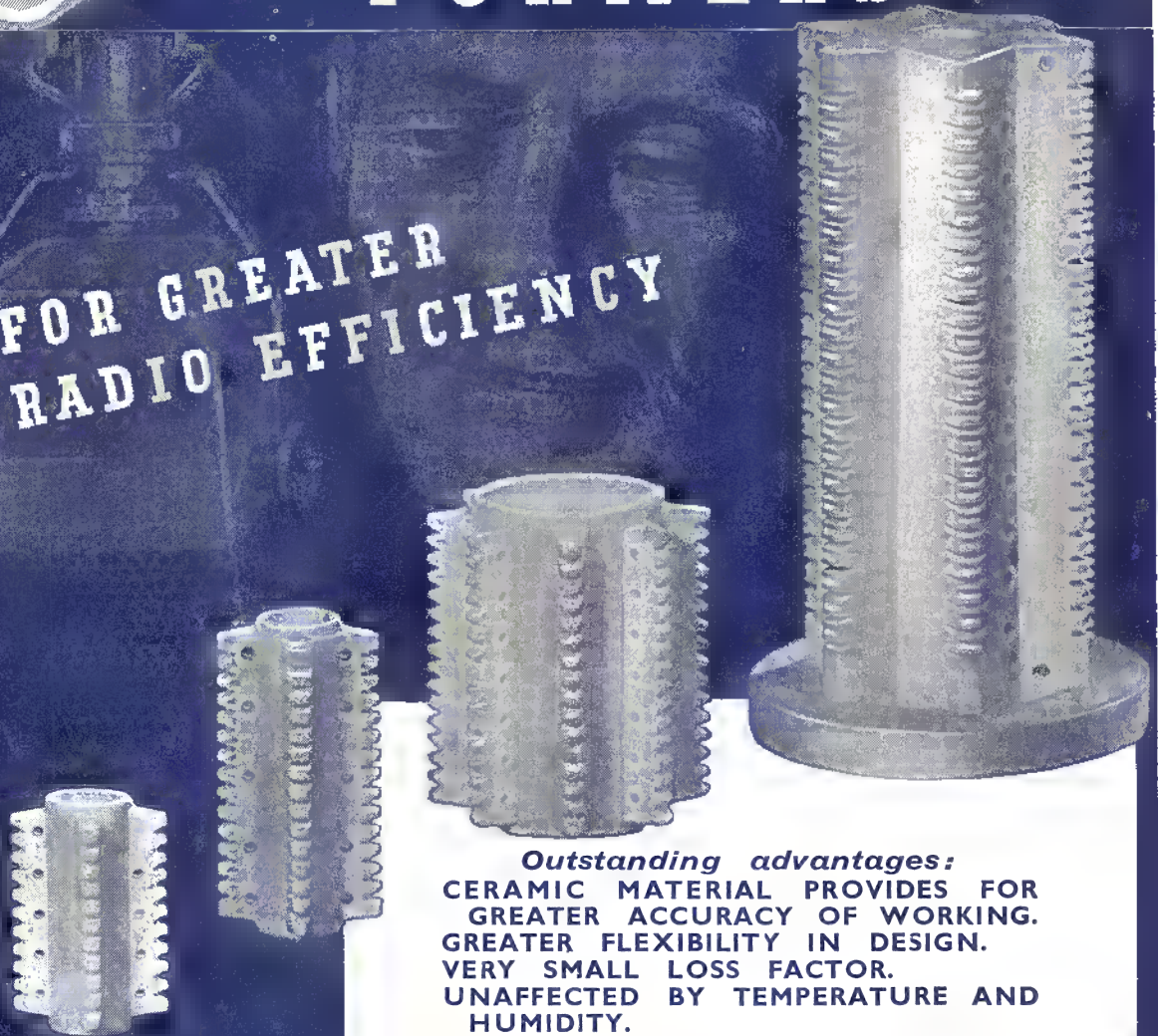

Outstanding advantages:
CERAMIC MATERIAL PROVIDES FOR
GREATER ACCURACY OF WORKING.
GREATER FLEXIBILITY IN DESIGN.
VERY SMALL LOSS FACTOR.
UNAFFECTED BY TEMPERATURE AND
HUMIDITY.
COMPLETE STABILITY.
MORE ECONOMICAL TO PRODUCE.

Write for details.

CONTRACTORS TO G.P.O. AND GOVERNMENT DEPARTMENTS.
ON A.I.D. APPROVED LIST.

UNITED INSULATOR CO LTD

The Pioneers of Low Loss Ceramics

12-16 LAYSTALL STREET
LONDON. E.C.1

Tel: TERMINUS. 4118-9

Grams: CALANEL, SMITH, LONDON

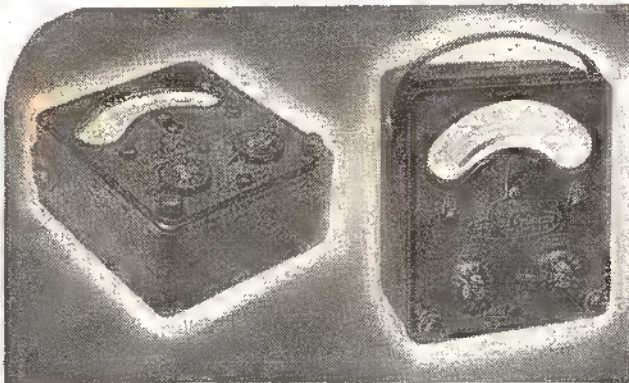

46-range Model 7
Universal AvoMeter



40-range Model 40
Universal AvoMeter

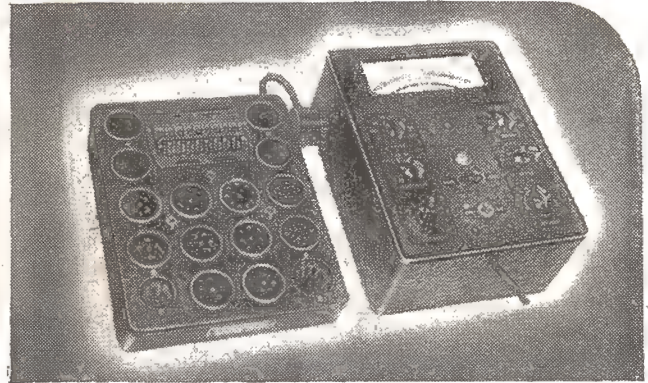

"Avo" Valve Tester with Universal Panel

PRECISION METERS

that Master every Testing Problem

The world-wide use of "AVO" Instruments is striking testimony to their outstanding versatility, precision and reliability. In every sphere of electrical test work—laboratory, shop or out on a job—they are appreciated for their dependable accuracy, which is often used as a standard by which other instruments are judged. There is an "AVO" Instrument for every essential electrical test.



ELECTRICAL MEASURING INSTRUMENTS

BRITISH MADE

Write for fully descriptive literature dealing with any instrument in which you are interested, and for current prices.

OTHER "AVO" INSTRUMENTS (not illustrated).
 High Resistance AvoMinor. The "Avo" Bonding Meter
 "Avo" Low Resistance Ohmmeter. The "Avo" MilliOhmmeter
 The Avodapter 9-pin AvoCoupler

Sole Proprietors and Manufacturers:

THE AUTOMATIC COIL WINDER & ELECTRICAL EQUIPMENT Co., Ltd., Winder House, Douglas St., London, S.W.1

Phone: Victoria 3404-7.

All-Wave "Avo" Oscillator

"Avo" Test Bridge

Universal AvoMinor

D.C. AvoMinor

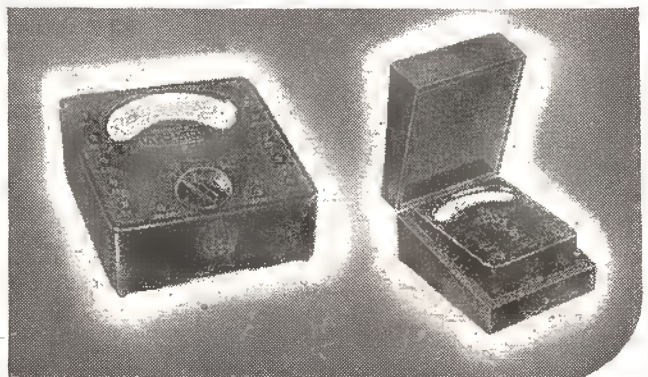

ROLA

TRANSFORMER
LAMINATIONS

EIGHT STANDARD SIZES
CORE WIDTHS $\frac{9}{16}$ " to $1\frac{1}{2}$ " (E's and I's)

AVAILABLE FROM STOCK

A Comprehensive Bulletin together with details
of Associated Covers and Clamps with design
data will be sent to manufacturers on request.

BRITISH ROLA LIMITED
MINERVA ROAD, PARK ROYAL, N.W.10
WILLESDEN 4322

Just to remind you
Of the fact that
Heedless of the interruptions by
Nocturnal aerial visitors
McClure's are making
Ghassis and Radio Apparatus which
Contribute more and more to
Listeners' desire for
Unfailing Quality in both
Reproduction and Workmanship and
Ensure the utmost enjoyment from
broadcast entertainment

Write to : _____

JOHN McCLURE LTD.

ERSKINE ROAD, LONDON, N.W.3. GULiver 5981

EVACUATION ADDRESS as from Dec. 2nd
CROXSON'S WORKS, HIGH WYCOMBE, BUCKS
Phone : High Wycombe 1370

NOISE SILENCER Applications

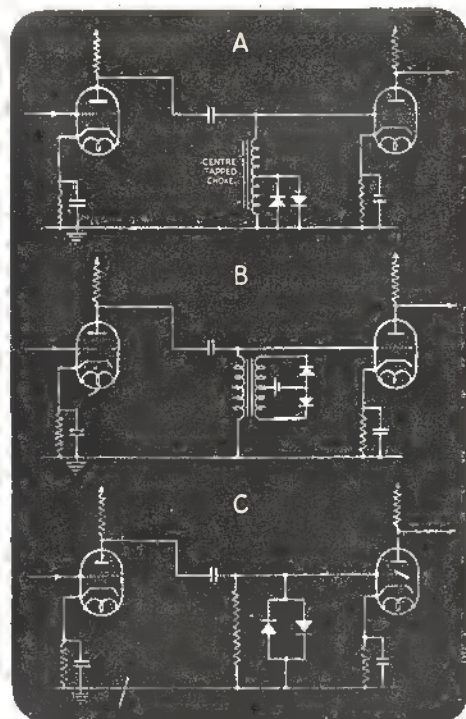

Westinghouse Metal Rectifiers may be used for the reduction of static interference, their operation in such circuits being entirely automatic, and dependent solely upon the property that their resistance decreases as the current passing increases. The rectifiers are connected to give a non-linear characteristic in both directions, the circuit being arranged that the normal maximum audio voltage across them does not raise the operating point on to the straight portion of the rectifier characteristic curve. Noise peaks cause the rectifiers to work on the straight portion and act as a short-circuit across the output for the duration of the peak.

- (A) This is the most simple circuit and uses "H" type units.
- (B) A more elaborate circuit using two W.6 Westectors and allowing the "cut-off" point to be varied to suit different conditions.
- (C) A circuit using two W.X.6 Westectors for use in an early low-frequency stage.

WESTINGHOUSE METAL RECTIFIERS

COUPON

To Westinghouse Brake & Signal Co., Ltd.,
Pew Hill House, Chippenham, Wilts.

Enclose 3d. in stamps.
Please send me a copy of
"The All Metal Way" giving
details of noise silencer
applications.

Name.....
Address.....

W.W. 1240

Every day sees another assembly problem

Solved

SPEED FIX

Here is a Speed Fix applied to integrally moulded plastic studs where an easily slideable assembly under firm spring tension is required. Ideal for use in heating and ventilating louvres. Replaces costly combination of brass insert, coil spring, washers and split pin.

SPEED FIX

Used in conjunction with any unthreaded member, rivets, integrally die-cast or plastic studs. Simply pushed on right into its final locked position, replacing a threaded member, flat washer, lock washer and nut.

SPEED FIX

An ingenious Speed Fix for Radio assembly. Designed to hold plastic coil former to chassis with tension arm for core adjustment. Compare the simplicity of this one-piece vibration-proof assembly with old-fashioned methods involving a number of parts and operations.

SPEED NUT

A time-saving application of the "U"-shaped Speed Nut for blind assembly. The Speed Nut holds itself in position, ready to receive the bolt, thus overcoming the difficulties of blind assembly and providing a vibration-proof lock.

SPEED NUT

Double plate type Speed Nut adapted to door hinges. Suitable for a wide range of sheet metal cabinet structures, stoves, refrigerators, storage cabinets, heating and ventilating equipment. This Speed Nut eliminates tapped strips and lock washers and avoids chipping of the enamel.

SPEED CLIP

For fastening integral studs or rivets where the back of the assembly is inaccessible. This Speed Clip is merely snapped into the hole already provided in the component, and the stud pushed into the Clip.

for LIGHTNING ASSEMBLY



Blind assemblies, difficult spacing jobs, those tricky knob to shaft assemblies, and concealed parts in sheet metal assemblies—problems like these which have hitherto presented great difficulties to the designer are easily solved by the Speed Nut System.

Above are shown only a few of the thousands of successful applications which have been designed by our Engineers in collaboration with the Manufacturer.

We welcome enquiries from Designers and Manufacturers and our Development Department will be pleased to collaborate and work out the most effective types to solve your assembly problems.

Move with the times—investigate the Speed Nut System now



Longleys

Here's the family's
Ideal Wartime Gift—

MUSIC WHILE



THEY WORK



& SHELTER

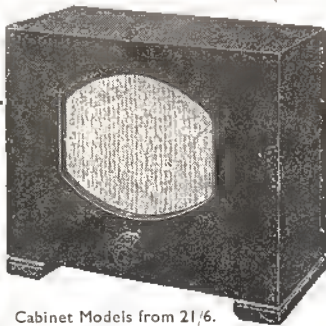

Cabinet Models from 21/6.

Nothing can form a more useful or practical gift for the family these harassing days than the means of conveniently enjoying bright and cheery radio entertainment. A famous Stentorian Extension Speaker will make your radio instantly available at any part of the home. The womenfolk can listen-in whilst they work or take it into their refuge room when the need occurs. And you will readily appreciate the brilliant reproduction—it does justice to the finest receiver. Thousands of listeners are getting the fullest enjoyment from radio by this means. Why not YOU? To avoid possible disappointment you are urged to place your order immediately with your local dealer.

WB Stentorian
THE PERFECT EXTRA SPEAKER FOR ANY SET

WHITELEY ELECTRICAL RADIO CO., LTD., MANSFIELD, NOTTS

RAYMART
CRAFT A CREED

Insulators and Ceramic Goods

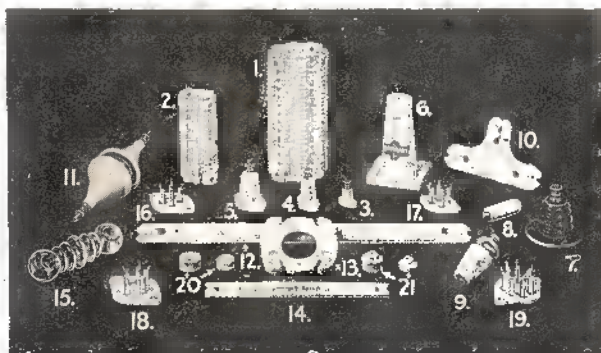

OUR ILLUSTRATION ABOVE GIVES BUT A SMALL INDICATION OF THE WIDE VARIETY OF INSULATORS AND CERAMIC GOODS, AVAILABLE FROM RAYMART'S, WHO CARRY THE LARGEST RANGE OF THESE PRODUCTS IN THE COUNTRY. THERE ARE MANY OTHER RAYMART LINES APPROVED AND USED BY H.M. SERVICES—MICRO-VARIABLE CONDENSERS, PRECISION DIALS AND A LARGE SELECTION OF SPECIALITIES FOR SHORT-WAVE WORK.

Government departments, Manufacturers, Servicemen, etc., are invited to send their enquiries to—

RADIOMART

44 and 48, HOLLOWAY HEAD, BIRMINGHAM, I.
Cable: Raymart, Birmingham. Telephone: Midland 3254.

Just Released!!!

A NEW **74** RANGE
UNIVERSAL TAYLOR METER
Sensitivity 20,000 ohms per volt on BOTH A.C. and D.C.



TAYLOR 81C
MODEL 81C

There is no other multi-range meter in existence which has the same sensitivity on BOTH A.C. and D.C.

£16-16-0

(No purchase tax payable)
Supplied complete with instruction book and 3 test leads.

IMPORTANT FEATURES TO NOTE:—**METER.** 4 1/2" square type-Taylor moving coil meter, the movement having a sensitivity of 50 microamps, full scale on both A.C. and D.C. **SCALES.** 6 scales, the outer being 3 1/2" long. **RANGES.** D.C. Volts 0-0.1 to 0-2,000. A.C. Volts 0-2.5 to 0-2,000. Output 0-2.5 to 0-2,000. D.C. Current 0-50 microamp. to 0-20 amp. A.C. Current 0-50 microamp. to 0-5 amp. Ohms 0-1,000, 0-100,000, 0-10 meg. and 0-50 meg. with internal battery. **Decibels**—22 to +60. 4 Adaptors available for increasing ranges. A fully descriptive Brochure of Model 81C at £16-16-0, and Model 81A (sensitivity 4,000 ohms per volt A.C. and D.C.) £12-12-0, is available free, on request.

BRITISH MADE & GUARANTEED 6 MONTHS.

TAYLOR ELECTRICAL INSTRUMENTS LTD.
419-422, Montrose Avenue, SLOUGH, Bucks.
Phone: Slough 20061.

ERIE Standard CARBON RESISTORS

10Ω to 9.5 megΩ. Tolerance ± 10%. Wired Ends)
Type No. 4, 1/2 watt - 6d. Type No. 3, 1/2 watt - 6d.
Type No. 2, 1 watt - 1/- Type No. 1, 2 watt - 1/6
Type No. 0, 3-5 watt - 2/6

The ERIE S.R. 48 RESISTOR KIT

If you wish to secure the S.R.48 Resistor Kit in its original form, as illustrated, we cannot urge you too strongly to order now. It may be necessary for us at any time to substitute a cardboard carton for the pressed steel box which we are at present supplying free of charge. Remember, the S.R.48 Resistor Kit offers you the right replacement in a form equally handy for toolbag, workshop or counter display.

Remember, too, that Erie 1/2 watt and 1 watt standard carbon resistors will carry a load of 1 watt and 2 watts respectively, allowing for a 50% overload, and in consequence this kit will cover all your requirements over the 1/2 watt to 2 watt range.

The Erie S.R.48 Resistor Kit contains 48 standard carbon resistors, 24 each 1/2 watt, and 1 watt in an assortment of most used values. List Price **36/-**

ERIE REPLACEMENT VOLUME CONTROLS

Erie Replacement Volume Controls are the only fitting companions for Erie Resistors.

STANDARD CONTROLS.

Without Switch - 2/6 With S.P. Switch - 3/-
With D.P. Switch - 3/6

Non-standard Spindles 2/- per control extra.

Centre tap controls, dual and gang controls have been withdrawn temporarily.

ALSO Vitreous Wirewound Power Resistors.

Send for complete Price List.

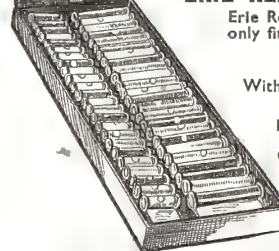

ERIE RESISTOR LTD. Carlisle Road, The Hyde, Hendon, N.W.9. Telephone: Colindale 8011.

PREMIER RADIO

PURCHASE TAX

We have sufficient stocks of all taxable radio goods (with very few exceptions), for a reasonable period. When these are sold tax will become operative. Purchase now and save money.

SHORT-WAVE GEAR

Short-Wave Coils, 4- and 6-pin types, 13-26, 22-47, 41-94, 78-170 metres, 2/- each, with circuit. Premier 3-Band S.W. Coil, 11-25, 19-43, 38-86 metres. Suitable any type circuit, 2/11.
4-pin or 6-pin Coil Formers. Plain or Threaded. 1/2 each.
Utility Micro Cursor Dials, Direct and 100 : 1 Ratios, 4/3.
New Premier 2-Gang S.W. Condenser, 2 x .00015 mf. with integral slow motion, 7/6.
Bakelite Dielectric Variable Condensers. .0005 mf. Suitable Tuning or Reaction, 1/6 each.
Short-Wave H.F. Chokes. 10-100 m., 10½d. each. High grade Pie Wound U.S.A. type, 1/9 each.
Lissen Dual Range Screened Coils: Medium and Long Waves, 2/9 each.

"LEARNING MORSE"

Premier Morse Practice Key on Bakelite Base and Brass Movement ... 3/3
General Purpose Morse Key ... 5/10
Heavy Duty TX Key on Cast Base ... 10/-
Bakelite Buzzers ... 2/-
3 Henry Chokes ... 7/6
Complete Kit of Parts for Valve Oscillator as described in W.W. "Learning Morse" 25/-

SHORT-WAVE CONDENSERS

Trolitul insulation. Certified superior to ceramic. All-brass construction. Easily ganged.
15 m.mfd. ... 1/9 100 m.mfd. ... 2/3
25 m.mfd. ... 2/- 160 m.mfd. ... 2/6
40 m.mfd. ... 2/- 250 m.mfd. ... 2/11

MAINS TRANSFORMERS

Wire-ends. All L.T. Windings Centre-Tapped

S.P.301 300-300 v. 150 m.a. 4 v. 2-3 a., 4 v. 2-3 a., 4 v. 1 a., 4 v. 1 a. ... 15/-
SP.350A 350-350 v. 100 ma. 5 v. 2 a. (not C.T.), 6.3 v. 2-3 a. ... 14/-
SP.350B 350-350 v. 100 m.a. 4 v. 2-3 a., 4 v. 2-3 a., 4 v. 2-3 a. ... 14/-
SP.351 350-350 v. 150 m.a. 4 v. 1-2 a., 4 v. 2-3 a., 4 v. 3-4 a. ... 15/-
SP.352 350-350 v. 150 m.a., 5 v. 2 a., 6.3 v. 2a., 6.3 v. 2 a. ... 15/9

MATCHMAKER UNIVERSAL OUTPUT TRANSFORMERS

Will match any output valves to any speaker impedance.
11 ratios from 13 : 1 to 80 : 1, 5-7 watts, 15/9.
10-15 watts, 20/6. 20-30 watts, 35/-.

PREMIER MICROPHONES

Transverse Current Mike, High grade large output unit. Response 45-7,500 cycles. Low hiss level, 23/-.

PREMIER SHORT-WAVE KITS for OVERSEAS NEWS

Incorporating the Premier 3-Band S.W. Coil, 11-86 Metres without coil changing. Each Kit is complete with all components, diagrams and 2-volt valves. 3-Band S.W. 1 Valve Kit, 14/9. 3-Band S.W. 2 Valve Kit, 22/6.

DE LUXE S.W. KITS

Complete to the last detail, including all Valves and coils, wiring diagrams and lucid instructions for building and working. Each Kit is supplied with a steel Chassis and Panel and uses plug-in coils to tune from 13 to 170 metres.
1 Valve Short-Wave Receiver or Adaptor Kit ... 20/-
1 Valve Short-Wave Superhet Converter Kit ... 23/-
1 Valve Short-Wave A.C. Superhet Converter Kit ... 26/3
2 Valve Short-Wave Receiver Kit ... 29/-
3 Valve Short-Wave Screen Grid and Pentode Kit ... 68/-

PREMIER 1940 "5V5" COMMUNICATIONS RECEIVER

A 5-valve Superhet, covering 12-2,000 metres in 5 wave bands.
Beat Frequency Oscillator
2-spread Band-Spread Control.
A.V.C. Switch.
Illuminated Band-Spread Dial.
Send-Receive Switch.
Iron-Cored I.F.s.
Phone Jack.
Over 4 Watts Output.
Built into Black Crackle Steel case providing complete screening. 10½in. Moving Coil Speaker in separate steel cabinet to match.
Receiver, complete with all tubes and Speaker ... £9.9.0

AMERICAN VALVES

We hold stocks of all types at competitive prices.

Auto Transformers. Step up or down. 100-125 v. to 200, 230 or 250 v. A.C., 60 watts, 9/11 ; 125 watts, 13/6 ; 250 watts, 18/6.
L.T. Transformers, all C.T.
4 v. 2-3 a. ... 9/11 6.3 v. 2-3 a. ... 9/11
2.5 v. 5 a. ... 9/11 7.5 v. 3 a. ... 9/11
5 v. 2-3 a. ... 9/11 12 v. 3-4 a. ... 15/-
Lissen Hypernik QPP Driver Transformers. Ratio 8 : 1. 4/3.
Push-Pull Driver Transformers ... 6/6
Universal Output Transformers. 11 Ratios. Single or Push-pull ... 6/6

Moving Coil Mike. Permanent magnet model requiring no energising. Response 90-5,200 cycles. Output .25 volt average. Excellent reproduction of speech and music. 49/-.
Microphone Transformers. Suitable for all

NEW PREMIER S.W. 4 VALVE A.C. RECEIVER KIT

Pentode H.F. Stage, Pentode Detector, Beam Power Output, and F.W. Rectifier. 200-250 v. A.C. Operation. Built-in Power Pack. Hum-free operation. For use in Phones or P.M. Speaker.
Complete Kit of Parts with drilled chassis, all components. Plug-in Coils covering 13-170 metres, 4 valves and full instructions and circuits, £4-10-0. Completely wired and tested, £5-10-0. Send for full details.

MOVING COIL SPEAKERS

All complete with transformer. Rola 6½ in., 15/- ; 8 in. P.M.s, 17/6 ; 10 in. P.M.s, 22/6.
ENERGISED MODELS
Plessy 8 in. 175 ohm field, 7/6 ; G.12 energised, 1,250 or 2,500 field, 63/- ; 10 in. B.T.H. 1,600 ohm field, less transformer, 11/6.

PREMIER 1940 HIGH FIDELITY AMPLIFIER KITS

Each Kit is complete with ready drilled chassis, selected components, specially matched valves and full diagrams and instructions.

| | Kit of Parts with Valves | Completely Wired and Tested |
|---------------------------|--------------------------|-----------------------------|
| 4-watt A.C. Amplifier ... | 2 14 0 | 3 11 6 |
| 4-watt A.C./D.C. ... | 3 0 0 | 3 17 6 |
| 6-watt A.C. ... | 6 16 6 | 7 13 6 |
| 8-10 watt A.C./D.C. ... | 6 11 6 | 7 9 0 |
| 15-watt A.C. ... | 7 18 9 | 9 8 0 |

Black Crackle Steel Cabinet, 17/6 extra.

PREMIER BATTERY CHARGERS for A.C. MAINS

Westinghouse Rectification complete and ready for use

| To Charge : | 6 volts at 1 amp. 22/6 |
|------------------------|-------------------------|
| 2 volts at ½ amp. 11/9 | 12 volts at 1 amp. 24/6 |
| 6 volts at ½ amp. 19/- | 6 volts at 2 amps. 37/6 |

REPLACEMENT VALVES FOR ALL SETS

Europa Mains Valves. 4 v. A.C. Types, A.C./H.L., A.C./L., A.C./S.G., A.C./V.M.S.G., A.C./H.P., A.C./V.H.P., A.C.P., all 5/6 each. A.C./H.P., A.C./V.H.P., 7-pin, 8/6. A.C./Pens. I.H., 8/6 ; A.C./P.X.4, 7/3 ; Oct. Freq. Changers, 9/6 ; Double Diode Triodes, 7/6 ; 3½-watt D.H. Triode, 12/- 350 v. F.W. Rect., 5/6 ; 500 v., 8/9. 13 v. .2 amp. Gen. Purpose Triodes, 5/6 ; H.F. Pens. and Var.-Mu. H.F. Pen., Double Diode Triodes, Oct. Freq. Changers, 8/6 each. Full and Half-wave Rectifiers, 6/6 each.

Premier Pick-up Heads

Will fit any tone-arm ... 7/6
Premier Pick-up with Volume Control ... 12/6
ANOTHER SPECIAL OFFER
Rothermel Brush Piezo Crystal Pick-ups
New Junior P.U. with arm, 24/6. Standard S.8, Model with arm, 34/9. P.U. head only, De Luxe Model 19/6. 1940 Marconi Pick-up, 25/8.

mikes. Tapped secondaries, A, 20 and 40 : 1 ; B, 30 and 60 : 1 ; C, 50 and 100 : 1, 6/6 each.
Microphone Stands. Bakelite table stand, 9 in. ring, 7/6 each. Adjustable Floor Stand, 8 in. ring. Chrome finish, 26/6.

ALL ENQUIRIES MUST BE ACCOMPANIED BY 2½d. STAMP.

PREMIER RADIO CO.

ALL POST ORDERS to: JUBILEE WORKS, 167, LOWER CLAPTON ROAD, LONDON, E.5. (Amherst 4723.)
CALLERS to: Jubilee Works, or 169, Fleet Street, E.C.4 (Central 2833), or 50, High Street, Clapham, S.W.4 (Macaulay 2381).

9 REASONS WHICH PROVE

Ambassador is this year's radio!

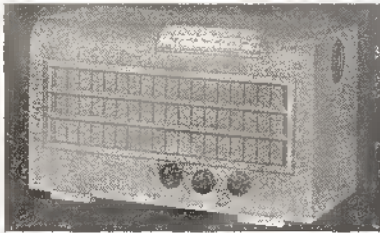

- Six Valves (International Octal Base).
- Six Wave Bands 10 to 565 metres continuously.
- Push Pull Output—8 Watts.
- Large Energised Speaker.
- Iron Cored H.F. Coils and I.F. Transformers.
- High L to C Ratios equivalent to the use of H.F. Amplification.
- Rotating Dial—only One Band visible at a time.
- Operates on either A.C. or D.C. Mains.
- Costs only £16.8.0 including Tax.

GOOD as other Ambassadors have been, this new model beats them for tone, reception, soundness of design, and for a new low level price. For it's an out and out winner. Look at the abbreviated list of its features and look at its price . . . what greater value is there in Radio to-day? Yes, this is an Ambassador year. Please write for full details.

Ambassador OUT VALUES THEM ALL

*Illustrated is the New Ambassador Table Model. Cabinet in Medium or Light Oak.

Write for details to the Manufacturers: R. N. FITTON LIMITED, BRIGHOUSE, YORKS, ENGLAND. Cable Export Enquiries to Ambassador, Brighouse, England.

M-R SUPPLIES

announce a further selection of their bargains in high-class RADIO AND ELECTRICAL EQUIPMENT. As always, satisfaction is assured.

TUNING MOTORS, 15/30 v. A.C. operation. Finest model imported from U.S.A. Spindle 60 r.p.m., reversible, with automatic 2-pole make switch. High torque, suitable for many other purposes, 8/6.

PANEL METERS of guaranteed accuracy, A.C. or D.C., 2 1/2 in. flush panel mount, finished black. Amps.: 0/11, 0/3, either 7/9. Amps.: 0/10, 8/6. Milliamps.: 0/20, 0/50, either 9/6. Volts: 0/10, 9/6. Get these good instruments while supplies are available!

PHOTO-ELECTRIC CELLS. Brand new, guaranteed, Cetron CE1 professional cells of standard rating, suitable for cinemas, laboratories, etc. (These would now cost over 60/- each to import). Last few at 39/6.

ROTHERMEL-BRUSH D.104 MICROPHONE INSETS. The heart of the famous 5-guinea D.104 Microphone, only require housing, but can be used just as supplied. Very remarkable opportunity, 22/6.

BRUSH PIEZO-CRYSTAL ELEMENTS, 2 1/2 in. dia., fitted stylus. For successful construction of mike, cardiophone, piano-repeater, tweeter, etc., 6/11.

L.T. RECTIFIERS. Great news, supplies again in stock! Permanent metal type of best spec. D.C. delivery, 12/14 v. 1 1/2 amp., 10/9. Also Heavy Duty model, D.C. delivery 12/14 v. 5 to 6 amps., 32/6.

STEP-DOWN TRANSFORMERS, suitable for above rectifiers and for low-voltage shelter lighting, etc. All prim. 200/250 v. Secondary, 7/11/15 v. 2 amp., 10/11. Sec. 22 v. 2 amp., 12/- Also special new model for use with above heavy duty rectifier, tapped for 6-volt and 12-volt charging, 32/6.

ELECTRO-MAGNETIC COUNTERS, various res. coil, mostly 500 ohms, counting up to 9999, 5/6.

MINIATURE P.M. M/COIL UNITS. 3in. dia., imp. 12 ohms. Perfect m/coil microphones or extension speakers, ideal for shelter or intercom., fine frequency response, high-flux magnet, 13/6.

MINIATURE NICKEL ALLOY TRANSFORMERS to suit above units, 2/11.

MR/331 DUAL MICROPHONE TRANSFORMERS (as reviewed in "W.W." October). Tapped for m/coil or carbon mike, fully screened, finest response, 19/6.

MAINS TRANSFORMERS (Std. Telephones). Pri. 200/250, sec. 350/0/350 v. 120 m.a., 2.5 v. 5 amp., 5 v. 2 amp., 8/6.

SLIDING RHEOSTATS, fully enclosed with bushed cable entries. Smooth action, very well made. 10 ohms 3 amp., 50 ohms 1 1/2 amp., 100 ohms 1 amp., 200 ohms 7 amp. and 400 ohms .7 amp., either 12/6.

ELECTRIC MOTORS (Asea and Century), 110 v. D.C., 1,500 r.p.m., one-quarter H.P., special offer to clear last few, 32/6. Also small induction A.C. motors 1/30th h.p., 2,200 r.p.m., first-class make, 27/6. Also special high-torque reduction gear motors, 200/250 v. A.C., geared to 6 or 3 r.p.m. (two models), either 25/- Hoover, 1/6th h.p. 200/250 v. A.C., 1,450 r.p.m., 57/6. Century, 1/4th h.p., 200/250 v. A.C., 1,450 r.p.m., 75/-, and others from time to time.

ROTARY CONVERTERS. Only a few of each, all perfect. Input 50 v. D.C., Output 230 v. A.C., 120 watts, 78/6. Input 12 v. D.C., Output 230 v. A.C., 150 watts, 47/10/- Also D.C. Input 200/220 v. D.C., Output 200/220 v. A.C., 90 watts, with cabinet and filter, 46/10/-

AUTODAPTOR VIBRATOR PACKS. Input 6 volts D.C., Output 115 v. 50 ma., D.C., with 25 v. .3 amp. tap A.C. for 43 valve (if required). Fully smoothed, in metal case 5 1/2 in. by 4 in. by 3 1/2 in., with long leads, 25/-

LARGE ELECTRIC WALL CLOCKS. Great opportunity for factories, offices, hotels, institutions, etc. Stomen's finest models at bargain prices. 10 1/2 in. dia., chromium, with matt silvered dial, black numerals, 42/6. 13 1/2 in. dia., chromium, as above, 49/6. Also magnificent 15 in. chromium model as above, 69/6. Also fine 12 in. model either in ivory or bronze-black, white dial with black chapters, handsome modern clock, 45/- Part packing and carriage 1/- extra in each case. **IMPORTANT**—Please note that all above have central seconds hand and market seconds divisions, making them ideal for lab. work, 6-BANK PUSH-BUTTON SWITCHES (Yaxley), 2/11. **KEY SWITCHES**, 2-pole c.o. 2/6.

M. R. SUPPLIES, 68, New Oxford St., London, W.C.1
Telephone: MUSEum 2958

It's more than a diary!

NOW ON SALE

The Wireless World DIARY & REFERENCE BOOK for 1941



- European Broadcasting Stations.
- Short-wave Stations.
- Base Connections British and American Valves.
- Circuit Diagrams of Receivers, Amplifiers, Whistle Suppressors, Tone Controls and AVC Systems.
- Data for Winding Coils.
- Prevention of Mains Interference.
- Morse and "Q" Codes.
- International Call Sign Allocations.

Size 3 1/2 by 4 1/2 inches, 192 pages. Bound leather cloth, back loop with pencil

PRICE 2/- net

Purchase Tax extra

By post, including purchase tax, 2/7

From bookstalls and stationers or direct from the Publishers

75 PAGES OF FACTS, FORMULAE & GENERAL INFORMATION

that is difficult to memorise but . . .

ESSENTIAL TO PROFESSIONAL AND AMATEUR!

IL FFE & SONS LTD., DORSET HOUSE, STAMFORD STREET, LONDON, S.E.1

FREQUENTITE

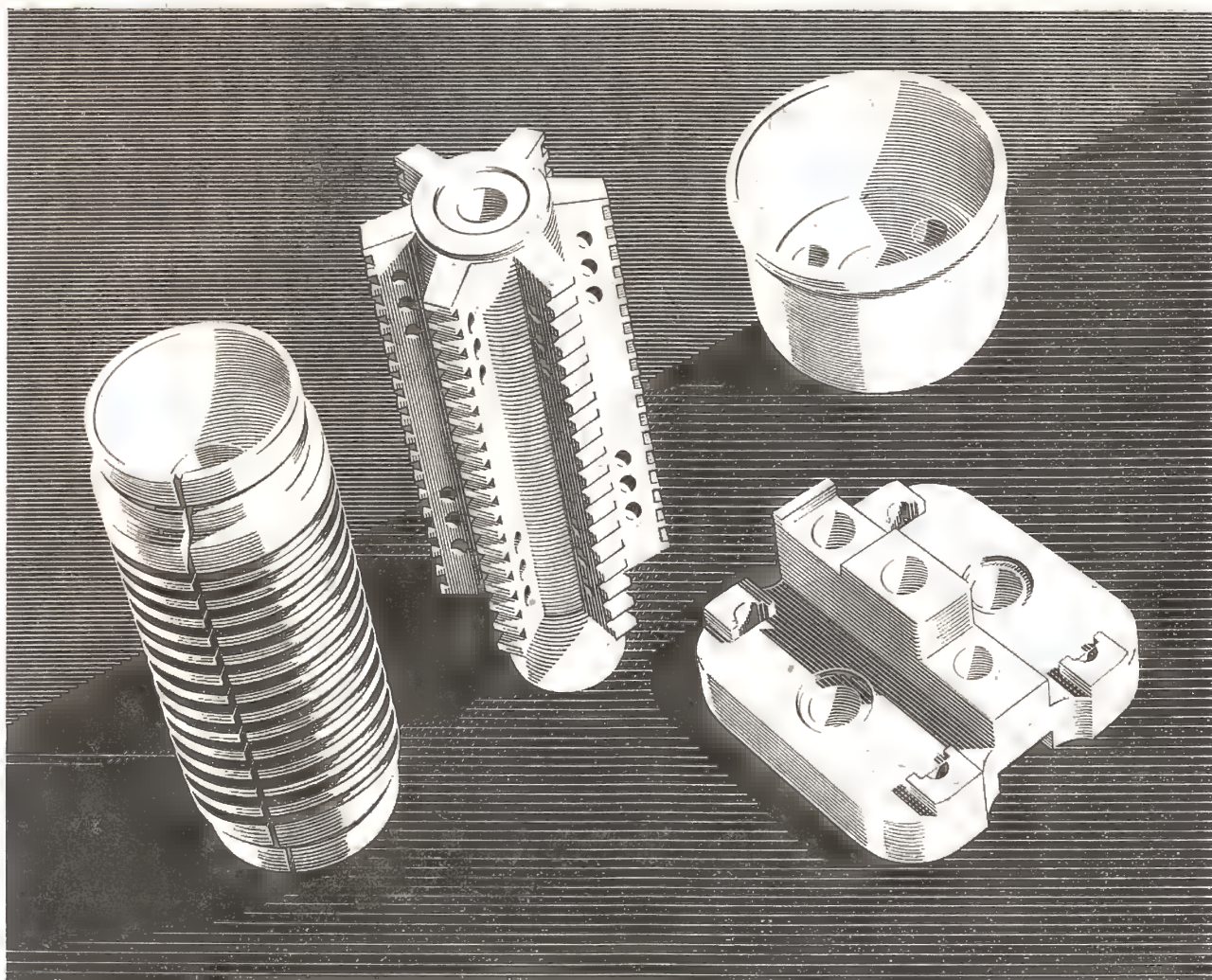

LOW LOSS • HIGH SURFACE RESISTIVITY
• COMPLETE STABILITY • These outstanding properties of "Frequentite" have led to its adoption by all leading radio manufacturers. "Frequentite" is suitable for every type of component however intricate the design. Full details will be sent on application—ask for Catalogue S.P.10.

STEATITE & PORCELAIN PRODUCTS LTD.

Head Office and Works :

Telephone : STOURPORT III.

STOURPORT-ON-SEVERN, WORCS.

Telegrams : STEATAIN, STOURPORT.

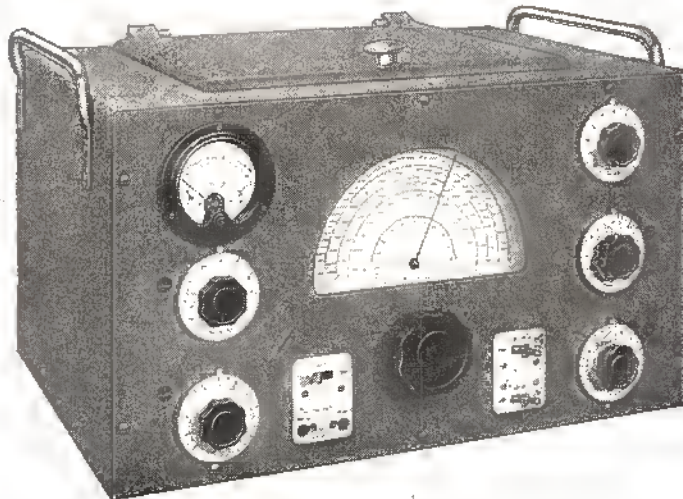

Presenting- the **EDDYSTONE 358** **COMMUNICATION RECEIVER**

Attention is drawn to a new "EDDYSTONE" Production—the 358 Communication Receiver—a first-class engineering job embodying all essential features of a dependable Communication Receiver.

Based on proved design the 358 gives a high performance and its reliability is calculated to meet the exacting requirements of Service operation. It is eminently suitable for every general communication purpose and is the product of engineers with wide practical experience of communication work. The 358 is the progressive development of previous well-known "EDDYSTONE" Receivers—it is designed to do a particular job of work—and to do it consistently well. When absolute reliability and outstanding performance are demanded the "EDDYSTONE" 358 will be found most fitting to the need—a fact given emphatic point by the orders already placed by Government Departments.

SPECIFICATION

Tuning range of 31,000 K/cs to 1,250 K/cs by the use of interchangeable range units. (Additional coil units will shortly be available to extend the range to 100 K/cs.) Power supply—A.C. mains (200-250 volts) for which a power unit giving 6 volts 1.4 amperes and 175-180 volts 65 mA. is provided. (Later it is hoped to offer the 358 to work from a 6 volt accumulator input.) Chassis of unit construction permitting ease of service. Housed in welded steel cabinet, ripple grey finish. **Dimensions:** 20½ in. by 12 in. by 13½ in. deep. **Weight:** 50½ lbs. **Selectivity:** I.F. total bandwidth : Two kilocycles at 2.5 db. down. Ten kilocycles at 40 db. down. **Sensitivity:** Better than 3 microvolts : 30 per cent. modulation for 50 milliwatts output on all ranges. **Audio Output:** 1.5 watts.

| Image Ratio | | Frequency Ranges of Coil Units are :— | |
|------------------|------------------------------|---------------------------------------|----------------------------|
| At 30 megacycles | 20/1 | Range A. | 22,000—31,000 K/CS. |
| " 12 " | 100/1 | " B. | 9,000—22,000 " |
| " 19 " | 210/1 (Range " B.") | " C. | 4,500—9,000 " |
| " 4.5 " | 400/1 | " D. | 2,100—4,500 " |
| " 3 " | 500/1 | " E. | 1,250—2,100 " |
| " 2 " | 1,500/1 (Range " D.") | | |
| " 1.6 " | 8,000/1 | | |
| " 1.2 " | 10,000/1 | | |

Output Circuit incorporates twin jacks for 120 ohm or 2,000 ohm Headphones. (Other impedances can be fitted to order.) To simplify maintenance a meter and test switch is fitted by which the emission of each valve can be checked while in position.

**ENQUIRIES ARE INVITED FROM GOVERNMENT DEPARTMENTS
AND ALL UNDERTAKINGS OR PERSONS ENGAGED ON
WORK OF NATIONAL IMPORTANCE.**

STRATTON & CO. LTD.

BROMSGROVE STREET, BIRMINGHAM.

TELEPHONE : MIDLAND 3771.

TELEGRAMS : "STRATNOID," BIRMINGHAM

The Wireless World

COVERING EVERY WIRELESS INTEREST

30th Year of Publication

Proprietors : ILIFFE & SONS LTD.

Editor :
HUGH S. POCKOCK.

Editorial,
Advertising and Publishing Offices :
DORSET HOUSE, STAMFORD STREET,
LONDON, S.E.1.

Telephone : Waterloo 3333 (35 lines).
Telegrams : "Ethaworld, Sedist, London."

COVENTRY : 8-10, Corporation Street.
Telegrams : Telephone :
"Autocar, Coventry." 5210 Coventry.

BIRMINGHAM :
Guildhall Buildings, Navigation Street, 2.
Telegrams : Telephone :
"Autopress, Birmingham." 2971 Midland (5 lines).

MANCHESTER : 260, Deansgate, 3.
Telegrams : Telephone :
"Iliffe, Manchester." Blackfriars 4412 (4 lines).

GLASGOW : 26B, Renfield Street, C.2.
Telegrams : Telephone :
"Iliffe, Glasgow." Central 4857.

PUBLISHED MONTHLY.
Price : One Shilling
(Publication date 20th of preceding month.)

Subscription Rates :
Home and Abroad, 14/- per annum.

As many of the circuits and apparatus described in these pages are covered by patents, readers are advised, before making use of them, to satisfy themselves that they would not be infringing patents.

No. 1062

Vol. XLVI. No. 14

DECEMBER, 1940

Contents

| | |
|---|-----|
| EDITORIAL | 481 |
| TESTING ELECTROLYTICS. By F. A. Boyer, B.Sc. .. | 482 |
| SHORT-WAVE RECEIVING CONDITIONS | 484 |
| ERRORS IN TRACKING. By W. Winder | 485 |
| ATTENUATOR DESIGN. By S. S. West and E. D. McConnell .. | 487 |
| TONE CONTROL. By E. O. Powell | 491 |
| PREMIER SHORT-WAVE S.G.3: Test Report | 492 |
| RECEIVERS FOR FM TRANSMISSIONS | 494 |
| CURRENT TOPICS | 497 |
| NEWS IN ENGLISH FROM ABROAD.. .. . | 500 |
| COMPRESSED DIPOLES (Concluded) By E. L. Gardiner, B.Sc | 501 |
| LAMP CONTRAST EXPANDER. By S. W. Amos, B.Sc. (Hons.) | 504 |
| RANDOM RADIATIONS. By "Diallist" | 505 |
| UNBIASED. By Free Grid | 508 |
| RECENT INVENTIONS | 509 |

WORLD CONTACT WITH A TROPHY

IN THESE HISTORIC TIMES WORLD LISTENING PROVIDES A NEVER ENDING SOURCE OF INTEREST AND ENTERTAINMENT.

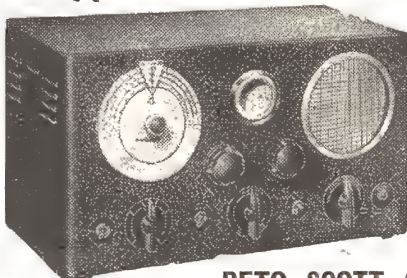

THE
TROPHY IS
SPECIALLY DESIGNED
FOR ALL-WORLD
RECEPTION

TROPHY 6 Valve
incorporating all latest
improvements. 6.5 to
545 metres. Built-in
Speaker, A.C.
£11. 11. 0 or 45/-
deposit and 34/6 monthly

TROPHY 8 Valve A.C.
A super communication
receiver with amazing
range. 7 to 550 metres.
£14. 19. 6 or £3
Deposit and 44/- monthly

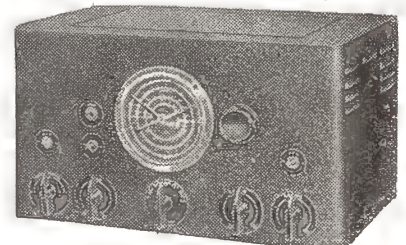

PETO SCOTT CO. LTD. Showrooms at 77, CITY ROAD, E.C.1. SEND FOR FULL SPECIFICATION

Ersatz

WITH ADVANTAGES . . .

DURING the war all the aluminium that we use must go into the apparatus that we make for the Services. There is none to spare for ganged tuning condensers, and if we are to carry on making radio sets to bring news and entertainment to the people, we must find a satisfactory substitute. Sheet zinc has been chosen for this purpose, and you may be interested, as we were, to discover that the zinc has some advantages over the aluminium it replaces.

When condenser vanes are pressed from sheet aluminium, the metal suffers a shearing action and the vanes produced are in a state of

strain because the structure of the metal has been distorted. To relieve this strain it is necessary to anneal the vanes by clamping them together in large numbers between heavy metal plates to keep them flat, and heating them in a muffle furnace to a temperature between 300 and 350 degrees Centigrade. The vanes are then flat and strain-free. When these strain-free vanes are pressed into the rotor shaft or bonded together to form a stator, or when the condenser is matched to the standard law by adjusting the split end-vanes, strain is again set up by the bending and pressing of the metal. The vanes slowly relieve a

part of this strain by small movements and changes of shape, so that some drift in the capacity of the condenser occurs, leading to small errors of ganging and of calibration.

Zinc has the valuable property that strain within the metal is easily and very quickly relieved at ordinary room temperature, so that the condenser vanes do not need annealing and there is very little tendency for them to creep after they have been pressed or bent. The zinc vane condenser keeps nearer to its initial adjustment.

It does seem that aluminium, although normally cheaper, lighter and somewhat easier to handle, may not have been the very last word in materials for condenser vanes, and that we have here a substitute with its own special merits—a substitute that we may well go on using after the war.

Matching Ganged Condensers to the standard law.



MURPHY

*All Murphy Sets, exclusive of Valves
and Batteries, guaranteed for one year.*

MURPHY RADIO LTD., WELWYN GARDEN CITY, HERTS.

The Wireless World

COVERING EVERY
WIRELESS INTEREST

ESTABLISHED
1911

No. 1062. Vol. XLVI. No. 14.

DECEMBER, 1940

Price One Shilling

Editorial Comment

Exports: The Co-operative Effort

FOR many years it has been a standing reproach to the British wireless industry that, with one or two notable exceptions, the export of broadcast receivers has not been taken seriously. True, many manufacturers half-heartedly produced a so-called "export model," generally differing only from the home receivers in that it covered an extra short-wave band in place of the long waves, and had what was fondly believed to be a "tropical finish"—for some unknown reason all inhabitants of "foreign parts" were assumed to enjoy a tropical climate. Few determined efforts were made to ascertain and satisfy the diverse requirements of buyers in different overseas markets.

All that is now being changed, and for the solid results that have already been achieved we have largely to thank the co-operation between manufacturers brought about by the efforts of the Radio Manufacturers' War Export Group, an offspring of the R.M.A. which enjoys the active support of the Board of Trade. Some overseas markets have been lost as a result of the war, but British firms are now energetically cultivating others in which they enjoy the advantage of being relieved, thanks to our blockade, of competition from enemy countries.

Writing in *The Wireless World* for July on the means whereby the British wireless industry could make its fullest contribution to the war effort, we urged "closer collaboration between all branches of the industry than anything it has known before . . . almost inevitably, a measure of sacrifice on the part of some of the interests concerned would clearly be necessary . . . team work is needed, and wasteful competition between ourselves is a luxury for which we must wait until peace returns."

It would seem that the present activities of the Export Group organisation go a long way towards giving effect to the ideas expressed in the sentences we have quoted; not only is there co-operation in the commercial sphere, but there is an interchange of technical information.

As a result, British firms are turning out some very fine receivers for various overseas markets. Not only has general design been improved, but there is greater attention to detail. Rightly, we are giving of our best to export needs, and the home market takes second place.

Pooled Service Organisations?

It is to be hoped that those principles of co-operation which are being employed in the production of British receivers for export will be applied to organising schemes for servicing and the supply of spares in those countries where a footing has been gained. We are well aware that one or two of the larger manufacturers have already built up in many countries an adequate organisation for dealing with these matters in so far as their own products are affected. But servicing is always a big problem to the smaller exporters, and especially to newcomers in the field, who can hardly afford to maintain efficient service depôts abroad; they must, therefore, depend almost entirely on local firms. Unfortunately, British sets will tend to lose some of their attractiveness to the more cautious type of overseas buyer unless he is satisfied that there exists a good service for their upkeep. Even the supply of spare valves needs some organisation, as, according to an official statement, the principle of basing export receiver designs on British, rather than on International, types is to be followed.

Testing Electrolytics

MEASUREMENT OF CONDENSER LEAKAGE CURRENT

By F. A. BOYER, B.Sc.

THERE are several methods of measuring the leakage current in electrolytic condensers. In essentials it is only necessary to place a milliammeter in-series with the condenser and the correct polarising voltage, but such a method may cause damage to the milliammeter if used by unskilled operators for rapid testing. The leakage current is of the order of $\frac{1}{2}$ millamp. for a high voltage smoothing condenser of, say, 8 microfarads. If the condenser has not been used for some time the leakage current may be 20 milliamps on switching on, falling to a lower figure rapidly. On the other hand, the current may be several hundred milliamps for a faulty condenser, and as the test is intended to find faulty condensers, it is essential to be able to deal with currents from several hundred milliamps down to a half-milliamper without fear of damaging the apparatus, and also to be able to obtain fairly accurate readings around the lower current value. If, for example, a 0.2 milliammeter is used it is generally shunted by a

Describing a safe method of measuring the leakage current of electrolytic condensers by means of an inexpensive test set employing a cathode-ray tuning indicator

ciently high to damage the meter.

There are two other methods in general use. One is to use a voltmeter across the condenser, which is placed in series with a resistance and the polarising voltage. The greater the leakage the less is the voltage read on the voltmeter. This method is quite safe, but a direct reading is not obtained. Moreover, a multi-range meter is required to give readings for different polarising voltages. A third method is to use a neon lamp. Here we only get a visual indication which is only useful for a rough check.

Accurate Checks

The instrument to be described overcomes all these disadvantages. It can be subjected to a dead short without fear of damage. Accurate readings can be obtained between 0.5 and 30 milliamps. It is extremely rapid in use and any condenser can be checked in a few seconds. The reforming action can be followed visually, giving an indication of the state of the condenser. The polarising voltage can be changed to any values required, or could be made continuously variable. It is extremely cheap to build as it does not employ either a voltmeter or a milliammeter.

The basis of the design is a cathode-ray tuning indicator, with which the angle of the fluorescent light varies with the voltage on the triode grid. An Osram Y64 was the actual valve used. The principle employed is to cause the leakage current to change the grid voltage, and then by means of a calibrated poten-

tiometer to back this voltage off to its original value, which is determined by obtaining the same angle of light as initially. Fig. 1 shows how this is done. R_1 and R_2 are both wire-wound potentiometers, while r_1 and r_2 in series with R_2 provide a fixed potentiometer circuit to give 130 volts for operation of the tuning indicator and also to provide a load for the power supply. With the negative power lead connected at point C, the junction between R_1 and R_2 , the upper portion of R_2 carries the combined currents of the fixed potentiometer plus the valve. The voltage developed across this upper portion appears as negative bias on the grid, so by varying the slider connected to the cathode we can vary the grid bias and hence the angle of the light. About 6 volts will close the angle.

Now turn to Fig 2. The negative power lead is connected to the slider of R_1 , and the load whose leakage we wish to measure is connected

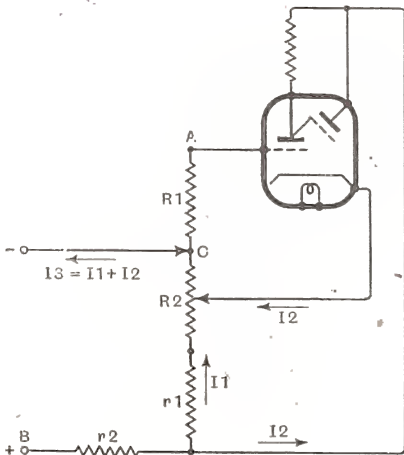

Fig. 1. The basic circuit, with slider of potentiometer R_1 at zero. Current I_3 flowing in part of R_2 produces a bias voltage.

push-button so that it is only placed in circuit after the leakage has become normal. It is necessary to have a short-circuit test first, but even then the current may be suffi-

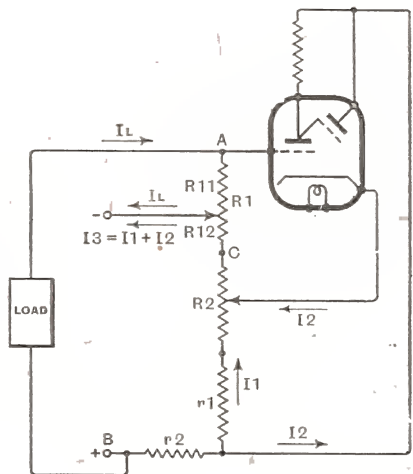

Fig. 2. Showing addition of a test load to the basic circuit. Current I_3 in $R_{12} + R_2$ gives bias $I_3 \times (R_{12} + R_2)$ volts. Load current I_L gives bias voltage $I_L \times R_{11}$ (positive).

across A and B. The leakage current we wish to find now flows through the upper portion of R_1 , developing a voltage across it which changes the grid to a more positive

Testing Electrolytics—

the milliammeter readings can be marked by hand on the scale.

A note about the power supply. As only a small current is used, it was found that an ordinary receiver transformer gave sufficient volts, owing to its poor regulation and a smaller voltage drop in smoothing. Transformers giving 350—0—350 under load are quite common and

cheap. The smoothing condensers must be at least 500-volt peak working.

Finally, the whole of the apparatus was mounted in a wooden box measuring 9in. by 6in. by 5in. high, making a compact and convenient unit that could be carried to any part of the workroom to test condensers without having to remove them from any of their associated equipment.

mum value for the year at about 0200 daily during the month of December.

Montreal: Midt, 31, 41 or 49 m; 0400, 41 or 49 m; 0600, 49 m; 0900, 31 or 41 m; 1200, 19 or 25 m; 1400, 13, 16 or 19 m; 1700, 19 or 25 m; 2000, 25 or 31 m.

Bombay: Midt, 31, 41 or 49 m; 0300, 41 or 49 m; 0600, 25 or 31 m; 0800, 16 or 19 m; 1100, 13 or 16 m; 1400, 16 or 19 m; 1800, 25 or 31 m; 2100, 31 or 41 m.

Capetown: Midt, 31 or 41 m; 0300, 41 or 49 m; 0700, 19 or 25 m; 0900, 16 or 19 m; 1200, 13 or 16 m; 1500, 16 m; 1800, 19 or 25 m; 2100, 25 or 31 m.

Short-wave Receiving Conditions

PROSPECTS FOR DECEMBER

(Communicated by the Engineering Department of Cable and Wireless, Ltd.)

IN general, short-wave reception during October was slightly less favourable than during September.

Ionosphere storm conditions were reported to be in evidence on October 1st, 7th, 8th, 21st, 22nd, 25th and 26th. These conditions brought about relatively poor reception during the earlier and latter part of the month, in contrast to the more settled conditions which were associated with the period covered by the maximum number of consecutive "quiet" days, i.e., from October 9th to 20th, inclusive.

Readers may recall the fact that, in reviewing reception for the month of August in a previous issue of this journal, it was stated that the first and last few days of October might prove to be less settled than the middle of the month.¹

Sudden ionosphere disturbances of the "Dellinger" type were not observed during the month.

Particulars of the broadcast bands which, it is considered, should prove most reliable during December under normal conditions of propagation at the times stated for five selected routes are given below; these may serve as a guide when considering the possibilities of reception from places not too remote from those specified.

(The times given in this report are G.M.T. on the 24-hour clock notation.)

Tokio: Midt, 31 m; 0600, 19 or 25 m; 0900, 16 or 19 m; 1200, 19 or 25 m; 1500, 25 or 31 m; 1800, 31 or 41 m; 2100, 41 or 49 m.

At the Winter Solstice the sun has already set at Tokio at the time of sunrise at London and in consequence the period of utility of the higher frequencies is considerably reduced compared with that prevailing during the

¹ See *The Wireless World*, October, 1940, page 436.

summer months. The period from midnight to 0600 is likely to present the greatest difficulties.

"Echo" signals may be audible on occasions from one or two hours before to one or two hours after 0800.

Melbourne: 0800, 25 or 31 m (Westward, via Pacific); 1000, 19 or 25 m (Westward); 1200, 16 or 19 m (Eastward, via Calcutta); 1500, 19 or 25 m (Eastward); 1800, 25 or 31 m (Eastward); 2100, 31 m (Eastward).

It is considered to be extremely improbable that signals will be audible for any appreciable length of time between 2300 and 0500 on account of the high attenuation encountered at Melbourne; this factor, which imposes a definite limit on the number of hours for which reliable reception may be anticipated, probably attains its maxi-

imum value for the year at about 0200 daily during the month of December. In winter, whilst the frequency of atmospheric disturbances is generally considerably less than in summer, the instantaneous effect of such disturbances as may occur may sometimes be almost as great; for, although the source of disturbance with respect to this country may be somewhat more distant in winter, the consequent tendency for reduced intensity may be offset by the decrease in attenuation exhibited at this season. On certain relatively long routes this effect may be particularly in evidence at mid-day or early afternoon in those cases where the field strength of the distant signal at this time of day is not appreciably different in summer and winter.

At the time of writing this report, which is necessarily prepared some time before publication, it would seem to be not unlikely that relatively adverse conditions may be experienced during the middle and latter portion of the month.

"RADIO DESIGNER'S HANDBOOK"

A Comprehensive Manual for Radio Engineers and Experimenters

THE publication of this handbook is an event which we have more than usual pleasure in announcing, for we feel that it is exactly what the radio set designer and experimenter has been wanting for some time, namely, a comprehensive collection of all the principal formulæ involved in the design of receivers and components.

The book is divided into eight parts: (1) Audio Frequencies, (2) Radio Frequencies, (3) Rectification, Filtering and Hum, (4) Receiver Components, (5) Tests and Measurements, (6) Valve Characteristics, (7) General Theory, (8) Sundry Data. In addition to the formulæ themselves there are full explanations of their application, and each chapter concludes with a bibliography of the literature of the subject. It is, in fact, more than a mere

reference book, and when used in conjunction with the "Wireless Servicing Manual" and the "Radio Laboratory Handbook," will lay the foundations of a liberal wireless education.

There are chapters on wireless mathematics, including vectors, simple trigonometry and the use of "j" in complex algebra, while the Sundry Data section contains, in addition to the usual wire tables, colour codes, etc., such elusive information as the frequency relations of the musical scale and the visibility curves of the human eye.

The handbook, which is edited by F. Langford Smith, B.Sc., A.M.I.E.E., should be available from our Publishing Department when this notice appears in print. The price, bound in cloth, will be 7s. 6d., or 8s. 1d. by post.

Errors in Tracking—And How

To Reduce Them

This article explains the nature of circuit misalignment in superheterodynes, and—an important matter in these days when help from servicemen is hard to obtain—shows how errors may be cured without elaborate equipment

By W. WINDER

THE methods of ganging a superheterodyne are well known, but what is not so universally appreciated is the possibility of errors at points other than the trimming and padding points. In a well-built set these defects should not develop to any extent, but where coils are not perfectly matched it is easy for the circuits to get out of step. It is the purpose of this short article to show how tracking errors can be tackled by purely empirical means which, after all, are the only ones available to many readers.

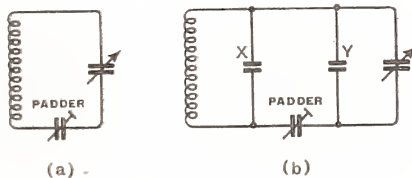

Fig. 1. Diagram (a) shows the conventional tuned circuit of a superheterodyne oscillator. The true circuit, with stray capacities, is represented by (b).

If one trims and pads correctly, there are two points on the dial at which the set is properly lined up, but at an intermediate tuning point it is often found that twiddling the RF trimmers can bring about some appreciable improvement in the received signal. This means a tracking error—the oscillator and RF circuits are getting out of step with each other as the tuning knob is turned. If the IF coils are correctly tuned to their proper frequency the cause of the trouble is usually that the oscillator coil is of the wrong inductance value to go with the others. If such is the case, fortunately something can be done about it.

To begin with, in these days of all-wave sets gang condensers with specially shaped oscillator vanes are almost museum pieces, and it is fair

to assume that tracking is now always obtained by means of a padding condenser, as in Fig. 1 (a). The actual circuit, however, is more truly represented by Fig. 1 (b). Condenser X consists of the self-capacity of the coil plus the capacity of the associated wiring, say, about 15 m-mfds. Condenser Y is made up of the residual capacity of the gang condenser section when fully opened and of valve and wiring capacities, amounting in a practical case to, say, 30 m-mfds. In addition, there is a semi-variable trimmer which can add capacity either to X or to Y. In some cases the trimmer is wired straight across the coil and is therefore outside the influence of the padding condenser, and in others it forms part of the gang condenser assembly and is placed at Y. Although it is not generally realised, the choice of trimmer position has a distinct effect on tracking errors. Calculations were made, using coils which were known to produce tracking errors, and the curves of Fig. 2 drawn to show the amount of those errors for the alternative trimmer positions. From these it must not be assumed that B is always the

aggravate the trouble. (See Fig. 3.)

Figs. 2, 3 and 4 show the whole story. A fixed RF inductance has been assumed for all cases, and the curves show the effect on tracking errors of varying oscillator inductance and trimming position. Incidentally, curve A on Fig. 3 is approaching the ideal, having three positions of zero error, and errors elsewhere being small.

Nature of Errors

Just a word about positive and negative tracking errors. It should be realised that when a superheterodyne is tuned in to any station the oscillator circuit automatically gets its correct setting. The RF signals dealt with by the set will be of a frequency calculated by subtracting the IF from the oscillator frequency, and this will differ from the actual setting of the RF circuits by whatever tracking error exists. Let us say that the RF circuits are tuned to f_1 and that the oscillator frequency minus the IF is f_2 . If f_1

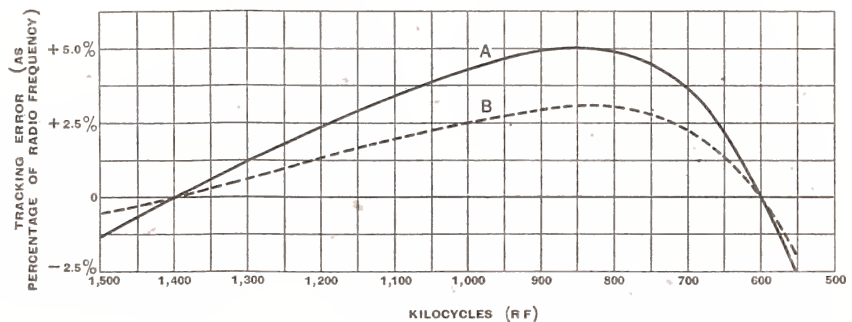

Fig. 2. Effect of trimming condenser position. Curve A, trimmer across coil; curve B, trimmer across gang condenser.

better position for the trimmer. If the tracking error is of the opposite sign to begin with, changing the trimmer from A to B would merely

is greater than f_2 we will call the tracking error positive, and if less than f_2 , negative. Obviously, some such convention must be assumed.

Errors in Tracking—

The lessons of the above curves are that a positive tracking error can be corrected by (a) bringing part or the whole of the trimming capacity under the influence of the padding condenser, or (b) decreasing oscillator inductance. A negative error will, of course, need reverse treatment—that is, the trimming capacity will need to be placed partly or wholly across the coil direct, or oscillator inductance will need increasing.

A third method of treating tracking errors is to alter the IF tuning, but this is not to be recommended. Besides being relatively inefficient compared with the other treatments it has the disadvantage of upsetting ganging on other wavebands. However, for the sake of completeness, the reader may like to know that tuning the IF coils to a higher frequency will produce a positive tracking error, and to a lower frequency a negative error.

Procedure

The reader should now be in a position to set about achieving a high standard of alignment in his own set, but those who prefer rule-of-thumb instructions may be guided by the

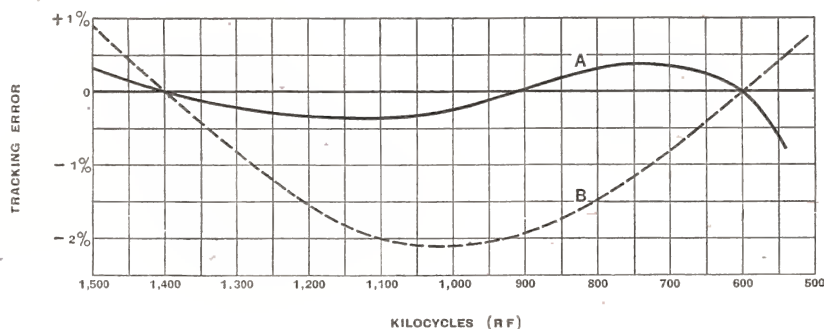

Fig. 3. When the tracking error changes its sign, the trouble is aggravated. Trimmer positions as in Fig. 2.

following. First of all make sure that the IF circuits are tuned to their correct frequency. Then proceed to trim and pad in the usual way, thus ensuring that the circuits are properly aligned at one point towards the bottom of the dial and at one point towards the top. Mark the setting of the RF trimmers. Now tune the set to a signal at an intermediate position of the dial, and

return to the RF trimmers. If any appreciable improvement in received signal can be made by altering the RF trimmers, then there is a tracking error. Return the RF trimmers to their marked setting and try again at, say, two other intermediate points on the dial. Don't go below the original trimming point or above

trimmer is already across the gang condenser, then it is necessary to make the oscillator coil smaller. If plenty of oscillator volts are available for frequency changing, the easiest way of reducing coil inductance is to fix a brass disc over the end of the coil, and to adjust its distance until the right position is

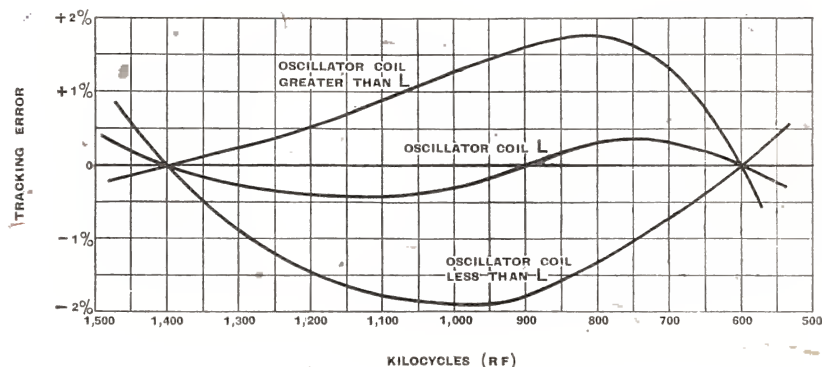

Fig. 4. Effect of variation of oscillator coil inductance value on the tracking error.

the padding point when setting the dial for these tests.

If at all these points an improvement in signal results from screwing in the RF trimmers from their marked setting, proceed with cure A, given below. If, however, best results are obtained when the RF trimmers are reduced—that is, unscrewed from their marked setting—

found. If the valve is not oscillating very strongly to start with, it would be better to take off turns from the coil in order to reduce its inductance. The disc method increases HF resistance, and therefore introduces losses. After a *small* reduction in inductance the set should be re-trimmed and re-padded, and the new RF trimmer position should be marked. If the tracking error still persists, and if it is such that the RF circuits still need more capacity to bring them into line, a further reduction of the oscillator coil is called for. And so on, but after reganging, should the RF circuits need *less* capacity at the intermediate positions, then the cure has been taken too far.

Cure B is just the opposite of Cure A. The first step is to see that the trimmer is directly across the oscillator coil. If more drastic treatment is necessary after this, then turns must be added to the oscillator coil (tuned winding). The actual number of such turns must be found by trial and error, but in a normal case only slight alterations will be necessary, say, one or two turns for a medium-wave coil.

Needless to say, no one should attempt any coil alterations unless they are sure what they are doing—otherwise their last state will be considerably worse than their first.

Attenuator Design

CALCULATING RESISTANCE VALUES FOR FIXED AND VARIABLE NETWORKS

By S. S. WEST and E. D. McCONNELL
(Baird Television, Ltd.)

After a discussion of the fundamental theory of attenuators, the authors give formulæ for calculating the constants of networks in special cases, and conclude with a table of basic figures for the rapid design of attenuators of various types.

THE radio engineer has frequent need for employment of some form of attenuating network. It is proposed in this article to deal only with the variable or fixed types of attenuators which are substantially independent of frequency. This class is indispensable in all forms of amplifiers, measuring gear, etc., as a means of varying a potential in discrete known steps.

Attenuators are usually classified under the following headings:—

- (1) Simple fixed or variable potentiometers.
- (2) Attenuators which present both constant input and output impedances.
- (3) Attenuators having constant impedance in one direction only.

Usually (2) and (3) are variously described as "π" (Pi), "T," and "L" networks. This nomenclature gives the clue to their schematic arrangement.

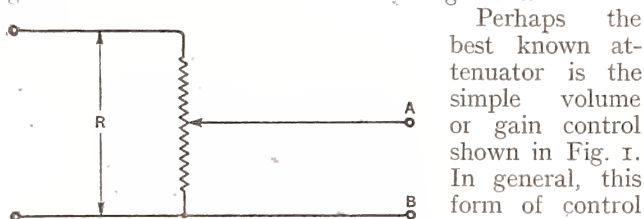
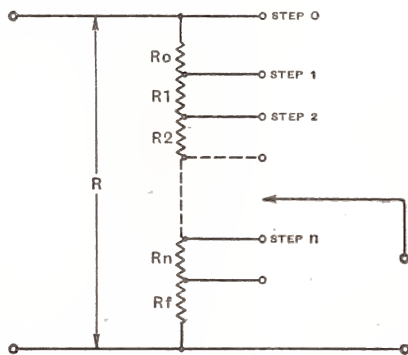

Fig. 1. (Above) In the simple potentiometer, voltage ratios are proportional to resistance ratios only when the load across AB is high compared with R.

Fig. 2. (Right) Formulæ for calculating the steps in a logarithmically graded potentiometer are given in the text.



is arranged to vary a potential linearly or logarithmically, and it is necessary that the load across the terminals A and B should be large compared to the total resistance R.

When a potentiometer is being used as a gain control it is preferable that it should be logarithmically graded, as this provides a fixed ratio of attenuation which is simply converted to decibels.

To determine the values of $R_0, R_1, R_2,$ etc., for a

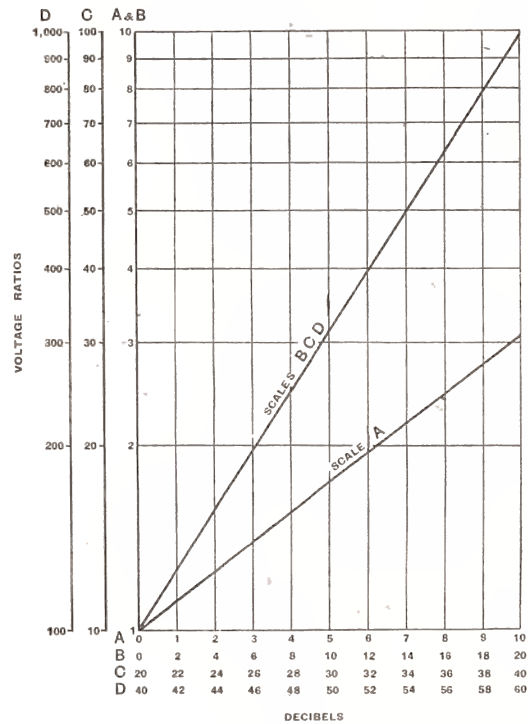

Fig. 3. Conversion chart giving the relation between voltage ratios and decibels.

logarithmic potential divider as represented in Fig. 2 is quite simple, but is not readily shown with simple formulæ. However, for those readers desiring to derive accurately the required values, a suitable formula is provided below.

$$R_n = \frac{R}{\text{antilog} \frac{Nn}{20}} - \frac{R}{\text{antilog} \left(\frac{N(n+1)}{20} \right)}$$

Where R_n denotes the value of the resistance n steps down the potentiometer, N is the number of decibels per step, and R is the total resistance of the potentiometer. For the first step obviously R_n becomes R_0 , here the numerical value of n is 0, for the second step R_n becomes R_1 so that the term Nn in the equation is, for the first step, N times 0 and for the second step is N times 1, and so on.

Attenuator Design—

A little consideration shows that the value of the final resistance R_f , which is simply an "on-off" step and not therefore a real part of the attenuator, is given

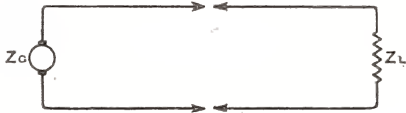

Fig. 4. Voltage generator working into a matched load.

thus. Let R_n equal the value of resistance for the penultimate step, then

$$R_f = \frac{R_n}{\text{antilog} \frac{N}{20} - 1}$$

The value of R_f can also be found by summing all the remaining elements and subtracting this total from the value of R . Whilst this method ensures absolute accuracy, it is felt that it may prove to be somewhat unwieldy in application. Accordingly the simpler method, provided by the graph, Fig. 3, is included.

It is also of interest to note that this graph will provide a ready means for converting voltage and current ratios into decibels.

The following example will indicate the procedure involved.

- (1) Assign a suitable value to R which satisfies the circuit conditions. For example, let $R = 1,000$ ohms.
- (2) Decide the attenuation, say, 6 db. per step.
- (3) From the graph it is seen that 6 db. corresponds to a ratio of approximately 2 : 1, thus the first resistance

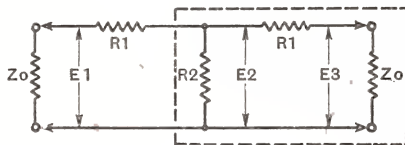

Fig. 5. "T"-type attenuator

in the potentiometer, i.e., R_0 (see Fig. 2), is equal to $R - R/x$ where x is the ratio given by the graph. In this case it is 2. R_0 is thus $1000 - 1000/2 = 500$ ohms. For the value of the second resistance R_1 , the R term in the equation naturally becomes $R - R_0$, that is $1000 - 500 = 500$ ohms. Thus $R_1 = 500 - 500/2 = 250$ ohms. Similarly for R_2 the R term in the equation becomes $R - R_0 - R_1$ and for R_3 the R term is $R - R_0 - R_1 - R_2$, and so on. Note that $R - R_0 - R_1 - R_2$ is more simply expressed as $R - (R_0 + R_1 + R_2 \dots)$. This procedure is adhered to for the requisite number of steps, the last resistance R_f being included so that $R_f + R_0 + R_1 + R_2$, etc., is equal to R , i.e., $R_f = R - (R_0 + R_1 + R_2 + \text{etc.})$.

Consider the circuit diagram, Fig. 4, where we have a generator of impedance Z_G feeding into a load Z_L and assume that $Z_G = Z_L$, as is the case in most transmission line applications. Assume now that it is required to vary the potential across Z_L without affecting the impedance match. It is apparent that an attenuator matching both the generator and load is entailed. The "T" type of attenuator depicted in Fig. 5 will fulfil these conditions.

Formulae for deriving suitable values is given here.

$$R_1 = Z_0 \left(\frac{n-1}{n+1} \right)$$

$$R_2 = \frac{2Z_0}{n - \frac{1}{n}}$$

Where Z_0 is the characteristic impedance and n is the attenuation, i.e., the ratio of E_1/E_3 .

It is of interest to note that these formulae are derived in the following manner, which is given in some detail as the method of derivation is conveniently applied to certain other types of symmetrical attenuators.

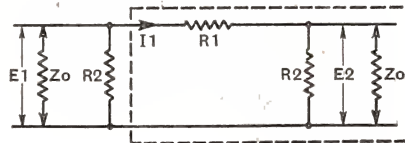

Fig. 6. "π"-type attenuator.

If the series and parallel combination of resistances within the dotted frame, in Fig. 5, be assigned a value A , then, in order to obtain the required matching conditions, obviously $R_1 + A = Z_0$ or $A = Z_0 - R_1$.

$$\frac{E_2}{E_1} = \frac{A}{R_1 + A} \quad E_2 = E_1 \left(\frac{Z_0 - R_1}{Z_0} \right) \dots (1)$$

$$\frac{E_3}{E_2} = \frac{Z_0}{Z_0 + R_1} \quad E_3 = E_2 \left(\frac{Z_0}{Z_0 + R_1} \right) \dots (2)$$

Substituting

$$(1) \text{ in } (2) \quad E_3 = E_1 \left(\frac{Z_0 - R_1}{Z_0} \right) \left(\frac{Z_0}{Z_0 + R_1} \right) = E_1 \left(\frac{Z_0 - R_1}{Z_0 + R_1} \right)$$

Therefore

$$\frac{1}{n} = \frac{Z_0 - R_1}{Z_0 + R_1} \text{ and } R_1 = Z_0 \left(\frac{n-1}{n+1} \right) \dots (4)$$

Similarly, by substituting this value for R_1 in the equation for the complete network, it can be shown that

$$R_2 = \frac{2Z_0}{n - \frac{1}{n}} \dots \dots \dots (5)$$

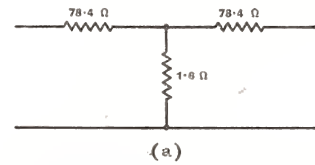
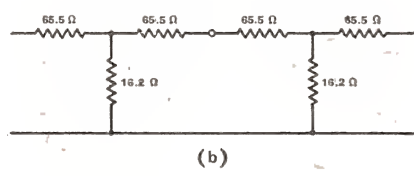

Fig. 7. The series-connected two-element network (b) gives the same attenuation as the single pad (a), but with more convenient resistance values. "π"-type pads can be treated in the same way.



The graph, Fig. 3, can again be used to obtain the ratio "n" in terms of decibels.

In Fig. 6 is depicted a "π" type attenuator. It has similar characteristics to the "T" type but, due to the

Attenuator Design—

high values which must be assigned to R_1 when high attenuation ratios are required, this type is unsuitable for radio-frequency purposes. However, as the value

Fig. 8. Balanced "T" and "π" pads in which the series elements are halved.

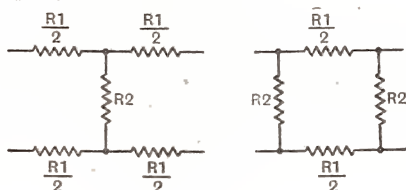

of R_2 in the "T" type becomes increasingly low for high attenuation ratios, some alternative arrangement is generally necessary. In this event probably the simplest plan is to employ one or more series-connected pads, as the following example will show.

Supposing we require an attenuation ratio, n , of 100 with a characteristic impedance of 80 ohms. A single pad would have the values shown in Fig. 7 (a) and the difficulty of obtaining the low value of 1.6

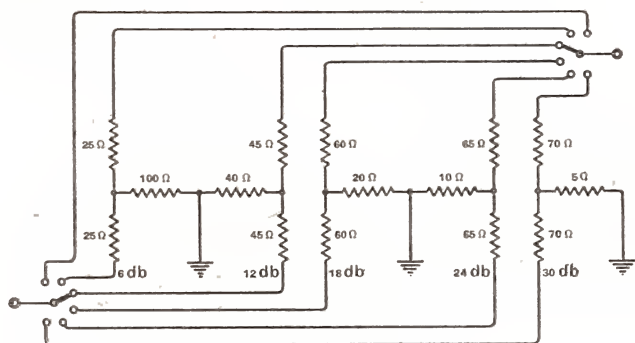

(a)

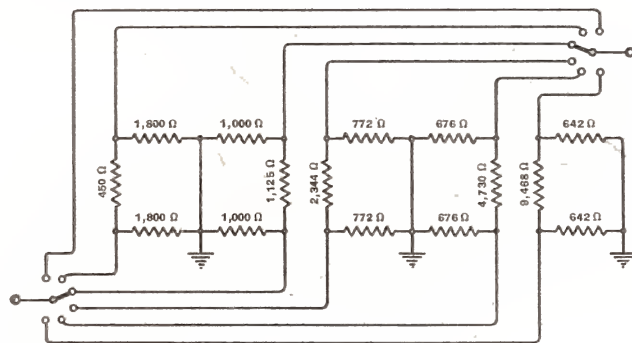

(b)

ohms is not the least of the disadvantages of this arrangement. If two series-connected pads are employed $n = \sqrt{100} = 10$ and $R_1 = 65.5$ ohms, $R_2 = 16.2$ ohms. For three pads $n = \sqrt[3]{100} = 4.64$ and $R_1 = 51.6$ ohms, $R_2 = 36.2$ ohms. These values are much more manageable in practice.

The formulæ for the "π" type attenuator is as follows :

$$R_2 = Z_0 \left(\frac{n+1}{n-1} \right) \text{ and } R_1 = \frac{Z_0 \left(n - \frac{1}{n} \right)}{2}$$

These formulæ are derived in the following manner and are referred to Fig. 6.

The matching requirements state that

$$\frac{I}{R_2} + \frac{I}{A} = \frac{I}{Z_0}, \text{ therefore } \frac{I}{A} = \frac{I}{Z_0} - \frac{I}{R_2}$$

where A is the effective value of the series-parallel combination of resistances within the dotted frame.

The current

$$I_1 = \frac{E_1}{A}, \text{ therefore } E_2 = I_1 \left(\frac{R_2 Z_0}{R_2 + Z_0} \right) = \frac{E_1}{A} \left(\frac{R_2 Z_0}{R_2 + Z_0} \right)$$

Substituting for $\frac{I}{A}$, $E_2 = E_1 \left(\frac{I}{Z_0} - \frac{I}{R_2} \right) \left(\frac{R_2 Z_0}{R_2 + Z_0} \right)$

Therefore $\frac{I}{n} = \frac{R_2 - Z_0}{R_2 + Z_0}$ and $R_2 = Z_0 \left(\frac{n+1}{n-1} \right)$

R_1 is then derived by substituting this value for R_2 in the general equation for the network.

Symmetrical pads for employment with balanced lines have values derived from the basic formulæ already given. However, the series elements, namely, R_1 , become $R_1/2$ in each side of the line. (See Fig. 8.)

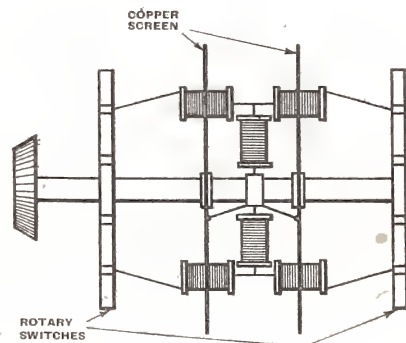

Fig. 9. (a) Six position "T"-type attenuator ($Z_0 = 75$ ohms) suitable for use up to 45 Mc/s when constructed on the lines suggested in the sketch. (b) "π"-type attenuator for audio frequencies. $Z_0 = 600$ ohms.

In its simplest form an attenuator with matched input and output can be arranged as a number of pads. Each has the required degree of attenuation and each is switched into circuit independently. Fig. 9 depicts such an arrangement. Included in this figure are suitable component values for two types of attenuators, (a) being a 6-position aerial attenuator having a 75-ohm characteristic and providing 6 db. steps, and (b) being an audio-frequency attenuator providing 6 steps of 6 db. each and having a characteristic of 600 ohms. In the case of (a) a drawing is included to indicate a convenient form of construction.

An attenuator constructed on these lines had an excellent degree of accuracy at a frequency of 45 Mc/s.

Fig. 10 depicts a continuously variable "T" type

Fig. 10. Continuously variable "T"-type attenuator.

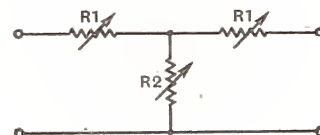

attenuator which can consist of three suitably graded rheostats or, perhaps preferably, three stud switches, which are ganged. Suitable values of components for this arrangement are readily obtained from the formulæ already given. One point requires consideration when this arrangement is employed. It will be

Attenuator Design—

apparent that for high attenuation ratios the fact that the switch resistance can become comparable with the

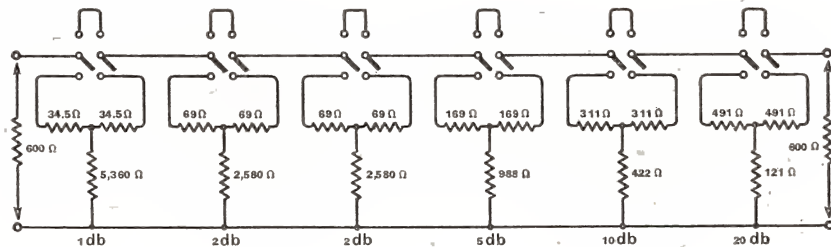

Fig. 11. Attenuator suitable for use with AF measuring gear. $Z_0 = 600$ ohms.

actual resistance element renders the design somewhat difficult when trying to cover a wide attenuation range.

A conventional method often adopted for attenuator switching, and one which many operators prefer, arranges for different degrees of attenuation to be obtained by switching into the circuit various combinations of pads, these being connected in various series arrangements by means of suitable individual switches.

Fig. 11 gives an example of this form of attenuator switching and includes suitable values for an attenuator having a 600-ohm characteristic and giving any attenuation between 1 and 40 decibels in 1 db. steps.

In quite a large number of cases it is permissible to employ an attenuator having constant impedance in one direction only. This, obviously, is the case when the attenuator is located between two impedances where one is high in value compared to the other, e.g., a low-impedance line feeding to the grid of an amplifying valve. (See Fig. 12.)

These attenuators also are frequently employed as an

output control on signal generators. Such an arrangement, whilst not being perfect, is far preferable to the straightforward potentiometer.

In Fig. 13 is given the circuit and component values for an attenuator which is suitable for inclusion in most types of service signal generators. It should be noted that the main purpose of employing an "L" attenuator as a gain control preceding a valve circuit is that it is far simpler to design such a device as compared to the potentiometer type, for it is only required to determine values for one step, all the steps

then have the same values.

The formulæ for deriving the component values of the ladder attenuator of Fig. 12 are as follows:—

$$R_1 = Z_0 \left(r - \frac{1}{n} \right) \quad R_2 = \frac{Z_0}{n - 1}$$

where Z_0 is the characteristic impedance and n is the

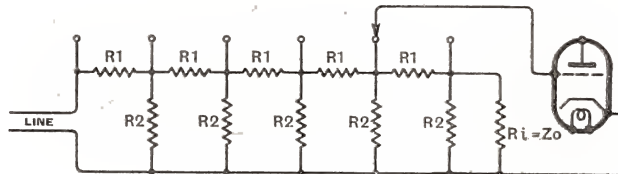

Fig. 12. Typical ladder attenuator for use between low impedance line and high impedance valve input circuits.

ratio of the input and output voltages. R_i is included in order to simulate the condition of an infinite number of repetitive steps, it is made equal in value to Z_0 .

It is felt that the data given in the table will prove useful as it permits suitable values for an attenuator to be derived with the minimum of effort.

The data are calculated (slide rule accuracy) for an attenuator having an impedance characteristic R_i of 1 ohm. It is only necessary to multiply the values given for R_1 , R_2 by the required characteristic impedance of the attenuator contemplated.

TABLE

| db | n | Ladder | | "π" Type | | "T" Type | |
|----|-------|--------|-------|----------|-------|----------|-------|
| | | R1 | R2 | R1 | R2 | R1 | R2 |
| 1 | 1.122 | 0.11 | 8.3 | — | — | — | — |
| 2 | 1.259 | 0.206 | 3.86 | 0.233 | 8.7 | 0.115 | 4.3 |
| 3 | 1.413 | 0.293 | 2.42 | — | — | — | — |
| 4 | 1.585 | 0.369 | 1.71 | 0.48 | 4.4 | 0.227 | 2.082 |
| 5 | 1.778 | 0.473 | 1.285 | — | — | — | — |
| 6 | 1.995 | 0.51 | 1.005 | 0.75 | 3.0 | 0.333 | 1.365 |
| 7 | 2.239 | 0.554 | 0.807 | — | — | — | — |
| 8 | 2.512 | 0.602 | 0.661 | 1.056 | 2.32 | 0.431 | 0.948 |
| 9 | 2.818 | 0.645 | 0.550 | — | — | — | — |
| 10 | 3.162 | 0.684 | 0.463 | 1.422 | 1.93 | 0.518 | 0.703 |
| 12 | 3.981 | — | — | 1.875 | 1.67 | 0.600 | 0.534 |
| 14 | 5.012 | — | — | 2.40 | 1.5 | 0.666 | 0.417 |
| 16 | 6.31 | — | — | 3.076 | 1.37 | 0.726 | 0.326 |
| 18 | 7.943 | — | — | 3.907 | 1.29 | 0.776 | 0.256 |
| 20 | 10.0 | — | — | 4.95 | 1.22 | 0.818 | 0.202 |
| 22 | 12.59 | — | — | 6.26 | 1.17 | 0.852 | 0.16 |
| 24 | 15.85 | — | — | 7.893 | 1.126 | 0.889 | 0.127 |
| 26 | 19.95 | — | — | 9.97 | 1.105 | 0.905 | 0.1 |
| 28 | 25.12 | — | — | 12.53 | 1.085 | 0.923 | 0.08 |
| 30 | 31.63 | — | — | 15.78 | 1.065 | 0.938 | 0.064 |
| 32 | 39.81 | — | — | 19.98 | 1.051 | 0.951 | 0.05 |
| 34 | 50.12 | — | — | 25.04 | 1.041 | 0.961 | 0.04 |
| 36 | 63.1 | — | — | 31.54 | 1.032 | 0.969 | 0.032 |
| 38 | 79.43 | — | — | 39.69 | 1.025 | 0.975 | 0.025 |
| 40 | 100.0 | — | — | 49.9 | 1.2 | 0.980 | 0.02 |

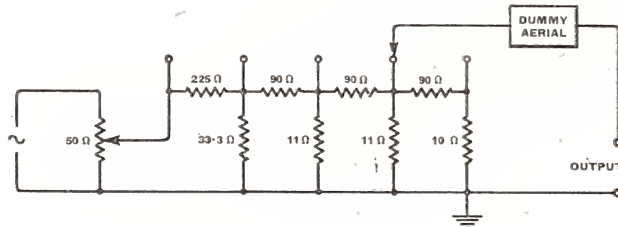

Fig. 13. Suggested design for an attenuator for use with signal generators.

The following example may help to clarify the process involved. Assuming the attenuation per stage is to be 2 db. and that a ladder attenuator having a characteristic impedance of 600 ohms is required, then R_1 is 600×0.206 and $R_2 = 600 \times 3.86$. R_i is, of course, 600 ohms.

In conclusion, the writers wish to acknowledge their gratitude to Baird Television, Ltd., for having given permission to publish this article.

Tone Control

PROPORTIONING THE RESISTANCE VALUES

By E. O. POWELL

TONE correction in AF amplifiers is usually brought about (a) by a variable impedance forming part of the anode load of a valve, or (b) by a potentiometer of which the input/output ratio is a

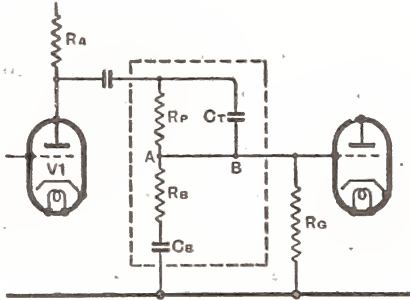

Fig. 1.—Tone control system for simultaneous bass and treble lift.

function of the frequency. The second method is preferable, since then the load on the preceding valve need not be very small at some frequencies. The effect of the first method, however, always takes place to some extent, and causes difficulty when a pure resistance-capacity network, used as a potentiometer, is arranged to give a response increasing with the frequency in the higher parts of the range.

Fig. 1 shows a typical network set up for simultaneous bass and treble lift. The potentiometer (enclosed within the dotted frame) has a basic ratio $\frac{R_B}{R_B + R_P}$. Now R_G cannot be

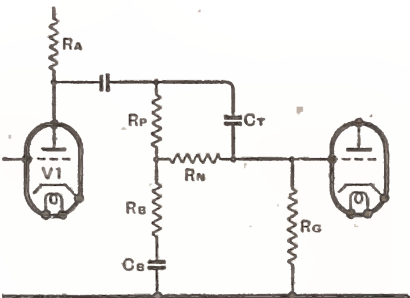

Fig. 2.—The circuit of Fig. 1 modified by the addition of an extra resistance.

increased indefinitely, and in order (i) that the potentiometer formed by R_P and R_G shall not attenuate the signal too much, and (ii) that R_G shall not at any frequency exercise an appreciable shunting effect on $R_B + C_B$, R_P and R_B cannot be very great. R_P is conveniently made about 2×10^5 ohms; for a possible maximum lift of 20 db., R_B will then have to be about 3×10^4 ohms. The input impedance at high frequencies is only about R_B ; R_A is generally of about the same order, so that the amplification of the preceding valve is reduced considerably, opposing

the pure resistance-capacity system overcome by connecting a resistance R_N between the points A and B of Fig. 1. Fig. 2 shows the modified circuit; its input impedance can never be less than $\frac{R_P R_N}{R_P + R_N} + R_B$, which can easily be made greater than R_A . Fig. 3 shows the relation between the output and input voltages of the potentiometer, expressed in decibels with the latter voltage as reference level, and calculated for the case in which $R_P = 2 \times 10^5 \Omega$; $R_B = 3 \times 10^4 \Omega$; $C_T = 2 \times 10^{-4} \mu F$; $C_B = 2 \times 10^{-2} \mu F$, and R_N (in the modi-

Fig. 3.—(Right) Relation between input and output voltages across the potentiometer of Fig. 2.

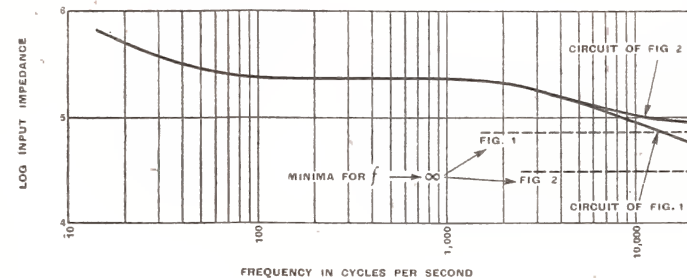
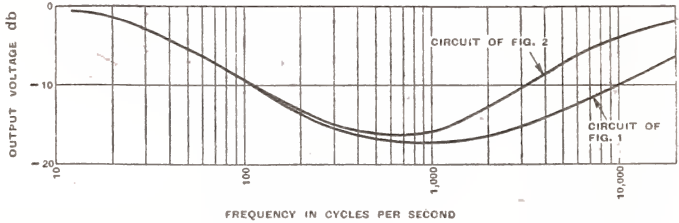

Fig. 4.—(Left) Corresponding impedances of the circuit shown in Fig. 2, with values as given in the text.

the desired effect. The higher are R_A and the anode impedance of V_1 , the worse is the result; moreover, there is a danger of amplitude distortion arising if the load on V_1 is too small.

It is therefore usually recommended that an inductance be put in series with R_B in order to effect treble lift.¹ The coil, however, may introduce resonance peaks and very easily picks up hum.

The use of the coil may be avoided and the disadvantages of

modified circuit) = $5 \times 10^4 \Omega$. Fig. 4 gives the corresponding impedances.

These results are borne out in practice. In an amplifier in which V_1 had to be of higher anode impedance ($25,000 \Omega$) than is usually necessary, the following values were used: $R_P = 2 \times 10^5 \Omega$; $R_B = 3 \times 10^4 \Omega$; C_T —variable, $0 - 5 \times 10^{-4} \mu F$; C_B —variable by 5-way switch, 0.2, 0.1, 0.05, $0.02 \mu F$; $R_N = 10^5 \Omega$. The inclusion of the tone control had no audible effect on the quality of reproduction and there was ample variation to compensate for scale distortion and losses in other parts of the apparatus.

¹ See, for instance, "Tone Control Systems," *The Wireless World*, June 8th, 1939.

Premier Short-wave S.G.3

A WELL-DESIGNED STRAIGHT RECEIVER FOR AC MAINS (THREE VALVES + RECTIFIER).
PRICE £5 10s. (Including Valves and Coils)

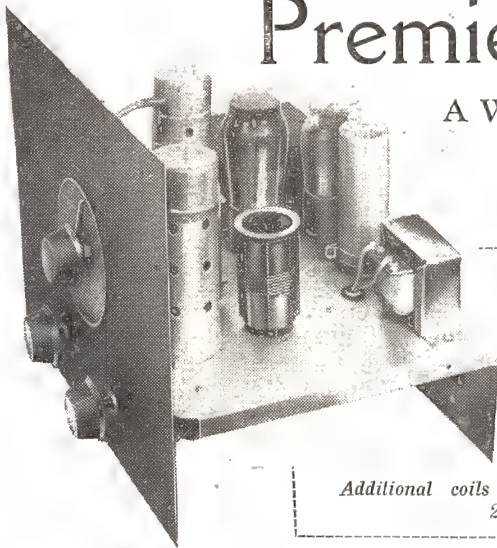

WAVERANGES

| | | |
|-----|--------|--------|
| (A) | 12- 26 | metres |
| (B) | 22- 47 | metres |
| (C) | 41- 94 | metres |
| (D) | 76-170 | metres |

Additional coils available for 9-15 metres and 200-2,000 metres

MANY people who have hitherto been content with the programmes provided by medium and long wavelengths and whose sets cover only these two wavebands are enquiring how best they can obtain an introduction to the short waves where B.B.C. and other programmes are now being relayed with regularity, and where the possibilities of world-wide reception are greater.

The simplest method is, of course, a short-wave frequency-changer or converter unit, but there is much to be said for a separate receiver specifically designed for short-wave work. The Premier S.G.3 is of this type, and its frequency range is much wider than that of the average converter unit, so that it will continue to satisfy the novice's

Complete circuit diagram of the Premier Short-wave S.G.3 for operation from AC mains. An RF gain control is provided in addition to regeneration in the detector valve.

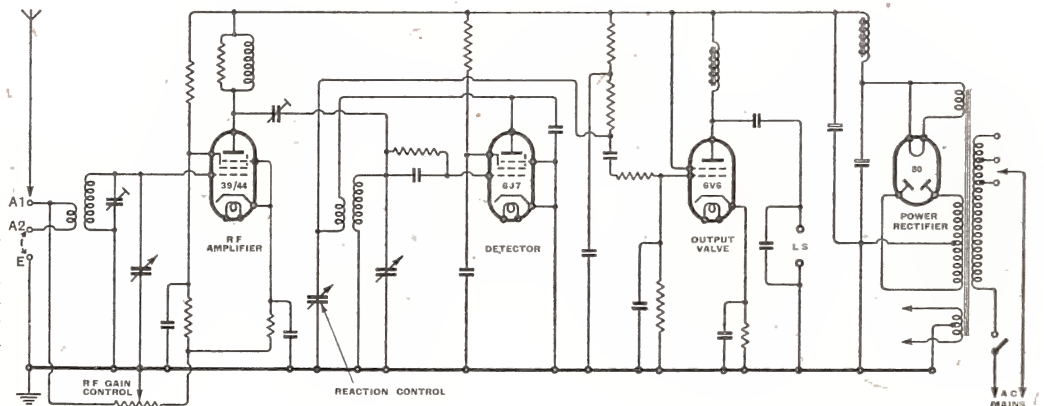

growing interest in short-wave matters. Coils for additional wavebands are readily added, and the receiver gives an excellent all-round performance.

Circuit.—Pentode valves are used in the RF and detector stages, and a tetrode in the output. The aerial and RF coupling coils are interchangeable as the same number of turns is used in primary and reaction circuits.

RF gain is controlled by simultaneous variation of the grid and screen voltages in the first valve and by shunting the aerial circuit. The latter, incidentally, may be used either with a dipole or a normal single-wire aerial and earth.

Tuned grid coupling follows the RF stage with a special short-wave choke, damped by a shunt resist-

ance in the anode circuit. The coupling condenser is variable.

The detector anode circuit includes decoupling and reaction is controlled by a variable condenser

which is so arranged that it serves as an RF by-pass which increases in efficiency as reaction is advanced. Additional RF filtering is provided in the AF coupling by a series resistance and a by-pass condenser across the grid leak.

The AF output is parallel fed and one socket is earthed so that either high-resistance phones or a loud speaker may be used. If a moving-coil unit is employed it should include a transformer with a ratio designed to present approximately 5,000 ohms to the output terminals.

Performance.—We were very much impressed with the general tractability of this set. The novice should have no difficulty in obtaining good results from the more powerful stations right from the start, and as his skill improves he will be able to appreciate the good points which enable the expert to tune in distant transmissions with ease and certainty.

Reaction is smooth at all frequencies and each waverange is covered with a very small pro-

gressive increase of the reaction condenser setting from the high to the low frequency end of the scale. There was no trace of "blind spots" anywhere in the range of the set, a

Premier Short-wave S.G.3—fact which may be attributed to the correct choice of circuit constants in the choke coupling between the RF and detector stages and proper control of stray RF currents.

The set is lively and there is no doubt that the RF valve makes an important contribution to the sensitivity as well as acting as a buffer to keep oscillation out of the aerial circuit. The aerial trimmer setting is sharp and the tuned circuits have good intrinsic selectivity. Compared with a superhet, however, in which there are at least four additional IF tuned circuits, the normal overall selectivity may not serve to separate adjacent stations, but much can be done to improve matters by reducing the RF coupling trimmer on the underside of the chassis, though this will cause some falling off in sensitivity. A compromise setting must be found to suit local conditions and individual requirements.

A check of the tuning limits of each set of coils gave figures closely approximating to the maker's rating, and using these as a basis it should be a simple matter to prepare calibration curves, using stations of known wavelength to obtain key points.

Mains hum is very low, and the only possible fault to find concerns the rigidity of the front panel which affects tuning if deflected. This would be overcome by installing the set in a cabinet or by fitting stiffening brackets at the sides if it is desired to operate the set in chassis form.

Constructional Features.—A semicircular 100-degree tuning scale is provided and a reduction gear of just the right ratio is incorporated in the main spindle of the two-gang main tuning condenser.

A compact chassis layout has been achieved without undue cramping of the components. The coils are easily changed and the aerial trimming condenser is accessibly placed on the top of the tuning condenser frame. For maximum efficiency slight readjustment of this trimmer may be necessary when changing from one band to another, but we found the alteration required was so small that an average setting could

be left undisturbed without appreciable loss of performance.

Components of good quality have been specified and the output AF choke has sectionalised windings. Well-fitting metal valve screens with top caps are provided for both the RF and the detector stages.

The receiver is obtainable ready made up, or as a kit of parts with circuit and wiring diagram. In the latter case the price is £4 10s.

Makers.—Premier Radio, 167, Lower Clapton Road, London, E.5.

Correspondence

High-quality Gramophone Records

TWO or three years ago some of your correspondents gave their views on the choice of high-quality recordings. At the present time it would, I think, be of great help to many of your readers who are unable to use their high-quality equipment with the present transmissions if this correspondence were revived.

The compiling of a list of high-quality discs need not necessarily be confined to the classics; any type of recording that complies with your readers' standard of "high fidelity" would be welcomed, as I presume that the readers interested would not submit any but the recordings which satisfied their critical taste, by being free from "echo," scratch, amplitude and frequency distortion, and at the same time giving good contrast and naturalness.

Even when recordings are carefully chosen I find it is essential to use a rather comprehensive tone control to give individual satisfaction. There is no doubt that the electric gramophone to-day can give far more entertainment value—if it is made to do justice to the best recordings—than many people even realise. The following list, I think, may interest your readers, who I hope will, through your valuable columns, respond with a few of their selections:

"Carmen" Suite; Sir Thomas Beecham and London Philharmonic Orchestra. Columbia LX 823-824.

Overture—"Morning, Noon and Night"; Boston Promenade Orchestra. H.M.V. C3020.

Overture—"Barber of Seville"; Arturo Toscanini and Philharmonic Symphony Orchestra of New York. H.M.V. D1835.

"Blaze Away" and "Washington Grays"; Bickershaw Colliery Band. H.M.V. BD726.

Stoke-on-Trent. G. R. GINNS.

For the New Year

"THE WIRELESS WORLD" DIARY AND REFERENCE BOOK, 1941

THE well-known "Wireless World Diary and Reference Book," which has just made its appearance once again, is, as its name implies, not only a wireless diary for 1941, but also a pocket reference book of technical and other data arranged in compact and handy form, suitable both for professional and amateur wireless men. Probably one of its most used features are the tabulated lists of medium and long wavelength broadcasting stations of Europe, and short-wave stations of the world; the latter has been re-arranged for easier reference.

In the sections devoted to useful formulae and abacs are to be found data which will materially assist all those concerned with both wireless and P.A. A large number of circuit diagrams is included, together with component values. Details of valve base connections of British, International and American types which have been so much appreciated in the past are again included, but in considerably revised form. Other sections include Practical Hints and Tips, Copper Wire Tables, Wattage Tables, and suggestions for eliminating electrical interference. The Morse Code and "Q" Code of Abbreviations are also to be found in this handy little volume.

The Diary and Reference Book, compiled by the staff of *The Wireless World*, is issued by our publishers, Iliffe and Sons Ltd., Dorset House, Stamford Street, London, S.E.1, at 2s., Purchase Tax 5½d. extra. By post, including Purchase Tax, 2s. 7d.

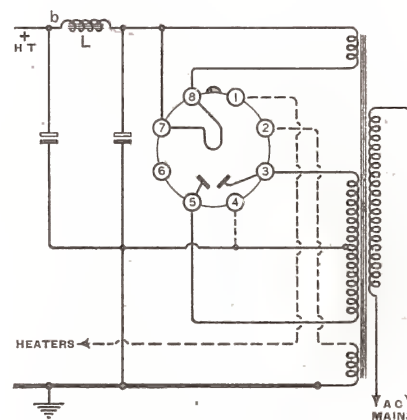

"EMERGENCY RECEPTION." This is a corrected version of the diagram published on p. 456 of last month's issue, in which it is regretted that two errors occurred.

Receivers for FM Transmissions—

Since a good deal of the interference met with on the wavelengths at which FM receivers operate is caused by car ignition, a short time constant in the limiter grid circuit is essential. With the values suggested above the time constant is between 1 and 2 microseconds, which is satisfactory. Two limiter stages in cascade are used in a receiver recently developed by E. H. Scott Radio Laboratories to obtain the desired characteristics. By this means amplitude variation due to selectivity cut-off in the IF stages is levelled and single peaked transformers can be used.

The detector in a receiver for frequency modulation must first convert variations of frequency into amplitude variations before rectifying and applying them to the audio stages of the set. The circuit used is similar to that of the discriminator in sets with automatic tuning control.⁵ Its action may be summarised briefly as follows.

When the primary and secondary circuits of a loosely coupled IF transformer are tuned to the applied frequency there is a 90-degree phase difference between the voltages in the two circuits. This phase angle changes when the applied frequency deviates from resonance, and if the two voltages are added vectorially (by connecting primary and secondary in series) the resultant takes the form shown by the full line curve in Fig. 3 (a). If the

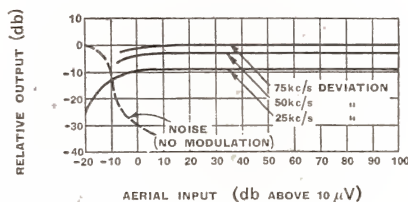

Fig. 4.—Limiter action curves for different frequency swings in the Scott FM tuner unit.

sense is reversed, the converse dotted curve is obtained. Now there is always a 180-degree phase difference between opposite ends of the secondary winding, so if the primary voltage is injected at the centre of the secondary, the response with

⁵ "Automatic Tuning," Foster and Seeley, *Proc. I.R.E.*, March, 1937

respect to earth is the difference between V_1 and V_2 and is zero at the resonant frequency. Further, the middle section is nearly linear and will not introduce distortion in

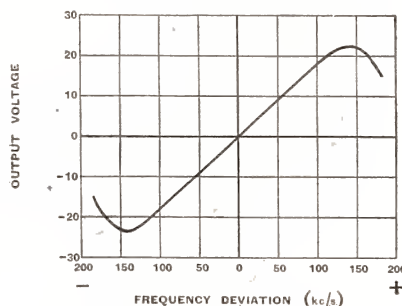

Fig. 5.—Detector-discriminator characteristic in the Scott FM tuner unit. The linear portion is more than adequate for the standard deviation of ± 75 kc/s.

the transfer from frequency to amplitude modulation.

The voltages from the ends of the secondary winding are applied to balanced diode rectifiers and the AF output is taken across the combined load resistance, one side of which is earthed (Fig. 1). A centre-zero voltmeter across the output terminals may be used as a tuning indicator. In the Scott receiver a "magic eye" is used and is biased to cut-off, so that the shadow is normally closed. The control grid is connected through an AF filter to the top of the diode load, and any deviation from correct tuning causes the shadow to open or the edges to overlap.

RF Circuits

Precautions necessary in other parts of the receiver are determined by the high frequencies used for FM transmissions and the wider band width which must be passed by the IF stages. The region of the spectrum at present allocated to FM transmissions in America is from 50 to 43 Mc/s (6 to 7 metres) and the frequency variation equivalent to maximum depth of modulation is ± 75 kc/s.

Television practice is indicated, with the additional precaution of obtaining the highest possible gain in the aerial and RF stage in order to give a good input to the frequency changer, which has a comparatively

poor signal-to-noise ratio. Neutralisation of the input conductance of the RF valve will improve the gain in the aerial circuit and give better image rejection. A variable- μ RF valve with some form of gain control is desirable to prevent overloading on strong signals which might otherwise produce a second harmonic which will beat with the second harmonic of the oscillator.

Frequency Stability

It goes without saying that frequency stability in the oscillator circuit is vital and temperature-compensated condensers should be employed. Even then about half a minute must be allowed as a warming-up period before final tuning. Any factor tending to produce frequency modulation of the oscillator such as microphony in coils or condensers, mains hum in the HT feed or noise due to heater-cathode leakage must be rigorously excluded.

Symmetry in the response curves of the IF stages is essential and some damping in the form of shunt resistances is helpful in preventing phase shift and also in avoiding any free oscillation of the tuned circuits as the signal passes through the mean frequency. Particular care must be exercised in the alignment of the transformer between the limiter and detector valves to ensure symmetry in the AF output as indicated by the centre-zero voltmeter. Earlier stages may be lined up with the help of a microammeter in the earth return of the limiter grid leak.

The Wireless Industry

PARTICULARS have been received of the "Mastalite" rechargeable hand lamp, made by Runbaken Electrical Products, 71-73a, Oxford Road, Manchester, I. No separate charger is required as a rectifier is housed with a dry accumulator in the carrying case. There is a cycle attachment and provision for a rear light. The price is 39s. 6d.

◆ ◆ ◆

The offices of Wild-Barfield Electric Furnaces, Ltd., have now been transferred to Watford By-pass, Watford, Herts, and their new telephone number is Watford 6094.

◆ ◆ ◆

We have received from Colt Ventilation, Ltd., Bush House, Strand, London, W.C.2, a technical catalogue of black-out ventilators suitable for workshops and factories.

Current Topics

RECENT EVENTS IN THE WORLD OF WIRELESS

PURCHASE TAX PRICE CHANGES

Higher Cost of Radio Apparatus

THE imposition of the 33 $\frac{1}{3}$ per cent. Purchase Tax on wireless apparatus on October 21st is gradually making itself felt, although it will be some time before the purchase-tax-free stocks are exhausted.

The following extracts from the new price lists issued by a number of set manufacturers will give some idea of the effect of the tax on receiver prices:—

| Old price | New price |
|-----------|-----------|
| £ s. d. | £ s. d. |
| 8 8 0 | 10 4 2 |
| 10 10 0 | 12 15 2 |
| 11 11 0 | 17 17 3 |
| 23 2 0 | 28 1 4 |
| 26 5 0 | 31 17 11 |

So far as batteries are concerned, the following examples from the list published by the Association of Radio Battery Manufacturers will give a rough idea of the increases imposed:—

| | £ s. d. | now | £ s. d. |
|-----------------------|---------|-----|-----------------|
| 9 v. grid battery ... | 10 | 1 | 0 $\frac{1}{2}$ |
| 120 v. HT battery ... | 6 0 | 7 | 6 |
| "All-dry" battery ... | 10 0 | 12 | 4 |
| 120 v. HT battery ... | 1 0 0 | 1 | 4 8 |

The tax has been felt much more suddenly where valves are concerned.

The reason being that, because of the multiplicity of valve types, dealers' stocks were necessarily low. Examples from the list of prices announced by the British Radio Valve Manufacturers' Association will suffice to give some idea of the increases:—

| Old price | New price |
|-----------|-----------|
| £ s. d. | £ s. d. |
| 7 6 | 9 2 |
| 10 0 | 12 2 |
| 12 6 | 15 3 |
| 15 0 | 18 3 |
| 17 6 | 1 1 4 |
| 1 5 0 | 1 10 5 |

It will, of course, be remembered that specialised valves for use with deaf aids are exempt from taxation.

The effect of the tax on gramophone records is exemplified by the following figures:—

| Old price | New price |
|-----------|-----------|
| £ s. d. | £ s. d. |
| 1 6 | 1 10 |
| 3 0 | 3 8 |
| 6 0 | 7 4 |

Records for the use of the blind having titles embossed in Braille and solely reproducing speech are not subject to the tax.

AMERICAN COMMUNICATIONS

Defence Board Created

THE creation by President Roosevelt on September 24th of the United States Defence Communications Board is considered by some to be the first grim manifestation of the war's effect upon broadcasting in the States. It is, however, emphasised in official quarters that there is no intention of upsetting the *status quo* of broadcasting stations.

The terms of the order do not give the six members of the Board, which is led by the chairman of the Federal Communications Committee, any power of radio censorship or the right to assume control of any station.

President Roosevelt's statement regarding the Board announced that its task of planning "is not confined to radio broadcasting, but also embraces common carriers such as commercial radiotelephone and radiotelegraph as well as other telephone, telegraph and cable facilities.

"The Board does not propose to interfere with the normal operation of broadcasting or other forms of communication any more than is necessary for the national protection. Through correlated planning, it will

seek to gear the great and strategically valuable American communications system, in both the domestic and international fields, to meet any situation the national interest may require."

So far as domestic broadcasting is concerned, the Board has to study the "physical aspects" and to "recommend such precautions, supplementary facilities and reallocations as it shall deem desirable under foreseeable military conditions."

FM PHOTOTELEGRAPHY

AN interesting demonstration of the transmission of photos by frequency modulation was recently witnessed in America. The photographs were transmitted over four miles of telephone line to the FM station WEOD at Boston. The transmissions from this station were picked up 43 miles away and rebroadcast by the FM station WIXOJ, and finally received a further 44 miles away.

The pictures received were of excellent quality, as was indicated by the illustration published recently by our contemporary *Communications*.

NORTH AMERICAN STATIONS

Reallocation of Frequencies

THE first wavelength allocation plan embracing the whole of the North American continent will be put into operation next March. This reallocation, which will affect the stations in the United States, Canada, Mexico, Cuba, Haiti and the Dominican Republic, is the outcome of the North American Regional Broadcasting Agreement reached in Havana in December, 1937. The reason for the delay in introducing the changes is that Mexico did not ratify the treaty until March this year.

So far as the United States is concerned 777 of the country's 862 medium-wave broadcasting stations will have new frequencies. In all, some 1,200 stations in N. America operating in the 550-1,600-kc/s' band are affected by the reallocation.

The stations just south of the Mexican-U.S.A. border, which are designed to serve Mid-western farmers and for the most part are operated by erstwhile American companies with super power and directional aerials, will not be permitted under the treaty terms and this hitherto uncontrollable source of interference will, therefore, disappear.

The reallocation will necessitate the readjustment of some ten million push-button receivers, according to our American contemporary *Broadcasting*. Plans to marshal the entire American radio industry in a co-operative effort to affect a speedy readjustment when the reallocation takes effect on March 29th are being prepared.

CAPT. R. L. NICHOLSON R.N.

IT is with regret that we record the death of Captain Richard Lindsay Nicholson, D.S.O., R.N., at the age of 58, on November 1st. Having served as wireless officer on the staff of H.M.S. *Vernon*, he subsequently qualified for the Naval War Staff and served on the Admiralty Committee (1914), which revised the naval wireless telegraph and signal books, etc. In September, 1914, Capt. Nicholson was appointed Fleet Wireless Telegraph Officer of the Grand Fleet, on the staff of Admiral Jellicoe. He was appointed Director of the Signals Division of the Naval Staff at the Admiralty in 1917 and during his three years at the Admiralty he proposed and carried to fruition the formation of the Wireless

Current Topics—

Board and the Imperial Communications Committee.

Capt. Nicholson, who retired from the Navy in 1920, was appointed Director of Wireless Telegraphy under the Government of India the following year, which position he retained until 1926.

BROADCASTING STATIONS AS RADIO BEACONS

U.S. Warning to Mariners

AS a result of the increasing use of broadcasting stations as radio beacons, it has been emphasised by the U.S. Hydrographic Office that the practice is not recommended except when better navigational aids are lacking and then only by personnel who appreciate the limitations and restrictions involved.

"Before taking bearings on a station broadcasting entertainment programmes," says the official instructions, "a mariner should consider that its frequency may differ widely from the frequency for which his set is calibrated; that the published location of the station may be that of its studio and not that of its transmitting aerial; that if the station is synchronised with other stations it may be impossible to tell on which station the bearing was taken; and that as the majority of these stations are inland, the coastal refraction may be excessive."

This caution applies particularly to merchant vessels which are normally calibrated on 300 kc/s, for obtaining bearings on the established U.S. Coast Guard radio-beacons. It should be pointed out that the calibration curves for 300 kc/s and the various broadcasting frequencies (550 to 1,600 kc/s) differ materially, and, if the operator does not have calibration curves available to suit the approximate frequency used by the broadcasting station, large errors may result in the bearing obtained.

WLWO DEDICATED

SINCE April, WLWO, the international short-wave station of the Crosley Corporation, has been operating experimentally with a power of 50 kW, but it was not until October 12th that the transmitter, which is situated adjacent to the medium-wave parent station WLW, at Mason, Ohio, was formally dedicated. Using a rhombic or diamond-shaped aerial, which is directed on Latin America, the station is licensed to transmit on six wavelengths. Application has recently been made to the F.C.C. for the power to be increased to 75 kW.

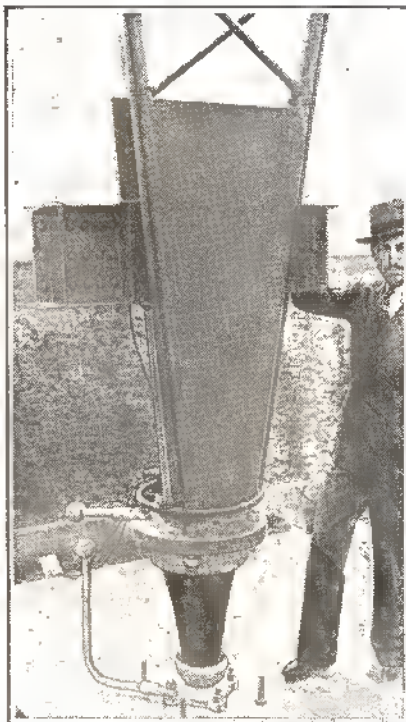

THE INSULATOR supporting the 40 tons of one of WBZ's two 500ft. masts is only 22 inches high and weighs 90 lbs. The entire mast can be raised by the cross arm to replace the insulator if damaged. Note the spark gap.

B.B.C. SHORT-WAVE TRANSMISSIONS

THE regular transmission of the B.B.C. Home and Forces programme on 48.82 and 41.49 metres respectively has necessitated changes in the wavelengths used for the transmission of news in English in the European short-wave service.

The call signs and frequencies to be used during this month are:—

GSA, 6.050 Mc/s (49.59 m); GSB, 9.510 Mc/s (31.55 m); GRX, 9.690 Mc/s (30.96 m); GSN, 11.820 Mc/s (25.38 m); GSE, 11.860 Mc/s (25.29 m); and GSO, 15.180 Mc/s (19.76 m).

The times (B.S.T.) of the transmission of news and the calls used are:—

| | |
|------|---------------------|
| 0030 | GSA. |
| 0715 | GSA, GRX. |
| 0900 | GSA, GSN, GSE. |
| 1245 | GSA, GSN, GSE, GSO. |
| 1415 | GSA, GSE. |
| 1700 | GSA, GSB, GRX. |
| 2345 | GSA, GSB, GRX. |

The transmission of the Home programme on the short waves has meant the introduction of a new frequency, 6.145 Mc/s (48.82 m), in the B.B.C. short-wave service. Its call letters are GRW. Listeners to the Home Service now have a choice of five wavelengths. They are 48.82, 203.5, 296.2, 391.1 and 449.1 metres.

TD-HF

Wired Wireless in Switzerland

ACCORDING to the Monthly Bulletin of the International Broadcasting Union, Geneva, telephone subscribers in Berne have now available a 4-programme "high frequency tele-diffusion" system, known in Switzerland as TD-HF. Distribution is effected over the telephone system at carrier frequencies of 172.4 kc/s, 205.6 kc/s, 279.3 kc/s, and 329.8 kc/s, in very much the same manner as was proposed for our own Post Office system, shelved on account of the war, which was described by Dr. Walmsley in *The Wireless World* of September, 1940. The modulated carriers are injected into the telephone network through small transmitters installed in the Berne Central Exchange, and the outputs are so adjusted that each of the 4,000 subscribers for which the system has been planned should receive an input of 15 millivolts at the aerial terminal of his receiver.

AMERICAN TRANSMITTING SITE

A SALT-WATER marsh was chosen by the owners of the American medium-wave station WBZ as the site for their new 50-kW transmitter which was recently put into service. Although of little use for other purposes, the marsh, which is situated at Hull, New England, has been found to be particularly good for the radiation of ground waves. To further increase the range and avoid wasted radiation over the Atlantic, dual mast-radiators have been used, one of which acts as a reflector.

It is planned to instal another two 50-kW transmitters in the new building. One will be for the international short-wave station WBOS, which will employ two aerials, one directed on Latin America and the other on Europe. It is proposed to use the other transmitter for frequency modulation, in which case the aerial will be mounted at the top of one of the two new 500-ft. mast-radiators used by WBZ.

COMPANY MEETINGS

AT the Ekco annual general meeting it was learned that the cessation of television transmissions in this country, had left the company with a stock of television apparatus valued at £30,000, cost price. Mr. W. S. Verrells, the chairman, referred to Ekco's interest in Scopphony, which company, he said, had partly overcome the difficulties with which it was faced at the beginning of the war and

Wireless World

Current Topics—

is now engaged on Government work.

Mr. T. A. Macauley, chairman of Cossors, stated at the recent general meeting that in spite of war conditions the company's general valve and receiver business had been substantially maintained. It was to be expected, however, that as their Government contracts increased, their production of sets should decline. That the company's proportionate position in the radio industry had been maintained was evidenced by the 30 per cent. increase in sales as compared with the previous year.

"HF" OR "FM"?

IN the rules issued by the Federal Communications Commission of America governing the operation of what has generally become known as frequency modulation stations, the term "high-frequency broadcast station" is used. Commenting on this change of nomenclature, *Broadcasting* states that popular usage, however,

will probably force the retention of FM rather than HF in other than official records.

FROM ALL QUARTERS

High-power FM

THE General Electric Company of America has asked the Federal Communications Commission for permission to increase the power of its frequency-modulated transmitter, W2XOY, from 2.5 to 50 kW. The station, which, together with the G.E. 10-kW television transmitter, W2XB, is situated in the Helderberg Mountains, operates on 43.9 Mc/s. Employing a special 3-bay "turnstile" aerial, it is planned to serve an area of 16,030 square miles.

Scottish Servicing Pool

TO meet the difficulties arising from the scarcity of wireless servicemen, the Scottish Radio Retailers' Association has formed a technical pool so that the available staffs may be utilised to the best advantage. It is also intended to start a training scheme for girls.

THE NOVACHORD

A Recent Development in Electronic Music

Made by the Hammond Instrument Co., of Chicago, this instrument, as its name implies, has been designed to produce a variety of new musical tones and effects. It has a single manual keyboard of 72 notes and there are two thermionic valves of standard type associated with each note. Above the keyboard are a number of controls which are divided into two groups. Those on the left control the harmonic



content, while those on the right determine the shape of the "envelope," i.e. the form of the transient at the moment of striking the key and the subsequent decay of the sound. While the Novachord can simulate the tones of many musical instruments, it has been designed primarily for experiment in new forms of musical expression. The agents in this country are Boosey & Hawkes, Ltd., 295, Regent Street, London, W.1.

Obituary

WE regret to record the deaths of two radio personalities. Mr. George Hinde Nisbett, whose name has for many years been associated with British Insulated Cables of which he had successively held positions on the Works Management Committee and the Board, and subsequently became managing director, passed away on October 21st, at the age of 73. He was a pioneer in the use of paper-insulated and concentric cables.

Mr. Sydney E. Smith, chairman and managing director of Varley, died at his home on October 27th, following a brief illness.

R. Signals Comforts

WE learn that there is a shortage of books and magazines for inclusion in the parcels which are being sent out by the Royal Signals Association Comforts Fund to signal units abroad. The need is urgent, and readers who are able to supply any reading matter for this purpose are asked to send it to the Fund's new address, 801, Hood House, Dolphin Square, London, S.W.1.

Morse Speed Tests

A SERIES of Morse speed tests to bring the receiving speed of American amateurs to 20 w.p.m. or more is being conducted by the American Radio Relay League. Readers desirous of improving their speeds may be interested to learn that practice speeds are transmitted by the A.R.R.L. headquarters station W1AW every day except Saturday at 4.15 a.m., B.S.T., simultaneously on 1,761, 3,825, 7,280, 14,254 and 28,510 kc/s.

American Radio Industry Wages

ACCORDING to recently issued statistics the American broadcasting industry maintained its position during 1939 as the best-paying industry. The average weekly wage of its 19,873 full-time employees, including executives, was \$45.96.

Braille Amateur Books

THE third publication of the American Radio Relay League to be transcribed into Braille is "How to Become a Radio Amateur," which is soon to be published in America. Those already published are the "Radio Amateur's Handbook" and the League's "Licence Manual."

Too Loud Speakers

REFERENCE is made in the report of the Noise Abatement League to the prevalent use of loud wireless receivers. It is recorded that the Wireless Bill which the League had prepared for presentation to Parliament had to be temporarily abandoned at the outbreak of war. The League is of the opinion that only legislation on the lines proposed will appreciably mitigate this form of noise nuisance.

Wireless—a Weapon of War

"FOR advance penetration into neutral and enemy territory, radio possesses

Wireless World

Current Topics—

special advantages," says the *World's Press News*. In the article which deals with the aspect of the Press and radio as front line allies, the fact is stressed that whereas in the war of 1914-18 our messages were conveyed to the enemy people by leaflets, to-day radio takes the place of pamphleteering. It is to-day definitely a weapon of war.

Blind Workers in the Industry

CAPTAIN SIR IAN FRASER, C.B.E., chairman of St. Dunstan's, recently appealed to the radio industry to afford his committee the opportunity of visiting their works to study the production methods with a view to obtaining openings for those who had lost their sight, but whose senses of touch and hearing were often much above the average.

Baird Television

In the Companies Court, London, a scheme was sanctioned providing for the merger of Baird Television with Cinema Television, to preserve its goodwill and retain the technical staff until television transmissions are resumed in this country. Subject to the sanction of the Board of Trade, it is proposed to retain the name of Baird.

NEWS IN ENGLISH FROM ABROAD

REGULAR SHORT-WAVE TRANSMISSIONS

| Country : Station | Mc/s | Metres | Daily Bulletins (B.S.T.) | Country : Station | Mc/s | Metres | Daily Bulletins (B.S.T.) |
|---------------------|--------|--------|--|---------------------|-------------------|--------|---|
| America | | | | Nova Scotia | | | |
| WNBI (Bound Brook) | 17.780 | 16.87 | 4.0†, 6.0. | CHNX (Halifax) | 6.130 | 48.94 | 10.45. |
| WCAB (Philadelphia) | 6.060 | 49.50 | } 12.45 a.m.†, 1.0 a.m.†. | Newfoundland | | | |
| WCAB | 9.590 | 31.28 | | | VONG (St. John's) | 5.970 | 50.25 |
| WBOS (Millis) | 9.570 | 31.35 | 11.45. | Rumania | | | |
| WCBX (Wayne) | 17.830 | 16.83 | 2.0, 3.0†, 4.0† 4.15§†, 5.0*†, 7.0, 8.30†. | Bucharest | 9.280 | 32.33 | 10.40†. |
| WGEO (Schenectady) | 9.530 | 31.48 | 8.30†; 9.55§†. 11.25†. | Spain | | | |
| WGEA (Schenectady) | 15.330 | 19.57 | 1.0, 2.0†, 7.45, 9.55§†. | FET1 (Valladolid) | 7.070 | 42.43 | 8.50. |
| WPIT (Pittsburgh) | 15.210 | 19.72 | 6.0. | EAJ7 (Madrid) | 9.860 | 30.43 | 12.30 a.m. |
| WRUL (Boston) | 6.040 | 49.67 | 1.0 a.m.§. | Sweden | | | |
| WRUL | 11.790 | 25.45 | 10.45. | SBO (Motala) | 6.065 | 49.46 | 10.45. |
| WRUL | 15.250 | 19.67 | 1.0 a.m., 10.45. | Thailand | | | |
| Australia | | | | HSP6 (Bangkok) | 11.715 | 25.61 | 2.45. |
| VLQ (Sydney) | 9.615 | 31.20 | 7.0 a.m., 7.0. | Turkey | | | |
| VLQ7 | 11.880 | 25.25 | 7.0, 9.30. | TAP (Ankara) | 9.465 | 31.70 | 7.15. |
| VLE (Melbourne) | 9.580 | 31.32 | 10.0 a.m., 3.0. | TAQ | 15.195 | 19.74 | 12.15. |
| VLR3 | 11.850 | 25.32 | 9.50. | U.S.S.R. | | | |
| China | | | | RNE (Moscow) | 6.000 | 50.00 | 10.30. |
| XGOY (Chungking) | 11.900 | 25.21 | 11.30 a.m., 12.10 9.30, 10.30. | RW96 | 6.030 | 49.75 | 7.30. |
| Finland | | | | | 7.545 | 39.76 | 7.30, 10.30, 11.30. |
| OFD (Lahti) | 6.120 | 49.02 | } 12.15 a.m., 8.55 a.m., 7.15, 10.15. | RW96 | 9.520 | 31.51 | 7.33 a.m., 7.30, 9.0, 10.30, 11.30. |
| OFD | 9.500 | 31.58 | | | | 9.600 | 31.25 |
| Hungary | | | | | 11.499 | 26.09 | 12.0 noon. |
| HAT4 (Budapest) | 9.125 | 32.88 | 1.30 a.m.§. | | 11.710 | 25.62 | 7.30, 9.0, 10.30. |
| HAT5 | 9.625 | 31.17 | 12.15 a.m.† 12.30, a.m.†. | RNE | 12.000 | 25.00 | 1.0 a.m., 9.0†, 10.30. |
| HAS3 | 15.370 | 19.52 | 3.55†. | | 14.720 | 20.38 | 12.0 noon, 5.0. |
| India | | | | RKI | 15.040 | 19.95 | 1.0 a.m. |
| VUD2/3 (Delhi) | 9.590 | 31.28 | 9.0 a.m., 1.30, 4.50, 6.30. | RW96 | 15.180 | 19.76 | 1.0 a.m., 7.33 a.m., 9.0 a.m., 9.0, 10.30, 11.30. |
| VUD4 | 11.830 | 25.26 | 9.0 a.m., 1.30, 4.50, 6.30. | | 18.540 | 16.18 | 12.0 noon. |
| VUD3 | 15.290 | 19.62 | 9.0 a.m. | Vatican City | | | |
| Iran | | | | HVJ | 6.190 | 48.47 | 8.15. |
| EQB (Teheran) | 6.155 | 48.74 | 7.30. | Yugoslavia | | | |
| Japan | | | | YUA (Belgrade) | 6.100 | 49.18 | 10.25. |
| JZJ (Tokio) | 11.800 | 25.42 | 9.5. | | | | |
| JZK | 15.160 | 19.79 | 9.5. | | | | |
| Manchukuo | | | | | | | |
| MTCY (Hsinking) | 11.775 | 25.48 | 8.0 a.m., 10.5. | | | | |

It should be noted that at this time of the year changes of wavelength are frequently made and readers are, therefore, advised to try alternative wavelengths. The times of the transmission of news in English in the B.B.C. Short-wave European Service are given on page 498.

REGULAR LONG- AND MEDIUM-WAVE TRANSMISSIONS

| Country : Station | kc/s | Metres | Daily Bulletins (B.S.T.) | Country : Station | kc/s | Metres | Daily Bulletins (B.S.T.) |
|-------------------|-------|--------|--------------------------|-------------------|-------|--------|--------------------------|
| Bulgaria | | | | Rumania | | | |
| Sofia | 850 | 352.9 | 9.55 (Th. and Sat.). | Radio-Romania | 160 | 1,875 | 10.45†. |
| Hungary | | | | Bucharest | 823 | 364.5 | 10.45†. |
| Budapest 1 | 546 | 549.5 | 11.10. | Spain | | | |
| Ireland | | | | Radio-Coruna | 968 | 309.9 | 1.10 a.m. |
| Radio-Eireann | 565 | 531 | 6.45†, 10.10†, 10.5†. | Sweden | | | |
| Latvia | | | | Motala | 216 | 1,389 | 10.45. |
| Madona | 583 | 514.6 | 10.0 (Tu. and Fri.). | Stockholm | 704 | 426.1 | 10.45. |
| Kuldiga | 1,104 | 271.7 | 10.0 (Tu. and Fri.). | Goteborg | 941 | 318.8 | 10.45. |
| | | | | Falun | 1,086 | 276.2 | 10.45. |
| | | | | U.S.S.R. | | | |
| | | | | Moscow 1 | 172 | 1,744 | 11.30. |

All times are p.m. unless otherwise stated. * Saturdays only. § Saturdays excepted. † Sundays only. ‡ Sundays excepted.

Compressed Dipoles

REDUCING THE DIMENSIONS OF SHORT-WAVE AERIALS

By E. L. GARDINER, B.Sc.

(Concluded from p. 456, November issue)

HAVING ascertained the design data for dipoles compressed to one-half of their usual length, and found that no excessive loss in efficiency occurs, it became possible to proceed to the practical aspect of the subject, and to discuss the construction of a compact directional aerial. The matter will be considered mainly from the point of view of direction-finding on wavelengths in the neighbourhood of 5 metres.

A compressed dipole was made up to the dimensions already given, and to ensure rigidity was supported from small stand-off insulators screwed to a 4-foot length of a white-wood pole, which was easily obtained by purchasing new broom handles and trimming off the rounded ends. The actual length of the dipole was 44 inches. A compressed reflector was next made up on exactly similar lines. In this case the loading coil was reduced to 10 turns, and a small tuning condenser permanently connected across the two central turns, so that the reflector could be tuned for optimum performance. The overall length of

length for the reflector in the interests of minimum backward radiation. The final assembly was less than half the size of that used last year, and is illustrated in Fig. 4. It could be carried about easily, and was light enough to be mounted and rotated upon a camera tripod of the usual light construction. The dipole and reflector were fixed at a spacing of 18 inches by means of light wooden cross-members, making the whole a rigid and self-supporting unit.

Directional Tests

The aerial was next coupled to the transmitter, and its directional properties measured. After careful tuning of the reflector to the wavelength used, curves typified by Fig. 5 were obtained. Under all conditions of adjustment two minima were always found, separated by approximately 75 degrees, but it was possible to achieve a ratio of maximum to minimum response reaching at least 30 to 1 on the assumption that the meter employed remains sensibly linear at the low readings obtained near the minimum directions. It is probable that the production of two minima is inherent in the use of a reflector spacing of less than an eighth wavelength, but in view of the very sharp minima obtained the aerial would seem quite useful for direction-finding work, the procedure being to find both minima on a signal and then to bisect the angle between them to give the direction from which the waves are arriving. It should be stressed that owing to the close reflector spacing, the signals picked up by this aerial are materially weaker than those received upon the compressed dipole alone. The voltage reaching a receiver is estimated to be about one-third that from a full-size dipole, the sole reason for adopting the system being portability combined with a high ratio

between that maximum and minimum directions.

The curve of Fig. 5 shows two interesting features. First, it will be seen to be slightly unsymmetrical, no doubt due to the nearby guttering, which was noticed to have a similar effect when plotting the polar curve of the normal dipole and reflector described in the first article.¹ Secondly, it was observed that on tuning the reflector by the variable condenser shown in Fig. 4 the point giving the smallest minima was not the same as that for maximum forward radiation. The latter was 67 units in the adjustment plotted when the minima were less than 2 units of field strength; whilst adjustment of the condenser for maximum forward radiation gave a reading of nearly 90 units whilst increasing the back lobe to 15 units, or about double its minimum value. The minima were then no longer sharply defined. The result of earlier tests using full-length dipoles were therefore confirmed in that the adjustments of the reflector for maximum forward or minimum

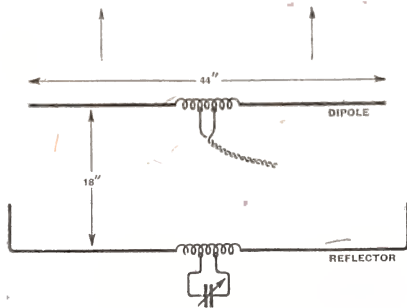

Fig. 4. Arrangement and dimensions of a compressed array for the 5-metre band.

the reflector proved to be about 50 inches, and to enable it to fit along a 4-foot pole, the ends of the wires were bent at right angles for about 3 inches, without any noticeable bad effects. From the information mentioned in the previous article it was decided to employ a spacing of rather less than an eighth wave-

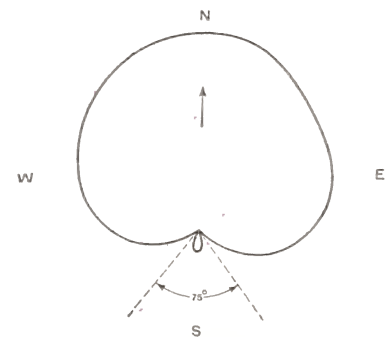

Fig. 5. Directional properties of the aerial array shown in Fig. 4.

backward radiation were not the same.

In cases where effective transmission or reception are of greater importance than a sharp directional

¹ "Aerial Reflectors," *The Wireless World*, October, 1940.

Compressed Dipoles—

effect, the compressed dipole and reflector can be separated by the conventional quarter-wave spacing, when the polar curve resembles that given for a dipole and reflector in the former article. There will be a single minimum only, and by tuning the reflector in the manner that has been described, this is likely to be better than for the usual arrangement in which the reflector is approximately tuned by the adjustment of its length only. The efficiency of this array in the forward direction is little inferior to that of the full-sized array, whilst in size it will be approximately a 4-foot square, and thus quite reasonably convenient.

It would, of course, be perfectly possible to erect more elaborate directional arrays comprising several dipoles, reflectors and perhaps directors, all of the compressed variety. In fact, the compressed unit is clearly interchangeable with the half-wave resonators used in the construction of the many types of array described in any good textbook on aerial design, whilst their use will considerably reduce the size of the system, and indirectly the difficulties of erection. Since under domestic conditions the chief obstacle to setting up elaborate aerial systems is the limited total space available, these savings may render possible the use of an array which could not be accommodated at all if full-length resonators were employed.

Multi-band Working

It may be interesting to describe a particular application of the loaded dipole principle which the writer has found extremely convenient. As applied to amateur conditions, this aerial provides operation in any one of three adjacent wavebands, such as 5, 10 and 20 metres, for example, whilst occupying only the space required by a dipole for the middle band, in the case quoted a length of about 16 feet. It is changed from one to another merely by altering the feeder connections, whilst the provision of interchangeable plug-in loading coils will extend it to any

desired wavebands intermediate to those mentioned.

Applied to general listening, the aerial will operate on the 7-metre waveband, for example, with extension to the 16-metre and the 30-metre broadcast bands, and any intermediate bands such as the 19- or 25-metre broadcast bands. In this case it might wisely be erected as a vertical system.

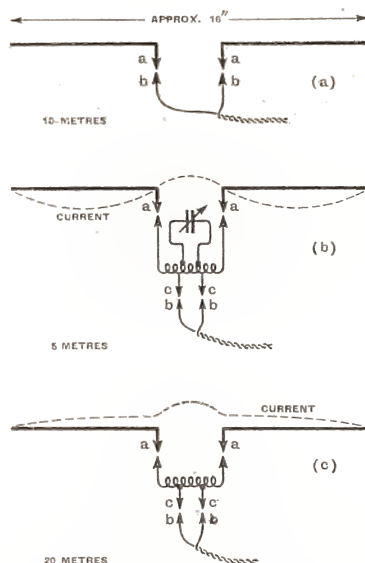

Fig. 6. A flexible aerial system for operation on three wavebands; its wave-range can be extended as described in the text.

The arrangement of the aerial is illustrated in Fig. 6, and to facilitate description we will assume that it is for use on 5, 10, and 20 metres, on which it has been tested by the writer. In this example the overall length will be 16 feet, or that of a 10-metre dipole, and thus only half that usually needed for 20-metre working; the advantage of the system being that the 32-foot span normally required for the latter was not available between the two supports which had to be used. Many such cases will be encountered when an aerial must be erected entirely above the roof of a moderate-sized house, whilst the effectiveness of the arrangement will be found much superior to an untuned wire.

At the middle waveband, which in the example quoted is 10 metres, the aerial functions as a normal

dipole, as shown in Fig. 6 (a). The 16-foot wire is broken in the centre, the ends terminating in two sockets mounted upon a piece of a good quality weatherproof insulator, such as a strip of Trolitul measuring 4in. by 1¼in. wide. The 80-ohm feeder cable used is also terminated by two plugs, b, b to fit the sockets a, a, thus completing the dipole as sketched. To operate on 5 metres, these plugs are withdrawn, and a loading coil wound on a Trolitul former and fitted with two identical plugs is inserted between the points a, a. Across a few turns at the centre of this coil are soldered two similar sockets, c, c, to which the feeder is now attached. The aerial now resembles Fig. 6 (b) and functions as two half-wave radiators in phase on 5 metres, giving a broadside directivity as before, but with improved directional properties and radiating efficiency.

Current Distribution

To illustrate the method of operation the current distribution is shown by the dotted line, and it will be seen that the loading coil forms a "mat phasing section" equivalent to the quarter-wave matching stub familiar to amateur operators. The dimensions of the coil in this case are somewhat critical, since it must resonate at 5 metres by virtue of its own self-capacity and the slight loading effect of the two radiating arms, which vary considerably with the proximity of the earth or of nearby objects. To avoid difficulties in finding the best inductance, a small tuning condenser can be joined across the coil without detriment to its performance provided that steps are taken to protect this from the weather. A satisfactory solution if the aerial is only used on the 5-metre band for limited periods is to place a compact type of 15- $\mu\mu\text{F}$ variable condenser inside the coil former, with its spindle protruding through the side, between a widely spaced pair of turns. A six-turn coil of 1¼ or 1½ inches diameter having the feeder tapped across from one to two turns can now be used, and will be found to resonate sharply at a point within the range of the 15- $\mu\mu\text{F}$ condenser specified.

Wireless World

Compressed Dipoles—

To operate the aerial on 20 metres, or any longer wavelength between the limits of 10 and about 30 metres, it is only necessary to plug in a fresh loading coil having the appropriate number of turns to transform the aerial into a compressed dipole at the desired wavelength. The conditions are sketched in Fig. 6 (c), and an idea of the size of coil required can be arrived at from the data of last month's instalment.

Adjustments

It will most probably be quite unnecessary to provide a variable condenser in this case, since the tuning of the system is not so sharp that a satisfactory adjustment cannot be reached by the removal or addition of turns. In making this adjustment it will be found very helpful to connect a variable condenser across the coil temporarily by means of crocodile clips, preferably providing an insulated support of some kind by which the condenser can be held in the hand and an insulated extension spindle to reduce hand-capacity effects. If it is then found that the aerial resonates to the desired wavelength with the condenser vanes partly in, as shown by maximum signal strength in reception, or increased aerial current in transmission, the coil is too small and should be increased until it gives maximum results with the temporary condenser at zero or disconnected. No signs of an optimum setting of the condenser suggests too large a coil from which turns should be removed.

From the foregoing remarks it will have become obvious that the aerial system described must be erected in such a way that feeder connection to it is accessible. This can, however, often be arranged, and may be preferable to the use of several fixed aeriels. In the writer's case the aerial is erected above a flat roof, and it is the work of a moment only to climb a step ladder kept handy for the purpose and from which the loading coils can be reached. In more difficult cases it may be necessary to provide a rope and pulley at one end of the aerial by which it can be quickly lowered to permit of changing the coils.

Incidentally, the plugs and sockets used should be a tight fit to prevent the feeder from pulling out, whilst they may with advantage be of the shrouded pattern which are almost weatherproof when assembled. Since the sockets are arranged to point downwards, they do not easily get filled with rain at times when no plugs are inserted, whilst no serious falling off in performance has been noticed when the loading coils are wet, bearing in mind, of course, that a waterproof type of former such as Trolitul or porcelain must be used. In other situations the aerial may well be erected vertically. It is then not difficult to arrange that the central point comes just outside a window, from which the loading coils can be readily interchanged. It thus provides an excellent solution for the listener who requires an efficient aerial which will be useful for short-wave listening over a wide range of wavelengths. It need hardly be repeated perhaps that whilst transmission has been frequently referred to in this description, the remarks apply equally to aeriels used entirely for reception, whilst it is perfectly possible to extend the system by the addition of a reflector similarly provided with interchangeable loading coils whereby it can be used on several wavebands.

A SERVICE MAINTAINED

THE present situation is rendering it increasingly difficult to obtain journals from abroad with any degree of regularity. Our sister journal, *The Wireless Engineer*, is, however, maintaining its abstracts and references section even if on occasion the number of pages occupied by this regular feature are slightly reduced. In addition to the abstracts from and references to nearly 300 recently published articles on wireless and allied subjects given in the November issue it also contains an article in which is discussed the problems connected with velocity modulation. The behaviour of resistors at high frequencies is dealt with editorially in the same issue.

A comprehensive index to the abstracts published throughout the year will be included in the December issue, which will be available on the first of the month.

The Wireless Engineer is obtainable to order through newsgagents or direct from the Publishers, Dorset House, Stamford Street, London, S.E.1, at 2s. 8d. post free.

The "Fluxite Quins" at work

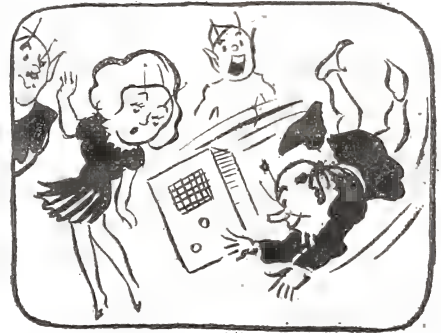

"Look out!" cried EE with a roar
As his wireless set dived to the floor.
See the grin on his face,
Not a wire out of place,
Thanks to Fluxite—could one expect more?

See that FLUXITE is always by you—
in the house—garage—workshop—
wherever speedy soldering is needed.
Used for 30 years in Government
works and by leading engineers and
manufacturers. Of Ironmongers—in
tins, 4d., 8d., 1/4 and 2/8.

Ask to see the FLUXITE SMALL-
SPACE SOLDERING SET—compact
but substantial—complete with full
instructions, 7/6.

Write for Free Book on the art of
"soft" soldering and ask for Leaflet
on CASE-HARDENING STEEL and
TEMPERING TOOLS with FLUXITE.

TO CYCLISTS! Your wheels will
NOT keep round and true unless the
spokes are tied with fine wire at the cross-
ings AND SOLDERED. This makes
a much stronger wheel. It's simple—with
FLUXITE—but IMPORTANT.

THE FLUXITE GUN

is always ready to put Fluxite on the
soldering job instantly. A little
pressure places the right quantity on
the right spot and one charging lasts
for ages. Price
1/6, or filled 2/6.

FLUXITE LTD.
(Dept. W.W.),
DRAGON WORKS,
BERMONDSEY
STREET, S.E.1

ALL MECHANICS WILL HAVE

FLUXITE

IT SIMPLIFIES ALL SOLDERING

Lamp Contrast Expander

ITS OPERATION AND EFFECTIVENESS ANALYSED

By S. W. AMOS, B.Sc. (Hons.)

IT is a well-known fact that the resistance of a metal filament lamp increases with increase of temperature, and hence with increase in the voltage across it. By virtue of this fact such lamps can be used in contrast expansion circuits. Experiments were therefore made on an ordinary 2.5 volt torch bulb with an ammeter and a voltmeter in order to see how great the increase in resistance was. The following readings were obtained:—

| PD across Bulb (Volts) | Current through bulb (Amps) | Resistance (Ohms) |
|------------------------|-----------------------------|-------------------|
| 0.10 | 0.10 | 1.00 |
| 1.00 | 0.20 | 5.00 |
| 2.00 | 0.27 | 7.41 |
| 3.00 | 0.33 | 9.00 |

The variation is hence considerable, which is not really surprising when it is realised that the Coefficient of Increase of Resistance with temperature of most metals lies between 0.003 and 0.005, and that the temperature of a white-hot filament must be over 1,000°C. Moreover the relationship between resistance and temperature cannot be considered linear over such an enormous range of temperature. The simple law:—

$$r_t = r_0 (1 + at)$$

only holds for temperature ranges of up to 100° C. Above this value a third and possibly fourth term will come into play thus:—

$$r_t = r_0 (1 + at + \beta t^2 + \gamma t^3 + \dots)$$

Consider a bulb such as the one whose characteristics are given above to be connected in parallel with the speech coil of a receiver, and suppose that the resistance of the speech coil (supposed constant for sake of simplicity) is 5 ohms. This gives the arrangement shown in the accompanying diagram.

Imagine that a current of 0.1 amp. is flowing in the bulb. Then from the table above, the PD across it must be 0.1 volt, and hence the energy being absorbed by the bulb is 0.01 watt. Moreover, 0.1 volt must also be the PD across the speech coil, and thus

| Current in Bulb (Amps) | PD across bulb (Volts) | Energy in bulb (Watts) | Speaker Current (Amps) | Speaker Energy (Watts) | Total Energy (Watts) |
|------------------------|------------------------|------------------------|------------------------|------------------------|----------------------|
| 0.10 | 0.10 | 0.01 | 0.02 | 0.002 | 0.012 |
| 0.20 | 1.00 | 0.20 | 0.20 | 0.20 | 0.40 |
| 0.27 | 2.00 | 0.54 | 0.40 | 0.80 | 1.34 |
| 0.33 | 3.00 | 1.00 | 0.60 | 1.80 | 2.80 |

this is taking a current of 0.1/5 = 0.02 amp. The energy being dissipated here, then, is 0.002 watt. By considering other currents in the bulb in the same way the table at the foot of previous column was obtained.

Thus as the total energy supplied by the output transformer increases from 0.012 to 2.80 watts (a variation of 1 in 230 approximately) the energy which the speech coil receives changes from 0.002 to 1.8 watts (a variation of 1 in 900). Thus the contrast between loud and soft passages has been increased by nearly 4 times.

Using this simple theory it can be shown that in general the ratio in which the contrast is increased is given by the expression:—

$$\frac{r_2(R + r_1)}{r_1(R + r_2)} : 1$$

where R = resistance of speech coil
 r_1 = resistance of bulb when cold
 r_2 = resistance of bulb when hot.

Thus substituting the values appropriate to the above example we get:—
 Ratio of expansion =

$$\frac{9(5 + 1)}{1(5 + 9)} : 1$$

$$= \frac{54}{14} : 1$$

$$= 4 : 1 \text{ nearly, as before.}$$

Now so far we have assumed the speech coil resistance to be constant, as it would be if it were handling direct current all the time. In prac-

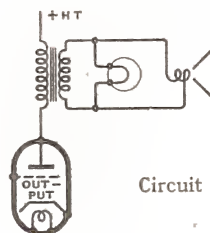

Circuit of the single-bulb expander.

tice, however, it has to deal with alternating current, and very complex AC at that; hence its resistance (or more accurately impedance) varies according to the well-known formula:

$$\text{Impedance} = \sqrt{R^2 + L^2w^2}$$

where R = resistance of coil

L = inductance of coil

w = angular velocity of AC
 $(= 2\pi f, f$ being frequency).

From this it can be seen that as the frequency of the current rises, so does the impedance. Moreover, as if to complicate matters, the impedance varies in practice much more quickly than this formula indicates, due to the "skin effect." This means that at high frequencies the bulb will not perform its duties so well as at low frequencies.

Fortunately, however, the inductance of the average moving coil is low so that the increase of impedance is not serious enough to prejudice unduly the performance of the contrast expander. The ratio of increase of contrast is, no doubt, smaller on account of this than the simple theory predicts, but, in the writer's opinion the inclusion of the bulb is still well worth while.

In practice, the simplicity of the scheme will readily be appreciated when it is pointed out that it is merely necessary to connect an ordinary torch bulb holder to the extension loudspeaker sockets of the receiver. The bulb should light brilliantly on loud passages and should not light at all on soft ones.

The improvement in the reproduction is quite marked, especially in the rendering of gramophone records, where a reduction in needle hiss is apparent. It was found that a 2.5-volt bulb displayed an alarming tendency to burn out on very loud orchestral crashes, and so a bulb of 5-volt rating was substituted. This proved most satisfactory.

It must be realised that, even a 2.5 volt bulb consumes 1 watt when burning brightly, and so the receiver to which it is connected must be able to supply this, in addition to the energy needed for the loudspeaker. It is obvious, too, that some diminution of volume is to be expected when the bulb is in circuit.

This arrangement does not give such good results as two bulbs used in a Wheatstone bridge circuit such as the Crossley Expander, described in *The Wireless World* of May 22nd, 1936, nor is it as good as those systems using valves which have been described since then. The expansion, too, does not follow any particular law, i.e., is not linear. But it is worth while when the negligible trouble and cost of adding it to a receiver are considered.

Random Radiations

By "DIALLIST"

Frequency Modulation

IT won't be for want of trying on the part of those who are developing it if frequency modulation fails to make rapid headway in the U.S.A. Several regular broadcast services are now running, and the system has also been adopted by some municipalities for their police and other services. I wish I had the chance of sampling FM reception to see how far it lives up to the claims made for it of better quality and decreased interference. If it's as good as its sponsors believe it is there should be a wonderful future for it. Quite apart from quality, interference and means of avoiding it are amongst the biggest radio problems of to-day. And so much apparatus of radiating kinds has been sold to the public since the war began that we're going to find conditions pretty bad when peace allows us to get down to serious wireless once more. I see that adaptors are now being sold in America which enable one to convert a standard amplitude-modulation set for receiving FM transmissions. I don't know whether FM signals are reaching this country, for I haven't handled an USW set since the war began. If they are it would be thrilling to try reception with one of these adaptors.

Pay Up and Look Pleasant!

YOUR wireless set, if you buy a new one, will cost you more! That's one of the blows that wartime brings, and we can but grin and bear it. Though no one likes taxes—except possibly those that apply to others and not to oneself—we really haven't much to complain of as regards the purchase tax on radio goods. All the money collected goes to the best of good causes, that of winning the war. And, after all, it does not make prices unreasonable, especially when one considers that we have been engaged for fifteen months now in the greatest war in history. The set that cost eight guineas is now going to cost a little over £10; the four-and-ninepenny valve will run to 5s. 10d., and the six-bob HTB to 7s. 6d. Not too bad, all things considered. There's sure to be some falling off in sales in this country, but that doesn't mean that either the country or the radio industry will suffer. Far from it; there has for some time been a big drive to develop wire-

less exports, which has met with real success. If the home trade slackens off a little, there will be more sets available to sell abroad, and it is of vast importance to us to market everything we can in other countries so as to have the money to pay for the enormous amount of goods that we must import. Think of these things when you have to pay the higher prices for a new set or for accessories, and you'll feel much more cheerful about fishing the extra shillings out of your trouser pocket.

From the U.S.A.

THE United States short-wave broadcasting concerns have been doing us very well in the matter of programmes, and though conditions haven't always been too favourable for reception, I've had many hours of enjoyment out of them. So, no doubt, have you. One American station did see fit to say that our need for programmes from outside was very great "since the B.B.C. transmissions close down during air raids." Well, I haven't noticed much of that, and I take off my hat to the Corporation for the way in which it has carried on. Still, there's no doubt that the American programmes are welcome or that they provide some highly interesting listening. Particularly welcome are their talks from observers in European countries, though in many cases these are much more severely censored than they were. One thing that must appeal to us all is the spirit of genuine friendship and sympathy that is evident in the U.S.A. programmes. It's clear that their interest in our doings isn't just that of detached and *blasé* folk in search of thrills.

Peace Dreams

"WHEN this blank-blank war is over,

Oh how happy shall I be.

When this blank-blank war is over,
Dreams will all come true for me."

So sang the bloodthirsty and licentious soldiery in the last war; and so I hum to myself in odd spare moments, when I am dreaming of the wireless set, that I'll build—or even, if the fates are kind, have built for me—when peace breaks out. I know just what I want, and, please the pigs, I'll have it. For one thing it will *not* contain just a few complicated valves,

BULGIN

COILS of all Types.

A SELECTION

(Full range, see Catalogue No. 163, 6d.)

| List No. | Range. | Price |
|----------|------------------------------|-------|
| C.42 | .200-550, 1000-2100m. | 2/6 |
| C.40 | " " | 4/6 |
| S.W.65 | 12-95m. | 6/- |
| C.69 | .200-550, 1000-2100m. | 4/6 |
| C.59 | " " | 5/- |
| C.6 | " " | 6/- |
| C.7 | " " | 6/- |
| C.73 | .I.F. Trans 465 kc/s. | 9/6 |
| C.20 | .200-550, 1000-2100m. | 8/6 |
| I.F.5 | .I.F. Trans 465 kc/s. | 10/- |
| C.50 | " " | 10/- |
| C.11 | .I.F. Trans 110 kc/s. | 10/- |
| I.F.1 | .I.F. Trans 465 kc/s. | 10/6 |
| C.80 | 18-55, 200-550, 1000-2100m. | 12/6 |
| C.52 | " " | 12/6 |
| C.56 | .15-80, 200-550, 1000-2100m. | 12/6 |
| C.63 | .I.F. Trans 465 kc/s. | 15/6 |

PLUS 16% WAR INCREASE

NATIONAL EFFORT

IN these times, in many directions, needless to say, we are directing our main efforts and supplies towards the requirements of the Government Services.

However, some supplies of components are still available for Radio Servicing, but should delays occur we know our friends will appreciate the difficulties which at present arise from day to day.

We would point out that delays can be minimised and often avoided if alternatives are, wherever possible specified when ordering.

Prices are being kept as low as possible despite increased costs in every direction. Meanwhile you still have the best and largest range of radio products in the United Kingdom to choose from.

THANK YOU!

FOR ALL RADIO COMPONENTS

ADVT. OF A. F. BULGIN & CO., LTD.,
BYE PASS RD., BARKING, ESSEX. RIP.3474 (4 lines)

Random Radiations—

each doing several jobs. What it will have is quite a lot of relatively simple valves, each doing its special job and doing it well. Nor will it be the kind of receiver which is pretty good on the long waves and the medium, with a short-wave range of doubtful efficiency thrown in as a makeweight. On the contrary, it will be at its best on the short waves. It won't take in the long waves at all—at least I don't think it will; but it will be a reasonable performer on the medium band. The tuning gear will be fully positive, with wide electrical band-spreading, and there'll be no creeping of the oscillator. It's dreams of that kind that make one's war life worth living.

Battery Salvage

IN past years heaps of people have said to me: "Why can't something be done with old dry batteries? It seems such a waste to throw them into the dustbin." I'm not going to pretend that these remarks were made by altruists. Those who gave vent to them nearly always had in mind a haunting wish that they could be recharged and made fit for further service. That can't, of course, be done; but there are some fine pickings for salvage purposes in old batteries, and I'm more than glad to see that our discards are no longer to be allowed to become mere waste material. Several firms are specialising now in recovering the valuable materials present in even the most worn-out of HTB's, flashlamp batteries, and so on. Some genius has invented a machine which squeezes out in one stroke the whole of the carbon rods of a HTB. And after a wash and brush up these carbon rods are as good as ever, for in the cells they act merely as conductors and undergo no chemical action. Dry cells work by "burning up" zinc. In the ideal cell, I suppose, the last active milligramme of electrolyte would consume the last milligramme of zinc just in time for the depolariser to make its expiring effort at keeping down the internal resistance. But things don't work out like that in practice. As the zinc forms the container of the cell, its perforation in one spot is the most usual cause of the cell's demise. Hence in a defunct cell there is a surprising proportion of the original zinc still left intact. And then, of course, there are the bitumen or wax seals, the paper wrappings of the cells and the cardboard of the cell compartments and the battery case. All of these things are now salvaged: even the solder of the joints is run off and made

ready for fresh use. Don't fling your old dry batteries and cells away as was once your wont. Local authorities, acting often through the wireless shops, will be glad to have, and to send to the proper place, all that you can give them.

Some'll Believe Anything!

WHAT the public will believe about wireless is just amazing. Some years ago I recall advertisements of a gadget which was guaranteed to rejuvenate dry HTB's suffering from senile decay. One of these affairs came into my hands and I spent a short but interesting time in examining it. The HTB and a 2-volt accumulator were to be connected, according to the directions in the accompanying leaflet, to two sets of terminals. The writer of the leaflet explained that in this way "live current" from the secondary cell was passed through the HTB, with the result that the latter took on a new lease of life. On the back of the leaflet were several glowing testimonials from purchasers who had benefited in this way. I think that the testimonials were probably perfectly genuine. Those who wrote them really believed that a miracle had been worked! And lately I was shown by a civilian in the part of the world where I am stationed what he called a new wonder aerial—or rather aerial eliminator. He had paid quite a number of shillings for something that acted more or less as an ordinary fixed condenser. Connect this between the earthy lead of the set and earth (there's another wire to the aerial terminal), and you get reception of a sort. But, as I demonstrated to the victim, you get far better reception by using the earth lead in the ordinary way and fixing up almost any kind of aerial. Was he grateful? I don't think so!

Screening and Interference

IN the hutted camp in which I've dwelt and moved for so long now, we have a good deal of interference due to one man-made source or another. Lately I've been interested to compare the performances of one or two different receivers under these conditions, and without the use of any sort of anti-interference aerial. I'd long believed that not a little of the interfering sounds experienced under certain conditions was due to direct pick-up on the part of the set. That belief has been strengthened. One of the sets tried was pretty sensitive, and it was found that it would bring in not only the B.B.C., but also other transmissions as well with no aerial at all. Another was equally sensitive when yoked to an aerial, but seemed completely dead when the aerial plug was removed. Now, number one brought in (and brought out!) all the nasty noises that were going, whilst number two was far freer from them. It's obvious, I think, that the first could pick up broadcasting stations and interference simply on its poorly screened wiring and components. The second, well screened, could make nothing of transmissions unless it had an aerial, just because its screening was so good. And that same good screening kept out a lot of local interference.

Lesdix "Nitnday" Charger

DESIGNED for charging a 2-volt accumulator cell, this unit consists of a well-made mains transformer, a metal oxide rectifier and a small series resistance. It is strongly made and well finished and may be obtained in two types, the NA/2½ at 12s. 6d. for bench fixing, or the NA/2½P at 15s. for wall mounting. The latter is enclosed in a sheet metal cover of modern design.

On test the cool functioning of all three components in the unit testified to the generous factor of safety which has been allowed in their design. The

mains transformer has an iron core of good cross section and the

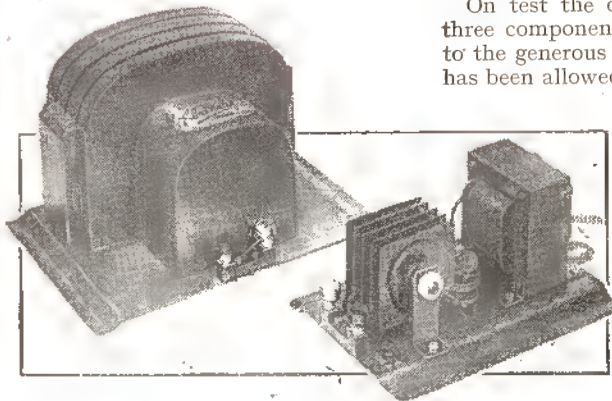

The Lesdix "Nitnday" charger may be obtained in skeleton form or with a metal cover for wall mountings.

Wireless World

primary is wound to accommodate AC mains voltages from 200 to 250.

The charging current ranged from $\frac{1}{2}$ to 1 amp., depending upon the state of the battery, but was never less than 0.5 amp.

The makers are Leslie Dixon & Co., 218, Upper Thames St., London, E.C.4.

Book Review

Introducing Radio Receiver Servicing.
By E. M. Squire. Pp. 97. 106 diagrams and drawings. Sir Isaac Pitman and Sons, Ltd., Parker Street, Kingsway, London, W.C.2. Price 6s. net.

HERE is a book that makes a very opportune appearance. The demands of the fighting forces have made serious inroads on the servicing, maintenance and testing staffs of wireless firms of all kinds, and new entrants are required to carry on the work of those who have joined up.

As the author points out in his preface, the book has been planned as a concise guide to practical receiver operation, and is intended to help newcomers in their initial training, while at the same time serving as an introduction to more advanced books in which some prior knowledge of the subject is assumed. There can be no doubt as to its conciseness, and a great amount of information has been packed into a small space.

After a very short introductory chapter on elementary electrical and wireless theory, the author proceeds to a practical survey of broadcast receivers; from this point onwards the

general treatment is essentially practical, with no more theory than is necessary to explain receiver operation. Later chapters deal with receiver components, valves and their operation, reading circuit diagrams, record-reproducing accessories, servicing equipment, and finally with the actual tracing of faults. The chapter on components, in which both functioning and construction are described, seems to be particularly helpful.

In one or two instances the sequence of the explanations appears susceptible to improvement, but admittedly any rearrangement might detract from the conciseness of the book. "Introducing Radio Receiver Servicing" can be safely recommended to the type of reader to whom it is addressed.

H. F. S.

Club News

British Short-Wave Correspondence Club

Headquarters: The Watring, Parham, Woodbridge, Suffolk.

Hon. Sec.: Mr. A. Richardson, The Watring, Parham, Woodbridge, Suffolk.

Members are invited to exchange their S.W.L. cards through the Q.S.L. Bureau. Those wishing to use this service should send six cards and an S.A.E. to Mr. D. G. Garrard, 135, Hervey Street, Ipswich, Suffolk, when they will be sent a list of members, whose cards are also for exchange, from which they can make their choice. Return postage must always be sent when communicating with club officials. Club stationery may now be had on application.

VORTEXION 50w. AMPLIFIER CHASSIS

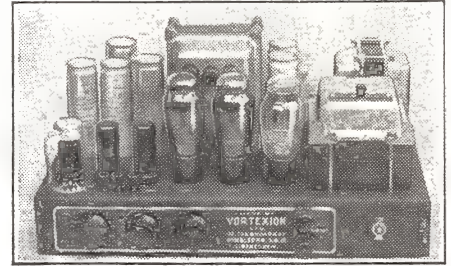

A pair of matched 6L6's with 10 per cent. negative feed-back is fitted in the output stage, and the separate HT supplies to the anode and screen have better than 4 per cent. regulation, while a separate rectifier provides bias.

The 6L6's are driven by a 6P6 triode connected through a driver transformer incorporating feed-back. This is preceded by a 6N7 electronic mixing for pick-up and microphone. The additional 6F5 operating as first stage on microphone only is suitable for any microphone. A tone control is fitted, and the large eight-section output transformer is available in three types:—2-8-15-30 ohms; 4-15-30-60 ohms or 15-60-125-250 ohms. These output lines can be matched using all sections of windings and will deliver the full response (40-13,000 c/s) to the loud speakers with extremely low overall harmonic distortion.

CHASSIS with valves and plugs £17 10 0

Or complete in black leatherette cabinet with Collaro turntable, Piezo P.U. and shielded Mike Transformer £22 10 0

Plus 10% War Increase on above prices.

Rello Horns £11 11 0

Rello M.C. Microphones £4 4 0

All P.A. and A.R.P. Warning Gear in stock.

**Many hundreds already in use for
A.R.P. & GOVERNMENT purposes**

15w. AC & 12-VOLT DC AMPLIFIER

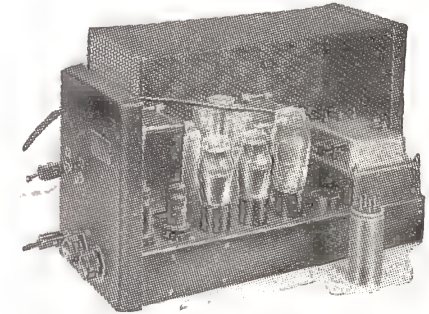

TYPE CP20

This small Portable Amplifier operating either from AC mains or 12-volt battery, was tested by "THE WIRELESS WORLD," October 1st, 1937, and has proved so popular that at Customers' demand it remains unaltered except that the output has been increased to 17.2 watts and the battery consumption lowered to 6 amperes. Read what "The Wireless World" said:—

"During tests an output of 14.7 watts was obtained without any trace of distortion so that the rating of 15 watts is quite justified. The measured response shows an upper limit of 18,000 c/s and a lower of 30 c/s. Its performance is exceptionally good. Another outstanding feature is its exceptionally low hum level when AC operated even without an earth connection. In order to obtain the maximum undistorted output, an input to the microphone jack of 0.037 volt was required. The two independent volume controls enable one to adjust the gain of the amplifier for the same power output from both sources, as well as superimpose one on the other, or fade out one and bring the other up to full volume. The secondary of the output transformer is tapped for loudspeakers or line impedances of 4, 7.5 and 15 ohms." Prices: Plus 10% war increase.

AC and 12-volt CHASSIS with valves, etc. £12 12 0

Or in Rexine Case with Collaro Motor, Piezo P.U. and Mike Transformers £17 17 0

AC only CHASSIS with valves, etc. £8 18 6

Or in Rexine Case with Collaro Motor, Piezo P.U. and Mike Transformer £14 0 0

Gauze Case for either chassis 12/6 extra.

Write for Illustrated Catalogue.

**Vortexion Ltd., 257, The Broadway,
Wimbledon, S.W.19. Phone: LIBerty 2814**

BOOKS ON WIRELESS

issued in conjunction with "The Wireless World"

| | Net Price | By Post |
|---|-----------|---------|
| "FOUNDATIONS OF WIRELESS," by A. L. M. Sowerby. Second Edition | 5/- | 5/6 |
| "RADIO LABORATORY HANDBOOK," by M. G. Scroggie | 8/6 | 9/1 |
| "WIRELESS SERVICING MANUAL," by W. T. Cocking. Fifth Edition | 5/- | 5/6 |
| "HANDBOOK OF TECHNICAL INSTRUCTION FOR WIRELESS TELEGRAPHISTS," by H. M. Dowsett. Sixth Edition | 21/- | 21/9 |
| "WIRELESS DIRECTION FINDING," by R. Keen. Third Edition | 25/- | 25/9 |
| "RADIO DATA CHARTS," by R. T. Beatty. Second Edition | 4/6 | 4/11 |
| "TELEVISION RECEIVING EQUIPMENT," by W. T. Cocking | 7/6 | 8/- |
| "RADIO INTERFERENCE SUPPRESSION," by Gordon W. Ingram | 5/- | 5/4 |
| "LEARNING MORSE." Fourth Edition | 6d. | 7½d. |
| "RADIO DESIGNER'S HANDBOOK," Edited by F. Langford Smith, B.Sc., B.E. | 7/6 | 8/1 |
| "THE WIRELESS WORLD DIARY AND REFERENCE BOOK FOR 1941" | 2/5½ | 2/7 |

Obtainable from Leading Booksellers and Railway Bookstalls or by post (remittance with order) from

ILIFFE & SONS LTD., Dorset House, Stamford Street, London, S.E.1

Unbiased

By FREE GRID

Patent Pending

NO doubt many of you, like myself, have often felt the need of the solace of radio during your lonely night patrols on A.R.P. duties. To the inexperienced the ordinary vest-pocket portable would at first seem the ideal solution, but I soon found out that this type of set in its accustomed form was no good. Needless to say, I got over the inconvenience of carrying the set in my hands by constructing a neat little pack which fits into the small of my back and is secured by means of a belt around my—pardon me, ladies—midriff. This, however, did nothing to get over the inconvenience of having to keep the frame aerial aligned on the station being received. Naturally, therefore, I immediately sat down and wrote off to *The Wireless World* technical department for a solution of the difficulty.

I received a somewhat cryptic reply referring me to the top of page 151 of the February 1940 issue. This rather nettled me, as in common with all my other valuables, I have long ago buried my back numbers of this journal in a deep hole in the garden. There was nothing else for it, however, and so I set to with pick and shovel, and, after a couple of hours of toil and sweat, I exhumed my copies of *The Wireless World* and turned eagerly to the page indicated.

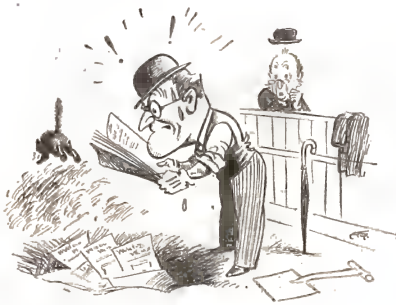

The evils of bad language.

I will draw a veil over the next few minutes, and merely state that on the same evening a tract pointing out the evils of bad language was thrust into my letter-box. Possibly, however, some of you will feel a little put out yourselves if, as is possible, you have just done two hours' hard labour excavating your own *Wireless Worlds* to see the cause of my annoyance.

After this contretemps there was of course nothing for it but for me to do

what I ought to have done in the first place, namely, use the brains with which nature has endowed me and think out the solution to my problem myself. I need hardly tell you that this course of action soon settled my difficulty. It was obvious, of course, that the frame aerial had to be abandoned in favour of an open aerial, but this got me no further, as I could not tow a barrage balloon behind me to support the aerial, and I was in a bit of a quandary until I suddenly remembered that I was carrying the ideal aerial on my head, namely, my tin hat.

It was but the work of a moment to fix a terminal to the brim and the job was done. As for an earth, all I had to do was to run a wire down the inside of my trouser leg and through a small hole bored through the sole of my boot, and thence to a soldered connection on one of the hob-nails. Even on dry earth results were good, but they were, I found, ten times better when I stood in a puddle of water.

"It's an Ill-wind—"

IT is extraordinary what a wide variety of trades and occupations there are in the world and how ignorant most of us are concerning the manner in which our next-door neighbour gets a living. For years past, when partaking of my evening pint at the village inn by which I live, I had noticed the same old faces evening after evening, year in and year out, but with the habitual reserve of the Englishman I had never actually spoken to any of their owners, as we have never been introduced. Indeed, had it not been for Adolf's myrmidons butting in on us with their habitual bonhomie I suppose we should have all been strangers still, but, after all, when you have fallen heavily on a man and upset a pint of beer down his neck, common decency demands that you enter into conversation with him. The result was that when we had finally disentangled ourselves, and used our tin hats to salvage some of the contents of the overturned barrels of XXX, we all fell a-talking together.

It was my good luck to be literally thrown into the arms of another habitué of the inn, whom I had for a long time past suspected of being con-

nected with the wireless industry owing to the intelligent look on his face. And so it proved to be, although in my wildest dreams I never suspected the fantastically unusual connection with wireless which he proved to have. He was, he told me, a professional watch demagnetiser.

It appears that in the early days of wireless when "leakage" of magnetic fields was considerable, and home construction was rife, casualties among wrist watches were extraordinarily high, owing to set builders constantly bringing their wrists into close



Salvaging the XXX.

proximity to moving coil loud speakers. As time went on, the amount of home construction grew less, and simultaneously the external field of the loud speakers grew less owing to improved design. The result was that watch casualties, and consequently the demagnetising trade, fell off considerably.

The thing which surprised me most about the whole business was to learn that it was possible to go up to the Clerkenwell Road district—the home of the clock-making industry—and buy a demagnetiser for home use. Needless to say, I took the first opportunity of going up there to see these things, and I was considerably surprised at what I was shown. The AC model consisted virtually of a large air-cored choke which plugged directly into the mains. The current is switched on, and the watch is placed in the centre of the core, and then slowly withdrawn. For people on DC mains, or on no mains at all, there were other models fitted with a natty little hand-generator to pump the necessary AC into the coil.

So the next time you pay for your watch to be demagnetised, you can dismiss from your minds all thoughts of a hard-working watchmaker sitting up until the small hours of the morning taking the watch to pieces and painstakingly demagnetising each separate component.

DECEMBER, 1940.

Recent Inventions

Brief descriptions of the more interesting radio devices and developments disclosed in Patent

Specifications will be included in these columns

TELEVISION AERIALS

IT is not always practical or convenient to erect a dipole aerial for receiving television programmes over and outside the roof of the house. Nor, except at close range, is it desirable or feasible to use an indoor aerial. It is accordingly proposed, by way of compromise, to erect the aerial so that it projects half-way through the roof, the inside limb being accommodated in the attic.

The dipole is supported by an insulator tile, which is made to resemble one of the ordinary roofing tiles, so that it is unobtrusive. The insulator tile is drilled at a slight angle so that the dipole projects vertically from the slope of the roof.

The same arrangement can also be used to carry a support for an aerial, or to take the downlead from it.

Kolster-Brandes, Ltd., and W. A. Beatty. Application date November 22nd, 1938. No. 521711.

TUNING BY REMOTE CONTROL

A LOCAL oscillator, situated at a point remote from the wireless set, is used to operate a relay associated with the set, thereby stopping a motor when the circuits are in tune with the desired station. The selection is made by varying the frequency of oscillations generated at the remote tuning point.

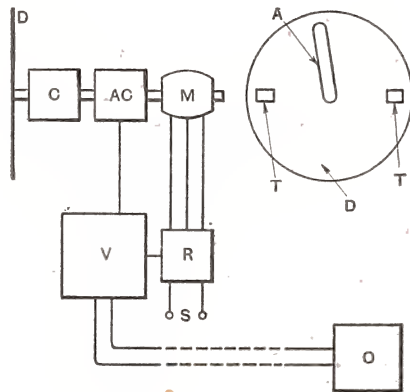

Motor-driven remote tuning control system.

As shown, a motor M drives an auxiliary condenser AC, the ordinary tuning condenser C, and a disc D, which (as shown separately) carries a contact arm A moving over fixed contacts T. The motor is connected to its supply terminals S through a switching relay R, which is also coupled to a valve relay V. The rotating contact arm is normally arranged to reverse the direction of the motor M when it reaches one or other of the contacts T.

When a frequency, corresponding to a selected station, reaches the valve relay V from the distant "control" oscillator O, the time comes when the auxiliary condenser AC brings the circuit of the relay V into tune with the control oscillations. As soon as this happens, the switching relay R is operated to break the supply and so stop the motor M. The condenser C will then have brought the receiver circuits into tune with the selected station.

In a more elaborate arrangement discriminator circuits are added to replace the reversing switches and apply a direct "homing" control to the motor M.

Kolster-Brandes, Ltd., and J. Arnold. Application date November 22nd, 1938. No. 521710.

VISUAL TUNING INDICATORS

RELATES to cathode-ray tuning indicators of the kind in which the resonance point is shown when a dark shadow or sector contracts to a narrow line on the fluorescent screen. It is found that, when handling strong signals, there is a tendency for the sector to contract to the full extent some time before the true tuning point is reached, so that the final adjustment is not clearly defined.

In order to overcome this difficulty, a second control electrode is mounted on the opposite side of the cathode to the first, and is connected to the latter by a resistance which holds it at a different potential. The differential effect of the two shadow-control electrodes ensures that the dark sector contracts gradually and continuously, right up to the final tuning point, even when the signals come from a powerful or near-by station.

The M.O. Valve Co. and C. W. Cosgrove. Application date November 30th, 1938. No. 521983.

AUTOMATIC DIRECTION FINDERS

SIGNALS received on an Adcock or frame aerial are combined through a radio-goniometer with those received on a vertical or non-directive aerial in the phase required to produce a cardioid or heart-shaped response curve, the major axis of which points directly towards the distant transmitter. The resulting voltages are then applied to a pair of push-pull amplifiers which are

connected, in turn, to the two field coils of an induction motor.

Owing to the shape of the cardioid curve, there will be only one direction of the frame aerial, relative to the distant transmitter, at which the currents supplied to the motor will balance out, and so maintain the motor at rest. For any other orientation of the DF aerial, the combined signal currents will drive the motor in one direction or other until it is brought to rest. In this position it will indicate the bearing of the distant transmitter both as regards direction and "sense." If desired, the motor can be used to rotate the frame aerial, so that it automatically points or "homes" on to the transmitter.

Standard Telephones and Cables, Ltd., and E. W. Braendle. Application date December 6th, 1938. No. 522129.

ULTRA-SHORT-WAVE GENERATORS

THE Figure shows the electrode arrangement of a valve of the magnetron type suitable for generating very short waves. The cathode or filament C is strung from supports S, S along the length of a tube T, which is made of insulating material. The tube is placed between the two pole pieces P, P1 of an external magnet, so that the field is axial. A number of bar "anodes" A, each half a wavelength long, are supported as shown by a central ring R connected to the high-tension supply.

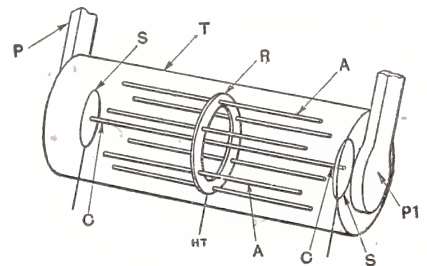

Magnetron used for USW generation.

When excited, the bars A oscillate electrically either to the fundamental half-wave, or to an odd harmonic of it, the potential at the ends of successive bars, taken in turn round the ring R, being in phase opposition.

The electrons from the cathode approach the bars obliquely, owing to the influence of the field from the external magnet, and are deflected from one bar to the next, as the phase changes from positive to negative, in such a way as to keep the whole system in sustained oscillation.

The energy radiated from the bars is collected by an outside loop or dipole,

The British abstracts published here are prepared with the permission of the Controller of H.M. Stationery Office, from specifications obtainable at the Patent Office, 25, Southampton Buildings, London, W.C.2, price 1/- each.

Recent Inventions—

placed close to the magnetron. Or the bars A may be coupled inside the tube, through a Lecher-wire system to an external transmitting aerial.

Standard Telephones and Cables, Ltd. (assignees of Le Matériel Téléphonique). Convention date (France) February 3rd, 1938. No. 522360.

RADIO LANDING-SYSTEM FOR AIRCRAFT

IN the so-called "leader-gear" type of installation, the boundary of an aerodrome; or the location of a landing field, is marked out in space by the fields of force which spread out inductively from cables fed with comparatively low-frequency currents. This aid to air navigation is to be distinguished from the production of a guiding course, or a blind landing path for aircraft, by the use of overlapping beams radiated on a comparatively short wavelength.

The invention is concerned with a system of the first-mentioned type designed to produce a landing beam of constant

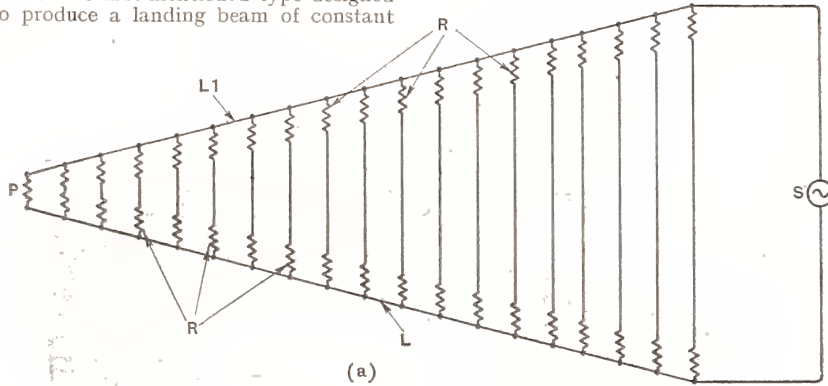

Use of buried cables for aircraft landing.

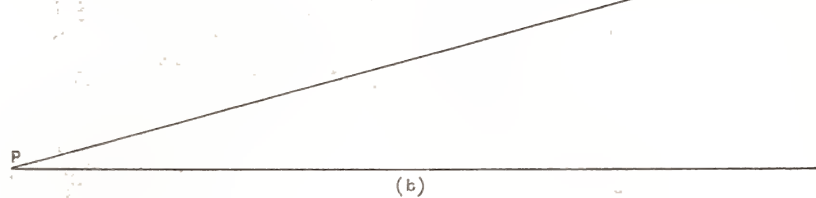

energy similar to that obtained in landing systems of the second type. As shown in plan in Fig (a), alternating current of, say, 500 cycles per second is fed from a source S into a network of buried cables, comprising two main lines L, L₁ which converge at the landing position P. The main lines are cross connected by a series of shunt lines with series resistances R, so that the inductive fields of force spreading from them progressively diminish in strength towards the landing position. As shown in elevation in Fig. (b), this produces a distribution of energy in the region above the cables, such that a pilot following a course of constant field strength would fly down the sloping line OP and reach the ground tangentially at P.

E. N. Dingley, Jr. Convention dates (U.S.A.) February 21st and March 21st, 1938. No. 522345.

BRIGHTER TELEVISION PICTURES

THE original effect of incident light on a photo-sensitive cathode is increased by causing the electrons liberated from that surface to follow a circular path along the axis of a ring-shaped tube until they strike against the back surface of the cathode.

Here they strike a coating of fluorescent material mounted on a semi-transparent layer of thin aluminium. Some of the light so produced passes through, on to the front surface, and so liberates a further supply of electrons from the photo-sensitive material.

In this way a regenerative action is applied, through the electron stream, to intensify the original effect of a light image focused from outside the tube on to the photo-electric side of the cathode.

The circular path of the electron stream is controlled, in part by a pair of positively charged anodes mounted inside the tube, and in part by an external magnetic winding, so as to ensure

all the electrons which go to make up the working stream had the same uniform velocity, the background of noise, or "shot," effect practically disappears, and the amplification could be pushed to a much higher level than is now feasible.

The inventors attain this object by subjecting the electrons emitted from the cathode to the action of an external magnetic field, so that those possessing the same initial velocity are deflected to the same extent, and so are able to pass through a "barrier" which stops all the others. A working stream of uniform velocity is thus made available.

Marconi's Wireless Telegraph Co., Ltd., and D. A. Bell. Application date December 13th, 1938. No. 522496.

o o o

FRAME AERIALS

THE turns of a frame aerial, particularly one used for direction finding, are wound on a flat spiral over a powdered-iron core, preferably in the shape of a toroidal ring. The arrangement is stated to reduce the electrostatic pick-up, thereby improving the signal-to-noise ratio. At the same time, for a given size of coil, the signal pick-up is improved and the "Q" factor increased. The powdered-iron core is also stated to increase the efficiency of the aerial when used as a transmitter.

Standard Telephones and Cables, Ltd. (communicated by W. J. Polydoroff). Application date December 13th, 1938. No. 522492.

o o o

A RADIO ALTIMETER

THE height of an aeroplane above ground is measured by transmitting a radio wave from the machine and comparing the phase of that wave, after it has been reflected back from the earth, with a locally generated wave of the same frequency. The phase difference is proportional to the total distance travelled during the outgoing and return journey of the reflected wave; in other words to twice the height of the machine. The outgoing wave is transmitted from an aerial mounted at the end of one wing of the plane, and the reflected wave is received by an aerial mounted at the opposite end of the other wing.

The indicating device is coupled to two detectors. One is fed by the reflected wave as picked up by the receiving aerial, and the other receives a fraction of the outgoing wave fed directly to it through a transmission line from the transmitter. The latter serves as a standard against which the reflected wave is compared, the resulting phase difference being recorded on a scale calibrated to show the corresponding altitude in feet. The receiving aerial is also connected to the transmitting aerial through a network which counterbalances any direct radiation from the transmitter.

Standard Telephones and Cables, Ltd. (assignees of A. Alford). Convention date (U.S.A.) December 10th, 1937. No. 522574.

that the image formed on the back of the cathode coincides exactly with that originally projected on its front surface.

H. G. Lubszynski. Application date December 20th, 1938. No. 522951.

o o o

AMPLIFIER VALVES

IN practice a limit is set to the amplification of a valve by the inherent "noise" due to the irregular emission of electrons from the cathode. This depends partly upon the absolute temperature at which the cathode is run, and partly upon the way in which the electron stream is divided between the anode and other positively biased electrodes inside the tube.

The essential fact is that the electrons are emitted from the cathode in more or less intermittent spurts or gushes, instead of in a steady stream. If, however,

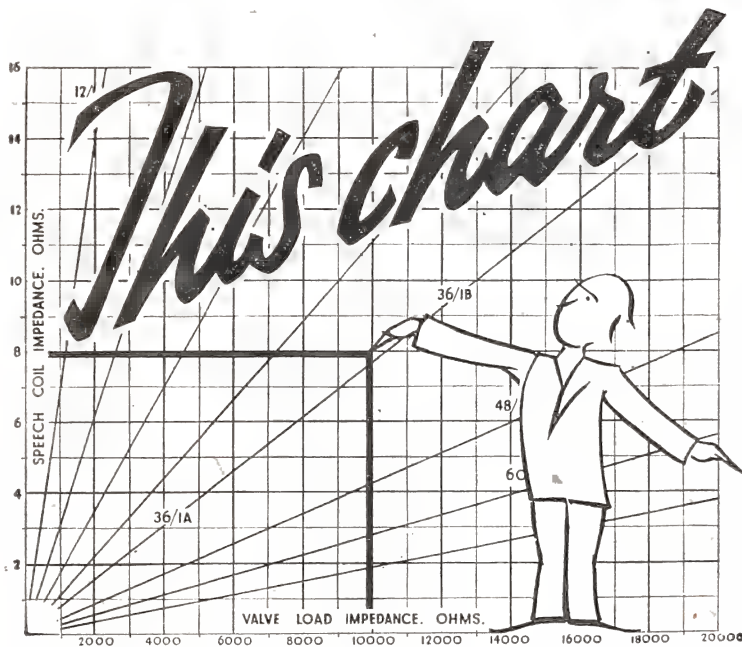

shows how

ONE
TRANSFORMER
meets All
REPLACEMENT
NEEDS



CORRECT MATCHING *Simplified*

Speech coil impedances may vary—valve loads may fall within a very wide range, yet, as this chart shows, you can always match up correctly with the ONE type Goodmans Transformer—the “101.” A typical example is shown. An 8 ohm coil to match a 10,000 ohm load . . . the correct ratio indicated is 36 : 1B. The tapping instructions provided with each transformer show the correct connections. It's as simple as that for any valve and coil combination. And because of the unique system of series and parallel winding, an exceptionally high degree of efficiency is attained almost irrespective of the tappings used. Send coupon for full description and chart with tapping instructions.

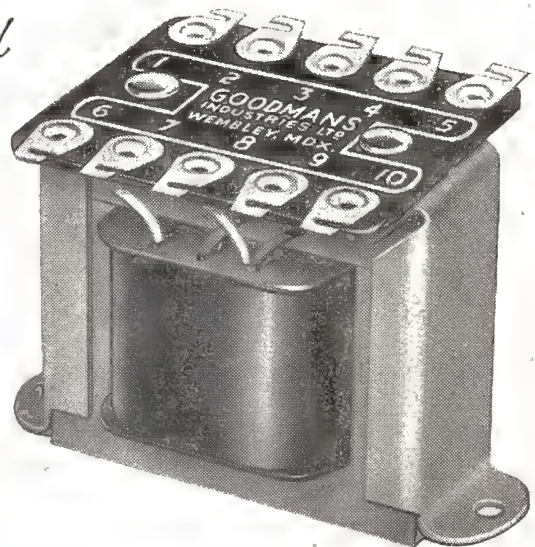

GOODMANS
101 MULTI-RANGE
REPLACEMENT

OUTPUT TRANSFORMER

GOODMANS INDUSTRIES, LTD.
Lancelot Road, Wembley, Middx. 'Phone : Wembley 4001 (5 lines).

For practically all output valves from 2,000 to 20,000 ohms (including Q.P.P., Class B and Push-Pull) and speech coils from 1 to 16 ohms.

RATIOS AVAILABLE :

| | | | |
|---------|---------|--------|--------|
| 12 : 1 | 18 : 1 | 24 : 1 | 30 : 1 |
| 36 : 1* | 48 : 1* | 60 : 1 | 72 : 1 |

(*Centre tapped).

LIST PRICE

6/3

Boxed complete with instructions

POST THIS COUPON to:—

GOODMANS INDUSTRIES LTD., Lancelot Rd., Wembley, Middx.
Please send me full particulars of GOODMANS “101” Multi-Range Replacement Output Transformer together with chart and tapping instructions.

W.W.1240

Please attach this to your card or letter heading.

Wireless World

CLASSIFIED ADVERTISEMENTS

THE CHARGE FOR ADVERTISEMENTS in these columns is 12 words or less, 3/- and 3d. for every additional word.

Each paragraph is charged separately and name and address must be counted.

SERIES DISCOUNTS are allowed to Trade Advertisers as follows on orders for consecutive insertions, provided a contract is placed in advance, and in the absence of fresh instructions the entire "copy" is repeated from the previous issue: 3 consecutive insertions, 5 per cent.; 6 consecutive, 10 per cent.; 12 consecutive, 15 per cent.

ADVERTISEMENTS for the January issue are accepted up to First Post on Tuesday, December 10th, at the Head Offices of "The Wireless World," Dorset House, Stamford Street, London, S.E.1, or one day earlier at the Branch Offices, 8-10, Corporation Street, Coventry; Guildhall Buildings, Navigation Street, Birmingham, 2; 260, Deansgate, Manchester, 3; 26a, Renfield Street, Glasgow, G.2.

Advertisements that arrive too late for a particular issue will automatically be inserted in the following issue unless accompanied by instructions to the contrary. All advertisements in this section are subject to prepayment.

Cheques and Postal Orders sent in payment for advertisements or deposits should be made payable to **ILIFFE & SONS Ltd.**, and crossed. Notes cannot be traced if lost in transit. They must therefore be regarded as being despatched at sender's risk. Alternatively, they may be sent per registered post.

All letters relating to advertisements should quote the number printed at the end of each advertisement and the date of the issue in which it appeared.

The proprietors are not responsible for clerical or printers' errors, although every care is taken to avoid mistakes. They also retain the right to refuse or withdraw advertisements at their discretion.

ARMSTRONG

DIFFICULT TIMES!

You know it and we know it! After many years of selling Armstrong Chassis and urging you to buy what we know to be good, circumstances beyond our control have compelled us, with the greatest reluctance, to decline many orders.

It can't be helped. Raw material is urgently needed by the Government for purposes far more important to us all than the making of Armstrong chassis, and like true Britons we must "grin and bear it."

To keep up a smiling philosophy in these strenuous times is essential, and if it means that we—you and us—have to suffer a bit in the process we must take it standing up and with cheerfulness.

A very limited number of the latest EXP48 chassis so favourably reviewed in the October issue of "The Wireless World" are still available to "W.W." readers. We are making the utmost effort to maintain a "skeleton" supply of our chassis and you can rest assured that whatever we supply will be of the same high quality.

We are fully aware of the obligations to the many thousands using Armstrong Chassis and even if we are unable to continue marketing these, a determined effort will be made to maintain our Service Department. In this way do we hope to retain your lasting Goodwill.

SPECIAL OVERSEAS MODEL EXP48
8-v. 4-BAND ALL-WAVE SUPERHET CHASSIS
 (13-160m. continuous & normal Broadcast bands)
6 Watts Push-Pull Output.

For the convenience of private advertisers, letters, other than circulars, etc., may be addressed to numbers at "The Wireless World" Office. When this is desired, the sum of 1/- to defray the cost of registration and to cover postage on replies must be added to the advertisement charge, which must include the words Box 000, c/o "The Wireless World." All replies should be addressed to the Box number shown in the advertisement, c/o "The Wireless World," Dorset House, Stamford Street, London, S.E.1. Remittances should not be sent through the post to Box Numbers.

DEPOSIT SYSTEM

Readers who hesitate to send money to advertisers in these columns may deal in perfect safety by availing themselves of our Deposit System. If the money be deposited with "The Wireless World," both parties are advised of its receipt. Notes and Money Orders save time. Cheques should be made payable to Iliffe & Sons Ltd., and are acknowledged to seller when "cleared."

The time allowed for decision is three days, counting from receipt of goods, after which period, if buyer decides not to retain goods, they must be returned to sender. If a sale is effected, buyer instructs us to remit amount to seller, but if not, seller instructs us to return amount to depositor. Carriage is paid by the buyer, but in the event of no sale, and subject to there being no different arrangement between buyer and seller, each pays carriage one way. The seller takes the risk of loss or damage in transit, for which we take no responsibility. Details of any arrangement made between parties which does not occur with any of the above conditions must be advised to us when the deposit is made. For all transactions whether a sale is effected or not a commission of 1 per cent. is charged on and deducted from the amount deposited (minimum charge 2/-). All deposit matters are dealt with by Iliffe & Sons Ltd., Dorset House, Stamford Street, London, S.E.1.

NEW RECEIVERS AND AMPLIFIERS

***CHALLENGER RADIO CORPORATION** announce their New Wartime Policy, "One Super Efficient Receiver a Year." Send 2½d. stamp for illustrated catalogue of this model. Also still available valves at competitive prices, and P.A. speakers.—Challenger Radio Corporation, 31, Craven Terrace, London, W.2. [9320]

£11/15 Only, usual price £22.—*Wireless World* 2 R.F. Receiver with push-pull quality amplifier, 10 valves, including tone control stage, 8 watts triode output, ideal for quality reproduction from radio and gramophone; limited number.—Bakers Selhurst Radio, 75, Sussex Rd., South Croydon. [9303]

RECEIVERS AND AMPLIFIERS SECOND-HAND, CLEARANCE, SURPLUS, ETC.

McCLURE A.F.C.5 R.F. Unit, 1940 model, unused; £6.—McKean, 150, Dorchester Avenue, Glasgow. [9288]

CROSLEY 1938-9 Table Model, £8/8; H.M.V. 907 All-wave Radio and Telesior. £25; Baird T50 telesior, £25; Marconi Table Model 346, £9/9.—A.O.S. Radio, 44, Widmore Rd., Bromley. [9317]

Wanted

WANTED, sensitive A.C./D.C. all-wave; full details.—Haynes, 42, Mayfield Rd., Dalston. [9311]

LEONARD BROOKS Wants Radio, any condition; spot, cash.—121, Becontree Av., Dagenham. [9310]

WANTED, Skyriver SX17 for Cash, full details; offers wanted for new SX23.—2, Church St., Evesham. [9318]

COMMUNICATION Receiver, Hallcrafters Skyriver Defiant, or equivalent.—Nahum, 13a, Ram Yard, Cambridge. [9292]

WANTED, H.M.V., R.G.D., Bush, Murphy or other well-known makes of new or second-hand sets and radiogram for cash, complete shop stocks bought.

FOR Sale or Exchange, three £20-volt A.C. Vactrio spin dry washers, pre-war list price £47.—Dugdale, Albert St., Hobden Bridge. Tel.: 247. [9307]

ARMSTRONG Company Service Department require several Second-hand Armstrong AW125PP Chassis, 1938-1939-1940 models; good cash prices offered.—Armstrong Manufacturing Co., Warlters Rd., Holloway, London, N.7. [9314]

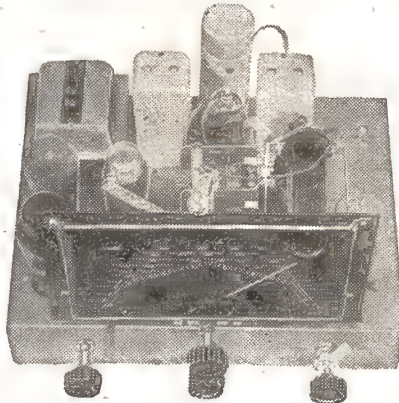

When reviewing this Model "The Wireless World" said they considered us far-sighted in providing "a really good output stage for high quality reception from the B.B.C. programmes." "The sensitivity is sufficient to ensure reliable reception from every worthwhile station" and they experienced "no difficulty in picking up American stations." Further points were "the reproduction is excellent, bass response is unrestricted and the general balance is just right." "The price clearly does not exploit any tendency of rising costs of materials and 8 gns. labour"

Send for illustrated specification.

With 8" P.P. Speaker **£9. 9. 0**

With 10" P.P. Speaker **£10. 3. 0**

Plus 4/6 for part cost of packing and carriage on all orders in the U.K.

TO OUR TRADE FRIENDS.

We have written to you explaining our supply difficulties and regret that for the time being we are unable to accept trade orders. This is a very reluctant decision to make in view of your many years of loyal support which we deeply appreciate. Should the position ease at a later date, we shall be only too happy to notify you immediately.

ARMSTRONG MANUFACTURING CO.
WALTERS RD., HOLLOWAY, LONDON, N.7, ENGLAND
 Phone: NORIA 3213.

RECEIVERS AND AMPLIFIERS SECOND-HAND, CLEARANCE, SURPLUS, ETC.

Wanted

MIDWEST (English make) 1939 Model, 6-waveband, 9 valves, 10in. speaker, jack for phones, output 9 watts.—Box 2547, c/o *The Wireless World*. [9312]

PUBLIC ADDRESS

VORTEXION P.A. Equipment

IMITATED, but unequalled.

WE Invite You to a Demonstration.

A.C.-20 15-20-watt Amplifier, 38-18,000 cycles, independent mike and gram., inputs and controls, 0.037 volts required to full load, output for 4, 7.5, and 15 ohms speakers, or to specification, inaudible hum level, ready for use; 8½ gns. complete.

C.P. 20 12-volt Battery and A.C. Mains Model, as used by R.A.F., output as above; 12 gns.

A.C.-20, in portable case, with Collard motor, Piezo pick-up, etc., £14; C.P.20 ditto, £17/17.

50-WATT Output 6L6s, under 60-watt conditions, with negative feed back, separate rectifiers for anode screen and bias, with better than 4% regulation level response, 20-25,000 cycles, excellent driver, driver transformer, and output transformer matching 2-30 ohms impedance electronic mixing for mike and pick-up, with tone control, complete with valve and plugs; £17/10.

COMPLETE in Case, with turntable, B.T.H. Piezo pick-up and shielded microphone transformer; £22/10.

80-WATT Model, with negative feed back; £25, complete.

120-WATT Model, with negative feed back; £40, complete.

250-VOLT 250 m.a. Full Wave Speaker, field supply unit; 25/-, with valve.

WE are Compelled Through Rising Costs to Increase our Prices by 10%.

ALL P.A. Accessories in Stock; trade supplied.

SEE Our Display Advertisement on page 507 (Edit.).

VORTEXION Ltd., 257, The Broadway, Wimbledon, S.W.19. Phone: Lib. 2814 [9232]

Ode
Partridge
No. 2

HOW?

How can we stop the evil growth
Of Nazi hate and horror?
How can we clip the Hunnish wings
And make a bright to-morrow?
How can we crush the sordid schemes
Hatched by a cunning mind?
How can we halt their bestial dreams
Of conquest, which twist and wind
Throughout the world in tortuous way,
And bring to all a happier day,

HOW?

One way is clear for all to see,
Cut out the needless spending,
For what you buy reduces stocks
And delays this great war's ending.
The smallest piece of metal rough
Has important work to do,
It helps to make a gun or plane
Which'll bring us smiling through.

THAT'S HOW!

For many years we've sold to you
Our Chokes and our Transformers,
Knowing well that you would find
They were the best performers.
But now we say "Unless you must,
Please forego that new replacement,"
Use what you have, search high and low
From attic to the basement.

We thank you for your loyal support
And if you really need us
You'll find us at your service still,
"Nunquam non paratus."

N. Partridge
B.Sc., A.M.I.E.E.

King's Bldgs., Dean Stanley St.,
LONDON S.W.1

Telephone: VICtoria 5035.

**ELECTRADIX BATTERY
CHARGER BARGAINS!!**

"NITNDAY" Metal Rectifiers—Steel Chassis

- Model N/A 2½, Radio Home Charger. To charge 2 volts, ½ amp. 12/6
- Model N/A 6½, Trickle Charger. To charge 6 volts, ½ amp. 17/6
- Model N/B6/1, Car Charger. To charge 6 volts, 1 amp. 24/-
- Model N/B6/1½, Car Charger. To charge 6 volts, 1½ amps. 27/6
- Model N/C6/2, Car Charger. To charge 6 volts, 2 amps. 37/-
- Model N/D 12/1, H.M. Car Charger. To charge 12 volts, 1 amp. 38/-
- Model N/D 12/2, N.K. Car Charger. To charge 12 volts, 2 amps. 55/-
- Model N/E 2, Doubler. Meter Car Charger. To charge 6 volts and 12 volts, 2 amps. 65/-

ALL MODELS FOR A.C. 200/250 VOLTS INPUT.

For further details or reply to enquiry; please send 2d. stamp and mention "The Wireless World." Thank you.

ELECTRADIX RADIOS
218, UPPER THAMES ST., LONDON, E.C.4

FOR SHORT-WAVE COMPONENTS

Communication Receivers for work of National importance; and all accessories for short-wave work and experiments. Call or write to

WEBB'S RADIO

14 SOHO ST., OXFORD ST., LONDON, W.1

NEW MAINS EQUIPMENT

VORTEXION Mains Transformers, chokes, etc., are supplied to G.P.O., B.B.C., L.P.T.B.; why not you?

WE are Compelled Through Rising Costs to Increase our Prices by 10%.

VORTEXION, Ltd., 257, The Broadway, Wimbledon, London, S.W.19. 'Phone: Lib. 2814. [9233

NEW LOUD-SPEAKERS

BAKERS Brand New Surplus Speaker Bargains.

EVERY Music Lover Interested in Realistic Reproduction should write for free descriptive leaflet now.

£4/17/6; usual price £10.—Brand new speaker, complete with beautifully finished cabinet in polished walnut.

£2/7/6; usual price £5.—Brand new super quality triple cone speaker, permanent magnet model; exceptional bargain; limited number.

SECURE One of These Exceptional Bargains Now.

BAKERS Triple Cone Conversions Will Immensely Improve Reproduction of Your Present Speaker. ("For a few shillings you have converted a speaker scheduled for the scrap heap into one worth pounds.—W. E. Darby, Grad., I.E.E.") Write for details.

BAKERS SELHURST RADIO, 75, Sussex Rd., Sth. Croymond. [9304

SECOND-HAND LOUD-SPEAKERS

SHOP Soiled 8in. Speakers, 2,500 ohm field with S Trans., 15/-; less Trans. 10/-; R-A 6½in. with Trans., 1,350 ohms, 15/-; Magnavox 66 less Trans., £2.—Ambrose, 19 Wellington St., Glasgow. [9285

Wanted

TWO 42in. P.A. Aluminium Horn Speakers, must be first class condition, also Taylor combined oscillator and oscillograph.—Lowest price to "Regal Radio," Atherstone, Warks. [9283

SHORT-WAVE EQUIPMENT

G5NI for Short Wave Equipment; largest stocks in the country; communication receivers; National agents; American and British Valves, etc. See advertisement on page 4—44, Holloway Head, Birmingham. [0531

"**H.A.C.'S**" Short-wave Receivers, famous for over eight years; latest model one-valve now available; complete kit of precision components, accessories, full instructions, requiring no soldering; only 16/- postage 6d.; illustrated catalogue free.—A. L. Bacchus, 109, Hartington Rd., S.W.8. [9322

CABINETS

A CABINET for Every Radio Purpose.

SURPLUS Cabinets (Undrilled) from Noted Make.

WE Have Hundreds in Stock (no Catalogues); send measurements of chassis, etc., and say what kind of cabinet required; stamp for reply.

INSPECTION Invited.

H. C. SMITH and Co., Ltd., 289, Edgware Rd., W.2. Tel: Pad. 5891. [0485

DYNAMOS, MOTORS, ETC.

ALL Types of Rotary Converters, electric motors, battery chargers, petrol-electric generator sets, etc., in stock, new and second-hand.

A.C. D.C. Conversion Units for Operating D.C. Receivers from A.C. Mains, 100 watts output, £2/10; 150 watts output, £3/10.

WARD, 46, Farringdon St., London, E.C.4. Tel.: Holborn 9703. [0518

GRAMOPHONE MOTORS

Wanted

SIMPSON'S Turntable and A.C.-D.C. Gram-motor and Turntable.—Box 2548, c/o The Wireless World. [9323

GARRARD RC2 or RC4 Auto-turntable and Pick-up, in new condition.—Trier, Woodlands, Kingston Hill, Surrey. [9319

RECORDING EQUIPMENT

AMERICAN Presto Junior Recorder, complete, as new, £42/10; 1940 V.G. Simplot recording amplifier, as new, £30; Permarec DT4 recording tracking head, £3/15.—A.C.S. Radio, 44, Widmore Rd., Bromley. [9316

ELECTRADIX BARGAINS

TESTERS. Field A.C. or D.C. Vest Pocket Tester, "Dix-Mipanta," bakelite case, 2½in. by 3in. No projecting terminals. Universal versatile high-grade moviron multi-range meter for service on A.C. or D.C. battery or mains. Three ranges of volts: 0-7.5 volts; 0-150 volts; 0-300 volts, 19/6 only.



SUPREME VALVE TESTER KIT. A.C./D.C. Volts, millamps and ohms. This service kit with fittings has moving coil meter, Range-switch on panel case with lid, 10in. by 8in. Incomplete set but new and ready for wiring, 45/-.

METERS for Switchboard and panel, all sizes and ranges, ENGINE-ELECTRIC SETS. ½ kW, 1 kW, 1½ kW and 4 kW from £13-10-0.

G.P.O. TYPE B TELEGRAPH RELAYS, with platinum points, 15/-; Silvertown Horizontal Galvos., two jewels, 5/-, post 6d. Other Relays as advertised last month.

Vertical needle G.P.O. teleg. Galvos., 4/6. Weston 2in. dial centre-zero ammeters, read 1 amp. to 15 amps., 5/-.

TAPPER KEYS for Morse Signal Transmission. Service Silent Practice Keys, 3/-; T.X. Practice Key, front contact, on black moulded base, a good small key, 3/6. Long Bar Type Practice Key, T.X.2, with cranked bar, 5/6. Superior model B2, with back contact, a well-finished key on polished wood base, 7/6. Operators' P.F. plated pivot bar and terminals, mahogany base, 9/6. Type I.V. Superior ditto, nickel-plated pivot bar and fittings, polished base, 10/6.



SERVICE KEYS. Ship and Army types, see list. Fullerphone double-acting Morse Key, solid brass on heavy base, 7/6. Three-colour light Switch Box with Morse key for code signals, 4/6. S.G. Brown totally enclosed type, 42/-.

LEARNERS' MORSE PRACTICE SET. Special Duplex with Key Buzzer and Lamp for sound and visual, 10/-.

BUZZERS, small type, with cover, 1/6. Power Buzzers, with screw contact and adjustable armature, 2/6. Heavy Buzzers, in Bakelite Case, 3/6. Siemens Morse Line Transmitters, with key and brass-cased Power Buzzer, 17/6.

PORTABLE FIELD PHONES FOR LISTENING POSTS, L.D.V. AND A.R.P. Leather-cased W.D. Type 135, Service Field Phones, soiled but serviceable and tested. In pigskin case, Morse key mike and phone.

EXCHANGES, Plug type, 5-line and 20-line. Wire and cables cheap.

TELEPHONES for all purposes. House, Shelter and Office.

L.R. SOLO PHONES. The extra receiver you want. For use with buzzer Morse. Single Earpiece, 40 ohms, metal hook loop; with cord, 1/3. Ditto, D3, 60 ohms, with cord, 1/6. W.E. 1,000 ohms with cord, 2/-, 2,000 ohms Earpiece, with cord, 2/6.

HIGH RESISTANCE AND RADIO PHONES. The finest always in the adjustable Browns A Reed Phone, aluminium swivel, headband, 4,000 ohms, 35/6. 1,800 ohms, 21/6. 120 ohms, 17/6. Cords, 1/9.

Various Makes. Second-hand Headphones, in good order, 2,000 ohms and 4,000 ohms, 5/-, 6/6, with cords.



MORSE RECORDERS. Ex W.D. Standard G.P.O. Work direct on line or through relay on radio, mahogany base drawer contains reel. All in good order, £7 10s. Lightweight folding portable Field Type in wood carrying case, £7. Super Type W.D. Field Recorder, totally enclosed, with indicator, Morse key, etc., unused, £3. Tape, 7d.

MORSE, Paper Tape for Morse, green or white, 6d. reel. Brass Tape Reels in mahogany case, 2/6. Wheatstone Strip Hand Performers, 15/-.

COMPASSES. W.D., Marching Compass, jewelled course setter, etc. Mahogany case, 3in. x 3in. x 1in., 10/-; W.D. Prismatic, Mariners 6in. Binnacle Boat Compass, portable, gimbal bases, etc., 45/-; Kelvin Ship Compass, pattern 14, liquid type, Mahogany case, 10in. x 10in. x 7in., 60/-; Plain lin. pocket compass, 1/-.

PHOTO-CELLS. ENERGY FROM LIGHT. RCA vacuum response, 50 micro-amps. per lumen, 25/-; Mov. Coil Micro-relay to work photo-cell output, panel type, 80/-; Westons, 70/-; 50 watt 10 v. exciter lamps, 7/6. X-Ray Tubes, brand new, 7in. bulbs, 15/-; for callers only. 6-volt 2-way relays, 5/-; Over 1,000 relays of all types in stock. **PHOTO-CELL UNITS,** Self-generating Barrier-Layer type, selenium-metal as used in Photometers and exposure meters, 21/-; Read Temperature at a Distance, 2½in. dial meter ether element and connection, 6ft. to 10ft. long. Car engine, radiator processes, etc., 7/6.

A.C. ELECTRO-MAGNETS for 230 volts 30 mA. holds 14 ozs., 2/6. D.C. to lift 10 lbs., 5/6.

DYNAMO BARGAIN. 100 volts, ½ amp. D.C. Shunt ball bearing Croymond dynamo, 15 lbs., 6in. x 6in., 10/6.

EMERGENCY PARCELS of useful experimental electrical and radio repair material and apparatus, 10 lbs. for 6/-. Post paid.

Stamped envelope must be enclosed for Free Bargain List "W" or for replies to enquiries.

ELECTRADIX RADIOS
218 Upper Thames Street, London, E.C.4

Telephone: Central 4611.

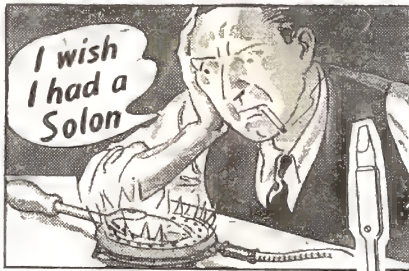

The SOLON saves time & trouble

No waiting for re-heating with the Solon! Once hot (and that takes only 4 minutes) it stays hot! 15 hours continuous soldering uses only 1 unit. That's why Solon Electric Soldering is better, neater, stronger, and far easier. Get a Solon and do the job properly!

Made for the following standard voltages:—200/220, 230/250.



Handyman model supplied complete with Resin-Cored Solder, Flex and Lamp Adaptor **9/4**
Solon Resin-Cored Solder **6p.** per reel.

W. T. HENLEY'S TELEGRAPH WORKS CO. LTD.
(Dept. 22/E), Engineering Sales Dept., Gravesend, Kent.

Miles in front!

A Candler trained operator now serving in the R.A.F. says:—

"... I should like to thank both yourself and the company for the great start which I obtained through taking your Junior Code Course. The experience which I gained from that, has kept me 'miles in front' of others who relied on obsolete means of learning code."

CANDLER CODE COURSE

There is a Candler Code Course for beginners and also for those who desire to increase their w.p.m. speeds.

There's no royal road to learning—but there IS a quick sure way to genuine CODE skill. Thousands of Candler Trained Operators, including many in the Services, have proved the value of this truly remarkable system of Code instruction.

In the "BOOK OF FACTS," which will be sent FREE on request, full information is given concerning the subjects covered by all Candler Courses.

Terms: cash or monthly payments.

COUPON

Please send me a Free Copy of Candler "Book of Facts."

NAME

ADDRESS

Post Coupon in 1d. unsealed envelope to London Manager.

CANDLER SYSTEM CO.
121, Kingsway, London, W.C.2.
Candler System Co., Asheville, North Carolina, U.S.A.

VALVES

ALL Types of American Tubes in Stock of Impex and Arcturus makes at competitive prices.

WE Can Also Supply a Full Range of Guaranteed Replacement Valves for Any British non-ring, American or Continental type at an appreciably lower price.

SEND for Lists of These, and also electrolytic condensers, line cords, resistances, etc.

CHAS. F. WARD, 46, Farringdon St., London, E.C.4. Tel.: Holborn 9703. [0452]

METROPOLITAN RADIO SERVICE.—American Valves, in all types, trade supplied.—1021, Finchley Rd., N.W.11. Speedwell 3000. [0436]

FOLLOWING at 10/—Raytheon RK11, Taylor T20, TZ20, 756, 866JR, Hytron 25, 51A, 60, 615, RCA802, 1851, 1852, Deforest 802, Radiocoin 866. Following at 30/—Taylor T55, Hytron 57, Western Electric 516A, 242A, w/socket, Deforest 800, Dumont 2in. cathode ray tube, 24xH w/socket, R.C.A. photocells 918 and 866, exciters, 75 watts, 5/—Ambrose, 19, Wellington St., Glasgow. [9286]

Wanted

OSTER-GANZ Valves, all types.—Wall, 5, Grantham Row, Navenby, Lincs. [9309]

METERS, ETC.

Wanted

FERRANTI 2½in. Flush 1 m.a., Moving Coil Meter.—Box 2546, c/o The Wireless World. [9308]

TEST EQUIPMENT

RADIO City D.C. Tester, 10 ranges, used, 50/-; Radio City A.C.-D.C. multimeter and analyser, 500 microamps-2½ amps., 5 volts-1,000 V., 40 meg., 6 ranges, 300 mfd., 5 ranges, used, £8/10, A.C. operated.—Ambrose, 19, Wellington St., Glasgow. [9284]

Wanted

3 or 4in. Electrostatic C.R.T., preferably hard type.—Write 21, Bath St., Werneth, Oldham. [9298]

COMPONENTS

SECOND-HAND, CLEARANCE, SURPLUS, ETC.

PREMIER RADIO.

PLEASE See Our Displayed Advertisement on page 5. [0488]

SOUTHERN RADIO'S Wireless Bargains.

ALL Goods Previously Advertised Still Available.

SOUTHERN RADIO, 46, Lisle St., London, W.C. Gerrard 6653. [9238]

L.T. Metal Rectifiers, 12v. 1 amp., 3/6; "All dry" valves, types 1.A.7, 1.N.5, 1.H.5, 1.C.5, 3/9.—Champion, 42 Howitt Rd., London, N.W.3. [9313]

VAUXHALL.—Rola 8in. P.M. speakers, 14/9; Rola G12 P.M. speakers, 69/6; Rola energised 8in. 1,500 ohm speakers, 12/6; all with transformers.

VAUXHALL.—Gramophone pick-ups, 11/- and 18/9; Nictel 3½-1 L.F. transformers, 5/9; Bar-type 2-gang 0.0005 mfd. straight condensers, 6/6.

VAUXHALL.—Skeleton H.T.10 rectifiers, 11/-; volume controls, 2/-, with switch 3/-; flat sheet copper, 12in. x 12in. 4/-, 18in. x 12in. 7/-.

VAUXHALL.—Iron-cored tuning coils on base, terminals, switch, 3-gang, 19/6; electrolytic condensers, 8 mfd. 500v. 2/-, 8+8 mfd. 500v. 3/6; Polar slow motion 0.0002 mfd. 3.W. condensers, 4/-.

VAUXHALL UTILITIES, 163a, Strand, London, W.C.2. Postage extra orders under 3/-; 1d. stamp for list. [9280]

5/- Only.—Bargain parcel comprising speaker cabinet, drilled steel chassis, and many other useful components; worth 35/-; limited number; postage 1/-.—Bakers Selhurst Radio, 75, Sussex Rd., South Croydon. [9305]

ONE A.C.-D.C. Generator Unit, new; 1 Clough Brengle oscillator; 1 gramophone motor, second-hand; 1 Collaro record changer, new; 1 Rola 12in. speaker, new; Ostar-Ganz high voltage valves; 500 assorted resistances; 1 Avometer; to be sold for best offer.—Eugen Forbat, 8, Charing Cross Rd., W.C.2. [9297]

COULPHONE RADIO, New Longton, Preston.—Prompt personal service; brand new goods only; Tungram valves, American valves 5/9, Octal 6/9; lowest prices for best service goods; B.I. condensers, Erie, Dubilier 1-watt resistors; Centralab volume controls; Rola G12 speakers; energised 1,250 and 2,500 ohms, with transformer, 55/-; all the latest models, G.E.C., Decca, R.G.D., Ferguson, K.B., tax free; stamp for list. [9306]

Masteradio —MALLORY

VIBRAPACKS
PERFECT PORTABLE POWER

British-made Vibrator Power Supply Units employing the **WORLD-FAMOUS "MALLORY" VIBRATORS**

OUTPUTS of up to 30 watts from either 6 volt or 12 volt battery supply.
EFFICIENCY as high as 70% including rectification.

LIFE. Masteradio-Mallory Vibrators mean longer life. Longer life means **LOWEST COST PER HOUR ACTUAL USE.**

DEPENDABILITY. In Masteradio-Mallory Vibrapacks the Vibrator is working under ideal conditions, thus ensuring utmost dependability.

Used by the War Office, Air Ministry, G.P.O.

Let our Technical Dept. solve your portable power problems. Write for details:

MASTERADIO Ltd.

(Dept. W. W.) Vibrant Works,
RICKMANSWORTH ROAD,
WATFORD, HERTS.

*Grams: Mastiola, Watford. *Phone: Watford 9885.

GREENWOOD

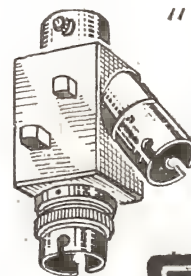

"SAFWAYS" ADAPTORS

The modern dual purpose fitment for radio or other domestic electrical appliances.

Plugs into any lampholder.

CLIX

British Mechanical Productions Ltd.
1, Church Rd., Leatherhead, Surrey

WARD WE MANUFACTURE:

ROTARY CONVERTERS DC/AC for operating P.A. amplifiers, Radio Receivers, etc.
DC/DC ROTARY TRANSFORMERS, SMALL ALTERNATORS, SMALL DC MOTORS, H.T. GENERATORS, MAINS TRANSFORMERS up to 10 k.v.a. **PETROL ELECTRIC** generator sets up to 50 k.v.a.

BATTERY CHARGERS for private and industrial use

We can also handle general small engineering work.
Full details of any of the above upon request

CHAS. F. WARD
46, FARRINGTON ST., LONDON, E.C.4
Telephone: Holborn 9703.
Works: Bow, E.

**COMPONENTS—SECOND-HAND,
CLEARANCE, SURPLUS, ETC.**

RADIO CLEARANCE, Ltd.

OWING to . . . Damage, have taken new premises at 95, High Holborn, W.C.1, where all orders will be executed with our usual promptness.

ALL-WAVE Superhet Chassis, 5-valve A.C. latest Mullard valves, T.H.4B, V.P.4B, T.D.D.4, Pen. A4, L.W. 4350V.; ranges: short wave, 16-48 metres; medium-wave 200-560 metres; long wave 800-2,200 metres. Size of chassis: 14 1/2 in. long, 7 1/2 in. deep; height overall 8 1/2 in. Controls: tuning at side, volume on/off at side, wave-change, provision for pick-up, complete with valves and knobs; £4/7/6 each.

2-VOLT Output Pentode Valves, 5- or 4-pin, side terminal, unboxed; 2/11 each

LISSEN 2-V. Screen-grid Valves, S.G.2V.; 4/6 each.

LISSEN 2V. Battery Pentodes, 4-pin, side terminals, P.T.2A.; 4/11 each.

LISSEN Rectifier Valve, U650; 2/11 each.

ULTRA Short and Short Wave Choque, Lissen Hi-Q., inductance 100 microhenries, boxed, list 2/-; our price 1/- each.

ULTRA Short and Short Wave Double Wound Low-resistance Choque, Lissen Hi-Q., resistance less than 0.05 ohms, boxed, list 2/6 each; our price 1/3 each.

LOW-LOSS Ceramic Valve Holders, Lissen High-Q., baseboard and chassis, 7-pin; 1/- each.

MANSBRIDGE Type Condensers, Lissen Hi-Q. 250 D.C. working, moulded case with feet, 1 mfd.; 6d. each.

LOW-LOSS Short Wave Variable Condensers, Ceramic insulation, brass vanes, Lissen Hi-Q., minimum capacity 5 microfarads, two types, boxed, with knobs, 160 mmdf., list 7/6; our price 3/- each; 20 mmdf., list 5/6; our price 2/6 each.

ROTARY Coil Units, Lissen Hi-Q., 4-band, from 4.8 to 91 metres, can be selected by turn of knob, with circuit, boxed, list 15/6; our price 6/11 each.

PUSH-PULL Switches, Lissen, 2-point, 4d. each; 3-point, 6d. each.

YAXLEY Type Switches, 4-pole, 3-way; 9d. each.

AMERICAN-Line Cords, with fittings; 3/6 each.

ROLA P.M. Speakers, latest model, 7 1/2 in. cone, with power and pentode transformer, boxed; 15/- each.

MAGNAVOX 10 in Energised Speaker, field resistance 3,000 ohms, with transformer; 12/6 each.

CLOCK-FACED Dials, 5 in. x 3 1/2 in., with printed 3-wave scale, and escutcheon; 2/6 each.

MAIN S Transformer, G.E.C., American windings, 350-0-350V., 65 m.a., 6.3V., 2.5 amps., suitable for replacements in G.E.C. models; 6/6 each.

MAIN S Transformers, Wearite, R.C.1., 250-0-250V., 80 m.a. 4V., 2.5 amps., 4V. 4 amps.; 9/11 each.

R.C.2. 350-0-350V., 120 m.a., 4V., 2.5 amps., 4V. 4 amps.; 12/6 each.

R.C.3. 350-0-350V., 150 m.a., 4V., 2.5 amps., 4V. 2 amps., 4V., 5 amps.; 15/- each.

R.C.4. 500-0-500V., 150 m.a., 4V., 2 amps., 4V., 2 amps., 4V., 2.5 amps., 4V. 5.6 amps.; 21/- each.

R.C.5 100-watt Auto Transformer, 100-110V., 200-250V.; reversible; 12/6 each.

ALL Above Transformers 200-250V. Tapped Primaries.

R.C.D. Drop Through Type Capped, 350V./350V., 100 m.a., 5V. 2 amps., 6.3V. 5 amps; 10/6 each.

CHASSIS Mounting Valve Holders, American, 4-5-6-7-pin, 4d. each; Octals, 6d. each; Octals, 10d. each.

VALVE Holders, Celestion, 5- and 7-pin, chassis type, 4d. each; baseboard type, 5-pin, 2d. each.

VOLUME Controls, Centralab, spindles, length 2 1/2 in., with switch, 100,000, 250,000, 500,000, 1 meg.; 2/11 each.

VOLUME Controls, C.T.S., wire-wound, 5-watt, 1,000 and 10,000 ohms only; 2/6 each.

ROTHERMEL Junior Model Piezo Electric Pick-up, with rest, brand new, boxed; 21/- each.

PRESS-BUTTON Units, size of unit 6 in. x 6 in. x 2 in., complete with six press buttons and capacitors; 4/11 each.

SPEAKER Cabinets, suitable for 8 in. speaker; 4/6 each.

SET Cabinets, various sizes; callers only; 4/- each.

RESISTANCES, 1/2-watt, 3/4-1/2 and 1 meg. only; 1/6 doz.

DROPPING Resistances, for all purposes, total resistance 535 ohms, 5 taps in steps of 50 ohms, standard for Pye, Lissen Ever Ready, etc.; 3/- each.

(This advertisement continued in column three.)

GALPINS

ELECTRICAL STORES
**75, LEE HIGH ROAD, LEWISHAM,
LONDON, S.E.13**

Telephone: LEE GREEN 5240
Terms: Cash with Order

ELECTRIC LIGHT CHECK METERS, small, late type well-known makers, in good condition, electrically guaranteed for 200/250 volts 50 cy. 1 phase A.C. mains. 5 amp. type, 6/-; 10 amp, 7/6; 20 amp, 9/- each. Post 1/- on all types.

"CRYPTO" SHUNT WOUND DYNAMO, 30 volts 10 amps., 1,900 r.p.m., in good condition, 65/-, carriage forward.

JOHNSON & PHILLIPS 8 in. DIAL 0 to 500 VOLT METER (Hot Wire), first grade, in new condition, 30/- each.

"CROSSLEY" APPROX. 1 H.P. GAS ENGINE, tube ignition, in good condition, 65/-, carriage forward.

D.C. ELECTRIC LIGHT CHECK METERS, 200/250 volts 5 and 10 amps., 4/6 each, post 1/- (in new condition).

VOLTAGE CHANGER TRANSFORMER, 2,000 watts, 110 to 200/240 volts or vice versa. Price 95/-, Guaranteed 12 months.

PHILIPS HIGH VOLTAGE CONDENSERS. Infid. at 4,000 volt working, 5/6 each, carriage paid.

REGULATORS, STARTERS AND LARGE DIMMER RESISTANCES. Stud Switch-arm type. Please state requirements.

SWITCHBOARD VOLT AND AMP METERS MOVING COIL AND MOVING IRON. All first-class makers. Please state requirements.

TEN LINE CORDLESS TELEPHONE PORTABLE EXCHANGE BOARD, complete with calling generator in new condition, £6/10/-, carriage forward.

EX R.A.F. GLASS ACCUMULATOR TANKS, 5x5x8 in., new and unused, 3/6 each, post 1/-.

EX R.A.F. SWITCH PANEL, with case (new), fitted 6 small knife switches, leads, cords and cleats, complete in wood case, 2/6 each, post 6d.

EX R.A.F. AEROPLANE DYNAMOS, for accumulator charging, 12 volt 8 amp., 1,750 r.p.m., 10/- each, carriage 2/6.

EX R.A.F. NEW NEGCO MOTOR BLOWER, 100 volt motor, shunt wound, 1,800 r.p.m., ball bearing, fitted to Cyclone fan, 4 1/2 in. inlet 5 in. outlet, massive aluminium casing 1 1/2 in. dia., new and unused, 55/- each, carriage 4/-.

SMALL ELECTRIC ROTARY CONVERTOR, 110 volts D.C. input, 10 volts at 30 amps. output. Useful for garage charging, 55/-, carriage forward.

D.C. MOTOR BLOWERS, 2 in. inlet and outlet. Aluminium body, laminated field, ideal for dug-out ventilation. 100 volt, 25/-.

CRYPTO SHUNT WOUND DYNAMO, 12/18 volts, 8/10 amps., 2,200 r.p.m., in new condition, 37/6, carriage forward

X-RAY TUBES by well-known makers, 7 in. bulb Tungsten Targets, 15/- each, carriage forward.

CROMPTON, self-exciting 50/100 cycle ALTERNATOR, 70 volts 500 watts, £3/10/-, carriage forward.

HIGH-VOLTAGE TRANSFORMERS useful for all test work, or television. Input 200/240 volts, output 5,000 and 7,000 volts, 6/6 each, post 1/-.

VOLTAGE CHANGING TRANSFORMERS (Auto Wound), 100/110 to 200/240 v., or vice versa, fully guaranteed. 250 watts, 25/-; 500 watts, 35/-; 1,000 watts, 60/-; 2,500 watts, 110/-.

DUG-OUT LAMPS, Ex R.A.F., solid brass construction, glass dome, complete with 12-volt bulb (any bulb can be fitted), wall fitting, 3/- each, post 6d.; Ditto, wing type, as new, 2/6, post 6d.

DUG-OUT LAMPS, Ex R.A.F., porthole type, or can be bracket fitted, glass dome, three colour fitting, white, red or green, solid brass construction, 6 in. dia., complete with bulb; any size bulb can be fitted to above lamps. Price 5/-, post 6d.

OSRAM 100 volt 15 watt pearl lamps, 8d. each, or 7/- per doz.

1 KW. TRANSFORMER, 100 v. input at 100 cycles, output 1,000 volts centre tapped, price 30/-, carriage forward.

EX R.A.F. AUTOMATIC CHARGING CUT OUTS AND VOLTAGE REGULATORS, to suit any dynamo up to 20 volts at 15 amps., fully adjustable, wiring instructions, complete in metal case, price 2/6, post 6d.

MANGIN LENSES, convex, 4 1/2 in. dia., new, 5/- each.

DOUGLAS ENGINE, 2 1/2 h.p., special air cooling, twin, on all bedplate, portable, complete with petrol tanks and in perfect working order, suitable for pumping, lighting, etc., price £10.

**COMPONENTS—SECOND-HAND,
CLEARANCE, SURPLUS, ETC.**

(This advertisement continued from first column.)

B.I. Wire-end Bias Electrolytics, 50 mfd. 12V.; 1/8 each.

TUBULARS, wire-end, non-inductive paper condensers, all sizes up to 0.1; 5d. each, 4/9 dozen.

B.I. 8x8 mfd., 550V. working, cardboard electrolytics, 376 each; ditto, 16x8 mfd., 4/6 each; ditto 8 mfd. tubulars, 2/- each; ditto 4 mfd.-tubulars, 1/9 each; ditto 8 mfd. Cans, 2/11 each.

HUNT'S Cardboard Wire-ends, 8 mfd. x 8 mfd. x 8 mfd., 450V. working, 2 negatives, 3/11 each; ditto 16x8 mfd., 350V. working, 3/3 each.

CONDENSERS, 0.0005, twin 1/3 each; triple, 1/9 each.

LISSEN Mica Condensers, our assortment; 1/3 doz.

TUBULAR CONDENSERS, our assortment; 2/- dozen.

RAYTHEON First Grade Valves, largest stockists, all types in stock, including glass series, glass Octal series, metal series, Bantam series, single-ended metal series, and resistance tubes, all at most competitive prices. Send for lists.

ALL Orders Must Include Sufficient Postage to Cover. Hours of business: Week-days 9 a.m.-4 p.m. Saturdays 9 a.m.-1 p.m.

PLEASE Write Your Address in Block Letters.

WE Cannot Undertake to Answer Enquiries Unless Full Postage included (2 1/2d.).

RADIO CLEARANCE, Ltd., 95, High Holborn, London, W.C.1. [9291]

G. A. RYALL, "Arnehuft," Marsh Lane, Taplow, Bucks (late Ryalls Radio of London), offers radio goods, all new, unless otherwise stated. Post free. Minimum orders 1/3, please.

ROLA 10 in., 2,000 ohm Energised Speakers, pentode transformers, with over 1 1/2 yards 3-way rubber cable with 5-pin plug, with 4-prong winder, in portable rexine carrying case, leather handle, brown finish, nickel plated corners. Note, speaker aperture is 8 in. only, made for Pathe cine outfit, in original wrappings, size 1 1/2 square, 7 1/2 in. deep; 17/9 each.

SPEAKER Only, as above, 9/6; cable and plug only, as above, 2/9; case with cable holder, as above, 7/9.

AMPLIFIER Chassis Complete, ex the Pathescope cine outfit, contains the two mains transformers as above, two Huuns 8 mfd. 500V. Mansbridge 2x1 mfd., pair low voltage cathode condensers, group board with resistances as above, Toggle switch, T.C.C. 0.01, two Erie resistances, 5-pin socket for speaker, fully wired, with mains leads and double adaptor, flat pancake-type chassis (SG as LF valve, pentode output, rectifier), gram. input socket, three valve holders, less valves; 18/6 the lot, carriage paid.

MAINS Transformers, made by Standard Telephones for Pathe amplifier, input 110-250V. A.C. outputs 350-0-350V. 120 ma., 4v. 2 1/2 amp., 4v. 4-5a., special heavy primary, used as 250w. Auto trans. for other items below; can be used as 300w. auto transformer, drop through type size, 5 1/4 x 4 3/4 x 2 1/2 in. deep; 10/9 each, used, as new.

A.C. Induction Motors, fitted with fan-cooling, 1,500 revs, one-tenth horse power, 110v., for use with above transformer, supplied 8 mfd. paper block condenser, as used motors fitted 4-pin plug; 14/9, used, as new.

A.C. Transformer, input 110v., for use with above transformer, secondaries 10v. and 2v. at 5 amps and 8 amps; 4/9.

HUNT'S 8 mfd. Wet or Dry Type Electrolytics, 500v. peak, upright aini cans, used, good condition, 1/6 each; Mansbridge blocks, for chassis mounting, 2 mfd. x 1 mfd., 400v working, 1/3.

TWIN Mains Leads, 25/36, in single rubber container, double vulcanised leads, 13ft. with 2-pin to bayonet adaptor; 1/6 each.

SIX-WAY Group Boards, with insulation sheet, for mounting, complete with 6 resistances, 1,200 1/2 w., 500 1w., 4,700 2w., 1,200 1w., 10,000 3w., 100,000 1/2 w.; 1/6 each.

R.C.C. Units on Small Paxolin Panel, comprise T.C.C. 0.01 mica condenser, 0.15 non-inductive tubular, 2 meg and 4 meg, 1/2-watt resistances; two for 1/6.

CELESTION Speakers, 600 ohm field with push-pull transformer, with 5-pin plug, 10 in. cone, 9/6; Celestion 1,000 ohm speaker, with push-pull transformer with 5-pin U.S.A. plug, 10/6; Celestion 700 ohm speakers, with pentode transformers, heavy magnet type, 10/6; all above have 10 in. cones.

CELESTION 10 in. Speakers, less transformers, with 4-pin Octal plug, fields 1,500 ohms, special curved (exponential type) cones, good bass response; 7/9 each; all have normal speech coils about 2 ohms.

(This advertisement continued on next page.)

FRED'S RADIO CABIN

has
HUGE STOCKS
of
MODERN RADIO COMPONENTS
and
SERVICE SPARES

- Line Cords, 2-way 2/6
- Condensers, 50 mfd., 12-v. working 1/-
- Push Back wire per coil 6d.
- 18ft. Power Cable per length 2/9
- Pilot Bulbs, 6-v. 3 amp. Bayonet 6d.

"EKCO 75" REPLACEMENTS

- Tapped L.T. Resistances 3/6
- 12 Assorted Volume Controls 1/-
- per doz. 3/-
- L.F. Mains Chokes, 350 ohms, 60 m.a. 4/6
- Twin Mains H.F. Chokes 2/6

MORSE CODE OSCILLATOR UNITS—1-VALVE

Complete with batteries, in case.
With 7 variable tones. Each 15/-

- Morse Code keys 2/6
- Rubber Grummetts per doz. 1/-

VALVES • RESISTANCES • ETC.

Please allow for postage.
Packing free.

Hundreds of other bargains for callers

at

FRED'S RADIO CABIN
75, NEWINGTON BUTTS,
ELEPHANT & CASTLE, S.E. 11

Phone: RODney 2180

Branch at

1, The Parade, Highfield Rd., Shepperton

SEE OUR ADVERTISEMENT NEXT MONTH

COMPONENTS—SECOND-HAND, CLEARANCE, SURPLUS, ETC.

(This advertisement continued from previous page.)

MAGNAVOX 152 Speakers, less transformers, 1,000, 2,250, 3,000 ohm, 7/9 each; Magnavox 1,000 ohm special type with ringed cone, less transformer, 8/9 each; Magnavox type III oval (elliptical), less transformers, 800 ohm heavy magnets, 6/9; 660 ohm ditto; all above are 10in. speakers, mostly rated to handle 8 watts, all are new oddments purchased from Messrs. Celestion, and are used normally in various commercial sets and radiograms.

NOTE.—All above speakers are energised types, and not permanent magnet, of which we have none to offer at present, and are not suitable for use as extension speakers, unless suitably energised.

BLOCKS Containing Two Large Capacity Mansbridge Condensers, low voltage for cathode bypass, inverted chassis type; 1/6 each.

AMERICAN Valves, sets three, 2-volt American bases, 1A4 VM/HFP, 1B4 HFP, 2101 ½-watt output Pentode; 6/6 the set of three; suit Philco sets.

SPECIAL Offer Europa Valves, AC/L, for power grid detector, and first stages amplifier, impedance 7,000 ohms, 2/3 each; AC/HP 5-pin with earth pin at side for metal screening, a fine 8G detector or HF valve, 2/3 each; both are 4-volt lamp valves with British bases.

SPECIAL Note.—We are obliged for the many letters of sympathy we have received from customers in connection with our recent difficulties caused by enemy action at our London address. We are now confining our business to mail orders, and shall be able to give prompt attention from a quiet situation.—G. A. Ryall, "Arnehurst", Marsh Lane, Taplow, Bucks. [9300]

Wanted

AUTO Changer, any make, state condition.—Ambrose, 19, Wellington St., Glasgow. [9287]

JACKSON Allwave Battery Unit, and suitable IF transformers.—5, Uppingham Rd., Wallasey. [9293]

WE Buy Used Radio Receivers, chassis, amplifiers, test meters, converters, speakers, etc., radio and electrical accessories; spot cash paid.—Phone Ger. 4447. [9296]

REPAIRS AND SERVICE

EPOCH. Epoch. Époque.—Genuine replacement diaphragms for every model.—"R.E.C.S.", Crown St., Reading. Phone: 2796, day or night. [9301]

GUARANTEED Repairs, any transformers, choke, motor armature, converter, dynamo, etc.; keenest prices, immediate quotation, prompt, dependable service.—See below.

L.T.P. (LONDON TRANSFORMER PRODUCTS, Ltd.), Willesden, N.W.10. Willesden 6486 (3 lines). [9227]

MAINS Transformer Service, repairs, rewinds, or construction to specification of any type, competitive prices and prompt service.—Sturdy Electric Co., Dipton, Newcastle-on-Tyne. [0516]

"SERVICE with a Smile."—Repairers of all types of British and American receivers; coil rewinds; American valves, spares, line cords.—F.R.I., Ltd., 22, Howland St., W.1. Museum 5675. [8934]

METROPOLITAN RADIO SERVICE.—Guaranteed repairs to American and British receivers; American valves, condensers, volume controls, linecord resistances, Majestic I.F. transformers, and rewinds, trade supplied.—1021, Finchley Rd., N.W.11. Speedwell 3000. [0435]

SERVICE With a Guarantee.—Let Challenger overhaul your radio and bring it up to date for the winter; low prices, best workmanship; 3 months' guarantee card given with every job; all replacements; valves 6/- each.—Challenger Radio Corporation, 31, Craven Terrace, London, W.2. [9321]

TUITION

RADIO Training.—P.M.G. exams, and I.E.E. Diploma; prospectus free.—Technical College, Hull. [0611]

MORSE Code Courses.—"Book of Facts," free.—Candler System Co. (Room 55 WO), 121, Kingsway, London, W.C.2. [9074]

WIRELESS Officers.—Short courses of training for young men for marine and air services.—Marine School, South Shields. [9166]

PRACTICAL Postal Courses, radio, television, test equipment design, trade-test coaching for R.A.F. post, I.P.R.E. and I.W.T. exams; booklet free.—Secretary, I.P.R.E., 3, Shirley Rd., London, W.4. [6838]

RADIO Engineering, Television and Wireless Telegraphy; comprehensive postal courses of instruction.—Apply British School of Telegraphy, Ltd., 179, Clapham Rd., London, S.W.9 (Estd. 1906). Also instruction at school in wireless for H.M. Merchant Navy and R.A.F. [9249]



FOR THE RADIO SERVICE MAN, DEALER AND OWNER

The man who enrolls for an I. C. S. Radio Course learns radio thoroughly, completely, practically. When he earns his diploma, he will KNOW radio. We are not content merely to teach the principles of radio, we want to show our students how to apply that training in practical, every-day, radio service work. We train them to be successful!

INTERNATIONAL CORRESPONDENCE SCHOOLS

Dept. 38, International Buildings, Kingsway, London, W.C.2.

Please explain fully about your instruction in the subject marked X.

Complete Radio Engineering
Radio Service Engineers

Elementary Radio Television

If you wish to pass a Radio examination, indicate it below.

Inst. of Wireless Technology

P.M.G. Certificate for Wireless Operators

Provisional Certificate in Radio Telegraphy and

Telegraphy for Aircraft

City and Guilds Telecommunications

Name..... Age.....

Address

(Use penny stamp on unsealed envelope.)

Introducing

RADIO RECEIVER SERVICING

By E. M. Squire

Radio service engineers and dealers have now got their ideal handbook. It is handy and concise and gives readers a sound knowledge of receiver operation and equipment in the briefest time. It will help in the initial training stages and will be of indispensable assistance later on. Practical is the word to describe this book. Lose no time wading through unnecessary theory that will not assist you to do the job. Get this book that almost does the job for you! Illustrated. Send for it (post free, 6/4) from 39, Parker Street, Kingsway, W.C.2.

PITMAN



Mains Transformers to customers' own specifications, or in accordance with our standard list—of which we would be glad to send you a copy.

W. BRYAN SAVAGELTD.
Westmoreland Rd., London, N.W.9. Phone: Colindale 7131

SITUATIONS VACANT

AIR MINISTRY.

DIRECTORATE of Signals.

APPLICATIONS are invited for Appointments as Civilian W/T Operators at Certain Air Ministry W/T Stations. These appointments are of a temporary nature in the first instance, but it may be possible to absorb a proportion of temporary posts into the permanent establishment after conclusion of hostilities.

APPLICANTS, who should be between the ages of 21 and 45 years at the date of making application, should preferably possess the 1st Class Postmaster-General's Certificate or the Air Operator's Certificate in Wireless Telegraphy and have had experience in radiotelephony, direction finding and maintenance work.

SALARY is at the Rate of 75/- a Week for the First Two Years, thereafter rising by annual increments for approved service to a maximum of 125/- a week. In addition, a temporary war bonus of 5/- a week will be paid.

THE Normal Hours of Duty are 45 a Week, exclusive of meal times, day or night, or 180 in periods of four weeks.

ARRANGEMENTS Will be Made for Suitable Candidates to be Interviewed at Renfrew, Manchester, London or Bristol.

REQUESTS by Postcard for Forms of Application Should be Addressed to the Under-Secretary of State, Air Ministry (S.1.e), Julian Rd., Bristol, 9, and should state the town at which an interview is desired. [9256]

RADIO Service Engineer, experienced, all makes, exempt military service and able drive car.—Particulars and wages to Star Radio, 35, Old Church Rd., Chingford, E.4. [9294]

SERVICE Engineer Wanted, over military age, or exempt from service.—Apply by letter, giving age and experience, to Electro Radio Co., 68, High St., Plumstead, S.E.18. [9290]

VACANCIES Exist for Civilian Wireless Instructors at the Electrical and Wireless Schools, Royal Air Force, at a rate of pay of £5/2/6 a week, rising by annual increments of 2/6 a week to a maximum of £5/10 a week.

CANDIDATES Must be Capable of Lecturing and Must have a Sound Knowledge of Electrical Principles and their Application to Radio and Low-power Electrical Engineering.

APPLICATIONS Should be Addressed to the Under Secretary of State, Air Ministry (S.S.D.), Dept. J.K., London, W.C.2, giving full particulars as to previous experience, age, etc.

CANDIDATES, who must be over 30 years of age, will be required to appear before a Selection Board at the schools for interview and test; but may be re-imbursed the cost of third class locomotion expenses for this purpose. The test will include the giving of a lecture on any subject which may be chosen by the candidate involving the principles of modern radio. Lecturing sequence and style are most important. [9155]

RADIO Service Engineer, experienced, and exempt military service preferred; write, stating age, experience, wage required, enclose copies references; congenial well-equipped workshop area, considered safe.—Chattell, Murphy Dealer, 40, High St. North, Dunstable, Bedfordshire. Phone: 340. [9299]

ARMSTRONG Company Have Staff Vacancy for a Young Man who has Completed, or is completing a recognised course covering radio service work; rapid advancement and congenial working conditions offered to suitable applicant.—Armstrong Manufacturing Co., Writers Rd., Holloway, London, N.7. Phone: North 3213. [9315]

VACANCIES Exist for Civilian Morse and Procedure Instructors at the Electrical and Wireless Schools, Royal Air Force, at an initial rate of pay of £4/12/6 per week, rising by annual increments of 2/6 a week to a maximum of £5/2/6 per week. Candidates must be able to send and receive Morse at not less than 25 w.p.m. and should have had experience of lecturing and teaching, but consideration will be given to others who consider themselves capable.

APPLICATIONS Should be Addressed to the Under Secretary of State, Air Ministry (S.S.D.), London, W.C.2, giving full particulars as to previous experience, age, etc.

CANDIDATES Will be Required to Appear Before a Selection Board at the Schools for Interview and Test, but may be reimbursed the cost of third-class locomotion expenses for this purpose. [9154]

SITUATIONS WANTED

RADIO Engineer, knowledge technical drawing, etc., requires progressive post; exempt; car owner.—Box 2545, c/o The Wireless World. [9295]

ORDER FREE OF PURCHASE TAX NOW!

DELIVERY FROM STOCK. NEW SUPPLIES WILL BE 25% HIGHER.

Don't miss this outstanding opportunity to secure Radio and Electrical goods at prices which cannot be repeated. The Purchase Tax becomes payable on all new deliveries, so by thinking ahead and ordering now you save from 25% to 33% plus the increase due to ever-rising costs of raw materials. EASY TERMS QUOTED ON REQUEST.

Choose your Christmas Gifts from the following list. It will save you money!

RADIO RECEIVERS, &c.

| | |
|---------------------------------------|---------|
| MULLARD MODEL MBS 23— | £ s. d. |
| 5-valve all-wave battery Superhet ... | 9 5 0 |
| MULLARD MAS-90— | |
| 4-valve all-wave Superhet. A.C. ... | 9 5 0 |
| COSSOR 46 AC/DC— | |
| 5-valve Superhet all-wave ... | 10 8 0 |
| COSSOR 31— | |
| Battery 4-valve all-wave Superhet ... | 8 2 0 |
| W.B. all-wave Superhet. AC ... | 11 0 0 |
| VIDOR all-dry ARP receiver 320 ... | 7 7 0 |
| EVER READY all-dry Superhet ... | 8 0 0 |
| ULTRA Model 70 ... | 9 19 6 |

| | |
|---|---------|
| LOUDSPEAKER UNITS: | £ s. d. |
| Goodmans PM. 10in. ... | 3 10 0 |
| Sound Sales 11in. PM ... | 5 10 0 |
| Magnavox 8in. mains energ. ... | 1 10 0 |
| Rola 10in. mains energ. ... | 1 10 0 |
| Celestion 10in. PM ... | 1 12 6 |
| Celestion 8in. PM ... | 1 10 0 |
| Sound Sales 12in. mains energ. Super Auditorium ... | 11 11 0 |
| Energising Unit for above ... | 6 0 0 |
| W.B. LOUDSPEAKER UNITS (Junior model) ... | 1 15 6 |
| GARRARD RADIOGRAM UNIT with Pick-up ... | 4 4 0 |

Part carr. 2/- extra on receivers. HEYBERD MODEL A 0-5 Battery Charger, Westinghouse 2-12 volts at 2 amps. ... 5 0 0 Post and Packing Charges: 8" Units, 1/6. Larger Sizes, 3/-. S.S. Auditorium, 5/- for case.

DOMESTIC ELECTRICAL GOODS

| | |
|--|---------|
| MORPHY RICHARDS IRONS, Auto-control Safety Model, post 1/- | £ s. d. |
| ... 1 5 0 | |
| MORPHY RICHARDS FIRES— | |
| Tubular Major, 1 KW ... | 1 7 6 |
| Tubular Twin Beam, 1 or 2 KW ... | 1 16 0 |
| Cray Twin Beam, 1 or 1 1/2 KW ... | 1 1 0 |
| Senior Twin Beam, 1 or 2 KW ... | 1 7 6 |
| MARY ANN DOUBLE-WAY AUTO IRONS, AC model ... | 1 10 0 |
| Universal AC/DC ... | 1 12 6 |
| ORMOND HAIR DRYER, State voltage and include 1/- carr. with order. | 1 12 6 |
| MARY ANN UPRIGHT VACUUM CLEANERS ... | 8 8 0 |

| | |
|---|---------|
| ACME "LION" WRINGERS, 16in. ... | £ s. d. |
| ... 2 7 6 | |
| STUART-TURNER AC/DC CENTRIFUGAL PUMPS: | |
| No. 10, 100 gals. per hour ... | 4 10 0 |
| No. 11, Pumps 280 gals. per hour ... | 5 12 0 |
| Foot valve and strainer 12/6 and 15/- extra (when water has to be lifted over 15ft.). | |
| First-class construction. Ideal for A.R.P. Shelters. | |
| LIONEL ELECTRIC TRAIN SETS, High-grade models ... | 4 4 0 |
| Details upon request. Goods or Passenger sets. | |
| QUALCAST "PANTHER" 12in. Roller Mower and grass box ... | 3 0 3 |
| (Price will be considerably higher next spring.) | |

CLOCKS • WATCHES • DRY SHAVERS

| | |
|---|---------|
| SMITH'S ELECTRIC CLOCKS | £ s. d. |
| Walnut, of pleasing design ... | 1 17 6 |
| Alarm ... | 1 10 0 |
| WESTMINSTER CHIMES CLOCKS | |
| With high-grade movements, 8-day, guaranteed Walnut cases ... | 3 0 0 |
| TRIPLE CHIMES CLOCKS | |
| A few only are available at ... | 3 12 6 |
| Postage 1/- extra. | |
| GENTS' HIGH-GRADE 15 JEWEL CHROME WATCHES, Swiss movement (wrist) ... | 1 15 0 |
| GENTS' FLAT POCKET DRESS WATCHES, CHROME, Same quality movement ... | 1 15 0 |

| | |
|--|---------|
| LADIES' HIGH-GRADE 15-JEWEL SWISS MOVEMENT WRIST WATCHES, CHROME ... | £ s. d. |
| ... 1 15 0 | |
| LADIES' MINIATURE, same movement as above quality, Chrome ... | 2 7 6 |
| A few Gents' and Ladies' watches in 9CT gold also available. (Write for complete watch and clock list.) Watches sent on 7 days' approval against cash. | |
| VICEROY NON-ELECTRIC SHAVERS (made by Rolls Razors, Ltd.). A welcome present for the Services. | 2 10 0 |
| REMINGTON RAND AC ELECTRIC SHAVERS ... | 2 15 0 |

Please send 2d. stamp for illustrated price lists of any item. All orders dealt with by return. Terms: Cash with order or C.O.D.

LONDON RADIO SUPPLY COMPANY

Established 1925 at 11, Oat Lane, London, E.C.2. All communications to evacuation address—

"WINDEN," ARDINGLY ROAD, BALCOMBE, SUSSEX.

VALVES—American and British types—large stocks carried.

Send Trade-card (and 2d. stamp) for Price-lists and Comparative Charts, to:

LEONARD HEYS, 36, Henry Street, Blackpool, Lancs. (Established 1922.)

THE INSTITUTE OF WIRELESS TECHNOLOGY
(Founded in 1925. Incorporated 1932)

PROFESSIONAL MEMBERSHIP
The advantages of professional membership are open to all qualified wireless engineers. Full information with syllabus, may be obtained from the Assistant Secretary, Institute of Wireless Technology, 25, Firs Drive, Palmers Green, London, N.13. Phone: PALMERS GREEN 2413

A COUSTICAL AMPLIFIERS

IF YOU WANT

- 30 watts Quality Output
- from A.C. Mains or 12-v. Car Battery
- for Mobile Patrol,
- Music for your workers or
- for A.R.P. purposes

OUR MODEL C25 will fill your need.

Write for full Specification and Circuit.

The ACOUSTICAL MANUFACTURING CO.
Electro-Acoustic Engineers,
201-205, Lever Street, City Road, London, E.C.1.
CLERKENWELL 5821.

MORSE EQUIPMENT

FULL Range of Transmitting Keys, practice sets, oscillators, recorders and other radio Telegraph apparatus, designed and manufactured by R. R. McElroy, world champion telegraphist. Sole distributors, Webb's Radio, 14, Soho Street, London, W.1. Phone: Gerrard 2089. [8768]

PATENT AND TRADE MARK AGENTS

GEE and Co. (H. T. P. Gee, Mem. R.S.G.B. etc.), 51-52, Chancery Lane, London, W.C.2. Hoborn 4547-8. Handbook free. [0001]

TECHNICAL TRAINING

GREAT Possibilities Exist for Technically Qualified Engineers, key men in wartime and afterwards. Through the home-study courses of The T.I.G.B. take a recognised engineering qualification such as A.M.I.Mech.E., A.M.I.E.E., A.M.I.R.E., A.F.R.Ae.S., A.M.I.Chem.E., C. and G., etc., in which examinations the T.I.G.B. students have gained 25 FIRST PLACES. Write to-day for "The Engineer's Guide to Success"—Free—containing the world's widest choice of engineering courses covering all branches, including Aeronautical, Mechanical, Electrical, Wireless, Chemical, etc.

THE TECHNOLOGICAL INSTITUTE OF GREAT BRITAIN, 82, Temple Bar House, London, E.C.4. [9289]

THE COIL PICKUP

This instrument is now made with a special head to reproduce hill and dale cuttings.

Details on application.

Delivery of Standard models, 10 days.

Order now for Xmas.

H. H. JONES,

62, Worcester Street, STOURBRIDGE



ENGINEERING OPPORTUNITIES

This unique Handbook shows the easy way to secure A. M. I. C. E., A. M. I. Mech. E., A. M. I. E. E., A. M. I. A. E., A. M. I. W. T., A. M. I. R. E. and similar qualifications. WE GUARANTEE—"NO PASS—NO FEE." Details are given of over 150 Diploma Courses in all branches of Civil, Mech., Elec., Motor, Aero, Radio, Television and Production Engineering, Draughtsmanship, Tracing, Inspection, Building, Government Employment, etc. Write for this enlightening Handbook to-day. FREE and post free.

Men with Radio knowledge can obtain attractive posts in the Services.
BRITISH INSTITUTE OF ENGINEERING TECHNOLOGY, 387 Shakespeare House, 17, 18, 19 Stratford Place, London, W.1

BUSINESSES AND PROPERTY FOR SALE, TO BE LET, OR WANTED

"THE Wireless and Electrical Trader" is an essential part of the equipment of every Wireless Trader; its pages reflect the very latest turn of trade events, and it is read by all the leading dealers and manufacturers, for particulars of businesses offered or wanted. By subscription, to the trade only, 17/6 per annum, post free.—Send your trade card for specimen copy to Dorset House, Stamford St., London, S.E.1. [0614]

VACUUM CLEANERS

HOOVERS. Hoovers. Hoovers from £10/10; Hot-points, Tellus, Electrolux and Goblins. from £3/3; all rebuilt as new.—"R.E.C.S.," Crown St., Reading. Phone: 2796. Generous allowance for old Hoovers. [9302]

BOOKS, INSTRUCTIONS, ETC.

A MATEUR Radio Handbook—Second Edition Now on Sale, 328 pages. Price 4/2.—Radio Society of Great Britain, 16, Ashridge Gardens, London, N.13. [9252]

WEBB'S Radio Map of the World Enables You to Locate Any Station Heard. Size 40in. by 30in. 2-colour heavy art paper, 4/6, post 6d. Limited supply on linen, 10/6, post 6d. Webb's Radio Globe, superb 12in. full-colour model. Radio prefixes, zones, etc. Heavy oxidised mount. Post paid, 27/6.—Webb's Radio, 14, Soho St., London, W.1. Phone: Gerrard 2089. [8767]

"WIRELESS Direction Finding." By R. Keen, B.Eng. (Hons.), Sheffield, A.M.I.E.E. Third Edition. Covers the latest developments, including medium- and short-wave Adcock systems and deals with Beacon Transmitters, Aircraft Approach and Blind Landing processes. There are also detailed descriptions of Commercial Shore, Ship and Aircraft Installation. Price 25/- net. By post 25/9, from Iliffe and Sons Ltd., Dorset House, Stamford Street, London, S.E.1.

EVERY Radio Dealer Who is Not a Regular Reader of "The Wireless and Electrical Trader" should send his trade card at once for a specimen copy and full details of the "Trader" Services. "The Wireless and Electrical Trader" has the widest influence, and is read by all the leading manufacturers and traders. Trade only, 17/6 per annum, post free. Published at Dorset House, Stamford St., London, S.E.1. [0615]

"RADIO Laboratory Handbook." By M. G. Scroggie, B.Sc., A.M.I.E.E. The only practical handbook on the subject. Gives the serious wireless worker complete information about laboratory equipment, the necessary instruments and correct methods of operation. Price 8/6 net. By post 9/1, from Iliffe and Sons Ltd., Dorset House, Stamford Street, London, S.E.1.

"RADIO Data Charts." By R. T. Beatty, M.A., B.E., D.Sc. Second edition. A series of Abacs providing most of the essential data required in receiver design and enabling problems to be solved without having recourse to complicated mathematical formulae. Price 4/6 net. By post 4/11, from Iliffe and Sons Ltd., Dorset House, Stamford St., London, S.E.1.

BOOKS, INSTRUCTIONS, ETC.

"HANDBOOK of Technical Instruction for Wireless Telegraphists." By H. M. Dowsett, M.I.E.E., F.Inst.P., M.Inst.R.E. Sixth Edition. A standard handbook for wireless operators containing a complete theoretical course for students anxious to qualify for the Postmaster-General's Certificate of Proficiency. Price 21/- net. By post 21/9, from Iliffe and Sons Ltd., Dorset House, Stamford Street, London, S.E.1.

"TELEVISION Receiving Equipment." By W. T. Cocking, A.M.I.E.E. A new handbook containing information for everyone interested in cathode-ray receiving equipment. The complete vision and sound receiver is described and the treatment throughout is substantially non-mathematical. Price 7/6 net. By post 8/-, from Iliffe and Sons Ltd., Dorset House, Stamford Street, London, S.E.1.

"ELEMENTARY Principles of Wireless Telegraphy and Telephony." By R. D. Banguay. Revised by O. F. Brown, B.Sc. Third edition (1930). The standard textbook for wireless students and beginners. Deals with the whole subject of wireless telegraphy and telephony, avoiding too technical a treatment of the problems involved. Well illustrated. Price 7/6 net. By post 8/1, from Iliffe and Sons Ltd., Dorset House, Stamford Street, London, S.E.1.

"FOUNDATIONS of Wireless." By A. L. M. Sowerby, M.Sc. Second Edition. An elementary textbook of receivers. Deals fully with the construction of wireless sets, valves, and the process of detection. Price 5/- net. By post 5/6, from Iliffe and Sons Ltd., Dorset House, Stamford Street, London, S.E.1.

TRIX SOUND REPRODUCERS
RELIABLE AMPLIFICATION
The TRIX ELECTRICAL COMPANY LTD.
65, Bolsover St., London, W.1. Euston 5471

CLASSIFIED ADVERTISEMENTS
intended for the
JANUARY ISSUE
can be accepted up to
Friday, December 6th

INDEX TO ADVERTISEMENTS

| | PAGE | | PAGE | | PAGE |
|---|--------------|--|-------------------|--|-------------------|
| Acoustical Mfg. Co. | 17 | Fred's Radio Cabin | 16 | Premier Radio Co. | 5 |
| Armstrong Manufacturing Co. | 12 | Galpin's Electrical Stores | 15 | Radio Clearance | Classified p. 15 |
| Automatic Coil Winder & Electrical Equipment Co., Ltd. | 1 | Goodmans Industries, Ltd. | 11 | Ryall, G. A. | Classified p. 15 |
| Birmingham Radiomart G5NI | 4 | Henleys, W. T., Telegraph Works Co., Ltd. | 14 | Savage, W. Bryan, Ltd. | 16 |
| British Institute of Engineering Technology | 18 | Heys, Leonard | 17 | Simmonds Aeroproducts, Ltd. | 3 |
| British Insulated Cables, Ltd. | | Institute of Wireless Technology | 17 | Steatite & Porcelain Products, Ltd. .. | 7 |
| Inside Back Cover | | International Correspondence Schools | 16 | Stratton & Co. | 8 |
| British Mechanical Productions, Ltd. | 14 | Jones, H. H. | 18 | Taylor Elecl. Instruments, Ltd. | 4 |
| British Rola, Ltd. | 2 | Lockwood & Co. | Inside Back Cover | Telegraph Condenser Co., Ltd. Back Cover | |
| Bulgin, A. F., & Co., Ltd. .. Edit. p. | 505 | London Radio Supply Co. | 17 | Trix Electrical Co., Ltd. (The) | 18 |
| Candler System Co. | 14 | Masteradio, Ltd. | 14 | United Insulator Co., Ltd. | |
| Electradix Radios, Ltd. | 13 | McClure, John, Ltd. | 2 | Inside Front Cover | |
| Erie Resistor, Ltd. | 4 | M.R. Supplies | 6 | Voigt Patents, Ltd. | Inside Back Cover |
| Erskine Laboratories, Ltd. | | Murphy Radio, Ltd. | 10 | Vortexion, Ltd. | |
| Inside Back Cover | | Partridge, N. | 13 | Edit. p. 507 & Classified Ad. p. 12 | |
| Fitton, R. N., Ltd. | 6 | Peto-Scott Co., Ltd. | 9 | Ward, C. F. | 14 |
| Fluxite, Ltd. | Edit. p. 503 | Pitman, Sir Isaac, & Sons, Ltd. | 16 | Webb's Radio | 13 |
| | | Player's Cigarettes | Inside Back Cover | Westinghouse Brake & Signal Co., Ltd. | 2 |
| | | | | Whiteley Electrical Radio Co., Ltd. | 4 |

Printed in England for the Publishers, ILIFFE AND STAMFORD STREET, LONDON, S.E.1. "The Wireless World" can be obtained abroad from the following: AUSTRALIA: Gordon & Gotch, Ltd., Melbourne (Victoria), Sydney (N.S.W.), Brisbane (Queensland), Adelaide (S.A.), Perth (W.A.), and Launceston (Tasmania). NEW ZEALAND: Gordon & Gotch, Ltd., Wellington. AUCKLAND, CHRISTCHURCH and DUNEDIN: INDIA: A. H. Wheeler & Co., Bombay, Allahabad and Calcutta. CANADA: Imperial News Co., Toronto, Winnipeg and Vancouver; Benjamin News Co., Montreal; GORDON & GOTCH, LTD., TORONTO. SOUTH AFRICA: Central News Agency, Ltd.; Wm. Dawson & Sons (S.A.), Ltd., Cape Town. UNITED STATES: The International News Co., New York.

B.I.

RADIO MATERIALS

We have had a long experience in the manufacture of all kinds of Cables and Wires, Aluminium Sheets and Strips, Static Condensers, Insulators and Iron Work, Telephone Cords and Copper Earthing Rods, for Radio use.



Regd. Trade Mark.

BRITISH INSULATED CABLES LTD
CABLE MAKERS AND ELECTRICAL ENGINEERS
Head Office :
PRESCOT, LANCS. Tel. No. PRESCOT 6571

THE NEW ERSKINE McMURDO 15-17 RECEIVER

Chassis price complete with valves and speaker - - 50 gns.

15 valves (including four duplex valves).
R.F. stage on all bands.
POLYSTYRENE COIL FORMERS.
SILVER-PLATED COPPER TUBE COILS.
10-2,000 metres coverage.
Variable selectivity.
Distortionless negative feedback detector.
15 watts push-pull output with negative feedback.
15" loudspeaker.
Beat frequency oscillator.
Inter-station noise suppression.

We are confident that the amazing performance of this new receiver will astonish even the most experienced enthusiast.

May we send you details now.

ERSKINE LABORATORIES LTD.
PROSPECT WORKS, NORTH STREET,
SCALBY, SCARBOROUGH.
Tel. : Scalby 83.

-Enjoy the long evenings-
WITH



The VOIGT MOVING COIL PICK-UP

Output 50 m.v. Price 26. VOIGT PATENTS LTD. Phone: SYDenham 6666
Delivery ... 8-10 weeks. The Courts, Siiverdale, S.E.26. Reg. Off.: 22 Castle St., E.C.1

Lockwood

CABINETS

ACOUSTICALLY DESIGNED

SPECIALISTS IN CABINETS FOR THE HOME
INSTRUMENT CASES in Wood, Metal and Fabric
We shall be pleased to quote for Work of National importance

Send 2½d. in Stamps for
STANDARD DETAILS

LOCKWOOD & CO.
65, LOWLANDS ROAD, HARROW, MDX. Byron 1818

Keep that happy expression



In good times or bad, wherever you are, keep to that happy expression "Player's Please." The cigarette which makes happy expressions everywhere.

*Player's
Please*



PLAYER'S NAVY CUT CIGARETTES. MEDIUM OR MILD.
PLAIN OR CORK TIPS.

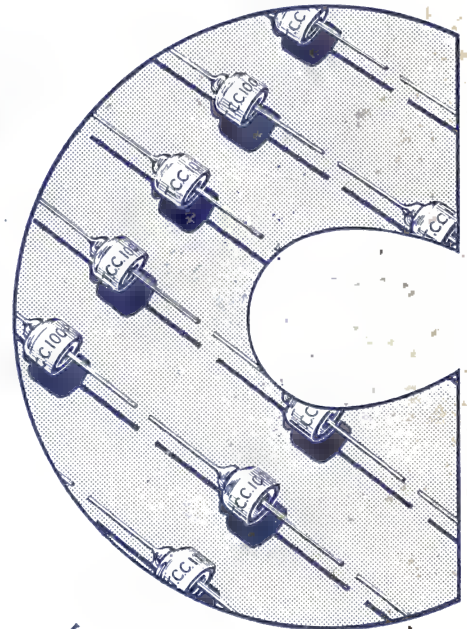
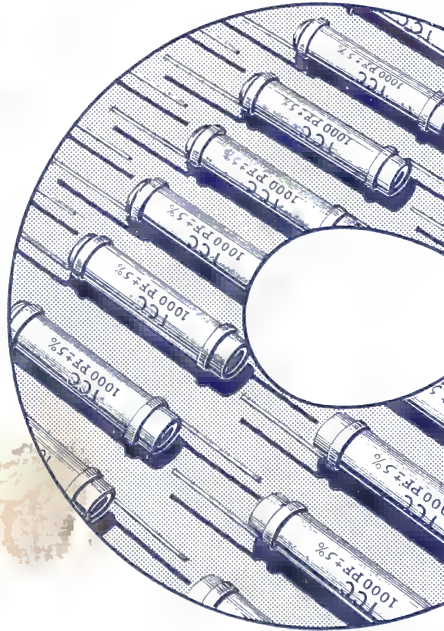
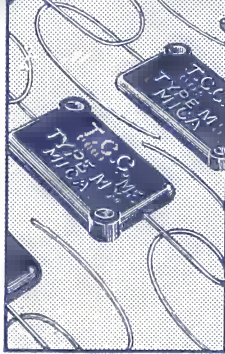
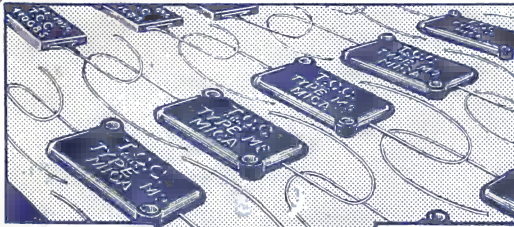

Condensers

**35 YEARS'
SPECIALISED
EXPERIENCE**