

DOUBLE FREQUENCY CHANGING FOR S.W. RECEPTION

Overstrand MONTHLY ONE SHILLING

The Wireless World

COVERING EVERY WIRELESS INTEREST

JUNE, 1940

W.R. 02



METHODICAL METHODS OF FAULT TRACING

Valves for Power Amplification

Osram Valves

MADE IN ENGLAND

Do you want technical information on the best choice and use of Power Valves?

New and Extended Technical Data Sheets

give full operating particulars, curves, and typical circuits, including push-pull.

Osram Valves
Made in England

TYPE KT61
POWER AMPLIFYING TETRODE
With Indirectly Heated Cathode

Type KT61 is a high impedance Power Amplifying Tetrode for use in the output stage of radio receivers and L.F. amplifiers operating from 2.5V. max. and with biasing till times a minimum of 2.5V. max. sensitivity. It is suitable for operation from a plate circuit, or directly from a high impedance source which already has a suitable low impedance for amplification.

Type KT61 may also be employed connected as a

All dimensions are in mm and are not correct where otherwise stated.

Heater Voltage
Heater Current

Anode Voltage
Screen Voltage
Anode Current
Screen Current
Grid Voltage
Grid Current
Anode Dissipation (watts)
Anode Temperature (°C)
Max. Anode Current (mA)
Max. Anode Voltage (V)
Max. Anode Power (Watts)
Max. Anode Temperature (°C)
Max. Anode Current (mA)
Max. Anode Voltage (V)
Max. Anode Power (Watts)
Max. Anode Temperature (°C)

Estimated For
Interference
Grid to Anode
Anode to other
Grid to other

Osram Valves
Made in England

TYPE KT63
POWER AMPLIFYING TETRODE
With Indirectly Heated Cathode.

The KT63 is suitable for use in the output stage of A.C. Receivers or Car Radio. It is capable of providing a considerable undistorted power output with a relatively small input signal voltage. For this reason the valve should be reconnected to suit when the stage is used for frequency amplification before it is connected to a low impedance load.

CHARACTERISTICS

| | |
|-----------------------------|-----------------|
| Single Valve Class A | 6.5 amp approx. |
| Tetrode connected | 300 mA |
| Triode connected | 300 mA |
| Max. anode current | 300 mA |
| Max. anode voltage | 300 V |
| Max. anode power | 100 W |
| Max. anode temperature | 100°C |
| Max. anode current (mA) | 300 |
| Max. anode voltage (V) | 300 |
| Max. anode power (W) | 100 |
| Max. anode temperature (°C) | 100 |

Osram Valves
Made in England

TYPE KT66
POWER AMPLIFYING TETRODE
With Indirectly Heated Cathode.

Type KT66 is a Tetrode for use mainly in the power output stage of radio receivers. It may also be used as a low power transmitter.

CHARACTERISTICS

| | |
|-----------------------------|-----------------|
| Single Valve Class A | 6.5 amp approx. |
| Tetrode connected | 300 mA |
| Triode connected | 300 mA |
| Max. anode current | 300 mA |
| Max. anode voltage | 300 V |
| Max. anode power | 100 W |
| Max. anode temperature | 100°C |
| Max. anode current (mA) | 300 |
| Max. anode voltage (V) | 300 |
| Max. anode power (W) | 100 |
| Max. anode temperature (°C) | 100 |

Osram Valves
Made in England

TYPE PX4
POWER AMPLIFYING TRIODE
With Directly Heated Filament.

Type PX4 is a Directly Heated Power Triode for the output stage of receivers and amplifiers where a considerable undistorted power output is required with an anode voltage up to 300V. For this purpose the valve has exceptionally good characteristics and is particularly suitable for operation from a plate circuit at considerable voltage without distortion.

The filament is in the robust metal type and may be heated from A.C. through a suitable step-down transformer.

CHARACTERISTICS

| | |
|-----------------------------|-----------------|
| Single Valve Class A | 4.0 amp approx. |
| Max. anode current | 300 mA |
| Max. anode voltage | 300 V |
| Max. anode power | 100 W |
| Max. anode temperature | 100°C |
| Max. anode current (mA) | 300 |
| Max. anode voltage (V) | 300 |
| Max. anode power (W) | 100 |
| Max. anode temperature (°C) | 100 |

Osram Valves
Made in England

TYPE KT35
POWER AMPLIFYING TETRODE
With Indirectly Heated Cathode

Type KT35 is an Output Tetrode suitable for use in D.C. Receivers or Amplifiers where the anode voltage is 200-300 volts.

By utilizing the heater circuit (see Fig. 1) the valve becomes suitable for operation from a Car Battery with low battery supply volt. as a Car Battery.

Type KT35 may also be employed in a Class A1 or Class AB1 stage in which an output of about 10 watts per pair may be obtained, depending upon the H.T. voltage.

CHARACTERISTICS

| | |
|-----------------------------|-----------------|
| Single Valve Class A | 0.3 amp approx. |
| Max. anode current | 30 mA |
| Max. anode voltage | 300 V |
| Max. anode power | 10 W |
| Max. anode temperature | 100°C |
| Max. anode current (mA) | 30 |
| Max. anode voltage (V) | 300 |
| Max. anode power (W) | 10 |
| Max. anode temperature (°C) | 100 |

A.C. BEAM TETRODES—

KT. 61 10/6, KT. 63 10/6, KT. 66 15/-.

A.C. POWER TRIODE—

PX. 4 9/6

D.C./A.C. BEAM TETRODE—

KT. 35 10/6

NOTE
Types KT. 66 and PX. 4 require a Post Office permit to purchase.

Technical data sheets available for every type of OSRAM VALVE. When applying for your copy, please state exactly the type or types required.

The General Electric Company
Head Office: Magnet House, Kingsway, London, W.C.2.

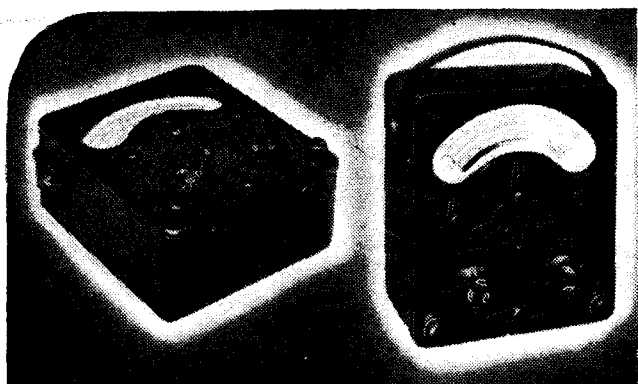

46-range Model 7 Universal AvoMeter. 40-range Model 40 Universal AvoMeter.

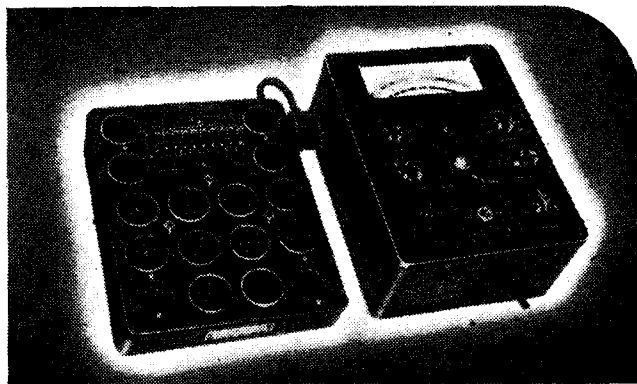

"Avo" Valve Tester with Universal Panel.

PRECISION METERS

that Master every Testing Problem

HIGH accuracy, simplicity, exceptional versatility and proven reliability have won for "AVO" Instruments a world-wide reputation for supremacy wherever rapid precision test work is demanded. There is an "AVO" instrument for every essential electrical test.



ELECTRICAL MEASURING INSTRUMENTS

BRITISH MADE

● Write for fully descriptive literature dealing with any instrument in which you are interested, and for current prices.

OTHER "AVO" INSTRUMENTS (not illustrated)
High Resistance AvoMinor. "AVO" Low Resistance Ohmmeter. The Avo Bonding Meter. The Avo Milliohmmeter. The AvoDapter. 9-pin AvoCoupler.

Sole Proprietors and Manufacturers:

THE AUTOMATIC COIL WINDER & ELECTRICAL EQUIPMENT Co., Ltd., Winder House, Douglas Street, London, S.W.1
Phone: Victoria 3404-7

All-Wave "Avo" Oscillator.

"Avo" Test Bridge

Universal AvoMinor

D.C. AvoMinor.

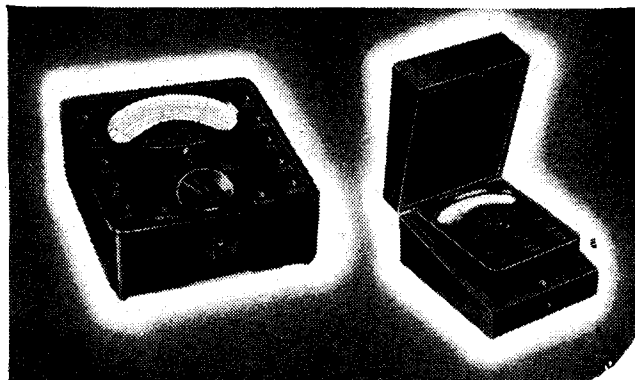
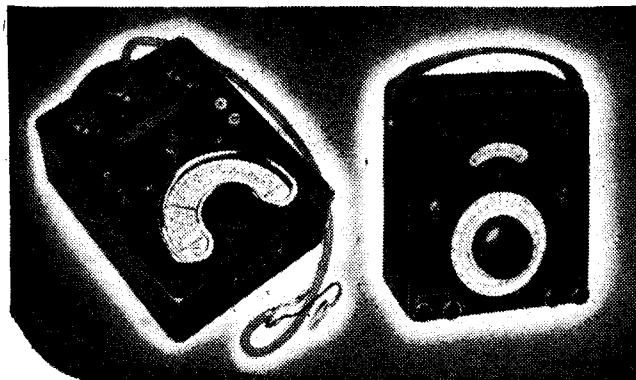

M-R SUPPLIES

Announce some further exceptional and **EXCLUSIVE BARGAINS** in brand new **PIEZO-ELECTRIC REPRODUCING EQUIPMENT** and other high-class electrical gear.

REMARKABLE OPPORTUNITY which cannot be repeated. We now hold final supplies of the original 4-guinea **ROTHEMEL DE LUXE PIEZO-CRYSTAL PICK-UPS**, lift-head model, designed in collaboration with Mr. P. Wilson of "The Gramophone"—the world's finest pick-up—which we are able to offer, fully guaranteed, at only **37/6** each. The fine bronze arm is swivelled on ball-bearings, giving perfect, free tracking and absolutely minimum record wear. We have 150 only and anticipate immediate sale. Also the new **JUNIOR** model, complete with arm, **19/6**. Also **STANDARD** model (green label), **29/6**. And the last few of the De Luxe **HEADS** to fit either acoustic tone arm or tracking arm (adaptor supplied free), **33/-** model for **19/6**. **NOTE:** Piezo-Crystal Pick-ups are suited for use with any radio set or amplifier and require no special arrangements. They give the finest possible reproduction.

ROTHERMEL-BRUSH D.104 MICROPHONE INSERTS. The heart of the famous 5-guinea D.104 Microphone, only requiring suitable housing, **22/6**. Also the complete Microphones in fine polished stone case with chromium bezel and suspension rings, employing D.104 inset, the most satisfactory and handsome microphone for recording and P.A., **57/6**. Supplies are very limited and we cannot repeat these offers.

MINIATURE P.M. MOVING COIL UNITS. The heart of the finest moving coil microphone. 12-ohms speech imp. Diameter 3", depth 2", with high-flux alni magnet. Suitable also for miniature speaker, handling about 4 watts. Ideal for intercommunication, **12/6**.

MICROPHONE TRANSFORMERS, miniature nickel alloy type to suit above units, **3/6**. New **DUAL-SERVICE** model, providing exact matching for either m/coil (10/15-ohms) or any carbon microphone, fully screened and fitted six terminals, weight approx. 5 lbs. For high-fidelity work, **19/6**.

TIME SWITCHES are a boon in all households. Our recent offer proved very attractive but we still have a few more left at the same keen price. Break up to 10 ampr. A.C. Will switch on and off at any predetermined times Radio (convenient for the early news bulletin), Lights, Domestic Appliances, etc. 5" square, can be mounted anywhere. Easily connected to any appliance, **42/-** model for **27/6**.

HEAVY DUTY OUTPUT TRANSFORMERS. Exact "W.W." specification providing all ratios from 12:1 to 75:1 with C.T. for push-pull. High inductance—lowest loss, weight 7 1/2 lbs. Response 20-10,000 c/s, getting the best out of any speaker. Final supply at **28/6**.

L.T. METAL RECTIFIERS (Standard) for battery chargers: Delivery 12/14 volts at 14 amp., **10/9**. Suitable mains **TRANSFORMERS**, 200/250 v. primary, for 2, 4 and 6 volt charging, **10/11**. For 12-volt charging, **12/-**.

PANEL METERS for chargers, etc., 2 1/2" dia. Guaranteed accuracy on either A.C. or D.C. Amps. 1-0-1, 0-3, or 0-5, either 5/11. Volts 1-0-10 or 0-250, either 7/6. Milliamps: 0-20, 0-50, 0-250, either 7/6.

HEAVY DUTY BATTERY CHARGERS. Very special offer—brand new "Tungar," Operation 200/250 v. A.C., charging 6 or 12 volt batteries at 5-amps. (or less if required), **£5 17/6**.

GRAMPIAN AMPLIFIERS. Latest model, complete equipments at keenest prices—please enquire. Last few **SHAFTESBURY** £16 10s. equipments, complete with mike, stand, speaker, leads, etc., ready for use. brand new, **£9 10/-**.

3-BANG .0005 VARIABLE CONDENSERS (Plessey) All-wave, with high-ratio slow-motion cond drive, standard spindle. Very fine job, cost 12/-, 5" long. Special clearance brand new, **2/6** (drive alone worth more).

AUTOMATIC RECORD CHANGERS, latest model, best maker, A.C. mains, 10-guinea model for **£7 15/-**, last few.

Postage **£2/6**. Will you please send stamp with enquiries.
M.R. SUPPLIES, 88, New Oxford St., London, W.C.1. 'Phone : MUS. 2958

**WHARFEDALE
EXTENSION SPEAKERS**

Prices from 24 -

List on application.

DE LUXE Model with "TRUQUAL" Vol. Control and BRONZE UNIT, Less transformer **69/6**

With transformer **78/-**

With GOLDEN UNIT from **90/-**

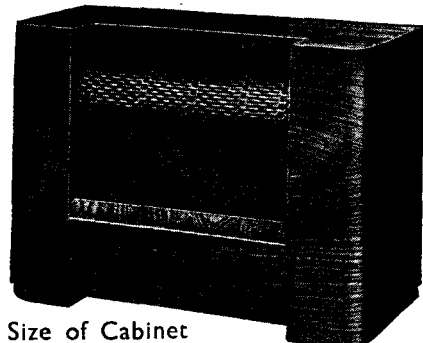

Size of Cabinet **16" x 12" x 8"**
Walnut. (Mahogany or Oak 2/6 extra.)

ALL WHARFEDALE EXTENSION SPEAKERS are available WITHOUT Transformer in the following type:—

- Type "32" for 1 1/2 to 4 ohms.
- Type "64" for 4 to 6 ohms.
- Type "98" for 7 to 10 ohms.

WHARFEDALE WIRELESS WORKS

Sole Proprietor: D. E. Briggs.

Hutchinson Lane, BRIGHOUSE, YORKS.
PHONE: BRIGHOUSE 50

ROLA

**TRANSFORMER
LAMINATIONS**

Stamped from High Grade Steel, wired and packed in the same consecutive order as they leave the press, ROLA laminations create low transformer costs by their saving on labour. Eight standard sizes of E's and I's are available from stock, together with associated clamps and covers. Core dimensions 1/8" to 1 1/2". A comprehensive Bulletin with design data for manufacturers will be sent on request.

BRITISH ROLA LIMITED
MINERVA ROAD, PARK ROYAL, N.W.10
WILLESDEN 4322

TUNGSRAM VALVES
THE VITAL LINK IN YOUR SET

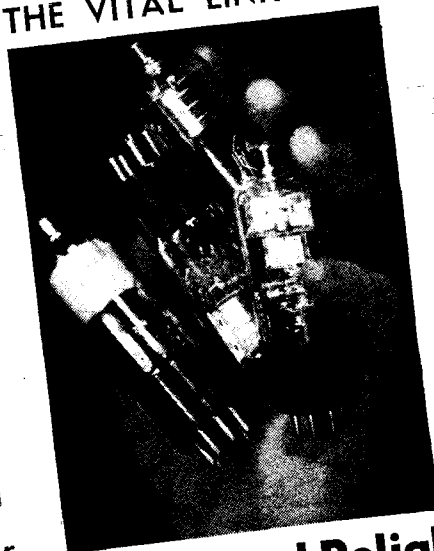

for **Efficiency and Reliability**
EQUIVALENT VALVES FOR ALL MAKES OF SETS

Sole Distributors in GREAT BRITAIN and EIRE:
SIEMENS ELECTRIC LAMPS AND SUPPLIES LIMITED
38-9, UPPER THAMES STREET, LONDON, E.C.4

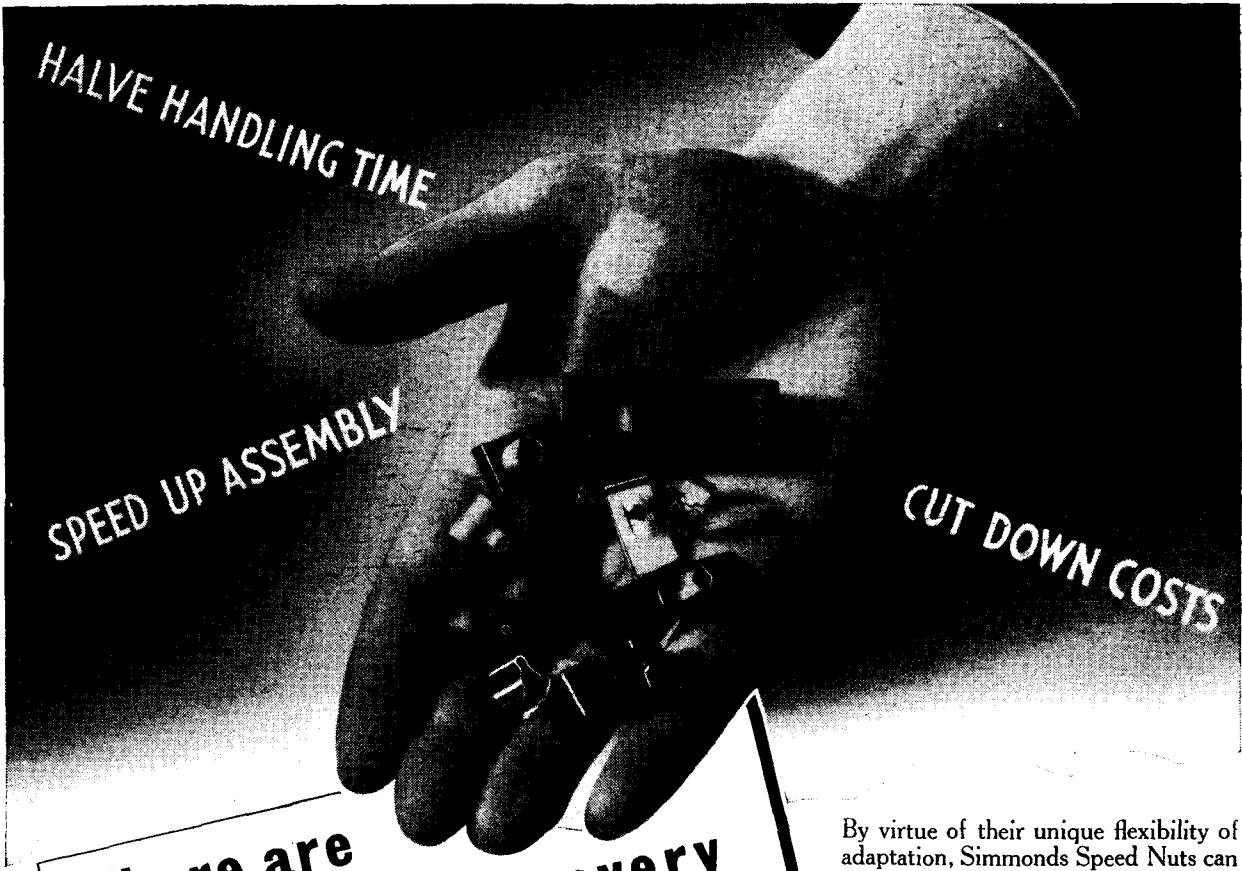

HALVE HANDLING TIME

SPEED UP ASSEMBLY

CUT DOWN COSTS

There are
Speed Nuts
 for every
 type of assembly

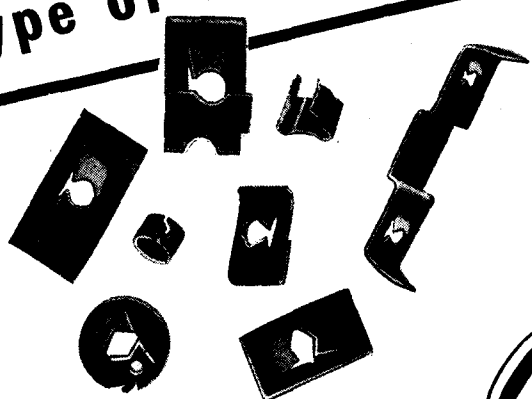

By virtue of their unique flexibility of adaptation, Simmonds Speed Nuts can be designed to meet not only usual assembly requirements, but those applications which call for something special and which, until the advent of Speed Nuts, persistently presented difficult problems to the designer.

Speed Nuts eliminate ordinary nuts and lock washers. They are unaffected by vibration, absorb any movement due to temperature changes and prevent sinking of the bolt head into wood or soft metal surfaces. For plastics, glass and porcelain, Speed Nuts are the perfect fastening.

We invite Manufacturers and Designers to investigate this modern fastening system. Our Development Department will be pleased to collaborate and work out the most effective designs to solve your assembly problem.

Move with the times—use

Simmonds
Speed Nuts
 (PATENTS APPLIED FOR)

SIA SIMMONDS AEROCESSORIES LTD **SIA**
 GREAT WEST ROAD, LONDON.

Longley

RAYMART

CRAFT A CREED

VARIABLE CONDENSERS

Our standard range of micro-variables are of all-brass construction with heavy gauge vanes and a special device electrically short-circuits the ball-bearing spindle, giving noise-free operation with smooth control and avoiding the troubles inherent with old-fashioned pigtails.

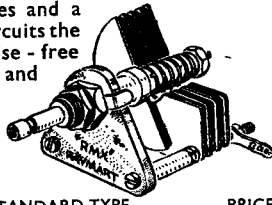

Ceramic insulation (RMX) is the latest product of the laboratories. Note how it improves at high frequencies.

| Loss factor at | 300 kc/s. | 50,000 kc/s. | STANDARD TYPE | PRICE |
|------------------|-----------|--------------|--------------------------------|-------|
| Quartz | 1.0 | 1.1 | VC15X 15 mmfd. | 1/7 |
| "RMX" | 4.1 | 3.2 | VC40X 40 mmfd. | 1/10 |
| Micalex | 11.9 | 18 | VC100X 100 mmfd. | 2/2 |
| Porcelain | 70 | 85 | VC160X 160 mmfd. (.00016 mfd.) | 2/6 |
| Moulded material | 100 | 260 | VC250X 250 mmfd. (.00025 mfd.) | 2/10 |

(Calculated from power factor with quartz taken as unity at 300 kc/s. (All types can be ganged.)

NEW MIDGET TYPE

In response to a high demand, particularly from Government Contractors and Aircraft Radio manufacturers, for a high frequency tuning condenser, occupying a minimum amount of space, we have produced a new range of Midget Micro-variables. Precision built on the same lines as our standard range and with the following features not found in any competitive range.

| MIDGET TYPE | (Approx. max. capacity) | PRICE |
|-------------|-------------------------|-------|
| MC15X | 15 p.f. | 1/8 |
| MC40X | 40 p.f. | 1/11 |
| MC100X | 100 p.f. | 2/3 |
| MC7DX | Double spaced 7 p.f. | 1/8 |
| MC15DX | Double spaced 15 p.f. | 1/10 |

Shaft turned from solid metal overall, giving accuracy not to be found in condensers where the shaft is fabricated from a drawn pin rod.

Ball bearing rotor with long bearing, so eliminating side play and at the same time giving an extremely smooth bearing.

Both ball races electrically shorted internally by special Phosphor Bronze shorting brushes, inside bearing.

First-grade Ceramic and all brass construction.

The New Raymart Catalogue shows dozens of New Shortwave Components. Post free for 2½d. stamp.

See further advertisement on page 312.

RADIOMART 44, HOLLOWAY HEAD, BIRMINGHAM, 1. Q5N1 (Birmingham) LTD.

JOHN McCLURE LTD.

beg to announce that

in spite of Budget, Control Boards, National Service calls and all other wartime handicaps they are still offering their

FEEDER UNITS, AMPLIFIERS AND RECEIVER CHASSIS

—at the same prices as before.

No doubt the time will come when we shall be forced to fall into line with other manufacturers and make further increases, but as long as we can possibly do so we intend to maintain all prices at the present level of a nominal 5% over pre-war ones.

Delays are inevitable, despite our most careful planning, and for this we have to thank, not only war conditions, but our customers themselves. By their number, they have increased the already heavy demand on our staff and resources which have no longer their pre-war elasticity.

Please help us by your patient co-operation, and let the excellence of the job be your reward. A further form of assistance, which we should greatly appreciate, is the enclosure of postage for reply with all enquiries.

JOHN McCLURE LTD.

Erskine Road, London, N.W.3. Phone: Primrose 5435-6

Wireless Direction Finding

Deals with the principles of Wireless Direction Finding and gives an account of the circuits and apparatus used in its application to navigation. The Adcock Aerial has a separate chapter covering its principles, installation and performance. Shore, Ship and Aircraft installations, as well as a special section on the choice of a suitable site for the Aircraft Ground D.F., with Adcock Aerials are included. Also useful references to a selected list of some 600 of the more important contributions to the literature of D.F.

By R. KEEN, B.Eng.

(Third Edition)

A BOOK OF INSTRUCTION AND REFERENCE FOR ENGINEERS, TECHNICIANS, TELEGRAPHISTS AND OTHERS ENGAGED OR INTERESTED IN THE USE OF DIRECTIVE WIRELESS TELEGRAPHY FOR THE NAVIGATION OF SHIPS AND AIRCRAFT.

800 pages
550 illustrations

25/- net

By post 25/9

From leading Booksellers or direct from the Publishers

ILLIFFE & SONS LTD., DORSET HOUSE, STAMFORD STREET, LONDON, S.E.1

H.M.V., R.G.D., MARCONI, PHILIPS, BUSH, SOLD OUT OF RADIOGRAMS.

BUT our bold policy of advance buying enables us to offer a number of the latest first-class models for immediate delivery, including instruments both with and without record changers for A.C. or D.C./A.C. Come to Imhof House and see and hear the finest show of radiograms in the country. Every instrument backed by our unique Free Service plan. We can arrange complete installations in any part of the country. Call or write for full details.

IMHOF'S

Alfred Imhof Ltd., 112/116 New Oxford St., W.C.1. Museum 5944

IM Long-playing needles are officially recommended by R.G.D., Philips, Pye, Philco, G.E.C. and Bush. They are used by the B.B.C. They eliminate record wear, pick-up chatter and surface hiss. They suit autoradiograms. 2/- per top-hat box. IM Pointmaster—the ultra rapid needle sharpener—3/6.

PREMIER RADIO

NEW PREMIER S.W. A.C. RECEIVER KIT

In response to many requests we have now produced an A.C. version of the popular Premier Short Wave SG3 Kit. Circuit: Pentode H.F. Stage, Pentode Detector, Beam Power Output, and F.W. Rectifier. 200-250 v. A.C. Operation. Built in Power Pack. Hum-free operation. For use with Phones or P.M. Speaker. Complete Kit of Parts with drilled chassis, all components, Plug-in Coils covering 13-170 metres, 4 valves and full instructions and circuits £4-10-0. Completely wired and tested £5-10-0. Send for full details.

"LEARNING MORSE"

| | |
|--|------|
| Premier Morse Practice Key on Bakelite Base and Brass Movement | 3/3 |
| General Purpose Morse Key | 5/10 |
| Heavy Duty TX Key on Cast Base | 10/- |
| Bakelite Buzzers | 1/9 |
| Complete Kit of Parts for Valve Oscillator as described in W.W. "Learning Morse" | 25/- |

SHORT-WAVE GEAR

Short-Wave Coils, 4- and 6-pin types, 13-26, 22-47, 41-94, 78-170 metres, 2/- each, with circuit. Premier 3-Band S.W. Coil, 11-25, 19-43, 38-86 metres. Suitable any type circuit, 2/11.

4-pin or 6-pin Coil Formers. Plain or Threaded, 1/2 each.

Utility Micro Cursor Dials, Direct and 100:1 Ratios, 4/3.

New Premier 2-Gang S.W. Condenser. 2 x .00015 mf. with integral slow motion, 5/9.

Bakelite Dielectric Variable Condensers .0003 and .0005 mf. Suitable Tuning or Reaction, 1/6 each.

Short-Wave H.F. Chokes. 10-100 m., 10½d. each. High grade Pie Wound U.S.A. type, 1/9 each.

Lissen Dual Range Screened Coils. Medium and Long Waves, 2/9 each.

PREMIER 1940 HIGH FIDELITY AMPLIFIER KITS

Each Kit is complete with ready drilled chassis, selected components, specially matched valves and full diagrams and instructions.

| | Kit of Parts with Valves | Completely Wired and Tested |
|-----------------------|--------------------------|-----------------------------|
| 3-watt A.C. Amplifier | £2 6 6 | £3 4 0 |
| 3-watt A.C./D.C. | £2 6 6 | £3 4 0 |
| 6-watt A.C. | £6 2 6 | £7 0 0 |
| 8-10-watt A.C./D.C. | £5 5 0 | £6 2 6 |
| 15-watt A.C. | £6 14 0 | £8 2 6 |

Black Crackle Steel Cabinet 15/- extra.

NEW PREMIER SELF-POWERED RF TUNING UNIT, incorporating a Var.-Mu pentode amplifier followed by a power grid detector. Designed for high-fidelity reception. Wave range 200-560 and 800-2,000 metres. **£5.5.0** Complete with valves.

MOVING COIL SPEAKERS

All complete with transformer. Rola 8 in. P.M.s, 16/6; 10 in. P.M.s, 22/6; G.12 P.M.s, 66/-.

ENERGISED MODELS

Plessey 8 in., 750 or 7,500 ohm. field, 7/6; G.12 energised, 59/6. 10 in. B.T.H. 1,600 ohm. field, less transformer, 11/6.

PREMIER SHORT-WAVE KITS for OVERSEAS NEWS

Incorporating the Premier 3-Band S.W. Coil. 11-86 Metres without coil changing. Each Kit is complete with all components, diagrams and 2-volt valves. 3-Band S.W. 1 Valve Kit, 14/9. 3-Band S.W. 2-Valve Kit, 22/6.

DE LUXE S.W. KITS

Complete to the last detail, including all Valves and coils, wiring diagrams and lucid instructions for building and working. Each Kit is supplied with a steel Chassis and Panel and uses plug-in coils to tune from 13 to 170 metres.

| | |
|--|------|
| 1 Valve Short-Wave Receiver or Adaptor Kit | 20/- |
| 1 Valve Short-Wave Superhet Converter Kit | 23/- |
| 1 Valve Short-Wave A.C. Superhet Converter Kit | 26/3 |
| 2 Valve Short-Wave Receiver Kit | 29/- |
| 3 Valve Short-Wave Screen Grid and Pentode Kit | 68/- |

MAINS TRANSFORMERS

Wire-ends. All L.T. Windings Centre-Tapped

| | | |
|----------|--|------|
| SP. 301 | 300-300 v. 150 m.a. 4 v. 2-3a, 4 v. 2-3a, 4 v. 1a, 4 v. 1a | 15/- |
| SP. 350A | 350-350 v. 100 m.a. 5 v. 2a (not C.T.), 6.3 v. 2-3a | 14/- |
| SP. 350B | 350-350 v. 100 m.a. 4 v. 2-3a, 4 v. 2-3a, 4 v. 2-3a | 14/- |
| SP. 351 | 350-350 v. 150 m.a. 4 v. 1-2a, 4 v. 2-3a, 4 v. 3-4a | 15/- |
| SP. 352 | 350-350 v. 150 m.a. 5 v. 2a, 6.3 v. 2a, 6.3 v. 2a | 15/9 |

MATCHMAKER UNIVERSAL OUTPUT TRANSFORMERS

Will match any output valves to any speaker impedance.

11 ratios from 13:1 to 80:1, 5-7 watts, 15/9. 10-15 watts, 20/6. 20-30 watts, 35/-.

SHORT - WAVE CONDENSERS

Trolitul insulation. Certified superior to ceramic. All-brass construction. Easily ganged.

| | | | |
|-----------|-----|------------|------|
| 15 m.mfd. | 1/9 | 100 m.mfd. | 2/3 |
| 25 m.mfd. | 2/- | 160 m.mfd. | 2/6 |
| 40 m.mfd. | 2/- | 250 m.mfd. | 2/11 |

GRAMOPHONE MOTORS and PICK-UPS

Special Offer of Record Auto-Changer Units for A.C. Mains by famous manufacturer. Play 8 records. Latest type Magnetic Pick-up, Auto-stop, Start and Rejector. Limited number only at £4.19.6. Carriage Paid.

| | |
|--|------|
| A.C. Gramophone Motors. | |
| 100-250 v. 12-inch turntable. Auto-stop. | |
| Hum free | 35/- |
| A.C./D.C. Model | 52/6 |

| | |
|---|------|
| A.C. Gramophone Unit. | |
| Complete motor and pick-up. Auto-stop and start | 52/6 |
| A.C./D.C. Model | 77/6 |

Premier Pick-up Heads.
Will fit any tone-arm ... 5/3

ANOTHER SPECIAL OFFER.
Rothermel Brush Piezo Crystal Pick-ups New Junior P.U. with arm, 19/6. Standard S.B. Model with arm, 29/6. P.U. head only, De Luxe Model, 19/6.

REPLACEMENT VALVES FOR ALL SETS

Europa Mains Valves. 4 v. A.C. Types A.C.H.L., A.C.I.L., A.C.I.S.G., A.C.IV.M.S.G., A.C.I.H.P., A.C.IV.H.P., A.C.P., all 5/3 each. A.C.I.H.P., A.C.IV.H.P., 7-pin, 7/6. A.C./Pens, I.H., 7/6; A.C./P.X.4, 7/3; Oct. Freq. Changers, 8/6; Double Diode Triodes, 7/6; 3½-watt D.H. Triode, 9/9. 350 v. F.W. Rect., 5/6; 500 v., 6/6. 13 v. .2 amp. Gen. Purpose Triodes, 5/6; H.F. Pens. and Var.-Mu. H.F. Pen., Double Diode Triodes, Oct. Freq. Changers, 7/6 each. Full and Half-wave Rectifiers, 6/6 each.

Triad U.S.A. Valves.
We hold the largest stocks of U.S.A. tubes in this country and are sole British Distributors for TRIAD High-grade American Valves. All types in stock. Standard types, 5/6 each. All the new Octal Base tubes, at 6/6 each.

Clearance Line U.S.A. Valves.
U.S.A. Types, 24, 30, 35/51, 55, 56, 57, 71, 85, 2A5, 2A6, 2A7, 2B7, 6A7, 210, 250, 12Z3, all 2 for 3/-.

NEW PREMIER 1940 5v5 COMMUNICATION RECEIVER
£9.9.0
Send for details.

PREMIER BATTERY CHARGERS for A.C. Mains

Westinghouse Rectification complete and ready for use

| | |
|------------------------|-------------------------|
| To Charge: | 6 volts at 1 amp. 22/6 |
| 2 volts at ½ amp. 11/9 | 12 volts at 1 amp. 24/6 |
| 6 volts at ½ amp. 19/- | 6 volts at 2 amps. 37/6 |

ALL ENQUIRIES MUST BE ACCOMPANIED BY 2½d. STAMP.

YOU MUST HAVE OUR GIANT 1940 ILLUSTRATED CATALOGUE AND VALVE MANUAL ——— OVER 100 PAGES. PRICE 6d.

PLUS POSTAGE 2½d.

PREMIER RADIO CO.

ALL POST ORDERS to: JUBILEE WORKS, 167, LOWER CLAPTON ROAD, LONDON, E.5 (Amherst 4723).
CALLERS to: Jubilee Works, or 169, Fleet Street, E.C.4 (Central 2833), or 50, High Street, Clapham, S.W.4 (Macaulay 2381).

"Big Set" performance for 5 mA!

THANKS TO THE 5 GREAT ECONOMY FEATURES

OF THE NEW

MARCONIPHONE 892

- 1** The Battery Economiser. With the switch in the "Normal" position, H.T. consumption is halved; yet volume and sensitivity are ample for ordinary listening requirements. Only when maximum sensitivity and even greater output are required need the Battery Economiser be switched out of circuit. H.T. consumption then goes back to 10 mA.
- 2** High Gain aerial circuit. As good as an extra valve but without the extra battery consumption.
- 3** Super-sensitive speaker. Works wonders from a very small output wattage — more volume, greater purity. Magnet efficiency of 10,000 gauss.
- 4** Duplex action A.V.C. Almost perfect control of volume. More stable output prolongs battery life still further.
- 5** Low price. In spite of all these technical improvements, exceptional manufacturing facilities have enabled the price to be kept down to 11 gns. including batteries.

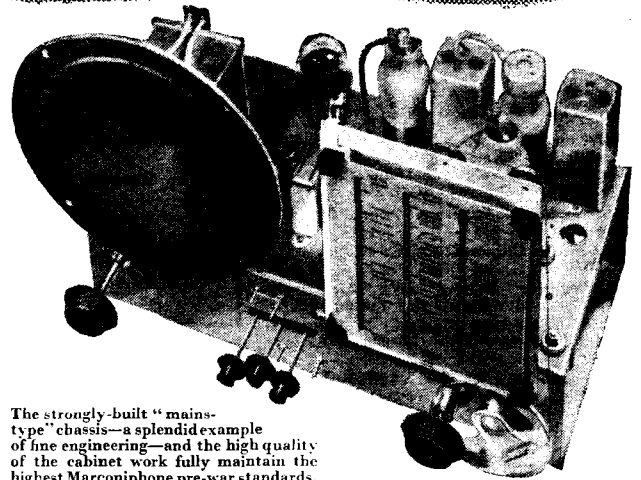

The strongly-built "mains-type" chassis—a splendid example of fine engineering—and the high quality of the cabinet work fully maintain the highest Marconiphone pre-war standards.



MARCONIPHONE 892, 4 valve
7 stage, all-wave battery superhet **11 GNS.**

The
REAL THING
in Radio

MARCONIPHONE

THE MARCONIPHONE COMPANY LIMITED · HAYES · MIDDLESEX

The Wireless World

COVERING EVERY WIRELESS INTEREST

30th Year of Publication

Proprietors : ILIFFE & SONS LTD.

No. 1056

Vol. XLVI. No. 8

Editor :
HUGH S. POCKOCK.

JUNE 1940

Contents

Editorial,
Advertising and Publishing Offices :
DORSET HOUSE, STAMFORD STREET,
LONDON, S.E.1.

Telephone : Waterloo 3333 (50 lines).
Telegrams : "Ethaworld, Sedist, London."

COVENTRY : 8-10, Corporation Street.
Telegrams : Telephone :
"Autocar, Coventry." 5210 Coventry.

BIRMINGHAM :
Guildhall Buildings, Navigation Street, 2.
Telegrams : Telephone :
"Autopress, Birmingham." 2971 Midland (5 lines).

MANCHESTER : 260, Deansgate, 3.
Telegrams : Telephone :
"Iliffe, Manchester." Blackfriars 4412 (4 lines).

GLASGOW : 26B, Renfield Street, C.2.
Telegrams : Telephone :
"Iliffe, Glasgow." Central 4857.

PUBLISHED MONTHLY.
Price : One Shilling
(Publication date 20th of preceding month.)

Subscription Rates :
Home and Abroad, 14/- per annum.

As many of the circuits and apparatus described in these pages are covered by patents, readers are advised, before making use of them, to satisfy themselves that they would not be infringing patents.

| | |
|---|-----|
| EDITORIAL COMMENT | 275 |
| DOUBLE FREQUENCY CHANGING. By D. W. Heightman | 276 |
| PRINCIPLES OF FAULT-TRACING. Part I—LOGICAL PROCEDURE <i>versus</i> HIT-OR-MISS. By W. H. Cazaly .. | 279 |
| CHOOSING A HEARING AID. By T. S. Littler | 283 |
| BALLOON TRANSMITTERS | 287 |
| SUPPRESSION AND THE PETROL ENGINE. By C. Attwood and B. Cole | 288 |
| LETTERS TO THE EDITOR | 291 |
| PROBLEM CORNER | 293 |
| PHILIPS MODEL 805A : Test Report | 294 |
| CURRENT TOPICS | 296 |
| NEWS IN ENGLISH FROM ABROAD | 299 |
| UNBIASED. By Free Grid | 300 |
| NEW PICK-UPS | 301 |
| AVC AND NOISE | 302 |
| SCREENED FRAME AERIALS. By "Cathode Ray" .. | 304 |
| DIRECT RECORDING BLANKS. Compiled by Donald W. Aldous | 308 |
| RANDOM RADIATIONS. By "Diallist" | 309 |
| BEETHOVEN "LITTLE PRODIGY" : Test Report .. | 311 |
| RECENT INVENTIONS | 313 |

INTEREST and ENTERTAINMENT

The limitations of the so-called all-wave type of receiver is most evident when listening in on the lively ether on 7 to 550 metres ...

WITH A

TROPHY

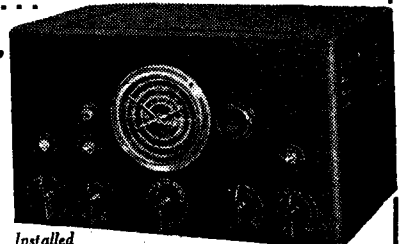

➔ "6" ➔

Recommended receiver in the junior communications class, 6 valves, electrical bandspreading and other refinements for reliable reception on 6.5 to 545 metres. **\$11.11.0**

➔ "8" ➔

A new super 8-valve A.C. communications model. R.F. all 5 bands, 7 to 550 metres. Solo-knob bandspread, **\$14.19.6** Speaker 48/3 extra.

Installed at RADIO ROYAL

• Deferred terms. Send now for lists. Demonstrations—note London addresses. Available from all Dealers. Scotland : Clydesdale Supplies. Manchester : Wellworth Radio Ltd.

Fully Guaranteed. **PETO SCOTT CO. LTD.,** 77, (W.M.7), City Road, London, E.C.1. Tel. : Ottisold 9875.
41, High Holborn, W.C.1. Tel. : Holborn 3248.

Presenting the new **MURPHY** short-wave
"STATION-MASTER"

The Murphy Short-Wave "Station-Master" mains and battery models feature short-wave station names which at last have a true meaning, and lead to unusual simplicity of short-wave tuning. The accuracy and stability of the calibration are such that it is possible to tune and re-tune any given short-wave station with certainty.

The Short-Wave "Station-Master" embodies marked advances in all the requirements which the Murphy tradition of short-wave 'specials' has established in the last few years: (1) Ease of tuning; (2) Adequate image suppression; (3) Adequate gain—more sensitivity being required on short waves than on the ordinary wavebands; and (4) Frequency stability to permit accurate tuning and re-tuning of a given short-wave station.

STATION NAMES ON SHORT WAVES.

The most striking feature of the "Station-Master" is the scale, on which no distinction is made between the six short-wave bands covered and the two normal broadcast bands. A separate scale with station names (95 in all) has been provided for each band, the required range being selected by one of the eight wave range push-buttons. A separate set of coils is brought into operation for each band, and band-spreading is achieved by small condensers in series with the main tuning condenser.

The effect is to make tuning on the short-wave bands as "broad" and as easy as it is on medium and long waves. Hitherto, tuning short-wave stations, even on sets with some form of band-spreading, has been more difficult than tuning medium-wave stations, largely because it has not been possible to provide the ten-fold increase in calibration accuracy needed to make the scale markings equally reliable. Under such conditions, calibrating short-wave scales with station names was not only useless, but also misleading.

As an alternative, logging dials of various sorts have been provided and have proved quite useful to people who were prepared to take a little trouble—but they still fell short of our ideal of real simplicity and certainty in tuning short-wave stations.

The "Station-Master" represents an approach to this ideal in producing commercial "band spread" receivers—an approach made possible by our previous experience, coupled with the evolution of more stable circuits, in the following ways. In the oscillator circuit 'warming up' drift due to changes in valve capacities has been reduced by using larger fixed tank capacities across the coils. One of these has a negative temperature coefficient, so that drift due to changes of temperature, whether due to the heating up of the set itself, or changes in room temperature, are compensated. Drift due to changes of atmospheric humidity has been reduced by suitable impregnation of the oscillator coils. The fixed tuning capacities are of the silver-on-mica type, and are wax impregnated.

WAVEBANDS COVERED.

The usual 21-metre amateur band has been replaced by the 13-metre broadcast band, and the 42-metre broadcast band has been incorporated with the 49-metre band. The tuning arrangements are such that this can be done while maintaining adequate band-spreading, but only a very rough station name calibration is possible on 42 metres. This band is not considered important enough to justify the added complication and cost of a button and scale to itself.

On laboratory tests the accuracy and stability of the short-wave scales are surprisingly good, but with such a radically new development caution is

necessary, and it would be unwise to expect the short-wave station names to be as completely reliable indications as the normal medium-wave station names, especially since the stations themselves cannot all be relied on to keep their allotted wavelengths.

But if the short-wave names are regarded as 'signposts,' they will be found extremely useful, and the improvement in ease of operation is remarkable.

OTHER TECHNICAL ADVANCES.

A new image suppression circuit has been developed for short waves, and is extremely simple and effective.

The type of pre-selector used has been designed so that the long-wave aerial coils provide higher gain at the lower wavelength end of the band, and at the same time act as an improved low-pass filter to minimise break-through of medium-wave stations. Automatic volume control on the "Station-Master" is undelayed. This tends to minimise the annoyance of selective fading on short waves, and also results in a slight increase of selectivity. Gain is increased by the use of an HL41DD valve in place of the usual variable- μ type. A heterodyne whistle-filter is connected in the anode circuit of the output valve.

A high-slope R.F. amplifying stage, using a Mazda television type SP41 valve, is employed on short waves only and is followed by the new and very simple image suppression device mentioned earlier. A Colpitts oscillator circuit is used, and is band-spread, in common with the inter-valve circuit, by small condensers in series with the main tuning condenser. As the aerial circuit is in any case damped by the aerial itself, it is pre-set to the middle of the various bands.

A limit is set by the prevailing noise-level to the amount of sensitivity which can be usefully employed in a receiver. Too much gain in the R.F. stage is a frequent cause of interference, due to

stations 465 Kc's apart interacting with each other and with the wanted station at the frequency-changer. There is thus a more or less definite optimum value, and advantage is taken of the fact that we use switched inductances in the "Station-Master" suitably "to doctor" the R.F. stage on each waveband to maintain its gain as close as possible on all wavebands to this optimum value.

REPRODUCTION.

Emphasis has been placed in the "Station-Master" on range and performance. Variable selectivity has been omitted in the interests of other features felt to be more important at the present time, but apart from this limitation, quality will be found to be of an unusually high standard. The Pen45 output tetrode delivers ample power to the 8-inch moving coil speaker, which has a remarkably well-balanced response.

Special attention has been given to the response on short waves. For short-wave reception, emphasis must be placed on speech rather than music, and a response which is optimum for music is liable to have too much bass for optimum intelligibility on speech. This effect is accentuated when the tone control is turned down, as is so frequently necessary on short waves to remove noise and interference. For this reason, the bass response has been slightly restricted on the short-wave ranges, and the intelligibility of 'difficult' short wave stations has been thereby improved.

THE BATTERY SHORT-WAVE "STATION-MASTER."

The battery-operated edition of the "Station-Master" incorporates most of the outstanding short-wave performance features of the mains model, including accurate short-wave station names on the scale and the advantages of band-spreading, making short-wave tuning as easy as on medium waves. It is, in fact, the first commercial battery receiver to offer anything like this high standard of short-wave performance.

A single pre-selector is used and a wavetrapp is provided where necessary. On medium and long waves, the circuit comprises a triode-pentode frequency changer, followed by an I.F. stage; a diode triode for detection; A.V.C. and L.F. amplification; and a Q.P.P. output stage. Grid bias is automatic.

As on the mains set, an R.F. stage is brought into circuit on short waves. It has a tuned anode coupling to the frequency-changer, because the limitations of battery valves make it necessary to forgo the refinement of the new image suppression circuit, except on 49 metres. A very stable Colpitts oscillator circuit is also used, and the oscillator and tuned anode couplings are band-spread, the aerial being pre-tuned on each band.

The addition of the R.F. stage in conjunction with the system of using a separate group of pre-set coils for each waveband results in adequate gain, a good signal-to-noise ratio, and good image suppression. Although in these respects the performance is not, of course, quite as good as the mains "Station-Master" with its high slope R.F. valve and special image rejector, it will be found to give a very high standard of short-wave performance, throughout the life of the H.T. battery.

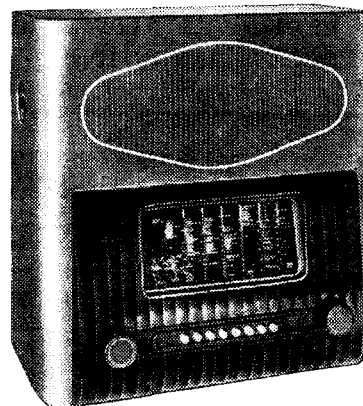

Cash Prices:

A.C. MAINS SHORT-WAVE "STATION-MASTER" £15.15.

BATTERY SHORT-WAVE "STATION-MASTER" (without Batteries) £14.10.

All Murphy Sets, exclusive of valves and batteries, guaranteed for a year. Prices do not apply in Eire. Hire Purchase Terms on all models.

C. R. Casson 963

The Wireless World

COVERING EVERY
WIRELESS INTEREST

ESTABLISHED
1911

No. 1056. Vol. XLVI. No. 8.

JUNE 1940

Price One Shilling

Editorial Comment

Standardisation: For Home and Export

WHEN a large part of a community's efforts is diverted towards producing war material and maintaining military personnel that contributes nothing to industry, it follows that the civilian population must forgo many of the good things of life; in other words, the average standard of living must decline. The economists never tire of reminding us of that fact, the truth of which must be self-evident, at any rate if one adds some such proviso as "all other things being equal" or, more specifically, assumes that the production and distribution of goods remains at the same level of efficiency.

In this proviso lies our main hope of avoiding intolerable dislocation of the machinery of production and distribution, not only in the wider sense as it affects the national life, but in our own specialised and limited field. Efficiency must be increased. We believe that some increase comes automatically in wartime, as in times of stress everyone concerned feels that his individual efforts are directly concerned with the common good. But that in itself is not enough. Other methods of increasing efficiency must be studied, and of all these standardisation is one of the most promising. There are few industries where its possibilities are greater than in wireless.

It is good to learn that this question of standardisation is already under consideration by the R.M.A. and others. The subject was also debated by the Wireless Section of the Institution of Electrical Engineers last month. All those taking part seemed to accept the idea in principle, but there seemed to be some lack of concrete suggestions as to details. One encouraging fact that emerged is that there is a possibility of closer liaison between the various branches of the industry—those catering for the

Services, broadcasting and communications. If and when standards are fixed, it is to be hoped that they will be adopted as widely as possible.

In opening the I.E.E. discussion just referred to, Mr. P. R. Coursey urged that wartime standardisation should not connote the *ersatz* or inferior substitute idea. Another speaker suggested that standardisation, though admittedly reducing waste, restricts development. That objection, though less tenable in wireless than other fields, must be allowed, but the general principle of a slowing-down of technical progress in wartime has already been widely accepted. A point of some importance was raised by a plea for uniformity in colour coding of broadcast receiver wiring; the demands of the fighting Forces have already made inroads on service staffs, and anything that facilitates fault-tracing and repairing is to be welcomed, as much of the work will now be carried out by less highly skilled men than hitherto.

It has been debated whether standardisation should be carried out by the Radio Manufacturers' Association, or, on a wider basis, by the British Standards Institution. Without expressing any view on this question, we urge that speed is vital; thanks to the spirit of co-operation now existing, it should be possible to devise the necessary machinery for formulating generally acceptable standards without those interminable delays to which we were accustomed in peacetime.

The British wireless industry has now an unexampled opportunity of establishing an export trade in broadcast receivers, and here standardisation is of even greater importance than at home. The foreign trader will fight shy of our products if he is forced to stock a wide variety of replacement valves and other parts for British sets.

Double Frequency Changing

ITS APPLICATION TO ULTRA-SHORT-WAVE RECEPTION

By D. W. HEIGHTMAN

THE use of a high intermediate frequency (herein after abbreviated as HIF), in receivers for high and ultra-high frequencies, provides a simple method of avoiding second-channel interference without the addition of RF stages and their attendant problems. HIF stages, however, do not give the same selectivity as those operating on 465 or 110 kc/s. By HIFs we

The method of ultra-short-wave reception described in this article has many attractions, especially when good selectivity is required. Although particularly adaptable to the reception of "single figure" wavelengths, it is also useful at lower frequencies.

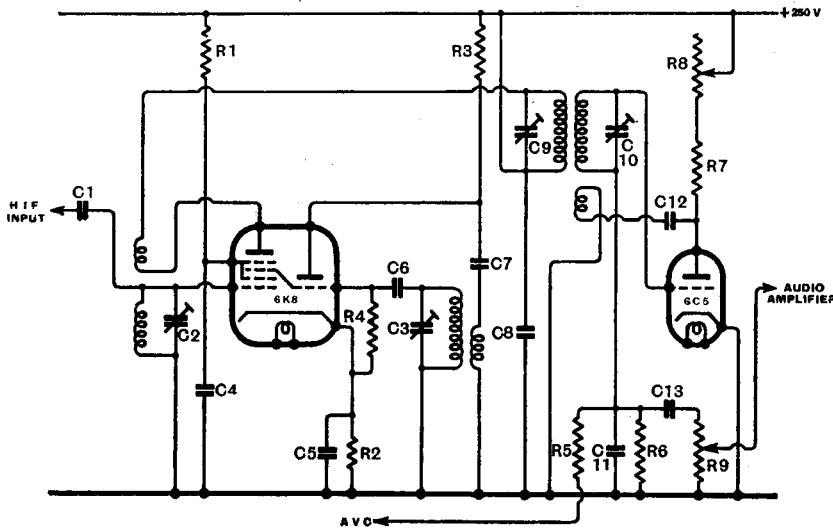

fore decided on, and this IF is used in the unit shown in Fig. 1. This unit connects up to the original HIF output and replaces the original second detector. The arrangement only necessitates the addition of two

Fig. 1.—Circuit of an auxiliary second-IF unit designed for operation at 110 kc/s. Values of components: R1, R3, R4, 50,000 ohms; R2, 250 ohms; R5, R6, R9, 0.5 megohm; R7, 100,000 ohms; R8, 0.25 megohm. C1, C6, C7, 0.0001 mfd. (mica); C2, C3, 0.0001 mfd. (ceramic trimmer); C4, C5, C8, C13, 0.05 mfd.; C9, C10, C11, C12, 0.0005 mfd. (mica).

refer here to frequencies in the order of 2 to 5 Mc/s.

Whilst for the reception of frequencies over 20 Mc/s it is generally advantageous to have fairly broad selectivity, it is very useful to be able to increase the selectivity when the receiver is being used between 5 and 20 mc/s (especially in these days of Continental jamming!). To this end some tests were carried out with the double frequency changing (DFC) system, and results proved to be quite satisfactory.

It may at first appear that the use of two frequency changers in a receiver would tend to make the noise level high, but, as the signal input to the second frequency changer is fairly high, this is not the case in practice.

The aim of the initial tests was to devise a means of introducing the system into an existing receiver with a minimum of alteration to the original circuit and layout; hence the unit described may be added to a receiver without alteration prior to the HIF stages. It will be seen also that the DFC system can be applied, with advantage, in other or new receiver designs, and some suggestions are given later in this connection.

A little thought will show that since the double-channel reception is avoided in the first mixer valve by the use of HIF, the second IF can be made quite low with advantage, for the lower the IF the better the selectivity it is possible to obtain. 110 kc/s was there-

valves and also, incidentally, provides a bias for AVC purposes.

A triode hexode (6K8) is used as the second frequency changer, the grid circuit being tuned to the HIF and the oscillator section to about 110 kc/s higher by ceramic pre-set trimming condensers. The efficiency is consider-

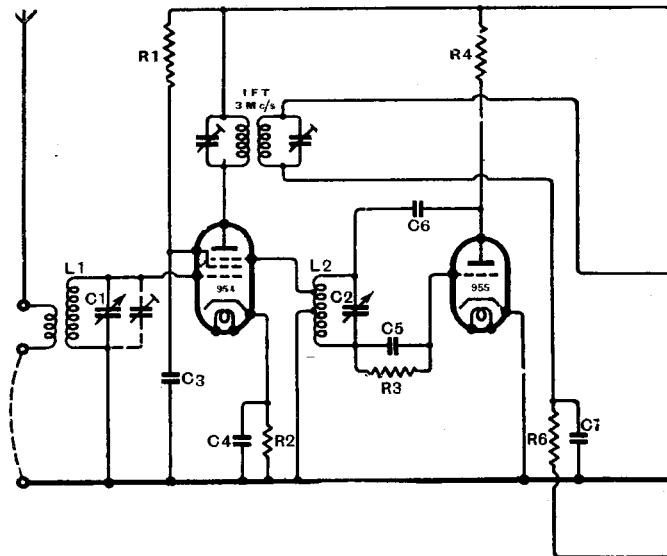

¹ UHF. Superhet., *The Wireless World*, Dec. 1st, 1938.

Double Frequency Changing—

ably improved by the provision of fixed regeneration in the hexode section. This is arranged by coupling about six turns in the anode lead back to the grid circuit, the coupling being adjusted initially until the hexode is near the oscillation point, and the regeneration winding is then fixed permanently on the coil former at this point.

An unscreened 110 kc/s IF transformer couples the hexode to the final detector. As the design of the transformer in the experimental unit was only "rough and ready," complete details will not be given here, apart from mentioning that variable coupling was arranged for and the optimum coupling required was found to be loose (about two inches between coils). The regeneration winding, coupled to the secondary, has about one-third the number of turns of the secondary winding. An ordinary 110 kc/s IF transformer, with the regeneration winding added, would do, though it may be necessary to separate the windings rather more than usual.

The second valve, an ordinary triode (6C5) which we have termed the final detector, uses a rather unusual circuit. Actually it will be seen that the grid-

cathode circuit works as an ordinary diode detector, while the anode circuit is only used for regeneration; no audio component being taken from this latter circuit. This arrangement was used because it was desired to provide AVC, and, of course, the orthodox triode grid detector overloads on the inputs necessary for AVC. Originally it was intended to use a double-diode-triode

and a separate triode for regeneration, but it became apparent that this could be simplified to the above arrangement. The audio component is taken from the grid-cathode circuit in the manner usual with diode circuits. A second diode for delayed AVC is unnecessary because, in any

case, some delay is provided in the controlled stages by the usual low-value resistances in their cathode circuits, (R8 and R9 in Fig. 2).

Regeneration, from the anode of the final detector, provides a control of selectivity and also sensitivity. On the edge of oscillation the selectivity is extremely good. Exact measurements have not yet been made, but it is anticipated that peak selectivity of considerably less than 5 kc/s is obtainable. R8 (Fig. 1), an ordinary carbon compound potentiometer, in series with R7, gives

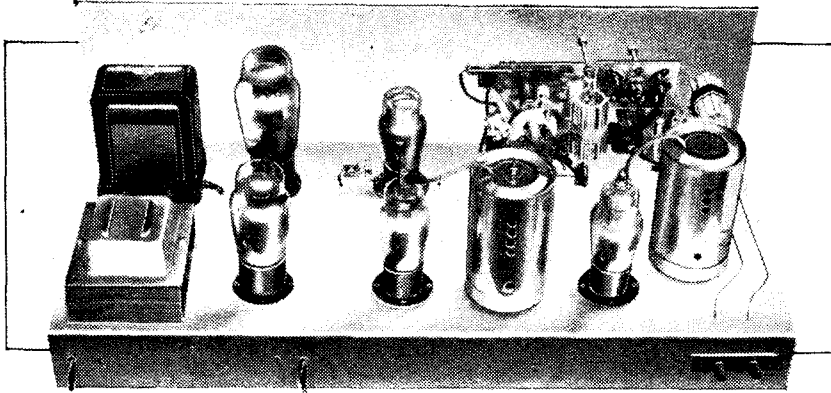

The UHF Superhet, described in our issue of December 1st, 1938, lends itself to double frequency changing by adding the unit shown in Fig. 1.

Fig. 2.—Complete circuit diagram of an ultra-short-wave receiver with double frequency changing. Values of components: R1, R16, 0.25 megohm; R2, 3,000 ohms; R3, 25,000 ohms; R4, R17, 100,000 ohms; R5, 30,000 ohms; R6, R7, 10,000 ohms; R8, R9, 400 ohms; R10, R11, R12, R20, 50,000 ohms; R13, 250 ohms; R14, R15, R18, 0.5 megohm; R19, 20,000 ohms; R21, 1,000 ohms; R22, 500 ohms. C1, C2, 50 m-mfds. (variable); C3, C4, C7, C8, C9, C10, C11, C12, C13, C23, C26, 0.05 mfd.; C5, C6, 50 m-mfds. (mica); C14, C16, 0.0001 mfd. (mica); C15, C19, C20, C21, C22, 0.0005 mfd. (mica); C17, C18, 0.0001 mfd. (ceramic trimmers); C24, 4 mfds.; C25, C27, 25 mfds. (electrolytic).

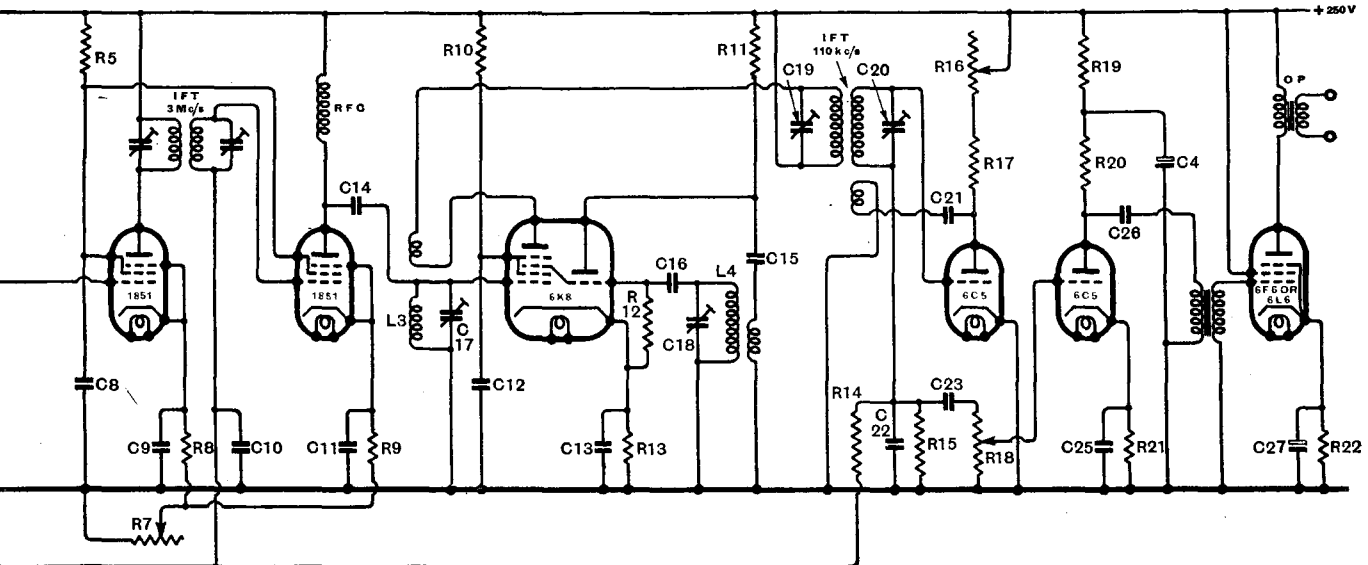

Double Frequency Changing—

a surprisingly smooth control of regeneration. The coupling of the regeneration coil on the 110 kc/s IF transformer is adjusted so that the final detector just oscillates with R8 at minimum resistance. The actual anode voltage on this valve is quite low.

The oscillator section of the second frequency changer should be well screened and isolated as far as possible from the earlier stages so as to avoid any trouble with unwanted beats or "whistles." Provided this precaution is taken no trouble has been experienced in this direction.

With the unit connected up, the receiver circuits are aligned in the usual manner. Starting with the 110-kc/s transformer, the HIF is injected into the grid circuit of the second frequency changer and the frequency of the oscillator section is adjusted for maximum output at the final detector.

Actually there will be two 110-kc/s beats fairly close to one another, obtained when the oscillator is tuned approximately 110 kc/s above or below the HIF. It is immaterial which beat is used in this case, but in accordance with usual practice the higher frequency was chosen.

Having obtained maximum output with the HIF input to the second frequency changer, the HIF stages can then be lined up from the same source. At the same time the regeneration in the hexode circuit is adjusted until the hexode section is near the oscillation point, but

also lower valve holder losses. Unfortunately these valves are very expensive. It has been said that they are fragile and unreliable but this has not been borne out by the writer's experience; a 954 and 955 are still in use after more than 2,000 hours operation in a receiver which has had rough usage and much transit.

If the receiver is not to be used over 30 Mc/s one of the modern triode-hexodes may be substituted for the acorns with only a slight reduction in sensitivity between 15 and 30 Mc/s.

In a receiver of this nature, where no RF stages are used, great care must be taken to make the input circuit (L₁, C₁) as low loss as possible and it is recommended that polystyrene or similar material be used for coil, tuning condenser and valve-holder insulation. The circuit should also have a fairly high L/C ratio. For frequencies between 5 and 20 Mc/s C₁ should not have a

greater capacity than 50 m-mfds, while above 20 Mc/s this value should be 25 m-mfds.

The HIF recommended is 3 Mc/s. The first oscillator then works 3 Mc/s higher than the required signal. Oscillator and signal-frequency tuning condensers C₁, C₂ may be ganged, especially over 15 Mc/s, provided a small trimming condenser, which can be operated from the panel, is placed across the signal circuit. Alternatively, the two condensers C₁, C₂ may be operated independently, tuning not being appreciably complicated in this way.

No screening is necessary between the signal and oscillator circuits, hence layout and construction is simplified. Switched coils may be used for frequencies lower than 25 Mc/s, but are not to be recommended for higher frequencies, as it is nearly impossible to obtain as short RF wiring and low circuit capacity as with plug-in coils.

The 3-Mc/s HIF stages are quite straightforward. It is recommended that screened television pentodes, such as the American 1851, be used for these stages as they give much increased gain compared with the old types. Grid and plate leads, where exposed, should be shielded to avoid any possibility of pick-up at the HIF (i.e., from a strong signal which may happen to be on the HIF).

An alternative arrangement, which would give somewhat greater selectivity than the circuit of Fig. 2, would be to follow the first frequency changer by only one HIF stage, then change to 110 kc/s and use one IF amplifying stage at this frequency, before the final detector. This alternative is depicted in the block diagram of Fig. 3.

When less selectivity is required on, say, the UHF, a useful provision is a change-over switch to cut out the 110 kc/s selectivity section and connect the second HIF valve direct to the second detector.

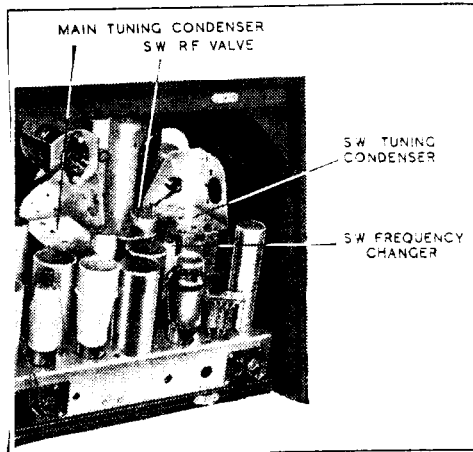

An early but very successful example of double frequency changing in a commercial receiver was embodied in the Murphy A36.

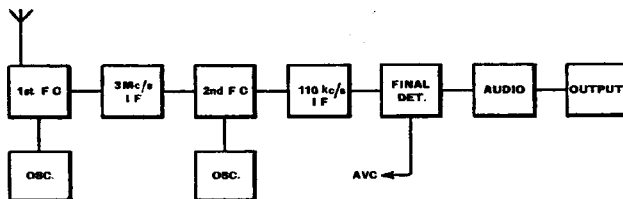

Fig. 3.—Block diagram of an alternative arrangement to that shown in Fig. 2.

not unstable, and the overall HIF alignment rechecked at this adjustment.

For those who do not already possess a receiver of the UHF Superhet type but who contemplate building a receiver using DFC, Fig. 2 gives a complete circuit diagram of such a receiver. Provided care is taken with the layout of the first frequency changer stage this receiver will give excellent results from 4 to 120 Mc/s.

It will be noted that acorn valves are specified for the first stages. This is because for operation at frequencies above 35 Mc/s there are at present no valves made which will give the same performance. Not only is the acorn pentode unrivalled in the matter of high input resistance but it also allows for a far better layout and

Principles of Fault-tracing

Part I.—LOGICAL PROCEDURE VERSUS HIT-OR-MISS

By W. H. CAZALY

SOME years ago there were put on the market in America a group of gramophone records which reproduced the noises made by faulty receivers. By listening to both records and set and comparing the sounds the semi-trained were supposed to be enabled to trace faults instantly. Nothing seems to have come of this enterprising attempt to replace intelligence by rule-of-thumb, but it deserves mention because similar ideas seem still to be popular in this country. The impressive spectacle is still often to be seen of the local "radio expert" listening gravely to the sounds given out by a defective receiver; administering a sagacious prod or two with a screwdriver; and then announcing with the aplomb of a Harley Street specialist that "there's something wrong with the grid circuit!"

This may fool the blankly ignorant set owner, to whom radio is just scientific magic. But it amuses the properly trained man, because he knows that radio receiver servicing simply isn't done like that. Sometimes the local expert knows this too, and is merely stalling for time until he can get the set away to his workshop and do some real testing with his wits and instruments. But there are, unfortunately, cases where it is a piece of abracadabra preparing the unlucky owner for an exorbitant repair bill. This sort of thing in the past has given the radio service industry a bad name, but, as its counterpart in the automobile trade did long ago, it is gradually emerging from disrepute through the efforts of honest and properly trained service-men.

The truth is that such purely aural tests are almost useless by themselves. A radio receiver is like a young baby, in that both have only a very limited repertoire of protest against internal disorders—they can only make objectionable noises about them. The keen maternal ear may possibly be able to distinguish intuitively between one sort of infantile howl and another

and know instantly whether clean nappies or gripe-water are indicated. But to the clay-souled father it is all just a meaningless din, the cessation of which can be brought about only after long, anxious and logical investigation of the case. And he is a very remarkable service-man who can distinguish infallibly between a noise made by a green-spot in an IF transformer winding and a noise made by a defective soldered joint elsewhere. These are two very different sources of trouble, both in their nature and in the cost of repairing them.

No. Faults in receivers and their accessories are traced by close inductive reasoning from the data supplied by instruments and a knowledge of the circuit. There is no real short cut; though, after years of experience, a skilled service-man may seem to skip much of the laborious primary test procedure and go almost at once to the source of the trouble with what seems, to the uninitiated, uncanny intuition. But that is only because the reasoning takes place subconsciously and by habit in his mind; it does not mean that it does not take place at all. Until he has had a good deal of experience the ordinary fault-seeker will have consciously to carry out each step of logical

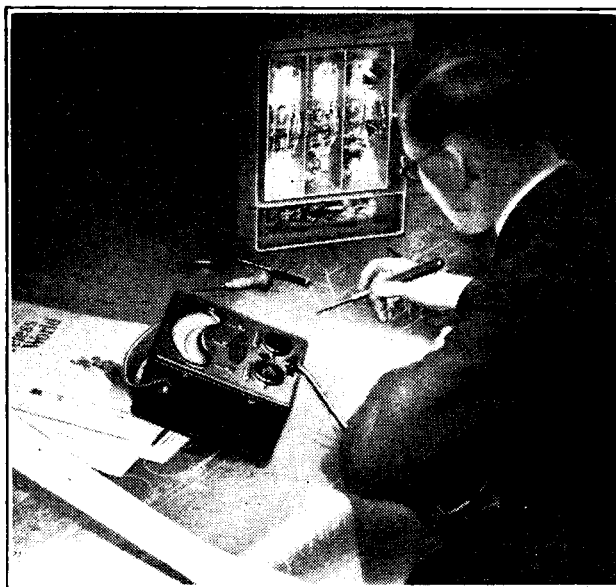

This is the first of a short series of articles explaining the correct and logical procedure in tracing faults in wireless receivers. Though dealing primarily with broadcast sets, the interests of those who have joined the wireless branches of the Services have not been overlooked.

procedure without any short cuts.

The first logical step in fault-tracing is to classify symptoms. These symptoms are of two kinds, aural and electrical. The former are the more usual causes of a set being brought in the first instance to the repair bench; but a few electrical symptoms are gross enough to convince even the layman that something is wrong—excessive consumption of HT battery power, for example, or overheating and burning smells in a mains-driven receiver, or serious dial calibration errors. The aural symptoms consist of noises or the absence of them, and they may be listed as under:—

(1) No sounds whatever, not even the slight hum or rushing noise of a "live" set. (2) No signal. (3)

Principles of Fault-tracing—

Weak signal. (4) Distorted signal. (5) Signal plus noise. (6) Noise only, no signal. (7) Lack of control of signal, either manual or automatic.

Few of these symptoms can by themselves point to a defect in any particular component. Sub-dividing them up into fine distinctions is useless, because these fine distinctions between sounds depend so much on subjective factors in the first place and in the second place still do not help in localising the area of fault. There is no point, therefore, in describing a great variety of symptoms of an aural nature. The above list covers practically every sort of audible reaction that a defective receiver can make to its condition. These symptoms, however, are extremely helpful in suggesting initial avenues of investigation to be pursued by instrumental tests. They are general sign-posts. For example, Symptom No. 6 obviously demands a test sequence quite different from that required by Symptoms Nos. 2 or 4. Beginning with a logically indicated series of tests is far more likely to lead quickly to the defective component than a muddle-headed dabbling at the wiring with instrument leads in the hope of fluking on to the cause of the trouble.

But even before proceeding with the series of specific tests suggested by some particular symptom it is necessary to make sure that certain basic conditions are satisfactory. It is taking a quite unnecessary risk of wasting one's time, energy and money to proceed further with a case until one is satisfied that

(1) The HT and LT power supplies, either battery or mains, are in good order and reaching the circuits requiring them;

(2) The valves are in good condition and making firm contact in their holders;

(3) The speaker and, if existing, extension accessories, are in good order;

(4) The aerial-earth system is in good condition.

These are fundamentals in the performance of a receiver. The man who wastes a morning searching in the bowels of a big chassis for a crackle that originates in a poor aerial connection is in the position of a burglar who spends the night blasting open the back of a safe, the door of which, the police inform him at dawn, is not locked. He will find it difficult not to feel—and look—a bit of a fool.

All these parts of the receiving installation can be tested fairly easily and quickly without even transferring the set to the workbench. Tests of them should be carried out as a matter of routine before any expense and trouble in moving the set are incurred.

It is not proposed here to describe elementary methods of testing components. After all, a receiver or even a television is little more than a hatful of condensers,

resistors, coils, valves and structural parts, wired up together and positioned in certain ways. The testing of these parts individually is not very difficult. What is difficult without logical procedure is the selection for test of a few components out of the mass of them in a crowded chassis. That is fault-tracing; and fault-tracing is quite 80 per cent. of repair work. Once the defective part has been found, it is a schoolboy's task to wield soldering iron and pliers in replacing it. Indeed, in a manufacturers' service department it is usual for a skilled man to be put on to the actual fault-tracing and for the repair itself to be carried out by a technically ignorant female wirer, who merely does exactly what she is told without in the least knowing why.

A few words on the subject of manufacturers' service departments may at this stage be suggestive. It is a mistake to think that manufacturers have expensive, elaborate and specialised apparatus in their service departments, operated by highly skilled engineers conducting highbrow tests. The service benches of at least one leading manufacturing firm have on them only the following gear: a bench test speaker, a modulated test oscillator worked by mains or dry batteries, an amps.-volts-ohms meter, an electric soldering iron, an indoor

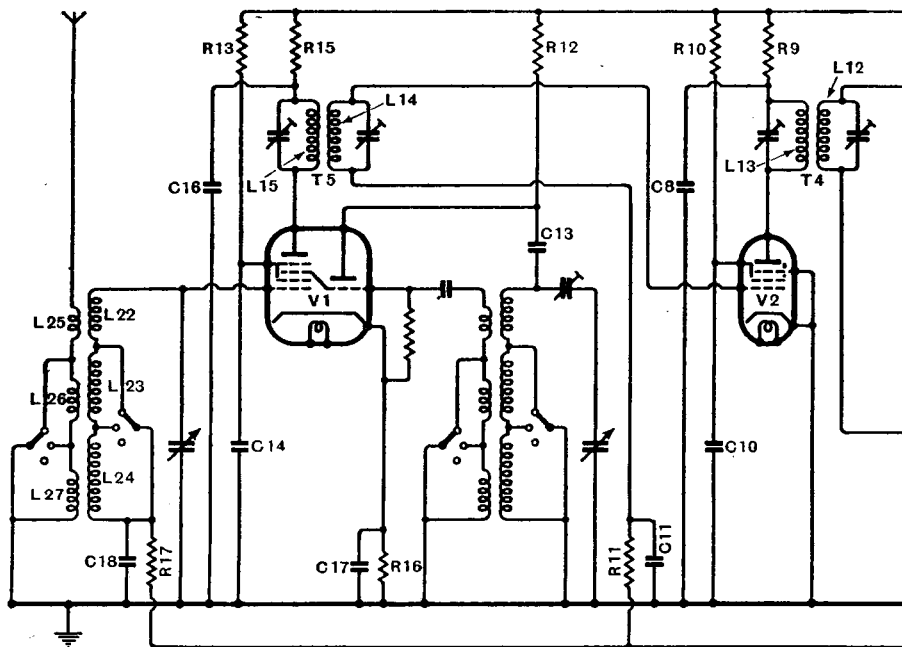

aerial, a couple of pairs of good pliers, a couple of screwdrivers, a pouch of trimming tools, a tray or two of small spares such as condensers, resistors and the like, and some odds and ends in the way of a substitute speaker "pot," a simple form of uncalibrated valve-voltmeter for testing AVC circuits, a rack of test valves, and so on. With this simple gear and their own common sense, the fault-finders are expected to diagnose the defects in anything from four to ten receivers a day. These receivers may be sent back under guarantee with obvious and easily traceable faults such as bad valves, or they may be "sticky" jobs that have baffled the

greatest brains of the local dealers and service-men and have been sent back to the makers as a last desperate resort. It is very rare for anything but an intermittent fault that demands the "cooking" of the receiver—i.e., leaving it running for hours until the fault shows up and then pouncing on it—to take up more than an hour or two of the fault-finder's time. Many owners would be amazed to see how simply and quickly faults that have annoyed them for days are revealed by the methodical tests employed by manufacturers' service-men. The conditions under which these gifted and long-suffering creatures work, too, might astonish those who are accustomed to leisurely operations in the quiet and calm of their own workshops. As many as ten test speakers may be braying their loudest in the same room, and every aerial carries its load of squeals and interference from neighbouring sets under test. But the bellowing of the speakers is the least important factor of all—a trivial stage in final testing. The real work is done by small pointers moving noiselessly over meter dials, which tell the observant fault-finder more than the utmost din from his bench speaker.

The actual repair work is not done by the fault-finder. When he suspects a component, he passes the chassis to

are also pieces of furniture of good cabinet workmanship. A scratch on the surface of a polished or sprayed cabinet will ruin the effect of a sound repair job in the chassis. So cabinets should never be handled on screw-littered and dirty workbenches; if possible they should be kept on a special shelf until wanted. Chassis should be cleaned with petrol-soaked rags, the valves cleaned with soft bread, chipped paint touched up, loose knobs replaced or soundly repaired, and odd knobs replaced by a matched set. Cellulosed cabinets can be resurfaced with Cellabrase and careful rubbing down.

Assuming that such factors have been attended to, we may now begin the outlining of the principles underlying fault-tracing methods.

It must be clearly understood throughout what follows that the assumption is made that the preliminary tests mentioned before, of power supply circuits, electrode potentials, aerial-earth system and speaker, have been properly carried out. These preliminary tests very often reveal the source of the trouble right away, and nothing further is necessary but the manipulation of soldering iron and pliers.

One example will be given of how these basic checks can be used in deducing the whereabouts of a fault. Symptom No. 1, the absence of any sound at all, even the slight hum or rushing noise heard normally when the ear is close to the speaker, is useful for demonstration purposes in this connection. It may be stated at once that such a symptom indicates only two possible forms of breakdown; either the speech-coil and output transformer secondary circuit is O/C (open-circuited) or the power supply has failed.

An experienced and intelligent fault-tracer would direct his attention at once to those parts of the circuit, doing a number of things with his test meter that might puzzle an uninitiated onlooker, who might think that something extremely serious was bound to be the matter with the set, necessitating its being torn to pieces and put together again. Of course, something like this might perhaps be required. But it might equally well be a matter of a few minutes before the investigator put away his instruments and announced that some trifling defect had developed which could be put right with a pen-knife.

It would be more useful to the onlooker in such a case to know *why* the fault-tracer made the tests he did than to know *what* the tests were. Mere lists of possible faults and their remedies are not very helpful; nor is it of much use merely to know how to use meters. One must have logical reasons, "whys," for using meters and making particular tests with them and not others. It will be instructive, therefore, to assume that some definite defect exists, and to follow the steps in the deductive process by which it is traced

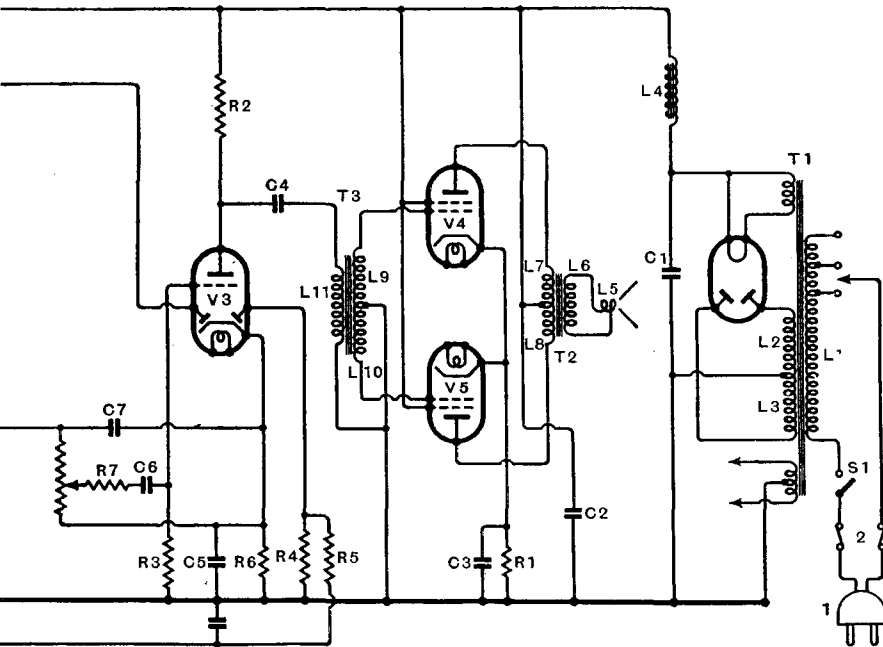

Fig. 1.—This keyed circuit diagram of a typical superheterodyne is used to illustrate methods of applying tests. It will be referred to in subsequent instalments.

a girl at one end of his bench, with laconic orders to replace such-and-such a part. The girl has not the faintest idea of what goes on in a radio receiver, but with experience she develops surprising skill in remembering how wiring goes and can practically rebuild a receiver from eye alone.

Leaves may be profitably taken from the manufacturers' book. For one thing, it should never be forgotten that modern radio sets to most of their owners

Principles of Fault-tracing—

The large keyed diagram (Fig. 1) gives the basic circuit of a typical and popular class of domestic superheterodyne receiver. Even the most modern developments in domestic reception are, when all is said and done, merely variations or minor improvements in parts. The man who thoroughly understands the working theory of a simple regenerative one-valve receiver, if he does not "know it all," at least finds that even the most complex modern circuit is quite within his mental grasp in general terms. The principles to be outlined are applicable, therefore, to almost any domestic type of receiver, either mains or battery driven—and, by certain obvious extensions, to that new development, television.

It will be assumed for the sake of illustration that the field coil, L₄, is O/C and that this fault is unknown to a hypothetical fault-tracer. His probable procedure will be described.

First, he will set his meter for continuity tests, and

connect its leads to the pins of the power plug. Then he will switch the set on and off a few times, both slowly and fast.

The reason why he does this is fairly obvious. The surest way of rendering a set completely dumb is to prevent power reaching it; and power will not be conveyed

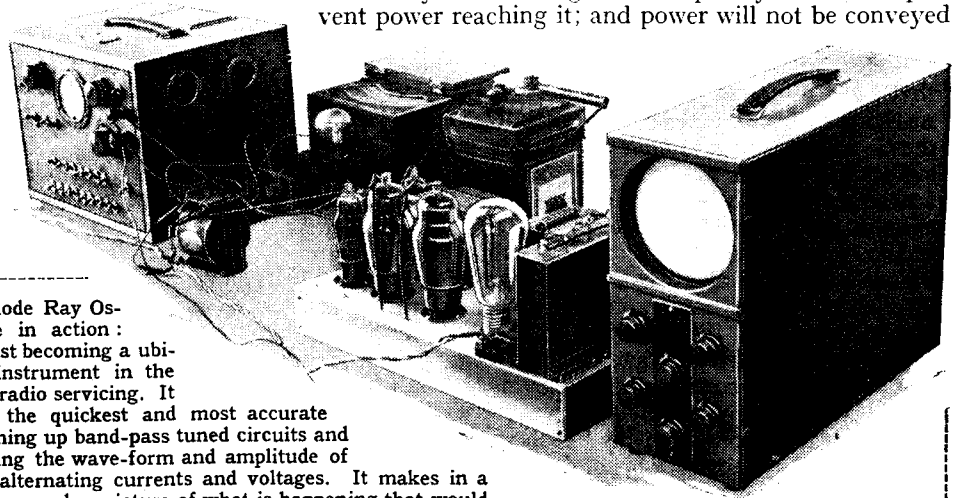

The Cathode Ray Oscilloscope in action: This is fast becoming a ubiquitous instrument in the realm of radio servicing. It provides the quickest and most accurate way of lining up band-pass tuned circuits and of checking the wave-form and amplitude of complex alternating currents and voltages. It makes in a few microseconds a picture of what is happening that would be impossible or take many hours to obtain by the usual measurement and graphical means.

to the set if the primary circuit is O/C. In this particular case, of course, he will find, when the set's main switch is on, that continuity is shown on his meter; the only appreciable resistance shown will be that of the mains input transformer primary winding, L₁. If, for the sake of illustration, it is assumed that he did *not* find continuity with the switch closed, he would begin a process of elimination of possibilities. Lack of continuity might be due to (a) a blown fuse; (b) a break in the flex lead from the plug to the fuses; (c) an O/C primary, L₁; (d) a defective switch, S₁. The philosophical tool known as "Occam's Razor"—limitation of theories to those only which are absolutely necessary to explain phenomena—is used very largely in fault-tracing, even if the fault-tracer has never heard of William of Occam and his razor and the ancient theological discussions wherein it was used. It is applied here, in that only those four possibilities are necessary to account for the lack of continuity. They are eliminated in turn by pretty obvious employments of the meter, hardly necessary to describe. Not until there remain only the two possibilities (c) and (d) does the need arise to begin removing the chassis from the cabinet; this will have to be done in most cases to get at the switch and the transformer leads.

This elementary test procedure has been described in detail to show that even the simplest of fault-tracing demands strictly logical procedure and intelligent reasoning if time and temper are not to be wasted. What a fool the fault-tracer would have felt had he lugged the whole chassis out of the cabinet, strewn the bench with bits, and then found that all he needed to do was to renew the flex which, through long use, had parted under its rubber and braiding! Such regrettable gaffes occur every day in radio servicing.

(The next instalment will deal more specifically with the correct procedure in fault finding.)

BOOKS ON WIRELESS

Issued in conjunction with "The Wireless World"

| | Net Price | By Post |
|--|-----------|---------|
| "FOUNDATIONS OF WIRELESS," by A. L. M. Sowerby. Second Edition ... | 5/- | 5/5 |
| "RADIO LABORATORY HANDBOOK," by M. G. Scroggie ... | 8/6 | 9/- |
| "WIRELESS SERVICING MANUAL," by W. T. Cocking. Fifth Edition in preparation | 5/- | 5/5 |
| "HANDBOOK OF TECHNICAL INSTRUCTION FOR WIRELESS TELEGRAPHISTS," by H. M. Dowsett. Sixth Edition ... | 21/- | 21/9 |
| "WIRELESS DIRECTION FINDING," by R. Keen. Third Edition ... | 25/- | 25/9 |
| "RADIO DATA CHARTS," by R. T. Beatty. Second Edition ... | 4/6 | 4/10 |
| "ELEMENTARY PRINCIPLES OF WIRELESS TELEGRAPHY AND TELEPHONY," by R. D. Bangay. Revised by O. F. Brown. Third Edition ... | 7/6 | 8/- |
| "LEARNING MORSE" ... | 6d. | 7d. |

Obtainable from Leading Booksellers and Railway Bookstalls or by post (remittance with order) from

LIFFE & SONS LTD., Dorset House, Stamford Street, London, S.E.1

Choosing a Hearing Aid

APPROPRIATE MEASURES FOR DIFFERENT TYPES OF DEAFNESS

By T. S. LITTLER, M.Sc., Ph.D.

IN clinics for advising the deaf on the suitability of a hearing aid an audiometer test of the patient's hearing acuity is almost invariably made. It must be understood that however useful such a test may be for giving information on the nature and degree of deafness of the patient, it cannot always be used to forecast the type of aid that will usually be found suitable. With our present knowledge of the subject and owing to the fact that responses of hearing aids vary so considerably amongst themselves it is found necessary in many instances to make subjective tests on one or two of the aids under actual conditions of use by the patient. There are, however, a number of points which, considered in conjunction with the results of audiometer tests, can assist considerably in the final choice of an aid.

The audiometer test usually made consists in determining, at a number of frequencies, the sound intensity that is just audible to the patient. This is done both by air and bone conduction and the results are plotted as the number of decibels below normal hearing or what is known as decibels hearing loss. The curve showing the results is usually known in technical circles as an audiogram.

In the case of air conduction any interference or obstruction in the hearing mechanism results in a loss of acuity. This is not so, however, in the case of hearing by bone conduction as a simple experiment with a normal person will show. If a bone conduction receiver or a tuning fork is allowed to generate sound by application to the mastoid process or other bone of the head one hears by bone conduction. If one or both of the ears are now closed with the finger tips or some form of plug the sound becomes much louder provided the frequency of the sound is not higher than about 1,000 cycles per second. The maximum change possible under these conditions is about 15 decibels in the region of 500 to 800 cycles.

In this, the last of a series of three articles dealing with hearing aids, the author describes the various kinds of deafness and discusses the characteristics of apparatus suitable for the different types

The explanation that this effect is due to the masking effect of outside noise does not hold, for the experiment can be reproduced in a sound-proof room and also the increase does not occur for high frequencies. The phenomenon can be explained if one assumes that hearing by bone conduction is dependant on relative motion between the shell of the cochlea and the cochlea fluid. Thus, closing the meatus restricts the freedom of the oval window, produces more relative motion for low frequencies and therefore a louder sound stimulus. On the other hand, at high frequencies the inertia impedance of the fluid in the inner ear is so high and the stiffness of the closed meatus so low that closure of the meatus produces little change in the sound stimulus.

From the above observation it is obvious, that if there is some restraint or obstruction in the outer or middle ear whereby free movement of the ossicles or oval window is impeded, while the inner ear is normal, we should expect bone conduction, at some frequencies, to be slightly supernormal while air conduction would be reduced. This is found to occur in certain cases of deafness where the defect is in the outer or middle ear. On the other hand, if there is a defect in the inner ear, hearing both by air and bone conduction is below normal—the so-called inner ear, nerve and perceptive types of deafness. A combination of the two types of deafness is also experienced.

Other types of deafness that are met with are known as old age and occupational deafness; they are of inner ear type and always show an increasing loss in the hearing for high frequency sounds. It appears probable that in such cases the ends of the cochlea which are nearer to the basal turn and therefore during the whole of life are the first to be exposed to sudden or transient changes of pressure, deteriorate some considerable

time before the parts more remotely situated.

The nature of a defect in hearing has an important bearing on the extent to which a hearing aid can be used to



This photograph, taken by courtesy of the Hearing Aid Department of the Western Electric Company, shows a patient undergoing an air conduction test with an audiometer. This instrument, which is also provided with facilities for bone conduction tests, can be set for any frequency up to 10,000 c/s, and enables the operator to plot an audiogram showing the extent and characteristics of a patient's hearing loss at various frequencies.

Choosing a Hearing Aid—

alleviate deafness. Outer and middle ear deafness or so-called conduction deafness, represented physically by lowered air conduction without appreciable bone conduction loss, is the easiest to assist physically. The defect is equivalent to a general lowering of the level of the sound intensity falling on the ears by approximately the amount of the hearing loss curve.

Since, in the case of incident air-borne sound, transmission by the bones of the head occurs at a level of about 50 to 60 decibels below that of the incident sound, it is probable that an air conduction reading greater than 60 decibels is impossible if there is no inner ear defect. In normal life owing to the fact that the head forms such a large receiving surface, whereas the entrance to the meatus is small, hearing by air conduction is only about 50 decibels higher than hearing by bone conduction and if the ears are closed or obstructed hearing by bone conduction increases by 5 to 15 decibels at low frequencies. We conclude, therefore, that a middle ear deaf patient with a hearing loss as high as 50 decibels probably hears much of the sounds of normal life by bone conduction.

When the middle ear patient listens to speech amplified by means of a hearing aid he hears it at a lower level corresponding to the amount of his hearing loss and it is possible to make use of a high speech level without discomfort or pain. With such a patient the amount of amplification can sometimes be as much as the hearing loss shown by his air conduction reading

and in severe cases of middle ear deafness amplifications extending up to the power limits of large amplifiers can be used to obtain a high level of intelligibility for speech. Physically, middle ear defects can produce hearing loss curves of varying gradients. Although instances occur in which the defect is accompanied by increased loss to low frequencies, the majority are those with either approximately the same hearing loss throughout the range or with greater loss to high and middle frequencies.

Steinberg's Experiments

The problem of inner ear deafness is an entirely different one, involves greater difficulty in alleviation when the hearing loss is severe, and occasionally it is not amenable to physical methods of assistance. Invariably an inner ear defect is accompanied by loss of hearing by bone conduction and unless accompanied by a middle ear defect such a patient hears by air conduction and gets the maximum alleviation by an air conduction aid. It is found in general that in the case of a patient suffering from purely inner ear deafness the upper threshold of feeling is not greater than normal and may be below normal. Consequently, high levels of speech intensity cannot be used with comfort. When hearing tests are made with such subjects it is found that a sound appears to be very loud

even when it is only 20 or 30 decibels above threshold and it has been believed for a long time that hearing in cases of inner ear defects is subnormal for weak sounds but almost normal for loud sounds.

Recent experiments by Steinberg illustrate the difference between middle ear and inner ear types of deafness as shown in Fig. 1. Steinberg found that with subjects who were deaf on one side only he could make measurements of the intensities of the sounds falling in the two ears which were considered by the patient to be equally loud. Two types were found which have been termed "uniform" and "non-uniform" deafness. Fig. 1(a) indicates that at all intensities the patient found the sound falling on the deaf ear had to be 40 decibels more intense than that falling on the normal ear; that type of deafness is known as uniform. In the inner ear type, as shown in Fig. 1(b), the sound at threshold required to be 60 decibels louder for the deaf ear, while at an intensity of 100 decibels above threshold equal intensities appeared to be equally loud; this is the type non-uniform deafness. It can be seen from this that inner ear deaf patients will find that if amplification in a hearing aid is sufficient to make the weak sounds

of speech audible it may make the louder sounds of speech appear disagreeably loud.

The solution appears to be, therefore, either to limit the amplification of the aid, thus sacrificing weak sounds, or to use an automatic gain circuit which gives greater amplification for weak sounds than for loud. Devices are in use in commercial hearing aids which attempt

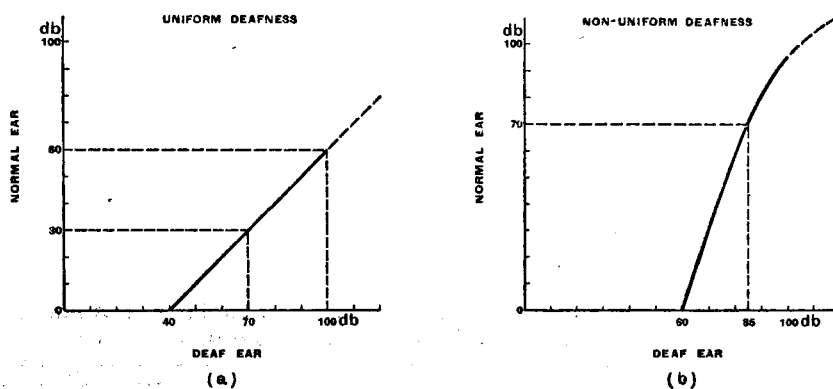

Fig. 1.—The difference between uniform and non-uniform types of deafness. Sound levels are given in decibels above normal threshold.

to overcome these difficulties. They work in various ways; overrunning a valve circuit by means of grid current, shunt circuits operating at high intensities, and rectification circuits acting on variable mu valves, as in radio receivers. Of course, in very small amplifier aids automatic gain control is present accidentally, due to power limits.

The non-uniform characteristic of inner ear deafness explains why such patients object to parasitic background noise present in a hearing aid using a carbon microphone. Such background is sometimes of the order of 60 to 70 decibels above normal threshold so that although the inner ear patient may have about 40 or 50 decibels hearing loss the noise may appear very loud to him. When he puts the aid into use his condition changes from hearing nothing at all to that of hearing an objectionable roaring noise. The middle ear patient under the same conditions would only hear the noise as 20 decibels above threshold, which would not be objectionable.

Steinberg has pointed out that the phenomena of some deaf patients hearing better in a noise can be explained on the grounds of the non-uniform character of their deafness. If there is appreciable noise present when conversation is taking place a certain amount of masking is produced and to overcome the decreased intelligibility normal speakers automatically raise the power levels of their voices. The non-uniform deaf subject is then placed in a condition in

Choosing a Hearing Aid—

which he hears more nearly normally than when speech is at a lower level. He therefore gains by the raising of the level and appears to be hearing much better. There are deaf subjects, however, whose hearing for weaker sounds is apparently genuinely increased by the presence of a noise and the phenomenon must be explained differently. It may be there is some stickiness or inertia in the hearing mechanism which is overcome by a noise of a certain level, after which any additional sound is effective; or again, there may be some looseness in the mechanism such that weak sounds below a certain level produce no effective response. It appears that all phenomena of apparent non-uniformity in deafness produce the same effects as backlash in mechanical instruments.

Audiometer Tests

We now come to the question of the choice of a hearing aid as it is helped by a record of the patient's hearing loss curve. The results given must be considered as of a very empirical nature and it should be borne in mind that the ultimate choice of a hearing aid depends on a period of test by the user under actual conditions of use. However, within certain limits, it is possible to guide the patient as to what type of aid will probably give him the best help. Speaking generally, it seems possible that if a hearing aid could be produced that had a uniform acoustic amplification throughout the whole audible frequency range, the response of such an aid could be modified in several desirable ways and we should have a universal instrument adaptable to give the maximum possible help to all cases of deafness. The results of tests already published* show that such a response is not at present forthcoming and we are forced to make use of the limited responses that are available. In addition, factors other than response must sometimes be taken into account, such as initial cost, upkeep, size, form and portability.

Perhaps the most straightforward way of attacking the problem is to determine by means of an audiometer test whether the deafness is due mainly to middle ear or inner ear defect or whether it is a combination of both. If the hearing loss as measured by bone conduction is negligible or considerably less than that measured by air conduction the deafness will be mainly of middle ear or uniform type. It is found that such a patient does not object to a moderate amount of background noise and it depends on the character of his hearing loss curve as to whether he will prefer his amplifier to have a good carbon microphone or a crystal microphone. Usually, if his hearing loss curve does not drop seriously in the upper frequencies, he will prefer the more uniform characteristics of a good carbon microphone of the immersed electrode type or transverse current type. If the loss is much greater for high frequencies he will probably prefer a crystal microphone or a carbon microphone with a high-pass filter incorporated in the amplifier. If the middle ear loss is only of the order of 30 decibels such a patient can get some help by the use of a mechanical aid or by means of a good micro-telephone type, but it must be remembered that neither of these aids gives any-

thing like the results as a good valve amplifier aid. The micro-telephone can only be chosen on grounds of small size and usually gives more trouble in its upkeep than any other type. With serious middle ear deafness (say up to 50 decibels) it is possible to make use of the full available amplification of good amplifiers.

Inner ear deafness, indicated by bone conduction loss, is dealt with differently. It depends on the magnitude of the hearing loss as to whether the annoyance of background noise is serious. Usually, as mentioned earlier, to the inner ear patient sounds well above his threshold appear very loud. His hearing loss curve is also generally one showing greater loss to high frequencies. An aid with a carbon microphone having a noise level of about 60 decibels above normal threshold is heard as an objectionable sound by an inner ear patient if his hearing loss curve is 40 decibels or less over any part of the speech range 200 to 4,000 cycles. In other words, the background noise in a carbon aid is objectionable as soon as the amplification is large enough to be helpful. Consequently, since in general tone control systems do not always prove satisfactory except near the threshold, it is better to use non-carbon aids with such subjects.

When the hearing loss is 60 decibels or more over the whole of the frequency range, background noise is not serious and both types of aid can be used. If the average hearing loss over the range 200 to 2,000 cycles per second is not more than 40 decibels, effective amplifications greater than 30 decibels are usually found undesirable. If the average is greater the user needs greater amplifications for the weaker or more distant sounds of speech, but it is found that he must adjust the aid for different listening conditions or for different sound intensities to avoid high levels of amplified speech which may become disagreeable

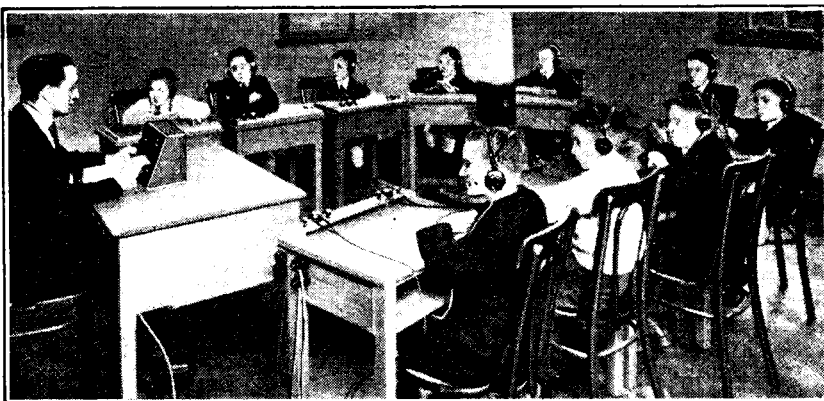

Reproduced from "The Handicap of Deafness," by Irene R. Ewing and H. W. G. Ewing (Longmans Green & Co.), the above photograph shows hearing aid apparatus in use in the new amplifier rooms at the Royal Residential Schools for the Deaf, Manchester. The pupils are being taught by lip-reading in combination with hearing.

or alternatively his aid must be designed to have a greatly reduced amplification for high intensities.

The reason why a speaking tube is sometimes preferred by an inner ear deaf patient is because its amplification is never high enough to produce disagreeable levels of sound, there is no background noise, and at the same time the ear is not closely coupled to a telephone whose transient vibrations may reach high levels.

It appears that incorporation of amplifier systems giving excessive response at the frequencies of greatest hearing loss may, under certain conditions, produce disagreeable sounds due to overloading of a part of the inner ear which

* *The Wireless World*, March, 1940.

Choosing a Hearing Aid—

is seriously damaged or defective. The writer feels that it is a great mistake to compare the problem of the choice of a hearing aid with the correction of optical defects. There is probably some analogy in the case of middle ear defects, but it is a different problem when the inner organ of hearing is damaged and much further work needs to be done before our knowledge on the subject is anything like complete. When the hearing loss at any frequency is very great it seems probable that the corresponding part of the inner organ of hearing is defective to such an extent that it can no longer contribute effectively to reception of intelligent speech. It may then be better to make use of the parts of the ear which are less defective, irrespective of the fact that the limited range is one such as would produce diminished intelligibility in normal hearing.

When deafness is a combination of both middle and inner ear types there is the problem of amplification required to overcome the middle ear loss together with the problem outlined above. It is then found that great amplification is required and the limits of present-day apparatus show themselves.

A point that often arises in the choice of a hearing aid is, "When is a bone conductor type found to be the most suitable and efficient form?" The answer is "Owing to the inefficiency and limits of transmission by bone, in a small number of cases only." It does happen occasionally that when the bone conduction loss is considerably less than the air conduction loss that the power required to give the sensation of sound by an air conduction receiver is less than that required by a bone conductor. Even then the superiority of the bone conductor does not usually extend to the higher frequencies.

While sufficient knowledge is not yet to hand on the ideal conditions under which aided hearing may occur, experimental work on present-day apparatus does indicate certain defects. Also the measured responses of different hearing aids suggests directions in which improvement is to be sought. This improvement must be at the two extremes of the frequency range, namely, below 800 and above 2,000 cycles.

Intelligibility of Speech

Writers commenting on the contribution of different frequency ranges to intelligible speech often point out that high notes contribute more to intelligible speech than do low notes. It is important to realise, however, that the frequency band below 1,500 cycles is as important as the band above and that with normal subjects 65 per cent. intelligibility can be obtained with either band alone. In the case of deafness it is not always possible to make use of all frequencies and therefore the aim in giving the maximum alleviation to a deaf subject is to make use of every available sound, whether high or low, so long as it contributes something to the intelligibility of speech. We have seen that the threshold curve of a deaf subject does not always tell us how he hears amplified speech which is well above his threshold and it sometimes happens that a patient who has a hearing loss curve which drops rapidly at high frequencies obtains less good results when his hearing aid is given reduced low frequency response by use of a high pass filter. Here it is a case of the intensity of the reproduced sound being of greater importance than the type of response. In fact, even with a poor hearing aid a deaf patient may get much help although the aid only amplifies over a narrow band of frequencies, while it diminishes the sound at other frequencies, provided the

range over which it amplifies occurs where his hearing is relatively efficient.

It seems that owing to acoustic feed-back from the telephone case and components of a hearing aid, effective amplification greater than 60 decibels are not yet possible. Even so, an amplification of this order does not appear possible at very high and low frequencies owing to the low efficiency of the telephone. Smaller hearing aids with improved response would be possible if the efficiency of the telephone receiver could be increased.

Simplifying Push - Button Tuning

CONDENSER WITH 60-DEGREE ROTATION

OF the three main systems of push-button tuning, the so-called mechanical one has a very strong appeal on the grounds of economy and simplicity. In this system the button is mounted at the end of a rod, which drives the main tuning condenser through a cam or similar device. In this way the cost and complication of a tuning motor are obviated, as are the duplication of components and the proneness to frequency drift which is apt to affect pre-tuned circuit systems unless very great care is taken.

The mechanical system is, however, by no means free from disadvantages, the principal of which is that when changing from a station at the minimum end of the tuning scale to one at the maximum end, the operation of the tuning button has to make the ordinary condenser rotor travel through an arc of 180 degrees. If the "drive" is attached close to the hub of the

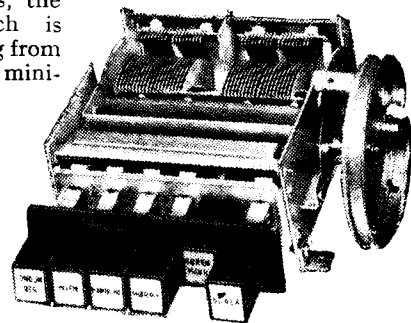

Considerably less than half the usual angular movement is required to change from minimum to maximum capacity.

condenser, the pressure needed on the button is very considerable, whereas if a greater radius is used the button will have to have an abnormally long "travel." In either case the rods will be of considerable length, and therefore very susceptible to temperature changes, so that tuning, even if accurate in the first place, is not likely to remain so.

An interesting solution to the problem was reported from Denmark shortly before that country was overrun by Germany. The Danish firm of Torotor has produced a special condenser assembly in which the full range of tuning is accomplished with an angular movement of only a little more than 60 degrees. This obviously gets rid of the disadvantages mentioned, although, needless to say, very great care has to be exercised in manufacture since the effect of any tuning error or drift must necessarily be approximately three times as great as in a condenser of conventional type. These difficulties do not, however, outweigh the manifold advantages of this convenient method of mechanical push-button tuning which bids fair to make it a serious rival to present motor tuning methods, more especially in the case of the less expensive sets.

Balloon Transmitters

COMPACT METEOROLOGICAL APPARATUS

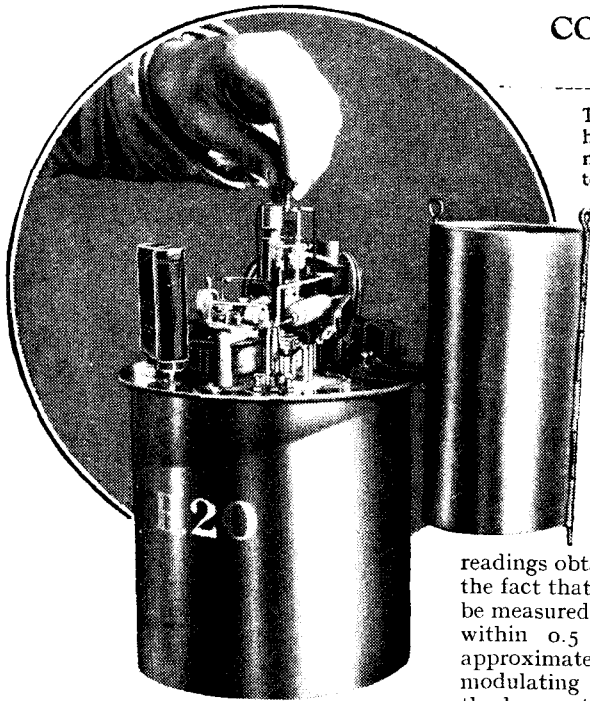

The transmitter, seen here with the cover removed, complete with temperature and pressure units weighs 2,390 grammes. The open-ended cylinder contains the thermometer unit.

The oscillator of the barometer unit, which is fixed inside the transmitter case, has a frequency variation of about 250 cycles per 1,000 millibars.

The accuracy of the readings obtained may be judged from the fact that the frequency change can be measured at the receiving station to within 0.5 cycle, which represents approximately 8 millibars. The modulating frequencies employed for the barometric transmissions are from 700 to 1,000 cycles.

The temperature unit is mounted in an open-ended cylinder attached to the transmitter case. This works on the principle of the hot-wire ammeter, with a frequency variation of 200 cycles, the range being from +20 deg. down to -80 deg. Centigrade. The frequencies employed by this element

which the current is approximately 50 mA. The aerial is suspended between the parachute and the transmitter container. In order to reduce the angular swing of the aerial, which leads to errors when taking a DF bearing, a length of cord, about 30ft., is sometimes inserted between the parachute and the aerial.

Power is provided by an 86-volt HT battery, which, together with the two filament dry-cells, is housed in the lower section of the container just below the inverted valves, the radiated heat from which is sufficient to prevent freezing. The transmitter is automatically switched on when the aerial is plugged in.

At the meteorological centres from which these "radio-sonde" balloons are released, meteorologists use sensitive short-wave receivers for picking up the transmissions. The two modulation frequencies employed for the temperature and pressure elements are measured at the receiving end by using two AF oscillators, the output from which is inserted in series with the telephones. The frequencies of these oscillators are then adjusted by the zero-beat method to synchronise in turn with the incoming modulation frequencies. As in the transmitter the frequency variation is obtained by varying the air gap of an inductance coil. The scale readings on the oscilla-

ALTHOUGH the oft-repeated phrase "a deep depression centred over . . ." is no longer heard by listeners, the Meteorological Office of the Air Ministry is none the less busy in preparing weather forecasts, which are of vital importance in modern warfare. So far as the wireless fraternity is concerned, probably the most interesting method of collecting data is that employing balloon transmitters.

These transmitters, mounted in an aluminium canister little more than a foot high and about six inches in diameter, radiate signals continuously on 35 Mc/s (8.6 metres). The transmissions are easily receiveable at a distance of 100 miles; by the time the balloon has travelled that distance it has probably risen to a height of 40,000 feet. At this altitude the balloon bursts, and the apparatus is safely brought to earth by means of a parachute. The average time for ascent and descent is approximately two hours.

It will be seen from the accompanying diagram that the transmitter circuit is a series-fed Hartley arrangement. The outputs of two tuned oscillator circuits, of which the frequencies are controlled by the temperature- and pressure-measuring instruments, are applied to the modulation valve.

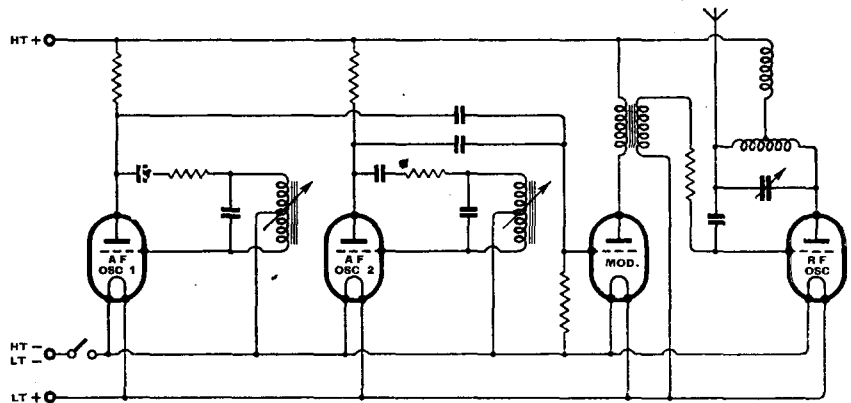

Schematic circuit diagram of the balloon transmitter.

are from 1,400 to 1,700 cycles. Frequency variation in both pressure- and temperature-controlled oscillators is obtained by varying the air gap of a small inductance coil.

The transmitter employs a voltage-fed half-wave aerial, at the centre of

factors are converted by means of calibration curves into values of temperature and pressure.

Reception of the signals by two loop or spaced aerials enables the air velocity and direction to be obtained during the balloon's ascent.

Suppression and the Petrol Engine

DO ANTI-INTERFERENCE MEASURES IMPAIR PERFORMANCE?

By C. ATTWOOD and B. COLE

WHILE briefly considering the operation of an ignition coil in last month's article it was stated that suppression resistances in the secondary circuit of the coil modify the operation of the primary circuit. The most important practical effect occurs at the contact-breaker points, but before this effect can be fully appreciated the operation of the condenser must be considered in greater detail.

In the absence of a condenser across the contact points the inductive voltage on breaking the primary circuit will produce an arc across the gap as it opens, thus delaying the cessation of current and reducing the rate of collapse of the flux. The secondary voltage will then be too low to produce ignition, while the arcing will cause a most destructive effect on the contact points. A condenser is shunted across the contact points to prevent the formation of this arc, thus speeding up the cessation of the current, and producing a sufficiently high rate of change of flux to induce the required secondary voltage.

The condenser must have a capacity sufficiently small to permit it to charge up to a high voltage very quickly but, at the same time, the capacity must be large enough to maintain the voltage at a low value until the points have separated a sufficient distance to prevent an appre-

In our April issue the ignition systems of petrol engines and the effects of radio interference suppression were discussed in general terms. A more detailed study of effects on performance made with the help of apparatus not available to the ordinary motorist is now described

even with a condenser, and it will be shown that the effect of resistance suppressors is to increase this disruptive action.

The disruptive effect on the points is governed by the primary current at the instant of break, and the working inductance of the circuit. The primary current depends chiefly on engine speed, for on closing the contact points the current builds up according to the exponential law for an inductive circuit, and the time during which the contacts are closed is so small at high engine speeds that the primary current reaches an appreciably lower value than at low speeds. The disruptive effect on the contact points is therefore greater at low engine speeds.

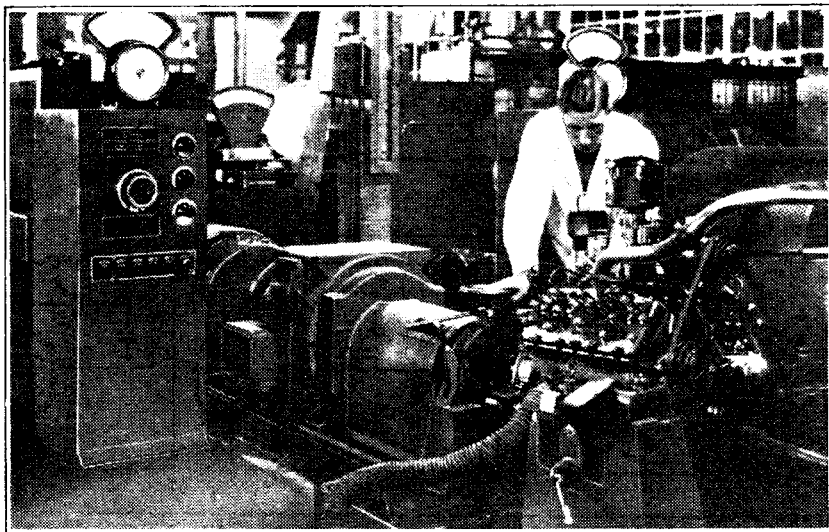

Using a dynamometer to measure change in available engine power when suppressors are fitted. Tests show that unless unnecessarily high resistance values are used, power loss is too small to be detected by the limited means available to the average car user.

ciable spark. The value chosen for the condenser is a compromise between these two conflicting factors; it must be as small as possible while being large enough to protect the points from excessive arcing. There is therefore a small disruptive effect on the contact points

The working inductance of the primary circuit will be lower than the measured inductance owing to the current flow in the secondary circuit which reduces the flux in the core. It will readily be realised that any suppression of secondary current will reduce this opposing effect so that the working primary inductance will rise, and the disruptive effect on the points will increase. In the extreme case of an open secondary circuit, the working primary inductance will rise to its measured value, and the maximum voltage at the contact points immediately after they have opened will be considerably higher. If means are provided for allowing the contact breaker to be observed while in operation the increase in arcing when resistances of high value are inserted in the secondary circuit is easily visible.

It is clear that the optimum value of capacity for the condenser when suppressors are fitted is not necessarily the same as in the absence of suppressors. This would be taken into account by designers if suppressors were incorporated as an integral part of an ignition system but it is far too technical a matter for the ordinary motorist.

Suppression and the Petrol Engine—

Having now dealt with the effects of suppression on the ignition system itself, the more general effects to be expected on the running of an engine may be considered. When operating under full load conditions suppression should make less difference to an engine than at any other time, for the working conditions go a long way towards assisting the ignition. The petrol, for example, is completely vaporised and the compression being high the temperature of the mixture also is high at the instant before it is fired. In these circumstances the mixture is in the best state to be easily ignited, and the weakest spark will suffice to initiate combustion. A rather higher voltage is necessary owing to the increased pressure, but this is somewhat offset by the increased temperature. In these circumstances a measurable difference in the maximum power due to the fitting of suppression resistors is not to be expected. Nor should there be any increase in the specific fuel consumption, unless suppression is carried to so ridiculous a degree that the engine begins to misfire.

At starting, however, conditions are entirely different. The temperature may be far below that required to produce an appreciable degree of vaporisation, and there may be little increase in temperature during the compression stroke, for, compression taking place at a slow rate, the heat due to compression may be conducted away by the cold cylinder walls and combustion chamber as quickly as it is generated. Moreover, the vaporisation of the fuel extracts heat from the mixture so that the temperature at the end of the compression stroke may actually be below the temperature of the surroundings. Carburettor designers have helped considerably to combat these effects by regulating the mixture strength at starting to a value that gives a maximum of startability. It is obvious that the ignition system is required to operate at a great disadvantage during starting, and consequently any modification that decreases the intensity of the spark is to be deprecated.

It is not possible to give exact figures for the degree of suppression that can be tolerated at starting, for there are so many variable factors that need to be considered. In practice, there have been cases of 25,000 ohm resistors so seriously impairing starting that cars have been returned to garage for repair, but this is unusual, and trouble is most unlikely to be experienced with resistances up to 20,000 ohms. With many cars the effects of suppression on starting do not become felt until resistances are raised to far higher values than are ever used for interference suppression purposes.

Finally we must consider the most difficult aspect of this matter—the effect of suppression on the performance of an engine at low throttle openings. As in the case of starting, there are the same difficult conditions

of low temperatures and low compression pressures as the throttle opening is reduced. Both conditions are comparatively big disadvantages from the point of view of ignition but there is a more serious matter that requires a fuller explanation.

Modern carburettors of the so-called economy type operate with the correct fuel-air ratio for maximum power at full throttle openings, but the proportion of fuel is automatically reduced as the throttle is closed in order to achieve maximum economy at partial throttle openings. By every artifice at his disposal the carburettor engineer endeavours to reduce the proportion of fuel, but at the same time he must ensure consistent firing and steady running of the engine. High output coils and wide-plug gaps are sometimes used to help achieve this object.

Any modification to the engine system that reduces

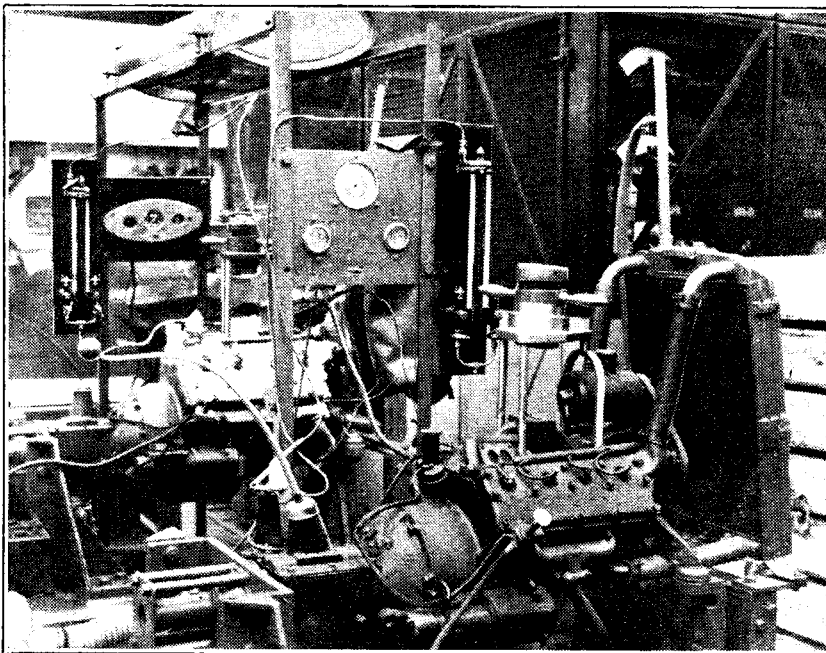

Fuel consumption of a car fitted with suppressors is, in normal conditions, very little affected. In any case, so many other factors govern the rate of fuel consumption that the ordinary motorist cannot hope to draw any reliable conclusions from such tests as he is able to make without the aid of elaborate and costly apparatus.

the spark intensity may, in these conditions, produce misfiring and erratic running of the engine. Such occasional misfiring is hardly likely to be detected by the motorist, for it must not be confused with the erratic firing, generally of one cylinder, that is usually implied by this name. Moreover, such misfiring may have a detrimental effect on fuel consumption but this is unlikely to be detected unless the motorist drives for long periods at low throttle openings. The effect on the smooth running of an engine at idling speed is, perhaps, the most serious effect of suppression, especially when the carburettor has been adjusted for the utmost economy.

The various effects of suppression resistances on engine performance that are to be expected have now been covered in reasonable detail. The main conclusions are:—

Suppression and the Petrol Engine—

(1) Resistance suppression completely alters the nature of the spark discharge. The reduction in the capacity component of the spark, due to the reduction in the effective plug capacity, may affect idling or starting, but the reduction in the inductive component due to the ohmic value of the suppression resistors is of practically no consequence. Under normal running conditions the power of an engine is unaffected by resistances of the values used for suppression purposes.

(2) The retardation of spark timing at any engine speed can be ignored.

(3) A single resistance in the distributor lead can be expected to have a less detrimental effect than resistances of equal value in each sparking plug lead, but the difference in practice is very small. At the same time, the single resistance is less effective as a suppressor of interference.

(4) The reduction in the secondary surge is beneficial to the life of the coil, while the increased secondary voltage produced by suppressor resistances is of no importance.

(5) There is an increased disruptive effect on the contact points which may involve more frequent adjustment and cleaning of the points, but generally does not appear to cause serious trouble in practice.

(6) Suppressors can cause trouble at starting with certain cars, but no difficulties are to be expected if resistance values are not too high. With some cars resistances may be raised far beyond their usual value without affecting starting.

(7) The most serious effect of suppression is on the slow running of certain engines, particularly when the carburettor has been adjusted for the utmost economy.

(8) There are no grounds for expecting increased fuel consumption except possibly at low throttle openings with engines designed for extreme fuel economy.

The Solution of the Problem

In conclusion, it is not possible to assign precise values to resistors that will assure no deleterious effect on engine performance for conditions vary so much with different cars, even with cars of the same make and type. Generally speaking, all the effects mentioned in these articles are negligible in practice with resistors up to 20,000 or 25,000 ohms. There are, however, exceptions. Authentic cases are known of 25,000 ohms resistances reducing startability below the critical point, while an E.R.A. report refers to the case of a luxury car whose suppressor resistors had to be reduced to 5,000 ohms in order to ensure satisfactory idling of the engine.

Although the above cases are exceptional it is essential for the radio industry to be in a position to convince every motorist that his car performance will in no way be affected by fitting suppressors, and the question arises as to whether present-day suppressor resistance values are not unnecessarily high. It is the authors' contention that 15,000 to 25,000 ohm resistances, which first came into use for internal car-radio interference suppression, are unnecessarily large for television and short-wave suppression outside a vehicle.

It is difficult for either the radio technician or the

motorist to look at the question of motor car interference from an impartial point of view, but whereas in the past the extensive work carried out by private firms and official organisations on car interference suppression has concentrated on the interference suppression and ignored the car, the eventual solution to this problem must ensure that, first and foremost, the motorist will be convinced that the performance of his car will be affected to a negligible extent, and, secondly, interference will be reduced to such a degree that it will cause negligible interference with either short-waves or television within the service area of a station.

At present, the motorist is not convinced, but perhaps he could be if resistors were reduced to 1,000 to 5,000 ohms, for there has never been any suggestion that resistances of this order affect performance in any way. This raises the question as to whether the resulting suppression of interference will be sufficient. A series of experiments has been conducted to test this contention. When 5,000 ohms resistors were fitted to a car, it was found to produce no interference at all with a television receiver, the aerial of which picks up interference from unsuppressed cars which are 200 or 300 yards away. With 1,000 ohm resistors interference could just be detected with no television signal and full receiver sensitivity, but there was no interference at all with either sound or vision when sensitivity was reduced to the level required for normal reception. These tests were very limited in scope, and the results of a complete investigation by one of the organisations equipped with apparatus for testing the suggestion quantitatively would be of considerable interest.

Motor car ignition interference with the short-wave and television services is a very serious matter, and the average car owner is quite unaware of the inconvenience he is unwittingly causing. There will be no complete solution to this problem until the car manufacturers themselves suppress their products, but in the meantime, the conscientious motorist who fits suppressors to his car will earn the gratitude of an increasingly large number of people, and he will have the satisfaction of knowing that the effect on his own car is, in the majority of cases, all but negligible. If measurements support the contention in the latter part of this article, it will be *entirely* negligible.

REFERENCES.

There appears to be almost no published work dealing with the effect of suppressors on engine performance. There is a brief reference at the end of E.R.A. report No. M/T47. An article in *The Wireless World*, "Interference Suppression and Engine Performance" (April 13th, 1939), dealt with the matter from a practical point of view with reference to one particular car.

For sufficiently detailed explanations of the process of ignition reference must be made to original articles in the Journals of the Automobile and Electrical Institutions. The most valuable articles are the following:—

(1) *The Process of Ignition*. Young and Warren, I.A.E. February, 1920.

(2) *Notes on Ignition of Explosive Gas Mixtures by Electric Sparks*. Morgan, I.E.E. January, 1916.

(3) *Magnetos for Ignition Purposes*. Watson, I.E.E. May, 1921.

(4) *Coil Ignition Systems*. Watson, I.E.E. January, 1932.

It should be mentioned that the British Standards Specification referred to at the beginning of the article published in the April issue of this journal is No. 833, April, 1939.

Letters to the Editor

THE EDITOR DOES NOT NECESSARILY ENDORSE THE OPINIONS OF HIS CORRESPONDENTS

Morse Key Manipulation

WITH reference to the letter from "Radiophare" in your April issue, I am sending some pages from a booklet that I published in 1917 for the training of students in the last war. With nearly 40 years' experience in telegraphy, I can assure your readers that the method illustrated and described in that booklet is the most practicable, particularly for avoiding cramp or strain.

This information is gladly given in the hope that it will help trainees to acquire a correct style. Speed and the necessary flexibility of wrist will automatically follow with assiduous practice.

Newcastle-on-Tyne. J. K. A. NICHOLSON.

[We reproduce Mr. Nicholson's sketches, which show the recommended position of the hand holding the key knob. The relevant text from his booklet reads:—

"Sit comfortably facing the table, with the chair a little to the left of the telegraph key so that the right hand falls naturally on to the key. Rest first and second fingers lightly on the top rim of the knob of the key, with the thumb pressing slightly upward on the lower side of the knob. Allow the third and fourth fingers to hang freely, inclined towards the palm of the hand. The two fingers resting on the knob should form a convex figure or arc.

"The elbow should be about six inches from the body, with the wrist as free as possible. The knob, wrist and elbow should be in a straight line; and the whole attitude free from restraint.

"The nature of the 'grip' upon the key should be very similar to that in using a pen. It should be light, gentle, but even and sure. It must be firm enough to secure absolute control of the key, but must not be rigid.

"There should be no skipping, jerking, hopping or timidity; neither is any special vigour required. The downward pressure of the hand should cease after the lever comes to rest, otherwise there will be wasted energy and unnecessary stress on the working muscles.

"There is no time for surplus movements. The upholstery of flesh at the finger ends is a cushion, sufficiently elastic to secure this firmness of contact without laborious efforts on the part of the telegraphist if he is cool,

Mr. Nicholson's sketches showing the recommended positions of the hand in obtaining the correct position on the key knob.

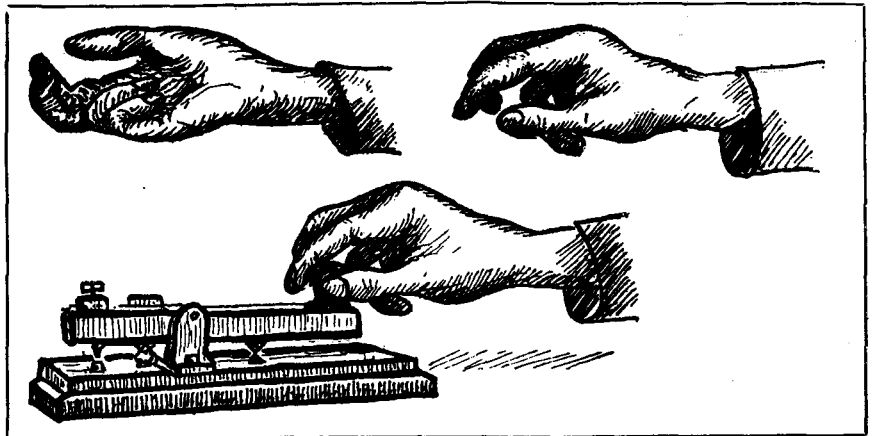

concise and even in his pressure, avoiding convulsive impulses. Arm or wrist must not rest on any part of the table; and the pressure of the thumb should be maintained against the underside of the knob of the key.

"Signals should be formed with an easy wrist action. Indeed, suppleness of wrist is an important factor. Working the arm up and down, or moving the fingers, as in writing, must be avoided. Guard against a 'tapping' style. In wireless telegraph it is essential to make clear, heavy signals, well spaced.

"Having mastered the 'grip' upon the knob, practise alternately with dots and dashes."—Ed.]

Constant Potential Rectifiers

I HAVE read with interest the above article in the April issue of *The Wireless World*. I notice that in the text relating to Fig. 7 the authors contend that the output of a 3-phase rectifier is some 45 times as easy to smooth as the output of a single-phase unit. It appears that this statement is based on the well-known facts illustrated by the oscillograms in Fig. 3, but surely the efficiency of any smoothing device must be judged by its capacity to prevent the noise content of the rectifier output reducing the articulation efficiency of the communication system to which power is being supplied.

When considering smoothing requirements it is usual to refer the permissible residual noise content to some reference frequency. The psophometer weighting curve adopted by the C.C.I.F. in 1934 is based on the amount of noise which degrades the articulation efficiency by 5 per cent. and gives weighting factors for calculating the disturbing effect, relative to 800 c/s, of any frequency between 50 and 4,000 c/s. The factors for 300 and 100 c/s are 0.3 and 0.015 respectively, i.e., a ratio of 20:1, and if this aspect is considered together with the authors' contentions it appears that a given filter will only be about twice as effective on a 3-phase as on a single-phase rectifier.

Referring to Fig. 8 it will be seen that the ripple content of the rectifier output when the rectifier is not loaded is $2\frac{1}{2}$ times that obtaining when the rectifier is operating on full load and, as the smoothing filter must be designed to take care of the worst condition, it seems that unless there are other factors to be considered it would be unwise to rely on a smaller filter than would normally be required for

a straightforward single-phase rectifier of similar output characteristics.

Harrogate.

ICH DIEN.

Learning Morse

YOUR correspondent Mr. Leahy raises an interesting point in connection with the study of morse; the two systems mentioned are not quite so irreconcilable as they would at first appear, but it is important that the matter be clarified if serious misconception is to be avoided in the minds of students.

Since correct morse is based on rhythm it would not be unfair to make a comparison with the study of music, an art which is also fundamentally based on rhythm.

The dots and dashes of the morse code and the spaces separating them have relative values exactly as the crotchets and quavers used in standard musical notation. These values vary according to the tempo or speed of sending and to suggest that there is an arbitrary and fixed value for a dot and dash is, to put it mildly, misleading. Sending speeds can vary from the beginner's 5 WPM to the automatic at 200 or more WPM; it is obvious that a complete letter sent at 200 WPM may occupy a smaller time interval than a single dot at the lower speed.

Here, however, is the crucial point. When the speed becomes excessively slow the rhythmic character of the signal is less easily grasped. It must not be forgotten that the aim of the learner is to send and receive at normal operating speeds and, just in the same way as a teacher explaining the meaning of musical symbols might go over a single bar of music at normal speed and then pause before going on to the next bar in order to give his listeners time to grasp the rhythm, so also it is a very distinct advantage for a learner to hear the rhythm of a single letter sent at moderate normal speed, say 20 WPM, with a longer-than-normal pause before the next letter. Any attempt, however, to play a piece of music with longer-than-normal pauses between the bars would result in a travesty of the correct tune and it is precisely the same with morse. Once proficiency has been attained a good sender will maintain his time intervals and ratios accurately whatever his speed.

It is true that there are almost imperceptible variations from strict accuracy which permit one to recognise the man at the key by his sending and distinguish hand-sending from the coldly mathematical accuracy of the automatic. Here, again, my musical analogy holds good: automatic sending has the cold accuracy of the player-piano, human sending has expression.

Clarkston, C. H. CAMPBELL GRAY.
Renfrewshire.

YOUR correspondent Mr. C. F. N. Leahy raises an interesting matter on the subject of letter and space ratios in the learning of morse.

I agree with Mr. Leahy that a constant-length dot and dash (I cannot bring myself to accept dit and dah) is to be commended, but he is perfectly correct in surmising that a speed of 40 WPM makes confusion confounded for a learner.

The speed of 25 WPM is still, to my mind, too high, but I have had a certain success in training men to read under this system if the letter formation be maintained at between 15 and 20 WPM.

However, one cannot lay down any hard-and-fast rules, for learning morse is, like everything else in life, largely one of individual aptitude. I have known men who could read 20 WPM in a few weeks from scratch, whilst others in the same time were only just sure of their alphabet.

Having trained Army telegraphists from the raw during the war 1914-18, I formed the opinion, which I proved conclusively, that should the beginner be a musician or even musically inclined he started with an advantage which generally made him the quickest pupil and finally a good operator.

A. A. TURNEY, M.I.W.T.,
Bridgwater. O.C. 29th Div. Signal School, 1918.

AS I am learning morse, I was interested in the system of constant-length dits and dahs described in Mr. Leahy's letter.

Though I am by no means an expert, the method seems to me to have one rather big disadvantage. If the beginner has to rely for the greater part of his practice on commercial and service transmissions picked up on the short waves, he will never find any suitable ones. In a message sent slowly with constant-length dits and dahs the reader has time to think after each letter. In an orthodox transmission there is no such breathing space, and the reader has to acquit the habit of "copying late," which is where I, personally, find the greatest difficulty. Until the beginner could receive a message sent normally at the fundamental speed corresponding to the lengths of his symbols, he would experience considerable difficulty in receiving a normal message at, say, 10 WPM.

Possibly this method is responsible for the style of those who can send beautifully at speed, but cannot keep their ratios correct when sending slowly.

Cambridge. R. T. L. ALLEN.

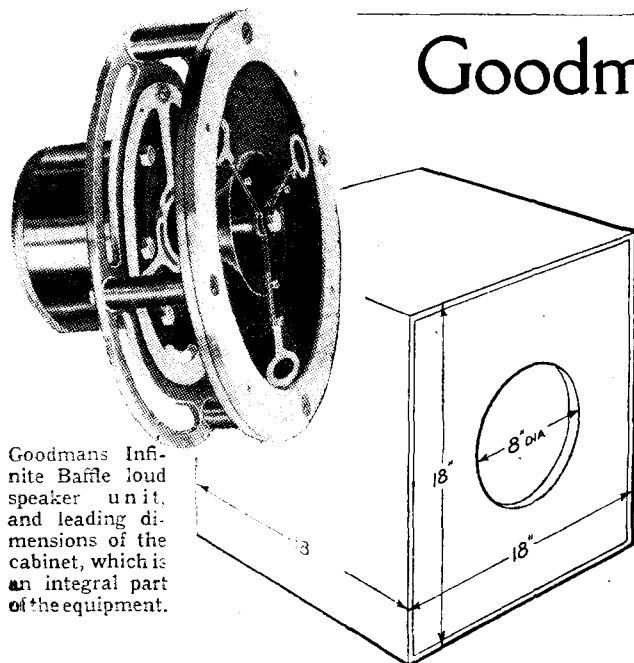

Goodmans Infinite Baffle loud speaker unit, and leading dimensions of the cabinet, which is an integral part of the equipment.

Goodmans Infinite Baffle Loud Speaker

THE principle of the totally enclosed baffle has in recent years gained steadily in favour, and there can be no doubt that it offers many advantages for quality reproduction. Chief among these is its ability to sustain a level output far down into the bass without growing to the unmanageable size of the horn type loud speaker.

Goodmans Industries, Ltd., Lancelot Road, Wembley, Middlesex, were one of the pioneers in this field, and have made considerable strides in the design of the special type of loud speaker unit required. A very free diaphragm suspension is necessary if the fundamental resonance is to be kept low, since the air enclosed in the baffle imposes a considerable compliance on the diaphragm. Further, the diaphragm amplitude at low frequencies is a very large, and precautions must be taken not only against chattering but also to avoid harmonic distortion.

These problems have now been solved, and the current

Goodmans Infinite Baffle Loud Speaker —

model is a really first-class reproducer which no one need hesitate to use in conjunction with the highest grade of receiving or amplifying equipment. We say this advisedly, for the frequency response is wide enough to reveal harmonic distortion, background noise, needle scratch or land line distortion, if they are present, and it is unfair to expect it to suppress or correct faults in the preceding links of the chain.

The frequency response is at least 40 to 12,000 cycles, and throughout this range there is no appreciable resonance or trough. The general level rises slightly towards the high-frequency end.

The electro-acoustic efficiency is good and much less than the full output of the "W.W." Quality Amplifier (4 watts) was required to produce orchestral volume in a room of twice the size of the average living-room. No trace of overloading could be detected with 6 watts input (the maximum available at the time of testing) and the maker's figure for peak AC load is 15 watts.

The loud speaker is sold complete with 18in. cube baffle ready for mounting inside a more elaborate cabinet if desired. A large output transformer with low iron core distortion is sold specially for use with this loud speaker. The current price of the loud speaker is £10 and of the transformer £1 15s.

Short-wave Receiving Conditions

(COMMUNICATED BY THE ENGINEERING DEPARTMENT OF CABLE AND WIRELESS, LTD.)

DURING the period March 26th-April 25th conditions on the short waves were erratic at the beginning and end of the time under review, due to extensive ionosphere storms covering the following dates: March 26th to April 4th (inclusive), April 15th, 16th and 20th to 25th (inclusive).

Communication proved to be difficult on many of these days, particularly over transatlantic routes; in general, the most reliable period was from 12.00 to 18.00 GMT.

Magnetic activity has progressively increased during recent years, and is frequently most prevalent during Equinoctial months; the recent disturbances were thus not altogether unexpected.

Sudden ionosphere disturbances of the "Dellinger" type were experienced in this country at the following times: March 26th, 15.50 GMT; March 27th, 16.25 GMT; March 30th, 16.45 GMT; April 15th, 16.18 GMT; April 18th, 08.15 GMT.

Examples of wavelength utility periods for the month under review are tabulated below:—

| Route | Waveband (Metres) | Period (GMT) |
|--------------------|-------------------|--|
| North Atlantic ... | 20—22 | 09.30/22.00, but extending to 01.00 during the latter part of the month. |
| | 40—42 | 22.00/09.30. |
| South Atlantic ... | 16—18 | 08.00/12.00, 19.00/22.00. |
| | 13—15 | 12.00/19.00. |
| | 28—35 | 22.00/08.00. |
| Far East... .. | 15—17 | 07.00/18.00. |
| | 20—22 | 05.00/20.00. |
| | 30—35 | 20.00/01.00. |

The usual decline in the noon value of the critical frequency of the F2 Layer with the approach of summer months was again in evidence; the difference of the winter and summer values is likely to be less pronounced than of recent years, due to the change in solar activity.

Henry Farrad's Problem Corner

No. 47.—Wartime Improvisations

c/o Traidre and Co., Ltd.,
Metropolis,
Nutralia.

Dear Henry,

Owing to the war it is almost impossible to get new components out here, and one has to make do with what one has got. This is not always easy, as instance my present problem, which I hope you can solve for me, as it has got me whacked.

I am making up a special amplifier that necessitates a bias control giving 0.6 volts. This supply is tapped off from the bias supply to the output stage, 40 volts. The proper way of doing it is with a 7,500-ohm potentiometer and 40,000-ohm series resistance, as shown in my diagram, giving just over 6 volts maximum. But the only valves

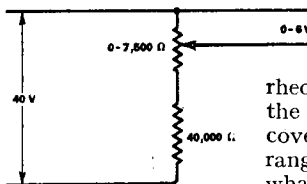

I have are a 25,000-ohm rheostat and half a dozen 10,000-ohm resistors. I might try to convert the rheostat into a potentiometer, but the required 6-volt range would be covered by much less than the full range of the control, which is not what I want. Can you suggest anything? The current that may

be drawn from the 40-volt supply is limited to about a milliamp.

Hoping to see you when the unpleasantness is over,

Yours ever,

JOHN.

Can the requirements be met with the components available?

(Henry Farrad's solution is on p. 310.)

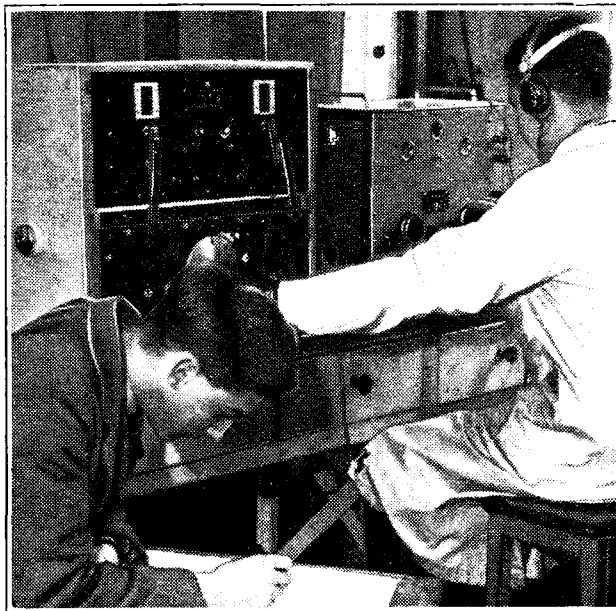

Meteorologists receiving and recording transmissions from the "radio-sonde" balloons referred to on page 287.

Philips Model 805A

AC SUPERHETERODYNE (FOUR VALVES + RECTIFIER) WITH
 "SILENTRON" RF STAGE PRICE: 13 GUINEAS

BUILT to provide an outstanding short-wave performance at a reasonable cost, this new Philips receiver dispenses with "frills" such as push-button tuning which do not contribute to that end. An efficient cathode-ray tuning indicator is fitted, however, since this provides a valuable indication of comparative signal strength and the degree of fading which may be present. Medium- and long-wave ranges are, of course, included, and there is provision for a gramophone pick-up.

Circuit.—The so-called "Silentron" pentode valve with aligned grids is employed in the RF stage to give the highest possible signal-to-noise ratio. It is preceded by a single tuned circuit in the aerial and is coupled by transformers, tuned on all three wavebands, to the triode-hexode frequency changer. The high intermediate frequency of 470 kc/s has been chosen to reduce second-channel interference as far as possible.

When the circuit is switched for gramophone reproduction the pentode valve in the IF stage is converted

The cathode-ray tuning indicator is of an improved type designed to give two degrees of sensitivity. Instead of the usual single amplifying stage there are two triodes, connected to individual deflecting plates which control separate shadows, one on each side of the target. Signals producing AVC voltages up to approximately -3 are shown by one shadow, while the other will accommodate stronger signals up to -15 volts in the AVC line before closing up.

The pentode section of the final stage is rated for a maximum anode dissipation of 9 watts, and no permit is required to purchase the set. The undistorted output available is 4 watts.

Performance.—There is ample volume from the permanent-magnet loud speaker, and an internal cone diffuser gives good distribution of high-note response. The middle register is well filled out, and if there is a suggestion of rather less bass than usual this must be accounted an advantage from the point of view of short-wave listening, since it ensures microphonic stability

Circuit diagram of Philips Model 805A. The IF stage is used for AF amplification when reproducing gramophone records.

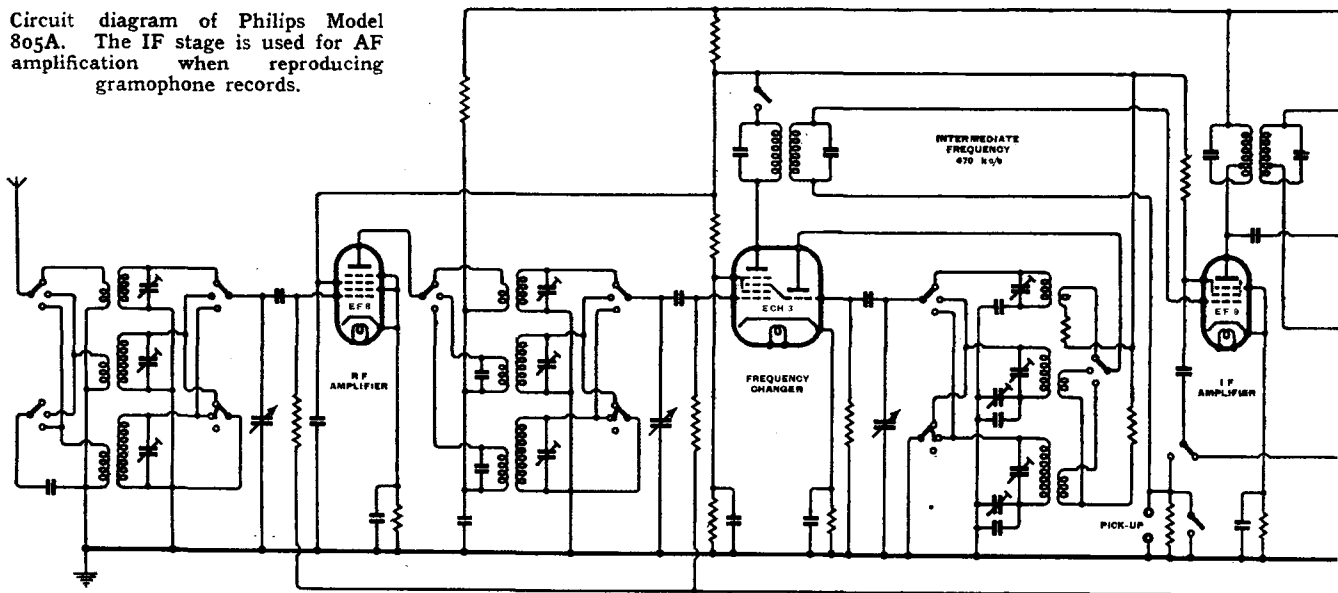

to a triode, using the screen grid as anode, and is then connected as a first-stage AF amplifier before the pentode output valve.

Diodes for signal rectification and AVC bias are included in the same envelope as the output stage. Both the tuned circuits from which they derive their input are tapped down to reduce damping. AVC is applied only to the RF and frequency-changer stages.

and better tonal balance when top has to be severely cut in the presence of external interference.

As regards internally generated noise, the set is one of the quietest we have tested, and the signal-to-noise ratio is remarkably high. On short waves the performance as regards sensitivity and general liveliness bears comparison with the best communication-type receivers. Most of the American short-wave broadcast stations

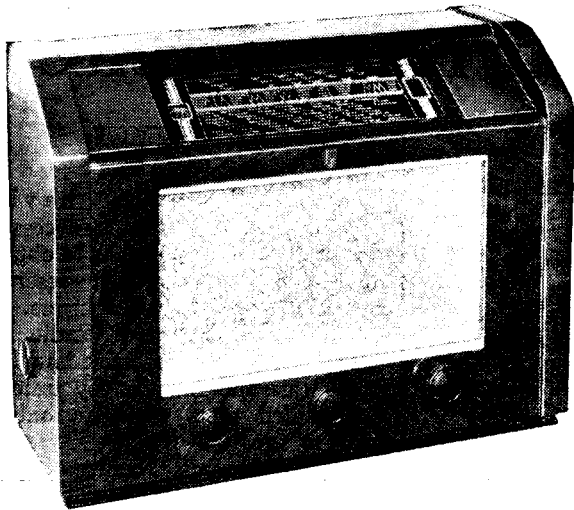

WAVERANGES

| | |
|----------------|-------------------|
| Short | 16.7 - 51 metres |
| Medium | 197 - 580 metres |
| Long | 708 - 2000 metres |

easily close up the sensitive section of the tuning indicator, and are tuned on the "coarse" section, like the majority of medium-wave stations.

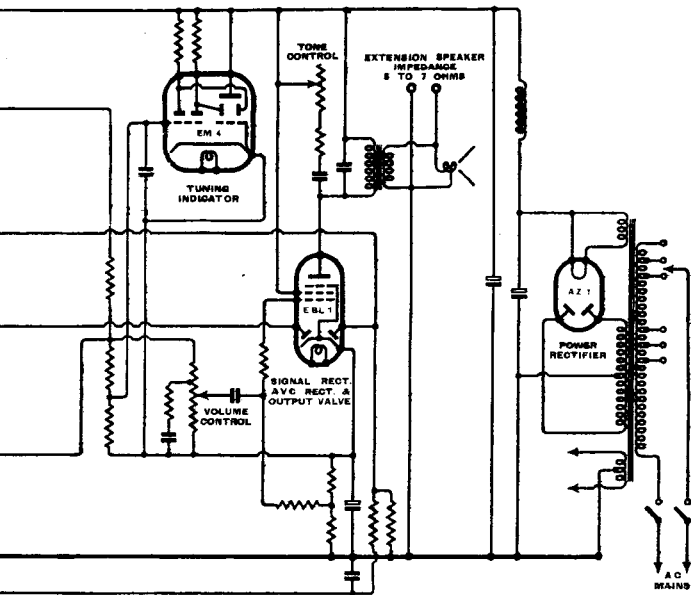

With two stages of pre-selection and a high intermediate frequency it was expected that image suppression would be good, and on test this prediction proved to be well founded. No self-generated whistles were traced on any waveband, and repeat tuning points at the lower end of the short-wave range were conspicuous by their absence.

The range and selectivity on medium and long waves

are above the average, and there can be no doubt that for the man of moderate means whose principal interest is general listening to the broadcast stations of the world this is the ideal type of set.

Constructional Features.—All the controls have the silky feel which is a characteristic of recent Philips sets. The tuning control has a single reduction ratio which is a good compromise between the requirements of the three waveranges.

The dial is illuminated by a single pilot light on the chassis, backed by a parabolic reflector. An illuminated waverange indicator is provided, and the short-wave scale is supplemented in the region of the principal broadcast bands by the ingenious stepped zig-zag "micrometer" scale in enlarged form, which has proved itself such a successful feature of other Philips sets.

Dustless Wire Stripper —with Vacuum Waste Collector

DRIVEN by a $\frac{1}{4}$ horse-power motor, this steel-brush-type wire stripper is equipped with a vacuum exhaust which sucks up all loose insulating material and deposits them in the drawer at the bottom, thus completely eliminating the usual dust and dirt of stripping. The stripping is done by passing the wire ends between the faces of rapidly revolving steel brushes ($1\frac{1}{2}$ in. diameter, 2 in. face) fixed one

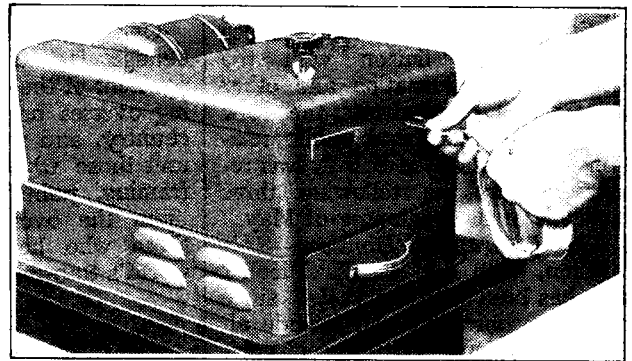

above the other. According to the American correspondent who sent this photograph, the unit quickly and thoroughly strips and cleans solid or stranded wire, removing cotton, silk, enamel, asbestos, and all other types of insulation, including the sticky, gummy type embedded in stranded wire.

Terminology of Direction Finding

IT is all to the good that the precise meaning of the terms used in wireless should be clearly defined and generally agreed. The publication of a glossary of terms used in radio direction finding will, therefore, be welcomed by all concerned with this specialised branch of the art. Issued in the form of a supplement to the British Standard Glossary of Terms used in Electrical Engineering, the booklet defines not only terms of purely radio significance, but also expressions (such as "magnetic declination") used in applying direction finding.

Alternatives are given in some cases, and it is noted that such well-established terms as "indirect ray" and "sky wave" are deprecated; "ionospheric ray" and "ionospheric wave" are preferred.

The booklet, numbered Section 12 of B.S.205-1936, is issued at 1s. (by post 1s. 2d.) by the British Standards Institution, 28, Victoria Street, London, S.W.1.

Current Topics

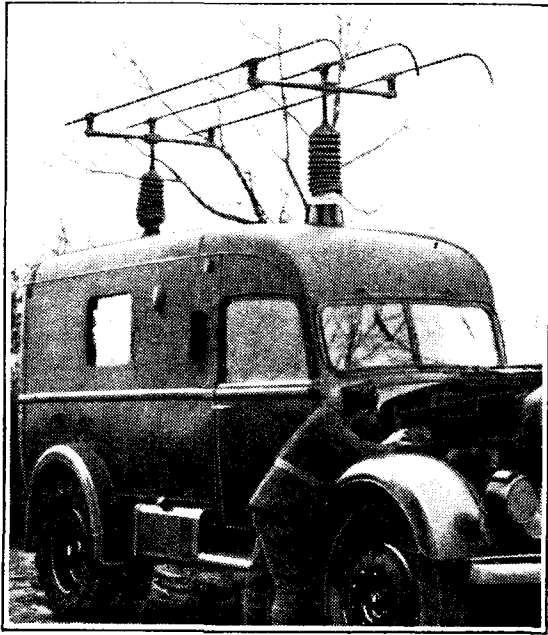

RECENT EVENTS IN THE WORLD OF WIRELESS

◆ ◆

CONCERTINA SUP-
PORTS are employed
by the French army
for mounting aerials
on the roofs of mobile
transmitter-receivers.
The curvature of the
elements ensures a
close fit to the roof
when the aerial is not
in use.

◆ ◆

B.B.C. REORGANISATION

Unifying an Essential Armament

IN order to meet the extensive developments of wartime broadcasting, including the maintenance of continuous liaison with the Ministry of Information and other Government departments, the work of the programme and public relations divisions of the B.B.C. was reorganised in the following three divisions at the beginning of May.

The Programme Division.—This division, with Mr. B. E. Nicolls, who has been with the B.B.C. since 1924, as controller, will include all programme departments except news and talks and those which specialise in planning overseas programmes. It will also be responsible for the Listener Research Service.

The Home Division.—Mr. A. P. Ryan, who has been assistant controller (public relations) since 1936, will be controller of this section, which will include the home news and talks departments, the Press section, and the editorial direction of the B.B.C.'s home journals.

The Oversea Division.—This section, with Sir Stephen Tallents, who has been controller of public relations since 1935, as controller, will be responsible for the planning and direction of the B.B.C.'s services to the Empire and foreign countries. It will also include the Corporation's

oversea publicity and information services, and the monitoring service.

One of the main purposes of the changes is that it unifies the management of the outgoing and incoming overseas broadcast traffic of the country, and so knits into a single unit those who are responsible for framing, publicising and reporting upon the overseas broadcasts and those who keep watch upon the world's transmissions.

THE N.P.L. : A YEAR'S WORK

THE recently issued Annual Report for 1939 of the National Physical Laboratory would indicate that there are sufficient facilities elsewhere for war research to allow the laboratory to continue, at least in part, to remain on a peacetime footing, in so far as it continues to assist industry in solving its problems. Naturally, many of these problems are brought about by wartime conditions.

During the year under review, the Radio Department was mainly concerned with matters of ultra-short-wave propagation, including studies of the ionosphere and direction-finding, and some interesting information on these subjects is given.

The Report, published by H.M. Stationery Office, costs 2s. 6d.

SERVICEMEN

Training by Post

REPRESENTATIONS having been made without success to the authorities with a view to obtaining some modification in the reserved age for radio service engineers, the National Association of Radio Retailers has been considering how best it can ease the situation by training semi-skilled men who are outside military age.

As a result a postal course of training in radio servicing, which will comprise twenty lessons written by Mr. Paul D. Tyers, has been started. Those taking the course, which, costing £2 2s., is available to any member of the Association or his employee, will receive one lesson at a time. A lesson should, on an average, be completed in a week, but no such stipulation is made. Corrected papers are returned to the student with the following lesson.

R.A.F. TECHNICAL OFFICERS

Signals Branch Opportunities

THE Air Ministry announces that in order to meet the need for a number of technical officers for employment on signals duties in the Royal Air Force, commissions in the R.A.F. Volunteer Reserve will be granted for the duration of hostilities to suitable applicants between the ages of 21 and 50 years possessing the requisite personal and technical qualifications.

Applications are invited from holders of engineering or science degrees, or those with technical college or approved institute diplomas, and two years' experience in telecommunications engineering (preferably on the radio side).

A number of vacancies is also open for candidates possessing a sound theoretical knowledge of elementary electricity and magnetism, of the principles of wireless telegraphic and telephonic communications, and of transmitter circuits, modern wireless receiving apparatus, and apparatus for the measurement of high-frequency potentials and currents. Some practical experience in addi-

tion is desirable, and specialised knowledge in one or more of the practical aspects of telecommunications would be an asset.

Candidates selected for commissions will be entered in the newly formed technical branch of the R.A.F. Volunteer Reserve in the rank of Pilot Officer on probation, for whom the present minimum rate of pay is £264 per annum, plus allowances.

Candidates whose qualifications do not reach the high standard required of officers of the technical branch, but whose services can be utilised on special duties of a technical character, may be offered commissions as Acting Pilot Officers on probation (if requiring initial training), or Pilot Officers on probation (if suitable for immediate posting to a Service unit) in the administrative and special duties branch of the Volunteer Reserve. The present minimum rates of pay are: Acting Pilot Officer £182 a year, Pilot Officer £215 a year, plus allowances.

Candidates should apply in writing to the Air Ministry, S.7.e.5, Adastral House, Kingsway, London, W.C.2, giving full particulars of their qualifications, training and experience.

MR. A. R. BURROWS

MR. ARTHUR R. BURROWS, who, as announced in last month's issue, was leaving the Geneva office of the U.I.R. where he had been secretary-general, has been appointed by the B.B.C. temporary Newcastle Director. Prior to his appointment in the U.I.R. at its foundation in 1925, he was with the B.B.C. and can justly be called a pioneer of British broadcasting, for he was largely responsible for the inauguration of the B.B.C.'s service from London, Manchester and Birmingham in 1922.

During his fifteen years with the U.I.R., Mr. Burrows has worked untiringly for the furtherance of friendship between the broadcasting organisations of the world.

Although the international situation has severely restricted the activities of the Union, it is understood that the office is to continue in Geneva. The post from which Mr. Burrows resigned will be filled by a Swiss.

TELEVISION IN AMERICA

President Roosevelt's Statement

THE controversy arising out of the announcement of the Federal Communications Commission suspending its concession permitting "limited commercial" operation of television transmitters from September 1st, culminated in a statement by President Roosevelt in which he advocated a free, competitive television industry on the lines of present-day sound broadcasting in the States.

"The F.C.C. and the industry," says a writer in *Broadcasting*, "were placed under a virtual mandate from the Senate Interstate Commerce Committee to get together quickly and stop what has been termed the bickering and bungling that are delaying television development."

The question of standardisation of transmitting systems is the crux of the television situation in the States. R.C.A.-N.B.C. has a 441-line system, whilst the recently licensed DuMont transmitter employs 625 lines. Philco's vertical-polarisation 605-line system has, however, been dropped, and the American R.M.A. 441-line standard adopted.

OPERATOR TRICKS NAZIS

"City of Flint" Echo

THE story of the capture of the American steamer *City of Flint* by the Nazi raider *Deutschland* is recalled by the story of the steamer's chief radio officer, published in the May issue of *Radio News*.

When the *Deutschland* signalled the *City of Flint* ordering her not to use her wireless, the radio operator, Bill Schuss, did what he was ordered and a little more. He shifted the tank coil clips to a point where he estimated the transmitter would operate on a wavelength on which he had heard British patrol ships.

"Unfortunately," said Schuss, ironically, "the two German operators who came on board could not contact their submarine escort, cruiser or radio station DAN." It was only when the German commander became suspicious and they put into Norway for orders, that Schuss realised that the game was up, and he therefore surreptitiously replaced the tank coil clips to their original position.

MARCONI DAY

ON April 25th the Italian Chamber celebrated the 66th anniversary of the birth of Guglielmo Marconi,

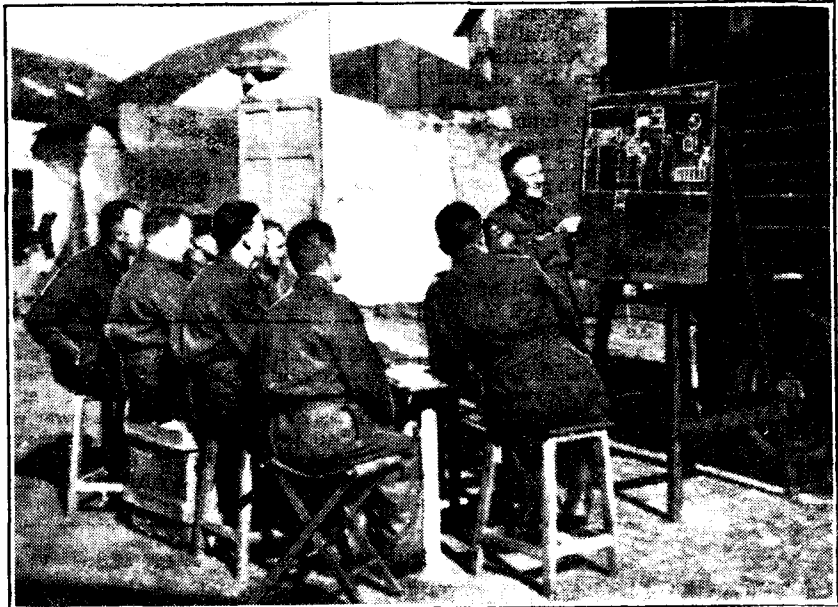

TRAINING THE B.E.F. IN FRANCE. This photograph, sent to *The Wireless World* by a reader with the B.E.F., shows an instructor lecturing soldier students on the principles of a standard signal generator in the yard of a R.A.O.C. workshop somewhere in France.

Wireless World

Current Topics—

who, as a writer in *The Times* stated, when the honours of history are properly distributed will assuredly be allowed the title of "great" with far ampler justification than most of those to whom the epithet has been attached. He won his way to imperishable fame by bringing—as the President of the Italian Chamber said—a new source of power to humanity.

"Britain may without presumption," says the writer, "claim to have helped to make the greatness of Marconi. Italy produced the man; Britain produced the means. . . . But he belongs less to a country than to mankind."

B.B.C. NEWS ON SHORT WAVES

WE give below the times (B.S.T.) of the B.B.C.'s short-wave European transmissions of news in English.

From GSA, 6.05 Mc/s (49.59 metres), and GSW, 7.23 Mc/s (41.49 metres), at 12.30, 1.30, 7.15 and 9.0 a.m., and 12.30, 2.15, 5.0, 7.0 and 11.0 p.m.

From GRX, 9.69 Mc/s (30.96 metres), at 12.30, 1.30, 7.15 and 9.0 a.m., and 7.0 and 11.0 p.m.

From GSE, 11.86 Mc/s (25.29 metres), at 12.30, 2.15 and 5.0 p.m.

FROM ALL QUARTERS

Iconoscope Inventor Honoured

DR. VLADIMIR KOSMA ZWORNYKIN was among the nineteen engineers and scientists who received national awards given by the National Association of (American) Manufacturers for original research and inventions, to mark the 150th anniversary of the founding of the American patent system. Dr. Zworykin was honoured for his contributions to electronic research resulting in basic devices such as the Iconoscope and Kinescope, applicable to television.

Obituary

WE regret to record the death at the age of 75 of the Right Hon. H. A. L. Fisher, Warden of New College, Oxford, on April 18th, as a result of a street accident. It will be remembered that he was one of the five Governors of the B.B.C. whose appointment was terminated with the change in the Corporation's Board within a few days of the outbreak of war.

Too Much Wireless

THE view that many aircraft operating authorities are prone to "clutter up the ether" with inter-aerodrome messages that might better be handled by landline was expressed by a speaker at an I.E.E. meeting on May 1st. The occasion was the reading of a paper "Civil Air Transport Communication" by Mr. A. D. Hodgson, of the Air Ministry, who covered the subject comprehensively, making some interesting comparisons between American practice and that followed on the European and Empire routes.

Navigational Science

THE Council of the Royal Society of Arts is offering a prize of £50 under the Thomas Gray Memorial Trust, the objects of which are "the advancement of the science of navigation and the scientific and educational interests of the British mercantile marine," to any person who brings to its notice an invention, publication, diagram, etc., proposed or invented by himself during 1940, which is considered to be an advancement in the science or practice of navigation.

Iranian Short Waves

IRAN'S short-wave broadcasting service was recently opened by the Crown Prince. The ceremony and the subsequent transmissions were radiated from Teheran on 19.87 metres. Announcements are frequently made in English.

International SW Club

OWING to the war, subscriptions to the International Short-wave Club can no longer be accepted at the London Headquarters (Mr. Arthur E. Bear, 100, Adams Gardens Estate, London, S.E.16). Members and intending members should send the equivalent of one U.S. dollar direct to the club at East Liverpool, Ohio, U.S.A.; this subscription entitles them to receive the club magazine for one year.

Brit. I.R.E.

At the annual general meeting of the British Institution of Radio Engineers held on April 24th, Sir Arrol Moir, Bart., who was re-elected president, drew attention to the increase of membership by 71 during the year. The proposal to increase the subscription paid by registered students of the Institution was defeated as being opposed to its policy of encouraging young engineers or radio engineering students. The proposal to increase the subscription of associate members to £1 11s. 6d. was, however, carried.

Royal Signals Comforts Fund

IN order to help in raising the money needed to buy wool for all the knitters who are working for the Royal Signals Comforts Fund, Mrs. Ozanne, wife of Col. G. D. Ozanne, has opened a shop opposite Olympia. Saleable gifts will be welcomed at 18, Trevor Place, London, S.W.7.

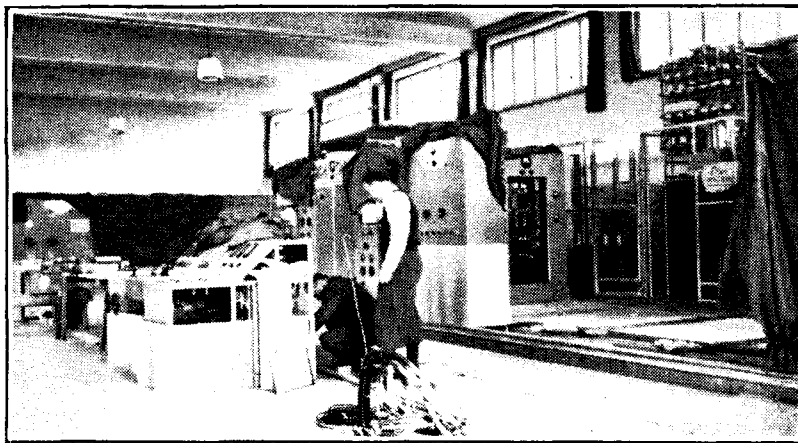

INSTALLING the short-wave transmitting apparatus in the recently rebuilt Swiss broadcasting station at Schwarzenburg. Until the station is put into service later in the year, Swiss transmissions are being radiated by the League of Nations' station at Prangins. Transmissions in English for North America are radiated from 2.45 to 4.10 a.m. (B.S.T.) on Thursdays by HBJ on 20.64 metres (14.54 mc/s). On Saturdays from 6.45 to 8.10 p.m. (B.S.T.) a transmission in English and French beamed on South Africa is radiated by HBO on 26.31 metres (11.40 mc/s).

Order Your "Wireless World"

DUE to the situation in Scandinavia, still more drastic rationing of paper is now in force. To avoid waste, newsagents are no longer permitted to return unsold copies of journals, and so order no more than will cover their anticipated requirements. It is therefore imperative that readers should place a definite order with their newsagents; this is particularly important in the case of a specialist publication like *The Wireless World*. Orders can, of course, be countermanded from issue to issue in the event of change of address.

NEWS IN ENGLISH FROM ABROAD

REGULAR SHORT-WAVE TRANSMISSIONS

| Country : Station | Mc/s | Metres | Daily Bulletins (B.S.T.) | Country : Station | Mc/s | Metres | Daily Bulletins (B.S.T.) |
|--------------------------|-------|--------|---|----------------------------|-------|--------|-------------------------------------|
| America | | | | Hungary (continued) | | | |
| WNBI (Bound Brook) .. | 17.78 | 16.87 | 5.0, 6.0. | HAS5 | 9.62 | 31.17 | 12.15 a.m. †, 12.30 †. |
| WCBX (Wayne) | 11.83 | 25.36 | 12.30 a.m. † | HAS3 | 15.37 | 19.52 | 3.55 †. |
| WCBX | 15.27 | 19.65 | 8.30 †, 10.50 †. | India | | | |
| WCBX | 17.83 | 16.83 | 1.0, 2.0 †, 3.0 †, 3.15 †, 4.0* †, 4.30 †, 6.0, 6.30 †, 7.55 †. | VUM2 (Madras) .. | 11.87 | 25.28 | 4.50. |
| WGEO (Schenectady) .. | 9.53 | 31.48 | 8.30 †, 9.55 †, 11.25 †. | VUD2 (Delhi) | 9.59 | 31.28 | 4.50. |
| WGEA (Schenectady) .. | 15.33 | 19.57 | 1.0, 2.0 †, 9.55 †. | Italy | | | |
| WPIT (Pittsburgh) .. | 15.21 | 19.72 | 6.0. | I2R03 (Rome) | 9.63 | 31.15 | 4.0 a.m., 7.35 a.m., 7.28, 10.15 †. |
| WRUL (Boston) | 6.04 | 49.67 | 11.0 †. | I2R09 | 9.67 | 31.02 | 12.30 a.m. |
| WRUL | 11.79 | 25.45 | 8.30 †. | I2R04 | 11.81 | 25.40 | 4.0 a.m., 4.40, 8.25. |
| WRUW (Boston) | 11.73 | 25.58 | 11.0 †. | I2R06 | 15.30 | 19.61 | 4.0 a.m., 7.35 a.m., 12.15, 8.25. |
| WRUW | 15.13 | 19.83 | 8.30 †. | I2R08 | 17.82 | 16.84 | 12.15, 4.40. |
| WLWO (Cincinnati) .. | 6.06 | 49.50 | 7.25 a.m. | Japan | | | |
| Australia | | | | JZJ (Tokio) | 11.80 | 25.42 | 9.5. |
| VLQ (Sydney) | 9.61 | 31.22 | 9.15 a.m. | JZK | 15.16 | 19.79 | 9.5. |
| VLQ2 | 11.87 | 25.27 | 9.15 a.m. | Manchukuo | | | |
| VLR (Melbourne) .. | 9.58 | 31.32 | 10.0 a.m., 2.50. | MTCY (Hsinking) .. | 11.77 | 25.49 | 7.30, 10.0. |
| VLR3 | 11.88 | 25.25 | 9.50. | Portugal | | | |
| China | | | | CSW7 (Lisbon) | 9.74 | 30.80 | 10.0 (Tues., Thurs. & Sat.) |
| XGOY (Chungking) .. | 9.50 | 31.58 | 10.30. | Rumania | | | |
| XGOY | 11.90 | 25.21 | 11.30 a.m., 12.10, 10.30 | Bucharest | 9.28 | 32.33 | 10.55 †. |
| Finland | | | | Russia | | | |
| OFD (Lahti) | 6.12 | 49.02 | 12.45 a.m., 2.15 a.m., 8.55 a.m. †, 7.15, 10.30. | RW96 (Moscow) .. | 6.03 | 49.75 | 9.0, 11.0, 11.30. |
| OFD | 9.50 | 31.58 | 12.45 a.m., 2.15 a.m., 8.55 a.m. †, 7.15, 10.30. | RWG | 7.36 | 40.76 | 10.30. |
| OIE | 15.19 | 19.75 | 12.45 a.m., 2.15 a.m., 8.55 a.m. †, 7.15, 10.30. | RKI | 7.52 | 39.89 | 10.30, 11.30. |
| France | | | | RIA | 8.07 | 37.17 | 9.0, 10.30, 11.30. |
| TPC3 (Paris-Mondial) .. | 9.52 | 31.51 | 2.30 a.m., 5.45 a.m., 7.30 a.m. | RW96 | 9.52 | 31.51 | 9.0, 11.0, 11.30. |
| TPA4 | 9.68 | 30.99 | 9.15 a.m., 8.30. | RAL | 9.60 | 31.25 | 1.0 a.m., 9.0, 10.30, 11.30. |
| TPA4 | 11.72 | 25.60 | 2.30 a.m., 5.45 a.m. | RIC | 11.64 | 25.77 | 12.0 noon. |
| TPB8 | 11.84 | 25.33 | 2.30 a.m., 5.45 a.m., 4.45, 8.30. | — | 11.90 | 25.21 | 12.0 noon. |
| TPA3 | 11.88 | 25.25 | 8.30. | RNE | 12.00 | 25.00 | 1.0 a.m., 4.0 †, 11.30. |
| TPB6 | 15.13 | 19.83 | 9.15 a.m., 4.45. | RKI | 15.04 | 19.95 | 1.0 a.m. |
| TPC5 | 15.24 | 19.68 | 2.0. | RW96 | 15.41 | 19.47 | 9.0 a.m. |
| TPB3 | 17.85 | 16.81 | 12.0 noon. | Spain | | | |
| French Indo-China | | | | FETI (Valladolid) .. | 7.07 | 42.43 | 8.50. |
| FZR (Saigon) | 11.78 | 25.47 | 12.0 noon, 4.45. | Sweden | | | |
| Germany | | | | SBO (Motala) | 6.06 | 49.50 | 10.45. |
| DJC (Zeesen) | 6.02 | 49.83 | 8.0. | SBU | 9.53 | 31.48 | 10.45. |
| DJI | 7.29 | 41.15 | 11.15. | Turkey | | | |
| DJA | 9.56 | 31.38 | 7.15. | TAP (Ankara) | 9.46 | 31.70 | 8.15. |
| DJL | 15.11 | 19.85 | 10.15 a.m., 2.15. | TAQ | 15.20 | 19.74 | 1.15. |
| DJB | 15.20 | 19.74 | 5.15, 8.15, 9.15, 10.15. | Yugoslavia | | | |
| Hungary | | | | YUA (Belgrade) | 6.10 | 49.18 | 8.30, 10.30. |
| HAT4 (Budapest) .. | 9.12 | 32.88 | 1.30 a.m. §. | | | | |

The times of the transmission of news in English for Europe from the B.B.C. short-wave station are given in Current Topics, page 298.

REGULAR LONG- AND MEDIUM-WAVE TRANSMISSIONS

| Country : Station | Kc/s | Metres | Daily Bulletins (B.S.T.) | Country : Station | Kc/s | Metres | Daily Bulletins (B.S.T.) |
|--------------------|-------|--------|---|-------------------|-------|--------|----------------------------|
| Estonia | | | | Hungary | | | |
| Tartu | 731 | 410.4 | 10.5. | Budapest 1 | 546 | 549.5 | 11.10. |
| Finland | | | | Ireland | | | |
| Lahti 1 | 166 | 1,807 | 12.45 a.m., 8.55 a.m. †, 10.30. | Radio-Eireann .. | 565 | 531 | 6.45 †, 10.10 (10.5 Sun.). |
| France | | | | Italy | | | |
| Radio-Paris | 182 | 1,648 | 9.30. | Rome 1 | 713 | 420.8 | 12.30 a.m., 7.28, 10.15 †. |
| "Radio 37" | 832 | 360.6 | 6.45, 9.15, 10.45. | Milan 1 | 814 | 368.6 | 12.30 a.m., 7.28. |
| L'Île de France .. | 1,204 | 249.2 | 6.45, 9.15, 10.45. | Latvia | | | |
| Germany | | | | Madona | 583 | 514.6 | 10.0 (Tues. and Fri.) |
| Bremen 2 | 224 | 1,330 | 10.15 a.m., 5.15, 7.15, 8.15, 9.15, 10.15, 11.15. | Kuldiga | 1,104 | 271.7 | 10.0 (Tues. and Fri.). |
| Bremen 1 | 758 | 395.8 | 12.15 a.m., 10.15 a.m., 2.15, 5.15, 7.15, 8.15, 9.15, 10.15, 11.15. | Rumania | | | |
| Hamburg | 904 | 331.9 | 12.15 a.m., 10.15 a.m., 2.15, 5.15, 7.15, 8.15, 9.15, 10.15, 11.15. | Radio-Romania .. | 160 | 1,875 | 10.55 †. |
| | | | | Bucharest | 823 | 364.5 | 10.55 †. |
| | | | | Russia | | | |
| | | | | Moscow 1 | 172 | 1,744 | 11.0, 11.30. |
| | | | | Sweden | | | |
| | | | | Motala | 216 | 1,389 | 10.45 †. |
| | | | | Stockholm | 704 | 426.1 | 10.45 †. |
| | | | | Falun | 1,086 | 276.2 | 10.45 †. |

All times are p.m. unless otherwise stated. * Saturdays only. § Saturdays excepted. † Sundays only. ‡ Sundays excepted. || Approx. time.

Unbiased

By FREE GRID

Personal Degaussment

I WAS exceptionally interested when the Government released the news of this degaussing business, as it so happens that I have for some time past been working on similar lines, although not in connection with ships, it being the human body which I have been attempting to degauss and it being in the interest of radio that I have been doing it.

I was induced to commence my

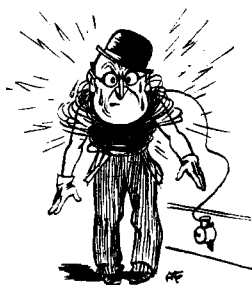

A technical hitch.

experiments by the simple fact that, although you can eliminate a tremendous amount of electrical interference to broadcasting by such highly commendable methods as the use of anti-static aerials, you certainly cannot eliminate all of it. After you have done all that is known to radio science there still remains a small but very pernicious and irritating residue of interference which cannot be accounted for by thermal agitation and similar "explanations" beloved of the orthodox radio engineer.

I was for a long time sorely puzzled over this question, and I was put on the track of the solution by Mrs. Free Grid, although no credit is due to her for this. Actually she had been suffering from insomnia after an orgy of spring cleaning and furniture rearranging, which, by reason of some curious kink in their mental make up, all women indulge in from time to time.

The medico whom she consulted told her that she had a very sensitive nature, and that her sleeplessness was due to the fact that in her rearranging of the furniture she must have put her bed in an east-

and-westerly direction, thereby causing disharmony between the magnetic field of her body and that of the earth, and he advised her to apply the obvious remedy. I must confess that I have often heard of this so-called remedy for insomnia, but have always classed it as an old wife's tale like slipping a key down your throat to stop nose bleeding.

We live and learn, however, and in my case I certainly learned a lot as it incited me out of pure curiosity to measure the strength of my own magnetic field, and to my intense surprise I found it to be fluctuating wildly, thereby being a prolific source of interference to my enjoyment of broadcasting. I soon found that the fluctuations of the magnetic field of the body were in some way bound up with the process of digestion, or rather of indigestion, and that by a careful course of dieting it could be lessened but not completely eliminated.

I was in fact up against a technical brick wall when the Government released the news of this degaussing business, and it was not long before I had passed a few turns of cable round my midriff, and had plugged into the mains. There was a slight technical hitch at first as in my haste I had used insulated heater wire of a type that is normally employed for electric blankets, and I soon began to get uncomfortably warm. However, this little contretemps was soon overcome and I know now what real interference-free reception is like, and I am trying to interest manufacturers in marketing these personal degaussers for listeners, as there is, I feel sure, a fortune in the idea.

Wartime Worries

EVER since the beginning of the war my *Wireless World* battery-driven A.R.P. set has been straining at the leash waiting to do its bit in adding to the din of falling bombs and crashing masonry.

There is, however, one great snag about keeping the batteries up to snuff, and that is the elementary scientific fact that an accumulator

thrives when doing its stuff and pines away if left too long in idleness. The obvious way to keep the LT battery in use is to switch the set on, and this I did when first putting the set into commission.

The cost of charging an LT accumulator at home is negligible, and I solved the problem of HT battery wastage by fitting a vibrator. Wastage in any form is abhorrent to my nature, and it cannot be denied that this unnecessary use of the set to give the battery exercise has a slow deteriorating effect on the emission of the valves, to say nothing of the vibrator contacts.

I am pleased to say, however, that I have now satisfactorily solved the problem of discharging the accumulator without wear and tear of the set, or even the necessity of providing a fiddling discharge resistance. I keep two accumulators, and while one is standing by in a fully charged condition I discharge the other one by putting it on charge backwards; this has the effect of passing a discharging current through it which is inappreciably greater than the nor-

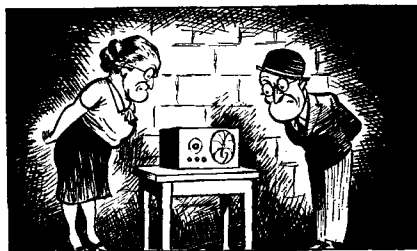

Waiting to do its bit.

mal charging current. After discharging I simply reverse the connections and recharge it.

Actually the tip was given me by a man who keeps the battery of his laid-up car in trim in this fashion. His mains happen to be DC, and he keeps the battery in series with the household mains, thus obtaining "free" charging, the cost being represented by the loss of 6 volts from the 240 lighting voltage, which, negligible as it is, he gets back when discharging, as the 6 volts are then added to the 240 volts.

New Pick-ups

TWO MOVING COILS AND A CRYSTAL

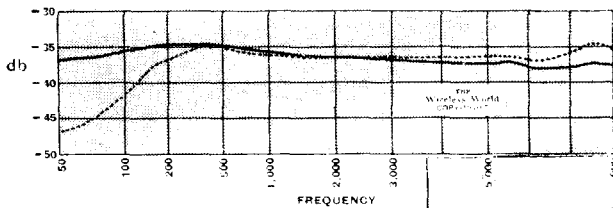

The "Coil" pick-up employs a movement similar to that of a moving coil meter. Above is shown the output characteristic of the pick-up with output transformer and equaliser. Zero db is equivalent to 1 volt RMS. The dotted curve is the recording characteristic of the test record.

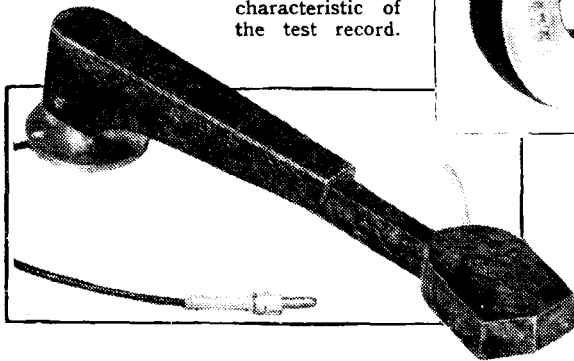
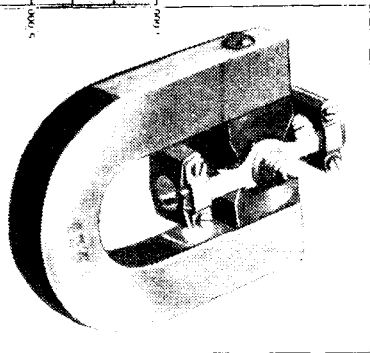

point. This is mounted at right angles to the surface of the record to minimise high-frequency loss—particularly near the centre of the record.

A coupling transformer and equaliser as well as a volume control are included, and with these in circuit a remarkably good frequency characteris-

tic is obtained. Compensation for constant amplitude recording below 250 cycles in the test record is very close, and between 50 and 8,000 cycles the deviation from level response does not exceed ± 1.5 db.

The price of the "Coil" pick-up complete is £7 10s. New sapphire points cost 10s., including fitting.

The new Voigt pick-up, although still in the experimental stage, is sufficiently far advanced to justify a description of its leading features and performance. A very low moment of inertia is achieved by winding the coil in the form of a narrow loop and mounting it between rubber pads in a parallel slit in the magnetic circuit so that it rotates about its long axis. The sapphire needle is vertical and is supported to give great longitudinal rigidity to resist the frictional drag of the groove. The forces required to produce the normal lateral displacement are so small that a downward pressure of only $\frac{1}{2}$ oz. is sufficient on many records.

The output is low and a step-up unit incorporating a correction cir-

THE prospect of a shortage of high quality imported pick-ups has provided a welcome stimulus to British manufacturers, and it is gratifying to be able to report that two moving coil types are now ready to go into production.

We have had advance models of these instruments on test, and there can be no doubt of their superiority over moving iron armature types in the matter of amplitude distortion and the introduction of harmonics. The low inertia of the moving parts is also apparent in the improved transient response, and the performance generally is a most distinct advance over the standards to which we have grown accustomed. Unfortunately, the voltage output is low, but the inconvenience of having to find more amplification is amply repaid by the results finally obtained.

The "Coil" pick-up made by H. H. Jones, Worcester Street, Stourbridge, employs a miniature circular coil, similar to that of a loud speaker, which is mounted between curved pole pieces and is suspended on a thin flat metal strip so that it rotates in a manner similar to that of a moving coil meter. The record vibrations are transmitted to it through a hollow cone in the apex of which is embedded a sapphire needle

Frequency characteristic of the Voigt moving coil pick-up taken with corrector circuit. Zero db corresponds to 1 volt RMS.

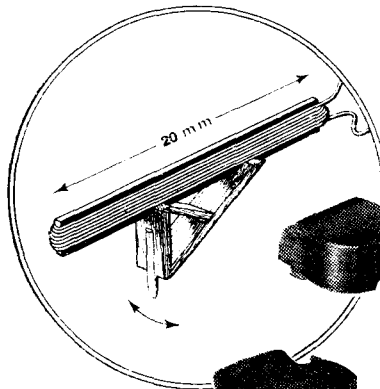
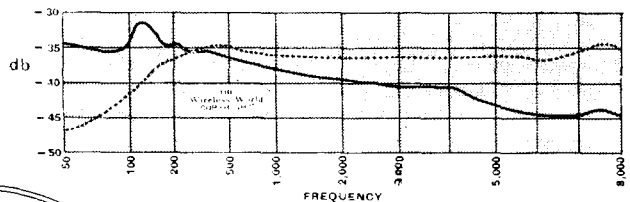

The Voigt moving coil winding is narrow and long, giving an extremely low moment of inertia.

An ingenious tone arm mechanism has been devised for the Voigt moving coil pick-up. R is a felt-lined rest for the head; C and L, the cam and lever for raising the tone arm; S, a notched segment for locating the needle over the starting groove of 10in. and 12in. records; H, hinge for inspecting the underside of the pick-up head.

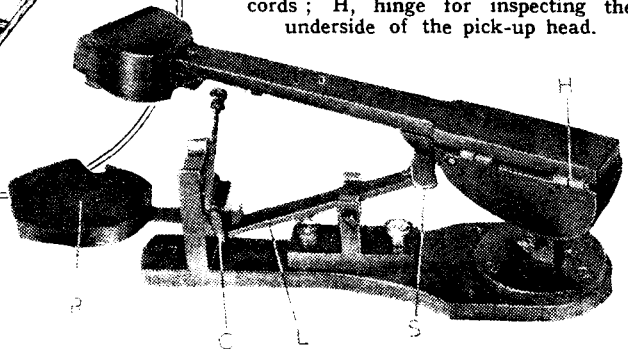

New Pick-ups— circuit for "constant amplitude" recording in the bass is provided. The capacity of the two yards of screened cable to the amplifier is included in the correction circuit. Apart from the small hump at about 150 cycles, which is probably due to the fact that

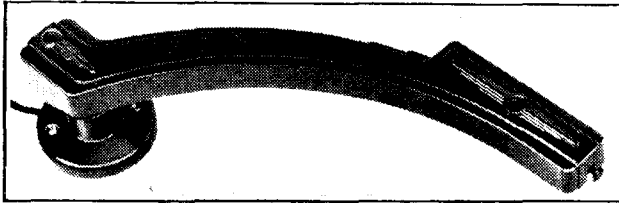

Cosmocord Series III crystal pick-up.

Output characteristic of Cosmocord Series III pick-up taken with HMV High Fidelity long-playing needle. Zero db corresponds to 1 volt RMS.

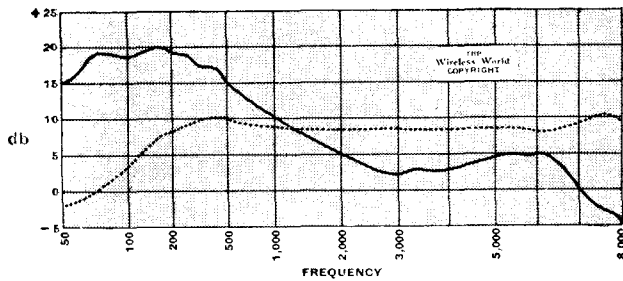

the instrument tested was mounted in an earlier type of tone arm than that illustrated, the response is smooth and rises 10 db throughout the range from 8,000 to 50 cycles. For use with old records a further reduction of high-note response is provided by a control on the coupling unit.

To ensure that the sapphire point and small moving parts of the pick-up receive the careful handling which is their due an ingenious tone arm has been developed. When not in use the pick-up head is locked in position on the felt pad R by a catch. The arm is released and lifted by a small handle working a cam C, which depresses the lever L and raises the segment S. Notches are cut on the underside of this segment which locate the needle over the starting grooves of 10in. or 12in. records when the tone arm is moved by hand towards the centre of the record. The needle is then gently lowered on to the record by the cam mechanism. The pivoting of the tone arm is designed to minimise "wow" on warped records and also to ensure that the needle always remains vertical to the record surface.

The makers, Voigt Patents, Ltd., The Courts, Silverdale, London, S.E.26, are prepared to accept orders for pick-ups on the general lines of the one described, and deliveries will be made in rotation. It is stated that

the price will be of the order of £6.

For those who cannot conveniently provide the amplification required by the moving-coil type of pick-up and who wish to reproduce gramophone records through the medium of a wireless receiver, there is no doubt that the piezo-electric crystal pick-up offers many advantages. Its output is high, and as the voltage output is a function of the amplitude of vibration it gives a good bass response without

the harmonic distortion often associated with an artificially boosted bass in moving iron armature pick-ups.

The latest Cosmocord Series III is in every way an excellent example of the crystal-type pick-up. Its average output is of the order of 3 volts, and even at 8,000 cycles it gives 0.5 volt RMS. The frequency characteristic is smooth and, if desired, can be modified to any required slope by simple tone control circuits without the necessity of using special filters.

Mechanically the design is well thought out and attractive in appearance, the tone arm being a thin die casting finished in old gold. Correct needle track alignment is obtained by setting the head at an angle, and the pivots in the base are arranged to take up the same angle with the major axis of the tone arm. In this way the needle is kept vertical irrespective of minor differences in the height of the turntable or the thickness of records. The new pick-up, which is made by Cosmocord, Ltd., Enfield, Middlesex, costs 22s. 6d.

AVC AND NOISE

An Improved Method of Control
AN AVC development of more than usual interest was made known by the Siemens and Halske Laboratories just before the outbreak of war. It is

well known that in order to prevent overloading on strong signals, the AVC bias circuits of a receiver are often arranged so that the bias is applied in a graduated manner, so that the earlier valves of the receiver are fully controlled while the later valves, which are likely to have to handle large signals, only receive a fraction of the control bias. Arrangements of this kind frequently have the disadvantage that even on weak signals the gain of the first RF stage may be lowered sufficiently to reduce the signal/noise ratio to an objectionable extent. This disadvantage can, however, easily be overcome by a slight redesign of the AVC circuit as follows.

Referring to the Figure (a), IF energy is fed to L in any suitable manner. Connected in series with L is the diode V₂, and its load resistance R₄, which is shunted by condenser C. The resistance R₁, the diode V₁ and a battery or other source of potential B are connected in series across R₄, the anode of V₁ being connected to R₁. The resistances R₂ and R₃ in series with the source of potential B are also connected across R₄. The AVC potentials are fed from point X to the mixer stage and/or to the RF amplifying stage of the receiver forming the earlier amplifying stage or stages. AVC potentials are fed from point Y to one

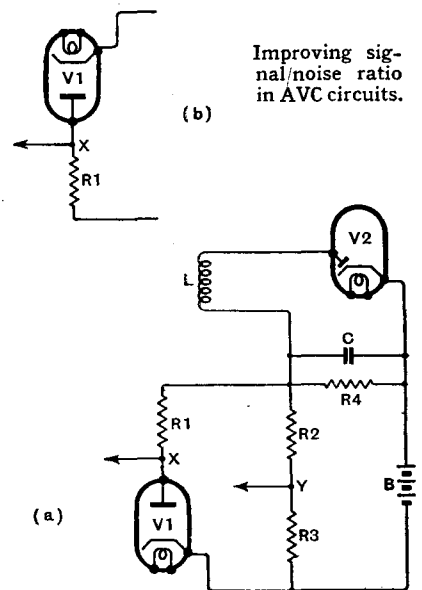

or more IF amplifying stages forming the later stage or stages.

In operation, when no signals are being received, current from the source R₃ flows through the arms R₂, R₃ and the arms R₁, V₁, resulting in the points X and Y assuming potentials which can be arranged to be of suit-

AVC and Noise—

able values by adjustment of the circuit elements. When a signal is received, the IF energy is rectified by V₂, and a DC potential is set up across R₄ in such a manner as to oppose the source of potential B, and having a value which depends upon the magnitude of the received signal. As the signal strength increases, the potential at Y falls and when the potential across R₄ is greater than that of B, the potential at Y increases in a negative sense.

As the signal strength increases from zero the potential at X remains at substantially the same value until the potential across R₄ is greater than that of B; the diode then stops conducting, and for further increase of signal strength the potential at X is the same as that of the potential of the junction point of resistances R₂ and R₄.

Hence, it will be seen that for weak signals the amount of AVC voltage passed to the earlier stages of the receiver from X is less than the control voltage passed to the later stages from

Y. When, however, the signal becomes so strong that V₁ ceases to conduct, the voltage at X varies in a manner which exactly corresponds to the variations of the voltage across R₄. The voltage at Y varies in proportion to the variation of voltage across R₄, but the amplitude of these variations is less than the amplitude of the variation at X in a ratio which depends upon the relative values of R₂ and R₃, so that the control voltage passed to the earlier stages is greater than the control voltage passed to the later stages.

If desired, R₂ and R₃ may be replaced by a potentiometer, point Y being connected to the tapping point. Intermediate degrees of control can be provided by tapings on R₁, or by potentiometers between such taps and earth.

In the figure (b) the positions of R₁ and V₁ are reversed, the anode of V₁ being connected to point X as before. In this case, however, V₁ remains non-conducting until the potential set up across the resistance exceeds the potential of the source B.

from a QPP stage. The average HT consumption on medium and long waves is 10 mA from a 120-volt battery—slightly more on short waves. Grid bias is automatic.

The price of the AC model A92 is £15 15s., and of the battery B91 £14 10s., without batteries.

Radiogramophone versions of the "90" series have also been introduced. They are the A90RG at £26, and the D90RG at £27 10s. A 10in. loud speaker is fitted and the pick-up is of improved design, with low record wear. As in previous Murphy radiogramophones, the motor board is flush with the top of the cabinet.

The Wireless Industry

THE sales and administration Offices of Marconi-Ekco Instruments, Ltd., have now moved to Ridgmont Road, St. Albans, Herts.

The Scott Insulated Wire Co., Ltd., Westmoreland Road, London, N.W.9, have sent tables showing the physical and electrical properties of "Manganamron" wire, which is produced entirely in this country and serves as an alternative to "Manganin," formerly imported from Germany.

The Marconi Y63 tuning indicator has been replaced by the Y61, a valve of similar characteristics but contained in a glass bulb of considerably smaller size. The price remains unchanged, namely 8s. 6d.

Grampian Reproducers, Ltd., Kew Gardens, Surrey, inform us that Government work has not prevented them from maintaining supplies of their standard public address equipment. A recent product is the "Ensa" dance band and stage amplifier, which gives 12 watts, weighs 48 lbs., and sells complete with microphone and two loud-speakers for 24 guineas.

A record changing version of the G.E.C. BC4058 radiogramophone is now available. The radio circuit employs a five-valve circuit with push-button tuning and includes short waves down to 16.5 metres.

Export Enquiries

A firm in Egypt is looking for a source of supply of coil winding machines. Second-hand machines would be considered.

A Swiss firm wishes to import British portables designed to work interchangeably on batteries or mains. Replies to this and the preceding enquiry will be forwarded if sent in a stamped envelope to this office.

New Murphy Receivers

MAINS AND BATTERY SHORT-WAVE "SPECIALS" WITH STATION CALIBRATIONS DOWN TO 13 METRES

THE principle of electrical band-spread tuning which has always found a place in Murphy short-wave "specials" is again applied in the recently introduced A92 receiver, but with the important addition of station calibration down to the shortest wavelengths. Each important short-wave broadcast band—13, 16, 19, 25, 31 and 41-49 metres—is selected by a push-button switch and has been given a separate scale; altogether there are 95 station names. Accuracy of calibration has been assured by close attention to frequency stability in the oscillator and IF circuits.

As in the A76, a high-gain RF stage is used on short waves to give a high signal-to-noise ratio, and the image suppression and selectivity generally are claimed to be superior to those of the earlier design—no mean performer in these respects. The Pen45 output valve delivers 4½ watts to an 8in. loud speaker and quality should be good, though there is some restriction of frequency range, as variable selec-

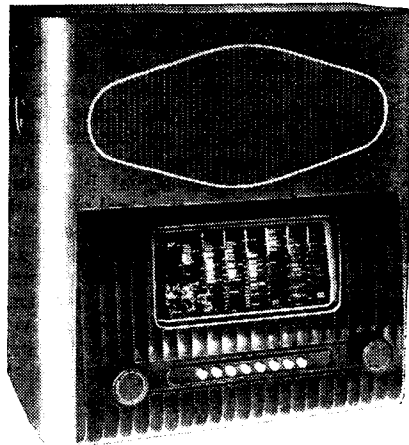

Separate scales for the principal short-wave bands with individual station calibrations are a feature of the new Murphy A90 short-wave "special."

tivity is not included as it was in the A76.

The new B91 is the battery equivalent of the A92 and it has the same features of high sensitivity, signal-to-noise ratio and image suppression, as well as the station-calibrated band-spread dial. There is an RF stage on short waves only and the output is

Screened Frame Aerials

WRONG AND RIGHT IDEAS ABOUT HOW THEY REDUCE INTERFERENCE

By "CATHODE RAY"

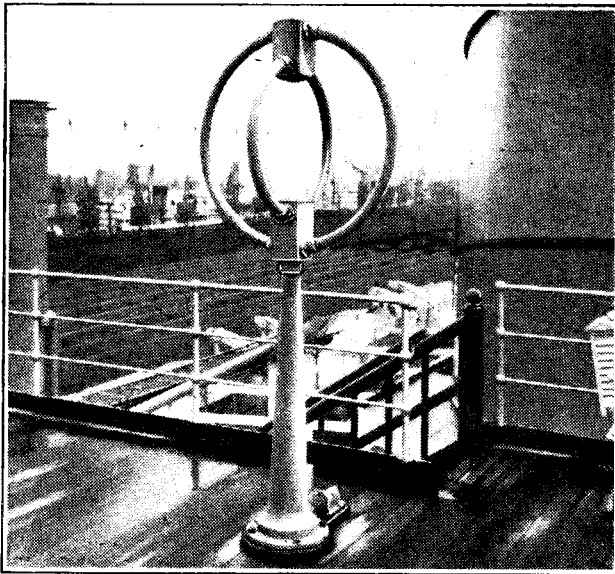

A PASSING comment by my old friend Scroggie on the subject of screened frame aerials has aroused some controversy, and as a matter of topical interest about which there is undoubtedly much confusion of thought it is probably a good one to discuss.

I tackle it with some fear and trembling though, for the reason that it takes one straight to the fountain head of fundamental theory. You may suppose that this makes it very safe, because all that sort of thing must have been settled definitely at the beginning. Actually, it is quite easy to discuss electrical matters—so long as you stick to what is *derived* from the really basic theory; it is when you refuse to take that for granted and get back to what it is derived from that the trouble starts. Every word has to be weighed, and even then your statements will be shot at by some pedant for "lacking in rigour," or something of the sort. Bearded professors and F.R.S.s and the like argue fiercely and become quite rude to one another about it.

You see, any explanation of screened frame aerials must either put you off with stuff you must swallow like a good Nazi, or else it must get right down to precisely what is meant by screening and by electric and magnetic fields. Well, of course,

may be considered as a condenser of large dimensions, a frame aerial is an inductance coil of large dimensions. So, knowing that a radio wave consists of both electric and magnetic parts, one not unnaturally jumps to the conclusion that the frame aerial functions by picking up the magnetic part, in the same way as any coil of wire will pick up a signal by being brought close to another coil that sets up a varying magnetic field around itself. Further, it may be supposed that putting an electrostatic screen around the frame shuts out the electric part of the radiation and so gives one an advantage when the desired radiation has a larger proportion of

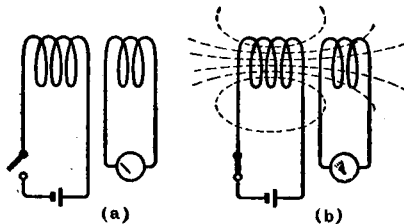

Fig. 1.—(a) Switch of primary coil open: no current in either coil. (b) Switch closed: current flows in primary coil, sets up magnetic field, which induces momentary current in secondary coil. Secondary current ceases when primary current reaches a steady amount.

if your education has been really badly neglected in these matters I cannot hope to repair the omission in a page or two, but I'll do my poor best.

Marine practice: Marconi double screened frames installed on board the *Mauretania*.

First of all, let us think about how an *un-screened* frame aerial works. Compared with an ordinary open aerial, which

magnetic component than the interference has.

Such ideas contain a dash of truth, but are hopelessly confused. They can only be straightened out by distinguishing clearly between electric and magnetic fields that are radiated and those that are not.

Whenever an electric current passes through a coil—or anywhere else—the space within and around mysteriously shows magnetic effects. Nobody knows how or why, so the affected space is described as "a magnetic field." A coil shows it most strongly, because the current is repeated with each turn of wire. If another coil is situated in the magnetic field nothing happens to it unless the strength of

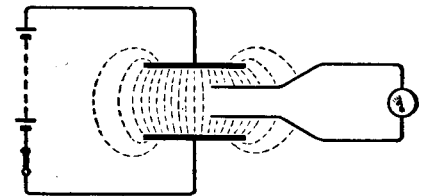

Fig. 2.—Voltage between two plates produces electric field, which by attraction and repulsion of electrons in a neighbouring circuit causes a current in it whenever the field is changing.

the field is changed, either by varying the current in the first coil or moving the coil itself about. Then there is induced in the second coil a voltage, which passes a current if there is a closed circuit for it to flow round. The way all this is usually shown is as in Fig. 1, in which the invisible field is represented by dotted lines.

Now for the corresponding facts about the electric field. Whenever a voltage is maintained between two closely spaced plates—or anything else—the space between and around mysteriously shows electric effects (such as attraction and repulsion), and this condition is described as an electric field. If it varies, it induces electric currents in neighbouring circuits, due to the attraction of unlike (and repulsion of like) electric charges (Fig. 2).

Both of these sorts of fields act right through many solid materials, as can be demonstrated by making iron filings stand up on a piece of paper

Screened Frame Aerials—

when a magnet is moved underneath. The same can be done on a sheet of copper. But metals are more or less effective screens against both sorts of fields if they are varying rapidly and continuously. The reason for this is that a *varying* magnetic field induces a current in the metal screen, and this current is in such a direction that its own magnetic field neutralises the

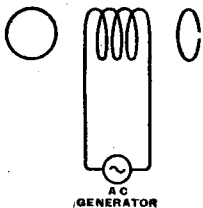

Fig. 3.—No current is induced by the changing magnetic field if the circuit is broken (right) or if it is at right angles to the primary coil (left).

other. The better the screen conducts, the heavier the current set up and the more complete the neutralisation. The books that describe this induction business in detail explain that the induced voltage (and hence any current that results from it) occurs only in certain directions. For example, a change of current in a wire will induce a voltage in a second wire if it is parallel, but not if it is at right angles. And, of course, the voltage cannot produce any current if there is not a complete circuit. In Fig. 3 the coil shown connected to a source of alternating current induces a voltage in the single turn of wire on the

right, but no current, because the circuit is broken. The turn of wire on the left is complete, but it is at right angles to the middle coil, so no voltage is induced and therefore no current is generated. A sheet of metal can be looked upon as a series of closed rings, one inside the other; so if it is parallel to a coil carrying alternating current it has heavy currents induced in it. For reasons given in the books these secondary currents flow in the opposite direction to the primary currents that give rise to them; so the resulting magnetic fields are in opposition and tend to cancel out (Fig. 4). Therefore the effect on a coil at the far side is reduced by the intervening screen, and if the screen is thick and extended to cover the primary coil completely it is very effective. There are two ways of undoing the effects of a dose of poison—by removing the poison, or by leaving it where it is and giving an antidote. A metal screen acts in the latter manner when it confines a magnetic field: it cannot prevent the field from passing through itself, but it generates an equal and opposite field that neutralises it.

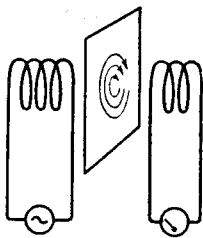
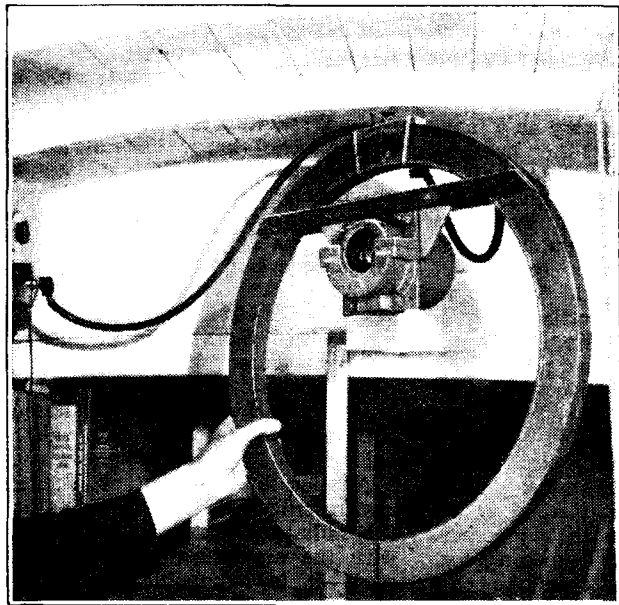
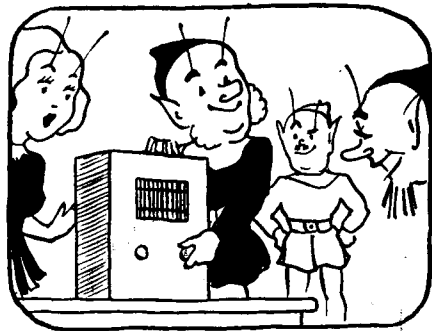

Fig. 4.—A metal plate between the two coils acts as a screen because the induced currents in it oppose the magnetic field that generates them.



Amateur DF: The construction of this screened frame designed primarily for small yachts, was described in *The Wireless World* for August 24th, 1939.

The "Fluxite Quins" at work



As Eh said, when Haw-Haw "went dead,"
"P'haps it's due to our 'planes overhead."
But Ee said, "Maybe,
Other reasons there be,
No Fluxite, for example," he said.

See that **FLUXITE** is always by you—in the house—garage—workshop—wherever speedy soldering is needed. Used for 30 years in government works and by leading engineers and manufacturers. Of Ironmongers—in tins, 4d., 8d., 1/4 and 2/8.

Ask to see the **FLUXITE SMALL-SPACE SOLDERING SET**—compact but substantial—complete with full instructions, 7/6.

Write for Free Book on the art of "soft" soldering and ask for Leaflet on **CASE-HARDENING STEEL and TEMPERING TOOLS** with **FLUXITE**.

TO CYCLISTS! Your wheels will NOT keep round and true unless the spokes are tied with fine wire at the crossings **AND SOLDERED**. This makes a much stronger wheel. It's simple—with **FLUXITE**—but **IMPORTANT**.

THE FLUXITE GUN

is always ready to put Fluxite on the soldering job instantly. A little pressure places the right quantity on the right spot and one charging lasts for ages. Price 1/6, or filled 2/6.

FLUXITE LTD.
(Dept. W.W.),
DRAGON WORKS,
BERMONDSEY
STREET, S.E.1

ALL MECHANICS WILL HAVE

FLUXITE

IT SIMPLIFIES ALL SOLDERING

Screened Frame Aerials—

induced currents shown in Fig. 5 (b) it might as well not be there. The magnetic field due to the enclosed coil is hardly opposed at all by the "screen," and penetrates it quite easily. An even more completely ineffective magnetic screen is shown in Fig. 5 (c), where the coil is enclosed

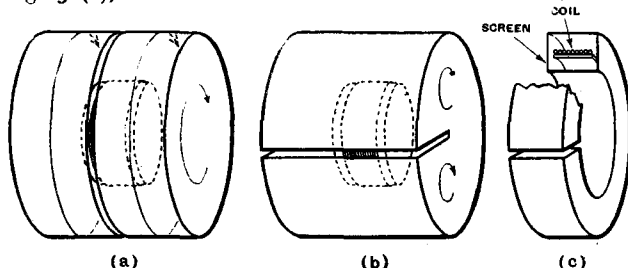

Fig. 5.—(a) A metal screening can is almost unimpaired as a magnetic screen when cut as shown, because no current paths are cut, but a cut as shown at (b) interrupts the main current paths, leaving only the minor paths shown; and the screening is largely destroyed. (c) Another screen, effective for electric fields and ineffective for magnetic. This is a type commonly used for frame aerials.

in a ring-shaped container sawn across at one place.

How about the electric field? Different parts of the primary coil are at different voltages, and therefore an electric field is set up between them. If another coil is close to it, currents may be induced in it by the electric field. The fact that the two circuits are in the form of coils has no significance at all so far as this process is concerned. The electric field always exists when two localities are at different voltages—or potentials. The result is electrical attraction; and if the parts concerned are too firmly fixed to move towards one another (as they do in electrostatic voltmeters) there is still some movement of electrons within the metal, which constitutes an electric current that continues so long as the potential is varying.

Purely as a matter of convenience, the potential of the earth is reckoned as zero. Suppose, as in Fig. 6, that a metal plate or wire is connected to an AC generator that keeps its potential constantly varying, first above (positive) and then below (negative) earth potential. If another plate or wire is somewhere near, and connected to earth through a resistance,

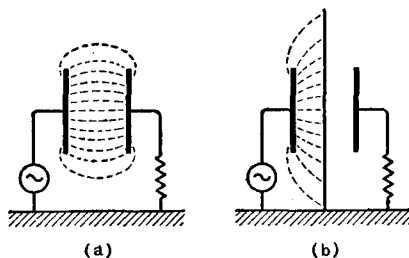

Fig. 6.—(a) Induction of current in a neighbouring circuit due to electric field is shut off by earthed plate (b).

the alternating positive and negative attractions cause electrons to move to and fro between the plate and earth, and this alternating electric current through the resistance results in a difference of potential across it (good old Ohm's Law!). Next, suppose that a large metal plate is set up between the others, and connected solidly to earth (Fig. 6 (b)).

The fact that there is negligible resistance between any part of this new plate and earth means that even if there are quite large movements of electrons in it there is negligible difference of potential. In other words, the whole of the plate remains at earth or zero potential. As the plate on the right is also connected to earth, there is no difference of potential between them, and no electric field. The middle plate effectively screens off the electric field due to the alternating potential of the one on the left.

Note carefully what is necessary: the resistance (or other forms of impedance) between any part of the screen and earth must be negligible. If the plate itself were of very thick low-resistance metal, but disconnected from earth, or connected through a high resistance, there would be nothing to prevent its potential varying, and it would fail utterly as an electric screen. Yet it might be quite satisfactory as a magnetic screen. On the other hand, a system of wires arranged so that no closed circuits existed, but giving low-resistance paths to earth, would be useless as a magnetic screen yet quite good as an electric screen.

By taking advantage of the above knowledge, screens can be designed for electric or magnetic fields separately, or both together. Obviously, a completely sealed metal container connected to earth answers the last purpose. A cover of the form shown in Fig. 5 (c), if connected to earth, is an effective

electric screen that hardly interferes at all with the magnetic field, while a system of closely spaced but insulated metal rings is vice versa. It is possible in these ways to do a lot towards separating the two fields when (as is always more or less the case) they occur together.

If the system connected to the AC generator is large in dimensions, its fields spread out to a considerable distance. And if the AC is of high frequency, the time taken to spread out and collapse again as the current or potential drops to zero is an appreciable part of the cycle. When this is so, part of the energy stored up in the fields fails to return to the generating circuit, and goes off into space as radiation. The strength of the radiation dies off as the distance from the source gets greater, but it dies off much less rapidly than the non-radiated fields. The result is that at distances comparable with or greater than the wavelength corresponding to the frequency of the generator, the radiation fields predominate. At a

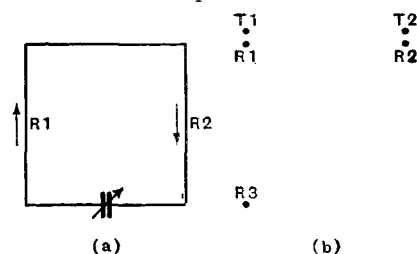

Fig. 7.—Simple one-turn frame aerial in elevation (a) and plan (b).

distance of many wavelengths (as in radio communication) it is only the radiated fields that matter.

Now, radiation is half magnetic and half electric (hence its full name—*electromagnetic* radiation), and if either half is absorbed in any way the other half necessarily disappears, too. Divorce is absolutely barred. A moving electric field generates a magnetic field, and a moving magnetic field generates an electric field; so in radiation, where there is no independent generator close at hand, they both depend absolutely upon one another. That is the first important difference between radiated and non-radiated fields.

Another difference is that in normal circumstances—at a distance from the radiator that is large compared with the dimensions of the radiator itself—it is impossible to find two places close together, say within a foot or so, where a radiated field is of opposite polarity or materially different strength. This sounds rather complicated, but its significance

Screened Frame Aerials—

appears when one comes to consider how a frame aerial works. Fig. 7 shows a frame aerial, and, to make matters as simple as possible, it has only one turn. Also for the sake of simplicity, suppose that the transmitting aerial is of the frame type, too, and exactly the same size. Then if the two are placed together, so that in a plan view T_1 T_2 is the transmitting aerial and R_1 R_2 the receiving, when the current in T_1 is increasing upwards it is increasing downwards in T_2 , and producing corresponding magnetic fields. R_1 is so much closer to T_1 than to T_2 that it is affected almost exclusively by the magnetic field from the upward current; and similarly R_2 by the downward. The result is that when a voltage is induced upwards in R_1 it is induced downwards in R_2 , and therefore both assist one another in sending current round the frame clockwise.

Now suppose R is placed as shown by R_1 R_2 ; both are nearer T_1 than T_2 , so both voltages act upwards at the same time and oppose one another; however, R_1 is so much nearer to T_1 than R_2 that its induced voltage easily overpowers the other and gives a resultant. Those are the sort of things that can happen when the two coils are so close together that the induced field predominates. But now separate the two aerials so far that the radiated fields predominate. The widths of the aerials, T_1 T_2 and R_1 R_2 , are then so insignificant in comparison with the distance from R to T that within such a small space as R_1 R_2 the radiated field at any moment is of the same polarity and practically the same strength. Both R_1 and R_2 have voltages generated in them, but as they are always in the

same direction (upwards or downwards) and equal in strength they cancel out around the frame. At least, that is so if the receiving aerial is broadside on to the transmitter. If not, there is a small difference in time between the arrival of radiation at R_1 and R_2 . If R_1 comes first, then by the time the crest of the wave reaches R_2 it has already begun to diminish at R_1 . In other words, there is a phase difference giving a difference between the voltages generated in R_1 and R_2 . In order for this difference to be appreciable, compared with the two voltages themselves, it is necessary for the width of the frame to be appreciably compared with a wavelength. The best results are given when it is half a wavelength, for then a positive crest occurs at R_1 when there is a

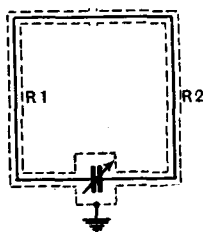
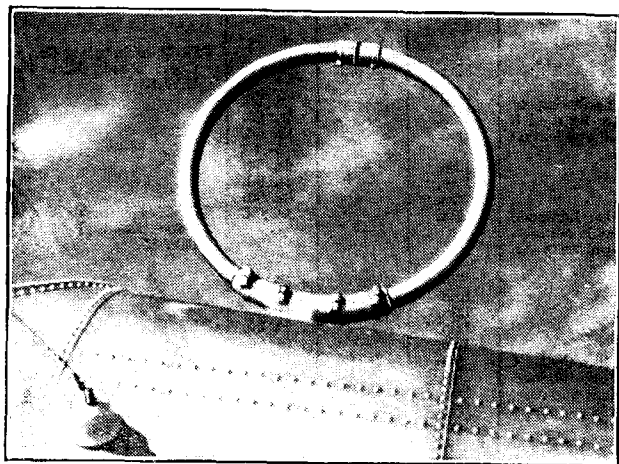

Fig. 8.—Diagram of screen for frame aerial.

negative crest at R_2 . For this to happen when the wavelength is, for example, 400 metres, it is necessary for the frame aerial to be 200 metres, or over 600ft. wide. Such an aerial would be hard to fit into the average portable set, which consequently depends on comparatively small differences in voltage even when the aerial is end on to the transmitter.

In the foregoing explanation account is taken only of the radiated magnetic field. The same result would have been arrived at if it had been considered in terms of the electric field.

Now at last we can consider screening the frame aerial. Fig. 8 shows a screen, consisting of a tubular cover, earthed at the foot and broken in one place at the top to avoid forming a short-circuited turn. Although it may be possible to make the resistance of the screen very small, its impedance is not negligible, because in size it must be at least as large as the aerial; and just as the aerial is



Single rotatable screened frames of this type are widely used for aircraft DF.

BULGIN

for CHOKES

BULGIN Chokes need no introduction whatsoever. They are popular and reliable, and have an excellent record among radio experimenters, technicians, and service men.

Below is a small selection from our extensive ranges. The H.F. range includes a choke for practically every need, from 75 μ H to 500,000 μ H priced from 1/3 upwards.

L.F. chokes are also well represented. All Bulgin chokes have mono-metallic windings, and are wound with the finest quality wire. Flexible leads are fitted for connection, and all points are welded, with core tightly clamped against vibration. Rated inductances are at rated currents.

L.F. CHOKES

| Henries | at mA. | Ω | List Nos. | List Prices |
|---------|--------|----------|-----------|-------------|
| 0.25 | 750 | 6-7 | L.F.47s | 12/- |
| 10 | 60 | 320 | L.F.18s | 10/6 |
| 15 | 100 | 450 | L.F.21s | 15/- |
| 20 | 20 | 700 | L.F.16s | 6/6 |
| 20 | 50 | 400 | L.F.14s | 9/6 |
| 32 | 15 | 900 | L.F.20s | 7/6 |
| 32 | 30 | 600 | L.F.15s | 9/6 |
| 50 | 25 | 1000 | L.F.17s | 10/6 |
| 100 | 10 | 1800 | L.F.34s | 12/- |
| 0.25 | 500 | 6-7 | L.F.44 | 6/- |
| 8.5 | 60 | 400 | L.F.39 | 7/6 |
| 25 | 20 | 750 | L.F.40 | 7/6 |
| 5 | 60 | 210 | L.F.67 | 6/3 |
| 7 | 50 | 260 | L.F.68 | 6/3 |
| 10 | 45 | 300 | L.F.69 | 6/3 |
| 15 | 35 | 580 | L.F.70 | 6/3 |
| 20 | 30 | 660 | L.F.71 | 6/9 |
| 30 | 25 | 1000 | L.F.72 | 6/9 |
| 40 | 20 | 1250 | L.F.73 | 6/9 |
| 50 | 15 | 1500 | L.F.74 | 6/9 |
| 3 | 12 | — | L.F.43 | 7/6 |

Max. permissible current overload = 25%.

H.F. CHOKES

| Inductance in μ H | Ω | List Nos. | List Prices |
|-----------------------|----------|-----------|-------------|
| 500000 | 1000 | H.F.10s | 3/6 |
| 200000 | 400 | H.F.35s | 2/6 |
| 198000 | 400 | H.F.8 | 2/9 |
| 80000 | 100 | H.F.33 | 2/6 |
| 75000 | 180 | H.F.34 | 2/6 |
| 30000 | 90 | H.F.32 | 2/6 |
| 18000 | 60 | H.F.31 | 2/6 |
| 15000 | 360 | S.W.69 | 2/9 |
| 8000 | 30 | H.F.30 | 2/- |
| 5000 | 20 | H.F.29 | 2/- |
| 2500 | 10 | H.F.28 | 2/- |
| 900 | 0.65 | H.F.26 | 4/- |
| 400 | 0.225 | H.F.36 | 10/6 |

PLUS 16% WAR INCREASE.

The New Bulgin Catalogue No. 163 can be had upon application with 6d. in stamps, post free, mentioning "The Wireless World."

FOR ALL RADIO COMPONENTS

Advert. of A. F. BULGIN & CO., LTD., Bye Pass Road, BARKING. Tele.: RIpleway 3474

Screened Frame Aerials—

tall enough to have an appreciable voltage developed between the tops and bottoms of the vertical wires, so must the screen too.

In addition to the generation of a voltage round the frame aerial, due to the difference in phase between the two vertical portions, the whole affair acts as a simple vertical aerial with a capacity to earth. Whereas the former effect ceases to exist when the frame is broadside on to the transmitter, the latter occurs at all positions. That wouldn't matter if the aerial were balanced to earth, but unless a complicated arrangement is adopted one side of the aerial is connected to earth (or at least the cathode of the first valve), while the other side is connected to grid. In trying to get to earth, the currents in the side connected to grid set up a difference of potential at the grid and thus become amplified. When the screen is used, however, both sides are equally connected to cathode or earth, and the currents in them are balanced and don't affect the receiver.

"Noise" sources close to the re-

ceiver are often strongly capacity-coupled to the frame aerial and the screen protects it from the worst of this. Looking at Fig. 9 (a), C1 represents the capacity to earth of the "earthy" side of the receiver—negative HT, etc.—and C2 the capacity of the frame acting as an open aerial. Any noise generator effectively in series with C1 and C2 tends to yield a signal between grid and cathode of the valve, owing to cathode being "earthy" and not the grid. But if the frame is screened (b) the aerial capacity is short-circuited to screen, and the noise "circuit" is kept outside.

Thus the screen is helpful in excluding local noise electric fields; and also

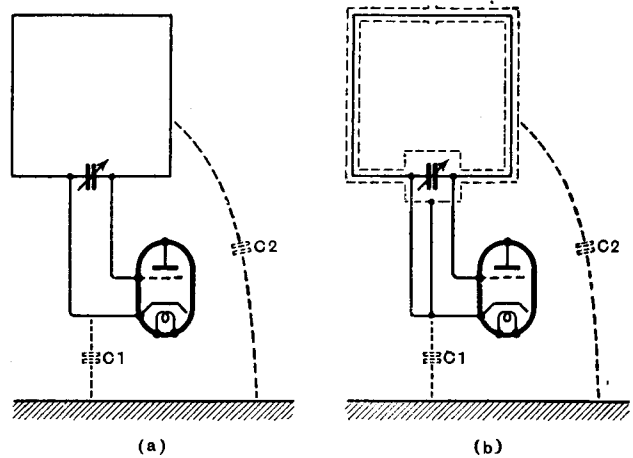

Fig. 9.—(a) How the action of an unshielded frame aerial as an ordinary vertical aerial is open to noise interference, whereas the effect is excluded by a suitable screen.

including all reception from directions along the axis of the frame, so that an interfering station can be cut out by turning the frame broadside on to it. If it were not for the screen there would still probably be a residue of reception owing to the "open aerial" or "vertical" effect.

Direct Recording Blanks

COMPILED BY DONALD W. ALDOUS

Here is a revised version of the table of blanks for home recording which we published in May last year. Only those blanks which are still readily obtainable in this country under present conditions have been listed

| Name | Type | | | Diameter | Prices Retail Each | | Manufacturer or Main Stockists |
|--------------------|---------------------------|---|--|--|--|---|--|
| | Base | Surface Coating | Processing | | Single-sided | Double-sided | |
| Neo-Cire | Metal | Cellulose compound ... | Electrolytic, as these blanks are primarily intended for use as masters when solid stock pressings are required. | 11in. 13in. | 4s. 0d. 5s. 0d. | — | V. G. Manufacturing Co., Ltd., Gorst Road, Park Royal, N.W.10. |
| Phono-Disc: | Aluminium | Non-fluid chemical lubricant impregnated in surface of aluminium. | None | 5in. 10in. | — | — | Phono-Disc Ltd., 65, Bolsover Street, W.1. |
| Pyral | Cardboard | Cellulose compound ... | — | 6in. 8in. | 8d. 10d. | — | V. G. Manufacturing Co., Ltd., Gorst Road, Park Royal, N.W.10. |
| Pyral | Zinc | Cellulose compound, plus black varnish. | None, although a hardening or polishing fluid may be used if desired. A light oil application facilitates cutting. | 8in. 10in. 12in. | — | 1s. 6d. 2s. 0d. 3s. 0d. | |
| Pyral | Aluminium | " " " | " " " | 10in. 12in. 16in. | — | 2s. 6d. 4s. 0d. 8s. 0d. | |
| Simplat | Unbacked, i.e., flexible. | Gelatinous composition (non-flam). | Chemical treatment, i.e., hardened and polished by fluids containing formaldehyde and waxy oils respectively. | 7in. | — | 1s. 0d. | V. G. Manufacturing Co., Ltd., Gorst Road, Park Royal, N.W.10. |
| Simplat | Glass | " " " | " " " | 7in. 10in. 12in. 14in. 16in. | — | 2s. 0d. 3s. 0d. 4s. 0d. 6s. 0d. 8s. 0d. | |
| Supercut | Aluminium | Cellulose compound with stabilising medium. | Chemical treatment, if desired. A light non-penetrating lubricating oil applied before and after cutting will prolong useful playing life. | 8in. 10in. 12in. 13in. 16in. | 2s. 0d. 2s. 8d. 3s. 0d. 5s. 0d. | 2s. 10d. 3s. 6d. 4s. 6d. 7s. 0d. | M.S.S. Recording Co., Ltd., 83, The Green, Kew, Surrey. |
| W.D. | Metal | Cellulose acetate ... | Polishing fluid only. | 8in. 10in. 12in. | — | 2s. 0d. 3s. 0d. 4s. 6d. | Will Day Ltd., 19, Lisle Street, W.C.2 |

* (Phono-Disc.) 10in. size available, in quantity, for export purposes only at present.

Random Radiations

By "DIALLIST"

The Short-wave Boom

WHATEVER else this strange war has or has not done, there cannot be any doubt that it has produced the biggest boom in short-wave listening in the history of wireless. Everyone is athirst for news and the short waves are the place to find it. Almost every civilised country (and one or two that aren't civilised, as well!) now seems to have its regular transmissions in English. Add to that the fact that there are heaps of short-wave stations of high and medium power in all parts of the world and the reasons for the boom are not far to seek. Short-wave listening would be even more popular than it is were the tuning arrangements on the S/W range of the small domestic receiving sets rather better than they usually are. Even with the somewhat coarse and crude tuning available, numbers of the nearer and more powerful stations can be received by anyone possessing a modicum of skill and patience, though the more distant ones may be rare captures except under particularly favourable conditions.

A Grand Opportunity

Is it too much to hope that manufacturers will grasp the opportunity that they now have of establishing short-wave listening firmly as a great popular hobby? If they want to do so they must offer the public sets which are both efficient and easy to use on the wavelengths below 100 metres. Some have already done this, and I know that the harvest reaped has surprised them. Others again have turned their attention to the simplified form of communication receiver of which I've had a good deal to say from time to time in these notes. Such sets have been selling like hot cakes; the great difficulty has been to keep pace with the demand. But I still haven't seen that £25 semi-communication set that we've discussed before now. One of them was actually on the stocks just before the war broke out. I know, because I spent a whole day and the best part of the night, too, in trying out the laboratory model of it. It was a fine little receiver: RF, 1st detector, separate oscillator, two IF, 2nd detector-cum-AVC, two AF. And it did deliver the goods. The tuning arrangements

were a joy to handle, for they divided the frequencies between 30 and 4 megacycles into four bands, each with a full-scale range on the large band-spread dial. I'm sure that there's a place for a set of that kind on the market to-day and I hope that we shall see it this summer. Apart from CR's or semi-CR's, the makers have a wonderful chance of giving the short-wave ranges of less ambitious sets the attention that they deserve, for, with Droitwich silent, there is little to hear on the long waves and I'm pretty sure that receivers *minus* a long-wave range, but with good performance on the medium and the short waves, would find a ready market. Whether or not makers feel that the long-wave range can be omitted from, at any rate, some sets, they can be sure that there are plenty of folk who however unwilling they have been in the past to discard the old receiver in favour of a new one, will gladly do so now if they are offered something that really does enable them to explore the wonders of the short waves without having to perform feats of skill and endurance with coarse tuning and cramped dials.

Why Not Log It?

RECENTLY I lamented in these notes the fact that under wartime conditions weather reports had had to vanish from the dailies and that particulars of magnetic disturbances, such as affect short-wave radio, could not be obtained for a long time after such happenings. But if you keep any kind of log, as I expect you do, even a "stale" report is of interest, for it enables you to see whether or not you were right in inferring what you did when stations on the short waves began to play strange pranks. Those who haven't hitherto kept even rough logs will find that it adds greatly to the interest of wartime wireless to do so. Enter up any out-of-the-way experiences with the date and time, and, if you feel so inclined, pencil in a guess at the state of magnetic affairs. However belated is the information eventually received, it will prove interesting when you compare it with your estimate.

A Queer Week

From the doings of the receiving set on the short waves I gathered that

VORTEXION

50w. AMPLIFIER CHASSIS

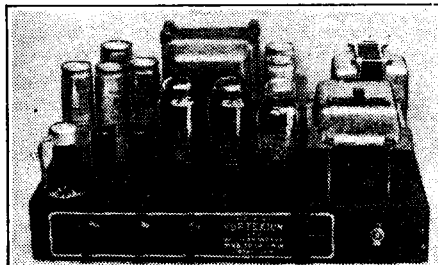

A pair of matched 6L6's with 10 per cent. negative feed-back fitted in the output stage, and the separate HT supplies to the anode and screen have better than 4 per cent. regulation, while a separate rectifier provides bias.

The 6L6's are driven by a 6F6 triode connected through a driver transformer incorporating feedback. This is preceded by a 6N7 electronic mixing for pick-up and microphone. The additional 6F5 operating as first stage on microphone only is suitable for any microphone. A tone control is fitted, and the large eight-section output transformer is available in three types:—2-8-18-30 ohms; 4-15-30-60 ohms or 15-60-120-240 ohms. These output lines can be matched using all sections of windings and will deliver the full response (40-18,000 c/s) to the loudspeakers with extremely low overall harmonic distortion.

CHASSIS with valves and plugs £17 10 0

Or complete in black leatherette cabinet with Collaro turntable, Piezo P.U. and shielded Mike Transformer £22 10 0

Plus 10% War Increase on above prices.

Goodmans P.A. Speakers in stock.

Reslo Horns £11 11 0

Reslo M.C. Microphones £3 15 0

Amperite Ribbon Microphones from £5 5 0

All P.A. and A.R.P. Warning Gear in stock.

Many hundreds already in use for
A.R.P. & GOVERNMENT purposes

15w. AC & 12-VOLT DC AMPLIFIER

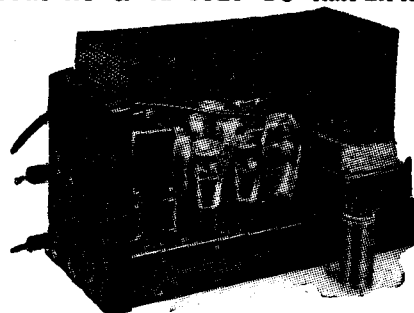

TYPE CP20

This small Portable Amplifier, operating either from AC mains or 12-volt battery, was tested by THE WIRELESS WORLD, "October 1st, 1937, and has proved so popular that at Customers' demand it remains unaltered except that the output has been increased to 17.2 watts and the battery consumption lowered to 6 amperes. Read what "The Wireless World" said:—

"During tests an output of 14.7 watts was obtained without any trace of distortion so that the rating of 15 watts is quite justified. The measured response shows an upper limit of 18,000 c/s and a lower of 30 c/s. Its performance is exceptionally good. Another outstanding feature is its exceptionally low hum level when AC operated even without an earth connection. In order to obtain the maximum undistorted output, an input to the microphone jack of 0.037 volt was required. The two independent volume controls enable one to adjust the gain of the amplifier for the same power output from both sources, as well as superimpose one on the other, or fade out one and bring the other up to full volume. The secondary of the output transformer is tapped for loudspeakers or line impedances of 4, 7.5 and 15 ohms." Prices: Plus 10% war increase.

AC and 12-volt CHASSIS with valves, etc. £12 12 0

Or in Resine Case with Col laro Motor, Piezo P.U. and Mike Transformer £17 17 0

AC only CHASSIS with valves, etc. £8 18 6

Or in Resine Case with Col laro Motor, Piezo P.U. and Mike Transformer £14 0 0

Case Case for either chassis 12/6 extra.

Write for Illustrated Catalogue.

Vortexion Ltd., 182, The Broadway,
Wimbledon, S.W.19. Phone: LIBerty 2814

Random Radiations—

conditions at the end of March were of an unusual kind, and I expect that you did the same. The American cosmic data record for the week ending April 6th has just reached me, such are the mails nowadays. But better late than never, for it discloses that the magnetic disturbances during that week really were something worth writing about. Reports of magnetic conditions are collected from observatories in the U.S., including Alaska, in Hawaii, Puerto Rico, Australia and Peru. From these reports the "magnetic character" of the day is worked out. Complete calm is indicated by 0.0 and a period of maximum disturbance by 2.0. The latter figure appears only rarely in reports. However, it was assigned to the period from midnight to 12 hours GMT on March 30th. There was a drop to 1.6 from 12 hrs. to 24 hrs. that day; but the whole of the 31st was rated at 1.8. The two periods of April 1st were 1.5 to 1.0 respectively. April 2nd at 0.4 was comparatively calm till midday; then the figure jumped to 1.1. April 3rd ranged from 1.6 to 1.2. On the 4th the two periods were rated at 0.6 till midday and 0.5 from then till midnight. April 5th began at 0.4, but for the midday-to-midnight period the figure 0.0 showed that complete magnetic calm had been restored.

Towards the Trough

In the camp where I'm living I haven't my file of cosmic data records by me; but, speaking from memory, I don't think that such a rating as 2.0—full marks—has occurred before during this sunspot maximum that seems so loth to leave us. A figure such as 1.7 or 1.8 represents a state of great disturbance: 2.0 is terrific. By the way, a kind correspondent who has been able to keep a graph of sunspot activity confirms my suggestion that the maximum, which according to the reference books occurred a good time ago, has proved to be double humped instead of having a single peak. The second peak did not rise quite so high as the first; but it was very marked and it is clear that we have by no means finished yet either with big spot-groups on the sun's disc, or with the wireless upsets that so often accompany them. The next year or two, as the curve drops down from the second hump of the maximum towards the minimum trough, should be a time of great interest. Since the last maximum numbers of very powerful medium-wave stations have come into being on both sides of the Atlantic. Heterodynes between U.S.A. stations and those in Europe were not uncom-

mon in the late evenings a few years ago. With the increased numbers of high-powered medium-wave stations they may present a serious problem at and about the sunspot minimum time.

At Last!

At long last they really have given this camp the electric light for which we have been hoping, and almost praying. Until you've lived through a winter like the last with no light but that of oil lamps you don't realise what a blessing it is to have electricity laid on. A click of a switch and on comes a lovely illumination. What a relief it is not to have to be constantly watching it to make sure that it is not smoking or otherwise misbehaving. What a relief too, when you come in late off night duty, to have no need to speculate whether or not your batman has remembered to trim the wick and fill the reservoir with oil. But best of all, a good big mains set can now be used in such spare moments as there are, instead of a little fellow run from batteries. No more worries about accumulator charging or about obtaining dry HTB replacements.

Henry Farrad's Solution

(See page 293)

BY shunting the 25,000-ohm rheostat with one of the resistors, its range is reduced to 0.7, 150 ohms. If this is then put in series with four of the resistors, as shown, the voltage corresponding to the full range of rheostat adjustment (assuming the

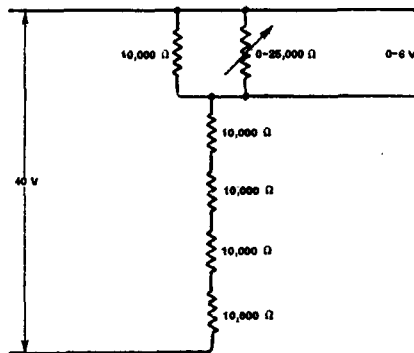

values of all the components are exactly correct) is 0.6, 07 volts, which ought to be quite satisfactory. The minimum resistance of the arrangement is 40,000 ohms, taking just 1 milliamp from the 40-volt source. The only possible criticism is that the range 0.3 volts occupies a smaller proportion of the rheostat scale than 3.6 volts, but this inequality does not exist to an excessive extent.

UHF Instruments

TWO new instruments for use in the ultra high frequency field have been introduced by Marconi-Ekco Instruments, Ltd. One is the TF517 signal generator, which is a development of the Model TF390 but with a frequency range from 150 to 300 Mc/s. The output is 0.1 volt max. and the calibration accuracy ± 1 per cent. An attenuator with a range of 100 db is accurate to ± 2 db or 2 μ V. Internal modulation is supplied at 400 c/s, 30 per cent.

The other instrument is a diode indicating wavemeter, Type TF643, with a range of 20 to 300 Mc/s in four bands, with an accuracy of ± 1 per cent.

Club News

Slough and District Short Wave Club

Headquarters: 48, High Street, Slough, Bucks.
Meetings: Alternate Thursdays at 7.30 p.m.
Hon. Sec.: Mr. K. A. Sly, 16, Buckland Avenue, Slough, Bucks.

At a recent meeting there was a discussion on data collected concerning the relationship between fading and other factors associated with the 19.50 metre transmissions of WGEA.

A midget portable was also demonstrated, after which there was a discussion on various technical matters including the Armstrong frequency modulation system. The meeting closed with morse practice.

Ordinary members subscription is 2s. 6d. per annum, plus 3d. for each meeting. Members of the forces in the district can become honorary club members.

British Short-wave Correspondence Club

Headquarters: The Watring, Parham, Woodbridge, Suffolk.
Hon. Sec.: Mr. A. Richardson, The Watring, Parham, Woodbridge, Suffolk.

Owing to military duties, Mr. Hodgson has relinquished the position of secretary, and has been succeeded by Mr. Richardson.

The QSL service under the direction of Mr. Garrard is still operating, and members wishing to exchange cards should send them to him at 135, Hervey Street, Ipswich, Suffolk.

The Society has now an international membership of 120. Full particulars can be had by post from the Hon. Sec.

Journals of the World

FRENCH, American, Japanese, Russian, German, Italian, Dutch, Australasian and, of course, British journals are among the 150 regularly perused by the Radio Research Board for the purpose of summarising the articles on wireless and allied subjects for inclusion in the Abstracts and References section which is a monthly feature of our sister journal, *The Wireless Engineer*. In the May issue, which was published on the first of the month, abstracts from, and references to, nearly 400 articles recently published in the technical journals of the world are included. Another monthly feature is the publication of a summary of recently accepted wireless patent specifications.

The May issue, which is obtainable through newsgagents or direct from the Publishers, Dorset House, Stamford Street, London, S.E.1, at 2s. 8d., post free, also includes articles on the dielectric losses in components such as valves, valve holders, condensers and coils. Another article gives complete design tables of resistance networks in telecommunication.

Beethoven "Little Prodigy"

FOUR-VALVE SUPERHETERODYNE

"ALL DRY" PORTABLE

PRICE £6 19s. 6d.

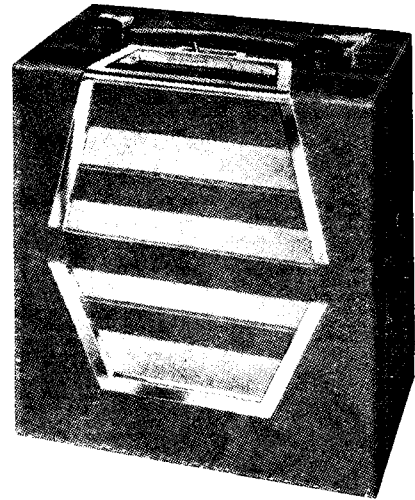

IN designing this receiver the makers have not failed to make the most of the advantages offered by the 1.4 volt range of valves. The compactness of the batteries and of the valves themselves have been supplemented by ingenuity in the arrangement of the other components, with the result that the only unoccupied volume inside the cabinet is that required for the removal of the valves from their sockets.

Space has not been saved, however, by installing a midget loud speaker and the 6½ inch Rola PM unit gives the set a clear and lusty voice for its size.

Circuit.—A heptode frequency changer is followed by a pentode IF amplifier, a diode-triode signal and AVC rectifier and first AF stage and a pentode output valve. The frame aerial consists of the usual two sections in series with the long-wave winding shorted when working on medium wavelengths. Iron cored coils are used in the IF stage, which operates at the unusual frequency of 450.5 kc/s.

The diode rectifier circuit is of the simplest basic design and provides AVC bias for both the IF and the frequency-changer stage. Bias for the output valve is derived from a resistance in the common negative

HT line. Both HT and LT batteries are switched off when the set is not in use.

Performance.—The efficiency of the superheterodyne circuit more than compensates for the smallness of the frame aerials and good reception should be obtained from the B.B.C. Home Service in any part of the country. It is unlikely that full amplification will be required on this service, but when called for on distant stations it will be found that the set has a remarkably low level of background noise.

The intrinsic selectivity, apart from that conferred by the directional properties of the frame, is

batteries an undistorted power of about 200 milliwatts is available from the output pentode, and with the efficient loud speaker provided this gives all the volume required—even out of doors.

Constructional Features.—The set at first sight appears to be built round the inside of the cabinet, but this is an illusion resulting from the close spacing of the components. Actually it is a simple matter to remove the chassis complete with its loud speaker. All that is necessary is to remove the batteries and the two control knobs and unsolder the three frame leads when the unit may be lowered and withdrawn.

The waverange switch is operated by a lever working in a slot in the top of the cabinet, through which it was possible to see the main trimmers. Some sort of slide should be an improvement here to prevent the ingress of moisture or dust.

The cabinet itself is covered with cellulosed blue waterproof cloth and its overall dimensions are 9½ in. by 9 in. by 5½ in. The weight is approximately 13 lb.

Separate LT and HT dry batteries are used. The LT unit has a two-pin plug connection and the HT has spring contacts pressing against terminal plates in the side of the case. With new batteries the HT consumption is 7 mA.

WAVERANGES

Medium ... 200 - 500 metres
Long 900 - 2,000 metres

good, and tuning is sharp enough to call for reasonable care in order that over-emphasis of high frequencies may be avoided.

When accurately tuned the balance of tone is good and there is enough bass and treble response to cover the range of programme material to which one normally listens with a portable. With new

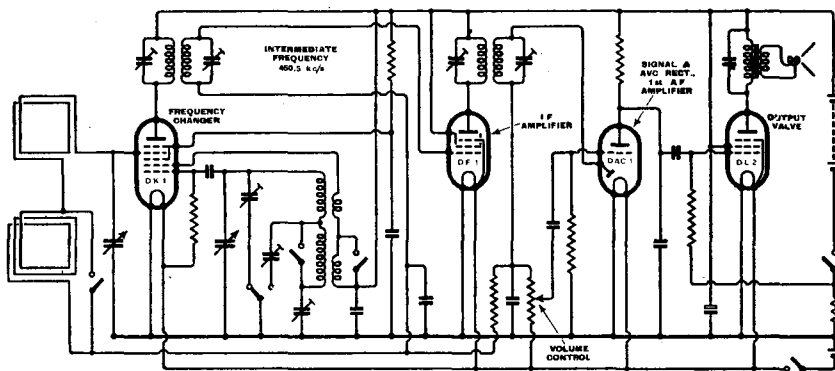

Circuit diagram of the Beethoven "Little Prodigy."

FOR HIGHEST EFFICIENCY

USE EDDYSTONE SHORT WAVE COMPONENTS



EDDYSTONE SHORT-WAVE H.F. Choke with patented low loss and connection D.L.-9 formers with spaced honeycomb wound coils. D.C. resistance 22 ohms. Inductance 1.25 millihenries. 5.180 metres. No. 1010. 2/2



Extension Control Outfit made from precision drawn paxolin tube. Cannot warp or bend; insulating part 4in. long. Brass insert 3in. long. No. 1008 1/5



Frequentite Insulator for carrying H.F. leads through metal baseboards with minimum loss. No. 1018. 2/2



New Type Microdensers with improved D.L.-9 insulation. No. 1094. 18 m.m.f. high-voltage type. Min. 3 m.m.f. Max. 18 m.m.f. D.C. flash-over voltage, 3,500 volts 4/3
No. 1129. 40 m.m.f. high-voltage type. Min. 3.8 m.m.f. Max. 40 m.m.f. D.C. flash-over, 2,300 volts. 4/9
60 m.m.f. 4/11
160 m.m.f. 6/6



"EDDYSTONE" Pillar Insulators, made of glazed Frequentite and tested to a breakdown voltage of 30,000. In two types, one having a 2 BA fixing bolt and wing nut, the other a heavy duty plug and socket fitting with soldering tag connections. No. 1049 1/8
No. 1095 1/10



"EDDYSTONE" Adjustable Insulated Bracket for mounting components which are controlled from an extension spindle or flexible coupler. The insulated portion, made from D.L.-9 high frequency dielectric, is adjustable. No. 1007. 1/8



Flexible Coupler. Free from backlash but very flexible, this coupler banishes alignment troubles. D.L.-9. HF Insulation. For 1in. spindles. No. 1009. 1/8.



Flexible Driving Shaft. For front panel control of awkwardly placed components. Drives through 90 degrees perfectly. Cable length 5 1/2. No. 1096. 3/11

ORDER FROM YOUR DEALER—

EDDYSTONE

OR WRITE OUR SERVICE DEPOTS.

London Service: Webb's Radio, 14, Soho St., W.1

BROMSGROVE ST. BIRMINGHAM

Birmingham Service: Webb's, 41, Carrs Lane



WHICH ROOM

is most convenient for your set?

MANY serious radio experimenters prefer to operate their sets in the privacy of their own "dens." In such cases a good extension speaker is essential to serve the other members of the household with popular programmes. But wherever the set is placed, there are numerous occasions when it is inconvenient to confine your listening to one room. "Extension speaker listening" provides the only satisfactory solution. Ask your dealer to demonstrate Stentorians—the economically priced speakers which do full justice to the finest sets. Chassis models from 19/3. Cabinet models from 21/6. Literature on application.



CADET CABINET £2-3-6

Stentorian

THE PERFECT EXTRA SPEAKER FOR ANY SET

WHITELEY ELECTRICAL RADIO CO. LTD., MANSFIELD, NOTTS.

RADIOMART

G.S.N.I. (B'HAM) LTD.

THE SHORT-WAVE SPECIALISTS

WE CARRY LARGE STOCKS OF ALL TYPES OF SHORTWAVE AND COMMUNICATION EQUIPMENT, INCLUDING AMERICAN VALVES. RADIOMART SPECIAL OFFERS! Fully shrouded Transformers by America's largest manufacturer. While they last, all 230 v. 50 cy.

| | |
|--|------|
| T.3008—300/390 v. 80 m/A. 4 v. 4 ACT. 4 v. 2.5 a. unshrouded | 6/6 |
| T.890Y—350/350 v. 150 m/A. 4 v. 6 a. 4 v. 2.5 a. | 15/- |
| T.19610—350/350 v. 150 m/A. 2.5 v. 6 a. 2.5 v. 2 a. 5 v. 3 a. | 12/6 |
| T.7236—375/375 v. 120 m/A. 6.3 v. 4 a. 5 v. 3 a. | 10/6 |
| T.6025—320/320 v. 80 m/A. 2.5 v. 6 a. 5 v. 3 a. | 7/6 |
| T.46419—10 v. 4 a. primary tapped 110-250 v. | 5/6 |
| W.379Y—440/440 v. 200 m/A. 6.3 v. 3 a. CT. 5 v. 3 a. | 25/- |
| W.305Y—550/550 v. 200 m/A. 6.3 v. 3 a. CT. 5 v. 3 a. | 25/- |
| T.1113AB—230 to 110 v. 500 watt auto transformer | 29/6 |
| T.2311A—230 v. to 110 v. 100 watt auto transformer | 12/6 |

The following chokes are interleaved and impregnated:

| | |
|---|------|
| T.7007—250 m/A. 135 ohms, 20-8 Hy., cadmium shrouded | 12/6 |
| T.7007A—150 m/A., 250 ohms, 30-12 Hy., cadmium shrouded | 12/6 |
| 100 m/A., 20 Hy., 500 ohms, unshrouded | 4/11 |
| 60 m/A., 15 Hy., 250 ohms | 1/11 |

FERRANTI Meters at less than half price. 3 1/4in. Moving Coil, projecting 5, 10, 25, 50, 100, 150, 300 m/A., 16/6. Flush 17/6. Triple range Milliammeters 22/6. All based.

MOVING COIL SPEAKERS. Bala, Magnavox, etc. 8in. cone: 1,200, 2,000, 2,500, 6,500 ohms. 8/6. 10in. cone: 400, 800, 1,650, 2,000, 2,500 ohms. 12/6. Magna 10in. 1,650 ohms. 17/6. M.C. Speaker Transformers, Power, Pentode or Push-Pull, 1/11.

GANG CONDENSERS with Airplane Dials, 8 and 80-1. Cost 35/-. Few only, 4/11 Utility Microdials. List 7/6. Our Price, 4/-. Ideal for Short Waves.

PUSHBACK Wire, 6 yds., 6d.; heavy, 9d. Resin-cored Solder, 6ft., 6d.; Screened Flex, single, 6d. yd.; twin, 9d. yd. Assorted Solder Tags, 6d. packet. Humdimmers, 6d. each. Centralab pots, all sizes, 1/9; switched, 2/3; tubular fuses, 2d. Milliammeters, 25 m/A. upwards, 6/9.

VALVES: Reliable replacements for all types, British and American, showing saving of 50 per cent. NOTE: All enquiries should be accompanied by 2d. stamp for reply.

AMERICAN COMMUNICATION RECEIVERS are now a prohibited import. Despite this, we are offering our present stock, whilst it lasts, without further price increase.

OUR NEW 66-PAGE MANUAL, packed full of valuable information. Metro-Kilocycle Charts, Shortwave Stations, Times of News Bulletins, Shortwave Receivers, construction: articles, etc. 7id. post free.

THE NEW RAYMART CATALOGUE shows dozens of New Shortwave Components and is yours for 2id. post free.

RADIOMART 44, HOLLOWAY HEAD, BIRMINGHAM

G.S.N.I. (Birmingham) Ltd.

Recent Inventions

Brief descriptions of the more interesting radio devices and developments disclosed in Patent Specifications will be included in these columns.

CENTIMETRE WAVES

THE Figure shows a valve of the "resonator" type for generating ultra-short waves of the order of a few centimetres. The valve is a diode, the indirectly heated cathode being entirely enclosed by the anode. The primary discharge of electrons takes place between the upper and lower faces of the cathode C and the adjacent surfaces A of the anode. The hollow extension Ar of the anode forms a resonating chamber in which oscillations of the desired frequency are built up.

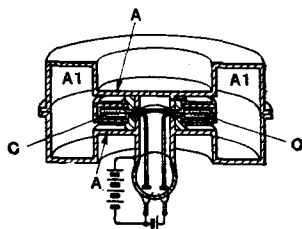

Micro-wave generating system.

The generation of sustained oscillations depends upon the fact that a uniform stream of electrons moving between two equidistant surfaces (the cathode C and anode A) develops a negative resistance within certain frequency bands. These depend, in turn, upon the capacity between the two surfaces in question, and upon an inductance factor which is determined by the geometry of the system, including the inside length and radius of the resonating chamber Ar. The power generated depends upon the specific resistance of the discharge stream, and upon the transit angle or "transit time" required by the electrons to pass from cathode to anode.

Standard Telephones and Cables, Ltd. (assignees of F. B. Llewellyn). Convention date (U.S.A.), July 31st, 1937. No. 516750.

VALVE CONSTRUCTION

TO reduce the inherent input and output capacitance of a valve, particularly for handling ultra-short waves, the base of the bulb is sealed off by a flat "header" of glass through which metal contact prongs pass. The inner ends of the prongs are connected to the electrodes inside the bulb, whilst the outer ends are plugged directly into the usual socket or valveholder.

To supplement the effect of the screening grid and to ensure a more complete electrostatic isolation of the electrodes, a metal plate is fitted around the exterior of the flat glass base, and is perforated to allow the contact prongs to pass through.

Hygrade Sylvania Corp. Convention date (U.S.A.) May 28th, 1937. No. 516110.

NAVIGATION SYSTEMS

TWO half-wave transmitting aerials are spaced half a wavelength apart, and a "passive" reflector is placed mid-way between them. The two aerials are alternately energised and keyed, one with the morse signal T and the other with the morse signal E. The reflector throws each signal, as it is radiated, to one side or other of the centre line of the aerial system, thus delineating a navigational course along the common or overlapping part of the two radiated fields. An aviator or other navigator knows that he is keeping on the centre line of the course when he hears the T and E signals merge into a single continuous note.

Marconi's Wireless Telegraph Co., Ltd., B. J. Witt, and J. G. Robb. Application date July 2nd, 1938. No. 516642.

o o o o

INPUT COUPLINGS

THE Figure shows an aerial coupling and transmission line design to operate efficiently over a wide band of frequencies. The aerial A is matched to the capacitive impedance of the line L through a transformer T. The line is terminated at the receiver end by a surge resistance R, which prevents reflection, and a series condenser C.

For very short waves, the condenser can be ignored, since practically all the signal voltage is developed across the terminals of the resistance R, which is coupled to the primary of the input transformer T₁.

For longer waves the condenser C is the effective impedance, passing on the incoming signals through the single connecting lead formed by the two parallel windings of the input transformer. The aerial transformer T is not required if

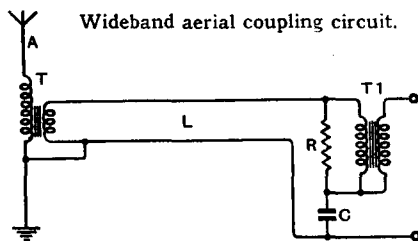

Wideband aerial coupling circuit.

the capacity of the line L is made substantially equal to that of the aerial.

Telefunken Ges. für drahtlose Telegraphie m.b.h. (Additions to Patent No. 501051). Convention date (Germany). June 9th, 1937. No. 515710.

o o o o

PUSH-BUTTON TUNING

IT is common practice to drive the tuning condenser of a push-button receiver by a motor which is provided

with two field windings, so that it can be made to rotate in one direction or the other. The motor is stopped at the critical point by a contact which is arranged to slide, at the proper moment, on to an insulating gap which divides the two segments of a rotating commutator switch. If the gap is made too narrow, there is a danger that the motor will override the proper setting, whilst if it is made too wide the tuning will not be accurate. Again, if the sliding contact is arranged to bridge the gap completely, both field windings are energised simultaneously, and the motor will stop, though there is then a tendency to "chatter."

As shown in the drawing, the difficulty is met by inserting a thin strip

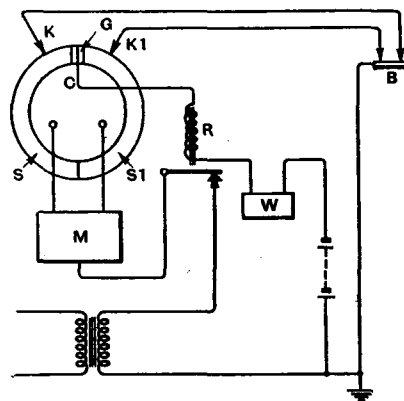

Exact tuning in push-button sets.

conductor C in the middle of the gap between the two segments S, S₁ of the commutator switch feeding the two field windings of the motor M. When a press button, such as B, is depressed, the commutator rotates until one or other of the contacts K, K₁ comes against the conductor C. At that moment a relay R opens the motor circuit, and a magnetic winding W simultaneously applies a brake. This promptly stops any further movement, until another selector button is operated, to release the first, in the ordinary way.

E. K. Cole, Ltd., and A. W. Martin. Application date, June 17th, 1938. No. 515292.

o o o o

CATHODE-RAY TUBES

THE final anode of a cathode-ray tube may be at a potential of, say, 50,000 volts above that of the deflecting coils. If a flash-over occurs, or if the HT supply is accidentally short-circuited, the inherent capacity between the two parts may momentarily throw the deflecting coils 50,000 volts negative to earth. This is likely to damage any associated parts

Recent Inventions—

of the circuit, besides being a definite source of danger to anyone handling the tube.

In order to reduce the risk, solenoid windings are inserted between the HT terminals and the various component parts concerned. The occurrence of a short circuit or flash-over then creates a large voltage-drop across the protective windings, thereby reducing the momentary potential thrown on to the deflecting coils to a less dangerous level.

E. L. C. White and A. D. Blumlein. Application date, April 13th, 1938. No. 514825.

o o o o

TONE CONTROL

IN the type of tone control where a series resistance and capacity are shunted across the load circuit of the

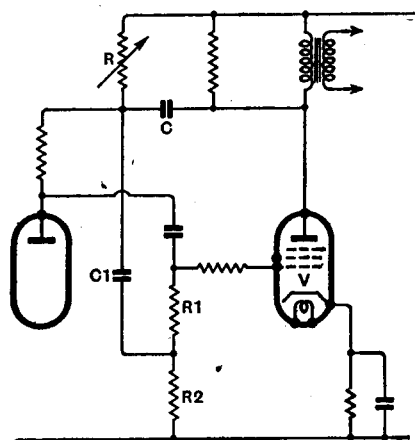

Tone control by negative feedback.

output valve, the upper cut-off frequency is usually fixed, so that the attenuation can only be varied above this point. In such a circuit arrangement the resistance is always the variable element.

According to the invention, tone control is effected by using a negative feedback derived from a resistance-capacity circuit RC shunted across the output of a pentode V, the control grid of which includes a potentiometer R1, R2. The reverse feedback is applied from the variable control resistance R to the mid-point of R1 and R2 through a blocking condenser C1.

With increasing frequency, the reactance of the condenser C diminishes, and a larger negative feedback is therefore applied to the amplifier. The amount of feedback will also depend upon the setting of the resistance R, which thus governs the high-frequency cut-off point. The attenuation above this point is, however, substantially constant.

The Mullard Radio Valve Co., Ltd., and R. G. Clark. Application date, June 20th, 1938. No. 516286.

o o o o

ELIMINATING INTERFERENCE

INSTEAD of tuning exactly to the carrier wave, it is an advantage, particularly in the presence of an interfering

station, to tune deliberately to one side or other of the carrier frequency, so that, in effect, one concentrates on the particular sideband that is farther away from the source of interference. To assist in this selective manipulation, a discriminator circuit which is tuned slightly above or below the intermediate frequency can be coupled to one of the intermediate-frequency amplifiers. The discriminator circuit includes a rectifier which develops a DC control voltage that rises to a maximum at the desired "off-tune" point and so can be used to adjust the tuning of the circuits automatically to the point of least interference. A reversing switch allows the off-tune point to be tried out, both above and below the precise carrier frequency.

As a further refinement, the control voltage is applied to a variable-impedance valve so that the tuning of the set is automatically adjusted to the most favourable point, as determined either by the strength of the desired signal, or by the strength of the interfering signal.

Kolster-Brandes, Ltd., and C. N. Smyth. Application date July 12th, 1938. No. 516891.

o o o o

SELECTIVE CIRCUITS

IT is desirable, particularly in the IF stages of a superhet, that the frequency-response curve should have steep sides and a relatively flat top, so as to give uniform amplification over the band-pass width, combined with a sharp cut-off.

To secure this effect, a frequency-selective feedback circuit is provided between the anode and the screen grid of a pentode valve. Preferably, the feedback circuit consists of two parallel-tuned rejector circuits, connected in series with each other and with a decoupling resistance. One of the rejector circuits is tuned 9 kilocycles above, and the other 9 kilocycles below the IF frequency. The degree of feedback applied is controlled by varying the screen-grid voltage.

Marconi's Wireless Telegraph Co., Ltd., and K. R. Sturley. Application date, April 14th, 1938. No. 513605.

o o o o

TELEVISION TRANSMISSION IMPROVEMENTS

WHEN television signals are generated in a transmitter tube of the Iconoscope type, the picture, as seen at the receiving end, is often marred by a diffused dark area, which appears approximately at the centre of the fluorescent screen.

The invention is based on the dis-

covery that the scanning beam in the transmitter tube contains an undesirable mixture of secondary electrons, produced by the impact of the primary beam of electrons against the highly positive electrodes. To avoid this cause of trouble, the first anode, which normally carries a voltage in the neighbourhood of 3,000, is followed by a second, cylindrical anode, which is biased to a much lower voltage, of the order of 800. Any secondary electrons emitted by the first anode will thus be repelled by the second anode, owing to its lower voltage, so that they do not reach the mosaic screen. The higher velocity of the primary beam is, however, sufficient to carry it through.

Electrical Research Products, Inc. Convention date (U.S.A.) February 19th, 1938. No. 517756.

o o o o

INTERFERENCE SUPPRESSION

THE Figure shows a typical arrangement for preventing the electric motor of a vacuum cleaner, refrigerator, fan, or similar domestic appliance from producing electrical interference with broadcast reception. The arrangement is shown in the drawing applied to a direct-current motor. The two series

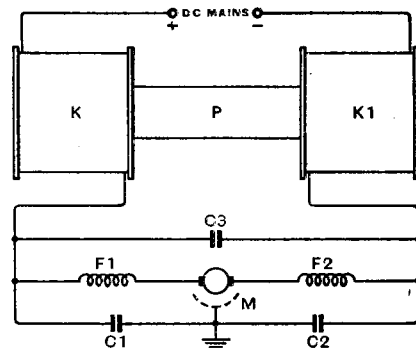

Suppression chokes applied to a DC motor.

fieldwindings F1, F2 are connected through condensers C1, C2 to the point where the frame M of the motor is earthed. A third condenser C3 is shunted across the DC supply, and RF chokes K, K1 are connected in series with each lead. The two chokes are mounted on a common core P so that the magnetic fields produced by the main current are opposed to each other. It is found that the suppression of interference due to any earth leakage that may occur, or to any radio-frequency currents that may be set up, depends very largely upon the correct degree of coupling between the two chokes.

According to the invention, the chokes are made movable on the core; or they may be fixed and the core made movable; or the number of the laminations forming the core may be varied; in order to allow the degree of coupling to be adjusted to the optimum value.

The General Electric Co., Ltd., and H. C. E. Jacoby. Application date, August 11th, 1938. No. 517606.

The British abstracts published here are prepared with the permission of the Controller of H.M. Stationery Office, from specifications obtainable at the Patent Office, 25, Southampton Buildings, London, W.C.2, price 1/- each.

Goodmans P.A. Loudspeakers

for **EVERY PURPOSE!***

★ Where **HIGH QUALITY** with **BIG POWER** is demanded ...

★ for **DIRECTIONAL PROPAGATION**
GOODMANS DUPLEX HORN

gives a wide angle of propagation equivalent to two separate horns.

Power handling capacity 15 watts A.C. Peak. Speech Coil impedance: 15 ohms **£5.17.0**

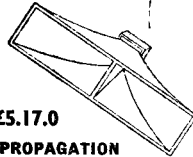

★ for **NON-DIRECTIONAL PROPAGATION**
GOODMANS CONCENTRIC DIFFUSER

Provides the most economical method of distributing sound over wide areas. Specially suitable where echo effects and other acoustic problems are troublesome. Ideal for Factories, Ice Rinks and Dance Halls, etc.

Power handling capacity 20 watts A.C. Peak. Speech Coil impedance: 15 ohms **£15.0.0**

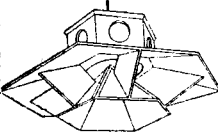

GOODMANS P 12 E and P 12 P.M.
P.A. Loudspeakers

These two reproducers are capable of really high quality reproduction and will handle up to 20 watts A.C. peak, giving absolute reliability over sustained periods. An exceptionally high degree of sensitivity is attained as a result of the careful design of speech coil and magnetic gap. A particular characteristic of these two instruments is the fine "fullbodied" rendering of orchestral and band items. Successfully operated in many Cinemas and Dance Halls, etc., throughout the country.

PERMANENT MAGNET MODEL £6.15.0
ENERGISED MODEL £4.10.0

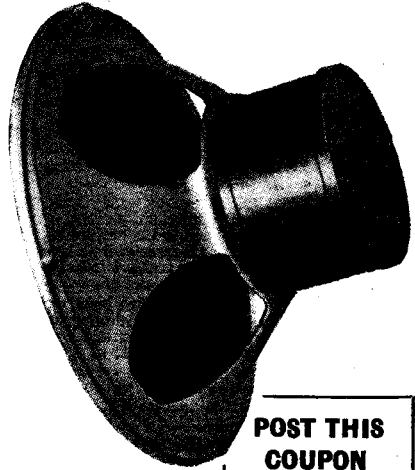

● With detachable diaphragm

POST THIS COUPON

for booklet entitled "The Attainment of an Ideal" giving valuable information and data on the principles of Loudspeaker production.

Attach your card or letter heading.

GOODMANS INDUSTRIES LTD., LANCELOT RD., WEMBLEY, MIDDX. Telephone: WEMbley 4001 (5 lines).

"ALL WAVE" RADIO RECEIVERS

ALSO INTRODUCING SPECIAL EXPORT MODELS

the **DOUBLE-DECCA** the **DECCA model AW6x**

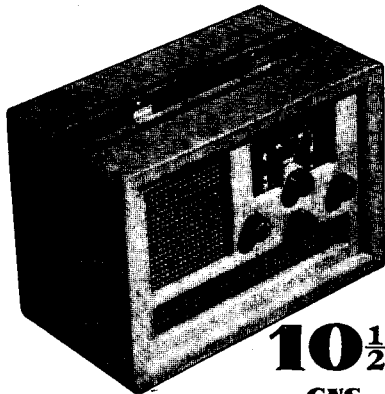

10½

GNS.
INCLUDING BATTERY

PRESENTING THE DOUBLE-DECCA TO THE OVERSEAS BUYER

This set is of outstanding interest to the Export Markets and is available to agents at particularly favourable prices.

This 5-valve superhet Double-Decca is the first ALL-WAVE portable to operate on AC/DC mains, wherever available, or on its own "all dry" battery anywhere. The special built-in aerial gives you the choice of the World's broadcasting stations. Voltage, 100/250 volts AC.DC. Wave-band range, 16-49, 200-550, 1,000-2,000 metres.

Specially designed for the Export Market — the AW6X is an extremely sensitive 5 valve superhet all wave receiver, its 3 wavebands cover 13-35, 35-100, 200-550 metres and has an undistorted output of 4½ watts. The AW6X operates on AC mains with a voltage range of 100-120 and 200-250 volts AC.

EXPORT ENQUIRIES INVITED FOR BOTH THESE MODELS

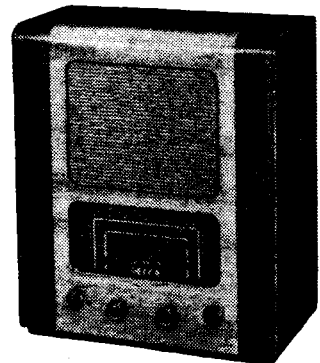

DECCA RADIO

It is with every confidence that we present the AW6X to the overseas buyer, we suggest you write immediately for full details of the favourable Export prices available to agents.

**Wireless
World**

CLASSIFIED ADVERTISEMENTS

THE CHARGE for advertisements in these columns is 12 words or less 3/-, 3d. for every additional word. Each paragraph is charged separately.

ADVERTISEMENTS, with remittance, should reach Dorset House, Stamford Street, S.E.1, not later than first post Wednesday, June 10th, for the July issue, or one day earlier at the Branch Offices, 8-10, Corporation Street, Coventry; Guildhall Buildings, Navigation Street, Birmingham, 2; 260, Deansgate, Manchester, 3; 263, Renfield Street, Glasgow, C.2.

SERIES DISCOUNTS are allowed to trade advertisers on orders for consecutive insertions provided a contract is placed in advance, and in the absence of fresh instructions the entire copy is repeated from the previous issue. 3 insertions, 5 per cent.; 6 ins., 10 per cent.; 12 ins., 15 per cent.

Advertisements received too late for one issue, or crowded out, are published in the first following in which there is space. The Proprietors retain the right to refuse or withdraw advertisements at their discretion.

The Proprietors are not responsible for clerical or printers' errors, although every care is taken to avoid mistakes.

BOX NO. ADVERTISERS should include the words "Box 000 c/o 'The Wireless World'" which must be paid for. An additional 1/- is charged for registration and cost of forwarding replies.

NEW RECEIVERS AND AMPLIFIERS

BAKERS' Super Quality Receivers for Realistic Reproduction. Brand new surplus bargains as follows:—

£11 Only, usual price £22.—10-valve receiver, specially designed to give the best possible quality reproduction from radio and gramophone, complete with tone control stage, 8-watt triode output, push-pull, limited number; write for descriptive leaflet now.—Bakers' Selhurst Radio, 75, Sussex Rd., South Croydon. [9034]

RADIOGRAMS, 8-valve all-wave 8-watt, £16; auto-radiograms, £20; sets from £1 to £100; 1½d. stamp secures list; part or complete exchanges.—Stewart and Roberts, Amersham. [9000]

14-Gn. Push-button Car Radios for 95/-; others from 79/6. Car aerials, etc. Midget, A.C./D.C. and all dry portables. Cheapest in Britain. Catalogues free.—Shippers' Radio, 18, Corporation St., Manchester, 4. [8992]

BANKRUPT Bargains.—Brand new 1939-40 models, makers' sealed cartons, with guarantees, at less 30% to 40% below listed prices; also Midgets, portables, car radio; send 2½d. stamp for lists.—Radio Bargains, Dept. P.W., 261-3, Lichfield Rd., Aston, Birmingham. [9028]

* **CHALLENGER RADIO CORPORATION**, "the best firm for reliable and fully guaranteed ultra-short-wave radio, have on view in London some of the finest receivers ever made; for instance, a five-valve TRF Midget (2 bands) at 75/-; a mains-battery transportable (operating without alteration on A.C., D.C., or batteries), at £8; an 8-valve radiogram chassis with valves and speaker, 4 wave-bands, at £8/8; a 6-valve tuning unit with five wave-bands, including 4½-10 metres, at £8/18/6; tuning unit with output stage and speaker at £11; a 13-valve receiver with five wave-bands, including 5-10 metres, variable selectivity inter-station noise silencer, chassis, valves and auditorium speaker complete, £16/16; an 18-valve twin chassis including such refinements as variable selectivity, contrast expansion, C.W. beat oscillator, variable sensitivity, inter-station noise silencer, with valves and auditorium speaker, £28/17/6; any American valve for 1925-1940 receivers for 6/- each (only firsts such as Raytheon, National Union, &c., supplied). Why not call and handle these receivers at your leisure? There is no obligation to purchase. Alternatively, fully illustrated catalogues will be forwarded on receipt of 2½d. stamp.

CHALLENGER RADIO CORPORATION, 31, Craven Terrace, London, W.2, Paddington 6492. Nearest point Marble Arch, down Bayswater Rd., turn 5th right. [9045]

ARMSTRONG

FURTHER DIFFICULTIES AHEAD!

Please don't think we are becoming pessimistic—we are not, but facts must be faced. There is a further vigorous tightening up in the supply of raw materials which of necessity limits the number of chassis we can supply and increase the time required for delivery.

Unfortunately, this position will intensify as the war progresses, and we know you will appreciate that such matters are beyond our control, but we repeat yet again that in accordance with our well-known Fair Trading Policy we shall never take advantage of these regrettable conditions to increase our prices more than is absolutely essential.

PAPER RATIONING

We are reluctantly compelled to charge 6d. towards the cost of our Illustrated Catalogue in future, which gives full details of our complete range.

Write for your copy to-day!

MODEL SS10 — 10-V SUPERHET-STRAIGHT ALL-WAVE HIGH-FIDELITY R-G CHASSIS

incorporating Two Independent Circuits, Superheterodyne and Straight, having R.F. Pre-amplifier and R.C. Coupled Push-Pull Triode Output capable of handling 8 watts.

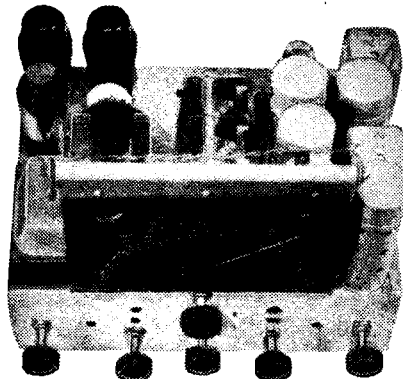

The circuit of the SS10 is unique. When used as a STRAIGHT receiver two H.F. stages are in operation with A.V.C. Diode Detector is used for distortionless detection together with Triode Push-Pull output. A turn of only one knob is necessary to switch from "Superhet" to "Straight." The Gramophone 12 gns. Amplifier has been specially studied and 12 gns. records can be reproduced with excellent quality. Plus 5%

MODEL AW38—8-V ALL-WAVE SUPERHET

This radiogram chassis has R.C. Coupled Push-Pull Output capable of handling 6 watts.

This being our Quality Year we have carefully studied the design of our more economically priced 8 gns. models and it's now possible to obtain excellent quality with economy plus 5%

Matched Push-Pull Speaker for above 1gn.

MODEL AW125PP—12-V 5-BAND ALL-WAVE R-G CHASSIS (12-550 continuous, 1000-2000m) with R.F. Pre-Amplifier, 2 I.F. stages with Variable Selectivity. Manual R.F. gain control and 10 watts R.C. coupled Triode P.P. Output.

Readers need no introduction to this most popular model, so favourably reviewed by **17 gns.** *The Wireless World* on Jan. 5th, 1939. Plus 5%

7 DAYS' APPROVAL—12 MONTHS' GUARANTEE

ARMSTRONG MANUFACTURING CO.

WALTERS ROAD, HOLLOWAY, LONDON, N.7
(Adjoining Holloway Arcade). 'Phone: NORth 3213.

Letters addressed to Box Nos. are simply forwarded to the advertiser. No responsibility is accepted in connection with these advertisements.

DEPOSIT SYSTEM. Readers may deal with advertisers in safety through our Deposit System. Purchase money payable to Hiffe & Sons Ltd. should be deposited with "The Wireless World," when both parties are advised of its receipt.

The time allowed for decision is three days, counting from receipt of goods, after which period, if buyer decides not to retain goods, they must be returned to sender. If a sale is effected, buyer instructs us to remit amount to seller, but if not, seller instructs us to return amount to depositor. Carriage is paid by the buyer, but in the event of no sale, and subject to there being no different arrangement between buyer and seller, each pays carriage one way. The seller takes the risk of loss or damage in transit, for which we take no responsibility. For transactions up to £10 a deposit fee of 1/- is charged; over £10 and under £50, 2/6; over £50 and under £75, 5/-; over £75 and under £100, 7/6; over £100 one-half per cent. All correspondence must be sent to Dorset House, Stamford Street, London, S.E.1.

Cheques and Postal Orders sent in payment for deposits or advertisements should be made payable to Hiffe & Sons Ltd., and crossed. Notes cannot be traced if lost in transit. They must therefore be regarded as being despatched at sender's risk. Alternatively, they may be sent per registered post.

COMMUNICATION RECEIVERS

NEW Trophy 6, perfect; £7/5.—Box 2516, c/o *The Wireless World*. [9039]

£11—Hallcrafters Sky Champion, new 1939, practically unused.—Phone: Put. 5937. [9038]

Wanted

DB20 Preselector.—Particulars and price to BRS 3744, 96a, New Walk, Leicester. [9024]

COMMUNICATION Receiver, late model.—Full particulars, Tavistock, 29, Risca Rd., Newport, Mon. [9019]

WANTED, Guisneau, M-Murdo silver super silver communication receiver.—Walter Garner, Pickering Lodge, Timperley, Cheshire. [9041]

VOIGT Corner Horn Speaker, communication receiver R.M.E. National, Hallcrafters SX.16.—Hardwicke, 29, Warwick Av., Crosby, Lancs. [9023]

USED SETS FOR SALE

HALLCRAFTER

HALLCRAFTER S.X.23, only been used one week; cost £33/10, accept £25, bargain.—M. Ellinger, 86, Inverness Terrace, W.2. [9043]

HAMMARLUND

HQ120, with speaker, 200% spare valves, little used, perfect; £25.—Box 2518, c/o *The Wireless World*. [9049]

MIDWEST

1940 17-valve De Luxe Midwest Chassis, 5-wave band, 10-2,460 metres, marvellous selectivity and sensitivity, organ-ionic tone filter, electric touch-key split second tuning dual-Rola speaker, push-pull 20 watts output, cost £55, only a few weeks old; will accept £32/10.—Box 2506, c/o *The Wireless World*. [8997]

McMURDO

McMURDO 1940 15-17 Georgic Autoradiogram, shop soiled, listed 82 gns.; snip, £67/10.—A.C.S. Radio, 46, Widmore Rd., Bromley. [9014]

PHILCO

PHILCO 39-95, all-dry, U.S.A., press-button superhet, perfect condition; £6/10.—A.G.H.M., 27, Hornsey Lane Gardens, N.6. [9048]

R.M.E. 69

R.M.E.69, with noise limiter and speaker, dem. soiled; £41/10.—A.C.S. Radio, 46, Widmore Rd., Bromley. [9012]



Firms experiencing difficulty in obtaining transformers from their usual source of supply should get into touch with us at once.

We are still living up to our reputation for prompt and personal service.

We are also open to consider sub-contracts for limited quantities.



King's Bldgs., Dean Stanley St., London, S.W.1.
Phone: VICToria 5035

Better Results with SOLON Electric SOLDERING

- NO DIRT—**
Heating element clamped inside bit. No flame, hence no dirt.
- CONSTANT HEAT—**
Switch on—ready in 4 minutes. Heat maintained while current is on.
- PERMANENT RESULTS—**
Perfect jobs always—no dirt or corrosion with Solon resin-cored solder.
- ECONOMICAL IN USE—**
15 hours' continuous use requires only 1 unit of electricity.
- WEARING PARTS REPLACEABLE—**
These can be supplied and fitted without trouble.
- Supplied complete with resin-cored solder, flex and lamp adaptor 9/4.
- Solon resin-cored solder 6d. per reel.

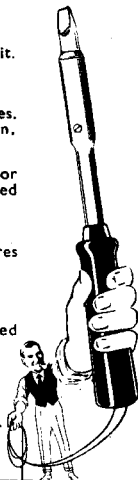

It's Easier with a **SOLON Electric SOLDERING IRON**

W.T. HENLEY'S TELEGRAPH WORKS Co., Ltd. (Dept. 4/E)
Engineering Sales Department, GRAVESEND, KENT.

USED SETS FOR SALE

SCOTT

SCOTT Quaranta, cost £1,000; bargain. £160; Scott Imperial Warwick Autoradiogram, £82/10.—A.C.S. Radio, 48, Widmore Rd., Bromley. [9013]
"SCOTT" De Luxe 12, with separate power amplifier, special short-wave model with a really amazing performance on the low wave-bands, 10-550 metres, dual-Rola speakers, in perfect condition, cost 120 guineas; accept £30.—Box 2507, c/o The Wireless World. [8998]

MISCELLANEOUS

SALE of Radiograms, receivers, etc., from £1 to £100, new or used; part or complete exchanges; 1½d. stamp for bargain list.—Stewart and Roberts, Amersham. [9001]

Wanted

WANTED, "Wireless World" Communication Receiver, specified parts.—State cash price to Box 2519, c/o The Wireless World. [9053]

WANTED, 10-12 watts output A.C.-D.C. gram. and mic. amplifier (good frequency response essential), with universal motor turntable, pick-up, etc.—Full particulars and price to J. Coombs, 90, Queen St., E.C.4. [9006]

PUBLIC ADDRESS

V

VORTEXION P.A. Equipment

IMITATED, but unequalled.

WE Invite You to a Demonstration.

A.C.-D.C. Dance Band Amplifier, 10 watts output, complete in case, with moving coil microphone, speaker and cables, weight 22lb.; 12 gns.

A.C. 20-15-20-watt Amplifier, 38-18,000 cycles, independent mike and gram, inputs and controls, 0.037 volts required to full load, output for 4, 7.5, and 15 ohms speakers, or to specification, inaudible hum level, ready for use; 8½ gns. complete.

C.P. 20 12-volt Battery and A.C. Mains Model, as used by R.A.F., output as above; 12 gns.

A.C.-20, in portable case, with Collard motor, Piezo pick-up, etc., £14; C.P. 20 ditto, £17/17.

50-WATT Output 6L6s, under 60-watt conditions, with negative feed back, separate rectifiers for anode screen and bias, with better than 4% regulation level response, 20-25,000 cycles, excellent driver, driver transformer, and output transformer matching 2-30 ohms impedance electronic mixing for mike and pick-up, with tone control, complete with valve and plugs; £17/10.

COMPLETE in Case, with turntable, B.T.H. Piezo pick-up and shielded microphone transformer; £22/10.

80-WATT Model, with negative feed back; £25. complete.

120-WATT Model, with negative feed back; £40. complete.

250-VOLT 250 m.a. Full Wave Speaker, field supply unit; 25/- with valve.

6- or 12-volt Car Battery Charger, 30/-; complete in gauze case, 35/-.

WE are Compelled Through Rising Costs to Increase our Prices by 10%.

ALL P.A. Accessories in Stock; trade supplied.

SEE Our Display Advertisement on Edit. page 309.

VORTEXION, Ltd., 182, The Broadway, Wimbledon, S.W.19. Phone: Lib. 2814. [8241]

NEW MAINS EQUIPMENT

VORTEXION Mains Transformers, chokes, etc., are supplied to G.P.O., B.B.C., L.P.T.B.; why not you?

WE are Compelled Through Rising Costs to Increase our Prices by 10%.

VORTEXION, Ltd., 182, The Broadway, Wimbledon, London, S.W.19. Telephone: Liberty 2814. [8242]

ALL-POWER TRANSFORMERS, Ltd.—Transformers and chokes to specification, rewinds; write for quotation.—8a, Gladstone Rd., Wimbledon, S.W.19. Liberty 3303. [9015]

NEW LOUD-SPEAKERS

BRAND New Speakers.
SAVE Pounds. 2½d. stamp for list of British and American P.A. speakers. Example: P.A. speaker with transformer, weight 21lb., incorporating curved cone; 52/-.

CHALLENGER RADIO CORPORATION, 31, Craven Terrace, London, W.2. Paddington 6492. [8789]

L-R-S EASY TERMS

The modern method of acquiring the most modern radio at a modest monthly outlay

ARMSTRONG Model SS10 10-VALVE SUPERHET—STRAIGHT ALL-WAVE CHASSIS

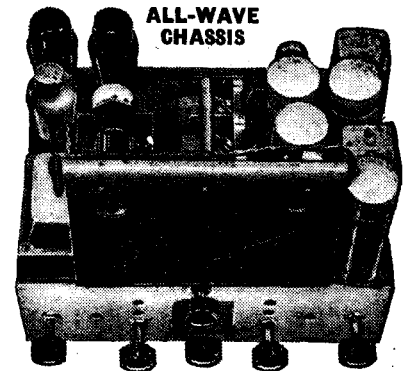

Fully described in Armstrong advert., p. 11.
Cash or C.O.D. £13.4.0
Or 45/- with order and 10 monthly payments of 23/-.

MODEL AW125PP—12-v 5-Band RG Chassis (12-550 continuous, 1,000-2,000 m.)
Cash or C.O.D. £18.15.0
Or 76/- with order and 8 monthly payments of 40/-.

MODEL AW38—3-v All-Wave Superhet
Cash or C.O.D. £8.16.6
Or 45/6 with order and 7 monthly payments of 20/-.

WRITE for full specification. Price Lists and Terms for complete Armstrong range, enclosing 2½d. postage.

In addition we shall be glad to quote for all other high-grade equipment, such as Ambassador Chassis and Receivers, Sound Sales Amplifiers, Voigt Speakers, Haynes Radio, Avometers, and PORTABLE A.R.P. RECEIVERS.

JOHN MCCLURE FEEDER and TUNING UNITS

on convenient terms—
These excellent Feeder Units so favourably reviewed and recommended by "The Wireless World" in March are now available from us on our usual terms. For example:

TYPES AC4 & UF4. Cash or C.O.D. £8.18.6
Or £1.8.6. with order and 8 monthly payments of 20/-.

Full details of other Units on request.

DRY SHAVERS on 14 DAYS' APPROVAL

against cash or on first instalment of 10/-. Should the shaver be returned, 7/6 will be refunded.

VICEROY Non-electric - - £2.10.0
Or 10/- with order and 6 monthly payments of 7/2.

SHAVEMASTER Electric - - £4.4.0
Or 10/- with order and 8 monthly payments of 10/-.

ELECTRICAL APPLIANCES
Fires, Vacuum Cleaners, Clocks, Irons, Fans are all available on our convenient terms.
Write TO-DAY for illustrated details.

The Evacuation address: Est. 1925
LONDON RADIO SUPPLY COMPANY
"Winden," Ardingly Road, Balcombe, Sussex

COMPONENTS—SECOND-HAND,
CLEARANCE, SURPLUS, ETC.

VAUXHALL—Rola P.M. speakers, 8in., 14/9; 10in., 18/6; Rola energised 1,500 ohm speakers, 8in., 12/6; 10in., 15/3.

VAUXHALL—Rola G12 P.M. speakers, 69/6; G12 energised, 55/-; all brand new with input transformer.

VAUXHALL—A few Magnavox loudspeakers available; modern pick-ups, volume control, 11/- and 18/9.

VAUXHALL—Collaro A.C. gramophone motors, turntable, 30/-; Collaro A.C. motors with magnetic pick-up, complete, 52/6; Collaro A.C. motors, with crystal pick-up, complete, 65/-.

VAUXHALL—Flat hard sheet copper, 12x12in., 3/9; 12x24in., 6/6; 24x24in., 13/-; volume controls, 2/-; with switch, 3/-.

VAUXHALL—Electrolytic condensers, 50 mfd. 50v., 1/9; 50 mfd. 12v., 1/6; 0.1 mfd. 350v., 3d.; 8 mfd. 550v., metal can, 3/-.

VAUXHALL—Cardboard case electrolytics, 8 mfd. 500v. 2/-; 8 plus 8 mfd., 3/6; 6 plus 4 mfd., 350v., 1/9; Polar Q.J. 0.0002 mfd S.W. condensers, 4/-.

VAUXHALL—Bar-type condensers, straight 0.0005 mfd., 2-gang, 6/6; 3-gang, 8/6; Fullvulsion drives, 6/-; domestic electrical appliances, gramophone records, supplied.

VAUXHALL UTILITIES, 163a, Strand, London, W.C.2. Stamp for free list. [9022]

5/- Only—Bargain parcel comprising speaker cabinet, drilled steel chassis, condensers, resistances, and many other useful components; worth 35/-, limited number; postage 1/-—Bakers Selhurst Radio, 75, Sussex Rd., South Croydon. [9037]

WESTINGHOUSE Rectifier, 300 volt 60 m.a., 7/6; high voltage television type, 10/-; G.E.C. home broadcaster and "Wireless World" transverse mike, 10/- each; Telefinder type 1,001 pick-up, 20/-; Weston moving coil relay, 20/-; sundry components, list stamp, all perfect, mostly unused.—Box 2515, c/o *The Wireless World*. [9033]

COULPHONE RADIO, Grimshaw Lane, Ormskirk.—Collaro A.C. gramophone motors, 12in. turntable, 27/6; radiogram units, 45/-; record changers, £6/10; high-grade crystal pick-ups, 25/-; guaranteed American valves, 4/6; Octal, 5/6; Rola G.12 energised, 52/6; G.12 P.M., 65/-; R.G.D., Ferguson, K.B., Decca, G.E.C. receivers; 1d. stamp for lists. [9021]

Wanted

J.B. Linacore Allwave Tuner and I.F. Transformers.—5, Uppingham Rd., Wallasey. [9050]

WANTED, power driven recording turntable, head not required.—Box 2520, c/o *The Wireless World*. [9054]

MISCELLANEOUS

CARDS, memos, billheads; 1,000, 6/9; samples—"B," Tices, 11, Oaklands Grove, London, W.12. [9009]

WANTED, "Wireless World," July and August, 1933. Price, condition.—Box 2508, c/o *The Wireless World*. [8894]

HOOVERS (Accessories Included), £4/10; also Goblins, 49/6; Electrolux, £4/4; Vacrics, Tellus, Hotpoints, Gems, from 30/-; all perfect! Guaranteed—"R.E.C.S.," Crown St., Reading. Phone: 2796. [9051]

EVERY Radio Dealer Who is Not a Regular Reader of "The Wireless and Electrical Trader" should send his trade card at once for a specimen copy and full details of the "Trader" Services. "The Wireless and Electrical Trader" has the widest influence, the largest weekly circulation, and is read by all the leading manufacturers and traders. Trade only. 15/- per annum, post free. Published at Dorset House, Stamford St., London, S.E.1. [0615]

REPAIRS AND SERVICE

EPOCH Diaphragms, genuine replacements, for "Domino," 99's, etc.—"R.E.C.S.," Crown St., Reading. Phone: 2796. [9052]

ALL Types of Radio Sets Serviced under our Guarantee. Estimates free.—Will Day, Ltd., 19, Lisle St., W.C.2. Gerrard 7105. [8996]

LOUD-SPEAKER Repairs, British, American, any make, 24 hours' service; moderate prices. Sinclair Speakers, Pulteney Terrace, Copenhagen St., N.1. [8991]

GUARANTEED Repairs, any transformers, choke, motor armature, converter, dynamo, etc.; keenest prices, immediate quotation, prompt, dependable service.—See below.

L.T.P. (LONDON TRANSFORMER PRODUCTS), Ltd., Willesden, N.W.10. Willesden 6486 (3 lines). [6892]

MAINS Transformer Service, repairs, rewinds, or construction to specification of any type, competitive prices and prompt service.—Sturdy Electric Co., Dorman, Newcastle-on-Tyne. [0516]

for PERFECT PORTABLE POWER

Masteradio

MALLORY

VIBRAPACKS
& VIBRATORS

for all Supply Requirements.

Any Output Range up to 300 volts at 100 m/a from 6 or 12 volts. Also 150 watts A.C. from 110 or 220 volts D.C.

3 out of 4 Vibrators in use throughout the World are Mallory made.

Ask for technical data from Concessionaires:

MASTERADIO Ltd.,
Vibrant Works, 193, Rickmansworth Road,
Watford, Herts.

Telephone:

Watford 9885

Greenwood

THE WAR
AND
LOCKWOOD

Although materials are scarce we shall continue with our standard models also with the manufacture of cabinets to customers' own designs, but it is likely that as things go on manufacture will be severely curtailed, therefore we would ask all intending purchasers to let us have their instructions as soon as possible so that where possible we may reserve materials.

You can insure against disappointment by forwarding a deposit of approximately 20% of the cost of a completed case.

We are grateful to all those customers for their help and consideration during the last few months of difficult trading.

Send 2d. in stamps for details of Standard Models.

LOCKWOOD & CO., LOWLANDS ROAD,
HARROW, MIDD.-
Phone: BYRon 1818

TRIX

RELIABLE AMPLIFICATION
The TRIx ELECTRICAL COMPANY LTD.
65, Bolsover St., London, W.1. Euston 5471

SOUND
EQUIPMENT

MOTORCYCLE

Every
Thursday
4d.

W.W.15

REPAIRS AND SERVICE

"SERVICE with a Smile."—Repairers of all types of British and American receivers; coil rewinds; American valves, spares, line cords.—F.R.L., Ltd., 22, Howland St., W.1. Museum 5675. [8934]

METROPOLITAN RADIO SERVICE.—Guaranteed repairs to American and British receivers; American valves, service parts and rewinds; trade supplied.—1021, Finchley Rd., N.W.1. Speedwell 3000. [0435]

REPAIRS to Moving Coil Speakers; cones/coils fitted or rewound; fields altered or wound; prices quoted, including eliminators; pick-ups and speaker transformers rewound, 4/6; trade invited; guaranteed satisfaction; prompt service.—L. S. Repair Works, 5, Balham Grove, London, S.W.12. Battersea 1321. [0394]

SITUATIONS VACANT

AIR MINISTRY.

A NUMBER of Technical Officers are Required at the Royal Aircraft Establishment, South Farnborough, Hants.

COMMENCING Salary up to £455 a Year, men; (£347 women), according to qualifications and experience.

CANDIDATES Should Possess a University Degree or Evidence of Equivalent Technical Standing, in a subject appropriate to the requirements specified below, and suitable practical experience.

(A) Design and Development of Small Mechanical and electrical devices.

(E) Radio or Communication Engineering, with specialist knowledge of small transmitters, or receivers, or direction finding equipment.

(F) Design, development, testing and installation of aircraft instruments, or similar equipment.

REQUESTS for the Necessary Application Form Should be Made by Postcard (Quoting Ref. A.500), addressed to the Chief Superintendent, Royal Aircraft Establishment, South Farnborough, Hants. [9016]

AIR MINISTRY.

A NUMBER of Assistants, I, II and III, are required at the Royal Aircraft Establishment, South Farnborough, Hants.

SALARY:—

REF. A.501. Assistants I, £400 a year (£325 a year women).

REF. A.502. Assistants II, £315 a year (£265 a year women).

REF. A.503. Assistants III, salary up to £260 a year, according to qualifications and experience.

CANDIDATES Should have had Good Technical Education and Practical Works or laboratory experience, and experience in one or more of the following categories:—

(A) Design and Development of Small Mechanical and Electrical Devices.

(E) General Aircraft Instruments and Allied Equipment.

(F) Radio or Communication Engineering, preferably with knowledge of design of small radio equipment.

REQUESTS for the Necessary Application Form Should be Made by Postcard Addressed to the Chief Superintendent, Royal Aircraft Establishment, South Farnborough, Hants. [9017]

SERVICE Engineer Required for Safe Area 60 miles from London.—Send full details of experience, salary required, etc., to Box 2511, c/o *The Wireless World*. [9010]

ENGINEER Operator, experienced on L.F. amplifiers, knowledge of communication equipment an advantage, must be 35-40 years; write, stating experience and salary required.—Box 2512, c/o *The Wireless World*. [9011]

AIR MINISTRY.—Civilian Wireless Instructors Required.

VACANCIES Exist for Civilian Wireless Instructors at the Electrical and Wireless Schools, Royal Air Force. The commencing rate of pay is £4/5 a week, inclusive, which may be increased to £4/10 a week after a short period of satisfactory service. Candidates must be capable of lecturing and must have a sound knowledge of electrical principles and their application to radio and low-power electrical engineering. Applications should be addressed to the Under-Secretary of State (S.5.d.), Air Ministry, Kingsway, W.C.2. giving particulars as to previous experience, age, &c. Suitable candidates will be required to appear before a Selection Board at the School for interview and trade test, but may be reimbursed the cost of third class travelling expenses for this purpose. The test will include the giving of a lecture on any subject which may be chosen by the candidate involving the principles of modern radio. Lecturing sequence and style are most important. [0616]

MCCARTHY

The Chassis Specialists

have removed their entire business to their Sussex factory:

**CLARENDON WORKS,
MONTAGUE ROAD,
WORTHING,**

where all orders and correspondence should be addressed in future.

We have

THREE NEW RECEIVERS

available in Chassis form or complete in Cabinet for those who desire

Individuality and Reliability

R.S. 640 - - - £9.17.6

P.P. 840 - - - £12.12.0

P.P. 940 - - - £15.15.0

Cabinets - - - from £10.6
Matched Speakers from £1.50

Write for Illustrated Brochure giving full details and specifications, enclosing 2½d. for postage.

H. MCCARTHY LTD.

(C. H. S. Smith, Receiver and Manager)

External Speaker CONTROL PANELS

Controls both Internal and External speakers by slight angular movement of plug.



PRICE 1/-

CLIX

British Mechanical Productions Ltd.
1, Church Road, Leatherhead, Surrey

SITUATIONS VACANT

EXPERIENCED Instrument Makers Required, rate 1/8 to 2/- per hour for 46½ hr. week.—Apply Employment Dept., Murphy Radio, Ltd., Welwyn Garden City, or nearest Employment Exchange. [8828]

PUBLIC Address Systems.—Experienced man wanted for planning installations and for maintenance, permanency.—Write, giving experience, age and salary required, to Box 2517, c/o *The Wireless World*. [9042]

RADIO Testers Required, applicants must have had technical training and experience of receiver circuit trimming on factory production lines.—Apply Employment Dept., Murphy Radio, Ltd., Welwyn Garden City, or nearest employment exchange. [8820]

RADIO Engineer Required for Testing and Special Servicing; also opportunity for development work; must be fully competent and able to drive car. Experienced radio wireman, youths for assembly, and a storekeeper also required.—Dynatron Radio, Ltd., Ray Lea Rd., Maidenhead. [9005]

ENGINEER in Charge for Relay Wireless Service in Midlands, salary £250 p.a.; applicants must possess adequate technical knowledge backed by practical experience; successful applicant will attend training course in London.—Box 2509, c/o *The Wireless World*. [9007]

VACANCIES Exist for Civilian Morse and Procedure Instructors at the Electrical and Wireless Schools, Royal Air Force, at an initial rate of pay of £4/5 per week, increasing to £4/10 per week on the satisfactory completion of a probationary period, and thereafter by annual increments of 2/6 per week to a maximum of £5 per week. Candidates must be able to send and receive morse at not less than 25 w.p.m. and should have had experience of lecturing and teaching, but consideration will be given to others who consider themselves capable. Applications should be addressed to the Under Secretary of State, Air Ministry (S.S.D.), London, W.C.2, giving full particulars as to previous experience, age, etc. Candidates will be required to appear before a Selection Board at the Schools for interview and test, but may be reimbursed the cost of third-class locomotion expenses for this purpose. [8824]

DEAF AID EQUIPMENT

DEAF Aid.—3 valve instrument by Multitone, excellent condition; user deceased.—82, Woodford Rd., Bramhall, Cheshire. [9026]

MORSE EQUIPMENT

FULL Range of Transmitting Keys, practice sets, oscillators, recorders and other radio Telegraph apparatus, designed and manufactured by T. R. McElroy, world champion telegraphist. Sole distributors: Webb's Radio, 14, Soho Street, London, W.1. Phone: Gerard 2089. [8768]

CHARGING EQUIPMENT

CHARGING Boards (2), Newton 36v. 6 amps. two fixed, two variable outputs, Philips rectifier; offers.—Bradshaw, 33, Mavis Rd., Birmingham, 31. [9003]

PATENT AND TRADE MARK AGENTS

GEE and Co. (H. T. P. Gee, Mem. R.S.G.B., etc.). 51-52, Chancery Lane, London, W.C.2. Holborn 4547 8. Handbook free. [0001]

BUSINESS & PROPERTY FOR SALE, TO BE LET, OR WANTED

"**THE** Wireless and Electrical Trader" is an essential part of the equipment of every Wireless Trader; its pages reflect the very latest turn of trade events, and it is read by all the leading dealers and manufacturers, for particulars of businesses offered or wanted. By subscription, to the trade only, 15/- per annum, post free.—Send your trade card for specimen copy to Dorset House, Stamford St., London, S.E.1. [0614]

TECHNICAL TRAINING

WARTIME Engineering Training with The T.I.G.B. is Your Best Investment. Write to-day for Great Free Guide which shows how to qualify for well-paid posts in aeronautical, automobile, chemical, mechanical, electrical, telecommunications, etc., branches, and alone gives the regulations for A.M.I.R.E., A.M.Inst.C.E., A.M.I.Mech.E., A.M.I.E.E., A.F.R.Ae.S., A.M.I.Chem.E., C. & G., etc., in which examinations T.I.G.B. students have gained 22 first places.

THE TECHNOLOGICAL INSTITUTE OF GREAT BRITAIN, 82, Temple Bar House, London, E.C.4 (Founded 1917). [8999]

Lowther

INDEPENDENT BASS & TREBLE CORRECTOR (Non-resonant)

Sent on 7 DAYS APPROVAL against cash.

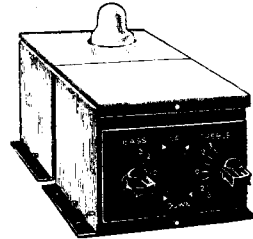

In these troubled times when the quality of transmission deviates so much from standard a controllable compensating unit of this description is indispensable to the lover of quality.

It is incorporated in all Lowther-Voigt Radio Gramophones over 92 gns.

The complete corrector can easily be fitted to any amplifier and is invaluable for adjusting the response to suit gramophone records, room acoustics, etc. Full technical details on request.

Price complete 5 gns.
Less Amplifying Stage 3½ gns.

RECEIVERS • AMPLIFIERS AND TUNING UNITS

Our Illustrated Art Brochure giving full specifications of Lowther Products will be sent upon receipt of 3½d. for postage. Will readers who already have this kindly note that, except for the Corrector, we are now obliged to increase our pre-war prices—but only by 5%.

The LOWTHER MANFG. Co.

Lowther House, St. Mark's Rd., Bromley, Kent.

Phone: RAVENSBORNE 5225.

GOOD REASONS for Learning code the Candler way!

"I have heard the Candler system for learning morse highly praised by many of my friends in the morse world." C.S.H.

"Perhaps you may think it a little strange wanting to study this as I am already a radio op., but I met one or two other sea going ops. who had greatly improved themselves and who recommended the Candler course." J.H.M.

(Original letters of above can be seen on request.)

CANDLER CODE COURSES

The Candler system of Code Training was devised for those who have entered or intend to enter the commercial side of telegraphy, the Services, or who take a real interest in Amateur Radio work.

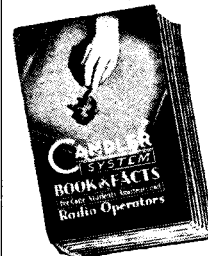

JUNIOR Scientific Code Course for Beginners. Teaches all the necessary code fundamentals scientifically.

ADVANCED High-Speed Telegraphing for operators who want to increase their w.p.m. speed and improve their technique.

TOUCH-TYPEWRITING for those who want to become expert in the use of the typewriter for recording messages.

Courses supplied on Cash or Monthly Payment terms.

COUPON

Please send me a Free Copy of the Candler "Book of Facts"

NAME

ADDRESS

Post Coupon in 1d. unsealed envelope to London Manager
CANDLER SYSTEM CO. (Room 55W), 121, Kingsway, London, W.C.2
Candler System Co., Ashville, North Carolina, U.S.A.

ENGINEERING OPPORTUNITIES

FREE 268 PAGES

This unique Handbook shows the easy way to secure A. M. I. C. E., A. M. I. Mech. E., A. M. I. E. E., A. M. I. W. T., A. M. I. R. E. and similar qualifications. WE GUARANTEE—"NO PASS—NO FEE." Details are given of over 150 Diploma Courses in all branches of Civil, Mech., Elec., Motor, Aero, Radio and Television Engineering, Draughtsmanship, Training, Inspection, Building, Government Employment, etc. Write for this enlightening Handbook to-day. FREE and post free. Men with Radio knowledge can obtain attractive posts in the Services.

BRITISH INSTITUTE OF ENGINEERING TECHNOLOGY, 387 Shakespeare House, 17, 18, 19 Stratford Place, London, W.1

ESSENTIAL!

MODERN RADIO COMMUNICATION

by
J. H. REYNER, B.Sc. (Hons.), etc.

Vol. I. Seventh edition. Includes all recent developments and full descriptions of latest apparatus and instruments. **7/6 net.**

Vol. II. Third edition. Specially written to assist students preparing for City and Guilds Examinations. With its companion volume, it provides a complete groundwork in the theory and practice of Modern Radio Engineering. **7/6 net.**

PITMAN

THE INSTITUTE OF WIRELESS TECHNOLOGY

(Founded in 1925. Incorporated 1932)

PROFESSIONAL MEMBERSHIP

The advantages of professional membership are open to all qualified wireless engineers.

Full information, with syllabus, may be obtained from the Assistant Secretary, Institute of Wireless Technology, 25, Firs Drive, Palmers Green, London, N.13
Phone: PALMERS GREEN 2413

CLASSIFIED ADVERTISEMENTS

intended for the
JULY ISSUE
can be accepted up to
Monday, June 10th.



Mains Transformers to customers' own specifications, or in accordance with our standard list—of which we would be glad to send you a copy.

W. BRYAN SAVAGE LTD.

Westmoreland Rd., London, N.W.9. Phone: Colindale 7131

TRIPLE CONE CONVERSIONS

BAKERS Triple Cone Conversions Will Immensely Improve Reproduction of Your Present Speaker. The following is typical of many unsolicited testimonials:—"Enstone," Lincoln Grove, Newcastle-Ulyme, Staffs. My speaker arrived safely on Saturday and has now been put into commission. The results are truly amazing, the bass register is reproduced faithfully whilst the upper frequency response is brilliant. For a few shillings you have converted a speaker scheduled for the scrap heap into one worth pounds. I am indeed very satisfied.—W. E. Darby (Grad. I.E.E.).

FREE Descriptive Leaflet from Bakers Selhurst Radio, 75, Sussex Rd., South Croydon. [9036]

TUITION

RADIO Training.—P.M.G. exams. and I.E.E. Diploma; prospectus free.—Technical College, Hull. [0611]

RADIO Officers (Marine), P.M.G. Special Certificate; free prospectus.—Marine School, South Shields. [8825]

MORSE Easily Learnt by Gramophone Records by ex-Service Instructor; speaks from two words per minute; also private tuition in London.—Masters, Pound Hill, Crawley, Sussex. [8965]

PRACTICAL Postal Courses, radio television, test equipment design, trade-test coaching for R.A.F. posts, I.P.R.E. and I.W.T. exams; booklet free.—Secretary, I.P.R.E., 3, Shirley Rd., London, W.4. [8838]

BOOKS, INSTRUCTION, ETC.

NEW Edition, American Amateur Relay League Handbook 500 pages of up-to-the-minute technical information. 7/- post free. 1940 JONES Handbook; approximately 700 pages dealing with every aspect of short-wave radio, 8/6 post free.—Webb's Radio, 14, Soho St., London, W.1. Phone: Gerrard 2089. [8765]

WEBB'S Radio Map of the World Enables You to Locate Any Station Heard. Size 40in. by 30in. 2-colour heavy art paper, 4/6. Limited supply on linen, 10/6. Webb's Radio Globe, superb, 12in. full-colour model. Radio prefixes, zones, etc. Heavy oxidised mount. Post paid, 27/6.—Webb's Radio, 14, Soho Street, London, W.1. Phone: Gerrard 2089. [8767]

LEONARD HEYS

for prompt and careful attention to RADIO DEALERS' WANT-LISTS.

- Send us your trade card for our interesting *Catalogue* and ask us to mail you our *Monthly Bulletins*.
- Our *Postal Service* covers the British Isles. Wholesale only.

LEONARD HEYS, Faraday House, 36, Henry Street, Blackpool, Lancs.

WARD

WE MANUFACTURE:

ROTARY CONVERTERS DC/AC for operating P.A. amplifiers, Radio Receivers, etc.

DC/DC ROTARY TRANSFORMERS, SMALL ALTERNATORS, SMALL DC MOTORS, H.T. GENERATORS, MAINS TRANSFORMERS up to 10 k.v.a. PETROL ELECTRIC generator sets up to 50 k.v.a.

BATTERY CHARGERS for private and industrial use.

We can also handle general small engineering work.

Full details of any of the above upon request

CHAS. F. WARD
46, FARRINGDON ST., LONDON, E.C.4
Telephone: Hoiborn 9703.
Works: Bow, E.

RADIO LABORATORY HANDBOOK

By M. G. SCROGGIE, B.Sc., A.M.I.E.E.
Issued in conjunction with "The Wireless World"

"Radio Laboratory Handbook" gives the serious wireless worker complete information from first-hand experience about laboratory equipment, the instruments which are necessary and the correct methods of operating them. The fundamental principles are fully discussed, as well as the sources of power and signals, instruments and measurements. Ultra-high-frequency work, the working out of results, and reference data are also dealt with. There is a collection of the most useful symbols, abbreviations, formulæ, laws, curves, tables and other data. A complete index, numbered sections and cross references enable the reader to find what is required without loss of time.

384 pp. 211 illustrations

PRICE 8/6 NET By Post 9/-

From all leading Booksellers or direct from the Publishers
LIFFE & SONS LTD.,
DORSET HOUSE, STAMFORD STREET, LONDON, S.E.1
W.W.22

INDEX TO ADVERTISEMENTS

| | PAGE | | PAGE |
|---|-------------------|--|--------------------|
| Acoustical Mfg. Co. | 13 | Galpin's Electrical Stores | 14 |
| Armstrong Manufacturing Co. | 11 | General Electric Co., Ltd. | Inside Front Cover |
| Automatic Coil Winder & Electrical Equipment Co., Ltd. | 1 | Goodmans Industries, Ltd. | 10 |
| Birmingham Radiomart G5N1 | 4 & 312 | Henleys, W. T., Telegraph Works Co., Ltd. | 12 |
| British Institute of Engineering Technology | 16 | Heys, Leonard | 17 |
| British Insulated Cables, Ltd. | Inside Back Cover | Inhof, Alfred, Ltd. | 4 |
| British Mechanical Productions, Ltd. | 16 | Institute of Wireless Technology | 17 |
| British Rola, Ltd. | 2 | Lockwood & Co. | 15 |
| Bulgin, A. F., & Co., Ltd. | Edit. p. 307 | London Radio Supply Co. | 12 |
| Candler System Co. | 16 | Lowther Mfg. Co. | 16 |
| Decca Radio & Television, Ltd. | 10 | Marconiphone, Ltd. | 6 |
| Erie Resistor, Ltd. | Inside Back Cover | Masteradio, Ltd. | 15 |
| Electradix Radios | 13 | McCarthy, H., Ltd. | 16 |
| Erskine Laboratories, Ltd. | Inside Back Cover | McClure, John, Ltd. | 4 |
| Fluxite, Ltd. | Edit. p. 305 | M.R. Supplies | 2 |
| | | Murphy Radio, Ltd. | 8 |
| | | Partridge, N. | 12 |
| | | Peto-Scott Co., Ltd. | 7 |
| | | Pitman, Sir Isaac, & Sons, Ltd. | 17 |
| | | Player's | Inside Back Cover |
| | | Premier Radio Co. | 5 |
| | | Savage, W. Bryan, Ltd. | 17 |
| | | Siemens Elec. Lamps & Supplies, Ltd. | 2 |
| | | Simmonds Aeroaccessories, Ltd. | 3 |
| | | Stratton & Co., Ltd. | 312 |
| | | Telegraph Condenser Co., Ltd. | Back Cover |
| | | Trix Electrical Co., Ltd. (The) | 15 |
| | | Vortexion, Ltd. | Edit. p. 309 |
| | | Ward, C. F. | 17 |
| | | Wharfedale Wireless Works | 2 |
| | | Whiteley Electrical Radio Co., Ltd. | 312 |

Printed in England for the Publishers, LIFFE AND SONS LTD., Dorset House, Stamford Street, London, S.E.1, by THE CORNWALL PRESS LTD., Paris Garden, Stamford Street, London, S.E.1. "The Wireless World" can be obtained abroad from the following: FRANCE: W. H. Smith & Son, 248, Rue Rivoli, Paris; Hachette et Cie, Rue Réaumur, Paris, and branches; Messageries Dawson, 4, Rue de Faubourg Poissonniere, Paris. BELGIUM: W. H. Smith & Son, 74-75, Boulevard Adolphe Max, Brussels. AUSTRALIA: Gordon & Gotch, Ltd., Melbourne (Victoria), Sydney (N.S.W.), Brisbane (Queensland), Adelaide (S.A.), Perth (W.A.), and Launceston (Tasmania). NEW ZEALAND: Gordon & Gotch, Ltd., Wellington, Auckland, Christchurch and Dunedin. INDIA: A. H. Wheeler & Co., Bombay, Allahabad and Calcutta. CANADA: Imperial News Co., Toronto, Winnipeg and Vancouver; Benjamin News Co., Montreal; Gordon & Gotch, Ltd., Toronto. SOUTH AFRICA: Central News Agency, Ltd.; Wm. Dawson & Sons (S.A.), Ltd., Cape Town. UNITED STATES: The International News Co., New York.

B.I. CONDENSERS

FOR
RADIO & GENERAL USE

B.I. CONDENSERS
for Radio Receivers, Battery Eliminators, Smoothing Circuits, etc., are made in several different types to suit the various uses for which Condensers are required in connection with Wireless circuits.

These Condensers are the result of 36 years' experience in the manufacture of all kinds of Condensers from the smallest sizes up to those weighing more than 2 tons.

In addition to the Standard Types, B.I. Condensers can be supplied in special forms to suit manufacturers' requirements.

The illustration shows Type 212 recommended for use with eliminators.



BRITISH INSULATED CABLES LTD.

Cable Makers and Electrical Engineers

PRESCOT, LANCS.

Telephone No.: PRESCOT 6571.

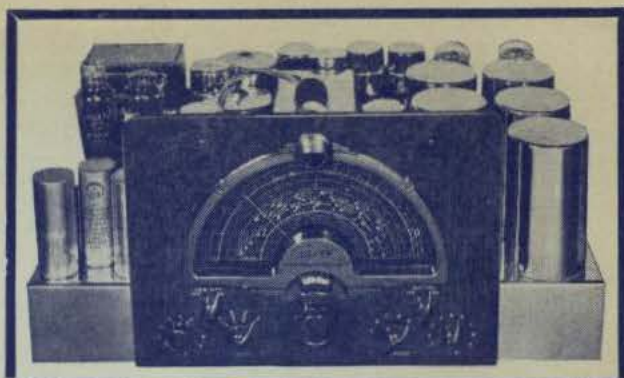

McMURDO SILVER RADIO

The quality receiver with communications receiver performance.

May we send you details?

**THE ERSKINE
LABORATORIES LTD.**
PROSPECT WORKS NORTH STREET
SCALBY, SCARBOROUGH

Keep that happy expression



In good times or bad, wherever you are, keep to that happy expression "Player's Please." The cigarette which makes happy expressions everywhere.

*Player's
Please*



PLAYER'S TOBACCOS AND CIGARETTES AT **DUTY FREE PRICES** FOR MEMBERS OF THE S.E.F. ASK YOUR TOBACCONIST FOR DETAILS

ERIE REPLACEMENT VOLUME CONTROLS

at pre-war prices
and pre-war quality

Nothing is skimmed in the manufacture of Erie volume controls. Only the finest raw materials that are so essential for efficient operation are used. Even in the face of rising production costs cheaper substitutes that are almost-as-good do not find their way into Erie volume controls. That is why Erie replacement volume controls are the best value on the market to-day.

SO REPLACE WITH ERIE
or better still—**BUILD** with ERIE

Standard Controls

| | |
|----------------------------------|----------|
| Less switch | 2/6 each |
| With single pole switch | 3/- |
| With double pole switch | 3/6 |
| Centre tapped with switch | 5/6 |

Dual and Ganged Controls

| | |
|--------------------------------|-----------|
| Less switch | 10/- each |
| With single pole switch | 10/6 |
| With double pole switch | 11/- |

All fitted with 2 1/2" Brass Spindle. Non-standard spindles 2/- extra.

DEALERS AND SERVICE MEN, who pride themselves on speedy repairs, are asked to remember that although we can offer pre-war quality, and pre-war prices, we cannot always offer pre-war delivery, and we shall appreciate any assistance they can give us by placing orders well in advance.

Complete price list sent on request.

ERIE RESISTOR LIMITED
Carlisle Road, The Hyde, Hendon, N.W. 9.
Telephone: COLINDALE 8011.



**THE MESSAGE
GETS
THROUGH!**

THE ship was a total wreck, but its passengers and crew were saved. Thanks to Radio the message got through. And, in all probability, thanks also to the dependability of the T.C.C. condensers in its Transmitter. For these familiar and ubiquitous green condensers are to be found in the wireless cabins of most of the liners flying the Red Ensign that sail the Seven Seas. This dependability—this freedom from breakdown under the most arduous conditions—is something which has long been associated with T.C.C. condensers the whole

world over. It is one reason why even foreign Broadcasting Companies have bought T.C.C. condensers—why so many of the largest Radio manufacturers in this country have used vast quantities of them. If you want your Sets to be trouble-free—if you are determined to get your service costs reduced to the minimum—you can't do better than specify T.C.C. condensers. Remember they are available in all the usual types—electrolytics (wet and dry), mica, ceramic, silvered mica, etc., etc. And finally, don't forget that T.C.C. make nothing but condensers.

T.C.C.
CONDENSERS