

The Wireless World

THE
PRACTICAL RADIO
JOURNAL
24th Year of Publication

No. 805.

FRIDAY, FEBRUARY 1ST, 1935.

VOL. XXXVI. No. 5.

Proprietors: ILIFFE & SONS LTD.

Editor:
HUGH S. POCOCK.

Editorial,
Advertising and Publishing Offices:
DORSET HOUSE, STAMFORD STREET,
LONDON, S.E.1.

Telephone: Hop. 3333 (50 lines).
Telegrams: "Ethaworld, Watloo, London."

COVENTRY: Hertford Street.
Telegrams: "Autocar, Coventry." Telephone: 5210 Coventry.

BIRMINGHAM:
Guildhall Buildings, Navigation Street, 2.
Telegrams: "Autopress, Birmingham." Telephone: 2971 Midland (4 lines).

MANCHESTER: 260, Deansgate, 3.
Telegrams: "Iliffe, Manchester." Telephone: Blackfriars 4412 (4 lines).

GLASGOW: 26B, Renfield Street, C.2.
Telegrams: "Iliffe, Glasgow." Telephone: Central 4857.

PUBLISHED WEEKLY. ENTERED AS SECOND
CLASS MATTER AT NEW YORK, N.Y.

Subscription Rates:

Home, £1 1s. 8d.; Canada, £1 1s. 8d.; other
countries, £1 3s. 10d. per annum.

As many of the circuits and apparatus described in these pages are covered by patents, readers are advised, before making use of them, to satisfy themselves that they would not be infringing patents.

CONTENTS

	Page
Editorial Comment	103
Noise Suppressors	104
First Continental Single-span Receiver	107
Current Topics	109
High Quality Receiver Technique	110
Broadcast Brevities	113
Designing a Wireless World Receiver—II	114
Scanning in Television	117
Listeners' Guide for the Week	118
Murphy Radio-gramophone Reviewed	120
Foundations of Wireless—X	122
Random Radiations	124
Why Do Listeners Like "Boom"?	126
New Apparatus Reviewed	127
Readers' Problems	128

EDITORIAL COMMENT

Effect of the Television Committee's Report

No Change in Broadcast Receivers

THE imminence of the publication of the Television Committee's report to the Postmaster-General has produced a crop of rumours and speculations as to the effect which television is going to have on our broadcasting organisation, and it has even been suggested that existing receivers for broadcasting and new models which manufacturers are working on at present will be rendered obsolete.

Such statements and suggestions are startling and may, in consequence, in some quarters be regarded as good journalism, but there is little foundation in fact for such ideas and unfortunately they have a disturbing effect upon those who, through ignorance, accept them.

It is, perhaps, just as well to consider the position briefly and marshal some of the facts which serve to repudiate any idea that a revolutionary change in our broadcast receiving arrangements is upon us.

First of all, the recommendations of the report, however promptly they may be acted upon, will certainly take some months for the B.B.C. to carry out. Then the B.B.C. has to get started with the transmissions and the public must acquire apparatus for their reception. The present order of broadcasting on the long and medium wavebands is far too firmly established to allow of any change to be brought about as a result of the development of television in its initial stages. The change which television might ultimately bring would be the transfer of local broadcasting to the very short wavelengths, but common sense decides that this would come only after tele-

vision had been accepted as an essential part of the broadcasting service by the majority of the European countries, and, even then, international agreement would have to be reached first. It is hardly necessary to point out that such agreements are not easily consented to, and probably long deliberation and a succession of international conferences would precede the adoption of any such scheme.

Again, there is such a thing as the responsibility of the Post Office and the B.B.C. towards both the listener and the manufacturer, and it is quite absurd to imagine that any step would be taken which would leave the public and the manufacturer with sets rendered obsolete by reason of such drastic changes.

There are good technical reasons for supposing that ultimately sound for the television programmes may be broadcast on channels adjacent to the television transmission itself as pointed out in an article in last week's issue, but this is looking a long way ahead, and even then this would not affect the present broadcasting service.

Suggestions have been made that short-wave convertors may be employed for television, to precede the existing receivers as an attachment. As far as television is concerned, this idea can at once be dismissed as technically unsound because for high-definition television present-day receivers are quite unsuitable in design. They would not pass anything approaching the frequency band required for the purpose.

There seems little doubt, therefore, that the present types of broadcast receivers will still be required for an unchanged system of broadcast sound reception, and the television set will be a separate entity marketed as an entirely independent instrument and designed for transmissions on independent wavelengths.

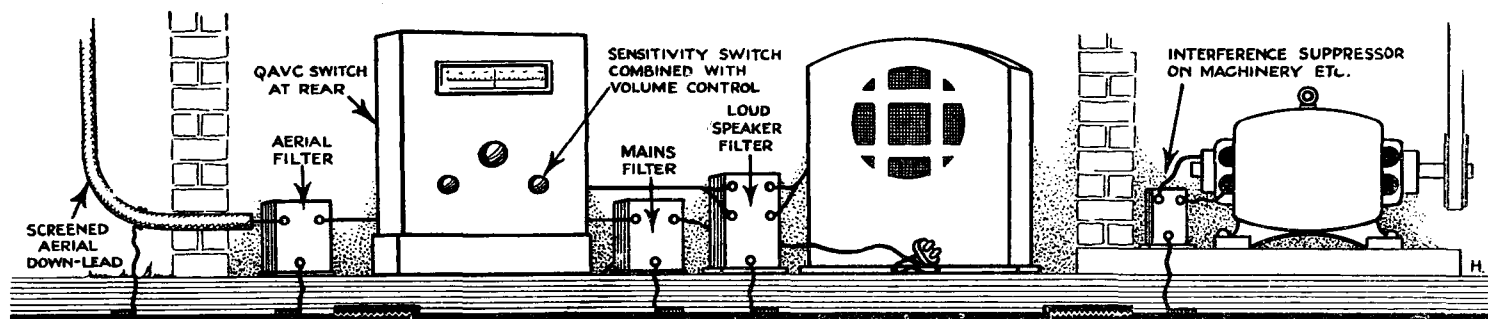

NOISE SUPPRESSORS

Effective and Ineffective Methods Described .

ALL kinds of devices, ranging from truly automatic and highly developed "Quiet" AVC systems to the simplest form of mains disturbance filter or "sensitivity limiting switch" are loosely described as noise suppressors. This article will help to clear up many popular misconceptions on the subject.

By M. G. SCROGGIE, B.Sc., A.M.I.E.E.

PEOPLE who go to Olympia, or any other place where numerous wireless sets are to be seen, for the purpose of selecting a receiver, presumably proceed something like this: They first find out what general type they require, or can pay for, and realise that they have to choose from among (say) forty models of that type. They then commence an eliminating process based on the points for and against each model. That is the idea, at any rate.

In order to spare their prospective customers undue brain fag, the vendors of the said models often draw up their "selling points" into lists, which, naturally, are made as overwhelming as possible.

One of the star points this season is "Noise Suppression." The term suggests an obvious advantage, for the association of undesirable noise is one of the chief stumbling-blocks in the way of those who remain to be numbered as licensees.

What sort of noise is there to be suppressed? What methods are available for suppressing it? And how much of it do they suppress?

It will be granted that it is a disadvantage to be deaf. One is thankful for good hearing. But if it were in our power to gain still better hearing, our thankfulness for it would probably be short-lived. A normal pair of ears brings in sounds from a sufficient range to make life quite uncomfortable in some situations as it is; and the advantages of super-sensitive hearing would be neutralised by the multifarious noises which it would make intolerable.

Much the same applies to radio. Modern valves and circuits have increased the range and sensitiveness of receivers, but there are electrical noises in great variety which may turn this into a doubtful advantage. These noises, according to their sources, fall into three classes.

The first is often given the unpleasant and rather inaccurate title of "man-made static." Most electrical machinery and appliances—trams, transmission lines, refrigerators, cleaners, signs, motor car ignition systems, etc.—cause electrical noises that can be heard with a radio receiver. Most of them can be more or less effectively silenced at the source by an appropriate system of condensers and/or chokes. The difficulty lies in persuading the owners of the interfering equipment, who usually are not inconvenienced thereby, to go to trouble and expense for someone else's benefit. Still, this class of

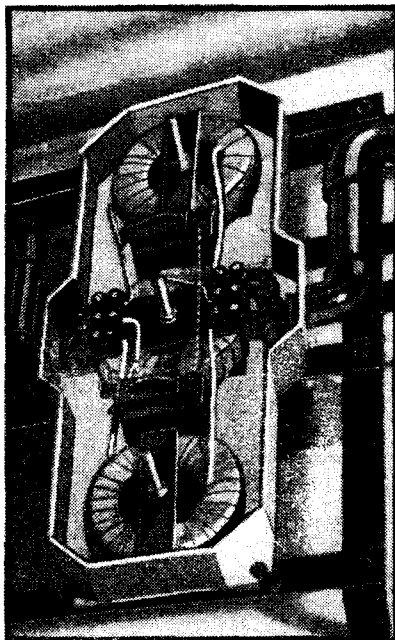

Electrical disturbances are likely to prejudice the accuracy of laboratory work: as a guard against mains interference, banks of Belling-Lee Suppressors have been installed in the power supply circuits in the H.M.V. research department. One of the choke units is shown with its cover removed.

noise may perhaps be classed as avoidable.

The major operations of Nature, however, are less subject to control. "Atmospherics" have worried radio people for the last thirty years, and they are still with us. They are caused chiefly by lightning, and their intensity depends on whether the nearest flash of lightning is taking place immediately over the aerial or a few thousand miles away. One can count on thunderstorms somewhere in the world at all times, and a single flash puts out far more power than all the broadcasting stations in the world combined; so a sensitive receiver is never entirely free from atmospheric noises.

Even if everything from without is excluded, the receiver itself makes its own noise. Often this is due to faulty working or poor design, but the best receiver is noisy if it is sufficiently sensitive. Valve hiss is a limiting factor.

Thus the valves cause hiss; atmospherics have been likened to the delivery of coals into the cellar; and the "man-made" noises are as varied as the human activities to which they are due.

The condensers, chokes, etc., suitable for abating the last-named nuisance, form one well-known class of noise suppressor. With them may be included such things as screened aerial down-leads for moving the collector away from the source of interference.

The last few Radio Exhibitions have included a prominent demonstration by the Post Office of how nearly all interfering appliances may be silenced with great success. There would be little trouble due to noises under this heading if only existing knowledge on methods of suppression were fully applied. In one sense this is the true noise suppression, for there is nothing lost to the receiver. But—we have no power over the other two sorts of noise.

Noise Suppressors—

Nobody has presumed to fit filters to a thundercloud.

Turning from prevention to the inferior doctrine of cure, we have the types of noise suppressor that apply to the receiver. In judging these one has to consider not only whether they dispose of the chaff satisfactorily, but also how much of the grain is lost with it.

Extravagant claims are sometimes made for devices to be connected between the aerial and the receiver. While one would not go so far as to say that none of these has any value at all, it remains to be proved that anything can be done in this way which does not cut down good and bad alike, or nearly alike. A filter in the mains connection, and a screened mains transformer, however, are sometimes quite useful in keeping out "man-made" noise, particularly when the source of the disturbance is beyond one's jurisdiction.

Suppression—At a Price

Devices claimed to "purify" reception are not confined to the input end of the receiver; there are others for attaching to the loud speaker; there are others for attaching to the loud speaker. This sort generally consists of a fixed condenser in a sealed box, sold at a profitable figure. The more irritating and obvious noise-sounds are high in pitch, and are reduced by the condensers at the expense of the corresponding frequencies in speech and music. Some people like "mellow" tone and write testimonials to the makers of such appliances. But the method is not for those who want natural reproduction.

One of the "noise suppressors" that figure on receiver specifications consists of nothing more than an extra resistor (R in Fig. 1), connected in the cathode circuit of the variable-mu valve or valves, and provided with a switch (S) to short-circuit it. When it is un-shorted the sensitivity of the receiver is thereby cut down with regard to noises and everything else alike. Although this sounds rather futile, the arrangement is not a mere pretext for publicity; in most sets provided with AVC there is an abominable row when one is tuning from station to station, and if the sensitivity can be temporarily reduced it is a comfort.

One might think that the same thing

could be done more simply by turning down the volume control, without any need for an extra gadget; but this is not so. To see why, refer to Fig. 2. This is a typical curve showing the relation between output available for the loud speaker (milliwatts) and the signal strength at the aerial (microvolts) necessary to produce it. "Signal" includes what is received from desired or undesired radio stations, and from the first two forms of noise interference.

A perfect AVC system would give the same output all the time, irrespective of the signal strength. Actually, of course, the weak signals are not enough to produce full output; and it is only above a certain signal strength that it is advantageous for the AVC to be brought into action to minimise any further rise in volume. These two conditions are shown by the two parts of the graph: the steeply rising part which applies when the delay effect prevents the AVC from being effective, and the flatter part corresponding to AVC action. The more effective the AVC the flatter it is.

Now programmes that are worth listening to are generally strong enough to come well beyond the "knee," on to the flat part. Unless the conditions are such as to make satisfactory reception impossible, the noise is weaker in comparison. But while tuning between the stations, when the AVC action is temporarily suspended, the receiver becomes fully sensitive and the noises may sound nearly as loud as the programmes. This produces the distressing effect that noise suppressors are designed to alleviate.

If the ordinary volume control, which affects the output, were turned down as suggested, everything, programmes and noise alike, would be reduced, as shown by line A. The balance between the two would be unaffected. But the sensitivity reducing device, instead of shifting the curve bodily downwards, shifts it to the right; line B for example. Obviously the weak signals (which we are assuming to

So we have the rather curious result that although this type of noise suppressor desensitises the amplifier towards everything that it handles—noise and programmes alike—it appears to cut down noise far more than programmes.

One of the chief objects of AVC is to counteract fading. Suppose the desired programme has a strength of 100 microvolts. Then (referring to the example

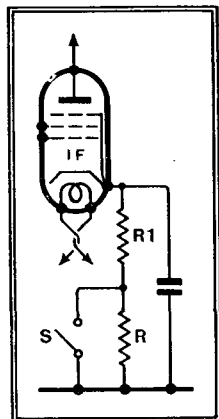
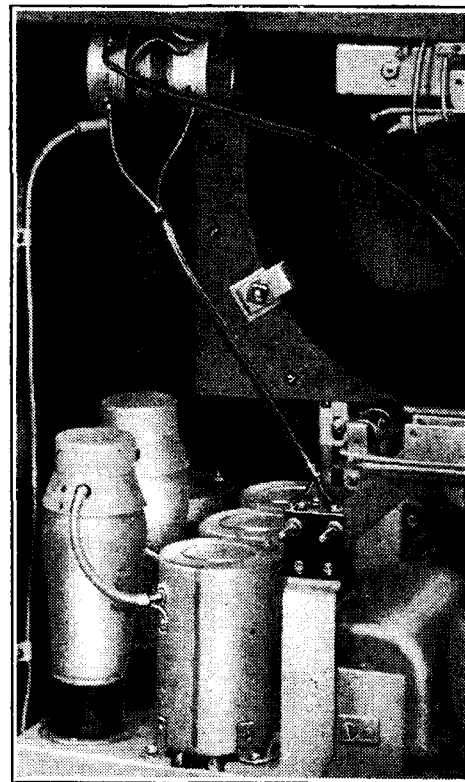

Fig. 1. When the noise-suppressor switch (S) is opened it inserts resistance R, which increases the bias on the valve and reduces its sensitivity. The resistor R1 is to provide the usual initial bias.



Built-in mains filter (top left-hand corner) in a Philips set.

illustrated in Fig. 2) with the noise suppressor out of use it is possible for it to fade down to 10 microvolts without noticeable drop in volume; but when the suppressor is in, the fading is just as bad as if there were no AVC—which is in fact exactly the situation.

If one were perfectly free to map out an ideal shape it would be a vertical line: C in Fig. 2. The AVC portion remains unmolested, but the portion corresponding to noise and to weak and almost worthless signals is completely removed, giving a perfect silence between the tuning points of the more powerful stations. This ideal is more or less closely approached by the various systems of Quiet AVC. Not many receivers embody any of these, because they add to the cost or complication, or are otherwise open to criticism. There is a remarkable amount of scope for difference in method, leading to subtle differences of behaviour; and it is on these that the pleasure of using the set largely depends.

For instance, it might well be argued that the correct system would give the result indicated by Fig. 3. No station having a strength of less than, say, 100 microvolts would be heard, but, once tuned in, it could fade down to the lower limit of the AVC (10 microvolts in this example) without being cut off. Some-

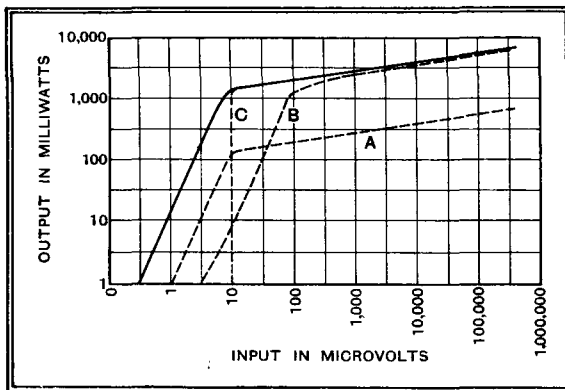

Fig. 2.—The full line is a normal curve, showing the relation between input and output of a receiver. The effect of ordinary volume control is shown at A; of the noise-suppression switch at B; and of QAVC at C.

include everything that is undesirable) are severely curtailed; but thanks to AVC there is very little reduction in those programmes that are still able to reach past the "knee" of the curve.

Noise Suppressors—

thing approaching this action is actually accomplished in some systems.

Again, the designer may arrange that the "Q" is worked from an exceedingly selective tuned circuit, so that the station is cut in only when it is exactly tuned. This makes it impossible for even the careless listener to mistune it, and avoids "side-band shriek." There are still other refinements. And on the contrary there are all sorts of possible defects, such as distortion, fluttering, and reduction in AVC efficiency. So QAVC is a considerable test of a designer's skill.

Any system of interstation noise suppression may take the outward form of a mere switch, giving the alternatives of "On" and "Off"; or it may allow the listener to control—within limits—the level below which signals are weakened or cut off. Obviously the latter permits one to make the best of whatever conditions happen to prevail at the time; the noise level is seldom constant.

At the risk of being guilty of repetition it is perhaps worth emphasising that the last two methods—desensitising switch and QAVC—do nothing to reduce the noise *when one is actually listening*. If the noise is comparable in strength with the desired programme there is no true remedy other than tackling the noise before it reaches the receiver at all.

Summarising: the only way to suppress noise without losing something else is to silence each noise-producing source, or to remove the aerial from the zone of interference. When the receiver is so sensitive as to pick up an unpleasant amount of noise that cannot be stopped at the

source there is a choice of several methods of noise suppression. Those that act by affecting the tone impair the quality of all programmes when in use, and they are not very effective as suppressors; aerial filters usually reduce sensitivity generally, and actually increase the proportion of noise generated in the set itself, but mains filters can be very useful.

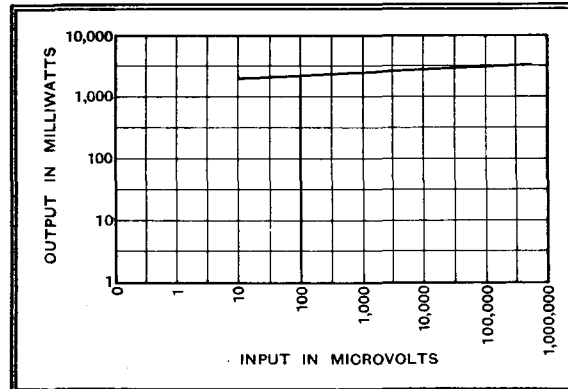

Fig. 3.—Ideal QAVC characteristic curve showing overlap to preserve AVC action intact.

AVC systems provided with a switch or control to insert extra bias for the pre-detector valves are effective in reducing noise, and leave the strongest programmes practically unaffected, but restrict the AVC action on programmes of moderate strength.

True QAVC, if skilfully designed and carried out, progressively eliminates noise and weak stations without affecting the better programmes.

DISTANT RECEPTION NOTES

A GOOD many reports of freak reception are reaching me at the present time. Most of them are concerned with the reception of some station or other with a highly selective receiving set when tuned to quite a different wavelength. Those who experience such happenings are not a little puzzled that a set, whose tuning may be described as of knife-edge sharpness, can misbehave itself in this uncanny way. Their mystification is increased when they find, as sometimes they do, that their own superheterodynes insist upon bringing in two stations at once, or one is a background to another, and that far less selective straight sets belonging to friends do neither of these things.

In genuine cases of the Droitwich or Luxembourg effect both straight sets and superheterodynes are equally at a disadvantage since the double reception that then occurs is due to natural causes and no kind of receiving equipment can prevent it. But there is also what may be termed a superheterodyne effect, which accounts for numerous kinds of freak reception.

Many superheterodynes are distinctly unselective in the tuned stages preceding the first detector, particularly those which have no signal-frequency amplifier. In numerous different ways either the locally generated oscillations or the carrier wave of another station may beat with the carrier of an unwanted transmission so as to produce oscillations either exactly on the inter-

mediate frequency or very close to it. When this occurs the unwanted station is more or less strongly heard according to the closeness of the beat frequency to that of the intermediate stages. The big increases in output power which are taking place will make it necessary for designers in future to pay special attention to the selectivity of the pre-detector stages in superheterodynes.

A considerable amount of heterodyne interference is observable at the present time on the medium waveband. Few stations of importance are continuously affected; but at the same time there is hardly an evening now when some transmissions that are normally good are not found to be accompanied by unwelcome whistles. A good many of these heterodynes are due to Russian stations, some of which have rather hazy ideas about wavelength keeping. Others are undoubtedly caused by harmonics of stations of longer wavelength.

Amongst the important stations that have been heterodyned on occasion are Stuttgart, Leipzig, Breslau, Königsberg and Nürnberg. Königsberg has been the worst sufferer, for this station is comparatively seldom to be received clear of interference. A new wavelength plan is urgently needed, though, judging from the results of the Lucerne Conference, any attempt to devise a scheme acceptable to all countries concerned would seem to be an almost hopeless task. We must resign ourselves to the fact that whatever the sensitiveness or the selectivity of a receiving set the reception of every important European station on any evening is not possible, and apparently never can be. But when all is said and done each evening provides us with a large number of genuine alternative programmes from which to make our selection.

The best of the long-wave stations at the time of writing are Huizen, Radio-Paris, Warsaw, Luxembourg, Kalundborg and Oslo. Zeesen, however, is apt to be none too strongly received at times, and Luxembourg is prone to heterodyne interference.

Of the medium-wave stations the group at the top of the band continues to be well received. This includes Budapest, Bero-münster, Stuttgart, Vienna, Florence, Brussels No. 1 and Prague, though Florence is subject to certain variations. The most dependable stations on lower wavelengths are Stockholm, Rome, Munich, Berlin, Hamburg, Brussels No. 2, the Poste Parisien, Hilversum, Bordeaux and Frankfurt. It should be noted that Radio Toulouse is now permitted to use greatly increased power, and that this station is usually well received. D. EXER.

NEW LAMPEX RECEIVERS

A Table Model Superheterodyne and Radio-gramophone

DESIGNED for operation from AC mains, the Lampex Superhet Four is fitted in a walnut cabinet with birdseye maple inlays. The frequency changer is coupled to the double-diode-triode second detector through an IF filter operating at 473 kc/s, and a high-slope pentode is used in the output stage. Tungram valves are used, and the price of the table model is 10 gns. This set is now available, and a radio-gramophone version at 19 gns. will be released shortly.

The makers are Lampex Radio & Electric Co., Phantom House, Brewery Road, London, N.7.

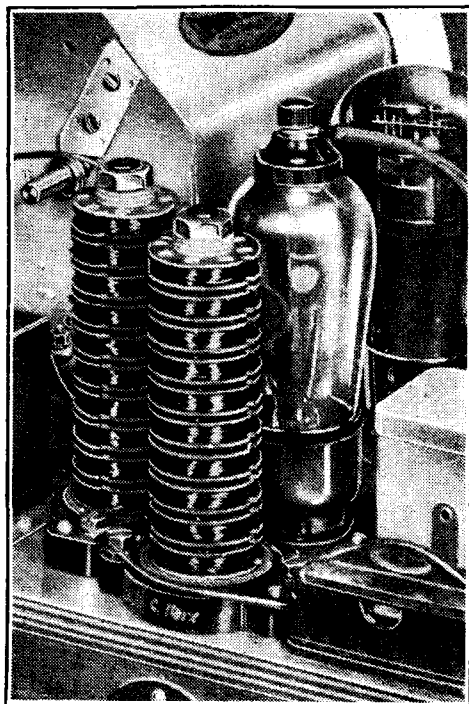

Heavy-duty HF chokes in the "Wireless World" DC Superhet.

First Continental Single-Span Receiver

THE "VOLKS-SUPER"

By H. J. WILHELMY (Munich)

THE Single-Span system of tuning has now firmly established itself as a practical method of obtaining single control tuning without involving either ganging or waveband switching. In this article is given a description of a new German Single-Span receiver. It is a three-valve mains set for broadcast reception, and one of the chief aims in design has been to reduce the cost to the utmost.

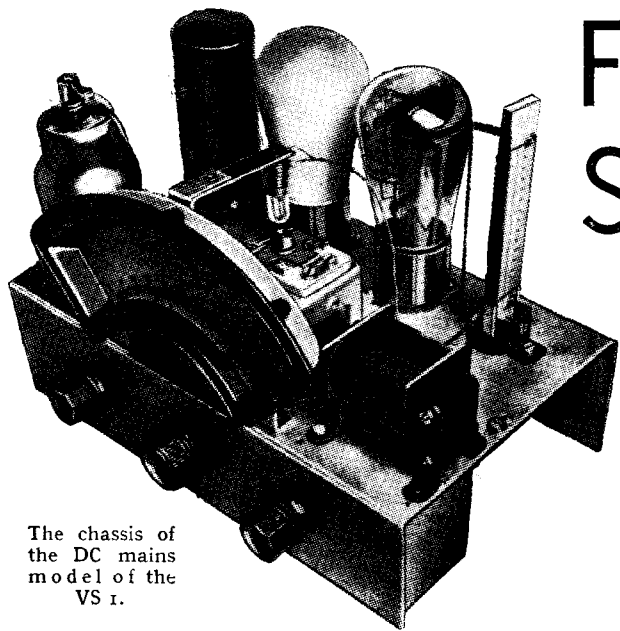

The chassis of the DC mains model of the VS 1.

THE first German superheterodyne in which tuning was carried out by a single circuit only embodied double-frequency-changing. It employed a first intermediate frequency of 2,200 kc/s and a second of 100 kc/s, and was tuned over the range of 150 to 1,500 kc/s by a single small condenser of approximately 120 mmfds. This set is said to have given an entirely satisfactory performance, in spite of the inherent difficulties discussed in *The Wireless World*,¹ and it was produced commercially. This set appeared as early as August, 1933, but is no longer produced to-day, because of the large number of valves used and its consequently high price, compared with standard superheterodynes of equivalent performance.

The first superheterodyne of practical

¹The *Wireless World*, July 27th, 1934.

value to include the principle of tuning by means of a single circuit was the "Single Span" developed and published by *The Wireless World*. It works without ganging and waveband-switching, and has a selectivity and sensitivity quite adequate for distant reception. This set, however, is not very suitable for the Continental, or, at least, the German market. It demands one or two valves more than an ordinary superheterodyne of the same performance, and the writer believes that its selectivity is not so high as is usually expected of a set having so many valves. In Germany, for instance, the largest superheterodynes normally sold this year are equipped with four valves only, and they have the very difficult task of receiving and selecting

almost every station worth hearing, including the short waves, from 20 to 60 metres. A Single-Span cannot do this with four valves, and it was because of this, therefore, that the writer did not attempt the design of a large Single-Span receiver.

It was the extreme economy of Single-Span tuning that caused the development of the first German and Continental Single-Span receiver. The chief advantages of the new system are "no ganging" and "no waveband-switching"; these advantages lead to an extremely simple and inexpensive set, and, in the case of the German "Volks-Super 1," this was the decisive point. The omission of an accurately manufactured two- or three-

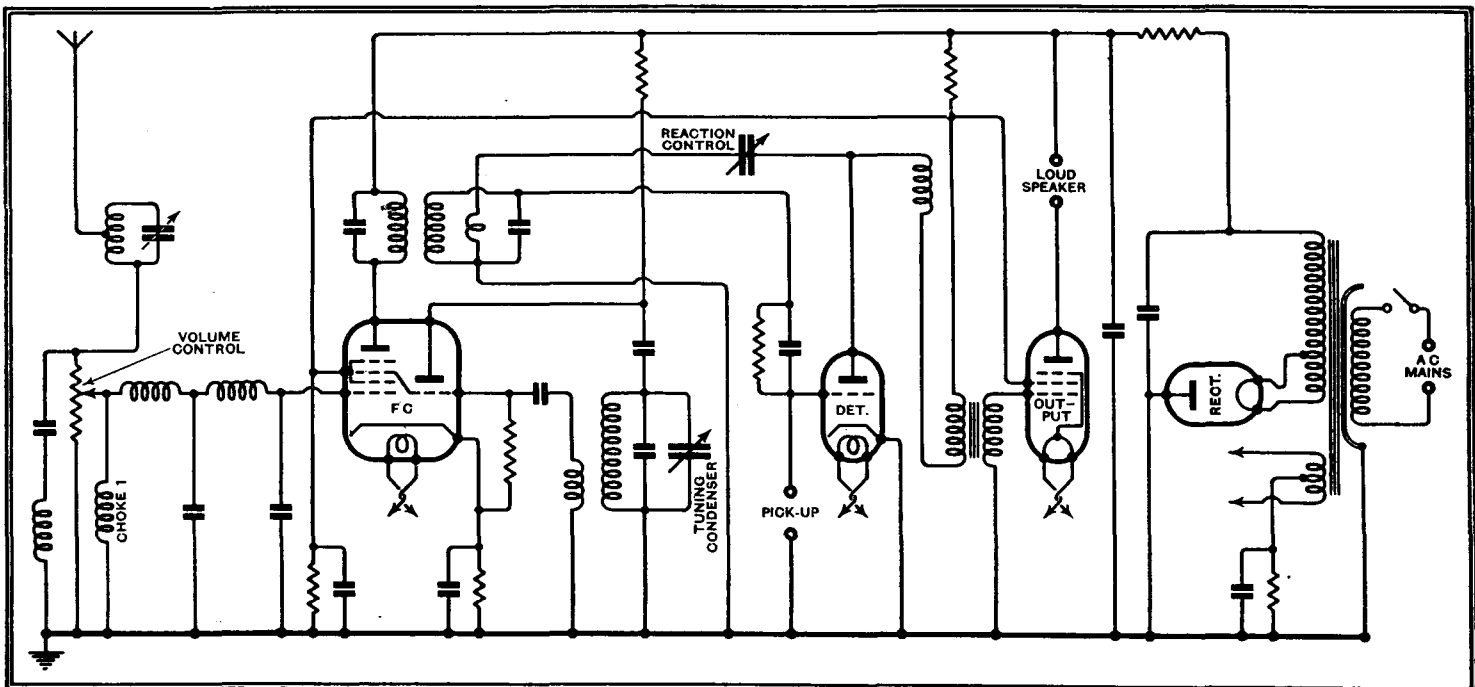

Fig. 1.—The circuit diagram of the AC model of the VS 1 shows that a pair of coupled coils is employed in the IF circuits and reaction is applied from the detector. Two wavetraps are included in the aerial circuit—one tuned to the local station and the other to the intermediate frequency.

First Continental Single-Span Receiver—

gang condenser, of two exactly matched coil assemblies and many trimmers means a radical reduction in the cost of such a receiver. Thus, on this principle, it was possible to construct the cheapest superheterodyne available up to the present day, and it seems that this new class of superheterodynes is destined to replace the small straight set and the cheap superheterodyne of to-day. Thus, extreme economy is an outstanding feature of Single-Span tuning, and the writer believes that, hitherto, this great advantage of the new system has not been sufficiently emphasised.

The smallest type of superheterodyne available to-day makes use of three valves: the first of these is the frequency-changer, preceded by a single tuned aerial circuit; it is followed by an IF band-pass filter directly connected to the second detector valve, and fitted with reaction; the third valve is the output valve. When Single-Span is applied to this type of receiver

the total selectivity depends upon the two circuits of the IF filter, as there is no signal-frequency tuned circuit. Unexpectedly this simple device could be brought to a very satisfactory adjacent-channel selectivity, making possible interference-free reception of all European high-power stations. This result was unexpected, because of the very wide bandwidth of a circuit tuned to a frequency as high as 1,600 kc/s, but it could be attained by the use of modern low-loss components and of critical reaction. The sensitivity of such a receiver is sufficient for the daylight reception of some four or five stations, even with an indoor aerial, and in the evening it even has to be greatly reduced by a volume control operating upon the input to the frequency-changer in order to eliminate the weak stations which cannot be satisfactorily selected from their strong neighbours. The reception of our high-power stations, however, is entirely satisfactorily and exceptionally free from disturbance.

The Aerial Circuit

The input voltage is taken from the slider of a potentiometer connected across a wavetrapped tuned permanently to the local station. Between the slider and the input grid of the frequency-changer there is inserted a filter device similar to that of *The Wireless World* Single-Span receiver. Some modifications were made to this, and an IF wavetrapped was inserted to prevent

whistle-production due to harmonics of strong broadcast stations. In addition an HF choke Ch1 was included to prevent low-frequency currents from entering the receiver, and this is sometimes of great importance in preventing AC hum from being introduced by the aerial. A very efficient valve was employed as a frequency-changer, in spite of the desire to make the receiver as cheap as possible, because the very small difference between the oscillator and intermediate frequencies when receiving a signal as low as 150 kc/s made it impossible to attain satisfactory results with simple tetrode or pentode

frequency-changers. The valve employed, therefore, is a triode-hexode, which is capable of fulfilling its important task without any difficulty. The oscillator and IF circuits are of standard design, the band-pass coils being coupled by their mutual inductance, and not capacitively, as in *The Wireless World* Single-Span receiver.

The buffer valve is dropped, of course, as extremely critical reaction is possible by the grid leak second detector itself. The output valve is a small pentode of 0.8 watts undistorted output, and it is coupled to the second detector by a transformer, in order to attain a satisfactory high degree of LF amplification. Good bass response is secured by the electrolytic by-pass condenser of 20 mfd. across the cathode resistance.

The Mains Equipment

The rectifier is fed from the AC mains by a simple transformer and thermionic rectifier, smoothing being accomplished by a resistance of 1,500 ohms joined by two condensers of 8 mfd. There are only two different DC voltages taken from the mains unit: a high voltage of 190 volts, approximately, feeding the anode circuits of the frequency-changer and output valves, and a low voltage of 72 volts for the screens of the frequency-changer and of the output valve, and for the second detector triode. In this manner the receiver was designed as economically as possible throughout, in order to retain the inherent economy of single-span tuning.

"VS 1" is a midget: it is built on a chassis of 250 by 150 by 65 mm. These small dimensions, however, are not attained by crowding the components, as is the case with some American midgets, but by the exceedingly low number of components and by the small size of the components themselves. Of chief interest is the IF filter, for it has been fitted with

iron-cored coils, in spite of the objections which might be raised against their use at the comparatively high IF of a Single-Span receiver. Indeed, the iron cores were not provided to get a better performance than with air-cored coils, but to save space and cost. The iron-cored coils used are of very small size, and, in addition, may be enclosed within a very narrow screen (40 mm. diam.); the correct frequency of the IF circuits is not adjusted by variable condensers, but by a variable air-gap in the cores. Thus, it is possible to provide fixed mica-condensers instead of variable air-dielectric condensers, this meaning another very important saving. The coils are litz-wound, of course, and there is no noticeable difference in performance between these coils and very good air-core types. The oscillator coil, however, is a simple cylindrical air-cored coil, as it is unnecessary to screen it or to match its inductance accurately. Reaction is controlled by a small trimmer accessible from the rear of the receiver—the possibility of varying selectivity being thus dropped, as it is not essential for this extremely simple edition of a "Single-Span."

In spite of its very economical design, high quality was maintained from every point of view. Thus, the first Continental "Single-Span" is not merely an extremely cheap midget, as it might seem at first sight, but a soundly designed receiver of an entirely new class. "VS 1" is a set designed for home-constructors only, but we may expect that sets of this or similar circuits will soon be produced by the radio industry. Thus, the new "Single-

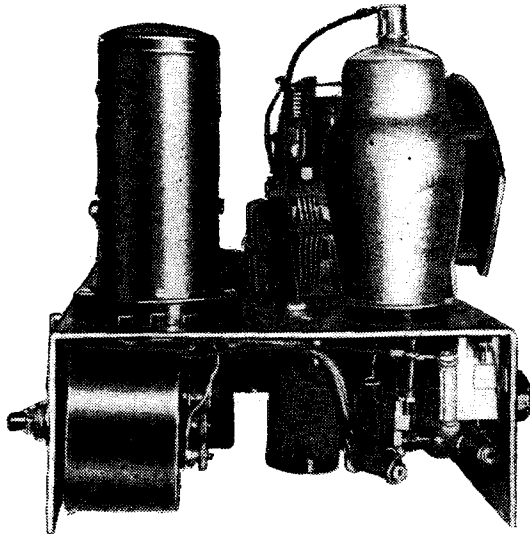

The IF coil assembly is mounted to the left of the triode-hexode frequency-changer and the oscillator coil is underneath the chassis.

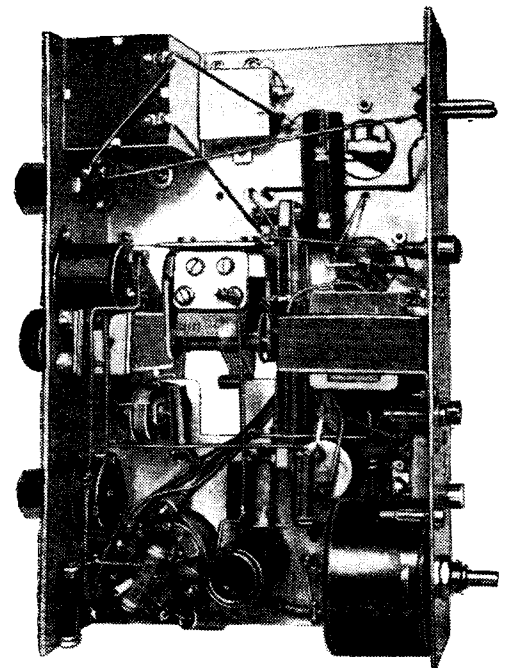

An underbase view of the DC receiver—the oscillator coil can be seen on the right behind the valveholder.

Span" principle developed by *The Wireless World* seems to have found a wide area for its successful expansion, and, as we must anticipate that considerable further progress will be made in the future this area is likely to increase still more.

Current Topics

Wireless for the Deaf Fund ?

A WIRELESS for the Deaf Fund has been suggested by a correspondent of the *Times*. "There could be no greater joy," he writes, "for a deaf person than to hear—sometimes, even if imperfectly. Many deaf people could hear broadcast programmes if they had suitable receivers with suitable telephones."

Date of Birth

THE French Postmaster-General has been asked in the House of Deputies why applicants for radio licences must state "the place and date of birth"—an obligation not waived even in the case of the ladies. The official reply explains that the particulars are needed to facilitate identification.

A disgruntled licensee last week insisted on adding the size of his gloves.

Ultra-short Waves Save Human Contacts

"TO enable students to hear a lecture without being subjected to my presence" was one of the reasons put forward by Dean E. J. Kilduff, of New York University School of Commerce, last week, when he delivered a talk by ultra-short waves from an easy chair in his apartment three blocks away from the lecture room. The tests employed two-way radio so that the students could ask questions and secure immediate responses.

Who will be the first clergyman to adopt similar methods by broadcasting from the vicarage to the church next door?

What Language Was That ?

A STORY is going the rounds of Europe concerning the recent programme addressed by Budapest to Holland. In a praiseworthy attempt to make the proceedings intelligible to Dutch listeners, the announcer interspersed the remarks at the microphone with brief phrases in Dutch. A few days later a eulogistic letter was received from Amsterdam in which the writer enquired: "What was the foreign language that we heard between announcements in your own tongue?"

Down on the Farm

THE Riga broadcasting station now begins the day with a gramophone record of farm noises. A cock crow starts the concert, followed by the lowing of cows, a dog barking, and the grunting of the pigs.

EVENTS OF THE WEEK IN BRIEF REVIEW

Radio in Agriculture

M. KATAEVICH, of the Moscow Institute of Cereals, is reported to be carrying out experiments to determine whether short waves can be used as an artificial manure. A twelve-acre farm at Dnieprostrol is being used for the tests.

Music v. Talks

DANISH listeners are up in arms at a proposal of the Broadcasting Board, the director of which is Mr. Emil Holm, that late musical programmes

receivers between January 31st and July 31st of this year. In the past a number of firms have produced the so-called "between season" types for the Leipzig Spring Fair, but this year owing to the special contracts, the firms have been compelled to place any new types on the market before the end of January. Several new sets have appeared, including an entirely new one-circuit two-valve set by Telefunken, replacing the one produced for the Radio Exhibition last August. The "Tefag"



ARMCHAIR LECTURING BY ULTRA-SHORT-WAVE. Professors of the New York University of Commerce have just carried out teaching experiments with ultra-short-wave equipment, the transmitter being installed half a mile from the lecture room. The pictures show the test in progress.



should be abandoned in order to provide additional funds for educational programmes. At a meeting of representative clubs a plea has been put forward for a listeners' plebiscite. It is suggested that licence cards should carry a detachable slip on which the listener could vote for or against late musical programmes.

New Finnish Station

FINLAND is to have a new 20-kilowatt broadcasting station at Sortavala, in the Eastern Provinces. The wavelength will be 400.5 metres, being shared with Marseilles PTT.

New German Sets

MUTUAL contracts bind the German radio industry not to introduce new types of re-

firm, according to our Berlin correspondent, makes use of a reflex circuit in a standard three-valve receiver.

The R.S.G.B. Lounge

ESPECIALLY for the benefit of members visiting headquarters at 53, Victoria Street, London, S.W.1, the Radio Society of Great Britain has just opened a lounge where amateurs can meet and discuss mutual problems. Showcases of short-wave apparatus are being installed.

English Talks from Poland

MR. THAD ORDON'S English talks from Warsaw are being given at 9.45 p.m. on the first and third Thursdays of each month.



Lord Gainford, elected President of the Radio Manufacturers' Association for 1935.

Lord Gainford

NO more fitting choice could have been made by the Radio Manufacturers' Association when, at the eighth annual general meeting in London last week, they elected Lord Gainford as their president. Quite apart from his distinguished political career, Lord Gainford has won the respect of all interested in wireless progress for his close association with broadcasting from its earliest days. It was in December, 1922, that Lord Gainford became first chairman of the then British Broadcasting Company. When the present Corporation was formed in 1927 he was vice-chairman of the Board of Governors.

Pips in Egypt

FOLLOWING the example of the B.B.C., the Egyptian State Broadcasting organisation now transmits a six-dot Observatory time signal at 4.30 p.m. and 11 p.m., the hour and half-hour being indicated by the last of the six dots.

National Radio Engineers' Association

A MEETING of the new Association is to be held on Wednesday, February 6th, at 8.15 p.m., at King George's Hall, Y.M.C.A. Buildings, Caroline Street, Tottenham Court Road, London, W.C. Copies of the agenda can be obtained on application to Mr. J. N. de Gruchy, 48, High Street, London, N.2.

High-Quality Technique

Developing Distortionless Receiving Equipment

By W. T. COCKING

THE design of a receiver, as distinct from a low-frequency amplifier, for the highest quality of reproduction is a matter which is greatly complicated by questions of selectivity and interference. The essential requirements are discussed in this article, and it is shown that, except in local reception, some restriction of the high-frequency response is necessary.

IT is now nearly a year since *The Wireless World* Push-Pull Quality Amplifier¹ was described—an amplifier which can truly be said to be perfect so far as sound reproduction is concerned. For outputs up to 4 watts the amplitude distortion is negligible, over the whole range of audible frequencies the departure

the superheterodyne principle is only justified in a long-distance receiver. It was decided, therefore, that a three-stage receiver feeding the amplifier would give a performance meeting the requirements of most users of the amplifier, but it was realised that a conventional design would not be satisfactory from the point of view of quality.

Since the amplifier is practically perfect, we need only consider here the receiver which is to feed it, and for a close approach to perfection in quality we require a minimum of amplitude distortion and an overall frequency response flat within very few decibels between 30 c/s and 10,000 c/s. It is quite possible to attain this, but, paradoxical as it may seem,

experience shows that the full frequency response may actually be undesirable on account of interference. Broadcasting stations are, in general, spaced by 9 kc/s, which means that if the overall frequency response of the receiver extends as high as 9,000 c/s an audible note of this frequency will be imposed on the desired programme. Nothing can be done in the receiver, save to use directional aerials, to eliminate such a whistle without also affecting the quality of reproduction by restricting the upper register.

If two adjacent stations are of equal field strength at the receiver the heterodyne note between them will be repro-

duced at the same strength as a 9,000 c/s note in the desired programme with a modulation depth of 50 per cent. Such deep modulation rarely occurs in practice for notes of high frequency, so that the whistle will actually be louder than similar frequencies in the wanted transmission. It is easy to see, therefore, that reproduction up to 9,000 c/s cannot be tolerated under these conditions, which apply to the general case of distant reception.

Heterodyne Interference

Now if the field strength of the wanted station is greater than that of its neighbour the strength of the whistle is reduced, and if the disparity in field strength be great enough it will fall below the level of audibility and no longer trouble us. The exact degree of disparity naturally depends upon the volume level, and increases with volume, but is probably about 60 db., or a field strength ratio of 1,000-1. Only under such conditions can the full range of musical frequencies be reproduced without any interference.

In local reception during daylight such a ratio is often naturally present and no difficulty is attached to the attainment of the highest quality. At night, however, the field strength of distant transmissions greatly increases, with the result that at such a short distance as ten miles from a local station the 9 kc/s whistle may become audible, although it is never very loud.

If these facts be borne in mind it is easy to see that the frequency response of the

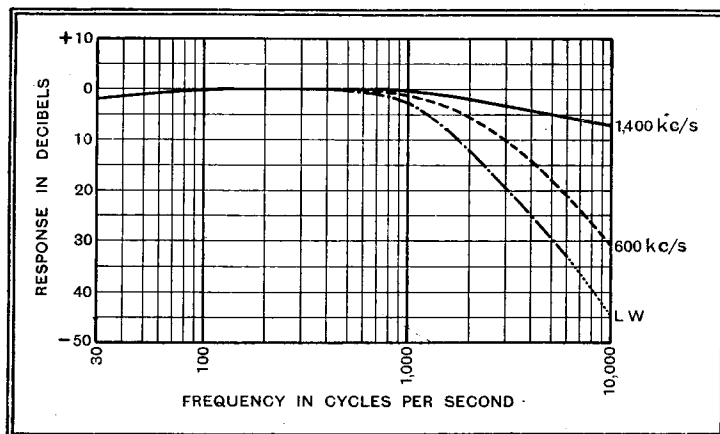

Fig. 1.—The fidelity curves of an experimental receiver embodying variable condenser tuning show how greatly the quality of reproduction varies over the tuning range.

from even amplification is so small that it cannot be detected by ear, and the hum level is below audibility. As originally described, the amplifier was most readily available for gramophone reproduction, but it is equally suitable for use on broadcasting, and several articles have appeared dealing with this aspect, while the modifications necessary to a particular set—the Single-Span Receiver—were given in full.²

That the discriminating listener can appreciate high-quality apparatus is thoroughly proved by the reception accorded to this amplifier and by the steady and insistent demand for a receiver worthy of being coupled with it. As regards freedom from distortion, the modified Single-Span Receiver meets all requirements, and can hardly be improved upon, but the frequency response is rather too good for present-day broadcasting conditions. Moreover, many people feel that

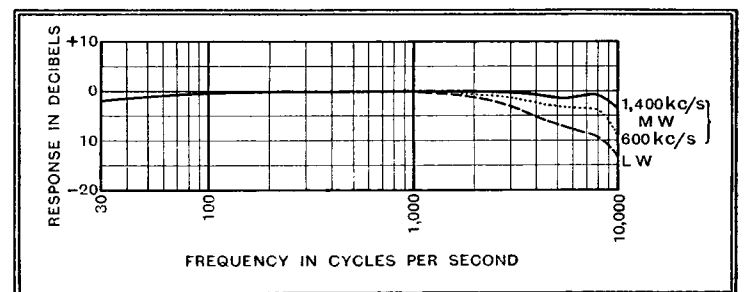

Fig. 2.—When permeability tuning is employed the fidelity becomes much less variable; on the medium waveband the changes are so small that it is difficult to detect them aurally.

receiver must be variable within certain limits. It should extend to 10,000 c/s or beyond to enable the highest standard of quality to be obtained under suitable conditions, but one should be able to limit it to about 8,000 c/s at will to avoid inter-

¹ *The Wireless World*, May 11th and 18th, 1934.

² *The Wireless World*, June 22nd, 1934.

High-Quality Technique—

ference under poorer conditions. If the receiver is to be employed for distant reception to any great extent the response must be curtailed at a lower frequency in order to avoid sideband splash.

Now, in designing any receiver, the problem of the superheterodyne *versus* the straight set is one which must be settled very early. The *superheterodyne principle* has quite an undeserved reputation for causing distortion, and many refuse to consider it when high quality is required. This is no doubt due to the fact that many superheterodynes do introduce distortion, but the fact that some examples give poor quality is no reason for condemning the principle. Actually, it is not difficult to

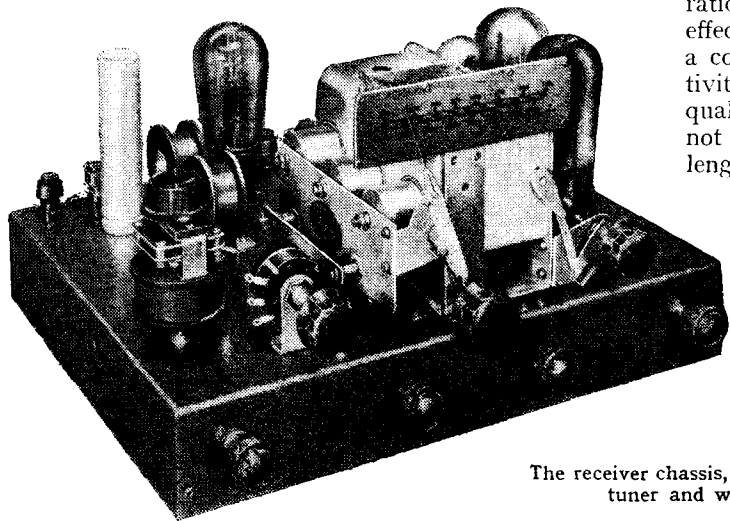

The receiver chassis, showing the permeability tuner and whistle suppressor.

show that, from the point of view of quality, the superheterodyne, and particularly that version of it known as single-span, is inherently better than the ordinary straight set!

Up to the present tuning has almost invariably been carried out in straight sets by means of variable condensers. It is easy to show that this results in the selectivity varying with the wavelength to which the set is tuned—being greater the longer the wavelength—and the extent of the variation increasing with the efficiency of the tuned circuits. As a consequence, the sideband cutting is greater at long wavelengths than at short, and the high-frequency response poorer. In order to ascertain the extent of this effect in practice a receiver was built which comprised two HF stages using pentode-type valves and a diode detector followed by a triode phase-reversing valve to feed the amplifier. Three tuned circuits were employed using good-quality Litz-wound air-core screened coils of standard commercial design and tuned by a three-gang condenser. From the points of view of sensitivity and selectivity the set was very satisfactory, but it failed in the matter of quality. Measurement showed the response at 10,000 c/s to be -7.0 db. at 1,400 kc/s and -31.0 db. at 600 kc/s, while on the long waveband at 150 kc/s it was too great to measure accurately, but it was estimated at -45.0 db.! The actual fidelity curves obtained are shown in Fig. 1.

This effect does not occur to the same extent in the superheterodyne because selectivity is obtained in the fixed IF amplifier, and the signal-frequency circuits can be fairly flatly tuned. It is non-existent in the single-span receiver because there are no tuned signal-frequency circuits. The use of the superheterodyne principle hardly seems justified in a receiver intended chiefly for local station reception, however, but, in view of the serious defect of the straight set described above, it would have been necessary if a new development in tuning had not taken place.

It can be shown that if tuning be carried out by means of a variable inductance instead of a variable condenser, and if the ratio of inductance to effective HF resistance be a constant, then the selectivity, and hence the quality of reproduction, is not affected by the wavelength to which the receiver is tuned. A variable inductance of the requisite type has only recently been produced, and, since the varia-

tion is obtained by altering the position of an iron core relative to the winding, it is known as a permeability tuner.

If the constant selectivity obtainable with such a tuning system is to be retained in practice, it is necessary for it to be correctly used, and this involved much research. The commercial example of the

should be used with permeability tuning. Transformer coupling is definitely wrong unless the windings are so arranged that the ratio of tuning coil inductance to mutual inductance is a constant.

Having obtained a tuning system giving approximately constant selectivity, and found out how to use it, the next step was to decide upon the type of HF amplifier. Many arrangements were tried out and found unsatisfactory, including both one and two stages of amplification with screen-grid type valves. With two HF stages the usual difficulties from instability were found, and even with one valve only symptoms of incipient instability were present. In ordinary receivers these symptoms would be of little moment, for a slight tendency to instability merely means that the amplification and selectivity are increased somewhat. The increase in selectivity, however, is not constant, but varies with wavelength, thus tending to destroy the advantages of the tuner. Of much greater importance, however, is the fact that the feed-back would be most unlikely to be the same in different sets. Depending as it does upon the exact positions of the various components and connecting wires and upon the *precise* values of the components themselves, the feed-back would vary greatly from receiver to receiver, and the selectivity, and hence the quality, would vary in like manner. Thus, although no difficulty was found in obtaining good results by ordinary methods, it was felt that the possibility of reproducing them in different sets was too small, and the screen-grid valve was abandoned in favour of a system which is inherently stable.

It was recently pointed out in this journal³ that if two triodes be employed instead of a screen-grid valve for each stage of amplification, both the stability and linearity are much greater, and the

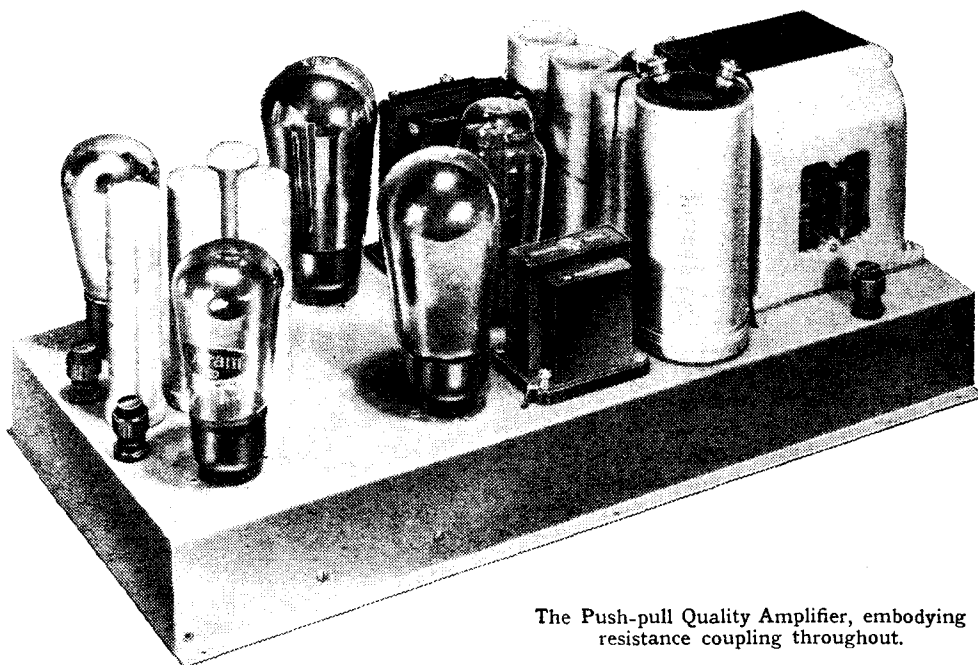

The Push-pull Quality Amplifier, embodying resistance coupling throughout.

unit which was available was provided with small coupling coils, but these were found to be unsatisfactory, and a mathematical investigation showed that under normal conditions only capacity couplings

amplification is of the same order. A single stage of double-triode amplification was tried out, therefore, and found to be such a big improvement over the screen-

³The *Wireless World*, January 18th, 1935.

High-Quality Technique—

grid valve that its use was decided upon. The fidelity characteristics of the receiver under these conditions are shown in Fig. 2, and the great improvement in constancy is very evident and is to be attributed to the adoption of permeability tuning.

Various details of design which need not be described here demanded attention, and when these points had been satisfactorily settled the receiver was found to have a sensitivity of the order of 1,000 μ V. A moderate degree of tone correction was included to compensate for the small but essentially constant amount of sideband cutting, and a whistle suppressor was added to permit the removal of heterodyne notes.

This proved a very necessary feature,

and many arrangements had to be tried before one was found which would effectively remove the interference without greatly affecting the quality of reproduction.

Before concluding, it may be remarked that the receiver is intended chiefly for the reception of the local station and Droitwich, and it is designed to do this with as little distortion of any kind as interference conditions will permit. In addition, however, it will give good reception of many Continental stations at the somewhat lower standard of quality dictated by the greater amount of interference to which they are subject. Under all conditions amplitude distortion is very low at normal volume, for every effort has been made to keep it as small as possible at the present stage of the art.

In Next Week's Issue:—**QA Receiver**

**A Special High-quality
Radio Unit for the
Push-pull Quality
Amplifier**

DISTORTIONLESS reproduction of broadcasting demands that no less care be taken in the design of the HF circuits of a receiver than in the low-frequency amplifier, and the problems involved are, in fact, more difficult of solution. The Push-pull Quality Amplifier meets all domestic requirements for the highest quality of reproduction so far as LF amplification is concerned, but a receiver of equal quality and of moderate size has hitherto been lacking. This gap is now filled by the QA Receiver.

The receiver includes a single HF stage employing the new double-triode circuit for high stability and freedom from amplitude distortion, while a diode detector feeds a triode LF amplifier and phase-reversing valve. In order to maintain constant quality throughout the tuning range, permeability tuning is used, while reaction is fitted to enable a number of distant transmissions to be received when required. A moderate degree of tone correction for sideband cutting is included, and a filter circuit for the suppression of inter-carrier heterodyne whistles forms an important feature of the apparatus. It may be thrown in and out of circuit at will by a switch which is linked with an effective tone control.

THE LIST OF PARTS

After the particular make of component used in the original model, suitable alternative products are given in some instances.

RECEIVER UNIT

- 1 Metal Chassis with valve holders, screws, nuts and washers C.A.C.
1 Permeability Tuner, three-gang Varley BP100

- 1 Tapered volume control potentiometer, 250,000 ohms Rothermel "Centralab" 72-121
1 Tapered volume control potentiometer, 500,000 ohms Rothermel "Centralab" 72-105
1 Tapered volume control potentiometer, 250,000 ohms, with switch Rothermel "Centralab" 62-105 (Erie, Ferranti, Claude Lyons, Magnum)
1 $\frac{1}{2}$ in. shaft connector and 6 ins. $\frac{1}{2}$ in. shaft rod Bulgin
1 HF Choke Kinva Standard Type
2 HF Chokes Bulgin HF8
1 Whistle suppressor coil, 0.875 henrys (see text)
2 Tone control chokes (see text)
Condensers:
2, 0.01 mfd. T.C.C. "M"
1, 0.001 mfd. T.C.C. "M"
5, 0.0001 mfd. T.C.C. "M"
1, 0.0002 mfd. T.C.C. "M"
1, 0.0003 mfd. T.C.C. "M" (Dubilier)
1, 0.015 mfd. tubular T.C.C. 250
3, 0.01 mfd. tubular T.C.C. 250
2, 0.2 mfd. tubular T.C.C. 250 (Dubilier, Graham Farish, Peak, T.M.C.Hydra)
1, 50 mfd., 12 volts electrolytic T.C.C. "AT"
1, 8 mfd., electrolytic T.C.C. 502 (Dubilier)
1 Air dielectric trimmer, 65 mmfd. Eddystone 978
2 Reaction condensers, 0.0005 mfd. Ormond R509
1 Knob for above Ormond
Resistances:
2, 500 ohms, 1 watt Dubilier
1, 2,000 ohms, 1 watt Dubilier
2, 5,000 ohms, 1 watt Dubilier
1, 10,000 ohms, 1 watt Dubilier
3, 50,000 ohms, 1 watt Dubilier
2, 100,000 ohms, 1 watt Dubilier (Amplion, Erie, Ferranti, Graham Farish, Claude Lyons, Watmel)
1, 1,000 ohms, 20 watts Bulgin PR5
1, 7,500 ohms, 20 watts Bulgin PR10
1 SPDT Toggle switch Bulgin S81B
2 SPST Toggle switches Bulgin S80B
1ft. Shaft rod for above, 5/32in. dia. Bulgin
1 Reducing sleeve for knob Bulgin
2 Dial lamps, 4v. 0.2 amp. Bulgin 420
1 6-way Connector Bryce
1 5-way Cable with twin 70/36 leads and 5-pin plug Goltone
6 Ebonite shrouded terminals, A., E. pick-up (2), output (2) Belling Lee "B"
4 Knobs, $\frac{1}{4}$ in. Bulgin K14
2oz. tinned copper wire, 8 lengths Systoflex, wood, etc.
Valves: 2 Osram MH4; 1 Osram ML4 (Marconi); 1 Mullard 204A.
AMPLIFIER
1 Mains transformer, primary, 200 to 250 volts, 50 cycles; secondaries, 425-0-425 volts, 120 mA.; 4 volts 2.5 amps, centre-tapped; 4 volts 1 amp, centre-tapped; 4 volts 1 amp, centre-tapped; 4 volts 7.8 amp, centre-tapped Sound Sales Type PP/QA (B.S.R., British Radio Gramophone Co., Bryce, Challis, Hayberd, Claude Lyons, Parmeko, R.I., Rich and Bundy, Varley, Vortexion, Wearite)
1 Smoothing choke, 7/13 henrys at 120 mA., 215 ohms Ferranti B2
1 Smoothing choke, 20 henrys at 50 mA., 400 ohms R.I. "Hypercore"
(Alternatives same as mains transformer above)
Condensers:
1, 4 mfd., 450v. working, cylindrical container Dubilier LEC 9204
3, 8 mfd., electrolytic, 500v. peak Dubilier 0281
2, 4 mfd., electrolytic, 500v. peak Dubilier 0283 (Ferranti, Peak, T.C.C.)
2, 50 mfd., electrolytic, 50v. peak Dubilier 3003
2, 200 mfd., electrolytic, 10v. peak Dubilier 0283 (T.C.C.)

- 2, 0.1 mfd., mica Dubilier B775 (T.C.C.)
2, 0.05 mfd., non-inductive, tubular Dubilier 4403 (Graham Farish, Peak, T.C.C., T.M.C.Hydra)
Resistances:
2, 1,000 ohms, 2 watts Claude Lyons
2, 100 ohms, 1 watt Claude Lyons
2, 1,000 ohms, 1 watt Claude Lyons
2, 5,000 ohms, 1 watt Claude Lyons
2, 10,000 ohms, 1 watt Claude Lyons
2, 25,000 ohms, 1 watt Claude Lyons
2, 250,000 ohms, 1 watt Claude Lyons
2, 500,000 ohms, 1 watt Claude Lyons (Dubilier, Erie, Ferranti, Graham Farish, Watmel)
1 5-pin Plug Bulgin (British Radio Gramophone Co.)
3 Ebonite shrouded terminals, Input (2), Earth (1) Belling Lee Type "B"
1 Metal chassis with valve holders, screws, nuts and washers C.A.C.
Valves: 2 Osram MH4; 2 Osram PX4; 1 Osram MU4 (Marconi).

New H.M.V. Receivers

Table Model, Console and Radio-gram. Superhets Incorporating QAVC.

Three new instruments are released to-day by the Gramophone Co., Ltd. The same basic circuit is employed in each case, namely, a four-stage superheterodyne for AC mains. An undistorted power output of 2 watts is available, and quiet inter-station tuning is arranged with an adjustable threshold control. The volume control is tone compensated to give equal balance at all levels.



The new H.M.V. "Console Superhet Five."

The table model (441) is housed in a walnut cabinet inlaid with macassar ebony, and is priced at 12½ guineas. In the console receiver at 17 guineas the scale is set at a convenient angle, and the controls are mounted at a level which facilitates their operation from an armchair. The radio-gramophone is fitted with a heavy-duty motor, and its price is 22 guineas.

Recent orders placed by the Wireless for the Blind Fund with Burne-Jones & Co., Ltd., of Magnum House, 296, Borough High Street, London, S.E.1, will bring the total of sets supplied for the use of blind persons up to some 25,000. All these receivers are provided with special tuning dials having Braille characters.

BROADCAST

By Our Special

Correspondent

The Wavelength Changes

AS *The Wireless World* exclusively predicted on June 23rd, 1933, and has reminded readers at intervals ever since, the B.B.C. is about to carry out a General Post in wavelengths. The changes, which take place on February 17th, are as follows:—

	Present	New
	Metres	Metres
North National	296.2	261.1
Midland ..	391.1	296.2
Scottish ..	373.1	391.1
West ..	307.1	373.1
Belfast ..	267.4	307.1
Newcastle ..	209.9	267.4

I understand that the Newcastle allocation is a temporary one, the 267.4-metre wavelength (as forecast in this journal, together with the above changes) being intended ultimately for North Scottish.

Medium-wave Droitwich: Starting Date

February 17th will also see the new 50-kW. Midland transmitter at Droitwich come into operation on the wavelength stated above.

Some delay has occurred in announcing these changes in order to allow for the preparation of suitably marked tuning dials.

Respite for Heavyside Layer

THE unsportsmanlike attitude which the B.B.C. engineers recently adopted towards the Heavyside Layer has been modified; in fact, in common decency, Mr. Ashbridge and his assistants are no longer blaming the ionised regions for the fading of Droitwich. An official apology seems called for.

Question of Responsibility

There have been some minor dissensions among the staff on the question of the ultimate responsibility for the design of the long-wave station. Reading between the lines, one may guess that it is not tactful to mention the famous British spa in the hearing of a B.B.C. engineer.

And Now Midland Regional

And what of the new Midland Regional? Will it share the obloquy meted out to its big brother? I think not. The B.B.C. experience with long-wave stations is, after all, limited, but of the making of medium-wave transmitters there has been no end, and if experience can teach there must be little left to learn at Broadcasting House on the probable behaviour of any station working below 500 metres.

BREVITIES

A Remote Hope

WALES goes on wishing for a new transmitter, but although there has been some talk of a relay station to be served by the new Bangor studio, I think we must relegate this idea to the dim and distant future.

Not to mention Droitwich, the B.B.C. engineers have enough projects on hand to occupy them for many moons ahead. The North Scottish, North-Eastern and Belfast stations have all to be got under way, and there is the promised Plymouth relay station, which, I understand, will have a power

Wireless Military Band, 37.
Midland Orchestra, 35.
Northern Orchestra, 35.
Scottish Studio Orchestra, 8.
Western Studio Orchestra, 9.
Belfast Wireless Orchestra, 32.

Add to this the multitude of professional musicians who make frequent appearances at the microphone.

Gloved Hand

THE B.B.C. had a rough passage last week, but took arms against its sea of troubles very successfully by launching a public apology.

The censoring hand of the B.B.C. is usually enclosed in a

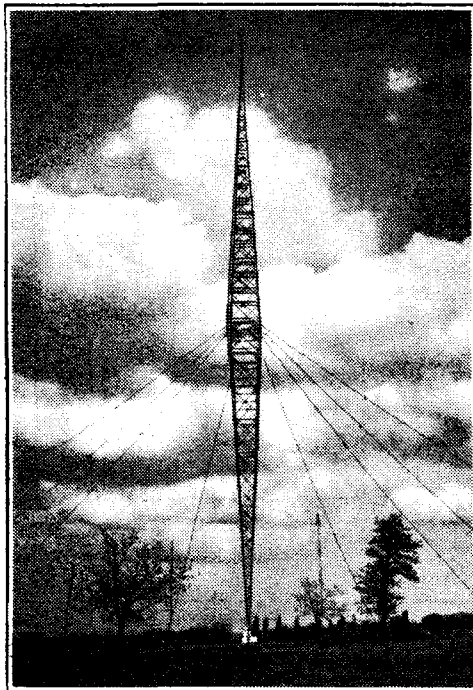

RADIO BUDAPEST has copied Vienna with its new vertical aerial, which is nearly 1,000 ft. high. The chamber music studio, seen below, shows that Hungary is not lagging behind Western Europe in station design and equipment. Note the air vents and control window.

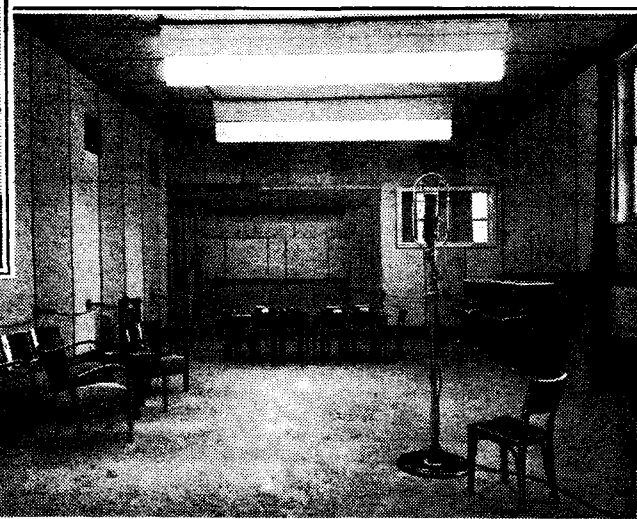

in the neighbourhood of 5 kilowatts.

And there is also that chain of ultra-short-wave television transmitters.

The B.B.C.'s Musicians

Complaints that the B.B.C. has not done enough to encourage British musicians are not supported by an investigation of facts. I have just been looking through the list of staff musicians. There are no fewer than 353 in continuous employment. The list of players is made up as follows:—

- The B.B.C. Symphony Orchestra, 119.
- Variety Orchestra, 16.
- Theatre Orchestra, 27.
- Empire Orchestra, 16.
- Dance Orchestra, 14.

velvet glove. Perhaps this is why people have been surprised to learn that a certain dance tune might be broadcast provided that the vocal chorus was omitted. Actually, this mode of censorship has been in vogue for quite a long time. Why we have not noticed it is because of the number of broadcast vocal choruses which still surprise one by their banality and suggestiveness.

Knife Fight at the Microphone

THE B.B.C. has received an interesting letter from Mr. R. Caprara, whom listeners will remember for his vivid contribution from South Africa to the Christmas Day programme, "Empire Exchange."

A Bad Moment

"A moment or two before the compound item was switched in," he writes, "a knife and knobkerrie fight started among the thousands of waiting natives. This was quickly quelled by the native police boys, who are highly efficient in their methods of dealing with this type of disturbance. It was a bad moment for all concerned in the broadcast!"

Order Restored

"During the translation of Chief Mdingi's speech another disturbance occurred, but was just as quickly quelled as the first—so quickly, in fact, that by the time that Mdingi called upon the natives to give 'the salute, which is given only to kings,' order had been restored.

"This type of thing is unusual, but, as many different tribes are located in the compound, the compound manager and his police boys are always ready for action—especially on holidays.

A Thunderstorm

"Chief Mdingi, who normally wears the most immaculate European clothes, turned up in full war-paint for this broadcast, supported by his brothers and lesser chiefs."

Within a minute of the broadcast a thunderstorm ensued with such a downpour that natives fled helter-skelter in all directions. The broadcast was happily timed!

Designing a WIRELESS WORLD Receiver

II. Reaction and Selectivity

Concluded from page 80 of last week's issue

IN this article the description of the design of a receiver is continued and the method of selecting important component values is described. It is shown that the method of trimming exercises an important influence on the selectivity.

HAVING concluded the design of the IF stage, the next step was to choose the optimum value for the filter coupling condenser C6 (Fig. 1) It was known that the coupling could not be greater than optimum if the maximum selectivity were to be obtained

been loaded by the HF potentials and its output would become just as restricted as that of a grid detector. It was thought that this difficulty might be overcome by adopting the arrangement of Fig. 3. The reaction coil is connected in the triode anode circuit and tightly coupled to the

A trial of this scheme, however, proved disappointing, for either the reaction effects were inadequate or the system oscillated uncontrollably. No arrangement could be found which was wholly satisfactory and it had to be abandoned. The possibility of obtaining reaction in the IF valve itself was then considered, and various methods of coupling the anode and control-grid circuits were tried but none proved feasible.

Now it was believed that increasing the grid-anode capacity of the valve would

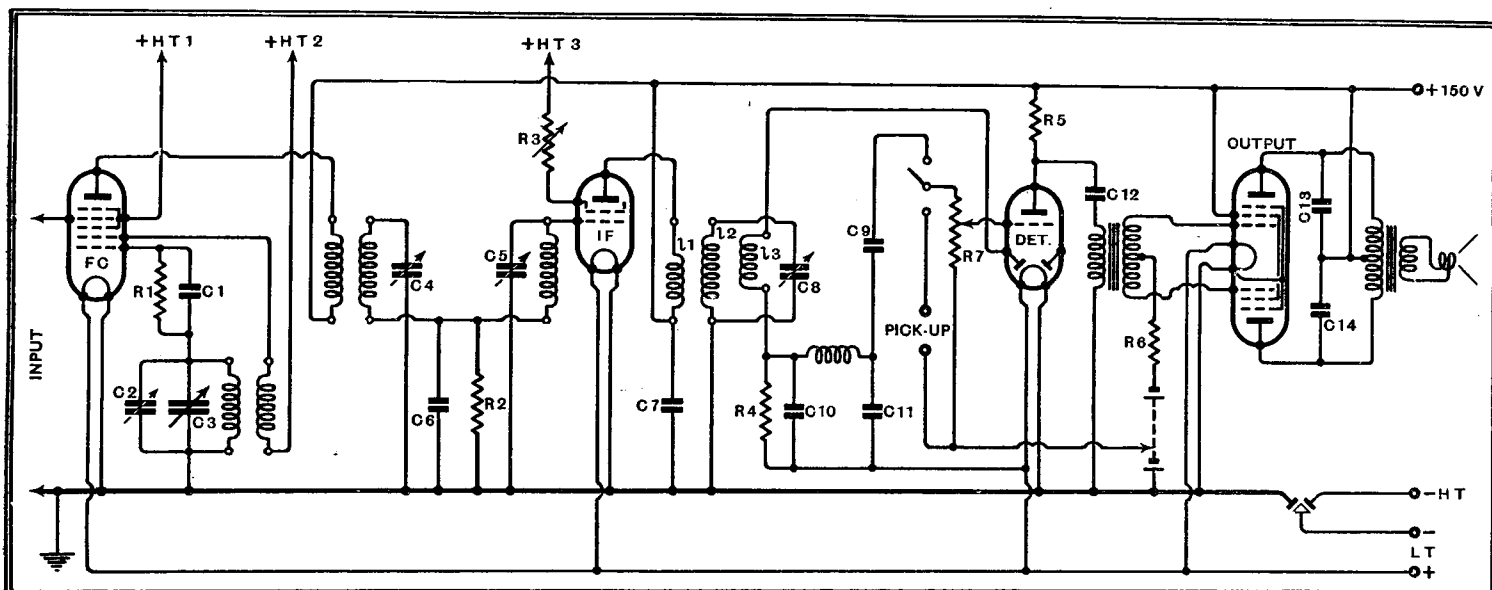

Fig. 1.—The complete diagram of the circuits following the frequency-changer has been repeated here for easy reference.

together with easy trimming of the circuits. Accordingly, the sensitivity of the set without reaction was measured with a number of different values for C6, and this enabled the curve of Fig. 2 to be plotted. It can be seen that a capacity of about 0.003 mfd. gives optimum coupling, and a capacity of 0.005 mfd. was accordingly selected, since it should give slightly greater selectivity with only a small loss in sensitivity.

The next problem to be tackled was that of finding a satisfactory method of obtaining reaction, and it was at first hoped to make use of the triode section of the HD22. This could be done by connecting a reaction coil in its anode circuit in any standard manner, and connecting a small condenser between the diode anode and the control grid so that HF potentials were applied to the grid. Unfortunately, this was out of the question, for it would have meant that the triode would have

tuned circuit. Reaction is controlled by the condenser RC, which permits HF potentials to be applied to the grid of the triode. The difference between this scheme and the ordinary reaction circuit is that in the latter the HF output of the valve is controlled, whereas with the new arrangement the input is controlled so that the valve is less heavily loaded.

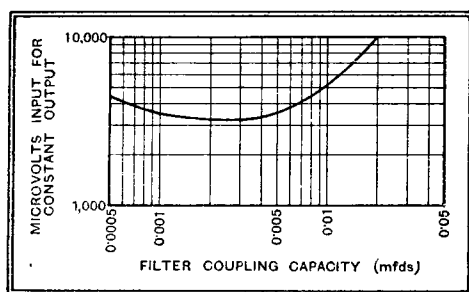

Fig. 2.—The effect on sensitivity of varying the coupling capacity C6.

provide good reaction effects if a suitable method were available. It was out of the question to use a variable condenser connected between grid and anode, since a satisfactory performance would demand a component with zero minimum capacity, and a maximum of perhaps only 0.1 mmfd. The low inter-electrode capacity of a screen-grid valve is due to the presence of the screen-grid, and this must be earthed as far as HF currents are concerned if the screening is to be effective. An inadequate by-pass capacity between the screen-grid and the cathode of a valve is a well-known cause of instability. The idea then naturally presented itself of deliberately inserting an impedance in the screen circuit, so that the screen-grid would not be efficiently earthed and more feed-back could exist in the valve. In other words, the effective grid-anode capacity of the valve would be increased.

The use of a fixed resistance in the

Designing a "Wireless World" Receiver— screen-feed circuit with a variable condenser between the screen and cathode for controlling reaction was then tried. The only difficulty was found to lie in the method of controlling reaction, since a variable condenser of at least 0.002 mfd. maximum capacity was necessary. Such condensers are not readily obtainable, so that the obvious alternative of a variable resistance in the screen supply was tried. Eventually the best results were obtained with the arrangement of Fig. 1 in

ance. Having thus found a satisfactory reaction system, it remained to see whether it would function reliably with different valves, or whether its usefulness was confined to the particular specimen employed. Valves of various makes were tried, therefore, and although some required a greater resistance than others to provoke self-oscillation, none failed to operate satisfactorily. The HF pentode proved a failure, however, probably owing to the suppressor grid between the screen-grid and anode.

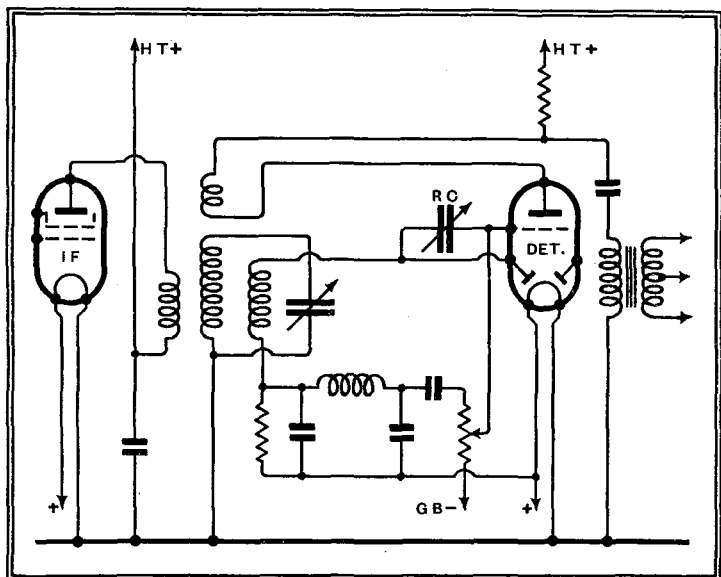

Fig. 3.—An experimental reaction system which proved unsatisfactory in practice.

which the resistance R_3 is included in the screen-feed circuit and no by-pass condenser is used. It was soon found that the reaction effects depended at least as much upon the inductance of the component employed as upon its resistance. With one style of construction a 60-ohms resistance proved inadequate, whereas with another 30 ohms was far too much. Resistances of small physical dimensions were found to be superior to large components on account of their lower inductance, and eventually a component having a resistance of 50 ohms was found which would send the valve into oscillation at about one-half the travel of its slider.

stability, as one would expect. In the case of C_5 and C_8 , the trimmer settings corresponding to minimum reaction for just maintaining stability were taken as the optimum, but for C_4 the setting requiring maximum reaction was taken. It was thought that this procedure would give the best performance and the selectivity curves were taken for minimum and maximum reaction, and are shown in Fig. 4.

The performance is obviously not good, for although the selectivity is reasonable with reaction for frequencies lower than resonance, it is much lower on the other side, and the selectivity without reaction is decidedly poor. The selectivity was,

The next step was to measure the selectivity and to find the best method of trimming the circuits. The Signal Generator was set to feed 1,600 kc/s to the grid circuit of the frequency-changer and the three IF circuits were adjusted to this frequency without reaction. Reaction was then increased close to the oscillation point and the circuits retrimmed; as the circuits came into tune with one another, reaction had to be reduced to maintain

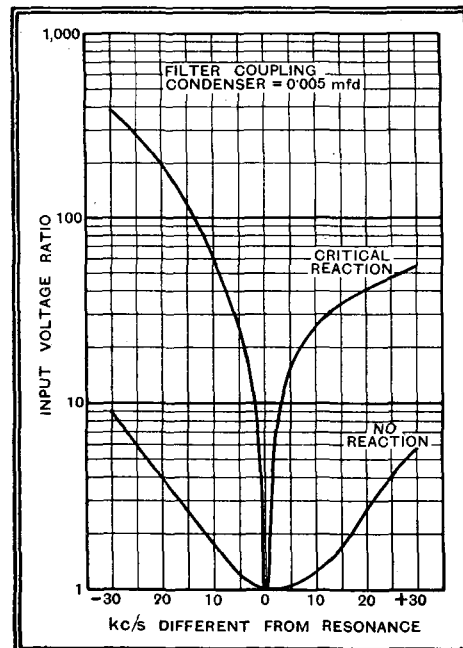
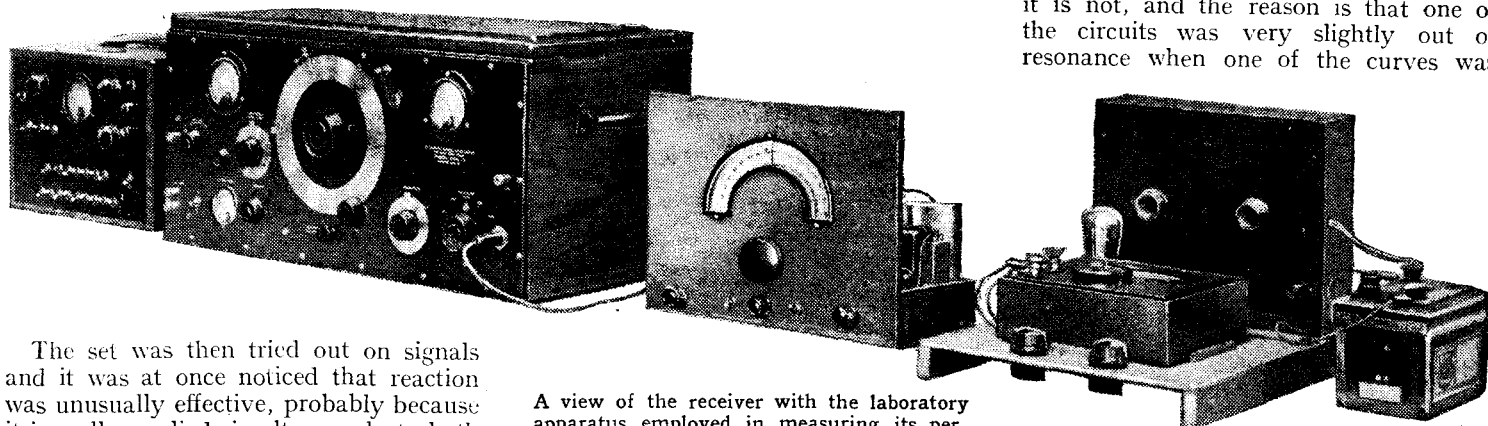

Fig. 4.—The overall selectivity with a value of 0.005 mfd. for C_6 and trimming performed with reaction.

that there was a tendency for a double-humped resistance curve to be formed at a frequency 20 kc/s lower than resonance. It was argued that this might be due to the use of too small a coupling condenser in the filter (C_6 , Fig. 1), and response curves were taken with values of 0.01 mfd. and 0.02 mfd., and the results are shown by the full-line and dotted-line curves of Fig. 5. The sensitivity figures for these curves are marked against them, and it can be seen that while there is a big difference as regards selectivity between 0.005 mfd. and 0.01 mfd. coupling condensers, the sensitivity is only affected to a small degree. The use of a condenser of 0.02 mfd., however, improved selectivity to only a small extent, but dropped the efficiency by an appreciable amount.

A condenser of 0.01 mfd. was decided on, and the curves of Fig. 6 taken with the circuits trimmed accurately without reaction. It should be noted that the "no reaction" curve of Fig. 6 should be the same as the full-line curve of Fig. 5; it is not, and the reason is that one of the circuits was very slightly out of resonance when one of the curves was



A view of the receiver with the laboratory apparatus employed in measuring its performance.

The set was then tried out on signals and it was at once noticed that reaction was unusually effective, probably because it is really applied simultaneously to both grid and anode circuits of the valve, and so operates on two circuits instead of one. The only disadvantage was that it affected tuning to a greater extent than usual, but this was considered to be of minor import-

therefore, measured again, this time lining up the circuits without reaction, and the results are shown by the dash line of Fig. 5. It could be seen from this

taken. Comparing Figs. 5 and 7, it can be seen that the change of C_6 and the different trimming procedure have effected a big improvement. Without reaction, the selectivity has been just about

Designing a "Wireless World" Receiver—

doubled, and although the improvement is less when reaction is employed, it is very definite over the range of frequencies higher than resonance by more than 10 kc/s. The practical improvement in performance was noticeable, for it was just possible to receive Radio-Paris clear of Droitwich without reaction, whereas this was previously out of the question.

The fidelity was the next point to receive attention, and the curves of Fig. 7 were taken and are self-explanatory. The curve for "Gramophone," however, showed a far from even response, which must be occurring in the LF circuits. Investigation showed that this was due to the use of too high a value for R₅, and this resistance was accordingly reduced to 25,000 ohms. This reduced the amplification somewhat and increased the current consumption of the HD22 to 1.5 mA., but the frequency response was very greatly improved, and the curves now obtained are shown in Fig. 8.

The Frequency-changer

The design of the receiver was now finished save for two most important parts—the aerial filter and the frequency changer. Little difference was found between the different valves available,

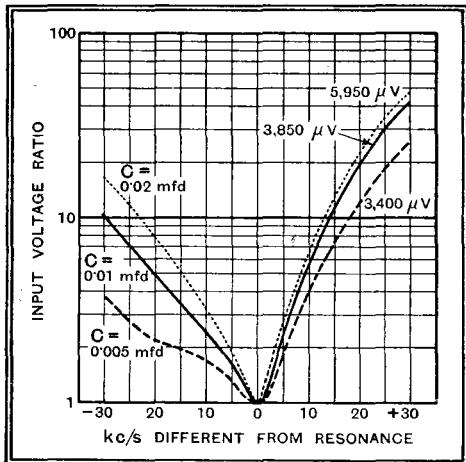

Fig. 5.—The selectivity without reaction for various values of coupling capacity in the filter.

provided that the correct operating conditions were employed, and the VHT2 was selected. This valve was employed with the original type of single-span oscillator coil assembly, and it was noticed that present specimens of the valve failed to oscillate over the whole tuning range. The number of turns on the reaction coil was accordingly increased, but it was then found that the effective stage gain was only about unity! The theoretical gain should have been about 6 to 10 times, so that something was obviously very wrong. It was at first thought that the low amplification was due to the valve oscillating too feebly, but the potential on the oscillator grid was found to be about 10 volts—the correct figure. A further investigation, how-

ever, showed that a voltage of the same order was applied to the oscillator anode. Now the potentials on these two electrodes are in opposite phase, but they both have an effect upon the electron stream through the valve. The action of the voltage on the oscillator anode, therefore, is to reduce the effect of the grid voltage.

The remedy was obviously to reduce

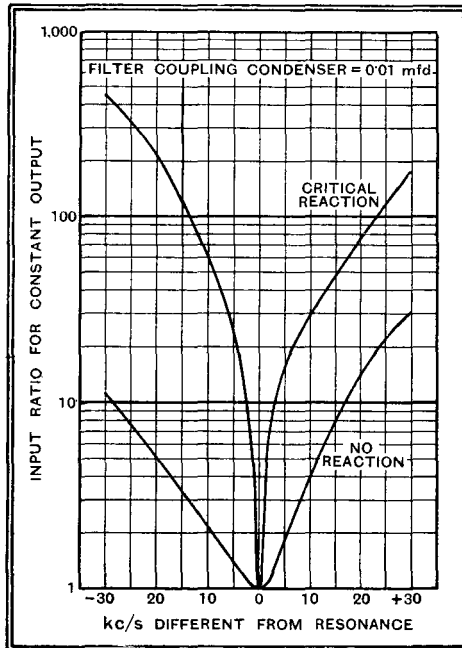

Fig. 6.—The final selectivity curves with a 0.01 mfd. condenser for C₆ and trimming carried out without reaction

the number of turns on the oscillator anode coil, for this would reduce its reactance, and so lead to a lower voltage across it. In order to maintain the valve oscillating efficiently, the reaction coil would have to be coupled more tightly to the tuned winding, and it was accordingly wound directly over it. The effective stage gain was then found to be very close to the theoretical figure.

The next point to receive consideration was the aerial filter, and this need not be gone into at any length here, for the theoretical considerations involved in its design have already been dealt with.¹ Before the final arrangement was decided upon, however, dozens of circuits were tried out. The work on this portion of the receiver, in fact, took as long as that on all the rest of the apparatus together!

¹ New Single-Span Aerial Filter, *The Wireless World*.

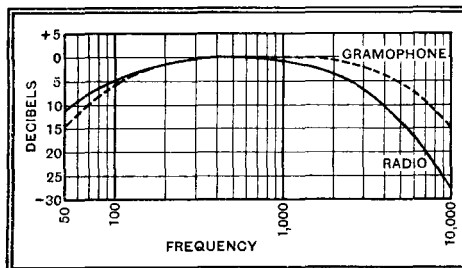

Fig. 7.—The fidelity curves obtained with the selectivity shown in Fig. 6 and a 50,000 ohms resistance for R₅.

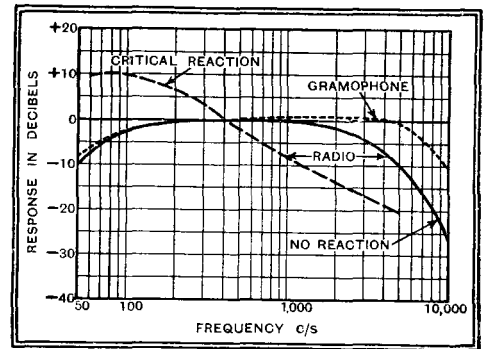

Fig. 8.—Changing R₅ to 25,000 ohms altered the fidelity to the curves shown in this illustration.

From the foregoing, some idea can be gleaned of the process of designing a receiver in *The Wireless World* laboratory, and it can be seen how essential such a process is to the production of efficient apparatus. A fairly simple receiver has been chosen for the purpose of illustration, since, while covering the chief points of importance, the detail is sufficiently limited to be dealt with in the course of a comparatively short article.

Marconiphone "Jubilee Range"

Three New Superheterodyne Receivers Just Released

AN up-to-date four-stage superheterodyne chassis is employed in all the receivers in this series. The frequency changer is a heptode preceded by a band-pass input filter incorporating a second channel suppressor. The single IF stage is followed by a double-

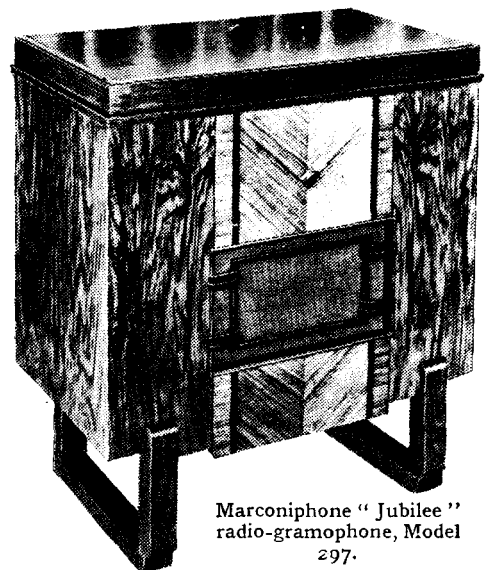

Marconiphone "Jubilee" radio-gramophone, Model 297.

diode-triode second detector arranged to provide amplified AVC with silent tuning between stations. Not only is the threshold level of the "quiet" action adjustable, but this part of the circuit can be switched out for distant reception.

In the radio-gramophone Model 297 at 22 guineas, the tuning scale is mounted on the motor board, but in the console Model 287 at 17 guineas it is recessed into the top of the cabinet. The remaining set is the table model (264) at 12½ guineas.

All three receivers include a variable tone control and the volume control is tone compensated.

Scanning in Television

An Attempt to Make Better Use of the Medium Waveband

ALTHOUGH television inventors have, from time to time, toyed with the idea of devising a system of television free from the complexities of scanning, no practical solution of the problem has yet been produced. Possibly it never will, though it is hardly safe in these times to place a limit on the march of progress.

In ordinary scanning the definition of the received picture depends upon the number of scanning lines used, whilst the smoothness of movement, as seen on the screen, is determined by the number of times the complete picture is repeated in each second.

Recent developments, particularly in cathode-ray reception, have made it possible to use a line-scanning frequency as high as 240 in combination with a picture-repetition frequency of, say, 24 cycles. This is amply sufficient to satisfy the eye both as regards clearness of definition and absence of flicker. But, unfortunately, when both frequencies are transmitted through the ether the sideband "spread" becomes excessive.

Assuming the height of the picture to be one-third as much again as its width, then if the light-and-shade values are distributed equally over the length and breadth of the scanning-line, the maximum "signal" frequency in the case given will be just over a million cycles, corresponding to a total side-band spread of 2,000 kc/s. Applied to a carrier-wave of, say, 300 metres, this would obviously overlap more of the available broadcast band than could be tolerated under present conditions.

A Subdued Background

There is, of course, room for such transmissions in the ultra-short waveband below ten metres, but attempts are still being made to make better use of the medium wavelengths by improving what may be called the technique of scanning, as distinct from the type of apparatus used. It is possible, for instance, to increase the line-scanning frequency over those parts of the picture where motion is taking place, and to reduce it over the larger background area, which remains practically stationary. The observer's attention is naturally more closely focused

A PROPOSAL to transmit greater definition over important parts of the subject which are in motion and reduce definition over the practically stationary background.

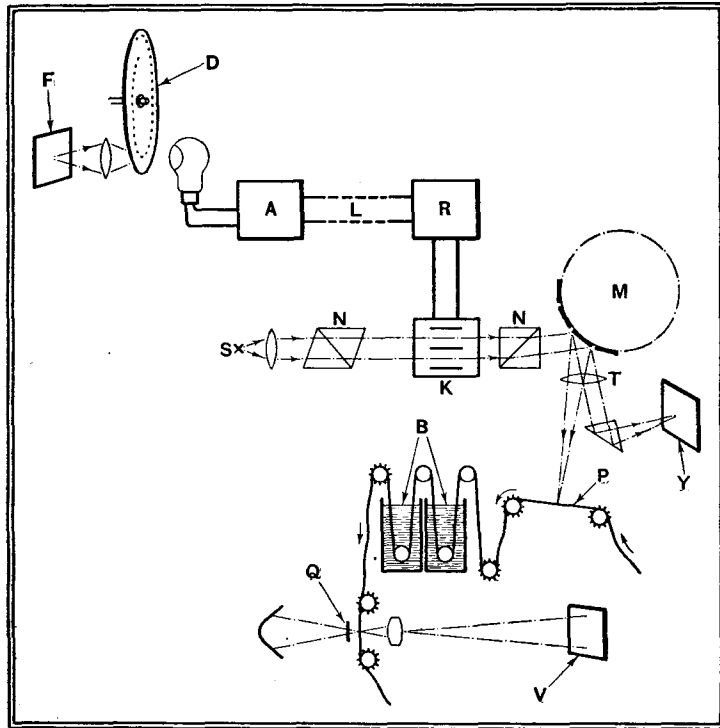

Schematic diagram of the scanning system described.

on the local centre of interest, and if this is shown in clearer detail one can put up with some loss of definition in the more distant background.

The merit of such a scheme is that better use is made of the frequencies available for a permissible side-band spread. In other words, high definition is applied more effectively where it is wanted than in the usual method of scanning.

The same problem has also been attacked by deliberately reducing the picture-repetition frequency (at the transmitting end) below the point necessary to produce the well-known persistence-of-vision effect; at the receiving end some form of compensation is applied in order that the final result may readily be tolerated by the eye.

Broadly speaking, the argument is that what one loses on the swings can be made good on the roundabouts. For instance, by reducing the picture-repetition frequency from the normal 16-20 to, say, four per second, it becomes possible to increase the line-scanning frequency to

such an extent that, without adding to the total side-band spread, the improved definition of each completed picture more than offsets the abnormally low "repetition" frequency.

One is then left with the problem of eliminating the unbearable "flicker" which would result from showing only four completed pictures on the viewing screen in each second. This difficulty is met by the simple expedient of projecting each of the four pictures four times in succession, at equal intervals, so that the viewing screen receives sixteen images per second.

It is claimed that this fills the eye of the observer sufficiently to prevent any suspicion of "flicker," whilst there is no appreciable loss in the "smoothness" of the moving effects reproduced. Whatever falling off there may be in "continuity of movement" is more than made good by the improved definition of what is seen.

As shown in the accompanying diagram, the original picture F (which may be a cinematograph film), is scanned by a rotating disc D, or any other suitable device arranged to produce a high line-scanning frequency and a very low "frame" or picture frequency. The resulting signals are amplified at A and fed into a line L or transmitted through the ether.

At the receiving end the signals are amplified and rectified at R in the usual way, and applied to a Kerr cell K, so as to modulate the light passed from a lamp S through associated Nicols N. The modulated rays are then traversed by a mirror drum M over a sensitised film P.

The resulting "photograph" is passed first into a rapid developing and fixing bath B, and then through a cinematographic projector Q. The gate of the latter remains stationary for the interval of time normally occupied by four separate films so that each picture is "repeated" this number of times on the viewing screen V. It is then rapidly moved to bring the next picture before the lens.

For "monitoring" purposes, and to facilitate adjustment of the synchronising circuits, a double-image prism T may be used to divert part of the modulated light from the mirror drum M on to a fluorescent screen Y. The material on the screen has a perceptible time-lag, the persistence being sufficient to give the operator a direct image of the incoming signals.

★ ★ ★ Listeners' Guide

Outstanding

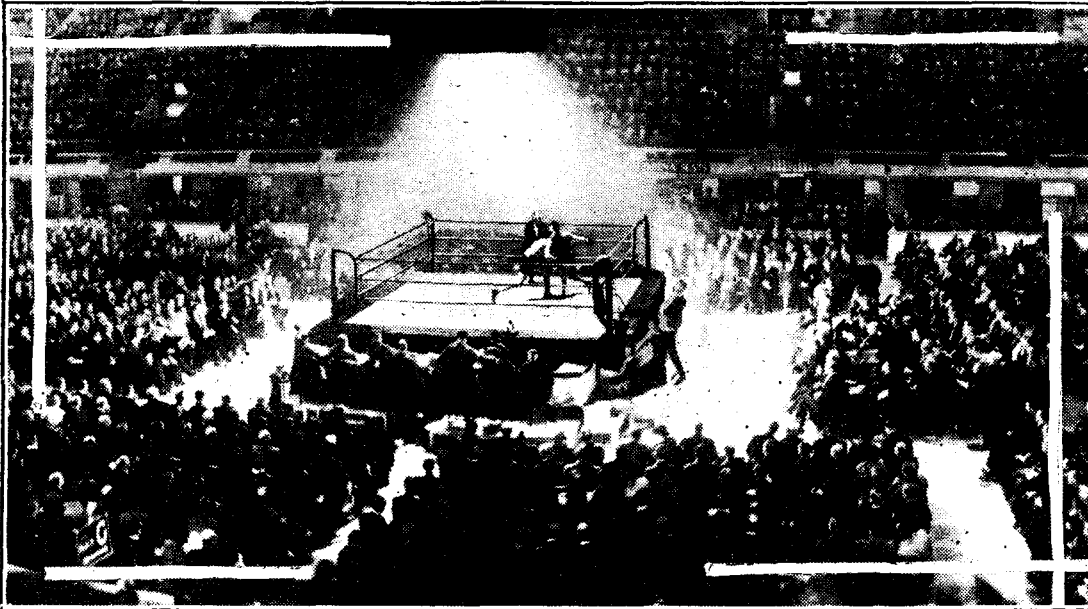

THE WEEK AHEAD

To sum up the programmes for the next seven days calls for more effort than listening to certain of the items, which is saying much. The quality curve rises spasmodically, only to fall again, like the toes of a Dancing Daughter.

And yet who would have it otherwise? If perfection were attained and maintained there would be no "feature" programmes.

FOUR HANDS: ONE PIANO

LAST week two dance bands shared the same studio; this week two artists, Alec Rowley and Edgar Moy, share the same pianoforte. On Thursday evening (National, 8) they will play three of Grieg's works arranged for four hands. I wonder whether they will actually use the same instrument? It should be very difficult to detect the use of two properly tuned pianos . . . and there are so many at Broadcasting House.

OPERA ABROAD

TO-MORROW (Saturday) at eight Rome is relaying Mozart's "Don Giovanni" from the Royal Opera House.

On Sunday afternoon at 2.30 Kalundborg is broadcasting Offenbach's opera, "The Drum-major's Daughter," and on Monday his operetta, "La vie parisienne," in a concert version, can be heard from Toulouse at nine.

BOXING AT THE EMPIRE POOL, WEMBLEY. At 9.30 p.m. on Monday next (Regional) Mr. Lionel Seccombe will give a running commentary on the heavyweight contest between Jack Petersen and Walter Neusel.

Radio-Paris is broadcasting Ibert's "Le roi d'Yvetot" at 8.0 on Monday, February 4th. On Tuesday, Paris PTT is relaying Boieldieu's "La dame blanche" from Marseilles at 8.30, while Leipzig broadcasts his two-act operetta, "Jean de Paris," the same evening at 7.10.

The list of opera broadcasts can be concluded by Moscow's version of "Djamileh," Bizet's opera, on Tuesday, February 5th, with Orlov conducting.

CYRIL SCOTT'S MUSIC

MODERN musicians consider that the great Bach himself would to-day fail to obtain a Mus.Bac. at any of our Universities. This view may have fostered the common notion that celebrities are duffers at exams. So far as music is concerned, Cyril Scott "debunked" this legend last year when his "Festival Overture" took first prize in the *Daily Telegraph* competition. The qualities which won him this triumph (all competitors were anonymous) should be evident in to-night's programme (National, 10.20) of Cyril Scott's music. The composer and Esther Fisher will be at the pianofortes, Elcanor Kaufman (mezzo-soprano) being the soloist.

GERMAN MUSICAL COMEDIES

REALLY effective samples, as opposed to mere snippets, of new musical comedies and operettas are promised from Leipzig at six on Wednesday, February 6th. The same evening we can attend a Radio Ball from eight to ten at Kalundborg. Alternatively, there is a varied programme of music and drama on Radio-Paris, in which Marguerite Pifteau sings songs by Schumann and others. And if this fare is not quite light enough, we can spend the evening in the music-hall to which Paris PTT invites us from half-past eight to eleven o'clock.

"BERKELEY SQUARE"

THE dramatic event of the week is "Berkeley Square" by John L. Balderston (in collaboration with J. C. Squire). This romantic play is to be broadcast on Thursday (Regional, 8), with Lydia Sherwood in the part of Kate.

The spirit of the play, which is based on a story by Henry James, is conjured up in the introductory lines: "There are still adventures . . . inconceivable adventures . . . Perhaps Time, real Time, with a capital T, is nothing but an idea in the mind of God."

CLASSIC COMIC OPERA

AT 6.30 to-morrow evening (Saturday) Berlin (Deutschlandsender) will transmit from the German Opera House in Charlottenburg Adolphe Adam's famous comic opera, "Le postillon de Longjumeau." This work was first produced at the Opéra Comique in 1836, and within four years had been produced all over the world and translated into all the principal languages. On account of its clarity and melodiousness the opera is considered the classic example of the French comic opera.

DANCING THROUGH AGAIN

GERALDO is one of the few dance band leaders who have initiated programme features other than the usual string of "hits." In the second edition of "Dancing Through Again" on Monday (National, 8) Geraldo and his Orchestra will



THE "INDIA" TALKS will be wound up by the Rt. Hon. Stanley Baldwin on Tuesday next in a speech on the National wavelengths at 10 p.m.

give us another pageant of popular music during the past fifteen years. Soloists will include Wynne Ajello, Eve Becke, and Peter Bernard, with the Revue Chorus.

for the Week

Broadcasts at Home and Abroad

LEONARD HENRY'S NIGHT

LEONARD HENRY always seems to enjoy himself at the microphone just as much as his listeners. Anyone who has watched him broadcasting will confirm this. Tuesday is Leonard's night, for he brings a concert party of his own to the studio (National, 8), assisted by the Dancing Daughters with Harry S. Pepper and Doris Arnold at the pianos.

"INDIA"

Two illustrious speakers bring the "India" talks to a close, viz., the Rt. Hon. George Lansbury, M.P. (tonight, National, 10) and the Rt. Hon. Stanley Baldwin, M.P. (Tuesday, National, 10). That the series has been a success has been evident from the fact that no two of the speakers have been in entire agreement.

BACH AND HANDEL ANNI-VERSARY

THE commemoration of music's *annus mirabilis*—1685—is now in full swing, and the German stations offer a good choice of Bach and Handel programmes. Berlin (Funkstunde) has scenes from the life of Bach to-night



"THE WIRELESS MILITARY BAND, conducted by B. Walton O'Donnell" is one of the most familiar items in the B.B.C. programmes. Here is an unusual glimpse of the band in full blast.

(Friday) at eight; and Leipzig will broadcast Bach's Harpsichord Concerto in D minor, played by Li Stadelmann and the Leipzig Symphony Orchestra on Sunday evening next at 8.30 p.m.

B.B.C. SYMPHONY CONCERT

WALTER GIESEKING is solo pianist in Beethoven's Concerto No. 4 in G at the B.B.C.'s Symphony Concert in the Queen's Hall on Wednesday

next (National, 8.30). Adrian Boult will conduct. Elgar's "Introduction and Allegro" for the unusual musical combination of string quartette and string orchestra will also be played.

"BREAKFAST IN EVENING DRESS"

CHARLES BREWER'S sentimental comedy, "Breakfast in Evening Dress," should provide agreeable light entertainment on Wednesday (Regional, 8). The music is by Alan Paul. The Revue Chorus will assist with the B.B.C. Theatre Orchestra, conducted by Mark Lubbock.

LIGHT MUSIC

LISTENERS may wander from Kalundborg to Barcelona for light entertainment this week, and find it all the way. Listen to the concert from Radio-Paris at 8.0 on Sunday evening (February 3rd). The orchestra is conducted by Maurice André, and there are many gay songs on the programme. As usual, this station provides dance music throughout the week at half-past-ten in the evening.

On Tuesday, February 5th, at 6.15, there is a concert by the Warsaw Prison Guards' Band, which does not sound too lively—but perhaps it is better to guard than be guarded.

THE AUDITOR.



HENRY HALL'S GUEST NIGHTS are now a regular feature. At 11 p.m. to-morrow (Saturday) the B.B.C. Dance Orchestra will again welcome distinguished visitors to No. 10 studio, where this picture was taken a fortnight ago.

HIGHLIGHTS OF THE WEEK

FRIDAY, FEBRUARY 1st.
Nat., 7.30, B.B.C. Orchestra (Section D), conducted by Joseph Lewis. 8.45, Ord Hamilton and his 20th Century Band. 10, "India," by the Rt. Hon. George Lansbury, M.P.
Reg., 7.50, Harold Ramsay's "Symphony in Rhythm." 8.30, "The Queen of Cornwall."

Abroad.
Strasbourg, 8.30, Albert Roussel Festival Programme.

SATURDAY, FEBRUARY 2nd.
Nat., 7.30, "The Road to St. David's," by Filson Young. 8.30, "Music Hall," with Evelyn Laye, Parry Jones, Ronald Frankau, Ann Penn and others.
Reg., 7.55, "Tosca" (Puccini) Act I, relayed from Sadler's Wells. 9.5, B.B.C. Orchestra (Section C), conducted by Julius Harrison.

Abroad.
Radio Paris, 8, Operetta: "Viktorina and her Hussar" (Abraham).

SUNDAY, FEBRUARY 3rd.
Nat., 1.30, Violin Recital by Oscar Lampe. 5.30, Griller String Quartet. 9, Albert Sandler and the Park Lane Hotel Orchestra.

Reg., 4.30, B.B.C. Orchestra (Section C). Soloist: Foster Richardson (bass). 5.30, Medvedeff's Balalaika Orchestra. 9.20, B.B.C. Sunday Orchestral Concert. Conductor: Sir Landon Ronald.

Abroad.
Kalundborg, 7.15, Russian Ballet Music by the Radio Orchestra.

MONDAY, FEBRUARY 4th.
Nat., 8, Geraldo and His Band. 10, London Symphony Orchestra conducted by Pedro Morales.
Reg., 8, B.B.C. Orchestra (Section E), conducted by Julius Clifford. 9, Students' Songs by the Wireless Male Voice Chorus with Thorpe Bates (baritone).

Abroad.
Cologne and Hamburg, 8.30, Microphone Report relayed from the Rheingold Express.

TUESDAY, FEBRUARY 5th.
Nat., 8, Leonard Henry's Concert Party. 10, "India," by the Rt. Hon. Stanley Baldwin, M.P.
Reg., 7.15, Henry Hall and the B.B.C. Dance Orchestra. 9, The B.B.C. Theatre Orchestra.

Abroad.
Paris (PTT), Opera: "La Dame Blanche" (Boieldieu).

WEDNESDAY, FEBRUARY 6th.
Nat., 7.30, The Wireless Military Band. 8.30, B.B.C. Symphony Concert.

Reg., 7.30, Concert of Scottish Music by the Scottish Wireless Singers and the Reel Players. 8, "Breakfast in Evening Dress."

Abroad.
Poste Parisien, 8.15, Programme by the Colonne Concert Society.

THURSDAY, FEBRUARY 7th.
Nat., 8, Pianoforte Duets by Alec Rowley and Edgar Moy. 8.30, Variety programme: "Who is It?"

Reg., 8, "Berkeley Square." 9.15, Sullivan and German programme by the B.B.C. Theatre Orchestra.

Abroad.
Kalundborg, 7.10, Seventeenth Thursday Concert by the Radio Symphony Orchestra.

MURPHY RADIO-GRAMOPHONE

MODEL A24 RG

A Cabinet of Outstanding Acoustic Design

FEATURES.—*Type.*—Superheterodyne radio-gramophone for AC mains **Circuit.**—Triode-pentode frequency changer—variable- μ pentode IF amplifier—duo-diode-triode second detector—pentode output valve. **Controls.**—(1) Tuning. (2) Volume. (3) Tone. (4) Waverange and on-off switch. (5) Radio-gram.-switch. **Price.**—£26. **Makers.**—Murphy Radio Ltd., Welwyn Garden City, Herts.

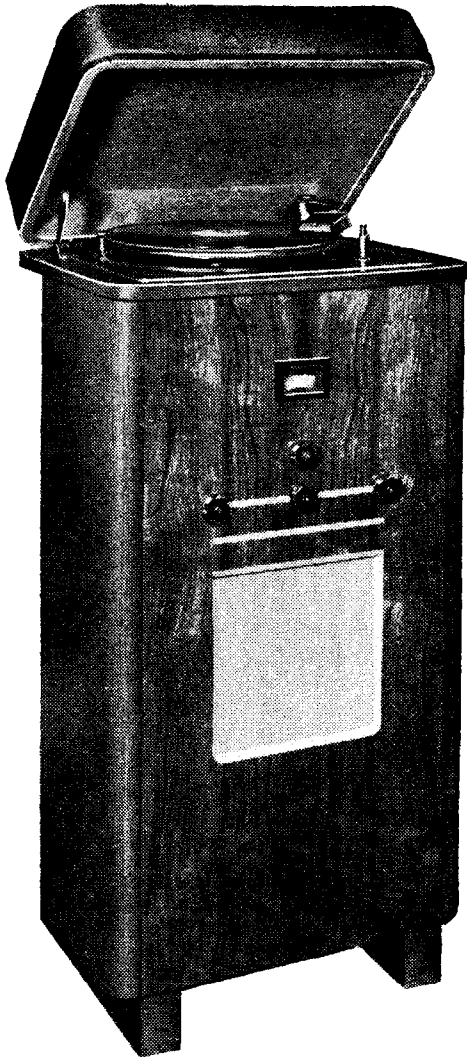

space in conjunction with the thin three-ply walls of the cabinet form an evil alliance for the production of bass resonances.

It is because of this long-standing convention in cabinet design that the first comment of most people on becoming acquainted with the Murphy Radio-gramophone is related to its comparatively small size. Actually the dimensions are approximately 39in. \times 19in. \times 15in., the area of the top being dictated, of course, by the size of the gramophone turntable. The designers decided, however, that these dimensions gave a depth of cabinet from back to front which was far from ideal from the acoustic point of view, and the cabinet-maker's solution, though unconventional, is undeniably practical and at the same time agreeable to the eye when the cabinet is viewed, as it normally is, from the front.

Solid Construction

Not content with reducing the depth of the cabinet, and supporting the overhang at the back by pillars, the makers have reinforced the side and front panels with thick Celotex sound-absorbing material, and in addition the back and base of the cabinet are left entirely open. Walnut and Indian laurel are the woods employed, and the generous scantlings of the component members give an extremely rigid

assembly. The front panel is relieved with pear wood inlays and the finish is matt.

A large B.T.H. energised loud speaker is employed, and the results from the point of view of quality of reproduction amply justify the precautions which have been taken in the design of the cabinet. There is not the least trace of cavity or wood resonance, and at first the reproduction appears to be deficient in bass. This is only because the ear has become accustomed to bass resonance in commercial receivers of all kinds, and after a time the true quality of the bass becomes apparent. There appears, however, to be some masking of the bass by a rather over-generous response in the region of 2,500 and 3,500 cycles, but this is easily corrected with the tone control. The top cut-off is at 5,000 cycles, and this has been made sharp by a specially designed filter preceding the output stage. The cut-off frequency has been happily chosen, as it permits the reproduction of most of the frequencies which are to be found on modern recordings and at the same time eliminates the pick-up resonance and with it most of the needle scratch.

The pick-up is of the needle armature type, and the gramophone motor has a higher torque than usual to ensure freedom from pitch variation on loud passages. The motor-board is flush-mounted

THERE is a tendency in some quarters to assume that a radio-gramophone must of necessity be an "imposing piece of furniture." Underlying this assumption is the belief that to command ready sales the impression must be created that one is receiving "a lot of set for a little money." Consequently, it is common to find many low-priced radio-gramophones in which only a small proportion of the interior volume is occupied by the chassis and loud speaker. The remaining empty

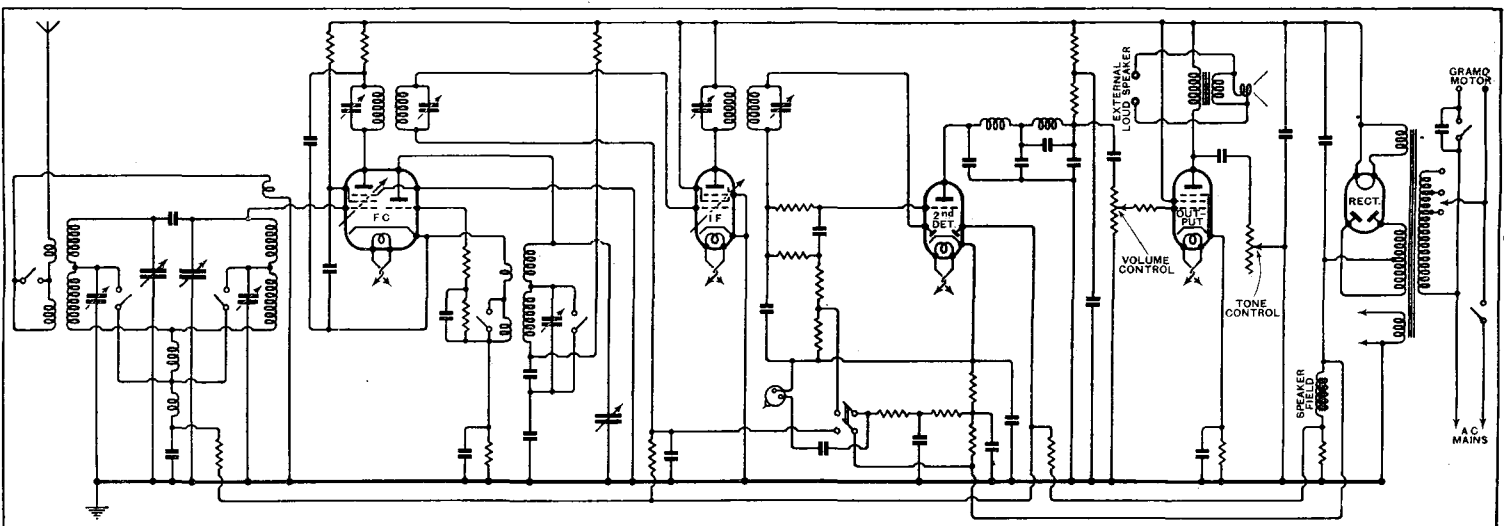

Simplified circuit diagram. The input band-pass filter incorporates a whistle-suppressor circuit and a two-stage low-pass filter follows the second detector valve.

Murphy Radio-gramophone, Model A24 RG—to facilitate the removal of the needles should they be dropped accidentally, and the needle cups, as well as the inside of the lid, are lined with felt to avoid the possibility of rattles.

The amplification succeeding the pick-up has been carefully adjusted to ensure

over-biasing these valves. The low-pass filter in the anode circuit of the triode portion of the second detector functions both on radio and gramophone, as do the volume and tone controls associated with the pentode output valve.

Both wavebands are free from self-generated heterodyne whistles, and there

that the selectivity was unusually uniform over the medium waveband.

The automatic volume control works well, and in London there is no perceptible change in volume when the receiver is tuned successively to the North and Midland transmitters and only a slight increase when tuned to London Regional—the manual volume control being untouched, of course.

To sum up, the makers have succeeded in producing a solid and compact instrument, in which the bugbear of cabinet resonance has been completely eliminated. The reproduction, particularly on gramophone records, reaches a very high standard, and the radio performance is capable of bringing in all the foreign programmes which are likely to be of the slightest programme value. The set is easy to handle and the effective automatic volume control relieves the operator of the necessity of continual manipulation of the hand volume control.

Models are available for AC mains at frequencies other than 50 cycles at an additional cost of £1, while there is also a DC version at £27.

MORLEYS SHORT-WAVE COILS

THE short-wave coils made by Morleys, 115, Borough High Street, London, S.E.1, are available in two types, viz., the MSWI and the TRSW2. The type MSWI is a two-range coil wound on an eight-ribbed ebonite former 2½ in. in diameter and 3 in. long. It is intended for use as an aerial coil, and consists of two grid windings, well spaced so that short-circuiting one section has negligible effect on the other, an aerial and a reaction winding.

A tuning condenser of 0.00025 mfd. is recommended, while one of 0.0002 mfd. will serve for reaction control. Using these condenser values and assembled in a straightforward circuit, the tuning ranges were found to be 12 to 37 metres and 35 to 100 metres respectively. If the tuning condenser is reduced to 0.00015 mfd. the two ranges do not overlap.

Reaction is smooth and quite satisfactory over the entire wave-range, and the aerial coupling is nicely adjusted for both bands. A wave-range switch is included, and the price is 6s. 9d.

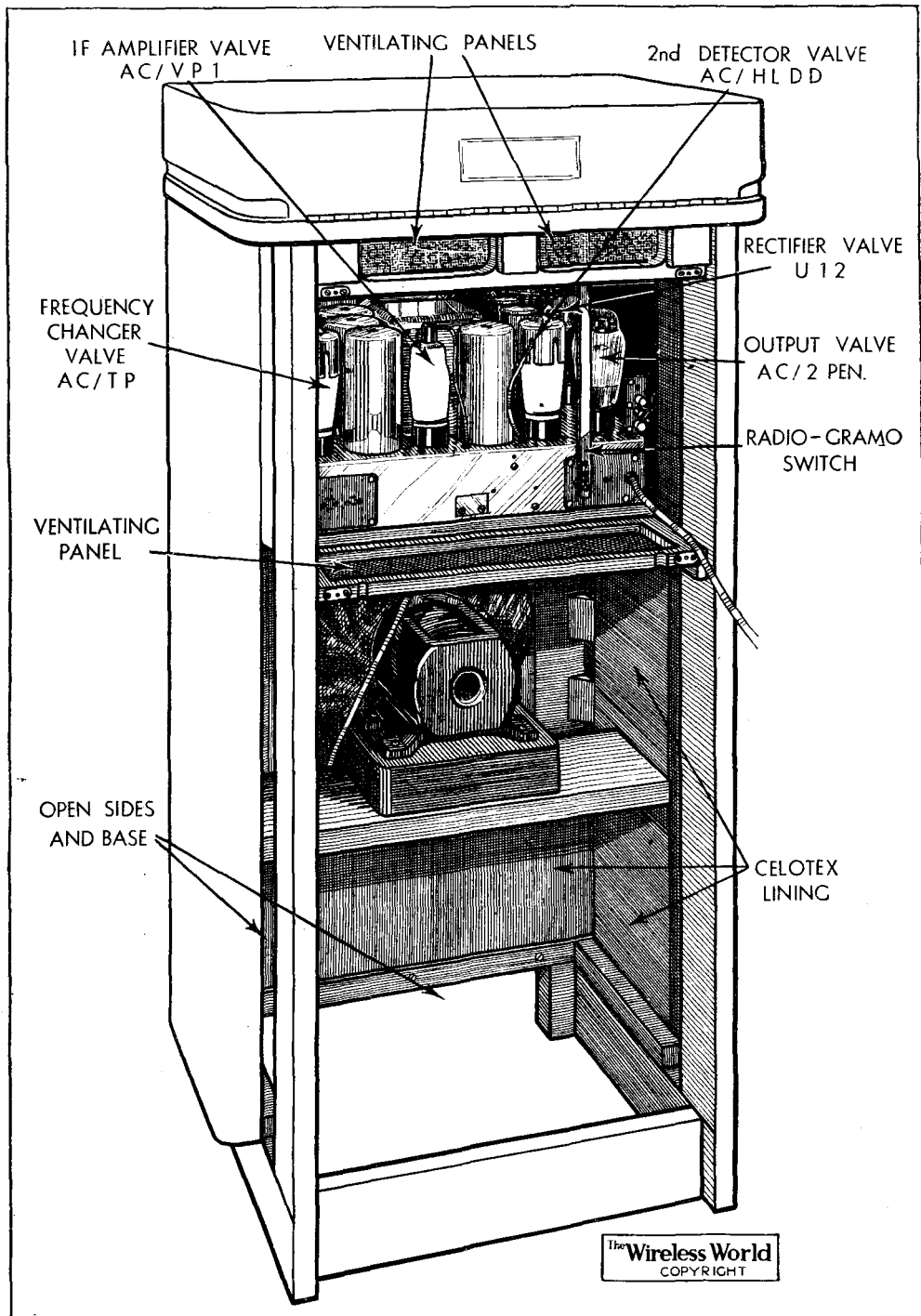

Rear view of cabinet with chassis back panel removed. The lower half of the cabinet is left open.

that with the volume control at maximum overloading of the output stage and loud speaker is avoided.

On the radio side the chassis of the A24 receiver is employed with minor modifications. The frequency changer is a triode-pentode preceded by a band-pass input filter incorporating a second-channel whistle suppressor. Both the frequency changer and the IF amplifier are controlled by amplified AVC bias, and the set is silenced when using the gramophone by

is little doubt that the sensitivity is as high as it can be made with a four-stage super-heterodyne circuit. The selectivity is sufficient to give clear reception of the Deutschlandsender on long waves except for occasional side-band interference from Droitwich and Radio-Paris on deeply modulated passages. On the medium waveband only one channel was lost on either side of the Brookmans Park transmitters with the receiver operating in Central London. Incidentally, it was noted

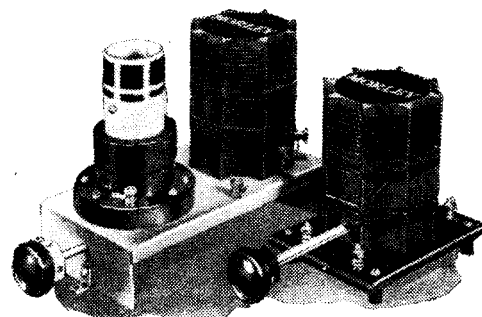

Morleys two-range and three-range short-wave coils.

The type TRSW2 covers a wider wave-range, and in three steps extends to 200 metres. One coil former is identical to the type MSWI coil, and the extra range is provided by a coil on a separate former. A three-position switch is embodied in the base of the metal chassis, and the price is 15s.

Foundations of Wireless

Part X.—The Magnetic Effects of a Current

By A. L. M. SOWERBY, M.Sc.

THE concluding instalment of the purely theoretical section of this series: succeeding articles will show the direct application of the ideas already discussed to practical wireless circuits.

(Continued from page 98 of January 25th issue)

WE have already dealt with the magnetic effect of a current so far as this provides the factor of inductance, but the treatment was very sketchy. To get an insight into the working of transformers and loud speakers we shall need to go a little deeper.

It is conventional to represent a magnet, as in Fig. 48, as being the source of lines of "magnetic force," which leave the magnet by the North Pole and re-enter it by the South. The lines trace out the path along which a north magnetic pole, if free

straight wire carrying a current sets up a magnetic field, though this is usually inappreciably small. Coiling the wire enables the fields of successive turns to reinforce one another, thereby enhancing the effect; that is why an electro-magnet or an inductance is made up as a coil.

The magnitude of the field depends upon the number of the turns and on the current through them. Ten turns carrying one ampere give rise to the same field as a hundred turns carrying one-tenth of an ampere; ten *ampere-turns* are available in either case to set up the field.

Terrestrial Magnetism

Everybody knows that a compass-needle will point to the north. The needle itself is a magnet, and turns because its own field interacts with the magnetic field of the earth. Put differently, the north magnetic pole of the earth attracts the north-seeking pole of the magnet while the earth's South Pole attracts its south-seeking pole. This is the only known case of "Two North Poles" or two "South Poles" attracting one another, and is simply due to convenient, but muddled, nomenclature; the earth's "North" Pole has the same polarity as the "South" Pole (more correctly, south-seeking pole) of a magnet. By bringing the two poles of a bar magnet, in turn, towards a compass needle it is very easy to demonstrate that, as in Fig. 49, like poles repel one another and unlike poles attract.

Now suppose we hang a coil in such a way that it is free to rotate about a vertical axis, as suggested in Fig. 50. So long as no current is passed through the coil it will evince no tendency to set itself in any particular direction, but if a battery is connected to it the flow of current will transform the coil into a magnet. Like the compass needle, it will then indicate the north, turning itself so that the plane in which the turns of the coil lie is east and west, the axis of the coil pointing north. If the current is now reversed the coil will turn through 180 degrees, showing that what was the North Pole of the coil is now, with the current flowing the opposite way, the South.

The earth's field is weak, so that the force operating to turn the coil is small; when it is desired to make mechanical use of the magnetic effect of the current in a coil, as in the milliammeter illustrated in Part III, an artificial field of the highest attainable intensity is provided by a powerful magnet arranged to be as near to the coil as possible. The same principle is found in the galvanometer, in the electric motor (in essence Fig. 50, with a powerful field and automatic reversal of current) and in the moving-coil loud speaker.

Since the loud speaker is the only

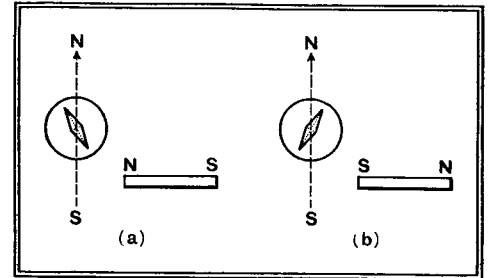

Fig. 49.—Deflection of a compass needle by a magnet, proving that like poles repel and unlike poles attract. The N and S poles of the bar magnet may be found by suspending it like a compass needle and marking as N that pole which turns to the north.

piece of wireless apparatus embodying the principle of movement of a coil carrying current in a magnetic field we will stop to examine its mechanism. Fig. 51 shows the cross-section of an energised speaker, in which the magnet is provided by passing a current through the winding A. Through the centre of this winding runs an iron rod B, the purpose of which is to guide the lines of magnetic force due to the current. This it does because the *permeability* of iron to the lines is very high, and they therefore pass through the iron in preference to the air in much the same way that an electric current passes through a copper wire, and not through the air around it. The analogy is not complete, because the air does carry some lines; there is no "insulator" for magnetic lines, but only materials of very high "resistance." The high permeability of

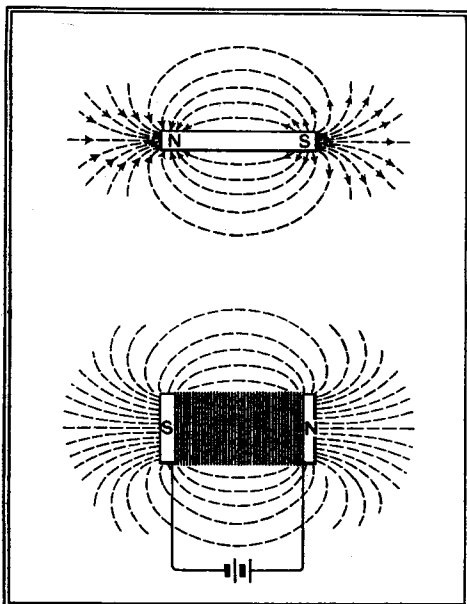

Fig. 48.—Conventional representations, in terms of "lines of magnetic force" of the fields round a magnet and a coil of wire carrying a current.

to move, would be impelled by the field, and are as real, or as unreal, as the parallels of latitude on the map. The field is at its most intense in the neighbourhood of the poles, but theoretically it extends indefinitely in all directions, dying away rapidly in intensity as we retreat from the magnet.

By sending a steady current through a coil of wire this becomes, as we have seen, a magnet, and remains so as long as the current is maintained. Even a simple

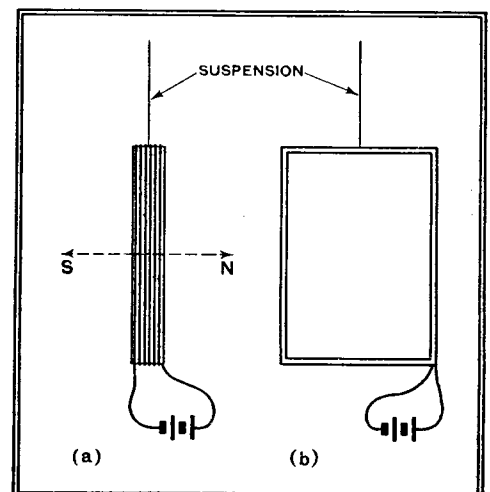

Fig. 50.—A coil, free to rotate, sets itself in the orientation indicated when a current is passed through the winding.

Foundations of Wireless—

iron as compared with air results in the iron core enhancing the intensity of the field as well as directing it, much as a conductor of low resistance will carry a larger current between two points of different electrical potential than will one of high resistance.

The outer shell of the cylindrical magnet is also of iron, so that except for the small annular gap at G there is a complete iron circuit. The lines are thus guided round the iron and are all made to complete their path by jumping the gap, in which there is, in consequence, an extremely concentrated magnetic field.

Production of Sound Waves

In this gap is suspended the coil of wire C, wound on a former firmly attached to the paper diaphragm D. If we lead a current through C the coil will tend to move along the gap, driving D towards or away from the face of the magnet according to the direction of the current. By a series of rapid reversals of current the diaphragm could be made to jump violently in and out. Going a step further, we could pass an alternating current

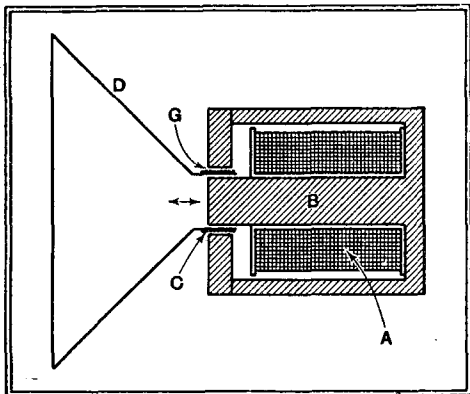

Fig. 51. Cross-section of a moving-coil loud speaker.

through the coil, whereupon this would take up a rhythmic to-and-fro movement at the frequency of the current.

If the current supplied had a frequency of 256 cycles per second, the diaphragm would vibrate at this frequency, driving the air in contact with it back and forth as it moved. As we saw in the introduction to this series, such a rhythmic movement of the air travels outwards from its origin as an air-wave and is recognised by the ear as *sound*; in this particular case we have generated, by electro-mechanical means, an audible note corresponding to middle C on the piano.

The same mechanism would operate if the current supplied were an extremely complex ever-varying one, compounded of many simultaneous frequencies; given the perfect speaker, this would be converted into an exactly corresponding air-wave. The loud speaker thus serves as the link between a wireless set, in which music exists as electric currents, and the listener's ear, which can only appreciate it in the form of air-waves.

The fundamental effect upon which the loud speaker is based, the movement of a

coil carrying a current in a magnetic field, is reversible. That is to say, if a coil is moved in a magnetic field a current—or more strictly, a voltage which will drive a current if the circuit is closed—is set up in it, the direction of the voltage depending upon the direction of motion and upon the polarity of the field, while its magnitude depends upon the amount by which the intensity of the field passing through the coil is changed, the speed with which the change is effected, and the number of turns in the coil.

The action of the loud speaker itself can therefore be reversed; by moving the coil to and fro in the magnetic field voltages which in their rise and fall picture the movements of the coil are generated. Thus the speaker can be used to convert sound-waves into equivalent electric voltages—in other words, it forms a *microphone*. Not a very perfect one, perhaps, and certainly not much like the microphones used by the B.B.C. Nevertheless, it will serve to show what the microphone does and, approximately, how it does it.

A change of magnetic field round a coil can be effected by other means than mechanical movement of the coil or of the magnet. Suppose we have two coils, wound over the same iron core in such a way that as far as possible all the lines of force generated by passing a current through one coil will be led through the other. We then have a *transformer*, the symbol for which is seen in Fig. 52. The lines between the coils represent the iron core; an air-core transformer, consisting of two coils in close juxtaposition, would be indicated by the same symbol without these lines.

If alternating current is supplied to the *primary* winding P, the current through it is continuously rising and falling in alternate directions, with the result that P is surrounded by a continuously varying magnetic field. In the *secondary* winding S there is consequently set up a voltage, rising and falling in step with the changes in the field. With such *close coupling* between the coils that all the magnetic flux from P passes through S, the voltages across P and S will be equal if they have the same number of turns. If S has more or fewer turns, the voltage

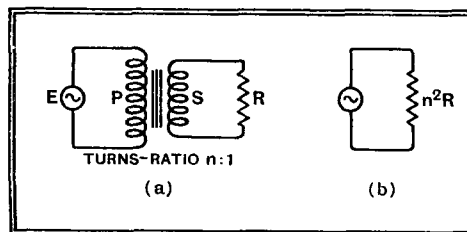

Fig. 52.—Iron-cored transformer drawing current from the generator E and delivering it, at a voltage equal to E/n , to the load R. From the point of view of loading the generator, diagram (b) represents an equivalent circuit (assuming a perfect transformer).

developed across it will stand to that across P in the ratio of the turns. There may be 2,000 turns in P and 40 in S; then if P is connected to 200-volt alternating mains S will deliver 4 volts A.C., and

may be used to light the filaments of 4-volt valves. In practice it is not uncommon to have several secondary windings, delivering different voltages for different purposes, on the same iron core, all energised by a single primary.

In addition to their use in supply-fre-

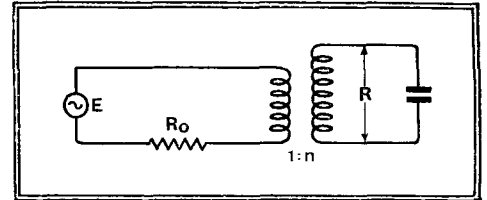

Fig. 53.—High-frequency transformer, with secondary of dynamic resistance R, tuned to the frequency of the generator. This represents a stage of HF amplification, where R_0 is the AC resistance of the valve and E/μ is the signal voltage on its grid.

quency circuits, transformers are employed for handling speech-frequency currents in amplifiers; the general design is much the same as for power transformers.

In a high-frequency transformer it is usual to omit the iron core, but if it is included it no longer consists of laminations but of finely pulverised iron dust supported in an insulating "binder." Further, it is usual to tune either one or both windings to the frequency of the current to be handled.

Transformer Losses

In all calculations in which transformers enter, the relative voltages and currents in the two windings have to be computed on the basis of equal power, allowing, if necessary, for the small discrepancy due to losses in the transformer itself. If we have a step-down transformer giving 100 volts at 1 amp. on the secondary side, the power output is 100 watts. The useful power input to the primary is also 100 watts, so that from 200-volt mains the current taken would be $\frac{1}{2}$ amp. The load on the secondary in this case is very clearly 100 ohms; the equivalent load on the primary, to take $\frac{1}{2}$ amp. at 200 volts, would be 400 ohms. In general, if the turns-ratio of the transformer is n , a resistance R connected across one winding has the same effect on the other as if there were connected across it a resistance of n^2R or R/n^2 , according to whether we are stepping down or up.

Applying this to a circuit such as that of Fig. 53, which represents a step-up high-frequency transformer fed, in series with a resistance, from the high-frequency generator E, and having a tuned secondary of dynamic resistance R, we can find the voltage across both primary and secondary quite easily.

The impedance of the primary, which is untuned, is usually minute compared with the dynamic resistance of the tuned secondary; the effective primary impedance at resonance is, therefore, due almost entirely to the transferred load from the secondary. It will be R/n^2 . The voltage across the primary will there-

Foundations of Wireless—

fore be $\frac{E.R/n^2}{R/n^2 + R_0} = \frac{ER}{R + n^2R_0}$. Since there is a step-up of n to 1, the voltage across the secondary will be n times that across the primary, making $\frac{ERn}{R + n^2R_0}$. In practice, lower voltages are found at both points, since the coupling between primary and secondary is not infinitely close. This lessens the effective resistance of the primary, and hence the voltage across it, while at the same time making the voltage on the secondary less than n times that on the primary. But the result so simply found is, nevertheless, a very good approximation to the truth in this important case, which represents a stage of high-frequency amplification.

We can go farther yet, and calculate the effect of R_0 in flattening the tuning of the secondary. R_0 is, from this point of view, connected in parallel with the primary; it is therefore equivalent to a resistance n^2R_0 connected across the tuned secondary. By comparing this with the value of R for the undamped circuit, an estimate of the decreased sharpness of tuning can be made, or if preferred, first

R , and then the resultant of R and R_0 in parallel, can be converted into equivalent series ohms and the two corresponding m -values directly compared.

Looking at a single coil as being simultaneously primary and secondary of a transformer, we have a view of the meaning of inductance which differs a little from that already put forward—though, needless to say, the final conclusions are the same. If we think of the rise and fall of the magnetic field surrounding a coil carrying a current, it is clear that this field must induce a voltage *in the coil itself*.

We may regard the reactance of the coil as due to this property of producing an induced voltage which is at every instant in opposition to the voltage driving the current. The reader is recommended to apply this conception to the curves of Fig. 28 (Part 6); it would be an interesting, if difficult, exercise to fit the physical interpretation to the curves.

This instalment concludes the "purely theoretical" section of this series; from now on we shall be chiefly concerned with making use of the ideas so far discussed in studying the working of circuits of more direct and obvious wireless interest.

(To be continued.)

Random Radiations

By "DIALLIST"

Still Going Strong

WHEN the V24 valve first made its appearance I can't quite remember, but if it was not a war-time product it must date from very shortly afterwards, for I used it in a home-built set of the 1920 or 1921 vintage. It is surprising to learn that a demand for it still exists after all those years and that it is yet to be obtained by those who care to plank down twenty-five shillings.

The V24 is a most interesting relic of the past, for it represents the valve designer's first serious attempt to cut down inter-electrode capacity. It was the first of the "test-tube" valves, so called from their long narrow bulbs. Instead of pins, the cylindrical bulb had four small metal caps, which formed the contacts for the holder. The filament was connected between the pair at the ends of the bulb, whilst the grid and plate leads were taken to the caps on the walls. There was also a special detector pattern, the QX, and some time later dull-emitter counterparts—DEV and DEQ—made their appearance.

Amongst other staunch old friends which are still available one finds the DER, the LS5 series and the S610, the original screen-grid valve of sausage-like shape.

Car Radio Facts and Fancies

THE coming of car radio has led—as is so often the case with wireless innovations—to not a few misleading suggestions or statements in the lay Press. Recently it was hinted that the Road Traffic Advisory Committee had been asked by our high-potential Minister of Transport to inquire

into the subject of car radio, the idea being that it might be banned by legislation were the case against it sufficiently strong. As Mark Twain wrote, after reading his own obituary notice in a certain paper, the report is much exaggerated. There is no evidence that the use of car radio lessens the safety of the roads and no "anti" legislation is contemplated.

Another wild statement that should have been scotched at birth, if not sooner, was that insurance companies were to demand an extra premium on cars provided with wireless. The implication was that such cars were regarded as more prone to accidents. The facts are simply these. A car radio set is an accessory of much greater value than those normally fitted to motor vehicles; owing to its nature it is naturally less robust than most other parts of the equipment. Where an extra premium is required it is to cover *not* increased driving risks but loss or damage of the set itself.

May I mention one further point about which there has been some misconception? Your household receiving licence covers the use of a portable in the car, but if a set is built in so as to form part of the car's equipment an additional licence is required for it. Instead of an address, the number of the car appears on this licence.

A New Use for the Wireless Valve

VERILY the applications of the valve, invented originally for the transmission and reception of wireless, are legion. Recently, for instance, I acquired a book on the applications of the valve and of electron tubes that are its lineal descendants to

industry and manufacture. This runs to nearly 500 pages and describes, amongst other marvels, its use for controlling the speed of conveyor belts, for counting with almost incredible speed and accuracy, for measuring the thickness of materials and for maintaining temperatures.

I knew that radiations of very short wavelength were employed by the medical profession for treating a variety of ailments, but a recent pronouncement of Dr. Arthur H. Ring, of Arlington, Massachusetts, seems to open up an entirely new field. "Radio wave therapy," says he, "can be used to warm up the walls of the stomach, causing them to relax and bring comfort to the patient and to eliminate the craving for strong liquor."

Use a Blue Ribbon receiver and cease to worry about the bass!

The Monthly Revues

THE first of the B.B.C.'s monthly revues, the January edition, was undoubtedly a huge success and listeners are looking forward to those to be staged during the coming months. Revue is a type of entertainment admirably suited to broadcasting. It is topical and it gives fine opportunities for delicate satire on events of our everyday lives. The monthly revues should be made a permanent part of the programmes. They are widely appreciated and they do provide a most welcome relief from the slapstick-seaside-landlady-mother-in-law-kipper kind of tosh.

The Television Dog Fight

EVEN before the report of the Television Committee reached the P.M.G. it became clear that there was going to be no small struggle for the televised programmes in this country.

At the moment of writing the report has not been made public, but it is generally believed that it will recommend that the control of television in this country should be in the hands of the B.B.C., at any rate during the term of its present charter, which expires at the end of next year. This has roused the cinema people to arms. They claim to be the right and proper people to undertake the job and they say that they have forgotten more than the B.B.C. ever knew about the transmission of talkie films.

On the other hand, it is contended, and with some show of reason, that the film people derive their revenue from the movie theatres and that if they were in charge they would not be likely to empty their own houses by televising the best entertainment available.

The Crux of the Problem

The matter bristles with difficulties. So far as I can see television would be a poor thing if it were not accompanied by sound. And the broadcasting of sound is without a shadow of doubt the prerogative of the B.B.C. You could hardly have one concern sending out the images and another responsible for the appropriate sounds!

Then again, the addition of visual transmission would be so obvious an improvement to programmes of the type which the B.B.C. conducts. It is admirably adapted for linking with such items as plays, revues, music-hall entertainments, "In Town Tonight" descriptions of important events and running commentaries on races, boxing matches, football matches and the like. Some broadcasting artistes are no doubt

better heard than seen, but television is unquestionably a most desirable concomitant for any item of a spectacular nature. Not all items, though, are spectacular.

Programme Difficulties

As a matter of interest examine to-day's programmes and ask yourself just how much of them you would like to see as well as to hear. Do you want to see Professor Mugwump reading his paper on the "Courtship of Earthworms," or Mrs. Guffin giving her discourse on "Twenty-four Ways of Cooking a Brussels Sprout"?

Definitely no.

Then there is somebody or other at the organ, somebody else giving a song recital, a concert by the studio orchestra, and so on and so forth. If you mark with a pencil those items that you would like to have televised—except possibly just once as a matter of curiosity—you will find that there is not an enormous amount left.

It follows that unless the television service is to be confined to an odd item here and there something besides the ordinary broadcast programmes will be required.

That is where talkie films might come in; but will they?

Short-wave Broadcasting

Re-radiating Empire Programmes in Malaya

AN important addition to the already long list of Empire broadcasting stations is Penang. The Penang Wireless Society's own broadcasting station has been assigned the call-sign ZHJ, and works on 49.4 metres. One of the aims of the Society is to re-radiate the Empire programmes through this station, and to develop inexpensive receivers capable of giving satisfactory service on these "local" transmissions.

This, of course, is no new development, but the principle of re-radiating short-wave transmissions, *again* on the short waves, is interesting. Most other parts of the Empire re-broadcast Daventry on the medium waves, but the writer has always considered that a re-broadcast on the 49-metre band would have a definite value and probably a better service-area.

The scheme of entrusting re-radiation of this kind to a local wireless society is also one that seems to be increasing in popularity. The Malayan Amateur Radio Society of Kuala Lumpur has been doing similar work for some time, and it is understood that for the past six years this society has put out three transmissions a week.

Incidentally, the Kuala Lumpur station has now changed its wavelength from 48.9 to 75 metres.

It is believed that special facilities will be given to amateur transmitters in out-of-the-way localities, where they are prepared to undertake the regular re-radiation of the Empire programme. Here, again, short waves will probably be used exclusively. The whole point of this, of course, is that local inhabitants will be able to obtain satisfactory programme value on much more simple apparatus than they would require for the direct reception of Daventry.

What are "Average" Conditions?

The reliable service area of the Empire Station is being steadily increased, but there must inevitably be large areas over which really first-class reception is extremely difficult, and it is in these circumstances that local low-power relay stations, themselves equipped with first-class receiving apparatus beyond the reach of the average listener, can carry out really valuable work.

Conditions continue to maintain the level generally described as "average"—though one's idea of "average" conditions, where short waves are concerned, is apt to vary considerably! All the high-powered American transmitters seem to have settled down to a kind of regular routine. That is to say, they are always to be found at the same times, and the fade-out occurs at the times one expects, although the level of signal-strength may vary considerably from day to day.

Easily the most consistent—apart from the many stations on the 49-metre band—is W8XK on 19.72 metres. This station never seems to let one down, and really reaches an amazing strength at times. The bout of rapid fading and distortion to which the 19-metre stations were subject a few weeks ago seems to have come to an end.

The number of regular broadcasting stations working outside the official broadcast bands is increasing weekly. The part of the spectrum in greatest demand seems to be that between the 31- and 49-metre bands. Most of the stations concerned are in Central or South America, but we also have Rabat on 37.33 metres and Rome on 37.41. Tokio,

JYR, has also been reported by many listeners in this country; this station is now listed as working on 38.07 metres.

Probably there will be a drastic revision, sooner or later, of the whole distribution of short-wave broadcasting stations. At present the so-called "broadcast bands" can only be regarded as areas in which a concentration of stations occurs! Commercial demands upon short-wave space are increasing daily, and acute congestion is bound to arise sooner or later. MEGACYCLE.

G.E.C. "Droitwich Super 5"

A New AC Superheterodyne Band Pass Tuning

THE circuit of the latest addition to the range of G.E.C. receivers comprises a heptode frequency changer, variable-mu pentode IF, double-diode-triode second detector, and pentode output valve. The power rectifier is a full-wave valve, and the mains transformer is designed for mains from 190 to 250 volts and 40 to 100 cycles.

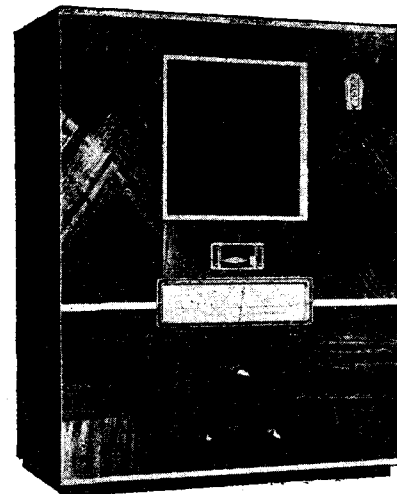

G.E.C. "Droitwich Super 5."

Delayed and amplified AVC is included, and a variable sensitivity control serves to reduce background noise between the more powerful stations. A self-contained extensible aerial is a useful feature which should appeal to flat dwellers.

The figured walnut cabinet houses a large diameter energised loud speaker which is fitted with a silencing key. A shadow tuning indicator is included, and the large horizontal tuning scale is calibrated in wavelengths and station names.

The dimensions of the new receiver are 20½ in. x 15¾ in. x 9½ in., and the price has been fixed at 12½ guineas.

AN "EMPIRE STATION" IN DENMARK

DENMARK'S principal short-wave station is at Skamlebaek, a picturesque village in the north-west of Seeland, some 70 miles from Copenhagen. The station (OXY) transmits nightly from 6 to 11 p.m., relaying the Copenhagen programme on 49.5 metres. The power is 500 watts. It is interesting to note that Greenland, for whom the short-wave transmissions are intended, prefers long-wave Kalundborg during the winter months.

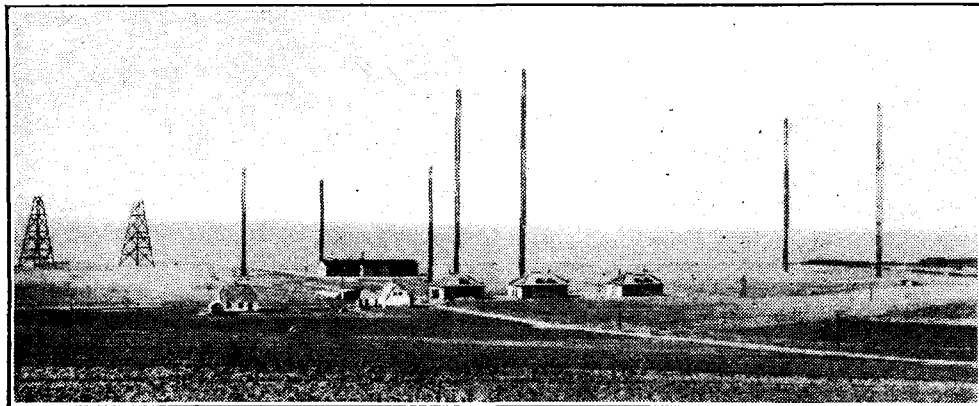

Masts and station buildings of "Danmarks Kortbolgesender," which relays the Copenhagen programme to Greenland. The station has been heard in all parts of the world, as its museum of QSL cards amply testifies.

Why Do Listeners Like "BOOM"?

The Difficulties of Obtaining True Musical Value

By "CATHODE RAY"

THE commercial designer with ideas about high quality reproduction is constantly being shocked and grieved to find, or to be told, that the sort of reproduction that the public likes is what he knows to be bad. His pearls of brilliant "top" are rejected in favour of baser matter; and he is constrained to draw the conclusion that the public are the proverbial swine. If they prefer to go after the big bad "whoof," let them suffer the consequences. So he provides a tone control with which they can have thumping and booming to their silly hearts' content.

I have been trying to get to the bottom of this mystery—for it is surely a mystery that the majority of ordinary listeners should turn the tone control round to the low tone position, where the reproduction obviously bears little relationship to real speech or music. The present-day receiver, when accurately tuned to a station, gives reproduction which is already sadly shorn of the upper tones. Yet the usual type of tone control starts at this point and proceeds to cut them down more. It is like a barometer marked at one end of the scale "Wet" and at the other end "Very Wet."

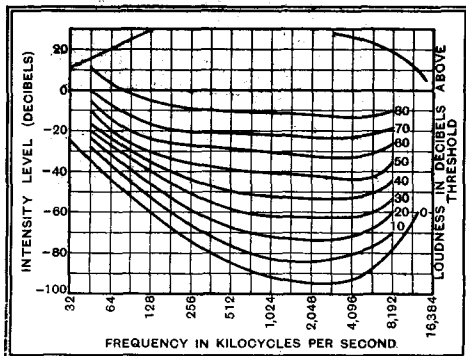

Diagram showing curves where the loudness is the same at all frequencies. When the volume is small, a much greater proportion of low frequency sound is required than when the volume is great. This shows that bass accentuation is necessary when sound is reproduced at less than its original volume.

From this indictment present company may, very justly, be excepted. The term "ordinary listener" must be understood to refer to the people who buy ordinary mass-produced sets, and not to those who either make their own or who exercise knowledgeable discrimination in their purchase. This qualification, by the way, is not the prelude to a violent condemnation of the depravity of the masses. That is the easy explanation. There must be something more in it than that.

"Each wrong step leads to another."

I do believe that if equipment giving perfect reproduction, or even the existing nearly perfect but very expensive apparatus, were universally available, few people would demand "boom." To sell super-hets with AVC, visual tuning, noise suppression, and a host of other features at a mere dozen guineas—a really amazing achievement when one compares values of four or five years ago—it is not possible to include a ten-guinea loud speaker. Until somebody very clever comes along, we have to make the best of a reproducer that gives an impression of "top" by a peaky resonance at 2,000 or 3,000 cycles, and an impression of bass by another peak of about 100 cycles (added to, no doubt, by the resonance of a thin plywood cabinet).

Watts and Loudness

The ear, mercifully for the designer, is remarkably tolerant of these fakes. Except to the trained listener, the effect is a very fair balance of tone. But a less obvious result is that the reproduction sounds unpleasantly loud when it is still well below "life-size." One reason why high-quality equipment provides for so many watts output is that the listener can stand far more volume when the reproduction is true than when it is false, even although the ear is not conscious of the falsity as such.

This works in two ways. When the volume is raised the high tones sound strident, and the listener is glad to be able to cut them down with the tone control. And because the volume even then is really less than that of the original performance, the low tones appear relatively less prominent. This is a well-known characteristic of the ear. As the volume is reduced the low tones seem to disappear first. The only way to get enough depth and sonority is to use the tone control.

There are other reasons. Few and favoured are the listeners who have absolutely no extraneous "mush" or other noise to mar their programmes. Generally, when tone is adjusted to the maximum brilliance, there is enough background disturbance to be distracting. New listeners are far more sensitive to this than we more experienced folk who seem to be able to tune it out from our consciousness, if it is not too severe. Mr. (and Mrs.) Everyman soon finds out that when the tone control is turned to "Low" the noises fade out to a very large extent, and this cure is so much simpler than filling up Post Office interference complaint forms.

These reasons, if they reflect discredit on anyone, do so on the engineer rather than on the general public. That is assuming that if true noise-free reproduction were generally available the public would have it. In his more cynical moments the engineer strongly suspects that they would not. He joins with Sir Thomas Beecham in deploring the popular acceptance of a mechanical dance-band-thump cum cinema-organ-bellow form of background to life, of no cultural value. In this case, of course, the fact that the sound coming out of the loud speaker is not music is quite beside the point; and the duty of the designer is to make the machine supply the sort of noise the people like most as a substitute for rest and thought. There are always the minority, thank goodness, who know real music when they hear it, and who will continue to demand a closer and closer approach to perfection in reproduction.

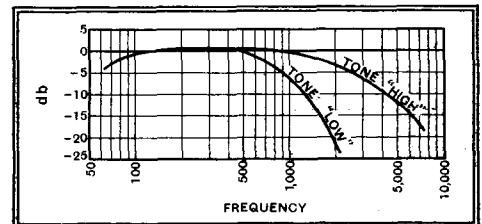

The common type of tone control has only the power of removing the top frequencies. There are more elaborate systems providing also for increase of top frequencies to compensate for loss in the tuning circuits.

It would require a very widespread survey to determine what proportion of each of these views goes to make the truth of the matter. What do you think yourself?

MULLARD OUTPUT PENTODE

A NEW output valve for A.C. operation is announced by Mullard; this is the Pen.4VB, which is provided with a heater consuming 1.95 ampere at the usual 4 volts. The valve has a mutual conductance of no less than 10 mA/V, and is rated for screen and anode potentials of 250 volts; the grid bias should be 5.8 volts, obtained through the use of a cathode biasing resistance of 145 ohms. A seven-pin base is fitted.

If 10 per cent. total harmonic distortion be permitted, the output in the optimum load of 8,000 ohms is 3,800 milliwatts, and the input need be only 3.6 volts RMS. If the distortion be restricted to the usual 5 per cent., however, the output is 2,600 milliwatts for an input of 2.5 volts RMS. This distortion is made up of some 4.2 per cent. third harmonic and about 3.2 per cent. second harmonic—the fourth and higher harmonics being below 1.5 per cent.

Although technical details of the valve have been published; it is understood that supplies are not available just yet.

New Apparatus Reviewed

Recent Products of the Manufacturers

GOODMANS ENERGISED LOUD SPEAKER

IN these days when the performance of small moving-coil loud speakers tends to conform to a stereotyped average, any effort to improve the response, within the limitations of the class, is deserving of support. The majority of 7in. diaphragm units have their fundamental resonance in the region of 100 cycles with a sharp cut-off below, but in the new Goodmans Model E8, Type B, speaker the resonance has been lowered, by using a special diaphragm with a very flexible corrugated surround, to 75 cycles. Furthermore, the resonance is well damped, with the result that the region from 100 down to 50 cycles is adequately filled.

The energised field magnet is constructed of high-permeability steel, and the sensitivity is appreciably higher than equivalent permanent magnet types, even those with nickel-aluminium alloy magnets.

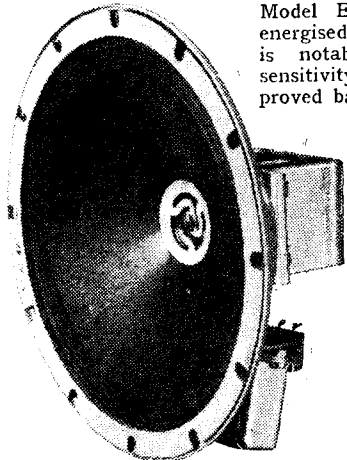

The new Goodmans Model E8, Type B, energised loud speaker is notable for its sensitivity and improved bass response.

Apart from a moderate peak at 3,000 cycles the output is aurally uniform up to 4,750 cycles, and above this frequency it drops fairly rapidly. On the pure tone tests some frequency doubling was noted below 100 cycles, but this could not be detected when listening to broadcasting. Under these conditions the performance, particularly in the bass, gives the impression of a much larger unit, and there are many loud speakers in the £5 category which would be hard pressed to show any points of superiority.

The price complete with output transformer is 35s., and field windings of 1,500, 2,000, 2,500, 6,500, 7,500, 8,000 and 10,000 ohms resistance are available. The makers are Goodmans (Clerkenwell), Ltd., Broad Yard Works, Turnmill Street, London, E.C.1.

BULGIN INTERFERENCE SUPPRESSOR MODEL P50

THE model P50 mains interference suppressor, recently introduced by A. F. Bulgin and Co., Ltd., Abbey Road, Barking, Essex, is assembled in a neat bakelite case measuring 2½in. x 1½in. x 1in., and is

fitted with a 5-amp. two-pin plug for inserting into a wall socket. On the front is a socket of the same rating to take the receiver mains plug, or that of any electrical apparatus that it is desired to silence. There is also an insulated terminal for an earth connection.

It contains two 0.25 mfd. condensers joined in series across the supply point with the junction of the condensers

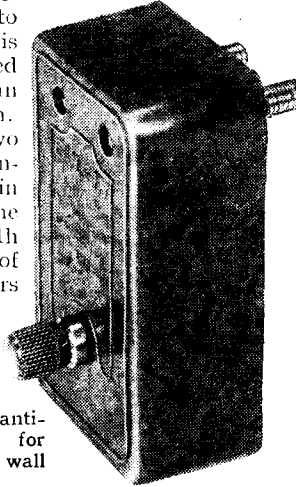

Bulgin model P50 anti-interference unit for fitting in a mains wall socket.

brought to the external earthing terminal. This device is efficacious in reducing most types of mains-borne interference, and may even be used with AC sets for eliminating modulation hum. The condensers are rated for 250 volts AC or DC working, and the price of the model P50 is 5s. 6d. It should have a particular appeal to all who wish to install a filter unit and require one that is simple and convenient to fit.

LYONS-STACKPOLE POTENTIOMETERS

STACKPOLE volume control potentiometers are made as high-resistance units, and the element fitted is a moulded ring of resistance material similar to that employed in the manufacture of B.A.T. fixed resistors. The resistance is not uniform throughout, but is graded to follow a logarithmic law, and it is specially treated to give a glass-hard surface. Since a very prevalent cause of

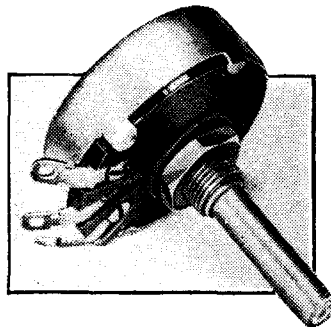

Lyons-Stackpole high resistance volume control.

noise in a variable resistance when the slider is rotated is due to oxidation of the contact stud, the Stackpole is fitted with one made from pure nickel-chrome and the contact face is ground perfectly smooth and then polished. The sliding member is insulated from the shaft and from the fixing bush. This is a single-hole pattern ¾in. diameter, and a "Shakeproof" washer is provided to ensure secure fixing.

Potentiometers of from 75,000 ohms to one megohm are available with or without a built-in mains switch, the price being 3s. 6d. plain and 4s. 3d. with switch.

The specimen tested was quite silent in operation and the action perfectly smooth, and its measured resistance was within 4 per cent. of the marked value. A spun metal dust cover is fitted which, if earthed, would serve as an electrostatic shield for the resistance should there be likelihood of hum pick-up from nearby mains leads.

The component, which is of American design, is now made in this country by Claude Lyons, Ltd., 40, Buckingham Gate, London, S.W.1.

"REGULAR" EARTH TUBE

THE importance of a good earth connection cannot be overstressed, as a noisy background, hum and sometime instability are often traceable to a high-resistance earth connection. In order to lower the resistance at the point of contact with the ground, Polchar's, Ltd., 20, Bridge Street, Bristol, 1, has introduced an earthing device consisting of a short perforated copper tube, the centre of which is filled with a chemical after it has been buried. A liberal quantity of water is then poured on to the surrounding soil.

The chemical percolates through the holes, thus providing a lower resistance contact than would be obtained normally.

We find that when a small quantity of the chemical is added to a beaker of water the electrical resistance of the solution is some forty times lower than the water alone, so

Polchar's "Regular" chemical earth tube.



that while the soil is moist an exceptionally good earth connection should result. The price is 2s. complete.

THE RADIO INDUSTRY

IN our issue of January 18th reference was made to the fact that safety fuses, when used to protect mains-operated receivers, must normally have a considerably higher current-carrying capacity than the rated consumption of the set; otherwise they will be incapable of coping with the heavy surges which take place, particularly at the moment of switching on. While this is true of ordinary fuses, Messrs. A. F. Bulgin & Co., Ltd., remind us that they have evolved a special type of fuse (the Bulgin "Pak" cartridge fuse) with a thermal lag, which enables it to withstand momentary current surges which would blow fuses of the ordinary type. The obvious advantage of such fuses in conferring extra protection need not be stressed.

Pifco, Ltd., makers of the Pifco Rotameter and AC-DC Radiometer, etc., have decided to appoint agents in Africa, India, China, Japan, Canada, and America. Mr. Alfred D. Webber, Director and General Manager of the firm, has just left England on this mission.

Readers' Problems

Variable Selectivity

THE perfect method of obtaining variable selectivity control has yet to be devised, and we fear that a suggestion made that it might be brought about by applying reaction to one of the IF circuits of a conventional superheterodyne does not bring us much nearer a solution.

Although reaction does, in some cases, provide an excellent control of selectivity, this only applies where the inherent selectivity of the circuits is initially not too high. The selectivity of a circuit of ordinary intermediate frequency (e.g., 110 kc/s) is distinctly high, and that is why it is usually necessary, in the interests of quality, to use band-pass couplings. Unfortunately, any attempt to apply reaction to such a circuit is almost certain to bring about an asymmetrical resonance curve, especially if the coupling is adjusted to cover the bandwidth necessary for a wide range of selectivity.

An Ineffective Switch

IT will normally be found that the switches of a domestic electric wiring system are interposed in the "live" (or unearthed) side of the mains. The opposite practice is indefensible, but, nevertheless, it is by no means uncommon to find switches in "dead" leads, especially in buildings that were wired some time ago.

This, we think, probably provides an explanation for a rather puzzling effect noticed by a correspondent. His DC mains receiver is fed through a wall fitting with its own switch, and it has been discovered accidentally that, even when this switch is "off," a mild shock is obtained by touching the internal wiring of the receiver. A

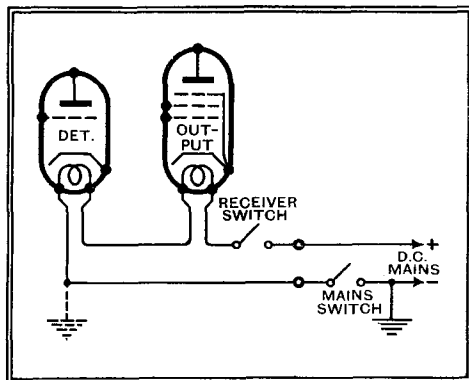

Fig. 1.—A mains switch wired in the earthed lead gives a false sense of security; when it is "off," the receiver wiring may still be at full mains potential with respect to earth.

test of the switch shows that it is working properly, and our correspondent, who asks for suggestions, is sure that the effect is not due to a residual charge in one of the condensers.

What is probably happening is illustrated in Fig. 1. Even though the mains switch (which is incorrectly inserted in the earthed main) is "off," a difference of potential will still exist between most of the wiring of the receiver and earth, and it is not surprising to hear that a shock is obtained by touch-

ing this wiring, even though the "toucher" may be very imperfectly connected to earth. A good earth connection, as indicated by dotted lines in the diagram, would impose a complete short-circuit across the mains switch, which would thus be inoperative. But the built-in receiver switch would still work.

Mechanical QAVC System

A READER who has a sensitive relay asks how this piece of apparatus may be used as a "quiet" AVC control in his superheterodyne, which already includes ordinary amplified AVC.

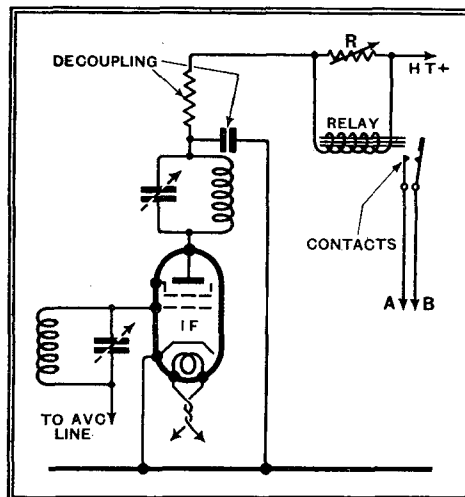

Fig. 2.—Connections of a QAVC relay, which automatically renders the receiver dumb in the absence of an incoming signal of predetermined strength.

Connections usually recommended for a mechanically operated QAVC system are given in Fig. 2. The relay, shunted by a variable resistance R, is inserted in the anode feed lead of one or more of the valves controlled by the AVC system. When the anode current rises to a predetermined value, either in the absence of an incoming signal or in the absence of a signal strong enough to be worth while listening to—the relay contacts are closed and a short-circuit is imposed across whatever part of the receiver circuit the leads marked A, B, are connected. In practice it will generally be

The Wireless World INFORMATION BUREAU

THE service is intended primarily for readers meeting with difficulties in connection with receivers described in *The Wireless World*, or those of commercial design which from time to time are reviewed in the pages of *The Wireless World*. Every endeavour will be made to deal with queries on all wireless matters, provided that they are of such a nature that they can be dealt with satisfactorily in a letter.

Communications should be by letter to *The Wireless World* Information Bureau, Dorset House, Stamford Street, London, S.E.1, and must be accompanied by a remittance of 5s. to cover the cost of the service.

Personal interviews are not given by the technical staff, nor can technical enquiries be dealt with by telephone.

THESE columns are reserved for the publication of matter of general interest arising out of problems submitted by our readers. Readers requiring an individual reply to their technical questions by post are referred to "The Wireless World" Information Bureau, of which brief particulars, with the fee charged, are to be found at the foot of this page.

convenient to connect these leads across the grid load of the LF or output valve.

To save our querist from possible disappointment, it should be emphasised that, for satisfactory operation, the relay should be a high-grade instrument capable of operating consistently on small changes of current and free from backlash. The rheostat R, which may have a maximum value equal to about twice the ohmic resistance of the relay windings, provides a convenient means of adjusting operating conditions so that the opening and closing of the relay contacts coincides with the desired minimum level of signal strength.

Metallised Valves

THE user of an AC superheterodyne, designed some two years ago, has replaced the original first-detector valve by a new one with a metallised bulb, and finds as a result that reception is slightly impaired. Moreover, signals are further weakened by touching the bulb.

It seems probable that the set is of a type where oscillations are induced into the first-detector grid circuit by means of a "pick-up" coil in the cathode circuit of the valve. The extra capacity to earth of the metallic shield (connected internally to the cathode) will thus be effectively in parallel with this pick-up coil, and is undoubtedly responsible for a certain amount of detuning of the oscillator circuit. This detuning effect is, of course, increased when the bulb is touched.

It is asked whether re-trimming will be necessary. In all probability it will, but our correspondent may possibly be able to avoid this by removing the metallising from the new valve. It is not generally known that this coating can, in some cases, be removed with amyl-acetate solvent.

A New Battery Receiver

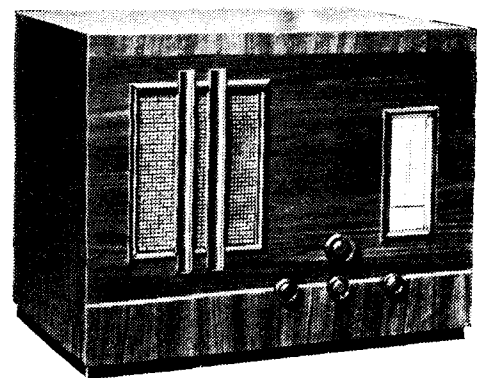

THE new "Invicta" 4-valve AVC superheterodyne will shortly be released by Orr Radio, Ltd., 70a, Parkhurst Road, London, N.7. A nickel-aluminium alloy permanent magnet loud speaker is used, and the circuit includes an octode frequency changer, variable-mu pentode HF, double-diode-triode detector and pentode output valve.

The Wireless World

THE
PRACTICAL RADIO
JOURNAL
24th Year of Publication

No. 806.

FRIDAY, FEBRUARY 8TH, 1935.

VOL. XXXVI. No. 6.

Proprietors: ILIFFE & SONS LTD.

Editor:
HUGH S. POCOCK.

Editorial,
Advertising and Publishing Offices:
DORSET HOUSE, STAMFORD STREET,
LONDON, S.E.1.

Telephone: Hop. 3333 (50 lines).
Telegrams: "Ethaworld, Watloo, London."

COVENTRY: Hertford Street.

Telegrams: "Autocar, Coventry." Telephone: 5210 Coventry.

BIRMINGHAM:

Guildhall Buildings, Navigation Street, 2.
Telegrams: "Autopress, Birmingham." Telephone: 2971 Midland (4 lines).

MANCHESTER: 260, Deansgate, 3.

Telegrams: "Iliffe, Manchester." Telephone: Blackfriars 4412 (4 lines).

GLASGOW: 26B, Renfield Street, C.2.

Telegrams: "Iliffe, Glasgow." Telephone: Central 4857.

PUBLISHED WEEKLY. ENTERED AS SECOND CLASS MATTER AT NEW YORK, N.Y.

Subscription Rates:

Home, £1 1s. 8d.; Canada, £1 1s. 8d.; other countries, £1 3s. 10d. per annum.

As many of the circuits and apparatus described in these pages are covered by patents, readers are advised, before making use of them, to satisfy themselves that they would not be infringing patents.

CONTENTS

	Page
Editorial Comment	129
The Acoustic Side of Broadcasting	130
The QA Receiver	134
New Circuit for Resistance Tuning	138
Unbiased	140
News of the Week	141
Report of the Television Committee	142
R.I. Airflo Superhet Reviewed	144
Listeners' Guide for the Week	146
New Apparatus Reviewed	148
Broadcast Brevities	149
Sound Reinforcement in Theatres	150
Foundations of Wireless—XI	152
Principal Broadcasting Stations	156

EDITORIAL COMMENT

Television

Comments on the Report

SO far so good. Now that the first excitement of the publication of the report of the Television Committee has died down, it may be of interest to consider what effect it may be expected to have in bringing about a broadcast service of television of high definition.

The Television Committee has carried out an extremely difficult task with most commendable thoroughness. The report is not only an unbiased estimate of the present stage of development of television, but it has the merit, in addition, of being frank in its recognition of some of the difficulties.

It has certainly come to us as a surprise that the Committee recommended that the degree of definition at the outset should correspond to 240 lines with a minimum picture frequency of 25 per second. This is indeed a high standard to demand of the service in its initial stages, but if the Committee are satisfied that it can be satisfactorily carried out we can only commend their enterprise in not being content with less.

The report states that it is undesirable to abandon the present facilities of 30-line transmissions until "at least a proportion" of the observers have the opportunity of receiving a high-definition service, and they therefore recommend that the low-definition broadcasts might reasonably be discontinued "as soon as the first station of a high-definition service is working." The cost of maintaining a 30-line transmission must, of course, be taken into account, but it seems to us rather unsatisfactory that these transmissions at present receivable over a wide area should be discontinued because a higher definition service is working for the benefit of those in the London area.

It depends largely, of course, on how many observers of the present 30-line transmissions there are beyond the probable range of the high-definition service in London.

On the question of patents we are sorry that the Committee did not find it possible to take a firmer line. In the report they state that they have seriously considered whether they should advise the Postmaster-General to refuse to authorise the establishment of a public service of high-definition television until a comprehensive Patent Pool had been formed on terms considered satisfactory by the Advisory Committee. They explain that they came to the conclusion that the formation of such a Pool at an early stage would present extreme difficulty.

The Real Problem

It is only natural that the publication of this report should have awakened a great deal of interest in television, if only on account of the amazing scientific achievement which it represents. There seems to have been created, however, an idea that the Committee's report actually heralds a television service as essential to sound broadcasting as sound now is to the film. Such a view is, we think, premature.

When the first high-definition station is set up in London what, in fact, we shall have is a service which is an improvement upon the present experimental television broadcasts in so far as the pictures will show very much greater detail, and the broadcasts will be more frequent. Before the public is likely to maintain enthusiasm for television something more than this must be achieved. The greatest problem of television has yet to be solved, and this, in our opinion, is devising programme material rather than overcoming technical difficulties.

The Acoustic Side of Broadcasting

What Happens to the Sound Before the Transmitter and After the Receiver

By M. G. SCROGGIE, B.Sc., A.M.I.E.E.

ONE of the two chief objects of broadcast listeners is to hear the programmes as well as possible (the other object being to secure the choice of as many of them as possible; but just now we are not going to argue about that). So there is much discussion about the faults and merits of various types of receiver, loud speaker, and so on, and how to avoid distortion. And thus we tend almost to assume that if our apparatus were perfect our listening would be perfect—apart from the substance of the programmes themselves, of course.

In the early days of broadcasting the imperfections of the equipment were so gross that there was good reason for dealing with them. This has been done so well that now it is possible to make a very close approach to perfection. One could build — at a price

—a receiver that treats all audible frequencies of any importance equally, within close limits, and which is practically free from harmonic distortion. And yet . . .

Having become accustomed to broadcast listening, on a real "quality" receiver, maybe, go and hear a programme in the concert hall or studio. Then, if you have any critical faculty at all, you will come away wondering what it is that makes such a difference. Radio experts may know all about "straight-line amplification" and "linear detection," but everything outside the apparatus itself they are apt to term vaguely "acoustics." It is gradually being realised that attempts to smooth out tiny hollows in the amplification curve are like straining at a gnat, when all the time many camels are unconsciously being assimilated. The amplification curve A in Fig. 1 looks much better than B, with a 10 per cent. peak. Yet acoustic effects, seldom considered by the technical enthusiast, commonly introduce peaks of hundreds per cent. ! And what about the ear, which itself produces almost every known sort of distortion?

It seems quite clear that as the ear is common to all listening, whether direct or "mechanical," it can be left out of account and attention concentrated on producing an effect at the threshold of the ear which is as nearly as possible the same as that produced there by presence at the original performance. As it happens, however, the behaviour of the ear cannot be entirely disregarded.

The reason for this is obvious if one takes an example, say, the performance of a full orchestra or military band. This is meant to be heard in a suitable auditorium, or, perhaps,

out of doors. If by the working of a miracle all the performers and their instruments could be accommodated in one's suburban sitting-room and still leave room for the family to listen, the result would not be pleasing. The room being prob-

ably about one-hundredth part of the size of a public hall, the intensity of sound might be about a hundred times as great, and the listening ear could not fail to notice it. This would, emphatically, *not* be a perfect *re-representation* of the original.

Very well, then; the obvious thing to do is to install a loud-speaker system that reproduces everything exactly like the original, with the one exception of *volume*. In other words, do for the sound what a photographer does to a picture when he reduces it. Everything remains in perfect proportion, true to the original, but on a reduced scale. This, surely, would give exactly the same effect in a small room as the louder original heard at a greater distance and in a bigger space?

The answer is—*no*. The process of hearing is much too subtle and complicated for that. And so are the acoustic effects that exist at both transmitting and receiving ends. The proud owner, in a burst of enthusiasm, may declare that it is just as if the orchestra were in the room; but he knows perfectly well that it is not —if he has ever heard a real orchestra.

REVERBERATION in studios and listening rooms plays such an important part in modifying the sound which eventually reaches the ear through the medium of broadcasting that investigation of these effects should take precedence over further efforts to obtain "straight-line" characteristics in transmitting and receiving apparatus.

Things that can be measured on a foot-rule, or even a voltmeter, are easy to study, and to arrange just as we want them; and one expert can get others to agree with him as to the results of his work. But things that depend on personal impressions usually lead to nothing more enlightening than endless arguments. So the acoustical and physiological aspects of broadcasting seem to be less definite than the electrical. The distribution of sound by films and radio is becoming so important, however, that these things are now being reduced to something more like an exact science.

What is a "Good Transmission"?

A few of the problems that are left over after everything has been done to the receiver—and transmitter—will now be considered; some of them refer to the receiving end, and may help the listener to improve his reproduction. Others refer to the transmitter, and are beyond his control. As they are being actively looked after by competent people, perhaps that is just as well. But a certain degree of co-operation would be of advantage, and it is to be regretted that the B.B.C. does not take us more into its confidence in a practical sort of way by explaining over the microphone what it is doing. Mere written publication is no substitute for actual demonstration.

Even an unobservant listener has probably noticed that a particular sort of programme can sound differently in a way that he finds difficult to describe, and which cannot be put down solely to the receiver. A good orchestra may sound

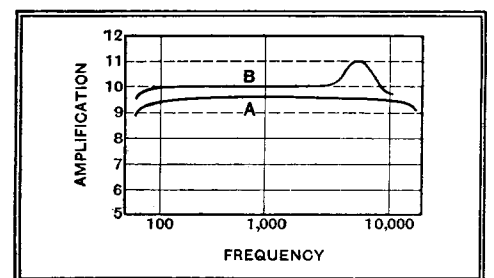

Fig. 1.—Curve B, with a 10 per cent. peak, looks very much worse than A. But to the ear the imperfection is negligible; very much larger departures from a straight-line characteristic are inevitable in sound transmission, but are seldom taken into account, owing to absence of "curves."

dull and lifeless from a certain building. A speaker is surprised to find that a comparatively small auditorium swallows up his voice, and is more trying to speak in than a larger one. A violinist, perhaps, who broadcasts from one particular place

The Acoustic Side of Broadcasting—

achieves a reputation which he finds difficult to sustain when he moves elsewhere.

When listening, part of the sound that is heard comes direct from the thing that is making it and part is reflected from the surroundings. The latter has a longer journey, and so it smites the ear a short time after the original. Take as an extreme example an enormous empty cavern,

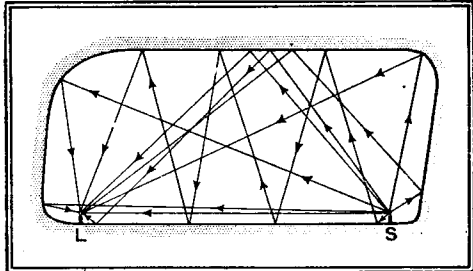

Fig. 2.—Some of the paths taken by the sound from a speaker (S) to a listener (L) in a rocky cavern. In addition to the sound directly received, a much larger volume comes as reflections, but as these arrive later the speech is confused.

with smooth rocky walls everywhere, and someone a hundred yards away trying to talk to you (Fig. 2). The sound of his voice is reflected from the walls in all directions and comparatively little comes direct. So any particular syllable is still arriving when the speaker has passed on to the next, and causes confusion. It is quite easy for him to give you a large volume of sound, but it is not clear. It corresponds exactly with a badly focused photograph in which the light from any particular part overlaps other parts.

Controlling Reflections

The acoustics of a cave are hopeless for speech, but a broad, slow organ piece might sound very impressive. The detail would not be sufficiently fine to be obscured by the echoing, while the augmented volume would be grand.

For speaking purposes the reflection of sound might be reduced by lining the cave with felt. Then your friend would have to speak much more loudly. The speech would still be difficult to follow, but for another reason. It would sound "woolly," without life or crispness. Felt absorbs the high voice frequencies that convey the "intelligibility" and clearness, and leaves the lower-pitched sounds that merely make a boomy noise.

One could go a stage farther and provide a more elaborate lining to absorb sounds of all frequencies. The speaker would then have to shout to be heard at all; it would be just like talking in the open air, but his voice would be heard clearly.

It may be human perversity, but it is an established fact that things sound more pleasing with a certain amount of echo—or reverberation, to use the correct term. Very little is enough for speech, and slow music needs most. Probably the effect of distance, associated with spaciousness and grandeur, underlies the preference.

The ordinary small living room naturally does not impart this sense of spaciousness to any sounds coming out of the receiver; consequently, if it is to exist at all it must be put in at the transmitting end. Outside broadcasts from concert halls are, of course, coloured by the acoustics of the buildings, which are generally reasonably good. In the early days of broadcasting the studios were very small. It was found that the reverberation in a small room is bad. Although it may be possible, by having bare hard walls, to ensure a considerable amount of echo, the ear is sensitive to the time element even although in the largest hall the sound takes only a fraction of a second to travel from end to end. You can very easily test that by being led blindfolded around an unfamiliar building. Not only is it instantly apparent whether the room is bare or furnished (judging from the amount of reflection or absorption respectively), but the approximate size of the room can be estimated provided that absorption is not so complete as to allow little reflected sound as a clue.

Or when one is holding the line during a telephone call and there is a background of sound from the distant end, one can judge of the sort of room in which the instrument is placed.

There is another room characteristic besides the amount and the distance of reverberation; the room itself resonates to one or more frequencies and over-empha-

used for broadcasting. Any general noise in the room tends to cause a sound of this pitch, and unless the room is very large the effect is generally undesirable.

So the studios were thoroughly padded with sound-absorbing materials to remove the "boxy" effect that disclosed to the listener their smallness. The resulting absence of reverberation was unpleasant, both for artist and listener, so the next stage was to introduce synthetic reverberation by means of an "echo room," entirely bare save for loud speaker and microphone. The programme was reproduced from the loud speaker, and picked up, plus echo, by the microphone. The result could be mixed in any desired proportion with the echoless programme taken direct from the studio.

Sound Absorbing Materials

For reasons which have already been given, this fake is not equivalent to the desired acoustics of a large hall. So the present practice of the B.B.C. is actually to use a studio of a size appropriate to the type of programme, and to aim at a desired amount of reverberation by means of carefully selected materials. This is not merely a matter of using a material with the right percentage absorption; the behaviour of any material depends very largely on frequency, as we observed in our felt-lined cavern. Certain sorts of building board are fairly uniform. Fig. 3

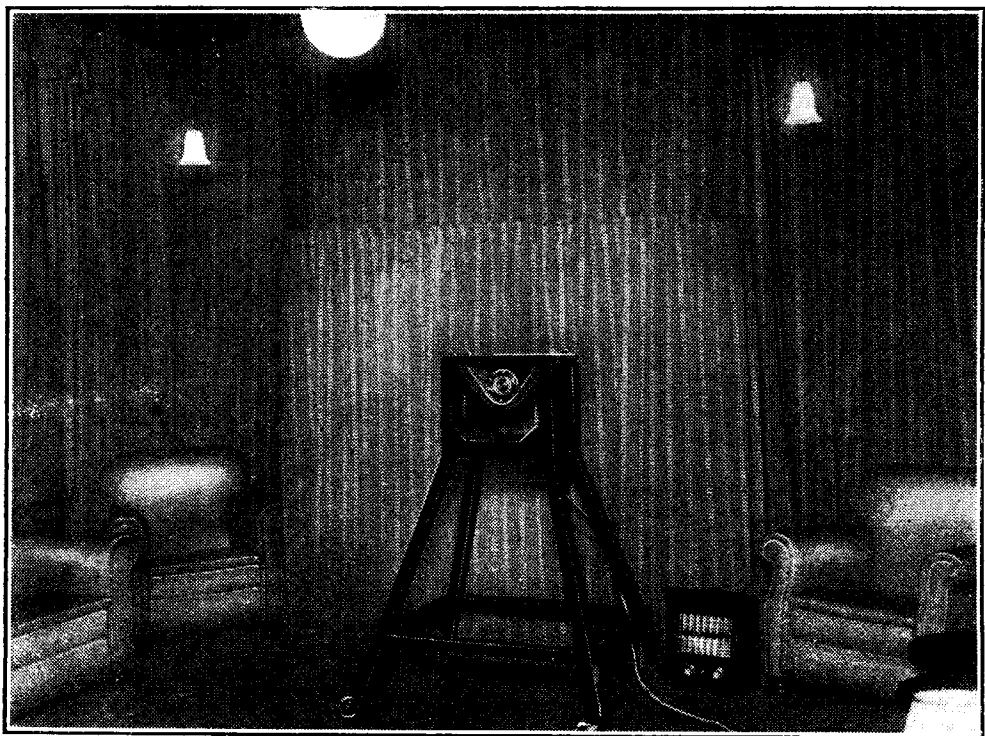

One of the small and heavily draped studios used in the early days of broadcasting.

sises them. Next time you are in a bathroom, or other scantily furnished apartment, try humming a continuous note, beginning as low down as you can manage and gradually rising in pitch. It is more than likely that you will find a note to which the room seems to respond, and at which there would be a pronounced peak in the frequency characteristic if it were

gives a number of examples, which show very clearly how the frequency characteristic of broadcast transmission—and reception, too—can be utterly altered by acoustic effects alone.

It is really remarkable what a change in the acoustics can be produced by a relatively small alteration in the surface of a room. Everybody knows that it is quite

The Acoustic Side of Broadcasting—

different walking into a previously empty room when a few articles of furniture have been pushed into it. Some foreign studios are provided with means for changing the exposed material on the walls; and it has even been proposed to make use of a device something like a gigantic roller towel for varying the acoustics during the performance of a musical item to get the maximum effect (Fig. 4).

Microphone Position

The B.B.C., however, prefer to use a special studio for each job. The position of the microphone obviously has a lot to do with the matter. If it is very close to the source of sound, the reflected sound is negligible in comparison, and no reverberation is apparent. So when announcements have to be made during a programme in a large studio there is no need for the announcer to speak from another place; all he has to do is to murmur gently into the ear of the microphone. As a matter of fact, it is possible to provide the illusion of a speaker walking away by gradually fading from a nearby microphone to a more distant one. The increase of echo gives the effect.

Have you ever happened to have a loud speaker bawling loudly in a distant part of the house—or someone else's house—and then turned on another near you doing the same programme very faintly? If so, you were probably surprised to get an effect like that of walking into a lofty hall. Although the local speaker seems to contribute negligible sound, it reproduces artificially the conditions of direct and reflected sound in an "echoey" room.

Another subtle shortcoming of loud speaker reproduction is that the benefit

that. It hears a sound a little earlier or later than the other (unless the sound is equidistant from both), and from this the brain is able to judge the direction of the sound. Precisely the same principle is employed in certain submarine-locating devices used on ships with two microphones spaced apart. Binaural hearing, as it is called, can be provided; but as it necessitates duplicating the entire broadcasting system, from microphone to receiver, and applying the separate outputs each to a telephone ear piece, the system is not likely to be generally adopted, even although the results are very remarkable. In a test carried out, a whole audience of people was made to jump round suddenly when a voice appeared to shout into one ear. The speaker was actually in the studio. This form of amusement is exactly analogous to the illusion sometimes provided by supplying an audience with special coloured "glasses"; people wearing them duck in alarm when missiles appear to be coming straight for them from the stage.

The effect of distribution of the players in an orchestra, or of movement of actors on a stage, can be conveyed only by binaural hearing. Another and rather unexpected benefit is that owing to the ability to concentrate on a sound coming from a particular direction, there is less distraction caused by other sounds and disturbances.

There is another directional effect that causes frequency distortion. Most microphones receive equally well from all directions at low frequencies, but as the frequency of the sound rises the reception is confined more and more to the direction straight in front. Microphones have now been developed which are either directional or non-directional as desired, but in either case treat all frequencies alike. The direc-

tional types are useful for special purposes; for example, in a film studio, where the noise of the camera is *not* desired; or on a stage, where the vapourings of political maniacs in the audience, or even coughs, form no part of the legitimate programme. This technique appears to be more deeply explored in America than here.

Directional Effects

At the receiving end it is quite easy to detect a noticeable difference in tone due to the directional effect of the loud speaker. At the side the tone is woollier, speech less distinct, and hiss or gramophone scratch less apparent than straight ahead of the cone. One reason why radio-gramophones sound less brilliant in tone than the corresponding table models of receivers is that the loud speakers are pointing at the legs of furniture, people, etc., which absorb the high notes considerably, and direct radiation at upward angles is comparatively weak. A particularly effective way of introducing top-note loss is by fitting the loud speaker in the base of the cabinet pointing towards the floor. For a good dance-band "thud" it is, of course, superb. But announcements sound as if the speaker "muttered mumbly and

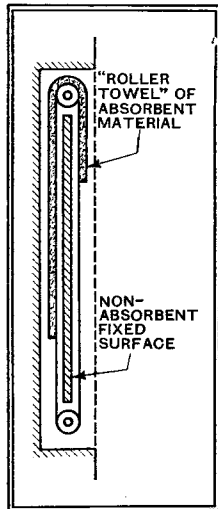

Fig. 4.—Device fitted in wall recesses for obtaining rapid variation of room echo. The rollers are operated by motors, and it is proposed that they should be controlled by the musical conductor.

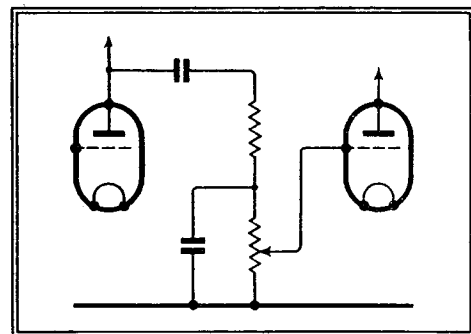

Fig. 5.—Very simple type of tone-corrected volume control circuit.

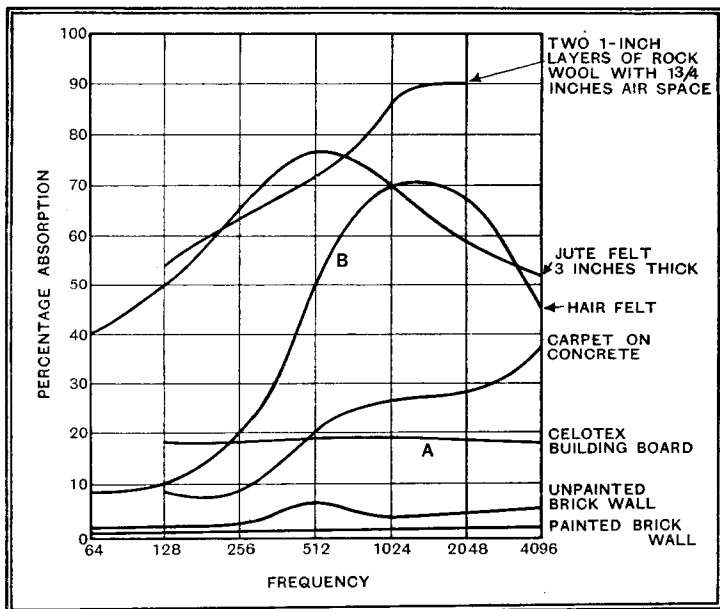

Fig. 3.—Curves showing the degree to which various surfaces absorb sounds of different frequencies. A characteristic such as B would be unsuitable for lining a studio, as it would weaken the high tones in relation to the low. Something more like A is now generally favoured.

conferred by Nature of having two ears is lost. It might be supposed that the second ear is just a spare in case one gets damaged; but it does much more than

front. Microphones have now been developed which are either directional or non-directional as desired, but in either case treat all frequencies alike. The direc-

low, as though his mouth were full of dough."

A contributory cause is one acoustic effect that has received quite a lot of popular publicity—cabinet resonance. If you put your hand partly over your ear in a sort of deaf-man attitude, you will notice that a certain moderately high note in music is over-accentuated owing to the resonance of the hollow of the hand. The pitch of this note can be varied by moving the hand. The hollow formed by the cabinet, being larger, accentuates a much lower tone. The remedies are, in ascending degrees of effectiveness, using good solid timber for the cabinet in place of the plyboards commonly employed, leaving as much as possible open to the air, lining the interior with suitable acoustic materials, or adopting a proper box baffle filled with slag wool or similar absorbent matter.

But the most troublesome problem standing in the way of producing a perfect miniature of a large volume of assorted sound is that the behaviour of the ear is hopelessly complicated with regard to the

The Acoustic Side of Broadcasting— matter of loudness. It might seem that if the volume of sound in the air is doubled, it sounds twice as loud, and that is an end to the matter. There is room for a good deal of argument as to whether the loudness increases twofold, or by some other amount. But that is relatively unimportant. The real difficulty is, first,

tones appear, but, of course, they sound relatively weak. They increase more rapidly than the high notes, however, so that the very large difference that existed at low volume gradually becomes levelled out. At very great intensities, verging on the loudest that the ear can tolerate, the rate of increase for nearly all frequencies except the very highest is reduced.

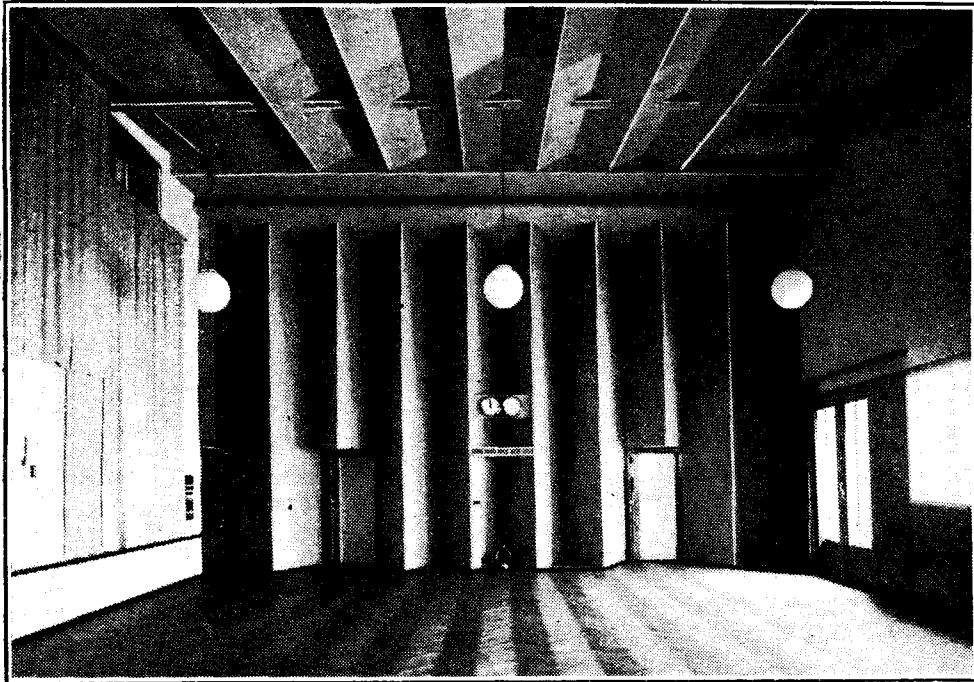

An example of modern studio design—the Small Orchestra Studio at Königsberg. The walls are movable and the area covered by draping is adjustable to give the required acoustic characteristics.

that by whatever amount the loudness appears to change at one frequency, it is different for another frequency. And, as if that did not complicate matters enough, the whole loudness-frequency characteristic alters as the loudness alters. When one goes abroad the coinage problem is exasperating enough as it is. But if the rate of exchange varied widely according to the particular coin used, and also according to the number of them involved in any transaction, things really would be difficult.

The outstanding features are that only moderately high frequencies (1,000-5,000) are audible at very low intensities of sound. As the intensity rises the lower

Some receivers try to compensate for the relative weakness of low notes at low volume by means of a "tone-compensated" volume control. The simplest method is illustrated in Fig. 5. When the volume control is set low, the high frequencies are weakened by the condenser so that the low tones are given a reasonable look in.

There are plenty of other acoustic effects that help to thwart any attempt to get perfect reproduction by electrical means alone. We have only considered some of the more important ones. It is interesting to interpret the results one gets from broadcasting, in the light of what has been discovered about acoustics.

International Frequency Checking

B.B.C. Co-operation in Beat Note Tests on March 12th—13th.

THE Scottish B.B.C. stations will next month combine with Droitwich in a frequency measurement test conducted by arrangement with the International Union for Radio Research, which has organised special radio emissions for the international comparison of standards of frequency.

The growing extension of radio transmission demands continually increasing accuracy and steadiness of frequency, and it is important that the standard apparatus of different countries used for measuring frequency should agree to a high order of

accuracy. An emission of a frequency of great steadiness also enables information to be obtained on the physics of radio propagation by observing the changes introduced into the waves by their passage to receiving stations at various distances.

The intercomparison of standards of frequency is made by sending out a very steady frequency from a radio transmitting station, the value of which can be measured at any place equipped with the necessary apparatus. The actual measurement is made by observing "beats" between two frequencies which are very nearly equal.

In the past a frequency in the form of a musical note of a value of 1,000 cycles per second has been generated at the National Physical Laboratory as a "frequency of reference," and it has been emitted as a modulation of a carrier wave by the B.B.C. On the last occasion, in March, 1934, this was done on two carrier frequencies from different stations simultaneously, which enabled their mode of arrival to be compared. It was found that there were distinct differences in the steadiness of the frequency arriving by the two routes. At distances of 400 km. to 800 km. there was a slight variability of the modulation frequency arriving by the lower carrier frequency, 200 kc/s. The variability was much more pronounced with the higher frequency, 877 kc/s.

Observations of differences in mode of arrival can be made without requiring a local source of steady frequency. A comparison of the modulations arriving by the two carrier frequencies can be made by means of a low-voltage, cathode-ray oscillograph supplied from radio-receiving apparatus, which must be free from distortion.

On the occasion of the next emission (on the night of March 12-13th), the B.B.C. will modulate Droitwich and the Scottish Regional and Scottish National stations simultaneously with the frequency of 1,000 cycles per second. A great part of England will be in the "fading" area of the Scottish stations, and it is for physical observations, among which "fading" is an important phenomenon, rather than for quantitative measurements, that the two Scottish stations are being provided. The main emission will last continuously for an hour and a half, preceded and followed by shorter ones for subsidiary purposes.

The National Bureau of Standards, Washington, U.S.A., is co-operating by a special emission of a frequency of reference of five million cycles per second. This is expected to be accurate to one cycle per second, and to be of sufficient intensity to be received satisfactorily in Europe.

In order to make the best use of this opportunity it is requested that persons and institutions having suitable oscillograph apparatus will assist by making observations. More detailed information can be had on application to Dr. E. H. Rayner, National Physical Laboratory, Teddington, Middlesex.

A New Bush Receiver

Model SB4 Battery Superheterodyne

AN ingenious feature of this receiver is the tuning scale, in which the pointer moves diagonally across the rectangular scale. By this means a longer travel is provided without restricting the space available for marking station names and without increasing the size of the dial unduly.

The four-valve circuit comprises an octode frequency changer preceded by a band-pass filter, a variable- μ pentode IF amplifier, double-diode-triode second detector with AVC, and a pentode output valve. Automatic grid bias is included, and it is claimed that the normal HT consumption of 9 mA is independent of the volume used or the input signal strength.

The price, including batteries, is £11 19s. 6d., and the makers are Bush Radio, Ltd., Woodger Road, Shepherd's Bush, London, W.12.

QA Receiver

By W. T. COCKING

THE attainment of the highest standard of reproduction of broadcasting involves the reduction of all forms of distortion to a minimum, not only in the purely LF circuits, but also in the HF and detector stages. The matter is greatly complicated by the necessity for avoiding interference, and the receiver, constructional details of which appear in this article, has been designed to approach perfection in local reception while giving an acceptable compromise between selectivity and quality on more distant transmissions.

IT is generally accepted that a receiver designed primarily for high-quality reproduction must introduce a minimum of amplitude distortion and have an overall frequency response flat within very few decibels for frequencies between some 30 c/s and 10,000 c/s. It was shown in last week's issue, however, that questions of interference may often render a poorer response desirable, so that within limits it should be readily adjustable by the operator. It was shown also that if a straight set be used variable condensers cannot be employed for tuning, since the selectivity would increase so greatly with wavelength that it would seriously affect the quality of reproduction. Because of this, permeability tuning, which leads to approximately constant selectivity, is employed in the receiver which has been designed to do justice to the excellent characteristics of the Push-Pull Quality Amplifier.

The circuit diagram of the receiver appears in Fig. 1, and it will be seen that a single HF stage, embodying two triode valves, is used, a diode detector, and a triode LF valve. Two tuned circuits are employed before the first valve and are

coupled together in the manner of a band-pass filter—the actual degree of coupling, however, being slightly sub-optimum. The aerial coupling is unusual, the change from normal practice being dictated by the requirements of permeability tuning. It will be seen that the aerial is connected to the junction point of two condensers, C1 and C2, which are joined in series across the first tuned circuit. The net result is to make the efficiency of the whole input circuit rise as the wavelength falls, and this almost exactly compensates for an inverse effect in the HF amplifier.

The HF Amplifier

The HF stage is of the double-triode type described by Colebrook in a recent article,¹ and it is employed in preference to a screen-grid or pentode valve owing to its inherent stability and a marked absence of non-linear effects. The major portion of the amplification is given by the second of the two valves, and a gain of 30 times is obtained on the medium waveband—the gain being constant with

High-Fidelity Tuner for the Push-Pull Quality Amplifier

wavelength. Although the coupling between the two HF valves is nominally resistance coupling, it is actually chiefly capacitive, the capacity being the inter-electrode valve capacities and the inevitable stray wiring capacities. Consequently, the load on the first HF valve varies with wavelength, so that the gain of this stage varies from 2 times at 200 metres to about 4 times at 550 metres. The overall HF amplification thus varies from 60 times to 120 times. As already explained, however, the efficiency of the input circuit has been arranged to vary in an inverse manner so that the sensitivity of the receiver is approximately constant. It is, in fact, much more nearly constant than usual and does not vary at all from the 1,100 μ V mark between 200 and 300 metres. At longer wavelengths it falls slightly, but never below 1,400 μ V.

The third tuned circuit acts as the coupling between the second triode and the detector, and it is this portion of the receiver which differs most from conventional practice. The cathode of the LF valve cannot be at earth potential, since it provides the phase reversal necessary for feeding the push-pull amplifier, and the cathode varies in potential just as much as the anode, but, of course, in opposite phase. As no point on the input circuit to this valve can be earthed, the

¹ The Wireless World, January 18th, 1935.

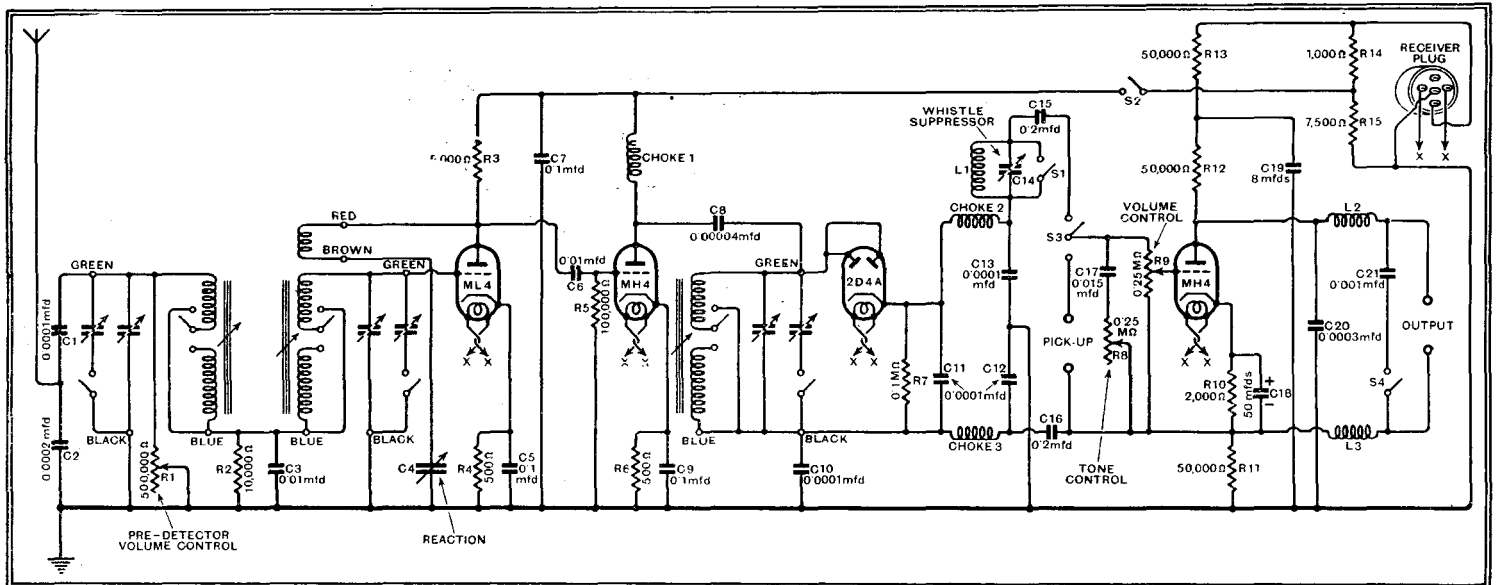

Fig. 1.—The complete circuit diagram of the receiver in which permeability tuning is used with a single HF stage embodying two triode valves for stability and linearity.

Q A Receiver—

detector circuits cannot be earthed either. The difficulty is usually got over by employing transformer coupling between the HF valve and the detector, but this cannot be done with permeability tuning at the present time owing to the absence of a suitable component. Apart from this question, a step-up transformer or its equivalent is necessary for coupling the HF valve to the tuned circuit, for the AC resistance of the valve is only some 13,000 ohms under working conditions.

It does not seem to be generally known that the equivalent of a transformer can be obtained by feeding the tuned circuit through a condenser. The circuit, in fact, is identical with that of the tuned grid coupling so widely used, and the differ-

this resistance. Now these LF potentials must be applied between the grid and cathode of the following valve, but as regards high-frequency currents both terminals are live with respect to earth. It is necessary, therefore, to include filter circuits in both leads, and two HF chokes, Ch2 and Ch3, are used with two by-pass condensers of 0.0001 mfd. each, C12 and C13.

When the switch S1 is closed the LF potentials are applied through the condensers C15 and C16 of 0.2 mfd. to the

control circuit is also connected in this portion of the set and consists simply of the 0.25 megohm resistance R8 and the 0.015 mfd. condenser C17. This resistance and the switch S1 are linked together and operated by a single panel control; when this is fully rotated in an anti-clockwise direction S1 is closed and the whistle suppressor is in circuit, but otherwise the full high-frequency response is secured. A small clockwise rotation of the control closes the switch and throws the filter out of circuit, so that the upper register is fully reproduced. For the rest of its rotation the control acts as a tone control to give a progressive reduction of the high-frequency response.

The triode used as the LF amplifier is an MH4, and it derives its grid bias from

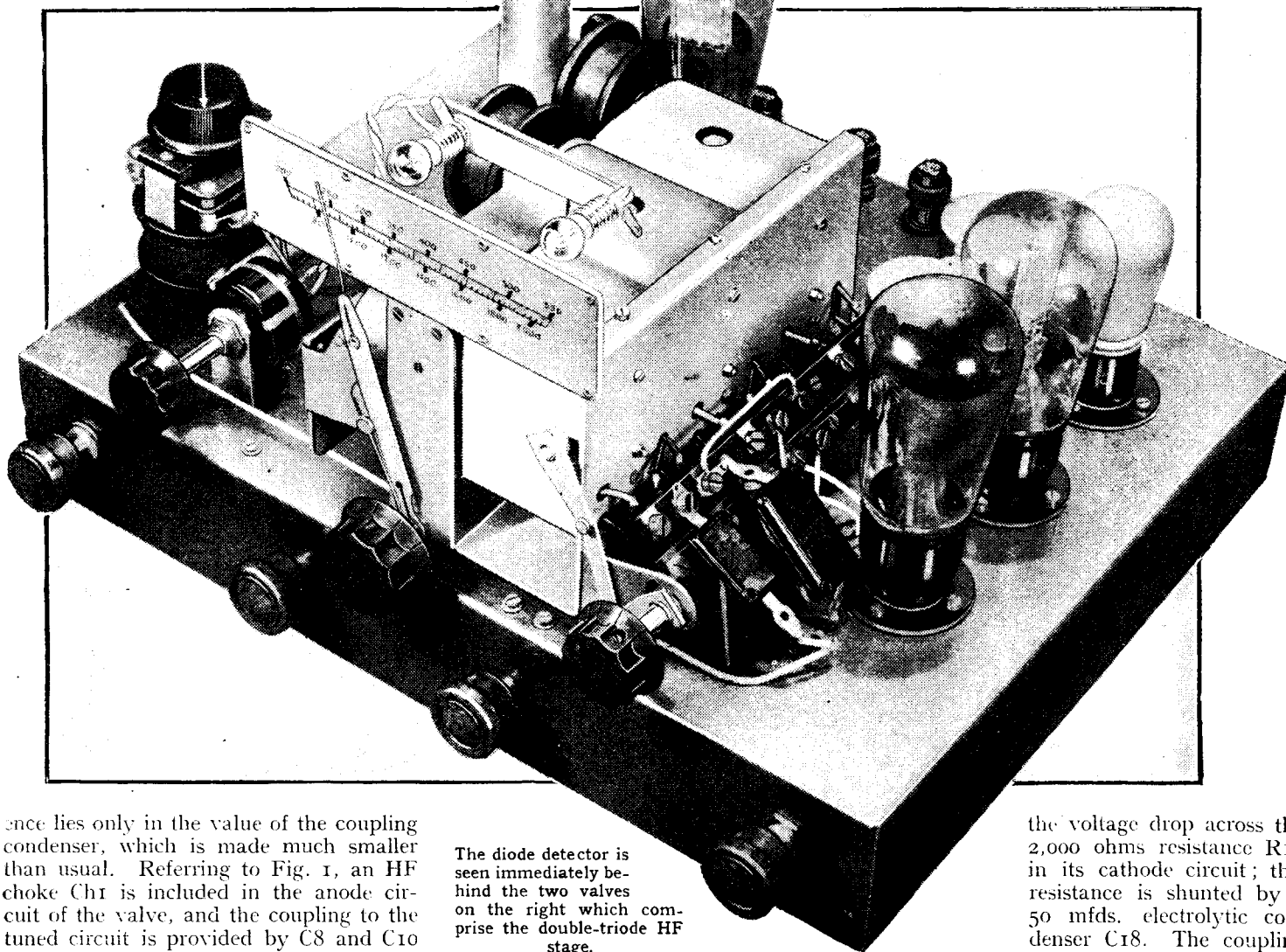

The diode detector is seen immediately behind the two valves on the right which comprise the double-triode HF stage.

ence lies only in the value of the coupling condenser, which is made much smaller than usual. Referring to Fig. 1, an HF choke Ch1 is included in the anode circuit of the valve, and the coupling to the tuned circuit is provided by C8 and C10 in series. C10 has a value of 100 mmfds. (0.0001 mfd.), and in this case optimum coupling is secured when C8 is about 40 mmfds.

Normally, of course, only one condenser would be used, but by using two in the manner shown we can feed the tuned circuit with full efficiency, and yet have neither side at earth potential. The detector circuit itself is entirely conventional, and a duo-diode with its two anodes strapped acts as the detector with a load resistance R7 of 100,000 ohms, shunted by a 0.0001 mfd. by-pass condenser C11, and the LF potentials appear across

0.25 megohm volume control resistance R9, from which the voltages are applied in a conventional manner to the triode LF valve. As the volume control resistance is considerably higher than the diode load resistance, its presence introduces negligible distortion. When S1 is open, however, the parallel-resonant circuit L1 C14 is included. This circuit, which is tuned to 9,000 c/s, has a very high dynamic resistance and provides an attenuation of about 30 db. at its resonance frequency for the purpose of suppressing the heterodyne note between adjacent stations. A tone

the voltage drop across the 2,000 ohms resistance R10 in its cathode circuit; this resistance is shunted by a 50 mfd. electrolytic condenser C18. The coupling resistances are the two

50,000 ohms resistances R12 and R11 in the anode and cathode circuits respectively, decoupling being provided by the 50,000 ohms resistance R13 in conjunction with the 8 mfd. condenser C19. Now, in spite of the HF filtering included in the diode output circuit, a small HF input may be applied to the triode; in order to prevent this from having an adverse effect upon the performance it is necessary to provide by-pass condensers in the output circuit. As regards LF potentials, the condensers C12, C10 and C8 can be regarded as being effectively in parallel

Q A Receiver—

with the cathode coupling resistance, so that we must use an anode by-pass capacity C_{20} approximately equal to their sum in order to retain a balanced output circuit at high audible frequencies. This condenser, therefore, has a value of 0.003 mfd.

In spite of the moderate selectivity of the tuning system, a certain degree of sideband cutting takes place, and a tone correction circuit is accordingly connected

of interference from broadcasting stations. As already stated, this receiver is designed primarily for very high quality reception of the local stations; it has been

valve. The quality naturally deteriorates somewhat when it is used, but in general it is only needed for those stations upon which interference does not permit the retention of the full high-frequency response. The pre-detector volume control

takes the form of a variable resistance R_1 connected across the first tuned circuit. In many districts this will not be needed, for the HF stage and detector will handle quite a large input and the LF control

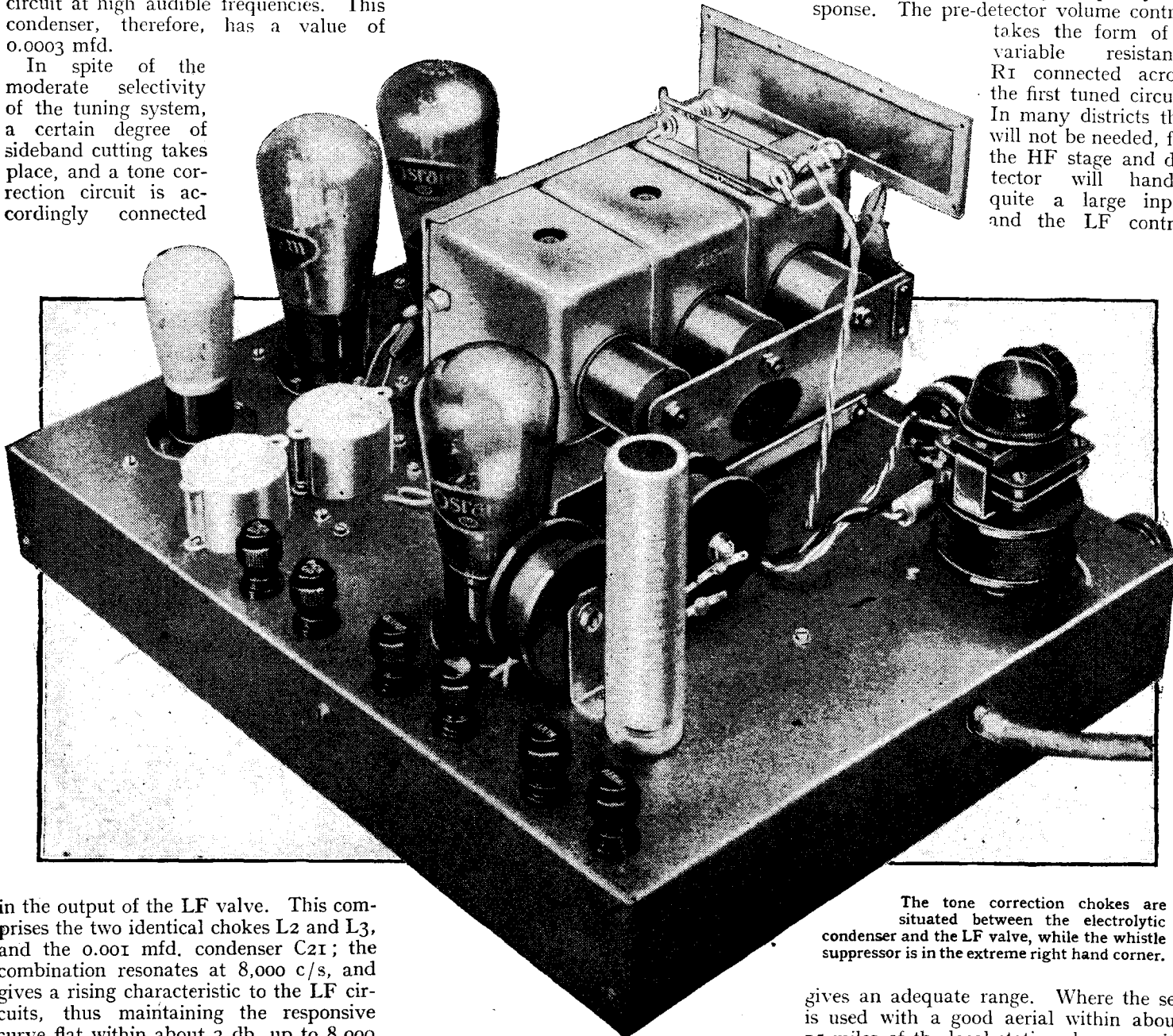

in the output of the LF valve. This comprises the two identical chokes L_2 and L_3 , and the 0.001 mfd. condenser C_{21} ; the combination resonates at 8,000 c/s, and gives a rising characteristic to the LF circuits, thus maintaining the responsive curve flat within about 3 db. up to 8,000 c/s. Such correction is not needed on gramophone, and the switch S_4 is accordingly used to throw it out of circuit and it is linked with the radiogramophone changeover switch S_3 and the switch S_2 which removes the HT from the HF valves on gramophone to prevent any possibility

felt, however, that most listeners like to be able to receive a few Continental transmissions on occasion. With a good aerial the sensitivity is actually sufficient to permit this, but to give some factor of safety reaction has been included and it is applied to the grid circuit of the first HF, or Buffer,

The tone correction chokes are situated between the electrolytic condenser and the LF valve, while the whistle suppressor is in the extreme right hand corner.

gives an adequate range. Where the set is used with a good aerial within about 15 miles of the local station, however, its use will usually be essential in order to avoid overloading.

The performance of the receiver as regards fidelity is shown in Fig. 2, with the tone control set for full brilliance and the whistle suppressor out of circuit. The three curves for the medium waveband

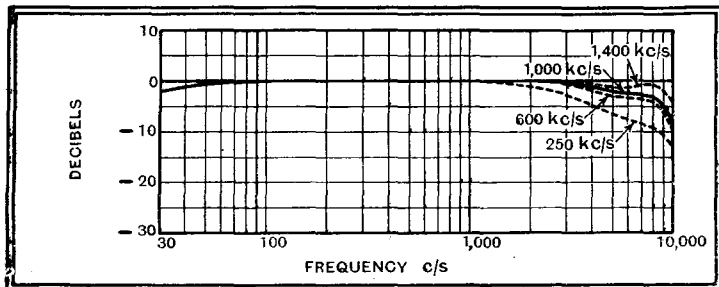

Fig. 2.—The overall fidelity curves of the receiver and amplifier for various signal frequencies. The small amount of variation with tuning is a direct result of the permeability tuner.

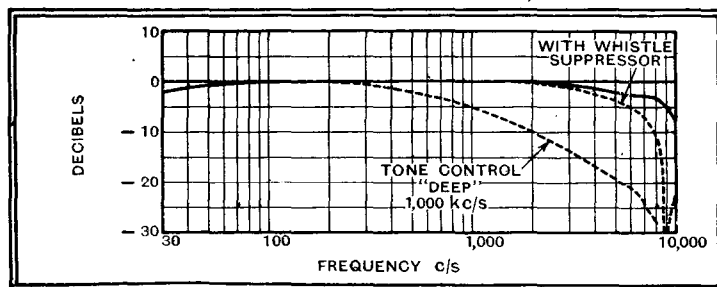

Fig. 3.—The response at 1,000 kc/s. is illustrated here together with curves showing the effect of inserting the whistle suppressor and the tone control.

New Circuit for Resistance Tuning

A Development with Interesting Potentialities

By F. M. COLEBROOK, B.Sc.,
D.I.C., A.C.G.I.

WE have become so generally accustomed to regarding both capacity and inductance as essential constituents of a tuned circuit that a new development which dispenses with the need for inductance comes as a surprise. An interesting new development along these lines is described here and mention is made of possible applications

THE issue of *The Wireless World* dated July 27th, 1934, contained a description of a receiving circuit, suitable for the reception of broadcast transmissions, in which tuning was accomplished by the variation of a resistance instead of by the usual method of varying a capacitance.¹ The basic circuit was that shown in Fig. 1, and the essential principle involved was the balancing of a negative resistance, the magnitude of which depended upon frequency, against a variable positive resistance, just as the ordinary tuning process is essentially the balancing of a positive (i.e., inductive) reactance against a negative (i.e., capacitive) reactance. The negative resistance required for this circuit was realised by the well-known "dynatron" mode of operation of a tetrode valve. The arrangement, as described, was due to S. Cabot, who, however, acknowledged his indebtedness to Van der Pol, who had earlier called attention² to the possible applications of negative resistance in this connection.

The principal interest of this circuit lay in the fact that it presented, for the first time, a possible alternative to the hitherto universally accepted practice of reactance tuning, suggesting that even in this field finality had not yet been reached. This new arrangement, however, was still

linked up with reactance tuning, inasmuch as the variation of the effective negative resistance with frequency was, in part, due to variations of positive and negative reactance with frequency. In a more recent development, now to be described, Van der Pol, in collaboration with a colleague, J. Van der Mark, has arrived at a system capable of sine-wave oscillation, retroaction, and selective tuning, all controllable by resistance variation only, in which, moreover, inductance plays no essential part at all. Triode (or tetrode) valves, condensers, and resistances are the only elements involved.

Basis of the System

The starting point of this new system is a well-known resistance-coupled, push-pull oscillating circuit called the multi-vibrator, illustrated schematically in Fig. 2. Here we have already a circuit which oscillates without inductance, but the kind of oscillation which is produced by it is fundamentally different from that given by the ordinary tuned-circuit oscillator. It is of the type to which Van der Pol has given the name "relaxation oscillation," implying the sudden swinging over or "relaxing" from one state of quasi-equilibrium to another. The waveform is consequently very different from a sine-wave. Fig. 3 illustrates the type of

multi-vibrator oscillation. Such a waveform is very rich in harmonics, and the name "multi-vibrator" arises from this fact. The most important technical application of this circuit is to the precise measurement of frequency. The fundamental frequency is determined by the coupling condensers, anode resistances and valve AC resistances, and can be set to about 1,000 cycles/sec. by suitable choice of components. This frequency can be controlled by a 1,000 c/s fork and the various harmonics up to very high orders can be picked out for comparison with frequencies to be measured.

Van der Pol had already shown that by a delicate adjustment of the couplings the multi-vibrator circuit could be brought to a "just oscillating" state, and that in this condition a sine-wave oscillation was generated. The adjustment is, however,

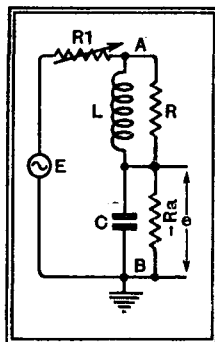

Fig. 1.—The fundamental circuit for resistance tuning is shown here. The resistance R_1 controls the tuning and the negative resistance $-R_a$ is actually a dynatron valve.

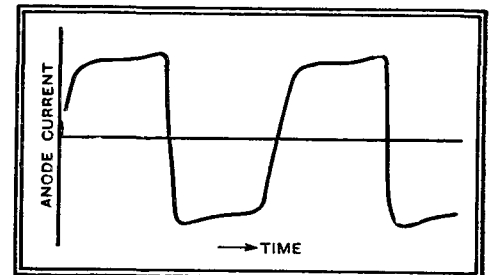

Fig. 3.—Wave form produced with the circuit of Fig. 2.

very critical, and the degeneration to the very distorted relaxation oscillation of the type shown in Fig. 3 occurs very rapidly. He has since found that by the simple addition of a third stage, similarly constituted and coupled, as in Fig. 4, oscillations of very nearly pure sine-wave form are produced over a wide range of retroaction value, and that, on the stable side of the oscillation adjustment, the network behaves like a selective tuned circuit.

The reason for this marked difference in behaviour between the two- and three-stage systems cannot be very simply explained in all its completeness, but is approximately as follows: Each valve, considered as a separate amplifying stage, produces a certain phase change as between the input and output voltages, the amount of this phase change varying fairly rapidly with frequency. There is, for any given set of equal values of the coupling resistances and condensers, one frequency for which the phase change is exactly

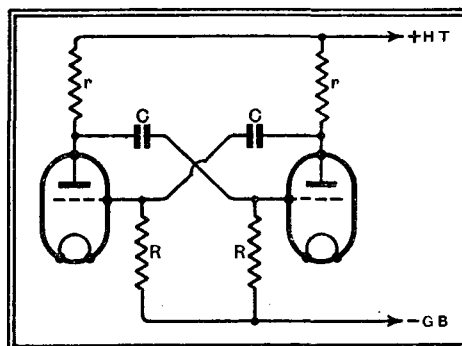

Fig. 2.—The basis of the system. A circuit which will oscillate without inductance.

¹"Resistance Tuning: A New Development." *The Wireless World*, July 27th, 1934, p. 58.

²"A New Transformation in Electric Circuit Theory." Van der Pol: *Proc. Inst. Rad. Eng.* Feb., 1930, Vol. 18.

New Circuit for Resistance Tuning—

120 deg., i.e., one-third of a complete oscillation. If, now, we assume that a small oscillation of this frequency is applied to the grid of the first valve, then in its passage through the remaining two valves and back to the first grid it will have been changed in phase by exactly 3×120 deg., i.e., 360 deg. In other words, it will return to the first grid exactly in phase with the initial oscillation, and will reinforce and thus tend to maintain the initial oscillation.

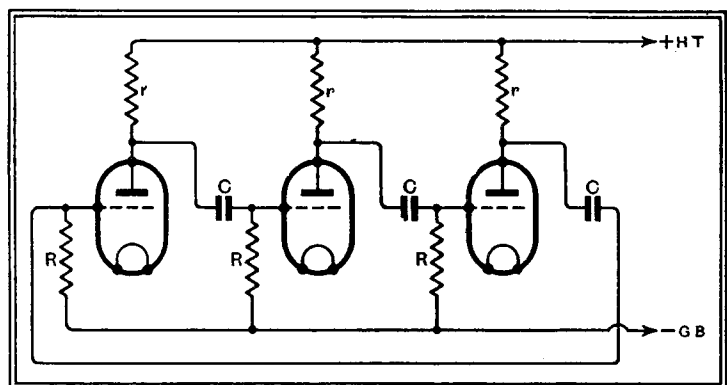

Fig. 4.—Van der Pol's circuit which produces oscillations very nearly of sine-wave form.

In the three-stage case this condition of maintenance will tend to be sensitive with respect to frequency, for, apart from any other consideration, any departure from the postulated 120 deg. will be amplified three-fold in the passage of the oscillation through the network. In the two-stage circuit the phase change per stage is 180 deg. This is inherently less sensitive to frequency than the smaller value, and any departure from it is only amplified two-fold. For two reasons, therefore, the three-stage network is likely to be far more sensitive to frequency in its state of oscillation or in its amplification in a stable state than the original two-stage or "multi-vibrator" circuit, and it is this sensitivity with respect to frequency, i.e., selectivity, that the network resembles a tuned circuit.

Mathematically, the system has, in fact, the interesting feature that the equation which describes its oscillating state is of the same form as that describing the oscillation of a simple tuned circuit, and it may therefore be expected to behave as a tuned circuit would behave. Van der Pol has shown by analysis that, assuming the anode resistances r to be small compared with the internal AC resistances of the valves, and small also compared with the grid resistances R , then the condition for maintenance of oscillation is:—

$$r \cdot g = 2$$

where g is the mutual conductance of the valves (assumed to be substantially the same for each), and the frequency of oscillation f is given by:—

$$f = \frac{1}{2\sqrt{3} \times \pi \times CR}$$

This gives $T = 11CR$ as the approximate value of the periodic time of the oscillations.

One very interesting possibility of the arrangement is the generation of frequencies very much lower than those obtainable by means of the ordinary types of oscillating circuit. For example, if C is $15 \mu F$. and R is 10 megohms, the periodic time is approximately 28 minutes! This is a frequency of $1/60 \times 28$, or 0.0006 cycles per second. It appears that such low frequencies can actually be realised. In his published description, Van der Pol includes a photograph of an oscillographic record, taken over the interval from 9 a.m.

to 8 p.m., of an oscillation having a period of about 6.5 minutes. It took practically the whole of the eleven-hour run to build up to a final steady state.

Alternatively, very high frequencies can be generated. Thus, with $C = 10 \mu\mu F$. and $R = 90,000$, T is approximately one-millionth of a second, i.e., the frequency is about one million cycles per second.

For such radio frequencies it would be necessary to use tetrode (screen-grid) valves in place of the triodes shown in Fig. 4, chiefly in order to minimise the valve capacitances in shunt to the grid resistances R .

Conditions for Oscillation

Before leaving the oscillator aspect of the system, it may be mentioned that the analysis shows that the alternating anode currents have the same amplitude in each

valve. Thus, they are equal in amplitude and symmetrically distributed in phase (i.e., 120 deg. apart), and constitute what the electrical engineer refers to as a "symmetrical three-phase system," and could be used, if desired, to produce a uniformly rotating magnetic field.

As already stated, oscillation will only be maintained if the anode resistances r are adjusted to a value greater than $g/2$, i.e., about 1,000 ohms for ordinary small receiving valves. If they are just less than this, oscillation will not be maintained, but there will be a tendency to oscillate. That is to say, the system will behave like a tuned circuit, with retroaction controllable by adjustment of r , which adjustment, incidentally, does not enter, to a first order, into the expression for the tuned frequency. In this condition the system should respond to a radio transmission in the same way as would a sharply tuned circuit of ordinary construction. It appears from Van der Pol's account that a suitably adjusted network has actually been used in this way, though no detailed description is given of this part of the experimental work. The only reference is, "Considering the higher range of frequencies, it was thus found possible to construct a sharply tunable radio receiver without any inductance coils whatever."

There is clearly a very interesting field for further experimental work in this connection—in particular, the shape of the resonance curve and the possibilities of producing a band-pass effect by modifications of symmetry in the three-stage. More detailed investigations in this field may form the subject of a later article, but, apart from any such possibilities, the circuit as it stands is of sufficient practical and theoretical interest to justify the present brief description.

THE RADIO INDUSTRY

THE ordinary type of paper-dielectric condenser is hardly sufficiently robust for fitting as a suppressor of interference on a motor car. The Telegraph Condenser Co., Ltd., of Wales Farm Road, North Acton, London, W.3, draw our attention to the fact that they are producing for this purpose a metal-shielded tubular condenser, which is available in capacities of 0.5 or 1 mfd.

In order to popularise classical music, albums of H.M.V. records will be given away with "His Master's Voice" radiogramophones during the present Jubilee year.

It is anticipated that the new Ferranti factory at Moston (about a mile from the present works) will give employment to at least 3,000 people. The building, which has a floor space of 260,000 sq. ft., is to be devoted

entirely to the manufacture of Ferranti radio apparatus (including valves), and is already in an advanced state of construction.

The Go-page catalogue just issued by Ward and Goldstone, Ltd., Pendleton, Manchester, deals with components, anti-interference devices, and also with electrical accessories, wire, etc., that are difficult to obtain from ordinary sources.

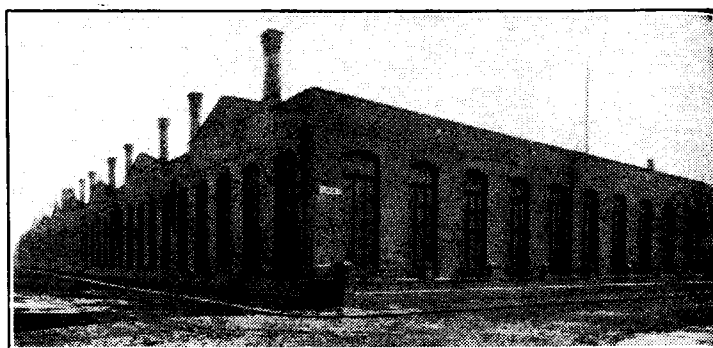

A general view of the new Ferranti factory at Moston, Lancs. The enormous size of the building can be gauged by the fact that it extends to the right-hand side of the picture almost as far as to the left.

UNBIASED

Light on the Subject

A READER who recently attended a demonstration of telechics in which a model electric train was caused to stop, start and go through all manner of other evolutions at the word of command uttered into a microphone, asks me how it was done.

The answer is, of course, that not being in the confidence of the demonstrator, I haven't the faintest idea. Different people would doubtless employ different methods, but there are at least half a dozen ways in which it could be done, and one of the simplest methods is no doubt the one which I should employ myself if I desired to mystify my friends. The noteworthy part of my scheme is that I cause the trains to go through their drill at the word of command without employing any microphone whatever.

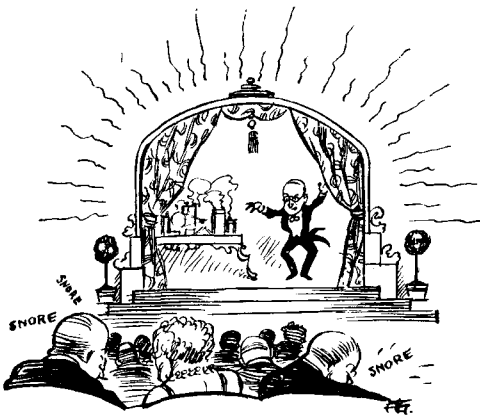

How I would have done it.

Since this is the party season and there may be many disciples of Maskelyne who want to add a fresh trick to their repertoire, I will give brief details. In the first place the model railway is set up on a large-sized table in the middle of the room. At the far end of the room is another table containing the necessary electrical gear for producing the remote control effects. The demonstrator should take up his stand between these two tables when he is ready to give his little performance.

When doing remote control by word of mouth all I do is to take up my stance in the position indicated and address my trains in the same manner as I would if coaxing a pet dog to go through some tricks; in fact, the only difference between the trains and a pet dog is that they are ten times more reliable.

How is it done? Black Magic? Not on your life. Concealed microphones? Nothing of the sort, for you can whisper or merely *think* of your commands without giving them utterance, and the results are just as good.

On the main table I have a couple of photo-electric cells controlled by a similar

number of invisible rays emanating from the control table. By moving my body slightly during my lecture-demonstration I am able to cut either one or both of these rays at will, and it is this which does the controlling through the customary "sequence" rotary relay. By a little ingenuity it can be arranged to work with one ray only, but I use two and sometimes more, chiefly because I sometimes like to elaborate my little performance by causing the trains to go through their evolutions by appropriate gestures of beckoning, etc., using my arms, of course, in such a way that the requisite ray is cut.

I must once more make it quite clear that I have only given one possible explanation. I may not have answered my reader's question as to how it was done, but merely how I would have done it.

Certain Kind of Fading

IT is very seldom that new inventions fail to bring certain disadvantages in their train and nowhere is this fact more strongly exemplified than in the case of wireless.

One of the most striking wireless innovations of recent years has been AVC, which has been universally acclaimed. It has not, however, been an unqualified success, its chief disadvantage being that it does not compensate for the distortion which accompanies a certain type of fading. The result is that when fading of this kind is troublesome it is manifested in the loud speaker, not by any fading of the signal, but by transitory distortion. Thus, if one is listening to a B.B.C. station from some place in the wilds of Europe, this form of fading will cause the announcer's voice to become temporarily even more unctuous than usual.

There are, however, more serious consequences than this which can be brought about by the indiscriminate use of a modern AVC receiver. According to a certain technical journal there is a type of

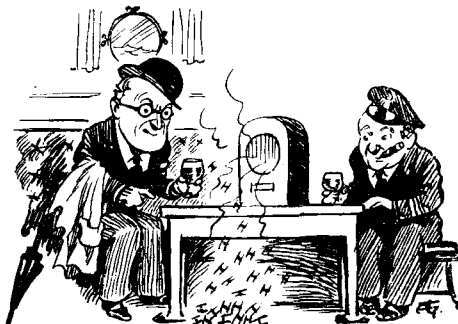

We were amazed!

fading distortion which takes the form of a transposition of aspirates from one word

to another. I can, so it happens, personally vouch for the truth of this assertion, as the following incident will show.

Quite recently when I was paying a visit to a few friends who have sought to dodge the English winter by hibernating in a yacht in mid-Atlantic, we tuned in to hear a certain political talk by Mr. Winston Churchill. We were amazed to find that alternate sentences of his speech were given by Mr. Thomas and could not account for serious statesmen indulging in

By FREE GRID

such unseemly levity as to engage in a kind of Alexander and Mose dialogue. It was not, in fact, until well after the port had gone round for the last time (the beverage I mean, not the cabin window) and we were about to retire to rest that the true explanation occurred to me.

Morse

ONE of the worst forms of humbug is the pretence on somebody's part to knowledge that they do not possess. Usually it is the B.B.C. or its announcers whom I find guilty of such conduct, but on this occasion, by some strange chance, it is not so. The thing that is getting my goat at present is the lordly pretence of certain salesmen to a facile acquaintance with the Morse code, whereas, in reality, they scarcely know a dot from a dash. It is not so much their ignorance which gets me down—although Heaven knows this is blameworthy enough in the case of those who call themselves *radio* experts—as the lordly air of superiority which they adopt when demonstrating to an ignorant and gullible public.

I have recently come across innumerable instances of this sort of thing in the big stores, and it is time, I think, that a stop was put to it. To anybody who is acquainted with the Morse code it is, of course, only necessary to listen for a few moments to the absurd manipulation of the key by these salesmen, in their endeavours to sell the Morse code practice sets to schoolboys and others, to glean the knowledge that they are completely ignorant of it. They rattle off their dots and dashes at an incredible speed and in such a clipped and slovenly manner that it would disgrace even an American wireless operator. If further proof were needed of their utter lack of knowledge of the code it is only necessary to seize the key and send out a deliberately provocative remark.

When I did this at a well-known store the other day, not the slightest sign of recognition came to the salesman's face nor indeed to that of any other person in the department, even though I repeated my morsed observations many times very deliberately and slowly.

Current Topics

Noise Drowns Noise

BABY carriages fitted with broadcast receivers are now on the U.S. market. It is claimed that a restive child makes no further trouble when dance music is switched on.

The Russian Ladies

BRITISH listeners to the Radio Centre, Moscow, transmission on January 28th heard an interesting statement in connection with the voting competition to decide the correct designation for female announcers. In future they are to be known in Russia as "lady announcers."

Radio and Paris Show

WIRELESS is to be used on a large scale to herald the opening of the great Paris Exhibition of 1937. Besides keeping listeners supplied with a thousand and one facts concerning the exhibition and its contents, the authorities will arrange for frequent broadcasts from the exhibition grounds, enabling listeners to hear the work of construction going on.

League Morning Broadcasts

RADIO Nations now broadcasts Monday talks at 8.15 a.m. dealing with the activities of the League of Nations. The wavelength during this month will be as follows: February 11th, 20.64 metres; February 18th, 24.94 metres; February 25th, 31.27 metres.

High Definition Television

IMMEDIATELY the B.B.C. begins broadcasting high definition television, Electric and Musical Industries, it is stated, will be ready to market television receiving sets. Although it is too early to say what the price of these sets will be, the company believes that the price mentioned in the committee's report, viz., £50 to £80, will be more or less correct.

"We quite agree," continues the E.M.I. statement, "that radio sound broadcasting will still, for many a year to come, dominate the B.B.C. programmes. Moreover, we do not believe that television will in any way interfere with developments in radio sound broadcasting, with its ever increasing entertainment value. Therefore our company, as well as all other manufacturers in the radio industry, are going right ahead with the development of the manufacture and sale of radio sets for sound."

Swiss Amateurs

SWISS radio amateurs are united by the U.S.K.A. Society, the headquarters of which are now located at Neu-Allschwil, near Basle.

Short Waves in Aberdeen

A SHORT-WAVE club is to be formed in Aberdeen. Enquiries should be addressed to Messrs. G. Cormack and G. Will (G2MJ), 8, Tanfield Avenue, Woodside, Aberdeen.

Trolley Buses and Interference

HEAVY copper coils carried as static stoppers on the roofs of London Transport trolley buses have been found to upset the balance of the vehicle, especially on steep cambers.

Tests are now being made to evolve more satisfactory



BLESSING A RADIO STATION. The inaugural ceremony at Torun, Poland, where a new 24 kW transmitter has been installed. Torun is the

methods of preventing interference with broadcast reception.

Meanwhile Nottingham listeners are bitterly protesting against the alleged apathy of the Corporation Passenger Transport Department in the matter of eliminating trolley bus interference. It is stated that only six vehicles are fitted with suppression coils, and these have been lent by the Post Office.

It is urged that, since the agitation has gone on for more than twelve months, the Transport Department should conclude its "experiments" and come to a decision.

Ten Years of Transmission

ONE of the oldest amateur radio societies in Europe, the Réseau Emetteurs Français, celebrates the tenth year of its foundation in 1935. It is organising a celebration transmitting contest, open to all, in which one point is scored for every contact made with a French amateur. The contest runs from midnight on March 23rd until midnight on March 31st.

EVENTS OF THE WEEK IN BRIEF REVIEW

High-power from Normandy

THE new 120-kilowatt French Regional station at Rennes, Normandy, has been re-christened. Originally the title was "Radio-PTT Ouest." It is now to be known as Radio-Bretagne.

More Power from Heilsberg

HEILSBURG is the last remaining high-power station in Germany which has not increased its power to the internationally permitted limit, viz., 100 kilowatts. Work has now started on the high-power trans-

Switzerland Buys British

THE new 100-kilowatt transmitter for Radio Suisse-Romande is to be built by a British firm, Standard Telephones and Cables, Ltd. The approximate value of the order is £30,000. The new station will begin operation in the autumn.

The Radio Premier

THE residence of the French Prime Minister in Paris is to be equipped with a transmitting as well as a receiving station to enable the chief Minister to communicate with French representatives abroad.

Progress in Norway

THE year 1935 is to break records in Norwegian broadcasting, according to a statement by the Norwegian State Broadcasting Company. A programme of station extensions includes 10-kilowatt transmitters at Vigra, Tromsø and Stavanger. The Bergen transmitter is to be raised to a power of 20 kilowatts within the next few months.

Broadcast Advertising

THE suppression of publicity broadcasts in France has met with praise in Italy, and a similar measure is demanded for the Italian organisations.

The *Messagero* is of the opinion that if the private Italian broadcasting company (the E.I.A.R.) fails to abolish advertising, the programmes will be abandoned by listeners.

The E.I.A.R. is raising the power of the Rome (Santa Polomba) station from 50 to 120 kilowatts. There will be a total power advance in all its stations from 190 to 450 kilowatts.

1935 Car Radio in America

WITH two million cars already equipped with radio, United States car manufacturers are now without exception including radios as standard equipment, or making suitable provision for radio connections, writes our Washington correspondent. For the most part aerials are concealed in the roofs of the cars, but the new steel-turret-top bodies and roadsters and convertible models have necessitated hiding the wireless elsewhere — usually under the running board.

All cars have proper shielding of the ignition system.

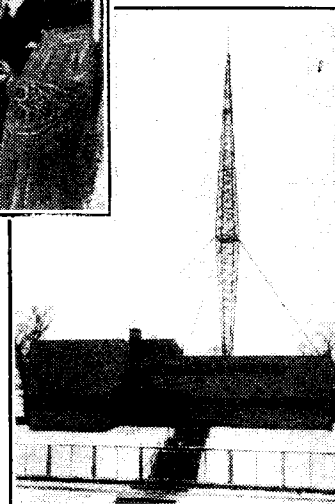

third European station to adopt the Blaw-Knox type of aerial as now in use at Vienna and Budapest.

mitter, however, and Heilsberg programmes are now radiated by a 17-kilowatt stand-by installation.

The alterations and the erection of an anti-near-fading aerial will be completed by the end of April.

The Modern Composer

UNKNOWN modern composers are to be given a chance by the German broadcasting stations every second Thursday, beginning on February 14. Modern music will be broadcast from 11 till midnight (local time).

REPORT OF THE TELEVISION COMMITTEE

Technical Recommendations Summarised

THE long-awaited report of the Television Committee was published towards the end of last week. It will be remembered that this Committee was appointed by the Postmaster-General in May, 1934, with the following terms of reference:—

"To consider the development of Television and to advise the Postmaster-General on the relative merits of the several systems and on the conditions under which any public service of Television should be provided."

The report naturally goes into a good deal of detail which it is scarcely necessary to include in a summary here. There are, however, several points of outstanding interest contained in the report which will be briefly referred to.

The Committee makes it clear that the present 30-line broadcast television system is not suitable for a regular public service, although it is acknowledged that it has served a useful purpose so far. The recommendation is therefore made that the existing low-definition broadcast should be maintained if practicable for the present but that it might reasonably be discontinued as soon as the first station of a high-definition service is working. It should then be a matter for an Advisory Committee, which it recommends should be set up to guide the development of television broadcasts in the early stages, to recommend whether or not low-definition broadcasting should continue in addition.

High-quality Transmissions

It had been generally supposed that 180 lines might be recommended as a starting-off point for the new service. It is interesting, therefore, to find that the Committee recommends that a beginning should be made with 240 lines per picture, with a minimum picture frequency of 25 per second, and that the possible use of an even higher order of definition and a frequency of 50 pictures per second is not excluded. It is stated that the price of receivers to the public is expected to be between £50 and £80 at the start, although when receivers are made on a large scale under competitive conditions this price may be expected to come down substantially.

The Committee has been quite definite on the point that the proper authority to undertake the transmissions should be the B.B.C., giving as one reason the fact that sound is an essential adjunct to television and that sound broadcasting is already a B.B.C. monopoly. It is, however, stated that whilst it is thought that the British Broadcasting Corporation should exercise control of the actual operation of the television service to the same extent and subject to the same broad principles as in the case of sound broadcasting, the initiation and early development of this service should be planned and guided by an Advisory Committee, to be appointed by the Postmaster-General. Since the report appeared, the Postmaster-General has appointed such a committee, which is to be composed as follows:—

Lord Selsdon (chairman).

Sir Frank Smith, secretary of the Department of Scientific and Industrial Research (chairman of a technical sub-committee).

Col. Angwin, Assistant Engineer-in-Chief of the Post Office.

Mr. N. Ashbridge, Chief Engineer of the B.B.C.

Vice-Admiral Sir Charles Carpendale, Controller of the B.B.C., and

Mr. F. W. Phillips, Assistant Secretary of the Post Office.

Secretary, Mr. J. Varley Roberts, of the Post Office.

The report explains the necessity for the use of ultra-short waves for high-definition transmissions, and points out that at present there should be no difficulty in the choice of suitable wavelengths in the spectrum between 3 and 10 metres for public television, although in allocating such wavelengths regard must be paid to the claims of other services.

Limitations of Range

The transmitting stations should be situated at elevated points, and it is mentioned that the mast at present used in Berlin is about 430 feet high, and the question of employing masts of even greater height is under discussion in Germany.

It is stated that experience both here and abroad seems to indicate that these ultra-short waves cannot be relied on to be effective for a broadcast service much beyond what is commonly called "optical range." Generally speaking, it is at present assumed that the area capable of being effectively covered by ultra-short-wave stations is a radius of approximately 25 miles, whilst in hilly districts this may be considerably reduced. But, nevertheless, it is thought that with the erection of ten stations it should be possible to provide a service for 50 per cent. of the population.

The Committee is quite emphatic in recommending the P.M.G. that there should be no delay in starting a service, and that at first a station should be set up in London, and other stations as quickly as possible thereafter, each new station to take advantage, as far as possible, of any new developments which may take place in the mean-

time. Having examined the systems of all those who were prepared to demonstrate, the Committee recommends that in the first instance the Baird system and the Marconi-E.M.I. system should both be set up to operate a London transmitter alternately, and that the nature of the transmissions should be such that the same receiving equipment should be suitable for the reception of both with minor, if any, adjustments.

No Receiver Monopoly

The Committee considered that the establishment of a Patent Pool which would include all television patents, so that the operating authority could be free to select from this Pool whatever patents it was desired to use for transmission, would be the ideal solution, but the Committee explain that they were compelled to abandon the idea that the formation of a comprehensive patent Pool should be a condition precedent to the establishment of a public service, although they maintain that in the interest of the trade itself and the public such a Pool should be formed. They express the hope that events will shape themselves in such a way as to lead to the formation of a satisfactory Patent Pool at no distant date.

Having agreed that the Baird Company and the Marconi-E.M.I. Company should both be given the opportunity of supplying apparatus for the London station, it is recommended that besides any other conditions imposed, acceptance of offers should be subject, in each case, to the following conditions precedent:—

(a) The price demanded should not, in the opinion of the Advisory Committee, be unreasonable.

(b) The British Broadcasting Corporation to be indemnified against any claim for infringement of patents.

(c) The Company to undertake to grant a licence to any responsible manufacturer to use its existing patents, or any patents hereafter held by it, for the manufacture of television receiving sets in this country on payment of royalty.

(d) The terms of a standard form of such licence to be agreed upon by the Company with the Radio Manufacturers' Association, or, in default of agreement, to be settled in accordance with the provisions of the Arbitration Acts, 1889 to 1934, or any statutory modification thereof, either by a single arbiter agreed upon by the Company

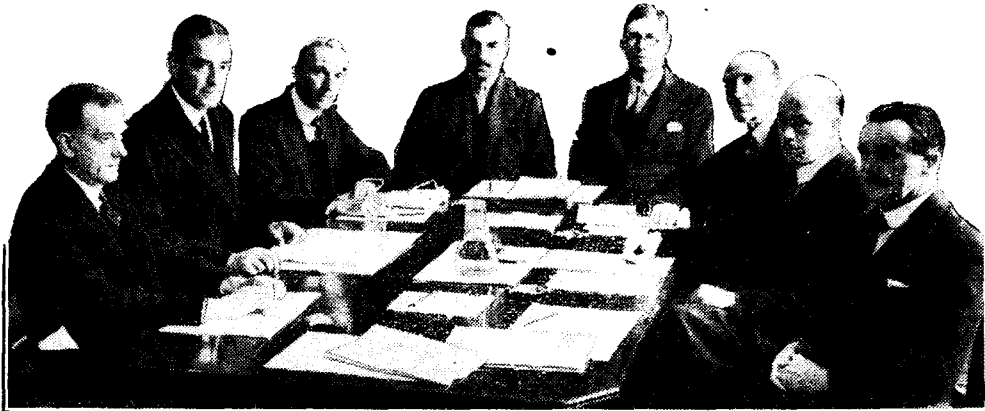

The Television Committee. Left to right: Sir John Cadman, Lord Selsdon (chairman), Mr. F. W. Phillips, Mr. J. Varley Roberts, Mr. O. F. Brown, Vice-Admiral Sir Charles Carpendale, Mr. Noel Ashbridge, and Col. A. S. Angwin.

¹ The full text of the report can be obtained from H.M. Stationery Office, price 6d. net.

Report of the Television Committee—

and the Radio Manufacturers' Association, or failing such agreement, by two arbiters—each of the parties nominating one—and an umpire nominated by the Postmaster-General.

(e) The Company to agree to allow the introduction into its apparatus at the stations of devices other than those claimed to be covered under its own patents, in the event of such introduction being recommended by the Advisory Committee.

(f) Transmissions from both sets of apparatus should be capable of reception by the same type of receiver without complicated or expensive readjustment.

(g) The definition should not be inferior to a standard of 240 lines and 25 pictures per second.

(h) The general design of the apparatus should be such as to satisfy the Advisory Committee, and when it has been installed tests should be given to the satisfaction of the Committee.

The Committee recognises that in the development of the service constant change, at least in detail, may be necessary as improvements are made, and they point out

that a more difficult situation will arise if a completely new system, requiring a new type of receiving set, should be evolved. It is suggested that no drastic change in the system, necessitating a change in receivers, should be made without reasonable notice being given by the B.B.C., and that in the initial stages this notice should not be less than, say, two years.

The report discusses the finance side of the problem and recommends that there should be no special television licence, nor any increase in the present amount of the broadcast receiving licence, but that the revenue from this licence should, for the present at least, meet the requirements of the television service.

The report concludes with the Committee's hope that every encouragement will be given to experiment and research in television, both by firms and by private persons, indicating that in their view the establishment of a broadcast television service should not interfere with the granting of licences by the Postmaster-General for experimental transmissions in addition to the regular service suggested by the Committee in its Report.

are not widely known. Here surely is a fine field for some enterprising manufacturer. An inverter designed to deliver 220 volts AC at 50 cycles, and for operation from a 6-volt or 12-volt accumulator, should meet with a big demand if its existence were made widely known.

Some Advantages

The advantages of the system are many. By no means the least is that that worry of the battery user, the HTB, passes out of the picture. In its stead there is one accumulator—or, rather, a pair—one in use and one at the charging station—long-lived and easily and cheaply rechargeable. One imagines that most charging stations would be only too happy to make special rates for the regular "refilling" of such batteries.

And not only the HTB departs but also the battery type of valve, which, good as it is, can never equal its AC mains counterpart.

■ ■ ■
Tired Transmitters

MANY readers must have noticed the curious way in which certain transmitting stations make a splendid start when they are first brought into operation, maintain their fine performance for a few months or even years, and then show unmistakable signs of growing feebleness.

The classic instance is Motala, which for some time after its inauguration was receivable all the year round, both by daylight and after dark, at enormous loud-speaker strength with even the rather inefficient three-valve sets that we used in those days. Motala's output power was then, as it is now, 30 kilowatts. To-day it is not easy to receive at loud-speaker strength (I am speaking of times when it is not heterodyned) with a good superheterodyne. Then there was Radio Iberica, a 4-kilowatt Spanish station, which flashed out like one of the astronomers' *novæ* with a sudden blaze of glory, lasted for perhaps a couple of years, and then pretty well disappeared. Other examples are Zeesen, Madrid Union Radio, Nürnberg, Stockholm, and Oslo. Some of the stations mentioned are still fairly well received, but their strength is nothing like what it was a few years ago.

What is the Cause ?

There are several possible explanations. One is that when few stations were using more than 4 or 5 kilowatts, a 4-kilowatt, such as Radio Iberica, might be well heard, especially as there was in those comparatively early days no great need to sacrifice sensitiveness for selectivity in the receiving set. Then, as other stations increased their output power and receiving sets became more selective, the 4-kilowatts were, so to speak, elbowed out.

There is probably something in this, but it does not explain the performances of high-powered stations such as Stockholm, Oslo, and Motala.

What seems to me to be a much more reasonable explanation is that the soil surrounding a transmitting station may undergo an actual change in character owing to the effects of electrolysis or something very like it. The plant itself does not deteriorate, for careful measurements prove that stations which show a falling-off, so far as reception is concerned, are genuinely radiating all their original power.

That changes in the surrounding soil are to blame is a view strongly supported by the fact that no falling-off in the range of ships' transmitting sets has ever been observed.

Random Radiations

By "DIALLIST"

The New Wavelengths

POSSIBLY a scare of some kind will be got up when the B.B.C. makes the wavelength exchanges between its stations which will shortly be necessary. All that will happen, of course, is that the dial settings for certain stations will be a little different, but that's quite sufficient to provide the more irresponsible writer with all the material he needs for an article of the "your-set-will-become-useless" type. Like the Fat Boy, he wants to make your flesh creep—and doesn't much mind how he does it.

Actually, the B.B.C. was faced with a rather pretty problem when it was found that what we now call the little Nationals (50 kilowatts!—and we used to class 5-kilowatt stations as powerful) could not be dispensed with after the opening of Droitwich. Since their wavelengths will be needed in the near future for the North-Eastern and North Scottish stations, the only thing to do is to synchronise the London, West, and North Nationals. This will involve certain other changes, the most important of which is the reduction of the Midland Regional's wavelength from 391.1 to 296.2 metres.

■ ■ ■
Rejuvenating Bakelite

We don't use nowadays large ebonite or bakelite panels that once used to be a feature of receiving sets; but modern receivers contain small panels, escutcheons, mouldings, or knobs made of this material. Though it is less prone than ebonite to reflect the passing of years in its outward appearance, bakelite *does* become to some extent dull and discoloured as time goes on.

Here's a very useful tip that I discovered accidentally some time ago. During the overhauling of a set some vaseline was somehow smeared on a small bakelite panel. It was removed by hard rubbing with a duster, and to my surprise I found that the rubbing readily produced a wondrous effect. The

panel, in fact, "came up" just like new. If you have any bakelite parts that have lost their school-girl complexion, just try the effect of vaseline plus elbow-grease.

■ ■ ■
Wavetraps for Droitwich

MANY complaints reach me from listeners, particularly those living in the Birmingham area, about the enormous spread of Droitwich on the long-wave band. So great is the spread in some instances that no other long-wave station is receivable clear of background.

The only satisfactory means of preventing a somewhat unselective set from being swamped is to make use of a wavetrap and several good designs are on the market. The employment of a wavetrap seems rather like a reversion to the bad old days, but desperate diseases demand desperate remedies. A well-designed wavetrap can be surprisingly effective.

■ ■ ■
Why Not Use the Inverter ?

WE are accustomed to regard America as a country in which almost every house is supplied with alternating current at standard voltage and frequency. This is by no means the case. Large areas of the United States still have DC, and there are thousands upon thousands of homes in the more remote districts that have no outside electric supplies at all. Many of the farms have their own 32-volt lighting sets.

Several American firms have developed a most useful piece of apparatus known as the inverter. This, on being connected to a 6-volt, 32-volt, or 110-volt DC supply, delivers AC at 110 volts 50 cycles, which is the standard alternating current over there. The AC receiving set, with all its big advantages, thus becomes available for use in any home.

Apparatus of this kind is confined in this country almost entirely to car radio. Inverters for domestic use are made, but they

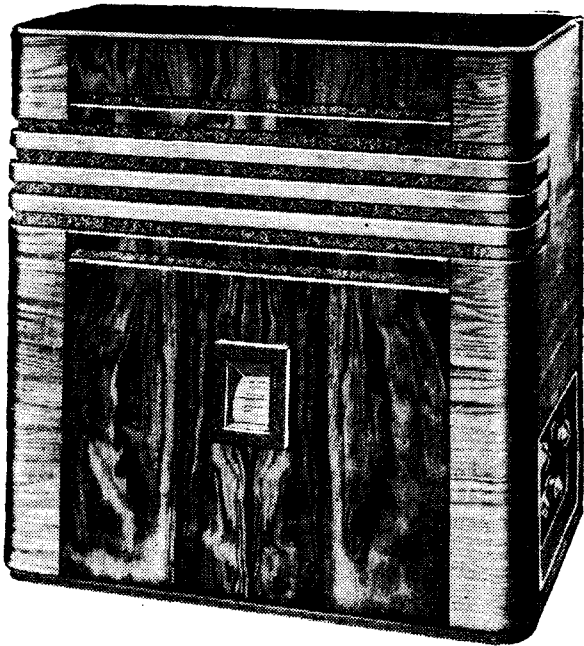

R.I. Ritz Airflo

A Sensitive Superheterodyne with Many Points of Originality

FEATURES.—Type.—Table model superheterodyne for AC mains incorporating QAVC. **Circuit.**—Triode-pentode frequency changer—variable-mu pentode IF amplifier—triple-diode-triode second detector—pentode output valve. Full-wave valve rectifier. **Controls.**—(1) Tuning. (2) Volume and on-off switch. (3) QAVC threshold control. (4) Waverange switch. (5) Tone control **Price.**—16 guineas. **Makers.**—Radio Instruments Ltd., Purley Way, Croydon.

ALTHOUGH this receiver falls into the four-valve class of superheterodynes, its specification and performance definitely place it on a plane above the majority of low-priced receivers in this category. It is fitted, for instance, with genuine valve-operated QAVC for suppressing background noise between stations, the level at which the suppressor action comes into operation being under the control of the user. The quality of reproduction is also distinctly above the average, and it is interesting to note that a ten-inch moving-coil loud speaker has been included.

The feature which first attracts attention, however, is the design of the cabinet and the disposition of the controls. The latter are mounted on a subsidiary panel recessed into the right-hand side of the cabinet, thus relieving the front panel of unsightly knobs. The loud speaker grille takes the form of a number of horizontal slits which are carried some inches round the sides

of the cabinet. This not only gives the set a striking and original appearance, but also has some acoustic value. The loud speaker baffle is set back several inches from the front panel of the cabinet, and this permits a much greater radiation of sound energy at the sides than is usual in the majority of sets. The loud speaker itself also appears to give less focusing of the high frequencies, and the quality on a line at right angles to the axis of the loud speaker differs very little from that on the axis itself. When listening to this receiver the instinct to move one's chair opposite the loud speaker does not make itself felt.

Good Tone

The general tone of the instrument is very good indeed. It is smooth and full, and while there is plenty of top this is not accompanied by hardness. Another attractive quality of the reproduction is

that it appears to be more than usually free from harmonic distortion, even with the volume control at maximum. Furthermore, the action of the automatic volume control does not introduce overloading of the early stages when the set is working at full power from the local station.

The frequency changer is of the triode-pentode type, and is preceded by a band-pass filter with a combination of high and low potential capacity coupling. The IF stage is straightforward and makes use of a variable-mu pentode. The threshold control for the QAVC action takes the form of a variable bias resistance in the cathode of this valve. This controls the sensitivity of the IF stage and so limits the number of stations capable of generating the input voltage to the detector required to remove the silencing bias from the grid of the triode portion of that valve. The third diode in this stage is used solely as a DC conductor in the QAVC circuit. Resistance coupling follows the second

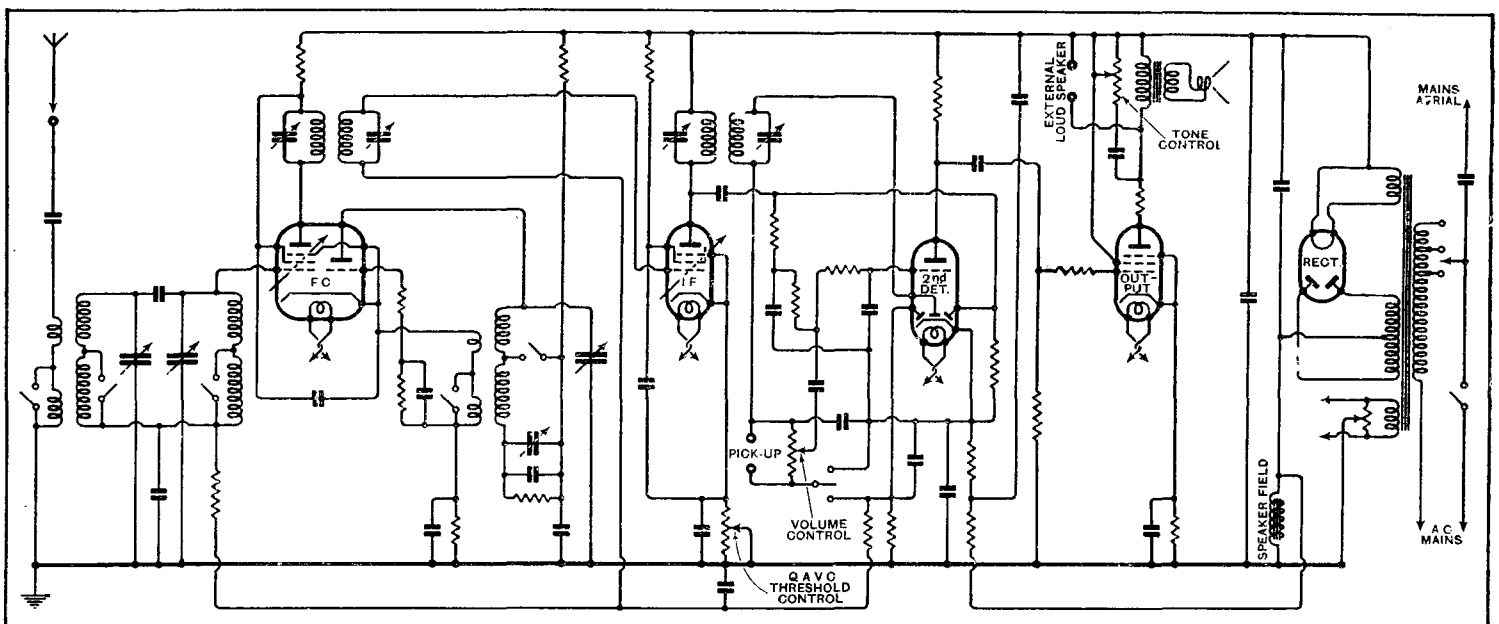

Complete circuit diagram. The triple-diode-triode in the second detector stage provides automatic noise suppression between stations.

R.I. Ritz Airflo—

detector stage and the output valve is a power pentode.

The overall sensitivity is much above the average for a set of this type, and the numerous Continental stations which are available on the medium waveband in daylight come through with a remarkably low level of background noise even with the QAVC control out of action. Of course, as soon as the tuning dial is moved away from the station the background is

Central London, occupied bands a little under 40 kilocycles. In other words, two channels would be lost on either side under these conditions. With the exception of a fairly energetic second channel whistle, due to the London Regional transmitter, and one of somewhat lower amplitude from the National, the set was free from all self-generated interference. The long-wave range showed no trace of whistles due to oscillator harmonics.

This is a set which will undoubtedly

which results from insufficient bias. The valve is, in effect, acting as a grid detector—a most undesirable state of affairs.

Not to Blame

USERS of superheterodyne receivers can rest assured that their apparatus is not to blame for the production of heterodyne interference whistles of which the pitch is unaffected by alterations in the tuning adjustment. Whistles of which the pitch remains constant (although the intensity varies as tuning is altered) are due to outside causes, such as heterodyning between adjacent stations. An excessive number of such whistles may indicate exceptionally good high note response, but that is hardly a fault.

A Clue

AS a general rule there is considerable latitude in the value of resistances used for grid-circuit decoupling. As often as not, one can halve or double the accepted values without noticeable effect.

When the use of an abnormally high value of decoupling resistance is found to be definitely prejudicial to quality, we have a fairly certain indication that current is flowing in the grid circuit of the valve concerned. A reader who finds it necessary in the interests of quality to use a low value of grid decoupling resistance would therefore be well advised to assure himself that sufficient negative bias is applied.

Variable Tone Correction

WE are asked to supply a diagram of a variable tone-correction circuit for addition to a resistance-coupled amplifier. It is required that the correcting system shall have sufficient scope to compensate for

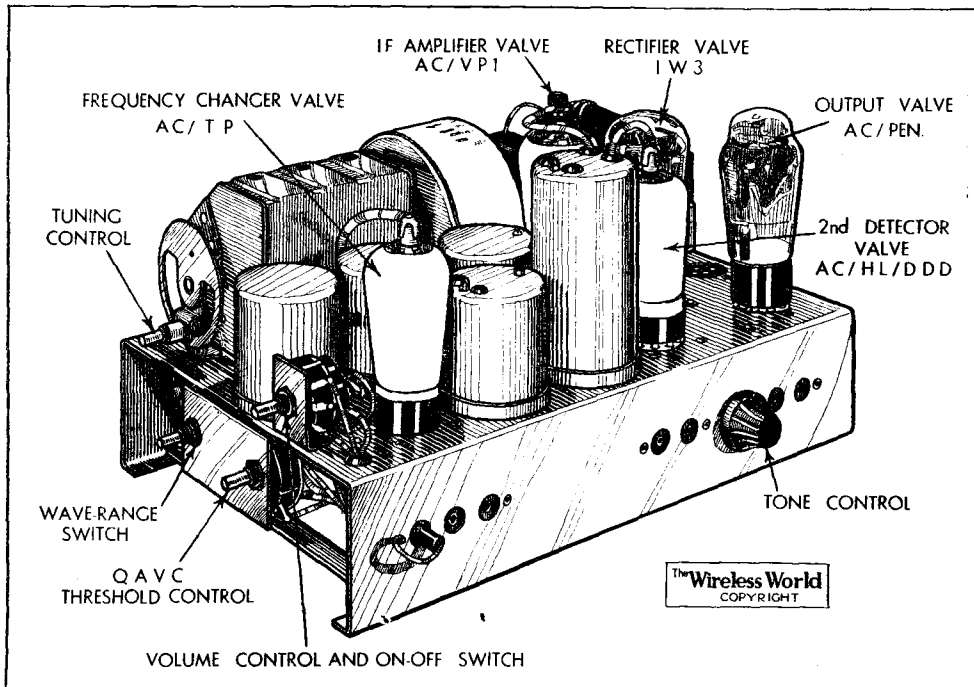

With the exception of the tone control, which is mounted at the back, the main controls are fitted at the side of the chassis.

excessive unless the threshold control is properly adjusted. The AVC itself has a wide range of control, and its performance is much above the average at the top end of the range.

The selectivity on long waves is sufficient to keep the Deutschlandsender programme free from all but occasional sideband interference from Droitwich, and the volume from the German station at all times of the day is unusually good. On the medium waveband the two Brookmans Park transmitters, when received in

attract a large number of prospective buyers on account of its original cabinet design, and there is little doubt that those who finally decide on this set will be more than pleased with the quality of reproduction. The high sensitivity, in conjunction with the automatic control of background noise, will provide a choice of stations of good programme value which is much wider than one would normally expect from a four-valve superheterodyne receiver, while the selectivity provided is quite sufficient for most needs.

READERS' PROBLEMS

Valve Symbols

REFERRING to the system of stable HF amplification with triode valves which was described in our issue of January 18th, a querist, referring to the fact that directly heated battery valves are shown in the diagrams illustrating the article, asks whether the system is applicable to AC valves.

There is no reason why this circuit arrangement should not be used with any type of triode valve. Although there is no accepted convention, it is usual in diagrams illustrating principles rather than practice to use the simpler representation of a battery-heated valve in preference to the more elaborate representation of its in-

directly heated counterpart. Failing any statement or obvious reason to the contrary, it may be always assumed that arrangements illustrated in this journal by battery valve symbols are applicable to mains valves and vice versa.

Grid Current Flowing?

A QUERIST notices that the anode current of the intermediate LF valve of his resistance-coupled amplifier tends to fall during loud musical passages. It is asked whether this symptom is to be taken as an indication of excessive negative bias.

On the contrary, the effect in question would indicate the flow of grid current,

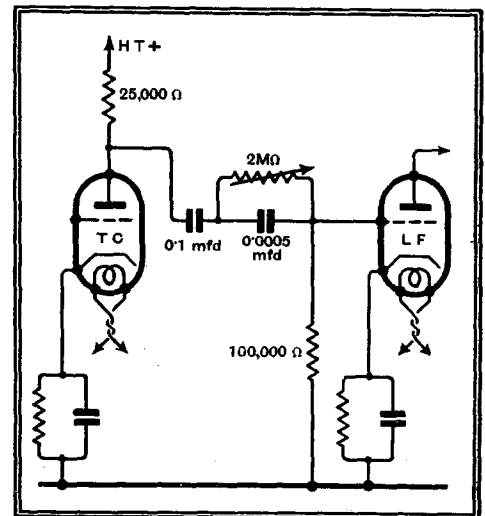

Fig. 1.—A simple tone-correction circuit to compensate for high-note loss.

the high-note loss likely to occur in "a very sharply tuned circuit." As such drastic control is required it will be virtually essential to employ an extra valve; this is apparently realised by our querist.

In the circumstances, we suggest the circuit shown in Fig. 1. As is usual in such arrangements, proportional amplification of high notes is increased by attenuation of the lower register, and thus the desired correction is achieved. Tone is progressively raised by increasing the value of the 2-megohm resistance.



Listeners' Guide

Outstanding Broadcasts and



TWO BANDS, ONE CONDUCTOR.

"THE RHYTHMIC SERENADERS" and the "Novelty Accordion Band" contribute to the popular series, "One Band to Another," on Tuesday next, February 12th, in the Regional programme (9 p.m.). A. W. Hanson, who is responsible for this series, places the two bands in the same studio. In this way the suggestion of competition between the players is emphasised. The Rhythmic Serenaders will provide the "sweet" music in contrast to bright novelty

"SCRAPBOOK" RECALLS WRITTLE DAYS.

A "SCRAPBOOK" programme gives colour to any week's programmes, such is the abiding vitality of Leslie Baily's idea. This week it is "Scrapbook for 1921"—not a year that stands out in the memory, but representative of the fairly gay period after the War which preceded the onset of depression and disillusion. To readers of *The Wireless World* the most interesting episode, perhaps, will be the appearance of Captain P. P. Eckersley, who will recall those great days at Writtle when British broadcasting was finding its feet.

The Writtle broadcasts were picked up by a handful of experimenters on Tuesday nights, the programmes being provided by the engineers themselves. No one who heard them could forget Captain Eckersley's "one-man" performances of Italian opera.

"Scrapbook of 1921" has been devised by Leslie Baily and Charles Brewer, and will be broadcast Nationally on Tuesday next, February 12th (8 p.m.), and in the Regional programme on Wednesday (8.30 p.m.).

CHOPIN.

LOVERS of Chopin's music have two treats this week. On Tuesday, February 12th, at 8 p.m., Brussels No. 1 will give an exact repetition of Chopin's last concert, which he gave on February 16th, 1848.

On the following evening at 8 p.m. there will be a Chopin pianoforte recital by Smidowicz from Warsaw.

By the way, listeners who miss this recital might like to tune in a record of it which will be rebroadcast at 9.30 the same evening from Munich.

ELGAR'S MUSIC FOR CHILDREN.

THE greatness of Elgar is reflected in the manner in which his music can serve simple purposes. If he could write a "Falstaff" suite, he could also compose "Land of Hope and Glory" and "The Starlight Express." The last-named is one of his Pieces for Children which will make up a special programme at 10.15 on Thursday (National), when the B.B.C. Orchestra (Section E) will also play "Dream Children" and the "Wand of Youth" suites.

BEETHOVEN'S "MISSA SOLEMNIS."

COPENHAGEN'S "Thursday Concert" on February 14th should be tuned in by lovers of Beethoven, for it will comprise the "Missa Solemnis." The conductor will be Fritz Busch, and the soloist Koloman von Pataky (7 p.m.).

SHAKESPEARE ON SUNDAY.

BARBARA BURNHAM produces the Shakespearean broadcast on Sunday next (National, 5.30), when "Troilus and Cressida" will be given in the studio. Angela Baddeley will

THE BAND OF H.M. ROYAL HORSE GUARDS (The Blues) will be heard in a programme of Ketelby's music, to be relayed to-morrow (Saturday) from the Kingsway Hall (National, 7.30). The composer will conduct part of the concert.

take the part of Cressida, with Margaret Rawlings as Cassandra. The male cast includes J. Fisher White as King of Troy, while the four sons, Hector, Troilus, Paris, and Helenus, will be taken respec-

numbers by the Novelty Accordion Band. Both bands will be under the direction of Harry Bidgood.

GERMAN VARIETY

A CHANCE to hear a real Rhineland Carnival occurs on Monday at 10 p.m., when Cologne and Stuttgart are to broadcast a programme of this description with the promising title, "Jolly Sounds at a Late Hour." Earlier in the evening (7.15) Stuttgart will be relaying a "Great Variety Evening" from the Municipal Hall.

OPERA AND OPERETTA.

ITALIAN, French, German, and Russian opera can be had for the asking this week. Tonight at 7, Beromunster relays Verdi's "The Force of Destiny" from the Municipal Theatre, and to-morrow (Saturday) Prague offers Bellini's "Norma," relayed from the State Opera House. On the same evening at 8.30 Strasbourg relays "Waltzes from Vienna" (Strauss) from the Metz Theatre.

There should be fun for those who can follow German dialogue in the "Near-Operetta" which Berlin (Funkstunde) will broadcast on Sunday at 5 p.m. It is called "He, She and the Others."



"WRITTLE CALLING!" Captain P. P. Eckersley, formerly Chief Engineer of the B.B.C., who conducted the early broadcast tests from Writtle, Essex, fourteen years ago. He will take part in "Scrapbook of 1921" on Tuesday and Wednesday next.

tively by Ion Swinley, Eric Berry, Kenneth Villiers, and Barry Ferguson.

The recent broadcast of "The Winter's Tale" brought a large post bag of appreciations.

or the Week

roadcasts at Home Abroad



"TRANSATLANTIC"—an All-American variety programme to be broadcast to-night (Friday) at 8 on the Regional wavelengths, includes Buddy Rogers and June Clyde. The photograph shows them in "Dance Baid"—a forthcoming B.I.P. picture.

B.B.C. ORCHESTRA IN BRISTOL.

FROM all accounts, Bristol is fiercely excited over the approaching visit of the B.B.C. Symphony Orchestra on Wednesday, February 13th, when Dr. Adrian Boult and the 119 players will take the stage at the Colston Hall. Actually, the Orchestra is the biggest permanent musical combination in Europe.

The concert, which will be broadcast (National, 7.45 p.m.), includes Berlioz's overture, "Le Carnaval Romain," Beethoven's Symphony No. 8 in F, and the Delius Rhapsody, "Brigg Fair."

MUSICAL JOKES.

MUNICH should enhance its reputation for playing musical jokes at 7.45 on Wednesday in a programme entitled "Sonny Boy." There are to be amusing variations on the theme of this notorious song with more than an attempt at burlesque.

KING DAVID IN MODERN MUSIC.

HONEGGER'S Symphonic Psalm, "King David," must be accounted one of the most significant of modern oratorios, and, whether we can appreciate its musical idioms or not, it should be worth an attempt at listening at 9.20 on Sunday evening (Regional). The

Psalm comprises the entire "Sunday Orchestral Concert."

Soloists will be Isobel Baillie (soprano), Enid Cruickshank (contralto), and Frank Titterton (bass). Stuart Hibberd will be the narrator, and the B.B.C. Orchestra (Section B) will be conducted by Dr. Boult.

PRIZE WINNERS.

PRIZE-WINNING works in the recent Polish Radio Music Competition are to be broadcast from Warsaw at 8 p.m. on Tuesday, February 12th.

A RADIO DETECTIVE PLAY.

PLAYS written specially for broadcasting are still rare enough to be events of importance. "Roundabouts," a straight detective play by F. W. Beasley, is to be broadcast Nationally on Thursday next (8 p.m.), with Lance Sieveking as producer. The play, which won the first prize in the *Popular Wireless* Radio Play Competition, has most of its scenes laid in the general office of Bannister and Co.

It should, therefore, have the added glamour that mystery gives to everyday surroundings.

KEEPING YOUNG.

THE week's best title is offered by the EmDe Orchestra at Leipzig, broadcasting in the variety programme this evening at 8. The title is "Stopping Time's Tooth."

THE AUDITOR.

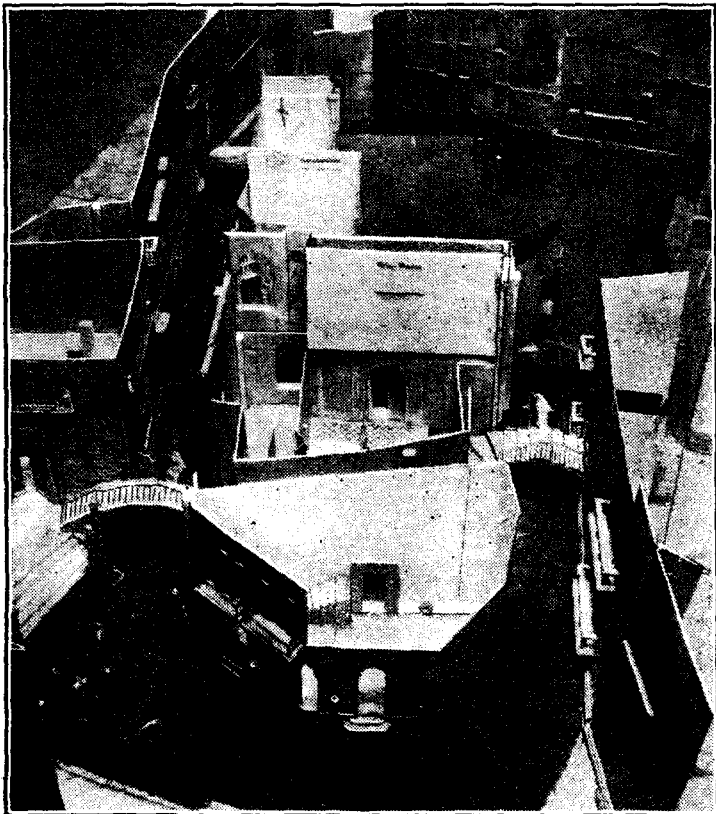

"BARCAROLE," a new UFA film, will be featured in songs and choruses in the Leipzig programme on February 11th at 7.10 p.m. Here is a model of the Venetian scenery used in "Barcarole."

HIGHLIGHTS OF THE WEEK

FRIDAY, FEBRUARY 8th.
Nat., 8.15, "Berkeley Square."
10, "The Tuppenny ha'penny Opera."
Reg., 7.15, The Wireless Military Band. 8, "Transatlantic," an all-American Variety Bill.
Abroad.
Milan, 8, Symphony Concert. Soloist: Wanda Landowska (harp-sichord).

SATURDAY, FEBRUARY 9th.
Nat., 7.30, Ketelby Concert by the Band of H.M. Royal Horse Guards. 8.30, "Music Hall," with Geraldo and His Gaucho Tango Orchestra. 10, "Macabre."
Reg., 7.30, The Serge Krish Septet. 8.30, Pianoforte Recital by Arthur Rubinstein.
Abroad.
Strasbourg, 8.30, "Waltzes from Vienna" (Strauss).

SUNDAY, FEBRUARY 10th.
Nat., 2, The B.B.C. Northern Orchestra. 5.30, "Troilus and Cressida." 9, The Bournemouth Municipal Orchestra. 10, Fred Hartley and his Novelty Quintet.
Reg., 4.30, The B.B.C. Orchestra (Section C). 5.30, The Wireless Military Band, conducted by B. Walton O'Donnell. 9.20, "King David."

Abroad.
All German stations, 8.30, Master Concert. Soloist: Wilhelm Backhaus (pianoforte).

MONDAY, FEBRUARY 11th.
Nat., 8, Songs from the Films—VIII. 9, Violin Recital by Isolde Menges.
Reg., 7.15, The B.B.C. Dance Orchestra. 8, "For it's my Delight" (from Lincoln).

Abroad.
Warsaw, 8, Concert of Lithuanian Music.

TUESDAY, FEBRUARY 12th.
Nat., 8, "Scrapbook of 1921."
9, A Programme of Gramophone Records, arranged by Francis Toye. 10.15, The Boyd Neel String Orchestra.

Reg., 6.30, Andrew James and His String Rhythmic Orchestra. 7.15, The Wireless Military Band. 8, Recital by Alma Moodie (violin) and Erdmann (pianoforte). 9, "From One Band to Another."

Abroad.
9, Brussels No. 1, Concert commemorating the crowning of Pope Pius XI.

WEDNESDAY, FEBRUARY 13th.
Nat., 7.45, The B.B.C. Symphony Orchestra (from the Colston Hall, Bristol).
Reg., 7.30, Organ Recital by G. Thalben Ball (from the Concert Hall, Broadcasting House). 8.30, "Scrapbook of 1921."

Abroad.
Munich, 7.45, Burlesque variations on "Sonny Boy."

THURSDAY, FEBRUARY 14th.
Nat., 8, "Roundabouts"—a radio play. 8.50, B.B.C. Theatre Orchestra.

Reg., 6.30, Parade of Northern Music Halls. 8, Café Colette Orchestra in Continental and other Dance Music.

Abroad.
Toulouse, 8.15, "Faust"—Opera in 5 Acts by Gounod.

New Apparatus Reviewed

Recent Products of the Manufacturers

PERTRIX 60-VOLT HT BATTERY

THE specimen battery that was sent in for test by Britannia Batteries, Ltd., Britannia Works, Union Street, Redditch, Worcestershire, was a 60-volt unit of the Yellow Carton series or standard capacity type, the normal discharge rate being between 7 and 10 mA. Following our usual custom, the battery was discharged intermittently through a fixed resistance for periods of four hours with similar time intervals for rest and recuperation.

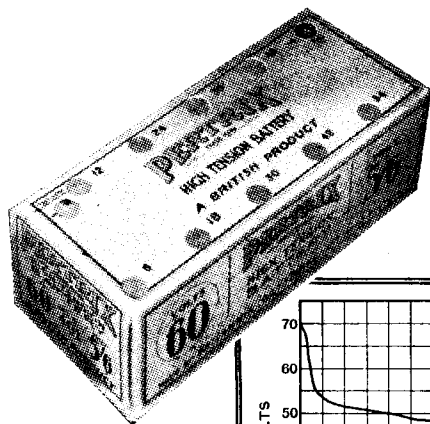

Discharge curve of Pertrix Yellow Carton 60-volt HT battery.

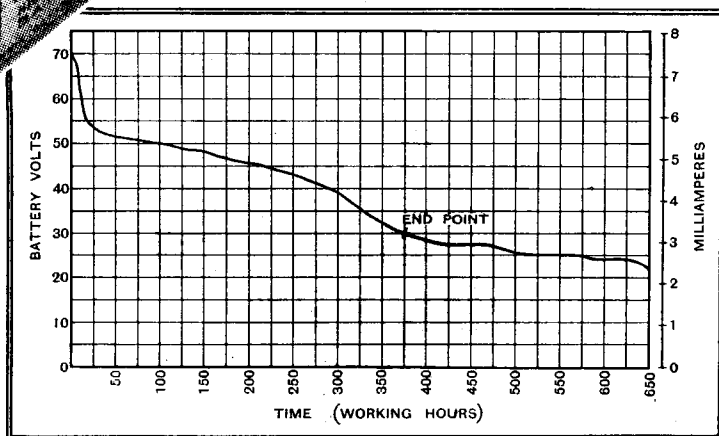

On the graph, however, only the actual working hours are given, while the curve shows the mean battery voltage during the discharge periods.

From this a reasonably good idea of its life can be obtained, for if we decide to keep it in use until each cell drops to 0.75 volt the end-point can be placed at a battery voltage of 30, which state is reached after 375 hours of use.

It is apparent from the curve that the battery is far from exhausted, nor does it show any tendency to cut-off on its own accord. The output continues for some 300 hours more at a fairly constant level, but below the theoretical end-point voltage.

The total capacity up to the assumed end-point is 85 watt-hours, and as it contains 40 cells each contributes 2.12 watt-hours. For cells of the size used in this battery a watt-hour capacity greater than two is very satisfactory indeed.

The battery is tapped every six volts, and the price is 5s. 6d.

RAYMART SHORT-WAVE COMPONENTS

SEVERAL new items that should interest the short-wave experimenter have been placed on the market by The Radio Mart, 19, John Bright Street, Birmingham. They are mostly of American origin and consist of coil formers, HF chokes and insulating

pillars. The coil formers are of two types, one a bakelite and the other an Isotex moulding, and both are fitted with base pins to fit American-type valve holders. The bakelite former is 1¼ in. in diameter and 2 in. long; the walls are thin and good quality material is used.

The Isotex former measures 1½ in. across and has eight ribs, the winding length being 2¼ in. The walls are comparatively thick, but as the material has good HF properties this should not introduce undue losses. In bakelite the price is 1s. 3d. for a 4-pin and 1s. 6d. for a 6-pin style, whilst in Isotex the prices are 2s. and 2s. 6d. each respectively.

Of the two HF chokes, one is a plain solenoid winding on a ¾ in. bakelite tube 2 in. long. It has a measured inductance of 135 microhenrys and is suitable for use up to about 50 metres. The other model consists of four honeycomb sections wound on a porcelain-type rod fitted with metal end-caps and wire connecting leads. Its inductance is

2,100 microhenrys, and this model should have a useful range of 10 to 200 metres or so. The standard model costs 9d., and the super type, as it is termed, 2s. 3d. The various sizes of stand-off insulators range in price from 6d. to 8d. each, whilst a flint-glass aerial insulator costs 6d.

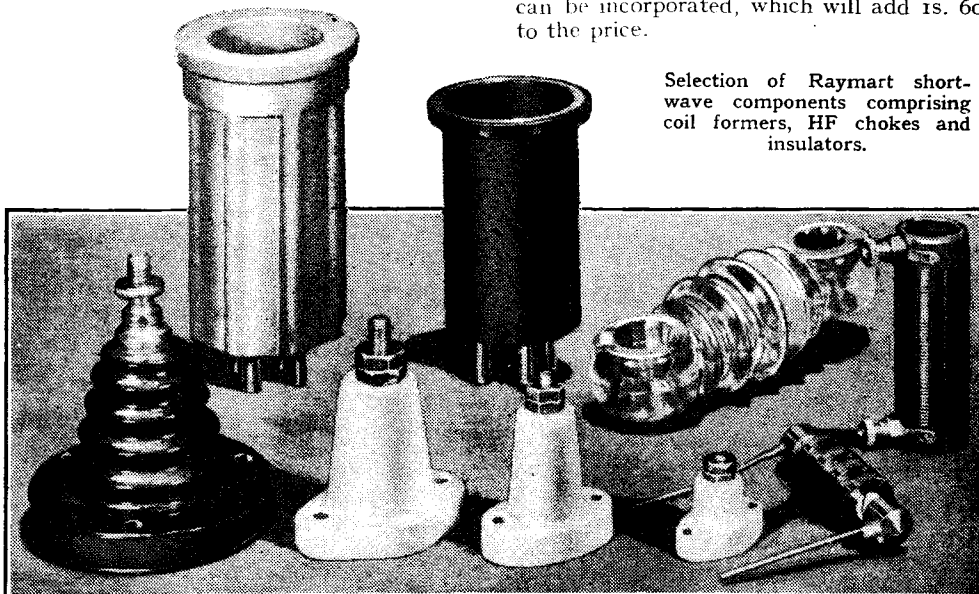

Selection of Raymart short-wave components comprising coil formers, HF chokes and insulators.

NEW MAGNUM SWITCH

THE multi-contact switches made by Burne-Jones & Co., Ltd., 296, Borough High Street, London, S.E.1, hitherto were fitted with gold-silver contacts, and this firm

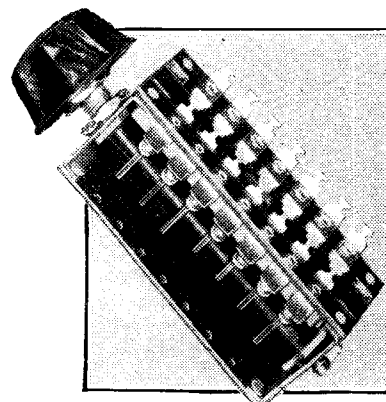

One of the new style Magnum multi-contact switches.

has now introduced a cheaper version for which are employed contacts of nickel-silver. The springs are rivetted to a bakelite strip with the ends projecting and shaped to form soldering tags.

The body of the switch is of box-type construction, and contact springs can be assembled on each side of the spindle which carries the operating cams. In quite a small space, therefore, a switch with as many as thirty-two pairs of contacts can be obtained.

We have tested a sample and find the switch perfectly reliable. The contact points "make" with a slight wiping action which appears to be quite sufficient to maintain a clean surface, for the contact resistance did not change within a measurable amount during our tests.

Prices range from 4s. for a switch with five pairs of contacts to 5s. 6d. for one with nine pairs, and three-, four- or five-position models are available at the same price.

A QMB switch for mains use or the like can be incorporated, which will add 1s. 6d. to the price.

BROADCAST BREVITIES

The P.M.G.'s Television Party

SIR KINGSLEY WOOD infused a rare sort of expectancy among the party of hard-boiled journalists who met in a House of Commons Committee Room last week. The excitement was natural, for the subject of television is outside the Pressman's usual range of topics.

When, with pardonable pride, the P.M.G. had made his statement on the findings of the Television Committee, he invited questions. One could tell from the questions that television is still suspect. No one really knows where it may end, and though Sir Kingsley raised a laugh, it was well that he did say that the art does not confer the ability to look into other people's houses.

New High Frequency Cable

One of the more important announcements was that a special new Post Office cable would permit the transmission of sufficiently high frequencies to link up the various ultra-short-wave stations which will eventually comprise the television chain.

The Provincial Transmitters

No decision has been taken regarding the position of the provincial stations which will follow the initial experiments in London, but we may assume without doubt that all the natural vantage points in the neighbourhood of large cities will be utilised. Height is the first essential.

The 30-line Tests

It is gratifying to know that 30-line experimenters are not to be left in the lurch. The Baird process tests from Broadcasting House will definitely continue until the hoary pioneers of today have a chance to acquire more ambitious gear.

The Pioneer Television Producer

When high-definition television tests really get going I hope that we shall not forget the pioneer work of Eustace Robb, who has done miracles with the material at his disposal in providing programmes of real entertainment value on the 30-line system.

Mr. Robb's Future

The list of artists who have built up these television programmes includes some of the most famous in this or in any other country; and the fact

that they were induced to make appearances in the flickering 30-line scanning beam must be largely ascribed to the vigour and optimistic outlook of Mr. Robb.

If he could make such a success of low-definition television, what could he not do with 240-line scanning and a larger picture?

When We Look

By the way, the man at the receiving end at last has an official designation. On page 22 of the Television Committee's report, reference is made to a "television looker's licence."

As Sir Walford Davies will say: "Good evening, television lookers all!"

Colonel Dawnay

THE resignation of Colonel Alan Dawnay from the Controldership of Programmes at Broadcasting House has aroused real regret among the staff. Those with whom I have spoken on the subject say that Colonel Dawnay "would have been just the man for the job" if his health had permitted it.

He never used his position of authority to embarrass his subordinates, and had a cheery word for everyone.

Americans and Dr. Boulton

DR. ADRIAN BOULT, who has just returned from America, covered himself and the B.B.C. with glory while in Cambridge, Massachusetts, where he conducted the Boston Symphony Orchestra.

Said the *Boston Evening Transcript*: "The performance of the symphony, Elgar No. 2 was warm and passionate."

And the *Boston Post*: "Dr. Adrian Boulton, who led the Boston Symphony Orchestra as guest, can say 'I came, I conducted, I conquered' . . . Tall, erect, spare, moustached and quite bald, Dr. Boulton is characteristically British of aspect. His light waistcoat and dark cut-away lent him a smart and worldly air. Of von Bülow's two kinds of conductors: those who have their heads in the score and those who have the score in their heads, it is the second to which Dr. Boulton belongs. He conducted Elgar's Symphony from memory."

Mr. J. H. Whitley

SIR JOHN REITH'S tribute to the late Mr. J. H. Whitley was notable for its deep sincerity. The association between the Chairman and the Director-General was more than that ordinarily subsisting between the chiefs of large organisations; they had great interests in common, and it is realised that Sir John will feel the loss acutely.

Mr. Whitley, after the conclu-

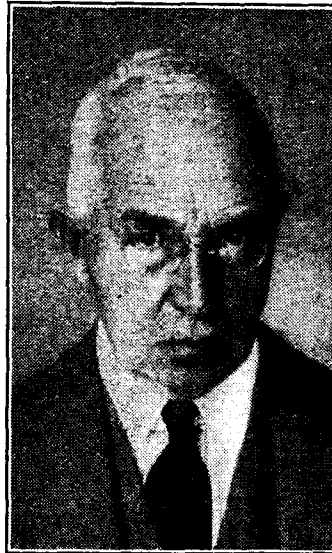

THE RIGHT HON. J. H. WHITLEY, P.C., whose death occurred on Sunday last. Mr. Whitley had been Chairman of the B.B.C. Board of Governors since 1930.

sion of his long and honourable political career in 1928, when he had been Speaker of the House of Commons for seven years, cheerfully assumed the burdens attaching to the chairmanship of the B.B.C., and at all times was ready to place his unique experience at the disposal of his fellow governors and the staff.

It is probable that the vice-chairman, Mr. R. C. Norman, will be his successor.

Breakfast Broadcasting

ONLY the fact that another shift of engineers would be required is staying the hand of the B.B.C. in the matter of early morning broadcasts.

I would direct the attention of the B.B.C. to France, Holland and Germany, where morning broadcasts are considered, like the morning milk delivery, to be part of civilised life

By Our Special

Correspondent

No Public Tests for Midland Regional

ARE the B.B.C. engineers growing cocksure? For the first time they are launching a station without preliminary public tests. Midland Regional will take the air on February 17 and Daventry 5GB will close down completely.

A Helping Hand

Just in case the new wavelength of 296.2 metres causes some difficulty among inexperienced listeners the B.B.C. has issued a booklet, "The New Midland Regional Transmitter," which can be had on application to the Corporation at Portland Place or Birmingham. It is emphasised that this book is purely for Midland listeners.

Newcastle in Fancy Dress

ALTHOUGH the completion of the North-Eastern broadcasting station seems a long way off, the Newcastle studios have been completely refurbished to bring them up to the status of an Area headquarters. The entrance hall and studios have been refitted from designs by Mr. Wells Coates, of London, who was responsible for several studios in Broadcasting House.

There are three studios, an echo room, listening room, control room, battery room and machine room. The control room is somewhat like a signal box at a railway junction, for it is equipped for handling all programmes passing to and fro between England, Scotland and Northern Ireland.

In the listening room a quality check can be made on the transmissions as they pass through. If necessary, Newcastle can give a boost to a wilting soprano note on its way from Portland Place to Queen Street, Edinburgh.

The Trudge to Work

LONDONERS who pass through Trafalgar Square at 8.15 a.m. on February 27 may be forgiven for a touch of self-consciousness, for Mr. J. C. Cannell will be perched on the roof of St. Martin's-in-the-Fields, giving Empire listeners an eye-witness impression of London going to work.

Mr. Cannell, who will have an excellent view of the Square and Charing Cross station, will describe the mighty tide of workers.

Many a Colonial listener in fly-infested mud hut, on hearing this broadcast, will thank his lucky stars.

Sound Reinforcement in Theatres

Acoustic Deficiencies Remedied Electrically

By A. T. SINCLAIR

STEADY advances are being made in improving audibility in theatres by means of amplifying apparatus. It is now claimed that there is no technical reason why speech from the stage should not be heard with ease and clarity from every seat in the auditorium—even when conditions are poor from the acoustic point of view.

IN recent issues of *The Wireless World* attention has been drawn to the apparent lack of application of sound amplifying apparatus to the reinforcement of the speech and music in theatres. Apparatus specifically designed for this purpose is now available, and it is thought, therefore, that some details of such equipment may be of interest to readers.

Up to a year or two ago the application of sound reinforcement in theatres was not seriously considered for a number of reasons. First, the theatre patrons themselves, prior to the advent of talking pictures, did not realise the limitation of the human voice and took their inability to hear distinctly in certain parts of the theatre as a matter of course. Secondly, the quality of the reproducing apparatus available but a few years ago was poor at best—certainly no better than the radio sets of the same date—and the few isolated early installations gave sound reinforcement a bad name. Thirdly, there still exists some trace of resentment against the mechanisation of the entertainment industry, as repre-

sented by the "talkies," and it was maintained that as the theatre had succeeded in the past without artificial aids to hearing, so it could continue to do so in the future.

During the last few years the public has become "sound conscious" and critical, thanks to the steady improvement and widespread use of wireless receivers and talking pictures, and in consequence is less inclined to go to a theatre where, in the less favourably situated seats at least, they have to strain to hear the dialogue, and frequently miss important words in the play.

Recently, considerable attention has been given to this problem in America, and it has become common practice for sound reinforcing apparatus to be included in the specification for new theatres in that country.

Basically, sound reinforcement equipment consists of a number of microphones grouped near the stage and coupled through suitable mixers to an amplifier, the output of which is fed into suitably positioned loud speakers. A typical installation is shown below.

Considering the apparatus in detail, we have first the microphones. Various types are used, the main requirements being high quality and reasonable sensitivity combined with a strong compact construction. The "velocity" or ribbon microphone has proved particularly satisfactory, for not only has it an excellent frequency response but its highly directional

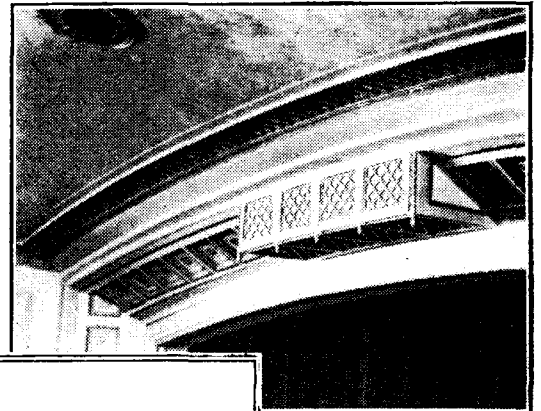

Loud speakers inconspicuously installed above the proscenium arch.

characteristics render it largely immune from "feedback" troubles.

In the majority of installations the microphones are set in the footlights trough where they are favourably situated for picking up the stage sounds and yet are concealed from the view of the audience. To provide

an even pick-up from all parts of the stage, they are usually placed about 8 feet apart, and hence on a large stage there will be from five to eight microphones in the footlights. Occasionally, these are supplemented by additional microphones located in the orchestra pit, in the wings, or on the lighting bridge over the stage, according to the shape of the stage or the nature of the production.

In one system each microphone is coupled *via* a jack panel to a microphone amplifier and thence to a mixer panel, where the signals from the microphones

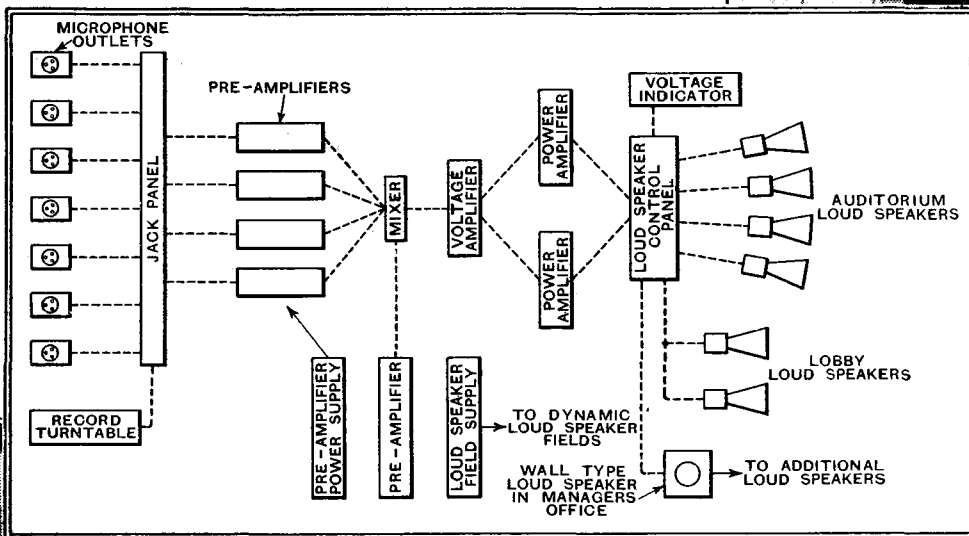

Electrical arrangement of a typical sound-reinforcing installation.

Suitable apparatus is now available from a number of manufacturers in this country which, when correctly applied, enables sound from the stage to be reinforced and distributed in the most "difficult" theatres so as to give entirely satisfactory volume and intelligibility in all parts, and—most important—without the audience being conscious of the artificial aids employed. It has also been found that such apparatus appreciably increases the scope of the musicians and stage artists by enabling them to put over effects and subtleties previously impossible.



A microphone installed in the footlights trough

Sound Reinforcement in Theatres—

are combined at the desired relative values and thence transmitted to the main amplifier. In other systems the individual microphone amplifiers are omitted, the signals being mixed at a low signal level and subsequently passed through a "booster" amplifier before reaching the main amplifier input.

The main amplifier usually has two or

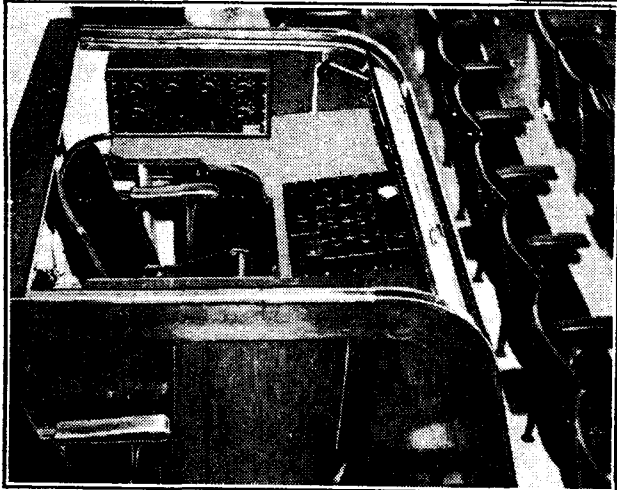

Sound control console, showing mixer panel and loud speaker controls.

three stages of "voltage" amplification, terminating in a power stage of a size dependent on the seating and cubic capacity of the theatre.

An approximate estimate of the power of the amplifier may be obtained by using the figure of 10 watts maximum undistorted power output per 1,000 seats. This figure assumes the use of high-efficiency directional loud speakers and average acoustic conditions.

The amplifiers follow modern talking picture amplifier practice, and are entirely mains operated, suitable rectifiers being incorporated in each amplifier assembly. All-steel construction is employed, and elaborate precautions are taken to keep hum and other extraneous noises at a very low level. The microphone amplifiers, in view of the number required, are more economically fed from a central rectifier panel, and are therefore of somewhat simpler construction.

Electro-dynamic loud speakers are used in association with short horns or directional baffles to project the sound in the required directions. They are preferably located at the sides or above the proscenium arch, concealed from the view of the audience by ornamental grilles or other devices according to the nature of the theatre. In new theatres, of course, it is possible to incorporate the loud speakers in the general scheme of decoration.

An example of the addition of loud speakers to an existing theatre is shown in an accompanying illustration.

To obtain the best results from the more elaborate installation, all of the reinforcing apparatus is placed under the control of a supervisor who is seated in a suitable position at the rear of the auditorium where, although screened from the view

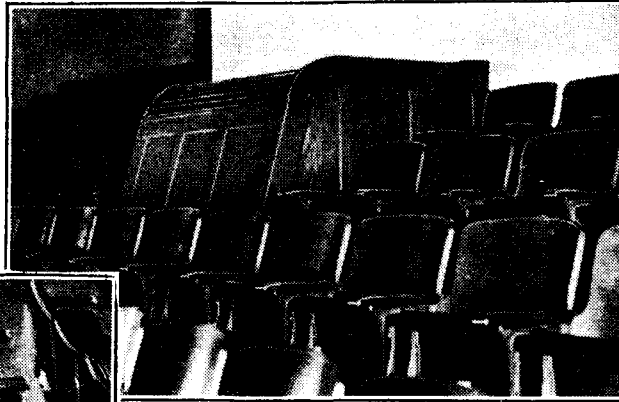

The control console, at the rear of the theatre balcony, may be closed up like a roll-top desk.

of the audience, he has an uninterrupted view of the stage. He is provided with equipment in the form of a sound control console which enables him to adjust the degree of sound reinforcement according to the action proceeding on the stage.

In those theatres already equipped with talking picture apparatus it is usually possible to use the "talkie" amplifiers for sound reinforcing purposes, but as the stage is occupied by actors and scenery the normal cinema loud speakers cannot be used, and it is necessary to have additional units arranged around the front of the proscenium arch as described above. In such instances the microphone pre-amplifiers and power supply units are installed in the projection booth adjacent to the exist-

ing main amplifiers in order to centralise the installation. In theatres not already equipped with talking picture apparatus, however, the position of the amplifiers, etc., may be varied to suit circumstances, and in some instances they are grouped entirely back-stage.

Some of the larger cinemas in this country, where stage turns are provided as part of the regular programme, have already installed modern stage reinforcing equipment, and it is hoped that the excellent results

that are being obtained with such installations will induce our enterprising theatre managers to provide this overdue improvement in their theatres. An interesting example is that of the open-air theatre in Regent's Park, where the success of the venture depends to a large extent on the skilful employment of sound reinforcing apparatus.

Thus it may be seen that with the satisfactory equipment now available there is no reason why—even in the largest or in acoustically defective theatres—speech from the stage should not be heard with ease and clarity from every seat in the auditorium. Once the theatre-goer has realised the possibilities of this, we may hope that perfect speech audibility in the theatre may become an accepted fact.

Thanks are due to Messrs. R. C. A. Photophone, Ltd., for permission to publish the photographs illustrating this article.

Twenty Years Ago

Extracts from *The Wireless World* of February, 1915

Letter to the Editor from a reader sentenced by court martial to six months' imprisonment:—

"I would like to thank you, sir, for giving due prominence to my unfortunate case, as I hope it will serve as a warning to other experimenters to have every particle of their apparatus removed, sealed, or obtain a permit to keep component parts of apparatus on their premises, as part of the apparatus mentioned in my case was simply a buzzer set with which my wife and I had been keeping up our morse practice. I, therefore, tremble to think what would happen to any unfortunate amateur who was found by certain Territorial officers to have in his possession a practice set as described by Mr. Cyril C. Barnard in your November issue.

"Apologising for taking up your valuable space, I am,

"Yours faithfully (sgd.) —"

A Loud Speaking Telephone, by "L. W. P." (Pomponne, France).

"I have now completed a loud speaking telephone. . . . I took a thin copper tube and soldered it to the centre of the diaphragm of a 6,000 ohm receiver, taking great care not to overheat the diaphragm, and so deform it. In this I fixed the lead of an HH pencil and approached a small block of carbon armed with a copper spring $\frac{3}{16}$ mm. x 1 mm. This microphone is connected to another receiver of about

25 ohms, which is again armed with another microphone exactly similar to that on the 6,000 ohm, which in its turn works a receiver of 10 ohms fitted with a trumpet.

"I get all FL signals very clearly; they can be heard nearly all over the house. I have had KAV, but to be able to be certain of getting him every time I am making a sound-proof box so that the microphones will not pick up outside noises."

From "Wireless Telegraphy in the War"

"Carpentier, the famous French boxer, is serving with the French Army as wireless operator signalling to aeroplanes. For a week he was engaged with the 3rd Siege Battery, when, at Soissons, one of its guns was put out of action through a German shell smashing the axle of one of the wheels. Shells were falling all around, and one of them smashed the apparatus with which Carpentier had been receiving messages from the aeroplanes telling the battery the range."

COSSOR MODEL 369

A New Universal AC/DC Mains Receiver

DESIGNED to appeal to the man of moderate means, this latest addition to the Cossor range employs "Super-Ferrodyne" iron-cored coils in a "straight" circuit comprising a variable- μ pentode HF amplifier, HF pentode detector, and a power pentode output valve. The specification includes a permanent magnet moving-coil loud speaker, and the price has been fixed at the very attractive figure of £8 18s. 6d.

FOUNDATIONS OF WIRELESS

XI.— Transmission and Reception in Simplest Terms

A PARTICULARLY helpful exposition of the essentials of wireless communication. Readers who have missed the purely theoretical section of this series may conveniently start at this point

By A. L. M. SOWERBY, M.Sc.

(Continued from page 124 of February 1st issue)

As mentioned at the end of Part X, we have now covered with fair completeness the basic theory that forms the foundation of wireless. But the bare bones of theory certainly do not take us very far towards a comprehension of the performance of a wireless receiver. Valves, for example, have hardly been mentioned; there is no "theory of valves" in any absolute sense, but there are plenty of experimentally determined facts about valves to which no particular meaning can be attached, and from which no useful information can be gained until the theory we have discussed is applied to them.

But before we can make any useful progress along such lines as these we must digress, for this one Part, from the main path, and apply our theory to a fuller elucidation of the nature of the signal received from a wireless station. This will mean going over, to some extent, the ground covered in the introduction to this series,¹ now making concrete and definite several points there touched upon only in the vaguest and most general terms.

We have seen that a simple high-frequency current consists of electricity surging back and forth an enormous number of times per second. If we imagine that high-frequency currents are generated, in some unspecified way, in the tuned circuit L_1C_1 of Fig. 54, then if L_1 is coupled to L_2 , as the diagram suggests, similar currents will appear in the latter coil. If this is connected between earth and an aerial, the capacity between the aerial and the ground beneath it can be used to tune L_2 to the frequency of the current, as indicated by the dotted lines which represents the aerial-earth capacity.

This means that the aerial will be charged and discharged at high frequency exactly as was the condenser in the simpler circuit described at the beginning of

Part IV. *An aerial which is charged and discharged in this way radiates some of the energy supplied to it out into space in the form of a wireless wave.* In this Part we shall consider the way in which this carrier wave is made a vehicle for carrying music and speech to the listener, and how the receiver disentangles from it the message it has brought.

We have already had occasion to represent the high-frequency current in an oscillating circuit by a sine-wave, as in Fig. 55. If this current is conveyed to the aerial in some such way as suggested in Fig. 54, the aerial and earth system will send out into space an electromagnetic wave consisting of varying electric and magnetic fields which travel outwards from the aerial with the speed of light. At any point to which these fields reach on their travels, their intensity varies with time in exactly the same manner as does the current in the aerial. Fig. 55 will therefore serve to represent this wave, although the curve is in no sense a physical picture of it; it is simply a record of the way in which the intensity of the field varies with time.

If a continuous wave of this type were sent out from a transmitter it could convey no more information than a steady beam of light from a lighthouse. Lighthouses are accustomed to announce their identity to the navigator by periodic rhythmic interruption of their light, sending out in this way a sort of "call-sign" of long and short flashes. In just the same way

To convey speech and music, something more elaborate than simple interruption of the transmission is required, though the continuous carrier wave is still the basis of this more advanced type of transmission.

Modulating the Carrier

We will imagine that it is desired to transmit a pure note of 1,000 cycles, available in the form of an electric current derived, eventually, from the microphone before which the note is being sounded. This current will also have a form like that of Fig. 55, but the time-scale will be profoundly different from that used when the curve represents a radio wave. If the wave corresponds to 300 metres, each audio cycle will extend over a thousand radio cycles. To enable the musical note to be conveyed by the carrier wave these two oscillations have to be combined to make a single wave. It is essential to grasp the character of the resulting complex oscillation, because it is this, as picked up by the receiving aerial, that forms the raw material with which the receiver is designed to deal.

In Fig. 56a is depicted the "wave-form" of a high-frequency carrier wave, while *b* shows, to the same scale, the musical note which we wish to combine with it. At first sight it might seem that it would be sufficient to add the two currents together and allow them both to flow in the aerial. Such a mode of combining them results in the wave-form shown in

full-line in Fig. 56c. Examination of this figure will show that the two currents, although they are flowing simultaneously in the same circuit, are still independent, the whole consisting of the original high-frequency current "wrapped round" the original low-frequency current *b*, which is shown dotted.

Successive peaks of the high-frequency voltage are still alike, as in *a*; the only change lies in replacing the straight zero-line of that curve by curve *b*. In view of the known fact that an aerial will not radiate a low-frequency voltage to any

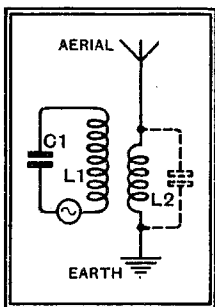

Fig. 54.—Schematic diagram showing how a wireless wave originates at the transmitting station. The coil L_2 is tuned by the capacity (shown in dotted lines) existing between the aerial wire and the ground beneath it.

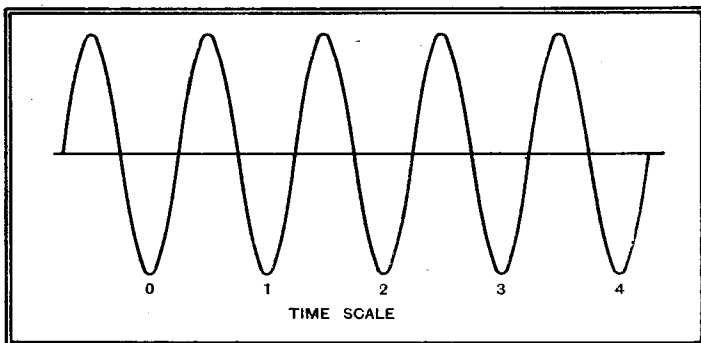

Fig. 55.—Curve representing rise and fall of current in L_1, C_1 (Fig. 54), rise and fall of voltage on aerial, or rise and fall in strength of field due to radiation. If $f = 1,000$ kc/s ($\lambda = 300$ m.) the unit of time is one-millionth of a second.

a wireless transmitter can convey messages by periodically interrupting its wave, breaking it up into the short and long bursts of transmission that represent the dots and dashes of the Morse code.

¹ "Broadcasting in Outline," *The Wireless World*, November, 9th, 1934, p. 360.

Foundations of Wireless—

appreciable extent, it is clear that if an attempt were made to send out *c* as a signal, the high-frequency component would set up its usual wave, as at *a*, in which the low-frequency component would not be represented.

It is clear, therefore, that simple addition of the currents will not provide us with a resultant current of a suitable type for radiation; we will therefore try multiplication.

Let us suppose that the amplitude of the high-frequency voltage in the aerial

frequency output from the generator would also rise and fall, this rise and fall being strictly in time with the audio-frequency voltage we wish to transmit.

The result of this more elaborate means of combining the two curves, which amounts to multiplication of the one by the other, is shown at *d* in Fig. 56, where it will be seen that the amplitude of the high-frequency voltage is now actually changing at audio-frequency. Except as an impress on the total amplitude of swing the audio-frequency voltage has disappeared; it is now represented by the *en-*

a wavelength of 30,000 metres. To show a 1,000-kc/s (300-metre) carrier in its correct relationship to *b* there should be 100 complete high-frequency cycles in the place of every one shown. A little imagination must therefore be applied to Fig. 56 before it can give a correct impression of a normal broadcast wave.

Even so, *d* represents nothing more exciting than a tuning-in note; for music or speech the form of *b* is extremely complex, and this complexity is faithfully represented in the envelope of the modulated carrier *d*.

Nevertheless, the diagram gives a very fair mental picture of the modulated carrier which flows, as a current, in the transmitting aerial, and is radiated outwards through space as a wireless wave.

At the receiving aerial, this wave sets up currents which, apart from any distortion they may have suffered in their journey through space, are an exact duplicate in miniature of the currents in the aerial of the transmitter. By some simple circuit, such as that of Fig. 57, they can be collected and caused to flow, in magnified form, round a tuned circuit. The function of even the simplest receiver is to convert these electric currents into sound so that the programme may be enjoyed.

Why Detection is Necessary

If telephones were connected to the circuit, either by inserting them at X to allow the circulating current to flow through them or by joining them across A and B so that the voltage on C would drive a current through them, no sound would be heard. The reason for this can readily be appreciated by considering Fig. 58*a*, which repeats the diagram of the modulated carrier. Any two consecutive half-cycles of the current are approximately equal (in a practical case, much more nearly equal than in the diagram) and so neutralise each other so far as the telephone diaphragm is concerned, it being understood that this cannot possibly vibrate at the frequency of the carrier. The average current through the telephones, even measured over an interval as short as a ten-thousandth of a second, is therefore zero.

But if we could find some means of wiping out one-half of the wave, so that it took on the form shown at *b*, we should have a current to which the telephones could respond, for the average current would then be greater at A than at B. While unable to follow the carrier-frequency alternations individually, the telephone diaphragm would then rise and fall at the rate of their variation in ampli-

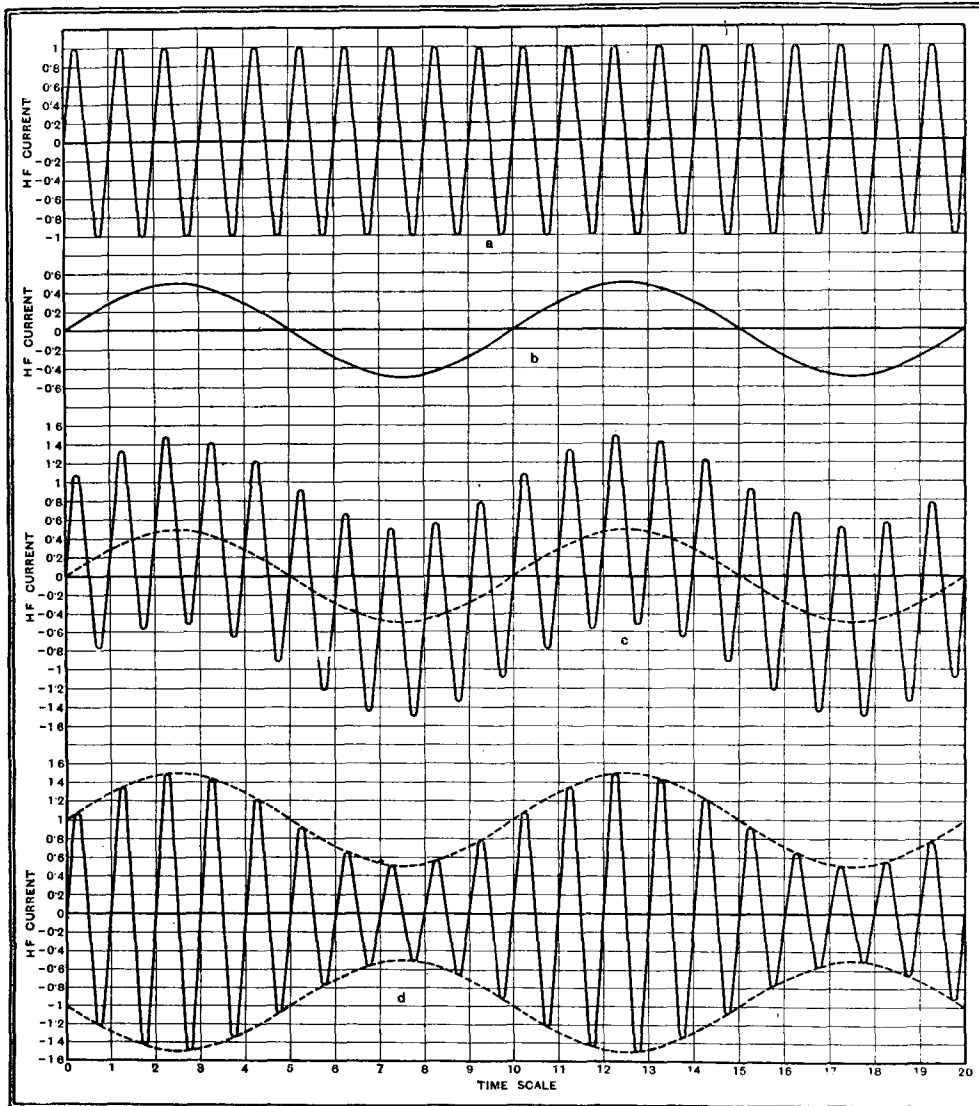

Fig. 56.—Diagrams *a* and *b* shows a high-frequency current and a musical note to be combined with it for transmission. Mere addition of the currents results in *c*, in which the currents remain separate so that only the HF component would be radiated. Diagram *d* shows the modulated carrier resulting from multiplying the curves as described in the text: it is radiated complete from the aerial.

depends upon the DC voltage used to drive some part of the apparatus generating the oscillation. The height of curve *a* might then be 100 volts if a 500-volt battery were used, but might rise to 150 or drop to 50 volts if the battery were suitably increased or decreased in voltage. We might now introduce the audio-frequency voltage we desire to transmit in series with this imaginary battery; then the total voltage reaching the HF generator would swing about its mean value, the audio-voltage alternately adding to and subtracting from the battery voltage. In consequence the amplitude of the high-

velope (dotted) of the curve as a whole.

A curve such as *d* represents a modulated high-frequency current or voltage. It is fairly evident that if this is allowed to flow in an aerial the radiated wave will follow, in its rise and fall, the rise and fall of the current, since the whole is now a high-frequency phenomenon.

The observant reader will have noticed one important inaccuracy in the diagram: it does not bring out clearly enough the enormous difference in frequency between the carrier and the modulation. If, as suggested, *b* shows a 1,000-cycle (1 kc/s) note, *a* represents a 10-kc/s carrier, having

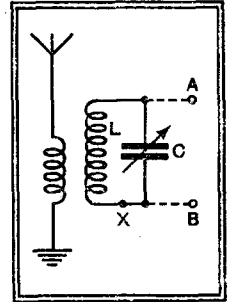

Fig. 57.—Showing how the modulated carrier (Fig. 56*d*) is "collected" by the aerial in the form of currents of the same wave-form and passed to the tuned circuit LC as the first stage in reception.

Foundations of Wireless—

tude. Since these variations are due to the 1,000-cycle note modulating the carrier, it

will be seen that for 0.25 volt in one direction the current is 95 microamps., whereas for the same voltage in the other direction

current through the crystal will vary, as Fig. 60 shows, between 15 and 75 microamps. as the carrier rises and falls. The current through the telephones will follow the curve of Fig. 62b, and will have an average value, as read by a milliammeter reading DC, of about 45 microamps. Fig. 62b thus represents the sum of two currents; a direct current of 45 microamps. on which is superposed an alternating current of frequency 1,000 cycles and peak value 30 microamps. This last, it will be observed, is the modulation-current that the carrier-wave has conveyed from the transmitter to the listener's ear. The whole process can be completely studied with the aid of the voltages and currents added to the curve of Fig. 60.

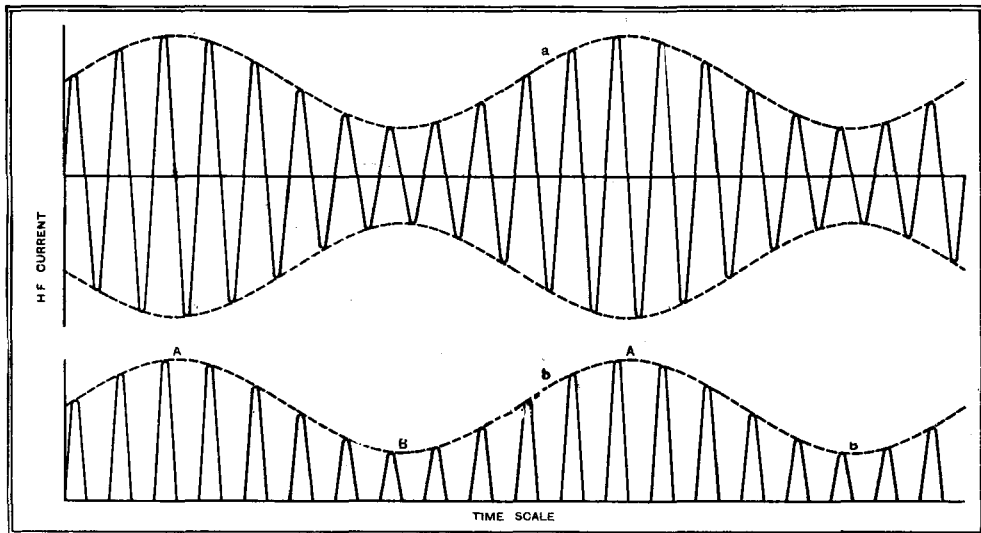

Fig. 58.—Modulated HF current (diagram a). Over any period of time appreciably greater than an HF cycle, the average current is zero, and so is inaudible in telephones. The same current, rectified, is shown in diagram b. The average current now rises and falls at modulation-frequency and can now be heard in telephones.

is this note, which we want, that would be heard.

The process of suppressing half of a complete wave, thus converting alternations of current into a series of pulses of unidirectional current, is called by the general term *rectification*. The particular case of recti-

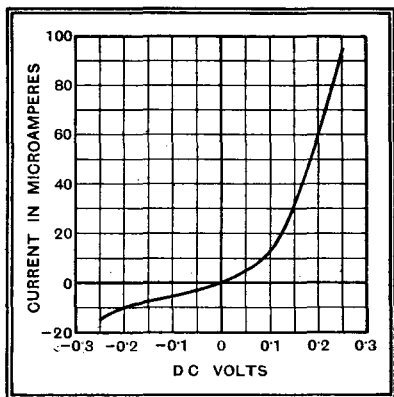

Fig. 59.—Current through crystal detector for various values of applied DC voltage. Note the marked difference in current for equal voltages in opposite directions.

fying a modulated carrier in such a way as to reveal the modulation is known, in this country, as *detection*, and in America as *de-modulation*. It can be performed by any device which conducts current, or responds to a voltage, in one direction only, or, less perfectly, by any device which has a lower resistance to currents, or a greater response to voltages, in one direction than in the other.

For the purpose of a simple set a *crystal detector* has been very widely used, this consisting of two dissimilar crystals, or one crystal and a metal point, in light contact with one another. Curves (based on data from Morecroft's "Principles") of a "perikon" (two-crystal) detector are shown in Figs. 59 and 60.

In the first of these is plotted the current through the crystal for various applied potentials from -0.25 to +0.25 volt. It

is only 15 microamps. If an alternating voltage of the same peak value is applied the current will vary rapidly between these very different limits in the two directions, so that there will be an average current derived from the differences shown. The curve of Fig. 60 shows how the average unidirectional current varies with the value of the AC voltage applied.

If we make up a receiving circuit as shown in Fig. 61, putting crystal and telephones in series across the tuning condenser, we shall apply the modulated

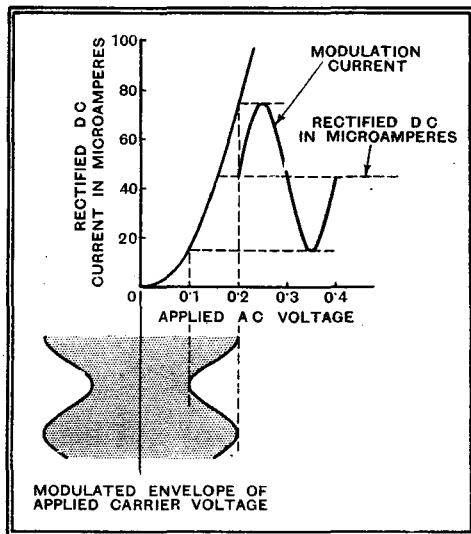

Fig. 60.—Curve shows direct current through crystal resulting from application of AC voltage. It represents difference between average positive and average negative currents. Also rectification of modulated carrier.

carrier voltage to the crystal, and the resulting unidirectional current will flow through the telephones. If we suppose that the voltage across the crystal is due to the unmodulated carrier is 0.15 volt., and that when the 1,000-cycle modulation is applied it varies between 0.1 and 0.2 volt, as suggested in Fig. 62a, then the

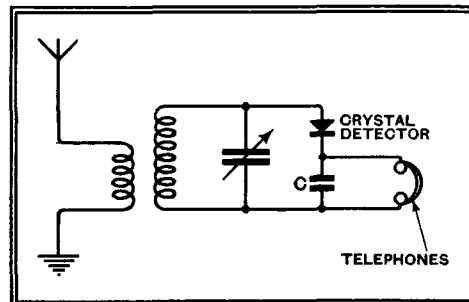

Fig. 61.—Circuit diagram of simple crystal receiver.

The condenser bridging the telephones in Fig. 61 is inserted so that the high impedance that the windings of the telephones would offer to the high-frequency currents may be effectively short-circuited. The capacity must be high enough to offer a reasonably easy path to high frequency, but must not be so high that the currents of modulation frequency find it an easier path than the telephones.

We have only discussed the reception of a carrier-wave modulated by a single 1,000-cycle note. The microphone-currents representing a whole orchestra are of a complexity almost infinite in comparison,

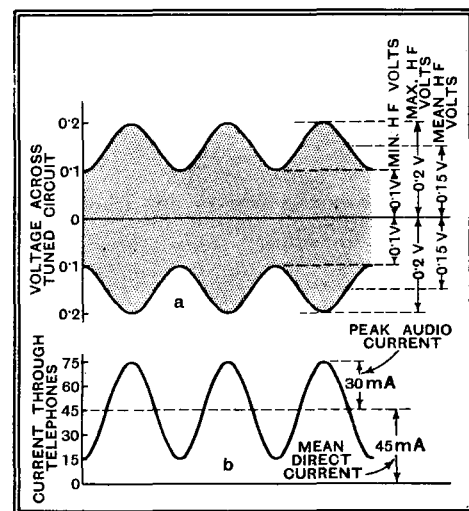

Fig. 62.—Rectification: Diagram a shows voltage across tuned circuit (Fig. 61) and hence voltage applied to crystal. High-frequency cycles shown by shading only: there should be some thousands of them. Diagram b shows rectified current through telephones resulting from a. Figures taken from Fig. 60. Note that current consists of 45 μ A. DC, plus 30 μ A. (peak) of modulation-frequency current. Compare Fig. 60.

Foundations of Wireless—

but the processes of modulation, transmission, and detection apply just as well to a complex modulation-envelope as to a simple one. In discussing our 1,000-cycle note we have therefore covered, in principle at least, the whole problem of transmitting music and speech.

The circuit of Fig. 61 is that of a simple receiver, but it contains the kernel that every receiver must have. The two essentials are tuning, to select the required signal, and detection, to extract the modu-

(To be continued.)

lation-frequency currents from the received carrier. In addition, of course, telephones or loud speaker are needed to convert these currents into air-waves.

We may add more tuned circuits to increase selectivity, and amplifiers operating on the signal either before or after detection (or both) to render the set more sensitive. But all these additions are only "frills"; the crystal set described contains the central nucleus of tuning plus detection upon which every set, no matter how ambitious, is ultimately dependent.

Letters to the Editor

The Editor does not hold himself responsible for the opinions of his correspondents

Frequency Separation

THE letter from Mr. A. H. Wickham, in your issue of January 18th, is not a good example of clear reasoning.

First he says that to transmit up to 13 kc/s would call for a station separation of 26 kc/s; later he says that we can, in practice, get reception up to 6 kc/s from stations 9 kc/s apart! He can't have it both ways: if the latter statement is true, only 20 kc/s separation is required for reception up to 13 kc/s, so only half the transmitters need go.

Next he implies that the "top octave," containing only "the feeble higher harmonics and hiss" (in his own words), is not important. Hasn't he yet realised that it contains the "colour" which distinguishes the upper notes of a violin, an oboe, and a piccolo from one another?

He postulates, as a test, the cutting in and out of filters on a really good transmission before an audience of ordinary people. Is he really unaware that this was done by the Bell Telephone Laboratory some years ago? The published record of the tests gives all the data, showing that the audience had no clue as to what changes were being made; and the result was conclusive that response up to 10 kc/s was wanted for music, and up to 14 kc/s for "effects" noises.

P. K. TURNER, M.I.E.E.,
Hartley Turner Radio, Ltd.

Isleworth.

"W.W." Sets—Single Span AC

I WELCOME the suggestion of your correspondent that readers should report on the results obtained with *Wireless World* receivers in their own localities.

My present receiver is a Single-Span AC model entirely home-constructed. The receiver chassis is built exactly to specification, with home-made coils, but the power unit has been modified to the extent that choke capacity output has replaced the transformer, so that an inductor speaker on hand might be used. A fairly good aerial and earth are used.

As far as can be judged with a speaker deficient in "top" this set gives better quality than any I have yet handled. (Incidentally, it gives a good clear image on television—always an acid test of frequency response.) The sensitivity is sufficient to enable many medium-wave foreigners to be received at good strength in daylight, and AVC works well. The selectivity is

entirely adequate on all strong stations, but as it depends on a combination of reaction and AVC it sometimes allows one station to pass right cut and another come in when fading is bad. I am a little troubled by what appears to be modulation hum when using critical reaction. The only complaint I can make against this excellent set (and this is no doubt due to some as yet undiscovered fault) is that most transmissions (locals as well as foreign) are accompanied by a faint high-pitched whistle. This applies to medium waves only after dark, but at all times on Droitwich. Experiments with wave-traps and re-trimming at different frequencies have not enabled a cure to be made, and I should be very interested to learn if other readers are troubled in this way, and should welcome any suggestions as to its cause and cure.

To my mind this set is the ideal one for all who desire a medium-range, high-quality receiver, and I am only waiting the suppression of the above-mentioned whistles before building the W.W. Quality Amplifier and obtaining a speaker more worthy of the splendid quality available.

JAMES F. NOAKES.

Tunbridge Wells.

Pitch Distortion

IN your first issue of this year, under "Broadcast Brevities," I found a small note entitled "Key Distortion," which explained the difference in pitch of the various contributions to the National Anthem symposium by the Empire as due to "atmospheric distortion."

By "atmospheric distortion" I presume that the radio link between relay and receiving station is referred to, as it is inconceivable that the Canadian chorus, for example, was receding from the microphone (or vice versa) at a speed of about 100 m.p.h., as would be required to account for the Doppler effect in dropping the pitch by nearly two tones, as we all heard.

We must presume, then, that the distortion occurred in the reflection from the ionised layers and took the form of an approach of the sidebands of all the modulation by about 0.05 k/c to the carrier, and, moreover, remained steady (within audible limits) during the performance.

I should be very much obliged if your Special Correspondent (or any ingenious reader) could enlighten me on this matter, as hitherto I have been under the impression that, although practically everything else

in the modulation is distorted in long-distance transmission, the pitch remains true.

What about those transmissions of standard frequency? E. F. POWELL.

Sutton Coldfield.

I WOULD like to point out that the probable cause of "Key Distortion" was that the various countries concerned in the simultaneous broadcast of the National Anthem commonly use a different "pitch." As is well known, new Philharmonic is in common use in this country, with C at 522 cycles, or near, per sec. "Continental" is, I believe, nearly a semitone lower, and, as every musician knows, military bands use a slightly higher pitch.

Although all the singers used the nominal key of G it does not follow that they were all singing in the same actual key.

D. H. WALTON.

West Molesey.

Reception of Droitwich

THE report published by Mr. Meunier, of Bourg, France, may give a wrong idea of the strength of British stations. I am living only 80 miles from Mr. Meunier, and with my New Monodial AC Super (built exactly to specification, except that I replaced the American heptode by an octode) I can tune in Droitwich at noon every day at full strength, without background noise. This station comes in stronger than Zeesen, which is probably due to the AVC system and deep modulation of Droitwich.

Since December I have been able to tune in West Regional, Brookmans Park, and North Regional, from 1 p.m. There is a serious background noise at noon on these stations which gradually decreases; at 1 p.m. reception is quite good, and at 3 o'clock the strength of North Regional is the same as Sottens, which is only 30 miles from here, and yet it is quite clear of that station.

May I suggest that Mr. Meunier tries a directional aerial, as this has resulted in an improvement in reception to several friends who were anxious to receive English programmes.

R. BOULLAY.

Pontarlier, Doubs, France.

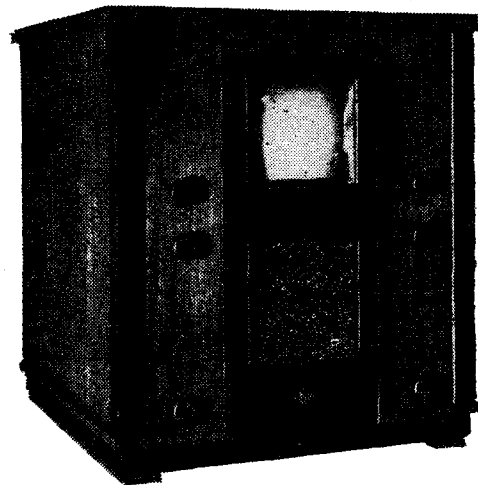
German Television Receiver

The new Telefunken television receiver for ultra-short waves. It gives reception of both sight and sound, is synchronised by wireless impulses superimposed on the "picture," and makes use of "hard" cathode-ray tubes.

PRINCIPAL BROADCASTING STATIONS OF EUROPE

Arranged in Order of Frequency and Wavelength

(Stations with an aerial power of 50 kW. and above in heavy type)

Station.	kc/s.	Tuning Positions.	Metres.	kW.	Station.	kc/s.	Tuning Positions.	Metres.	kW.
Kaunas (Lithuania)	155		1935	7	Strasbourg, P.T.T. (France) ..	859		349.2	15
Brazov (Romania)	160		1875	20	Poznan (Poland)	868		345.6	16
Huizen (Holland). (<i>Until 3.40 p.m.</i>)	160		1875	7	London Regional (Brookmans Park)	877		342.1	50
Kootwijk (Holland) (<i>Announced Huizen.</i> <i>3.40 p.m. onwards</i>)	160		1875	50	Graz (Austria). (<i>Relays Vienna</i>) ..	886		338.8	7
Lahti (Finland)	166		1807	40	Limoges, P.T.T. (France) ..	895		335.2	0.5
Moscow, No. 1, RW1 (Komintern) (U.S.S.R.)	174		1724	500	Helsinki (Finland)	895		335.2	10
Paris (Radio Paris) (France)	182		1648	75	Hamburg (Germany)	904		331.9	100
Istanbul (Turkey)	187.5		1600	5	Toulouse (Radio Toulouse) (France)	913		328.6	60
Berlin (Deutschlandsender Zeesen) (Germany)	191		1571	60	Brno (Czechoslovakia)	922		325.4	32
(<i>S.w. Stns., 16.89, 19.73, 25.51, 31.38 and</i> <i>49.83 m.</i>)					Brussels, No. 2 (Belgium). (<i>Flemish Prog' mme</i>)	932		321.9	15
Droitwich	200		1500	150	Algiers, P.T.T. (Radio Alger) (Algeria)	941		318.8	12
Minsk, RW10 (U.S.S.R.)	208		1442	35	Göteborg (Sweden). (<i>Relays Stockholm</i>)	941		318.8	10
Reykjavik (Iceland)	208		1442	16	Breslau (Germany)	950		315.8	17
Paris (Eiffel Tower) (France)	215		1395	13	Paris (Poste Parisien) (France) ..	959		312.8	100
Motala (Sweden). (<i>Relays Stockholm</i>)	216		1389	30	West Regional (Washford Cross) ..	977		307.1	50
Novosibirsk, RW76 (U.S.S.R.)	217.5		1379	100	Cracow (Poland)	986		304.3	2
Warsaw, No. 1 (Raszyn) (Poland) ..	224		1339	120	Genoa (Italy). (<i>Relays Milan</i>) ..	986		304.3	10
Ankara (Turkey)	230		1304	7	Hilversum (Holland). (<i>7 kW. till 6.40 p.m.</i>)	995		301.5	20
Luxembourg	230		1304	150	Bratislava (Czechoslovakia) ..	1004		298.8	13.5
Kharkov, RW20 (U.S.S.R.)	232		1293	20	North National (Slaithwaite) ..	1013		296.2	50
Kalundborg (Denmark) (<i>S.w. Stn., 49.5 m.</i>)	238		1261	60	Barcelona, EAJ15 (Radio Asociación) (Spain)	1022		293.5	3
Leningrad, RW53 (Kolpino) (U.S.S.R.)	245		1224	100	Königsberg (Heilsberg Ermland) (Germany)	1031		291	60
Tashkent, RW11 (U.S.S.R.)	256.4		1170	25	Paredo (Radio Club Português) (Portugal)	1031		291	5
Oslo (Norway)	260		1154	60	Leningrad, No. 2, RW70 (U.S.S.R.)	1040		288.5	10
Moscow, No. 2, RW49 (Stchelkovo) (U.S.S.R.)	271		1107	100	Scottish National (Falkirk) ..	1050		285.7	50
Tiflis, RW7 (U.S.S.R.)	280		1071.4	35	Bari (Italy)	1059		283.3	20
Rostov-on-Don, RW12 (U.S.S.R.) ..	355		845	20	Tiraspol, RW57 (U.S.S.R.) ..	1068		280.9	4
Sverdlovsk, RW5 (U.S.S.R.)	375		800	50	Bordeaux, P.T.T. (Lafayette) (France)	1077		278.6	12
Geneva (Switzerland). (<i>Relays Sottens</i>)	401		748	1.3	Zagreb (Yugoslavia)	1086		276.2	0.7
Moscow, No. 3 (RCZ) (U.S.S.R.) ..	401		748	100	Falun (Sweden)	1086		276.2	2
Voroneje, RW25 (U.S.S.R.)	413.5		726	10	Madrid, EAJ7 (Union Radio) (Spain)	1095		274.7	7
Oulu (Finland)	431		696	2	Madona (Latvia)	1104		271.7	50
Ufa, RW22 (U.S.S.R.)	436		688	10	Naples (Italy). (<i>Relays Rome</i>) ..	1104		271.7	1.5
Hamar (Norway) (<i>Relays Oslo</i>) ..	519		578	0.7	Moravska-Ostrava (Czechoslovakia) ..	1113		269.5	11.2
Innsbruck (Austria). (<i>Relays Vienna</i>)	519		578	0.5	Alexandria (Egypt)	1122		267.4	0.25
Ljubljana (Yugoslavia)	527		569.3	5	Belfast	1122		267.4	1
Viipuri (Finland)	527		569.3	13	Nyiregyhaza (Hungary)	1122		267.4	6.2
Bolzano (Italy)	536		559.7	1	Hörby (Sweden). (<i>Relays Stockholm</i>)	1131		265.3	10
Wilno (Poland)	536		559.7	16	Turin, No. 1 (Italy). (<i>Relays Milan</i>)	1140		263.2	7
Budapest, No. 1 (Hungary)	546		549.5	120	London National (Brookmans Park)	1149		261.1	50
Beromünster (Switzerland)	556		539.6	100	West National (Washford Cross) ..	1149		261.1	50
Athlone (Irish Free State)	565		531	60	Kosice (Czechoslovakia). (<i>Relays Prague</i>)	1158		259.1	2.8
Palermo (Italy)	565		531	4	Monte Ceneri (Switzerland) ..	1167		257.1	15
Stuttgart (Mühlacker) (Germany) ..	574		522.6	100	Copenhagen (Denmark). (<i>Relays Kalundborg</i>)	1176		255.1	10
Grenoble, P.T.T. (France)	583		514.6	15	Kharkov, No. 2, RW4 (U.S.S.R.) ..	1185		253.2	10
Riga (Latvia)	583		514.6	15	Frankfurt (Germany)	1195		251	17
Vienna (Bisamberg) (Austria)	592		506.8	120	Prague, No. 2 (Czechoslovakia) ..	1204		249.2	5
Rabat (Radio Maroc) (Morocco) ..	601		499.2	6.5	Lille, P.T.T. (France)	1213		247.3	5
Sundsvall (Sweden). (<i>Relays Stockholm</i>)	601		499.2	10	Trieste (Italy)	1222		245.5	10
Florence (Italy). (<i>Relays Milan</i>) ..	609		492.6	20	Gleiwitz (Germany). (<i>Relays Breslau</i>)	1231		243.7	5
Cairo (Abu Zabal) (Egypt)	620		483.9	20	Cork (Irish Free State) (<i>Relays Athlone</i>)	1240		241.9	1
Brussels, No. 1 (Belgium). (<i>French Programme</i>)	620		483.9	15	Juan-les-Pins (Radio Côte d'Azur) (France)	1249		240.2	2
Lisbon (Bacarena) (Portugal) ..	629		476.9	15	Rome, No. 3 (Italy)	1258		238.5	1
Trøndelag (Norway)	629		476.9	20	San Sebastian (Spain)	1258		238.5	3
Prague, No. 1 (Czechoslovakia) ..	638		470.2	120	Nürnberg and Augsburg (Germany) (<i>Relay</i> <i>Munich</i>)	1267		236.8	2
Lyons, P.T.T. (La Doua) (France) ..	648		463	15	Christiansand and Stavanger (Norway) ..	1276		235.1	0.5
Cologne (Langenberg) (Germany) ..	658		455.9	100	Dresden (Germany) (<i>Relays Leipzig</i>)	1285		233.5	1.5
North Regional (Slaithwaite)	668		449.1	50	Aberdeen	1285		233.5	1
Sottens (Radio Suisse Romande) (Switzerland)	677		443.1	25	Austrian Relay Stations	1294		231.8	0.5
Belgrade (Yugoslavia)	686		437.3	2.5	Danzig. (<i>Relays Königsberg</i>) ..	1303		230.2	0.5
Paris, P.T.T. (Ecole Supérieure) (France)	695		431.7	7	Swedish Relay Stations	1312		228.7	1.25
Stockholm (Sweden)	704		426.1	65	Budapest, No. 2 (Hungary) ..	1321		227.1	0.8
Rome, No. 1 (Italy) (<i>S.w. stn., 25.4 m.</i>)	713		420.8	50	German Relay Stations	1330		225.6	1.5
Kiev, RW9 (U.S.S.R.)	722		415.5	36	Montpellier, P.T.T. (France) ..	1339		224	5
Tallinn (Esthonia)	731		410.4	20	Lodz (Poland)	1339		224	1.7
Madrid, EAJ2 (Radio España) (Spain)	731		410.4	3	Dublin (Irish Free State) (<i>Relays Athlone</i>)	1348		222.6	1
Munich (Germany)	740		405.4	100	Milan, No. 2 (Italy) (<i>Relays Rome</i>) ..	1348		222.6	4
Marseilles, P.T.T. (France)	749		400.5	1.6	Turin, No. 2 (Italy). (<i>Relays Rome</i>)	1357		221.1	0.2
Katowice (Poland)	758		395.3	12	Basle and Berne (Switzerland) ..	1375		218.2	0.5
Midland Regional (Daventry) ..	767		391.1	25	Warsaw, No. 2 (Poland)	1384		216.8	2
Toulouse, P.T.T. (France)	776		386.6	0.7	Lyons (Radio Lyons) (France) ..	1393		215.4	5
Leipzig (Germany)	785		382.2	120	Tampere (Finland)	1420		211.3	1.2
Barcelona, EAJ1 (Spain)	795		377.4	5	Paris, (Radio LL) (France)	1424		210.7	0.8
Lwow (Poland)	795		377.4	16	Newcastle	1429		209.9	1
Scottish Regional (Falkirk)	804		373.1	50	Béziers (France)	1429		209.9	2
Milan (Italy)	814		368.6	50	Miskolc (Hungary)	1438		208.6	1.25
Bucharest (Romania)	823		364.5	12	Fécamp (Radio Normandie) (France)	1456		208	10
Moscow, No. 4, RW39 (Stalina) (U.S.S.R.)	832		360.6	100	Pecs (Hungary)	1465		204.8	1.25
Berlin (Funkstunde Teget) (Germany)	841		356.7	100	Bournemouth	1474		203.5	1
Bergen (Norway)	850		352.9	1	Plymouth	1474		203.5	0.8
Sofia (Bulgaria)	850		352.9	1	International Common Wave ..	1492		201.1	0.1
Valencia (Spain)	850		352.9	1.5	International Common Wave ..	1500		200	0.6
Simferopol, RW52 (U.S.S.R.)	859		349.2	10	Liepāja (Latvia)	1737		173	0.1

The Wireless World

THE
PRACTICAL RADIO
JOURNAL
24th Year of Publication

No. 807.

FRIDAY, FEBRUARY 15TH, 1935.

VOL. XXXVI. No. 7.

Proprietors: ILIFFE & SONS LTD.

Editor:
HUGH S. POCOCK.

Editorial,
Advertising and Publishing Offices:
DORSET HOUSE, STAMFORD STREET,
LONDON, S.E.1.

Telephone: Hop. 3333 (50 lines).
Telegrams: "Ethaworld, Watloo, London."

COVENTRY: Hertford Street.
Telegrams: "Autocar, Coventry." Telephone: 5210 Coventry.

BIRMINGHAM:
Guildhall Buildings, Navigation Street, 2.
Telegrams: "Autopress, Birmingham." Telephone: 2971 Midland (4 lines).

MANCHESTER: 260, Deansgate, 3.
Telegrams: "Iliffe, Manchester." Telephone: Blackfriars 4412 (4 lines).

GLASGOW: 26B, Renfield Street, C.2.
Telegrams: "Iliffe, Glasgow." Telephone: Central 4857.

PUBLISHED WEEKLY. ENTERED AS SECOND
CLASS MATTER AT NEW YORK, N.Y.

Subscription Rates:
Home, £1 1s. 8d.; Canada, £1 1s. 8d.; other
countries, £1 3s. 10d. per annum.

*As many of the circuits and apparatus described in these
pages are covered by patents, readers are advised, before
making use of them, to satisfy themselves that they would
not be infringing patents.*

CONTENTS

	Page
Editorial Comment	157
The QA Receiver	158
Tone-Compensated Volume Control	161
Wireless in the Wilds	164
Unbiased	166
News of the Week	167
Ferranti Arcadia Reviewed	168
Hints and Tips	170
New German Receivers	171
Listeners' Guide for the Week	172
Frequency Transformation	174
Random Radiations	176
Letters to the Editor	178
Broadcast Brevities	179
Principal Broadcasting Stations	180

EDITORIAL COMMENT

High Quality Sound Broadcasting

Possible By-Product of Television

WHEN broadcasting started in 1922 there was, for a short time at least, sufficient ether accommodation to give stations the frequency spread that we now know to be necessary and which, in present conditions, simply cannot be obtained. But in 1922 we had distinctly loose ideas of what frequency band was really necessary for good reception and, even if we had known, neither transmitters nor receivers were then capable of handling it. We now know that frequencies up to 15 or 16 kilocycles are involved, although 10 kilocycles give very good quality of reproduction of speech, music and most noises. But this involves sidebands of ± 10 kilocycles and separation between stations of at least 20 kilocycles (or proportionately more if we aim at the 15 or 16 kilocycles). With the present distribution scheme this simply cannot be obtained, so we have to be content with an average station-separation of 9 kilocycles, and trust to geographical location and receiver selectivity to give us immunity from interference. The result, which has often previously been discussed in our columns, is that we cannot have as good broadcast reception as we could or might have, certainly not as good as broadcast transmitters *could* be made to send out, or as good as receivers *could* be designed to receive.

In the 7-metre band things are completely different. In the first place there is little crowding in that region at present and room both for station allocations and for adequate frequency width. The limited range and lack of interference at any great distance mean that the same wave-

length could be used for *local* broadcasting, say, in London and in Manchester without mutual interference. In the second place it is relatively easier to get sufficient width of frequency response in our apparatus, since the sideband spread is such a very small percentage of the carrier frequency.

In addition, there are no "Heavyside layer effects" such as fading, and the limitation of range means that neither by day nor by night need reception be spoiled by interference from distant stations which come up in the hours of darkness. An increase of this "optical-path" range can, of course, be obtained by elevation of the transmitter and receiver, but for purposes of local broadcasting in the 7-metre band—either of sound or of sight—a restricted range is implied.

In a recent article on television reference was made to the arrangement of having the sound and sight carriers close together in the 7-metre region, receiving both on one aerial and beating from a common oscillator to give two intermediate frequencies. The intermediate frequency amplifier for the picture channel requires a band width of over 1 megacycle, and it is known that amplifiers of this performance have been made.

Thus in the ultra short-wave band there is plenty of room for really high quality sound broadcast, but it is somewhat of an irony that we have to wait for the television to give us a lead.

The present broadcasting scheme on longer wavelengths is so firmly established that any general change-over to ultra-short-waves must be regarded as a very remote possibility. The only likely development seems to be in the direction of short waves for the sound associated with television programmes, leaving the present broadcasting scheme unaffected.

QA Receiver

By W. T. COCKING

Constructing and Adjusting the Tuner Unit

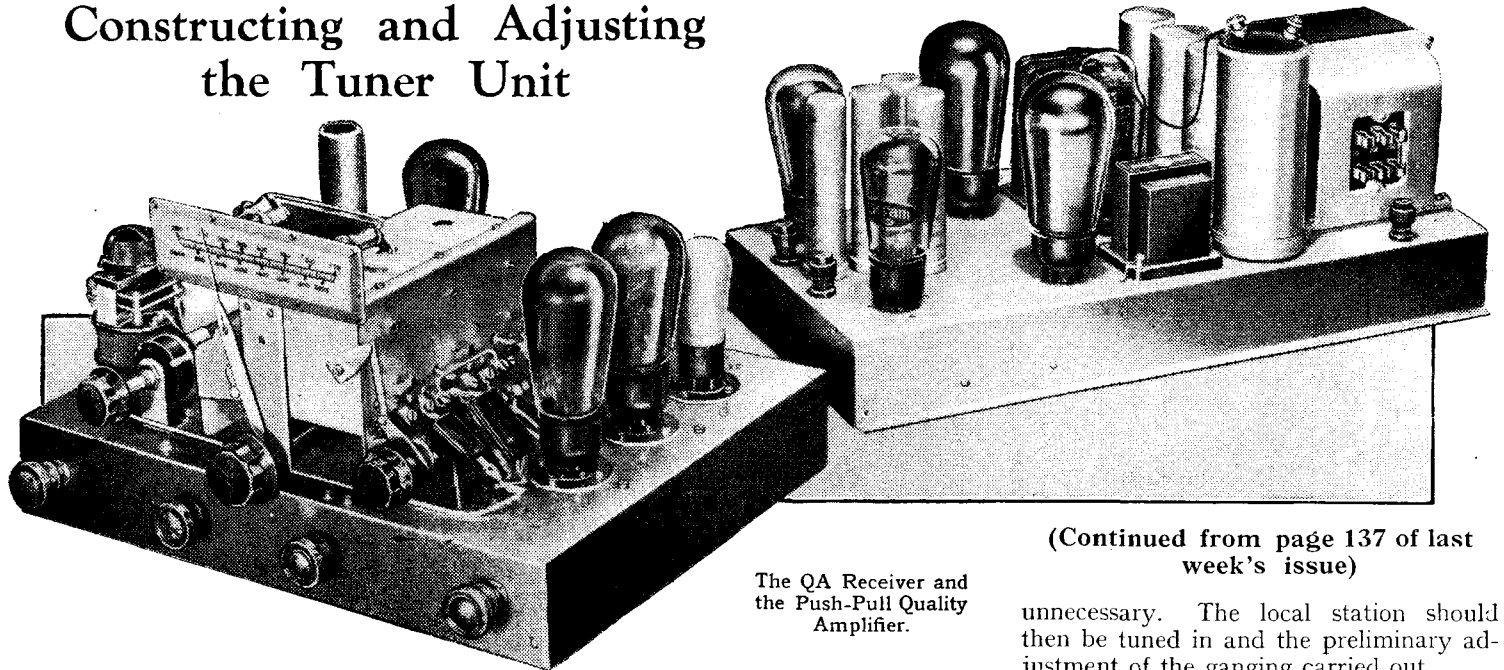

The QA Receiver and
the Push-Pull Quality
Amplifier.

(Continued from page 137 of last
week's issue)

DETAILS of the construction and operation of the QA Receiver, which has been designed for use with the Push-Pull Quality Amplifier, appear in this article. The apparatus is designed for the highest standard of quality of reproduction, and as the issues in which the amplifier was originally described are now out of print, all the essential information will be repeated next week.

THE apparatus comprising the receiver unit is assembled on a metal chassis which is obtainable with all holes drilled and with valve holders ready mounted. Care should be taken to see that all fixing screws are well tightened, and it should be remembered that the resistance R15 must be mounted before the permeability tuner, otherwise its fixing holes will be inaccessible. Since the chassis is cellulose finished the paint must be removed around all holes at which a connection to the chassis is desired—these are chiefly the mounting holes of the tuner, the electrolytic condenser C19, and all earthing points.

The two tone correction chokes L2 and L3 are mounted above the chassis on brackets, but the whistle suppressor coil L1 is mounted by its centre spindle and itself carries a bracket which supports its tuning condenser C14. The spindle of this condenser is live, so that an insulated support is used, as shown in the drawings.

As far as possible the wiring should be carried out in the manner of the original receiver; that is to say, not only must the same points be connected, but as far as possible the various leads should lie in the same relative positions. Any convenient gauge of wire run in insulating sleeving may be employed, but No. 22 tinned copper is particularly suitable since it is small enough to handle easily and yet

possesses a fair degree of rigidity. If this gauge be used for the heater wiring, however, it will be necessary to run a separate pair of leads from the terminal block to each valve, since it cannot carry more than about one ampere without an excessive voltage drop. If a single pair of wires be used for the first three valves, as shown in the drawings, these wires must be of No. 16 gauge.

The various coils used in the tone-correction circuit and the whistle suppressor can readily be made, but can doubtless be obtained ready made if desired. The drawings of Figs. 1 and 2 show the construction, and it is unnecessary to make an attempt at an even layer winding. It suffices to run on the wire haphazardly, maintaining the general level evenly, and the operation is greatly facilitated if some form of simple winding machine fitted with a revolution counter be available.

The Preliminary Adjustments

When setting up the receiver the voltages and currents should be checked to make sure that all is in order. The waverange switch should be rotated in an anti-clockwise direction to the medium waveband position, the pre-detector volume control set at maximum and reaction at minimum. The intervalve coupling condenser C8 should be set at the position indicated by the sketch of Fig. 3, and any further adjustment of this component should be

unnecessary. The local station should then be tuned in and the preliminary adjustment of the ganging carried out.

Each section of the tuner is provided with two concentrically arranged trimmers—one for the medium waveband and the other for the long. The medium wave trimmers are all adjusted by means of screws, and a narrow-bladed screwdriver should be used. In the case of the rear trimmer it is important that the screwdriver have an insulated handle, and it is desirable that the metal part be very small, for this circuit is not earthed. *It should be noted that with these trimmers an anti-clockwise rotation of the adjusting screw gives an increase of capacity.* The long-wave trimmers are operated by nuts, for which a o.BA box spanner must be used; these operate normally and the

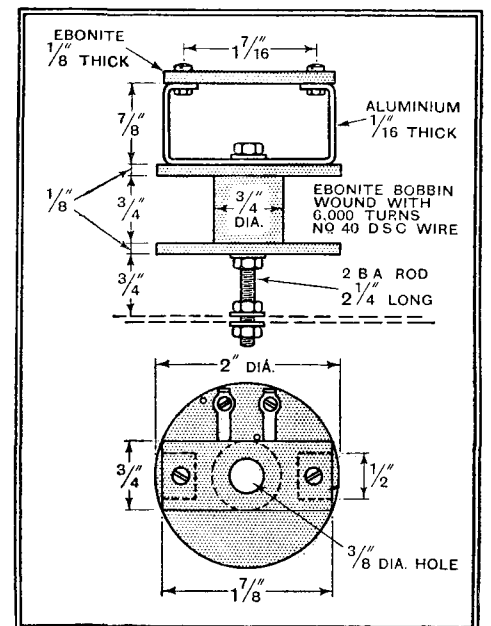

Fig. 1.—The construction of the whistle suppressor is clearly shown in this drawing; the condenser C14 is carried by the bracket.

QA Receiver—

capacity is increased by a clockwise rotation of the control.

Having tuned in the local station, adjust each of the three medium wave trimmers for maximum signal strength, progressively reducing volume by means of the LF control if necessary. Then set the tuning control so that the dial setting agrees with the wavelength of the station and readjust the trimmers for maximum volume. If the readjustment of the main control is to give a lower dial setting, the capacity of each trimmer must be increased, which means an anti-clockwise rotation of the adjusting screws, and vice versa. A weak station on a lower wavelength should next be tuned in and each

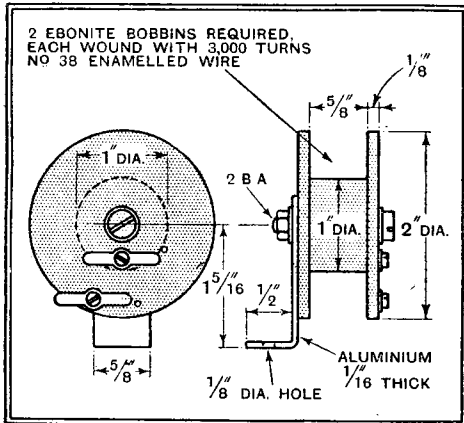

Fig. 2.—Two identical coils, L2 and L3, are needed for the tone correction circuit, and this illustration gives full winding data.

trimmer very carefully readjusted for optimum signal strength. The ear will have to be used as the indicator, for there is no circuit giving a suitable change of direct current to operate a tuning meter.

When satisfied with the medium-wave ganging the long waveband should receive attention, and here only the three nuts require adjustment; the medium-wave adjusting screws must not be touched. The simplest course is to set the dial to read 1,500 metres and tune in Droitwich by the adjustment of these three trimmers only.

The only other adjustment necessary is to the whistle suppressor condenser C14, and naturally this can be done only when a station is found suffering from whistle interference. The filter is intended to provide maximum attenuation at 9,000 c/s, and when it is so adjusted it greatly attenuates all frequencies higher than about 8,500 c/s. It will not, and is not intended to, cut out whistles of lower frequency; it should, therefore, be adjusted on the medium waveband on a station which is known to be separated by 9 kc/s from each of its neighbours, and which is consequently accompanied by a very high-pitched heterodyne whistle. The medium waveband is preferable to the long for this purpose, since stations on the latter are sometimes separated by less than 9 kc/s and the filter cannot be expected to remove these. The adjustment is simple and consists merely of turning C14 to the point at which the whistle disappears; in

general, the setting will be about one-third of the way from the maximum position of the control, and is usually fairly critical.

When used with a good outdoor aerial no difficulty should be found in obtaining good reception of the chief Continental stations, and several should give adequate volume without reaction. The chief purpose of the receiver, however, lies in local reception, and even with a poor aerial full volume should be obtained in most districts from the local medium wave transmitters and Droitwich. The set is much more sensitive than most local station receivers, but it cannot be expected to give good volume from distant transmissions unless the aerial is reasonably good.

Operating the Receiver

The quality of reproduction obtainable when a suitable loud speaker combination is employed is of a very high standard indeed. The departure from an even frequency response of the combined receiver and amplifier are undetectable by ear except in the extreme upper register where they are necessary under present broadcasting conditions in order to avoid interference. The presence of the 9 kc/s heterodyne note would mar reproduction far more than does the loss of frequencies of this order. As regards amplitude distortion, the equipment is essentially linear provided that no attempt is made to obtain excessive volume.

Before concluding this article it may be as well to make some mention of the various panel controls, for although the purpose of the tuning control, waverange switch, and radio-gramophone switch are obvious, the two volume controls and reaction may cause some confusion. It is not intended that these be employed simul-

taneously, and for local reception reaction should normally be set at zero and volume controlled by the LF control, the HF resistance R1 being really a type of local-distance switch, and not meant for providing a smooth variation of volume. For

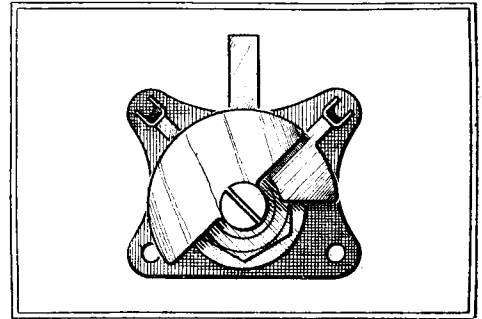
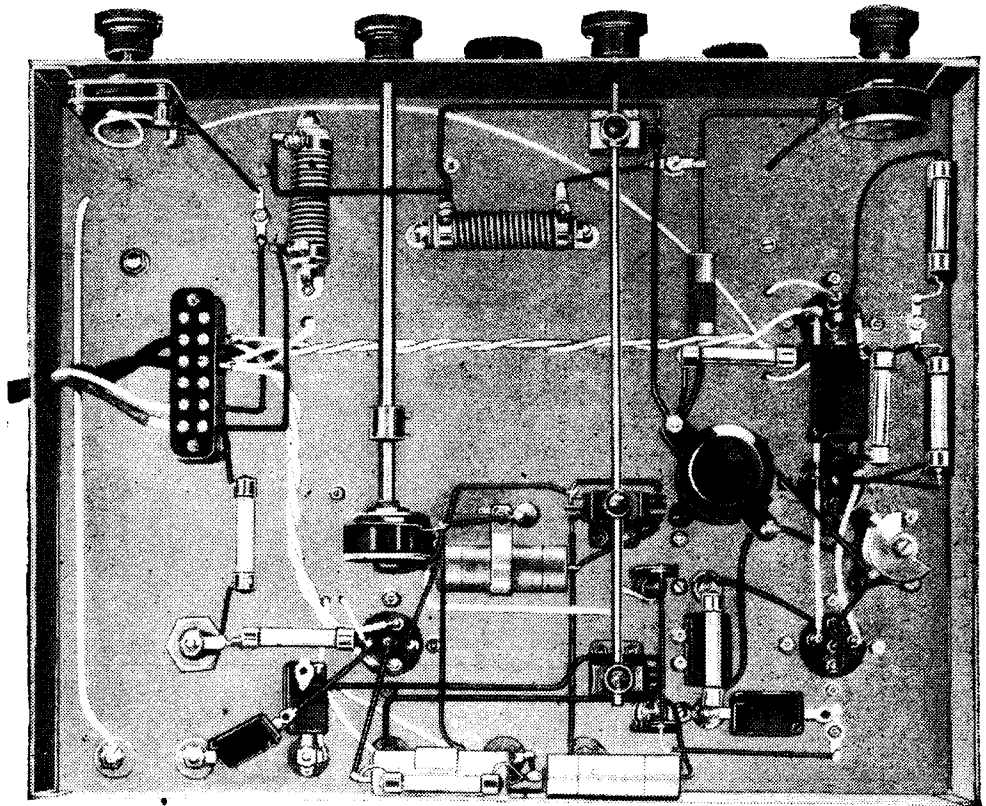

Fig. 3.—The coupling condenser C8 should be set so that its vanes overlap to the degree shown in this drawing. No further adjustment will usually be needed.

everything but local reception, R1 should be at maximum, and it should only be used on local stations if it be found that with the LF control at maximum overloading is severe. In general, R1 should be as high a setting as possible without severe overloading occurring when the LF control is set for full volume. The extent to which it is used, therefore, will depend upon the efficiency of the aerial and upon the distance from the local station. It may be remarked at this point that a form of motor-boating may occur when overloading commences, and if this effect occurs it should be taken, not that there is anything wrong with the equipment, but that the input is too strong, and R1 should be accordingly reduced. This effect does not occur until the full 4 watts output of the amplifier is obtained, and is rather an advantage than



An underbase view of the receiver showing the wiring and layout of components.

QA Receiver

otherwise, since it gives a timely reminder that one is attempting to obtain excessive volume.

When receiving stations other than the local, R₁ should always be at maximum,

and if the strength of the signal be sufficient volume can be adjusted only by R₉. If the volume is not enough, reaction must then obviously be employed, but it is sometimes advantageous to use it on stronger signals and to reduce the ampli-

A full-size blue print of the wiring diagram of the receiver, combined with the Push-Pull Quality Amplifier, is available from the publishers, Dorset House, Stamford Street, London, S.E.1. Price 1s. 6d. post free.

WIRING PLAN FOR RECEIVER

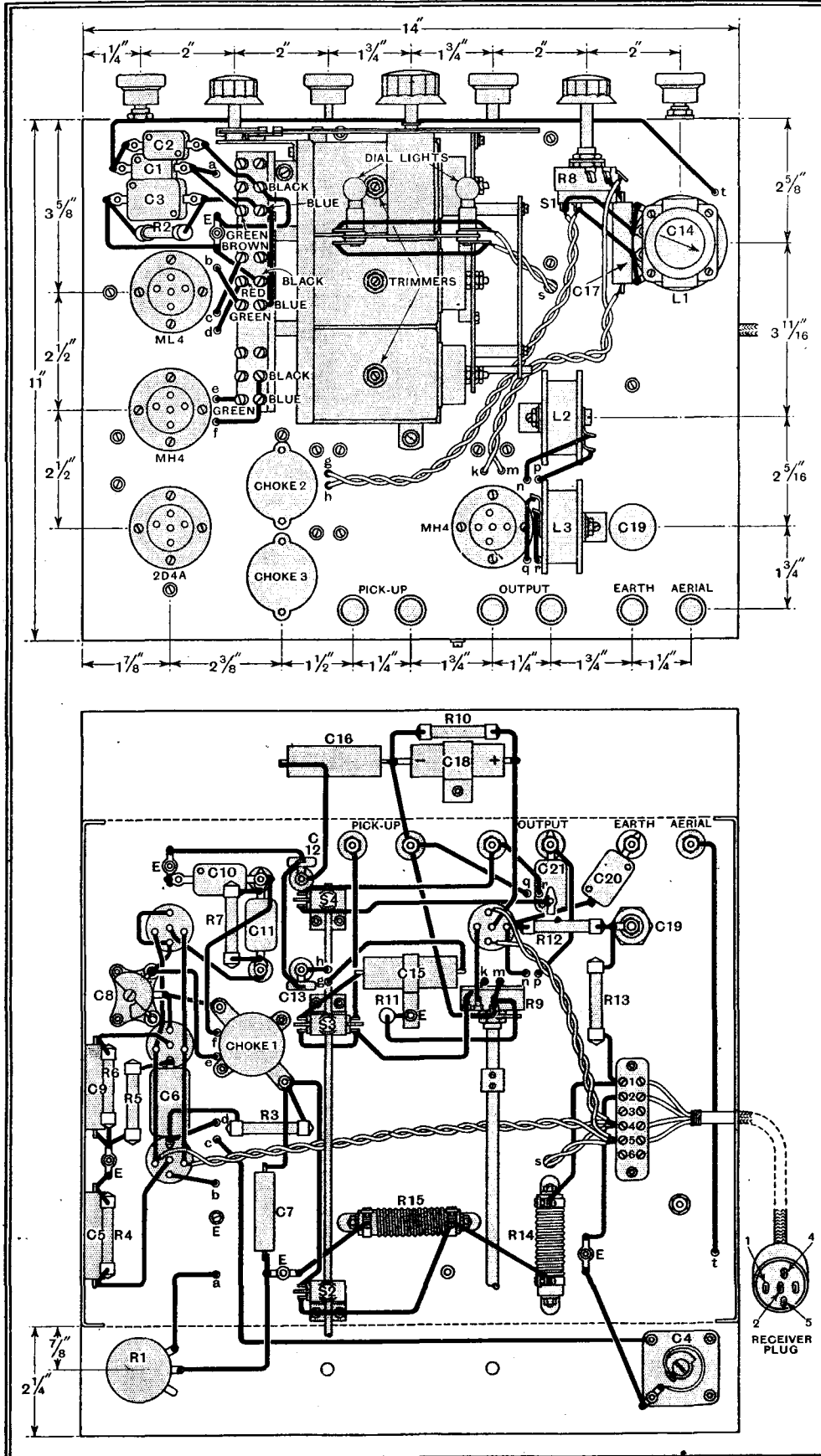

Full details of the construction and wiring of the receiver are given in this drawing.

fication by R₉ in order to maintain the desired volume, for the selectivity can in this way be increased somewhat.

The use of the tone-control and whistle suppressor was dealt with in the previous article, but it may be as well to remember that when the knob is rotated in an anti-clockwise direction to a position just short of that at which the switch opens, the full high-frequency response is obtained. A further rotation in the same direction throws the whistle suppressor into circuit, while rotation in the other direction reduces the upper register. Owing to the particular taper of the resistance employed, it will be found that the major portion of the control occurs towards the end of the travel.

The LF Unit

The Push-Pull Quality Amplifier which is employed with this receiver is built as a separate unit, making it suitable for use in conjunction with other special circuits, including those for television purposes. This amplifier was described in *The Wireless World* for May 11th and 18th, 1934, but as these issues are now out of print, the essential details will be repeated next week, together with some notes on the choice of a loud speaker.

A specimen receiver built to the specification described in this article is available for inspection by readers at 116, Fleet Street, E.C.4.

THE RADIO INDUSTRY

BELLING AND LEE, LTD., of Cambridge Arterial Road, Enfield, Middlesex, are planning interesting working demonstrations of the functioning of disturbance-suppressing devices at the forthcoming British Industries Fair, which opens on February 18th. The beneficial effects of connecting suppressors will be made visible by means of cathode-ray apparatus and will also be audible through a loud speaker. In the Olympia section the stand number is G38, and at Birmingham C736.



It is probable that a number of readers are unaware that, in addition to manufacturing broadcast receivers, the firm of E. K. Cole, Ltd., of Southend-on-Sea, also engage in the production of equipment for receiver testing and development work. A leaflet describing a beat-frequency oscillator, type TF195, is now available; the instrument is mains-operated and has a low-frequency output continuously variable from 10 to 10,000 cycles.



The Telegraph Condenser Co., Ltd., Wales Farm Road, North Acton, London, W.3, are now producing a new series of high voltage condensers specially designed for use in large amplifiers and cathode-ray television apparatus. The condensers are of the paper type, but petroleum jelly impregnation is employed; this is claimed to give an appreciable increase in protection against breakdown and a much longer life than the ordinary wax impregnation.

Tone-Compensated Volume Control

A Method of Avoiding Attenuation of the Higher and Lower Frequencies

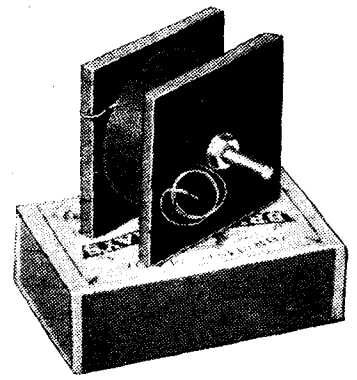

SINCE the ear must be the final judge of the quality of reproduction some justification might be found for the use of a tone-compensator that corrects for aural imperfections. The reasons for a corrector of this nature are discussed by the author and details given of a suitable tone-compensated volume control.

IT is well known that to obtain anything like realism from a first-class receiver adequate volume is necessary, quite apart from fidelity of reproduction. That is why those who have a keen appreciation of music usually like to listen, say, to an orchestral performance over the radio, with a considerable output volume. They realise that when the volume is turned down below a certain level something is missing in the reproduction. Though the melody and general rendering may be unaffected, the correct balance of tones is lost. Similarly, speech that is quite clear at normal volume becomes indistinct when the volume is lowered, and it often requires an effort to follow what is being said.

These effects do not arise through a fault in the receiver performance but are due to the characteristics of the normal human ear. The loudness of a sound as appreciated by the ear depends on the pressure and frequency of the air vibrations reaching the eardrum. When the RMS air pressure is lowered the loudness is diminished, but the effect is not the same on sounds of all frequencies. If the air pressure is reduced by a given percentage the loudness of low-pitched and very high-pitched sounds is reduced to a greater extent than for medium-pitched ones. This

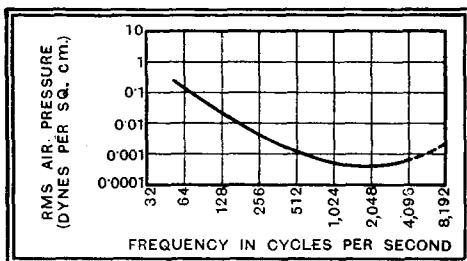

Fig. 1.—Threshold of audibility—air pressures required to produce just audible sounds at various frequencies.

is the real reason for the apparent loss of quality when the volume control of an ordinary good receiver is turned down. By a good receiver it is implied that the overall frequency response, with the loud speaker included, is nearly uniform.

As the volume is progressively lowered there comes a time when bass notes and

By S. O. PEARSON, B.Sc., A.M.I.E.E.

the highest frequency treble notes and harmonics become inaudible, only a narrow band of middle frequencies being heard. This simple experiment proves conclusively that reducing the volume in the ordinary way does result in a loss of the highest and lowest frequencies *as far as the ear is concerned*, even though the volume control lowers the amplitudes of all notes by the same percentage.

The various groups of instruments in a symphony orchestra are placed in positions giving the best blending as far as the majority of the audience are concerned. When the performance is broadcast the microphone is placed where the balance is best and the overall effect most pleasing. Obviously then, for the best quality of reproduction the intensity of sound reaching the ear of the listener must be about the same as that at the microphone, because changing the volume to any extent upsets the balance. Although the human ear has a wonderful power of accommodation and automatically compensates for many faults in the reproduction the process entails mental fatigue after a short time. In truth one can listen to *good* reproduction more restfully at full volume than at greatly reduced volume when an ordinary volume control is used.

Variable Correction

But in spite of this there are occasions when it is desirable to reduce the volume to quite a low level, if only out of courtesy to others in the room who may be engaged in some occupation such as reading, or for other reasons do not wish to be compelled to listen to the wireless programme. In these circumstances it is a great boon to be able to retain the high quality and realism to the full extent when the volume is considerably reduced. Fortunately it is quite possible to do this without much difficulty, and some high-class commercial receivers are actually provided with such a refinement. The device consists essentially of a compensating filter, whose influence is automatically increased as the volume is lowered.

The tone-compensated volume control described here is designed to give, as far as possible, complete correction for the effect referred to above when the volume is turned down, but to have no influence on the fidelity curve of the receiver when turned to full volume. The design is based upon a curve obtained by Dr. Harvey Fletcher, showing the RMS air pressure variation required to produce pure tones just audible to the normal human ear at

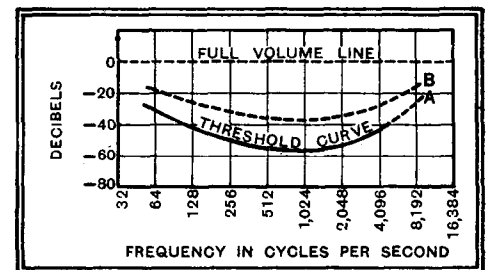

Fig. 2.—(A) Curve derived from the pressure curve of Fig. 1 and giving db values for threshold conditions. (B) Estimated intermediate curve for lowest operating volume.

various frequencies. This curve, shown in Fig. 1, gives what is referred to as the "threshold of audibility."

Now, in dealing with a radio receiver we are concerned with the amplitudes or the RMS values of the electrical variations, and so the first step is to derive a second curve in terms of these electrical variations. For a given amplitude or vibration of the loud speaker diaphragm the air pressure is proportional to the square of the frequency, but for a given loud speaker current the amplitude of vibration is itself *inversely* proportional to the frequency (for a theoretically perfect loud speaker). So in the radio-electrical link between microphone and loud speaker the relative values of LF amplitude for threshold audibility can be found by multiplying the threshold pressures by the square of the frequency and then dividing by the frequency, that is, merely by multiplying all the values given by the curve of Fig. 1 by the corresponding frequencies. The new curve is then plotted to a decibel scale as at A in Fig. 2.

This modified curve shows the relative

Tone-Compensated Volume Control—

levels required in the receiver to produce just audible sounds over the whole frequency range. But the volume will never be reduced to this low level, and so, in the absence of exact data, it is necessary to make an estimate of the response required for a comfortably low volume, taking the curve A as a guide. At full volume the response curve must be as nearly as possible a horizontal straight line, and so for any intermediate volume a compromise must be made between the full volume line and the threshold curve A of Fig. 2.

From results obtained by Fletcher the threshold of audibility at 1,000 c/s occurs at about 60 db below the average volume level of the male singing voice, and experience shows that a normal volume control has a range of 30 or 40 decibels between full volume and minimum operating volume settings. This gives a rough guide to the position of the intermediate curve, for the lowest operating volume, relative to the threshold curve A of Fig. 2. As the curve is raised it becomes gradually straighter until at the full volume position it becomes a horizontal straight line. The curve of estimated values is shown as a broken line B in Fig. 2, and this curve represents approximately the relative response the receiver should give with the volume control set to minimum. It should be observed that the lowest response must occur at about 1,000 cycles per second.

Circuit Values

The ordinary potentiometer type of post-detector volume control, shown in Fig. 3 (a), reduces the amplitude at all frequencies to the same percentage of the maximum. If R_1 and R_2 are the resistance values above and below the sliding contact, the amplitude is reduced $\frac{R_2}{R_1 + R_2} \times 100$ per cent. at all frequencies. With this form of volume control set to minimum operating position the *apparent*

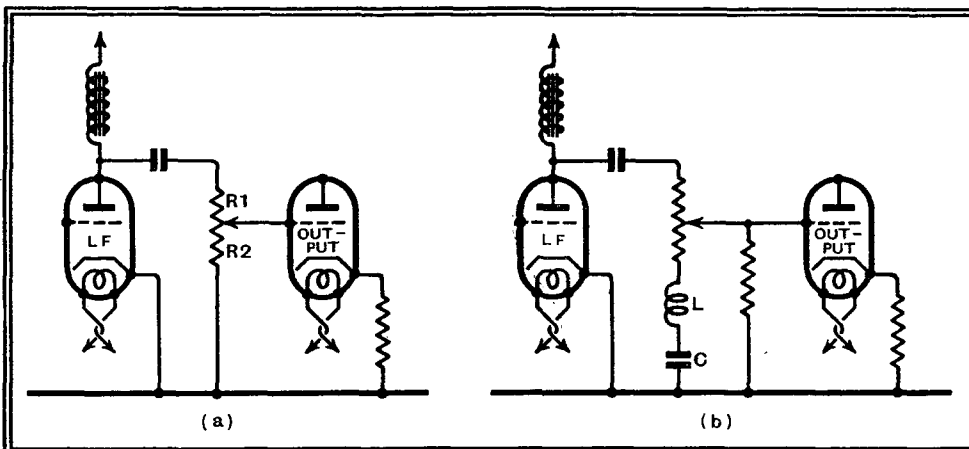

Fig. 3.—(a) Normal potentiometer type volume control. (b) The coil and condenser reduce the output at the resonant frequency relative to other frequencies.

response of the receiver would be as indicated by Fig. 4 by the lower curve A, which is merely the reverse of curve B of Fig. 2. It shows clearly that the upper and lower frequencies will sound weak

compared with the middle frequencies; in practice, notes represented by frequencies at the two extremes actually become inaudible at low volumes.

Now to eliminate this effect the ampli-

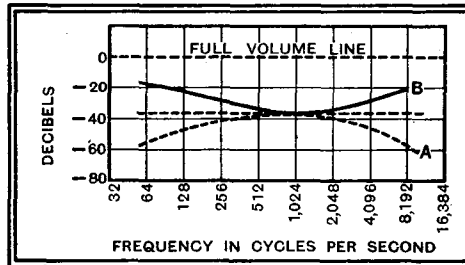

Fig. 4.—Curve A indicates the aural effect with uncompensated volume control, and B is the response curve of the compensated control when set to minimum. The overall effect is shown in Fig. 6.

tudes in the neighbourhood of 1,000 c/s must be reduced to a greater extent than those at the upper and lower ends of the musical scale, and it occurs at once to make use of the principle of resonance. What is required is a filter circuit with a response curve like B in Fig. 2 when the volume control is set at minimum, but so arranged that it does not affect the fidelity of the receiver at full volume. As a first approximation towards the fulfilment of these conditions, a coil L and a condenser C can be connected in series with the lower end of the potentiometer resistance, as at (b) in Fig. 3. Minimum impedance occurs at the resonant frequency $1/2\pi\sqrt{LC}$ cycles per second and for this to be 1,000 the product LC must be about 0.025, L being in henrys and C in farads. So C could conveniently be made $0.5\mu\text{F}$ and L about 0.05 henry.

Using these values, if the response over the whole frequency range is calculated with the control set to give, say, 35 db reduction at 1,000 c/s, it would be found that the dip in the curve is too pronounced, the resonance being too sharp. The effect would be a complete suppression of the middle frequencies! So, to

when the constants are well chosen. It comprises the ordinary potentiometer control with the resonant circuit LC connected across a fraction of the total resistance at the "earth" end.

Having decided upon the values $L = 0.05$ henry and $C = 0.5\mu\text{F}$, calculations are made to find the values of R, R_1 and R_2 giving a response curve as nearly as possible the same as B in Fig. 2. In the first place R_1 must be considerably greater than the AC resistance of the preceding valve to avoid undue loss of signal strength at full volume. On the other hand, if the volume control is to feed into the primary winding of an intervalve transformer, its impedance must not be too high. R_1 could be made about 30,000 ohms to satisfy these conditions and this figure has been adopted as a suitable value for a volume control which can be used with either capacity or transformer coupling. This point is referred to again later.

At the resonant frequency the impedance of the by-pass circuit LC is equal to

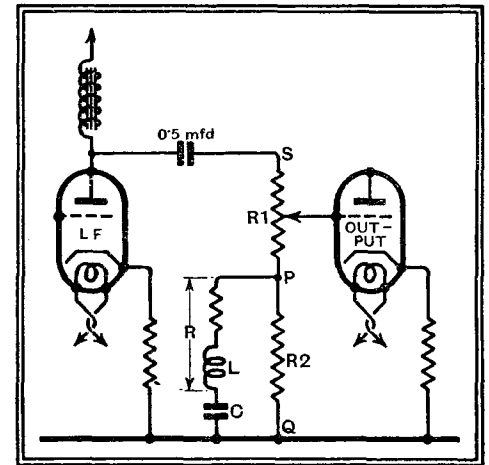

Fig. 5.—The compensated control. $L = 0.05$ H, $C = 0.5\mu\text{F}$, $R_1 = 30,000\ \Omega$, $R_2 = 6,000\ \Omega$, $R = 500\ \Omega$. If higher total impedance is required all resistances may be trebled, L and C remaining the same.

its total resistance R, the reactances balancing out. Thus at 1,000 c/s the impedance between P and Q is equal to the resultant resistance of R and R_2 in parallel. Now, reducing the amplitude of the LF variations to 1.5 per cent. of the full value corresponds to a reduction of about 36.5 db, and this is roughly what is required at 1,000 cycles per second. It calls for 450 ohms between P and Q. Making R and R_2 equal to 500 ohms and 6,000 ohms respectively gives a resultant resistance of 461 ohms, and this combination is found to be the one which gives the correct degree of reduction not only at 1,000 c/s but also over the remainder of the frequency scale.*

The resistance R of the by-pass circuit LC comprises the resistance of the coil L and sufficient added resistance to make a total of 500 ohms. With the values given the response curve of the compensated

* At minimum volume the ratio of output to input voltage at any frequency is given by $Z/\sqrt{Z^2 + 2RR_1 + (R_1)^2}$, where Z is the impedance of the by-pass circuit LC, and $1/R_1 = 1/R_1 + 1/R_2$.

Tone-Compensated Volume Control—

volume control, set to minimum with the slider at P, is shown at B in Fig. 4, and it will be noted that this closely resembles curve B of Fig. 2. The two curves of Fig. 4 show, on the one hand, the apparent attenuation of the upper and lower frequencies due to the reduced volume, and, on the other, the strengthening of

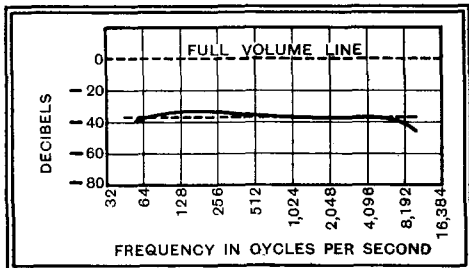

Fig. 6.—Curve indicating approximately the overall effect on the ear when the compensated volume control is set to minimum.

them by the compensated control. By combining the curves A and B we obtain the curve of Fig. 6, which gives an approximate indication of the reproduction, as appreciated by the normal ear, when the tone-compensated volume control is set to minimum. It will be noted that there is not more than 4 db variation from the mean level between 50 and 7,000 cycles per second! But it must be remembered that from the outset it has been assumed that the receiver has a level response curve at full volume. If this is not the case the curve of Fig. 6 means that the minimum-volume curve of apparent response would not differ in shape from the full-volume overall response curve of the receiver by more than 4 db between 50 and 7,000 cycles per second. Consequently, in all circumstances, the reproduction will have very nearly the same quality at minimum as at full volume

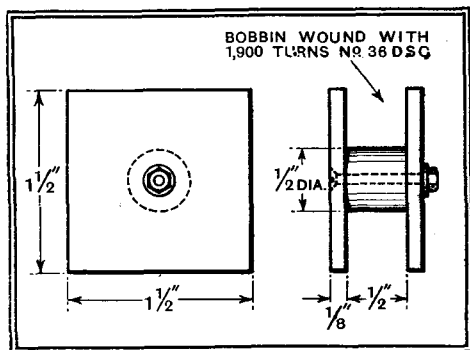

Fig. 7.—Details for constructing a 0.05 henry air-core inductance.

The compensation applies equally well to intermediate volumes, for, as the control slider is moved from P to S (Fig. 5), the influence of the circuit LC becomes progressively less, until at full volume the 30,000 ohms resistance R₁ effectively swamps the relatively small variation of impedance between P and Q, as far as the input to the succeeding valve is concerned.

The great advantage to be gained from the use of such a compensated volume con-

trol must be experienced to be realised, but, of course, the set must be a good one in the first place. It could be added to many an existing receiver with very little difficulty. Fig. 5 shows the arrangement for choke-capacity coupling, but it is equally effective with resistance-capacity coupling, and can be applied to transformer coupling. In the last case the "parallel feed" method of connection is essential, the primary winding of the transformer being connected between the volume control slider and the earth line.

It should be pointed out that the degree of compensation, with the given values of L and C, is approximately the same with other resistance values providing their ratios remain unaltered. For instance, R₁, R₂ and R can be made 90,000Ω, 18,000Ω, and 1,500Ω respectively. These figures would be preferable with resistance- or choke-capacity coupling if the valve preceding the volume control had a somewhat high AC resistance, say, 20,000 ohms. The best position for the device is between the penultimate and output valves.

A word is necessary here regarding the relationship of the compensated control to the usual *pre-detector* volume control. The latter is essential to cater for different strengths of the transmissions received and may be of the automatic type (AVC). The receiver must be tuned to the desired station with the compensated control set

to *maximum*; the pre-detector volume control is adjusted to give normal full volume, and then the compensated control is used to reduce the volume to the required level, thus maintaining the quality of the output.

With an AVC receiver the disadvantage of having two manual volume controls is automatically eliminated by the fact that the pre-detector control can be set once and for all to give normal full volume with the compensated control at maximum. In other cases, the disadvantage is more than outweighed by the great gain in quality at low volumes. In particular, speech is very much more distinct because the conditions approach much more closely to those of an actual person speaking in a subdued voice—the voice itself is lowered but the consonant sounds produced in the mouth are not reduced to the same degree.

For the benefit of those who wish to make up a compensated volume control on the lines indicated, particulars for constructing a 0.05 henry inductance are given in Fig. 7. The bobbin should be made of ebonite and a brass screw and nut should be used for clamping the flanges to the circular core. 1,900 turns of No. 36 DSC copper wire will be required, wound on evenly but not in layers. The resistance of the coil will be about 81 ohms, and, as the weight of wire needed is a little less than 1½ ounces, a 2-oz. reel will be ample.

British Car Radio

C.A.C. "Austin" Details

IN our issue of January 11th there was published a brief description of the new C.A.C. "Austin" car radio set, with special reference to its highly practical but somewhat unconventional layout—single-unit construction with remote control of everything except wave-range switching, which is actuated through a conveniently placed lever on the set itself.

With regard to circuit details, the set employs an HF stage followed by a heptode frequency-changer, IF stage, double-diode detector-AVC valve and three-watt output pentode; valves are of the Osram 13-watt type. An important feature of the design is the inclusion of anti-interference devices which reduce to a minimum the amount of external suppression required on the electrical equipment of the car.

Remote control of both tuning and volume is effected through flexible cable with a rotating core—like the dental cable of the well-known instruments of torture, but with provision for absorbing "lost movement" or backlash.

Thanks to the extra sensitivity conferred by the HF stage, a perfectly ridiculous aerial—by ordinary standards—is quite good enough to ensure a satisfactory range. An aerial under the

running board of the car is actually recommended in most cases. The fitting of such an aerial to almost any car is naturally a very simple matter.

Mention of the wave-changing system has already been made, so it is hardly necessary to stress the point that the "Austin" differs from most of the foreign-made sets in that it covers both medium and long broadcast wavebands. As a consequence, the long-wave National transmitter is receivable—a matter of some importance to users in this country. The set costs 24 guineas complete with suppressors. Makers: The City Accumulator Co., Ltd., 18/20, Norman's Buildings, Central Street, London, E.C.1.

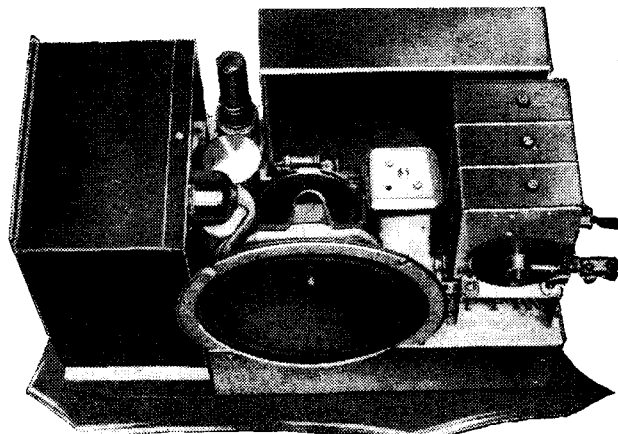

A COMPACT LAYOUT. Chassis of the C.A.C. "Austin" car set; the rotary HT generator is enclosed in the box on the left.



Wireless in the Wilds

Problems of LT and HT Current Supply

By R. W. HALLOWS, M.A.

IN localities where broadcast reception is most appreciated, conventional methods of supplying current to the receiver are often impracticable. This article suggests several ways of overcoming such difficulties.

ONE can hardly imagine a greater boon to a dweller in some out-of-the-way corner of the Empire than a wireless receiving set, preferably of the type which, if not genuinely "all-wave," will, at any rate, receive both the medium- and the short-wave stations. Medium-wave broadcasting has become so general nowadays, and the range of high-powered stations is so great, that there must be few places in which something cannot be heard after dark when conditions are favourable.

But the great standby of the dweller or the traveller in the wilds is the vast number of short-wave transmissions that are now made from almost all civilised countries. From the Empire station at Daventry the programmes are so timed that in nearly every part of the Empire they can be received in the early evening. Since they include not only music and other forms of entertainment, but also news from the Home Country and Blattnerphone records of sporting and other events, no great amount of imagination is required to realise the difference that they make to the lives of those who are scores, maybe hundreds, of miles from anything deserving the name of town, and who may have to wait from six weeks to three months for replies to letters sent to the Home Country.

One of the biggest difficulties encountered by those who want to use a wireless set in the wilds is the question of filament-

current supply. High-tension current is comparatively easy, for the dry-cell, high-tension battery, if it is of suitable capacity, has a long life, and in almost any climate replacements of the inert-cell type can be kept in store for months without deterioration.

Before passing on to the filament battery it may be as well to say a word about the inert-cell, high-tension battery. The

they are not in use such batteries slowly become discharged, owing partly to minute leakages of current, partly to a local chemical action, and partly to the drying up of the moisture in the paste. The inert-cell battery is completely inactive when sent out by the makers, since the cells do not contain moisture. To bring it into action water must be poured into them. Unless and until this is done no appreciable action of any kind takes place, and the cells remain in new condition.

The chief difficulty about the low-tension current supply is this: The plate circuits of the valves require only a few milliamperes of current, and the set will work within quite large limits of HT battery voltage. For the filaments of the average three-valve set the best part of half an ampere of current is required, and the EMF must remain almost steady at round about 2 volts. Any fall in the EMF delivered to the filaments will interfere seriously with short-wave reception.

The ideal way of heating the filaments of a battery set is, of course, to use an accumulator, which has a steady EMF of almost exactly 2 volts per cell. At home there are no difficulties; when the accumulator runs down it is merely sent to the charging station, and in due course it returns ready for work again. But in out-of-the-way places there are usually no charging stations.

Their absence does not entirely rule out the use of the accumulator. So ubiquitous have the motor car and the motor lorry become that they are found

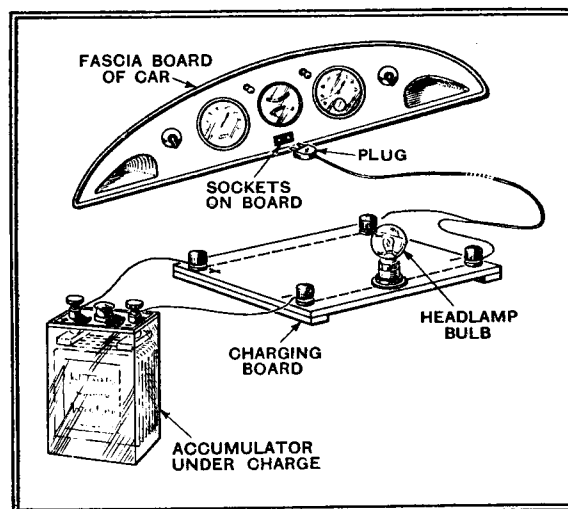

Fig. 1.—"Milking" the car battery.

ordinary type of dry-cell HT battery is made up of cells of which the electrolyte consists of a semi-liquid paste. Even when

Wireless in the Wilds—

nowadays in the most unlikely spots. Now every motor vehicle contains a starting and lighting battery, which is charged by the dynamo operated by the engine. In places where roads are few and far between, and bad at that, comparatively little driving is done at night; hence the car battery has often not sufficient work to do.

Fig. 1 shows a way in which it can be "milked" and made to charge a single cell used for filament heating. On the fascia board of many, if not most, cars and lorries there is a pair of sockets connected to the lighting battery and intended to serve as a connection for an inspection lamp. It is necessary to discover which is the positive and which is the negative socket, and this can be done, supposing that they are not marked, by tracing out the wiring.

Regulating Charging Current

The charging board shown in the drawing is a very simple affair, consisting as it does only of a piece of seasoned wood some 6in. or 8in. square furnished with four terminals and a holder for a head-lamp or side-lamp bulb. To one pair of terminals a plug to fit the sockets on the fascia board is connected by means of flex leads. These should be red and black, so that there can be no confusion between positive and negative. Failing sockets on the fascia board, connection may be made direct to the battery. The two positive terminals of the board are connected together, whilst the lampholder is wired between the two negatives. The accumulator under charge is wired up as shown in the drawing: positive to positive and negative to negative.

If a rapid charge is required, a head-lamp bulb is inserted in the holder. Assuming that the car has a 12-volt lighting set and that the head lamps are rated at 36 watts, the bulb will pass approximately 3 amperes. With a 6-volt lighting set a 24-watt bulb will pass 4 amperes.

For a long, slow charge use a side-lamp bulb. The filaments of these are generally designed to pass about half an ampere of current, whether the lighting battery is 6-volt or 12-volt.

Failing a car or a lorry to "milk," there are other ways of charging accumulators which may be found useful. If a stream of water is available, the method shown schematically in Fig. 2 answers well.

Either a pipe or a conduit delivers a head of water to a water-wheel connected by a belt to a small dynamo, and the latter supplies the charging current.

A simple water-wheel can usually be

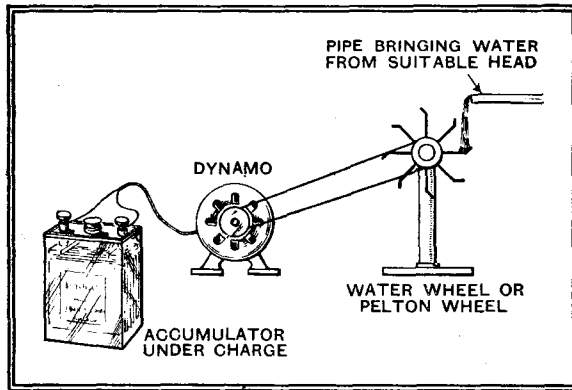

Fig. 2.—The principle of charging by water power.

made by a native craftsman, but better still is the Pelton wheel, a remarkably efficient source of power which is by no means expensive and quite small in size.

The dynamo need not be an expensive item. Second-hand or superfluous-stock car dynamos are obtainable in this country and probably elsewhere at absurdly low prices, and these answer the purpose admirably. With such a dynamo a charging board like that shown in Fig. 1 is required.

Should there be no water supply a simple windmill may be rigged up, and I have heard of more than one case in which a discarded bicycle was pressed into service. The machine, with the back tyre removed, was fixed into a wooden stand which raised the back wheel an inch or two so that it could revolve freely. A belt was passed round the rim of the back wheel and the pulley of the dynamo. The motive power was provided by a native sitting on the saddle and pedalling manually—either a defaulter working out his punishment or someone anxious to turn an honest penny.

But the accumulator is by no means the only method of filament heating with which good results can be obtained. Fig. 3 shows how two large cells can be used in series where the current drain is not in excess of 0.3 ampere. For larger drains four cells in series-parallel will

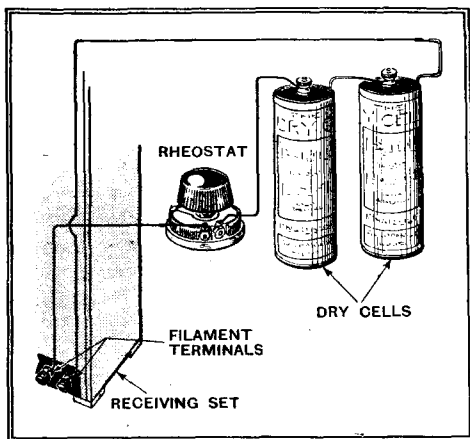

Fig. 3.—Series-connected dry cells as a source of filament current.

be required as illustrated in Fig. 4.

Useful though it is, the dry cell has several disadvantages as a source of filament-heating current. In the first place, its EMF when new is 1.5 volts or a little more. This means that two cells in series are required and that 1 volt must be dropped by means of a rheostat, as shown

in Fig. 3. The resistance value of the rheostat windings is easily worked out by dividing the total filament current of the set into the volts to be dropped. Thus, if the filament current is normally 0.4 ampere the sum is 1/0.4, or 2.5 ohms. To be on the safe side, a 3-ohm rheostat would be suitable.

Unfortunately the dry cell does not maintain a steady EMF. This starts to fall as soon as the cell is placed under load, and continues to drop the whole time that it is in use. During a rest period the cell recovers a considerable proportion of its lost EMF, and the process starts again when it is brought into use once more. Rather frequent adjustments of the rheostat are therefore needed, and one has to be careful never to switch on without first throwing the maximum amount of resistance into circuit.

Another type of Leclanché cell is much more satisfactory for filament heating. This is the Air Depolariser pattern, of which a description was given recently in *The Wireless World*. Again, a rheostat is required, since the EMF of these cells is also about 1.5 when new or after a period of recuperation. However, there is a big difference between their subsequent per-

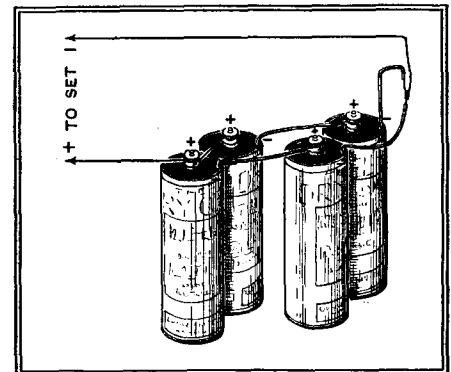

Fig. 4.—Dry cells arranged in series-parallel for comparatively heavy filament current loads.

formance and that of the dry cell. Within a few minutes of switching on, the EMF drops to a little over 1 volt and there it remains perfectly steady for hours on end.

Daniell cells of large capacity can also be used for filament heating. Their great advantage is that the EMF of each cell is only a fraction over 1 volt and that it is well maintained under reasonable loads. The Daniell cell is largely used in telegraphy and is obtainable from or through most large electrical shops.

Foundations of Wireless

Part XII, explaining the functioning of the simple triode valve, will be included in next week's issue.

"The Wireless World" Index and Binding Case

THE Index for Volume XXXV, July to December, 1934, is now ready and may be obtained from the publishers at Dorset House, Stamford Street, London, S.E.1, price 4d., post free, or with binding case 3s. 1d., post free.

UNBIASED

"Vox Populi"

By
FREE
GRID

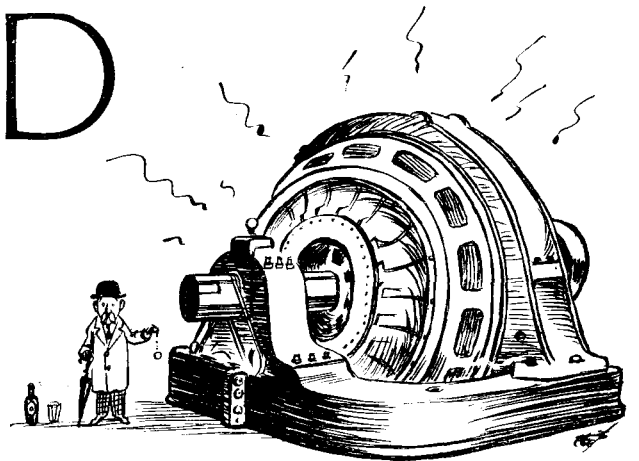

Far simpler to climb a pylon.

AS time goes on, passport regulations seem to get more and more vexatious and irksome, and if things continue at their present rate it will soon be extremely difficult for the more honest amongst us to get in and out of the country at all.

Not content with demanding a smudgy record of your features, the powers-that-be are now toying with the idea of securing your voice. One rather obscure South American country has, in fact, actually carried this idea into effect in the case of passports issued to its nationals, and I have recently been privileged to inspect one of these new curtailers of human liberty.

The idea is evidently copied from the gramophone records made on postcards which were issued some time ago. In this case, however, the record is impressed on the inside back cover of the passport,

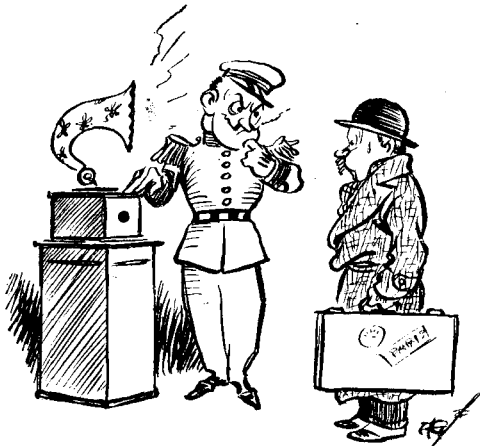

Requests the passenger to recite.

which is made of some substance similar to ivory instead of the usual stout cardboard. When applying for a passport, the unfortunate citizen, in addition to providing a photograph and sundry details concerning himself and his forebears on the application form, has to speak these particulars into a microphone which is connected via the usual amplifier to an apparatus recording it on the back of the passport.

A hole is provided in the cover to accommodate the spindle of an ordinary gramophone turntable, and when crossing a frontier, the presiding official, after glancing suspiciously at the photograph in the manner with which we are all familiar, puts the passport on his little portable gramophone and plays it over, at the same time requesting the passenger to recite the details so that he may see whether or no the two voices tally. It is hoped that in this manner impersonation will be checked.

I suppose that every great invention is

capable of being put to ignoble uses by unscrupulous people, whether they be government officials or private citizens, but who would have thought that when home-recording, that lusty off-shoot of radio, was first introduced, it would eventually be employed for these base ends? I wonder, by the way, what the officials will do in the case of a man with a bad cold in the head.

Balmy Words

I ALWAYS think that the most interesting part of many of our great Sunday journals is the helpful advice corner where the lovelorn may find balm for their broken hearts, the diseased may be delivered from the mercenary maw of the medico, and those in legal difficulties may be snatched from the rapacious clutches of the law.

Naturally, I always take a special interest in those answers to correspondents in which any matter appertaining to wireless or its associated sciences is touched upon. Only last week I came across a heartrending cry from a faithful reader who had been fool enough to tune his receiver while still wearing his gent's simulation gold wrist watch, with the inevitable result that it had been hopelessly magnetised by the powerful field of the adjacent loud speaker.

The advice given to him was nothing if not ingenious. The presiding Solomon of the particular newspaper concerned had learned from somewhere or another—probably by perusing the columns of the "W.W."—that the proper cure for such a calamity was to hold the watch in a powerful alternating magnetic field. He had accordingly advised his wretched consultant to do this, but true genius came out in the instructions given concerning the practical method of carrying out this advice. It was necessary, so it was said, to hold the watch in the field for some considerable time and the reader was counselled to approach the Chief Engineer of some large power station, such as Lots Road, for permission to spend a day there holding the watch in the vicinity of one of the generators.

Personally, I fail to see why it is necessary to go to all this trouble. Surely it would be far simpler to climb a pylon and

to form a solenoid by taking a couple of turns round the watch with one of the transmission lines.

Breakfast Broadcasts

I AM very pleased to see that agitation has been started in favour of breakfast broadcasts.

I do hope, however, that, when it does finally decide to institute this much-needed reform, the B.B.C. will give us music and not attempt to fob us off with some of the physical uplift stuff beloved of certain foreign stations such as several scribes of the lay Press are advocating.

It is quite obvious from their writings that these people have never bothered to tune in one of these ghastly early-morning broadcasts or they would not talk as they do. I made a special point the other morning of tuning in a well-known Russian station which indulges in this particular form of barbarism, and found that heart-



The whole effort left me cold.

less physical jerks were being broadcast together with adjurations to take a health-giving snow-bath, whatever that may be. The whole effort left me cold.

CURRENT TOPICS

Events of the Week in Brief Review

Television-Conscious

THE DAILY TELEGRAPH is believed to be the first newspaper in the country to include a regular television section.

French Licence Figures

REGISTERED listeners in France up to November 30th number 1,730,248. Of these 760,518 were included in the Paris region.

Parachute Chat

DANISH stations will shortly broadcast a running commentary by Mr. John Tranum during a parachute jump of 30,000 feet. The parachute will be unopened until he has fallen some 26,000 feet. The item will probably be relayed to American and European stations.

Lancashire's Choice

AN interesting plebescite among the urban district councils of Lancashire has been conducted to decide whether the Home Office bylaw against noisy loud speakers should be put into practice. Fifty districts replied that it was not considered necessary by their individual councils; twenty-three wished for the bylaw to be made applicable to their areas.

Television Lectures

THE Optical Principles of Television" is the title of a course of six lectures by W. D. Wright, D.Sc., A.R.C.S., D.I.C., in the Physics Department of the Imperial College of Science and Technology, South Kensington, S.W.7. The lectures will be given on Tuesdays and Thursdays at 4 p.m., commencing on Tuesday next, February 19th. Full particulars can be obtained on application to the Registrar at the Imperial College.

The Shorter the Better?

IS the $2\frac{1}{2}$ -metre wavelength more tractable than 5 metres? The answer is in the affirmative, according to a report of the American Radio Relay League. On Saturday, January 26th, and for a period of several days, a series of schedules on a frequency of 110 megacycles was run with clock-like precision between the hill-top laboratory of the League at West Hartford, Connecticut, and Harvard University's Blue Hill meteorological observatory near Boston—a distance of over a hundred miles. 5-metre transmissions proved less satisfactory.

220 Kilowatts From Finland

THE foundation stone has just been laid of a new 220-kilowatt transmitting station at Lahti, Finland, to replace the existing 50-kilowatt plant.

German Co-operation

TO assist the Norwegian broadcasting authorities to participate in ionosphere investigations under the auspices of the *World Radio Research League*, the German short-wave transmitter, DJN, 31.45 metres, will cease transmission on Sundays from 5 to 6 p.m. (G.M.T.) until March 17th next.

More Money for Radio

AMERICAN radio set buyers paid an average of £12 for home receivers during the last year as compared with £9 10s.

Danish Listeners

DENMARK'S broadcast listeners numbered 568,175 at the end of December. Nearly 25 per cent. of the number are in Copenhagen.

All-Powerful Radio

THE influence of broadcasting was well illustrated at Stockholm recently when a message was broadcast on a Saturday night to the effect that the 4,000 woodworkers involved in a trade dispute should return to work on the following Monday morning. No workman who did not put in an appearance on

Old French Custom

IF French broadcasting has not yet reached the stabilisation stage (writes our Paris correspondent) it is not because of a lack of decrees. The last ones were made by the previous Postmaster-General, M. Mallarmé, in October, 1934, but these were immediately suppressed when the present Postmaster-General, M. Mandel, took office.

Publication of new decrees is imminent. According to well-informed sources French broadcasting is to be rigorously separated into two departments—technical and artistic. Each station council will include five representatives of the radio manufacturers, five of the postal administration, and ten of the listeners' associations.

The essential reform would be, suggests our correspondent, that regulations could not be altered by any future Postmaster-General without very good reasons. Otherwise it is difficult to guess when the French broadcasting organisation will be completed.

Jobs for Wireless Operators

APPROVED plans for the establishment of new civil aviation wireless stations in this country will provide openings for a substantial number of experienced wireless operators. For the present, applications will be entertained only from time-expired wireless operators of the Royal Air Force who have extensive practical experience of direction finding ground stations, radio telephony and telegraphy and general maintenance of wireless. Good rates of pay are offered. Applications should be addressed to the Secretary, Air Ministry, Kingsway, London, W.C.2.

Demonstrating a 50-watt Speaker

A 50-WATT loud speaker and its associated amplifier will be demonstrated at the next meeting of the Institute of Wireless Technology on Thursday next, February 21st, at 7.30 at the works of Nuvolion Electrics, Ltd., Park Crescent, Clapham Park Road, London, S.W.4. The lecturer and demonstrator will be Mr. W. Baggally, M.I.W.T.

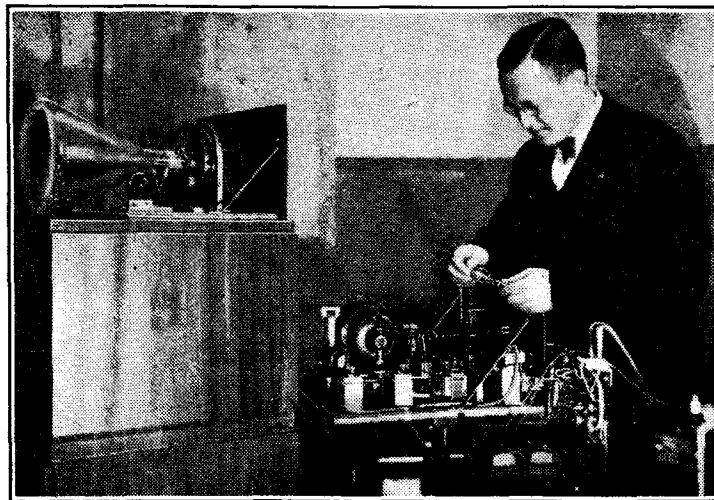

HIGH DEFINITION TELEVISION is the subject of ceaseless research in the laboratories of the Telefunken Company in Berlin. The Chief of the laboratory is here seen inserting a valve in an ultra-short-wave receiver. A completely evacuated cathode ray tube is employed.

during the preceding year, according to the U.S. Radio Manufacturers' Association. The increase is attributed not only to slightly higher prices but to the greater demand for console models.

National Radio Engineers' Association

AT a meeting of the new association in London last week a draft constitution was passed and Mr. W. MacLanachan was elected chairman. Other officers are: Mr. Gibson, vice-chairman; Mr. J. de Gruchy, secretary; and Mr. H. King, treasurer. The council, which now consists of nine members, will be increased at the first general meeting. The secretary's address is 48, High Street, London, N.2.

Monday morning was allowed the excuse of not having heard the broadcast order.

German Anti-Static Laws

WE understand that the new German anti-interference regulations will shortly be proclaimed. Among the clauses will be one stating that priority (*i.e.*, the existence of a source of interference before the erection of a radio receiver) will be no excuse for interruption to broadcast reception. Anti-interference officers will have the right to make use of "lawful coercion." The owner of the interfering plant will have to bear the cost of silencing it, though provision is being made for poor persons to obtain State help. A corps of anti-interference officers will enforce the regulations.

Ferranti Arcadia

A Superhet of Attractive Cabinet Design and Good All-round Performance

FEATURES. — *Type.* — Table model superheterodyne for AC mains.
Circuit. — Heptode frequency changer—pentode IF amplifier—double-diode-triode second detector—triode output valve. Full-wave valve rectifier.
Controls. — (1) Tuning. (2) Volume and on-off switch. (3) Waverange switch. (4) Tone control. **Price.** — 15 guineas. **Makers.** — Ferranti Ltd., Hollinwood, Lancs.

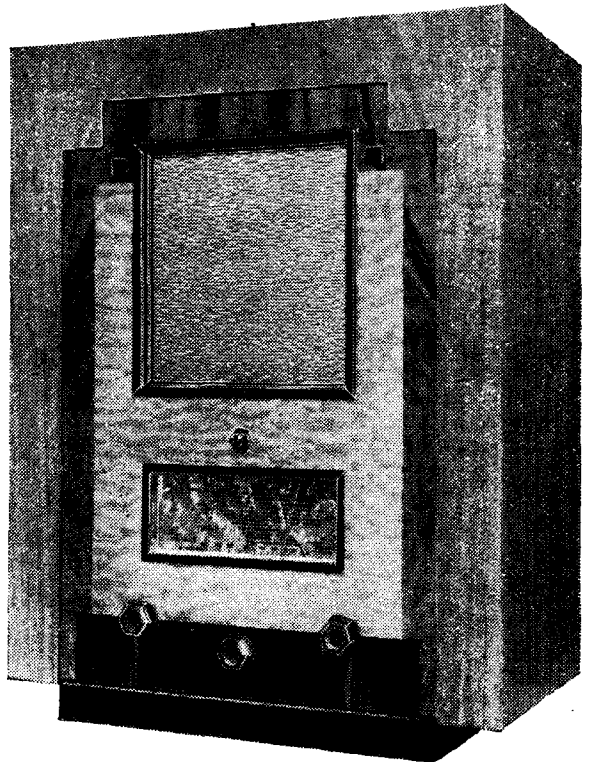

THERE is a strong family likeness in the cabinets of the "Consolette" range of Ferranti receivers, an example of which has already been reviewed in this journal. However, the general design and the blending of the veneer woods on the front panel with the covering of the loud speaker fret has been so happily accomplished that few will wish for an alternative design. The most interesting feature is the combined indicating dial on which the movement of all the control knobs is duplicated by pointers. Station settings as well as wavelengths are shown and in addition to pointers showing whether the set is on the medium or long waves, the position of the tone and volume control and whether the set is on or off, there is a metre-type tuning indicator to indicate when the station is accurately tuned.

The first valve in the circuit is a heptode frequency changer preceded by a band-pass input circuit in association with which there is provision for second-channel suppression. The IF stage employs a variable-mu pentode which, like the frequency changer, is controlled partly from the AVC line and partly by bias from

its own cathode resistance. The second detector is a double-diode-triode in which one diode is used for signal rectification and the other for AVC supply. The method of connecting the gramophone pick-up is, however, somewhat unconventional as the circuit is altered, not by the waverange switch but by removing a flexible connection from the pick-up terminals to the back of the set before the connections are made. Another unusual feature is the incorporation of the tone control in association with the LF transformer coupling the output from the triode portion of the second detector valve to the output stage. The latter employs a large triode valve and the Type D4 Ferranti loud speaker is provided with a silencing switch for use when only an external loud speaker is required.

Tonal Quality

The tone of the instrument is certainly arresting and its outstanding quality is a clear and sonorous middle register. This is the foundation of all good quality and is often neglected in the search for im-

provement at the upper and lower extremities of the frequency range. There is ample bass with only a trace of box resonance which might go unnoticed were it not for the fact that it occasionally sets the station pointer in vibration. With the high magnification available it is easy to overload the output valve and this manifests itself first by distortion in the upper middle register, due to the production of harmonics. Slightly more volume is obtainable without distortion by making use of the tone control and the best results were obtained from the local stations on medium waves with both the tone and volume controls in their mid positions. On long waves owing to the slightly greater sideband cutting the tone control

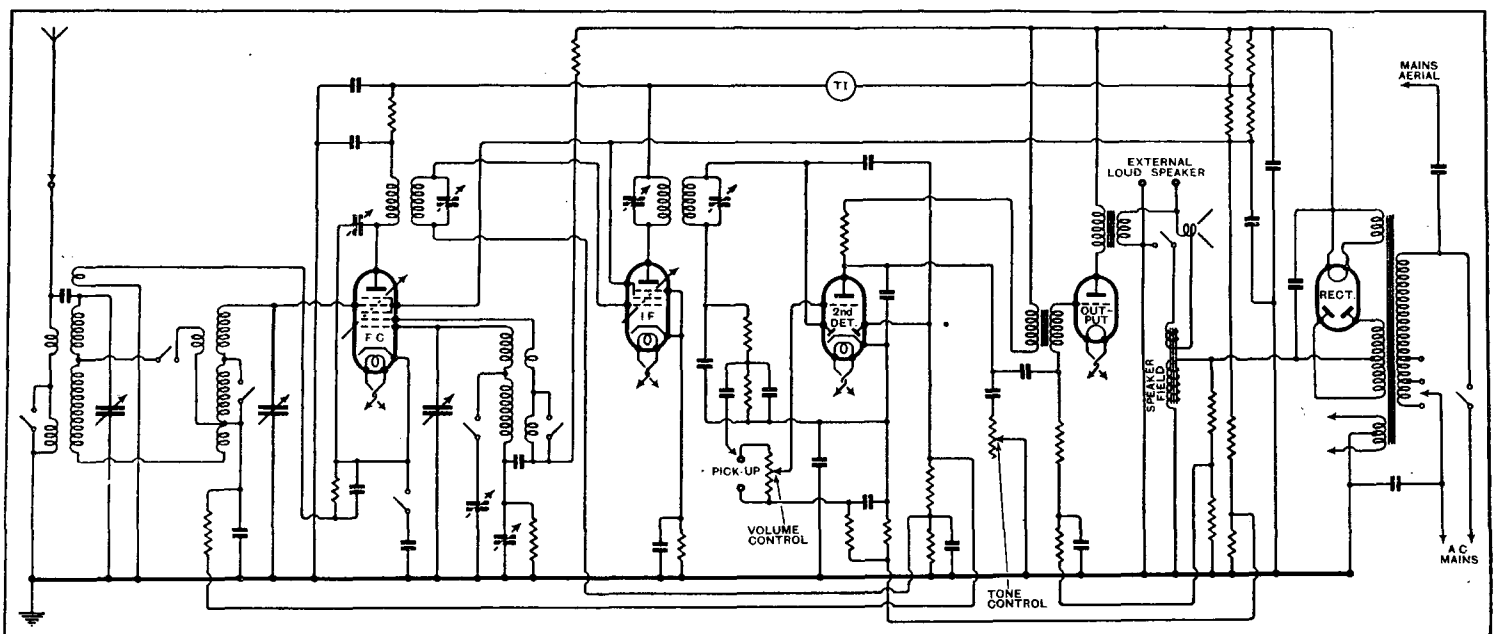

An unusual feature of the circuit is the association of the tone control with the transformer coupling the second detector to the output stage.

Ferranti Arcadia—

could be safely left in the "Brilliant" position.

The range of the set is deceptive, as the background noise between stations does not suggest high overall magnification. Nevertheless, six or seven lunch-hour programmes from foreign stations came in on

missions without further attention to the control knob.

The selectivity is sufficient in Central London to give reception clear of interference from the Brookmans Park transmitters outside a band extending two channels on either side of the local stations. The quality of reproduction in-

ing about in the way of background or other interference. Yet in other cases a small and distant station may interfere badly with one of far greater output power. Not so long ago, for instance, the 60-kilowatt Königsberg was completely jammed by the 5-kilowatt Parede, and interference is still frequently noticeable.

Rennes, at present operating on 40 kilowatts, though shortly to have its power increased considerably, is to be officially known in future as Rennes-Bretagne. Except that it is rather a mouthful, this is the kind of station-name to which the listener does not object, since it shows him both the town and the district in which the transmitter is situated. I fear, though, that whatever may be the official desires on the subject, Rennes will still be known by listeners simply as Rennes.

Readers will probably find that the British wavelength changes introduced on February 17th will make very little difference to their reception of foreign stations.

I am glad to be able to record that there is very little fading on foreign transmissions at the present time—hardly any, in fact, that cannot be dealt with adequately by a well-designed and properly adjusted automatic volume control. Surely automatic volume control is one of the greatest boons that the advances of recent years have conferred upon the long-distance listener.

Heterodynes have been less in evidence since I wrote my last report. Breslau is still suffering badly, and Königsberg frequently receives the unwelcome attentions of Parede, though these are much less in evidence than they were. Stuttgart, Leipzig and Nürnberg are all quite clear at the time of writing, and Luxembourg is having less trouble in this way.

Huizen, Radio - Paris, Luxembourg, Kalundborg and Oslo are all good long-wave transmissions, but Zeesen, Motala and Warsaw must be classed amongst the un-reliables. The best of the medium-wave stations are Budapest, Stuttgart, Vienna, Lyons Doua, Cologne, Stockholm, Rome, Munich, Leipzig, Berlin, Hamburg, Frankfurt, Trieste and Nürnberg. Others generally worth attention are Brussels No. 1, Paris PTT, Hilversum, Milan and Rennes.

D. EXER.

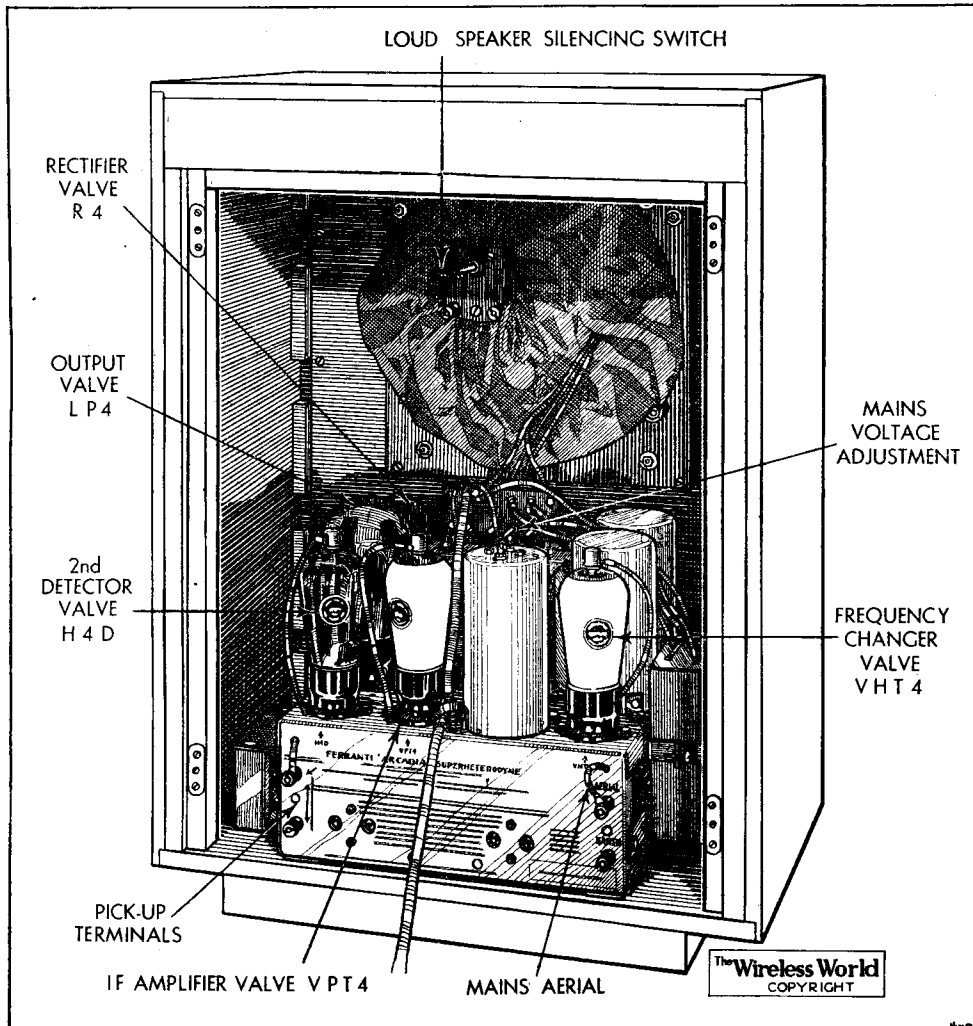

The chassis of the Ferranti "Arcadia" is unusually compact and the LF transformer is mounted outside the base on the left and the dry electrolytic smoothing condensers on the right.

the medium waveband with ample strength. Fécamp is a good test of sensitivity under daylight conditions and in this case came in very much above the average both in strength and clearness.

Provided the manual volume control is not advanced beyond the half-way mark, the AVC can be relied upon to cope with the variation of strength between the London, Midland and North Regional trans-

mits slightly higher selectivity on the long-wave range, but the German station between Droitwich and Radio Paris cannot be extricated from the background from these two stations sufficiently to rank as a reliable programme station.

Second-channel whistles are absent from the medium waveband and only one faint oscillator harmonic was detected on the long-wave range.

DISTANT RECEPTION NOTES

WHAT a curious business interference between stations is. An interesting case in point is Kootwijk, which takes over the Huizen service after 3.40 p.m. (When, by the way, I say the Huizen service I mean at present the Hilversum programmes, for these are being transmitted on the long waves until the end of next month). Kootwijk works on 160 kilocycles. Five kilocycles below it is the 7-kilowatt Kaunas transmitter, and six kilocycles above

the 40-kilowatt Lahti. From either or both of these one might expect there to be highly unpleasant carrier-wave heterodynes.

To make matters worse, the 20-kilowatt Brasov works nominally on exactly the same frequency as Kootwijk, though actually it is prone to a certain amount of wobbling. For all these things Kootwijk, in my locality at any rate, is usually well received in the evenings, and not for many weeks has there been anything worth talk-

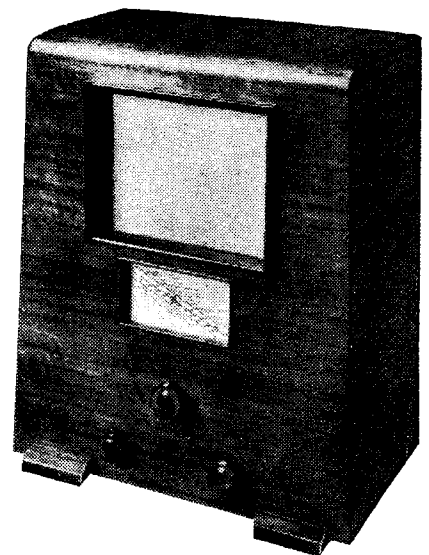

REACTION FROM VICTORIANISM. Modern tendencies in cabinet design exemplified in the new Bush Radio battery superhet., described last week.

HINTS AND TIPS

IT is generally accepted that a tendency towards distortion in LF transformers increases with increase in step-up ratio; therefore a 1:3 ratio is bound to be better than a 1:7. While there is a good deal of justification for such statements, they

Comparing LF Transformers

should be qualified by some saving clause such as "all other things being equal." A high-ratio transformer of good design is likely to be actually better than an indifferent low-ratio component.

Generally speaking, the imperfections of high ratio transformers will manifest themselves by loss of bass notes. When matters are carried to extremes, however, the lower middle register may be attenuated, and in extreme cases the gain of volume anticipated through the use of a high ratio may not be realised.

THE two methods in common use of changing inductances in receivers are (a) interchanging the coils bodily, and (b) wave-range switches whereby separate coils or sections of coils may be switched in and out of circuit. Method (a) survives only in specialised short-wave sets.

Multi-range Receivers

The purpose of this paragraph is to suggest a sort of half-way house between the undoubted convenience of switching and the cheapness and simplicity of changing coils. The scheme, which employs a series of sockets and wander plugs, is

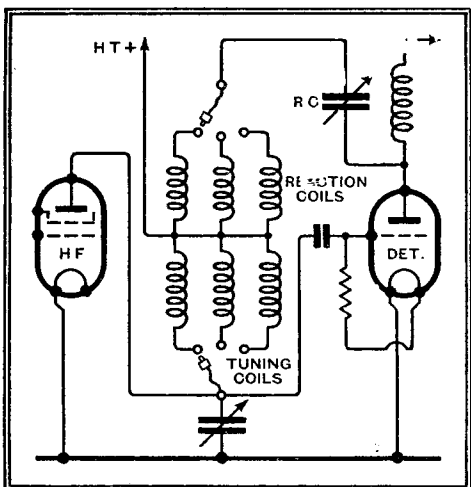

Fig. 1.—Plug-and-socket waveband selection: a simple substitute for switching in multi-range receivers.

reminiscent of the telephone operator's switchboard. In spite of its apparent crudity it has definite applications to non-standard receivers covering an abnormally large band of wavelengths for which ready-made switches and coils are

not available or are, at any rate, difficult to procure.

The idea will be readily understood by referring to Fig. 1, which shows its application to the very simple case of the tuned-anode HF circuit of a three-range set with reaction. Of course, the sockets must be mounted in an accessible position, and, with a little care, a very practical and neat waveband-changing system can be devised. It would perhaps be wisest, however, to restrict its general use as much as possible to receivers where the change-over plugs are not of necessity connected to points of high HT voltage.

THE installation of an aerial, although generally simple enough, is apt to prove a difficult matter to those who live in service flats, hotels, etc. Indeed, listeners in such circumstances are often compelled to adopt a mains aerial, even

Earthed Aerials

though the results obtained from it are far from satisfactory. In such cases it is useful to know that a reasonably good signal-collector can sometimes be contrived by substituting for the aerial what would normally be the earth system. No connection is made to the earth terminal of the receiver, but a lead is taken from the aerial terminal to a convenient point on any large mass of metal common to the whole building—for example, water pipes, radiators, steel girders, etc.

Such networks, although perhaps nominally earthed, will always be at sufficiently high signal potential above earth to act as an aerial, although their efficiency is admittedly uncertain and difficult to predict. Sometimes it is surprisingly good.

A CERTAIN amount of latitude is usually permissible with regard to the energy dissipated in a loud speaker field winding, particularly when the instrument is of the heavy-duty kind rated to dissipate 10 watts or more. But with

Excessive Energising Current

regard to the small lower-priced models where sensitivity is largely obtained by means of very small air gaps and light speech coils, it is unwise to exceed the manufacturer's dissipation figure.

This opinion is borne out by a case recently investigated where the field dissipation was nearly double that recommended by the maker. Results were normal for half an hour or so, but after a while a peculiar form of distortion became noticeable. Quality then deteriorated still further until a slight scraping sound could be heard during loud

passages. It was ultimately found that the magnet and field coil were almost too hot to touch. A closer examination revealed that the distortion was caused by

Aids to Better Reception

the paper former of the speech coil becoming so warped by excessive heat that it rubbed against the magnet.

OBVIOUSLY, the risk of accidental short-circuits is likely to be increased when a metal chassis is used in a receiver construction. Experience shows that such short circuits are particularly likely to arise in circumstances similar to that

Careless Wiring

illustrated—in perhaps rather exaggerated form—in Fig. 2, which represents a bushed terminal passing through the side or back of the base compartment of a typical receiver. It seems to be fatally easy in such circumstances to push the connecting wire too far through the hole of the soldering tag;

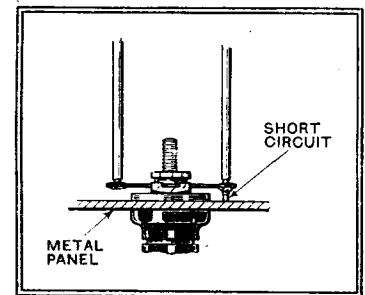

Fig. 2.—An accidental short-circuit of this kind may be difficult to find.

even if the wire does not itself make contact with the metal, it is more than possible that the short-circuit will be completed by the running of solder during the making of the joint.

THE older type of straight battery set usually continued to work—after a fashion—until the HT voltage had declined to perhaps half its original value. Quality was, of course, bad, but there was no very obvious falling off in sensitivity or selectivity.

Minimum HT Voltage

It is, perhaps, not the least of the advantages of certain modern battery super-heterodynes that they may fail to work altogether when HT voltage has fallen by perhaps as little as 25 per cent. At any rate, an unmistakable indication is given that something is wrong.

This state of affairs is particularly likely to arise in a receiver with an HF pentode frequency-changer; the valve may fail to oscillate, particularly on the long waves, unless supplied with ample HT voltage.

New German Receivers

"Between-Season" Models With Novel Features

FOR many years past it has been the custom of a number of leading German firms to provide so-called "between-season" sets in the spring. These sets either took the place of types which had been sold out or they filled some requirement of the public which had not been foreseen before the Radio Exhibition.

This year, however, according to mutual contract, no new sets may be placed on the market between January 31st and August 1st, so that several inter-

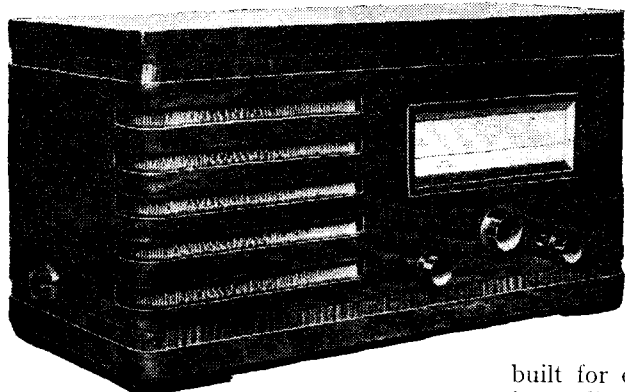

Placing the loud speaker to the side of the tuning dials is a new departure in German cabinet design. The picture shows the new Lorenz two-valve "Tonmeister."

esting "between-season" sets have been rushed out earlier than usual.

The majority of firms have produced improved models of their single-circuit 2-valve sets. The Seibt Company makes use of a reflex circuit for its latest model. Two firms, Tefag and Seibt, have adopted cabinet designs which are entirely new to Germany, the loud speaker being placed to the side of the tuning dial. Public demand for a set priced between the simple single-circuit model and the more expensive 3-valve reflex super-het has led to the reintroduction of our old friend the two-circuit 3-valve straight receiver.

The Germans have hitherto always claimed that a radio receiving set should look like a technical instrument and that the lines prescribed by technical requirements are beautiful enough without camouflage. The practice which is popular in America of hiding a receiver in what seems to be a book-case or a Jacobean cabinet was considered bad taste. But times change and with them the taste of the public. Siemens have produced what certainly is a sensation for Germany—a set which does not look like one.

The "Siemens Schatulle," as it is called, is in a small upright cabinet of

By a Special Correspondent

deep redwood with silver hinges and lock standing on four ivory spheres. This houses an improved edition of the Siemens four-valve superhet. When the doors of the cabinet are opened a silver metal panel is disclosed. The makers have abandoned the familiar celluloid band tuning dial, substituting a full-vision screen containing the names of all the more important stations arranged according to countries. The tuning indicator shows the relative field-strength of the incoming station. The intermediate frequency used is 129 kc/s. The receiver has seven tuned circuits, two of which comprise the band-pass filter. Needless to say the set is fitted with automatic volume control, tone control and a local-distance switch.

The Telefunken short-wave superhet is the first commercial receiver of its type in Germany. It has been specially built for export, but is also available to home listeners. The bakelite cabinet is designed to withstand the worst tropical conditions.

The receiver is a 5-valve superhet for AC mains. A battery receiver of the same type is in preparation. The dial is calibrated in kilocycles and metres. No station names appear, but the surface of the glass has been roughened so that the owner can inscribe the tuning positions of his favourite stations where they appear on the dial. The wavebands are from 13.6 to

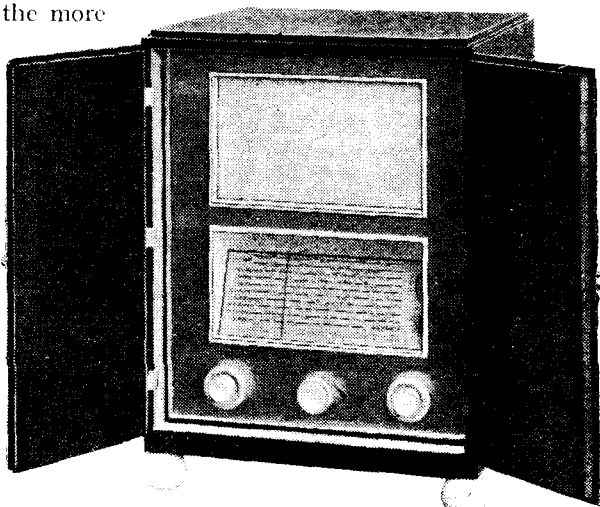

A four-valve superhet—the "Siemens-Schatulle"—in a redwood cabinet. The panel is of silver metal.

30.5 metres, 29 to 75 metres and 200 to 560 metres.

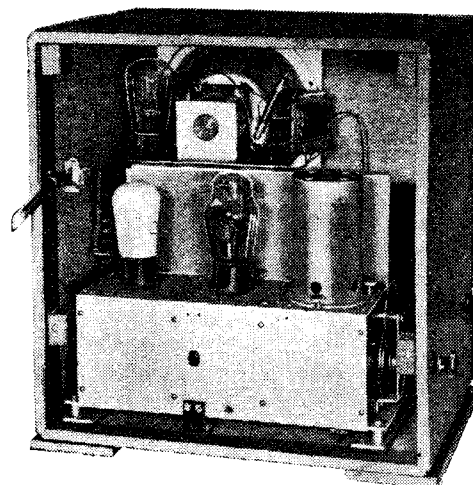

A back view of the new Telefunken mains-operated ultra-short-wave receiver which caters for experimenters who tune in the ultra-short-wave sound transmissions from Berlin.

For the first two bands special short-wave coils are used, while the iron-core type are employed for the medium waves. Automatic volume control and fluid light tuning are incorporated.

For those interested in the experimental ultra-short-wave sound broadcasts at present being sent out from Berlin, Telefunken have produced a special receiver.

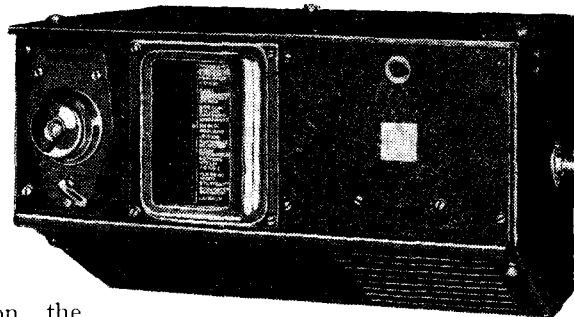

The Telefunken automobile set is shaped to fit cars of small dimensions.

This is available only through special channels and is not generally on sale.

The receiver is a three-valve reflex, AC mains-operated for a waveband of from 6.6 to 7.2 metres (42 to 46 kc/s). A length of wire up to ten feet is used as an aerial, together with an ordinary earth connection.

More About the Inverter

CONSIDERABLE interest has been aroused by "Diallist's" reference in our last issue to the possibilities of the inverter, which delivers AC on being connected to the DC supply. We now learn that American inverters will be available in this country within the next month from Universal Importers, Ltd., 24, Fitzroy Square, W.1. The ranges covered are:—

6v. DC	to 110 AC
12v. DC	" 110 AC
110v. DC	" 220 AC
120v. DC	" 220 AC
220v. DC	" 220 AC
240v. DC	" 220 AC

The Company have been appointed sole distributors in this country.



UNRAVELLING THE TANGLE in the last act of "The Chocolate Soldier," Oscar Strauss's tuneful comic opera, to be broadcast on Tuesday next (National, 8) and Wednesday (Reg., 7.30). Anne Ziegler sings in the rôle of Nadina Popoff.

THE HANDEL ANNIVERSARY

ANNIVERSARY celebrations often distort by over-emphasis the image of the great man they are intended to honour. There is little danger, however, of over-emphasising the greatness of George Frederick Handel. The 250th anniversary of his birth at Halle occurs on February 23rd, but already the festival concerts both here and abroad are in full swing.

This is a Handelian week. The B.B.C. will crown it with a symphony concert at the Queen's Hall on Wednesday next (National, 8.30) in which the outstanding item will be Handel's Serenata "Acis and Galatea," in which Isobel Baillie (soprano) will take the part of Galatea and Heddle Nash (tenor) that of Acis. John Kentish (tenor) will be Damon and William Parsons (bass) Polyphemus. The B.B.C. Chorus will comprise "The Chorus of Nymphs." Sir Thomas Beecham conducts.

Part II at 10.5 will include the Concerto Grosso in D Minor.

All next week the B.B.C.'s "Foundations of Music" series will be devoted to Handel's works for the harpsichord.

GERMAN CELEBRATIONS

ANOTHER performance of "Acis and Galatea" is being given by the Berlin Philharmonic Orchestra on Monday, February 18th, at 7.30, and will be broadcast by Berlin (Funkstunde).

At Leipzig's Fourteenth Concert of Masterpieces on Sunday next at 8.30, Günther Ramin will play the solo part in Handel's Organ Concertos in B flat and D minor with the Leipzig Symphony Orchestra.

"THE CHOCOLATE SOLDIER"

"The Chocolate Soldier," which must take its place with "The Merry Widow" as a "classic" comic opera, is to be broadcast twice next week by the B.B.C. (Tuesday, National, 8; Wednesday, Regional, 7.30). The music is by Oscar Strauss and the broadcast version by Stanislaus Stange.

Anne Ziegler, who scored such a success in "Love Needs a Waltz," will take the part of Nadina Popoff. The cast also includes Amy Augarde (Aurelia), Betty Huntley-Wright (Mascha), Horace Percival (Bumerlie), Franklyn Kelsey (Massakroff), Percy Heming (Casimir Popoff), and Jan van der Gucht (Alexius Sparideff).

The scenes of this gay and tuneful comedy are laid in Dragoman Pass, Bulgaria.

BOOKSHELF

A NEW feature on Sunday evenings is "Bookshelf," in which excerpts will be given from new publications on a given theme. At 6.45 on Sunday (National) Mr. W. E. Williams will take down some volumes from the bookshelf for our edification and delight.

ENGLISH MUSIC IN GERMANY

BRITISH composers come into their own this week with two important concerts. One is at Leipzig, where the Symphony Orchestra will broadcast an "English Concert" at 8.10 p.m. on Wednesday. William Turner Walton's Concerto for Viola and Orchestra will be given, with Cyril Kopatschka as soloist, and this will be followed by the well-known "London Symphony" by Vaughan Williams. Hans Weissbach conducts.

The B.B.C. will also pay homage to British music on Monday (Regional, 9 p.m.), when Section E of the Symphony Orchestra, under Joseph Lewis, will perform works by German, Mackenzie, Sullivan, Elgar and Coleridge-Taylor.

OPERAS AND OPERETTAS

TO-MORROW night (Saturday) at 7.10 Berlin (Funkstunde) will relay Suppé's opera comique, "Boccaccio," from the German Opera House. As an alternative we have the Strauss operetta, "Die Fledermaus," from Munich during the same period.

The Toulouse concert versions of operas are well worth tuning in. On Sunday next at 9 Radio-Toulouse gives Rossini's "Barber of Seville," and on Tuesday at the same hour a similar version of Mozart's "Figarro." Toulouse is also broadcasting extracts from operas and operettas throughout the week.

Listeners ★ ★ fo

LITHUANIA'S DAY

LITHUANIA'S national day, which celebrates its recognition in 1918 as an independent State, is marked by special programmes not only of its own from Kaunas, but also by Riga (Latvia) on February 16th. On the previous day there will be concerts of Lithuanian music broadcast by Rome at 7.45 and Prague at 8.30.

SURPRISES IN JACK PAYNE'S PARTY

JACK PAYNE brings his own party to the studio on Thursday next (National, 8), when he and his Boys will be accompanied by a number of artists

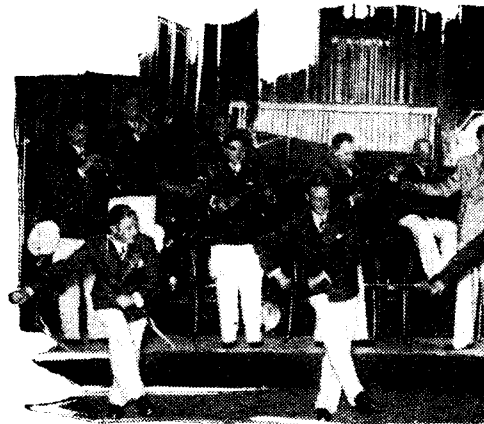

JACK PAYNE'S PARTY occupies the National. Jack and his Boys will entertain a number

"some of whom you have heard and not seen, some of whom you have seen and not heard on the radio, together with a surprise or two!"

"THE MYSTERY OF THE TEMPLE"

THE fate of the young Dauphin following the execution of his parents, Marie Antoinette and Louis XVI in the French Revolution is the theme of "The Mystery of the Temple," a specially written radio play which figures in the Regional programme on Thursday next (8 p.m.). Jeanne de Casalis plays the part of Marie Antoinette. The author, Norman Edwards, will act as narrator and the producer will be Val Gielgud.

Guide Outstanding Broadcasts at Home and Abroad for the Week

A CHOPIN DISCOVERY

A RECENTLY discovered Prelude in A flat by Chopin will be played by Arthur Alexander in the Wireless Military Band Concert on Wednesday next, National, 7.30.

I hope this will not clash with another very interesting item to Chopin lovers, viz., a recital on Chopin's own piano which is in the National Museum, Warsaw. This is to be broadcast from Warsaw at 7.50 on the same evening to celebrate the birth of the composer. The pianist at the museum will be Sztomka.

The second part of the Warsaw concert will be given

HANDEL CELEBRATIONS direct attention to the little town of Halle where the composer was born in 1685. The Handel statue in the main square (right) was erected by English and German admirers.

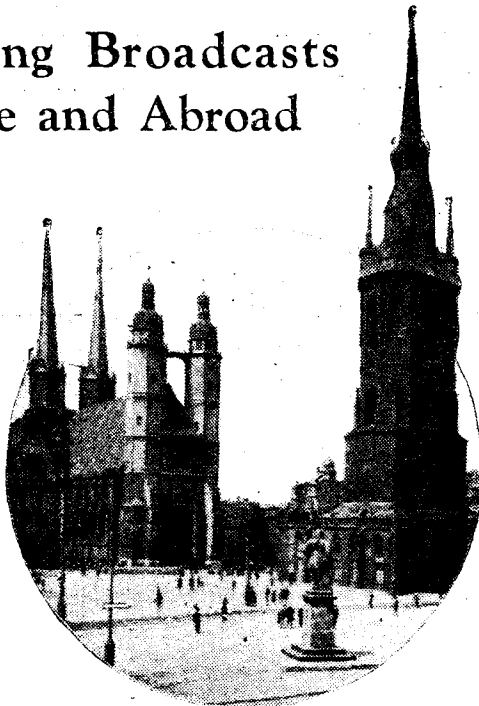

following evening Johannes Strauss's recital of Chopin Etudes will be broadcast by Berlin (Deutschlandsender) at 8.15.

RADIO GIFT BOOKS

MR. THAD ORDON is worth listening for. He is the English-speaking journalist at Warsaw who has contracted the pleasant habit of concluding his talks with an offer of free literature to those who ask for it. These gifts take the form of charmingly illustrated guide books. Mr. Ordon's next talk is at 9.45 p.m. on Thursday, February 21st. Letters to Mr. Ordon can be addressed to him, c/o *The Wireless World*.

"THE DOMINANT SEX"

GIVEN very careful selection, it is a good move to broadcast excerpts from current stage plays. To-night the B.B.C.

broadcasts a scene from "The Dominant Sex" at the Shaftesbury Theatre. Michael Egan, the author, has been a writer on electrical and wireless subjects for many years, so it is not surprising that the action of this clever comedy is set in an all-electric house. A radio-gramophone plays its part in the miniature "sex war" that is waged between the young married couple on the stage.

THE GREAT DEFECTIVE

ITEM: "The Speckled Hat Band," not by Sherlock Holmes but John Dighton (Wednesday, February 20th, Regional, 9.25). Bobbie Comber as Purelock Jones, Claude Hulbert as Dr. Watson. I am glad that the good doctor will be supported by Doris Arnold, Philip Wade and Clifford Bean.

THE AUDITOR.

HIGHLIGHTS OF THE WEEK

FRIDAY, FEBRUARY 15th.
Nat., 7.30, "The Air-do-Wells."
8.45, "I've Got to Have Music."
10.20, The B.B.C. Orchestra (Section D).
Reg., 7.40, The Belfast Philharmonic Society's Subscription Concert, from the Ulster Hall. 9, Radio play: "Roundabouts."

Abroad.

Sottens, 7.30, Symphony Concert from the Cathedral, Lausanne.

SATURDAY, FEBRUARY 16th.

Nat., 4.45, "Five Hours Back"—programme from U.S.A. 8, "B.I.F.—a Poster in Sound." 8.30, "Music Hall." 10, B.B.C. Theatre Orchestra.
Reg., 7.30, The Wireless Singers. 8.10, B.B.C. Orchestra (Section D). 9.10, Conversations in the Train.

Abroad.

Cologne, 9.35, Cologne Radio Ball from the Tonhalle, Dusseldorf.

SUNDAY, FEBRUARY 17th.

Nat., 1.30, Pianoforte Recital by Cecil Baumer. 2, The Wireless Military Band. 9, Leslie Jeffries and Orchestra at the Grand Hotel, Eastbourne.
Reg., 5.30, Callender's Senior Band. 6.45, B.B.C. Orchestra (Section C) with Frank Mannheimer (pianoforte). 9.20, Sunday Orchestral Concert.

Abroad.

Vienna, 7.5, Operetta: "The Flower of Hawaii" (Abraham).

MONDAY, FEBRUARY 18th.

Nat., 8, "One Crowded Hour"—variety compered by John Watt. 9.20, Pianoforte Interlude by Ernest Lush.
Reg., 6.30, "The Radio Follies" (from Midland). 8, Recital by Spencer Thomas (tenor), Lauri Kennedy (cello) and Maurice Vinden (organ).

Abroad.

Warsaw, 8, Dvorak's "New World" Symphony (E minor). 4

TUESDAY, FEBRUARY 19th.

Nat., 8, "The Chocolate Soldier." 10.15, Gershom Parkington Quintet.
Reg., 7, Henry Hall and the B.B.C. Dance Orchestra. 7.45, Liverpool Philharmonic Concert. 8.35, "The Lover"—an ironic comedy. 9, Canadian Music.

Abroad.

Frankfurt, 7.10, Opera "Tosca" (Puccini) relayed from the Grand Opera House, Darmstadt.

WEDNESDAY, FEBRUARY 20th.

Nat., 7.30, Wireless Military Band. 8.30, Handel Anniversary Concert at the Queen's Hall. 10.5, Part II of Concert.
Reg., 7.30, "The Chocolate Soldier." 9, "Best Sellers"—popular songs of the day.

Abroad.

Warsaw, 7.50, Chopin Commemoration Concert.

THURSDAY, FEBRUARY 21st.

Nat., 8, Jack Payne's Party. 8.45, Recital by William Primrose (violin) and Sydney Harrison (piano).
Reg., 8, "The Mystery of the Temple"—a radio play. 9.15, The B.B.C. Theatre Orchestra.

Abroad.

Radio-Paris, 8.45, Symphony Concert by the National Orchestra.

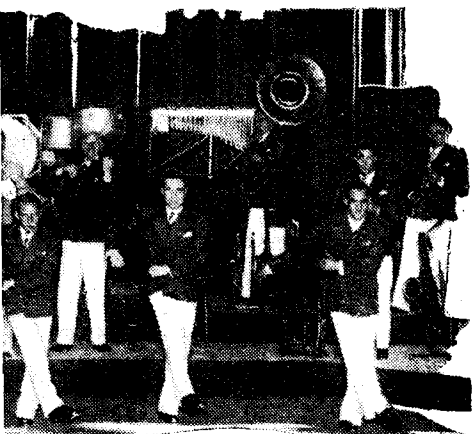

at wavelengths at 8 p.m. on Thursday next. . . of friends and offer us a surprise or two.

in the studio by the station orchestra and soloists. On the



"ALL-ELECTRIC" in more senses than one is the home in which Diana Churchill and Richard Bird dispute each other's claims in "The Dominant Sex"—the Shaftesbury Theatre comedy from which an excerpt will be broadcast this evening (Friday) at 7.20. Michael Egan, the author, has written a number of books on wireless and electrical subjects.

Frequency Transformation

A Simple Account of the Theory, with Special Reference to "Single-Span"

By F. M. COLEBROOK, B.Sc., D.I.C., A.C.G.I.

THE development of the single-span system of tuning has given rise to doubt in some quarters as to the precise mechanism of the frequency-changer, for as the intermediate frequency is higher than the signal frequency, the usual graphical illustration of its operation fails to give any intelligible picture. It is shown in this article that the frequency-changer of a single-span receiver operates in exactly the same manner as that of an ordinary superheterodyne.

IT is well known that in ordinary super-sonic heterodyne (or, colloquially, "superheterodyne") reception the incident electric wave is combined with a locally generated oscillation, and that, as a result of their interaction, there is produced an oscillation (i.e., an alternating current or potential) the frequency of which is equal to the difference between the two original frequencies. Thus, if the signal is on 1,000 kc/s, and the local oscillator is set to 890 kc/s, the resultant difference-frequency oscillation will be at 110 kc/s (i.e., 1,000 - 890 kc/s). The signal wave is thus transformed down in frequency before being further amplified and finally rectified. The frequency to which it is transformed has always been referred to as the "intermediate frequency," because it lies, in magnitude, between the original carrier-frequency and the band of modulation frequencies which is produced by the final rectification.

The process can be, and usually is, explained by showing the resemblance between the combined oscillations and a single-frequency oscillation which is modulated at the difference- or intermediate-frequency, and non-technical

readers with some interest in theory have found no difficulty in understanding the process in these terms. Recently, however, *The Wireless World* has introduced a receiver (the now well-known "single-span" receiver described in the issue of March 23rd, 1934) in which, though it is described as a superheterodyne, this frequency change has been, so to speak, turned inside out. The intermediate frequency in this case is intermediate only in the sense of intervening in, the reception process, for, as far as actual magnitude is concerned, it is actually higher than the highest signal-frequency received. That is to say, the signal is transformed *up* in

A frequency-changer unit similar to the type used for the *Wireless World* Single-Span receivers.

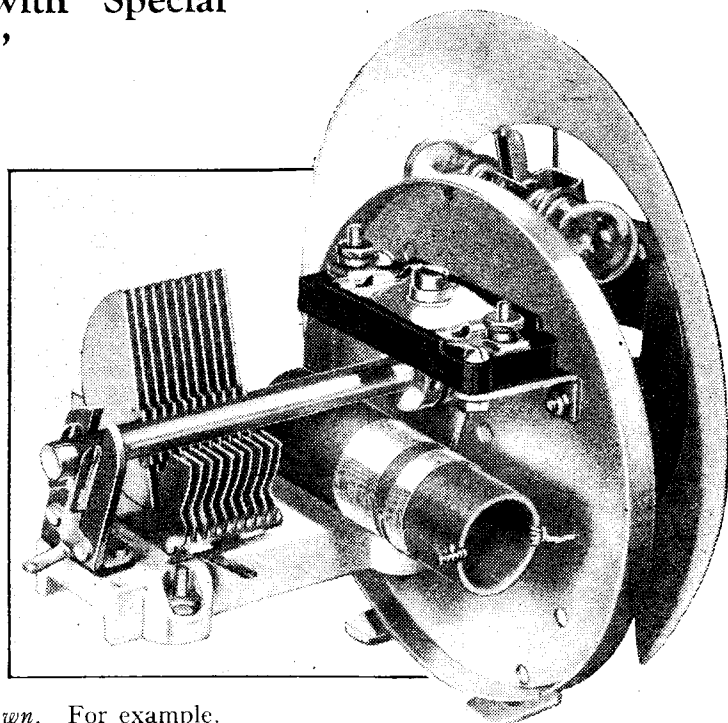

frequency and not *down*. For example, a signal on 200 kc/s (1,500 metres) is, in the single-span receiver, transformed *up* as much as eight-fold to 1,600 kc/s. Now, although there is not, in this modification of the usual process, any essential innovation in theory (for the higher intermediate frequency is still the difference between those of the signal and the local oscillation), it cannot be depicted in quite the same simple fashion as the usual process. From enquiries received it is clear that

some readers have realised this fact, and, indeed, find it difficult to frame for themselves any simple explanation of the theory. It appears, therefore, that there is some demand for more insight into the mechanism of frequency-transformation, whether up or down. The

present article is an attempt to meet this demand, and will be mainly confined to the fundamental theory of the matter with no more than needful reference to circuit details or other technical matters.

In the first place, it will be well to emphasise a fact that even now is frequently overlooked, namely, that the mere addition in the same circuit of two oscillations of different frequencies leaves each frequency completely unaffected, and produces no new frequencies whatever, just as, to use a rather crude analogy, the mere addition of apples to oranges in the same bowl does not produce a new fruit combining the flavours of both. This is not

only true, but very fortunate, for if it were untrue radio-communication would be practically impossible. The radio medium—ether, or what you will—is full at almost all times of a multitude of electric oscillations of different frequencies, which are all added to each other in the above sense, but it is a fact of experience that they do not interact or cross-modulate or produce new frequencies at all.* A tuned circuit or an aerial will respond to each and every oscillation just as it would if all the others were absent, and the actual instantaneous currents or potentials induced will simply be the sum of the contributions from each oscillation. The resulting oscillation-pattern, even though it contains no more than the original frequencies, will, of course, be more or less complicated in form, and will depend on the frequencies and amplitudes involved. This can be illustrated by reference to the two types of superheterodyne process referred to above, the comparison of which will bring out the apparent difficulty of explaining the step-up transformation which was mentioned in the beginning of the article.

Small Difference Frequencies

Fig. 1 shows the kind of pattern given by the addition of two oscillations of frequencies not very different from each other. If the one, for example, is 100 c/s and the other 99 c/s, then when the faster has made one complete oscillation in one-hundredth of a second, the other will have

* This statement is not universally true without reservation, for there is now some evidence of interaction in the ionosphere, but this is rather a special case.

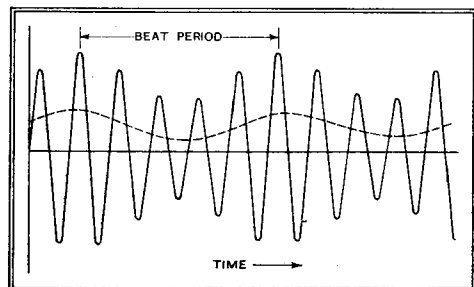

Fig. 1.—Heterodyne combination of two oscillations of nearly equal frequencies.

Frequency Transformation—

made only ninety-nine-hundredths of an oscillation, i.e., it will be one-hundredth of an oscillation behind in one-hundredth of a second, or a complete oscillation behind in one second. Thus, the two oscillations will come exactly into phase (or in step), giving a maximum amplitude once every second, as indicated in Fig. 1. The combined waves are thus similar in appearance to an amplitude-modulated wave, the amplitude modulation having a frequency equal to the difference of the two frequencies (one cycle per second, of 100-99 c/s in the numerical example quoted).

Fig. 1 will, of course, be recognised as the picture appropriate to the usual heterodyne process, but it must again be emphasised that the complete pattern does not contain any frequencies other than the two original frequencies. If, however, the negative half-waves are suppressed (as in perfect rectification), then the average value of the remainder will be somewhat as shown by the dotted line, i.e., an oscillation of difference-frequency, but this implies two additional requirements beyond the mere summation of the oscillations, namely, some form of rectification and a circuit which "smooths out" the product of rectification to an average value over a radio-frequency period.

In the single-span receiver the interference picture is quite different. In receiving a long wave, for example, the signal-frequency is small compared with the local-oscillator frequency. The combination is therefore as shown in the three curves of Fig. 2. In this case there is not even any appearance of a difference-frequency modulation. It is, nevertheless, a fact of experience, and is consistent with theory, that any form of rectification of this combined oscillation, perfect or otherwise, will produce an alternating component of difference-frequency. This is merely an instance of the general observation that only in the simplest cases is the

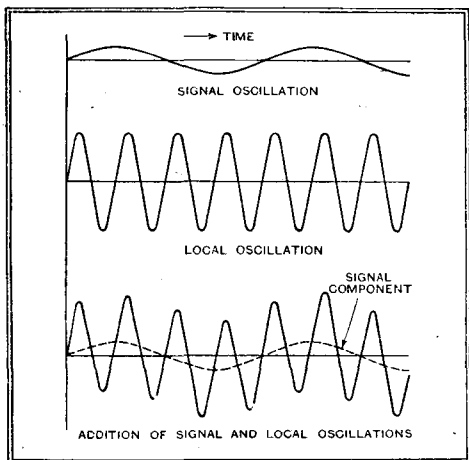

Fig. 2.—Heterodyne combination of an oscillation with another of much higher frequency.

eye capable of appreciating the frequency constitution of a complex oscillation. The ordinary heterodyne case is not typical in this respect, but is a fortunate exception.

The graphical depiction of the process will not therefore give the desired insight into it, and cannot by any means known to the writer be made to do so directly. It is necessary, unfortunately, to examine the matter in a more analytical and intellectual fashion, though the analysis can be, and will be, made easier to apprehend by a graphical illustration.

Cross Multiplication

It has already been said that mere addition of the oscillations produces no frequency-transformation, and the nature of the additional element required has, moreover, been indicated in the preceding paragraphs, i.e., rectification. This, however, is not the most accurate way of specifying the additional requirement, for the desired frequency-transformation is, in fact, brought about by any circuit arrangement, rectifying or otherwise, which produces not addition, but multiplication, of the oscillations. The distinction between rectification and multiplication is quite a real one, for in modern frequency-changing circuits (such as that of the single-span receiver) there is no rectification in the ordinary sense of the word, but there is precisely this cross-multiplication of oscillations which is essential for the desired frequency-change. To put it compactly, if e_1 be the e.m.f. due to the signal, a sine-wave or modulated sine-wave of frequency f_1 , and if e_2 be that due to the local oscillation, with frequency f_2 , then the supersonic-heterodyne process requires that the frequency-changing stage shall give an output current or voltage which is proportional at every instant to the product $e_1 \times e_2$. The reason for this is that the product $e_1 \times e_2$ is equivalent to the sum of two equal oscillations of frequencies $f_1 + f_2$ and $f_1 - f_2$ and of amplitude equal to half the product of the amplitudes of e_1 and e_2 . This is a perfectly general proposition, which is true whatever the frequencies f_1 and f_2 , and whatever the amplitudes of the two oscillations e_1 and e_2 .

Unfortunately, there is no simple proof of this statement. Those who have not forgotten all the trigonometry they learned at school will recognise it as the formula—

$$\frac{1}{2} \{ \cos 2\pi(f_1 - f_2)t - \cos 2\pi(f_1 + f_2)t \}$$
 but those who have forgotten or never learned it will simply have to accept it as the law for the multiplication of oscillations.

The process can, however, be illustrated. In Fig. 3 the bottom curve is the result of multiplying together the ordinates or heights of the two other curves. If these curves represent oscillations with frequencies f_1 and f_2 respectively, then the dotted line running through the bottom curve is an oscillation of frequency $f_1 - f_2$, and the solid curve alternates above and below this dotted line with a frequency $f_1 + f_2$, so that the product is thus exhibited as the addition of oscillations of sum- and difference-frequencies.

How, then, is this multiplication brought about in a receiver? As already

stated, one way is the rectification of the combined oscillations. Even those who have forgotten all the rest of their mathematics will probably remember the formula for the square of the sum of two numbers, i.e.—

$$(a + b)^2 = a^2 + b^2 + 2ab,$$

from which it will be seen that the square of the sum of e_1 and e_2 will contain the term $2e_1e_2$. The so-called "perfect" or "linear" rectification can be regarded as an extreme case of rectification by a curved characteristic, in which the output will be proportional, not only to the square, but to

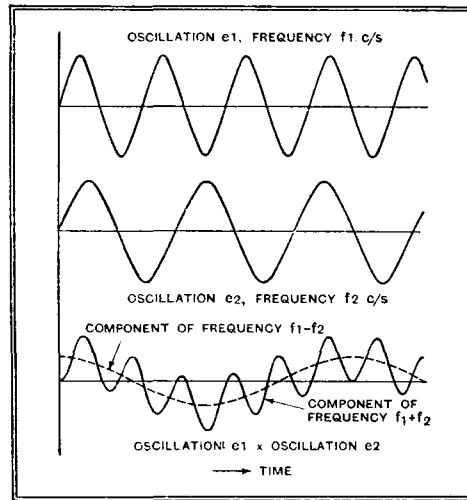

Fig. 3.—Illustration of the multiplication of two oscillations.

the cube, fourth, fifth, and higher powers of the combined e.m.f.s $e_1 + e_2$. The result is similar to that of the simpler type of rectification, namely, a number of terms containing the product $e_1 \times e_2$.

But, as already stated, the mechanism employed in a modern superheterodyne receiver is not rectification, but direct multiplication of the oscillations. This has been made possible by the recent introduction of special multiple electrode valves, such as the frequency-changing heptode. A full account of the theory of operation of such valves is outside the scope of this article, but as far as frequency-transformation is concerned it is sufficient to know that the slope of the mutual-conductance (i.e., anode current-grid voltage) characteristic for one of the grid-electrodes depends in an approximately linear manner on the potential of another grid-electrode. Thus, if the signal-oscillation e_1 is applied to the first-mentioned grid, the corresponding anode-current oscillation will be proportional to e_1 , i.e., say, $k \times e_1$, where k depends on the mutual-conductance for this grid. If, now, the e.m.f. e_2 due to the local oscillation is applied to the second-mentioned grid-electrode, k will vary periodically in phase with e_2 , i.e., the anode current will contain a component proportional to the product $e_1 \times e_2$. Thus we have a direct multiplication of the two oscillations, even though the valve-characteristics involved are, very approximately, straight lines.

The advantages of this mechanism are such that it is likely to supersede all other types of frequency-changing circuit,

Frequency Transformation—

whether the desired frequency-transformation is down, as in ordinary superheterodyne reception, or up, as in the "single-span" and some other receivers. From the point of view of theory it has the advantage of effecting the necessary interaction of oscillations by the production of the multiplication $e_1 \times e_2$ in the most direct manner possible, with a minimum of other frequency components, due to parasitic combinations of the two oscillations, which do not contribute to the desired difference-frequency.

Finally, one other feature of the frequency-transformation process may be mentioned. It has been shown that the difference-frequency $f_1 - f_2$ arises from the product of the oscillations e_1, e_2 . It may further be stated that this is, in general, the only way in which it can be produced (apart from certain special cases in which there are particular numerical relations between f_1 and f_2). It has also been stated that the production of this difference-frequency $f_1 - f_2$ is inseparable from the production of an equal component of frequency $f_1 + f_2$. Although this is true as far as electromotive forces are concerned, it does not, obviously, imply that the sum-frequency is equally prominent in the output of the frequency-change circuit as a whole, for the circuit will be designed so as to select the desired difference-frequency by means of suitable tuned circuits.

Alternatively, of course, the sum-frequency component can be selected and used as the intermediate frequency, the local oscillator being set at a frequency below that for which the output-circuit is tuned. The writer has, on occasion, used the sum-frequency in this way, when other circumstances made it desirable to do so, and there was no observable difference in the functioning of the receiver.

Modulation

This production of the sum-frequency does not, of course, constitute a third channel of reception—after the manner of the second channel of the ordinary heterodyne process—for where the difference-frequency is intended to be used the whole range of the local oscillator will already be above the fixed intermediate frequency, and any additional frequencies will be still further above it. It would simply mean that if the local oscillator range extended appreciably *below* the fixed intermediate frequency by, say, F c/s, then transmissions on frequencies less than F c/s would appear twice in the tuning range of the local oscillator, unless prevented by signal-frequency selection.

It will be observed that throughout in this discussion the signal has been regarded as a single-frequency or pure sine-wave oscillation. In the reception of broadcast transmissions, however, it will actually be a pure radio-frequency wave modulated at one or more audio-frequencies. This, however, does not affect the transformation process in any essential way. Considering, for example, a pure-

tone modulation at n cycles per second on a carrier of f_1 kc/s, then, as is well known, the signal-wave can be regarded as the sum of a pure sine-wave carrier, with additional sine-wave oscillations at $f_1 + n$ and $f_1 - n$ kc/s. The product of this composite oscillation with the local oscillation on f_2 kc/s will result, for the reasons already given, in a sum-frequency carrier ($f_1 + f_2$ kc/s) with its associated side waves, and the difference-frequency carrier ($f_1 - f_2$ kc/s) also with its associated side-waves. The same reasoning will apply

to a modulation of complex wave-form, which can be regarded as the sum of a large number of pure tones. Each corresponding constituent side-wave is translated in frequency in the two directions represented by the sum and difference formation respectively, and the whole group of radio frequencies is thus linearly transformed to two bands, the lower of which will, assuming correct tuning adjustment of the local oscillator, lie symmetrically about the fixed intermediate frequency of the receiver.

Random Radiations

By "DIALLIST"

Where Will the Site Be?

ONE of the topics of the hour is the choice of the position for London's television station. So far four places have been suggested: the Crystal Palace, the Alexandra Palace, Hampstead Heath, and Highgate Hill. Since the ultra-shorts are quasi-visual, height is, of course, a matter of great importance, and at any of these places an aerial four hundred feet or more above sea level could be erected.

The simplest course would seem to be to take over the existing Baird station at the Crystal Palace. It has been thoroughly tested and its range in different directions is pretty well known, for maps showing field strength "contours" have been prepared. The trouble, though, is that the Report recommends that E.M.I. transmissions should alternate with those of the Baird people, so that perhaps a neutral site might be preferable.

My own purely selfish hope is that one of the North London sites will find favour, for I happen to live in one of the long, narrow Chiltern valleys where reception from the Crystal Palace might be blanketed, as, in fact, would be the case with considerable areas north of the Hampstead and Highgate hills.

Ultra-shorts and the Future

Once the public has had a taste of reception on wavelengths between 6 and 7 metres I have an idea that it will emulate Oliver Twist by asking for more. The strong points about transmission and reception on the wavelets are first of all that there is no fading; secondly, that atmo-

spherics just don't happen; and, thirdly, that they seem to be more or less immune from the unwelcome intrusion of man-made interference in certain forms.

I may be a bad prophet, but my forecast is that there will be a growing demand amongst those situated within the service areas of television stations for the transmission on the wavelength devoted to "sound" or larger and larger portions of the B.B.C.'s ordinary non-visual programmes. The medium- and long-wave stations will probably continue to exist and to be used for years, but as problems of interference between stations and of wavelength distribution become increasingly difficult to solve I fully expect to see the ultra-shorts more and more widely used for the relaying of "sound" programmes.

Service After Sales

SOME manufacturers have first-rate service-after-sales policies, but others, I regret to say, are by no means so accommodating when breakdowns due to faulty components occur in their sets. In their guarantees they undertake to make free replacements of defective parts, but there is also frequently a clause that labour charges will be made.

So long as the labour charges are reasonable I have not a word to say, but often the owner of a set which has had to be returned for servicing after a month or two's use has the unpleasant feeling that under the guise of labour costs he is really being made to pay in full for the new part used to replace the "dud."

By far the fairest scheme is to have a



The new Advisory Committee on Television at their first meeting after the appointment of the Committee by the Postmaster-General. The names of the members, reading from left to right, are: Mr. Noel Ashbridge, Mr. O. F. Brown, Sir Frank Smith, Lord Selsdon (chairman), Mr. F. W. Phillips, Col. A. S. Angwin, and Mr. J. Varley Roberts. The first task of the Committee will be, it is understood, the selection of a site for the London television transmitter.

Random Radiations—

small fixed labour charge, whatever the job may be. The customer then knows exactly where he stands.

**The Aerial Question**

WITH the modern highly sensitive receiving set it may be even more important to have a thoroughly good earth contact than to erect a first-class aerial. In fact, I would almost go so far as to say that on the medium and long waves on modern sets you will get good results with almost any kind of aerial so long as it is of reasonable size and reasonably well insulated.

Years ago we really believed that it was of the utmost importance to use plenty of porcelain insulators in series, and even to give them baths at fairly frequent intervals. Stranded wire must be used, and it was held to be a matter of real moment that "roof" and down-lead should be all in one piece.

Then one day my eyes were opened. For some reason, now forgotten, my big aerial was out of action, and as I particularly wanted to use a receiving set that evening, a makeshift had to be erected right quickly. A length of No. 18 bare copper wire was slung between a top-floor window frame and the gutter spout on an outbuilding, the only insulation being the bits of string to which it was tied. The lead-in was connected to the "roof" by the simple process of twisting the two together tightly with pliers. Worse still, the naked lead-in lay upon the window sill, and as the evening was chilly the window was shut down upon it.

A pretty grim contraption, what? Still, it functioned so well that in the small hours of the following morning American stations were coming in splendidly. I am afraid that I have never bothered since to re-erect the aerial masterpiece that used to decorate my garden.

The Earth's Another Matter

But no matter what kind of comic aerial may suffice, you cannot expect good reception if your earth isn't up to the mark. Time and time again I have traced poor results in friends' receiving sets to bad earths, and the very first thing that I look for nowadays when a newly installed set is not behaving as it should is a poor earth contact.

Many people have the idea that so long as you bury a metal plate here or drive in an earth tube there you have done all that can be done in the way of making an earth connection. This is very far from being the case. Results depend enormously upon finding the right soil.

An earth buried in or driven into light chalky or gravelly soil may make the poorest of connections, except possibly in very wet weather. Get down to a heavy subsoil—clay for preference—and you can be sure that you have an earth that is doing its job as it should be done.

**The "Acorn" Tube**

UNTIL recently that minute valve the "Acorn" tube was not to be found outside the laboratories of the American R.C.A., who originated it. It is now on the market in the United States, and some interesting results should follow when amateurs have done some experimental work with it.

It gets its name from the fact that its shape is just like that of an acorn in its

cup, the contacts for the electrodes being sealed into a glass ring near the base of the tiny bulb. The complete mains "Acorn," with heater, cathode, grid and plate, is just about the size of a fat acorn. An amazing quality of this valvelet is that it will oscillate at frequencies up to about 600 megacycles, or, say, half a metre. I believe that besides the triode there is also a screen-grid Acorn.

An Early Miniature

The "Acorn" tube is by no means the first tiny valve to be produced. Many old hands will remember the "Weco" valve, which appeared in this country a good many years ago. It measured little more than two inches over all, its bulb having a diameter not much greater than that of a lead pencil. The moulded base fitted into a special midget holder of the bayonet type. The filament required a quarter of an ampere at just over 1 volt. This queer little valve never became very popular for its uses were so limited. It was made only in the medium impedance type; its efficiency was not great and inter-electrode capacity was on the high side. It was, however, quite useful for the construction of miniature portable sets for headphone reception, which at that time had something of a vogue.

Short-wave Broadcasting

THERE cannot be a single owner of a short-wave receiver who has not, at some time or other, heard a programme from Zeesen, on one of its many wavelengths. Of all the European stations, Zeesen seems to be the most consistent as far as reception in this country is concerned.

It is interesting to note that the station is still being improved and developed, and that when the scheme is fully completed directional systems will have been installed for transmission to practically all parts of the world.

Most of us have heard the announcement "Dear friends and listeners in Africa . . ." and additional transmitters "beaming" at Central America and Australia are now under way.

The directors of the station are aiming at "maintaining close personal touch" with their world-wide audiences.

In a way, listeners overseas are better served in this way than we are at home. There are very few short-wave stations in the world putting out special programmes for British listeners, but the short-wave man in South Africa, for instance, has the choice of at least three high-power transmissions put out specially for his benefit.

Naturally, as we in this country have a first-rate medium-wave service, it would be asking too much to expect regular programmes on short waves; but they will come, sooner or later, either from the U.S.A. or from one of our own Dominions.

The tremendous popularity of short-wave broadcast receivers in the U.S.A. is, of course, due to the fact that reception of foreign stations is only possible by this means. Moreover, it is a new sensation for the American listener, whereas the average European enthusiast has been swamped with foreign programmes on the medium waves for several years.

One of the latest crazes in the States

is the home-recording of foreign programmes received on the short waves. In some cases these recordings are actually used as "verifications" by listeners ardently seeking QSL-cards from distant stations that they have heard!

The idea is certainly attractive, and might well be applied to the amateur bands. One or two European amateurs that one might name would probably learn a lot from a careful playing-over of a record of their own signals!

The establishment of regular ultra-short-wave broadcast stations seems to be favoured once more. Many short-wave listeners are already building 5-8-metre sets in readiness for the high-definition television transmissions, and in some countries it is proposed to establish experimental stations working on this band and re-radiating the local broadcast programme.

A low-power station of this type would give adequate service in a medium-sized town that is not too well served by the existing medium-wave broadcast. Naturally, the scheme has not much to recommend it in this country, thanks to the efficiency of the Regional scheme; but in larger countries it seems to have distinct possibilities.

New stations heard on the short waves during the past fortnight include the following: PK-YDB, Bandoeng, Java, on 49.67 metres; HIZ, Santo Domingo, Dominican Republic, on 47.5 metres; HKE, Bogota, Colombia, on 41.55 metres (in the 40-metre amateur band—a sign of the times?); and KZRM, Manila, Philippine Islands, on 31.3 metres.

Activity on the 19-metre band is not very marked; all the well-known stations have settled down into a very consistent routine, and there are no newcomers. The 31- and 49-metre bands provide most of the material for the keen "DX" listener, particularly as many stations, as yet unlisted, may be heard from time to time carrying out experimental transmissions. MEGACYCLE.

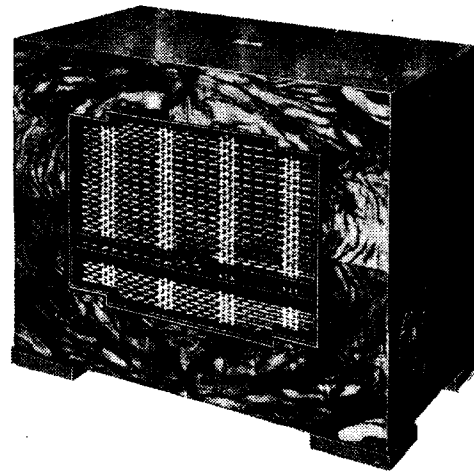
New Marconiphone Speaker

THE new Model 195 moving-coil loud speaker recently introduced by the Marconiphone Co., Ltd., is fitted with a "multi-functional" composite metal and paper elliptical cone which, in addition to increasing the frequency response, also gives a better sound distribution. The built-in volume control is of the constant impedance type and actually incorporates three ganged potentiometers. The speech coil impedance is approximately 9 ohms at 800 cycles and no input transformer is fitted. The price is eight guineas.

Letters to the Editor

The Editor does not hold himself responsible for the opinions of his correspondents

The Luxembourg Effect

From Dr. Roland Walter, Chief of the Technical Division of Latvian Broadcasting.

IT will perhaps be of interest to know that here in Riga the Luxembourg Effect is also to be found, the programme from Warsaw being frequently heard on the carrier-waves of Prague and Budapest.

One such occurrence was quite amusing. One of the features of our broadcast programme consists of re-transmissions of foreign programmes, which take place about once a week late in the evening after our own programmes. I make these re-transmissions myself from my own house, which lies rather outside the town in an electrically quiet neighbourhood. On the 7th January, 1935, from 22.37 to 23.02 (East European Time), Prague was being transmitted, when for the first time on such a transmission the effect caused a direct interference. I called the attention of listeners to it and explained the interest of the phenomenon. When, at the end of the concert, Prague gave a pause from 23.02 to 23.04, the programme from Warsaw—dance music—was so clearly heard that I increased the amplification and, as a curiosity, transmitted it at full strength from our stations. It is true that the background noise was quite loud and the reception had no musical value, but I was able to tell our listeners that they had been hearing a particularly fine example of the celebrated Luxembourg Effect, and that this dance music was sent out from Warsaw and then, in the stratosphere 100 kilometres above Warsaw, was transferred to the carrier-wave from Prague and so had reached us. Our four stations, Riga, Madona, Kuldiga and Liepaja, took part in the broadcast.

Later on, the following re-transmissions were seriously interfered with by the Effect: On January 16th, from 22.39 to 22.57, the European concert from Basle was received alternately from Beromünster and Budapest: Budapest disturbed by the Warsaw programme. On January 20th, from 23.29 to 00.03, Tzigane music from Budapest was disturbed by the Warsaw programme.

ROLAND WALTER.

Riga, Latvia.

Mains Interference—New Version

I SHOULD be grateful if your readers could suggest the cause and remedy for interference to reception caused by boiling of water in the supply system in my house. When steam begins to rise through the cold water feed cistern, or when a tap is turned on, violent and continuous interference is heard until the water ceases to boil.

The water is hard, and so the pipes are probably coated internally with an insulating deposit of limestone. A direct earth for the receiver and bonding of hot and cold water pipes have no effect.

W. R. MORTON.

Newcastle-on-Tyne.

New Monodial Super

IN response to the request of one of your correspondents, whose letter appeared in your issue of the 11th ult., I built the New

Monodial Super, constructional details of which were given in your issues of July 21 and 28, 1933, and have had it in use for the past sixteen months.

Whilst I can say with the utmost confidence that it is the finest receiver I have ever handled or listened to, mine suffers from one defect; when a station on the medium waveband is fading badly, not only do distortion and background noise appear, but the volume increases.* So far, I have been unable to effect a cure.

C. W. WAVELL.

Gurnard, Isle of Wight.

* It is not abnormal for fading to be accompanied by distortion, for this is often present in the received wave, and AVC can do nothing to correct it. Background noise naturally increases when the signal weakens, for the ratio of field strength to noise is reduced. The increase of volume should not occur and is probably due to AVC affecting the oscillator frequency: this would also cause the receiver to introduce distortion. In the few cases of this nature which have been encountered it has been found possible to overcome the effect by connecting the lower end of R₂ directly to the chassis instead of to the AVC line.—Ed.

Olympic S-S Six

I BUILT the Olympic S-S Six last November, and got it working during the day time. I was amazed and delighted at the quality of reproduction it gave, also the number of stations it received free from interference. It was a disappointment when first tried out at night, for a good many whistles appeared; also every station was heterodyned. Increasing reaction weakened it slightly, but would not make it disappear.

I built the wave-trap as suggested and it cured the whistles, but not the high-pitched heterodyne note.* I have tried all ways to do so, such as setting the I.F.'s differently, shortening the aerial, improving the earth, etc., but it still remains, and I can only suggest it is one of the disadvantages of the Single-Span principle. Otherwise I could recommend the Single-Span as the ideal set.

Cheam, Surrey.

H. A. MILLS.

* Steady heterodyne whistles are inevitable with any type of receiver which reproduces the full range of audible frequencies, and there is no known method of eliminating them which does not in some way affect the quality of reproduction. The best remedy is to include a tuned filter circuit in the LF amplifier, and if a good design be employed reproduction up to about 8,000 c/s is unaffected, while the heterodyne notes of stations spaced by 9 kc/s disappear.—Ed.

Estimating Current

I NOTICE in your issue of January 18th that a method of estimating the consumption of a mains set with the aid of the supply meter is described in the "Hints and Tips" section. Although this is sufficiently accurate for most needs, I think that a quicker and more accurate method would be of interest to other readers.

The chief drawback in the method your contributor describes is that the consumption is estimated by comparison with that of a lamp, which in itself is often uncertain,

especially with regard to "cheap" lamps of foreign manufacture.

A method which I have used for some considerable time now is very certain, and is given by a simple calculation:—

$$W = K/T.$$

where W = watts consumed.

$$T = \text{time in seconds taken by disc of meter to make one revolution.}$$

$$K = \frac{3.6 \times 10^6}{\text{Revs. per kWh}}$$

(of disc—usually indicated on meter).

As an example, let us suppose that one switch on the set (no other load being connected, of course), and finds with a stopwatch that the disc makes a complete revolution in 50 seconds. On the meter one sees the inscription 900 revs. per kWh. From the formula

$$K = \frac{3.6 \times 10^6}{9 \times 10^2} = 0.4 \times 10^4 = 4,000.$$

Watts consumed = $W = K/T,$

$$= 4,000/50 = 80 \text{ W.}$$

This method applies only to AC meters of the induction type, and, besides being useful in the manner described, one can often keep a check on other apparatus which is connected to the house supply.

WM. E. THOMPSON.

Pitsea, Essex.

Table Model:—

—New Style



The Invisitone Table Receiver.

THE expression "table model," as applied to a broadcast receiver, always brings to mind a compact set designed to stand on a table. However, it seems equally logical to apply it to a table which includes a built-in receiver. Such a description fits the new Invisitone receiver, made by The Invisitone Company, of Bereys Buildings, George Street, Liverpool, 3.

As shown in the accompanying illustration, the receiver chassis (an Atlas Model 7-5-8-superheterodyne) is housed in a drawer which must be partially open to give access to the control panel. The loud speaker is fitted behind the chassis on an inclined baffle facing forward and downwards. It is claimed that this method of mounting gives good distribution of sound; reproduction is unaffected by closing the drawer in which the chassis is housed.

The price of the complete equipment is 27 guineas, and the makers are prepared to install any chassis in one of their tables.

Broadcast Brevities

By Our Special Correspondent

A Short-Wave Plan ?

A DUTCH member of the International Broadcasting Union will have the courage to propose at next week's meeting (February 20th to 26th) the formation of a wave plan for the short waves. Such a scheme would, of course, require to be world-wide in scope, and might well stagger a less case-hardened assembly than the U.I.R.

Geneva Programme Pool

The B.B.C. delegation, which leaves London in a day or two, is more interested in a scheme for standardising the recording of broadcast programmes to facilitate international exchanges. The time may come when a recorded programme pool may be formed at Geneva to which broadcasting organisations would become subscribers like members of a circulating library.

The present recording methods vary considerably. Britain and Italy use magnetic tape, while the Germans prefer wax records.

Coup for Tatsfield

IT is a feather in the cap of Mr. Partridge, reception chief at Tatsfield, that the B.B.C. is relying solely on the short-wave receivers there to relay the weekly half-hour programmes of the National Broadcasting Company of America.

"Five Hours Back"

The first relay takes place at 4.45 p.m. to-morrow afternoon, corresponding to 11.45 a.m. in New York, and, very appropriately, the relay will be called "Five Hours Back." No special programmes are being prepared for these experimental relays; the intention is simply to dip into the morning programmes of America. The N.B.C. is co-operating in the experiment by arranging for the programme material to be sent out from those stations which are best heard over here.

Unpopular Droitwich

THE discovery that very few Continental listeners appear to listen to Droitwich is not very surprising. In the old days long-wave Daventry was the only British transmitter which could be heard with any degree of reliability beyond these shores; the high-power medium-wave transmitters, however, have ended all that, and the Regionals get a regular fan mail from the Continent.

Long-Distance Reports

In justice to Droitwich I may mention that it has achieved some quite remarkable DX for a long-wave station. Reports have been received from the United States, Newfoundland, and Tangier.

New Post for Sir John Reith ?

SIR JOHN REITH has now served British broadcasting faithfully and well for more than twelve years. Would it be inappropriate to appoint him Executive Chairman to the Board of Governors? Since the Charter was prepared there has been a change in the hierarchy at Broadcasting House; two main departments have been set up—Administration and Programmes—each in the charge of a very able chief. This has meant that less attention to detail is required of the Director-General, so that it should be possible for him to bestow more time on administrative control.

Five-Figure Salary

A combination of the two offices of Director-General and Chairman of the Board of Governors would bring Sir John Reith's salary up to the five-figure mark which, considering past achievements as well as present responsibilities, need not be regarded as excessive.

Mr. Gladstone Murray

I UNDERSTAND that Mr. Gladstone Murray will be temporarily Controller of Output at Broadcasting House for at least six months and, in all probability, will then assume permanent control. It is ten years ago that Sir John Reith invited Mr. Gladstone Murray to handle the public relations side of the B.B.C.'s activities.

Anomalous Position

Born in British Columbia, Mr. Murray occupies a rather anomalous position. He was quite a young man when he left Canada, and there is a feeling in some circles in the Dominion that he is more British than Canadian, seeing that he has been longer out of Canada than in it! Hence the possibility of his being the Director-General of Canadian broadcasting has become fairly remote.



MR. GLADSTONE MURRAY, whose future is the subject of interesting speculation.

A Popular Figure

On the other hand, like his chief, Sir John Reith, Mr. Murray has striven to place British broadcasting on a pinnacle. His position as Director of Public Relations has brought him in closer contact with the outside world than has been, perhaps, the case with any other official in the B.B.C.

Future Television Chief

WITH the imminent departure of Mr. Lionel Fielden, B.B.C. talks official, for India

to take charge of broadcasting there, the "probables" for the post of Television Chief at Broadcasting House are narrowed down to two, viz., Gerald Cock, the "O.B." chief, and G. C. Beadle.

Mr. Robb

Mr. Beadle has been an assistant of Roger Eckersley, Entertainment Director, for several years past. One of the earliest members of the B.B.C. staff, he went to Johannesburg to organise the broadcasting company, later became station director of Belfast, and then brought a wealth of experience back to headquarters.

Meanwhile Mr. Eustace Robb pluckily continues directing the 30-line transmissions.

The Council of Thirty

THIRTY eminent persons, headed by the Archbishop of York, compose the new General Advisory Council of the B.B.C. which will hold its first meeting at Broadcasting House on Wednesday next. This Council, which includes Mr. Lloyd George, Sir Walford Davies, Mr. Bernard Shaw, and Dame Sybil Thorndyke, has been set up in view of the increasing scope of responsibilities of the broadcasting service.

Mixed Opinions

The fact that these members seem to present almost every shade of opinion in the country is no accident for, according to an official statement, it is hoped that they will be prepared to interpret the policy and principles of the Corporation to the various sections of the community with which they may be specially associated.

New Droitwich Transmitter

5GB, the first "Regional" transmitter, will be heard for the last time at midnight to-morrow. The new Midland station at Droitwich, which takes over on Sunday, has the distinction of being the first B.B.C. station to take the plunge without a preliminary public test.

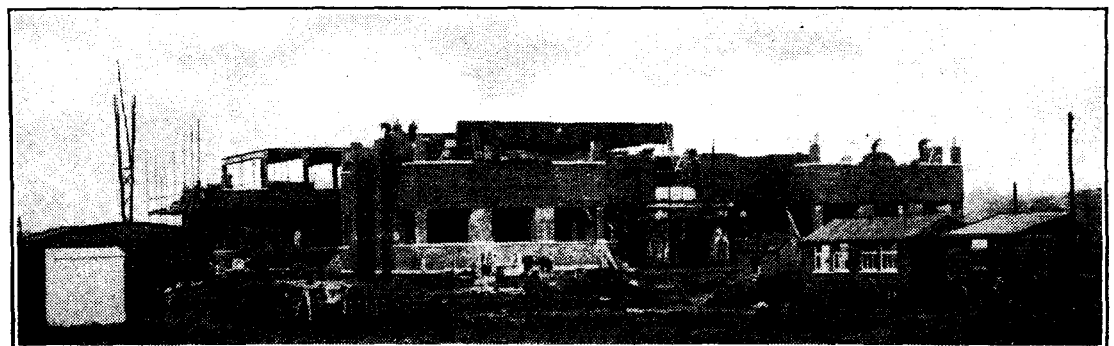

COMPLETING THE REGIONAL SCHEME. Constructional work in progress on the North Ireland broadcasting station at Lisburn, near Belfast. The station is expected to come into operation towards the end of the year.

PRINCIPAL BROADCASTING STATIONS OF EUROPE

Arranged in Order of Frequency and Wavelength

(Stations with an aerial power of 50 kW. and above in heavy type)

Station.	kc/s.	Tuning Positions.	Metres.	kW.	Station.	kc/s.	Tuning Positions.	Metres.	kW.
Kaunas (Lithuania)	155		1935	7	Strasbourg, P.T.T. (France) ..	859		349.2	25
Brazov (Romania)	160		1875	20	Poznan (Poland)	863		345.6	16
Huizen (Holland). (Until 3.40 p.m.)	160		1875	7	London Regional (Brookmans Park)	877		342.1	50
Kootwijk (Holland) (Announced Huizen).	160		1875	50	Graz (Austria). (Relays Vienna) ..	886		338.6	7
(3.40 p.m. onwards)					Helsinki (Finland)	895		335.2	10
Lahti (Finland)	166		1807	40	Hamburg (Germany)	904		331.9	100
Moscow, No. 1, RW1 (Komintern) (U.S.S.R.)	174		1724	500	Toulouse (Radio Toulouse) (France)	913		328.6	60
Paris (Radio Paris) (France)	182		1648	80	Limoges, P.T.T. (France)	913		328.6	0.5
Istanbul (Turkey)	187.5		1600	5	Brno (Czechoslovakia)	922		325.4	32
Berlin (Deutschlandsender Zeesen) (Germany)	191		1571	60	Brussels, No. 2 (Belgium). (Flemish Prog' mme)	932		321.9	15
(S.w. Stns., 16.89, 19.73, 25.51, 31.38 and					Algiers, P.T.T. (Radio Alger) (Algeria)	941		318.8	12
49.83 m.)					Göteborg (Sweden). (Relays Stockholm)	941		318.8	10
Droitwich	200		1500	150	Brestlau (Germany)	950		315.8	100
Minsk, RW10 (U.S.S.R.)	208		1442	35	Paris (Poste Parisien) (France)	959		312.8	100
Reykjavik (Iceland)	208		1442	16	Belfast	977		307.1	1
Paris (Eiffel Tower) (France)	215		1395	13	Cracow (Poland)	986		304.3	2
Motala (Sweden). (Relays Stockholm)	216		1389	30	Genoa (Italy). (Relays Milan)	986		304.3	10
Novosibirsk, RW76 (U.S.S.R.)	217.5		1379	100	Hilversum (Holland). (7 kW. till 6.40 p.m.)	995		301.5	20
Warsaw, No. 1 (Raszyn) (Poland)	224		1339	120	Bratislava (Czechoslovakia)	1004		298.8	13.5
Ankara (Turkey)	230		1304	7	Midland Regional (Droitwich)	1013		296.2	50
Luxembourg	230		1304	150	Barcelona, EAJ15 (Radio Asociación) (Spain)	1022		293.5	3
Kharkov, RW20 (U.S.S.R.)	232		1293	20	Königsberg (Heilsberg Ermland) (Germany)	1031		291	60
Kalundborg (Denmark) (S.w. Stn., 49.5 m.)	238		1261	60	Parade (Radio Club Português) (Portugal)	1031		291	5
Leningrad, RW53 (Kolpino) (U.S.S.R.)	245		1224	100	Leningrad, No. 2, RW70 (U.S.S.R.)	1040		288.5	10
Tashkent, RW11 (U.S.S.R.)	256.4		1170	25	Rennes, P.T.T. (France)	1040		288.5	40
Oslo (Norway)	260		1154	60	Scottish National (Falkirk)	1050		285.7	50
Moscow, No. 2, RW49 (Stechkovo) (U.S.S.R.)	271		1107	100	Bari (Italy)	1059		283.3	20
Tiflis, RW7 (U.S.S.R.)	280		1071.4	35	Tiraspol, RW57 (U.S.S.R.)	1068		280.9	4
Rostov-on-Don, RW12 (U.S.S.R.)	355		845	20	Bordeaux, P.T.T. (Lafayette) (France)	1077		278.6	12
Sverdlovsk, RW5 (U.S.S.R.)	375		800	50	Zagreb (Yugoslavia)	1086		276.2	0.7
Geneva (Switzerland). (Relays Sottens)	401		748	1.3	Falun (Sweden)	1086		276.2	2
Moscow, No. 3 (RCZ) (U.S.S.R.)	401		748	100	Madrid, EAJ7 (Union Radio) (Spain)	1095		274	7
Voroneje, RW25 (U.S.S.R.)	413.5		726	10	Madona (Latvia)	1104		271.7	50
Oulu (Finland)	431		698	1.2	Naples (Italy). (Relays Rome)	1104		271.7	1.5
Ufa, RW22 (U.S.S.R.)	436		688	10	Moravska-Ostrava (Czechoslovakia) ..	1113		269.5	11.2
Hamar (Norway) (Relays Oslo)	519		578	0.7	Alexandria (Egypt)	1122		267.4	0.25
Innsbruck (Austria). (Relays Vienna)	519		578	0.5	Newcastle	1122		267.4	1
Ljubljana (Yugoslavia)	527		569.3	5	Nyiregyhaza (Hungary)	1122		267.4	6.2
Viipuri (Finland)	527		569.3	10	Hörby (Sweden). (Relays Stockholm)	1131		265.3	10
Bolzano (Italy)	536		559.7	1	Turin, No. 1 (Italy). (Relays Milan)	1140		263.2	7
Wilno (Poland)	536		559.7	16	London National (Brookmans Park)	1149		261.1	50
Budapest, No. 1 (Hungary)	546		549.5	120	North National (Slaithwaite)	1149		261.1	50
Beromünster (Switzerland)	556		539.6	100	West National (Washford Cross)	1149		261.1	50
Athlone (Irish Free State)	565		531	60	Kosice (Czechoslovakia). (Relays Prague)	1158		259.1	2.6
Palermo (Italy)	565		531	4	Monte Ceneri (Switzerland)	1167		257.1	15
Stuttgart (Mühlacker) (Germany)	574		522.6	100	Copenhagen (Denmark). (Relays Kalundborg)	1176		255.1	10
Grenoble, P.T.T. (France)	583		514.6	15	Kharkov, No. 2, RW4 (U.S.S.R.)	1185		253.2	10
Riga (Latvia)	583		514.6	15	Frankfurt (Germany)	1195		251	17
Vienna (Bisamberg) (Austria)	592		506.8	100	Prague, No. 2 (Czechoslovakia)	1204		249.2	5
Rabat (Radio Maroc) (Morocco)	601		499.2	25	Lille, P.T.T. (France)	1213		247.3	5
Sundsvall (Sweden). (Relays Stockholm)	601		499.2	10	Trieste (Italy)	1222		245.5	10
Florence (Italy). (Relays Milan)	610		491.8	20	Gleiwitz (Germany). (Relays Breslau)	1231		243.7	5
Cairo (Abu Zabal) (Egypt)	620		483.9	20	Cork (Irish Free State) (Relays Athlone)	1240		241.9	1
Brussels, No. 1 (Belgium). (French Programme)	620		483.9	15	Juan-les-Pins (Radio Côte d'Azur) (France)	1249		240.2	2
Lisbon (Bacarena) (Portugal)	629		476.9	15	Rome, No. 3 (Italy)	1258		238.5	1
Trøndelag (Norway)	629		476.9	20	San Sebastian (Spain)	1258		238.5	3
Prague, No. 1 (Czechoslovakia)	638		470.2	120	Nürnberg and Augsburg (Germany) (Relay	1267		236.8	2
Lyons, P.T.T. (La Doua) (France)	648		463	15	Munich)				
Cologne (Langenberg) (Germany)	658		455.9	100	Christiansand and Stavanger (Norway)	1276		235.1	0.5
North Regional (Slaithwaite)	668		449.1	50	Dresden (Germany) (Relays Leipzig)	1285		233.5	1.5
Sottens (Radio Suisse Romande) (Switzerland)	677		443.1	25	Aberdeen	1285		233.5	1
Belgrade (Yugoslavia)	686		437.3	2.5	Austrian Relay Stations	1294		231.8	0.5
Paris, P.T.T. (Ecole Supérieure) (France)	695		431.7	7	Danzig. (Relays Königsberg)	1303		230.2	0.5
Stockholm (Sweden)	704		426.1	55	Swedish Relay Stations	1312		228.7	1.25
Rome, No. 1 (Italy) (S.w. Stn., 25.4 m.)	713		420.8	50	Budapest, No. 2 (Hungary)	1321		227.1	0.8
Kiev, RW9 (U.S.S.R.)	722		415.5	36	German Relay Stations	1330		225.6	1.5
Tallinn (Esthonia)	731		410.4	20	Montpellier, P.T.T. (France)	1339		224	5
Madrid, EAJ2 (Radio España) (Spain)	731		410.4	3	Lodz (Poland)	1339		224	1.7
Munich (Germany)	740		405.4	100	Dublin (Irish Free State) (Relays Athlone)	1348		222.6	1
Marseilles, P.T.T. (France)	749		400.5	5	Milan, No. 2 (Italy) (Relays Rome) ..	1348		222.6	4
Katowice (Poland)	758		395.8	12	Turin, No. 2 (Italy). (Relays Rome)	1357		221.1	0.2
Scottish Regional (Falkirk)	767		391.1	50	Basle and Berne (Switzerland)	1375		218.2	0.5
Toulouse, P.T.T. (France)	776		386.6	0.7	Warsaw, No. 2 (Poland)	1384		216.8	2
Leipzig (Germany)	785		382.2	120	Lyons (Radio Lyons) (France)	1393		215.4	5
Barcelona, EAJ1 (Spain)	785		382.2	5	Tampere (Finland)	1420		211.3	0.7
Lwow (Poland)	795		377.4	16	Paris, (Radio LL) (France)	1424		210.7	0.8
West Regional (Washford Cross)	804		373.1	50	Béziers (France)	1429		209.9	1.5
Milan (Italy)	814		368.6	50	Miskole (Hungary)	1438		208.6	1.25
Bucharest (Romania)	823		364.5	12	Fécamp (Radio Normandie) (France)	1456		208	10
Moscow, No. 4, RW39 (Stalina) (U.S.S.R.)	832		360.6	100	Pecs (Hungary)	1465		204.8	1.25
Berlin (Funkstunde Tege) (Germany)	841		356.7	100	Bournemouth	1474		203.5	1
Bergen (Norway)	850		352.9	1	Plymouth	1474		203.5	0.3
Sofia (Bulgaria)	850		352.9	1	International Common Wave	1492		201.1	0.2
Valencia (Spain)	850		352.9	1.5	International Common Wave	1500		200	0.25
Simferopol, RW52 (U.S.S.R.)	859		349.2	10	Liepāja (Latvia)	1737		173	0.1

NOTE. Since the publication of the previous list, alterations have been made to the particulars of the following stations: Florence (Italy), Midland Regional, Barcelona (Spain), Scottish Regional, Limoges (France), West Regional, North National, Belfast, Newcastle.

The Wireless World

THE
PRACTICAL RADIO
JOURNAL
24th Year of Publication

No. 808.

FRIDAY, FEBRUARY 22ND, 1935.

VOL. XXXVI. No. 8.

Proprietors: ILIFFE & SONS LTD.

Editor:
HUGH S. POCOCK.

Editorial,
Advertising and Publishing Offices:
DORSET HOUSE, STAMFORD STREET,
LONDON, S.E.1.

Telephone: Hop. 3333 (50 lines).
Telegrams: "Ethaworld, Watloo, London."

COVENTRY: Hertford Street.

Telegrams: "Autocar, Coventry." Telephone: 5210 Coventry.

BIRMINGHAM:

Guildhall Buildings, Navigation Street, 2.
Telegrams: "Autopress, Birmingham." Telephone: 2971 Midland (4 lines).

MANCHESTER: 260, Deansgate, 3.

Telegrams: "Iliffe, Manchester." Telephone: Blackfriars 4412 (4 lines).

GLASGOW: 26B, Renfield Street, C.2.

Telegrams: "Iliffe, Glasgow." Telephone: Central 4857.

PUBLISHED WEEKLY. ENTERED AS SECOND
CLASS MATTER AT NEW YORK, N.Y.

Subscription Rates:

Home, £1 1s. 8d.; Canada, £1 1s. 8d.; other
countries, £1 3s. 10d. per annum.

As many of the circuits and apparatus described in these pages are covered by patents, readers are advised, before making use of them, to satisfy themselves that they would not be infringing patents.

CONTENTS

	Page
Editorial Comment	181
Cathode Ray Television	182
Non-Resonant Loud Speaker	185
The Television Transmitter	186
Push-Pull Quality Amplifier	188
Current Topics	192
The Detector as a Radio-frequency Load	193
Random Radiations	195
New Apparatus Reviewed	197
Listeners' Guide for the Week	198
Letters to the Editor	200
Broadcast Brevities	201
Foundations of Wireless	202
Principal Broadcasting Stations	205

EDITORIAL COMMENT

Television and Sound

Have Wavelengths Been Settled?

ALTHOUGH the Television Committee's report has the merit of being fairly explicit as a whole, there is one point which has come to our notice where the public is left in some uncertainty and to which we think it is desirable to draw attention, in the hope that the position may be cleared up.

The wavelength to be employed for television transmission is clearly indicated as around seven metres, but as regards sound to accompany the television programmes, no such definite indication is given.

It may be argued that a sound broadcasting channel on a band adjacent to the television transmission is implied in the Report, but we have come across so many expressions of doubt as to whether this is really the intention of the Committee, that it leaves a feeling of some uncertainty.

Possibly the assumption that sound will be on an adjacent wavelength has been made because, in the private experimental transmissions which the Baird Company and others have been conducting for some time, this practice has been adopted. But is not the reason in this case mainly that other wavelengths have not been available for experimental purposes?

If the intention is that an adjacent channel should be employed, are we entirely satisfied that this is the best course to adopt?

Sound on an adjacent channel has some disadvantages.

It would mean monopolising another band and robbing other waveband requirements; to provide a sound receiver in conjunction with a television receiver would mean a serious increase in complication of the design of the complete unit, and would add

to the cost to the public; in addition, it would increase the complexity of transmission distribution. Again, the public would want to feel satisfied that there was ample justification for being asked to pay for an additional sound receiver and good reasons would have to be put to them why their existing broadcast receivers could not do this part of the work as they stand.

Again, it must be remembered that if sound is transmitted on these waves the transmissions will be capable of putting out very high quality, because of the wide frequency band available, and we believe that listeners would tend to become very dissatisfied with the quality of sound broadcasting on the normal wavelengths by comparison.

Case for Short-wave Sound

An objection to employing the present B.B.C. wavelengths for the transmission of the sound is to be found in the fact that the material broadcast would not always be attractive in itself, and yet it would monopolise periods of the day most attractive to the ordinary broadcast listener. But, on the other hand, there would be the advantage that these transmissions would be a constant reminder to the owners of ordinary broadcast receivers of the existence of the television programmes, and would in this way contribute very largely to providing propaganda for the new art.

It seems extremely desirable that the question of the wavelength for sound accompanying television should be cleared up. Until we are quite sure what the policy is going to be, the design of apparatus and other developments must stand still. It is not safe to jump to the conclusion that the Television Report implies an adjacent channel for sound, so long as no definite statement to this effect has been made.

Cathode Ray Television

Explanation of the General Principles

THE cathode ray tube is certain to feature largely both at the transmitting and at the receiving end of the high-definition television service arising out of the Report of the P.M.G.'s Committee. This article explains the manner in which "The Bulb of Many Uses" serves as the scanning and picture-reproducing link in television systems.

RECENT articles¹ described the general circuits of the cathode ray tube and some of the many uses to which it can be put. Of these uses none is, at the moment, more strongly in the public mind than that of television. Indeed, practically all the high-definition televisions which are in any state of development are now using the electron beam. Naturally, it is impossible in the course of a single article to describe all of these systems. While they all follow the same general principles, they differ considerably in details, and it is the intention of this article to give a brief description rather of the general principles, without reference to any particular system.

Although it is, perhaps, somewhat unusual, we will start by considering the receiving end in greater detail.

The essential principle of television scanning can be summed up briefly by saying that the picture to be transmitted is progressively traversed by a moving point of light (or its equivalent) and that electrical impulses are generated in a photoelectric cell in accordance with the variations of light and shade encountered in the process. At the receiver the process of reproduction then consists in causing a spot of light to move in synchronism with the scanning source and at the same time causing the intensity of the light to vary from instant to instant during this process in accordance with the light and shade encountered in the scanning process at the transmitter.

This process of reproduction can be illustrated by means of Fig. 1.

Suppose our reproducing spot of light is moved about, starting at the top left-hand corner of the picture and proceeding with a steady movement along the top line. Suppose, also, that during this time it moves very slightly downwards. If at the end

of this line it returns sharply to the left, then it can do its next horizontal line a little below the first, and so on. After doing, say, thirty lines (as actually illustrated for convenience of following the movement), it will have reached the bottom right-hand corner, whence it is rapidly returned, by the diagonal dotted path, to the top left-hand corner of the pattern.

Deflecting the Beam

If the whole process described above occupies $\frac{1}{25}$ th of a second, then each line will occupy $\frac{1}{750}$ th of a second, as shown in Fig. 1.

From what has previously been written about the cathode ray tube it will be realised that the whole process described is equivalent to deflecting the fluorescent spot by two saw-tooth voltages such as those shown in Fig. 2, the slow voltage sending the spot up and down twenty-

fluorescent spot is caused to vary in accordance with picture-forming impulses from the transmitter, then we have a complete means of picture reproduction. In practice this can be done by some form of intensity-control electrode which varies the instantaneous intensity of the electron beam and, therefore, also the brightness of the spot, these variations occurring in accordance with the picture voltages received.

The particularly valuable feature of the electron beam as a television reproducer consists in its ability to be moved at very high speeds, and, therefore, capable of operating at the high scanning rates now envisaged as necessary for high-definition television. Frankly, the properties of the cathode ray tube are wasted on a thirty-line scan. The recent tendency has been towards 180 or 240 lines and the P.M.G.'s Committee has now definitely recommended the latter, with picture repetitions at the rate of twenty-five per second. In the practical case the reader can, therefore, imagine the horizontal lines of Fig. 1 being congested six or eight times more closely together than actually shown.

As was stated in the previous articles on the cathode ray tube, the ordinary type of soft-vacuum tube (normally used for measurement and experimental purposes) is not suitable for television for a number of reasons. One of these is in the matter of intensity control, since the Wehnelt cylinder surrounding the cathode in a soft tube has only a partial control over *intensity* of the beam *as such*, and has a much more serious effect on the focus of the spot.

In the case of a tube for television, it is necessary that the control electrode should only vary the intensity without affecting the focusing of the spot, so that only the *brightness* is varied and not the sharpness. The type of behaviour required is illustrated in Fig. 3, where the fluorescent response varies between the limits representing black and white extremes of picture reproduction.

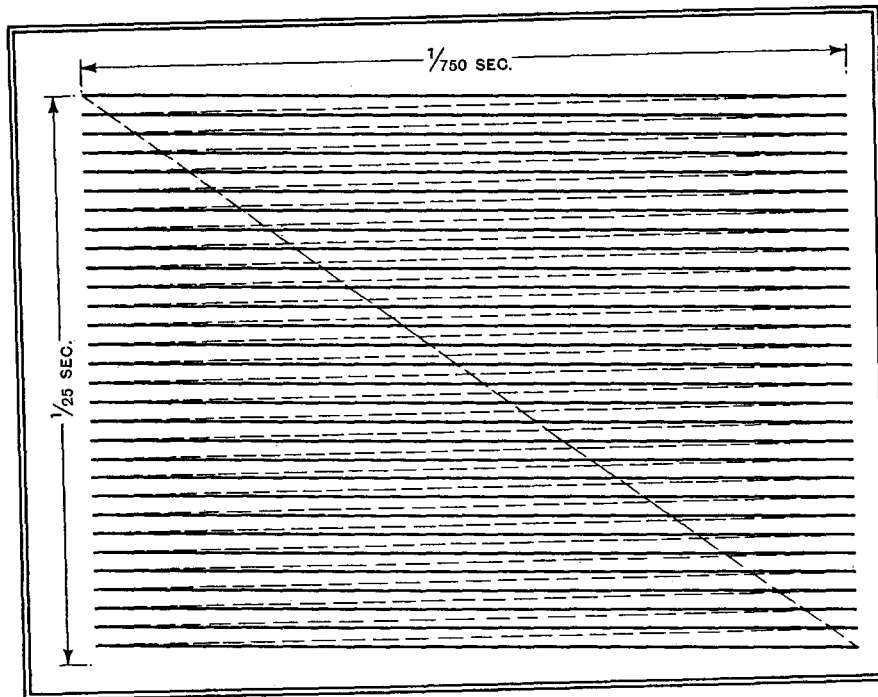

Fig. 1.—Television scanning in a cathode ray tube by two saw-tooth voltages.

five times per second, and the higher frequency sending it backwards and forwards thirty times during each of these vertical sweeps. This arrangement forms the basis of a reproducing scanning system, giving twenty-five picture frames per second, each frame scanned in thirty lines.

If, during each of the line movements shown in Fig. 1, the brightness of the

¹ "The Bulb of Many Uses," *The Wireless World*, January 4th, 11th and 18th, 1935.

Cathode Ray Television—

In the different tubes that are now being used by various of the companies working on television, this control is effected in a number of ways. One of these is illustrated in Fig. 4. The electrode controlling the intensity of the beam is a modified form of the cylinder familiar in the soft tube. Focus of the beam is controlled by adjustment of the potential V_1 of the first anode (which is of the order of 1,000 to 2,000 volts) and of V_2 , which is about four times this value. This second anode is, in the case illustrated, in the form of a thin metal coating running internally along the length of the tube.

In some other constructions the control electrode is of cylindrical form, with first a wide cylinder round the cathode with a narrower cylindrical extension, and two anodes in the form of discs with central holes, focus again being controlled by adjustment of their mutual potentials. The construction shown in Fig. 4 is of American origin, and in Fig. 5 there is shown a recent British design of hard tube due to the Ediswan Company.

The electrode systems in these hard tubes operate on the electron beam in

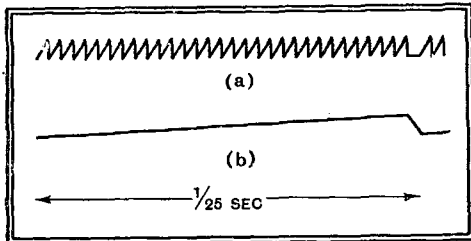

Fig. 2.—Time relations of saw-tooth scanning voltages of Fig. 1.

much the same manner as an optical lens system operates on a ray of light in bringing it to a focus at a desired point. The various electrodes correspond approximately to the separate elements of a compound lens and have their "beam-passing" properties regulated by the convenient means of adjustment of their potentials. With fixed potentials and dimensions, they could, of course, be moved as the cells of an optical lens system are moved for adjustment of focus, but the ability to control the focus by external electrical adjustment is a valuable feature of the "electron-lens" system, as it is now usually called.

Synchronising Systems

Reference has been made above to the advantage of the cathode ray tube in its high speed of operation. Another advantage which is not so obvious, but is possibly quite a real one from the point of view of practical television, is in the matter of synchronising. It has already been stated that the scanning movements of the electron beam are effected by saw-tooth voltages. Some simple saw-tooth circuits for experimental work have already been illustrated in previous articles, and there are many other forms of electrical generator for the purpose which are in use in

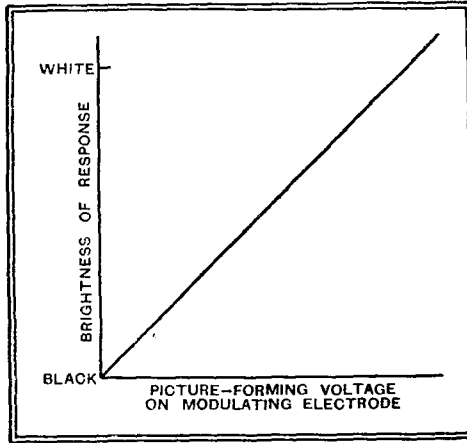

Fig. 3.—Response characteristic of tube for intensity modulation.

working television systems. These are invariably purely electrical systems having no mechanical moving parts. A typical feature of all such generators is that they are very easily triggered and controlled by short transient impulses *recurring at the correct rate*. Impulses for this purpose can, therefore, be generated at the transmitter and sent out in their normal time order along with the picture currents. At the receiver it is then necessary to sort them out from the picture currents and apply them to the saw-tooth generators, which they are to trigger into action.

Turning now to the transmitter, and considering transmitting systems as a whole, it must be said that the cathode ray tube is, perhaps, less prominent than at the receiver. This is comprehensible, since there is less objection to moving parts at that end, on the general principle that all the technical difficulties should be at the transmitter so that the receiver (of the idealised broadcasting system) may be as simple as possible. Nevertheless, even at the transmitter the cathode ray tube has many features of promise of

which its nimbleness is not the least—and at least two cathode ray scanning systems for transmission are now well advanced. Indeed, present technical tendencies appear to indicate that the greatest possibilities of direct scanning now lie with the cathode ray devices.

Perhaps the simplest type of transmitter scanning that we can picture is that shown in Fig. 6 for the scanning of a cinema film. The film is arranged to be drawn downwards in a continuous motion (not in jumps as in ordinary cinema projection), the speed being such as to run through twenty-five frames per second. A light source is focused on to the photo-electric cell with the film in between. The source is rocked backwards and forwards horizontally in a *saw-tooth* motion, so that during the time that one picture frame is being drawn through it is scanned in the

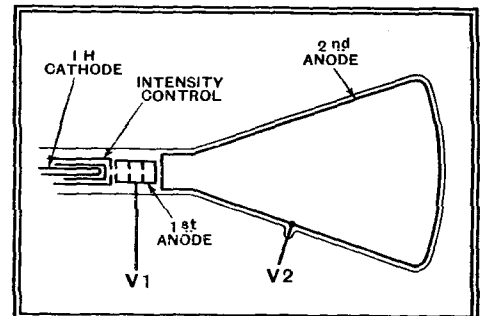

Fig. 4.—Hard vacuum cathode ray tube for "intensity modulation" television.

requisite numbers (say 240) of lines. The illumination of the photo-cell will vary according to the light and dark portions of the picture encountered in each line scan, and will thus generate the picture-forming currents which, after amplification, will modulate the radio transmitter. Several methods exist by which synchronising impulses can be transmitted at the end of each line scan, and at the end

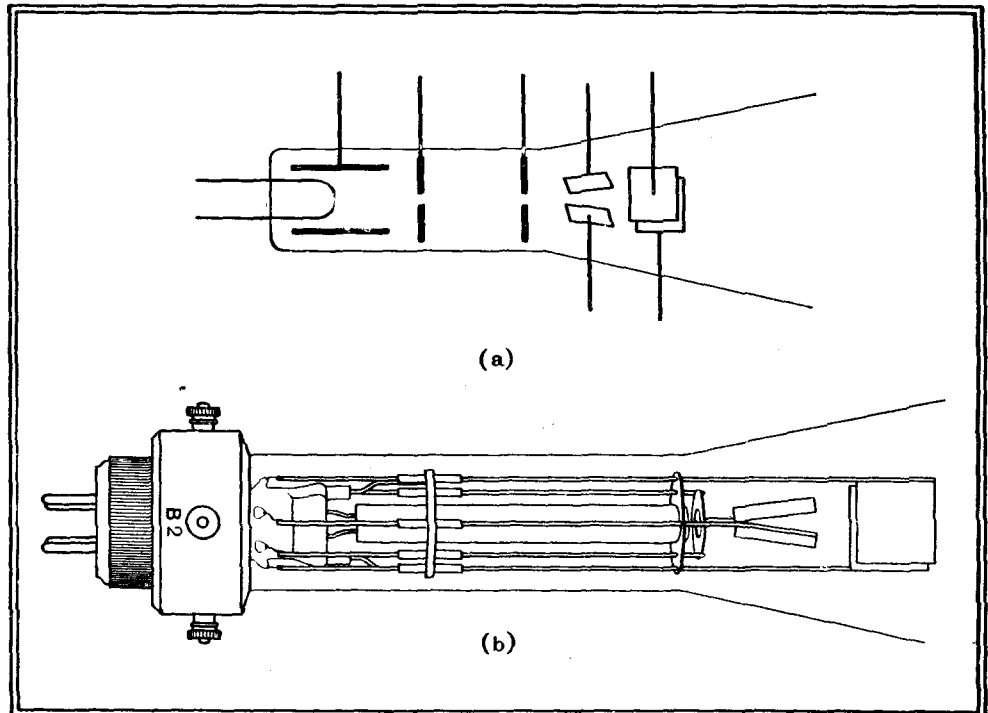

Fig. 5.—Ediswan "Hard Vacuum" cathode ray tube. (a) Skeleton diagram of "electron-lens" system. (b) Construction and mounting of electrodes.

Cathode Ray Television—

of each frame (that is in the black portion between pictures), and these impulses can be transmitted and used to synchronise the line-scanning (horizontal) and picture-framing (vertical) saw-tooth sources at the receiver.

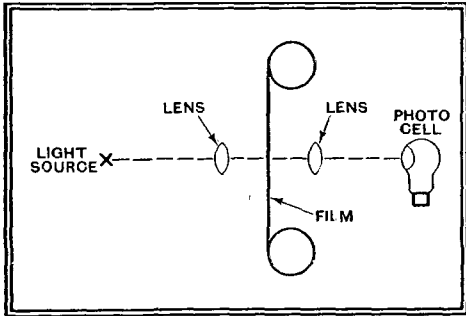

Fig. 6.—Principles of scanning a film for television.

The difficulty of the scheme illustrated is, of course, that of rocking a light source at the high line-scanning speed and in a saw-tooth motion. But it is not a far cry from the hypothetical light source of Fig. 6 to an actual source which can easily be rocked in the manner suggested. This is illustrated in Fig. 7, where our hypothetical source is now replaced by a cathode ray tube whose electron beam is deflected in a saw-tooth motion to give the line scan. With adequate voltage on the tube, and with a fluorescent screen of a suitable colour for the photo-cell, there is then no difficulty in using the tube as a light source, the remainder of the operations being effected as described.

Scanning the Object Direct

So much for film scanning, but when it comes to the scanning of an actual scene—the final objective of all television—there is greater difficulty in using cathode ray tubes following the normal principles of construction. Several solutions of this problem, however, have been devised. Two of these, as stated, give considerable promise, although only one will be illustrated here as being representative of the process of scanning an actual scene by the cathode ray method.

This instrument is the Iconoscope, devised by the American television experimenter, Dr. V. K. Zworykin. It is illustrated in Fig. 8, and is essentially a cathode ray tube with the "electron gun" system generally similar to that shown for a reproducing tube in Fig. 4, except

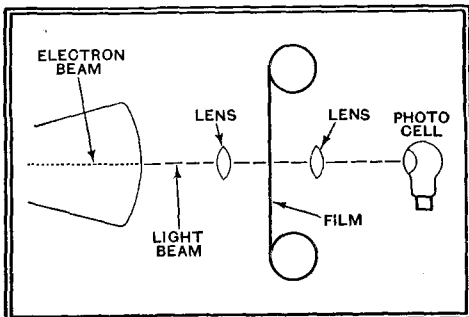

Fig. 7.—Use of a cathode ray tube as light source in television film scanning.

that the control electrode is not used as such but is at a fixed potential, giving a beam of constant intensity. The metal coating shown is again the second anode but is not carried all over the inner side of the spherical glass end. Instead of the normal fluorescent screen the electron beam impinges on a special photo-electric arrangement shown. The part marked "metal plate" in Fig. 8 is actually a metallic coating on one side of a square sheet of mica. The other side—that exposed to the electron beam—is covered with a fine mosaic of very tiny particles of a photo-electric material. In practice the Iconoscope is housed in a camera, and an image of the object or scene to be scanned is optically focused on to the photo-electric mosaic. At the same time the electron beam is moved by two saw-tooth voltages, a slow, vertical motion for the framing and a rapid one for the line scan. The action is that the photo-electric material, which is insulated from the back metal plate, has capacity to it, and when light from the projected image falls on the mosaic each

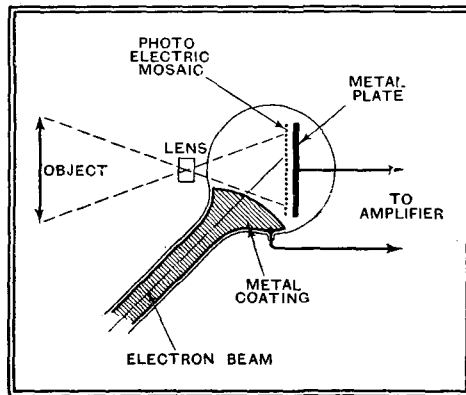

Fig. 8.—Cathode ray tube (Iconoscope) for television scanning of a direct scene.

minute element of it emits electrons according to the intensity of the illumination at each point. This is equivalent to charging a small condenser made up between that region of the mosaic and the metal plate. As the electron beam sweeps over the spot in the course of its scanning motions, it discharges, or partially discharges, this condenser, the discharge cur-

rent depending on the charge on the photo-electric condenser element and, therefore, on the illumination at that spot. The metal plate then becomes effectively the cathode of an electron-current source whose anode is the metallic coating forming the second anode of the cathode ray tube itself. If these two metal coatings are joined by a high resistance, current fluctuations are set up across it and can be fed to the grid of the amplifier as picture-forming currents for modulation and transmission.

It would be an incomplete review if we were to leave the subject of cathode ray television without reference to another system of reproduction. This is known as the "Velocity Modulation" method. It uses a scanning system exactly similar to that already discussed for intensity modulation of the beam, but is based on the fact that the brightness of the light produced by the moving spot is proportional to the time taken by the spot to travel any particular length along the scanning line. For example, if, during one line scan, the spot moves uniformly for the whole line then we should see a line of uniform brightness all along its length. If, however, the spot, while taking the same time to travel the whole length of the line, does so at varying speeds, then the brightness of the line varies along its length. At those times when the spot is moving rapidly the impression of light is very small indeed, that is to say, we have a dark place; where it is moving slowly we have a bright place, and so on. Light and shade in picture reproduction can thus be built by varying the *instantaneous speed* of the spot velocity, hence the name of "velocity modulation."

In this system transmitter scanning is essentially by cathode ray tube, and so far as is known has only been applied to film transmission. The principles of scanning follow those illustrated in Fig. 7, with the addition that it is arranged that the saw-tooth line scan of the scanning tube is itself varied in speed according to the light and shade of the picture. This method is particularly suitable with soft tubes, which are unsuitable for intensity modulation.

QA RECEIVER COILS

A SET of tone-correction and whistle-suppressor coils for the QA Receiver has been received from the City Accumulator Co., Ltd., 18-20, Norman's Buildings, Central Street, London, E.C.1. This comprises two chokes for the tone-correction circuit and one for the whistle suppressor; they are fitted with mounting brackets, and the latter with an insulated support to carry the tuning condenser. The components are well finished and wound on ebonite bobbins, and can confidently be recommended for use in this receiver. The tone-corrector chokes are

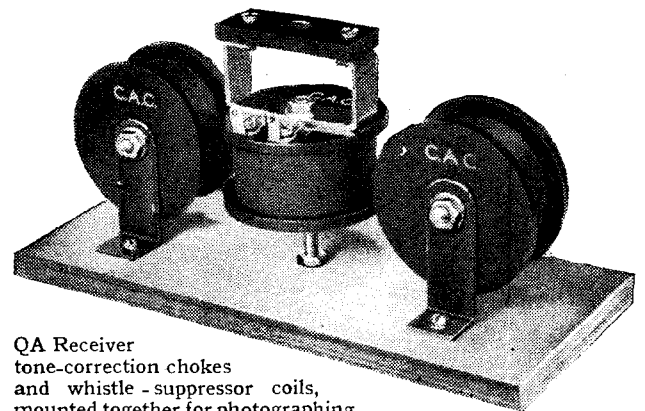

QA Receiver tone-correction chokes and whistle-suppressor coils, mounted together for photographing.

priced at 4s. 6d. each, while the whistle-suppressor coil is listed at 10s. 3d.

Non-Resonant Loud Speaker

Cabinet with a Novel High-Note Diffuser

By PHILIP JESSOP, A.R.C.S., D.I.C.

DESCRIBING the construction of a loud-speaker cabinet designed to eliminate resonances, and also of a device for giving improved high-note distribution

IT is well known that the conventional loud-speaker cabinet is open to many objections, of which the most serious is the introduction of resonances other than those inherent in the loud speaker itself. First, the air enclosed by the box vibrates in sympathy with some particular frequency, usually a rather low one. This "box-resonance" is a most fruitful cause of woolly and booming reproduction. By lining the box with sound-absorbent material this effect is considerably reduced, but by no means eliminated.

Secondly, a plain box suffers from another serious defect: the sides themselves have individual resonant frequencies which can at times be particularly annoying, especially since the frequency usually happens to be in the neighbourhood of a hundred to two hundred cycles per second. Further, the front may also vibrate at some particular frequency of its own.

Another source of imperfection of reproduction—and, in the author's opinion, quite a serious one—is found in what is known as the High-note Beam. The lower audio-frequencies are radiated by the speaker at sensibly uniform strength in all directions; the highest frequencies, on the other hand, are principally thrown straight forward in a narrow beam. Unless the listener is directly oppo-

site the speaker the majority of these high notes are lost, even if they are present in the output from the set.

The size of a baffle needs some consideration. Its presence is necessary, whether as a flat board or as a box, to prevent the low-frequency air-impulses generated at the back of the speaker diaphragm from interfering with those generated at the front. Generally speaking, the smaller the baffle the higher will be the cut-off point in the musical scale.

As an article of furniture, a cabinet is preferable to a flat baffle, and, from the æsthetic point of view, should be as small as possible; whilst, as we have just seen, for effectiveness it should be as large as possible. A compromise has to be effected, in which the ordinary box-cabinet is good enough for ordinary reception, but for quality reproduction something better is required.

Palliatives for all these troubles are many: cabinets may be felt-lined, the sides braced by battens, double baffles fitted, and so on. But a palliative is not a cure; some considerable alteration in general design is necessary, having full regard to the acoustic requirements of sound-reproduction by loud speakers.

With this clearly in mind, the author made experiments with cabinet-form speakers, using a 7in. diam. Sinclair PM speaker unit. Eventually a design was evolved which, though primarily arranged as a separate speaker, could readily be adapted for use in the same cabinet as the set, with better results than those usually given by commercial designs. It must be admitted that there was no very great change in the general principles of previous types of cabinet, at least to outward appearances, but it is maintained that the fundamental principle is rather different, as will shortly appear, in that mere size of cabinet is not of such great importance provided a certain minimum be exceeded.

It took the form of a box, 18in. square and 10in. deep, constructed of 3/8in. plywood on a framework of 1in. square strip-

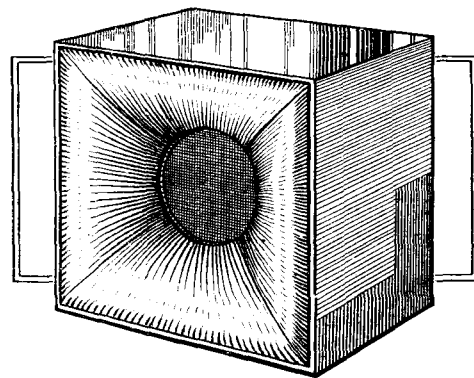

Fig. 1.—The completed cabinet.

wood, with a baffle secured inside, 3in. from the front, which latter was left completely open. The speaker unit was mounted over a 6 1/2in. hole in the centre of the baffle, and wiring arranged to a 2-pin plug socket in one side. The whole of the speaker and the wiring were loosely covered with a double thickness of butter-muslin, tacked down at the edges. The space between this and the back of the box was loosely filled with kapok (obtainable from furnishing stores) and another double thickness of muslin stretched across the back.

The front of the baffle was upholstered in a similar way to form a wide trumpet shape, the narrow end of the "trumpet" being the aperture for the speaker unit, and the mouth the front edges of the sides

of the box. A covering of silk net and trimming with furniture gimp were added for the sake of appearances and domestic peace! An aspect of the completed cabinet and a section are shown in Figs. 1 and 2, respectively.

As thus arranged, no resonances could be detected. On account of the complete filling-up of the vacant space

usually producing box-resonance, there was none of this annoying form of distortion; there was no perceptible vibration of the sides of the box, even on loud passages by military bands; and a very full reproduction of the lower frequencies was obtained.

There was only one objection to this type of mounting for the speaker unit—but one that is applicable to practically all speakers—the production of the high-note beam. However, with further experimenting, this beam has largely been eliminated, or, rather, spread out. The means finally adopted for this purpose took the form of a trumpet-shaped cone of shellacked cloth on a wooden former,

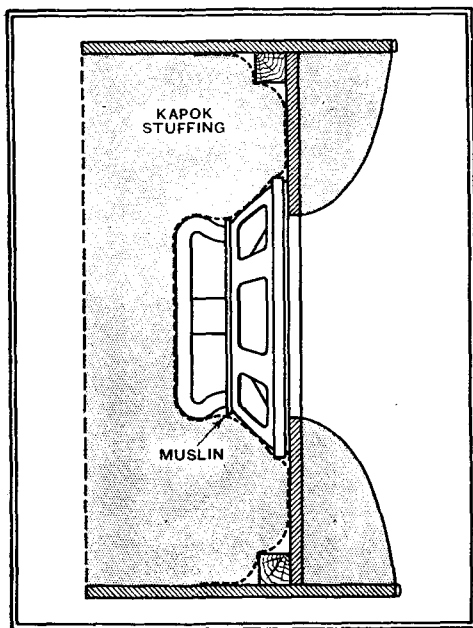

Fig. 2.—Section through the cabinet, showing recessed baffle board and absorbent packing.

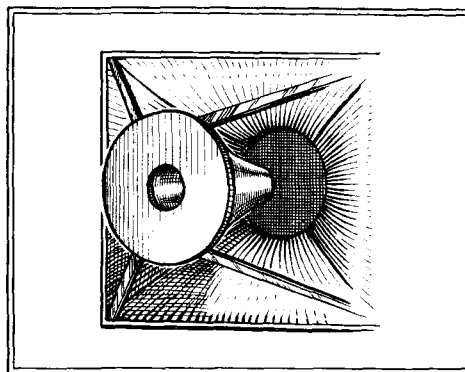

Fig. 3.—The high-note diffuser in position.

Non-Resonant Loud Speaker—

mounted a few inches from the speaker. As shown in Fig. 3, the mouth of the trumpet bell is formed from a disc of wood with a circular aperture at the centre. This aperture communicates with a tubular passage along the axis, and open at both ends. The sides of the trumpet were

diffuse the high-note beam. The axial passage was introduced to enable a proportion of the high notes to travel straight forward.

In actual use the spreader is very effective. Whereas the angle of the high-note beam (as roughly determined by aural methods) was previously about 20

area, and at greater range of distance from the speaker than is otherwise obtained. This is obviously an advantage, for, after all, one cannot always sit directly in front of the loud speaker. It is to be noted, however, that although the high notes were more widely disseminated, there was little or no actual absorption or blocking.

In case any reader should care to construct one of these "spreader," a self-explanatory diagram has been included (Fig. 4) showing the method of assembly. The spreader should be mounted centrally in front of the speaker described above, at such a distance that the small end of the "spreader" is just level with the front edge of the cabinet. Four struts of metal or hardwood from the corners of the cabinet to the front plate are quite suitable for this purpose.

There are a number of possible variants for both schemes. For instance, the shape of the cabinet could be circular, octagonal, or hexagonal, or the whole of the front may be covered with silk gauze, though always the wide trumpet shape of the padding in front of the baffle should be preserved. The high-note spreader could be made of a corresponding shape. A turned block of wood could be used as a spreader, though this would be rather more massive than is necessary.

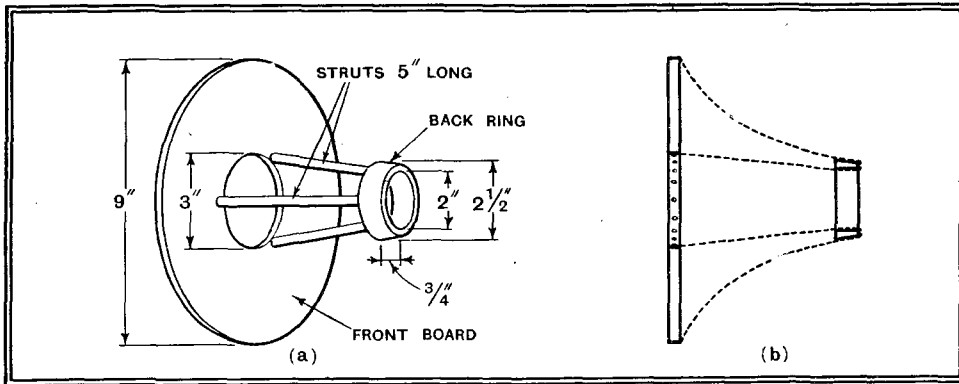

Fig. 4.—The "high-note spreader": construction of the wooden frame and (on right) the varnished fabric covering indicated by dotted lines.

made from a shaped piece of cloth stretched on to the frame and then given two coats of shellac varnish. The whole structure is entirely non-resonant, and yet has reflecting properties sufficient to

degrees, it was widened to approximately 140 degrees, though rendered correspondingly more attenuated. The effect of the spread is that the quality of the music, etc., is nearly constant over a much larger

THE TELEVISION TRANSMITTER

Where Will It Be Located?

ONE of the first tasks devolving upon the Television Advisory Committee is the selection of a site for the first transmitter in the London area.

Although both Baird Television and the

respective systems, the Television Committee's report recommends a single station, and that the two companies should so install their equipment that they can carry out transmissions alternately under strictly comparable conditions.

order that as large an area as possible should come within optical range of the station.

The accompanying drawing which has been prepared for *The Wireless World* from a relief model, the property of the

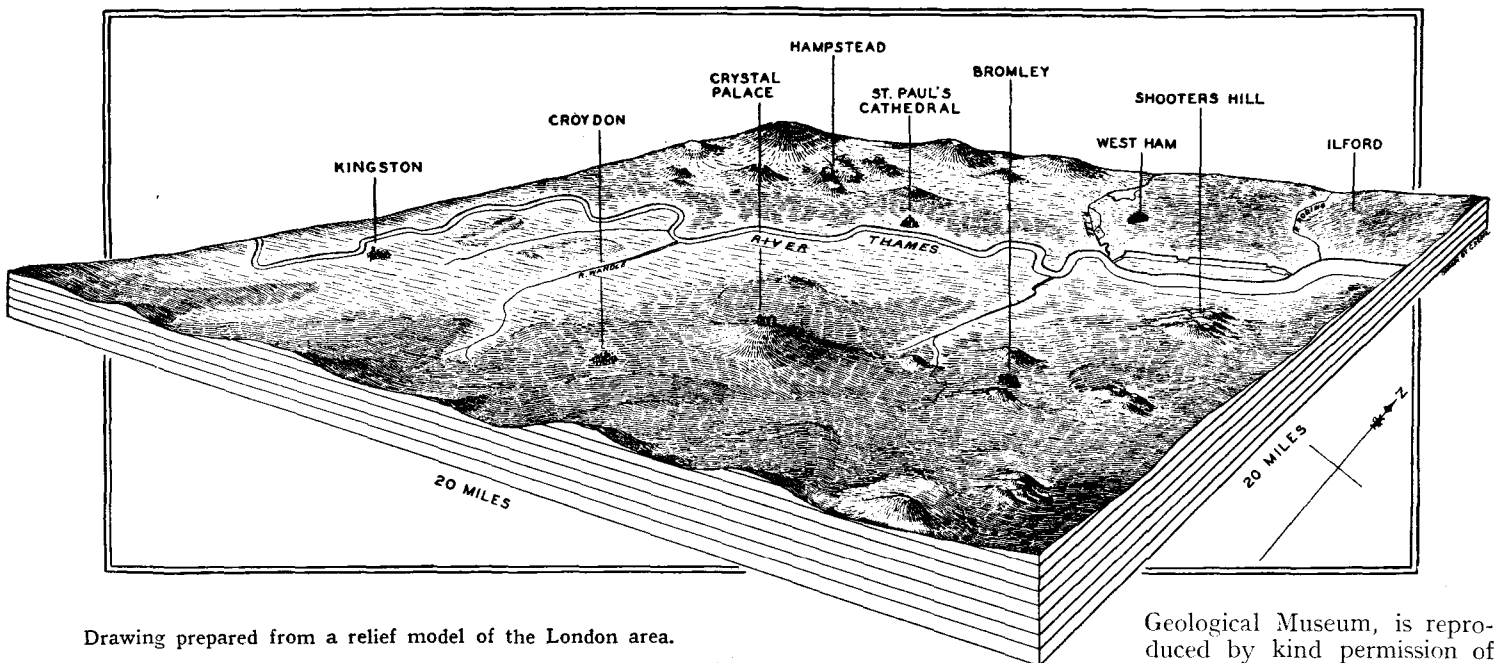

Drawing prepared from a relief model of the London area.

Marconi-E.M.I. Television Company are to be given the opportunity to supply apparatus for the operation of their

For technical reasons it is desirable that the transmitter should be on high ground and the aerial as elevated as possible in

Geological Museum, is reproduced by kind permission of the Curator. This drawing indicates the rising ground and principal hills around London. Incidentally, the model reveals that the London area is not

The Television Transmitter—so hilly and irregularly contoured as is commonly supposed.

Our second illustration gives some very interesting information regarding field strength of television signals emanating from the 10-kW. 7-metre experimental transmitter of the Baird Company at the Crystal Palace.

The indication given above that good conditions mean remoteness from a main road emphasises how troublesome electrical interference generated by motor cars can be, and no doubt this problem will have to be tackled seriously before town dwellers, or those near busy thoroughfares, can get the best from a television service.

creasing this height is at present under consideration.

It may be mentioned that the country round about Berlin is relatively flat as compared with London, so that the necessity for such high masts would probably not arise if some point such as the Crystal Palace or the Hampstead or Highgate hills is chosen for our station.

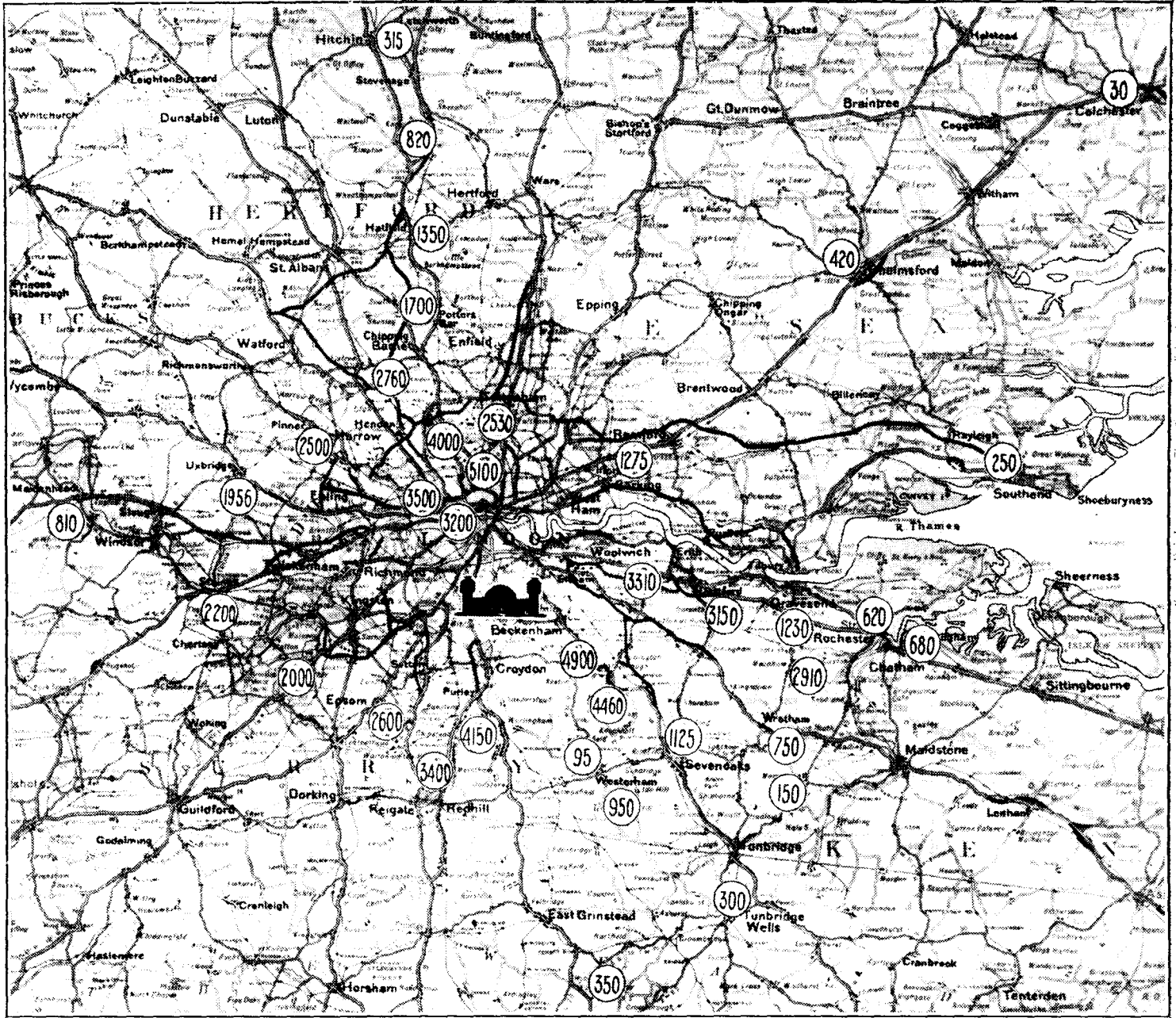

G. W. BACON & CO. LTD.

Map showing field strength of signals, at ground level, from the Baird 10-kW 7-metre television transmitter located at the Crystal Palace.

represent the field strength measured by Baird engineers at the locations indicated using a vertical dipole aerial at ground level. Experience shows that a good picture under all conditions may be expected when the signal strength is above 1,000 microvolts. When the receiving aerial is not within 50 yards of a main or arterial road a good picture can be obtained on 250-1,000 microvolts, whilst with a field strength of only 100-250 microvolts a good picture may be expected provided there is freedom from electrical interference.

The field strength map rather goes to show that the masking of signals by hills is really serious only when receivers are located in the immediate shadow of the hills on the wrong side of the transmitter. For example, it is interesting to observe the screening effect of the North Downs. At a receiving point near Westerham, where the intervening hills rise to a height of some 230 feet, field strength falls sharply to 95 millivolts.

At the Berlin television experimental station masts 430 feet high are employed, and it is understood that the idea of in-

A study of the relief plan of London certainly suggests the top of Hampstead Heath as a really ideal site for the station. If, as has been suggested, the Alexandra Palace site were chosen, we might expect that the Hampstead hills would, by reason of their close proximity, screen the district lying immediately to the West of Hampstead. If Hampstead Heath is selected, there will no doubt be some outcry that the station would spoil the skyline of this famous spot, but it should surely be possible to devise an aerial tower that would not be unsightly.

PUSH-PULL QUALITY AMPLIFIER

for the QA Receiver

By W. T. COCKING

(Concluded from page 160 of last week's issue)

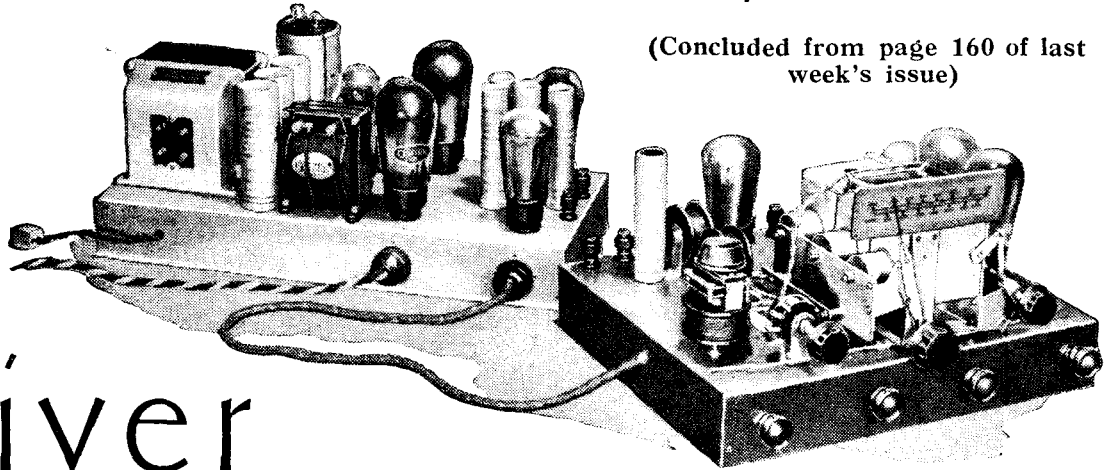

FULL details of the QA Receiver have appeared in the last two issues of *The Wireless World*, but only brief references have been made to the amplifier with which it is to be used because this amplifier has already been described in the issues for May 11th and 18th, 1934, and no changes whatever have been made to the original design. These issues of *The Wireless World*, however, are now out of print and no longer obtainable, so that it has been thought advisable to repeat the essential data.

and it will be seen that two PX4 valves are used in push-pull, the resistances R11, R12, R13, R14 being for the purpose of suppressing any tendency to parasitic oscillation. The valves are independently biased by the resistances R15 and R16, and the bias is somewhat greater than normal. Actually it is 35 volts, and the anode current of each valve is then 35 mA. This is done to conserve anode current, for the two valves take 70 mA. only, and a surplus of 50 mA. is available for the early stages. If the output valves were biased according to the maker's rating the

pair would consume about 100 mA. Rectifiers, however, are only rated for an output of 120 mA., so that this would leave only 20 mA. for the other valves, which is not sufficient. The increase in grid bias which has been adopted leads to some reduction in the output, but owing to the push-pull connection 4 watts can be obtained with negligible distortion and about 6 watts for the degree normally considered permissible. Owing to the unusual operating conditions the load impedance required by the output stage is higher than the normal value, and the best results are

The circuit diagram appears in Fig. 1,

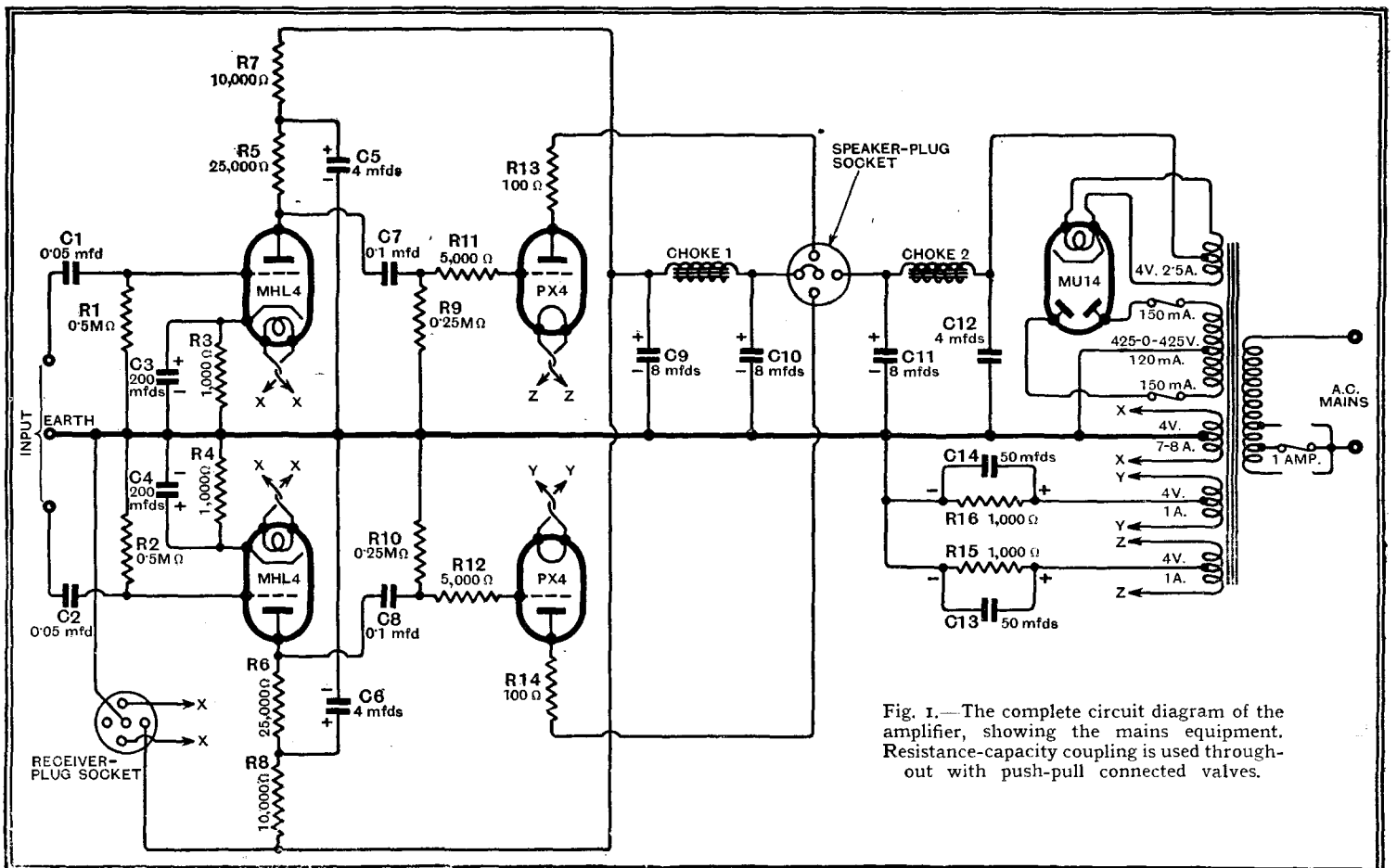

Fig. 1.—The complete circuit diagram of the amplifier, showing the mains equipment. Resistance-capacity coupling is used throughout with push-pull connected valves.

Push-Pull Quality Amplifier—

secured with a total load of 10,000 ohms.

The PX4 valve requires a maximum input of 35 volts peak, and this is provided by the previous stage, which consists of two MHL4 valves in push-pull. The couplings are of the resistance type, and the values of components are chosen so that both frequency and amplitude distortion are negligible. The stage gain is some 9.9 times, so that the maximum input to the amplifier is about 3.5 volts peak, or a total RMS input of 5 volts split between the two halves of the amplifier.

The mains equipment consists of the usual mains transformer fitted with fuses both in the primary circuit and in the HT secondary. This delivers 425-0-425 volts to the rectifier, which is of the indirectly heated type, and a rectified voltage of 450 volts is obtained across C12. Initial smoothing is carried out by Ch2 and C11, after which the total current passes

Some 275 volts appears across C10, and this is applied directly to the output stage for the anode potential and grid bias. The remaining current of 50 mA. passes through the choke Ch1, where it is still

of the two directly heated output valves, and this is necessary if they are to be independently biased in a satisfactory manner. A fourth winding provides the 2.5 amperes necessary for heating the rectifier.

FULL details of the QA Receiver have appeared in the last two issues of "The Wireless World," and the construction of the Push-Pull Quality Amplifier for which the receiver is designed is dealt with in this article. The amplifier is resistance-coupled throughout, and designed for the finest quality of reproduction.

further smoothed in conjunction with C9, and at this point a supply of some 250 volts is available. The two MHL4 valves are fed from this point through their coupling and decoupling resistances and consume just over 4 mA. apiece, the remaining current of some 42 mA. passing via the inter-unit cable to the receiver.

The heaters of all the indirectly heated valves, both in the receiver and amplifier,

The total power consumed from the mains can readily be computed by totalling the power withdrawn from the secondaries and allowing a reasonable figure for transformer losses. The secondary power is about 93 watts, so that if we allow an efficiency of 80 per cent. in the transformer, the primary power is 116 watts. It is not usually necessary to know this figure, but it is essential if it be desired to operate the equipment from DC mains with the aid of a rotary converter. If a converter be used, it should be rated for an output of not less than 120 watts.

There is nothing in the construction of the amplifier to occasion any difficulty, for the metal chassis is available with all holes

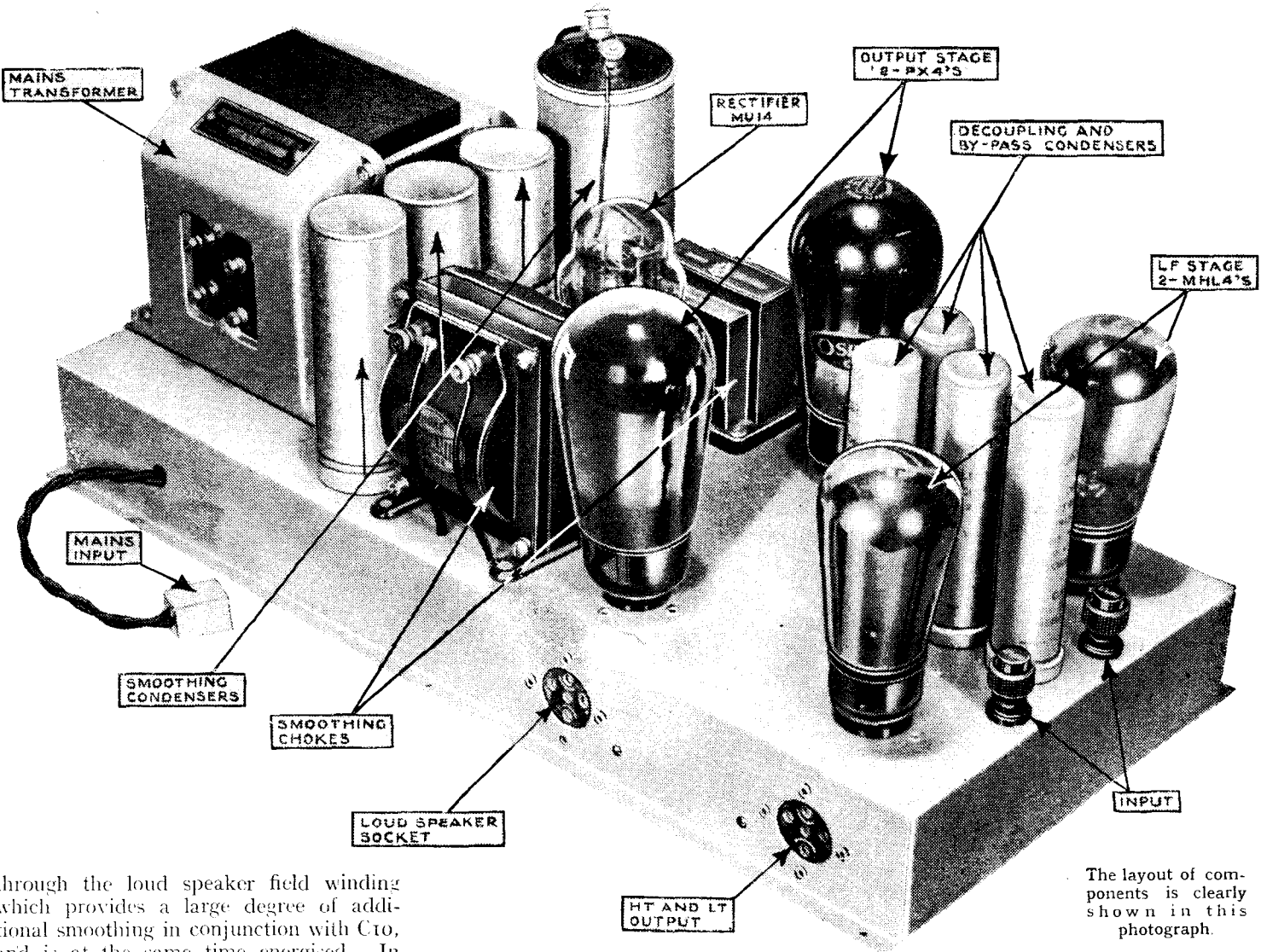

The layout of components is clearly shown in this photograph.

through the loud speaker field winding which provides a large degree of additional smoothing in conjunction with C10, and is at the same time energised. In order to maintain the correct voltages the field resistance must be 1,250 ohms, and if a separately energised or permanent magnet type of speaker be used, an extra choke having this resistance must be connected in circuit.

are run from a single winding on the mains transformer rated for an output of up to 8 amperes; actually only 5.5 amperes are drawn, apart from the dial light current. Separate windings are provided for each

ready drilled. Care should, of course, be taken to see that the cans of electrolytic condensers make sound contact with the chassis, and it will be advisable to scrape off the paint at such points. Many of the

Push-Pull Quality Amplifier—

leads in the amplifier carry high voltages, so that care must be taken to maintain adequate insulation, but no difficulty should be experienced on this score if a good quality insulating sleeving be used.

In operation the amplifier requires little attention, for no preliminary adjustments are needed and there are no controls. A check of the voltages and currents prevailing is certainly advisable and a table is given in this article showing the normal

figures; it should be noted that in every case save that of the feeder valve the voltages are measured from the chassis. The feeder valve anode voltage is measured between anode and cathode, but little

reliance should be placed upon voltmeter readings here, since they are subject to wide errors owing to the resistance of the meter. A measurement of anode current forms a more reliable guide to the operating conditions.

Minor general discrepancies in the readings obtained are of little moment, but the currents taken by the two PX4 valves should be as nearly the same as possible—they will rarely be exactly alike. Similarly, the two MHL4 valves should

A full-size blue print of the wiring diagram of the Push-Pull Quality Amplifier, combined with the receiver, is available from the publishers, Dorset House, Stamford Street, London, S.E.1. Price 1s. 6d. post free.

WIRING PLAN FOR THE PUSH-PULL QUALITY AMPLIFIER

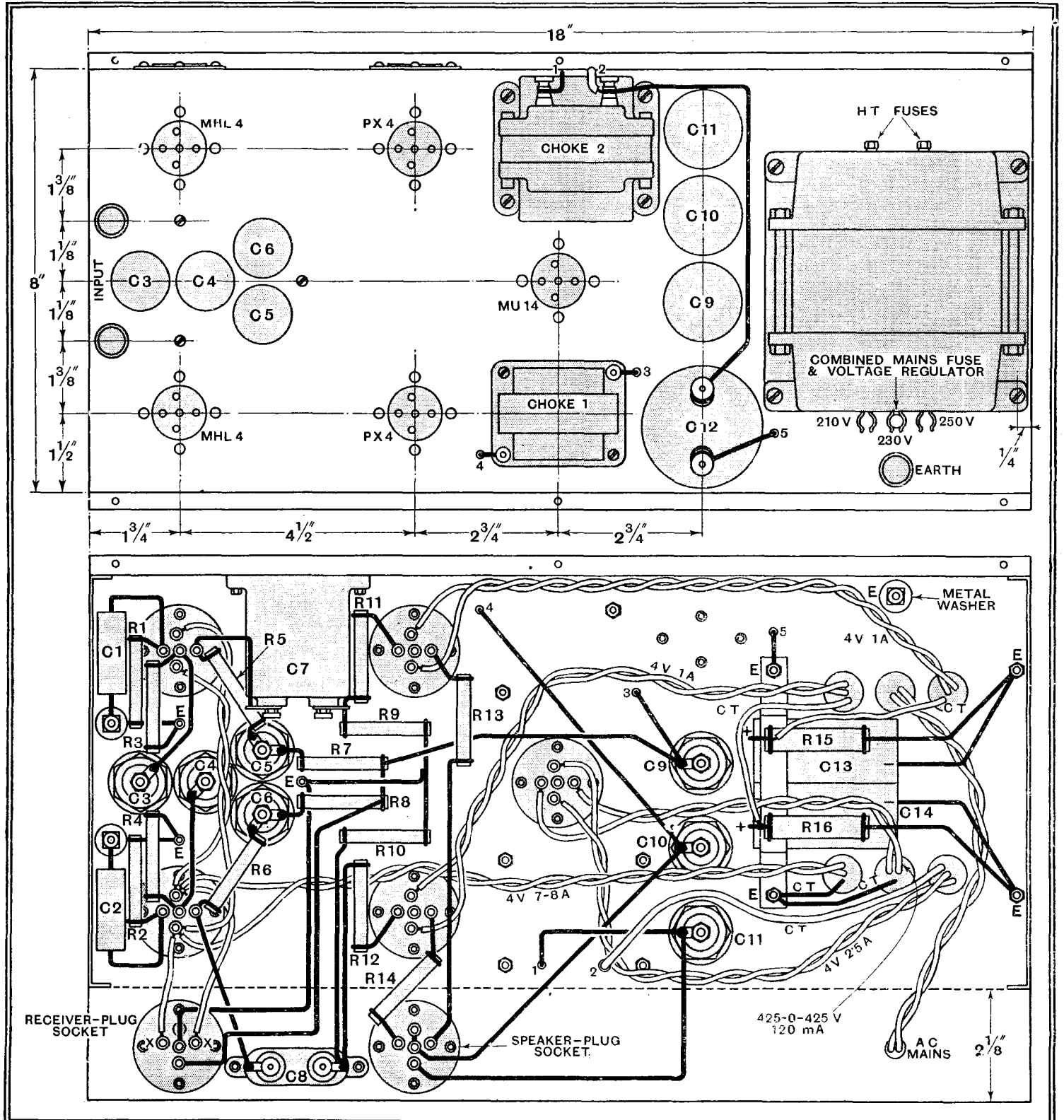

Full details of the layout and wiring can be gleaned from these drawings.

Push-Pull Quality Amplifier—
pass nearly the same current. When the amplifier is used with the QA Receiver no connections need be made to the "earth" terminal on the amplifier.

The receiver and amplifier have now been fully described and it only remains to comment upon the external equipment to be used. In the first place, an output transformer is necessary for the connecting link between the amplifier and the loud speaker. This should be of the push-pull type with a primary inductance of some 70 H., and the ratio required can readily be calculated by dividing 10,000 by the speech-coil impedance and taking the square root of the result. Constructional details of a suitable transformer have already appeared in *The Wireless World*,¹ and this component can be obtained ready made from Sound Sales. This firm can also supply the 1,250 ohms 120 mA. speaker field replacement choke which is necessary only if use is not made of the provision for free field current.

A loud speaker to be energised from the

¹ "Push-Pull Output Transformers," *The Wireless World*, September 8th, 1933.

amplifier should have a field resistance of 1,250 ohms and be adequately energised by a current of 120 mA. The quality of reproduction obtained from the equipment will depend very largely upon the charac-

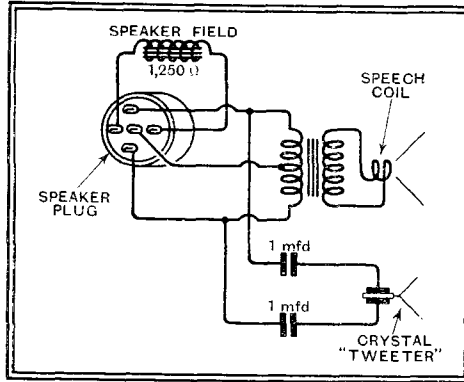
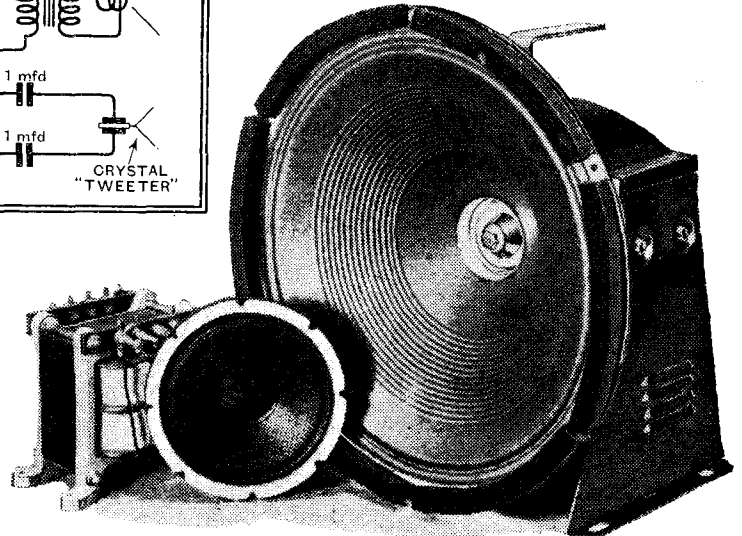

Fig. 2.—The connections to the speaker plug when an energised speaker is used in conjunction with a tweeter. The two speakers, together with the output transformer, are seen in the photograph.

one and as close to it as possible, so that it will generally be most convenient to mount both on the same baffle.

PUSH-PULL QUALITY AMPLIFIER LIST OF PARTS

- 1 Mains transformer, primary, 200 to 250 volts, 50 cycles; secondaries, 425-0-425 volts, 120 mA.; 4 volts 2.5 amps, centre-tapped; 4 volts 1 amp, centre-tapped; 4 volts 1 amp, centre-tapped; 4 volts 7/8 amp, centre-tapped. **Sound Sales Type PP-QA** (B.S.R., British Radio Gramophone Co., Bryce, Challis, Heyberd, Claude Lyons, Parmeko, R.L., Rich and Bundy, Varley, Vortexion, Wearite)
- 1 Smoothing choke, 7/13 henrys at 120 mA., 215 ohms, Ch2 **Ferranti B2**



- 1 Smoothing choke, 20 henrys at 50 mA., 400 ohms, Ch1 **R.I. "Hypercore"** (Alternatives same as mains transformer above)

Condensers:

- 1, 4 mfd., 450v. working, cylindrical container, C12 **Dubilier LEG/9204**
- 3, 8 mfd., electrolytic, 500v. peak, C9, C10, C11 **Dubilier 0281**
- 2, 4 mfd., electrolytic, 500v. peak, C5, C6 **Dubilier 0283**
- (Ferranti, Peak, Polar-N.S.F., T.C.C.)
- 2, 50 mfd., electrolytic, 50v. peak, C13, C14 **Dubilier 3003**
- 2, 200 mfd., electrolytic, 10v. peak, C3, C4 **Dubilier 0283**
- 2, 0.1 mfd., mica, C7, C8 **Dubilier B775**
- (T.C.C.)
- 2, 0.05 mfd., non-inductive, tubular, C1, C2 **Dubilier 4403**
- (Graham Farish, Peak, Polar-N.S.F., T.C.C., T.M.C.Hydra)

Resistances:

- 2, 1,000 ohms 2 watts, R15, R16 **Claude Lyons**
- 2, 100 ohms, 1 watt, R13, R14 **Claude Lyons**
- 2, 1,000 ohms, 1 watt, R3, R4 **Claude Lyons**
- 2, 5,000 ohms, 1 watt, R11, R12 **Claude Lyons**
- 2, 10,000 ohms, 1 watt, R7, R8 **Claude Lyons**
- 2, 25,000 ohms, 1 watt, R5, R6 **Claude Lyons**
- 2, 250,000 ohms, 1 watt, R9, R10 **Claude Lyons**
- 2, 500,000 ohms, 1 watt, R1, R2 **Claude Lyons**
- (Dubilier, Eric, Ferranti, Graham Farish, Polar-N.S.F., Watmel)

- 7 Valve holders, 5-pin **Clix Chassis Mounting Standard Type**

- 1 5-pin Plug **Bulgin P3**

- (British Radio Gramophone Co.)

- 3 Ebonite shrouded terminals, Input (2), Earth (1) **Belling-Lee "B"**

- 1 Metal chassis with screws, nuts and washers **C.A.C. Valves: 2 Osram MHL4; 2 Osram PX4; 1 Osram MU14 (Marconi)**

LOUD-SPEAKER EQUIPMENT.

- Loud-speaker, field resistance, 1,250 ohms, without transformer; **Magnavox Model 66W**

- Piezo-electric Tweeter **Rothermel-Brush R155**

- Push-pull output transformer, ratio 25:1 **Sound Sales PP3**

- 2 x 1 mfd. condensers **T.C.C.50**

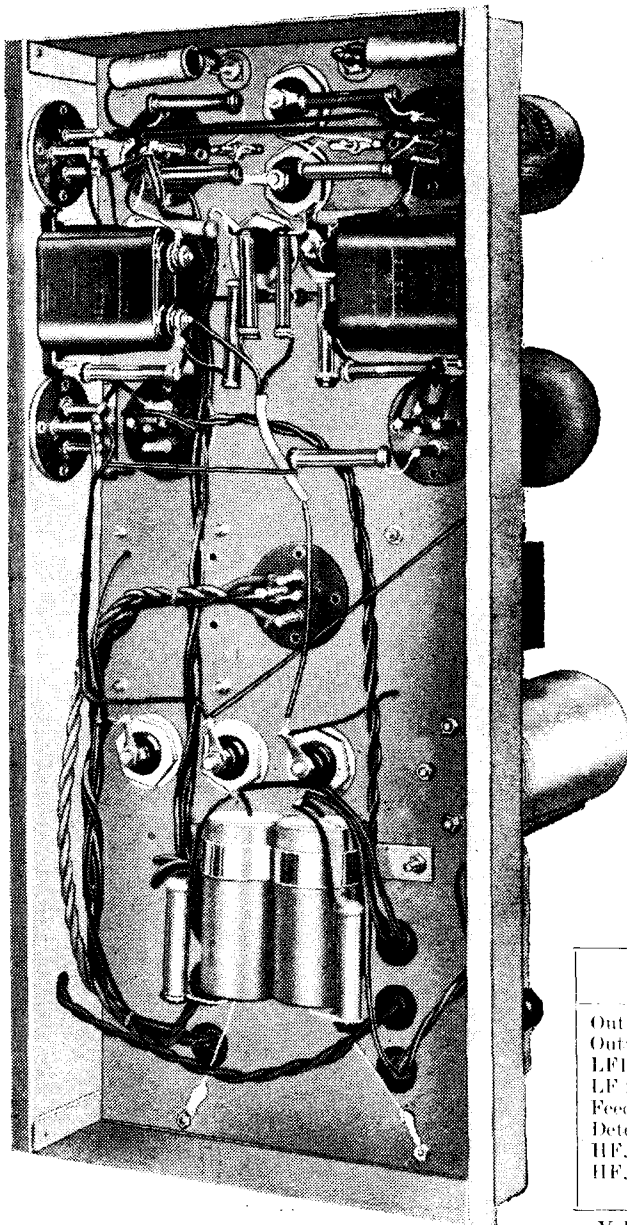

An underbase view of the amplifier.

teristics of the loud speaker, so that a careful choice is advisable. In this connection it may be mentioned that the combination of a Magnavox Model 66 speaker with a Rothermel-Brush piezo-electric tweeter has been found very satisfactory. This speaker has a speech coil impedance of 15 ohms, so that the output transformer ratio should be close to 25-1.

The piezo-electric tweeter does not need a transformer, but is best isolated from the HT supply by means of two 1-mfd. condensers. The connections of both loud speakers and output transformer to the speaker plug are shown in Fig. 2. If the full bass response is to be realised in practice, it is necessary to employ a baffle of large area for the moving-coil speaker; but no such baffle is necessary for the tweeter. This speaker, however, is best mounted above the large

VALVES, VOLTAGES AND CURRENTS

Valve	Anode volts	Grid bias	Anode current mA.
Output 1, PX4 ..	270	35	35
Output 2, PX4 ..	270	35	35
LF1, MHL4 ..	112* (121)	3.1* (4.4)	4.4
LF 2, MHL4 ..	112* (121)	3.1* (4.4)	4.4
Feeder, MH4 ..	90* (119)	1.1* (1.72)	0.86
Detector, 2D4A ..	—	—	—
HF, MH4 ..	190	1.9* (2.1)	4.2
HF, MHL4 ..	130	5.3* (6.25)	12.5

Volts across C12 = 450 v., C11 = 425 v., C10 = 275 v., C9 = 250 v. in amplifier.

* Measured values, true voltages in brackets.

Current Topics

Events of the Week in Brief Review

Sponsored Programmes Banned

RECENTLY all publicity programmes were banned by the Paris State Stations. On February 10th the order was extended to include all State-owned stations in the country.

Pro-Radio Centre

A "PRO-RADIO Centre" has been opened by the French radio trade in Paris to popularise broadcasting. Of the ten million homes in France, not more than two million have wireless sets, so the Pro-Radio Centre will have its hands full for some years to come.

£100 Essay Prize

A PRIZE of £100 is offered by the Royal Society of Arts for an essay on modern navigational appliances made possible by electricity on board, e.g., wireless DF, echo sounding, gyroscope, etc. Candidates must also deal with appliances not depending upon electricity.

The closing date for sending in essays is the 31st of December, 1935. Full particulars can be obtained on application to the Secretary, Royal Society of Arts, John Street, Adelphi, London, W.C.2.

Radio at Jubilee Exhibition

TWENTY-FIVE years of progress in engineering will be epitomised in a special exhibit at the 19th *Daily Mail* Ideal Home Exhibition, Olympia. Visitors will be able to study the development during the reign of King George V of electric lighting, telephones, aviation, travel, sound recording and wireless.

The General Post Office will, as usual, run a stand of great interest to wireless users.

The Jubilee Ideal Home Exhibition will be open from March 26th until April 18th.

Spanish Broadcasting Scheme

HIGHER powered broadcast programmes from Spain may be expected in the near future. The Spanish Government is inviting estimates for the erection of ten powerful stations in the chief cities of the country. Restrictions may be placed on sponsored programmes.

More German Listeners

GERMAN licensed listeners on February 1st numbered 6,439,232, an increase of 296,311 during the month of January. This is a record jump.

Programme from Portugal

A SPECIAL broadcast for British members of the International DX'ers Alliance comes from CT1GL, Parede, Portugal, from 1 a.m. to 2 a.m. (G.M.T.) on Sunday next, Feb-

It is believed in certain quarters that this move is the result of the recent refusal of the G.P.O. to permit a private transmitting station to be located in a British Fascist barracks.

Mr. Murphy on Receiver Testing

MR. F. MURPHY, B.Sc. (Eng.), will open a discussion on "Production Testing of Broadcast Receivers" at an informal meeting of the Wire-

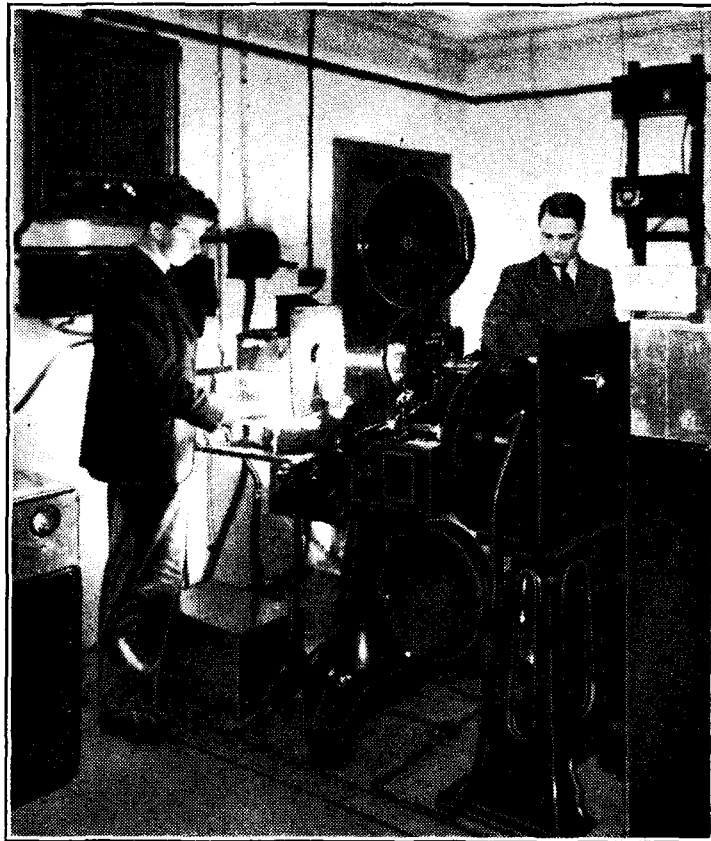

HIGH DEFINITION TELEVISION. The Baird Company's projector at the Crystal Palace, which is used for the 180-line film transmission tests. High-speed scanning of film presents fewer problems than that of actual scenes and objects.

ruary 24th. The wavelength is 291 metres. Reports are welcomed and will be acknowledged.

No Politics

THE General Post Office has just incorporated a new clause in amateur transmitting licences which forbids the licensee to radiate social or political propaganda, or to allow any social or political organisation to use the station in any way.

less Section of the Institution of Electrical Engineers on Tuesday next, February 26th, at 6 p.m. The meeting, which is open to non-members, will be held at the Institution, Savoy Place, Victoria Embankment, London, W.C.2.

Television Report Dazes U.S.

THE news of the publication of the Television Report in Great Britain fell like a bombshell on the ears of American

radio engineers, according to our Washington correspondent.

"Either the Britons are masters of the art of dissimulation," he writes, "or they are satisfied that they have something really good, for Lord Selous and his staff did not indicate during their American tour that they thought England was ahead of this country in television development.

"On the contrary, those who met them socially and in the laboratories aver that they were effusive in their praises of comparative American advances."

The television delay in America is probably due to financial difficulties. The hundreds of millions of dollars necessary to introduce television on a nation-wide scale are not available from the private sources which support present-day broadcasting in America. Thus in the matter of scientific development, the much-boasted principle of trade-sponsored broadcasting cuts a sorry figure beside a State-supported organisation.

Germany and Television Report

GERMAN reaction to the Television Committee's Report takes the form of emphasising that Germany has not lost the lead. The Secretary of State responsible for the German Post Office television tests publishes an article pointing out that the right of being the premier country in television belongs to Germany. For the past year and a half, he writes, high-definition television on ultra-short waves has been broadcast in Berlin. He omits to tell his readers, however, that reception of these experimental transmissions is limited to the laboratories of interested firms and that suitable receivers are not available on the German market.

Plans for giving Germany a high-definition television service provide for twenty-five ultra-short wave transmitters.

Short-Wave Dinner and Dance

THE annual dinner and dance of the International Short-Wave Club, London, will be held on Saturday, March 9th, at Maison Lyons, Shaftesbury Avenue, London, W.1. The chief guest will be the American Consul in London, and the function will be attended by well-known broadcasting personalities and radio manufacturers. All interested in short-wave working are cordially invited to attend. Full particulars may be obtained from the Hon. Secretary, Mr. A. E. Bear, 10, St. Mary's Place, Rotherhithe, London, S.E.16.

The Detector as a Radio-Frequency Load

Its Effect on Amplifier Design

By F. M. COLEBROOK, B.Sc., D.I.C., A.C.G.I.

DEALING with the design theory of tuned coupling circuits which are affected both by the preceding HF amplifying valve and by the succeeding detector. It is shown that a transformer designed for maximum voltage amplification is not necessarily the best when the detector load is taken into account.

MUCH has been written and published about the design of radio-frequency amplifying stages, and about the detector considered as a radio-frequency load—its damping effect on a tuned circuit and the control of this damping effect by suitable coupling and so on. But in every receiver embodying tuned-circuit radio-frequency amplification there will be at least one stage in which a tuned circuit is coupled not only to the anode circuit of a preceding valve, but also to a detector—a diode, or whatever it may be. Now, although such a combination of circuits figures in the great majority of present day receivers, there has not yet appeared, as far as the writer is aware, any simple account of the theory of the design of such a system, as distinct from the design of the amplifier and the detector coupling considered separately. The object of the theoretical investigation, which is summarised in this article, was to fill this gap, and to find out what differences in behaviour and in design arise from the combination of the two elements in a single system.

For this purpose, the typical system considered will be that shown in Fig. 1.

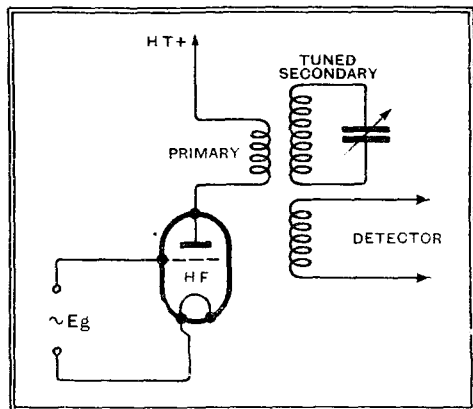

Fig. 1.—An H.F. amplifying stage of the type dealt with by the author.

where the tuned circuit is represented as coupled to the amplifying valve (of unspecified type) by a separate winding, referred to as the primary, and to the detector (diode, or whatever else it may

be) by another separate winding—referred to, for want of a better name, as the tertiary winding. In actual practice, all these windings may be the same—as in the tuned anode circuit, with a diode connected to its “live” end—or again, the tertiary winding may be a tapping on the secondary (an auto-transformer coupling), but these are all special cases and are covered by the same general theory. This theory finds its simplest exposition in terms of the three-circuit system illustrated, which has, moreover, the advantage of emphasising the point that three distinct circuits are, in fact, involved. Further, by making use of familiar conceptions of equivalent circuits, the actual arrangement of valves and windings will be replaced for discussion by that illustrated in Fig. 2. Here the valve is represented as a source of electro-motive force, the magnitude of which is μ' times the input grid voltage, in series with a fairly high resistance R_1 , which represents the AC internal resistance of the valve together with the relatively very small resistance of the primary winding itself. The effective radio-frequency input-resistance of the detector is represented as a pure resistance R_3 , which, for convenience, also includes the relatively small resistance of the tertiary winding. This representation of the detector will be substantially justified for the large-amplitude rectification which is usually aimed at in these days.

The Detector Load

In order to bring out clearly the effect of the detector load on the design of the amplifying system, the latter will first be considered very briefly by itself. The main features of this subject are so well known that a mere outline will suffice, though, for reasons which will appear later, it will be desirable to emphasise the dynamic or “power” aspect of the matter.

For the amplifying system constituted by the first two circuits only—the primary or anode circuit and the tuned secondary circuit, there is, at any given frequency, an optimum ratio of secondary to primary turns—a ratio, that is, which re-

sults in the maximum of amplified voltage across the tuning condenser. This best ratio is very approximately equal to the square root of the ratio of the so-called “dynamic resistance” of the tuned circuit to the AC resistance of the valve. Thus, if the dynamic resistance of the tuned circuit is 200,000 ohms, and the AC resistance of the valve is 30,000 ohms, the best ratio is $\sqrt{200,000/30,000}$ i.e., $\sqrt{20/3}$ or about 2.6:1.

This simple rule is well known, but its physical significance in terms of electric power is probably not always realised. By means of the coupling or mutual inductance between the primary and secondary

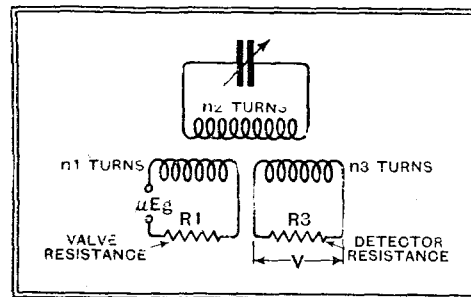

Fig. 2.—The equivalent circuit of Fig. 1.

circuits, the EMF in the primary circuit is made to supply current and, therefore, electrical power to the secondary circuit. This is useful power, utilised in maintaining the output voltage. At the same time, however, a certain amount of the total power supplied by the EMF in the primary circuit is necessarily dissipated in the primary resistance R_1 , and as far as the objective of the process is concerned, this is wasted power. It is obviously desirable that as much as possible of the total power shall be consumed usefully in the secondary circuit and as little as possible wasted in the primary circuit. The relative magnitudes of the two depend upon the mutual inductance between the two circuits and can thus be controlled to some extent, but the best compromise that can be arrived at is to make the two equal—a 50 per cent. efficiency. A full analysis of the theory shows that when the turns ratio has the optimum value

The Detector as a Radio-frequency Load—

already defined, the secondary power reaches a maximum value and that under these conditions (and only then) the total power is equally divided between the two circuits. In this respect the amplifying stage is typical of a large class of electric circuits, and a complete receiver embodies others of the same type. Wherever an EMF is associated with an internal resistance, and is made to supply power to some external circuit, the optimum or maximum output-power condition is one in which the external resistance is made effectively equal to the internal resistance, and the total power supplied by the EMF is equally divided between the internal and external circuits.

In the case we are now concerned with, however, there are not two circuits, but three, and the following questions naturally arise:—

Is there, in this case, any optimum proportioning of the three windings? Is there, that is to say, any set of turns-ratios $n_3:n_2:n_1$ which gives a maximum of useful power in the detector circuit realised as a maximum of audio-frequency output?

If there is any such optimum distribution of windings, is the secondary-to-primary ratio appreciably different from that appropriate to pure radio-frequency amplification alone?

In the optimum condition, if any, is there a simple distribution of the total power between the three circuits? Is there, for example, as might naturally be expected by analogy with a two-circuit case, a maximum output or detector power which is obtained when the total power is equally divided between the three circuits?

The answers to these and a number of related questions have been obtained by an analysis of the system shown in Fig. 2. The full details of this analysis will be published in *The Wireless Engineer*, and in the present article no more than a bare statement of the results will be given, with illustrations of their practical significance.

In practice, the secondary winding of n_2 turns, constituting the tuned circuit, is usually fixed by considerations of tuning range, and the practically variable quantities are therefore n_1 and n_3 , the numbers of turns in the primary winding and the tertiary or detector winding (or tapping). We are concerned, therefore, with the variation of the detector voltage V as a result of all practicable variations of n_1 and n_3 .

Optimum Ratios

In the first place, the complete analysis showed that there is not, in the amplifier-detector system, and absolute maximum of detector voltage obtainable by a suitable choice of n_1 and n_3 , and in this respect, therefore, we have already a distinction from the simple amplifier case. Briefly, for any given primary winding (i.e., for a given value of n_1), there will be a theoretically best or optimum value of n_3 , and similarly, for any given value of n_3 there will be an optimum value for n_1 . As approximate rules, assuming very close couplings between the windings, and

assuming that the inductances of the windings are proportional to the square of the number of turns, we have that, for a given primary winding, the best value of n_3 is given by

$$\frac{n_3^2}{R_3} = \frac{n_1^2}{R_1} + \frac{n_2^2}{R_d}$$

where R_d is the dynamic resistance of the tuned circuit.

On the other hand, for a given value of n_3 , the best primary winding is given by

$$\frac{n_1^2}{R_1} = \frac{n_3^2}{R_3} + \frac{n_2^2}{R_d}$$

The reason why there is no absolute best or optimum condition is that these two conditions cannot be satisfied simultaneously unless n_2^2/R_d is zero, i.e., unless the tuned circuit has no resistance and no loss.

In any case, the overall amplification, i.e., the ratio of the detector voltage V to the input signal, is given approximately by the formula

$$M = \frac{\sqrt{PT}}{P+T+S} \times \sqrt{R_3/R_1} \times \mu$$

where, for shortness, P , T and S have been written for

$$n_1^2/R_1, n_3^2/R_3, \text{ and } n_2^2/R_d.$$

Using the same letters, the two optimum conditions are

$$T = P + S$$

and

$$P = T + S.$$

For voltage amplification alone the optimum condition is, as already stated,

$$\frac{n_2}{n_1} = \sqrt{\frac{R_d}{R_1}}$$

or

$$P = S.$$

Thus, it follows at once that the transformer design for voltage amplification alone is not necessarily the best when a detector load is taken into account, and it will be necessary to consider practical cases to find out whether and under what conditions the difference is important.

Before considering these practical consequences, however, it will be of interest to describe the dynamic or power aspects of these optimum conditions.

The full analysis showed quite clearly that there is no very simple analogy with the amplifier case in respect of the power-balance. By adjustment of the primary and tertiary windings or tapings, it can be so arranged that the total power is equally divided between the three circuits, but this condition does not, as might have been expected, correspond to any optimum value of detector voltage. The optimum condition $P=T+S$ does actually represent a simple power-balance, between the primary circuit on the one hand and the detector and tuned circuit on the other, but the other optimum condition $T=P+S$ does not correspond to any simple power-balance at all. Briefly, the power aspect can be summed up by saying that the ideal function of the transformer windings is simply to transfer power from the valve to the detector. The tuned circuit merely functions as a necessary agent in

the process and charges a small commission, and the most efficient theoretical design—unfortunately not, in general, realisable—is one in which nearly the whole of the power is divided equally between the valve and the detector, as little as possible being consumed in the tuned circuit. This is equivalent to making P and T very large compared with S , which gives as the highest theoretically obtainable overall amplification $(\mu/2)\sqrt{R_3/R_1}$ —half the voltage factor multiplied by the square root of the ratio of the detector resistance to the valve resistance.

The Real Objective

Up to this point we have considered detector voltage alone. Intensity, however, is not the only nor even the most important factor involved in reception. Intensity relative to unwanted signals is the real objective, and this involves both sensitivity and selectivity. In practice it is usually necessary to compromise between these two, for they may, and frequently do, impose mutually inconsistent requirements on design. The above analysis indicates the means of obtaining maximum sensitivity. Up to these maxima sensitivity will increase and selectivity will tend to decrease. Beyond them both selectivity and sensitivity will decrease together. Thus, as in all such cases, a condition of too tight couplings is doubly damned.

The writer has suggested elsewhere¹ that, as a reasonable compromise between sensitivity and selectivity, the product of the two may be a useful criterion, selectivity being measured by the inverse of the effective power-factor (i.e., by $\omega L/R$) of the tuned circuit, as "damped" by the valve and detector couplings. This product actually shows a maximum-maximum value of the circuit considered, when the winding ratios are such that $P=T=S$, and this condition, which preserves a good degree of selectivity, gives about 66 per cent. of the theoretical maximum sensitivity.

We are now in a position to relate the theory to practical conditions and to see whether it indicates any substantial departure from current practice. For this purpose it will be necessary to assume certain representative values.

For large-amplitude rectification, by means of a diode circuit (or with the ordinary grid-circuit, if this is properly designed), the effective resistance R_3 can be taken as rather less than half the value of the diode load resistance (or grid leak). This condition is easy to realise in a suitably designed diode circuit, but with a triode the input resistance may easily be less than this, due to the so-called feedback effect. For illustration, 100,000 ohms will be taken as a reasonable figure for R_3 . The dynamic resistance of the coil

¹ "A Generalised Analysis of the Triode Valve Equivalent Network." J.I.E.E., Vol. 67, [p. 157-169.

The Detector as a Radio-frequency Load—

depends upon a number of factors—including frequency—but a good coil should give a figure of about 150,000 ohms.

Considering first the case of screen grid valves, tetrode or pentode, the internal resistance of these may be anything from 200,000 to 2,000,000 ohms. In such cases there is usually no attempt at satisfying the conditions of dynamic efficiency, for this would require a primary winding of more turns than the tuned circuit—hardly practicable in most cases, though it would be interesting to explore its possibilities. In practice the tuned circuit is connected directly (or in shunt) to the anode, i.e., $n_1 = n_2$, and the best detector tapping would be given by

$$\frac{n_3^2}{R_3} = n_2^2 \left(\frac{1}{R_1} + \frac{1}{R_d} \right)$$

and, as $\frac{1}{R_1}$ will be small compared with $\frac{1}{R_d}$, for most screen grid valves,

$$\frac{n_3}{n_2} = \sqrt{\frac{R_3}{R_d}} = \sqrt{\frac{100,000}{150,000}} = 0.82.$$

Thus there should be some slight gain in output and an appreciable gain in selectivity in tapping the detector down, at least on any circuit as good as that here assumed, so as to include about four-fifths of the coil. The effect will not, however, be very great, and the current practice of connecting the diode across the whole coil will not, as a rule, be far from the best practicable arrangement. It is interesting to note, however, that the efficiency of the arrangement is low in terms of the theoretical optimum, being about $\sqrt{R_d/R_1}$ —or 12 per cent., taking R_1 as 1,000,000 ohms.

Thus, for screen grid valve circuits the complete theory substantially justifies present practice. Recently, however, the

writer has shown² that for certain applications, more particularly for linear amplification up to large amplitudes, the triode is superior to the screen grid valve. It will therefore be of interest to note the relation of the complete theory to triode HF amplification with a detector load. Here the theory indicates that increased output will be obtainable by connecting the detector across the whole of the secondary and adjusting the primary winding or tapping to suit, in accordance with the formula

$$P = T + S$$

or, since $n_2 = n_3$,

$$\frac{n_1^2}{R_1} = n_2^2 \left(\frac{1}{R_3} + \frac{1}{R_d} \right)$$

² "A Study of the Possibilities of Radio-frequency Voltage Amplification with Screen grid and with Triode Valves," J.I.E.E., Vol. 74, pp. 187-198.

If this is compared with the formula

$$\frac{n_1^2}{R_1} = \frac{n_2^2}{R_d}$$

for voltage amplification without a detector load, it will be found that the modified formula indicates an increase in the primary turns of $\sqrt{1 + R_d/R_3}$ to 1, whatever the value of R_1 . For the assumed values of dynamic and detector resistance, this would amount to an increase of about 60 per cent. in the primary turns, and about 22 per cent. increase in the detector-circuit power, as compared with the circuit designed without consideration of the detector load.

These, however, are merely illustrative special cases, but the formulæ given, which are of general application, can be used as a guide in experiment in all cases and as a means of estimating whether, in any given case, the load effect of the detector circuit calls for any modification in the design.

Random Radiations

By "DIALLIST"

Uncanny Television

ONE part of a demonstration which the Baird people gave the other day was positively uncanny. The announcer told us that some horse races in the grounds of the Crystal Palace were going to be televised to the demonstration room in Victoria Street by means of the delayed method. This, as you know, consists in making a ciné-film of the event, which is developed and passed on to the transmitter in a matter of thirty seconds.

When the transmission started we saw that the judge had a telephone beside him. "You can ring him up and speak to him

if you like," said the announcer, "and then you will see just how long it takes, owing to the 'delay,' for him to pick up the 'phone and reply." It gave one really quite a creepy feeling to converse with the aforesaid judge. One picked up the telephone and spoke, what time others present pulled out their watches to count the seconds. Apparently heedless of the call, the judge went on with his business. Then half a minute (I made it just 29 seconds) later his telephone bell rang; he picked up his 'phone and replied. Some people asked him to do this thing or that so that we could see just when the response came. It was weird to see him apparently heedless for all those seconds and then suddenly galvanised into action.

A Speedy Spot

Have you, I wonder, ever thought of the amazing speed reached by the electron beam, which acts like an electric pencil in sketching out television images in the cathode-ray tube? Suppose we are dealing with 240-line transmission with 25 pictures a second, as recommended by the Television Committee. Take it that each line is only six inches in length, if you like. Then for each picture the electron beam travels 240 times six inches, or 120 feet, or 40 yards. Repeated twenty-five times a second, this means a total travel of just 1,000 yards in each second of time. One thousand yards a second is in round figures 2,000 miles an hour, which is pretty fast going.

The Electron Beam v. Mechanical Movement

The electron beam can be made to move very much faster than this without the slightest difficulty. In fact, 480-line television, which means a speed of 4,000 miles an hour, has been achieved experimentally. Compare this with what we regard as very

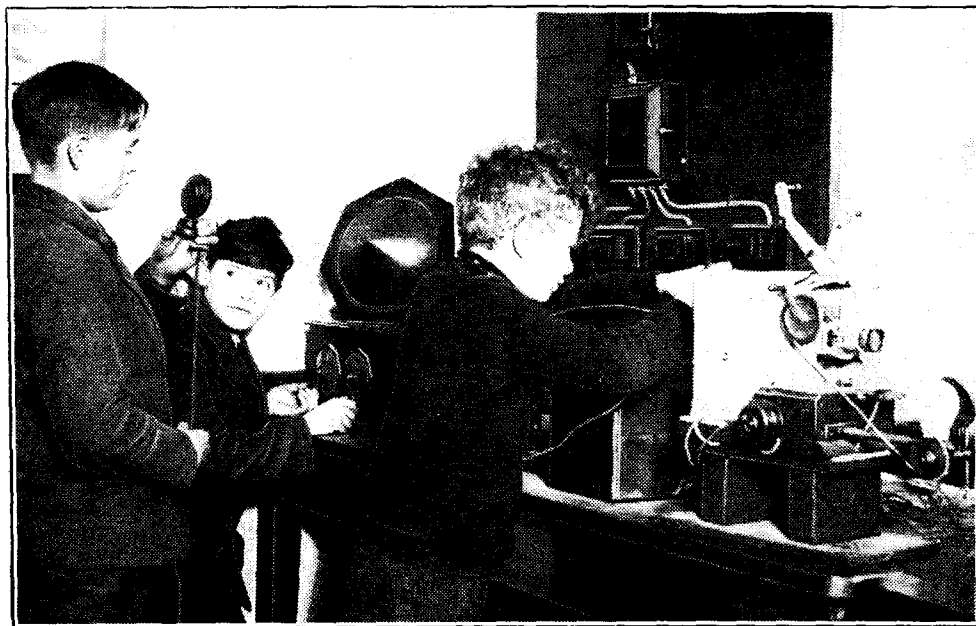

RADIO-MINDED PUPILS at the Northumberland Heath Senior School, Erith, Kent, with wireless and cinematograph apparatus of their own construction. The boy at the dials is evidently waiting for microphone howl in the loud speaker.

Random Radiations—

rapid mechanical movements. A motor car engine, when the vehicle which it drives is travelling at fair speed, may accomplish 4,500 revolutions a minute. Take it that each piston travels 4 inches downwards and the same distance upwards in each revolution—8 inches or two-thirds of a foot in all. Then, in one minute it moves through 3,000 feet, or 1,000 yards.

In other words, it moves at but one-sixtieth of the speed of the electron beam in 240-line television. The only mechanical movement comparable with that of the electron beam is the flight of a bullet up the barrel of a rifle. This may have a speed of even more than 2,000 miles an hour, but think of the enormous forces required to produce it and the ensuing wear and tear.

The mechanical scanning disc had probably reached its limit with 180-line television, but there seems to be no reason why even 480-lines should not be exceeded by the cathode-ray tube, for in the oscillograph

the electron beam has reached very much higher speeds.

Shall We Have a Short-wave Boom?

IT is curious, when you come to think of it, that up to the present short-wave reception has never appealed to more than a very limited number of our countrymen. In America all of the higher-priced sets are now made to cover wavelengths from about 12 to 550 metres, and some of them take in those up to 2,000 metres as well. A very large proportion of listeners in the United States make a good deal of use of the short waves, and there is no doubt that the popularity of this kind of reception is growing rapidly in that country.

Why it does not grow at the same pace over here is something of a mystery. Nearly every European country conducts short-wave relays of its chief programmes, and, apart from these, the short-wave set—or, better still, the all-wave set—keeps its

owner in constant touch with almost the entire civilised world. We shall, I think, suddenly awaken as a nation to the possibilities of the short waves, and then there will be something of a boom in sets that can receive them.

An Interesting Valve

WE get some remarkable valves nowadays, and from what I hear the new Marconi and Osram N.41 certainly seems to be one of them. This valve is an output pentode with indirectly heated cathode for A.C. mains operation. In addition to being capable of developing a large undistorted power output it has a nominal rating of 10 mA/V for mutual conductance and an amplification factor of 200. It is intended to be connected directly to the output of a diode detector.

Not so very long ago we regarded a mutual conductance of anything over 2 mA/V as pretty good for any sort of output valve, and here comes a pentode with a figure of 10. Owing to this high mutual conductance I expect that the new valve will need pretty careful handling. Any break in the plate circuit whilst it was in operation would almost certainly lead to its "blowing up."

Exchange Programmes

THE weekly news bulletins which we are exchanging now with the United States are a first-rate feature of the programmes, and I trust that the idea will be further developed. There is nothing like information straight from the horse's mouth, and talks by such men as Mr. Raymond Swing will help us to take a much closer interest in the doings of our cousins across the Atlantic. We shall not be able to hear the bulletins sent from this country to the United States, but we can be sure that they will be equally appreciated.

Then on Saturday evenings we have the relays of American programmes which are now so successfully conducted. These give us a taste of the "snappy" way in which broadcasting is conducted over there, and though I am sure that we should not like our own programmes to be planned entirely on American lines, these relays provide a welcome novelty.

On Tuning Dials

OFTEN I wonder what kind of tuning dial the man-in-the-street really likes best. Up to a few years ago all of them were marked off just into divisions from 0 to 100 or into degrees from 0 to 180, and the user either made a calibration chart or kept a list of the setting required for different stations. Now we have three different kinds of marking. There is a growing tendency to print the actual names of stations on the dials, though several makers prefer either a wavelength or a kilocycle marking.

If only it could be accurate, and if only stations would refrain from changing their wavelengths, name indication would be ideal. But I must confess that I have very little use for the set with which you have to turn to Prague when you want Cologne, or to Bordeaux when you desire to bring in Breslau. The kilocycle or wavelength markings have the advantage that they are unaffected by wavelength changes, but here again it is difficult to produce anything like real accuracy in commercial receiving sets.

In Next Week's Issue**Portable 40-Metre Transmitter****A Battery Set for
Telephony and
CW Work**

THE transmitter is a low-power battery-operated set designed to work on a wavelength of 41 metres. It embodies four valves, two being arranged as a Class "B" speech amplifier, and the output modulates an HF power amplifier driven by a master oscillator.

Construction is simple and straightforward, for readily obtainable components are employed, so that the amateur is relieved of intricate constructional work.

It should appeal to all amateur ex-

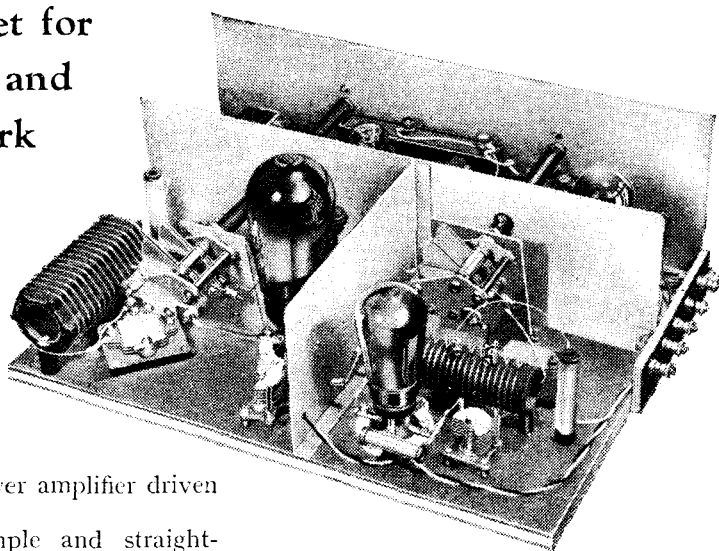

perimenters possessing a transmitting licence requiring a soundly designed, reliable and portable set for telephony and CW work.

LIST OF PARTS

After the particular make of component used in the original model, suitable alternative products are given in some instances.

- | | | | | |
|----------------------------------------------------------|----------------------------------------------------------------------------------|------------------------------------------------------------|-------------------------------------------------------------------------------------|------------|
| 2 Variable Condensers, 25-mmfd., with baseboard brackets | Cyldon "Bebe" Series-Gap | 1 On-off Toggle switch | (Claude Lyons) | Bulgin S89 |
| 2 Slow motion Condenser drives | Utility Micro-dial W181 (Graham Farish, Ormond) | 1 Class "B" Transformer | Scientific Supply Stores (Wireless), Ltd. | |
| 2 Air dielectric trimmer condensers, (5-mmfd.) | Eddystone 978 | 1 Modulation Transformer | Scientific Supply Stores (Wireless), Ltd. | |
| 2 4-pin Valve holders, short-wave baseboard type | Eddystone 951 | 1 Master Oscillator Coil | Scientific Supply Stores (Wireless), Ltd. | |
| 1 4-pin Valve holder, baseboard type | W.B. "Rigid" | 1 Aerial Coil | Scientific Supply Stores (Wireless), Ltd. | |
| 1 7-pin Valve holder, baseboard type | W.B. (Benjamin, Bulgin, Eddystone, Goltone, Wearite) | 1 Ebonite tube, 3in. outside dia. x 3in. bore x 18in. long | Quantity sheet brass, 0.018in. thick for fixed condensers; 4BA screwed rod and nuts | |
| 2 Resistances, 100,000 ohms, 1 watt | Amplion (Dubilier, Eric, Ferranti, Claude Lyons, Polar-N.S.F.) | 1 9-volt GB battery | | Eolux |
| 2 Fixed condensers, 0.005 mfd. | T.C.C. Type "S" | 2 Wander plugs | | Eolux |
| 1 Fixed condenser, 0.005 mfd. | T.C.C. Type "M" | Quantity sheet aluminium, No. 20 SWG for screens, etc. | | |
| 1 Fixed condenser, 0.001 mfd. | T.C.C. Type "M" | 1 Baseboard, 3in. thick, 16in. x 11 1/2in. | | Eolux |
| 1 Fixed condenser, 2 mfd. | T.C.C. 50 (Bulgin, Dubilier, Ferranti, Graham Farish, Polar-N.S.F., T.M.C.Hydra) | 6 Small brass terminals | | Eolux |
| 1 Neutralising condenser | J.B.1050 | 2 Ebonite terminal battens | | |
| | | Valves: 1 each PX4, P415, LF2 and B21 (Marconi) | | Osram |

New Apparatus Reviewed

Recent Products of the Manufacturers

GRAHAM FARISH MAINS SUPPRESSOR

A SMALL unit for the suppression of mains-borne interference has been placed on the market by Graham Farish, Ltd., Masons Hill, Bromley, Kent. It



Graham Farish "Mum," a compact interference suppression unit.

consists of two small condensers—their measured capacities are 0.19 mfd. each—joined in series and the junction taken to an earthing terminal. Two short rubber-covered leads, one from each condenser, are brought out for connecting across the mains input to the receiver or to any piece of electrical apparatus it is desired to silence. Separate fuses are not included, but the unit is wired internally with fuse wire to serve as a safeguard in the unlikely event of a breakdown. This plan has been adopted in order to reduce the cost to the bare minimum, for should a condenser fail in a unit of this kind it would need replacing whether or not it is fitted with replaceable fuses.

The "Mum," as the unit is described, is very compact, for the overall size is but 3¼ in. by 1½ in. by 1¼ in., and the price is 2s.

BRYCE CONNECTORS

THE range of bakelite connector blocks made by W. Andrew Bryce and Co., Woodfield Works, Bury, Lancashire, has now been extended to include two-, four- and five-way patterns, the last mentioned having been reintroduced owing to requests made by *Wireless World* readers.

The two-way and one of the four-way are of a heavier pattern than the original connector, the bore of the brass insert being a shade over ½ in. diameter and will accommo-

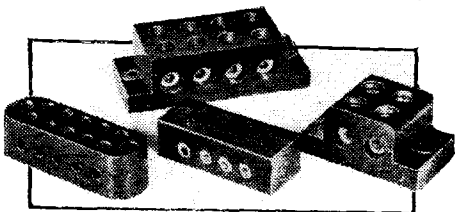

New Bryce Connector Blocks including two- and four-way heavy pattern.

date six wires of No. 18 SWG, whereas the smaller size will take but four only.

The new range should suffice to meet most present-day requirements and the larger size in particular will be found very useful. They cost 1s. 6d. for a two-way and 2s. 3d. for a four-way in the heavy pattern, whilst a four-way small size costs 1s. 9d. and the five-way 2s. 3d.

NEW BULGIN COMPONENTS

AMONG the new items introduced recently by A. F. Bulgin and Co., Ltd., Abbey Road, Barking, Essex, is a nine-pin cable plug, the body of which is a bakelite moulding having the pins riveted to the base and the top cap fixed by three screws. Hollow pins are employed and the wires are secured by soldering them to the tips in the manner adopted in valve construction.

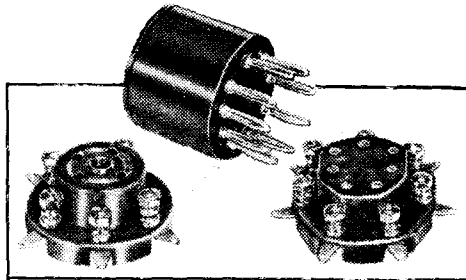

Bulgin nine-pin cable plug and new base-board valve holders.

It is a neat plug and should prove very useful for the inter-connection of units with a multiplicity of leads, such as in test apparatus, amplifiers and the like. The price is 2s. 3d.

Some new pattern valve holders for base-board fitting are now available in which flat springs, with a narrow longitudinal slot cut in them, are used in place of sockets. This type of contact is adopted to ensure a good connecting surface with valve pins of the resilient as well as the solid variety.

The specimens we have examined make good contact at all points and as the springs are made of stout material the likelihood of defective contact developing is very remote. Mottled green bakelite is used for the bases and both soldering tags and terminals are fitted. Five- and seven-pin types are made and the prices are 6d. and 1s. 6d. each respectively. The five-pin style would be used where four-pin valves are employed.

EDDYSTONE ALL-WAVE HF CHOKE

A SPECIMEN all-wave HF choke with the screen cut away to show the construction has been sent in by Stratton and Co., Ltd., Eddystone Works, Bromsgrove

Eddystone screened all-wave HF choke showing the sectionised winding.

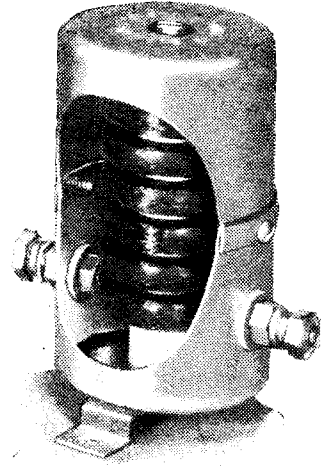

Street, Birmingham, 5. It consists of six small honeycomb coils assembled on a hollow Steatite former disposed centrally in a copper screening box 1½ in. in diameter and 2¼ in. high. Its effective range is claimed to be from 13 to 2,000 metres, and such tests that we have made show that no serious resonances are present over the whole of this waverange.

A slight absorption point was noticed between the medium- and the long-wave broadcast bands, but it is quite a minor resonance and in view of its position is of no consequence. The fundamental resonance is well above the upper limit of the long-wave band. The price is 5s.

There is made also by this firm a short-wave choke of similar construction for use on 10-200 metres; this model has a four-section winding and costs 3s. 9d.

AMPLION TYPE TB CONDENSER

THE type TB fixed condenser made by Amplion (1932), Ltd., 82-84, Rosoman Street, Rosebery Avenue, London, E.C.1, is constructed to be non-inductive and so suitable for use in decoupling and HF bypass circuits. A brown moulded bakelite case is employed with the terminals placed at the base and the working voltage is 350 DC. Capacities of from 0.1 mfd. to 4 mfd. are available, and prices range from 1s. 10d. for the smallest size to 5s. 6d. for one of 4 mfd.

Several specimens have been tested, and all withstood a potential slightly in excess of the stated test voltage of 700 DC. There

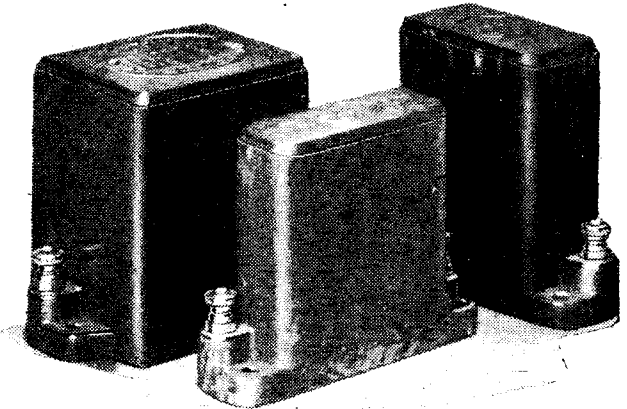

Amplion 350-volt working non-inductive condensers; the one-, two- and four-mfd. sizes are shown.

was no measurable leakage and the capacities were well within the usual limits allowed for this class of non-inductive condenser.

★ ★ ★ Listeners' Guide

Outstanding Broadcasts



HARKING BACK.

THE good old days are having a hearty boost at the hands of the B.B.C. Last week it was "Scrapbook of 1921"; this week we tread still farther down the corridors of musty time to "Theatre Royal, Memory Lane," to re-suscitate entertainments dear to our great grandparents.

The Handel revival is in full swing, "Retrospect" has not yet been abandoned, and looking backwards is so much the vogue that listeners will soon complain of crick in the neck.

The next few months will, I hope, register an opposite tendency. "Scrapbook for 1945" could be really stimulating, and instead of "Retrospect," "Forecast" for the next seven days would be, to say the least, exciting.

MEMORY LANE.

THE foregoing must not damp enthusiasm for Mr. Willson Disher's "Victorian Double Bill," which will be broadcast Nationally on Tuesday next, February 26th (8 p.m.). Listeners are to imagine that they are attending Theatre Royal, Memory Lane, to witness that very laughable farce, "The Lottery Ticket," followed by a grand pirated version of Dion Boucicault's moving spectacle in three acts, "The Relief of Lucknow, or Jessie Brown, the Highland Girl."

The cast includes Richard Golden, Ann Trevor, John Lambert, D. Hay Petrie, and

V. C. Clinton-Baddeley, so Lucknow will be relieved without difficulty.

NATIONAL MUSIC

KALUNDBORG will broadcast a concert of Scandinavian folk music at 7 p.m. on Wednesday next, February 27th, and this will be followed at 8.15 by a programme of Danish works sung by the Radio Chamber Choir.

Music inspired by Italy—whether by impressions received there, as in the case of Charpentier, or an overwhelming desire to go there, will be played in the concert by the French National Orchestra conducted by Inghelbrecht on Tuesday, February 26th, at 8.30. Paris PTT and all French stations, except Radio Paris, will relay the concert.

PARTIES IN THE STUDIO.

Two well-known stage favourites, Sandy Powell and Jack Barty, will bring parties

30-LINE TELEVISION

Band Process Transmissions
Vision, 261.1 m.; Sound, 296.2 m.

SATURDAY, FEB. 23rd, 4.30-5.15

Pat Waddington and Florence Oldham (songs); Bavera Trio (roller skating); The Espinosas in rhythm and speed; Sydney Jerome's Quintet.

WEDNESDAY, FEB. 27th, 11-11.45

Sandy Powell with Roy Jefferies and Peggy Whitty; Violet Victoria (comediienne); Annette Keith (dance band vocalist); Donald Peers (songs); Marie Colores (dances); Sydney Jerome's Quintet.

JACK BARTY'S PARTY is a highlight in the Regional programme at 9 p.m. on Thursday next, when the comedian's guests will include Eddie Pola and Dorrie Dene. Here are Jack Barty and Tessa Deane in a radio shop scene from "In Town To-night," a forthcoming British Lion picture.

SOPHISTICATED REVUE.

ALL unsophisticated listeners must be in bed by 10.15 on Tuesday, at which time the "February Revue" starts on the National wavelength. In this very sophisticated production Nelson Keys will sophisticate with the help of Sylvia Leslie, Hermione Gingold, Patrick Waddington, Joan Carr, Jack Clewes, and Helen Howard. Most of the music is by Jack Strachey and is also highly sophisticated.

OPERA

SOTTENS broadcasts Bizet's "L'Arlésienne" this evening (Friday) at 7.40. To-morrow

to the B.B.C. studio during the coming week.

Pages from Sandy's album will be presented by Sandy Powell's Road Show to National listeners on Monday, February 25th (8 p.m.). The cast includes Roy Jefferies, who aids and abets Sandy in most of his sketches; Paul Thomson, author of most of Sandy's records and stage successes; Maggie Scott, the Lancashire mill girl whom listeners recently heard in "In Town To-night," and Florence Oldham. They will be supported by the Harmonica Band.

Jack Barty, who introduces a number of friends to Regional listeners at 9 on Thursday, February 28th, first appeared on the music-hall stage in 1907. After the War he was at the London Coliseum for two-and-a-quarter years, taking part twice a day in "White Horse Inn" and "Casanova." He appeared in 1,900 performances without a break. His studio friends next Thursday include Eddie Pola, Dorrie Dene, and Mark Stone and Peter McSweeney.

ART IN THE MELTING-POT.

SPARKS may fly at 7.30 on Monday evening, February 25th, when Mr. Eric Newton and Sir Reginald Blomfield, R.A., discuss "The Artist and his Public" (National, 7.30). Eric Newton upholds modern art, but Sir Reginald Blomfield, if I am not mistaken, is a strong supporter of traditional styles. Seconds out of the ring!



SANDY POWELL filling the pages of his album. Excerpts will be broadcast Nationally on Monday next at 8. Sandy also appears in the television programme on Wednesday at 11 p.m.

Rome relays Puccini's "Turandot" from the Theatre Royal at 8 o'clock.

The death of Messenger on February 24th, 1929, is commemorated by Strasbourg at 8.45 on Monday next, by a performance of "Madame Chrysanthème." Wagner's Rheingold will be relayed by Bordeaux Lafayette on Wednesday next at 8.30.

or the Week

at Home and Abroad

HANDELIAN CELEBRATIONS.

TO-MORROW (Saturday) is the 250th anniversary of the birth of George Frederick Handel, and very appropriately "Terpsichore," a ballet for singing and dancing as performed at the New Theatre, Covent Garden, in 1734, will be broadcast Nationally at 10 p.m. Noel Eadie (soprano) and Heddle Nash (tenor) will be the soloists, supported by the Wireless Singers and the Vocal Octet. The characters represented are Apollo with the Muses, Erato as presiding goddess of music, and Terpsichore as presiding goddess of dancers, with attendant Graces.

All next week the "Foundations of Music" series at 7.5 p.m. (National) will be devoted to Handelian anthems sung by the Wireless Singers and Vocal Octet.

HANDEL ABROAD

HANDEL programmes figure in the majority of Continental programmes to-morrow evening. At 6.20 Beromünster broadcasts a Handel concert by the Basle Orchestral Society. Bucharest at 7.5 gives an orchestral concert which includes Handel's Concerto Grosso in G Minor and the "Harmonious Blacksmith." During the same period Kalundborg's Radio Orchestra, conducted by Mahler, will also honour the great

DR. ADRIAN BOULT and some little friends. The B.B.C.'s Director of Music conducts the B.B.C. Symphony Orchestra in a special concert broadcast from Birmingham Town Hall on Wednesday next, February 27th, at 7.30.

composer. On Sunday at 5 p.m. Strasbourg will relay the "Messiah" from the Palais des Fêtes.

Rather belatedly Barcelona will give its Handel concert at 10.15 on Tuesday, February 26th.

HUMOUR

"LET US SING, DANCE AND LAUGH" is the title of a two-hour programme of humour and music to be broadcast at 7 p.m. on Sunday next by Leipzig. This programme, which is sponsored by the Nazi Workers' Spare Time Organisation, will be continued at 9.35 p.m. and will last till midnight.

CHOPIN ANNIVERSARY

THE Handel celebrations rather overshadow the 125th anniversary of the birth of Chopin, which, according to Groves' Musical Dictionary, actually took place on March 1st, 1809. Berlin (Funkstunde) gives a Chopin programme this evening at 5.30,

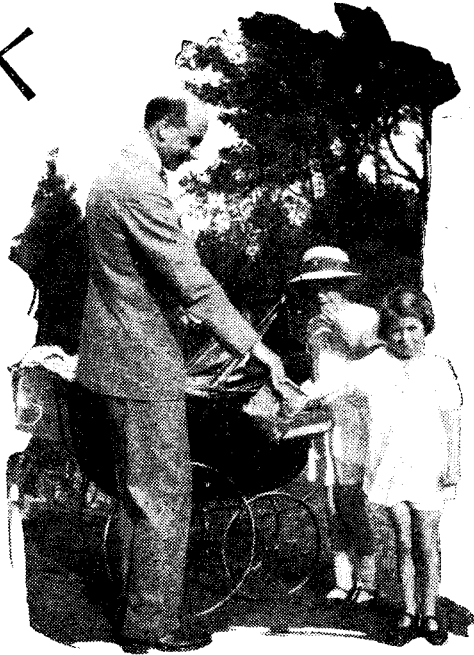

when Ursula van Diemen will sing some of Chopin's rarely heard songs. The programme concludes with the Pianoforte Concerto in E Minor, Frank Lukasicwic being the soloist.

At 8 o'clock this evening Dresden relays a Chopin memorial programme from the town hall, followed at 8.45 by a description of the unveiling of the Chopin memorial in Dresden.

At 9.30 Madrid EAJ7 offers a Chopin pianoforte recital by Jose Cubiles. Also this evening there comes a Chopin concert from Warsaw, the composer's old home, at 7.15. The Philharmonic Orchestra will be conducted by Fitelberg. Stuttgart at 6 p.m. gives a musical interpretation of Chopin's life and work.

The B.B.C. appears to have overlooked the anniversary.

TUNE IN

"WOMEN DO MAKE OUR LIFE PLEASANT" is Vienna's title for a musical radio medley to be broadcast at 7 o'clock on Sunday evening next.

MUSIC, MODERN AND OTHER

SIR HENRY WOOD always has a thought for the underdog. Although in the Sunday Orchestral Concert on February 24th (Regional, 9.20) the B.B.C. Orchestra will play music by Stravinsky and Prokofiev, the concert will conclude with the Theme and Variations (Suite No. 3 in G) by Tchaikowsky. So those who cannot soar to Prokofievian heights will still be satisfied.

THE AUDITOR.

HIGHLIGHTS OF THE WEEK

FRIDAY, FEBRUARY 22nd.

Nat., 7.30, "Chateau de Madrid." 8.15, "The Mystery of the Temple." 10.20, London Philharmonic Orchestra. Reg., 8.15, B.B.C. Orchestra, conducted by Julius Clifford. 9.15, Fred Hartley and His Novelty Quintet.

Abroad.

Milan, 8, Symphony Concert. Soloist: Giulio Bignami (violin).

SATURDAY, FEBRUARY 23rd.

Nat., 7.30, Music for the Theatre. 8.30, "Music Hall." 10, "Terpsichore." Reg., 7.55, Act I "Fra Diavolo" (Auber) from Sadler's Wells. 8.50, Pianoforte Recital by Katharine Goodson. 9.10, Conversations in the Train.

Abroad.

Hilversum, 9, Recital by Elisabeth Schumann (soprano).

SUNDAY, FEBRUARY 24th.

Nat., 1.30, Pianoforte Recital by Cyril Smith. 3.30, Leslie Bridgewater Quintet. 7.15, Recital by Leonard Gowings (tenor) and Emil Telmanzi (violin). 10.15, Organ Recital by C. H. Trevor.

Reg., 4.30, B.B.C. Orchestra (Section E). 5.30, Wireless Military Band. 6.45, Palladium Orchestra. 9.30, Sunday Orchestral Concert.

Abroad.

Strasbourg, 5, Oratorio: "The Messiah" (Handel).

MONDAY, FEBRUARY 25th.

Nat., 8, Sandy Powell's Revue. 10.5, Wm. Byrd's Mass for five Voices.

Reg., 8, B.B.C. Orchestra (Section E). 9, Callender's 2nd Band.

Abroad.

Berlin, 7.10, Medley of music and commentary on Berlin life.

TUESDAY, FEBRUARY 26th.

Nat., 8, "Theatre Royal, Memory Lane." 10.15, The February Revue.

Reg., 8, London Symphony Orchestra. 9.15, Wireless Military Band.

Abroad.

Radio Paris, 8, Opera "Gargantua" (Mariotte).

WEDNESDAY, FEBRUARY 27th.

Nat., 6.30, Books in General: G. K. Chesterton. 7.30, B.B.C. Symphony Orchestra's Birmingham concert. 10.20, Cershom Parkington Quintet.

Reg., 8, Students' Songs by the Wireless Male Voice Chorus. 8, "Theatre Royal." 9.40, B.B.C. Theatre Orchestra. 10.30, Roy Fox and His Band.

Abroad.

Kalundborg, 9.5, Acts III and IV of "Carmen" (Bizet).

THURSDAY, FEBRUARY 28th.

Nat., 8, Soft Lights and Sweet Music, presented by Austen Croom-Johnson. 8.35, B.B.C. Theatre Orchestra. 10.15, Recital by Thelma Reiss (cello) and Harriet Cohen (piano).

Reg., 8.15, Fred Hartley and his Novelty Quintet. 9, Jack Barty's Party.

Abroad.

All German stations, 10, Contemporary Music.



FROM THE BERLIN SCALA. The wandering microphone interviews three dancers in the latest Scala show. The girls were trained by M. Nellé, of the Prince of Wales Theatre, London.

Letters to the Editor

The Editor does not hold himself responsible for the opinions of his correspondents

Noise Suppressors

WE wish to congratulate Mr. Scroggie on his very sound and outspoken article on noise suppressors, and particularly on his candid comments referring to certain devices which have been sold for connecting in the aerial lead to a receiver.

He, of course, refers to devices selling at prices from 6d. up to 12s. 6d. which are connected in the aerial lead adjacent to the set, and which merely reduce programme and noise simultaneously. The wording of his article, however, might lead some readers to think that he included all screened down-leads and impedance-matched transmission lines in his criticism, whereas, of course, the best of these devices, when properly fitted with the aerial outside the field of interference, can be very useful. In severe cases of interference we find it is usually a question of cost to decide whether to use the more expensive types of mains filters or erect a high or remote screened aerial system. Sometimes both are needed.

We were also very glad to read Mr. Scroggie's authoritative and impartial explanation as to just what interference can or cannot be suppressed by devices within the set. Incidentally, interference of all types will always sound a great deal worse if any HF gets through to the output valve due to inadequate HF filtration in the set.

E. M. LEE,

Enfield.

Belling & Lee, Ltd.

I MUST apologise for having made, in my recent article on Noise Suppression, derogatory remarks regarding "devices to be connected between the aerial and the receiver" without having more clearly specified them.

It appears that these remarks have been taken to apply to screened aerial systems. This is very far from my intention. The effectiveness of such systems is well known to me, and I had hoped that this would have been clear from the following extracts from the same article:—

"... the only way to suppress noise without losing something else is to silence each noise-producing source, or to remove the aerial from the zone of interference."

"Condensers, chokes, etc. . . . form one well-known class of noise-suppressor. With them may be included such things as screened aerial down-leads for moving the aerial away from the source of interference."

In referring to devices to be connected between the aerial and the receiver I excluded all forms of the aerial itself. The claims made for sundry types of series condensers, "filters," etc., however, seem to me to be extravagant, and I still adhere to this opinion.

M. G. SCROGGIE.

Bromley, Kent.

Sound Output

WITH reference to Mr. Crawshaw's letter in the Jan. 25th issue of *The Wireless World*, I cannot believe that a pure note of 50 c/s is inaudible until (computing from his figures) it reaches a minimum of 1.5 watts actual sound power. The effect of

this in an ordinary room I should imagine would be akin to that of an earthquake. Even if the note had a considerable harmonic content, the proportion left at 50 c/s would surely be enough to blow out the windows.

Mr. Leach's letter ignores the fact that the attainment of high-note reproduction is beyond the power if not the means of most people. May we not do our best at the other end of the scale meantime, as we are choked off at about 7,000 c/s in the other direction, except with a local station or with very elaborate apparatus?

DAN W. THOMSON.

Dunfermline, Fife.

The National "Ghost"

IT would be of interest to hear if readers in any other vicinity noted the following.

On the evening of Saturday, January 19th, from 7.30 p.m. onwards the B.B.C. National transmission could be heard in this vicinity as a background behind each of the Regional transmitters taking the London Regional programme.

This National "ghost" could be obtained at good loud speaker strength from the London Regional transmitter during programme intervals, but considerably weaker from the other Regional transmitters.

There was no sign of a Regional "ghost" on any of the National transmitters, but the "Luxembourg Effect" of Radio Paris "ghosting" Luxembourg was noted, no "Droitwich Effect" being noticed on this occasion.

The reappearance of the National programme superimposed as a background of the Regional coincides with an eclipse of the moon, but so far no significance can be attached to this fact, but perhaps the B.B.C. engineers could throw some light on

the matter or suggest a possible explanation in line interaction.

It would be interesting to hear of readers who have data available of other "ghost" transmissions being observed.

W. E. M. CROOK.

Antrim, N. Ireland.

Good and Bad Mikes?

I HAVE recently devoted considerable time listening to programmes radiated by the Midland Regional transmitter, and have noticed that when the programme is relayed from London the quality of the transmission is far superior to that which originates from the Midland studio. I wonder if any other reader with high-quality apparatus has noticed this? Are the "mikes" at Portland Place better than those supplied to provincial studios?

J. E. NAYLER.

West Bromwich.

The Single-Span A.C. Receiver

I WANT to say how entirely satisfied I am with the single-span A.C. receiver just completed. The range is ample, the variable selectivity control and the absence of wave-change switching both contribute materially to the pleasures of listening, but the thing that strikes me most is the superb quality, which is remarked on by everyone who hears the set.

All my previous sets I have been dissatisfied with in some particular, but this is the first set that I have not wanted to "improve" in any way at all!

Please accept my congratulations on having produced such a splendid set!

Clapham, S.W.4. W. DOUGHARTY.

Morganite-Stackpole Potentiometers

WE understand that these potentiometers which were, in our issue of February 1st, erroneously reviewed under the name Lyons-Stackpole, are manufactured by the Morgan Crucible Co., Ltd., Battersea Works, Church Road, London, S.W.11, and are supplied to the wholesale trade by Claude Lyons, Ltd., under the name Morganite-Stackpole.

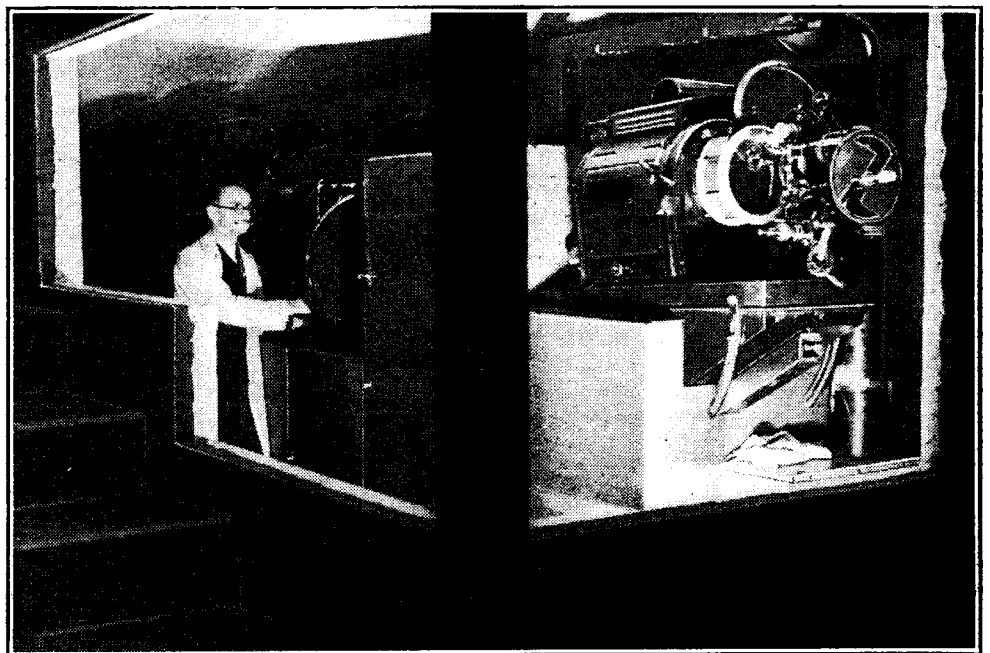

TELEVISION ON THE SCREEN. The projector room in the Fernseh Company's television theatre, Berlin. The received signals are transferred to film, which is developed, fixed and dried in less than a minute for projection to a size of 10ft. x 13ft. 180-line scanning is employed, with 25 frames per second. The principle of intermediate film scanning is also in use in this country.

BROADCAST BREVITIES

By Our Special Correspondent

The Might-Have-Been

GERALD COCK, the new B.B.C. television director, might have been a millionaire by now if he had not sold his San Francisco ranch in 1914 in order to join the Army.

The insignificant stretch of land is now "Sunset Avenue," Hollywood—one of the most important thoroughfares in the film city.

Television Cables

Television plans will not occupy Mr. Cock's attention until the summer "O.B.'s" are completed. These include some exceptional items owing to the Jubilee celebrations.

It is unlikely that high-definition television will make any exacting demands on the programme side for some months to come. The engineers are still seeking a London site for the first ultra-short-wave transmitter, and experiments are now proceeding on concentric cables to link up studio and transmitter. It is hoped to produce a cable having a flat characteristic over the entire band involved.

Army v. Navy Rugger

MR. COCK has arranged some excellent sporting outside broadcasts for the near future. On March 2nd, the epic Rugger struggle between the Army and Navy will find Captain Wakeham in his box, with his invariable shadow John Snagge, who will inevitably say "Square 4." It has become a new pastime on Saturday afternoons to listen exclusively to John Snagge.

Ice Hockey

On March 9th, the Ireland v. Wales match at Belfast will be broadcast, and on the same day Bob Bowman will describe England v. Canada Ice Hockey.

A Mild Complaint

THE unfortunate minority who still live outside the reliable service area of any of the B.B.C. stations are much to be pitied, but their plight is less unhappy than that of the luckless wights who live in the very shadow of the Droitwich aeri-als.

One such wrote last week to the B.B.C. in this strain:—"The old Daventry used to swamp this area, but Droitwich is worse. I should not think it clever if the Water Company supplied me through a fire hose."

Bombing the Control Room

THE B.B.C. may well ponder carefully over the news that the control room in the Berlin Broadcasting House is to be removed from its present position to a bomb-proof cellar well below the level of the street. It is recognised that the control room is the nerve centre, not only of the "Funkhaus," but also of German broadcasting as a whole, and that a single bomb might put the entire system out of action at a time when its assistance in subduing panic might be most welcome.

Glass Roof

Strangely enough, the control room at Portland Place occupies the most exposed position in the whole building. It is on the eighth floor and has a sloping glass roof.

That Council of Thirty

IT is being argued that the new General Advisory Council to the B.B.C., composed of thirty eminent persons, contains no



MR. GERALD COCK, the new B.B.C. Director of Television.

name representative of the lighter side of the B.B.C.'s activities.

On looking down the list I cannot agree. There are several first-rate comedians.

Line Synchronisation

BY the time these lines are read listeners will have had an opportunity of testing the quality of the three Nationals—London, North and West, which are now working in synchrony on 261.1 metres.

Synchronisation is carried out by line, not by tuning forks.

THE "D.G." HIMSELF. Lady Hilton Young applying finishing touches to a new bust of Sir John Reith.



"Radio People"

TO see broadcast stars in the flesh is the ambition of, perhaps, 80 per cent. of the B.B.C.'s listeners, all of whom should pay a visit to the new Radio Theatre, Old Compton Street, Soho, to see Clayton Hutton's "Radio People."

With a little more experience the management will put on an even slicker show than the original, because they will have learnt that sensitive microphones on the stage pick up the sounds of scene shifting which would go unheard in an ordinary theatre.

Aiding the Illusion

The artists are somewhat dominated by the presence of the microphones which feed public address speakers in the proscenium, but this, of course, adds to the illusion that we are witnessing a studio broadcast.

The "first night" programme introduced such favourites as Peggy Cochrane, Anne Ziegler, Stanelli and Claude Dampier, with the Three Loose Screws and the Sixteen Radio Beauties.

B.B.C. Orchestra in Brussels

ON March 12th the B.B.C. Symphony Orchestra makes its first appearance on a Continental platform at the Palais des Beaux Arts at Brussels. The importance of the occasion can be judged when it is realised that Brussels is a musical centre at which there appear annually the Berlin Philharmonic, l'Orchestre du Conservatoire de Paris, the Orchestra and Choir of the Concertgebouw of Amsterdam, the Orchestre Philharmonique de Paris, the Philharmonic Orchestra of New York, and the Orchestra of the Gewandhaus at Leipzig.

A Social Event

La Grande Salle de Concert of the Palais des Beaux Arts is a comparatively new building. Actually there are five different

concert halls, each designed for a special purpose. The acoustics of the Grand Salle de Concert are well-nigh perfect for orchestral playing.

The British Ambassador is collaborating to ensure that the Orchestra shall be heard by leaders of society, music critics and other eminent people in Brussels; and in order that the B.B.C. officials and principals of the Orchestra shall meet the leaders of the musical world at Belgium, His Excellency has arranged a reception at the British Embassy after the concert. The programme will be relayed to England, and has been offered to all the broadcasting stations of Europe.

Honourable Pen Pushers

"SELLING the World," a musical burlesque by L. du Garde Peach, will be broadcast in the National programme on March 5th, and to Regional listeners on March 7th. The music is by George Barker. The burlesque is based on life in a Fleet Street newspaper office where all employees must be members of the nobility; even the office boy is an "honourable" on his mother's side.

The son of Lord Blimp is in love with the daughter of the proprietor of the paper, and in order to prove his mettle he joins the staff under an assumed name. Then the fun begins.

Celestial Notes

THE B.B.C. Publicity Department blanched and took a deep breath when I showed it an advance Press notice just issued by the Egyptian State Broadcasting Organisation

"The talented vocalist," runs the paragraph, "will enchant his listeners with his celestial notes to the accompaniment of divers instruments played by accomplished artists of the eminent singer's selection."

Beside this the B.B.C.'s own "puffs" become almost libelous.

Foundations of Wireless

Part XII.—The Simple Triode Valve

By A. L. M. SOWERBY, M.Sc.,

A LUCID explanation of the functioning of the basic type of valve; without some working knowledge of this subject it is impossible to understand the operation of any modern wireless apparatus.

IT would be possible to go more deeply into quite a number of important matters, such as the design of tuning circuits, the behaviour of detectors, and the effects in connection with these of modulation-depth and modulation-frequency, using the simple crystal set described in Part XI as the basis for discussion. But the crystal set is so nearly obsolete that a treatment of these subjects along such lines would be sadly lacking in practical application. In consequence, we will postpone consideration of these various points until after we have some acquaintance with valves; by so doing we shall eventually deal with them as real problems, instead of allowing the discussion to be one of academic interest only.

The crystal set is obsolete because of its inability to amplify. The description of its operation given in Part XI shows that it is entirely dependent upon the energy collected by the receiving aerial; the set does no more than convert this into a form suitable for operating telephones. The energy that vibrates the telephone diaphragms is actually that radiated through space from the aerial of the transmitter. This limitation implies that loud signals can only be obtained when the receiver is quite close to the transmitter; at any distance greater than a few miles the energy collected by the aerial is too small to cause more than quite small movements of the diaphragm, so that the sound produced is only faint.

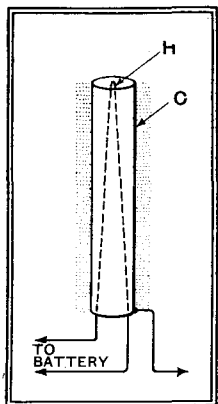

Fig. 63.—Diagrammatic sketch showing the cathode C and heater H of an indirectly heated valve for mains operation.

In a receiver employing valves conditions are quite different. The telephones or loud speaker derive the energy necessary for their operation from a battery or other source of electrical energy connected to the set; the signal itself is asked to do no more than control this locally supplied energy. In consequence, there is no necessary connection between the amount of energy collected by the aerial and the energy finally released in the form of sound-

waves, and it becomes possible to obtain loud reproduction even from distant transmitters. The ability to use a small amount of energy to control and release a much larger amount is due entirely to the valve; let us enquire a little into its behaviour.

In discussing the nature of an electric charge we saw that, if negative, it was due to an excess, or if positive to a deficiency of electrons. We further saw that an electric current, such as might be obtained by connecting together two charged objects, consisted of a flow of these same electrons. In neither case, however, did the electron appear as an independent entity, for it was always associated with matter.

In the thermionic valve we meet for the first time with electrons enjoying an entirely independent existence. Their source is the cathode of the valve, which is an electrically heated surface so prepared that when raised to a suitable temperature it emits into the vacuous space surrounding it a continual supply of electrons. These are too small and too light to feel appreciably the effects of gravity, and therefore do not tend to move in any particular direction unless urged by an electric field. In the absence of such

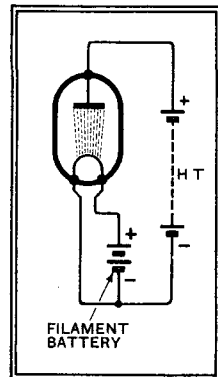

Fig. 64.—A directly heated (battery) diode valve.

a field they hover round the cathode, enclosing it in an electronic cloud known as the space charge.

Cathodes are of two types—*directly heated* and *indirectly heated*. The first, more usually known as a *filament*, consists of a fine wire heated by the passage through it of a current, the electron-emitting surface consisting of a film coated directly upon the filament wire itself. This type of valve is primarily used in battery-driven sets, though an occasional one finds its way into a mains-operated set in special cases. The indirectly heated cathode is a tube, usually of nickel, coated with the emitting material and heated by an independent filament, called the *heater*, enclosed within it (see Fig. 63). Since the cathode is insulated from the heater, three

(Continued from page 155 of February 8th issue)

connections are necessary in this latter case as against the two that suffice when the filament serves also as the source of electrons.

In all essentials the two types of cathode work in exactly the same way; in dealing with valves we therefore propose to take the liberty of omitting the heater of filament circuit altogether after the first few diagrams, indicating the cathode by a single connection. The operation of a valve depends upon the emission from the cathode; the means by which the cathode is heated to obtain this emission has no significance except in connection with the design of a complete receiver.

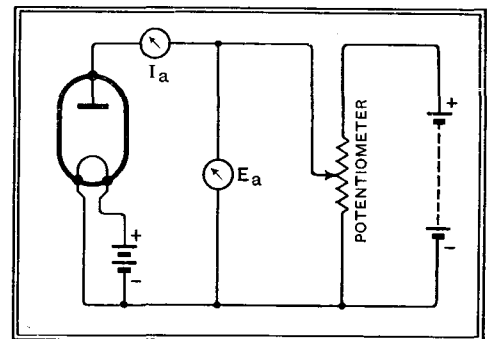

Fig. 65.—Circuit for finding relation between anode voltage E_a and anode current I_a of a diode.

The simplest type of valve contains one electrode in addition to the cathode, and is called a *diode*. This second electrode, the *anode*, will attract electrons to itself from the space-charge if it is made more positive than the cathode, so that a current can flow, through the valve, round a circuit such as that of Fig. 64. But if the battery is reversed, so that the anode is more negative than the cathode, the electrons are repelled towards their source, and no current flows. The valve will therefore permit current to flow through it *in one direction only*, and it is from this property that its name is derived.

Diode Anode Current

If the anode of a diode is slowly made more and more positive with respect to the cathode, as, for example, by moving upwards the slider of the potentiometer in Fig. 65, the attraction of the anode for the electrons is slowly augmented and the current increases. To each value of anode voltage E_a there corresponds some value of anode current I_a , and if the experiment is made and each pair of readings is recorded in the form of a dot on squared paper a curve like that of Fig. 66 is outlined.

The shape of the curve shows that the anode collects few electrons at low voltages, being unable to overcome the repel-

Foundations of Wireless—

ling effect of the space-charge. At the point A this is largely overcome and the increase in electron-flow with rising voltage becomes rapid and even. By the time the point C is reached the voltage is so high that electrons are reaching the anode practically as fast as the cathode can emit them; a further rise in voltage only collects a few more strays, the current remaining almost constant from C to D.

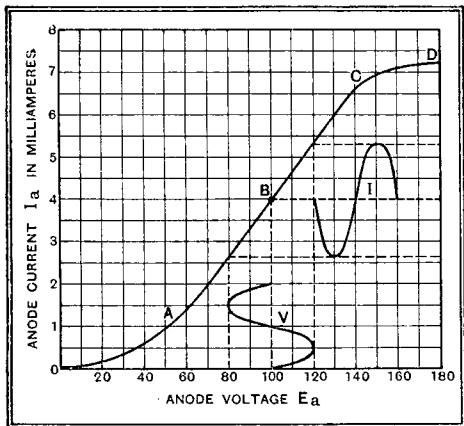

Fig. 66.—Characteristic curve of a diode valve. The sine wave curves indicate the effect of superposing an alternating potential of 20 volts peak on the steady potential of 100 V. to which point B corresponds.

At B an anode voltage of 100 volts drives through the valve a current of 4 milliamperes; it could therefore be replaced by a resistance of $100/0.004 = 25,000$ ohms without altering the current flowing at this voltage. This value is therefore the equivalent DC resistance of the valve at this point. Examination of the curve will show that the equivalent DC resistance of the valve depends upon the voltage applied; to drive 1 mA., for example, needs 53 volts, which leads to $R = 53/0.001 = 53,000$ ohms.

One may, however, deduce the resistance of the valve in another way. Over the straight-line portion of the curve, round about B, an increase of 30 anode volts brings about an increment in anode current of 2 mA. The resistance over this region of the curve would therefore appear to be $30/0.002 = 15,000$ ohms. This resistance is effective towards current variations within the range AC; if, for example, a steady anode voltage of 100 volts were applied (point B) and then an alternating voltage of peak value 20 V. were superposed on this, the resulting alternating current through the valve, as the curves on Fig. 66 show, would be 1.33 mA. peak. Based on this, the resistance, as before, comes out to $20/1.33 = 15,000$ ohms.¹ Thus the resistance derived from the slope of the curve at any point is that offered to an alternating voltage superposed on the steady anode voltage at that point; it is therefore called the AC resistance of the valve. Its importance in wireless technique is so great that it has had the special

¹ By now the reader should have noticed that volts, milliamperes, and thousands of ohms form a self-consistent system to which Ohm's Law applies. This is a short cut to many wireless calculations.

symbol R_a allotted to it by common consent of wireless engineers. It is also, but not so correctly, called the "impedance" of the valve. The two terms will be used more or less indifferently in this series, since both are in frequent use.

The equivalent DC resistance of a valve is a quantity seldom used or mentioned, so that the reader may forget it as soon as he pleases. It was mentioned here only to bring into prominence the strictly AC meaning of the valve's impedance.

The diode valve has a very restricted field of use in that it can be used for rectification only; it will not provide amplification. If a mesh of fine wire is inserted in the valve between cathode and anode in such a way that before they can get to the anode all the electrons emitted from the cathode have to pass through the meshes of this extra electrode a much fuller control of the electron-current becomes possible.

It is fairly evident that if this new electrode, the *grid*, is made positive it will tend to speed up the electrons on their way through its meshes to the anode; if, on the other hand, it is made negative it will tend to repel them back towards the cathode. In Fig. 68 are shown four curves of a three-electrode valve, or *triode*, for comparison with the exactly analogous curve of the diode (Fig. 66). Each of these curves was taken with a fixed voltage on the grid, the value for this being indicated for each case against the appropriate curve. It is to be noticed that this voltage, like all others connected with a valve, is reckoned from the cathode as zero. If, therefore, the cathode of a valve is made two volts positive with respect to earth, while the grid is connected back to earth, it is correct to describe the grid as "two volts negative," the words "with respect to the cathode" being understood. In a directly heated valve voltages are reckoned from the negative end of the filament.

Valve Amplification

Except for a successive displacement to the right as the grid is made more negative, these curves are practically identical.

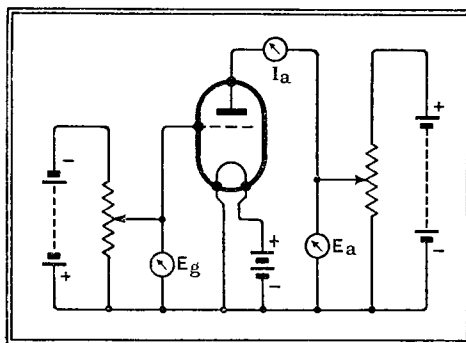

Fig. 67.—Circuit for taking characteristic curves, as in Fig. 68 or 69, of triode valves.

This means that while a negative grid voltage reduces the anode current in the way described, this reduction can be counter-balanced by a suitable increase in anode voltage. In the case of the valve

of which curves are shown, an anode current of 10 mA. can be produced by an anode voltage of 120 if the grid is held at zero potential ($E_g = 0$). This is indicated by the point A. If the grid is now made 6 volts negative the current drops to 4 mA. (point B), but can be brought up again to its original value by increasing the anode voltage to 180 V (point C).

A change of 6 volts at the grid can thus be compensated for by a change of 60 volts, or ten times as much, at the anode. For reasons that will presently appear, this ratio of 10 to 1 is called the *amplification factor* of the valve, and will be denoted in these articles by the Greek letter " μ " (mu). The letter *m* is also often used.

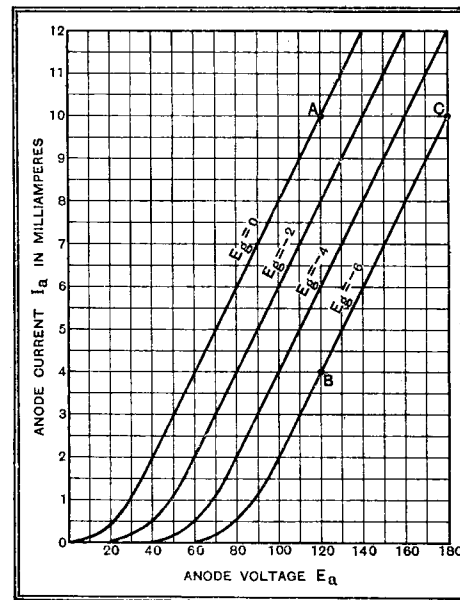

Fig. 68.—Characteristic curves of triode valve, each showing change of anode current with change of anode voltage.

As in the case of the diode, the AC resistance of the valve, by which is again meant the resistance it offers to the passage through it of a small alternating current when a small alternating voltage is superposed on some steady anode voltage, can be read off from the curves. All four curves of Fig. 68 will give the same value over their upper portions, since they all have the same inclination; over the lower parts, where the steepness varies from point to point, a whole range of values for the AC resistance exists. Over the straight-line portions of the curves this resistance is 10,000 ohms, as can be seen from the fact that the anode voltage must change by 10 to alter the anode current by 1 mA.

We have already seen that 1 volt on the grid is equivalent to 10 volts on the anode; a change of 1 volt at the grid will therefore also provoke a change in the anode current of 1 mA. This can also be read directly from the curves by observing that $E_a = 100$, the anode current for $E_g = 0$ and $E_g = -2$ are 8 and 6 mA. respectively, again a change of 1 mA. for each one-volt change on the grid.

The response of the anode current of a valve to changes in voltage at the grid is the main index of the control that the grid

Foundations of Wireless—

exercises over the electron-stream through the valve. It is expressed in terms of *milliamperes* (of plate-current change) *per volt* (of change at the grid), and is called the *mutual conductance* (symbol g). It is related to μ and R_o by the simple equation $g = \mu / R_o$, the derivation of which should be evident if the meanings of the symbols are considered. The magnitude of g is more clearly shown by valve-curves in which anode current is plotted, for a fixed anode voltage, against grid voltage. Some data from Fig. 68 are re-plotted in this form in Fig. 69, where the lines BC represent the anode-current change brought about by a change AB in grid voltage. The ratio BC/AB is very evidently the mutual conductance of the valve in milliamperes per volt. Since this ratio also defines the slope of the curve, it has become quite common to refer to g as the "slope" of the valve. Strictly speaking, this is a slang term, but, like

other words not of dictionary origin, it is both brief and expressive.

(To be continued.)

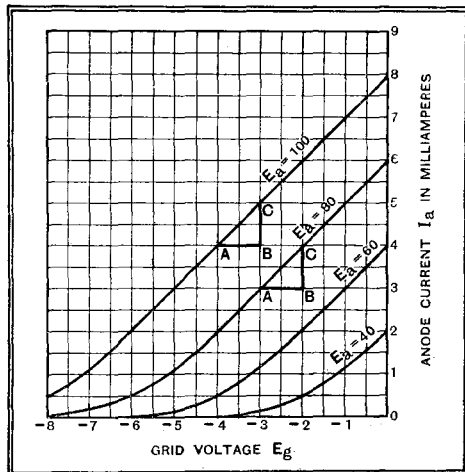

Fig. 69.—Changes of anode current corresponding to variations of grid voltage.

BOOK REVIEWS

Photo-electric Cell Applications. 2nd edition. by R. C. Walker, B.Sc. (Lond.), and T. M. C. Lance, Associate I.R.E. Pp. 245 + X, and 142 illustrations. (Sir Isaac Pitman and Sons, Ltd. Price 8s. 6d.)

This is essentially a practical book that will prove of real value to all engaged in work involving the use of photo-cells, and to students. In it the authors deal in a very authoritative manner with the application of the photo-electric cell to counting and timing devices, alarms and indicators, advertising, sound reproduction, telephotography and television, and also to scientific measurements and other miscellaneous uses.

Besides the chief characteristics of photo-cells, given in the first chapter, only sufficient photo-electric theory is given to enable the action of the cells, in the numerous uses and devices described, to be properly understood. The second chapter deals in a general way with the methods of using photo-cells, especially for operating various types of relays. It is a valuable feature that possible pitfalls are carefully pointed out.

Despite the remarkably wide field of applications covered, the various systems and devices in which a photo-cell plays the leading role are very lucidly explained, and in many instances the numerical values of circuit constants are given. The illustrations are excellent throughout. It was observed that, on pages 25 and 26, the text does not tally with the figure numbers, but the misprint is obvious.

The book is recommended with all confidence that the purchaser will obtain real value. O. P.

The Superheterodyne Receiver. By Alfred T. Witte, A.M.I.E.E. Pp. 125. (Sir Isaac Pitman and Sons, Ltd. Price 3s. 6d.)

The superheterodyne has developed so rapidly of recent years that, as the author remarks, adequate details of its practical application are to be found in few text-books. This is doubtless because it has been for so long regarded as a receiver chiefly of theoretical interest. In this book the author has endeavoured to remedy this omission and to present a clear account, not only of the underlying theory, but of present-day practice as exemplified in broadcast receivers.

The early chapters are devoted to the history of the superheterodyne, and it is shown that it was developed almost simultaneously by Levy in France, Schottky in Germany, and Armstrong in America, towards the end of the war. The cessation of hostilities made it less urgently needed, but development still proceeded, and much space is devoted to early attempts at obtaining a single-valve frequency-changer. This leads to a discussion of modern methods, and such recent systems as the heptode, octode, and triode-pentode are all included.

The book is, in fact, remarkably up-to-date, and the author has not confined himself to current British and American practice, but has included numerous references to German technique. A whole chapter is devoted to AVC systems, and another to a discussion of typical present-day commercially built receivers—complete circuit diagrams of the examples being given. *The Wireless World* Single-Span receiver is in-

cluded as a recent superheterodyne development, and an explanation of its peculiar properties is given.

The book is well printed and bound, and errors are unusually few. It is, however, hardly true to say that the frequency-changer employing a reaction coil in the screen circuit of an HF pentode (page 70) does not radiate, for this electrode has a very appreciable capacity to the control grid. W. T. C.

THE RADIO INDUSTRY

ACHESON colloidal graphite, suspended in suitable liquids, is already widely used for the lubrication of moving parts in receivers, etc., and in the making of resistors. In connection with television it has now been found highly suitable for forming an internal conductive coating on the bulbs of cathode ray tubes, and is so used in the new Ediswan hard tube. For this purpose graphite in water (known as Aquadag) is employed; practical information on the subject appears in Technical Bulletin No. 191.1, issued by E. G. Acheson, Ltd., Thames House, Millbank, London, S.W.1.

A new type of semi-unspillable Pertrix accumulator cell, type SU24, has just been introduced by Britannia Batteries, Ltd., Union Street, Redditch, Worcs. It is of the multi-plate type in a glass container; the capacity is 24 AH. at the 20-hours rate, and the price is 11s.

Marconi's Wireless Telegraph Co., Ltd., of Electra House, Victoria Embankment, London, W.C.2, have issued an interesting booklet dealing with wireless equipment for police services. Apparatus for fixed stations, motor cars, and motor cycle combinations is described and illustrated. The same company have sent us a leaflet giving a list of British aircraft equipped with Marconi apparatus.

We understand from the Mullard Wireless Service Company that the information given to us regarding VP2 and SV2 valves (published on page 102 of our issue of January 25th, 1935) was not quite correct. The position is that, as from February 1st, these screened pentode valves will be manufactured with thimble-top caps necessitating a special spring clip connector. Adapters for use when these valves replace earlier types can be obtained from dealers, but are not supplied with the valves.

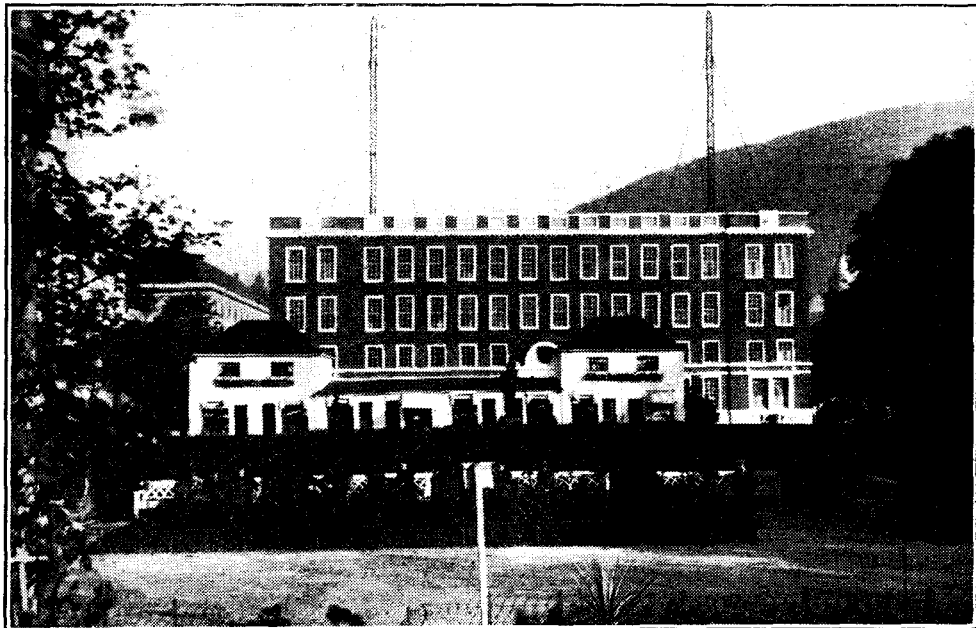

The station building of Radio-Bergen which operates on a wavelength of 352.9 metres.

PRINCIPAL BROADCASTING STATIONS OF EUROPE

Arranged in Order of Frequency and Wavelength

(Stations with an aerial power of 50 kW. and above in heavy type)

Station.	kc/s.	Tuning Positions.	Metres.	kW.	Station.	kc/s.	Tuning Positions.	Metres.	kW.
Kaunas (Lithuania)	155		1935	7	Poznan (Poland)	868		345.8	16
Brazov (Romania)	160		1875	20	London Regional (Brookmans Park)	877		342.1	50
Huizen (Holland). (Until 3.40 p.m.)	160		1875	7	Graz (Austria). (Relays Vienna)	886		338.6	7
Kootwijk (Holland) (Announced Huizen). (3.40 p.m. onwards)	160		1875	50	Helsinki (Finland)	895		335.2	10
Lahti (Finland)	166		1807	40	Hamburg (Germany)	904		331.9	100
Moscow, No. 1, RW1 (Komintern) (U.S.S.R.)	174		1724	500	Toulouse (Radio Toulouse) (France)	913		328.6	60
Paris (Radio Paris) (France)	182		1648	80	Limoges, P.T.T. (France)	913		325.6	0.5
Istanbul (Turkey)	187.5		1630	5	Brno (Czechoslovakia)	922		325.4	32
Berlin (Deutschlandsender Zeesen) (Germany) (S.w. Stns., 16.89, 19.74, 25.49, 31.38 and 49.83 m.)	191		1571	60	Brussels, No. 2 (Belgium). (Flemish Programme)	932		321.9	15
Droitwich	200		1500	150	Algiers, P.T.T. (Radio Alger) (Algeria)	941		318.8	12
Minsk, RW10 (U.S.S.R.)	208		1442	35	Göteborg (Sweden). (Relays Stockholm)	941		318.8	10
Reykjavik (Iceland)	208		1442	16	Breslau (Germany)	950		315.8	100
Paris (Eiffel Tower) (France)	215		1395	13	Paris (Poste Parisien) (France)	959		312.8	100
Motala (Sweden). (Relays Stockholm)	216		1389	30	Belfast	977		307.1	1
Novosibirsk, RW76 (U.S.S.R.)	217.5		1379	100	Cracow (Poland)	986		304.3	2
Warsaw, No. 1 (Raszyn) (Poland)	224		1339	120	Genoa (Italy). (Relays Milan)	986		304.3	10
Ankara (Turkey)	230		1304	7	Hilversum (Holland). (7 kW. till 6.40 p.m.)	995		301.5	20
Luxembourg	230		1304	150	Bratislava (Czechoslovakia)	1004		298.8	13.5
Kharkov, RW20 (U.S.S.R.)	232		1293	20	Miland Režiona! (Droitwich)	1013		296.2	50
Kalundborg (Denmark) (S.w. Stn., 49.5 m.)	238		1261	60	Barcelona, EAJ15 (Radio Asociación) (Spain)	1022		293.5	3
Leningrad, RW53 (Kolpino) (U.S.S.R.)	245		1224	100	Königsberg (Heilsberg Ermland) (Germany)	1031		291	60
Tashkent, RW11 (U.S.S.R.)	256.4		1170	25	Paredo (Radio Club Portugues) (Portugal)	1031		291	5
Oslo (Norway)	260		1154	60	Leningrad, No. 2, RW70 (U.S.S.R.)	1040		288.5	19
Moscow, No. 2, RW49 (Stichelkovo) (U.S.S.R.)	271		1107	100	Rennes, P.T.T. (France)	1040		288.5	40
Tiflis, RW7 (U.S.S.R.)	280		1071.4	35	Scottish National (Falkirk)	1050		285.7	50
Rostov-on-Don, RW12 (U.S.S.R.)	355		845	20	Bari (Italy)	1059		283.3	20
Sverdlovsk, RW5 (U.S.S.R.)	375		800	50	Tiraspol, RW57 (U.S.S.R.)	1068		280.9	4
Geneva (Switzerland). (Relays Sottens)	401		748	1.3	Bordeaux, P.T.T. (Lafayette) (France)	1077		278.6	12
Moscow, No. 3 (RCZ) (U.S.S.R.)	401		748	100	Zagreb (Yugoslavia)	1086		276.2	0.7
Voroneje, RW25 (U.S.S.R.)	413.5		726	10	Falun (Sweden)	1086		276.2	2
Oulu (Finland)	431		696	1.2	Madrid, EAJ7 (Union Radio) (Spain)	1095		274	7
Ufa, RW22 (U.S.S.R.)	436		688	10	Madona (Latvia)	1104		271.7	50
Humar (Norway) (Relays Oslo)	519		578	0.7	Naples (Italy). (Relays Rome)	1104		271.7	1.5
Innsbruck (Austria). (Relays Vienna)	519		578	0.5	Moravska-Ostrava (Czechoslovakia)	1113		269.5	11.2
Ljubljana (Yugoslavia)	527		569.3	5	Alexandria (Egypt)	1122		267.4	0.25
Viiipuri (Finland)	527		569.3	10	Newcastle	1122		257.4	1
Bolzano (Italy)	536		559.7	1	Nyiregyhaza (Hungary)	1122		267.4	6.2
Wilno (Poland)	536		559.7	16	Hörby (Sweden). (Relays Stockholm)	1131		265.3	10
Budapest, No. 1 (Hungary)	546		549.5	120	Turin, No. 1 (Italy). (Relays Milan)	1140		263.2	7
Beromünster (Switzerland)	556		539.6	100	London National (Brookmans Park)	1149		261.1	50
Athlone (Irish Free State)	565		531	60	North National (Slaitwaite)	1149		261.1	50
Palermo (Italy)	565		531	4	West National (Washford Cross)	1149		261.1	50
Stuttgart (Mühlacker) (Germany)	574		522.6	100	Kosice (Czechoslovakia). (Relays Prague)	1158		259.1	2.6
Grenoble, P.T.T. (France)	583		514.6	15	Monte Ceneri (Switzerland)	1167		257.1	15
Riga (Latvia)	583		514.6	15	Copenhagen (Denmark). (Relays Kalundborg)	1176		255.1	10
Vienna (Bisamberg) (Austria)	592		506.8	100	Kharkov, No. 2, RW4 (U.S.S.R.)	1185		253.2	10
Rabat (Radio Maroc) (Morocco)	601		499.2	5	Frankfurt (Germany)	1195		251	17
Sundsvall (Sweden). (Relays Stockholm)	601		499.2	13	Prague, No. 2 (Czechoslovakia)	1204		249.2	5
Florence (Italy). (Relays Milan)	610		491.8	20	Lille, P.T.T. (France)	1213		247.3	5
Cairo (Abu Zabal) (Egypt)	620		483.9	20	Trieste (Italy)	1222		245.5	10
Brussels, No. 1 (Belgium). (French Programme)	620		483.9	15	Gleititz (Germany). (Relays Breslau)	1231		243.7	5
Lisbon (Bacarena) (Portugal)	629		476.9	15	Cork (Irish Free State) (Relays Athlone)	1240		241.9	1
Trøndelag (Norway)	629		476.9	20	Juan-les-Pins (Radio Côte d'Azur) (France)	1249		241.2	2
Prague, No. 1 (Czechoslovakia)	638		470.2	120	Kuldiga (Latvia)	1253		238.5	10
Lyons, P.T.T. (La Doua) (France)	648		463	15	Rome, No. 3 (Italy)	1258		238.5	1
Cologne (Langenberg) (Germany)	658		455.9	100	San Sebastian (Spain)	1258		238.5	3
North Regional (Slaitwaite)	668		449.1	50	Nürnberg and Augsburg (Germany) (Relay Munich)	1267		236.8	2
Sottens (Radio Suisse Romande) (Switzerland)	677		443.1	25	Christiansand and Stavanger (Norway)	1276		235.1	0.5
Belgrade (Yugoslavia)	686		437.3	2.5	Dresden (Germany) (Relays Leipzig)	1285		233.5	1.5
Paris, P.T.T. (Ecole Supérieure) (France)	695		431.7	7	Aberdeen	1285		233.5	1
Stockholm (Sweden)	704		426.1	55	Austrian Relay Stations	1294		231.8	0.5
Rome, No. 1 (Italy) (S.w. Stn., 25.4 m.)	713		420.8	50	Danzig. (Relays Königsberg)	1303		230.2	0.5
Kiev, RW9 (U.S.S.R.)	722		415.5	36	Swedish Relay Stations	1312		228.7	1.25
Tallinn (Estonia)	731		410.4	20	Budapest, No. 2 (Hungary)	1321		227.1	0.8
Madrid, EAJ2 (Radio España) (Spain)	731		410.4	3	German Relay Stations	1330		225.6	1.5
Munich (Germany)	740		405.4	100	Montpellier, P.T.T. (France)	1339		224	5
Marseilles, P.T.T. (France)	749		400.5	5	Lodz (Poland)	1339		224	1.7
Katowice (Poland)	758		395.8	12	Dublin (Irish Free State) (Relays Athlone)	1348		222.6	1
Scottish Regional (Falkirk)	767		391.1	50	Milan, No. 2 (Italy) (Relays Rome)	1348		222.6	4
Toulouse, P.T.T. (France)	776		386.6	2	Turin, No. 2 (Italy). (Relays Rome)	1357		221.1	0.2
Leipzig (Germany)	785		382.2	120	Basle and Berne (Switzerland)	1375		218.2	0.5
Barcelona, EAJ1 (Spain)	785		382.2	5	Warsaw, No. 2 (Poland)	1384		216.8	2
Lwow (Poland)	795		377.4	16	Lyons (Radio Lyons) (France)	1393		215.4	5
West Regional (Washford Cross)	804		373.1	50	Tampere (Finland)	1420		211.3	0.7
Milan (Italy)	814		368.6	50	Paris, (Radio LI.) (France)	1424		210.7	0.8
Bucharest (Romania)	823		364.5	12	Béziers (France)	1429		209.9	1.5
Moscow, No. 4, RW39 (Stalina) (U.S.S.R.)	832		360.6	100	Miskolc (Hungary)	1438		208.6	1.25
Berlin (Funkstunde Tege) (Germany)	841		356.7	100	Fécamp (Radio Normandie) (France)	1456		206	10
Bergen (Norway)	850		352.9	1	Pecs (Hungary)	1465		204.8	1.25
Sofia (Bulgaria)	850		352.9	1	Bournemouth	1474		203.5	1
Valencia (Spain)	850		352.9	1.5	Plymouth	1474		203.5	0.3
Simferopol, RW52 (U.S.S.R.)	859		349.2	10	International Common Wave	1492		201.1	0.2
Strasbourg, P.T.T. (France)	859		349.2	25	International Common Wave	1500		200	0.25
					Liepāja (Latvia)	1737		173	0.1

NOTE: Since the publication of the previous list, alterations have been made to the particulars of the following station: Kuldiga (Latvia).

SHORT-WAVE STATIONS OF THE WORLD

(N.B.—Times of Transmission given in parentheses are approximate only and represent G.M.T.)

Metres.	kc's.	Call Sign.	Station.	Tuning Positions.	Metres.	kc's.	Call Sign.	Station.	Tuning Positions.
75.0	4,000	—	Kuala Lumpur (Malaya). (Relays Empire Broadcasting.)		31.45	9,510	LKJI	Jeløy (Norway). (Relays Oslo.) (Daily 10.00 to 13.00.)	
70.2	4,273	RV15	Kharbarovsk (U.S.S.R.). (Daily 06.00 to 14.00.)		31.45	9,510	DJN	Zeesen (Germany). (Daily 08.15 to 12.15, 13.00 to 16.30, 22.15 to 03.30.)	
58.31	5,145	OKIMPT	Prague (Czechoslovakia). (Experimental)		31.38	9,560	DJA	Zeesen (Germany). (Daily 13.00 to 16.30, 22.15 to 02.15.)	
55.56	5,100	HAT	Budapest (Hungary). (Mon. 01.00 to 02.00.)		31.36	9,565	VUB	Bombay (India). (Sun. 12.30 to 15.30, Wed., Thurs., Sat. 16.30 to 17.30, irregular Mon.)	
52.7	5,692	FIQA	Antananarivo (Madagascar). (Daily ex. Sun. 08.00 to 08.15, 15.00 to 16.00, Sat. 17.30 to 19.00, Sun. 07.30 to 08.00.)		31.35	9,570	WIXAZ	Springfield, Mass. (U.S.A.). (Relays WBZ.) (Daily 12.00 to 06.00.)	
50.26	5,969	HVJ	Vatican City. (Daily 19.00 to 19.15, Sun. 10.00 also.)		31.32	9,580	GSC	Empire Broadcasting	
50.0	6,000	—	Bucharest (Romania)		31.32	9,580	VK3LR	Lindhurst (Australia). (Daily ex. Sun. 08.15 to 12.30.)	
50.0	6,000	RW59	Moscow (U.S.S.R.). (Relays No. 1 Stn.) (Daily 20.00 to 23.00.)		31.28	9,590	W3XAU	Philadelphia, Pa. (U.S.A.). (Relays W.C.U.) (Daily 17.00 to 21.00.)	
49.96	6,005	VE9DN	Montreal (Canada). (Daily 04.30 to 05.00)		31.28	9,590	VK2ME	Sydney (Australia). (Sun. 06.00 to 08.00, 10.00 to 16.00.)	
49.96	6,005	HF3ABII	Bogotá (Colombia)		31.27	9,595	IBL	Radio Nations, Prangins (Switzerland). (Sat. 22.30 to 23.15.)	
49.85	6,018	ZHI	Singapore (Malaya). (Mon., Wed., Thurs. 23.00 to 01.30, Sun. 03.40 to 05.10.)		31.25	9,600	CT1AA	Lisbon (Portugal). (Tues., Thurs., Sat. 21.30 to 24.00.)	
49.83	6,020	DJC	Zeesen (Germany). (Daily 22.30 to 03.30, 17.00 to 21.30.)		31.0	9,677	CT1CT	Lisbon (Portugal). (Thurs. 21.00 to 23.00, Sun. 12.00 to 14.00.)	
49.67	6,040	W1XAL	Boston, Mass. (U.S.A.). (Sun. 22.00 to 24.00, Wed., Fri. 00.30 to 02.00.)		30.67	9,780	2RO	Rome (Italy). (Tues., Thurs., Sat. 00.45 to 02.15.)	
49.67	6,040	YDB	Sourabaya (Java). (Daily 03.30 to 06.30)		30.43	9,860	EAQ	Madrid (Spain). (Daily 22.15 to 00.30, Sat. 18.00 to 20.00 also.)	
49.59	6,050	GSA	Empire Broadcasting		29.04	10,330	ORK	Ruysselede (Belgium). (Daily 18.30 to 20.30.)	
49.5	6,060	W8XAL	Cincinnati, Ohio (U.S.A.). (Daily 12.00 to 01.00, 04.00 to 06.00.)		28.98	10,350	LSX	Buenos Aires (Argentina). (Daily 20.00 to 21.00.)	
49.5	6,060	W3XAU	Philadelphia, Pa. (U.S.A.) (Relays W.C.U.) (Daily 00.00 to 04.00.)		25.6	11,720	FYA	Paris, Radio Coloniale (France). (Colonial Stn. E-W.) Daily 00.00 to 03.00, 04.00 to 06.00.)	
49.5	6,060	VQ7LO	Nairobi (Kenya Colony). (Daily 16.00 to 19.00, Sat. to 20.00, Mon., Wed., Fri. 10.15 to 11.15 also, Tues. 08.00 to 09.00 also, Thurs. 13.00 to 14.00 also, Sun. 17.45 to 19.00 also.)		25.6	11,720	CJRX	Winnipeg (Canada). (Daily 00.00 to 05.00, Sat. 21.00 to 06.00 also, Sun. 22.00 to 03.30 also.)	
49.5	6,060	ONXY	Skaulebaek (Denmark). (Relays Kalundborg.) (Daily 18.00 to 24.00, Sun. 16.00 also.)		25.57	11,730	PHU	Eindhoven (Holland). (Daily ex. Tues., Wed. 13.00 to 15.30 (Sat. to 16.30; Sun. to 16.00.)	
49.43	6,069	VE9CS	Vancouver, B.C. (Canada). (Sat. 04.30 to 05.15, Sun. 16.00 to 04.00.)		25.53	11,750	GSD	Empire Broadcasting	
49.4	6,072	ZHJ	Penang (Malaya). (Relays Empire Broadcasting.)		25.49	11,770	DJD	Zeesen (Germany). (Daily 17.00 to 21.30)	
49.4	6,072	OER2	Vienna Experimental. (Daily 14.00 to 22.00.)		25.45	11,790	W1XAL	Boston, Mass. (U.S.A.). (Daily 23.00 to 00.30.)	
49.34	6,080	W9XAA	Chicago, Ill. (U.S.A.). (Relays WCLF.) (Sun. 19.00 to 20.30.)		25.4	11,810	2RO	Rome (Italy)	
49.3	6,085	2RO	Rome (Italy). (Mon., Wed., Fri. 23.00...)		25.36	11,830	W2XE	Wayne, N.J. (U.S.A.). (Relays WABC.) (Daily 20.00 to 22.00.)	
49.26	6,090	VE9BJ	St. John (N.B.). (Daily 00.00 to 01.30)...		25.29	11,860	GSE	Empire Broadcasting	
49.22	6,095	VE9GW	Bowmanville, Ont. (Canada). (Mon., Tues., Wed. 20.00 to 05.00, Thurs., Fri., Sat. 12.00 to 05.00, Sun. 18.00 to 02.00.)		25.27	11,870	W8XK	Pittsburg, Pa. (U.S.A.). (Relays KDKA.) (Daily 21.30 to 03.00.)	
49.2	6,097	ZTJ	Johannesburg (S. Africa). (Daily ex. Sun. 04.30 to 05.30, 08.30 to 12.00, 14.00 to 20.00 (Sat. to 21.45), Sun. 13.00 to 15.15, 17.30 to 20.00.)		25.23	11,880	FYA	Paris, Radio Coloniale (France). (Colonial Stn. N-S.) (Daily 16.15 to 19.15, 20.00 to 23.00.)	
49.18	6,100	W3XAL	Bound Brook, N.Y. (U.S.A.). (Relays WJZ.) (Mon., Wed., Sat. 22.00 to 23.00, Sat. 05.00 to 06.00 also.)		25.0	12,000	RW59	Moscow (U.S.S.R.). (Relays No. 2 Stn.) (Sun. 03.00 to 04.00, 11.00 to 12.00, 15.00 to 16.00.)	
49.18	6,100	W9XF	Chicago, Ill. (U.S.A.). (Daily ex. Mon., Wed., Sun. 21.00 to 07.00.)		24.83	12,082	CT1CT	Lisbon (Portugal). (Sun. 14.00 to 16.00, Thurs. 20.00 to 21.00.)	
49.1	6,110	VUC	Calcutta (India). (Daily 07.06 to 08.06 irregular 13.06 to 16.36, Sat. from 12.36, Sun. 04.36 to 07.36, irregular 12.36 to 03.36.)		24.2	12,396	CT1GO	Paredo (Portugal). (Sun. 15.00 to 16.30, Tues., Thurs., Fri. 18.00 to 19.15.)	
49.1	6,110	VE9HX	Halifax N.S. (Daily 14.00 to 16.30, 21.00 to 04.00.)		23.39	12,830	CNR	Rabat (Morocco). (Sun. 12.30 to 14.00)...	
49.02	6,120	YDA	Bandoeung (Java). (Daily 03.30 to 06.30)		19.84	15,123	HVJ	Vatican City. (Daily 15.30 to 15.45) ...	
49.02	6,120	W2XE	Wayne, N.J. (U.S.A.). (Relays WABC.) (Daily 23.00 to 04.00.)		19.82	15,140	GSE	Empire Broadcasting	
48.86	6,140	W8XK	Pittsburg, Pa. (U.S.A.). (Relays KDKA.) (Daily 21.30 to 06.00.)		19.74	15,200	DJB	Zeesen (Germany). (Daily 08.45 to 12.15)	
48.78	6,150	CJRO	Winnipeg (Canada). (Daily 00.00 to 05.00, Sat. 21.00 to 06.00 also, Sun. 22.00 to 03.30.)		19.72	15,210	W8XK	Pittsburg, Pa. (U.S.A.). (Relays KDKA.) (Daily 13.00 to 21.15.)	
48.4	6,198	CT1GO	Paredo (Portugal). Daily ex. Sun. and Tues. 00.20 to 01.30, Sun. 16.30 to 18.00.		19.71	15,220	PCJ	Eindhoven (Holland). (Experimental) ...	
46.69	6,425	W3XL	Bound Brook, N.J. (U.S.A.). (Experimental)		19.68	15,243	FYA	Paris, Radio Coloniale (France). (Colonial Stn. E-W.) (Daily 12.00 to 16.00.)	
45.38	6,610	RW72	Moscow (U.S.S.R.). (Relays Station Stn.)...		19.67	15,250	W1XAL	Boston, Mass. (U.S.A.). (Daily 15.50 to 18.30.)	
38.48	7,797	HBP	Radio Nations, Prangins (Switzerland). (Sat. 22.30 to 23.15.)		19.66	15,260	GSI	Empire Broadcasting	
37.33	8,035	CNR	Rabat (Morocco). (Sun. 20.00 to 22.30)...		19.64	15,270	W2XE	Wayne, N.J. (U.S.A.). (Relays WABC.) (Daily 16.00 to 18.00.)	
31.58	9,500	PRF5	Rio de Janeiro (Brazil). (Daily 22.30 to 23.15.)		19.56	15,330	W2XAD	Schenectady, N.Y. (U.S.A.). (Daily 19.30 to 20.30.)	
31.55	9,510	VK3ME	Melbourne (Australia). (Wed. 10.00 to 11.30, Sat. 10.00 to 12.00.)		19.52	15,370	HAS3	Budapest (Hungary). (Sun. 13.00 to 14.00.)	
31.55	9,510	G8B	Empire Broadcasting		17.33	17,310	W3XL	Bound Brook, N.J. (U.S.A.). (Daily 16.00 to 22.00.)	
31.48	9,530	W2NAF	Schenectady, N.Y. (U.S.A.). (Relays W.C.U.) (Daily 23.30 to 04.00, Sat. 19.00 to 22.00 also.)		16.89	17,760	DJE	Zeesen (Germany). (Daily 13.00 to 16.30.)	
					16.87	17,780	W3XAL	Bound Brook, N.J. (U.S.A.). (Relays WJZ.) (Daily except Sun. 14.00 to 15.00, Tues., Thurs., Fri. 20.00 to 21.00 also.)	
					16.86	17,790	GSG	Empire Broadcasting	
					13.97	21,470	GSH	Empire Broadcasting	
					13.93	21,530	G8J	Empire Broadcasting	
					13.92	21,540	W8XK	Pittsburg, Pa. (U.S.A.). (Daily 12.00 to 19.00.)	

Pick-up Design

Research work into pick-up design is being carried out by the City of London Phonograph and Radio Society. *Wireless World* readers who are interested are invited to attend the meetings at the Food Reform Restaurant, Furnival Street, Holborn, E.C.4, on the third Thursday of each month at 7 p.m. Hon. Secretary: Mr. R. H. Clarke, 5, Tynemouth Terrace, Tottenham, N.15.

Pros and Cons of Car Radio

"Is Car Radio Worth While?" was fiercely debated at a recent meeting of Slade Radio (Birmingham). The tide of opinion was definitely against in the early part of the debate. When, however, other members presented the

CLUB NEWS

opposite angle and the vote was taken, an overwhelming majority considered that car radio was worth while. Hon. Secretary: Mr. C. Game, 40, West Drive, Heathfield Park, Handsworth, Birmingham.

Forbidden Radio

Coherer days were recalled by Mr. Rivers-Moore, President of the Croydon Radio Society, in a recent lecture on the early days of wireless. An amusing early experience with wireless was when he fixed a 10-inch spark coil on a Post Office cable ship and got in touch with North Foreland when anchored to a buoy in

the Thames. Unhappily, the spark coil upset the skipper's compass, so wireless apparatus was forbidden henceforth. Hon. Secretary: Mr. E. L. Cumbers, 14, Campden Road, South Croydon.

1935 Valves

The new season's valves and their uses were described by Mr. G. L. Deal, of the Mullard Wireless Service Co. Ltd., at a recent meeting of the Smethwick Wireless Society. The lecturer mentioned that the need for a compact chassis was the prime reason for the introduction of the modern multiple valve. New members are welcomed at the Society's meetings. Hon. Secretary: Mr. E. Fisher, M.A., 33, Freeth Street, Oldbury, near Birmingham.