

3<sup>D</sup>

# The Wireless World

UNIVERSITY OF THE

FEB 14 1953

AND RADIO REVIEW

*The Paper for Every Wireless Amateur*

Wednesday, October 5th, 1927.

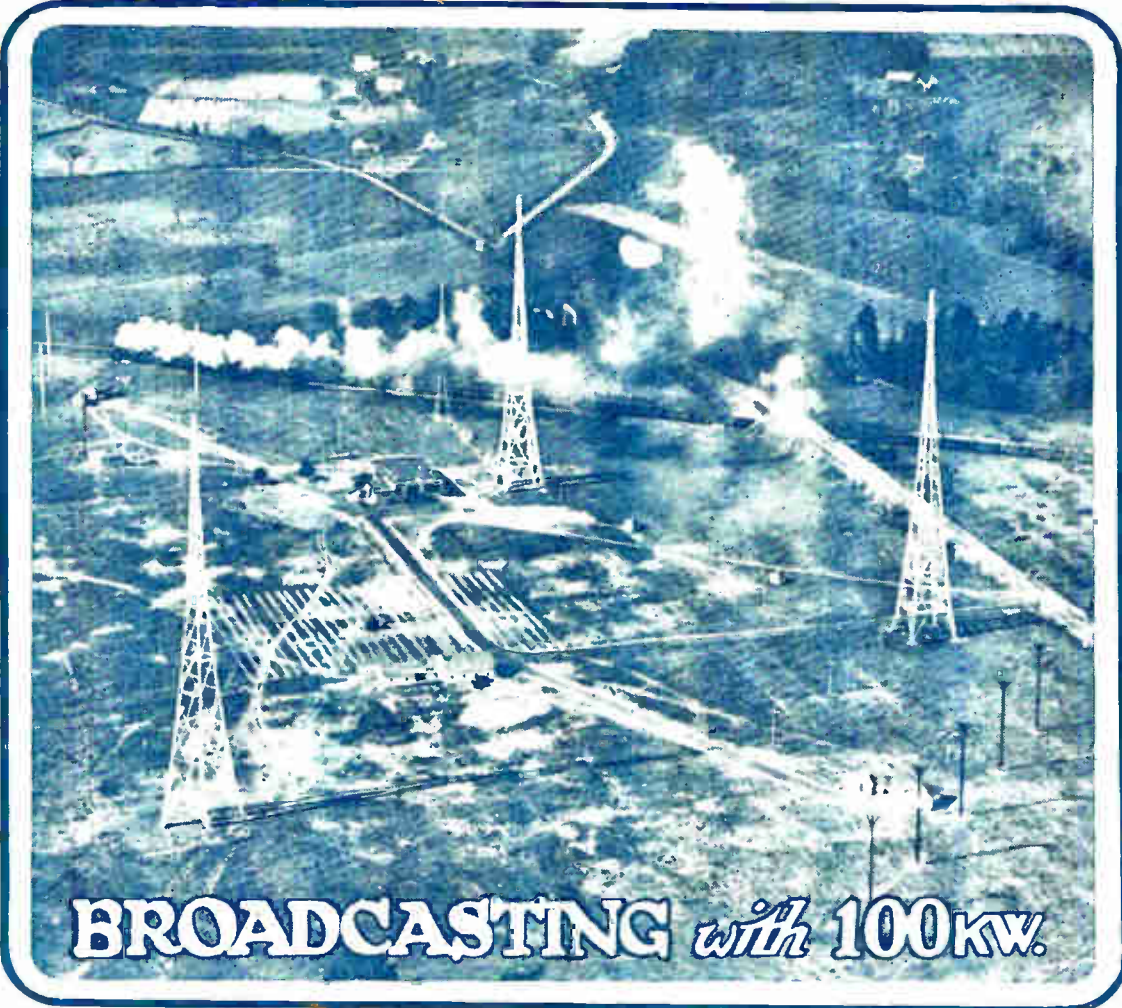

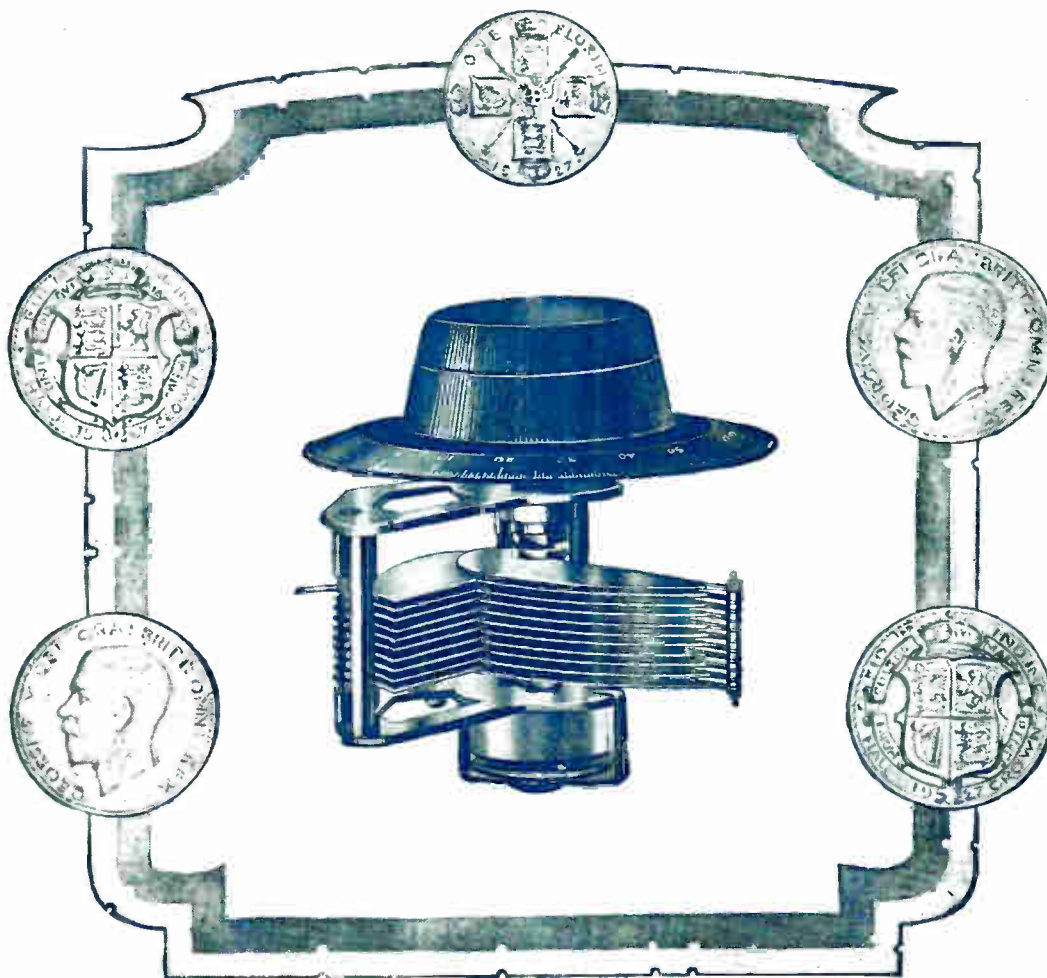

## TWELVE SHILLINGS.

The climax of our long and specialized experience in condenser manufacture has been reached in the K.C. variable condenser shown above. Both electrically and mechanically this is a perfect instrument in which the elimination of losses and the provision of selective tuning have been the two features chiefly held in view.

Both stator and rotor vanes are of heavy gauge brass separated by accurately turned spacers. The stator vanes are insulated by bakelite pillars held in compression and the rotor vanes are connected to the frame—these features making for extremely low losses.

When used in conjunction with either of the DUBILIER Toroids this condenser will give true Kilocycle (S.L.F) tuning; this means that radio stations will be received—not crowded together at one end of the scale, but evenly spread out throughout the dial readings. One hole fixing is provided and the instrument as a whole is beautifully finished.

Our new and improved methods of manufacture have enabled us to produce this condenser at the extremely modest price of 12/-, and the enthusiasm which has already been accorded to it on all hands proves clearly that the DUBILIER K.C. Condenser will take up its rightful position as the premier variable condenser of the new season.



Advt. of The Dubilier Condenser Co. (1925) Ltd., Ducon Works, North Acton, W.3.

TU 46

Mention of "The Wireless World," when writing to advertisers, will ensure prompt attention.

# Hear this New Speaker!

The Mullard  
Pure Music  
Model E

Price £3-5-0

Now you may enjoy Pure Music reproduction from a new inexpensive Mullard P.M. Speaker. Hear this new Model "E" and realize what startling value it offers you.

The power it handles and the rich tone it renders are a revelation.

Confirm this yourself—get your dealer to give you a demonstration to-day.

# Mullard

**MASTER · RADIO**

**CARBORUNDUM  
IN RADIO**

**Perfection in R.C. Coupling**

**THE CARBORUNDUM RESISTANCE CAPACITY COUPLING UNIT** is quite different from any other at present on the market, presenting as it does many distinct advantages over Units employing ordinary Grid Leaks and Anode Resistances. The Resistances used in the Carborundum Resistance Capacity Coupling Unit are solid rods of unbreakable Carborundum, which is created in the largest electric furnaces in the world, at the terrific temperature of 4060° F. They cannot burn out, present no capacity effects, and are absolutely non-microphonic. The Unit takes up far less room than the smallest L.F. transformer, and the complete absence of background noises enhances the already great possibilities of R.C. Coupling. Not being dependent on a metallic film, the resistances will not disintegrate and are unaffected by atmospheric changes.

**No. 73. Price 8/6.**



**CARBORUNDUM ANODE RESISTANCES AND GRID LEAKS** in all standard values. **Price - each 2/6.**

**CARBORUNDUM STABILISING DETECTOR UNIT.** The most satisfactory method of crystal detection.

**Price 12/6 (Dry Cell 5d. extra).**

Send for new 24-page Book containing circuits and much useful information.

All Carborundum Radio Products are sold under our complete guarantee that they will operate satisfactorily in properly designed circuits.

**THE CARBORUNDUM CO., LTD.,**  
**TRAFFORD PARK :: MANCHESTER.**

**Heavy Duty Resistors**

For Resistance - Capacity Coupling and H.T. Battery Eliminators. Particularly suitable for sets built to the B.B.C. Specifications. Any Resistance from 330 to 250,000 ohms can be obtained, each of the ten units giving four different resistance values. Capable of carrying heavy currents continuously. Details and prices on request.



**Fixed Resistors**

Enable each valve in a set to be operated at the correct voltage without variation and eliminate risk of damaging filaments, as by turning a rheostat on too far. Obtainable in 18 values from 0.5 to 50 ohms, 1/6 each. 400-ohm or 600-ohm Resistors, for Battery Eliminators and Automatic Grid-Bias, 3/6 each. Carton of two Screw Holders 1/- each. Full details on request.

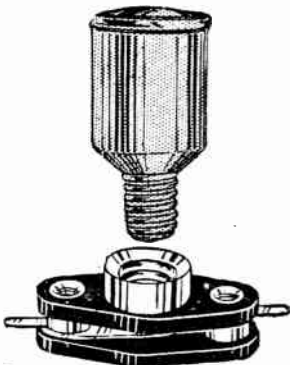

**Build with BURNDIPT Components for best results**

**WHEN** you are thinking of building a set, first glance through the pages of the Burndept Catalogue. You will thus become acquainted with a number of novel components which will improve or greatly assist in carrying out the ideas you have in mind. You can depend on Burndept products—they are guaranteed. Higher efficiency and better results will reward you if you use them.

Write to-day for your copy of the latest catalogue describing the range for 1927-28.

**BURNDIPT**

**BLACKHEATH, LONDON, S.E.3.**

Call at the London Showrooms, Bedford Street, Strand, W.C.2, and ask to see the latest Burndept Apparatus.

# Two New POPULAR POWER H.T. Batteries

for 10 to 16 milliampere emission.



**P.P. 64**      E.M.F. 64 volts      **17'6**

Dimensions,  $14\frac{3}{8} \times 5\frac{3}{8} \times 3\frac{1}{8}$  ins.      Weight, 11 lbs. 9 ozs.

**P.P. 105**      E.M.F. 105 volts      **29'-**

Dimensions,  $15\frac{3}{4} \times 8 \times 3\frac{1}{8}$  ins.      Weight, 20 lbs.

In new container to save you trouble.

TAPPED EVERY 6 VOLTS.

---

Write for your copy of our New Wireless Battery Catalogue.

---

Regd. Trade Mark.

“**EVER READY**”

**BRITAIN'S BEST BATTERIES**

Service Dept. D.L., Hercules Place, Holloway, London, N.7

ARE SAFE  
PUREST IN TONE  
CLEANEST IN USE  
FREE FROM TROUBLE  
LESS IN COST

Than any other form of  
High Tension supply.

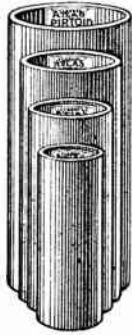

CLARKE'S  
**"ATLAS"**  
Radio Specialities

**PIRTOID  
TUBING**

The ideal former  
*For use in the Wireless World New  
Everyman Four*

Tubes of any diameter, wall, and length supplied for formers to make your Aerial coils and special H.F. Transformers

Pirtoid is recommended by the Technical Press and by the leading Wireless Journals. An expert writes: "Pirtoid is admirable for all wireless purposes, being easy to tap and drill—and is unbreakable."

Clarke's have been well known for many years as THE insulating material manufacturers, and Pirtoid incorporates the results of their experience

WRITE FOR PRICE LIST.

Sole Manufacturers: H. CLARKE & CO. [M/cr] LTD., Atlas Works, Old Trafford, Manchester.



**H.T.  
BATTERY ELIMINATORS**

There's a model for every need and for every purse. Each one removes the bogey of failing H.T. current for ever. By simply plugging into the nearest lamp socket, you have a smooth, constant H.T. supply until the power station runs out! There are variable voltages and grid-bias tapings on most models, and there is nothing whatever to burn out or go wrong

PRICES

Direct Current Models .. .. from £3 5s. to £6 10s.  
Alternating Current Models .. .. from £5 10s. to £9.

*Royalties and Valves Extra on Alternating Current Models only.*  
As with everything "ATLAS," each H.T. Battery Eliminator carries the "ATLAS" guarantee

**LOW TENSION UNIT for Alternating Current.** For 100/125 and 200/250 volt mains. Comprising a specially constructed Rectifying Unit and a Floating Storage Battery in Art Metal Cabinet. Can be used with an "ATLAS" H.T. Eliminator from same source of supply.  
Prices: 2-volt £4 15s.; 4-volt £4 19s. 6d.; 6-volt £5 4s.

SEND FOR FOLDER 24 FOR FULL DETAILS.

**LAMPLUGH RADIO  
PANEL PLATE TUNER UNIT**

PROV. PAT. REGD. DESIGN.

"THE MOST IMPORTANT HALF OF A SET."



FRONT VIEW

**OUTSTANDING  
SUCCESSSES  
at  
OLYMPIA**

ORDERS IN STRICT  
ROTATION.

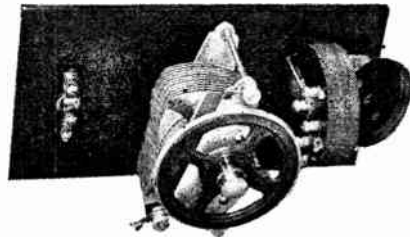

BACK VIEW

**FOR THE CONSTRUCTOR**

The Panel Plate Unit enables you to build a two or three valve Loud Speaker Receiver of high quality and efficiency, full wiring diagrams and layouts are supplied with each unit. Can be mounted to any form of cabinet. Ebonite panels not required. Metal Panel engraved in either Black & Gold or Black & Silver. Tuner Coils 250-2,000 metres, fitted with S.L.T. Slow Motion Condenser. PRICE **35/-**

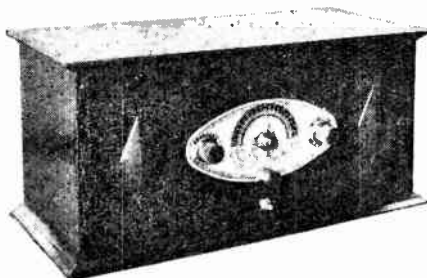

THE NEW POPULAR RECEIVER.

**FOR THE LISTENER**

A Set for the listener who requires Quality reproduction. No coils to change. One Switch to operate. Solid Oak Cabinet. All Batteries enclosed. Daventry, 5G B. and all local Stations at good Loud Speaker strength.

2-Valve Set **£5 0 0**  
3-Valve Set **£6 14 0**

Royalty Extra.

**S. A. LAMPLUGH, Ltd., King Road, Tyseley, Birmingham**

Agents for London and Southern Counties:—G. C. SHORE & CO., 28, Newman Street, Oxford Street, W.1.

Mention of "The Wireless World," when writing to advertisers, will ensure prompt attention.

The outstanding  
features of  
Olympia:—

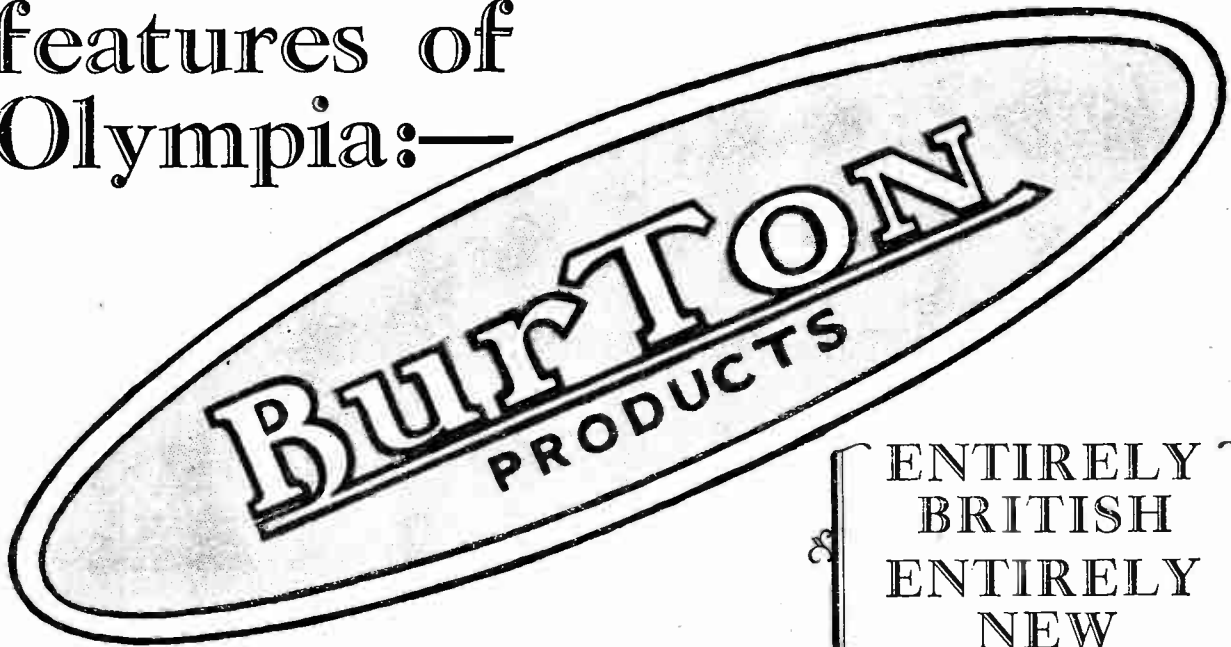

ENTIRELY  
BRITISH  
ENTIRELY  
NEW

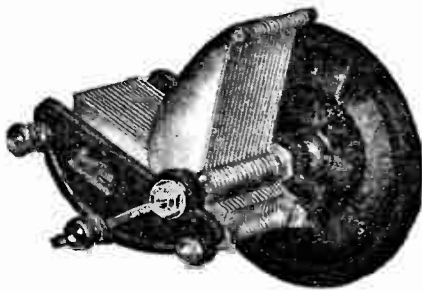

The new patented S.L.F.  
Condenser. Complete with  
4-inch dial.

·0003 5/9

·0005 6/-



The "Burton" Baseboard Resister Control.  
6, 10, 15, 30 ohms. 2/9 each.

C. F. & H. BURTON

Progress Works, Bernard Street, Walsall, England

Tel.: Walsall 560.

EVERYTHING **The G. E. C.** ELECTRICAL  
your guarantee

**GECOPHONE  
CONDENSERS**



For  
**NO HAND  
CAPACITY**

because grounded rotor, end-plates and dial are at earth potential—completely eliminating all body effects. "GECOPHONE" Condensers are essential for stable and accurate tuning of "Super-Het," Short-Wave and Neutrodyne receivers.

**Reduced Prices**

Square Law Type		Straight Line Frequency Type	
.0001 - 17/6	.0003 - 17/6	.0003 - 19/-	.0005 - 22/-
.0002 - 17/6	.0005 - 19/6		
.00025 - 17/6	.001 - 27/6		

**GECOPHONE**  
REGISTERED TRADE MARK  
**LOW LOSS SLOW MOTION  
CONDENSERS**  
MADE IN GREAT BRITAIN

Adv. of The General Electric Co., Ltd., Magnet House, Kingsway, London, W.C. 2.

Mention of "The Wireless World," when writing to advertisers, will ensure prompt attention.

As accurate  
as the  
**Greenwich time  
Ball**



**G**REENWICH! The very name stands for time-accuracy. The falling of the time ball at Greenwich is the signal by which England checks its time.

**T.C.C.**! The very name stands for condenser accuracy. Across the five continents of the World, T.C.C. accuracy is as famous as that of Greenwich. When you buy a T.C.C. Mansbridge Condenser you know that its capacity is identical with that stamped on its green case. Use T.C.C.—and be sure! All capacities from .009, price 1/8.

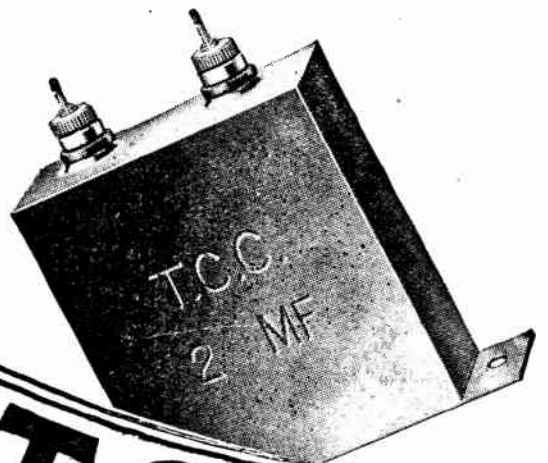

**T.C.C.  
Condensers**

**Always dependable**

CA 5625

Adv. Telegraph Condenser Co., Ltd., Wales Farm Road, N. Acton, W. 3



# Not Necessary to Buy a Tungstone Twice in a Lifetime

Because Standardised and Interchangeable renewable Die Cast and Machine Pasted Plates PERPETUALLY replace a set of Used Plates. Dry Plates partially first charged are ready for immediate use. Can be stocked for unlimited period in dry place. Spare Plates sold at reasonable prices with allowance of 4d. per lb. for returned disused Plates. Anyone can quickly and easily slip Set of New Plates into the Indestructible Guaranteed Metal Containers in use.

## TUNGSTONE'S "REVOLUTIONARY" SCIENTIFIC "DISCOVERY" COMPLETELY & RELIABLY REVERSES WORLD'S BATTERY PRACTICES AFTER 50 YEARS' STAGNATION

Without Cost to Purchaser, all Plates when made at the Works, are Fully Formed also given a Partial First Charge. All Plates are made chemically and electrically safe. Mechanically secure. Absolutely sure Preventative against damage to Plates on First Charge or shortened future Working Life. Also highest possible ratio of Storage Capacity is secured during working life. British Government's World's Record Test at 96 % Amp. Hr. 88 % Watt. Hr. are fully maintained.

## MANY OF THE WORLD'S MAKERS DISPATCH THEIR PLATES IN AN INCOMPLETE DELICATE MANUFACTURED CONDITION

Some are ONLY slightly formed. NOT all completely formed. NONE are Partially First Charged at the Works as Tungstone without cost to Purchaser.

## ALL THE WORLD'S MAKERS "PASS ON" TO THE PURCHASER

the many serious risks of Forming, and giving the First Full Charge, also the increased cost of a necessary and exceedingly long first charging period extending from 24 to 72 hours and longer.

## First Charge Only 4 Continuous Hours

FOR ANY TUNGSTONE STORAGE BATTERIES RATED FROM 6 TO 5,000 AMPS.

On Car or Bench Portable Batteries, charging rates from 6 to 30 amps. based on rated amp. hour House Lighting Works Central Station Batteries can be discharged for light ONLY during the first charging period.



## FREE FOR THE ASKING

112 Pages Battery Pocket Guide containing Special Illustrated Articles on—

## MODERN BATTERY FAILURES

Ask Local Wireless and Motor Dealer or send Name on Postcard

The Independent Battery of the British Empire.

Tungstone Accumulator Co., Ltd., 3, St. Bride's House, Salisbury Square, London, E.C.4

DO YOU

??

SAVE MONEY?

DO YOU SAVE MONEY BY USING

“**VARTA**”MONOBLOCKS  
FOR  
RADIO H.T. SUPPLY“VARTA” 20 VOLT H.T. MONOBLOCK  
TYPE “WA” (with one tapping at 10 volts).

PRICE NOW REDUCED TO

**9/-**THUS A 60 VOLT BATTERY OF 3  
“VARTA” MONOBLOCKS COSTS 27/-,  
JUST 3 TIMES AS MUCH AS A DRY  
BATTERY,

AND LASTS INFINITELY LONGER.

*“Don't scrap—recharge.”*

WRITE FOR LIST Nos. 1, 2 &amp; 3 to

A.F.A. ACCUMULATORS LTD., 120, Tottenham Ct. Rd., W.1

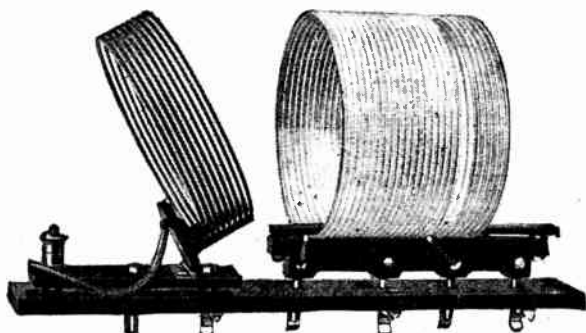
*Interchangeable . . . .  
Robust . . . . Air-spaced . . . .***C**OLVERN short-wave coils fulfil all the requirements for highly efficient functioning at the extreme higher frequencies.

The coils are robust, turns are air-spaced and are supported by the minimum of dielectric material. The leading-out wires pass outside the coil, and are soldered direct to pin contacts.

Inductive coupling links the closed and aerial circuits, between which the mechanical arrangement permits of a variable coupling.

Approximate tuning range with 00015 mfd. condenser:

Coil A: 10 to 17 metres.

Coil B: 17 to 34 metres.

Coil C: 34 to 70 metres.

Coil D: 60 to 130 metres.

The Colvern series of short-wave coils allow the short-wave enthusiast to make use of interchangeable coils, which, of course, is the ideal arrangement, since a small value tuning condenser may be used with maximum inductance value for a given frequency. This system also gives a better reaction control.

Complete details of two short-wave sets (one with one L.F., the other with two L.F.) were published in THE WIRELESS WORLD, September 14th, 1927.

Supplied in a set of four, with one suitable aerial coil covering the full wave-band. Mounted on low dielectric strip, fitted with six pins. A base is provided carrying six spring contacts.

Price  
**35/-****The Collinson Precision Screw Co. Ltd.,  
Provost Works, Macdonald Road, Walthamstow, E.17**

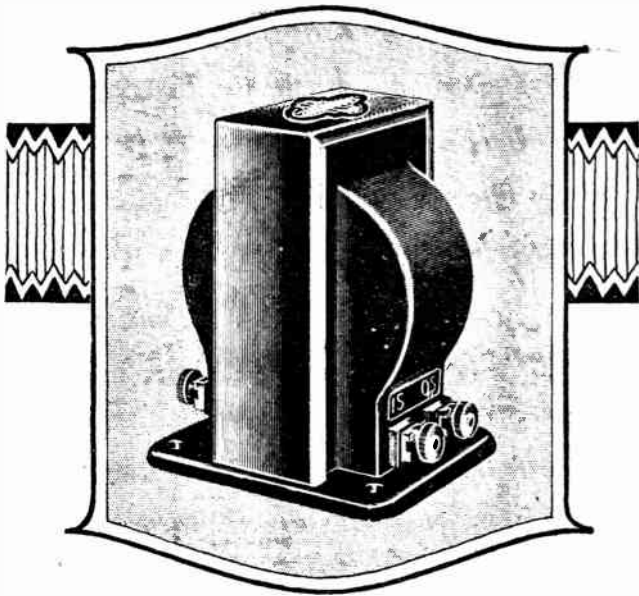

## All L.F. Transformers yield first place to this.

It is Igranic "G" Type L.F. Transformer—the latest product of Igranic research. For high amplification and faithful reproduction of all audible frequencies it is unapproached by any other instrument at present obtainable. Whenever L.F. Transformers are needed, use Igranic "G" Type. Totally enclosed to prevent interaction, and wound to entirely eliminate breakdowns.

It is made in two ratios—3·6 to 1 for use in first and single stages, and 7·2 to 1 for second stages and for use with low impedance valves.

Price  
30/-

Write for publication U.223 which describes this and all the recent Igranic developments.



149 Queen Victoria Street, London

WORKS: BEDFORD

BRANCHES: BIRMINGHAM, BRISTOL, CARDIFF, GLASGOW, LEEDS, MANCHESTER, NEWCASTLE.

# SELFRIDGE'S

## and the Famous "CLEARTRON" VALVES

*THE famous "Cleartron" Valve has during a usually quiet summer season created, what we believe to be, a record for the sale of Radio Valves in this country. "Ring" prices are still much higher than is economic. Compare them with those fixed for the coming season for "Cleartron"—British made and standard. The famous "Cleartron" Valve is now 3/9 for ordinary type and 6/6 for power and R.C.C. types.*

### SPECIFICATION OF THE FAMOUS "CLEARTRON" VALVES:

Valve.	Filament Volts.	Filament Amps.	Impedance Ohms.	Amplification Factor.
CT10	3·8	0·1	15,000	7·5
CT10*	3·8	0·1	8,000	3·8
CT15	1·8-2	0·15	18,000	7·5
CT15*	2·0	0·3	7,500	4·5
CT25	5·0	0·25	10,000	9·0
CT25B°	5·0	0·25	20,000	20·0
CT25*	5·0	0·5	4,000	5·0
CT215H°	5·0	0·15	100,000	45·0

\*Valves are Power Valves.

°Valves are Special Valves for resistance capacity amplification.

<b>General Purpose</b>	<b>British</b>	<b>Power</b>
<b>VALVES</b>	<b>VALVES</b>	<b>VALVES</b>
Ruling "Ring" <b>3/9</b>	Ruling "Ring" <b>6/6</b>	Ruling "Ring" <b>6/6</b>
Price 10/6	Price 12/6	Price 12/6
<b>SELFRIDGE</b>	<b>SELFRIDGE</b>	<b>SELFRIDGE</b>
Price, each	Price, each	Price, each

Postage 3d. extra.

Postage 3d. extra.

Radio Department, First Floor.

## "CLEARTRON" Famous "Di-Kast" Condensers

These are variable Air-Dielectric Condensers, with both Rotor and Stator cast in one piece. They were manufactured under direct licence from the Western Electric Co. Ltd., and under the registered design of Lamplugh of Birmingham. Specially designed vanes provide straight line readings and are very suitable for short wave work. Capacities '0005, '0003 and '0002 only. Complete with Detex 2½ inch slow-motion dial.

SELFRIDGE PRICE, each

**4/3**

Or complete with 4-inch Detex dial,

SELFRIDGE PRICE, each

**4/9**

Condensers only, SELFRIDGE PRICE, each

**2/6**

Postage 6d. each extra.

Radio Department, First Floor.

Selfridge & Co., Ltd., Oxford St., London.

'Phone—Mayfair 1234



RECUPERATING AGENT  
IN THE

# HELLESEN DRY BATTERIES.

It is the price you pay per hour for enjoyable radio reception that matters, not the price you pay of your dry battery.

Helleesen Dry Batteries have been known for over forty years as the best in the world. The No. 7 recuperating agent marks a development to meet a new need; the old Helleesen standard of construction, the best material in the hands of expert workmen, remains.

With quadruple insulation and sealed cover, buy a Helleesen for safety and satisfaction.

60-volt "WIRIN" 12/6

99-volt "WIRUP" 21/-

(Postage Extra.)

All types, voltages, etc., in Double and Treble capacities for H.T. and L.T. Supply. Ask your dealer for the type to suit your set and get the maximum service, or write us for full particulars.

Obtainable at all Radio, Electrical and General Stores, Harrods, Selfridges, etc., or direct from

A. H. HUNT, Ltd. (Dept.), CROYDON, SURREY.



Mention of "The Wireless World," when writing to advertisers, will ensure prompt attention.

**A GOOD  
ENGINEER'S  
TELESCOPIC  
WIRELESS  
MAST**

(Patent Nos. 233035 & 244883.)

Tubular, 17 ft. when telescoped, complete with guy wires, straining screws, base plate and ground pegs. The whole galvanised except ground pegs.

**LASTS A LIFETIME**

34 Feet  
**£3 - 15 - 0**

50 Feet  
**£7 - 5 - 0**

**HILDICK & HILDICK,  
PLECK ROAD, WALSALL.**

# "RAYOL"

Regd.

PORTABLE and SELF-CONTAINED  
RADIO RECEIVERS

**Exhibition Sensation!!**

The "RAYOL" II. is the only two valve portable Receiver that efficiently receives Daventry, 5XX, 5GB, and Local Station on self contained aerial and loud speaker, at good loud speaker strength.

**Price £22 complete**  
(Including Marconi Royalty).

The "RAYOL" V. is the finest value on the market. All self contained in a beautiful polished mahogany cabinet, with full size Celestion Loud Speaker. Giving choice of Daventry, 5XX, 5GB, Radio Paris and Local Main Station. Terminals are also provided for connecting an outside aerial and earth if desired.

**Price 30 GNS. complete**  
(Including Marconi Royalty).

Write for full particulars.

**ENGINEERING WORKS (Electrical & General) Ltd.**  
7, 8, Gt. Winchester St., London, E.C.2.  
Phone: London Wall 5428.

# THE ONLY PORTABLE—

The Langham is the only portable radio set with a full continental range (up to 1000 miles). The Langham gives perfect loud-speaker reproduction anywhere, indoors or out, yet it has only one tuning control and is amazingly easy to operate.

The Langham has no aerial and no earth—*everything* is completely contained in the solid leather case. At the Radio Show the Langham was an outstanding sensation.

We ask you to try the Langham Portable for yourselves—we offer one week's free trial for you to see that the set will do what we claim.

WRITE FOR FULL PARTICULARS.



## IMPORTANT

We are anxious to arrange with first-class retailers to act as sole agents in all districts. If the idea interests you write to us now.

The  
**LANGHAM**  
Portable Radio

Langham Radio,  
Albion House, 59, New Oxford Street, W.C.1.

Telephone: Museum 2878 & 8293.

T. McD. 50.

EVERYTHING **The G.E.C.** ELECTRICAL  
*Your Guarantee*

This New  
**2 Volt**  
**Osram**  
**Valve**

means

**Super Power**  
**for Your Set!**

**DEP 240**  
*Super Power Amplifying Valve*

Try this new valve in the last L.F. stage of your set to-day. You will be astounded at the immediate improvement in tonal quality.

The remarkable characteristics of the new OSRAM D.E.P. 240 stamp it as a Super-Power Valve far above the ordinary—and it requires a 2-volt (one-cell) accumulator only!

Particularly designed for use with cone speakers.

New **PRICE 20/-**  
**Osram**  
**Valves**

*with the New Filament*

**Your Dealer can Supply!**

**MADE IN ENGLAND.**

*Advt. of The General Electric Co., Ltd., Magnet House, Kingsway, London, W.C.2.*

# RADIO REVOLUTIONISED

- not a booklet  
- not a Blue print

But  
a wonderful  
new system of  
set building

THE makers of Cossor Valves have evolved an entirely new system of Set building which ensures perfect results without skill. Soldering is abolished, technicalities have been eliminated. Success is certain. It costs you nothing to get details of this new system. Post a coupon to-day. Even if you already own a Set don't neglect the opportunity. When you read about the amazing efficiency of the new Cossor 'Melody Maker you will quickly want to discard your out-of-date Receiver.

A simple efficient 3 Valve Receiver

Soldering abolished!  
-every detail as easy as ABC



# Free

Post the coupon to-day  
for your copy of

How to build the

# COSSOR "Melody Maker"

To A.C. Cossor Ltd., Highbury Grove, London, N.5  
Please send me free of charge one copy of  
"How to build the Cossor 'Melody Maker'."  
Name.....  
Address.....  
N. W.

Mention of "The Wireless World," when writing to advertisers, will ensure prompt attention.



# The Wireless World

AND  
RADIO REVIEW  
(15<sup>th</sup> Year of Publication)

No. 423.

WEDNESDAY, OCTOBER 5TH, 1927.

VOL. XXI. No. 14.

Editor : HUGH S. POCOCK.

Assistant Editor : F. H. HAYNES.

Editorial Offices : 139-40, FLEET STREET, LONDON, E.C.4

Editorial Telephone : City 4011 (3 lines).

Advertising and Publishing Offices : DORSET HOUSE, TUDOR STREET, LONDON, E.C.4.

Telephone : City 2847 (13 lines).

Telegrams : "Ethaworld, Fleet, London."

COVENTRY : Hertford Street.

BIRMINGHAM : Guildhall Buildings, Navigation Street.

MANCHESTER : 199, Deansgate.

Telegrams : "Cyclist Coventry."  
Telephone : 8210 Coventry.

Telegrams : "Autopress, Birmingham."  
Telephone : 2970 and 2971 Midland.

Telegrams : "Iliffe, Manchester."  
Telephone : 8970 and 8971 City.

Subscription Rates : Home, 17s. 4d. ; Canada, 17s. 4d. ; other countries abroad, 19s. 6d. per annum.

*As many of the circuits and apparatus described in these pages are covered by patents, readers are advised, before making use of them, to satisfy themselves that they would not be infringing patents.*

## WIRELESS MILESTONE.

**I**n this issue we publish a most important statement from the Marconi Company on the subject of royalties, in which it is explained that the Marconi Company has decided to act immediately upon a suggestion, made by Sir Edward Iliffe, M.P., at the inaugural banquet of the National Radio Exhibition, reported in our last issue. Sir Edward Iliffe, who it may be of interest to our readers to know is chairman of Iliffe and Sons Ltd., the proprietors of *The Wireless World*, in his remarks on the occasion of the banquet pointed out that broadcasting could not expect to take its proper position as a national service until obsolete and unsatisfactory receivers were replaced by modern and more perfect instruments, and that as things stood at present, whilst a receiver might be very unsatisfactory in its performance, yet the owner hesitated to discard it and purchase a new set, because he was expected to pay the Marconi royalties of 12s. 6d. per valve-holder over again with each new set that he bought. The suggestion was made that the licence payment on an old receiver might be carried over to apply to a new set.

This very important decision on the part of the Marconi Company will, we believe, have a considerable influence in raising the general standard of reception of broadcasting.

o o o o

## OLYMPIA—SOME LESSONS TO BE LEARNED.

Now that the Exhibition at Olympia is over there is time in which to survey the effects of the Show and review it in a more critical spirit. Elsewhere in these pages we deal with sets or components which are representative types of new apparatus developed or improved since last year, but apart from the details of apparatus we have the Exhibition to consider from the point of view of whether it has served its purpose adequately, and whether it has given to the public that information and guidance

on wireless and the choice of wireless receivers which the public expects.

In our opinion, the most urgent need in the wireless industry now is for the public to have the opportunity of hearing first-class broadcasting, such as they may expect to obtain in their own homes, provided that they replace their old apparatus with up-to-date and efficient receivers. There are, unfortunately, many thousands of obsolete wireless receivers still in use: these sets do nothing to help broadcasting, and only hinder the progress which this service deserves. Our aim should be to improve the standard of reception all round, and one of the surest ways of achieving this object is to give demonstrations to the public which will provide a contrast to what they have been accustomed to listen to with their obsolete sets. In our opinion, the annual Exhibition provides the opportunity for such demonstrations to be given, but they should not be carried out with an attempt to fill the whole of the Exhibition hall. They should be given in comparatively small enclosures comparable in size and furnishing with home conditions.

In the Gallery there appeared to us to be a good deal of space available, and it would have been a comparatively simple matter to construct at intervals round the Gallery a number of rooms in which broadcasting could have been reproduced with different types of loud-speakers and sets, each room, of course, having only one loud-speaker working. The public could have been permitted to pass through these rooms and listen to good-quality broadcasting in comparatively natural surroundings. We recommend to the organisers at the next Exhibition that they consider very carefully the question of providing public demonstrations, carried out on a scale which compares with the requirements of the home, with standard apparatus and standard loud-speakers. To attempt to fill the hall with a demonstration would be a mistake, because the apparatus used would be on a different scale from that supplied for domestic reception, and therefore would not serve the purpose of showing the public what may be expected from the modern set.

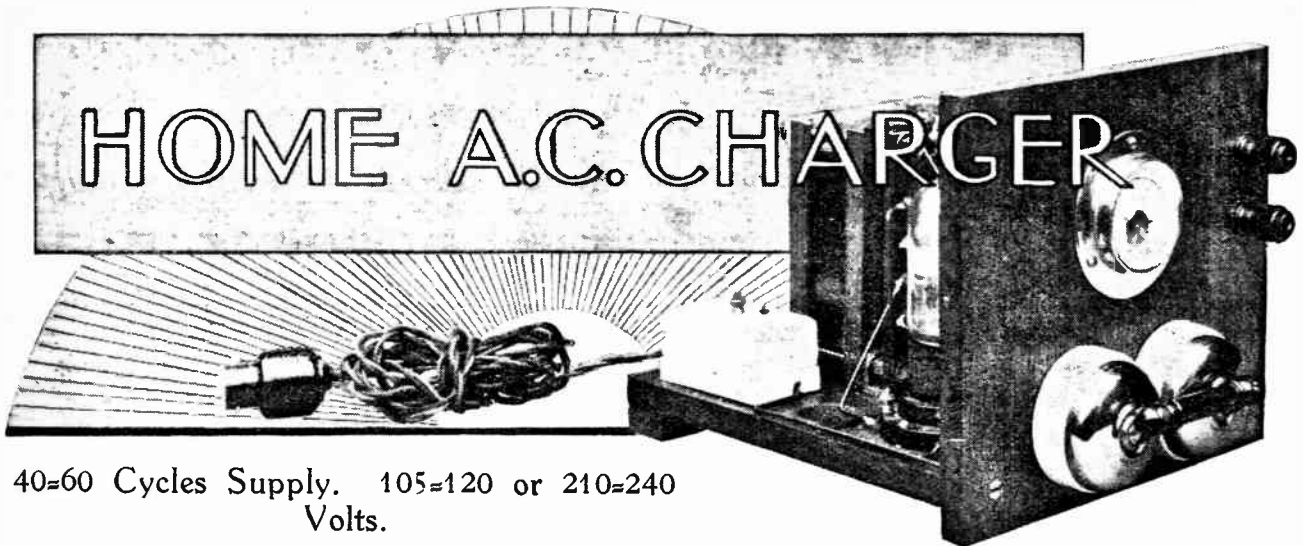

40=60 Cycles Supply. 105=120 or 210=240  
Volts.

By H. B. DENT.

It is perhaps not generally recognised that home charging of L.T. accumulator batteries from a D.C. source of supply is an expensive operation; however, a little consideration of the true facts should make this quite clear. For example, let it be assumed that a 6-volt, 40-amp.-hour accumulator is being charged from a 220-volt D.C. main and that the charging current is 1 amp. To bring the accumulator up to full charge it will be necessary to leave this connected to the source of supply for a period of at least 40 hours. Usually the charging would be carried on slightly longer than this in practice for the reason that an accumulator does not possess a 100 per cent. efficiency; however, relative figures only are being considered. To pass a current of 1 ampere through the accumulator, the mains deliver to the charging circuit 220 volts less 6 (the back voltage of the accumulator)  $\times$  1 ampere, which equals 214 watts, and if this is continued for 40 hours the total wattage taken from the mains is  $214 \times 40$  or 8,560 watt hours, which equals 8.6 units approximately.

Taking a hypothetical case, and assuming the Electricity Supply Company make a charge of 6d. per unit, it will cost  $6 \times 8.6d.$ , or 4s. 3d., to fully charge the accumulator. It does not necessarily follow that because the charging stations will undertake this service at a cost of about 1s. 6d. that they are philanthropists; on the contrary, it is a good business proposition. The current passing through your accumulator also passes through perhaps a dozen or more other accumulators without imposing any extra load on the mains. How-

ever, in the majority of cases the services rendered justify the fee imposed for the reason that the accumulator is examined, and if found to require topping with distilled water or the terminals cleaned, then this is done.

Home charging from an A.C. supply main is a totally different proposition and would seem to be justified. It is, of course, understood that an accumulator cannot be charged by directly connecting this to a source of alternating current, but that the supply must be rectified and converted into a direct current. If this was carried out on similar lines to the Trickle Charger<sup>1</sup> described in a recent issue of *The Wireless World* the cost would be commensurate with that for the D.C. case. Owing to the flexibility of A.C. and the easy way in which this can be transformed up to a higher voltage or down to a lower voltage, a great saving in cost can be made by adopting a transformer and stepping down the voltage to a suitable value before rectifying and passing to the accumulator it is desired to charge. This advantage is apparent only when dealing with the charging of low-tension accumulators, and the foregoing remarks do not apply to high-tension batteries in the order of 60 volts or more.

To continue, allowance must be made for at least 20 volts on the anode of the rectifier, because a slight drop in voltage will occur across this valve, and if the initial voltage is too low before rectification, then there will be insufficient pressure to overcome the back voltage of the accumulator and force through 1 amp. of current. Assuming full wave recti-

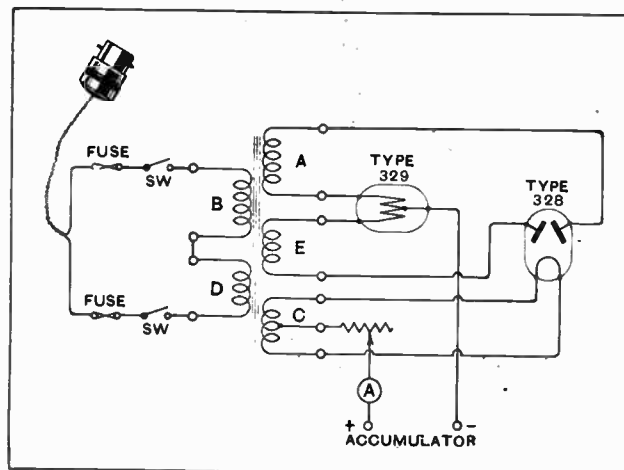

Fig. 1.—The circuit diagram. The value of the variable resistance in the centre tap of coil C is 10 ohms.

<sup>1</sup>*The Wireless World*, August, 3rd, 1927.



**Home A.C. Charger.—**

fication is used, then the transformer must have a secondary winding delivering 20 volts to each anode at half the full charging current. As the filament of the rectifier must be heated before it will function, its consumption in watts must be taken into consideration when working out the cost of charging. A suitable rectifying valve will require about 5 amps. at 2 volts, so that now the total voltage required of the transformer can be calculated. This will be  $2(20 \times 0.5) + (2 \times 5)$ , or 30 watts in all. A well-designed small-power transformer should have an output to input efficiency of at least 75 per cent., and taking this figure the primary wattage will be  $4/3$  of 30 or 40 watts. Assuming similar conditions to that obtaining in the D.C. case, then the total watts consumed by the primary will be approximately  $40 \times 40$ , or 1,600 watts. At 6d. a unit this would cost approximately  $1.6 \times 6d.$ , or 9½d. The extra trouble that must be taken to keep the accumulator in good condition will be amply repaid by the saving in cost.

**The Power Transformer.**

This will require three separate windings, a primary, a secondary to supply the charging current, and a filament winding to light the rectifier. The necessary constructional details will be given for the benefit of those who prefer to construct this at home, but if the experimenter's workshop does not provide the required facilities it would perhaps be advisable to purchase one ready-made.

The first problem which confronts the constructor of small-power transformers is the difficulty of obtaining the

core lamination cut to the required size, and to overcome this difficulty the transformer described in this article makes use of a standard shaped lamination which can be obtained from stock. These are known as Sankey No. 4 Stampings, and were obtained from Messrs. Jos. Sankey and Son, I.t.d., of Bilston, Staffs. The laminations are

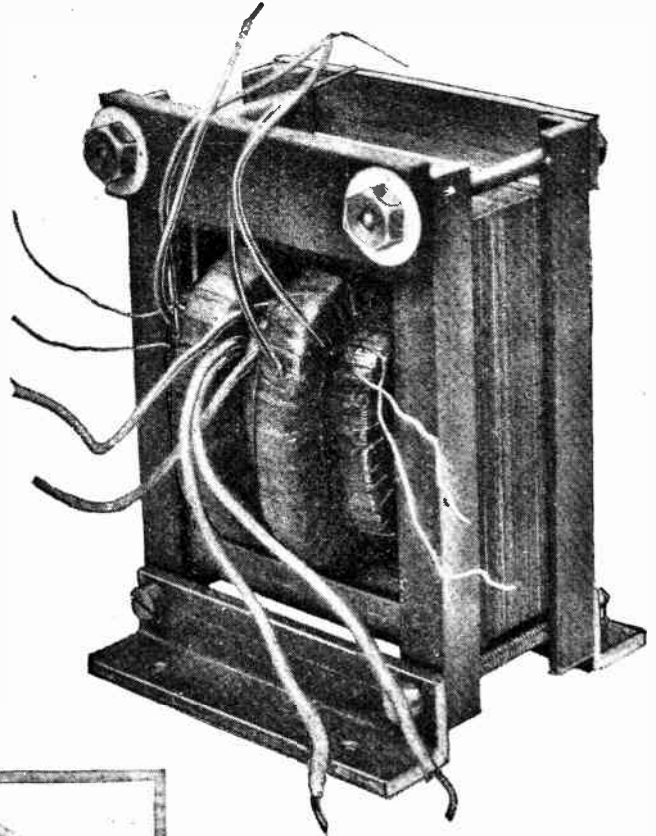

Fig. 3.—The power transformer before assembling the terminal battens.

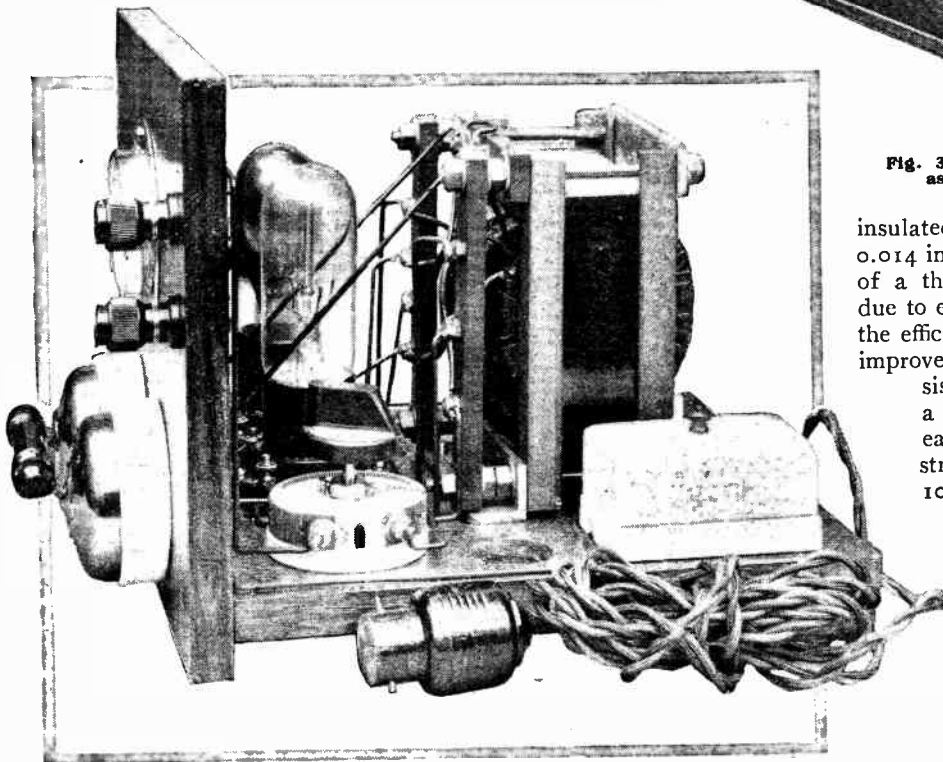

Fig. 2.—The charger assembled and ready for use.

insulated on one face, and the iron is 0.014 inch in thickness. The advantage of a thin lamination is that the losses due to eddy currents are kept down and the efficiency of the transformer thereby improved. The No. 4 stamping consists of a "T" shaped piece and a "U" shaped piece, and one of each form a pair. For the construction of the transformer about 100 pairs will be required, but it would be advisable to purchase slightly more than this number to allow for any slight discrepancy in the thickness of the insulation on each stamping.

Before commencing with the building of the transformer it will be necessary to construct a former on which the various coils are

**Home A.C. Charger.—**

to be wound, and this should be made from ebonite to the dimensions given in Fig. 4. It is important that the dimensions of the centre formers are accurately reproduced, a  $\frac{1}{16}$  in. plus or minus will result in the finished coils being either too large or too small for the purpose. The size of the outside, or supporting, cheeks is not important; however, these should not be smaller than the

ness, so that both centre pieces should be assembled on the coil-winding former, which can be held between either the centres of a lathe or a suitable support can be built up from hard wood, such as oak or teak. Before commencing to wind the coil, four lengths of strong thread—cobbler's waxed thread is quite good for this purpose—should be laid in the grooves and held in position by wrapping two layers of thin paper round the centre

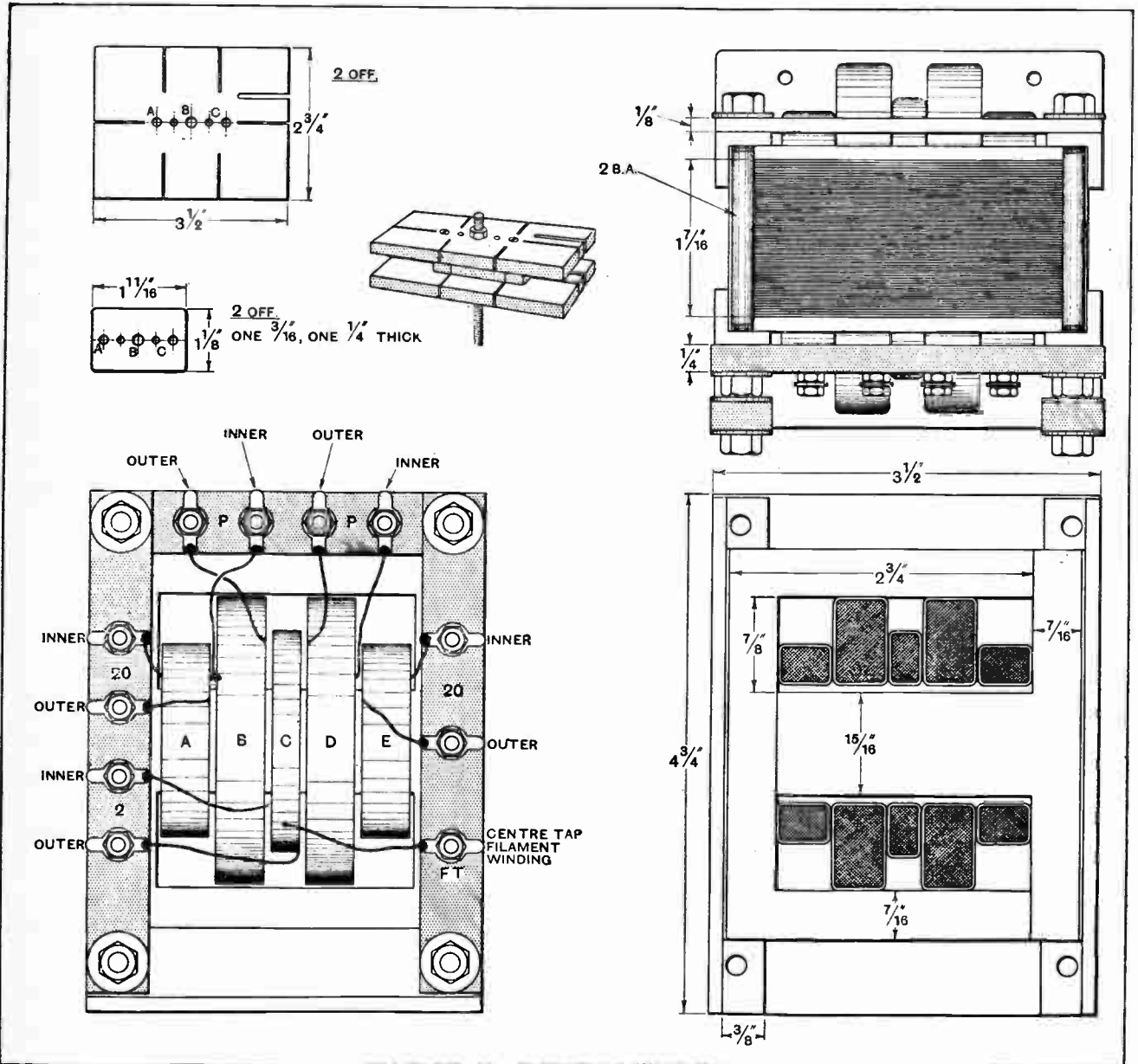

**Fig. 4.—Details of the coil-winding former, plan and elevation of the power transformer, and terminal connections of the transformer coils. Sizes of holes are as follows: A = 5/32 in., B = 3/16 in., C = 1/8 in.**

dimensions given. The two primary coils should be wound first, and for this purpose 1 lb. of No. 26 S.W.G. double silk-covered wire will be required. This should be obtained in one length if possible, or alternatively two  $\frac{1}{2}$ -lb. reels can be used. These coils are  $\frac{1}{16}$  in. in thick-

ness. The thread is for the purpose of tying up the coil when the winding is completed, and the layers of paper will facilitate its removal. The reel of wire should be supported so that it runs freely, and the winding commenced by passing the beginning of the wire through the

**Home A.C. Charger.—**

hole in one end cheek and anchoring it by taking a few turns round the spindle on which the former has been mounted. The turns must be put on in layers and evenly wound, otherwise difficulty will be experienced in accommodating the finished coil within the space available. Each layer should be given a coating of shellac varnish, and if it is found that the surface is becoming too uneven then a layer of thin paper should be interposed. When the total number of turns have been put on, the coil should be tied up by means of the four lengths of thread previously mentioned and put aside to dry. Any tendency to bulge during winding must be corrected and is an indication that the wire is not being held at sufficient tension.

When the coil is partially dry, it should be carefully removed from its former, given a coating of shellac varnish, and placed in a warm oven to bake. It would be advisable to sandwich the coil between two pieces of thin wood and rest a weight on it to prevent the coil from bulging at the sides. After the coil has been baked it should be wrapped with thin linen tape  $\frac{1}{2}$  inch wide, each turn overlapping the preceding turn by about  $\frac{1}{4}$  inch.

The following table gives particulars of the 5 coils on the transformer, and the method of construction detailed above should be followed in all cases.

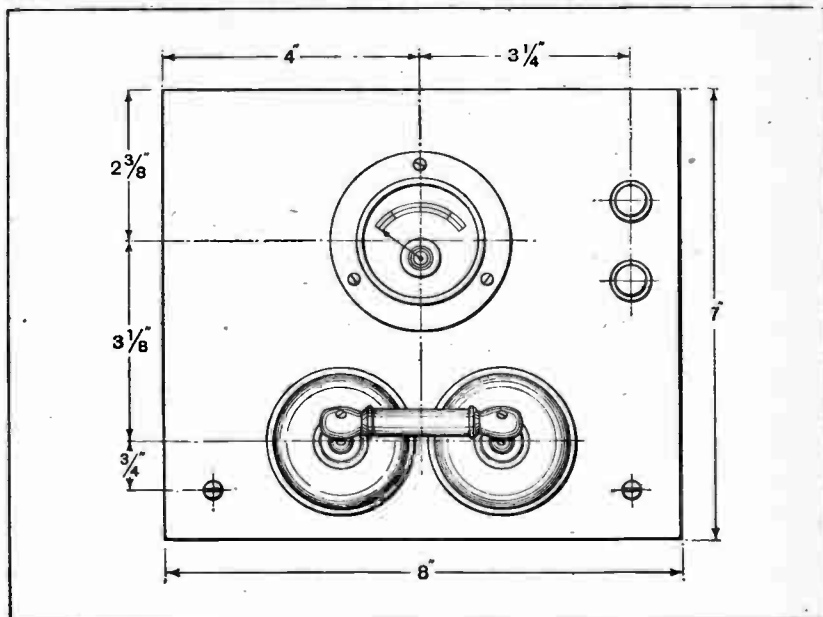

Fig. 6.—Baseboard layout showing position of the components.

Coil.	Thickness of Centre former.	S.W.G.	Insulation.	No. of Turns.	Function.
A	$\frac{7}{16}$ inch	No. 22	D.W.S.	125	Secondary
B	$\frac{1}{16}$ inch	No. 26	D.W.S.	660	Primary
C	$\frac{1}{4}$ inch	No. 16	D.C.C.	14	Filament
D	$\frac{7}{16}$ inch	No. 26	D.W.S.	660	Primary
E	$\frac{1}{16}$ inch	No. 22	D.W.S.	125	Secondary

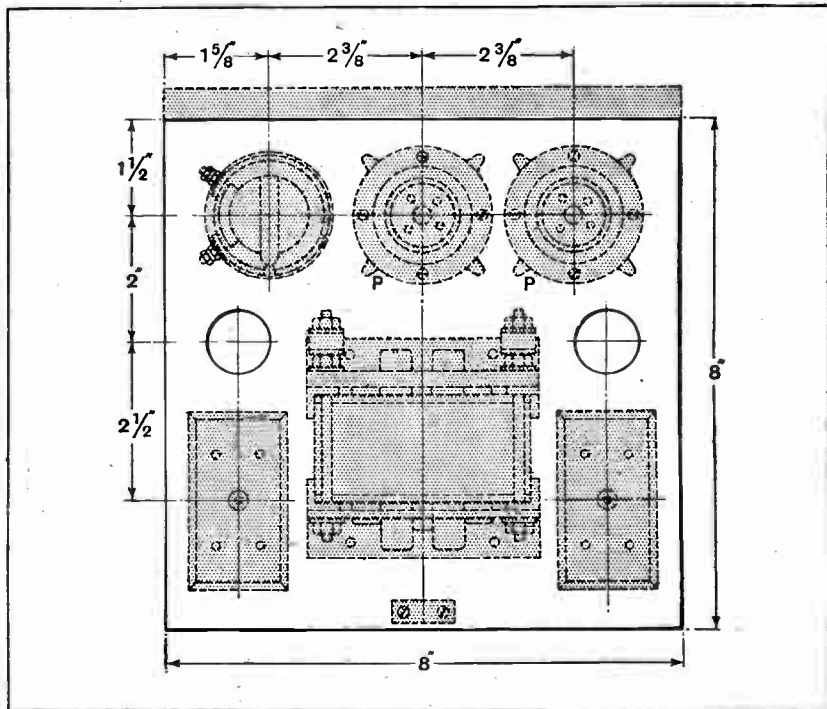

Fig. 5.—Dimensioned panel layout.

Coil C will require a tapping at the centre of the winding, and this can be obtained by passing the wire through the large slot in the cheek after 7 turns have been completed and returning this again through the slot but leaving a suitable length for connection purposes.

The finished coils should be tested for continuity, and it would be advisable to mark an arrow on the outside of each indicating the direction of winding.

**Assembling the Core.**

The efficiency of a transformer is to a great extent dependent upon the method adopted in assembling the iron core, and if large air gaps are present the flux density in the iron circuit will be greatly reduced. It follows therefore, that too much care cannot be exercised in this direction, and the instructions given below for assembling the laminations should be carefully followed. Before commencing this, the five coils should be placed side by side in the correct order, keeping the direction of winding the same in all coils.

A "T" shaped lamination should be inserted from one side, and a "U"

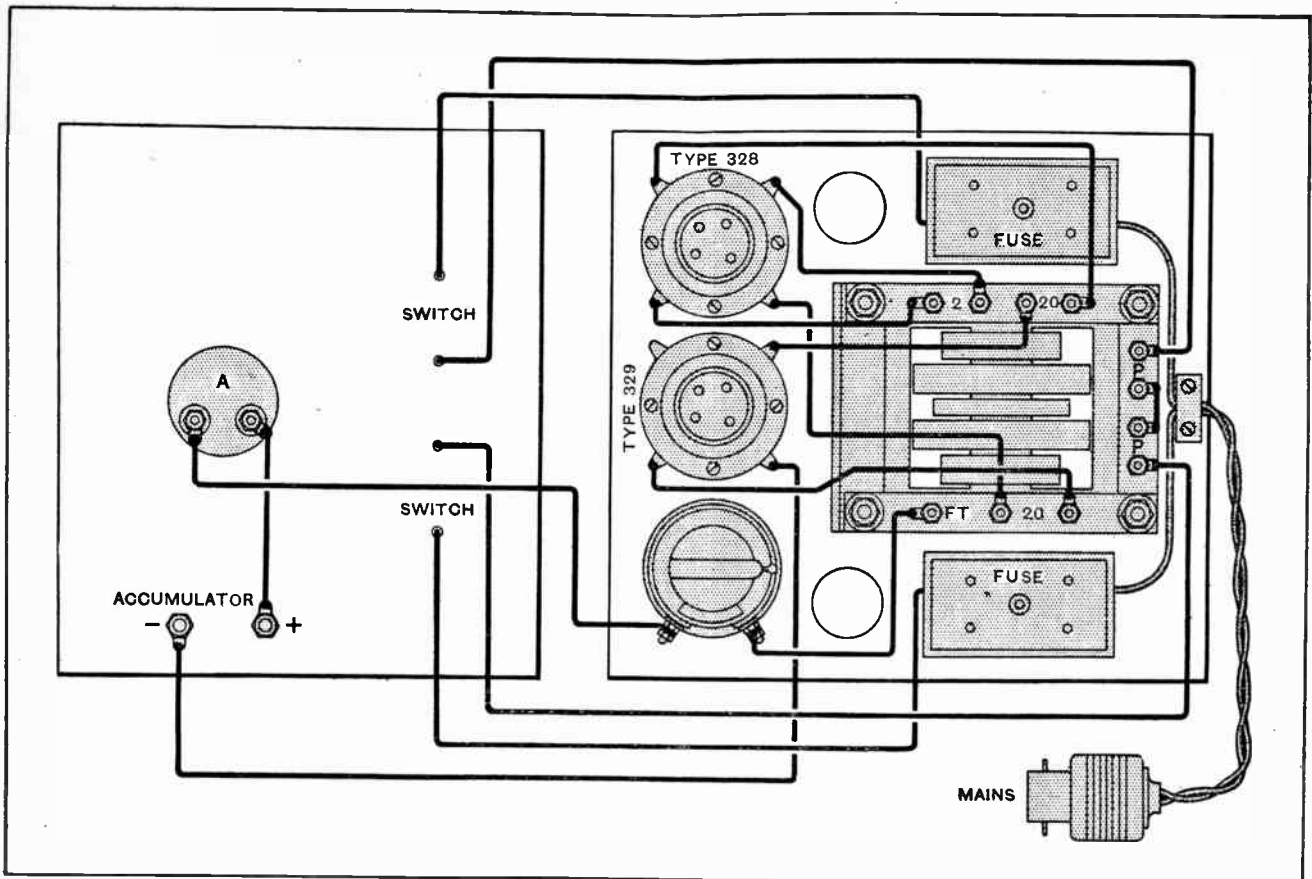

Fig. 7.—Practical wiring diagram.

shaped piece from the opposite side, and this followed by a "T" piece assembled from the same side. The next "U" piece goes on the core from the same side as the first "T" piece. This method of assembly should be continued until the whole available space is filled with iron. Care must be taken in building up the iron to see that the insulation on the inside of the coils is not damaged. This is most likely to occur when the last half-dozen pairs are assembled, but by cutting off the corners of the leading edge of the "T" piece and exercising great care, this is not likely to occur. If the foregoing instructions have been carefully

followed, it will be found that about 100 pairs of laminations can be accommodated in the space available. Some strip brass  $\frac{1}{8}$  inch wide will now be required, and this should be cut in lengths so that a frame is formed along the sides of the iron core. These are held in position by four pieces of angle iron cut to the dimensions given in Fig. 4, and the whole held together by means of four B.A. screwed rods and nuts. Four strips of insulating material should be laid along the core so that the brass rods do not short-circuit the edges of the laminations. Before fixing the terminal battens, two pieces of  $\frac{3}{4}$  inch angle-iron, to form a base for

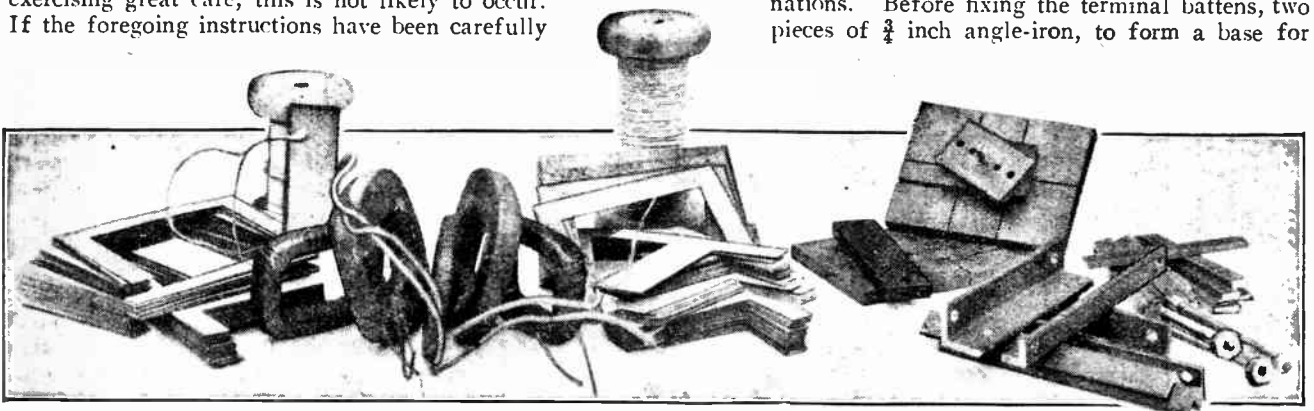

Fig. 8.—The power transformer before assembling the coils and the coil-winding former dismantled.

LIST OF PARTS.

- 2 5-amp. tumbler switches (linked) (G.E.C.).
- 2 5-amp. cut-outs (G.E.C.).
- 1 Philips rectifier, type 328 (Philips Lamp Works).
- 1 Philips safety resistance, type 329 (Philips Lamp Works).
- 2 Valve holders (Whiteley, Boneham & Co., Ltd.).
- 1 Gross transformer stampings No. 4 (Jos. Sankey & Sons, Ltd.).
- 1 Ammeter, 0-2.5 amps. (A. H. Hunt, Ltd.).
- 1 lb. No. 26 D.S.C. wire (London Electric Wire Co.).
- 1/2 lb. No. 22 D.S.C. wire (London Electric Wire Co.).
- 1/2 lb. No. 16 D.C.C. wire (London Electric Wire Co.).
- Quantity strip brass, 1/2 in. x 1/8 in.
- Quantity angle iron, 1/2 in. and 3/4 in.

- Quantity prespan sheet.
- 1 Lamp adaptor.
- 2 Ebonite shrouded terminals, + and - (Belling & Lee, Ltd.).
- 3 yards of twin flex.
- Wood for base and panel.
- Wood screws, 4B.A. brass screws, 4B.A. and 2B.A. nuts, washers, and soldering tags.
- Quantity thin linen tape, 1/2 in. wide (No. 2 width best Dutch tape).
- 10ft. No. 16 S.W.G. Glazite (London Electric Wire Co.).
- 2ft. 2B.A. screwed brass rod.
- Quantity 1/2-in. ebonite.
- 1 10-ohm. variable rheostat on porcelain (granitic).

Approximate cost - £3 0 0

the transformer, must be prepared, and these should each have two holes tapped 4 B.A. to take the fixing screws which are inserted from the underside of the baseboard. Fig. 3 shows the transformer assembled but without the terminal battens, and the general arrangement can be clearly seen from the photograph. The correct method of connecting the coils to their respective soldering tags is detailed in Fig. 4.

Final Adjustment.

Two pieces of fuse wire, blowing at a low amperage, should be inserted in the fuse boxes before the adaptor is connected to the supply mains. A Philips rectifier, type

No. 328, and a special resistance, type No. 329, should be fixed in their respective positions and the charger will be ready for final test. With the above rectifier the safe charging current is about 1.2 amps., and the 10 ohms variable resistance should be adjusted so that the current passing does not exceed this value.

The primaries of the transformers are shown connected for supply mains varying between 210 and 240 volts, but by connecting the two primary windings in parallel the charger can be used on supply circuits of from 105 to 120 volts. The wire connecting the two inside tags should be removed and alternate tags connected together for the parallel system of connections.

American Short-Wave Stations.

The note regarding interference with reception of NU 2XAD in our issue of September 21st has brought in a considerable amount of correspondence on this matter. One writer finds HJG most in evidence on Tuesdays, when 2XAD generally transmits an organ recital. It is understood that 2XAD has changed its wavelength from 22.02 to 21.96 metres, possibly on account of this same interference.

Another correspondent sends us the following extracts from his log:—

August 20th.—Unknown station heard, 22 metres, C.W., R8, signing HJG.

Sept. 2nd.—2XAD badly jammed by HJG sending dots and Vs.

Another complains that on the evening of September 22nd the station was sending out an almost interminable succession of Vs and dots from 10.10 p.m. onwards and again at 3.50 a.m., but that he cannot decipher the name sent.

Yet another writer states that the call-sign is not HJG, but SPG—in which case a Brazilian station would appear to be the delinquent.

o o o o

Short-Wave Broadcasting from Australia.

Several correspondents have reported the reception of the Amalgamated Wireless (Australasia) Ltd. experimental station OA 2ME, which transmits on 32 metres. One, writing from Newport, Mon., tells us that he heard the whole programme on Saturday, September 3rd, from 6.40 to 8.10 p.m. B.S.T., the

TRANSMITTERS' NOTES  
AND QUERIES.

strength being R5-6 on an 0-v-1 Reintartz receiver working off an indoor aerial. This type of receiver is similar to that used by the reader at Brockley whose reception was reported in our issue of September 21st, so it will be interesting to note whether other types are equally fortunate.

o o o o

New Call-signs and Stations Identified.

- 2BG (Ex 2BMB), G. R. Silverthorne, 4, Kimberley Rd., Six Bells, Abertillery, Mon.
- 2CN (Ex 2AXO), C. B. Cleland, 31, Dufferin Ave., Bangor, N. Ireland. Transmits on 23, 46, and 90 metres.
- 2CT C. L. Thompson, 5, Sinclair Grove, Golders Green, N.W.11.
- 2FD F. W. Davies, 13, Warbreck Rd., Walton, Liverpool. (Change of address from October 1st).
- 2HY J. G. J. Goddard, The Croft, Cark-in-Cartmel, Lancs.
- 2IJ W. J. Holroyd, Luddenden Foot, Yorkshire.
- 2KK R. H. Parker, The Bungalow, Willow Ave., Edgbaston, Birmingham (corrected address cancelling that given in error on page 310 of our issue of Sept. 7). Transmits on 36, 90, 100 and 200 metres and welcomes reports.
- 2OZ J. W. Norton, 6, Woodhurst Rd., Acton, W.5. (Change of address).
- 2PZ A. E. J. Symonds, "Bourn," Ashlawn Rd., Hillmorton, Rugby. (Change of address). Transmits on 45 metres.

- 2TU Radio Transmitters Union (Northern Ireland); Hon. Sec., J. A. Sang (GI 6TB), 22, Stranmillis Gardens, Belfast. Portable, 10 watts, transmitting on 8, 23, 45 and 90 metres.
- 5CD D. N. Corfield, "Queensmere," Kneeld Crescent, Hendon Central, N.W.4. (Change of address). Transmits on 165 and 45.6 metres and welcomes any reports.
- 5RS E. W. Rawlings, 22, Caxton Gdns., Guildford. Transmits on 150-200 metres and welcomes reports.
- 5SP J. Spafford, 15, Priory Rd., Blidworth, Mansfield. Transmits on 23 and 45 metres and welcomes reports.
- 6BN A. E. Bond, Groespluan, Welshpool. (Change of address after Sept. 30.)
- 6HF M. H. Wynter-Blyth, c/o Miss Dixon, "Whinwood," East Boldon, Co. Durham (temporary address); transmits on 46 and 23 metres.
- 6SB N. Mickle, 37, Bromham Rd., Bedford. Transmits on 45 and 175 metres.
- 6WB J. Bate, The Lodge, Stansty, Wrexham, N. Wales. Transmits on 45 and 150-200 metres.
- 2BPH A. R. Parker, "Glendaragh," Daisy Lea Lane, Lindley, Huddersfield.
- 2BPR H. E. Rainbow, 28, Spencer Ave., Coventry.
- 2BSJ A. F. Hembury, 57, Winstead St., Battersea, S.W.11. Will be glad to co-operate with other short-wave experimenters.
- EF 5FA P. C. Fellerin, 14, Route de Barentin, Malaunay (Seine Inférieure).
- KY 1AA L. D. G. Morrison, c/o Nairobi Club, Nairobi, Kenya Colony. Transmits on 23, 45, and 70 metres.

o o o o

QRAs Wanted.

- G 5RY, G 6KK, ISRA, KZET, SPW, WMM, YRYR.

o o o o

A Correction.

Mr. H. M. Cooper (OA 5HG) wishes us to correct an error in his address as printed in the R.S.G.B. Log Book. The correct address is 51, Hastings Street, Glenelg, S. Australia.



## Solutions of the H.T. Problem—Self-contained Sets—Battery Eliminators.

By B. H. DAVIES.

THE drawbacks of "wireless" in the past have been two in number. First, the ceaseless bother of supplies of current; and, second, the general untidiness of the hobby. These have naturally varied with individual circumstances and temperaments, but reach a not uncommon zenith in a farmhouse which I visited the other day. The receiver was two years old, and four bright-emitter valves projected vertically from a box cabinet decorated with a dozen and a half of knobs. A couple of Heath Robinson masts disfigured the garden, each being constructed of several knobbly saplings, lashed together with fencing wire. Inside the house wires trailed all over the place, as three downstairs rooms and two bedrooms were plugged for loud-speakers off a filter circuit, and each plug had its own earth. On two nights during my visit the set was out of action; the culprit in the first case was one of the cats, which had contrived to short the accumulator by pulling a wire off; on the other silent night the H.T. battery was down. The farm is situated seven miles from a charging station, and some member of the busy staff must make a total journey of 28 miles to restore discharged cells to their duties. A week in such a household would be calculated to frighten any intending listener off the hobby for ever. Technical men naturally fly to the new screened valves, and other scientific attractions, when they enter the Show; but the ordinary listener is seeking tidier wireless and the end of his difficulties about "juice."

He is naturally tickled by the innumerable "portable"

sets exhibited; almost every stand displays a receiver of this type, and at long last most of them are really efficient. They may be more "transportable" than "portable," but they are not too clumsy or weighty to satisfy my farmer acquaintance, for they can easily be moved into whichever room has a fire, or be carried upstairs in case of sickness. Their main defect centres, of course, round the folly of feeding the anodes of five valves from the smallest size of H.T. dry cells—a folly which is as expensive as it is tiresome, and cannot be perpetuated indefinitely. Symptoms of better solutions are visible: the Selector incorporates a high-tension accumulator, and is furnished with a mains charging unit; the Pelican is sold with optional mains units, which fit into



"Some member of the farm staff must make a total journey of 28 miles to restore discharged cells to their duties."

**Impressions at the Show.—**

the battery compartments and eliminate H.T., L.T. and grid batteries altogether.

Where price is no object, battery troubles and untidiness are at last readily ended at one swoop. Consider, for example, the Truphonic console type of receiver, a handsome piece of furniture, embodying frame aerial, powerful receiver, gramophone, and cupboard to hold a fine collection of records. £75 is more than most people can pay, but where all necessary currents can be taken off the mains this type of instrument represents a most attractive ideal.

**The H.T. Problem.**

I happen to live in an area where Morse wrecks practically every station except 5XX, and my wireless neighbours fall into two classes: the DX fiend, who is usually male and youthful; and the people who subsist on the 5XX programmes without ever touching their tuners.



"People who subsist on the 5XX programmes without ever touching their tuners."

Both of us alike find that the H.T. problem is our chief trouble. At the moment the big dry cells, such as the Siemens 50-volt 25s. pattern, are our favourite solution. Most of us have bought at least one set of H.T. accumulators, only to learn that the tiny cells spray most deplorably both on charge and for some time after charge; the resulting acid deposit bridges the (usually) brief leakage paths between cells, and instead of the capacity serving a four-valve set for three months as per catalogue, a 50-volt bank reads no more than 25 volts three weeks after return from the charging station. Continual mopping of the upper surfaces with rag tied to a short stick is a dreadful weariness in the flesh, and the most highly trained salesman now finds it difficult to sell H.T. accumulators in this district. But I noticed with profound approval at the Show that makers are beginning to be more sympathetic. Between the cells of the Ni-Fe H.T. accumulator there is a leakage path of at least ten inches, and the C.A.V. has a dead smooth polished top which can be wiped clean and dry in a single sweep when once the vent-plugs are removed. H.T. accumulators will obviously begin to deliver their rated capacity in 1928, though very few of them ever did so in 1927. But they have an evil past to live down, for people who have paid a fiver for an unserviceable article in the past will not readily be induced to invest again.

Mains units labour under special handicaps of their own; there have been one or two small accidents, which

spread quite unjustifiable alarm amongst people devoid of electrical knowledge; and some makers have marketed rather shoddy mains units, the repair of which entails most aggravating delays. It is so obviously absurd to be constantly hung up for want of four volts to supply filaments when anything from 100 to 250 volts is available for house lighting, that mains units are bound to come into their own presently. But the trade does not seem to realise that owners of multi-valve sets refuse to limit wireless reception to one room in their houses. The kitchen or servants' hall must have its loud-speaker in these days. There will probably be at least two reception rooms downstairs, in which speakers must be installed. In addition, the owner will occasionally require an upstairs installation during the convalescence of invalids. No firm as yet pushes such a comprehensive installation to take all current off the mains, though the Lotus remote-control unit for eliminators is a step in the right direction. Local traders will, of course, supply such outfits to special order; but if the work is not well done, there may be accidents, which will set the clock back rather seriously.

**The Boon of Reduced Filament Current.**

The cottager probably yearns for cheaper and less troublesome filament supplies more than for any other single improvement. He has no mains. He often resides at a considerable distance from a charging station, and has to take his discharged cells into town on a bicycle, or pay the local carrier 6d. freight on the double journey. Rural cottagers began by using a single-valve set with a .06 valve, several pairs of phones, and L.T. dry cells. The actual receiver was almost always home-made. The Filonator cells, if they are all they claim to be, could solve the chief problem which besets this type of user. He will learn to be grateful for the 0.1 ampere type of dull emitter, with its sturdy filament, likely to retain its pristine emission over long periods. There seems to be an opening for a mass-production campaign with lots of publicity to sell such users a two-valve loud-speaker set, possibly on easy payments.



"The kitchen or servants' hall must have its loud-speaker in these days."

The mast aerial tends to disappear from middle-class and wealthy homes. Such people do not spend all the year at one address, and in any case dislike the disfigurement of their grounds. Large console sets readily conceal efficient frame aerials, and the directional effect is not very important on the high-powered stations, whilst the Marconi type of frame aerial is by no means bad-looking, and much more graceful than the old diamond-

**Impressions at the Show.—**

shaped loops. DX work is quite unusual in such households.

**Self-contained Sets.**

The high-frequency stages of multi-valve receivers are increasing in efficiency by leaps and bounds. During the last year we have had the "Everyman Four" type of transformer, which is probably equal in efficiency to two H.F. stages of the old barrel transformer type; and this autumn has produced at least one new H.F. valve which confers still further reach on such stages. The superior tidiness and compactness of the self-contained sets which will spring into being within the next year or two should kill the mast aerial at most homes in which the income-tax collector is interested. The Show does not contain many sets on these lines, but such as exist are surely in the van of progress. Combined with a gramophone (or a gramophone compartment) and mains units, they meet every ordinary requirement. The one doubtful point is whether it will suffice to construct such sets so that they can be moved about a house by a couple of people without excessive exertion, or whether their output will be plugged into a domestic wiring system for tapping off in

various rooms. The latter seems to be indicated. Quality has made quite abnormal strides. The technical highbrow may be sighing for 250 volts on the anodes of a couple of super-power valves in parallel, in conjunction with a moving-coil speaker. But the ignorant ear will be perfectly satisfied with the modern cone speakers and a much lower output. Almost any three- or four-valve set, selected at random, and coupled to almost anybody's cone speaker, furnishes quality of a kind known to very few listeners twelve months ago.

Meanwhile the component people continue to confound all prophecies. Two years ago the pessimists were saying that even the red-hot enthusiast must presently tire of ever buying new parts and ever constructing new sets. But the crush at the stalls where condensers and transformers and other "bits" are staged is as thick as ever. Even in such sophisticated thoroughfares as the Strand an unusual crowd outside a shop-window generally marks the location of a wireless window just as infallibly as it does in Bishopsgate. The instinct to create dies hard in masculine breasts, at any rate; and it must be confessed that the 1928 components open the door to sets more fascinating and miraculous than any we have built in the past.



## CLUB REPORTS AND TOPICS

*Secretaries of Local Clubs are invited to send in for publication club news of general interest. All photographs published will be paid for.*

**In County Durham.**

Members of the South Hetton and District Radio Society listened to an interesting lecture on "The Care and Maintenance of Accumulators" at their general meeting on September 22nd.

Meetings during the winter will be held in the Old School, South Hetton. Membership is open to all in the district who are interested in wireless.

Hon. Secretary: Mr. M. G. Hall, 33, Forster Street, South Hetton, Co. Durham.

o o o o

**Institute of Wireless Technology.**

"The Design of a Resistance-Capacity Amplifier for Broadcast Reproduction" is the title of a lecture to be given by Mr. G. Leslie Morrow, F.R.S.A., at the opening meeting of the 1927-8 session of the Institute of Wireless Technology to be held at the Engineers' Club, Coventry Street, W., at 7 p.m. on Tuesday, October 11th. Those interested in this or other meetings of the Institute are asked to communicate with the Hon. Secretary, Mr. Harrie J. King, at 71, Kingsway, London, W.C.2.

o o o o

**Radio Experimental Society of Manchester.**

The Radio Experimental Society of Manchester will resume winter activities on October 7th, when an open meeting will be held. Full particulars are obtainable from the Hon. Secretary, Mr. J. Levy, 17, Lansdowne Road, West Didsbury, Manchester.

Society a general discussion will take place on the topic "Below 50 Metres."

An unusually interesting programme has been prepared for the winter session. Those interested in the activities of the Society should communicate with the Hon. Secretary, Mr. Gerald S. Sessions, 20, Grasmere Road, Muswell Hill, N.10.

o o o o

**A Visit to N.P.L.**

On a recent Saturday members of the North Middlesex Wireless Club were privileged to visit the National Physical Laboratory at Teddington. The party visited the wireless section, where several novel investigations are proceeding, and various sections dealing with other phases of scientific research. The visit was a distinct success; unfortunately such an opportunity rarely occurs, this visit having been booked nearly 12 months ago.

Hon. Secretary: Mr. H. A. Green, 100, Pellatt Grove, Wood Green, N.22.

o o o o

**Hackney Society's Annual Dinner.**

The Hackney and District Radio Society will hold their annual dinner, concert, and dance to-morrow (Thursday) at the Talbot Restaurant, London Wall. Organiser: Mr. W. J. Sanson, 77, Upper Clapton Road, E.5.

o o o o

**Stretford and District Society.**

A demonstration of the Loewe valve will be given to-morrow evening (Thursday) at a meeting of the Stretford and District Radio Society at 8 p.m. at 6a, Derbyshire Lane.

**Southend's Anti-Oscillation League.**

A novel demonstration of the evils of oscillation was provided by the Southend-on-Sea and District Anti-Oscillation League at the recent carnival in the town. The demonstration took the form of a realistic scene built up on a lorry. Two separate rooms were shown, separated by a party wall. In one room a valve set was being manipulated by a schoolboy, while the occupants of the other—an elderly gentleman and a lady—made fruitless attempts to receive the broadcast programme on their wireless set, being interrupted by the oscillating activities of the boy next door.

In the Market Square the Hon. Secretary addressed the crowd through a loudspeaker, explaining the objects of the League and pointing out that those in trouble from oscillation should apply to the headquarters of the League.

Hon. Secretary: Mr. F. L. Pearce, 12, Grange Gardens, Southend-on-Sea.

o o o o

**Muswell Hill and District Radio Society Resumes Meetings.**

At this evening's (Wednesday's) meeting of the Muswell Hill and District Radio



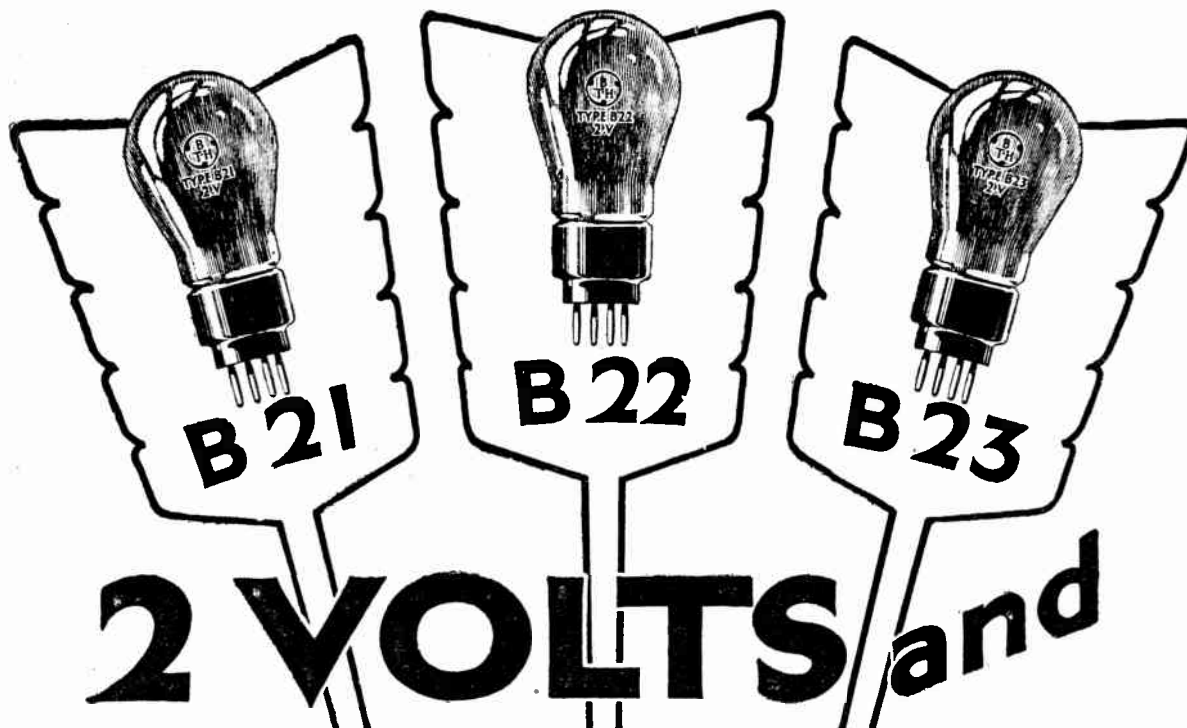

B.T.H. Valves are not "made-in-a-hurry" valves, much time and money—involving long and patient research work—having been expended in the search for the perfect 2-volt valve. At last it is an accomplished fact—a perfect 2-volt valve—and B.T.H. Not just one type, but a complete 2-volt series is now available, comparable in performance and length of service with the best of the 6-volt range.

B.T.H. 2-volt valves are perfect in every part. The filament has no superior in strength, endurance or emission, whilst the anode and grid, by their accurate placing in relation to each other and the filament, ensure the all-round working efficiency of the complete valve. They are exact valves, built to satisfy the most exacting requirements. Every valve is tested to fulfil the fundamental needs of radio viz :—(a) perfect reception (b) long life—no valve will last longer—and (c) economy in upkeep.

Type	Purpose	Fil. Volts	Fil. Amps.	H.T. Batt. Volts.	Ampl. Factor	Impedance	Price
B 21	H.F.	2	0.1	40 to 150	16.0	32,000 ohms	s. d. 10 6
B 22	G.P.	2	0.1	40 to 100	7.5	14,000 ohms	10 6
B 23	Power Amp.	2	0.2	40 to 100	6.0	8,000 ohms	12 6

If you are interested in R.C. Coupling, write for a copy of the "RESISTOR" booklet to Publication Dept., The British Thomson-Houston Co., Ltd., Rugby



The above prices are applicable in Great Britain and Northern Ireland only

The British Thomson-Houston Co., Ltd.  
Crown House, Aldwych,  
—London, W.C. 2—

The New  
**RI**  
 AND  
**Varley** LTD

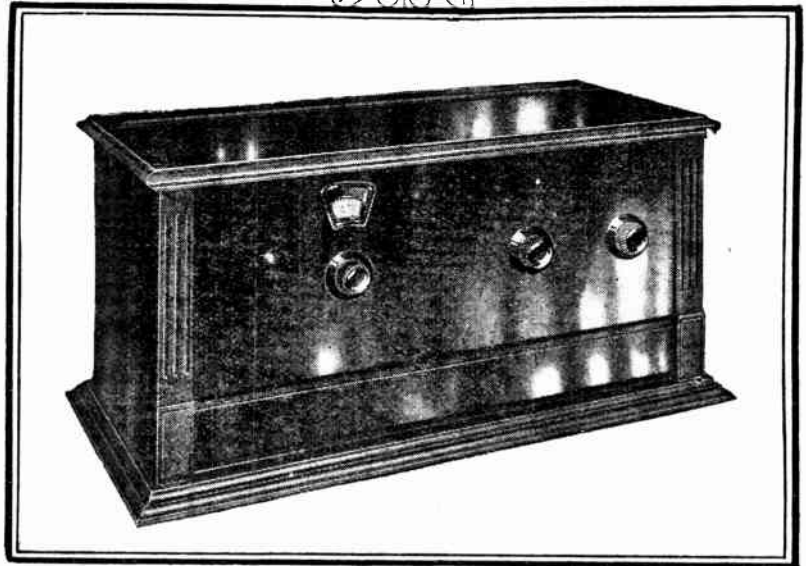

## INTERDYNE RECEIVER

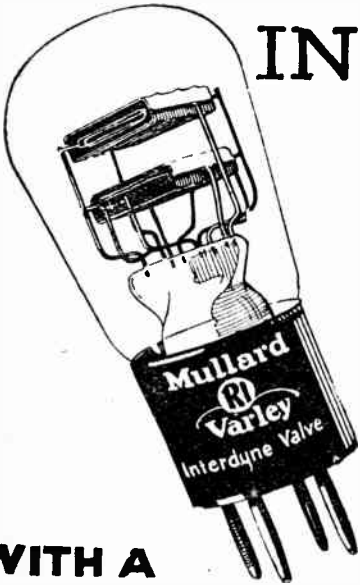

WITH A  
**WONDERFUL  
 NEW VALVE**

This new 5-Valve Receiver — incorporating the now-famous Mullard, R.I. and Varley Interdyne Valve (Dr. Robinson's Patent)—has been the big attraction at the National Radio Exhibition.

A Leading Daily Newspaper, realising the tremendous advance this Receiver marks in the progress of radio science, arranged for a special test, with results which proved beyond doubt that here at last was a device which eliminated that noisy background hitherto accepted as a necessary evil in all wireless receivers.

In this particular test, a large number of foreign stations were received, in a very short time, with a volume and purity of tone which made reception a real pleasure.

The special valves — two of which are incorporated in this Receiver—have four electrodes (a double grid and two separate anodes), with one filament so disposed that it affects only one of the anodes. With this particular arrangement any electrode capacities generated inside the valve are automatically cancelled, thereby enabling the maximum high frequency amplification to be obtained without instability or the necessity for using external devices. Owing to the very remote possibility of these valves oscillating, the loudspeaker can be pushed to its limit without any fear of distortion.

For **SUPER SELECTIVITY, VOLUME and PURITY OF TONE**, the R.I. and Varley Interdyne Receiver has no equal.

Two models are available, one for 250-550 metres and the other for both 250-550 and 1,000-2,000 metres, the change over from short to long waves being effected by a single switch.

Short Wave Model - - - £25 0 0

Long and Short Wave Model £42 0 0

"Interdyne" Receiver Leaflet, free on application.

**RI**  
**Varley**

**THE MARK OF BETTER RADIO**

Kingsway House, 103, Kingsway, W.C.2.

Telephone: Holborn 5303.

Mention of "The Wireless World," when writing to advertisers, will ensure prompt attention.

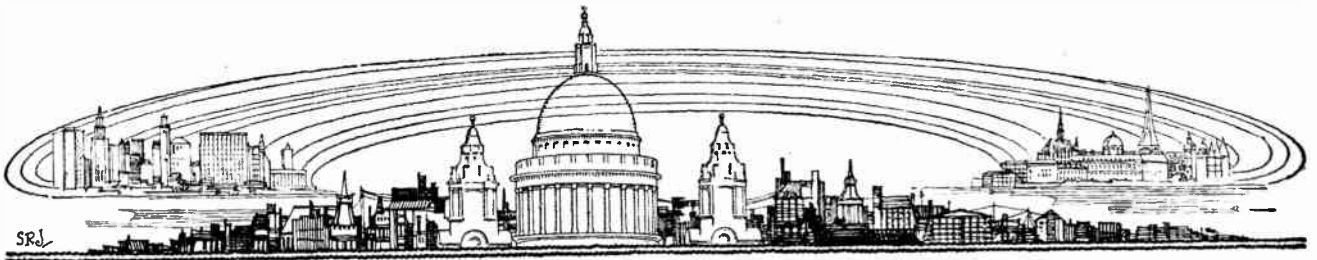

# CURRENT TOPICS

## Events of the Week in Brief Review.

### THE LONG, LONG TRAIL.

It is estimated that just under 80,000 paying visitors passed through the turnstiles at Olympia last week.

○○○○

### NO FURTHER BULLETINS.

Many men at Olympia, we are told, brought their wives into the discussion of proposed new sets. The man who did not is stated to be progressing as satisfactorily as can be expected.

○○○○

### LOUD-SPEAKERS AND EFFICIENCY.

A West Hartlepool contractor has installed a wireless receiver and loud-speaker in his workshop, declaring that the innovation has increased the output of his employees.

○○○○

### A TRUNK CALL.

A telephonist at The Hague had a startling experience the other day when, unknown to him, the line was connected via Amsterdam with the famous Eindhoven short-wave station. On his enquiring whether he was speaking to Amsterdam he received the reply, "No, you are speaking to Bandoeng!" (Bandoeng is in the Dutch East Indies.)

○○○○

### EVENING WIRELESS CLASSES.

Evening classes in electrical subjects, including radio engineering, opened at the Northampton Polytechnic Institute, St. John Street, London, E.C.1, on Monday, September 26th. The session will terminate with the examinations to be held during the week ending May 19th, 1928.

Full particulars regarding fees, hours, etc., can be obtained on application to the principal, S. C. Laws, Esq., M.A., M.Sc., at the Institute.

○○○○

### "WIRELESS LOUD-SPEAKERS."

Owing to a large demand a second edition of "Wireless Loud-Speakers," by Dr. N. W. McLachlan, has been prepared and is now available from all leading booksellers, price 2s. 6d., or direct from the publishers, Iliffe and Sons Ltd., Dorset House, Tudor Street, London, E.C.4, price 2s. 8d. post free. Dr. McLachlan's book describes in a simple manner the underlying principles of modern loud-speaker design, with special attention to the large diaphragm type.

### MAINS SET FOR HOSPITAL.

A broadcast receiver designed to work entirely from the local electricity supply is being installed in the Isolation Hospital, Oakley, Bedfordshire.

○○○○

### COMMON KNOWLEDGE.

"What is the B.B.C. and where are its headquarters?" a Bradford schoolboy was asked in a General Knowledge test a few days ago. The reply was: "Bradford Bowling Club—Park Avenue."  
—Leeds Mercury.

○○○○

### WIRELESS ON AERIAL AMBULANCE.

An aerial ambulance, equipped with wireless telephony, is to be inaugurated by the Australian Inland Mission, for service in the north-west. Medical service will thereby be available to isolated districts over a radius of 300 miles.

○○○○

### ONE MORE LISTENER.

A wireless set is becoming a favourite article for presentation to distinguished personages. Last week Mr. Weber Brown, chairman of the Bridge Estates Committee of the Corporation of London, was presented with a wireless set by the

Lord Mayor on behalf of the City Corporation, in recognition of his services towards the maintenance of the City's four bridges.

○○○○

### WILLESDEN'S WIRELESS HOUSES.

Permanent wireless equipment will be a *sine qua non* in the house of the early future, a certainty which has not been overlooked by the Willesden Urban District Council in planning their new estate between Neasden and Harlesden. The houses, which are reaching completion at the rate of 100 per week, each contain an aerial concealed in the roof, with an earth wire hidden in the plaster of the walls. An additional refinement is the provision of loud-speaker "points" in the dining-room and drawing-room.

○○○○

### B.B.C. SHORT-WAVE STATION.

As we go to press we learn that the short-wave experimental station at Chelmsford will use the call-sign 5SW, not 6SW, as stated on p. 495 of this issue. Power up to 25 kilowatts will be used. It is not expected that this experimental station will undertake a regular service though programmes may be transmitted if unexpected success is achieved.

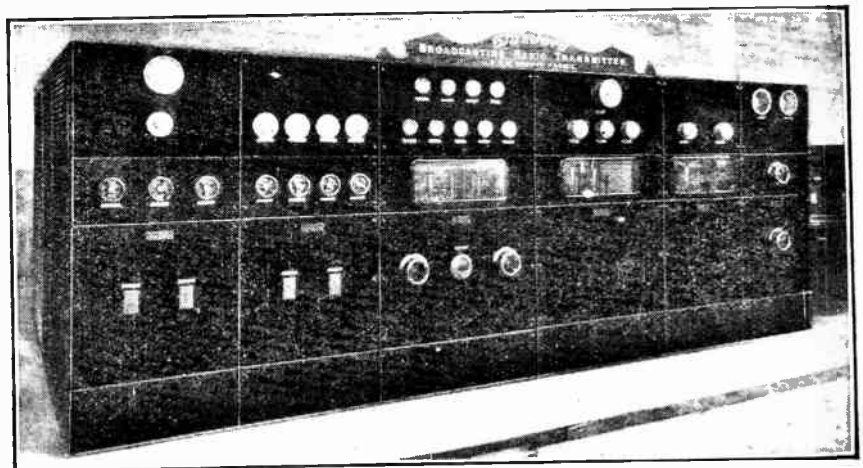

**LATEST IN BROADCAST TRANSMITTERS.** The new "Standard" transmitter on the B.B.C. stand at Olympia. Supplying an aerial power of 5 kilowatts, the transmitter embodies H.F. magnification, modulation being carried out at low power and amplified by successive power stages.

# THE TREND OF DEVELOPMENT.

A Critical Review of the New Designs and Devices Seen at Olympia.

"MANY real advances, with steady progress everywhere." Thus one may summarise the trend of design since last year's Show. It would probably be true to say that the greatest improvement has been made in the matter of selectivity. Gone are the directly-coupled aerial circuits of the past, except in a few of the cheapest receivers. Apparently the manufacturers have realised that when the Regional Scheme comes into operation a set which now gives satisfaction to the average "local" listener (who seldom requires real selectivity) will become hopelessly out of date, and they are wisely preparing in advance for the new order of things in order that purchasers may not be dissatisfied.

## Screened Valves.

The introduction of sets using the new screened valves is one of the very few radical departures from previously known practice. It seems clear that the average designer considers that these may be most usefully employed in circuits having more than one H.F. amplifier. An outstanding example of the three-stage screened valve amplifier is the Marconi-phone "Round Six," in which the apparatus associated with individual valves is enclosed in screening cases. The valves themselves are mounted horizontally, and, to reduce the space occupied, they are staggered so that the input end of the second is at the side of the output end of the first. H.F. coupling is by the tuned anode method with astatic (almost fieldless) coils. Long and short-wave inductances are placed in the same compartment, with an elaborate and ingenious switching arrangement, operated

by a single knob, for changing wavebands. It is observed that no special efforts are made to reduce the H.F. resistance of the coils; indeed, in the nature of things, "fieldless" inductances can hardly be expected to make a good showing in this respect, and in all probability a certain amount of resistance helps in giving stability. However, with three stages, it is quite unnecessary to strive after maximum amplification from each valve. As long as this is reasonably good, it is far more important that the set should be really stable, and there seems to be no doubt that the instrument in question gives the maximum useful magnification under average conditions.

an easy matter to set each individual dial of each pair in a position which will give substantially correct tuning over a certain waveband when each pair is rotated together by a single finger. Thus the set has, practically speaking, a "two-knob control."

There are several other receivers incorporating the screened valves, including the B.B.C. Radio Exchange (of which more later) and the "New Everyman-Four" which is now produced commercially by Peto Scott.

A great improvement is noticed in H.F. amplification; practically every set shown includes some form of capacity neutralisation, and we seldom find the

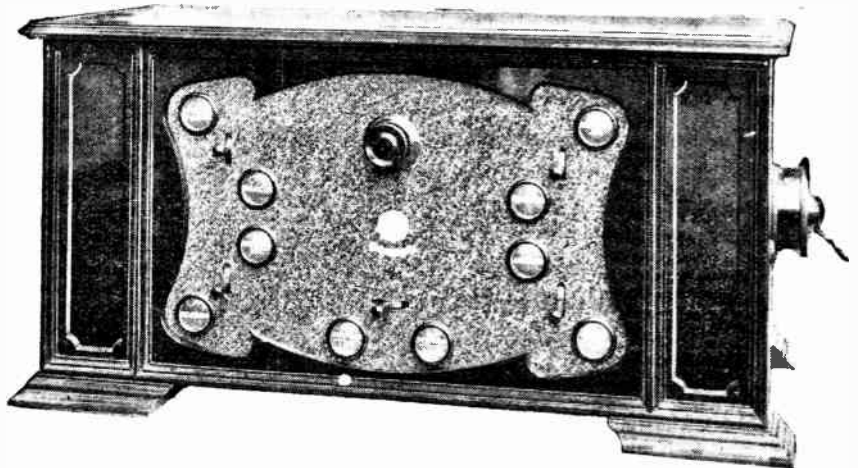

An example of advanced design. The B.R.C. "Radio Exchange"; it has no tuning dials.

Moreover, this magnification is likely to be associated with reproduction of high quality, as anode bend detection is followed by what is obviously a carefully-designed resistance-coupled amplifier, and there is likely to be little distortion in the H.F. amplifier, as none of the circuits are particularly sharply tuned.

The method of tuning has much to recommend it, as the difficulty of four separate circuits is overcome in a very simple manner by fitting two adjacent pairs of edgewise dials. When a few stations have been located it should be

"tuned anode" receiver "held down" only by aerial loading and incidental circuit resistances. There is, however, still a good deal of room for improvement, and very few coupling transformers capable of giving a magnification of, at a guess, more than 20 were observed in complete sets. As far as these are concerned, the use of interchangeable coils seems to be less popular. As a rule, elaborate and in many cases ingenious arrangements for making the necessary circuit changes for waveband alterations are included. The plug-in coils and transformers are used in the cheaper sets, and also in some of the more ambitious ones which are intended to appeal to the enthusiast who wishes for maximum amplification per stage, and who is unwilling to make any sacrifice in efficiency for a gain in convenience of operation.

## Fixed Tuning.

While on the subject of circuit switching, mention should be made of the B.R.C. "Radio Exchange," a five-valve set including two screened valves as H.F. amplifier. There are no fewer than 24 tuned circuits (8 sets of 3). A most

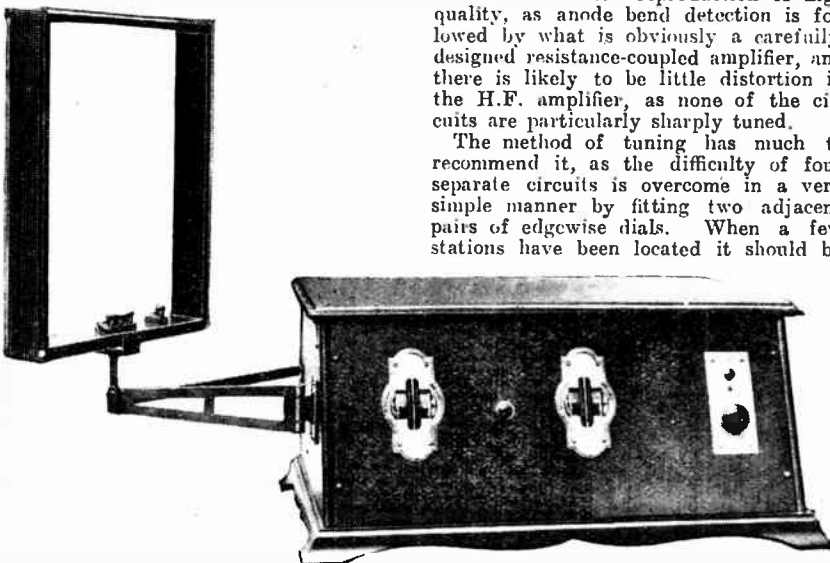

The "Round Six." Three screened grid H.F. stages are incorporated, and tuning is simplified by the edgewise mounted controls.

**The Trend of Development.—**

elaborate mechanical device is arranged to throw into circuit the set appropriate for the station required. This operation is carried out by depressing a key adjacent to an illuminated disc mounted on the panel and bearing the name of the transmitter. There is a choice of eight stations; these may be chosen at will, and the circuits are adjusted by the agent supplying the set. The prophets have opined since the earliest days of broadcasting that the set of the future will include an arrangement of this sort, and it will be generally admitted that it is distinctly attractive, especially from the point of view of the non-technical listener. The main objection at present is that the services of the agent may be frequently required to readjust for changes in transmitted wavelength. This difficulty will doubtless disappear in the not-too-distant future.

**Wave-change Devices.**

Credit for the design of particularly interesting change-over devices should be given to the General Electric and Marconiphone Companies. The former company includes provision for connecting a gramophone pick-up to all their new sets, while the "universal feed" arrangement of the latter firm must be recorded as a step in the right direction. As already stated in *The Wireless World* Show Report, each set is wired in such a way that the ends of filaments, anode supply leads, etc., are brought out to a row of small screw terminals mounted on top of the sub-panel. By connecting an appropriate battery cable, such alterations



The Langham glass-enclosed receiver on Console base housing the batteries and loud-speaker.

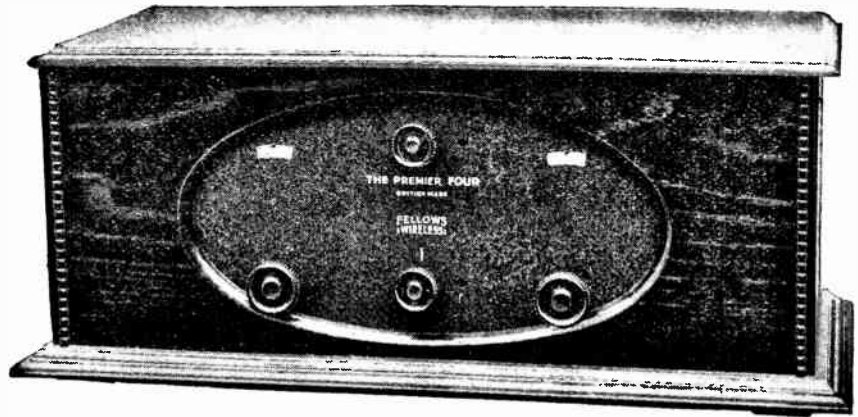

Four-valve receiver with neutralised H.F. stage and anode detection followed by a resistance-coupled L.F. amplifier.

as series-connecting the filaments and the provision of extra contacts for feeding A.C. indirectly heated valves are automatically effected. Thus the same set may be used for batteries, A.C. or D.C. The obvious advantage is that a smaller range of receivers is required; consequently larger quantities of each model may be manufactured with corresponding economies in production which can be passed on to the user.

Anode bend detection is still surprisingly rare if one takes into consideration its advantages from the point of view of selectivity only. Similarly, in receivers including a combination of resistance and transformer L.F. coupling, it is noticed that a number of manufacturers still prefer to use the resistance stage last. It is sometimes stated that this facilitates the separation of H.F. and L.F. components, but surely the difficulty is not insuperable if the other and more correct sequence is used?

Only one or two makers seem to have realised that a "high magnification" valve operating as an anode rectifier, followed by a single resistance-coupled L.F. amplifier, makes an extremely satisfactory and, above all, inexpensive short-distance receiver.

"Ganging" of condensers, which gives a single-knob tuning control, is increasingly popular; one may hazard a guess that this will become almost standard except perhaps for those who

are willing to learn enough about their sets to enable them to operate the more complicated arrangements.

To be able to take a self-contained wireless set away while on holiday or to carry it from room to room has obvious benefits which have prompted a large number of manufacturers at the Exhibition this year to pay attention to the production of this type of receiver. There is, moreover, a section of the public which is prejudiced against the erection of an outside aerial on the score

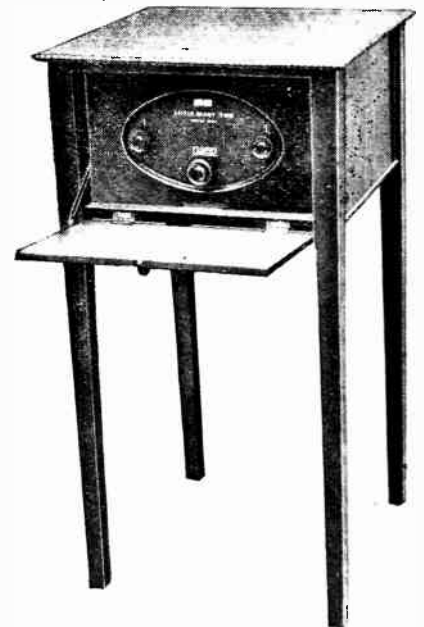

The Fellows 2-valve receiver, with anode detection and one resistance-coupled L.F. stage.

of its being unsightly—while those who live in flats are in most cases restricted to using indoor aerials or frame aerials; to both these classes of listeners the portable set appeals.

There are forty to fifty portable sets exhibited at Olympia, and an examination of thirty of these reveals a marked similarity in general design, and while

**The Trend of Development.**—

describing the various circuit arrangements used it would be as well also to discuss some of the difficulties that beset the designer.

A small frame aerial is reasonably efficient on short waves, but the phase dif-

ference across a frame of about 18in. is such that the pick-up on Daventry's wavelength is small and the only compensation is added high-frequency amplification. No portable set is complete as a commercial proposition unless there is provision, by switching, for both long and short B.B.C. waves. It is usual,

accommodate their frames within the containing cabinet or suitcase, and no example of this method was found. Two manufacturers, at least, utilise every turn of the frame for both wavelengths by winding three sections and throwing them in parallel for short waves

lately 0.075 ampere) with robust filaments and non-microphonic properties such that interaction is absent.

It is only within the last year or so that 0.1 ampere 2-volt valves of high mutual conductance have found their way on to the market concurrently with really unspillable accumulators; this combination has almost completely ousted the 3-volt 0.06 valve of somewhat low mutual conductance fed from a large unchargeable L.T. dry cell with an inconvenient discharge curve. A number of 2-volt power valves capable of handling about 20 volts grid swing at 120 volts H.T. are now on the market, so that a good volume of excellent quality signals should be available from the loud-speaker. The easy adaptability of the cone loud-speaker to portable sets (and quite 75 per cent. of sets are so fitted), together with the advent of really efficient 2-volt valves worked in conjunction with unspillable accumulators, have been the means of making the portable set emerge from a position of obscurity to one of predominance, as is evinced by a visit to the stands of set manufacturers. It would appear to be

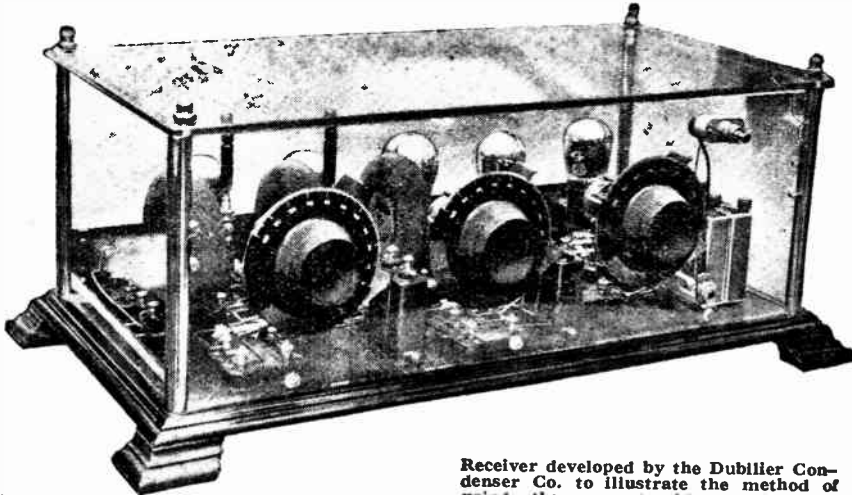

Receiver developed by the Dubilier Condenser Co. to illustrate the method of using the new toroid transformers.

and series for long waves, while those manufacturers who have had long experience in circuit design break the unwanted turns in no fewer than four places. The loading of a short-wave frame by a plug-in coil can only be found in a very few instances, and must be considered as out of date. Another difficulty which ought to be overcome is the inductive coupling of the frame with the H.F. chokes or transformers, and in this respect there appears to be little evidence of proper screening.

In self-contained sets of small proportions it is a *sine qua non* that the loud-speaker be within a few inches of the valves, with the likely result that acoustic reaction will be set up where low consumption filaments of the smallest diameter are used; with the 0.06 valve, trouble in this direction was always evident, but there is to-day on the market a plethora of 0.1 ampere valves (and more

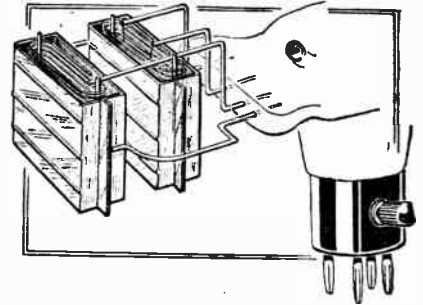

The new Robinson five element valve. The duplicated grid and plate electrodes replace the neutralising condenser customarily used in stabilised H.F. amplifiers

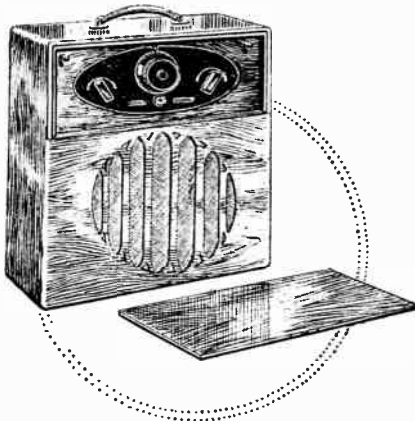

Hart-Collins 5-valve set. This is a typical example of this season's portable receivers.

therefore, either to wind two completely separate frames fairly close together on the same former or to tap the Daventry frame for the reception of the shorter waves. When the latter method is employed and the set is tuned to short waves the unwanted turns on the frame must either be left as a dead-end, short-circuited or disconnected; in all these methods, especially the first and third, the unused section of the frame is likely to have an influence on the tuned section, resulting in "blind spots." The ideal arrangement is the provision of two separate frames, which can be plugged in at will. but all truly portable sets

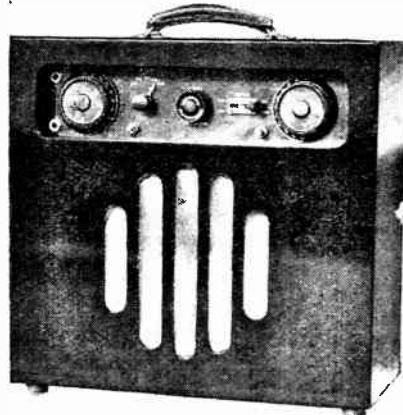

Another typical portable, the Rees-Mace.

the aim in most portable sets to prevent the valve from vibrating in its holder, and in a number of cases rigid holders are supplied; one manufacturer damps any movement by pressing a wad of rubber sponge against the glass bulbs of all the valves, while others use the vacuum-shrouded valves now on the market.

Turning now to circuit arrangements, it is found that the majority are straight, only a small number of superheterodynes being available, but in view of the fact that practically every maker has decided that more than one tuning control is beyond the ability of the average non-technical purchaser a limitation is at once put on efficient high-frequency amplification, and it is not surprising to find that of the thirty sets examined twenty-eight had five valves, two of which were high-frequency amplifiers. To obtain some degree of amplification, which per stage must undoubtedly be small, the usual practice is to have aperiodic chokes which do not have to be changed when switching over from short to long waves. The question immediately arises as to why for the sake of one-dial control such extreme sacrifice in H.F. efficiency is made, and an answer is given that reaction, properly applied, and all

**The Trend of Development.—**

the sets reviewed were provided with means for controlling reaction, brings the signal strength up sufficiently. Such a sweeping indictment of the methods of high-frequency amplification is not fair in the case of three or four manufacturers who have evolved tuned low-loss transformers or tuned impedance couplings, but it is rather regrettable that

fairly safe to predict that the screened-grid valve will before long have a profound effect on the design of portable sets.

No important advance in design has taken place, but a general improvement of the ordinary run of loud-speakers is evident. During the year the cone or diaphragm loud-speaker has firmly established its preponderance over the once popular horn type, and many new designs have made their appearance. The limit in size for this class of instrument appears to have been reached in the B.S.A. 36in. Kone, which is designed for garden parties, dancing, etc. At the other

been discovered, or rather the bulk of the manufacturers have acquired the knowledge, that the losses of the worst air dielectric condenser are small compared with the losses associated with the best coils. Having amicably decided this point of difference they have been able to turn their attention with extremely gratifying results to a much more important quality, namely, the mechanical perfection of their products. The variable condensers as a whole this year are a credit to British instrument making and engineering production. The condenser makers have set their house in order just in time, for recent develop-

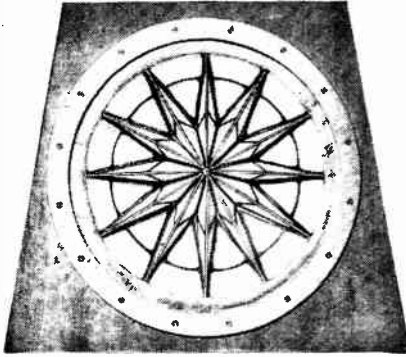

Reinforced cone diaphragm of the "Desertune" loud-speaker which is now sold as a separate unit mounted as shown.

only one case of neutralisation was discovered, and no case of ganging of log. condensers. The reaction employed in practically every case consisted in controlling by a variable condenser the amount of energy feed back to the frame (employing a few extra turns), by the Reinartz method, and so as to give unrestricted use of this, leaky grid rectification was universal, since bottom bend detection usually requires a big impedance in the anode circuit with consequent difficulty in obtaining ample regeneration. For the same reason where in the L.F. stages both transformer and resistance coupling were used it was noticed that the transformer was placed first, causing worse distortion if the last valve were overloaded than if the couplings were in the reverse order. About half the sets reviewed used two transformers in the L.F. stages. It is

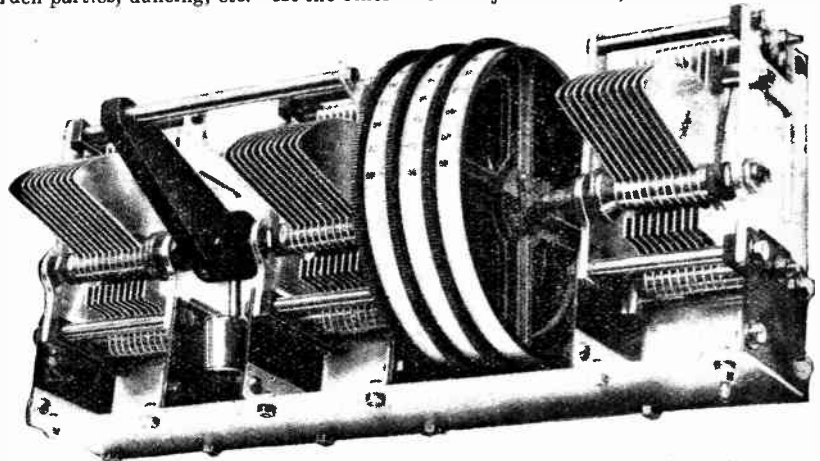

Cyldon triple condenser unit with independent thumb control for each condenser.

end of the scale numerous smaller cones are now available at extremely reasonable prices.

**Loud-speaker Diaphragms.**

A diaphragm that calls for special comment is that incorporated in the Desertune loud-speaker of Messrs. Walker Bros. This is fluted and reinforced, and is extremely light, being constructed entirely of parchment and veneer wood. The diaphragm itself, specially mounted with wash leather suspension, is sold separately, and should appeal to home constructors.

The Rice Kellogg still retains its position as the nearest approach to perfection so far achieved, and is manufactured by two firms—the B.T.H. and Marconi Companies. This will never be a cheap

ments in H.F. amplification and selectivity are going to show up any mechanical defects, now that stations come in at nearly every degree on the dial, and the circuit passes into and out of resonance in the space of half a degree or so.

Special short-wave condensers of low minimum and small maximum capacity are numerous, and there are signs that ganging and the American system of "thumb-control" are gaining in popularity.

The one-time ubiquitous plug-in coil shows signs this year of waning popularity—at least as far as wavelengths below 600 metres are concerned. In this region the cylindrical single-layer coil predominates, and was to be seen in some form or other on nearly every stand, generally wound with Litz, and frequently on paxolin formers. On longer wavelengths, however, the plug-in coil is not likely to be superseded, and those types which have survived and were shown this year are of efficient design. In some instances Litz is used, and the design follows the best practice as advocated by well-known authorities on coil design. It is significant also that certain pairs of coils are provided only with centre tapings, untapped coils being no longer available.

The importance of reducing the external field of coils is also more fully appreciated, and astatic, "binocular," and toroidal coils are examples of the various manufacturers' methods of solving this problem. The Cosmos astatic coils are

loud-speaker, as for obvious reasons a power amplifier must be built into the instrument. The power absorbed renders the use of mains almost imperative, so that its use is not likely to become general, but for those who must have the best the choice of a Rice Kellogg is a foregone conclusion.

The fierce controversy which was once waged over metallic or non-metallic end plates has now died down, and condensers with metal and Bakelite end plates are to be seen lying peacefully side by side on the stand of the same maker. For it has

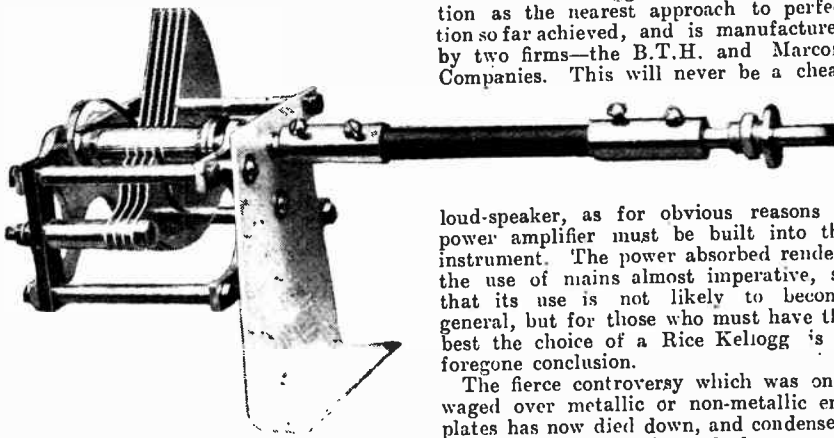

Cyldon short-wave condenser complete with baseboard - mounting bracket, ebonite extension rod and panel bush for dial spindle.

**The Trend of Development.—**

interesting on account of the inclusion of a few turns of resistance wire coupled to each section of the coil. The resistance coils are connected in series, and balanced one against the other, and it is claimed that while they do not affect the performance of the coil as a whole, they are effective in damping out parasitic self-oscillation of the individual sections of the coil.

Short-wave coils with air-spaced turns and special bases with widely spaced contact pins are more in evidence this year than last.

**Battery Eliminators.**

Scarcely sufficient time has elapsed since the introduction of the several specialised items leading to the production of the mains operated set.

Doubt has existed as to the perform-

that to derive plate or filament current from public supply mains would not

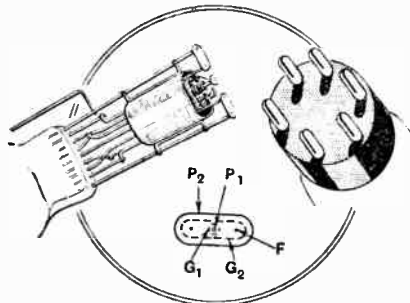

The electrode construction of the E.S. 220 valve.

prove satisfactory. Not only has experience led to greater confidence in the success of the eliminator, but the requirements of the modern set by way of high anode potential with liberal current have forced the adoption of other means of supply than primary and secondary batteries. Fundamentally there has been no change in the methods adopted. For deriving anode current from alternating current supply three forms of rectifiers have been manufactured, the electrolytic, glow discharge tube, and the thermionic valve. The first of these methods has not survived owing to its messy, corrosive and spillable properties. The second, although much in evidence last year, has practically disappeared, though still much

tion in the design of the electrodes and the nature of the rarified gas contained may render it admirably suited to the production of the high D.C. potentials now demanded for power output valves. The thermionic rectifier is now almost universally adopted, making use of such valves as the U4 and U5 with thoriated filaments, and DU2 and DU10, with coated filaments.

High anode voltages are now required, and the demand has been met by the appearance for the first time of a thermionic rectifier valve, the B.T.H. R.H.1, capable

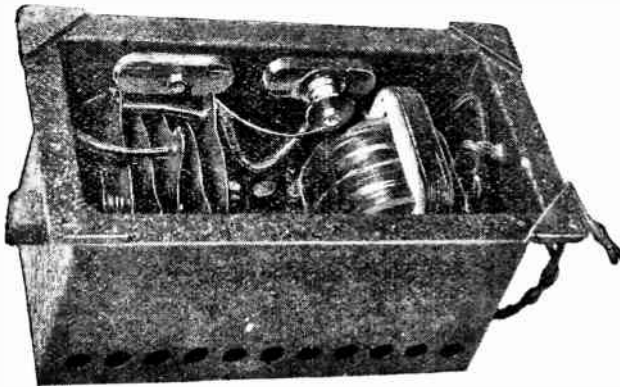

The new Ferranti battery charger making use of an entirely new method of rectification.

ance of the various H.T. and L.T. battery eliminators, and it has been suggested, though from what we have seen at this Exhibition is somewhat difficult to believe,

not survived owing to its messy, corrosive and spillable properties. The second, although much in evidence last year, has practically disappeared, though still much

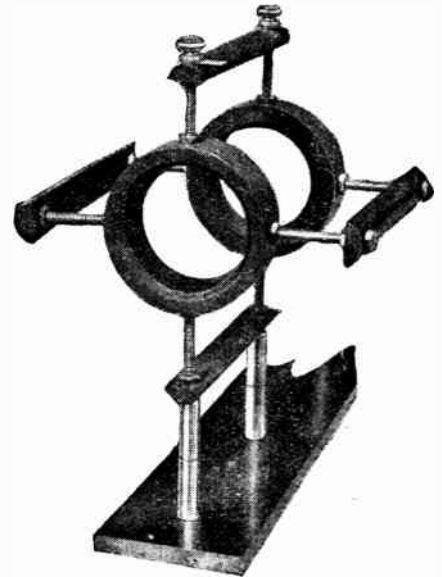

An adjustable coil mount useful in the construction of short-wave receiving sets (Jewel Pen Co.).

of giving a normal working anode current of over 65 mA, and suitable for use with an anode voltage of 550 R.M.S. Necessarily the filament watts are high, a current of 1.2 amperes being required at a potential of 7.5 volts, though this is of little consequence. The valve is suitable for maintaining a voltage drop in an external circuit of over 450 on a working load far in excess of normal power valve requirements.

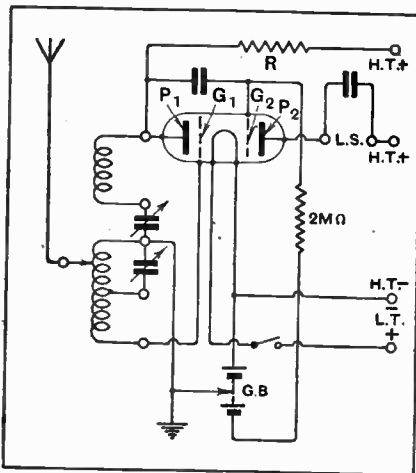

Suggested circuit arrangement making use of the new Ediswan E.S.220 Duplex Valve.

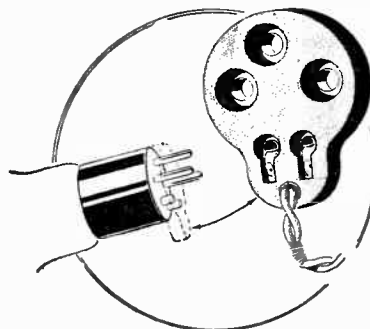

A useful Cosmos device for adapting a standard valve-holder for use with the indirectly heated cathode valve.

in favour in the United States. More liberal smoothing equipment is required than is the case with the thermionic rectifier owing to the non-linear anode characteristic. It is unsafe to assume, however, that this form of rectifier will disappear from the British market, and a modifica-



"Quixo" L.T. battery tester. Meters for determining the condition of batteries are now in more general use.



**The Trend of Development.—**

Power transformers giving the required filament current and arranged for full wave rectification with 400+400 volt secondary windings mark the trend both as regards battery eliminator production and the progress in L.F. amplifier requirements. Although high anode potentials have long been employed by the experimenter, one might reflect on the possible dangers of a 500-volt H.T. supply for general use when regulations limit household potentials to 250. Obviously the remedy is to incorporate the eliminator as part of the receiving set, though intervalve transformer manufacturers now suggest the adoption of push-pull amplifying circuits so that the existing types of intervalve transformers may be in keeping with power stage requirements. The several potential outputs needed may be obtained either by potential dividing, by a potentiometer or dropping volts through series resistances. Both methods are in general use, the former

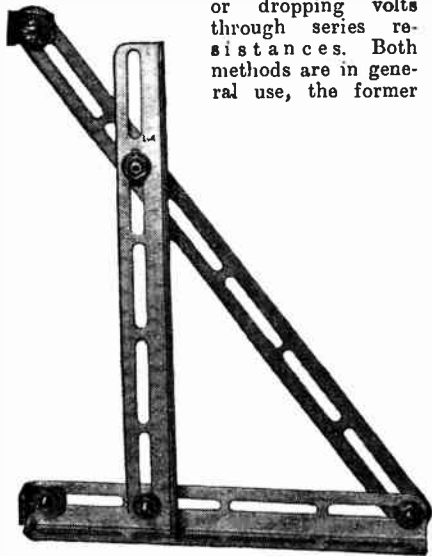

The Igranic Electric Co.'s adjustable angle brackets assembled from slotted aluminium strip.

being rather wasteful, though giving more constant low potentials.

A new feature is the use of the D.C. H.T. battery eliminator in conjunction with the A.C. rectifier. In several instances no provision is made for smoothing in the case of A.C. equipments, the potential regulating and smoothing apparatus for use with the A.C. rectifier being a standard D.C. eliminator. Assuming a maximum potential of 240, this arrangement has the advantage that the apparatus is universal, and can be used with any supply, for it was to be noticed that the majority of the A.C. equipments were designed so that by modification of internal connection they would be suitable for use on any supply voltage. Smoothing circuits are now more liberal, particularly in the design of low-frequency chokes, and the need for liberal cross-section of iron is no longer overlooked. Valves with indirectly heated cathodes as a means of eliminating the filament battery are gaining in popu-

larity, and a wide range is available, possessing various characteristics in the Marconi, Osram, and Cosmos series. It

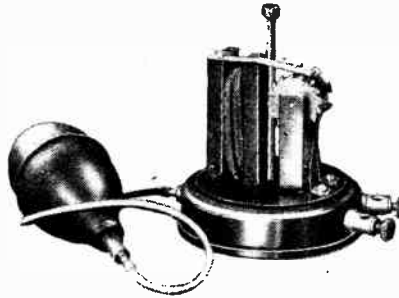

A pneumatic-operated distant control relay ("Quixo").

would seem, however, that these valves are only of interest to the home constructor, and that they have not yet found their way into commercial receiver design. In cases where L.T. supply is attempted for use with either D.C. or A.C. mains, the series connected filament arrangement is universal, a rectifier or current eliminator being made use of with receiving valves of the 6-volt class requiring 0.1 or 0.75 ampere. Battery charging from A.C. supply may be

**" WIRELESS WORLD " SETS ON VIEW.**

An invitation is extended to all readers to inspect the display of recent "Wireless World" sets now on view from 10 to 6 daily at 116, Fleet Street, E.C.4.

carried out by some half-dozen different methods, but the predominance of the arc rectifying valve endorses its superiority among the older methods. A new dry rectifier, although of small output suitably only for trickle charging, is radically new, and it is stated to be practically indestructible.

On the subject of new valves much interest has been created by the new E.S.220 duplex valve. This new Ediswan product has a novel electrode assembly, by which it virtually functions as both detector and L.F. amplifier, though its precise action must not be assumed from a casual glance at the published circuit, which is obviously that of a two-valve set. Interaction between the electrodes owing to their disposition and



Igranic potential divider for use in battery eliminator construction.

close proximity in the electron stream may produce other advantageous effects, though from an examination of the circuit diagram it will be seen that G<sub>1</sub>, P<sub>1</sub> are the electrodes of a reacting anode bend detector arranged with orthodox resistance coupling passing an input to G<sub>2</sub> with loud-speaker in the plate circuit P<sub>2</sub>, these elements serving as the L.F. amplifier. The grids and anode are concentric, P<sub>1</sub> being a vertical wire in the centre, and P<sub>2</sub> of the customary plate construction surrounding G<sub>2</sub>. The parallel connected filaments stand vertically between the grids.

**Accessories.**

The majority of relays used for distant control purposes are current operated, but an interesting departure from this practice has been made in the "Quixo"

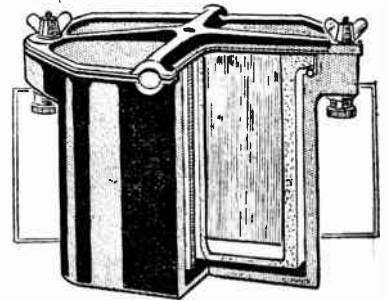

The new low consumption valves encourage the adoption of primary batteries where accumulator charging difficulties exist. The new two solution cell of the General Radio Company.

distant control switch. The switch is pneumatically operated by a small pair of bellows housed in the case and a bulb connected by rubber tube.

The employment of ordinary twin flex wire for the purpose of connecting distant loud-speaker points to the receiver introduces a capacity across the loud-speaker winding. If this capacity reaches

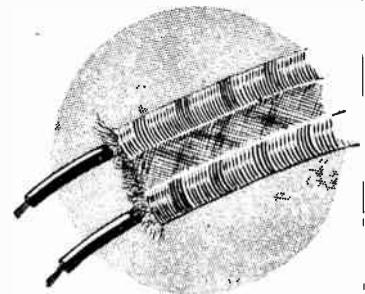

Spaced flexible conductors for wiring loud-speaker extensions arranged to produce a minimum of lead capacity.

a certain value it will by-pass the higher speech frequencies and "muffling" will occur. Capacity in the leads can be reduced to a minimum by employing two wires suitably spaced, or a special cable in which the wires are separated may be used. The "Harbro Easy-Fix" silk flex consists of two flexible wires vulcanised and run parallel, but spaced by a special braided silk covering. The capacity between wires is therefore kept down.

# RECENT INVENTIONS

The following abstracts are prepared, with the permission of the Controller of H.M. Stationery Office, from Specifications obtainable at the Patent Office, 25, Southampton Buildings, London, W.C.2, price 1s. each.

### An Interesting Four-electrode Circuit. (No. 262,083.)

Convention date (France): November 27th, 1925.

Two oscillations of different frequency are compounded in a four-electrode valve in such a way that the resultant currents may be collected from either the plate circuit or the circuit of the inner grid. For a given potential-variation applied to the outer or control grid of a "bigrille" valve, the curve IP in Fig. 1 shows the resultant plate-current variation, whilst the curve IG shows the simultaneous current-current variation in the circuit of the inner grid, the two currents being in phase opposition. It is therefore possible to utilise the compounded currents either simultaneously in two separate receiving or other working circuits, or to secure differential or additive effects by applying them collectively to the same working circuit.

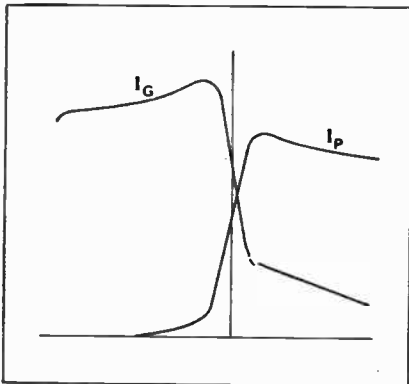

Fig. 1.—Plate and grid current curves of four-electrode valve. (No. 262,083.)

Fig. 2 shows the method applied to heterodyne reception. The circuit of the inner grid G comprises a tuned circuit LC and the primary coil of a transformer T, the return lead being taken to the negative terminal of the filament battery. The plate circuit includes an inductance L, and the primary of a transformer T<sub>1</sub>. The valve is first set into sustained oscillation by close coupling the coils L, L<sub>1</sub>, the frequency being determined by the tuned circuit LC. These local oscillations impose a corresponding voltage variation on the inner grid G, whilst signal impulses from the aerial are simultaneously applied to the control grid GC.

Under these circumstances the accelera-

tion effect of the two grids on the main electron stream add together and oppose one another periodically, thus giving rise

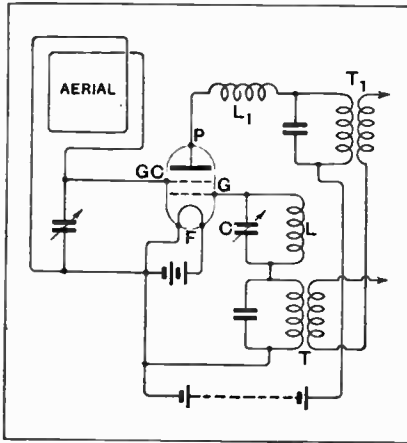

Fig. 2.—Heterodyne receiver with four-electrode valve. (No. 262,083.)

to a modulated or beat current both in the circuit of the plate and in that of the inner grid. As shown, the combined output is fed to a common receiver through the transformers T, T<sub>1</sub>, which are arranged in series to produce an additive effect. The two outputs may, how-

### Automatic Calling and Signalling Devices. (No. 273,811.)

Application date: April 9th, 1926.

Timing devices are used to energise the valve filaments of a thermionic transmitting or receiving apparatus at pre-determined intervals, and in the case of the transmitter a synchronous timing device also controls the signalling, so that impulses are only sent out during the periods when the receiver is energised and ready to accept them. For instance, the receiver may be switched on for fifteen seconds every ten minutes, and may be arranged to fire a fog signal unless during the fifteen-second interval a certain pre-arranged sequence of signals is received from the co-operating transmitter.

The method secures a great saving in filament consumption, since the valves are only energised for a total period of 36 minutes instead of 1,440 minutes in each 24 hours. A duplicate set of valves may be arranged as a standby in case of a "burn-out." In the receiving set shown a detector valve V<sub>1</sub> is followed by three low-frequency amplifiers V<sub>2</sub>, V<sub>3</sub>, V<sub>4</sub>. The filament switches S<sub>1</sub>, S<sub>2</sub> are periodically closed under the control of a clock or similar timing device. A sensitive moving coil relay R in the plate circuit of the last valve closes a set of contacts connected to a balance wheel B of the type

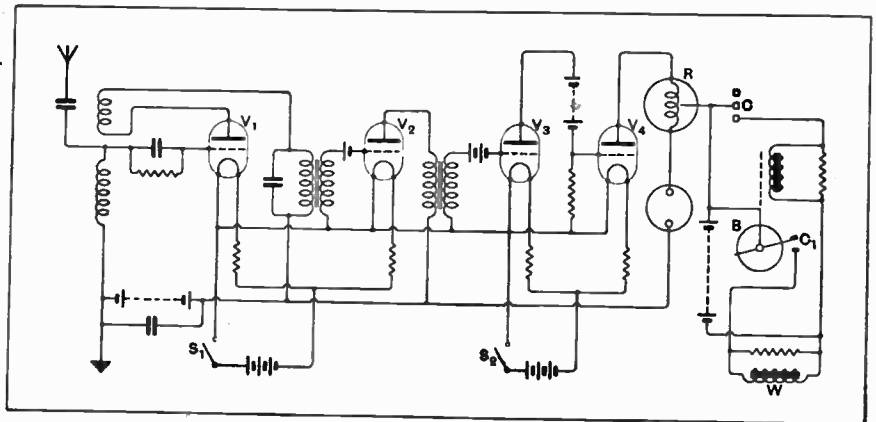

Circuit of automatic coil device. (No. 273,811.)

ever, be opposed and arranged so as to balance out the effect of atmospheric, leaving the desired signals only to reach the receiver. Patent granted to Sociéte des Etablissements Ducretet.

used in known calling-up devices. This in turn energises the control winding W of the final operating circuit through contacts C<sub>1</sub>. Patent issued to D. A. Stevenson.

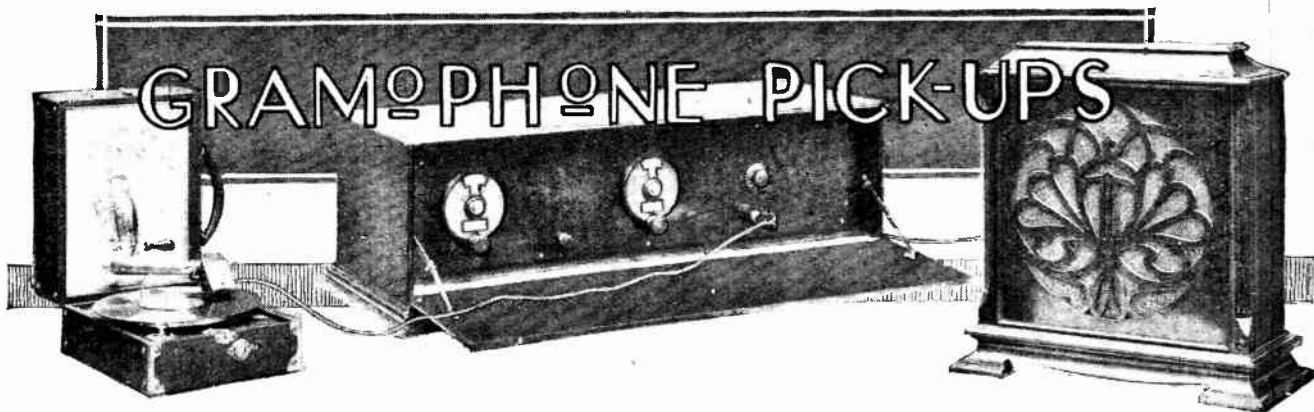

# GRAMOPHONE PICK-UPS

## The Possibilities of Electrical Gramophone Reproducers and Amplifiers.

By E. J. WYBORN, B.Sc.

“FOR me the first hearing of this instrument was the greatest thrill I have had since I began to be interested in the gramophone. . . . Such a method of reproduction must in time supersede all our sound boxes . . . and render our external and internal horns as obsolete as old Triton’s unwreathed horn. . . . For instance, the Columbia ‘Symphonie Fantastique’ played at full amplification was stupendous. . . . And the two dance records! Marvellous!”

In these glowing terms Mr. Compton Mackenzie, the Editor of *The Gramophone*, describes his feelings on first hearing an electrical gramophone reproducer, and coming as they do from one who has had such an extensive experience as a critic of gramophone reproduction, they should be sufficient to focus our interest on this rapidly developing branch of the electrical art.

As is probably well known, the leading gramophone companies have been recording electrically for a considerable time, and it is no exaggeration to say that the application of electrical technique to gramophone recording has brought about an incomparably greater advance

the quality of the music engraved on the record is comparable to that of the best B.B.C. transmissions.

The achievement of well-nigh perfect recording is valueless, however, unless the reproduction of the gramophone itself is of a correspondingly high character, and it is to the application of the electrical method that we

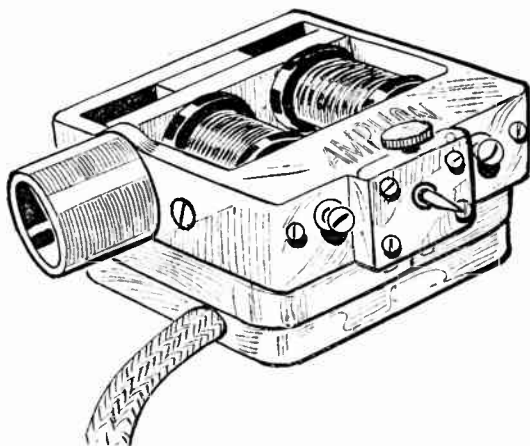

The Amplion pick-up.

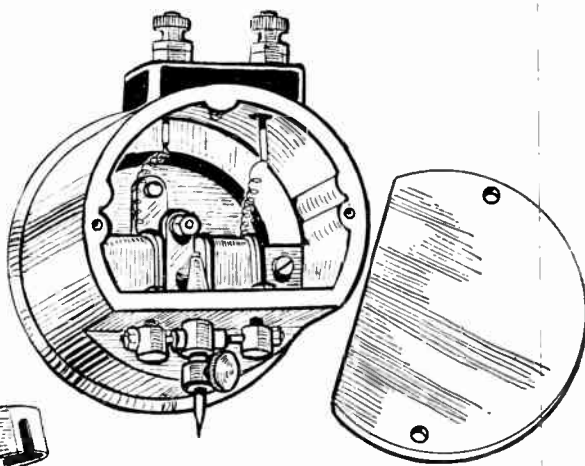

Interior of Brown pick-up with adaptor.

must look to obtain a reproduction which will do justice to the magnificent electrical recordings.

That the advantages of electrical reproduction are beginning to be realised is shown by the fact that many of the more enterprising manufacturers of broadcast receivers are equipping their latest models with special input terminals and arrangements so that an electrical gramophone pick-up can be attached, enabling the same amplifier and loud-speaker to be used for reproducing gramophone records. Thus the fortunate owner has only to obtain one of the several commercial pick-up devices and a motor-driven turntable, and he can use his broadcast receiver for playing gramophone records.

Although many readers are familiar with the electrical gramophone reproducer from the articles which have

in a few months than in many years of the old mechanical recording system. Some of the later electrically-cut records have indeed reached such a high standard that

**Gramophone Pick-ups.—**

already appeared in *The Wireless World*, a brief description of the principles involved will doubtless be of interest to many others.

In the ordinary gramophone the needle-point which runs in the record groove, and which is caused to vibrate by the lateral undulations of the groove, is connected by the stylus bar to the centre of a small diaphragm, which is usually of mica. The vibrations of the diaphragm are communicated to the air by a horn, which also serves to

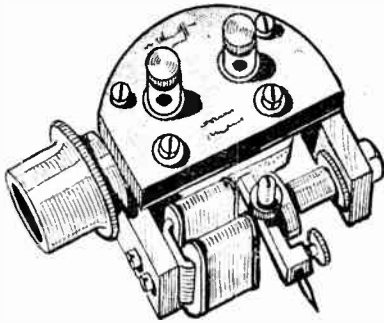

A well-known design—the Celestion-Woodroffe pick-up.

damp to some extent the resonance of the diaphragm. The disadvantages of this simple system are several, the most important being the resonance of the diaphragm, which, even when a very efficient horn is employed, definitely colours the reproduction. Then again, the bass notes are attenuated by reflection from the mouth of the horn, this cut-off being worse the smaller the area of the mouth of the horn.

**Principle of the Pick-up.**

In the electrical gramophone reproducer, the needle is fixed to and vibrates the moving part of the pick-up,

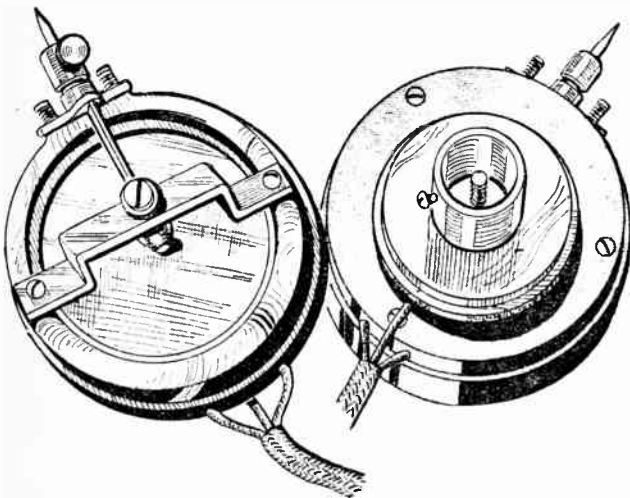

The Dubilier electrostatic pick-up incorporates a metal diaphragm. Note the three-wire connection.

which is in reality a small microphone, and which sets up oscillatory currents similar in wave form to the undulations of the record grooves. The oscillatory voltages set

up across the pick-up coil are applied either directly or through a step-up transformer to the grid of the first valve of a low-frequency amplifier. After a degree of amplification which depends on the volume of sound required and the sensitivity of the pick-up, the output is supplied to a loud-speaker.

At first this may strike one as being a somewhat round-about way of getting the same results as the ordinary gramophone, but in actual fact the more involved electrical system has a very great potential superiority.

In the ordinary gramophone, the whole of the sound energy is derived from the rotating record, whereas in the electrical system the energy which actually produces the sound is derived from the H.T. battery and bears no relation in amplitude to the undulations on the record. The volume of sound can thus be made extremely great, as the possible amplification is limited only by the power-handling capacity of the last valve and of the loud-speaker. Arising out of the greater flexibility of the electrical system, the distortion introduced can be kept extremely small in each stage, so that the actual sound reproduction can be achieved with a greater degree of fidelity than is possible with the simple gramophone. In

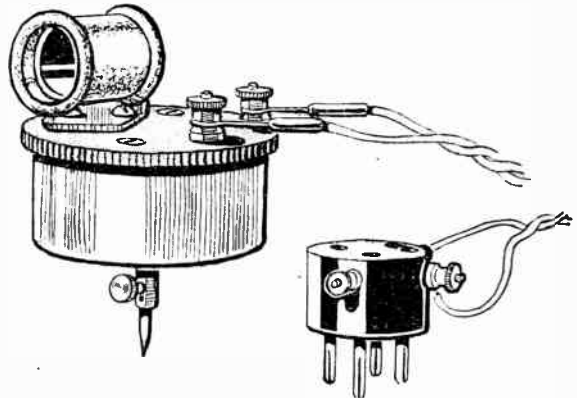

Edison Bell pick-up with adaptor for plugging into detector valve holder.

addition we have the easy control of strength and pitch which a low-frequency amplifier offers and the possibility of using several loud-speakers located in different rooms if desired.

It should not be assumed from these remarks that by merely coupling a pick-up to an indifferent amplifier and loud-speaker a startling improvement on ordinary gramophone reproduction will be obtained. As in the case of ordinary broadcast reproduction, the well-known conditions for efficient amplification must be observed, principal of which are ample high-tension voltage and correct grid bias, together with a power valve in the last stage capable of handling the desired output without overloading, and the use of intervalve coupling which will give approximately straight line amplification.

A well-designed amplifier in which all these conditions are fulfilled, working in conjunction with a good modern loud-speaker, will give a distinctly better reproduction of records than all but the very latest gramophones, whilst those fortunate ones who have constructed loud-speakers of the moving-coil floating-diaphragm type as described in several recent numbers of *The Wireless World*, are in

**Gramophone Pick-ups.—**

the fortunate position of possessing an instrument which is capable of giving an excellence of reproduction far in advance of that of any gramophone. This superiority is particularly pronounced in the lower musical frequencies, and the whole tone balance and realism are tremendously improved.

One of the most noticeable features of the electrical reproducer is the very considerable reduction of surface noise which is effected, and to take full advantage of this the turntable and record should be enclosed when playing, so as to eliminate the slight chatter which emanates from the pick-up.

The construction of the necessary clockwork-driven turntable with a tone arm or pivoted bracket to support the pick-up is quite a simple business, the ordinary gramophone horn and sound passages being of course not required.

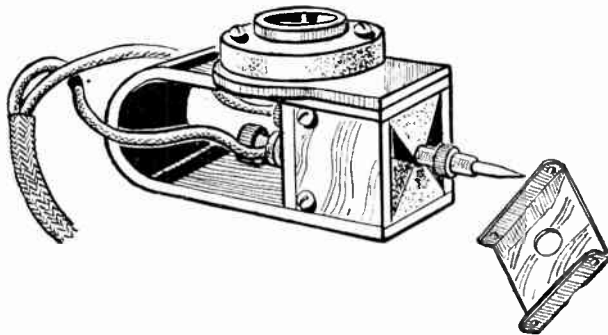

The G.E.C. pick-up with cover removed.

Having reviewed the general considerations, a more detailed description of some of the actual instruments used might be of interest, commencing with the pick-up device. One of the earliest designs, and that which was used for a long time by the B.B.C. for broadcasting gramophone records, consists of an E-shaped permanent magnet, as shown in Fig. 1. In the centre limb is fixed a short steel reed carrying a small iron armature in which the needle is fixed. The armature moves between two iron screws which project from the outer limbs and on which are mounted two small coils. The magnet is

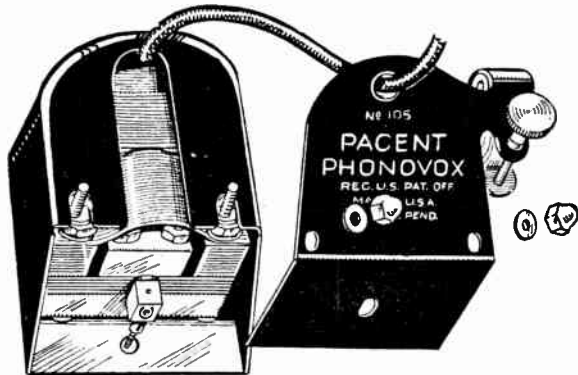

The Igranlic-Pacnet Phonovox.

magnetised with the two outer limbs of similar polarity, the opposite pole being in the centre limb, so that there

are two magnetic circuits (as shown by the arrows) which pass through the reed. When the armature moves to the left, the air gap in the left-hand magnetic circuit is



The Lissen pick-up.

shortened and that in the right-hand circuit is lengthened. The flux in the left-hand circuit is thus increased and that in the right-hand circuit is decreased, currents being set up in the coils which are connected in series in the correct sense.

Several other pick-up devices have since been produced, all working on the principle that the movement of the needle causes a variation of flux which sets up currents in a coil. The principal problem is to overcome the resonance of the reed, and this is done in the design shown in

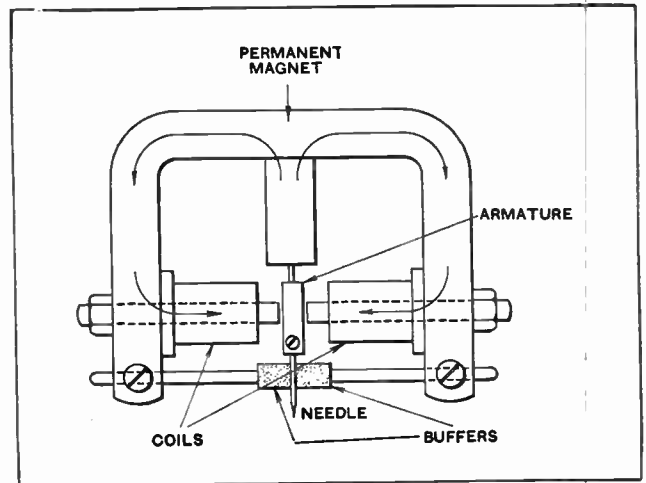

Fig. 1.—Diagram showing the working principle of an early type of pick-up used by the B.B.C.

Fig. 1, by means of two adjustable rubber buffers which press on each side of the needle. It cannot be said that perfection has yet been attained in this respect, and there is a considerable field for further investigation in the production of a pick-up which will be practically free from resonance without being sufficiently heavily damped to cause undue record wear.

If the pick-up coil is wound with a sufficient number of turns of very fine wire, it may be connected direct across the grid-filament circuit of the first valve, but a better method is to use a step-up transformer of which the



PRACTICAL HINTS AND TIPS

Aids to Better Reception.

Simple Circuit Theory.

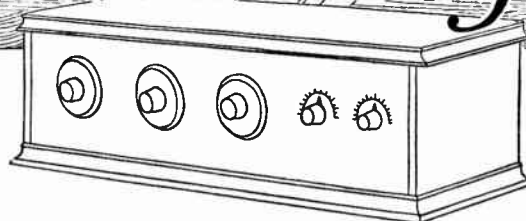

BATTERY RESISTANCE.

IT is well known that an aged H.T. dry battery generally develops a high internal resistance, which may give rise to an undesirable coupling between L.F. stages, with a consequent production (in certain circumstances) of low-frequency oscillation or howling. It is often thought that the high-tension accumulator battery is free from suspicion in this matter, but, although there is comparatively little risk of the development of a high internal resistance in the cells, it must not be forgotten that the presence of minute traces of acid on the terminals may start corrosion, which in time may produce a joint

a thin coating of vaseline. It must be remembered that this protective film does not serve its purpose fully unless the metal surfaces are dried previous to its application.

THEORY AND PRACTICE.

ALTHOUGH those responsible for the preparation of theoretical circuit diagrams published in this journal endeavour to draw them so that the fullest possible amount of information is conveyed, consistent with freedom from distracting complexity, it must be realised that such details as relative positions of coil windings, etc., cannot always be conveniently shown in these dia-

grammers. This may lead to the impression that the reaction coil is connected exactly as shown; actually, assuming both windings to be in the same direction, the anode should be joined to the end adjacent to the grid end of the closed-circuit coil, as in Fig. 1 (b). In this drawing, however, it will be noticed that there is an extra "cross-over" which, in the interests of simplicity, it is always desirable to avoid.

In Fig. 1 (c) is shown the conventional method of illustrating the connections of a neutralised H.F. transformer with what is usually called a "centre-tapped primary" balancing arrangement (strictly

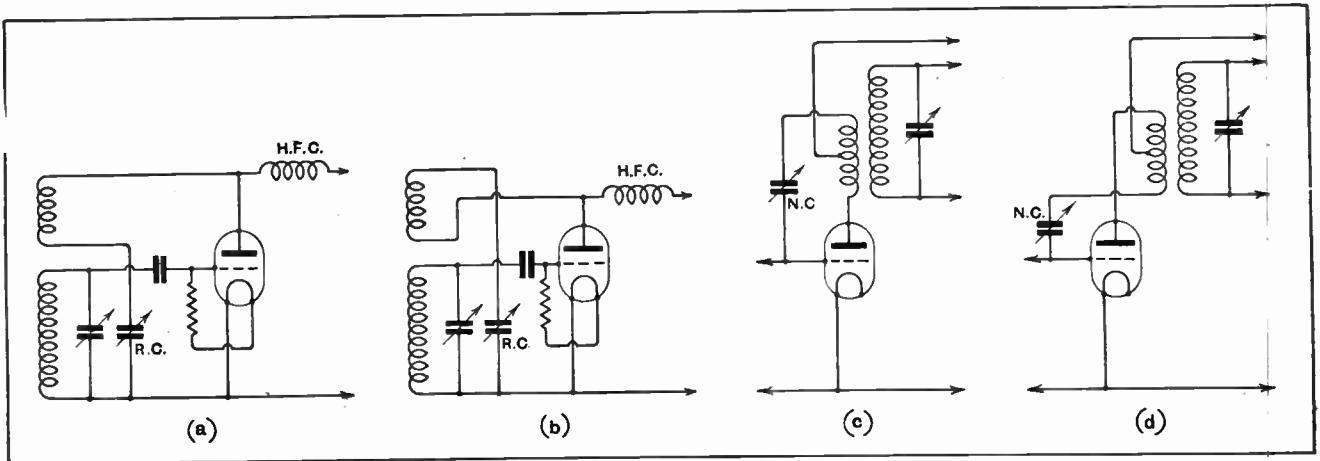

Fig. 1.—Illustrating the difference between theoretical diagrams and actual connections.

having a resistance of several hundred ohms, which is often quite sufficient to put an otherwise stable receiver into a state of oscillation.

The user of accumulator batteries, whether for H.T. or L.T., should make a practice of cleaning all terminals and connections at fairly frequent intervals, afterwards applying

grams, and in this respect the apparent method of connection should not invariably be followed implicitly.

Two cases in point are indicated in Fig. 1. The first, (a), shows the conventional method of drawing a capacity-controlled reaction circuit, variants of which are included in the great majority of short-wave re-

speaking, the neutralising winding is a continuation of the primary, which is untapped). In practice it is usual to join the anode to that point of the primary which is nearest to the grid end of the secondary, as shown in (d). Here, again, a "cross-over" is avoided by adopting the conventional method of drawing.

**SERIES OR PARALLEL ?**

WHEN two or more ordinary loud-speakers are placed directly in the anode circuit of a low-impedance valve, it is generally recommended that they should be connected in parallel. If the series arrangement is adopted, it is quite conceivable that the voltage drop in the combined windings may equal that in the valve, the anode of which will consequently receive very much less H.T. than is intended.

Conditions are completely changed, however, when a choke-filter output circuit is used. With this arrangement a high resistance in the loud-speakers is of comparatively small importance, as no steady anode current flows through them, but through the choke, which can easily be designed to have a low ohmic re-

frequency coupling with selective circuits, and may thus form a basis for the design of a long-range loud-speaker set, to which it is converted by the simple addition of another low-frequency amplifier. Where range is the most important consideration, it may be definitely stated that this should be coupled by means of a transformer, and that the first L.F. valve should be one of the modern so-called "H.F." types, with a voltage factor of about 20 and impedance of 20,000 ohms.

The circuit diagram of the complete receiver, with the suggested addition, is given in Fig. 2. It will be seen that an arrangement for eliminating the first L.F. valve at will has been included, for the reason that two stages may often be considered as superfluous for local station reception (in this case "local

When all four valves are to be used, connections are made between B, C, and D, E. To change over to a single stage, these links are removed, and a longer wire is used to connect B and E. At the same time the grid bias tapping marked G.B.<sub>2</sub> must be moved, as this is now connected to the output valve, which will require more bias, being presumably of the low-impedance type.

It will be observed that the separately tuned aerial circuit is shown in dotted lines; it may be pointed out that this refinement is by no means essential, except perhaps when the maximum possible degree of selectivity is required. Its advantages are most pronounced on the long wavelengths.

For information regarding the coils and values of the components (where not indicated in the present diagram),

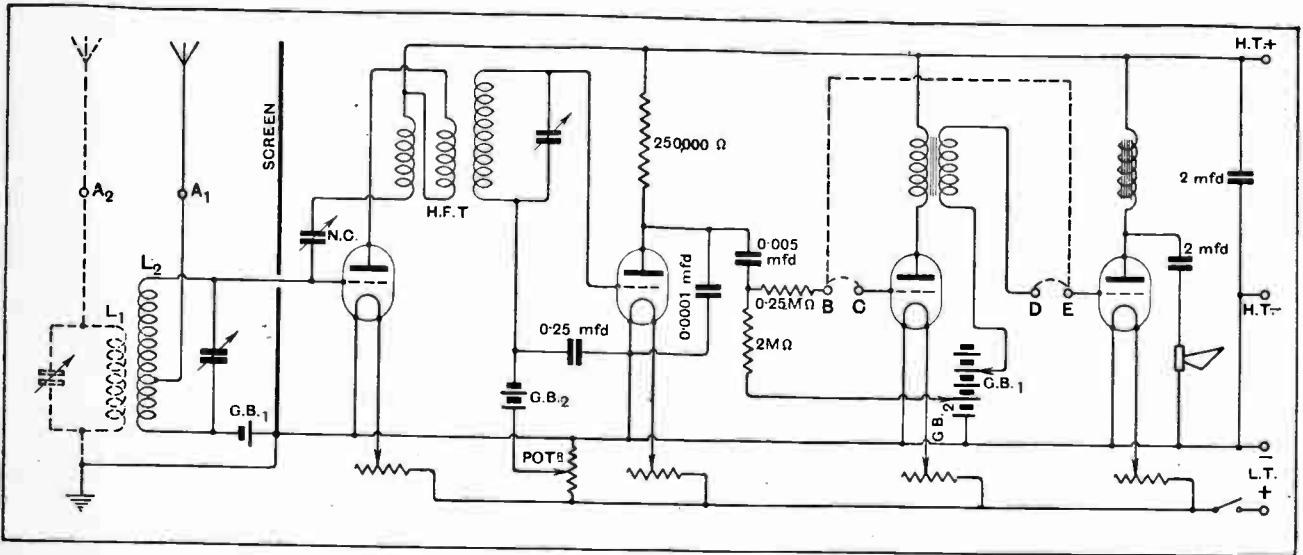

Fig. 2.—A sensitive and selective receiver for medium and long wavelengths.

sistance combined with a high impedance to speech-frequency currents. It is consequently advisable to connect the loud-speakers in series when an arrangement of this kind is used.

**MODIFYING THE "REGIONAL RECEIVER."**

THE above set, described in *The Wireless World* for August 17th and 24th, 1927, includes only one low-frequency amplifying valve (resistance-coupled), as it is not intended for long-distance loud-speaker reception. It does, however, make use of a modern system of high-

station" may mean the long-wave Daventry transmitter, perhaps 150 miles away). As has been pointed out on various occasions, risk of low-frequency instability is increased by bringing plate and grid leads to adjacent contacts of a switch; this possible source of trouble is almost entirely obviated by fitting a plug-and-socket arrangement. Four small sockets, shown at B, C, D, and E, are fitted in convenient positions, preferably on the actual terminals of the various components. Short lengths of wire, carrying a plug at each end, serve as connecting links.

readers are referred to the descriptive article before mentioned. There is no reason why the filament control jack included in the original receiver should not be retained if desired.

It may be added that the transformers and grid coils used in the "Regional Receiver" are designed for maximum magnification, and that they are made in such a way that the losses resulting from the provision for interchangeability are reduced to a negligible minimum. It is mainly for this reason that the design is recommended as the basis for a long-range "four-valver."



# The LISTENER

WIRELESS LEAGUE  NOTES AND NEWS

## THE WIRELESS LEAGUE BROADCAST BALLOT.

IN the early part of this year a London newspaper organised a "Broadcast Ballot," offering a money prize to the competitor whose forecast of the order of popularity of given programme items was nearest to the result of the Ballot. For the reasons that competitors were not necessarily listeners, any number of forecasts could be sent in by one person, and entrants did not always vote for their own preference but for the item which they *thought* would find general favour, we did not consider the result of the Ballot a fair reflex of public opinion. We decided, therefore, when circularising some 25,000 members in April, to invite their co-operation in ascertaining the extent to which the various sections of the programmes appealed. Overleaf will be found a copy of the Ballot Form issued by the League.

It will be seen that a novel feature was introduced, enabling listeners to indicate the source, *i.e.*, relayed or studio, from which they preferred the broadcast to emanate. We appreciate that, compared with the large body of licence-holders, the number of listeners whose views are expressed by our Ballot is small, but our members are drawn from every class and we are confident that the result is representative of general opinion.

The Ballot was closed in July, and the table overleaf gives the order in which the voting placed the various items. The last two columns show, on a percentage basis, the preferences for outside or studio performances.

### What the Figures Reveal.

A first glance at the figures reveals two outstanding points. Firstly, by a very clear majority the broadcasting of military band concerts is the most popular feature of the programmes, and, secondly, listeners have appreciated the atmosphere of reality that accompanies religious services which are relayed from actual places of public worship. It is interesting to recall that in a report made to the B.B.C. in February the League emphasised the popularity of Band Music, and that as far back as November last we pressed for the development of "variety" performances which find third place in our Ballot. A statement made by us in this latter report to the effect that "the demand for 'jazz music' appears to be diminishing" is confirmed by the lowly position in which Dance Music is placed. We have also made representations that Church Services should always be relayed from outside sources. Solos (instrumental and vocal),

Plays (from Studio), Choirs, Glee, etc., and Operatic performances are all well supported, whilst the growing dislike of Chamber Music is indicated by the fact that this item is placed fourth from last, only a few points ahead of Talks.

The result of the Ballot is another blow for those pessimists who are constantly decrying the British musical taste. "Variety" items are certainly liked by a large number, but music with "pep" and good orchestral broadcasts find approval with the majority of listeners.

We should like to take this opportunity of expressing our appreciation of the assistance our members have given in this matter, and for the many letters we have received in connection with the Broadcast Programmes.

o o o o

### 5GB EXPERIMENTAL.

A number of members have written from different parts of the country giving their views on the new experimental station—some of the letters are reprinted in this issue. From the observations of our members and from our own tests of the station, it appears to be rather early in the day to express decided opinions either as to reception in various parts of the country or as to programmes.

There seems to be an impression that the programmes transmitted by 5GB are better than those of 5XX. Whether this is so or not is doubtful. The impression probably is caused by 5GB giving more relays of the "Prom" concerts than 5XX, and also to the fact that up to now 5GB has not transmitted any talks.

Our listening friends in Birmingham have had a nasty jolt, but they must have patience. It is possible that the erection of the new masts at 5GB in a few weeks' time will make a considerable increase in the strength of their reception of 5GB.

As far as London is concerned, the reception of the experimental station in most districts is good, although it is marred too often by Morse and oscillation. The latter will lessen as the station gets more familiar, and it may be that before the station loses "experimental" from its name, some change in wavelength may be found which will make the transmission more free of Morse interruption.

Meantime, 5GB does give a good many thousand listeners a change of programme—that is the main point after all

**IMPRESSIONS OF THE PROGRAMMES.**

On Monday, September 19th we had two organ recitals, and the same on the Wednesday. On Monday and Wednesday from the Astoria and the New Gallery and on each evening of the week from Southwark Cathedral. I like organ music and I have much enjoyed these items. I fear, however, the B.B.C. will receive some protests from those whose taste differs.

o o o o

Henry Arthur Jones' comedy, "The Liars," was really well done. The whole of the cast did their parts splendidly, and Mr. Rosmer deserves our thanks for an enjoyable hour and a half.

o o o o

After this, 5GB transmitted an orchestral concert. Moszkowski's "Serenata" was one of the items—a beautiful melody which I have had the pleasure of often hearing. I was disappointed. I have many times heard the melody better played.

o o o o

Mr. G. M. Trevelyan's talk on "Bygone England" must have interested a large number of listeners. It is rather horrifying to think that so recently as the time of George II, children of the tender age of five and six were wage-earners and producers.

o o o o

Another talk of great interest to listeners was that on the Radio Exhibition, given by Mr. Hugh Pocock. He is a good broadcaster and this, coupled with good material, makes one regret that so short a time was allotted to a subject of so great interest to practically all listeners.

o o o o

The tone of the announcer's voice at 5GB sometimes impels me to say "Amen" at the end of his announcements.

o o o o

The last "Prom" concert gave me, I think, the item I liked best of all—Sir Henry Wood's Fantasia on British Sea Songs. I never heard anything more beautiful and inspiring. It was, too, I believe, actually the last item—a very appropriate ending.

o o o o

For some of the notes this month I am under obligation to correspondents in various parts of the country who have been kind enough to write me. Such letters are most helpful and I am always glad and

(Continued in col. 3.)

**BROADCAST BALLOT FORM.**

Valuable help in ascertaining the desires of the listening public as to broadcast programmes would be given the League if members would number, in the space provided, the following items in the order of their own individual preference. Members will observe that provision is made in the form for indicating in the case of each item, with the exception of No. 14, their preference (a) for outside broadcasts, or (b) studio performances:—

	(a) Outside Broad- casts.	(b) Studio Perform- ances.
1. Chamber Music ..	.....	.....
2. Choirs, Glee and Choruses .....	.....	.....
3. Church Services ..	.....	.....
4. Dance Music .....	.....	.....
5. Military Bands ..	.....	.....
6. Light Orchestral Music .....	.....	.....
7. Opera and Oratorio .....	.....	.....
8. Plays .....	.....	.....
9. Solos, Vocal .....	.....	.....
10. Solos, Instrumental .....	.....	.....
11. Symphony Concerts .....	.....	.....
12. Talks .....	.....	.....
13. Variety, Concert Parties and Revues .....	.....	.....
14. Foreign Stations ..	.....	.....

TABLE SHOWING RESULT OF BALLOT.

Order of Preference.	Items.	Total Points Gained.	Percentage for	
			Studio Performances.	Outside Broadcasts.
1.	Military Bands .....	221,492	53.35	46.65
2.	Light Orchestral Music .....	197,227	62.63	37.37
3.	Variety Concert Parties, and Revues .....	185,167	62.74	37.26
4.	Solos, Instrumental .....	157,004	66.65	33.35
5.	Church Services .....	150,089	32.79	67.21
6.	Solos, Vocal .....	131,023	67.77	32.23
7.	Dance Music .....	128,035	46.11	53.89
8.	Plays .....	126,703	59.85	40.15
9.	Choirs, Glee and Choruses ..	124,444	57.41	42.59
10.	Opera and Oratorio .....	120,697	40.85	59.15
11.	Chamber Music .....	116,149	62.82	37.18
12.	Symphony Concerts .....	110,723	59.26	40.74
13.	Talks .....	110,714	67.03	32.97
14.	Foreign Stations .....	25,421	—	—

**Impressions of the Programmes.—(cont.)**

eager to receive them. It will be a convenience if these correspondents would, in future, address their letters to "O. H.," c/o the League Offices. They can rest assured that their views and opinions on programme items will be welcomed by me.

o o o o

I find some difficulty this month in recording my impressions of the programme items I have heard. The cause of the difficulty is the alternative programme sent out by 5GB. My usual procedure has been to mark in my *Radio Times* the items that appeal to me as worth listening to and then, subject to other demands, to endeavour to hear them. I followed this course with the first two issues of the programmes this month with the result I found that a goodly number of the items marked in 2LO's programmes clashed in time with others similarly marked in 5GB's transmission. The consequence is that some of the marked items have had to be missed. Such a situation with one alternative programme makes one fear to think what the position will be when the full regional scheme is working!!!

o o o o

By the way, again I have to complain about the bad time-keeping in the broadcast of items. This fault was annoying when we had one programme, but the annoyance is multiplied a hundredfold with an alternative programme. Surely after the experience they have had the B.B.C. programme organisers should be able to estimate to within five minutes the length of time taken by an item and by a complete programme. Anyhow it is time they did.

o o o o

I think the most interesting and thrilling item this month was the relay of 2FC, Sydney, Australia. It was excellent and we should like to hear some more.

o o o o

The "Salisbury Singers" were very good and I shall look forward to hearing them again.

o o o o

"The New Morality," which came through Cardiff, was well produced. The play deals with an old theme treated in an original way and would probably have been very enjoyable had it not been spoiled by Auriol Lee speaking so fast as to be almost unintelligible at times.

Also there was not sufficient contrast between her voice and that of Flora McDowell. This difference of voice in broadcast dialogue is of the utmost importance.

o o o o

Later the same evening we heard Formichi, and this was a delight which more than made up for the earlier disappointment.

"The Bridge" was a good short play, and I offer congratulations to Elizabeth Young on her interpretation of her part.

So was "Catherine Parr," "The King has just cracked a boiled egg"!! Great! Think of the other eggs he cracked!!!

The broadcast of the "Proms" which I have heard have all been good. My only criticism is that some of the items, while they hold the interest of the audience in the hall, are too long for the broadcast listener.

One item I always try to hear is Mr. Basil Maine on "Next Week's Broadcast Music." He makes his talk interesting as well as instructive, but his delivery is too quick and I would suggest he be given more time.

One of the best programmes of the month was the German National Programme on the 9th. The Wireless Symphony Orchestra were in great form. The Budapest Trio were delightful, and Enid Cruickshank is one of my favourites. What a glorious voice she has!

The Budapest Trio broadcast brings to my mind that the B.B.C. have not yet given us the Flonzaley and Lener Quartettes. We hope to hear them some day.

Two other good short plays were "Spoiling the Broth." Mabel Constanduros was good, and she was well supported by her three colleagues. The other, "Taffy's Wife," was well done, but highly improbable.

The variety on the 10th was weak. I could describe it more forcibly, but the Editor would object. The only relief was again, Mabel. One of the comedians retailed some jokes which evidently were heirlooms handed down to him.

I enjoyed Solomon's playing of the four pieces by Chopin on Sunday, 11th. The orchestra played the same evening two pieces which have always interested me. Sant-Saëns' "Dance Macabre," and Sibelius' "Valse Triste." I have heard both played better by less well-known orchestras.

And I wonder why the B.B.C. do not get one of their dramatic staff to read the short stories instead of the authors?

And why do readers of poetry appear to the poor listener to be suffering from fearful pain or afraid of some impending disaster?

The suggestion made by a correspondent last month that as an alternative to the religious service on Sunday evening we should have a good classical concert from 5GB appeals very strongly to me. I am passing the suggestion on to the League's Programme Committee. I hope they will press it on the B.B.C. through their representative on the Listeners' Committee.

I was lucky enough during the month to hear one of the B.B.C. mid-day transmissions of gramophone records. It is a marvellously improved transmission compared with the one I heard many months ago, and the notes on the records supplied by Mr. Christopher Stone, the Editor of *The Gramophone*, materially helped one to enjoy it.

Miss Gerda Nette, who has been interpreting Handel, has the power of producing a beautiful resonance of tone, which is so often lacking in "showy" players of the pianoforte.



An enthusiastic young amateur writes that he often gets Greece on the crystal.

The Children's Hour staff deserve praise for their indefatigable efforts in providing new and interesting fare for the little ones. The programme on September 5th was especially good. The story of Mr. Pickwick meeting the Wardles was delightfully told by Mr. Cyril Nash, and our old favourite, Uncle Rex, who has such a beautiful rich voice, sang some songs. On the 3rd the children went over to Plymouth and had another pleasant hour. The transmission came over splendidly, and the staff gave that favourite sketch "The Kid," which points a lesson we elders should take to heart! There was also a very good reading about the boys, at a public school and their ruse for getting extra pocket money.

I think most listeners like the relays of music from restaurants, but it is not often that these relays are really good as the background of noise from the establishment spoils the performance. The transmission of Camille Courturier's Orchestra from Frascati's seems clearer than some of the others. It may be that some improvement could be made by varying the position of the "mike" in some restaurants.

One of the best broadcasts of the month—certainly one of the most thrilling—was Geoffrey Gilbey's running commentary of the St. Leger supported by

his brother Quinton. Despite the fact that the allocation of only fifteen minutes before the actual race rather cramped their attempts to describe the scenes, their story of this classic equine struggle held us breathless. I was told by a sporting friend that the tone in which Mr. Gilbey shouted "Book Law—Hot Night—Son and Heir" was quite reminiscent of the "what-else-did-you-expect" expression used by successful punters on the course. O. H.

THE CASE OF  
MR. POSSELTHTWAITE.

"The Rockery,"  
Clapham.  
June 2nd, 1927.

MESSRS. MCCOHEN & Co.,  
Complete Radio Stores,  
London, E.C.

DEAR SIRS,—Many thanks for the All-in-One valve set, which came this afternoon. May I point out, however, that the valve is missing. Perhaps you would kindly forward it at once as I want to listen-in very much indeed.

Yours faithfully,  
C. POSSELTHTWAITE.

London, E.C.

A. POSHTHWAITE, Esq.

DEAR SIR.—Yrs. of 2nd inst. to hand, and we are unable to trace as how the valve was not packed. Assuring you of our best attention at all times.

Yrs. faithfully,  
MCCOHEN & Co.,

per pro U. N. Derpaid, Mail Order Dept.

Clapham, June 6th.

MESSRS. MCCOHEN & Co.

DEAR SIRS.—Your courteous letter of yesterday leaves me rather in the air, whereas I want to be "on the air," as our American friends put it. Moreover, your investigations seem to have dealt with the negative aspects of the case. Can you trace whether the valve was packed? A positive answer would oblige.

Yours faithfully,  
C. POSSELTHTWAITE.

Clapham, June 11th.

MESSRS. MCCOHEN & Co.

DEAR SIRS.—I beg to enclose a copy of a letter addressed to you on June 6th. With apologies if I grow irksome.

Yours faithfully,  
C. POSSELTHTWAITE.

London, E.C.

June 13th.

G. POSSELTHTWAITE, Esq.

DEAR SIR,—Yours to hand. Sorry your previous letter was mislaid, our Mr. Derpaid being on sick vacation. We don't understand the valve being missing, also we beg to advise you same should have been pointed out on delivery. We got other clients to think of, and mistakes cannot be entertained when carman has left.

Assuring you of our best attention at all times,

Yours faithfully,  
McCohen & Co.,  
I. McC.

Clapham, June 14th.

McCohen & Co.

DEAR MR. MCCOHEN,—I hope Mr. Derpaid is better. I hate to think of him lying at home instead of at the office.

Apropos the second half of your letter, if I cannot obtain satisfaction by ordinary means, I may have to take other steps. Do write again when you have time.

Yours,  
C. P.

London, E.C., June 15th.

C. POSTMORTEM, ESQUIRE.

DEAR SIR,—Mr. McCohen being away I have to inform you that the valve was packed according to our Packing Department, he is ready to swear it and the facts are as stated.

Assuring you of our best attention at all times,

Yours faithfully,  
McCohen & Co.,  
per pro U. N. Derpaid.

P.S.—Threats don't move us.

Clapham, June 17th.

McCohen & Co.

DEAR SIR,—So Mr. Derpaid is back again. Well, well. As threats don't move you I must think of something else.

Cheerio,

CHARLIE P.

P.S.—I have to-day joined the Wireless League.

Handed in 8 a.m., June 18th:—

POSSELTHERWAITE THE ROCKERY CLAPHAM HAVE FOUND VALVE BEHIND WAREHOUSE WHICH IS BEING DISPATCHED IMMEDIATELY APOLOGIES LETTER FOLLOWS.

MCCOHEN AND CO.

LEAGUE MEETINGS.

The Executive Committee. A well-attended meeting of the Executive Committee, presided over by Sir Arthur Stanley, was held at the Royal Automobile Club on Friday, the 16th September. It was decided to recommend the General Council to adopt a new Constitution enabling the League to re-arrange its local organisations so that they would be more effective than in the past. The inclusion of a clause providing for additional classes of membership and giving the Committee power to take over other radio organisations was also recommended.

General Council. A meeting of the General Council of the Wireless League will be held at the Royal Automobile Club on Friday, the 28th October, at 2.45 p.m., and formal notices will be sent to delegates in due course.

INSURANCE.

By S. J. ADAMS.

The Claims under the League's Insurance scheme have been much more numerous and expensive than previously. Doubtless this has been due to the exceptionally stormy weather, to the damage caused by lightning and, in some cases, by fires consequent therefrom. An analysis of causes and cost is interesting: fires have accounted for 36 per cent. of the claims; lightning 46 per cent., and third-party claims 18 per cent. There have been no claims paid under the Burglary section.

The above indicate the concrete benefits to members of the League derived from the insurance cover they have as members. Many wonder how these valuable

benefits can be given to members for such a small subscription of 2s. a year. It is a good example of what can be done by combination, especially when one remembers the valuable work the League is doing in other directions for the benefit of ALL LISTENERS, including monthly meetings in London for the purpose of securing better programmes, and to minimise interference, give technical advice, etc. A much larger membership is confidently anticipated this year. Will those who are not now members join at once? By so doing they will not only reap concrete advantages immediately, but show an esprit de corps which cannot fail to prove invaluable to the cause of broadcasting from the listener's point of view.

APPROVED TRADERS AND REPAIRERS.

The following further list of firms registered as Approved Wireless Traders and Repairers by the Joint Committee of the R.S.G.B. and the Wireless League:—

- ABBOTS BROMLEY, Staffs.—Mr. S. W. Meadows.
- BIRMINGHAM.—Messrs. S. Dagnall, Ltd., 420, Stratford Road, Sparkhill.
- CANTERBURY, Kent.—Mr. S. W. Bligh, 1 and 2, North Lane.
- CHESHAM, Bucks.—Mr. A. S. How, 252, Berkhamsted Road.
- DROXFORD, Hants.—Mr. Alfred Barnes, South End Radio Depot.
- LEEK, Staffs.—Mr. D. Ainsworth, 56, Britannia Street.
- LONDON.—Mr. A. F. Archer, 121, Lee Road, Blackheath, S.E.3.
- LONDON.—Messrs. G. Scott, Sessions and Co., Hill Top, Muswell Hill, N.10.
- ROCHESTER, Kent.—Messrs. A. G. L. Acland, 147, High Street.
- SWINDON, Wilts.—Messrs. Tucker and Pearce, 96, Victoria Road.

MEMBERSHIP AND RENEWAL FORM.

To be filled in by readers who wish to become members of the League, or to renew their membership for a further eighteen months.

To the Secretary, The Wireless League, Chandos House, Palmer Street, Victoria Street, S.W.1.

.....19

Please enrol me as a member or renew my membership of the Wireless League. I enclose P.O. for Three Shillings,† which entitles me to membership with all the privileges and rights as enumerated in the constitution of the League, including FREE Insurance, Free Legal Advice, and Free Technical Advice, for the period ending 30th September, 1928.

\* Cross out Line not required.

† Keep the Counterfoil of your Postal Order.

WRITE IN CAPITAL LETTERS. Name (in full) ..... (State whether Mr., Mrs., or Miss.) ..... Address .....

My Membership No. is..... (This is only applicable in the case of renewals.)

Please enclose stamped addressed envelope.

"The Wireless World" devotes four pages in the first issue of each month to League Notes and News.

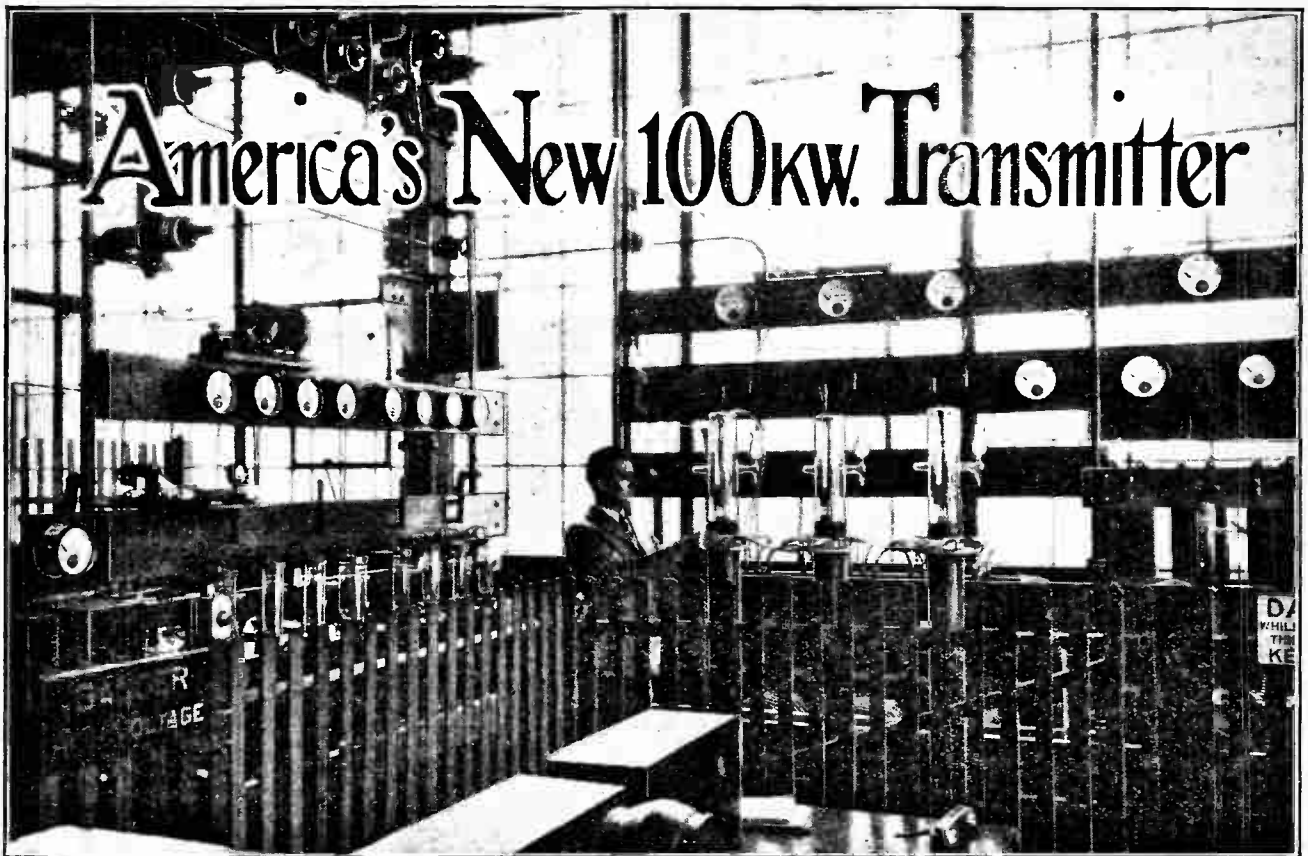

## Satisfactory Results of a Thirty Days' Special Test.

By A. DINSDALE.

ON August 4th last a new peak in high-power broadcasting was reached when WGY switched on a new 100 kW. transmitter for the first time to broadcast a test programme. For a period of thirty days from that date WGY continued these tests, which lasted from midnight to 1 a.m., E.S.T., in accordance with a special licence granted for the purpose by the Federal Radio Commission.

The object of these tests was to determine, by means of measurements and reports from trained observers and ordinary listeners situated in all parts of the United States, just exactly what the effect of this enormous increase in power would be. During the week commencing August 14th comparison tests were made between the new 100 kW. transmitter and the 50 kW. transmitter, which latter is now run at 30 kW., in accordance with the ruling of the Federal Radio Commission.

These investigations, which included measurements of signal strength, audibility and modulation, are part of an extensive development programme, as the result of which the General Electric Company's engineers hope to improve the broadcast service.

By courtesy of the General Electric Company we are able to give the following description of the new transmitter, together with the accompanying photographs, and

a brief *résumé* of some of the earliest reports of the results of the tests.

The South Schenectady transmitter laboratory covers 54 acres, and facilities are available for suitable aerial and counterpoise systems, and for the power and cooling requirements of a large number of transmitters, or for a single very large transmitter. There are, for example, four steel aerial towers, three 300ft. high and one 150ft. high, in addition to a large number of smaller masts. There is also a rectifier capable of supplying 750 kilowatts of direct current power at 15,000 volts.

### High-power Valves Save Space.

The development of the 100 kW. transmitter has been hastened, to some extent, by the production by the General Electric Company of a 100 kW. transmitting valve. This valve was described by the writer and illustrated in these pages recently.

The new transmitter occupies less than half the space taken up by the 50 kW. transmitter, heretofore one of the highest-powered broadcast transmitters in existence. Two 100 kW. valves are used in the high-power amplifier unit, and three more in the modulator unit. The 50 kW. transmitter (now operated at 30 kW., as already mentioned) uses seven 20 kW. valves in the amplifier and twelve valves of the same size in the modulator.

**America's New 100 kW. Transmitter.—**

A good idea of the saving in space can be obtained by comparing the photographs reproduced here with those illustrating the new 50 kW. WEAf transmitter, published in a recent issue.

The new 100 kW. valves are, as already described in the previous article, of conventional metal anode construction. The anode itself is of copper, approximately three feet long by 3¼ in. in diameter. The grid and filament leads are brought out through a glass cylinder at the top, the glass part being approximately 19 in. long by 5 in. in

**Crystal Control.**

The frequency of the transmitter is controlled by a quartz crystal, a method which is rapidly becoming standard practice with American broadcasting stations of the highest class. The output of the crystal-controlled oscillator is amplified by five stages of radio-frequency amplification to a power which is sufficient to energise completely the grids of the two 100 kW. power valves. All these stages of amplification are completely neutralised, so that there is little possibility of independent oscillations occurring in the amplifier chain. The last stage

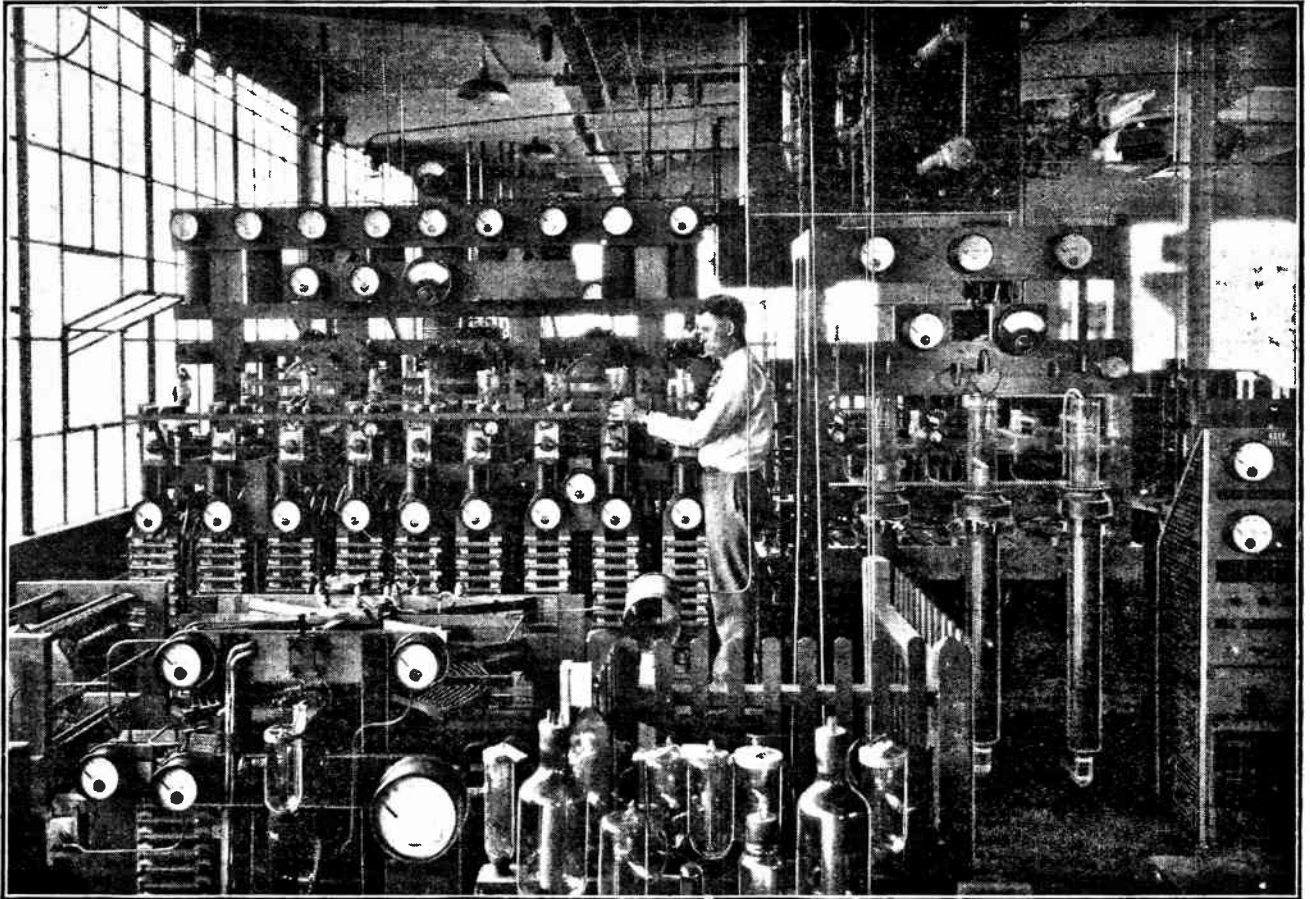

The 100 kW. and 50 kW. transmitters at WGY; the 100 kW. apparatus with its three high-power valves (one a spare) is seen on the right.

diameter. The overall length of the valve is 50 in., and the filament requires 210 amperes at 33 volts. During normal operation two such valves are used in parallel in the power amplifier, which is connected to a closed, or "tank," circuit, which is inductively coupled to the aerial by means of coupling coils and a high-frequency transmission line.

The aerial is of the vertical type, consisting of a cage 2 ft. in diameter and 240 ft. high. The wires of the cage are combined to form a single conductor for the lower part of the aerial, and a counterpoise, consisting of a radial wire system 240 ft. in diameter, is used instead of a direct earth connection.

employs a 20 kW. water-cooled valve, the output of which goes to the power amplifier.

The frequency of the transmitter is the same as that used by the ordinary WGY transmitter, 790 kC.

Speech or music to be broadcast is sent from the WGY studio over the telephone cable, at a level approximately equal to that used for ordinary telephone conversation. This input to the station is then amplified 1,000 times by an ordinary L.F. speech amplifier, the last stage of which also employs a 20 kW. water-cooled valve. The output of this intermediate L.F. power amplifier is then impressed upon the grids of the three 100 kW. valves comprising the modulator. These three valves operate

**America's New 100 kW.  
Transmitter.—**

directly in the plate circuit of the radio-frequency power amplifier valves, and vary the plate potential in accordance with the speech frequency.

**Power Rectifier.**

The high-tension power for the plates of these enormous valves is obtained from a rectifier which employs six two-electrode valves. These valves are the same size as the 100 kW. three-electrode valves, only they have no grid structure. The rectifier is capable of supplying 750 kW. of direct current power at a potential of 15,000 volts. Several large filter units smooth out the 60 cycle A.C. ripple before the output of the rectifier is applied to the plates of the transmitting valves.

A motor-operated voltage regulator enables the operator to vary the output voltage at will, under load. This rectifier is probably the largest of its type in use by a broadcasting station. It is capable of supplying a broadcast transmitter having an output of 250 kW. Although a transmitter of such power is not available at present, it is now considered as being practical.

**Cooling Arrangements.**

In order properly to cool the anodes of the large power valves, it is necessary to circulate twelve gallons of water per minute through the water jacket in which each valve is mounted. Thus, for the transmitter proper, exclusive of the rectifier, a flow of sixty gallons of water per minute is required.

This is obtained from a centrifugal pump which draws its supply from a cistern of approximately 20,000 gallons capacity. On its return from the valves this water is caused to flow through a radiator unit, which is kept cool by a current of air supplied by a large blower. The water is then returned to the cistern.

This type of cooling system is called a "closed system," since it is not necessary for the water to come into actual direct contact with the air in order to be cooled. In this way the water is protected from dust and other impurities which might adhere to the plates of the valves. Water cooled in this way can be used

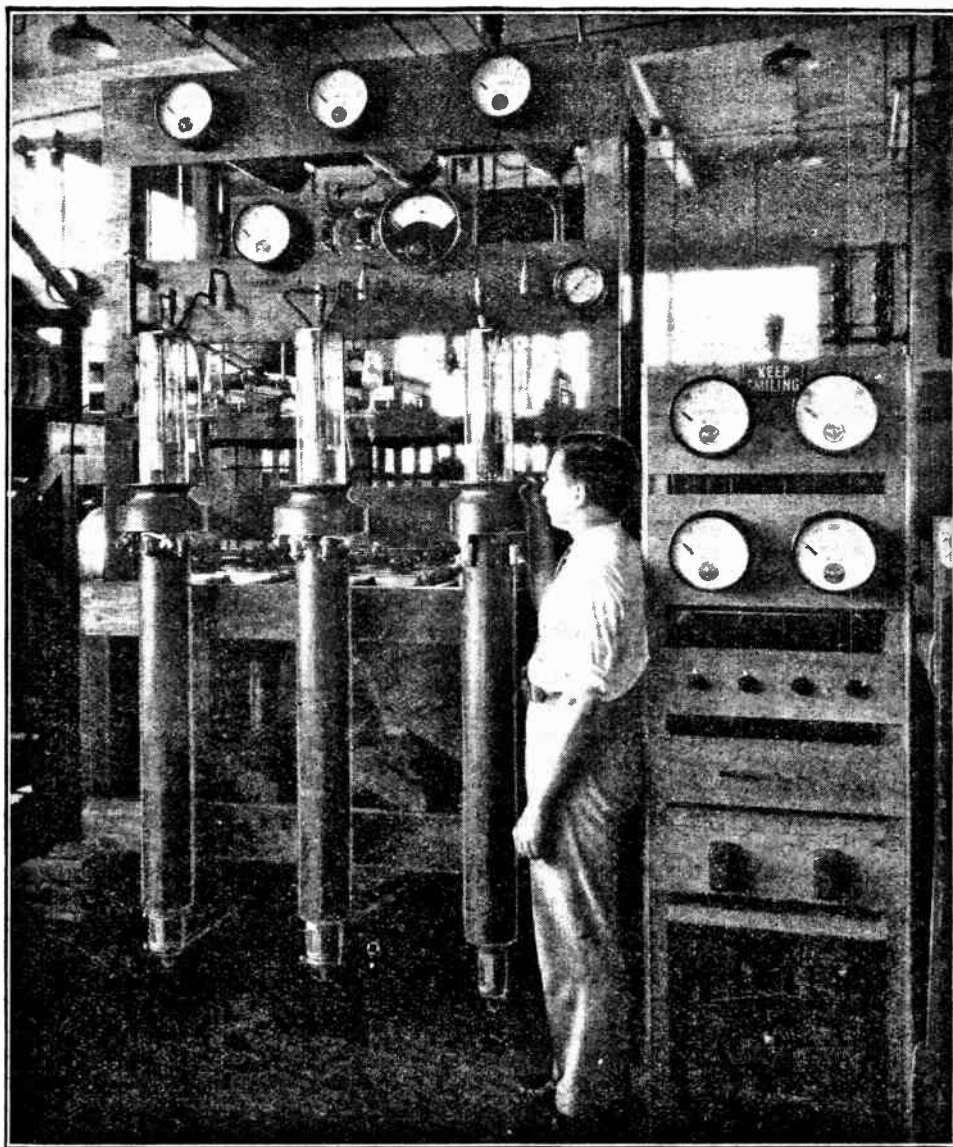

The size of the 100 kilowatt valves in the amplifier is more clearly shown in this photograph.

over and over again for long periods without replenishment.

**Simple Remote Control.**

The operation of this new high-power transmitter is rendered quite simple through the use of remotely controlled electrical relays and automatic protective devices. The operator has before him two major controls. One switch controls a small rectifier feeding the plate circuit of the (comparatively) low-power valve which supplies the grid excitation for the main power amplifier; while a second switch controls the high-power rectifier which supplies the plate circuit of the main amplifier and modulator power valves.

In getting the set ready to "go on the air," as the Americans put it, all motor-generator equipment (including pumps and blowers) is started, and rectifiers and an-

**America's New 100 kW. Transmitter.—**

plifiers, both speech and radio, are switched on. When all is ready, the carrier wave is finally switched on to the aerial by the manipulation by the operator of the two major control switches mentioned in the last paragraph.

Protective devices are employed automatically to trip off the power supply in case of valve failure, also to give warning to the operator in case of failure of the water supply. During the transmission of a programme, the operator is continually checking the degree of modulation by means of an oscillograph, and the quality of the transmission is also still further checked by means of a suitable "monitoring" loud-speaker.

**Results of Tests.**

At the time of writing it is too early to give full details as to the results of the thirty-day test of this new high-power transmitter, but a sufficient number of reports have already been sent to the General Electric Company to enable them to come to some conclusions. It must be remembered, when reading what follows, however, that all the tests were conducted between midnight and 1 a.m., at a time when the majority of the eastern broadcasting stations are closed down, and conditions for long-distance reception are almost at their best.

Especially interesting to the engineers engaged upon the tests is the fact that there is an almost unanimous endorsement of the fact that the temporary increase in power has brought about an improvement in quality, volume and sharpness of tuning. A survey of the letters received at the conclusion of the third early morning test indicates that:—

Signal strength over the region east of the Mississippi River and north of North Carolina (*i.e.*, within a range of 500 to 600 miles) is equal to that of ordinary broadcasting stations working within fifty miles of the receiver.

WGY was heard with good volume and clarity in parts of the country not reached since early in the spring, the volume being so great, in some cases, as to override static and even severe electrical storms.

Fading is not appreciably improved by high power in areas within 300 miles of Schenectady, where WGY's transmissions normally faded; but many of the more distant listeners reported that fading was less frequent and less pronounced.

Many listeners in areas outside the large population zones reported that the 100 kW. transmissions were the first static-clear music they had received for months.

**Static Overridden.**

It so happened that the first test transmission was conducted under the most severe conditions to which radio broadcast transmission could be subjected, for the greater part of the area reached was covered by electrical storms. One listener living in Portsmouth, Va. (about 300 miles from WGY) reported that lightning was so severe that the street lights in parts of the town were out of commission, yet the storm had no effect upon the music, which came in free from atmospherics.

Another listener about 600 miles away, in Minnesota, reported that WGY's volume exceeded that of his local station, eighty miles away; while Mr. C. C. Hollenback, chairman of the radio committee of station WAIU,

Columbus, Ohio (about 500 miles distant), wrote: "I wish to advise you that the power overrode the static in a very pleasing manner, and I also want to say that your station had a signal strength equivalent to the strength of our own station WAIU, which uses 5,000 watts, and is fifteen miles distant from my farm home."

A listener fifteen miles from KDKA reported that he got more volume on less (receiver) power from WGY than he did from KDKA (25 kW.).

A prominent engineer of the radio division of the U.S. Department of Commerce summarised a technical report on reception as follows: "It is my opinion that the efficiency of your station, so far as the delivery of reliable signals to broadcast listeners is concerned, has been increased 100 per cent. This not only holds for coverage, but for quality as well."

But one correspondent pronounced the test a failure. He is a resident of Newburyport, Mass., about 125 miles from WGY. He found that WGY faded badly on high power. "There never was a high-powered station but what was a failure," he stated. "You cannot expect a balloon to keep from bursting when you give it too much gas. What becomes of a wave if blown apart?"

These preliminary results are of particular interest to British listeners at present, in view of the discussion anent the proposed regional scheme, and have a special bearing on Captain P. P. Eckersley's remarks on the subject of increasing power, in his article on the regional scheme, recently published in these pages.<sup>1</sup>

When all reports, technical and otherwise, have come in and been duly tabulated and collated, the engineers' technical report on the experiments should prove highly interesting. Although no tests have so far been made in daytime, the night-time tests should yield valuable data on the relationship between fading and high power at varying distances.

In conclusion, it might be added that WGY's situation, some distance inland, and in a valley, does not seem to favour the radiation eastwards of his 790 kC. wave. The station is not easy to receive even in New York City. If, therefore, any readers in this country happened to hear the new transmitter testing, their reports will no doubt be welcomed by the engineer in charge of the station.

<sup>1</sup> *The Wireless World*, July 13th.

**"EXPERIMENTAL WIRELESS."**

The October issue of "Experimental Wireless" includes the following articles in addition to the usual features:—

**Calculation of the Polar Curves of Extended Aerial Systems.** BY E. GREEN, M.Sc.

**Measurements of a "Stalloy" Core with Simultaneous D.C. and A.C. Excitation.** BY L. B. TURNER, M.A., M.I.E.E.

**Properties of the Circle Diagrams for Telephonic Frequency Interval Transformers.** BY PROF. FELIX E. HACKETT, Ph.D. (DUBLIN).

**The Shielded Plate Valve as a High-frequency Amplifier.** BY R. T. BEATTY, M.A., B.E., D.Sc.

Copies are now available from the leading News-agents, price 2s. 6d. net, or direct from the publishers, Messrs. Iliffe & Sons Ltd., Dorset House, Tudor Street, London, E.C.4, price 2s. 8d. post free.



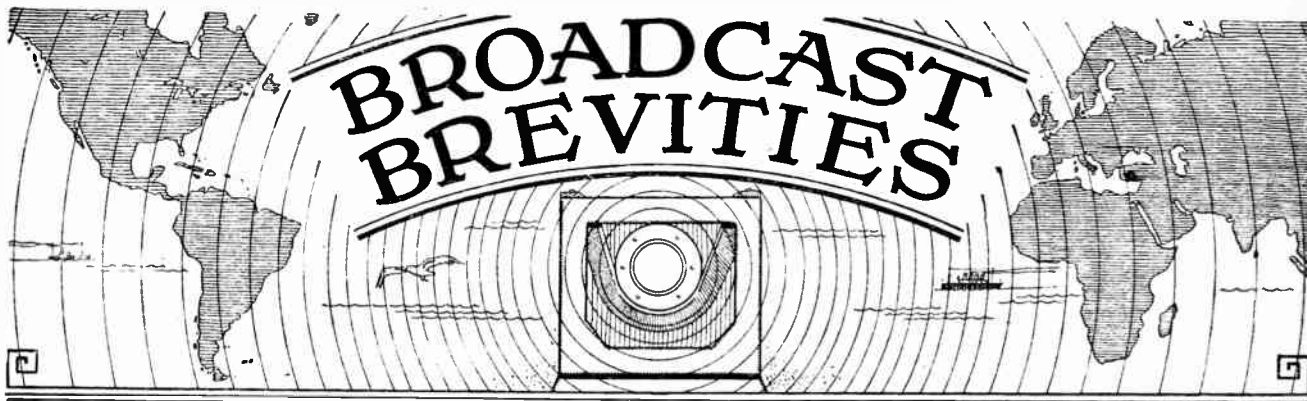

By Our Special Correspondent.

**"6SW Testing."—Problems for Washington.—Approaching Wavelength Chaos.—  
B.B.C. and Critics.—The Spice of Controversy.**

**The Chelmsford Tests.**

Something very near 25 metres has been allotted to the B.B.C. as the wavelength for their forthcoming experiments in Empire broadcasting, which are to take place at the Marconi Works, Chelmsford. Although it is stated that the tests will begin towards the end of the year, I should not be surprised if the first signals are launched on the ether (even if they do not reach the Dominions) in a very few weeks' time.

o o o o

**6SW Testing.**

If any reader should happen to hear "6SW testing" I believe he may rest assured that the B.B.C. tests have begun. But no garlands will be handed out to amateurs in Britain who report such a reception to broadcasting authorities, and the prudent listener will leave the QSL business to those for whom the transmissions are intended.

o o o o

**Helpers Overseas.**

Special arrangements have been made for the reception of the B.B.C. signals in various corners of the Empire, several well-known experimenters having been asked to assist.

o o o o

**Washington's Big Job.**

Meanwhile, Captain P. P. Eckersley is representing the B.B.C. at the Washington International Radio Conference, which opened yesterday (Tuesday). Among the multifarious questions which the delegates have to face is that of broadcasting wavelengths—a pleasant little topic which could quite easily absorb the whole of their time, and then some!

Take Europe alone. The Bureau Internationale de Radiophonie at Geneva, after preparing a brilliant scheme which took our breath away last autumn, is beginning to flounder. New stations are cropping up in all directions, and many of the older stations are assisting them to heterodyne everybody within reach.

**FUTURE FEATURES.**

- London and Daventry (5XX).**  
 OCTOBER 9TH.—Military Band Concert.  
 OCTOBER 10TH.—"My Lady Molly," a comedy opera.  
 OCTOBER 11TH.—Light orchestral music.  
 OCTOBER 12TH.—Popular Concert, relayed from the Albert Hall, Nottingham.  
 OCTOBER 13TH.—Variety programme and plays  
 OCTOBER 14TH.—"Twelfth Night," by a representative company of Old Vic players.  
 OCTOBER 15TH.—Concert, relayed from the Wigmore Hall, London.
- Daventry (5GB) experimental.**  
 OCTOBER 9TH.—Symphony Concert.  
 OCTOBER 10TH.—Variety Programme.  
 OCTOBER 11TH.—Orchestral Concert.  
 OCTOBER 12TH.—"The Magic Flute" (Mozart), as played by the National Opera Company.  
 OCTOBER 13TH.—Variety Programme.  
 OCTOBER 14TH.—"The Dogs of Devon," a comic opera.  
 OCTOBER 15TH.—"La Bohème," by Puccini.
- Bournemouth.**  
 OCTOBER 10TH.—A programme of British Music.  
 OCTOBER 13TH.—Modern French Music.
- Cardiff.**  
 OCTOBER 11TH.—A Symphony Concert.  
 OCTOBER 13TH.—"Tipperary to Tennessee," syncopating the Atlantic.
- Manchester.**  
 OCTOBER 11TH.—"The Intruder," an original play in one act.  
 "Gates of Heaven," a new play in one act.
- Newcastle.**  
 OCTOBER 11TH.—How a Daily Newspaper is Produced.

**Stations Heterodyned.**

Aberdeen and Newcastle appear to be most affected by the heterodyne nuisance, while complaints are also coming from several of the relay stations.

A passing glance at the list of new and projected stations in Europe will show that the trouble, far from diminishing, will tend to grow from day to day.

o o o o

**France and Germany.**

Before the end of 1928 France will have new stations at Vichy le Bains, La Bourboule, Chateau Thierry, and Nice, while the Eiffel Tower proposes to increase its power to 50 kilowatts.

The same tale can be told of Germany. The new high-power station at Zieser will open next month, at about the same time as the new station at Cologne, and other stations will soon be in operation at Altenburg and Raderthal.

o o o o

**Portugal, Greece, Holland and Russia.**

Portugal will shortly have a finger in the pie with new stations at Lisbon and Oporto, and Spain will assert herself with new stations at Barcelona University, Melilla, and Almera. Greece has prepared a scheme for seven stations at Athens, Gauina, Petras, Syre, Sante, Khios, and Salonica. Then Holland will come forward with two new stations, one of which will be at Amsterdam. A Hungarian 20-kilowatt station will make its debut this month.

Add to all these Russia's little estimate of fifty new stations and we see that a different basis of wavelength distribution must be sought.

o o o o

**The Only Solution.**

It looks as if the B.B.C. slogan "Fewer stations, higher power," points the way to the only real solution.

Discord will cease only when Europe is satisfied with a few super-power stations, linked up to as many studios as you like.

**Loud-speaker Design.**

A Wigan correspondent writes:—  
"Olympia having shown us that loud-speakers can be disguised as toadstools, oil paintings, dolls, parrots, Oriental figures, Welshwomen, etc., surely there should be no difficulty in making loud-speakers resemble umbrellas, pieces of chalk, slag heaps, hot-water bottles, omelettes, and—well, anything. But please let us have no more loud-speakers resembling loud-speakers."

○○○○

**B.B.C. and the Critics.**

Certain latent desires at Savoy Hill have been fanned into flame through contemplation of the case of Rear-Admiral Magruder, of the United States Navy, who recently wrote a magazine article criticising the naval organisation. In consequence of his literary activities the Admiral has been directed by Mr. Wilbur, Secretary of the Navy, "to submit to the Navy Department a full and detailed plan for the reorganisation of the Navy and the Naval Department."

The B.B.C. is fervently wishing that it could take the same disciplinary action with certain mordant critics, among whom are several former officials now outside the fold.

○○○○

**"My Lady Molly."**

Owing to copyright difficulties the broadcast of "The Lilac Domino," announced for October 10th, will not take place. "My Lady Molly" will be given in its stead. This "comedy opera" was first seen at Brighton in 1902, and was transferred to London a year later, when it was put on at Terry's Theatre.

○○○○

**The Shipping Forecast.**

In view of the complaint of master mariners that variations in programme timing cause inconvenience to seafarers who rely upon the broadcast weather reports, the B.B.C. intends for the future to announce each morning at 10.30 (when the weather report is broadcast from Daventry 5XX) the exact time at which the shipping forecast will be given the same evening.

○○○○

**Saint-Saëns Anniversary.**

The Manchester station has arranged a special programme for the afternoon of Sunday, October 9th, at 3.30 p.m., in commemoration of the birth of the famous French composer, Saint-Saëns. Among the orchestral items, which will be performed by the station augmented orchestra, will be the "Dance Macabre" and "Phaeton," both tone poems, while the concerto in A minor for 'cello and orchestra will be played with Miss Kathleen Moorhouse as solo 'cello. Saint-Saëns' compositions, which have had a good deal of influence on later composers, are now well known to a large number of music lovers, but it is perhaps not so well known that Saint-Saëns himself was almost as great a pianist as he was composer, and that he conducted the Queen's Hall orchestra in London.

**"The Creation."**

On October 16th 5GB will broadcast the famous oratorio "The Creation" from the Birmingham studio. The work will be performed in its entirety, i.e. including Part III., which is often omitted. The artists are all well known, and include Gertrude Johnson, soprano, John Armstrong, a young tenor who is rapidly making a great name for himself, and one of England's greatest basses, Robert Radford. The recent work of the Birmingham studio chorus and orchestra, under the conductorship of Joseph Lewis, will enable listeners to expect another great performance.

○○○○

**Chat by Famous Song Writer.**

For more than half a century the songs of Fred E. Weatherly, K.C., have been



**MUSIC UNCEASING.** It would appear that broadcast receivers are superfluous at Paterson, New Jersey, where WODA, the local station, "broadcasts" its programmes from the monstrous loud-speaker seen in the picture.

household words. His recent book of recollections, "Piano and Gown," deals with his long and busy life as a song writer and barrister. On October 13th Mr. Weatherly will tell 5GB listeners how some of his songs came to be written, interspersing the vocal illustrations with chat and recitations.

○○○○

**15,000 "Pirates."**

An unlicensed listener at Newry, Co. Down, prosecuted at the Newry Petty Sessions last week, pleaded that he was engaged on "experimental investigation." The immediate result of his investigations was a fine of 5s. and costs.

It was stated on behalf of the Postmaster-General that more than half the 30,000 sets in use in Ulster were unlicensed.

○○○○

**Exit the Crystal.**

Birmingham is bowing to the inevitable, subscriptions now being collected to

replace the present crystal sets in the local hospitals with valve instruments, so that 5GB can be picked up at the same strength as the transmissions from the old 5IT.

It is estimated that the cost of conversion in all the hospitals affected will amount to £600.

○○○○

**National Concerts Begin.**

The big event on Friday next, October 7th, will be the first of the B.B.C. National Concerts at the Queen's Hall. Sir Henry Wood will again be conducting. The first half of the programme will be devoted to Bach and the second half will include Beethoven's Choral Symphony.

The next concert of the series will be given at the People's Palace, Mile End Road, on October 14th.

Sir Landon Ronald will be conductor at the third concert in the series, to be given at the Queen's Hall on October 21st.

○○○○

**Sunday Evening Programmes.**

Beginning on Sunday next, October 9th, a new time schedule is to be observed in connection with the Sunday evening programmes this winter.

The usual opening transmission, consisting of bells or organ music, will begin at 7.50 instead of 8.0, thus allowing the religious service to open at 8 o'clock sharp. The appeal for "The Week's Good Cause" will follow at 8.45, with the News Bulletin at 8.50, and the concert proper will be timed for 9.5 p.m.

○○○○

**The Spice of Controversy.**

The B.B.C. will find it an easier task to provide really interesting debates this winter if negotiations now proceeding with the Postmaster-General bring about a relaxation of the stipulation that no topics shall be broadcast of a controversial nature.

Broadly speaking, there is no topic which cannot provoke controversy of some sort, even if the matter at issue concerns nothing more dangerous than cabbages or door-knobs.

○○○○

**How a Newspaper is Produced.**

Listeners to Newcastle station on October 11th will hear how a daily newspaper is produced. A description will be given in non-technical language of the whole process of printing and publishing—securing news items and editing and distributing papers to the various centres.

○○○○

**Speech by Lord Allenby.**

An important outside broadcast from Cardiff station will be given on October 17th from the Red Lodge, Bristol, the headquarters of the Savage Club. The occasion will be the dinner of the Royal Colonial Institute (Bristol branch), and Viscount Allenby will be the guest of the evening. Lord Allenby's speech will be broadcast and also that of the Duke of Beaufort, who will propose the toast of the City of Bristol. The Red Lodge is one of Bristol's greatest treasure houses, and the dinner will be given in the room known as the Wigwam.

# COSMOS (MET-VICK) VALVES

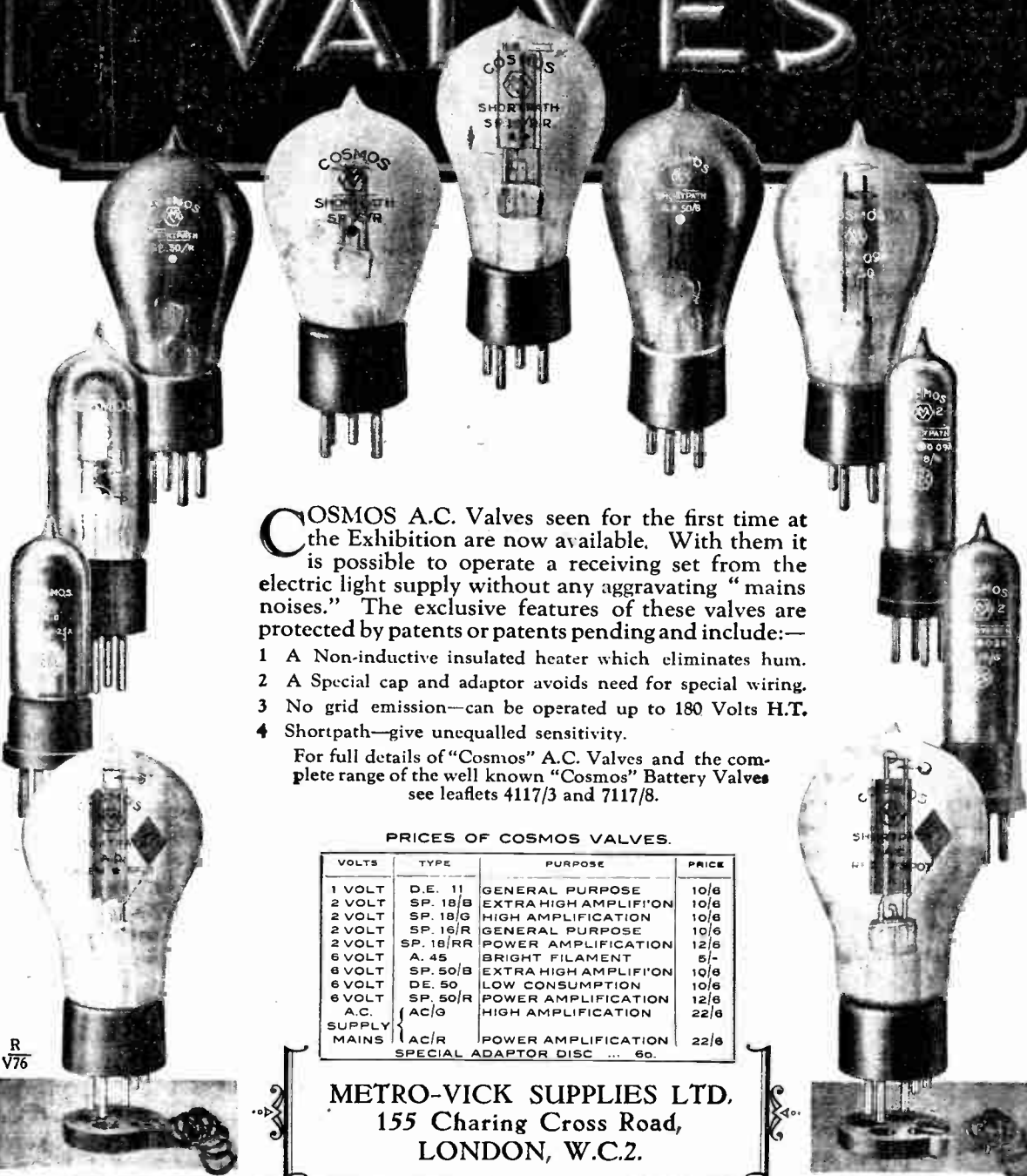

**C**OSMOS A.C. Valves seen for the first time at the Exhibition are now available. With them it is possible to operate a receiving set from the electric light supply without any aggravating "mains noises." The exclusive features of these valves are protected by patents or patents pending and include:—

- 1 A Non-inductive insulated heater which eliminates hum.
- 2 A Special cap and adaptor avoids need for special wiring.
- 3 No grid emission—can be operated up to 180 Volts H.T.
- 4 Shortpath—give unequalled sensitivity.

For full details of "Cosmos" A.C. Valves and the complete range of the well known "Cosmos" Battery Valves see leaflets 4117/3 and 7117/8.

**PRICES OF COSMOS VALVES.**

VOLTS	TYPE	PURPOSE	PRICE
1 VOLT	D.E. 11	GENERAL PURPOSE	10/6
2 VOLT	SP. 18/B	EXTRA HIGH AMPLIFICATION	10/6
2 VOLT	SP. 18/G	HIGH AMPLIFICATION	10/6
2 VOLT	SP. 16/R	GENERAL PURPOSE	10/6
2 VOLT	SP. 18/RR	POWER AMPLIFICATION	12/6
6 VOLT	A. 45	BRIGHT FILAMENT	5/-
6 VOLT	SP. 50/B	EXTRA HIGH AMPLIFICATION	10/6
6 VOLT	DE. 50	LOW CONSUMPTION	10/6
6 VOLT	SP. 50/R	POWER AMPLIFICATION	12/6
SUPPLY	A.C.	HIGH AMPLIFICATION	22/6
MAINS	AC/R	POWER AMPLIFICATION	22/6
	SPECIAL ADAPTOR DISC ...		6/-

**METRO-VICK SUPPLIES LTD.**  
155 Charing Cross Road,  
LONDON, W.C.2.

R  
V76

**DID YOU SEE THEM AT THE EXHIBITION?**

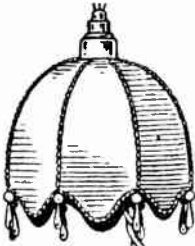

# For working entirely off the E.L. Mains

The illustration shows the new Met-Vick 5 with the eliminators contained in the side cupboards. It can be plugged into a lighting circuit just like any other Electric appliance. If used with H.T. and L.T. batteries these can be accommodated in the cupboards. The circuit employs two phase-balanced and stabilized H.F. stages before the detector, and two resistance coupled L.F. stages.

Operation is extremely simple, the local station can be easily cut out and a wide range of alternative programmes obtained.

Special attention has been paid to running costs which are remarkably low.

The Met-Vick 5 is a really beautiful instrument and while a distinct advance on any 1926 model it still remains at a reasonable price. Obtain Leaflet 4117/9 for complete range of prices.

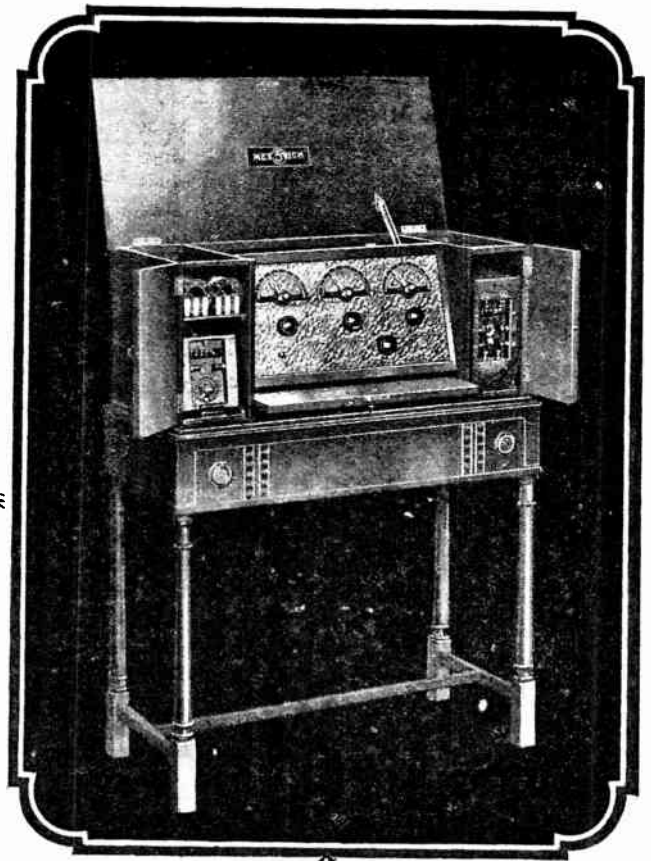

## Battery Eliminators

Met-Vick Battery Eliminators are supplied in two models, one for providing filament current and the other for anode and grid currents, by plugging in on electric light mains. The H.T.-G.B. Model provides a high voltage (up to 250 V.) for the last valve (ensuring a large volume without distortion). It is fitted with a switch, a protective fuse and a distributor panel enabling it to be used on various supply voltages of 40-100 periods. Grid Bias tappings at 5, 10, 15 and 20 volts.

The smoothing system is of exceptional efficiency. The eliminator can therefore be used successfully with multi-valve and the most sensitive sets even in districts where there are considerable irregularities in the electrical supply.

The L.T. Model gives an output of 5 amperes at 4 volts and a potentiometer ensures complete absence of hum. Obtain copy of List 7117/8.

# MET-VICK

(COSMOS)

## METRO-VICK SUPPLIES LIMITED

(Proprietors: Metropolitan-Vickers Elec. Co. Ltd.)

155 Charing Cross Road - LONDON, W.C. 2

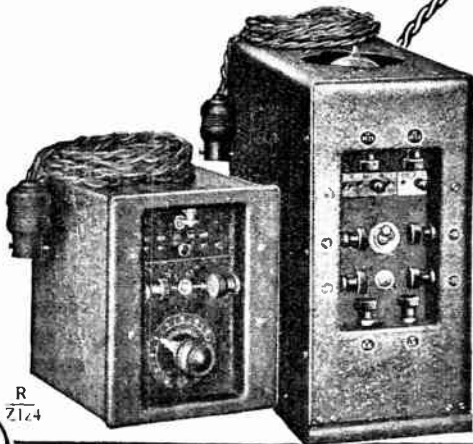

R  
7124

DID YOU SEE THEM AT THE EXHIBITION?

Mention of "The Wireless World," when writing to advertisers, will ensure prompt attention.

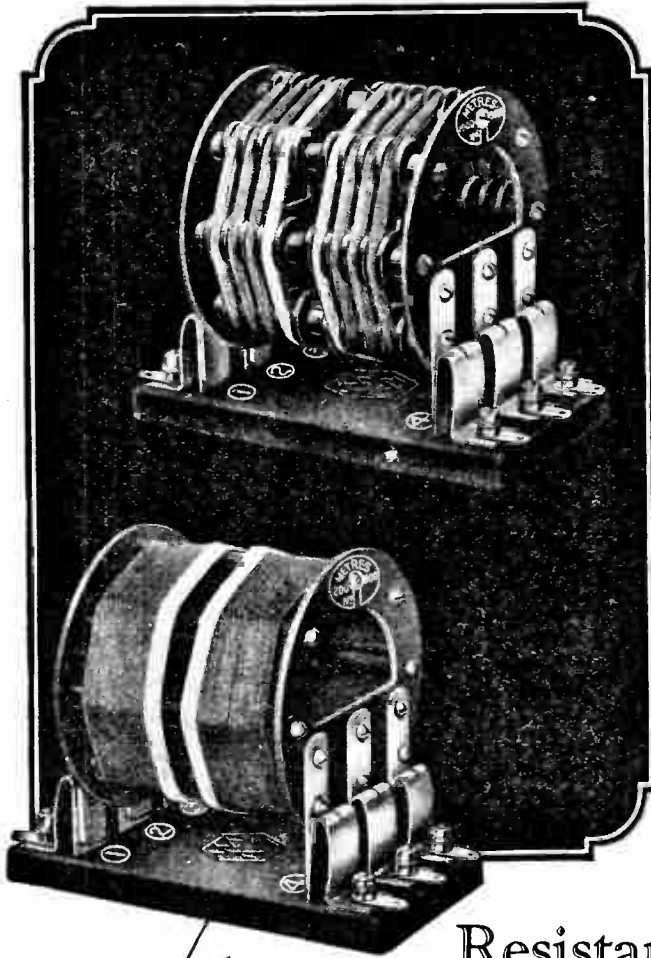

*Z*

# A·N·P

(Astatic-Non-Parasitic)

# Coils

A CLEVER SOLUTION OF A DIFFICULT PROBLEM.

*Patents pending.*

Designed to overcome in a simple manner the three difficulties associated with high frequency amplification namely: Magnetic coupling between coils, Stabilisation, and Parasitic Oscillation. The first named is prevented by Astatic winding, obviating the necessity for metal screens with their disadvantages, the second is obtained by centre and quarter-tappings accommodating valves of various impedances, and the third is avoided by balanced self-damping windings, thus dispensing with the expensive double condenser and resistance method previously used.

List 4117 '8 gives full details and prices.

## Resistance Coupling Units

Thousands of radio enthusiasts are loud in their praises of "Cosmos" (Met-Vick) Resistance Coupling Units. L.F. stages coupled by means of these Units result in clear Loud Speaker reproduction without distortion. The 'V' type unit can now be supplied fitted with the new 'Met-Vick' A.C. Valve Socket for use when building a set for working off the E.L. mains. The A.C. Valve-socket is also supplied separately for panel or baseboard mounting. Obtain List 7117/8 for full details and prices.

## MET-VICK

(COSMOS)

METRO-VICK SUPPLIES LIMITED

(Proprietors: Metropolitan-Vickers Elec. Co. Ltd.)

155 Charing Cross Road : : LONDON, W.C 2

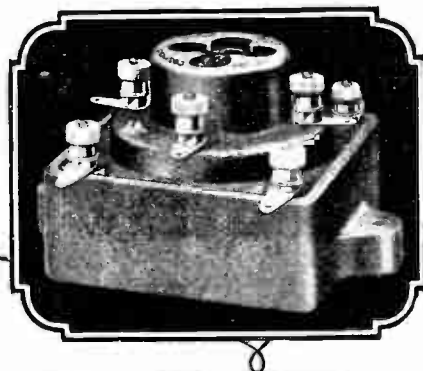
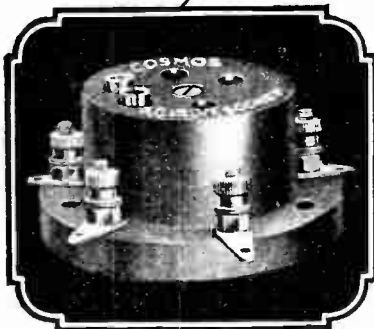

R  
P88

DID YOU SEE THEM AT THE EXHIBITION?



**£3**  
*—amazing!*

FOR the modest sum of three pounds you can become the possessor of a full-sized, full toned B.T.H. Loud Speaker—a speaker that has no rival in quality of reproduction or appearance, at anywhere near the same price. Quality and price considered this loud speaker is an amazing bargain. Ask your dealer to let you compare it with any other make.

Height 24" Flare 14"



# LOUD SPEAKER

TYPE C2

The above price is applicable in Great Britain and N. Ireland only

The British Thomson-Houston Co., Ltd.

2811

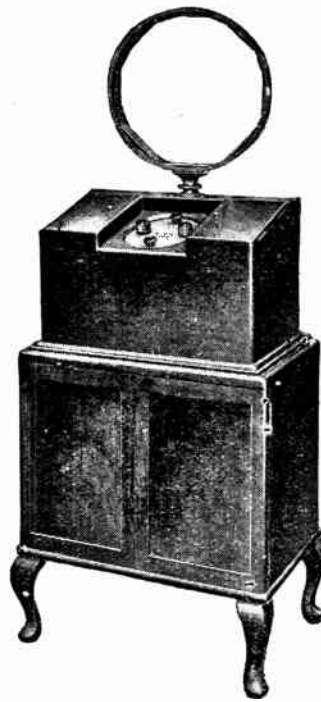

## B.S.A. 8-Valve de-luxe Super Heterodyne Set.

This set has been designed for extreme selectivity under all conditions. Its perfect reproduction, simplicity in operation, and attractive appearance make it a receiver de luxe. Price:

**£50**

Set only.

Accessories Extra.

## Two new B.S.A. Sets

In addition to the range of B.S.A. Radio Sets which are already well known, two new de-luxe sets have now been produced. You ought to see these sets before you choose a new receiver. The B.S.A. range now includes sets from 2-valve to 8-valve de-luxe super-het.—a set to suit every listener. Used with B.S.A. Kone Loud Speakers all B.S.A. sets give a quality of reproduction unsurpassed by any other combination. Ask your dealer for a demonstration.

### B.S.A. 4-Valve de-luxe Set

has been designed to give great volume of excellent quality with a B.S.A. Kone Loud Speaker, and is particularly suitable for dances, etc. Price:

**£27.10s.**

Set only.

Accessories Extra.

## B.S.A. Radio Sets

from **£6.15s.** Set only.

Catalogue Post Free from

B.S.A. Radio Ltd.,  
 21, Small Heath, Birmingham.

Proprietors: The Birmingham Small Arms Co., Ltd.



Mention of 'The Wireless World,' when writing to advertisers, will ensure prompt attention.

# The Experimenters' Notebook



## Absorption Wavemeters and their Application to Receiving Circuits.

By "EMPIRICIST."

THE season of "distant listening" is once more at hand, and, with the increase in signal strength characteristic of the longer nights, comes an increasing interest in identifying and logging foreign transmissions. To a certain extent this operation can be carried out by listening to the announcements between the items, but identification on a basis of wavelength is often a very much speedier operation, and a wavemeter is a very considerable help, particularly in cases where the same programme is transmitted from a group of stations.

An absorption wavemeter is at once one of the simplest and most reliable instruments for this purpose, and in view of the fact that many commercial firms are now marketing wavemeters of this type it seems opportune to review their leading characteristics and to describe the various uses to which they may be put.

Wavemeters of this type consist essentially of an inductance shunted by a capacity, constituting a closed oscillatory circuit, and the most general methods of using them depend upon the effect they produce upon apparatus to which they are coupled. An example will make this point clear. In Fig. 1 is shown an absorption wavemeter LC coupled to a heterodyne oscillator  $L_1C_1$ , which may be of any type, a "grid tuned" oscillator with condenser and leak being illustrated in the figure as a concrete example.

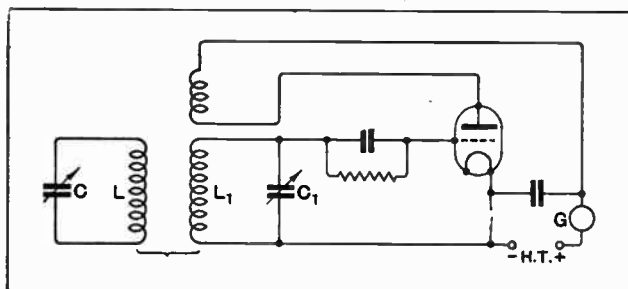

Fig. 1.—Absorption wavemeter LC coupled to tuned grid circuit of heterodyne oscillator  $L_1C_1$ ; if C is adjusted to bring the two circuits into tune a kick occurs in the feed current as indicated by G.

A feed current galvanometer G will indicate any changes which may occur in the amplitude of the oscillations in  $L_1C_1$ , since a decrease in the latter will be accompanied by a reduction in the negative voltage on the grid and a consequent rise in the feed current.

If now LC be tuned to resonance with  $L_1C_1$ , the gal-

vanometer will "kick" in an upward direction, its maximum deflection giving the point of exact resonance. If the coupling between the wavemeter and the heterodyne be increased the oscillations may either be extinguished at the resonant setting (and perhaps for a degree or so on either side of it), or else, if the reaction coupling is strong, the so-called "ziehen" effect may be observed. This effect consists of a sudden change from oscillation on one wavelength to oscillation on another, and is accompanied by a sudden change in the feed current. If a pair of telephones be placed in series with the galvanometer, these sudden changes will take the form of "clicks" and

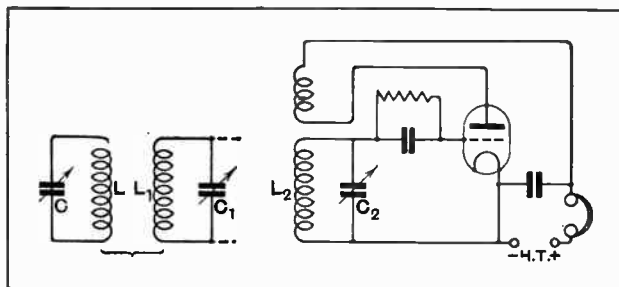

Fig. 2.—LC is the absorption wavemeter,  $L_1C_1$  a valve oscillator, and  $L_2C_2$  a heterodyne with phones. When LC is tuned in to  $L_1C_1$  a change in the beat frequency between the two oscillators may be observed in the telephones.

give a rough indication of resonance. A characteristic of the "clicks" is that they occur in different positions according to whether the wavemeter is brought into resonance from the higher or a lower wavelength; as the coupling between the two circuits is diminished the positions of the two clicks coalesce, and ultimately at weak coupling the click effect disappears and the galvanometer gives a simple upward deflection at the resonant setting.

The absorption wavemeter can in this manner be made to indicate a state of resonance with a heterodyne source by its effect on the amplitude of the oscillations of the latter.

A more accurate but somewhat more elaborate method consists in noting the effect of the wavemeter on the frequency of the oscillations. Referring to Fig. 2, the wavemeter is again coupled to a heterodyne source  $L_1C_1$  (the valve connections of which have been omitted for the sake of simplicity), and the oscillations of the latter are observed as a beat note in the heterodyne receiver  $L_2C_2$ . As the wavemeter is brought into resonance with  $L_1C_1$ , a sharp

**The Experimenter's Notebook.**—

change in the beat frequency will be observed, the general nature of which is indicated by the curve of Fig. 3. As the resonant setting is approached by adjusting the condenser C there will be first a slow rise in the beat note, then a sudden fall to a frequency below that of the original beat note, and lastly a gradual rise to the original frequency. The order of these effects may be reversed according to the setting of  $L_2 C_2$  in relation to  $L_1 C_1$ , but the effect of LC in the frequency of  $L_1 C_1$  will be, as it were, a "repulsion," i.e., if LC is tuned to a higher frequency than  $L_1 C_1$  the oscillations of the latter will be diminished in frequency, and *vice versa*. At the point of exact resonance, no effect in the frequency occurs at all;

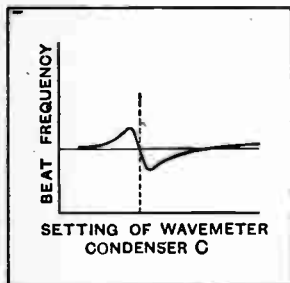

Fig. 3.—Curve showing change of beat note occurring with the circuit arrangement of Fig. 2. At the point of exact resonance (shown by the vertical dotted line) no change of the beat frequency occurs on making and breaking the LC circuit.

in the effect indicating resonance.

The examples given above serve to show how a heterodyne may be adjusted to a known frequency by means of a calibrated oscillatory circuit or absorption wavemeter. The advantage of using a standard of this type lies in the fact that its performance depends solely upon the inductance and capacity of the circuit and not upon the properties of associated apparatus such as detectors or buzzers. It may also be quite readily applied to reception work for the purpose of identifying a signal that has been picked up. If we imagine the circuit  $L_1 C_1$  of Fig. 1 to be the input circuit of a receiver tuned into a station, but not in a state of oscillation, the point of resonance between LC and  $L_1 C_1$  will be indicated by a sudden weakening and practical extinction of the received signals. A point of greatest sensitivity can be found by varying the coupling between the circuits by trial; with a coil and condenser of good quality the indication will be very sharp, and no difficulty will be encountered in setting the condenser of C as accurately as its scale can be read.

**Calibration.**

The accurate calibration of an absorption wavemeter is best carried out from a heterodyne according to the method of Fig. 2, the heterodyne being set in turn to the harmonics of a multi-vibrator or in some other manner adjusted to a known wavelength. For example, one absorption circuit can very easily be calibrated from another by setting each in turn to resonance with any uncalibrated heterodyne. The wavelength of the latter is de-

termined from the calibrated absorption circuit, and the corresponding setting on the circuit to be calibrated is correct for this wavelength. A practical method of working, if a roughly calibrated absorption wavemeter is desired, is to tune in a receiver to a number of stations which have been identified, and the wavelengths of which are exactly according to schedule. The settings of the absorption circuit may then be noted for these stations and plotted on a curve as wavelengths against condenser settings. Any abnormality will show up, as a general rule, so that, in the event of some station being wide of its correct wavelength, the corresponding point will not lie on a curve passing through the others. Now that many stations are settling down to precisely known wavelengths, this system of working provides a means for readily interpolating between these wavelengths and a degree of accuracy can be attained which is good enough for many practical purposes.

**A Dual-Purpose Instrument.**

The use of an absorption wavemeter as a wave-trap is fairly well known, but very frequently the coupling employed is too tight. If the wavemeter coil is of good quality, advantage can be taken of loose coupling between it and the receiving circuit, the rejection effect being adequately obtained with a coupling such that very little interference is caused with the tuning of the receiver. If the arrangement of the latter permit, inductive coupling to the grid circuit of the first valve is as satisfactory a method as any; alternatively a form of loose coupler

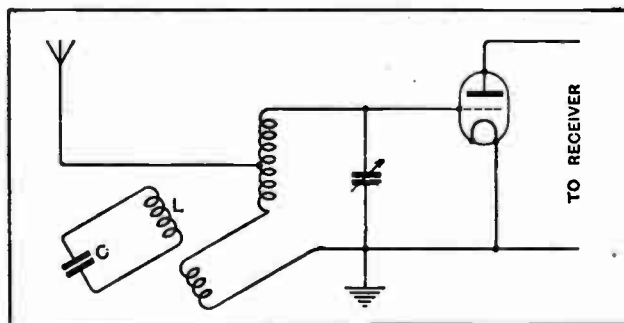

Fig. 4.—Use of an absorption wavemeter as rejector. Coupling turns are included in grid oscillatory circuit and are preferably wound on wavemeter coil former.

may be employed which consists of a coil of a few turns fitting loosely round the wavemeter coil or actually wound on the former of this coil after the manner of the primary of an "Everyman Four" transformer. The coupling coil may be inserted in series with the aerial, or preferably it may form part of the grid oscillatory circuit, as shown in Fig. 4. If this arrangement be adopted, the wave-trap is effective in respect of any stray pick-up on the grid circuit itself, which would not be the case if the wavemeter were coupled to the aerial circuit alone.

**Note on Switching in L.F. Amplifiers.**

In the article on the above subject appearing in the issue of August 10th last, the writer suggested an "ideal method" of cutting out a stage of amplification which involved the isolation of the "bridging lead" across the



**The Experimenter's Notebook.—**

stage and its connection to earth. A letter has since been received from Mr. P. Hooper, of Portsmouth, who states that he has for some time past had in use an embodiment of the method of Fig. 1 (b) in the above article, and comments upon the fact that he had never before seen this method advocated. His practical scheme is shown in Fig. 5, and is simplicity itself; it will be seen from this figure that the "bridging lead" consists of a flexible connector provided with a plug at each end, the transformer secondaries and their connecting points being attached to jacks, as shown in the diagram. When the flexible lead is not in use it is completely removed from the amplifier, and cannot, therefore, give rise to any coupling effects. The only disadvantage of the method is the necessity for a stray interconnecting lead, but this is far outweighed by the convenience with which it can be put into practice and the undoubted efficiency which its use would entail when compared with older methods using complicated change-over switches.

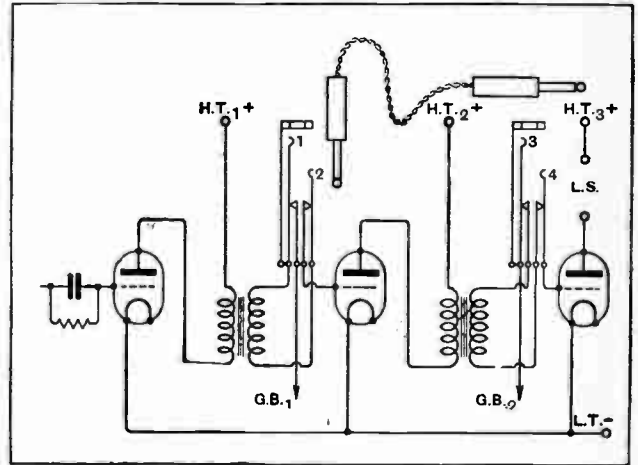

Fig. 5.—L.F. switching arrangement suggested by Mr. Hooper. It will be noticed that when the first L.F. valve is cut out, contact 1 of first jack is connected through the plugs to contact 3 of second jack and contact 2 to contact 4 of second jack.

**MARCONI ROYALTIES.**

The Following Important Statement was Issued Last Thursday by the Marconi Company.

**WIRELESS RECEIVER ROYALTIES.**

Sir Edward Iliffe's Suggestion.

Action By the Marconi Company.

AT the inaugural banquet of the National Radio Exhibition at Olympia Sir Edward Iliffe, M.P.—according to a newspaper report—referred to the rapid progress that is being made in the art of wireless, and said one of the drawbacks to efficient reception was the fact that many receiving instruments at present were out of date. He thought it would be greatly to the advantage of broadcasting generally if the possessors of these old sets could be induced to throw them away and to invest in new ones. He said he understood that one of the reasons why old sets were not discarded was that a royalty had to be paid on each set purchased and that a fresh royalty would therefore have to be paid for the new set. He suggested that the interests of listeners and of the wireless industry would be benefited if it were possible to induce the listener to discard his old set with greater frequency and purchase a new one and that the necessary inducement might be given in the form of a royalty rebate of, say, 50 per cent. when an old receiving set was discarded for a new one.

The Marconi Company are always ready to consider suggestions which may concern them for the advancement of the wireless industry, and particularly to consider anything that may be for the benefit of British wireless manufacturers, especially when they are made with authority such as that which attaches to an opinion expressed by Sir Edward Iliffe.

They had decided that in cases where listeners already possess receiving sets and are desirous of purchasing new receivers employing the same number of valves or more valves than are contained

in their old sets they will be credited with the whole of the licence fee they have already paid. The purchaser will then be called upon to pay a further royalty only on the number of valves fitted to the new set over and above the number used in the old set.

This means that if a listener has a three-valve receiver and wishes to buy a five-valve receiver to replace it he need only pay a further royalty on the two additional valves which he intends to use, provided that he hands in his old royalty plate and makes a declaration that the old set will not be disposed of to another listener without applying for a new plate and paying the appropriate royalty for the set as originally used.

The Marconi Company are supplying the wireless trade with forms upon which this declaration can be made. The procedure will be that a listener wishing to discard an old set and to replace it with a new one will obtain one of these forms on application to the retailer from whom he proposes to purchase his new receiver. He will fill up the form and attach to it the royalty plate from his old receiver. The new receiver will then be sold to him with a royalty charge for the difference between that charged on the valves in the set for which the returned plate was issued and those in the new set which he is purchasing. A man discarding a three-valve receiver and buying a new five-valve receiver would thus pay a fresh royalty of 25s. instead of 62s. 6d.

A copy of the form is attached, and it has been decided that the arrangement shall come into force immediately so that buyers at the Radio Exhibition may benefit.

To ..... 192

GENTLEMEN,

1. I have in my possession a (a) Valve Broadcast Wireless Receiving Set, No. (b) constructed by (c) (or MYSELF) and I hand you herewith Licence Plate No. which was attached to such Set.

2. I am anxious to get a (d) Valve Set in order that I may get the full benefit of the alternative broadcasting programmes now available.

3. In the price of my existing set I have paid the appropriate royalty to Marconi's Wireless Telegraph Company, Limited, namely (e) ; and in consideration of your crediting me with that sum upon my purchasing the larger set referred to in paragraph 2 of this letter I undertake that I will not sell or part with the set referred to in paragraph 1 of this letter unless I previously obtain from Marconi's Wireless Telegraph Company, Limited, a fresh Licence Plate for attachment to such set and pay to that Company the appropriate royalty.

I am, Gentlemen,  
Yours faithfully,

Usual signature .....  
Full Christian Names and Surname .....

Address .....

Occupation .....

**EXPLANATORY NOTE.**

(a) Insert Number of Valves.  
(b) Insert Number of Existing Set.  
(c) Insert Name of Manufacturer of Existing Set.  
(d) Insert Number of Valves desired in Set now being purchased.  
(e) This is 12s. 6d. on a One-valve Set; £1 5s. on a Two-valve Set; £1 17s. 6d. on a Three-valve Set; and so on.



The Editor does not hold himself responsible for the opinions of his correspondents.

Correspondence should be addressed to the Editor, "The Wireless World," Dorset House, Tudor Street, E.C.4. and must be accompanied by the writer's name and address.

#### EMPIRE BROADCAST TRANSMISSIONS.

Sir,—My attention has been directed to a paragraph in your issue of September 21st regarding Mr. Marcuse's short-wave broadcasts.

There is just one statement in that letter to which I should like to refer, and that is the suggestion that Mr. Marcuse's programmes, limited as they will be to gramophone records, will be of little intrinsic value.

Naturally, a programme of gramophone records has not the interest of performances given by the artists in person; but, as a recent arrival from Australia, I assure you that any programme broadcast by Mr. Marcuse would have the very greatest interest on the other side of the world. The fact of the music being transmitted around the globe, rather than the source of music itself, would be the aspect which would appeal to listeners.

It may interest your readers to know that the broadcasting of popular dance tunes and other items has increased and not reduced the demand for gramophone records.

May I, in conclusion, say that the interest taken in Empire broadcasting in Australia, and, presumably, in the other Dominions, seems to be greater than in Britain itself.

London, E.C.4, September 22nd, 1927. LLOYD DUMAS,  
Australian Newspapers' Cable Service.

#### TELEVISION IN 1925.

Sir,—With reference to the letter from Mr. Hays Hammond, published in this week's issue of *The Wireless World*, in which he states that "Mr. C. Francis Jenkins is entitled probably more than any other man to credit as the earliest successful worker in this important research." It should be made clear that Mr. Jenkins' transmissions were simply shadowgraphs and not true images, and that even up to the present time Mr. Jenkins has not demonstrated television.

The transmission of shadowgraphs were first shown by Rignoux and Fournier in 1908, but they did not make any pretension that their demonstration constituted a demonstration of television.

The transmission of shadows bears the same relation to television that a skiagraph does to a photograph.

Shadowgraphs have been transmitted by a number of workers, including M. Belin, M. Dauvillier and others. M. Dauvillier, after describing his experiments and apparatus, states: (*Comptes Rendus*, August 2nd, 1926). Mais aucun objet normalement éclairé de l'extérieur ne diffuse assez de lumière pour impressionner l'appareil et c'est un gain de sensibilité de l'ordre de mille qu'il faudra réaliser pour le rendre pratiquement utilisable." Translation: "No object illuminated from the exterior diffuses sufficient light to make an impression on the apparatus, and its sensitivity would have to be increased a thousand times to make it practicable."

It is noteworthy that Mr. Baird himself demonstrated in public the transmission of silhouettes by reflected light for two weeks at Messrs. Selfridges in April, 1925. There are Press cuttings in abundance from the principal papers both in this country and in America to verify this fact.

The problem of television was to transmit a true image by diffusely reflected light, and this problem was first solved by Mr. J. L. Baird when, in January, 1926, he showed the transmission and reception of the living human face, not as a shadow, but as a true image.

Up to the present time, the only demonstrations of television ever given are those arranged by Mr. Baird in this country and those by the American Telegraph and Telephone Company in U.S.A.

Mr. Baird's first demonstration of television given before the members of the Royal Institution in January, 1926, took place nearly eighteen months before that of the American Telegraph and Telephone Company.

For Baird Television Development Co., Ltd.,  
O. T. HUTCHINSON,  
Joint Managing Director.

London, W.C.2, September 28th, 1927.

#### REPRODUCTION OF GRAMOPHONE MUSIC.

Sir,—Previous to my conversion to radio I was a very hot gramophone enthusiast, and am naturally interested in the marriage between the gramophone and radio, brought about by the marketing of the pick-up.

To those who are considering the subject, may I suggest that, if means will allow, they build an amplifying set quite distinct from the receiver. By this means they will not only get the very best from gramophone records, but allow delicate adjustments, particularly with regard to volume control and elimination of surface scratch.

I notice that Mr. Duckworth mentions a fibre needle to reduce surface scratch, but I do not recommend this type; for to obtain this softness in reproduction, brilliancy is largely sacrificed, this effect being noticed particularly in the higher tones of orchestral work.

My experience has proved to me that different pick-ups require different needles. Strangely enough, from one pick-up I got much better results and absolutely no surface scratch by using a loud needle, whereas with another pick-up a fine needle was necessary to obtain the desired results. It would appear that the characteristics and damping of the reed have a great deal to do with determining the type of needle to be used.

C. D. CLAYTON.

London, W.C.2, September 7th, 1927.

#### SHORT-WAVE TRANSMISSIONS AND RECEPTION.

Sir,—May I congratulate your valued journal upon its fight for a British short-wave transmitter, and testify to my own knowledge of South Africa how this would be appreciated there?

It may interest your readers to know that, on September 2nd, I heard Station 2ME (Australia) announce that his power was 18 kilowatts.

Since August 1st I have not succeeded in picking up Station ANH, Radio Malabar, at Java, on 17.4 metres. Prior to that date I often heard him from 1,200 to 1,700, G.M.T. Perhaps a reader may know what has happened to the little truant and oblige with the information?

E. T. SOMERSET.

Burgess Hill,  
September 14th, 1927.

Sir,—May I ask the favour of a few lines in an early issue to ask amateur transmitters if they would be kind enough to state frequently the wavelength on which they are operating, particularly telephony transmissions?

I am certain that there are many like myself who are interested in and spend much time and trouble and, incidentally, receive much pleasure receiving short-wave telephony, and it would be a real help if amateurs often mentioned their wavelength.

I am only a novice at short-wave reception, and in consequence I haven't the faintest idea "whereabouts I am," except that I must be somewhere between 30 and 100 metres.

Harrow,  
September 12th, 1927.

J. BELLINGHAM.

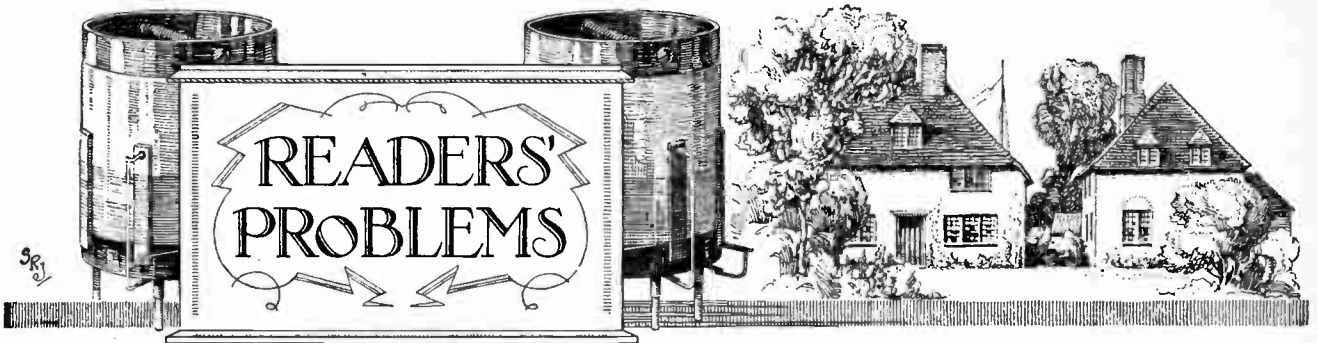

**"The Wireless World" Information Department Conducts a Free Service of Replies to Readers' Queries.**

Questions should be concisely worded, written on one side of the paper, and headed "Information Department." One question only should be sent at a time, and must be accompanied by a stamped, addressed envelope for postal reply. Any diagram accompanying the question should be drawn on a separate sheet. No responsibility will be accepted for questions sent in which do not comply with these rules.

**An Inexpensive Quality Set.**

I have hitherto been using a crystal receiver for wireless reception, confining my attentions solely to the local station, which is about 10 miles distant. I have decided now to invest in a loud-speaker and a receiver suitable for operating it. Reception is desired only from the local station, and the best quality is required, the volume being sufficient for an ordinary size living room. It is essential, however, that the receiver be economical both in initial outlay and in running costs, and I should be glad if you could supply me with a suitable circuit.

W. H. R.

We have no hesitation in recommending to you the circuit shown in Fig. 1. This circuit should suit your needs exactly. Contrary to the opinion of most people, the obtaining of good quality and volume from the local station only, so far from being an expensive matter, is exceedingly cheap both in initial outlay and in the cost of upkeep.

An anode bend detector is used, followed by a single stage of resistance-coupled amplification. This will give exceedingly good quality coupled with reasonably good volume, whilst the risk of L.F. troubles is practically eliminated by the use of one stage of L.F. Since there is only one tuning condenser operation is exceedingly simple.

We are assured, therefore, of simplicity, freedom from trouble, and good quality and volume, and there only remains the question of cost to consider. Initial cost is exceedingly low, the only components required being two valve-holders, a plug-in coil and single coil holder, four fixed condensers, an anode resistance and grid leak. whilst in addition, of course, we must have a small accumulator, an H.T. battery of 120 volts, and a grid battery, together with two valves and the loud-speaker. We presume, of course, that you already have an aerial and earth system for your crystal set. Now the cost of a plug-in coil is exceedingly low, and if desired, a home-made 50-turn basket coil may be used. The tuning condenser, since it does not require to have any slow motion arrangements, should not cost

more than 5s. or 6s. The anode resistance need not be of the wire-wound type, and is therefore inexpensive. No heavy outlay is required for fixed condensers, as the largest of the mica dielectric type has only a capacity of 0.005 mfd., the 1 mfd. condenser having a paper dielectric.

With regard to valves, we shall use two-volt valves, and thus reduce the initial cost of our accumulator. For the loud-speaker, we would recommend one of the diaphragm type, many excellent specimens of which can be obtained for about 2 guineas.

In the matter of running costs, the receiver is very economical, since the total filament current need not exceed  $\frac{1}{2}$  of an ampere, and it will thus be possible to run the receiver five or six hours daily

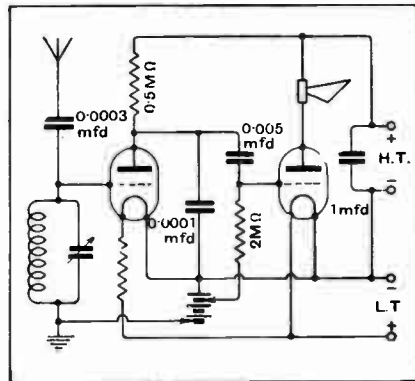

Fig. 1.—An economical loud-speaker receiver.

without the necessity of the accumulator being charged more than once per month, provided that it is of average size, such as 40 ampere-hour actual capacity. Such an accumulator of the 2-volt type is not heavy to carry.

In the matter of plate current the consumption of the detector valve is negligible, whilst that of the output valve can be kept within reasonable limits by a judicious adjustment of grid bias. A receiver of this type is a thoroughly practicable proposition for anybody intent on changing from a crystal set to good loud-

speaker reception with economy from the local station.

Full constructional details of a receiver employing a circuit of this type were given in our issue of October 27th, 1926.

o o o o

**"Diode" Rectifier.**

I propose converting the detector circuit of my receiver to the "Diode" detector given in Fig. 2 (c) on page 232 in "The Wireless World" of August 24th last. I should be obliged if you could give me the values of condensers  $C_1$ ,  $C_2$ , and resistance  $R_1$ .

L. C. F.

The condenser  $C_1$  functions as a coupling condenser between the aerial circuit and the detector valve, and is required to pass on the high-frequency oscillations. Its capacity therefore need not exceed 0.0003 mfd., and we think this value will be found quite satisfactory. The condenser  $C_2$  is a by-pass condenser for any high-frequency oscillations which may find their way beyond the H.F. choke, and a 0.0003 mfd. condenser will be sufficiently large for use in this position.  $R_1$  is the usual anode resistance, and a value of about 100,000 ohms is recommended.

o o o o

**An Up-to-date Four-valve Set.**

I wish to construct a modern and up-to-date four-valve receiver employing one H.F. stage, detector, and two L.F. It is necessary that the receiver be both sensitive and also selective in order to be of use to me when the new regional scheme is in operation. I should be glad if you could advise me of a suitable set.

L. W. C.

We should advise you, under the circumstances, to build "The Wireless World" "Regional Receiver," described in our issues of August 17th and 24th. This receiver complies in every respect with your specifications, except that it has but one L.F. stage, which is resistance coupled. It would be perfectly feasible, however, to add an extra transformer-coupled stage of L.F. to this receiver, when you would have a modern and up-to-date four-valve receiver such as you require.

**An Efficient Three-valve Receiver.**

I wish to build a straightforward three-valve receiver consisting of a regenerative detector valve with leaky grid rectification, followed by a two-valve amplifier. I desire that the first stage of L.F. be so arranged with a switch that either choke coupling or resistance coupling may be used as desired, and, moreover, I wish that control over volume be obtained by using a tapped wire-wound resistance and a tapped choke, the second stage of L.F. being transformer coupled, using a good transformer. Furthermore, I wish to use an output transformer, although, if possible, I should like also to be able to use a choke-filter output circuit when desired, for the purpose of using a single-wire loud-speaker extension system. Advice concerning the type of valves to use would also be welcome.

G. R. E.

We give in Fig. 2 a diagram according to your requirements. As you will see by studying the diagram, by putting the double-pole switch to the left, a choke-coupled amplifier is brought into use, and on putting the switch over to the right resistance coupling is used. We have also put in the type of volume control which you desire.

You will appreciate that the L.F. amplifier is of exactly the same design, including the volume control, as the power amplifier described in our March 31st, 1926, issue, and should be productive of excellent quality, whilst, owing to the presence of reaction, the receiver should be able to bring in quite a large number of distant stations on all wavelengths if properly handled. An important detail to note is the 0.0001 mfd. fixed condenser,

which virtually shunts the anode resistance or choke as the case may be, its object being to by-pass H.F., and so prevent it getting into the L.F. amplifier and causing trouble, an additional safeguard being provided by the 0.1 megohm resistance on the grid of the first L.F. valve.

With regard to the L.F. transformer, this should, needless to say, be of a good type, having a high inductance primary of not less than 50 henries if possible.

With regard to the output circuit, we have shown a transformer as you desire. It is not absolutely necessary, however, to use a choke-filter circuit in order to use the single-wire loud-speaker extension system, because if one terminal of the output transformer secondary is connected to the L.T.—busbar (or, in other words, to earth) then a wire can be extended from the other secondary terminal of this transformer and connected through to the distant loud-speaker, the other side of the loud-speaker being, of course, earthed. We show the connection between the transformer secondary and earth by means of a dotted line, and also show by dotted lines how to use a choke-filter output circuit when you desire it, the transformer primary acting as a choke. It should be pointed out that since you will naturally use a properly designed output transformer, its primary will act as a perfectly efficient choke when using a choke-filter output circuit.

With regard to valves, you should choose for the detector and first L.F. valve one which has an A.C. resistance of between 20,000 and 30,000 ohms, and, naturally, you will choose a valve which gives the highest amplification factor for this A.C. resistance value. The output valve must be one which will handle a

large grid swing without overloading, and you should choose one of the valves having an A.C. resistance of between 3,000 and 4,000 ohms, of which there are many specimens on the market. As suitable practical examples we would say that in the 6-volt range a Marconi or Osram D.E.5B as detector and first L.F. and a Marconi or Osram D.E.5A as output valve would give most excellent results. As we have explained before in this journal, 6-volt valves are more efficient than 2-volt valves, all other things being equal, while, naturally, 2-volt valves are the most economical. Four-volt valves occupy an intermediary position with respect to both economy and efficiency. Needless to say, valves of similar characteristics by other makers would serve equally as well as the ones we have quoted merely for the sake of example.

Tapped L.F. chokes may be obtained from Messrs. W. G. Pye, Ltd., Granta Works, Montague Road, Cambridge, among other makers, whilst, of course, several makers, such as Messrs. R. I. and Varley, Ltd., Kingsway House, 103, Kingsway, W.C., produce tapped anode resistances, although, if desired, an instrument can easily be made at home in accordance with the instructions given in the article which we have already mentioned as dealing with this particular form of L.F. amplifier. This is a thoroughly reliable and sound receiver.

o o o o

**Altering the "All-Wave Four."**

I am building the "All-Wave Four," but in place of the anode resistance, grid condenser and grid leak used am intending to insert a commercial R.C. coupling unit. Will this be quite in order?

T. H.

Provided that the values of anode resistance, coupling condenser and grid leak used in your commercial unit do not greatly vary from the values used in the original receiver, all will be in order. We would say that most modern commercial coupling units are quite suitable, but you must not forget that the small fixed condenser of 0.0001 mfd. capacity, marked C<sub>6</sub> in the original diagram of the receiver, will still be necessary in order to ensure rectification efficiency. Most commercial units do not include this condenser.

o o o o

**High-efficiency Transformers.**

I am intending to build the "Everyman Four" for a friend, and the "All-Wave Four" for myself, but do not relish the task of constructing the transformers. Can you recommend any commercial transformer which will do equally as well?

T. F. D.

There is no necessity whatever for you to make the transformers yourself if you do not feel that you are sufficiently skilled, as there are quite a large number of firms who now make excellent specimens of them. You will find several firms advertising almost every week in the advertisement columns of this journal.

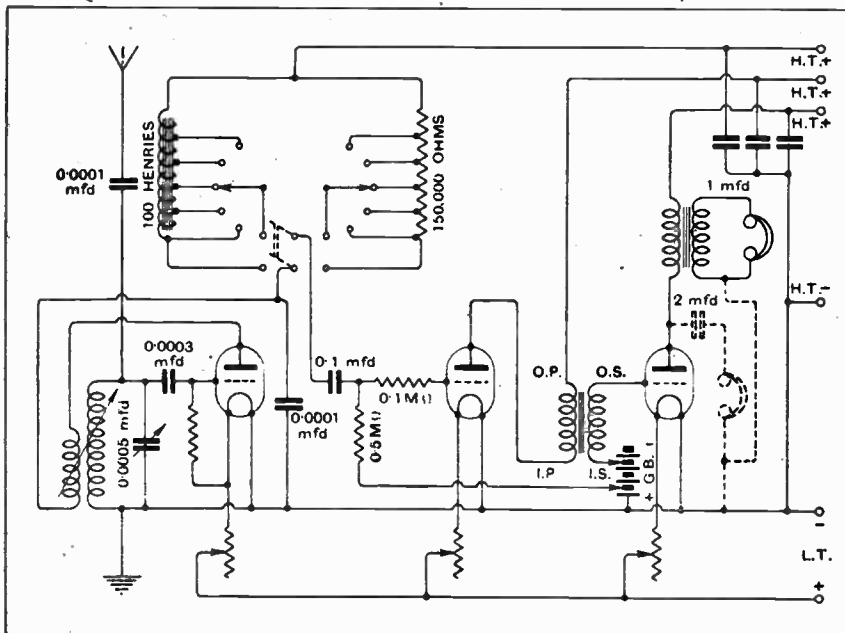

Fig. 2.—An efficient three-valve receiver with volume control and transformer or choke-filter output circuit.

# Build the wonderful *New and Improved* R.C. THREESOME

**EASIER .....  
THAN EVER  
MADE IN AN  
HOUR OR TWO  
ONLY 50/- FOR  
PARTS**

*The new and improved R.C. Threesome has all the quality-of-reception virtues of the first model . . . with additional merits.*

*A new idea of plugged-together coupling units is incorporated. This simplification materially reduces the number of parts for assembly, so that the whole job can easily be completed in an hour or two. No soldering is required. Wiring connections have been reduced from 24 to 5. You can build this "brain-wave" set for 50/- or less. . . Use the Coupon now !*

**Free!**

*Send  
TO-DAY for  
Instruction  
Book & Blue  
Print.*

**FILL IN  
COUPON  
POST  
NOW**

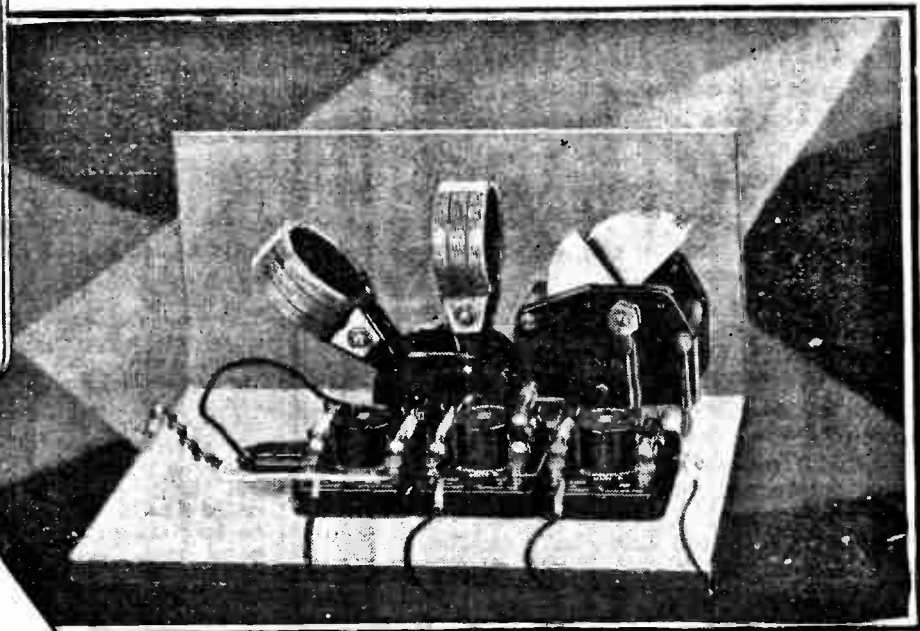

# EDISWAN

*To THE EDISON SWAN ELECTRIC CO., LTD.,  
(Publicity), 123/5, Queen Victoria St., London, E.C.4.*

*W.W. 5.10.27.*

*An Improved R.C. Threesome? I'd be delighted to  
have a copy of your Instruction Book and Blue Print!*

NAME .....

ADDRESS .....

.....

**NOW  
12/6  
WAS  
~~£1~~**

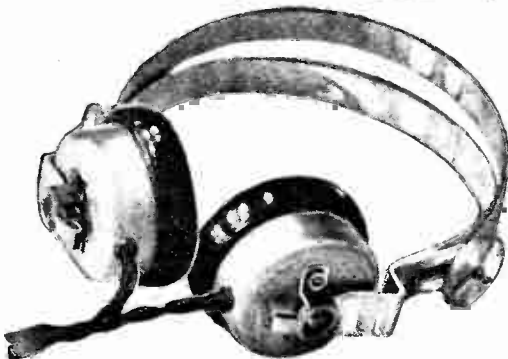

The reduction from £1 to 12/6 a pair brings Ericsson Super Sensitive Headphones within the reach of every pocket. Used by the B.B.C. in their studios. Adopted as standard by the Admiralty back in 1909, and in 1917 by the Air Board. To-day they are found in every DX experimenter's den. Wonderfully sensitive. Made in three resistances—120, 2000 and 4000 ohms, but remember—**one price, 12/6.**

Should you be unable to call remember all good wireless shops stock Ericsson Apparatus. Agents everywhere. Write to-day for Lists.

**ERICSSON TELEPHONES LTD.,**  
67-73, Kingsway, London, W.C.2.

**Ericsson**  
SUPERSENSITIVE  
TELEPHONES

*two  
good  
lines*

**EDISON BELL REGENT  
CABINET SPEAKER.**



Cat. No. R.364.

is incorporated which is not easily saturated. Clear reproduction is obtainable over the whole musical scale, volume and clarity being exceptional.

Price **£5 10 0** each.

**T**HIS Cabinet Model is of solid mahogany (piano finish) measuring 17½" × 17½" with an artistic mother o' pearl grill. It embodies all the characteristics of the Edison Bell original double cone speaker, and bears added improvements.

**EDISON BELL STRAIGHT LINE  
FREQUENCY CONDENSERS.**

**T**HESE Condensers are mechanically and electrically perfect. They provide an easy means of separating stations which are operating within a narrow wave band. A definite movement of the Dial makes a definite change in frequency, thus facilitating the method of tuning. They are fitted with an improved vernier movement (slow motion) of a high ratio, whilst a screened plate is supplied which when fitted under the Dial prevents hand capacity effects.

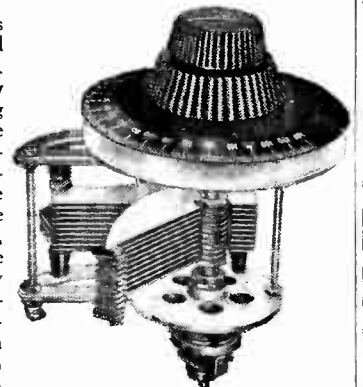

Cat. No. R/371—R/271B.

Cat. No. R/371	..	0003	..	16/6
.. .. R/371a	..	0005	..	18/6

**EDISON BELL  
RADIO**

**The Best After All.**  
**LONDON, S.E.15.**  
and at Huntingdon.

# CAV THE WORLD'S BEST BATTERIES for RADIO

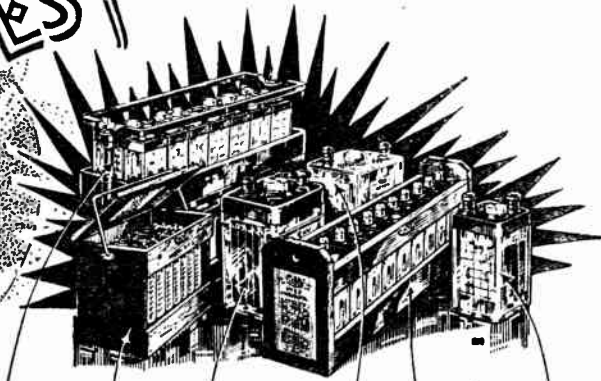

THERE IS A TYPE FOR EVERY RADIO USER —

SALES AND SERVICE DEPOTS  
Belfast, Birmingham, Bristol, Coventry, Dublin,  
Glasgow, Leeds, Manchester and Newcastle.  
Battery Service Agents in all important  
centres throughout the country.

**CAVandervell & Co., Ltd.**  
FACTORY, LONDON, W 3

Telephone: Chiswick 3801 (Pls. Branch Exchange).  
Telegrams: "Vanteria, Act., London."

**H.T.S. 2500 Military Use**  
The original H.T. Accumulator of repute design. Every cell is wound and contained in lead. — 7 groups can be taken from any cell. Obsolete in 30, 60 and 100-cell units.  
25-cell. Fully charged. £3 : 0 : 0

**ACTON CELLULOID.**  
Supplied in all capacities, the range of low tension batteries is extended to 2000 volts, while the quality is in every way representative of our 30 years experience in battery construction.  
2-cell. 70 amp. output. 12/6

**A.G.N. MASS PLATE.**  
The 30 amp. 2-cell mass plate cell is ideal for low and medium duty. — The charge rate for normal use equals that of sulphuric acid.  
2-cell. 30 amp. output. 8/6

**H.T.S. 1000 Military Use**  
A large capacity battery of novel construction design. Suitable for long running sets, public address systems and small generators.  
£3 : 10 : 0

**ACTON GLASS.**  
The "Acton Glass" low tension range provides an alternative to the celluloid range battery and is also suitable for special functions. All capacities supplied.  
2-cell. 40 amp. output. 12/6

**H.T.O.S. 1000 Military Use**  
The ideal High Tension supply for the average Broadcast Receiver. — Amp. output obtained by changing a variable number of cells. A 10-cell tapping point is provided.  
2-cell. 40 amp. output. 12/6

## THE BEST IN THE WEST

CAPTAIN ROUND'S latest screened valve as specified in the Wireless press and acknowledged to be the most wonderful yet produced.

Place your orders now. Do not fail to call at our showrooms to hear a demonstration of the moving coil Loud Speaker. All parts in stock.

It will also pay you to hear a demonstration of the marvellous apparatus for electrical Gramophone reproduction.

Every type of pick-up can be demonstrated upon request. Brown, Igranic, Marconi, Celestion, etc.

Latest devices and newest components always in stock.

Only a few left. Amplifex Aerial Loops (originally £3 : 10 : 0) now 30/- to clear.

Secure a copy of our latest catalogue just published (free to callers), by post 6d. to defray postage and packing.

**WILL DAY LTD. (Dept. W.W.)**  
19, Lisle Street, Leicester Square, London, W.C.2.  
Telephone: Regent 4577. Telegrams: "Titles, Westrand, London."

## SHOWN AT THE RADIO EXHIBITION FOR THE FIRST TIME.

ALL-BAKELITE CABINET MODEL,  
£4.4.0

OAK CABINET MODEL,  
£3.0.0

JUNIOR MODEL,  
SUITABLE FOR PORTABLE OR SELF-CONTAINED SETS,  
£2.10.0



THE W.B. ANTI-PHONIC LOW-LOSS VALVE HOLDERS in the "WIRELESS WORLD" EXHIBITION FIVE and THE "COSSOR MELODY THREE"

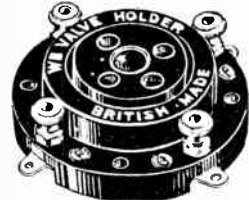

REDUCED PRICES, WITH TERMINALS,  
1/9  
WITH SOLDERING TAGS ONLY,  
1/8

Supplied by all good-class Dealers from stock. In case of difficulty write to the Makers.

Manufactured and Guaranteed by:  
**WHITELEY, BONEHAM & CO., Ltd.**  
NOTTINGHAM ROAD, MANSFIELD, NOTTS.

## DEAD SILENT

DAIMON H. T. BATTERIES do not make a whisper of sound to disturb the programme. That is because they have the lowest internal resistance of any battery of equal size. This also gives them the greatest recuperative power and the longest life.

60 volts .....	10/6 each
100 " " " " " "	17/6 " "
Grid Bias (9 volts) 1/10 "	" " " "

All good dealers or direct—  
**S.D.H. MANUFACTURING CO.,**  
 Colindale Avenue,  
 Hendon, London,  
 N.W.9.

# Chakophone

WIRELESS COMPONENTS AND RECEIVERS.

**AERIAL TUNER WITH REACTION.**  
 One-hole fixing. Covers 300-2,000 metres.

Thousands in use. Makes loose coils obsolete.

Complete with diagram and drilling jig .. Price **8/-**

**"EVERYMAN FOUR" COILS.**  
 Specially recommended boxed with 1/- "W.W." booklet, 31/- per pair.  
 Do. for long wave set 2,500 metres, 32/- per pair.

**"EVERYMAN FOUR" Constructor's Set.**  
 Complete set of parts, less Cabinet **£8 19 0**  
 Above parts assembled, wired up and tested **£13 0 0**  
 Ditto, fitted with Oak open panel Cabinet **£14 15 0**  
 Marconi Royalty extra.

**"JUNIOR THREE."**  
 An inexpensive three-valve set, capable of giving good reception with remarkably long range.  
 Instrument only .. **£5 17 6**  
 Marconi Royalty .. **£1 17 6**

**"JUNIOR TWO."**  
 A smaller but thoroughly capable instrument.  
 Price bare set .. **£3 15 0**  
 Marconi Royalty **£1 5 0**

**EAGLE ENGINEERING CO., LTD.,**  
 Eagle Works, Warwick.  
 LONDON SHOWROOMS:—44, FLEET STREET, S.W.1.

THE NEW [LOW LOSS. LOG LAW.]

## SIMPLICON-4.L.

13/-

·0003.  
 Other Capacities  
 13/6 ·0005.  
 12/9 ·00025.  
 12/6 ·00015.

---

16:1 GEAR

WITH KNOB AND DIAL.

THE CONDENSER THAT CAUSED THE SENSATION AT OLYMPIA.

THE ONE THAT IS DIFFERENT.  
 Those who could not see it send for leaflet.

A precision made Instrument fully guaranteed.

Sole Manufacturers: Grange Road, Small Heath, BIRMINGHAM.

WILLIAMS & MOFFAT, Ltd.

## FOR ALL GOOD RECEIVERS

The terminal which will give real Finish and Distinction to your Receiver. Beautifully finished and Bakelite insulated. Made in 30 different engravings.

Type 'B' illustrated, sold in attractive carton carrying a year's guarantee.  
**Price 9d. each.**  
 Type 'M' as type 'B' but non-insulated.  
**Price 6d. each.**

Patented. Illustrated catalogue free on request.

BELLING-LEE  
 TERMINALS

Bellings & Lee Ltd., Queensway Works, Ponders End, Middx.



**THE SAME RELIABLE  
VOLTRON  
WITH A WONDERFUL  
NEW FILAMENT**

ANOTHER year of exhaustive research places "Voltron" Valves in a position of leadership. The wonderful new "Voltron" T.T. Filament means operating efficiency increased all round by 25%.

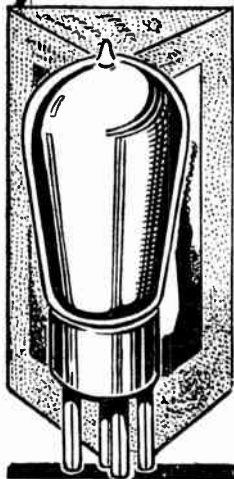

Remember too, the "Voltron" has the hardest vacuum-triple pumped—a unique "Voltron" feature—a guarantee of long life.

Price does not form a basis of comparison. You may pay more, you may pay less, but you cannot buy a better valve than "Voltron."

Type.

202.	H.F., Det., L.F.	1.8 volts.	.2 amps	5/9
201.	H.F., Det., L.F.	1.8 volts.	.1 amps	7/6
P.2.	Power	1.8 volts.	.2 amps	9/-
40r.	H.F., Det., L.F.	3.7 volts.	.1 amps	7/6
P.4.	Power	3.7 volts.	.15 amps	10/9
60r.	H.F., Det., L.F.	5.5 volts.	.1 amps	12/-
P.6.	Power	5.5 volts.	.1 amps	12/-

Of all principal Dealers. If any difficulty in obtaining write to—

**VOLTRON CO., LTD.**  
169, City Road, London, E.C.1.

DAME CLARA BUTT  
ALBERT SAMMONS  
DE GROOT  
JACK HYLTON  
J. H. SQUIRE —



BY APPOINTMENT

*Ave but a few of the  
eminent musicians who use*

**HART  
BATTERIES**

**FOR BETTER WIRELESS RECEPTION**

*The Choice of  
the Critical!*

You want to improve your results too!  
Write Dept. "W.W." for price list, and FREE  
Booklet of interest to all wireless users.

**HART ACCUMULATOR CO. LTD.,**  
STRATFORD, LONDON, E.15.

Branch Offices:

BIRMINGHAM: 165 Edmund Street. BRISTOL: 37 Victoria Street.  
CARDIFF: 60 Charles Street. MANCHESTER: 88 Chapel Street.  
GLASGOW: 107 Wellington Street. YORK: 6 Bridge Street.  
WESTMINSTER: 36 Victoria Street, S.W.1.

Goodall Ad.

**The Sensation of  
the Show!**

There were loud speakers in plenty at the Exhibition, but the one that stood out head and shoulders above the rest—the one that captivated the ladies and intrigued both expert and layman—the one that represented the biggest advance in the manufacture of beautiful Loud Speakers was the DESERTUNE.

Apart from being a handsome piece of furniture that will grace any room, the DESERTUNE gives NATURAL reproduction to a standard which you have, up to now, thought impossible to attain. The secret is in the combination of the flat open diaphragm and orthodox cone shape—the best of both, resulting in perfection.

The **W.B.** Place your order now for immediate delivery. We have made satisfactory arrangements at our Works to cope with the vast number of orders booked at the Show.

**"Desertune"  
PATENT No. 255174  
LOUD SPEAKER**

Price  
**84/-**

IN ATTRACTIVE OAK  
OR MAHOGANY CABINET.

**WALKER  
BROTHERS  
(GUILDFORD) TD.,  
BRAMLEY,  
GUILDFORD.**

Telephone: Bramley 117.



**LOAD?**



**2/-  
to 2'3**

We guarantee our new process (better than wire-wound resistances) to carry a load of 10 MILLIAMPERES without altering or breaking down—Bakelite Cased—Impervious to any external damp or heat. Used in conjunction with our well-known Bakelite Cased Condenser, these make the ideal R.C. Unit for your new or old set.

Advertisement of

**The Graham-Farish Mfg. Co.,**  
17, Masons Hill, Bromley,  
Kent.

'Phone: Ravensbourne 3674.

'Grams: "Grafar, Bromley."

**Startling Reduction**  
**from 3/9 to 2/3**  
**CASH PAID FREE**



THE MASTER NON-VIBRATORY VALVE-HOLDER

**NOW BEING SOLD DIRECT TO THE PUBLIC**

By cutting out the middleman, by initiating more efficient methods of manufacture, and being aided by the already large demand for this super Valve-Holder, we have pleasure in announcing that from SEPT. 21st The "ARTIC" Valve-Holder has been reduced in price from 3/9 to 2/3 each, POST FREE. Its superiority as a valve-holder has always been admitted, and this astounding reduction places it within the reach of EVERY valve user. Quality and construction have not been altered in the slightest degree.

WORLD PATENTS.  
 NO SPRINGS.  
 NO RUBBER USED.

The "ARTIC" principle guarantees perfect steadiness under all conditions of shock and vibration. Even when the valve is moved directly, it just sags back into position. No springs or rubber are employed—these are but makeshifts and success can never be possible with such mediums.

**DIRECT FROM US TO YOU MEANS A CHEAPER VALVE-HOLDER FOR YOU.**

2/3 each POST FREE with P.O. remittance or C.O.D. with G.O.D. charge extra.

MAKES A GOOD VALVE BETTER AND A BAD VALVE GOOD.



**YOUR WIRELESS NECESSITIES**  
**ELEX SPECIALITIES**

2D.W. A new Wander Plug. 3 colours 2d. each.

2D.W. OR T.14 Plug

T.14 Plug 3d. each.

Name Plates (33 varieties) 1d. each.

Socket 1d. each.

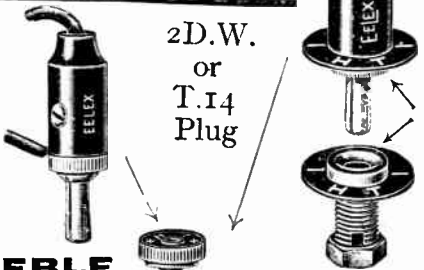

**TREBLE DUTY**

T.14 Plug 3d. each.

Eye, Pin and Spade Adaptors 1d. each.

**TERMINAL 4½ d. each.**

Write for List W.W.13 and obtain full details of this Terminal and other necessary Wireless Gadgets.

T.13. Chock End 2d. each.

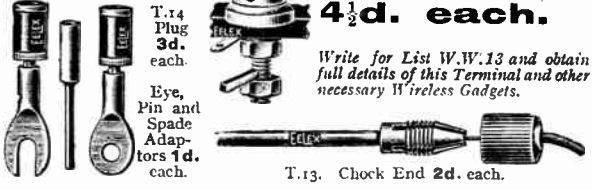

**J. J. EASTICK & SONS**

— ELEX HOUSE —  
 118, BUNHILL ROW, E.C.1

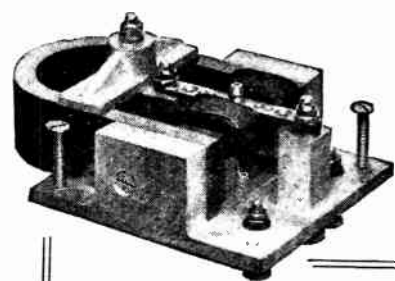
**The New "ZAMPA" CONE MOVEMENT**

for **HOME CONSTRUCTORS**

The new "Zampa" Cone Movement for Home Constructors gives a larger movement for the new 3 feet Cone than any on the present market—enables you to make a reliable 3 feet Cone Loud Speaker at home for

**£3 - 10 - 0**

No cheaper or easier way of building a Cone.

**Tapped HF Chokes.**  
 Catalogue Free.

**MIC WIRELESS CO.,**  
 MARKET STREET, WELLINGBORO'.

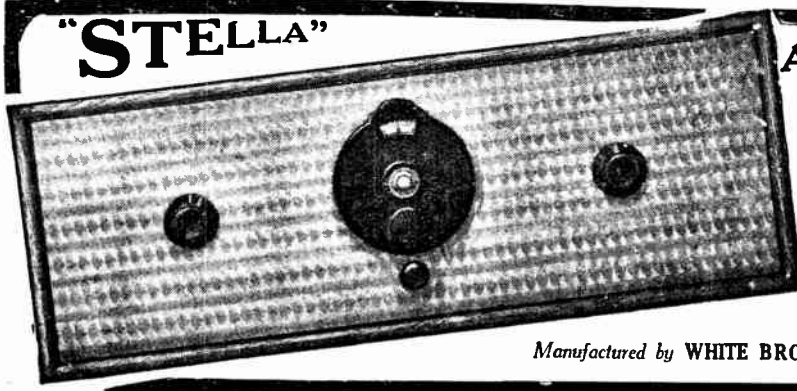

**ALUMINIUM PANELS**

Cut from 14 SWG Sheet, these panels are machine chased and lacquered by a special process.

In addition to their handsome appearance they are an effective shield eliminating hand capacity when tuning the receiver, therefore eminently suitable for SHORT WAVE RECEIVER construction.

For all types of Receivers

Use 'STELLA' ALUMINIUM PANELS  
 CHEAPER, MORE EFFICIENT AND HANDSOMER THAN EBONITE  
 PRICE 3/4 d. SQ. INCH.

Postage 9d. per Panel.

Manufactured by **WHITE BROS. & JACOBS, LTD.**, 46, Chalk Farm Road, N.W.1  
 Telephone: Hampstead 8778.



**The  
MAGNUM R.C. COUPLING UNIT**

INCORPORATING A VIBRO VALVE HOLDER.

With this economical unit, your set will reproduce with an astounding purity and faithfulness. It embodies a correctly proportioned condenser, anode resistance and grid leak, sealed in a Bakelite moulding, together with a Vibro Valve Holder.

**TO CRYSTAL SET USERS.**

One of the recommended uses for the Magnum R.C. Unit is in a two-valve amplifier, the complete set of parts (which can be assembled in 30 minutes) cost £1.10.0 only. Write for a leaflet giving wiring diagram.

PRICE 10/6

DESIGNED AND MANUFACTURED BY

**BURNE-JONES  
& CO. LTD.,  
MAGNUM HOUSE  
TELEPHONE: HOP 6257  
288, BOROUGH HIGH ST.  
LONDON. S.E.1**

**MICROSTATS**

Suitable for all Valves.

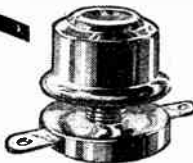

Sales approaching 1,000,000

SILENT

long lived

V.F.R. MODEL, Baseboard Mounting 3/- Post Free

Efficient control of Filament Temperature is vitally necessary for good reception.

**One Component Suits all Valves.**

There are over a hundred Valves on the market. Published tables give the filament resistance values of these from .1-ohms to 80-ohms depending upon the Nominal Accumulator Voltage. The "MICROSTAT" and the "V.F.R.," without change of Resistor Element, will govern the Filament Temperature of any Valve perfectly. There is, therefore, no need to possess a multitude of Resistor Elements—one simple Component, the "MICROSTAT," suits all Valves.

For Satisfaction Fit "Microstats."

STANDARD MODEL, 2/9 Post Free Panel Mounting

Send for Sample to Manufacturers:

**LIFFORD ENGINEERING CO.,  
Kings Norton, BIRMINGHAM.**



**OVER 2000  
EVERYMAN COILS**

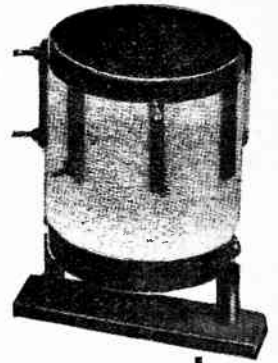

With the BERCLIF Trade Mark

Have now been incorporated in sets by readers of this journal: don't fail to have them in yours this season and ensure success. We were the first to introduce these coils commercially, and with them we issue indisputable test figures and invite comparison. We lead because we faithfully serve.

**SOME COIL PRICES:**

EVERYMAN FOUR	ALL-WAVE FOUR	PRICE
per set	per set	
£1 : 13 : 0	£2 : 2 : 6	<b>2/9</b>

**FIRST AGAIN**

With the BERCLIF "HIGHWIRING" VALVE HOLDER, specially designed for high-efficiency sets, short-wave work, etc. 2" leakage path between sockets.

Price List of components and test report on coils post free. Readers and the Trade supplied with all components, Home or Abroad.



**SIMMONDS BROS.,  
SHIRELAND SMETHWICK,  
ROAD, STAFFS.**

*Imperial Airways*  
**USE 'NIFE'**  
*accumulators only*

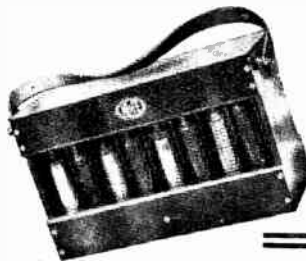

**WHY! absolute reliability is essential.**

*You will be interested in the new models of the 'NIFE' Steel Plate H.T. Batteries.*

**Send for leaflets now.**

**Batteries Ltd., Redditch, Eng.**  
220 Shaftesbury Avenue, London, W.C.2



## WIRELESS VALVE RECEIVERS & CIRCUITS IN PRINCIPLE AND PRACTICE

By R. D. BANGAY & N. ASHBRIDGE, B.Sc.

THIS BOOK will add to the pleasure of the amateur wireless experimenter by extending his theoretical knowledge of the whys and wherefores of valve receivers.

The subject is treated from a standpoint that will enable the home constructor to understand the working of any circuit which he may evolve, and he thus becomes independent of published diagrams and specifications. The volume is well illustrated.

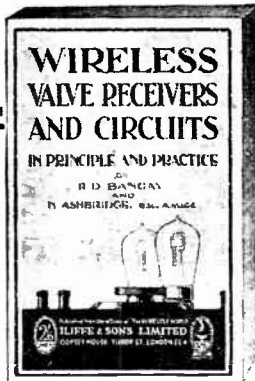

PRICE **2/6**  
net  
By Post **2/10**

Obtainable from all leading booksellers, or direct from the publishers.

ILIFFE & SONS LTD., Dorset House, Tudor St., London, E.C.4

W.W. 40

## The Wireless World AND RADIO REVIEW EVERYMAN FOUR

A 36-Page Booklet giving full Constructional Details of a remarkably efficient "Two-Control" Receiver for Long or Short Waves.

By W. JAMES.

The "EVERYMAN FOUR" attracted widespread attention when it was first described in "The Wireless World."

It is a very sensitive set and has a high degree of selectivity. The local station is perfectly received, and during a normal evening at least fifteen different stations may be received clearly at good loud-speaker strength. (Constructors claim up to twenty-eight stations.)

An additional long-wave attachment for Daventry is described in the booklet.

Price 1/- net By post 1/2

From the offices of "THE WIRELESS WORLD," Dorset House, Tudor Street, London, E.C.4. w.w.60

## WIRELESS VALVE TRANSMITTERS

By W. James

THE DESIGN AND OPERATION OF SMALL POWER APPARATUS

This book deals thoroughly with the design and operation of valve transmitters. Written by a recognised authority who has had a wide experience in the design and construction of valve transmitting sets, it is essentially a book for the practical amateur experimenter.

270 pages: 210 photographs and diagrams.

Price 9/- net. By post 9/6.

From leading booksellers or direct from the Publishers:

ILIFFE & SONS LTD.,  
Dorset House, Tudor Street,  
LONDON, E.C.4.

W.W.  
9

## DICTIONARY of WIRELESS TECHNICAL TERMS

Compiled by S. O. PEARSON, B.Sc., A.M.I.E.E., and issued in conjunction with "THE WIRELESS WORLD."

THIS volume contains definitions of terms and expressions commonly used in wireless telephony and telegraphy and is intended to serve as a guide to all those interested in wireless who come across, from time to time, unfamiliar words in their reading. In such cases the DICTIONARY OF WIRELESS TECHNICAL TERMS proves of very great use and value. It is well illustrated, and cross-referenced to enable the required information to be rapidly obtained.

PRICE  
2/-  
net  
By post  
2/3.

From leading booksellers or direct from the Publishers:

ILIFFE & SONS LTD., Dorset House, Tudor Street,  
LONDON, E.C.4.

W.W. 48

**REFUSE IMITATIONS**



New Standard Sizes in three finishes. The Guaranteed panels made by Ebonite experts at low prices.

Make sure of having the prize-winning original Former by buying only Formers bearing Trade Mark "Beacol."



The BRITISH EBONITE Co., Ltd., HANWELL, LONDON, W.7

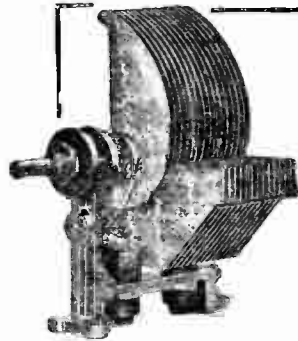

**LOG (or Mid-line) CONDENSER**

The most perfect and scientific Condenser ever produced. Buy Formo Handbook for simple methods of Ganging, Test Reports, Practical Circuits, Blue Prints, etc. Price 1/-

Full Catalogue Free on Request.

Crown Works, Cricklewood Lane, N.W.2.  
Phone: Hampstead 1787.  
Northern Representative:  
J. B. LEVRE, 23 Hartley Street,  
Levenshulme, Manchester.  
Phone: Heaton Moor 475.

.00035. .00025. .0005  
Price 10/6 each.

**TUNEWELL COILS**

PATENTED. BRITISH MADE.  
STANDARD POLARITY,  
tested, guaranteed, &c.

BETTER COIL at  
LOWER PRICES.

SIZES AND PRICES:—

25	35	50	75	each	1/6	200	225	each	2/9
30	40	60	100	"	1/8	250	"	"	3/3
125	150	"	"	"	2/3	300	"	"	3/9
175	(5xx)	"	"	"	2/6	400	"	"	4/3

Centre Tapped as above, 9d. each extra.  
Aperiodic (X) Type 1/- each extra.

Manufacturers: **TURNER & CO.**

54, Station Road, New Southgate, London, N.11.

**CUT THIS OUT FOR CABINETS**

and post to us for new FREE list illustrating Cabinets as shown in "Wireless World," etc., etc.

NAME .....  
ADDRESS .....



(Write in block letters please.)  
**CARRINGTON Mfg. Co., Ltd.,**  
CAMCO WORKS, Sanderstead Road,  
South Croydon.  
Telephone: Croydon 0623 (2 lines).

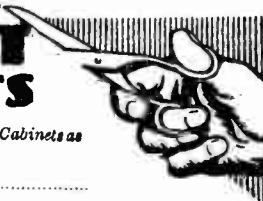

The right place for the **Watmel H.F. CHOKE**

PRICE **5/-**

The right Choke not only in the right place but at the right price. The special method of cross winding the double silk covered wire in four accurately balanced sections reveals the superiority of the Watmel and the extreme scientific care taken in its manufacture. Low self-capacity—constant impedance and small external field are features which no other H.F. Choke can as truly claim as the Watmel. Windings protected by transparent cover. Mounted in bakelite base with nickel-plated terminals. The right place for the Watmel H.F. Choke is in every circuit where radio frequency chokes are specified. **WATMEL WIRELESS CO. LTD.,** Imperial Works, High Street, Edgware. Middlesex.

**EVERYMAN FOUR COILS.**  
There is no need to wait days for the correct coils for this popular and highly efficient receiver.

"FINSTON" Coils are wound exactly to designers specification, with 27/42 wire and are supplied complete with Ebonite Supports and Base.

**AERIAL COILS 14/- TRANSFORMER 15/-**  
Complete Set 28'--

If your Dealer is sold out tell him we guarantee to supply by return of post.  
We supply Coils and Transformers for all "Wireless World" sets.  
Full details will be sent free on request.

Obtainable from all Dealers or  
**FINSTON MFG. CO., LTD.,** 45, HORSEFERRY ROAD LONDON, S.W.1.

**C.E. PRECISION WIRE WOUND ANODE RESISTANCE**

The wire used in their manufacture is specially made for the purpose and costs fifteen pounds a pound! The component is designed and most carefully manufactured to give the purest reproduction obtainable. Each value is absolutely constant.

PRICES:  
20,000 to 50,000 ohms ... 3/9  
50,000 to 100,000 ohms ... 4/9  
150,000 to 200,000 ohms ... 7/-  
250,000 ohms ... 5/-  
Other values to order.  
Clips and base, 1/3 extra.

Write for full list of **C.E. PRECISION Components and circuit diagram of THE ORCHESTRAL THREE.**  
**C. EDE & CO., LTD., BYFLEET, SURREY.**  
Telephone: Byfleet 226. Telegram: "Ceprecise, Byfleet."

**BRITISH made**

WHY pay a fancy price or buy an unreliable Foreign valve? These are British and guaranteed, at real pocket-saving prices.

**5/- ONLY EACH**  
Post Free.

**HOWARTH'S British Valve Depot, 288, Deansgate, Manchester.**

**Dull Emitter VALVES**

ALL TYPES & GUARANTEED.

Type 2v.06 amps.	H.F. and L.F.
Type 2v.1	H.F. and L.F.
Type 2v.25	POWER.
Type 4v.06	H.F. and L.F.
Type 4v.1	H.F. and L.F.
Type 4v.12	POWER.
Type 4v.25	POWER.
Type 6v.1	H.F. and L.F.
Type 6v.25	POWER.

(H.F. for Detector)

**TRADE SUPPLIED.**

# MISCELLANEOUS ADVERTISEMENTS.

## NOTICES.

**THE CHARGE FOR ADVERTISEMENTS** in these columns is:

12 words or less, 1/- and 1d. for every additional word, e.g., 18 words, 1/6; 24 words, 2/-. Name and address must be counted.

**SERIES DISCOUNTS** are allowed to Trade Advertisers as follows on orders for consecutive insertions, provided a contract is placed in advance, and in the absence of fresh instructions the entire "copy" is repeated from the previous issue: 13 consecutive insertions, 5%; 26 consecutive, 10%; 52 consecutive, 15%.

**ADVERTISEMENTS** for these columns are accepted up to **FIRST POST on THURSDAY MORNING** (previous to date of issue) at the Head Offices of "The Wireless World," Dorset House, Tudor Street, London, E.C.4, or on **WEDNESDAY MORNING** at the Branch Offices, 19, Hertford Street, Coventry; Guildhall Buildings, Navigation Street, Birmingham; 189, Deansgate, Manchester.

Advertisements that arrive too late for a particular issue will automatically be inserted in the following issue unless accompanied by instructions to the contrary. All advertisements in this section must be strictly prepaid.

Postal Orders and Cheques sent in payment for advertisements should be made payable to **ILLIFFE & SONS Ltd., and crossed & Co. Treasury Notes**, being untraceable if lost in transit, should not be sent as remittances.

All letters relating to advertisements should quote the number which is printed at the end of each advertisement, and the date of the issue in which it appeared.

The proprietors are not responsible for clerical or printers' errors, although every care is taken to avoid mistakes.

## NUMBERED ADDRESSES.

For the convenience of advertisers, letters may be addressed to numbers at "The Wireless World" Office. When this is desired, the sum of 6d. to defray the cost of registration and to cover postage on replies must be added to the advertisement charge, which must include the words Box 000, c/o "The Wireless World." Only the number will appear in the advertisement. All replies should be addressed No. 000, c/o "The Wireless World," Dorset House, Tudor Street, London, E.C.4. Readers who reply to Box No. advertisements are warned against sending remittance through the post except in registered envelopes; in all such cases the use of the Deposit System is recommended, and the envelope should be clearly marked "Deposit Department."

## DEPOSIT SYSTEM.

Readers who hesitate to send money to unknown persons may deal in perfect safety by availing themselves of our Deposit System. If the money be deposited with "The Wireless World," both parties are advised of its receipt.

The time allowed for decision is three days, during which time, if the buyer decides not to retain the goods, they must be returned to the sender. If a sale is effected we remit the amount to the seller, but, if not, we return the amount to the depositor. Carriage is paid by the buyer, but in the event of no sale, and subject to there being no different arrangement between buyer and seller, each pays carriage one way. The seller takes the risk of loss or damage in transit, for which we take no responsibility. For all transactions up to £10, a deposit fee of 1/- is charged; on transactions over £10 and under £50, the fee is 2/6; over £50, 5/-. All deposit matters are dealt with at Dorset House, Tudor Street, London, E.C.4, and cheques and money orders should be made payable to Illiffe & Sons Limited.

## THE SALE OF HOME-CONSTRUCTED UNLICENSED APPARATUS.

### A New Service to our Readers.

We have made an arrangement with the Patentees whereby readers who wish to dispose of a home-constructed receiver not licensed under the patents made use of, can license the set by means of the Deposit System referred to above.

The person desiring to sell, in sending us particulars for his advertisement, will in every case make use of a Box No., and should add to the price which he requires the amount of royalty customarily paid by manufacturers, viz., in the case of Marconi Patents the amount should be calculated at 12/6 per valve holder.

If the purchaser is satisfied with his purchase, the sum realised will be forwarded to the seller, less the amount due in respect of royalties, which amount will be paid by "The Wireless World" to the owners of the patents concerned, and a certificate will be handed on to the purchaser of the set.

## SPECIAL NOTE.

Readers who reply to advertisements and receive no answer to their enquiries are requested to regard the silence as an indication that the goods advertised have already been disposed of. Advertisers often receive so many enquiries that it is quite impossible to reply to each one by post.

Mention of "The Wireless World," when writing to advertisers, will ensure prompt attention.

## WONDERFUL WIRELESS OFFER

**THE Graves Two-Valve Loud Speaker Wireless Set offered to you on Easy Payment Terms will compare for VALUE and EFFICIENCY with any £10 Wireless Set offered by any other firm in the World.**

It is no use trying to accurately illustrate or even describe the Graves Set in a small advertisement, but a post card will bring you a fully illustrated descriptive catalogue which gives you exact and truthful details.

**BRIEF SPECIFICATION:** The Cabinet is of polished Oak and all components of highest quality. Mullard Dull Emitter Valves with patent Valve holders &c.; H.T. Battery, 2-Volt Accumulator and complete Aerial Outfit. Loud Speaker of exclusive design to match the Cabinet, with unique magnetic system and improved diaphragm. **£7:17:6**

**TERMS.**—Our Bargain Price is for Easy Terms. Send 10/- now, & complete purchase in 14 monthly payments of 10/-. Five per cent discount for cash. Full test approval in your own home.

Write for Free Catalogue.

Unchallengeable values in up-to-date Wireless Sets.  
**J. G. GRAVES Ltd.**  
**SHEFFIELD.**



**10/6 NOW**  
OF PROVED EFFICIENCY

## WEARITE COMPONENTS

**NEW EVERYMAN FOUR**  
COILS and BASES 35/- per set.

**EVERYMAN FOUR and EVERYMAN THREE**  
COILS & BASES 37/6 per pr.  
H.F. CHOKE . . . . 6/6

**REGIONAL RECEIVER**  
B.B.C. COILS with bases 18/9 each  
5XX COILS " " 22/6 each

Genuine Paxolin Formers and Panels.

Send for illustrated lists.

**WRIGHT & WEARE LTD.,**  
140 HIGH ROAD, TOTTENHAM, N.17.  
PHONE: Tottenham 3132.

## RECEIVERS FOR SALE.

**ALL-WAVE** Four and the Famous Everyman Four; high-class sets only, giving maximum efficiency; full particulars and prices on application.—H. Goodwin, Woodcock Hill, Elstree. [5050]

**PAY** later, buy now: Wireless sets, components, loud-speakers, etc., for deferred payments. Write or call for terms.—Ellis Nicholls & Co., 132, Caledon Rd., East Ham, London, E. [5446]

**4-VALVE** Neutrodyne Receivers in walnut cabinets, very sensitive and selective, easy to tune; coils for high and low wavelengths; only a few left; £5/19/6; royalties, £2/10; carriage paid.

**4-VALVE** Receiver, H.F., Det., 2 L.F. (R.C. and transformer); coils for high and low wavelengths; very sensitive, pure tone, in oak American type cabinet; £5/19/6; royalties £2/10; carriage paid.

**PHILIPSON and Co., Ltd.,** Radio Engineers, Holland St. Works, Astley Bridge, Bolton. [5002]

**RADIO** by Post.—We can save you money. We supply complete sets, also component parts for all advertised circuits at minimum prices; send us your enquiry or let us suggest the best set for your personal need; no obligation.—Radio Postal Service, 66, Burnaston Rd., Hall Green, Birmingham. [5713]

**2 Range** Everyman Four (specification components) in Mahogany Cabinet, complete with Cossor valves, 6 volt 80 accumulator, 120 volt Exide H.T. accumulator and B.T.H. speaker, long range with quality; pressure of business compelling sale, new few weeks ago; £22.—T. W. Allen, 48, Chesterfield Rd., Dranfields, Sheffield. [5729]

**GENUINE** Bargain.—Latest licensed model 8-valve Liberty super-het in mahogany cabinet complete with valves, frame aerial; Concert Grand Amplion L.S. 100v. H.T. and 4-volt H.T. Exide accumulators; the most selective and economical set made, perfect reception and gets anything anywhere with choice of over 40 stations guaranteed; heard any evening after 8 by appointment; cost over £75, accept £35.—Capt. Edwards, 111, Leaside Crescent, Golders Green, Speedwell 3395. [5764]

**GRANIC** Superheterodyne Kit, new and unused; cost £17/5, accept £13.—126, Eglantine Ave., Belfast. [5856]

**AMERICA'S** Best.—Fada neutrodyne kit, new, with book instructions, list £5 price 25/-; Silvertown Galvo, 10/-; details stamp.—K., 122, Albacore Cres., Lewisham, S.E.13. [5849]

**7-VALVE** Silver-Marshall Superheterodyne, in oak case, including valves and 1 set (interchangeable) coils, a powerful and up-to-date instrument; £25.—Box 3845, c/o The Wireless World. [5846]

**BURNDIPT** Ethodyne Model-de-Luxe, latest type, complete with frame aerials and 7 valves; cost over £80, accept £25; genuine bargain.—Box 3841, c/o The Wireless World. [5840]

**DON'T** Worry About Paying for that set all at once. Take it in easy stages. Our instalment system is a real help.—Write for particulars to desk W., New Times Sales Co., 77, City Rd., London, E.C.1. [5008]

**Receivers for Sale.—Contd.**

**4-VALVE** Receiver, modern neurodyne, complete with high tension eliminator, 4 Mullard valves, new loud-speaker, 2 2-volt accumulators, aerial, earth, etc., excellent condition, selling on account of leaving country; 24 guineas.—Gange, 51, Burgh Heath Rd., Epsom. [5837

**EVERYMAN** Four, complete: high class components, oak cabinet; any trial and inspection.—Write BM/BNMX, London, W.C.1. [5876

**4-VALVE** Neurodyne Set in Cabinet (Mondial), components by Jackson, Lissen, R.I., Igranic, Colvern; £7; appointment.—Gregory, 44, Narbonne Avenue, S.W.4. [5862

**ANY** Make of Receiver taken in part payment of new one.—Browne, 65, Sinclair Rd., W.14. [5866

**EPOCH** Electrical Society.—Before you buy your new set visit our Demonstration Room and hear the latest and most popular makes of sets side by side; largest number of sets in London to select from; prices from 5/9 to £100.

**EPOCH** Electrical Society.—Bring your old set in part payment for a new set.

**EPOCH** Electrical Society.—Installments may be arranged on all sets of £10 upwards.

**EPOCH** Electrical Society.—Let us build your sets to any published or special circuit; large selection of cabinets; lowest charges.

**EPOCH** Electrical Society, Ltd., 53, Gracechurch St., E.C.3. Call, write, or phone Royal 8570, twenty yards from Monument Station. [5864

**BATTERIES.**

**WET** H.T. Batteries.—Jars, 2 1/2 x 1 1/4 x 1 1/2, 1/3 doz.; zincs, 1/- doz.; sacs, 1/6 doz.; dozen cells complete (18 volts), 3/6; post 9d. extra. High efficiency, long life, upkeep practically nil. Orders for 3 dozen or over post free, packed in special carton with divisions for each cell, usable as container for complete battery. Send 6d. for sample complete unit with instructions. Write for free lists of wireless bargains.—W. Taylor, 57, Studley Rd., Stockwell, London. [0039

**"A.B."** Dry H.T. Batteries Cost Less Than Many other makes. The fact that they are manufactured by Messrs. Thomson Houston et Cie., of Paris, is proof of their high quality. Further, every battery carries a full and generous guarantee. Usual sizes stocked; 60 volt, 100 volt, and grid bias, etc. Ask your dealer for same. If he cannot supply you write us direct. Trade enquiries specially invited.—G. E. Ambatielo & Co., Ltd., Ambatielo House, Farringdon Road, E.C.1. Telephone: Clerkenwell 7440. [0063

**WHAT** Offers for Three 60 Volts C.A.V. H.T. Accumulators, purchased August, 1927.—Tetley, 1, Palace Gate, London, W.8. [5674

**WET** (sac Leclanche) H.T. Batteries, latest booklet on how to make and maintain these economical and simple batteries; give perfectly silent and smooth reception with unlimited power; suitable for small or multiple sets of all sizes; information also of L.T. batteries free; enclose postage, 1 1/2d.—Taylor, 57, Studley Rd., Stockwell, London. [0077



**Plantations and Panels.**

2. The Sap from the tree is now taken by the oxen-carts to the tanks.

**'W**AY back in a Malay rubber plantation our tree is giving forth its latex. This latex, or sap, is now collected in pails by the native and transferred to an oxen-drawn cart. This takes it to the factory where is begun the long process of transformation from a milky fluid into a Resiston Panel.

Only the pick of the rubber is used to make Resiston Panels. The slightest flaw which has crept in during the many stages of manufacture bars a piece of rubber from ever becoming a Resiston Panel. Utter purity is the Resiston Standard.

That is one of the reasons why the Resiston Panel is famed for its sheer beauty. Why Resiston has such amazing strength. Why Resiston's insulation is 100% efficient. Why Resiston's dielectric constant is so low. Why Resiston's colour is permanent. Why, in short, Resiston will give you that satisfaction which comes from knowing that the panel in your set is efficient. Ask your Dealer for Resiston.

**Q** Resiston Panels come in 13 stock sizes in black and Mahogany-grained. From 6 in. x 9 in. in black, 3/5, to 8 in. x 30 in. Mahogany-grained 19/-. [0036



**"24 hours Cut Panel Service"**

A vt. American Hard Rubber Co., Ltd., 13a, Fore St. E.C.

**Batteries.—Contd.**

**WHY** Buy Wireless Accumulators? London's Leading Hire Service improves reception. Saving time, trouble, and money. No big outlay. No deposit. Pay carman on each delivery. Low tension service from 1/3 per week. Fully charged and delivered free within 12 miles of Charing Cross. Explanatory folder post free.—Radio Service, 105, Torriono Av., N.W.5. 'Phone: North 0623/4/5. [5587

**ACCUMULATOR**, H.T., 60 volt Exide W.J., £1; 90 volt Hart R.A.O., £1/15; also Polar Twin set, £2; all good condition.—Evans, 8, Shrublands Ave., Berkhamsted, Herts. [5843

**EXPERIMENTERS** Must Have Reliance in their Accumulators; test with a Utility syringe hydrometer for certainty; post free, 4/6, with full instructions; satisfaction guaranteed.—The Utility Syringe Hydrometer Co., Dept. D, 16, Howard Rd., Ilford, Essex. [0060

**B.B.C.** H.T. Batteries. See advertisement, page 36.—British Battery Co., Ltd., Clarendon Rd., Watford, Herts. [0048

**CABINETS.**

**ARTCRAFT** Radio Cabinets and Panels for all "Wireless World" sets.

**ARTCRAFT** Cabinets made in Oak and mahogany, properly french polished, and are priced at 6/- to £11/11.

**ARTCRAFT** Cabinets made to any specification or design. Estimates by return.

**ARTCRAFT** Illustrated Catalogue Free.—The Artcraft Co., 156, Cherry Orchard Rd., Croydon. 'Phone: Croydon 1981. [0040

**FIRM** Able to Take Contracts for Wireless Cabinet Work; quotations on receipt of particulars or quantities.—196, Lewisham Rd. Lee Green 1206. [5719

**AGAR** for High-class Cabinets to customers' requirements from selected seasoned timber by competent craftsmen; maker of cabinets for P.M. series and other high class sets. W. H. Agar, 19, Whitecross Pl., E.C.2. London Wall: 3305. [5646

**MASSIVE** Oak Pedestal Cabinets, Jacobean finish (as illustrated in *The Wireless World* in May 4th issue), new, improved and very substantial model now ready, stands 3ft. high, 2ft. 9in. wide, 15in. deep, for panel up to 26in. x 8in. These cabinets are built to one standard size and will house almost all the best known and latest sets and circuits, including Everyman Four and Five, B.B.C. 3 and 4 valve sets. Simple adjustable fittings permit any length of panel up to 26in. to be fitted. £5 carriage paid, or free delivery by our own van London and suburbs. May be inspected on van before acceptance. Illustrated folder gives all details. Write to-day.—G. E. Ambatielo and Co., Ltd., Ambatielo House, Farringdon Rd., E.C.1. 'Phone: Clerkenwell 7440. Telegrams: Ambatielo, London. [0036

**AMERICAN** Type Cabinets, with hinged top and baseboard; in hand polished oak, 12in. x 8in., 10/6, post free; any size supplied.—Phoenix Wood Engraving Co., 28, Market St., Manchester. [5870

**BAKER'S** "Selhurst" Radio for Coil Drive speaker parts and suitable pedestal cabinets.—89, Selhurst Rd., South Norwood, S.E.25. [5897

## LOUD-SPEAKERS.

**REED Movements.**—Double Acting Reed movements specially designed to operate cone and other large diaphragms; extremely sensitive on small input, yet capable of enormous volume with sufficient input. Will work up to a 3ft. cone with ease. No rattle or distortion; 27/6 each. Fair allowance on Brown A earpieces, or Lissenolas and other units in part exchange. Send stamp for illustrated Lists of these and Seamless Cones.—Goodmans, 27, Farringdon St., E.C.4 [0066

**MIRROVOX** Loud-speaker, oval plated polished aluminium diaphragm, mahogany moun. eu, looks like a mirror; perfectly wonderful reproduction, equal to any speaker double the price; try one on 7 days' approval; satisfaction or money refunded; £2/10 post free.—A. Brixey, Coldharbour Lane, Hayes, Middlesex. [5579

**COIL Drive Loud-speaker Parts** to suit your requirements, manufactured under the personal supervision of W. J. Turberville-Crewe, M.Inst.R.E.; lists free.—J. Glascoe and Co., 49 Eastcheap, E.C.3. [5826

**UNITS for Cone Speakers.**—Highly efficient, patented, double acting reed movement, the result of years of experimenting. Very sensitive to small impulses, but capable of handling enormous power without overloading; special resonance damping device; high class workmanship and keenest value yet offered; complete with fixings for attaching cone. Fuller details, list of cones, complete speakers, etc., post free.—Everyman's Radio Service, Brent St., Hendon, N.W.4. 'Phone: Hendon 2378. [5105

**REPAIRS.**—All loud-speakers repaired and maximum efficiency attained, 4/- post free; every repair is accompanied with a three months' guarantee; don't discard if burnt out; trade invited.—Transform, 115, Links Rd., Tooting, London, S.W.17. [0084

**A Large Celestion Cone Speaker, model A3,** £7/10; accept 5 guineas; practically new, superb reproduction.—Box 3842, c/o *The Wireless World*. [5830

**WOOD Horns.**—Illustrated list of new models ready. There's one for every speaker base and gramophone attachments.—Maddison, Manufacturer of the Allwoodorn, 2a, Ronalds Rd., N.5. [5845

**SUPERB Speaker, concert Brown unit, 5ft. logarithmic horn, wonderful value;** £3/10.—31, Coleherne Rd., S.W.10. [5860

**B.T.H. Standard Rice Kellog, hardly used, owner going abroad;** £37/10.—M., Witten Lodge, Stoke Green, Coventry. [5888

**MOVING Coil Loud-speaker Parts.**—I have been asked by everyone, including a representative of the "W.W." (who has heard my results) how it is obtained without umpteen valves, stages of push, pull, and output transformer, and additional amplifier, etc. The result is that of many years experience with magnetic flux and 4 years with this type of speaker. The pot is of a grade of steel, of which I have used for the past 35 years with, of course, the required gauge and quantity of wire to suit the voltage and on a suitable high resistance coil of 2,000 turns 47G. wire (having designed and built a machine for winding same) mounted on a well-thought-out diaphragm (patents pending). When ordering coil give outside and inside dimensions and depth of gap.—Chas. Andrews, Hunton House, Hunton Hill, Erdington ('Phone: 203) Birmingham. [5788

Mention of "The Wireless World," when writing to advertisers, will ensure prompt attention.

## NOT AT OLYMPIA!

You will have looked in vain for these, and our other hundreds of American Advanced Components, at Olympia. We were not there because American goods were prohibited. The inference is very, very obvious, and very flattering to us.

See these at our Stand No. 13, Manchester Radio Exhibition, Oct. 24th to Nov. 5th, 1927.

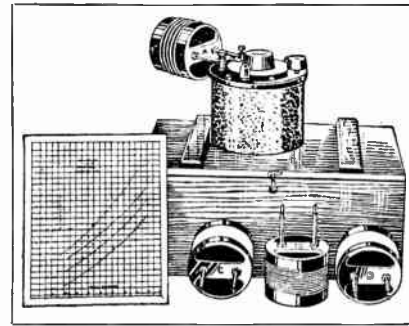

The "G.R." Type 358 Short Wave Wave-meter Kit. Accuracy 1% or better guaranteed. As used by "WIRELESS WORLD," and endorsed and recommended by them. In use at four Government Research Stations. Waveband 144 to 225 Metres. For receiver or transmitter calibration. One of 120 "G.R." 1927/8 Season Advanced Components. Built by Laboratory Instruments Manufacturers.

Price, per complete outfit, £5.17.6.

Descriptive folder entitled "Q.R.H." see on request.

The "Clarostat" 20 Watt Universal range heavy duty Variable Resistor, as used by nearly one hundred H.T. Eliminator Manufacturers. Also useful wherever a dependable variable resistor is desirable. Range 500 ohms to 5 megohms. Excellent as a tone control across transformer secondary.

Price 12/6 each.

Send for free leaflet entitled "Control." (Contains practical Wiring Chart of a most efficient H.T. Eliminator.)



## AERO LOOP—SILENCER OF STATIC.

A Unique Frame Aerial. "A loop within a loop." Inside loop can be used for a variety of useful purposes. The finest loop for Superheterodynes, T.R.F. Sets, Super-regenerative sets. Height 30"; a feature is that it turns in only 8" of space. An ideal "drawing room" loop and highly efficient.

1927/8 Season reduced price

57/6

Send for 2-colour descriptive folder, free.



**FREE!** Our 60 Page educational catalogue (usual price 9d.) will be sent free and post free on request. Profusely illustrated. Over 250 exclusive specialities. "The most instructive and interesting catalogue in the Trade." (See Miscellaneous ads. also.)

**CLAUDE LYONS LTD.**  
76, OLD HALL STREET,  
LIVERPOOL.

## Loud-speakers.—Contd.

**KONEDOPE** Makes Home Constructed Diaphragms Air- and Damp-proof. Tins sufficient for 2 large cones, 1/8, post free.—Everyman's Radio Service, Brent St., N.W.4. [5851

**AMPLION A.R.15** Swan-neck, all wood, mahogany horn, as new, £3.—Tuffs, 28, Harpenden Rd., Wanstead. [5865

**BROWN H.I.;** bargain, £3; perfect order, 2,000 ohms, cost £5/8.—Call after 6.30 p.m., or write, 11, St. Cuthbert's Rd., Cricklewood, N.W. [5852

**DID You See the Moving Coil Loud-speaker** built with Webson parts, manufactured by Star Engineering, on Stand No. 103 at Olympia Exhibition?

**IF So, you would appreciate the high class** workmanship and finish, which is the standard for all Webson parts manufactured by Star Engineering.

**WHEN You Order Webson Parts you obtain** goods made by engineers and recommended by the principal wireless journals. See *Wireless World*, Sept. 28; "Amateur Wireless," Sept. 24 and Oct. 1.

**FOR Highest Efficiency build your moving** coil loud-speaker with Webson parts, manufactured only by Star Engineering, Didsbury, Manchester.

**YOUR Name and Address in block letters** will ensure you free lists per return post.—Star Engineering, Didsbury, Manchester. 'Phone: Didsbury 1785.

**BAKER'S Selhurst Radio for Coil Drive** Loud-speaker Parts, as described in *Wireless World*, April 13, August 10, and September 28. We manufacture everything at our works, from the pot castings to the finished article. We are thus able to sell a superior article at a reasonable price. All parts are available for inspection. Call at our works and judge for yourself the superiority of our parts over all others available.—42, Cherry Orchard Rd., East Croydon Station. Twenty minutes main line from Victoria Station.

**BAKER'S Selhurst Radio for Coil Drive** Loud-speaker Parts, described by F. H. Haynes in *Wireless World*, September 28.

**BAKER'S Selhurst Radio for Coil Drive** Speaker Parts; quick delivery of magnet units with field windings for use with accumulators or D.C. mains as required.

**BAKER'S Selhurst Radio for 2in. Moving** Coils; lightest made.

**FRAMES and Cradles specially constructed** to enable unit to be assembled in a few minutes without tools; from Baker's Selhurst Radio; quick delivery.

**IMPORTANT.**—All coil drive speaker parts supplied by us are constructed by highly skilled engineers of the best possible materials; as we do not depart from specifications given in *The Wireless World* you are assured of good results. We manufacture everything, from the pot castings to the finished article.

**WE** have received testimonials from all over the country and also from Belgium, Holland and Italy, expressing complete satisfaction with the parts, and surprise at the wonderful results obtained.

**WE** shall be glad to show you all our coil drive speaker parts at our works at Croydon at any time.—Baker's Selhurst Radio, 89, Selhurst Rd., South Norwood, S.E.25. Works: 42, Cherry Orchard Rd., East Croydon. Telephone: Thornton Heath 1488. [5896



**Loud-speakers.—Contd.**

**THOMSON-HOUSTON** Moving Coil Horn Loud-speaker, as new, £4 or nearest; suitable for hall; no battery required.—Davies, 47, Cowbridge Rd., Bridgend. [5872]

**VALVES.**

**SCREENED** Grid Valves.

**THE A.P.** 412 S.G. for non-neutralised H.F. amplification and super R.C. amplification, amplification factor 110, standard 4-pin base; write to-day for full data of all the A.P. 4 electrode valves.—Aneloy Products, 36, Hindmans Rd., E. Dulwich, London, S.E.22. [5589]

**5/-**.—British valves: 2 volt .06 H.F. and L.F., 2 volt .11 H.F. and L.F., 2 volt .25 P.V., 4 volt .06 H.F. and L.F., 4 volt .11 H.F. and L.F., 4 volt 12 P.V., 6 volt .11 H.F. and L.F., 6 volt .25 P.V.; all one price, 5/- each, and all guaranteed; trade supplied; write your name and address clearly.—H. Howarth, British Valve Depot, 288, Deansgate, Manchester. [5611]

**KNOW** Your Valves; any standard British valve supplied with individual characteristics and all data; list price post free.—Radiolabs, 23, Walmsley St., Hull. [5873]

**CHARGERS & ELIMINATORS.**

**ACCUMULATOR** Chargers (A.C.), 45/- complete. Post free. Also components for same and for A.C. battery eliminators; fully guaranteed.—Stafford O'Brien and Partners, Ltd., 66, Victoria St., S.W.1. [0052]

**ALTERNATING** and Direct Current problems.—Kaynite components will solve them.—Call at The Lisle Radio Co., 37, Lisle St., W.C.2. [5686]

**WORK** Your Radio Receiver from the Mains with a Philipson Safety H.T. Eliminator; more volume, better tone, and more distant stations.

**PHILIPSON'S** Safety High Tension Eliminator for D.C. Mains, 200 to 250 volts, no hum or ripple, gives 7 voltages from 60 to 135 volts, maximum output 38 M.A.; fitted in well-finished oak cabinet, price £2/10/6, carriage paid.

**PHILIPSON'S** Safety High Tension Battery Eliminator for A.C. Mains, 200-250 volts, gives voltages from 20 to 120 volts at 20 M.A. discharge, and grid bias 5 voltages from 2 to 12 volts, maximum current output 50 M.A.; fitted in well-finished oak cabinet, £5/10/6, royalty 12/6; 12 months' guarantee given.

**PHILIPSON and Co., Ltd.**, Radio Engineers, Holland St. Works, Astley Bridge, Bolton. Phone: 2038 Bolton. Telegrams: "Safety," Bolton. [0081]

**COMPONENTS, ETC., FOR SALE.**

**BELLING-LEE** Panel Fittings are designed to give an expert finish to any home-constructed set. Catalogue post free.—Belling and Lee, Ltd., Queensway Works, Ponders End, Mdx. [0018]

**SERIAL** Grid Coils and H.F. Transformers for Everyman Four, with chart showing over 40 stations (on L.S.), price 17/6 each; H.F. transformers for the All-Wave Four, high and low wavelengths, set of two and base 35/-; all coils of highest quality materials and finish.—H. Goodwin, Woodcock Hill, Elstree. [0051]



**Cam Vernier Coilholders at the new reduced prices**

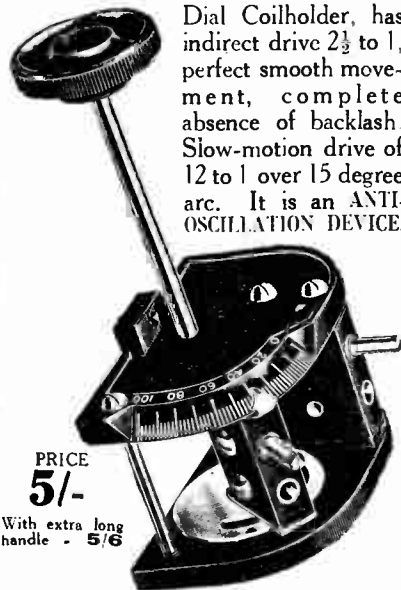

PRICE 5/-  
With extra long handle - 5/6

Dial Coilholder, has indirect drive 2½ to 1, perfect smooth movement, complete absence of backlash. Slow-motion drive of 12 to 1 over 15 degree arc. It is an ANTI-OSCILLATION DEVICE.

**"J" Type**

A safeguard against oscillation. Slow-motion either way over 10 degree arc. Three different movements accomplished with ONE KNOB.

**PRICES**

2-way 3/-

3-way 4/-

With extra long handles 6d. extra.

**Polar Products are Guaranteed.**

Call at the nearest Polar Service Agent or any RADIO Dealer and examine these Components.

**WINGROVE & ROGERS, Ltd.,**

Proprietors of the Broadcasting Business of Radio Communication Co. Ltd.

Arundel Chambers, STRAND, W.C.2

LIVERPOOL, MANCHESTER G LASKOV, NEWCASTLE

**Components, Etc., for Sale.—Contd.**

**REED** Movements.—Double Acting Reed movements specially designed to operate cone and other large diaphragms; extremely sensitive on small input, yet capable of enormous volume with sufficient input. Will work up to a 3ft. cone with ease. No rattle or distortion; 27/6 each. Fair allowance on Brown A earpieces, or Lissenolas and other units in part exchange. Send stamp for Illustrated Lists of these and Seamless Cones.—Goodmans, 27, Farringdon St., E.C.4. [0041]

**DECKOREM** Components are the finest you can include in any set you build. Write for free catalogue.—A. F. Bulgin & Co., 9-11, Cursitor St., London, E.C.4. [5881]

**ALL-WAVE** Coils (May 11th), pair with 6-pin base; 42/6.—Jennens, below.

**EVERYMAN** Coils, 3, 4, 5, on ebonite bases; 15/- each.—Jennens, below.

**TUBES**, 3in. x 3½in., genuine Mikopac: 1 1/4; 2 2/6; 3 3/6.—Jennens, below.

**SPACERS**, grooved, with screws, 8 aerial or anode, 1/-; All-wave 6 short, 1/-; 12 long, 2/6.—Jennens, below.

**LITZEN** Wire (Lewcos 27/42), to wind 70 turns; 4/8.—Jennens, below.

**WYCHE** Switch, 2-way, 1/3; both battery, 1/6.—Jennens, below.

**LEOVE** Multiple Valves, 3 L.F. and 2 H.F.; write for price and particulars; trade enquiries invited for all above.—Jennens Radio, 30, Chapel St., Birmingham. [0075]

**BRITISH** and Best.—High tension accumulators, pure reception and constant voltage: Ediswan 4-5,000 m.a.h. capacity, 20 volt units, 16/8; Exide 2,500 m.a., 10 volt units, 5/-; Oldham 20 volt units, 12/6 each; carrier and lid Oldham, extremely neat, 4/6 each; all above 80 volts or more carriage paid U.K.—Radio Service Depot, 678, Washwood Heath Rd., Birmingham. [5447]

**A.J.S.** Headphones, light, strong, adjustable Headans, perfectly clear and comfortable; full maker's guarantee (list price 15/-) on 7 days' approval; satisfaction or money refunded; 10/6 post free.—A. Brixey, Coldharbour Lane, Hayes, Middlesex. [5578]

**BROWN A's**.—A large purchase, on favourable terms, of these genuine original A type earphones enables us to offer them at 15/- each, 2,000 ohms, or complete with headbands, in original boxes, 30/- per pair; fully guaranteed (unused); trade supplied; this type Brown A is specially suitable for gramophone pick-ups, as described by G. W. Sutton in *The Wireless World*, July 20th issue.—Goodman's, 27, Farringdon St., E.C.4. [0067]

**ACCUMULATORS**, glass, 2 volt 20 amp. 3/9 each; 4 volt, 7/6 each.—Below.

**ACCUMULATORS**, celluloid, 2 volt 40, 7/6; 2 volt 60, 9/9; 2 volt 80, 12/-.—Below.

**ACCUMULATORS**, celluloid, 4 volt 40, 15/-; 4 volt 60, 19/6; 4 volt 80, 24/-; cash or c.o.d., all guaranteed new stock; 7 days' approval; postage extra; send for free list.—Bright & Hayles, 78, Church St., Camberwell, London, S.E.5. [0079]

**LAKE** 30ft. Handsome Steel Mast, 22/6. See descriptive advertisement, page 34. Easily erected. [0021]

**AMATEUR'S** Surplus Components; send for list.—Howarth, 59, Green Rd., Colne, Lancs. [5749]

**TANTALUM**.—Tantalum metal sheet for A.C. rectifiers.—Blackwell's Metallurgical Works, Liverpool. [5745]

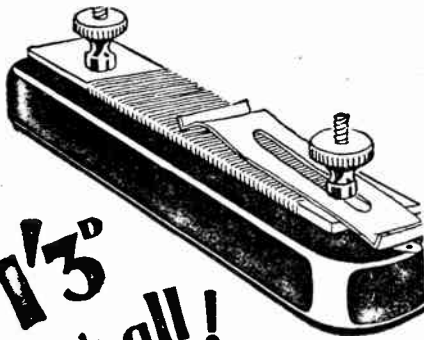

**1/3  
That's all!**

You should not pay more than 1/3 for a fixed resistor when you get a "Peerless" for that sum. "Peerless" is not only the trade name—it is a complete description. The base is moulded from first-class insulation that will not break. The former is cut from a strong impregnated material that atmosphere does not affect. Each turn of wire is wound tightly and evenly—it will not loosen after a while. Terminals are fitted, but soldering tags are also provided in case you wish to use them. A spring arm is now supplied free with each resistor, so that the exact resistance for a particular valve can be found and "fixed."

## "PEERLESS" FIXED RESISTOR

*Please give description  
of valves when ordering.*

From all good dealers or direct

**BEDFORD ELECTRICAL  
& RADIO CO., LTD.,**  
22, Campbell Road, Bedford

LONDON:  
21, Bartlett's Buildings,  
Holborn Circus, E.C.4.

GLASGOW:  
113, St. Vincent Street,  
C.2.

Mention of "The Wireless World," when writing to advertisers, will ensure prompt attention.

### Components, Etc., for Sale.—Contd.

**A**ERMONIC Valve Holders are the finest A value in British made components; model H: antimicrophonic, 1/6 each.

**G**RID Leak Holders for Vertical or Horizontal mounting; Bakelite mouldings with adjustable springs, fitted terminals, Aermonic No. 1, 1/-.  
**A**NGLE Bending Pliers, Aermonic; one nip of the jaws bends wire to a right angle; indispensable for workmanlike wiring.

**G**RID Leak Clip for Mounting direct on the G wires; Aermonic No. 2, 4d.; if your dealer does not stock, write to the manufacturers, James Christie & Sons, Ltd., West St., Sheffield. [0078]

**D**ECKKOREM Components are the finest you can include in any set you build. Write for free catalogue.—A. F. Bulgin & Co., 9-11, Cursitor St., London, E.C.4. [5882]

**U**SE a Die-cast Frame and heavy stand for that diaphragm loud-speaker you are making; 12in. diameter, gold finish, complete ready for use, price 10/6 each, post free; for use with Lissenola or other similar units, attachment for Brown A. earpiece, 3/6 each extra, post free; 7 days' approval against cash; trade enquiries invited.—Die-Casting Co., Great Hampton St., Wolverhampton. [5610]

**B.** & J. Everyman Coils, new and old type, 15/- each; guaranteed to specification; made under personal supervision.

**B.** & J. Mottled Aluminium Screens; 4/- each.

**B.** & J. Porcelain Panels, see Sept. 7th issue, page 298; any size cut and drilled to template; Everyman Four panel drilled 11 holes, 14/3.

**B.** & J. Screened Grid Valve Holders in polished ebonite, rigid each end and quickly detachable, no flex leads; 3/6.

**B.** & J. Keen Prices to Trade and Factors.

**B.** & J. Wireless Co., 2, Athelstane Mews, London, N.4. Mountview 1695. [0043]

**C**OUNTRY Listeners.—Time is money; all products displayed in this issue supplied at advertised prices, post free; special coils for screened H.F. Everyman Four, exactly to specifications; 30/- per pair; prompt, reliable, economical.—The Ready Radio Supply Co. (the radio house for the amateur constructor), 41, Newcomen St., London Bridge, S.E.1. [5668]

**C**HAKOPHONE Tuning Unit with Reaction, 300-2,000 metres, complete with instructions, 8/-; Everyman Four coils (Chakophone), boxed with "Wireless World" Booklet, 31/-.

**T**UNEWELL Coils, 25, 35, 50, 75, 1/6 each, 100, 1/8; 150, 2/3; 175, 2/6; 200, 2/9; 250, 3/3; air spaced, robust, efficient. Special Lines.—Wanderplugs, 1/3 doz.; terminals, with nut washer and indicating label, 2 B.A. pillar, 4 B.A. W.O., 2 and 4 B.A. phone, 2/- doz.; plated, 2/6 (state markings); coil holders, 2-way B.bd. 2/6, geared 2/9; switches, push pull, 11d.; S.P.D.T. on ebonite or porcelain, 9d.; D.P.D.T. on porcelain, 1/6; red and black flex, 1/6 doz. yds.; R.C. cable, 2 mm. 1/-, 4 mm. 1/9, 5 mm. 2/3 doz. yds.; insulated staples, 1/9 100.

**P**OSTAGE up to 5s., 6d.; over 5s., free; Send us your enquiries.—Radio Supplies Co., 37, Bedford St., Leamington Spa. Official Traders and Repairers to Radio Society of G.B. and Wireless League. [5685]

## C.D.M.

### FIXED CONDENSERS

Manufactured under true scientific principles, are being incorporated in many sets requiring components of good British make.



Patent No. 275893.

Outer cases are of best Brown Bakelite, fitted with two convenient sized terminals and solder tags for making connections. Best Ruby Mica used for insulation, and one-hole fixing for which screw is provided. Each Condenser is tested and we guarantee to be correct to within 5%.

Above reproduction is the actual size.

#### QUALITY TELLS!

·0005 to ·002 - - - - 2/- each.  
·0025 to ·006 - - - - 2/6 "  
Grid Condenser and 2 meg. leak - 2/6

If your dealer does not stock, write direct to the sole manufacturer:

### C. D. MELHUISE,

(Late Director and Works Manager Watnet Wireless Co. Ltd.)

8, Gt. Sutton St., Goswell Road, E.C.1.

Phone: Clerkenwell 7494.

Send for catalogue of our guaranteed products.

### More Power to your Wireless!

A. & N. STORES, GAMAGE, HARRODS, SHOOLBRED and leading Wireless Dealers — SELL —

## "LEION" RADIO POWER UNIT

(See "Wireless World," May 4, 1927)

It gives steady, silent power—volume without background.

To B.E.S.A. Specifications. 5 years Guarantee.

MAKERS:  
**P. B. G. Ltd.,**  
40, Vyse St., BIRMINGHAM.

For all types of D.O. Supply.



H.T. & Charter.

**Components, Etc., for Sale.—Contd.**

**REPAIRS.**—All transformers repaired and maximum efficiency attained, 4/- post free; every repair is accompanied with a three months' guarantee; don't discard if burnt out; trade invited.—Transform, 115, Links Rd., Tooting, London, S.W.17. [0083]

**MORE Storry Specialities.**—Reliable pocket voltmeters, double reading, 0-6, 0-120, 5/6; C.E.B. headphones, very sensitive, leatherette headbands, 6/6, usually 12/6; anti-microphonic valve holders, well designed, 1/3; post paid and guaranteed.—Storry's Ltd., Eastbank St., Southport. [5742]

**LAKER** 3oft. Handsome Steel Mast, 22/6. See descriptive advertisement, page 34. Easily erected. [0022]

**MATLOCK RADIO MANUFACTURERS.**—We specialise in components required for "Wireless World" Circuits, and have an expert staff ready to test, overhaul, or re-wire your set. All components are of the best quality, made to specification and guaranteed. **LET** us quote you for your next requirements.

**OUR** Everyman Transformers sent on approval against cash to prove their superiority; 30/- per pair complete.

**MATLOCK RADIO MANUFACTURERS.** Matlock House, Woodberry Grove, Finchley, N.12. Phone: Finchley 2837 [5823]

**REPAIRS.**—All headphones repaired and maximum efficiency attained, 4/- post free; every repair is accompanied with a three months' guarantee; don't discard if burnt out; trade invited.—Transform, 115, Links Rd., Tooting, London, S.W.17. [0083]

**EVERYMAN** Four Coils exact to specification, 22/6 pair, post paid, 23/- c.o.d.—I. Freeman, 47, Tenbury Rd., King's Heath, Birmingham [5793]

**DECKOREM** Components are the finest you can include in any set you build. Write for free catalogue.—A. F. Bulgin & Co., 9-11, Cursitor St., London, E.C.4. [5883]

**BROWN'S** Crystal Amplifier, latest model, At order; £3 or near offer.—E. S. Ramsden, 4, Camden Rd., Walthamstow, E.17. [5841]

**SUPERHET.** Parts.—4 Tropaformers, oscillator coil, also S.M. oscillator coupler and base; 50/-.—Write BM/YYAD, London [5859]

**MONMONDS BROS.,** Shireland Rd., Smethwick.

**ALL-WAVE** Four.—Coils, 42/6 per pair with base; see August 3rd issue for Editorial Notes on these; these coils can be made if required with reaction windings for einartz circuits, six-pin base.

**BUZZER** Wavemeter.—Coil to specification, 15/6.

**EMPIRE** Broadcast Receiver, aluminium cabinet, drilled, slotted and polished, with ahogany base, £2; coil with base, 8/6; special chokes, 7/6 pair. All other parts supplied.

**EVERYMAN** Four.—Coils, 33/- pair; Everyman Three, 35/-; "Wireless World" Five, 50/6 set, all with bases; reens, cabinets, panels, Litzendraht, Paxoformers, spacers; all components; complete lists free, with copies of testimonials and laboratory report; get all your parts from us, the Everyman specialists; trade supplied home and abroad.

**MONMONDS BROS.,** Shireland Rd., Smethwick. [5371]

**The Acme of Perfection and Portability**  
is reflected in the

**TRIX**  
**PORTABLE**  
**FOUR**

Test the **TRIX** Portable Four. Hearing is believing and you will learn for yourself how pure is the tone, how simple it is to operate, how handsome the polished oak cabinet. The **TRIX** Portable Four is the acme of perfection and portability. To prove this we will send a demonstrator with it to any address in the London area without obligation to yourself. Call at your local dealer or send to-day for full particulars of this unique set and complete range of **TRIX** products.

**18**  
Guineas plus royalty  
£2 10 0

**ERIC J. LEVER, 33, Clerkenwell Green, London, E.C.4, and Branches.**



**ANODE SUPPLY**  
**FILAMENT SUPPLY**  
**ROTARY-TRANSFORMERS**

Input ..... 12 to 250 v. D.C.  
Output ..... to 1,000 v. 100 w.

**MOTOR-GENERATORS**

Input ..... A.C. or D.C.  
Output ..... to 170 w. H.T., or 80 w. H.T. & 80 w. L.T.

**Efficient. Silent. Ripple-free.**

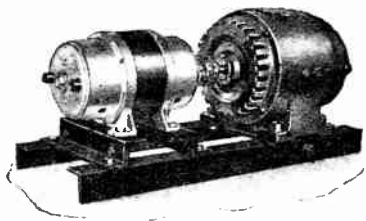

**M-L MAGNETO SYND., Ltd.,**  
**Radio Dept., COVENTRY.**

(Phone: 5001.)



**Components, Etc., for Sale.—Contd.**

**CONSTRUCTOR'S** Surplus.—R.I. L.F. transformer, 10/-; Etherplus Concerto ditto, 5-1, 6/-; Lissen ditto, 5/-; McMichael ditto, 300-600, with damper, 6/-; ditto neutraliser, 3 -; microstat, 1/6; variable grid leak, 1/6; 2 Pelican dials, 6/-; 2 S.T.21 valves, 2 v., 14/-; 1 Ediswan A.R.D.E. (H.F.), 6/-; 1 Fama, 2 v., 3/-; 1 Mullard bright, 4 v., H.F., 2/6.—136, Leam Terrace, Leamington. [5857]

**BROWN** Microphone Amplifier, 120 ohms input and 120 ohms output, perfect condition; £2.—Box 3843, c/o *The Wireless World*. [5848]

**IGRANIC** rheostat, 30 ohms, 2/6; ditto, 2 baseboard, 25 ohms, 6d. each; 2 Colvern 6-pin formers and bases, 2/6 each; ditto neutralising condenser, 1/6; Peto-Scott ditto, 3/-; 2 coil holders, 1/-; .002 fixed, 9d.; Ormonde .0003 variable, with vernier, 4/-; Ashley Jack No. 4, 1/6.—E. Waterhouse, 84, Little Hallam Lane, Ilkeston. [5833]

**WIRELESS** World Coils.—Everyman Four, 33/- per pair; Everyman Three, 35/- per pair; All Wave Four, 42/- per pair; Wireless World Five, 50/- per set; complete with bases to exact specification and tested, highest class workmanship, coils made to any specification.—Whittaker and Co., 2, Newport St., Oldham. Tel.: Oldham 2117. [5830]

**SPECIAL** Offer of Famous Burndept Goods, now deleted from catalogue. Burndept Peter Pan Loud-speakers, 2,000 ohms, bargain price 12/11; Burndept crystal detectors, originally 4/-, bargain price, 2/6; Burndept hot wire ammeters, originally 25/-, bargain price 4/11; Burndept .0002 condensers, bargain price 3/11; Burndept 3-way coil holders (geared), bargain price 5/11; Burndept 2-way ditto, bargain price 5/11; Dubilier grid leaks (1 meg. and 3 meg.), bargain price 1/3; Burndept concert coils (set of 4), bargain price 5/6; Burndept rheostats, bargain price 1/11; Burndept vernier condensers, bargain price, 1/11; Burndept valve holders, bargain price, 6d.; Burndept fixed resistors, bargain price, 9d.; Burndept anode condensers, .0002 low loss, bargain price 5/11; ditto, with vernier, bargain price, 8/11; Burndept Ethodyne, originally £75, bargain price £35; Burndept 5-valve Ethophone Grand, originally £75, bargain price £22/10; Marconi 2-valve amplifiers, bargain price 52/11; Marconi 1-valve amplifiers, bargain price 32/11; T.M.C. headphones, originally 17/6; bargain price 10/11; T.M.C. 3-valve sets with internal loud-speaker, bargain price £4/17/6. All the above Burndept goods are in original packages, and undamaged goods will be exchanged for any others, if purchaser wishes, within seven days. Enquiries from traders invited for quantities. Obtainable only from Chas. H. Rodwell, Ltd., London Bridge, S.E.1, and at the following branches: 31, Walbrook, E.C.4; 785a, Commercial Rd., E.14; 56, The Mall, Ealing, W.5; Waterloo Station (Main Entrance), Waterloo Rd., S.E. [0086]

**DECKOREM** Components are the finest you can include in any set you build. Write for free catalogue.—A. F. Bulgin & Co., 9-11, Cursitor St., London, E.C.4. [5884]

**BARGAIN.**—Send for a parcel of new wireless parts; 4/6, post 6d.; value guaranteed; sent c.o.d. if desired.—Box 3784, c/o *The Wireless World*. [5832]

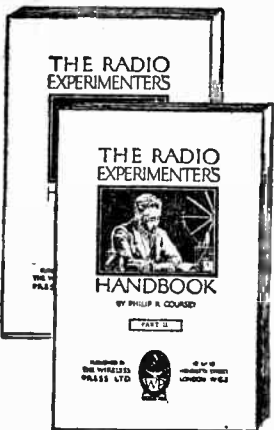

*The*  
**RADIO**  
EXPERIMENTER'S  
HANDBOOK  
in Two Volumes.

By Philip R. Coursey, B.Sc., F.Inst.P.

**PART ONE** deals with the general principles underlying the design of radio receiving equipment, and explains in clear and simple language the fundamental properties of the Aerial and the Aerial Circuit, Receiving Tuners, Receiving Amplifiers and Detectors, Heterodynes, etc., etc.

**PART TWO** is devoted to data and actual quantitative design as well as to the description of many suitable high-frequency measurements which can readily be carried out by the experimenter. A few of the subjects discussed are the Measurements of High-Frequency Currents and Voltages, Fundamental Formulae and Data, Aerials and Tuning Circuits, Tuning Coils and Inductances, Condensers, Valves and their Constants, etc.

**PRICE 3/6 NET.**  
per volume.

By Post 3/10 each.

From leading booksellers or direct from the publishers of  
"The Wireless World":

**ILIFFE & SONS LTD,**  
Dorset House,  
Tudor Street,  
LONDON,  
E.C.

4.

**Components, Etc., for Sale.—Contd.**

**USED** Components Suitable Night Hawk, perfect condition; cheap.—112, Meadvale Rd., Ealing. [5842]

**LAKER** 30ft. Handsome Steel Mast, 22/6. See descriptive advertisement on this page. Easily erected. [0023]

**COILS** Wound for any Special Circuit exact to specification: Everyman Four, 25/-; Everyman Three, 27/-; genuine Litz wire: "Wireless World" Five, 38/-; All-Wave Four, 35/6; screen and base 6-pin, 7/6; price for any special coil on application; trade supplied; prompt deliveries.—Norton Bannerman and Co., Bradfield Works, Hawksley Ave., Sheffield. [5722]

**DISTANCE** Control.—A few Siemen's 200 ohm. line relays for sale; an infallible unit for remote control; mounted in teak case with connecting terminals, 17/6; unmounted for fixing in set, 12/6 post free.—W. 11. Agar, 19, Whitecross Pl., E.C.2. [5895]

**SHORT-WAVE** wavemeters, 18-70 metres, every instrument individually calibrated by hand; enables any required station to be found immediately. In upright mahogany cabinet, complete with full instructions, 30/-, cash or c.o.d.—Deepees, 22, Ganton St., Regent St., W.1. [5894]

**GENUINE** Bargains.—2 6-volt Scott-Taggart 61 valves, 8/-; Beard & Fitch super choke, 8/-; L. McMichael H.F. Transformer (barrel type), 4/-; all perfect condition.—Bamberger, 16, Ellerdale St., Lewisham. [5890]

**RADIAX** Monotune 3-coil and Base, new, 200-600, 10/-.—Price, Penyball, Holywell, Flint. [5887]

**EXCHANGE.**—Select your new parts and let me take your old in part payment.—Browne, 65, Sinclair Rd., W.14. [5867]

**EPOCH** Electrical Society.—All standard lines and best foreign components in stock; mail orders despatched same day.

**EPOCH** Electrical Society.—Constructors' requirements specially catered for; let us quote for your kit.

**EPOCH** Electrical Society.—If you experiment for enjoyment's sake, buy your parts from us. If you want a guaranteed set, let our experienced engineers build it for you.

**EPOCH** Electrical Society.—Bring your old components in part payment for new ones.

**EPOCH** Electrical Society, Ltd., 53, Gracechurch Street, E.C.3. Call, write, or 'phone Royal 8570, twenty yards from Monument Station. [5863]

**OFFERS** Wanted for Mackie Generator, 600 v. 80 m.a. D.C., with spare armature, practically unused; 2 Eddystone condensers, 0.00015 and 0.0003 mfd., with vernier dials 128:1; C.A.V. L.F. transformer; all unused.—Cowan, Hallguards, Ecclefechan, Dumfriesshire. [5880]

**SELBY & Co.**—Guaranteed perfect new goods; Rothermel Preferred vernier dials, 3/6; Midite, the dependable crystal, 3/- doz. post free; bargain list free; see last week's advertisement, page 46.—6, Hauberk Rd., Lavender Sweep, S.W.11. [5877]

**WAVE** Meter (250-550) Gecophone, as new; what offers?—"Sherwood," Althorne Rd., Earlswood, Surrey. [5869]

**DECKOREM** Components are the finest you can include in any set you build. Write for free catalogue.—A. F. Bulgin & Co., 9-11, Cursitor St., London, E.C.4. [5885]

**OLYMPIA'S SURPRISE!**

Prov. "POY" Pat. 2983

**MULTIFORMER**

The Versatile Radio Component.

A Transformer which solves the break-down problem. Impedance values of windings completely under control. Can be used as Inter-stage, Output, Gramophone Pick-up or I.F. Transformer; also as L.F. Choke of any inductance value. Adaptable as Res. Cap. or Choke Cap. Unit of any electrical values by means of easily interchangeable units. An instrument of many uses at the cost of a transformer. Write or 'phone for full details.

Sole Manufacturer

**G. E. POHU,**  
16, COLVILLE ROAD, LONDON, W.11.  
'Phons' Park 5307.

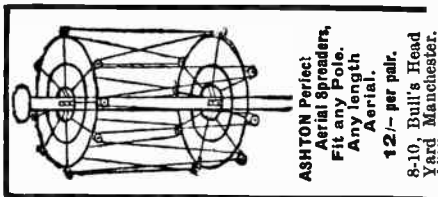

ASHTON Perfect Aerial Spindlers. Fit any pole. Any length. 12/- per pair. 8-10. Bull's Head Yard, Manchester.

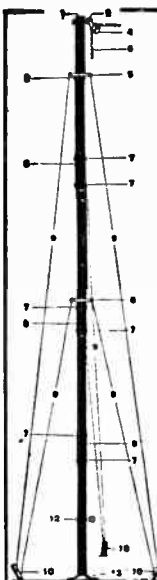

**LAKER STEEL MASTS**

are 100% efficient—

They are made by engineers and supplied to H.M. Government, the B.B.C., and to Colonial and foreign stations throughout the world.

There are 50,000 "Laker" masts in daily use.

By mass production we are able to offer a wonderfully efficient and handsome steel mast at the extraordinarily low price of

**30ft. 22/6**

Complete as Illustrated

Send 1/- extra for post carriage. We pay the rest.

Always bear in mind that an efficient aerial is the most important factor in good radio reception.

**J. & J. LAKER CO.,**  
Engineers,  
Beckenham, Kent



**KAY'S CABINETS**

This Cabinet 36" x 15", for panels 18", 19", or 20" by 12". Can be adapted to other sizes at slightly extra cost, or supplied with shelf to house your set. Strongly made of Oak and polished rich Jacobean **45/-**

Actual makers of every description of Wireless Cabinet.

Quotations for Specials by return.  
**H. KAY** Cabinet Manufacturer, MOUNT PLEASANT ROAD, LONDON, N.15

**Components, Etc., for Sale.—Contd.**  
**CAMBRIAN ELECTRIC LTD., Wrexham.**

THE Amateur Radio Enthusiast is usually at a serious disadvantage as regards facilities and equipment when it comes to wiring up a valve set. In the ordinary household space is generally restricted. Soldering has to be done under difficulties, and this is an art many amateurs have not mastered yet. Authors' designs should be meticulously adhered to as far as drilling and component mounting are concerned if the fullest limit of success is to be achieved in set building. The amateur too often overlooks these important items, and dry joints, incorrect spacing, wrong disposition of components and other faults mar his work. It will be conceded that the professional has several advantages over the amateur, and success often attends his efforts far and away above those of the man who builds perhaps one set in twelve months. The snag usually is the professional's charge for assembling and wiring up a set. This is usually more than it is considered worth while by the amateur. This is where we strike a new line, and offer equal and sterling

consideration. Briefly, we offer to all amateurs who order the necessary components from us to wire up their sets. This work is guaranteed to be strictly in accordance with the original set, even to the smallest detail. The introduction of electric soldering, power drilling, and what will be practically mass production of sets, enable us to do this at the rate offered. For example, if a complete kit of components is ordered (and in this case a royalty of 12/6 per valve is payable to the Marconi Co.) these are mounted in a strictly accurate manner on the baseboard, and panel fixed, and the set wired up exactly as originally done by the author. If a part kit of components is ordered, the same meticulous care is taken, our fee being merely 2/6 per valve. The charge, therefore, for wiring up the

NEW Everyman four is 10/- only. The following are the components required for this excellent set:—2 Ethovernier dials, 8/- (cheaper can be substituted); 3 valve holders (B. Lowe), 9/-; 1 valve holder (Athol), 1/-; 1 rheostat, 10 ohms (Burndept), 5/-; 1 rheostat, 2 ohms (Burndept), 5/-; 4 fixed condensers, 1 mfd. T.C.C., 15/4; 1 fixed condenser, 2 mfd. T.C.C., 4/8; 1 fixed condenser, .0005 (Dubilier), 2/6; 1 L.F. transformer, 1/1 (Ferranti, Ltd., A.F.3), £1/5; 1 16-volt grid battery, 3/6; 1 bi-duplex wire-wound L.C. coupler, Type B (R.I. & Varley), £1/2/6; aerial coil and H.F. transformer, best quality, £1/11; 1 shielding box, 7/6; 2 tapped valve supporting legs, 3/-; terminal strip, 2/-; 12 shrouded terminals (Belling Lee), 9/-; panel, best ebonite, 26x8x3/4, 17/6; on and off switch, 1/6; tapped supports for the V-holder, 1/-; £9/4. Mounting components, drilling panel, and wiring up, 10/- total, £9/14. Other components are as follows:—cabinet, best make, mahogany (baseboard free), £2; Marconi shrouded valve, 1/2/6.

The above is, of course, a part kit of components, and two .0005 variable condensers have been omitted, as it is found that most amateurs have these in their possession ready, and as the leads to the condensers are already in position in the set, the variable

(Continued third column.)

**2 AERMONIC STARS**

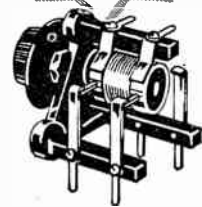
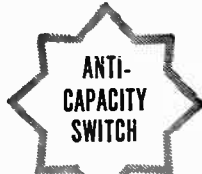

YOU can now buy a valve holder that combines anti-capacity and antiphonic virtues. Not only does this holder guard against losses, but it guards against vibration (and the valve doesn't wobble too much either).

If any difficulty write to either of addresses below.

**JAMES CHRISTIE & SONS LIMITED,**  
 248, West St., SHEFFIELD.  
 London Agents: A. F. BULGIN & CO., 10, Cursitor Street, London, E.C.4.

Aermonic Anti-capacity Switches do not introduce losses. Self cleaning and sweet acting. One hole fixing. Use them for all switch purposes for neatness and efficiency.

2-way 3/- each  
 3-way 5/- each



**AERMONIC DEPENDABLE PARTS**

**H.T. SUPPLY FOR RADIO**

CAN BE OBTAINED UP TO { 400 Volts / 130 M/amps.

FROM STANDARD MODELS OF **R. & B. POWER TRANSFORMERS**

WRITE FOR BROCHURE TO **RICH & BUNDY,**  
 NEW ROAD, PONDERS END.  
 Phone: ENFIELD 0777.

**LONDON LISTENERS!**

—Improved reception ensured— if you have your accumulators correctly charged by our skilled maintenance service. We collect weekly, fortnightly or monthly within 12 miles of Charing Cross, and exchange your accumulator (H.T. or L.T.) for one fully charged. If yours are not serviceable, you can hire ours. Both trouble-free, money-saving services. Terms—weekly, fortnightly, monthly or quarterly—no deposit required. And you can depend on our service for a solution in every wireless trouble.

Our service—the speciality of experts Write for full details and terms **RADIO SERVICE (London) Ltd.,** 105 Torrignano Avenue, (Camden Rd., N.W.5. Phone: North 0623 (3 lines)



**Components, Etc., for Sale.—Contd.**

(Continued from first column.)

condensers only require affixing to panel and the leads screwed down to make the set a complete receiver ready for immediate listening-in. We should like to emphasise that the above set is the last word in radio technique, and remarkable results are obtainable with it, far in advance of anything hitherto obtainable with four valves. Part kits as above are in stock, ready wired up, and can be despatched same day as order received. We offer this service with any sets published in *The Wireless World*. Details sent of Mr. W. James' "Long Range Five" ("Modern Wireless"), or of *Wireless World* Short Wave I., II., or III. sets, or of "Amateur Wireless" Shielded Valve Three (between 20 to 30 stations on loud-speaker with three valves). May we emphasise that these particular sets are equal to the best, and better than most, of the commercial sets on the market to-day. All enquiries and remittances to Cambrian Electric, Ltd., 14, Regent Street, Wrexham.

5827  
**LAKER** 30ft. Handsome Steel Mast, 22/6. See descriptive advertisement, page 34. Easily erected. 0035

**WESTON** Combined Moving Coil amp. and milliammeters; these are high-grade reading 0-6 amp. and 0-120 milliamper., with special bevelled glass, dust cover; cost £6, to clear, 25s. each.

**MICROPHONE** Amplifiers, 3/- each; Weston smoothing chokes, 3/- each; 1,000 and 2,000 ohms iron core chokes, 1/6; microphone buttons, 1/- each; intervalve transformers, 4/6 each; 2 M.F. condensers, 1/9; Sterling pocket galvos, 2/6 each; Osram G.E.C. 2-volt receiving valves, special, 1/3 each; Sterling solid back microphones, 5/- each; Dewar switches, 1/3; Marconi remote controls, 3/- each; 2,000 single earphones with cord, 1/3 each, post 4d.; Crompton dynamos, new, 50 volts 20 amps., £6, 50 volts 30 amps., £7, 100 volts 20 amps., £7, and hundreds of other generators in stock; Austin lighting sets, 3 1/2 k.w., £45; standard 3 1/2 k.w. sets, £45, etc., etc. We hold the largest surplus stock of all electrical apparatus, and should be pleased to quote you for all your requirements. Our prices are very lowest.

**T. W. THOMPSON** and Co., Government Surplus Depot, 39-43, London St., Greenwich, S.E.10. Offices and Showrooms: 1, South St., Greenwich, S.E.10. Telephone: Greenwich 1259. 5879

**EXPERIMENTER'S** Surplus.—L.S.5, 2 D.E.5B, D.E.5, V.24, Q. Q.X., D.E.V., Ferranti A.F.3, O.P.2, superaudioformer, Dimic No 1, Lotus remote control, .0005, .0003 Sterling square law, Burndept potentiometer, Varley H.F. choke, 100,000 resistance, 8 Dubilier condensers, at half list price or offer.—Can be seen at 10, Copland Rd., Wembley. 5874

**DECKOREM** Components are the finest you can include in any set you build. Write for free catalogue.—A. F. Bulgin & Co., 9-11, Cursitor St., London, E.C.4. 5886

**RELIABILITY WIRELESS GUIDE.**—New edition, No. 99A, just issued. Free upon request.

**RELIABILITY GOODS AND SERVICE.**—only obtainable from J. H. Taylor and Co., 15, Radio House, Macaulay St., Huddersfield. Trade supplied. Send for free Guide now. 0028



The  
1928  
"Allwoodorn"  
30/-

Low Speaker Unit, Extra.

**MODEL NO. 6.** Gives ample volume for a large room and has splendid natural definition and tone. Any Gramophone Unit with a rubber connecting tube will fit this horn. Can be supplied with any unit at maker's list prices.

**SPECIFICATION:**—14" Mahogany Bell. Solid Aluminium Casting. Height 19". Length 26".

**H. MADDISON,**  
2a, RONALDS RD., HIGHBURY, N.5.

7 x 5, 1/-	6 x 6, 1 1/2
7 x 6, 1.3	8 x 5, 1.2
8 x 6, 1/4	9 x 6, 1.7
10 x 8, 2.1	11 x 8, 2/3
10 x 9, 2/4	12 x 8, 2.6
12 x 10, 3/-	12 x 9, 2.10
14 x 12, 4/-	14 x 10, 3.6

**GREATER EFFICIENCY  
& GREATER ECONOMY.**  
**CROXSONIA  
PANELS**

have a higher electrical resistance than ebonite. Compare these prices! Why pay more for a less efficient article?

"THE WIRELESS WORLD" says:

"The principal property looked for in a panel is good insulation. The substance itself must be of infinite resistance and free from surface leakage, and when tested . . . the Croxsonia panel was found to be entirely reliable."

Panels cut to any size. Call, write, or phone Clarendon 7883 for quotations. Samples and prices post free to Trade.

**CROXSONIA CO., 10, South St., Moorgate, E.C.2.**

**GLASS CELLS  
for H.T. & L.T.  
Accumulators**

Our New Design. Reg. No. 727,093.

No. 1. Square. Dia. Hgt. Size 1", 1" x 3" 2.6 Per Dozen.

24/- gross quantities.

No. 2. Oblong. Dia. Hgt. Size 1", 2" x 3" 3/- Per Dozen.

30/- gross quantities.

Package & Carriage free.

Samples sent, 6d. each

Special Trade Terms.

**I. ISAACS & CO.,**

North London Glass Works, 106, Midland Rd., N.W.1. Estab'd. 100 years. Phone: Museum 4209



Inside ribs to separate Plates

Well

**EBONITE BUSHES**

FOR MOUNTING ON METAL OR WOOD.

PERFECT INSULATION  
Two required for each hole.

Orders under 1/- send 1/d. Postage NUMBER

0	1	2	3	4	5	6
Hole in Bush	8BA.	4BA.	2BA.	1",	5/16",	1", 7/16"
Price each:	1d.	1d.	1d.	1 1/2d.	2d.	2d.

(Complete List of sizes free on application.)  
**DAREX RADIO CO.,**  
Waldram Rd., Forest Hill, London. S.E.23.  
TRADE SUPPLIED

Mention of "The Wireless World," when writing to advertisers, will ensure prompt attention.

**Components, Etc., for Sale.—Contd.**

**SCREEN Coils.**—Split primary aerial, 250-550, 1,000-2,000, 5/6; split primary H.F., 250-550, 7/6; 1,000-2,000, 7/6; split secondary H.F., 250-550, 7/6; 1,000-2,000, 11/-; six-pin Bakelite base, 2/- each.—Below.

**EVERYMAN Four Coils**, complete with base: aerial, 15/-; transformers, 15/-; 28/- set.—Below.

**HYDRA Fixed Condensers**, tested 500 volts: .25 M.F., 2/-; .5 M.F., 2/3; 1 M.F., 2/6; 2 M.F., 3/6 each; other capacities in stock.—Below.

**VARIABLE Condensers.**—S.L.F. .0003, .0005, 7/6 each; L.M.L. .0005, .00035, .00025, 10/6.—Below.

**SUPER Filament Resistances**, 7, 15, 30 ohms, panel or baseboard types; 2/6 each.—Below.

**VALVE Holders**, Antimicrophonic; 1/6 each.—Below.

**H.F. Chokes and Anode Resistances**, 60,000, 80,000, 10,000 ohms; 5/- each.—Below.

**LITZ Wire**, 27-42, 20 yds., 5/-; 50 yds., 12/-; 9-40, 150 yds., 9/6; other lengths pro rata.—Below.

**PAXOLIN Tubes**, 3in. x 2 3/4in., 1/6 each; ebonite spacers and screws complete, 2d. each.—Obtainable all dealers or Stone Mfg. Co., 108-9, Great Saffron Hill, London, E.C.1. [0068]

**LAKER 30ft. Handsome Steel Mast**, 22/6. See descriptive advertisement, page 34. Easily erected. [0036]

**CONSTRUCTORS.**—Fit the Delophone C aerial tuner and dispense with plug-in coils; special model made for baseboard mountings, 250-4,000 metres; price 22/6; send for descriptive leaflet.—E. & F. Deal, 283, Shirley Rd., Southampton. [5844]

**MISCELLANEOUS.**

**THE Wireless Doctor Will Call** (London and Home Counties) if your set is troublesome; no cure, no charge; Wireless Association registered repairer; sets installed, maintained, and brought up to date; experiments and testing undertaken; Solodyne demonstrated.—Alexander Black, 2A, Woodville Grove, N.16. Clissold 3687 and Victoria 6215. [3841]

**MR. CLAUDE LYONS, M.I.R.E.,** will advise all constructors of supersonic-heterodyne receivers, without charge; if you have trouble with your present superhet, or contemplate building this most efficient form of receiver, write him, c/o Messrs. Claude Lyons, Ltd. (G.R. Quality Parts), 76, Oldhall St., Liverpool. [0065]

**LAKER 30ft. Handsome Steel Mast**, 22/6. See descriptive advertisement, page 34. Easily erected. [0037]

**WIRELESS Doctor Touring Midlands and South Coast.**—Ernest J. Baty, B.Sc., Luton. [5464]

**THE Little Imp.**—Combination gas blow pipe; indispensable to wireless workers, jewellers, opticians, amateurs, etc.; simplifies small soldering; fine intense flame; does away with soldering iron and blow pipe; marvellous invention; 2/6 post free; approval willingly.—Hammond, Market Hall, Burnley. [5563]

**SCOTLAND'S First Radio Doctor** (Glasgow and District) will call if your set is troublesome; no cure, no charge; sets installed, maintained and modernised; Everyman Four specialist; fees moderate; a post-card brings me.—"Radio," 74 1/2 New City Rd., Glasgow. [5684]

**H.T. BATTERIES**  
British and Better than slightly cheaper Foreign made goods.



You do get full value from B.E.C. Batteries.

Reliability with ultimate economy too.

This is our **CABINET TYPE** with full size cells, perfect insulation, highest efficiency. Best materials only used.

**60 VOLTS** Tapped 5, 10, 15, 30, 45, 60 .. **9/6**  
**100 VOLTS** Tapped every 15 Volts .. **16/-**  
(All Carriage Paid).

**There are many uses for these No. 1 W 4 1/2 volt Batteries**—Standard Pocket Lamp Size. Patent Spiral Wire Terminals and Wander Plug Sockets. Permanent connections without soldering. Illustration shows how to connect in series. Build up the voltage you need. 7/- Per doz. with plug. Carr. Paid.

We supply all standard types and voltages. Write for Details. Made at our Watford Works.

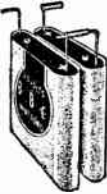

**BRITISH BATTERY CO., LTD.**  
Telephone Watford 617.  
Clarendon Road, Watford, Herts.

**OUR SPECIALITY:—  
PANELS**

Cut to any size in **BLACK EBONITE**, Polished or Matt.

3/4" thick 67 per sq. foot.

3/4" " 84 " "

**NEW WAVED EBONITE**, fadeless, same prices as above.

In **GREEN, YELLOW and RED Mottled Ebonite**.

1/2" thick 71 per sq. foot.

1/2" " 101 " "

1/2" " 117 " "

1" **Sponge Rubber for Valve Holders** 5/- per sq. foot. Post free.

Panel for the "Wireless World" Exhibition Five 30" x 8" Matt or Waved, 14.3, 11/-

**THE MOUNTFORD RUBBER CO., LTD.,**  
13, Weaman Street, BIRMINGHAM.

**RELIABILITY S.L.F. CONDENSER** with ebonite ends and 4" Trolite Dial.

.0005 5/8. .0003 5/8. Vernier Dial 1/8 extra. Post Free.

Further Attractive Items in Miscellaneous Columns. Send for FREE Guide now.

**J. H. TAYLOR & CO.**  
2 RADIO HOUSE, MACAULAY ST. HUDDERSFIELD. Trade Enquiries Solicited.

**WIRELESS** becomes much more interesting when you are able to read Morse. Now is your opportunity to acquire a knowledge of the Morse Code.

**PERRY'S AUTO-TIME MORSE SYSTEM** Price 6d. net. By post 7d., provides a ready means of becoming proficient in Morse reception.

Published from the Offices of "The Wireless World," Dorset House, Tudor Street, London, E.C.3. w.w.24

**DAREX**  
*Safety First*  
**TERMINALS**

SAVE VALVES and Batteries. Accidental Damage avoided. Description List free on request.

**DAREX RADIO CO.,**  
Waldram Rd., Forest Hill, London, S.E.23  
TRADE SUPPLIED

Miscellaneous.—Contd.

AKER 3oft. Handsome Steel Mast, 22/6  
See descriptive advertisement, page 34.  
asily erected. [0046]

ASY Payments.—We supply, by easy pay-  
ments, components, accessories and sets;  
ny make; 10 per cent. down, balance spread  
ver 10 months; send list of requirements to  
ndon Radio Supply Co., 11, Oat-la., Lon-  
on, E.C.2. [5591]

COTT SESSIONS, the radio doctor (Lon-  
don and environs); any set or component  
plied, installed, repaired, modernised;  
Wireless World" set specialist; officially  
pproved as radio repairer and trader by the  
adio Society of Great Britain and the Wire-  
less League; no work too big or too difficult!  
ill Top, Muswell Hill, N.10. 'Phone:  
ountview 4928. [5671]

AKER 3oft. Handsome Steel Mast, 22/6  
See descriptive advertisement, page 34.  
asily erected. [0047]

IRELESS Doctor (Croydon, Redhill,  
Dorking district) will call; send post-  
card; sets installed and repaired; and com-  
ment supplied.—T. White, 8, Clarendon  
d., Redhill. [5708]

ELEX Standardised Plug Socket System  
will improve your set; lists free.—Ask  
y trader, or Easticks, 118, Bunhill Row,  
C.1. [0025]

IRELESS Doctor, Plymouth district, will  
call, send postcard; sets modernised, all  
asses of repairs undertaken; terms moder-  
e.—W. Rose, Panmure, Wilderness Rd.,  
annamead, Plymouth. [5854]

OMPACT Low Power Short Wave Trans-  
mitter, American components, including  
ve; £6; photo; further particulars on re-  
est.—Machell, Lostock Hall, Preston, late  
WM. [5850]

AKER 3oft. Handsome Steel Mast, 22/6.  
See descriptive advertisement, page 34.  
asily erected. [0061]

HAT Offers?—Evershed's wireless  
generator, with pulley.—Smith, Bryn  
dyn, Colwyn Bay. [5838]

GAR'S Resin Cored Solder should always  
be used for making radio and electrical  
nections; it is non-corrosive and clean to  
idle; it has been tested and recommended  
*The Wireless World*; 1/- per carton, post  
e.—W. H. Agar, 19, Whitecross Pl., E.C.2.  
[5647]

.Y.P.—Your panel looks black in the face  
for the want of our gold panelling and  
oured centrepiece; 1/- packet post free;  
rd transfers in gold, silver, or white, 6d.  
ket.—D.Y.P. Co., 14, Daffodil St., Lon-  
n, W.12. [5824]

EEDS and 25 Miles Radius.—Wireless  
doctor attends on receipt of postcard;  
nite results guaranteed; moderate  
arges.—Wilson, 21, Roberts Ave., Hare-  
s Lane, Leeds. [5868]

AKER 3oft. Handsome Steel Mast, 22/6.  
See descriptive advertisement, page 34.  
asily erected. [0062]

IRELESS Doctor.—Your set put right  
quickly and efficiently; moderate terms,  
ning visits; any set altered to latest cir-  
s; screened valve circuits improved; Solo-  
e circuits.—Morley, 18, Grangemill Rd.,  
ford. [5891]



NO listener can avoid knowing when distortion is  
spoiling his reception, but hours of laborious  
overhauling may never reveal the source of trouble.  
The Milliammeter illustrated above, price 25/-, is one of the highly  
sensitive Sifam Radio instruments which tells you at once if distortion is  
due to L.F. Transformers, inaccurate H.T. or L.T. current, or  
incorrect grid bias. Without Sifam Radio Meters you are always liable  
to sudden failure at the critical time of an interesting programme.  
*Ask your dealer to show you complete range.*

(Dept. W.) SIFAM ELECTRICAL  
INSTRUMENT CO. LTD.  
10A, PAGE STREET WESTMINSTER,  
LONDON, S.W.1.

**9/6**  
**NEW MODEL**  
Pocket Voltmeter  
high resistance  
4,000 ohms.  
Double reading  
Heavy nickel-  
plated case.

*Remember!*  
**TEST YOUR SET TO-NIGHT**  
WITH A **SIFAM** METER  
GUARANTEED  
and it won't let you down to-morrow.  
M.B.24.



**LORIOSTAT**  
as used in the  
"Wireless World Regional Receiver."  
A multiple unit superseding the  
fixed Resistor. Can be used in  
1 way 2/- any circuit to control any number 5 9 -  
2 = 3/9 of valves. For downright efficiency 8 "10/8  
3 = 5/6 use a LORIOSTAT in your set.  
6. 15 or 30 ohm.  
**A. W. STAPLETON,**  
19a, Lorrimore Buildings, Lorrimore St., Waltham, S.E.17

PATENT AGENTS.

PATENTS and Trade Marks.—British and  
Foreign.—Gee and Co. (H. T. P. Gee,  
Member R.S.G.B. and A.M.I.R.E.), 51-52,  
Chancery Lane, London, W.C.2. 'Phone:  
Holborn 1525. [0001]

KING'S PATENT AGENCY, LTD. (B.T.  
King Registered Patent Agent, G.B.,  
U.S., and Can.). Free "Advice Handbook"  
and consultations; 40 years' references.—  
146a, Queen Victoria St., London, E.C.4.  
[0002]

REPAIRS.

ALL L.F. Transformers, 4/-; headphones,  
4/-, loud-speakers 4/- post free; maxi-  
mum efficiency attained; every repair is ac-  
companied with a three months' guarantee;  
don't discard if burnt out; trade invited.—  
Transform, 115, Links Rd., Tooting, Lon-  
don, S.W.17. [0011]

LOUD-SPEAKERS, headphones rewound to  
any resistance and remagnetised, 3/-;  
transformers rewound, 4/-; sets constructed  
and overhauled, work guaranteed.—Leeds  
Wireless Repair Service, 5, Boston Place,  
Green Rd., Leeds. [5811]

LOUD-SPEAKERS and Phones.—Guaran-  
teed repairs, any make or type, re-  
wound, remagnetised and adjusted by ex-  
perts, best materials only used; post free 4/-.  
—Howell, 42, Fotheringham Rd., Enfield,  
Middlesex [5858]

VALVES Repaired.—The North London  
Valve Co., Ltd., of 223, Cazenove Rd.,  
Stoke Newington, London, N.16, wish to  
notify their customers that their retail price  
list is now subject to 25 per cent. discount.  
If you had a valve that was good it will pay  
you to let us repair it. We guarantee its  
original characteristics. Write for price list.  
—'Phone: Clissold 0082. [5853]

HEADPHONES and Loud-speakers Re-  
wound, remagnetised and overhauled,  
4/-; transformers rewound, from 5/-; sent to  
our agents or direct to us.—Repairs fully  
guaranteed by M.I. Vaughton, 88, Vyse St.,  
Birmingham. Tel.: Mivyse, Birmingham.  
[5831]

HEADPHONES and Loud-speakers re-  
wound, remagnetised and overhauled, 3/-  
post free; guaranteed; Brown's A type,  
4/-; established 1923.—Bradford & Co., 16,  
Prospect St., Plymouth. [5861]

EXCHANGE.

EXCHANGE Canoelet Coachbuilt Side-  
car, perfect tyre, adjustable fittings, for  
good loud-speaker and 6-volt accumulator.—  
No. 4, Stanley Rd., Atherstone, Warwick-  
shire. [5855]

EXCHANGE, new, Lissenola, P.M. 1HF.,  
2 C.T.15, 1 3 v. .06. and other com-  
ponents for folding camera.—Roddis, North  
St., Hugglescote, Leicester. [5871]

WANTED.

CELESTION Loud-speaker; part exchange,  
cash balance; what offers 10 doz. drills?  
—Frost, 31, Cassland Cres., Hackney. [5828]

SOLODYNE Parts, except coils and screens;  
state lowest price; approval.—21, Douglas  
Rd., Bristol. [5829]

TWO Neutralising Condensers; 1 S.P. H.F.  
transformer, screen and base, 250-550  
metres; 5 baseboard dual rheo-stats.—Box  
3844, c/o *The Wireless World*. [5847]

Advertisements for "The Wireless World" are only accepted from firms we believe to be thoroughly reliable.

**Wanted.—Contd.**

**3** Gns. Offered for Good Cone Speaker.—  
Box 3847, c/o *The Wireless World*. [5893]  
**W**ANTED, complete battery eliminator or  
components for same; exchange ¼-plate  
camera, Ross lens, Harris changing box; cost  
£15.—Felts, Potton Sandy. [5889]  
**D**.E.H.612, Climax choke, large Hydra,  
2 mf. T.C.C. condensers.—H. Braith-  
waite, Southbourne, Bournemouth. [5836]

**AGENCIES.**

**A**GENTS Wanted for Cheapest and Safest  
Non-pumping Petrol-gas Lamps; good  
living made converting all paraffin lamps into  
150 c.p. Titus light; particulars, Titus, Kings-  
ston, Brighton. [5249]  
**L**ARGE German Factory of Wireless Sets  
and Accessories requires Agents in  
various districts of Great Britain and Ire-  
land.—Offers, with references, to A. Günther,  
Furtwangen, Baden, Germany. [5746]  
**S**ALES MEN Calling on Wholesalers and  
Dealers wanted to carry advertised line  
of Wireless Components, commission only;  
state ground covered.—Box 3688, c/o *The  
Wireless World*. [5736]

**SITUATIONS VACANT.**

**W**IRELESS.—Wanted, manager for high-  
class retail shop, also good mechanic,  
previous experience essential.—Apply by letter,  
giving all particulars and age, to J. W. Cald-  
cott, 2, Princes Bldgs., Bath. [5663]  
**I**NSPECTORS Wanted for Factory in  
South Midlands manufacturing wireless  
components, receivers, etc. Only those with  
full experience in inspecting all classes and  
details of wireless parts will be considered.—  
Write, stating experience, age, and wage,  
Box 450, Sells, Fleet St., E.C.4. [5834]  
**T**EST Room Assistants Wanted for Factory  
in South Midlands manufacturing wire-  
less components and receivers, previous  
similar experience essential.—Write, stating  
age, experience, wage, and full details, Box  
449, Sells, Fleet St., E.C.4. [5835]

**SITUATIONS WANTED.**

**T**WO Foremen in winding and assembling  
departments of wireless manufacturers  
desire change, similar positions.—Box 3848,  
c/o *The Wireless World*. [5892]  
**W**IRELESS Mechanic, ex R.A.F., seeks  
situation, 6 years' experience.—Write  
Goad, Holloway Hill, Godalming, Surrey.  
[5875]

**BOOKS, INSTRUCTION, ETC.**

**3**-VALVE Receiver for 30/.—Write now for  
booklet on how to build the L.R.C.3  
valve set for 30/., from guaranteed parts only  
—the ideal loud-speaker set.—1/., post free,  
from H. Howarth, Lustrolux Depot, 288,  
Deansgate, Manchester. [5612]

**Books, Instruction, Etc.—Contd.**

"THE ABC of the Superhet," by Mr. Claude  
L. Lyons, M.A.R.E., 88 pages, 17  
explanatory diagrams or photographs, and in-  
cluding complete schematic and point-to-point  
wiring plan of the famous *Evening Chronicle*  
8-valve superheterodyne receiver. The only  
book of its kind at present in existence; re-  
cently described by the Editor of *The  
Wireless World* as "A fascinating booklet."  
... A lucid description of the operation of  
the superhet receiver. ... With construc-  
tional details and useful hints and for the  
home constructor." Only 8d. complete, post  
free, from Claude Lyons, Ltd. (G.R. Quality  
Parts), 76, Oldhall St., Liverpool. [0064]  
**S**END Sixpence for the well-illustrated  
booklet giving comprehensive and con-  
structional details of successful high tension  
battery elimination from alternating current.  
—A. W. Knight & Co., 180, Tower Bridge  
Rd., S.E.1. [5687]

**ORDERS for £70****Finding  
a ready  
market***A recent advertiser writes:*

"The advertisement in your small  
advertisement columns of last  
week resulted in our obtaining  
**over £70 worth of orders in  
three days.** We know that sound  
components and good workman-  
ship can find a ready market  
through the columns of 'The  
Wireless World'."

T. J. Pearson,  
p.p. Matlock Radio Manufacturers,  
Woodberry Grove,  
Finchley, N.12.

w. w. 57.

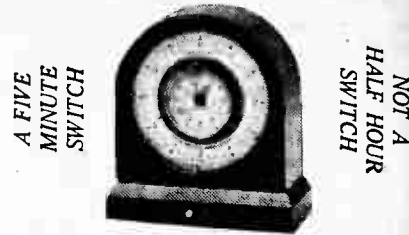
**"AXUEL" Radio  
Programme Selector.**A FIVE  
MINUTE  
SWITCHNOT A  
HALF HOUR  
SWITCH

Switches Radio Sets automatically on and off  
at any periods of  
**5 MINUTES or MORE.**

PRICE **50/-** COMPLETE (post free).

PELHAMS LTD. (W.W.),  
5, Banner Street, London, E.C.1.

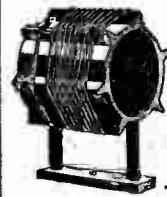
**'L&H' SHORT WAVE COIL  
20 to 70 metres.**

This coil is specially designed  
for Empire Broadcast Recep-  
tion. For full particulars see  
*Wireless World*, June 29, 1927.  
Price complete with base **6/-**  
**LAWRENCE & HULL**  
29 Parkhouse St., Camberwell, S.E.5  
Phone: Hodney 3810.



BOWYER-LOWE CO. LTD., LETCHWORTH

**SOMETHING NEW****STAR UNIVERSAL 12/1  
C.T. TUNER**

Used in place of centre post 50  
tapped coils. For all wavelength  
200/2,800 m.

"Duplex" type both C.T. and  
Reinartz for "Local" "5GB"  
and Daventry **7/6** post 4d.

Send now for particulars of the  
**NEW STAR REACTIVE TUNER, Price 12/6.**  
THE STAR WIRELESS SUPPLIES, BIGGLESWAD

**Insist on Parfait Brand**

In Four Qualities: Matt, Semi-Polished  
Mahogany, Hand-Polished.

Sole Manufacturers:—  
**H. B. POTTER & CO., LTD., Station  
Buildings, ROCHDALE. Phone: 1485.**

**THE PERFECT  
EBONITE****FROM YOUR DEALER**

Mention of "The Wireless World," when writing to advertisers, will ensure prompt attention.

AI



TRADE MARK "RED DIAMOND"  
 RED DIAMOND  
 REGD



THE RECOGNISED DETECTOR FOR ALL CIRCUITS USING CRYSTAL RECTIFICATION.

RD 40 2/-  
 SHIELD FOR SAME 6d.

By Insured Post 2/3 or 2/9 with shield. Can be mounted on brackets or through panel. Once set always ready. Not affected by vibration. Each one is tested on broadcast before despatch, and is perfect. Of all high class Radio Dealers or Sole Makers:—

**EWEL PEN CO. LTD.,**  
 Radio Dept. 44) 21-22, Gt. Sutton St., LONDON, E.C.1

**The TANNOY H.T. UNITS FOR D.C. MAINS**  
 KIT OF PARTS from 25/-. COMPLETE UNITS from 2 Gns.  
 WRITE FOR LISTS OF COMPONENTS, ETC.  
**TULSEMERE MANUFACTURING CO.,**  
 Tulsemere Road, West Norwood, S.E.27. Phone: Creetington 6731

**The H.T.C. TWIN RECEIVER**

A complete up-to-date set, including loud speaker and all accessories.  
 Seven days' trial and initial payment refunded if not entirely satisfactory.

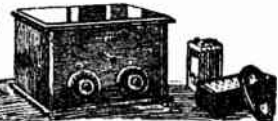

Immediate delivery for  
 Balance 2/6 per week or 10/- per month. Total cost £6.10.0.

**5/-**

Cash Price £6 4 0  
 Royalty Paid.

3 valve set, Cash Price £3 8 0  
 Deferred Terms £8 16 0

**H.T.C. ELECTRICAL CO. LTD.,**  
 2, Boundaries Rd., Balham, S.W.12.

Have YOU tried **PERTINAX**?

3,16" thick, cut standard sizes, in neatly labelled envelope, or cut to your own requirements at 1d. per square inch. Colours: Natural brown, mahogany, walnut and black. Send 11d. stamp for 1" sq. sample, stating colour, to Geo. L. SCOTT & Co., Ltd., 69, Fleet St., E.C.4.

**WE SELL**  
**"ORMOND" SLOW-MOVING DUAL INDICATOR DIALS**  
 (FAST enough for easy searching)  
 (SLOW enough for finest tuning)

IDEAL REDUCTION RATIO: 16 to 1.  
 NOTE THE PRICE: **5/- EACH**

ALSO  
**"ORMOND" STRAIGHT LINE FREQUENCY CONDENSERS**  
 (Has a greatly reduced Frame and highly finished BAKELITE End Plates)

Cat. No.	Description.	Capacity.	Price
R/214	No. 3 S.L.F. Condenser	'00025	5/6
R/215	"	'00035	5/9
R/216	"	'0005	6/-

VERY LARGE RANGE OF WIRELESS PARTS.  
**G. Z. AUCKLAND & SON,**  
 8 & 8a Cross Street, Islington, N.1.

**A FREE booklet for YOU**

Here is a free offer to all Battery users which shouldn't be missed. Just send a 1d. stamp to the address below and receive by return a valuable 20pp. booklet dealing with the wonderful ETON primary H.T. Battery. This offer is only for a limited period so write off for it TO-DAY to the ETON GLASS BATTERY CO., 46, St. Mary's Road, Leyton, E.10.

**DIGBY'S CABINETS**  
 Write for 16 page Art Catalogue.  
 9, BANBURY RD., S. HACKNEY, E.9.  
 Phone: Clissold 5458.

**CAXTON WIRELESS CABINETS**  
 THOUSANDS OF SATISFIED CUSTOMERS.

All Polished with new enamel that gives a glass hard surface that cannot be soiled or scratched. Ebonite or Radion Panels Supplied and Perfectly Fitted at low extra cost. SENT FREE—Catalogues of Standard Wireless Cabinets in various sizes and woods.

*Elstree "Solodyne"*

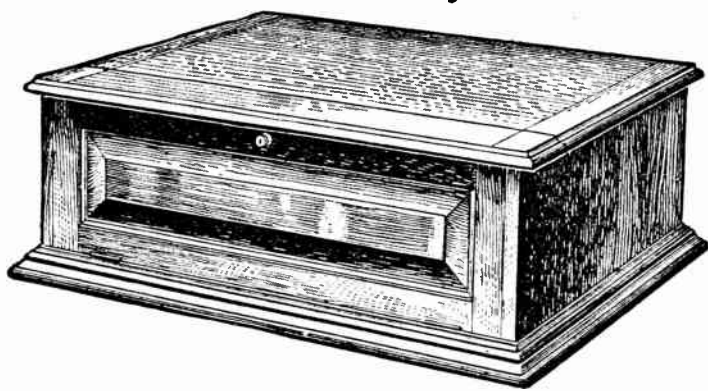

Specially designed for this famous Radio Press Circuit. All details and dimensions conform to their specification, enabling constructors to follow the layout without difficulty.

PRICES:  
 Light Fumed Oak **66/-** Dark or Jacobean Oak **70/-** Real Mahogany **73/-**  
 Prices include either "fall front" with handsome solid raised panel, as illustrated, or beaded doors, allowing ample space for tuning controls, etc. Glass panelled doors can also be supplied at 3/- extra.

**CASH WITH ORDER. CARRIAGE PAID U.K. PROMPT DELIVERY.**  
 Packing Case 5/- extra repaid if Case returned within 14 days Carriage paid to Works.  
**CAXTON WOOD TURNERY CO., MARKET HARBOROUGH.**

**ACCUMULATORS "ELITE"**  
 — The Elite of all —

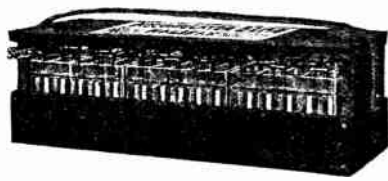

**H.T. ACCUMULATORS, 60 volts type, 02, Semi-oil Submerged. Complete, as illustrated. Price 22/6**

The World's Best High Tension Accumulator and of British Manufacture. The Unique Semi-Oil Submerged feature of the Elite, absolutely prevents surface leakage losses. The battery lasts a life-time. Write for lists. Sold on approval.

**ACCUMULATORS ELITE Bedford Street, HALIFAX.**  
 Telephone: 4304. Telegrams: Elite Halifax.

London Distributor:—**CECIL POHLMAN, 77, Great Portland Street, LONDON, W.1**

INDEX TO ADVERTISEMENTS.

	PAGE		PAGE		PAGE
Accumulators Elite	89	Edison Swan Electric Co., Ltd.	19	Mountford Rubber Co., Ltd.	38
A.F.A. Accumulators, Ltd.	8	Electradix Radios	40	Mullard Wireless Service Co., Ltd.	1
American Hard Rubber Co. (Brit.), Ltd.	29	Engineering Works (Electrical & General), Ltd.	10	P.B.G., Ltd.	32
Atkinson C. Creswick	40	Ericsson Telephones, Ltd.	20	Pelhams, Ltd.	38
Auckland, G. Z., & Co.	39	Eton Glass Battery Co.	39	Pohu, G. E.	34
Artic Fuse & Electrical Mfg. Co., Ltd.	24	Ever Ready Co.	8	Potter, H. B., & Co., Ltd.	38
Ashton, Harold	34	Fin-ton Manf. Co., Ltd.	27	Radio Service (London), Ltd.	95
Batteries, Ltd.	25	Forno Co.	27	Rathbourne Elec. & Eng. Co.	40
Bedford Elec. & Radio Co., Ltd.	32	Garnett, Whiteley & Co., Ltd.	Cover iii	Redfern's Rubber Works, Ltd.	Cover iii
Belling & Lee, Ltd.	22	General Electric Co., Ltd.	6 & 11	Rich & Bundy	35
Bowyer-Lowe Co., Ltd.	38	Graham-Farish Manf. Co.	23	R.I. & Varley, Ltd.	14
British Battery Co., Ltd.	36	Graves, J. G., Ltd.	28	S.D.H. Manf. Co.	22
British Ebonite Co., Ltd.	27	Hart Accum. Co., Ltd.	23	Scott, G. L., & Co., Ltd.	39
British Thomson-Houston Co., Ltd.	13 & 18	Hildick & Hildick	10	Scott Sessions, G., & Co.	40
B.S.A. Radio, Ltd.	18	Howarth's British Valve Depot	27	Selfridge & Co., Ltd.	9
Burne-Jones & Co., Ltd.	25	H.T.C. Electrical Co., Ltd.	39	Sifam Electrical Instrument Co.	37
Burndep Wireless, Ltd.	2	Hunt, A. H., Ltd.	10	Sinmonds Bros.	25
Burton, C. F. & H.	5	Igranic Electric Co., Ltd.	9	Stapleton, A. W.	37
Carborundum Co., Ltd.	2	Isaacs, I., & Co.	36	Star Wireless Supplies	38
Carrington Manf. Co., Ltd.	27	Jewel Pen Co., Ltd.	39	Taylor, J. H., & Co.	36
Caxton Wood Turnery Co., Ltd.	39	Kay, H.	34	Telegraph Condenser Co., Ltd.	6
Christie, Jas., & Sons, Ltd.	35	Laker, J. & J., Co.	4	Trelleborg's	40
Clarke, H., & Co. (Manchester), Ltd.	4	Lamplugh, S. A., Ltd.	34	Tuisenere Manf. Co.	39
Collinson Precision Screw Co., Ltd.	8	Langham Radio	11	Turner & Co.	7
Cossor, A. C., Ltd.	12	Lawrence & Hull	38	Vandervell, C. A., & Co.	21
Croxsonia Co.	36	Lever, E. J.	35	Voltron Co., Ltd.	23
Darex Radio Co.	36	Lifford Engineering Co.	23	Walker Bros. (Guildford), Ltd.	23
Day, Will, Ltd.	21	Lyons, Claude, Ltd.	30	Watmel Wireless Co., Ltd.	27
Digby, F.	39	Maddison, H.	36	White Bros. & Jacobs, Ltd.	24
Dubilier Condenser Co. (1925), Ltd.	Cover ii	Marconiphone Co., Ltd., The	Cover iv	Whiteley, Boneham & Co., Ltd.	21
Eagle Engineering Co., Ltd.	22	Melluish, C. D.	32	Williams & Moffat, Ltd.	22
Eastick, J. J., & Sons	24	Metro-Vick Supplies, Ltd.	15, 16 & 17	Wingrove & Rogers, Ltd.	31
Elec. Co., & Co., Ltd.	27	Mic Wireless Co.	24	Wright & Weaire, Ltd.	22
Edison Bell Radio, Ltd.	20	M-L Magneto Synd., Ltd.	33		

**THE**  
**'NULLI SECUNDUS V'**  
PORTABLE AND TRANSPORTABLE  
EFFICIENT **RECEIVERS** SIMPLE



Portable Receiver  
**£30-0-0**

Transportable Receiver  
**£33-2-6**  
No Extras

IN POLISHED OAK CABINET (Mahogany Cabinet £1 EXTRA)

Daventry received anywhere in British Isles. 5G.B. obtained up to 200 miles — FULLY TESTED —

**C. CRESWICK ATKINSON, M.I.R.E.**  
53b, High Street — Bedford.

**Rathbourne Electric & Engineering Co.,**  
18, Sylvester Road, East Finchley, N.2.

**Renown Transformers**  
are guaranteed for 12 months and made in 2 ratios, i.e. 5-1 and 3-1.



Junior 5/-  
Standard as illustration 6/6  
Power 8/6

L.F. Choke 5/6  
H.F. Choke 4/6

Wire Wound Resistance.  
60,000 ohms } 6/6 each.  
80,000 " }  
100,000 " }

Trade Enquiries Invited. ALL POST FREE.

**DIX - ONEMETER SALES**  
eclipse all others.

"The Rolls-Royce of Radio" is now used by the B.B.C., Scotland Yard, L.C.C. and other Authorities.

A £10 multi-range Precision Tester for 55/-.

For your big output Power Valves you need an Anode Converter; we can supply for 200 volts to a 2000 volts at 100 m.a. to 500 m.a., from £4 10 0.

Fine Morse Recorders, £7 10 0. Relays, 25/-.

Sale of 40 metre W.D. Wavemeters, 32 6.

Arc Lamps, 6 movements, cost £8, Sale 60/-.

Electric Immersion Heaters, 5-. Hot Plates, 7/6.

Electric Massage Vibrators cost £4, Sale 25 6.

Curling Irons, 5-. Electric Blowers, 30/-. Vacuum Cleaners, Large, £10. Medium, £8. Portable, £6 10 0. 2 years' guarantee.

R-K Coil Speakers, Horse-shoe Magnets, 3/6.

3-Range Micro-Ameters read to 1/2 micro-amp, 60/-.

Remote Control Switches, 10/-, 15- and 17 6.

ALTERNATORS, 70/-

Laboratory Apparatus in great variety, cheap.

**ELECTRADIX RADIOS** FOR EVERYTHING

Send your enquiries and ad. for Illus. Catalogue or call at 218, UPPER THAMES ST., E.C.4.



**BUY ZODAX**

Guaranteed H.T. Batteries of best BRITISH manufacture.

Standard Capacity. More hours for less expense.

PRICES: 100 Volts 15s. 6d. 60 Volts 8s. 6d. Carr. paid.  
GRID BIAS 9 Volts 1s. 9d.

RETAIL: **G. Scott Sessions & Co.,** Hill Top, Muswell Hill, London, N.10

WHOLESALE: **J. S. Plumtree & Son,** 90, High Holborn, London, W.C.1

**Trelleborgs**  
GUARANTEED  
GENUINE EBONITE  
THE FINEST QUALITY PANEL OBTAINABLE.  
ONLY 1/2d. Retail Price per square inch.

STANDARD GLOSSY FINISH 3/16" THICKNESS.

Other prices: — 3/8" Highly Polished, 3/4d. per sq. in.; 1/2" Standard Glossy, 3/4d. per sq. in.; 1/4" Highly Polished, 1d. per sq. in.

Mention of "The Wireless World," when writing to advertisers, will ensure prompt attention.

Use **REDFERN'S**  
REG. NO. 469456  
**Ebonart**  
NON-METALLIC SURFACE EBONITE  
**RADIO PANELS**  
for

easy working, positive insulation, beautiful appearance, and an entire freedom from surface leakage. In black and a beautiful mahogany grain, in nine standard sizes and prices. The "Ebonart Station Log Chart" given with each panel.

**Redfern's**  
**EBONITE H.F. CHOKE FORMER.**

With this former and a reel of D.S.C. wire, the experimenter can make an efficient H.F. Choke. Sold complete with base for baseboard mounting.

Price 2/6 each.

Send for Book of Ebonart.

Obtainable from all reputable dealers.

**REDFERN'S RUBBER WORKS, LTD.,**  
HYDE, CHESHIRE.



Lotus Relay

*Simultaneous Reception in every room!*

You can have simultaneous reception in every room in your home without interference by installing the Lotus Remote Control.

Complete outfit for wiring two rooms **30/-**  
Each additional room **7/6**

THE **LOTUS** REMOTE CONTROL

**FREE!**

Write for **FREE BLUE PRINTS** and instructions how to wire two rooms in half an hour to Dept. W.W.4, Garnett Whiteley & Co., Ltd., Broadgreen Road, Liverpool.

**NOW READY**  
**WIRELESS**

**Second Edition (Revised) of**  
**LOUD SPEAKERS**

By **N. W. McLACHLAN, D.Sc.**

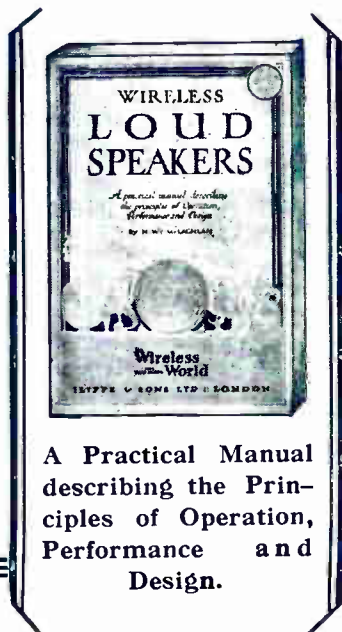

**T**HE purpose of the book, now in the second edition, revised throughout by the author, is to describe in a simple manner the major principles of the design of modern loud-speakers—chiefly of the large diaphragm type—and some associated circuits. Throughout the volume the author has refrained from a too technical treatment of the analytical side of the subject. The book is clearly written and fully illustrated by numerous diagrams and photographic reproductions. A chapter showing how to construct a loud-speaker will appeal to many amateurs.

**A Résumé of the Contents:**

**GENERAL ACOUSTIC PRINCIPLES: LOUDNESS OF REPRODUCTION AND ITS INFLUENCE ON QUALITY: RESONANCE CAUSING BLURRING OF COMPLEX SOUNDS: PRINCIPLES AND DESCRIPTION OF HORN-TYPE LOUD-SPEAKERS: LATERAL MOTION OF AIR: EFFECT OF HORN LENGTH: PRINCIPLES OF LARGE DIAPHRAGM SHAPE: CONE DIAPHRAGMS: REFLECTORS: ROOM RESONANCES: STANDING WAVES: ACOUSTIC SHADOWS, ETC., ETC.**

Price, 2/6 net. By post, 2/8.

From all booksellers or direct from the Publishers

**ILIFFE & SONS, LTD.,** Dorset House, Tudor Street, London, E.C.4.

A Practical Manual describing the Principles of Operation, Performance and Design.

# Build THE NEW RADIO SIMPLICITY into your receivers

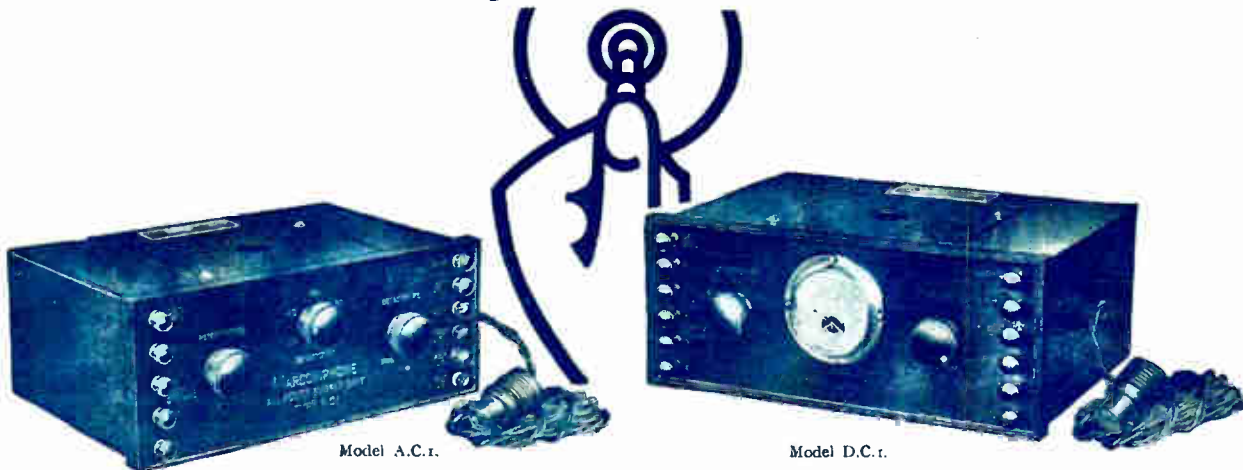

Enjoy, now, the convenience and economy of power from the mains. With a Marconiphone All-Power Unit, for either A.C. or D.C. supply, you can operate your receiver entirely from the mains. No accumulators—no batteries. Whenever the wireless is wanted you just switch on. Or if you only want H.T. from the electric supply, there is a complete range of Marconiphone H.T. Supply Units for every type of receiver. You simply plug the unit into an ordinary lampholder and you obtain continuous and steady H.T. supply requiring no attention and no renewal.

## ALL-POWER UNITS

For A.C. Mains.

### Model A.C.1.

For use with receivers employing from 1 to 4 Marconi K.L.1 valves. Provides H.T., L.T. and grid bias. H.T. Current is rectified by Marconi U.5 valve. Output at 100-110 volts, approx. 20 m.a.

Two models are available for 50 cycles:

B928 for 100-125 volts. B927 for 200-250 volts.

Price, including U.5 valve and royalty, £9.

Also two similar models for 25 cycles.

For D.C. Mains.

### Model D.C.1.

For use with Marconi 1 amp. valves. Provides all necessary voltages, and provision is made for five values of grid bias. Output at 120 volts, approx. 20 m.a.

Two models are available:

B929 for 100-125 volts.

B930 for 200-250 volts.

Price - - - - - £6 10 0

## H.T. SUPPLY UNITS

For one or two valve receivers.

For D.C. Mains.

### Model D.C.3.

For 100 to 125 or 200 to 250 volts, 35/-

For A.C. Mains.

### Model A.C.3.

For 100 to 125 or 200 to 250 volts. Complete with valve and royalty, 73/-

For multi-valve receivers.

For D.C. Mains.

### Model D.C.2.

With output more than sufficient for any standard receiver. Two models suitable for use on 100 to 250 volt mains. Price 82/6.

For A.C. Mains.

### Model A.C.2.

Two models for 100-125 and 200-250 volts, including valve and royalty. £7 12 6.

Two similar models for 25 cycles.



Model D.C.3.

# MARCONIPHONE

THE MARCONIPHONE COMPANY, LTD. (AND REDUCED).

Head Office: 210-212, Tottenham Court Road, London, W.1.

Registered Office: Marconi House, Strand, W.C.2.

# The Wireless World

3<sup>D</sup>

UNIVERSITY OF  
FEB 14 1950  
LIBRARY  
AND  
RADIO REVIEW

*The Paper for Every Wireless Amateur*

Wednesday, October 12th, 1927.

## TUNED-ANODE SINGLE-VALVE RECEIVER

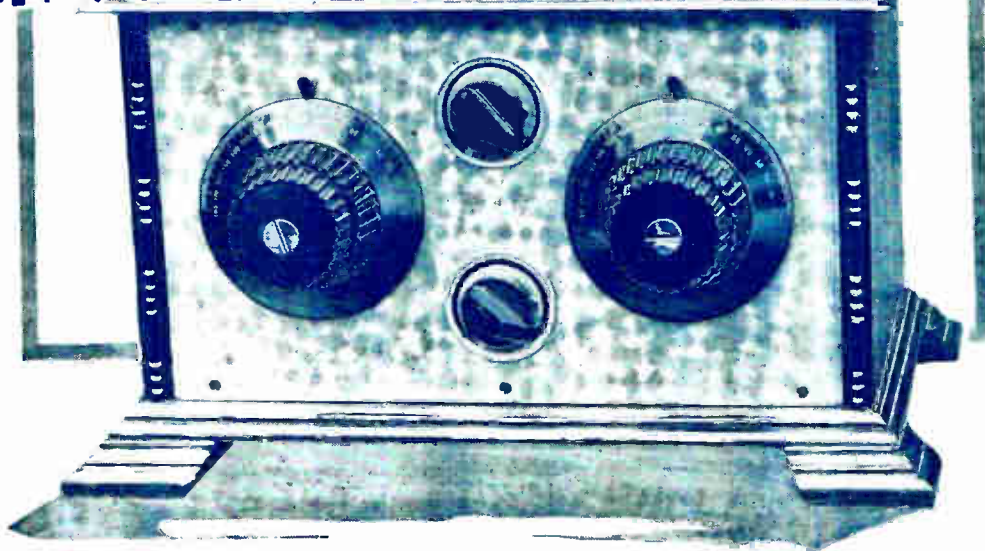

Have you heard these  
new **AMPLION**  
models?

These models contain a new type of unit of extreme sensitivity, capable of remarkable purity of reproduction. They have two adjustments, one on the unit and the other on the cone itself. They are of attractive appearance and very reasonable in price. Ask your radio dealer for a demonstration.



Model A.C.1, with adjustable support, which also acts as a hook by which the speaker may be hung from the picture rail, as a plaque.

**52/6**

Model A.C.4, in dark oak, with fretted grille. Particularly suitable for standing on narrow shelves, the depth being less than 6 inches.

**£4 - 0 - 0**

Mahogany model

**£4 - 4 - 0**

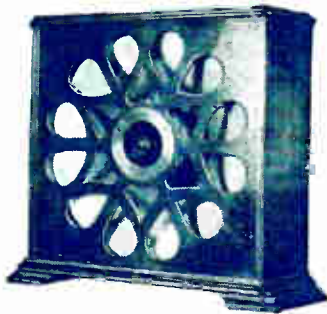

**AMPLION**  
**CONE**

Announcement of Graham Amplion Limited, 25, Savile Row, London, W.1.

Mention of 'The Wireless World,' when writing to advertisers, will ensure prompt attention.

EVERYTHING

The **G. E. C.**  
your guarantee

ELECTRICAL

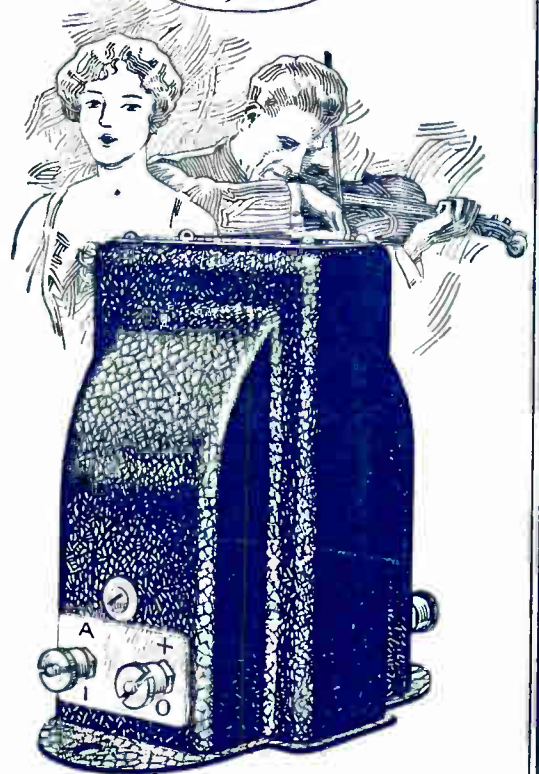

**L.F. TRANSFORMER FACTS**  
*Performance*

GECOPHONE L. F. TRANSFORMERS give results as near perfect as it is possible to obtain. With a good loud-speaker such as the GECOPHONE CONE, the purity and natural tone is amazing, and sets using them have been given unstinted praise by such famous artistes and musicians as Dame Clara Butt, Miss Edith Day, Albert Sammons, De Groot and many others.

Reduced Prices

Ratio 2-1 ... 17/6

Ratio 4-1 ... 20/-

MADE IN ENGLAND

**GECOPHONE**

**L.F. TRANSFORMERS**

*for volume and purity*

Sold by all Wireless Dealers and Stores.

Advt. of The General Electric Co., Ltd., Magnet House, Kingsway, London, W.C.2.



## Hear this New Speaker!

The Mullard  
Pure Music  
Model E  
Price £3-5-0

Now you may enjoy Pure Music reproduction from a new inexpensive Mullard P.M. Speaker. Hear this new Model "E" and realize what startling value it offers you.

The power it handles and the rich tone it renders are a revelation.

Confirm this yourself—get your dealer to give you a demonstration to-day.

# Mullard

## MASTER · RADIO



*Bring your Receiver closer to the Transmitter!*

**H.F. Amplification**  
with  
**MH COMPONENTS**

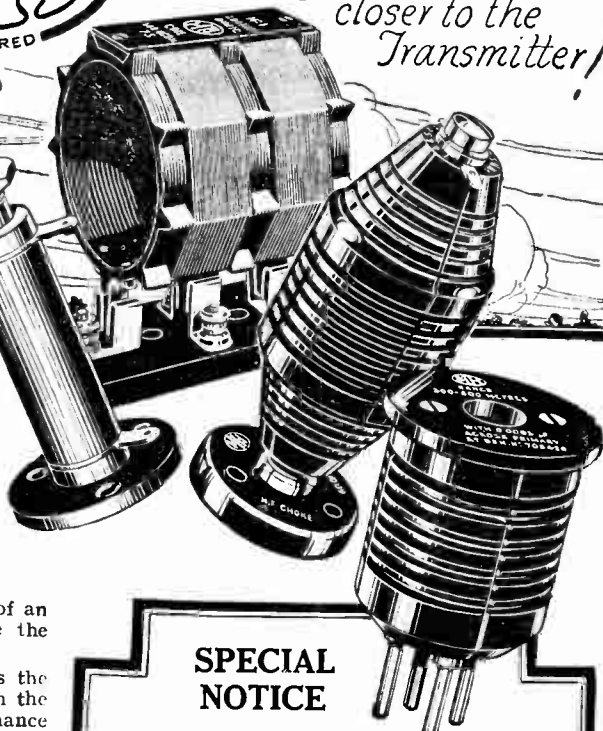

For purity of reproduction we have constantly advocated the use of an H.F. stage in the construction of receivers, and particularly where the reception of distant stations on the loud speaker is required.

The **MH** range of H.F. devices places in the constructor's hands the most efficient components, which, though many of them have been on the market for some years, are still in the forefront for efficiency in performance and quality in workmanship.

Each and all of our Components are manufactured to a high degree of precision on Instrument Makers' lines. On the technical side our components fulfil all modern requirements, and our efforts for the elimination of high frequency resistance have met with universally acknowledged success. You cannot do better than use **MH** components when making up that new set.

"There is a **MH** component for every H.F. Circuit."

We illustrate above the

**MH BALANCING CONDENSER**

Its unique design comprises the following advantages: High insulation resistance—high breakdown voltage—calibrated to allow of re-setting—precise adjustments for critical operation—ease and adaptability in fixing.

Price 4/9 each.

**MH H.F. TRANSFORMER**

Ideal for long-distance reception and beautifully made. Unique for its power of H.F. amplification from 80 to 7,000 metres. Price 10/- each.

We are exhibiting at the **MANCHESTER RADIO EXHIBITION**, Oct. 24 to Nov. 5.

Telephone Slough 442-442

**L.M<sup>c</sup> MICHAEL LTD**

Telegrams Radiether Slough

Manufacturers of Wireless and Scientific Apparatus  
**WEXHAM ROAD, SLOUGH, BUCKS**

Irish Agents: B.N.B. Wireless Ltd., Dublin & Belfast.

**SPECIAL NOTICE**

We give notice to the public of our latest contribution to H.F. Amplification. This consists of

**THE NEW 4-ELECTRODE SCREENED VALVE HOLDER**

in combination with our Dimic series of Coils.

The compact nature of the layout, the acknowledged supremacy of the Dimic Coils, together with the workmanlike layout and considered design, guarantee the highest efficiency.

Circuit diagrams and details will be sent by our Technical Department to requests accompanied by a stamped addressed envelope.

Box complete with Coil Holder, Valve Holder, and Filament connections on base.

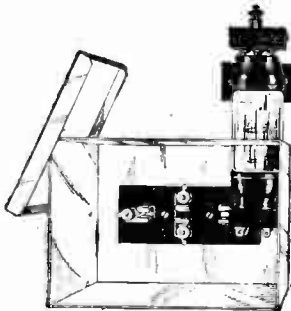

**PRICE**  
**12/6**



Mention of "The Wireless World," when writing to advertisers, will ensure prompt attention.



**ONLY**  
**90!**

now is all  
you need pay  
for a handsome  
Hornless Loud Speaker

THERE'S no need now to pay a high price for your Loud Speaker. Only ninety shillings will buy an instrument which will satisfy the most discriminating ear and the most fastidious eye. The BROWN Mascot Loud Speaker is unrivalled at its price both in performance and appearance. It will give you—now and always—a reproduction that is so true that it can only be compared with the original. That is

unmatched, in its class, in the purity of its tone, and unequalled in the majesty of its volume.

The reproduction you hear when first you listen to the Mascot is the reproduction you will hear after years of use. That is a guarantee upon which the world-famous BROWN reputation is staked. Hear the Mascot at your Dealer's, or, better still, get him to demonstrate it in your own home. Price 90/.

Hear also  
the new  
**BROWN**  
UNIVERSAL  
Loud Speaker  
Price £6

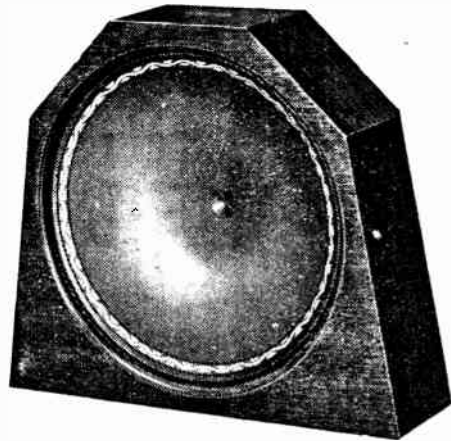

Unrivalled,  
at its price, for  
Performance  
and  
Appearance

# Brown Mascot Loud Speaker

S. G. Brown, Ltd., Western Avenue,  
North Acton, London, W.3.

9662

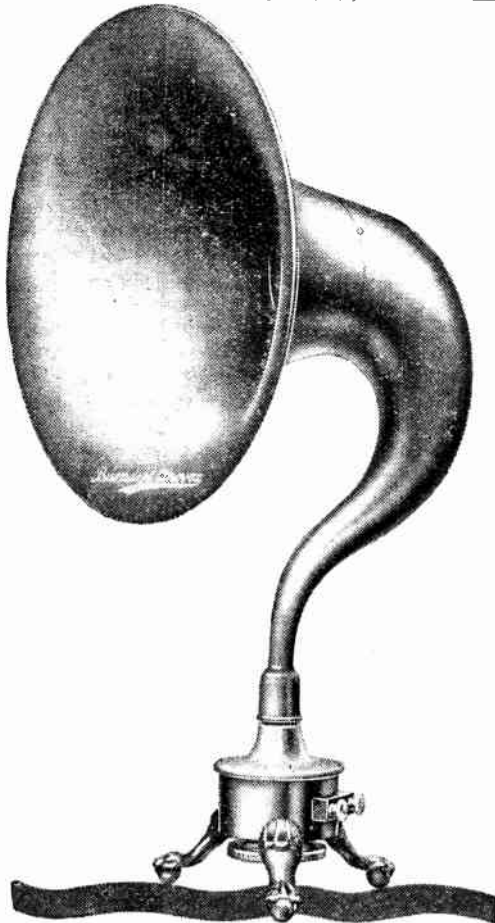

## THE ALTERNATIVE PROGRAMME

has made you far more interested—the

*Ethovox*

will make you far more satisfied! Either alternative will sound equally well through this Aristocrat of Loud Speakers, and if your set will run a speaker at all it will feel a lot happier with an ETHOVOX, and—so will you! For beauty and purity of tone it has never been equalled. To-day it is cheaper, but NOT cheapened—you can buy it for a round £3.

Ask us for descriptive booklet and name of nearest dealer stocking it.



**BURNDIPT**

WIRELESS APPARATUS  
BLACKHEATH  
LONDON, S.E.3

Demonstrations, any time, at Burndipt Showrooms, 15, Bedford St., Strand, W.C.2.

# WESTON

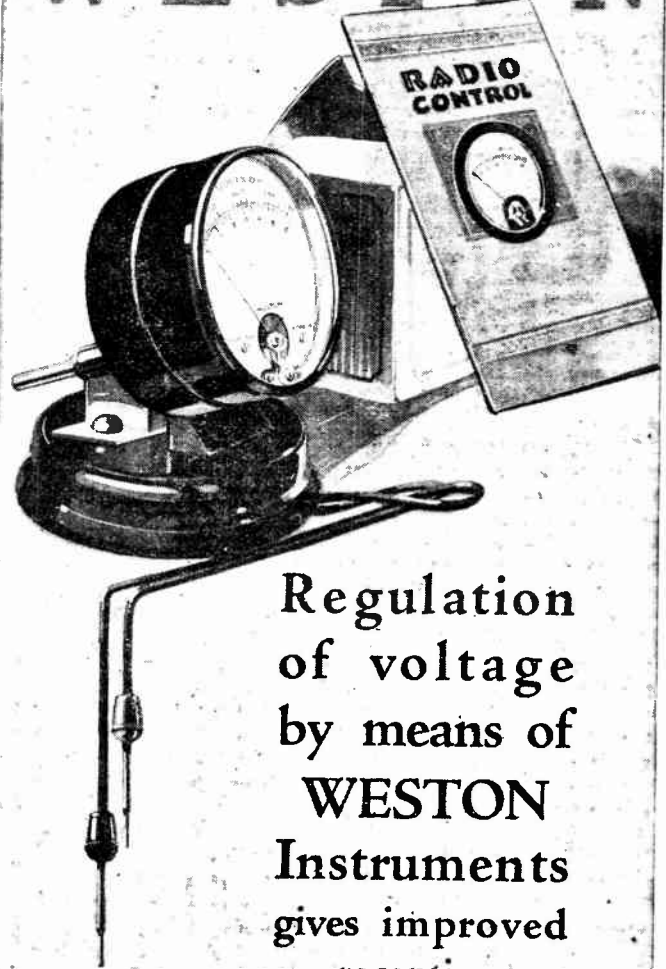

Regulation  
of voltage  
by means of  
**WESTON**  
Instruments  
gives improved  
reception.

To obtain maximum results from your receiver you must be sure that the H.T., L.T. and G.B. voltages are regulated correctly. For an exact measurement of these variable voltages use a Weston Pin-Jack Voltmeter with high-range stand. Only the Weston standard of accuracy and reliability is sufficiently fine to be of any use for such measurements.

The Weston free booklet "Radio Control" explains the necessity for accurate electrical control of your radio receiver and gives much helpful advice. Let us have your name and address.

**MODEL 506 Pin-Jack Voltmeter complete with high range stand and testing cables £2:10:0**

## WESTON

STANDARD THE WORLD OVER

*Pioneers since 1888*

Weston Electrical Instrument Co. Ltd.  
15, Gt. Saffron Hill,  
London, E.C. 1

Mention of "The Wireless World," when writing to advertisers, will ensure prompt attention.

# SPECIALISTS IN ~ LOW FREQUENCY ~ AMPLIFICATION

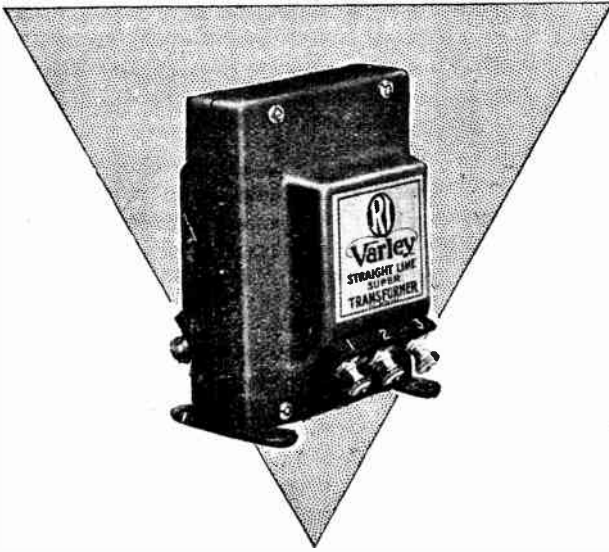

Every problem has at least two different sides. The firm who has studied both sides of a question has obviously a big advantage. This is the fortunate position in which R. I. & Varley, Ltd., find themselves. Prior to the amalgamation which has already done so much for Radio Science—vide all the leading Wireless Journals of the day—R. I. Ltd. had spent years in perfecting L. F. Transformers, and the success achieved by the famous Varley Bi-duplex Wire-wound Anode Resistances had made itself known in almost every corner of the world. The pooling of the resources of these two firms, both from a technical and manufacturing standpoint has resulted in the production of two of the finest Radio components ever known.

## The new Straight Line Super Transformer.

This transformer proved to be one of the biggest achievements at the National Radio Exhibition, Olympia. The National Physical Laboratory curve shows that its amplification is practically constant from 100 to 6,000 cycles, and that exceptionally good results can be obtained even at 20 cycles. The iron content of this transformer is considerably greater than in other models, and, further, the iron is of a special grade considerably higher in permeability, and lower in core losses than was hitherto obtainable; in fact, some idea of what has been achieved can be gauged from the fact that at 50 cycles the inductance is 122 henries, and at 500 cycles 123 henries.

Price 25/-

## The New Bi-duplex Wire-wound Resistance Capacity Couplers.

The National Physical Laboratory Curve of these remarkable components, shown for the first time at the Wireless Exhibition, proved beyond doubt the extraordinary efficiency of resistance capacity coupling when the high resistances are wound on the Bi-duplex system with the special alloy wire used only by this company. **Perfect Straight Line Amplification at all frequencies from 20 to 6,000** is assured, and for the first time it is now possible to get tremendous amplification and volume consistent with almost unbelievable faithfulness of reproduction.

Price Type A 20/-  
Type B 22/6.

*If you are seriously interested in L.F. amplification and in getting the purest results from your loud speaker, our new Booklet "Low Frequency Amplification" (Price 1/-) contains in simple language*

THE MARK OF

Kingsway House, 103, Kingsway,



*the fullest details of Transformer, Resistance Capacity and Choke Coupling. The information is absolutely reliable, and confirmed by independent tests made by the National Physical Laboratory.*

BETTER RADIO

W.C.2. Telephone: Holborn 5303.



RECUPERATING AGENT  
IN THE  
**HELLESEN**  
DRY BATTERIES.

The proof of a Dry Battery is the number of hours of efficient service you get out of it for the money you spend. We are confident of the result if you rely on a Helleesen Dry Battery for your H.T. Supply. Get a smooth uniform H.T. Supply at the minimum cost per hour from a sealed genuine Helleesen H.T. Battery with the quadruple insulation and the No. 7 Recuperating Agent.

60-volt "WIRIN" 12/6

99-volt "WIRUP" 21/-  
(Postage Extra.)

All types, voltages, etc., in Double and Treble capacities for H.T. and L.T. Supply. Ask your dealer for the type to suit your set and get the maximum service, or write us for full particulars.

Obtainable at all Radio, Electrical and General Stores Harrods, Selfridges, etc., or direct from  
A. H. HUNT, Ltd. (Dept.), CROYDON, SURREY.



Mention of "The Wireless World," when writing to advertisers, will ensure prompt attention.

Is your set wanting in strength?  
Are you in half a mind to build  
a bigger one?  
If so, before going to any expense,  
*make this test.*



The W.B. ALL-WOOD  
"JUNIOR" in Polished  
Oak and Mahogany.  
Movement by Messrs.  
S. G. Brown, Ltd.

£4:0:0 complete.

Horn only. £2:0:0

Ask your dealer or write to us for one of our W.B. ALL-WOOD "Junior" Speakers on 7 days' approval.

Apart from superlative quality in appearance and reproduction we guarantee that this loud speaker will add the strength of one valve to your set.

If you do not to your complete satisfaction obtain this decided increase in results, there is no obligation to purchase. Do it through your dealer and you will not even have the liability of 1/3, which would be the cost of posting back the speaker to us.

NOT A LITTLE WOOD-  
NOT HALF WOOD-  
**but ALL WOOD!**

### A Challenge

We believe that this W.B. ALL-WOOD Speaker is the most sensitive in existence, and to show our confidence in the results it gives we are prepared to put it to a publicly-judged test with any other model speaker. Should the popular vote go against us we will buy the other speaker and present it to any Hospital that is wireless equipped.

Not a scrap of metal is used in any W.B. Loud Speaker, and consequently there is no resonance. Did you see the W.B. "Desertune" Speaker at the Exhibition? It came in for praise from all quarters; let us send you details of it.

The

**W.B.**  
**LOUD SPEAKER** 

WALKER BROS. (GUILDFORD) LTD.  
BRAMLEY GUILDFORD

Telephone: Bramley 117.

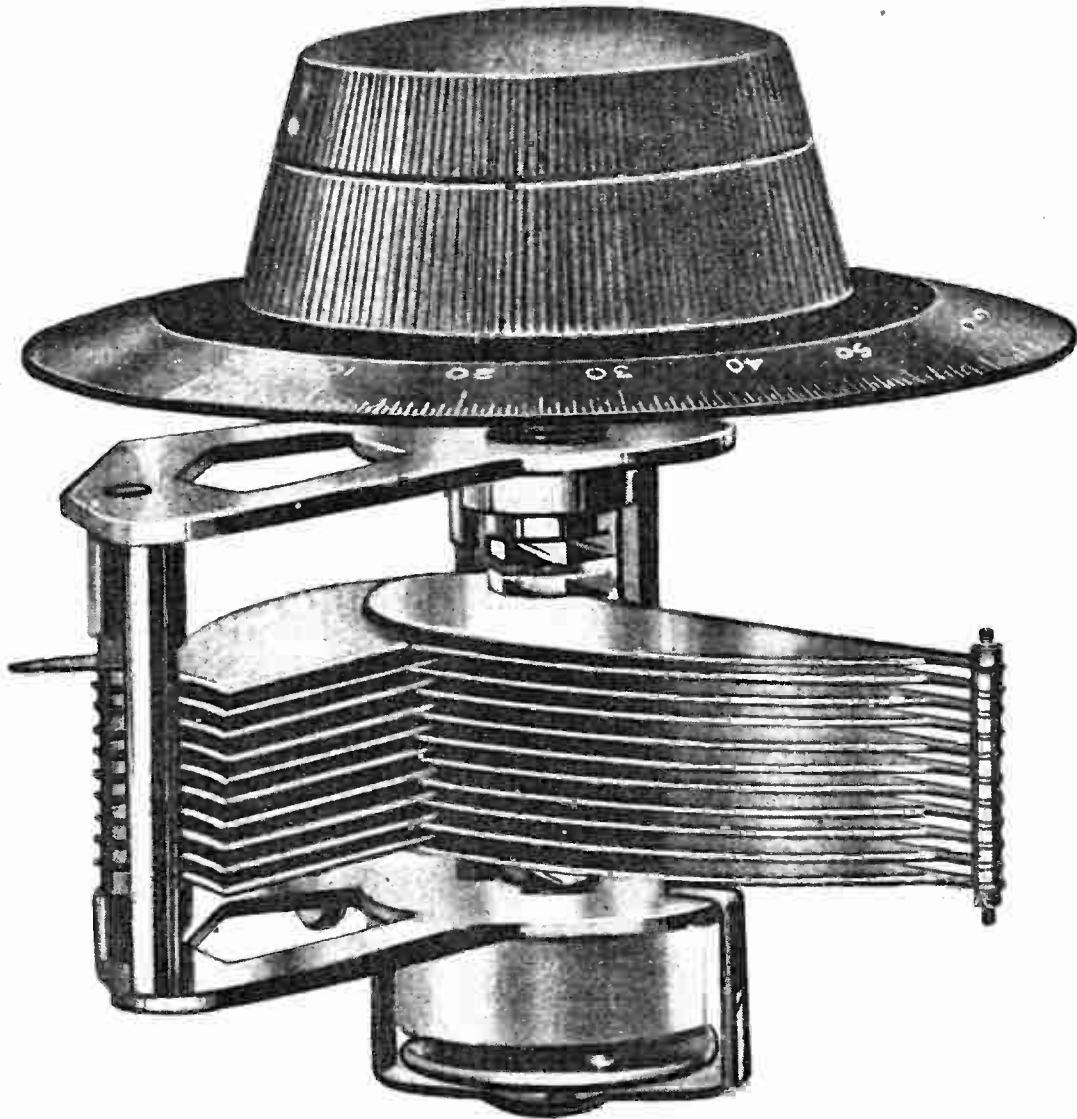

## THANK YOU!

To the many hundreds of people who at Olympia unanimously declared that our K.C. condenser was the finest variable that wireless has ever seen we wish to tender our thanks.

If you were unable to get to the London Exhibition, this condenser and all our many new products will be on view at the "Manchester Evening Chronicle" Exhibition, Stands 69 and 70.

In the meanwhile may we forward you a copy of our booklet fully describing the K.C. and the wonderful Toroid "fieldless" H.F. transformers post free 3d.?

**MAX CAPACITY 0.0005 mfd.**

**PRICE 12/- AS SHOWN**

**SLOW MOTION RATIO 200 to 1.**



*Advt. of The Dubilier Condenser Co. (1925) Ltd., Ducon Works, North Acton, W.3.*

T.C. 51

# CAV

## THE WORLD'S BEST BATTERIES for RADIO



**SALES AND SERVICE DEPOTS**  
 Belfast, Birmingham, Bristol, Coventry, Dublin,  
 Glasgow, Leeds, Manchester and Newcastle.  
 Battery Service Agents in all important  
 centres throughout the country.

**CAVandervell & Co. Ltd.**  
 ACTON, LONDON, W 3

Telephone: Chiswick 3801 (Plc. Branch Exchange)  
 Telegrams: "Anteria, Act., London."

**THIS IS A TYPE FOR EVERY RADIO USER**

<p><b>L.T.B. 2000</b> 2000 Mf. capacity 2000                  The L.T.B. is a unique design. Every cell is made of copper. Channels in 20, 10 and 50 amp. Fully charged 25.0 x 0.0</p>	<p><b>ACTON CELLULOSE.</b>                  Supplied in all capacities, the range of low tension batteries is defined in company price, which the quality is in every way representative of our 30 years experience in battery manufacture. 2 cell 30 amp actual. 13.0</p>	<p><b>A.G.M. PLATE PLATE.</b>                  The 20 amp 2 cell plate off is ideal for 500 set taking more than 1 amp. The charge can be spread over months without danger of sulphation. Supplied 4/1. 1.0</p>
<p><b>R.T.B. 2000</b> 2000 Mf. capacity 2000                  At large capacity battery of novel construction design. Suitable for large touring sets, public address systems and small transmitters. 25.0 x 11.0</p>	<p><b>ACTON GLASS.</b>                  The "Acton Glass" low tension range provides an alternative to the cellulose and battery and a choice suitable for tropical climates. All capacities supplied. 2-cell 40 amp actual. 16.0</p>	<p><b>H.V.G.B. 2000</b> 2000 Mf. capacity 2000                  The dead High Tension supply for the average Broadcast Receiver. Any voltage obtained by connecting a suitable number of cells. At 10 amp-tapping points provided. Supplied 4/1. 1.0</p>

# SIX-SIXTY Cone Speaker Paper



**Used exclusively throughout America**

The Northern Electric in Canada.  
 The Western Electric Ferrand.  
 Fada O'Neil Manufacturing Co.  
 Canon, Miller & Co.  
 All these well-known American Loud Speakers incorporate Six-Sixty Cone Speaker Paper.

Six-Sixty Cone Speaker Paper is the material that everyone has been waiting for. Used by the leading Cone Loud-Speaker Manufacturers in America, and now marketed in this Country and on the Continent by the makers of the famous Six-Sixty Valves, Six-Sixty Cone Speaker Paper ensures, by the unique processes in its manufacture, tonal qualities *unobtainable with any other material.* If you are making your own loud speaker ask your dealer for Six-Sixty Cone Speaker Paper and be sure of first class results. If you have any difficulty in obtaining it from your dealer write direct to us enclosing your dealer's name and address. Sold in attractive envelopes with full directions for cutting and mounting.

Saal of Chicago.  
 Vitalatone.  
 Brandes.  
 Pathe.  
 Radio Foundation.  
 Grabe.  
 All incorporate Six-Sixty Cone Speaker Paper.

**2/6** (approx. diam. 12")      3/6 size also supplied (approx. diam. 19")

**The Electron Co., Ltd. (Dept. W.W.), 122-124, Charing Cross Rd., London, W.C.2.**

Mention of "The Wireless World," when writing to advertisers, will ensure prompt attention.

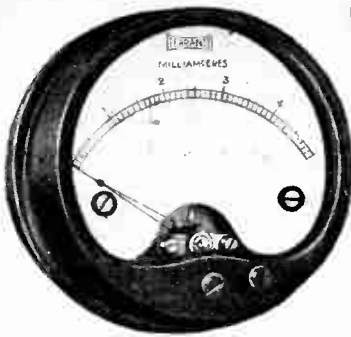

PROJECTING PATTERN,  
Type R1Pa.

# FERRANTI RADIO METERS

SINGLE RANGE INSTRUMENTS  
FOR PANEL MOUNTING.

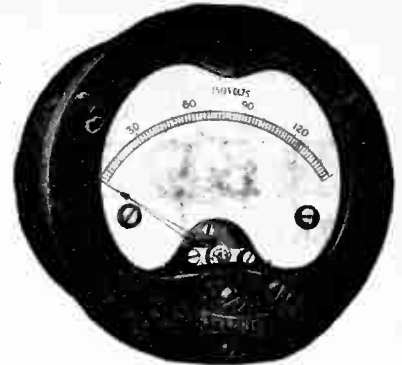

FLUSH PATTERN,  
Type R1Fa.

No.	MILLI-AMMETERS.	Price.	No.	VOLTMETERS. 200 ohms per volt.	Price.	No.	VOLTMETERS. 1,000 ohms per volt.	Price.
1	0-5	£ s. d. 1 10 0	9	0-7.5	£ s. d. 1 10 0 1 15 0	13	150	£ s. d. 2 2 6 2 7 6
2	0-15		10	0-25		14	250	
3	0-50		11	0-150				
4	0-150		12	0-250				
5	.75							
6	0-1.5							
7	0-10							
8	0-20							

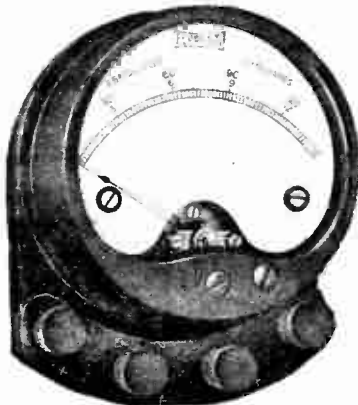

PORTABLE PATTERN,  
Type PR3a.

## THREE RANGE INSTRUMENTS

Front-connected { Portable Pattern, without switch.  
                          { Portable Pattern, with switch.  
Back-connected—Flush Pattern, with switch.

Every Instrument is fitted with a fuse, and a spare fuse is included in the price of each instrument. Additional spare fuses 6d. each.

For Non-Standard Ranges the price will be increased by 5/- per non-standard range.

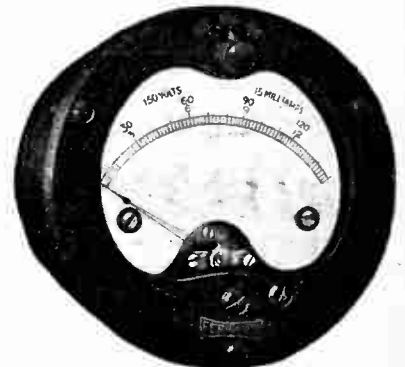

FLUSH PATTERN,  
Type R3Fa.

No.	COMBINED INSTRUMENTS. Ranges.	Portable Type, PR3a. 200 ohms per volt.		No.	Flush Type, R3Fa. 200 ohms per volt. With switch.	No.	Portable Type, PR3a. 1,000 ohms per volt. Without switch.
		Without switch.	With switch.				
15	7.5, 15 and 30 milliamps.	£ s. d. 1 17 6	—	—	£ s. d. —	—	£ s. d. —
16	7.5, 30 and 150 volts	1 17 6	—	—	—	25	2 10 0
17	10, 50 and 250 volts	2 2 6	—	—	—	26	2 15 0
18	5 milliamps, 15 volts and 150 volts	1 17 6	2 7 6	22	2 7 6	—	—
19	15 milliamps, 7.5 volts and 150 volts	—	2 7 6	23	2 7 6	—	—
20	30 milliamps, 7.5 volts and 150 volts	—	2 12 6	24	2 12 6	—	—
21	100 milliamps, 10 volts and 250 volts	—	—	—	—	—	—

**FERRANTI ELECTRIC  
LIMITED,**  
TORONTO, ONTARIO, CANADA.

**FERRANTI LTD.,**  
HOLLINWOOD, LANCASHIRE.

**FERRANTI  
INCORPORATED,**  
BUSH TERMINAL BUILDING,  
N.Y. CITY, U.S.A.

# 100% Anti-microphonic!

THE  
**REDFERN**  
Pneumatic Action  
VALVE HOLDER

Patent No. 269,388

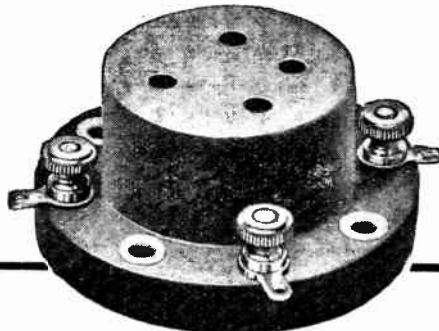

Recognise them by the  
well-known yellow carton

TRY THESE "NATURAL FREQUENCY"  
TESTS FOR YOURSELF.

Place your foot on the loud pedal of your piano and sound one note. What happens? It is a well-known phenomenon that the string of the piano having the same frequency as the note you sound picks up the vibration and starts emitting the same note, as if this note had been played in the ordinary way.

Now take an ordinary Valve Holder, with metal springs, and "twang" one of these springs with your finger. You will get a note. It is obvious that the ordinary Valve Holder which relies on springs has at least one, if not more, natural frequencies which will pick up and pass to the valve the vibrations caused by the corresponding note on the Loud Speaker. This is a far more potent cause of microphonic noise than the vibration caused by extraneous influences.

The Redfern Pneumatic Valve Holder positively absorbs vibrations caused by sound waves from the Loud Speaker, and effectively prevents them being passed to the valve filament.

The soft rubber holder in which the Valve sockets are mounted does more than absorb the cause of microphonic noises. It assures perfect contact between Valve Socket and Valve Leg.

Sold by all reputable dealers

PRICE **2/6** EACH

Send for the Book of Ebonart  
**REDFERN'S RUBBER WORKS, LTD.,**  
HYDE, CHESHIRE

*You must have a  
precision instrument*

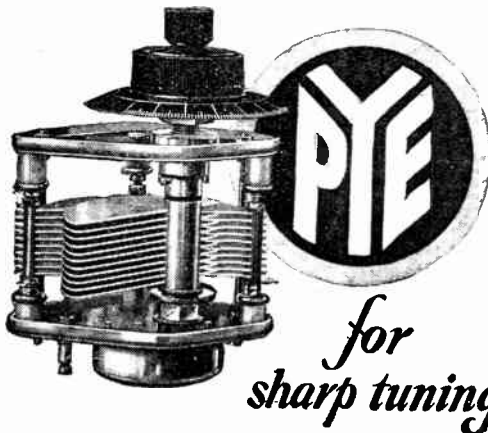

Modern radio circuits call for critical tuning—critical tuning demands precision condensers—precision condensers means Pye condensers for accuracy and reliability. Pye precision condensers are scientific instruments made one at a time with great care. You need them to get the best from your set.

PRICES—'0001, '0002, '0003 Mid. 17/6 each.  
'0005 Mid. 18/6 "  
'00075 Mid. 22/6 "



**W. G. PYE & Co.,**  
"Granta Works," Montague Road,  
CAMBRIDGE.

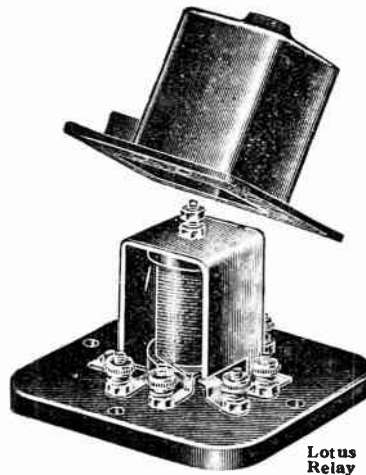

Lotus  
Relay

*Simultaneous  
Reception in  
every room!*

You can have simul-  
taneous reception in  
every room in your  
home without inter-  
ference by installing  
the Lotus Remote  
Control.

Complete outfit  
for wiring **30/-**  
two rooms  
Each additional  
room **7/6**

THE  
**LOTUS**  
REMOTE CONTROL

**FREE!**

Write for **FREE BLUE PRINTS** and instruc-  
tions how to wire two rooms in half an hour  
to Dept. W.W.4, Garnett Whiteley & Co.,  
Ltd., Broadgreen Road, Liverpool.

Mention of "The Wireless World," when writing to advertisers, will ensure prompt attention.



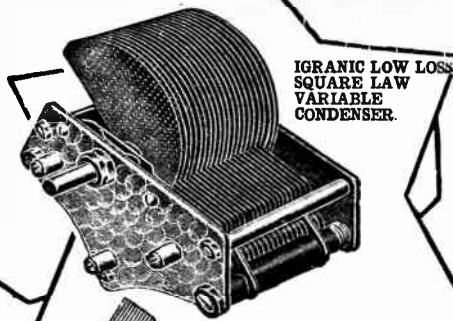

IGRANIC LOW LOSS SQUARE LAW VARIABLE CONDENSER.

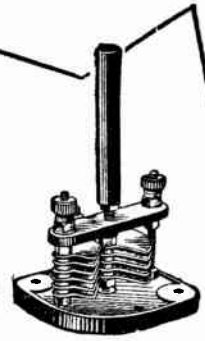

IGRANIC MICRO CONDENSER. Baseboard Type.



IGRANIC VERNIER BALANCING CONDENSER.

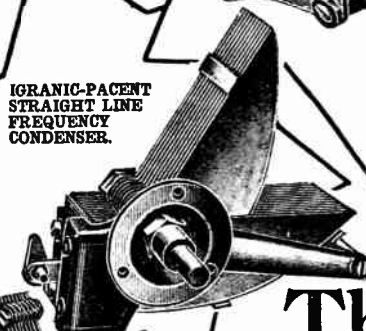

IGRANIC-PACENT STRAIGHT LINE FREQUENCY CONDENSER.

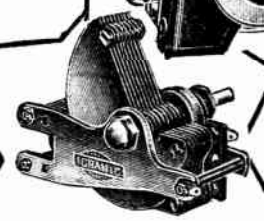

IGRANIC "LOKVANE" SQUARE LAW VARIABLE CONDENSER.



IGRANIC FIXED CONDENSER.



Write for the new Igranic Publication U. 224.

# The "stars" of the Condenser world

Here they are—the products of the Igranic Electric Company—a range to meet every radio requirement.

For tuning purposes there are "square law" or "straight line frequency" models whichever you prefer. The Igranic Low Loss Square Law Variable Condenser has received frequent editorial commendation and is a laboratory instrument at a reasonable price. The "Lokvane" is an entirely new Igranic Low Loss Square Law Variable Condenser having several novel features. The True Straight Line Frequency Variable Condenser is one of the famous Igranic - Pacent Radio Essentials which are standard equipment in 40 wireless receiver factories.

For dual control there is the Low Loss Dual model which possesses the

electrical features of the standard Igranic Square Law Condenser.

For use in connection with ordinary variable condensers there is the Igranic Micro Condenser which adds a vernier feature for extremely fine tuning.

Then, also, there is the Vernier Balancing Condenser for balancing out slight differences in oscillatory circuits which are tuned simultaneously by means of a dual variable condenser.

To complete the range there is the Igranic Fixed Condenser—the small component with huge sales and the Low Loss Transmitting Condenser.

All are built with that precision which characterises Igranic Radio Devices.

Ask your dealer to show them to you.

149, Queen Victoria Street, London.  
Works: Bedford.



BRANCHES:  
Birmingham, Bristol,  
Cardiff, Glasgow,  
Leeds, Manchester,  
Newcastle.



# KINGS OF THE AIR

**A**FTER four years Cossor still stands pre-eminent among valves. The famous Cossor Kalenised filament—the first ever to operate without visible glow—is still acknowledged to be without equal for strength, long life and economy.

Even if you know nothing about Radio you'll sense Cossor superiority the moment you start using Cossor Valves. Such wonderful tone—such majestic volume—such freedom from irritating background noises that every Cossor user quickly becomes a staunch enthusiast.

Remember this when you buy your next valves—demand Cossor Valves and be satisfied that you'll get valves which will serve you well, which will cost little to run and which will give you the most perfect broadcast music. A full range of types available from 10/6 each.

# COSSOR

*the melody maker*



Adv. of A. C. Cossor, Ltd., Highbury Grove, N.5

Mention of "The Wireless World," when writing to advertisers, will ensure prompt attention.

9659



A12

# The Wireless World

AND  
RADIO REVIEW  
(15<sup>th</sup> Year of Publication)

No. 424.

WEDNESDAY, OCTOBER 12TH, 1927.

VOL. XXI. No. 15.

Editor : HUGH S. POCOCK.

Assistant Editor : F. H. HAYNES.

Editorial Offices : 139-40, FLEET STREET, LONDON, E.C.4

Editorial Telephone : City 4011 (3 lines).

Advertising and Publishing Offices : DORSET HOUSE, TUDOR STREET, LONDON, E.C.4.

Telephone : City 2847 (13 lines).

Telegrams : "Ethaworld, Fleet, London."

COVENTRY : Hertford Street.

BIRMINGHAM : Guildhall Buildings, Navigation Street.

MANCHESTER : 199, Deansgate.

Telegrams : "Cyclist Coventry."  
Telephone : 5210 Coventry.

Telegrams : "Autopress, Birmingham."  
Telephone : 2970 and 2971 Midland.

Telegrams : "Illife, Manchester."  
Telephone : 8970 and 8971 City.

Subscription Rates : Home, 17s. 4d. ; Canada, 17s. 4d. ; other countries abroad, 19s. 6d. per annum.

*As many of the circuits and apparatus described in these pages are covered by patents, readers are advised, before making use of them, to satisfy themselves that they would not be infringing patents.*

## PROBLEMS OF MORSE INTERFERENCE.



INTERFERENCE by Morse with broadcast transmissions continues to present one of the most serious problems for solution by those responsible for controlling radio communication and broadcasting throughout the world. It provides one of the subjects under discussion at the International

Radio Conference at Washington. In the past many suggestions have been put forward with a view to bringing about the replacement of spark transmitters by C.W. sets, particularly for ship communication either at the coast stations or the ship stations themselves. Some time back we put forward the suggestion that a part of the revenue derived from broadcasting licences might be utilised to help compensate owners of ships fitted with spark sets and so enable them to replace the equipment with C.W. apparatus; but recently we have been given to understand that a very serious objection has been found in the way of replacing spark ship equipment with C.W. apparatus. The C.W. transmissions are, of course, much more sharply tuned, and consequently produce little interference, and in general they do not interfere with broadcast reception, for the reason that a broadcast receiver must be in a state of oscillation in order to receive a C.W. transmission. Spark transmission, however, will come through whether the receiver is oscillating or not, and, being comparatively flatly tuned, it occupies a wide frequency band. It is argued, therefore, that if ships are fitted exclusively with C.W. apparatus, SOS distress signals will not be nearly so easily picked up as when they are transmitted by spark, and it appears that this fact provides something of a deadlock, preventing any attempt at progress in the direction of reduction of spark interference. It is very essential that the distress signal should be distinctive and easy to pick up, and quite obviously, so long as this situation continues, those who are responsible for safety of life at sea cannot be expected to give way to any recommendations for

the improvement of broadcast reception which may interfere with the safety guarantees which are their special trust; but, after giving due consideration to the problem, we are of the opinion that there does exist a solution which, whilst not hindering the replacement of obsolete spark apparatus by C.W. equipment, will at the same time provide at least as satisfactory a means of communicating a distress signal as is at present in operation. The proposal is that there should be combined with the C.W. transmitter means whereby the C.W. carrier wave can be modulated by a series of suitably chosen musical notes of a frequency to be agreed internationally. We are, most of us, familiar with the distinctive notes which are sent out by certain of the German broadcasting stations, and corresponding to our tuning note. A series of musical notes would, in our opinion, be far more distinctive as an alarm signal than the Morse SOS transmission, and in the case of ships where fully qualified operators are not available for continual watch the risk of missing a distress call would be very small indeed because the most unskilled of operators in carrying out his search over the shipping band of wavelengths could not fail to recognise a series of musical notes transmitted regularly.

One other point in favour of early consideration being given to the suggestion is that automatic SOS receivers have been developed and are now being supplied as part of the wireless receiver equipment of ships. If any change is to be made it should come about early, before the distribution of these automatic receivers is extended, and we believe that an automatic receiver designed to respond to a series of notes would be very much easier to develop and simpler in operation than one which has to respond to the SOS signal.

If anything is going to be done, now is the time for action to be taken, for the Washington Conference is probably the only opportunity that there will be for some time to come for an international consideration of a proposal of this nature.

# TUNED-ANODE SINGLE-VALVE RECEIVER

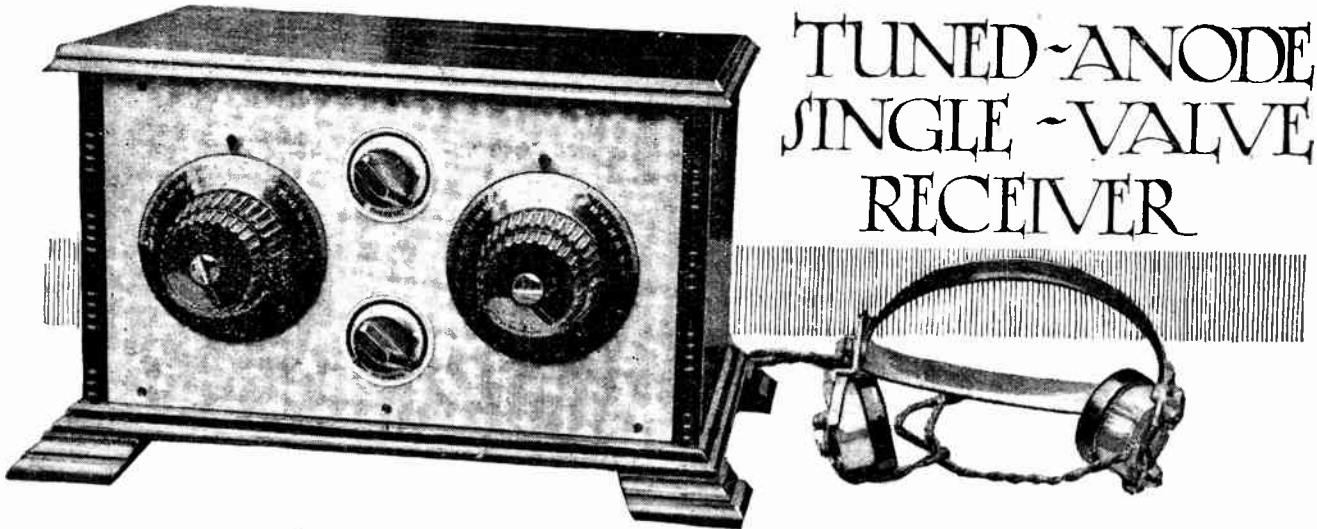

An Inexpensive Receiver of High Efficiency.

By N. P. VINCER-MINTER.

IN view of the fact that the establishment of the proposed regional scheme will to a large extent spell the doom of the crystal user, it is not inopportune to consider in what manner the crystal user can most easily and inexpensively make the inevitable change from crystal to valve. It is perfectly easy to advise the crystal user to make this change, but those in high places at the transmitting end, who are so fond of croaking out this advice from the depths of their comfortable arm-chairs, usually fail utterly to appreciate the fact that every wireless user has not the same unlimited financial resources at their disposal as themselves, and that very many crystal users would have long since made this change had they been able to do so. Now the difference in cost between a crystal receiver and a typical valve set, such, for instance, as the "Everyman-Four," capable of giving good loud-speaker reproduction from a large

number of stations, is so great that the cost of constructing it is prohibitive to many existing crystal users. Of course, it must be admitted that there are a large number of crystal users who can well afford a very expensive receiver, but surely the very fact that they can afford a loud-speaker receiver and have so far failed to obtain one indicates that they have a preference for simple headphone reception from the local station. It is apparent, therefore, that both these classes of crystal user require the same type of valve receiver, but for different reasons. The re-

quirements of those of limited means is, of course, a valve receiver which will enable them to take advantage of the new regional scheme at comparatively small expense, whilst the other class we have discussed require an instrument which will give them the same clear headphone reception with the same simplicity and freedom from trouble as did their old crystal receiver. A good one-valve receiver will fill the needs of both classes in an admirable manner.

### Selective Headphone Reception.

To receive both local and distant stations on the telephones we require only a well-designed single-valve receiver with a really smooth and easily operated control of reaction. We can use an inexpensive general-purpose valve of the two-volt type, thus bringing down the initial cost of the L.T. battery to 4s. 6d. Thirty volts is

ample for the high-tension battery, and since the plate current will not be large, one of the cheap small cell types of H.T. battery may be purchased. Our 4s. 6d. accumulator should operate our receiver three or four hours every evening for a month on one charge, and since even the most hardened garage proprietor will not venture to ask more than sixpence for recharging this small cell, our L.T. running costs work out at less than a farthing per day, although our H.T. bill may be slightly more than this. We can use the same telephones which we had for our crystal receiver,

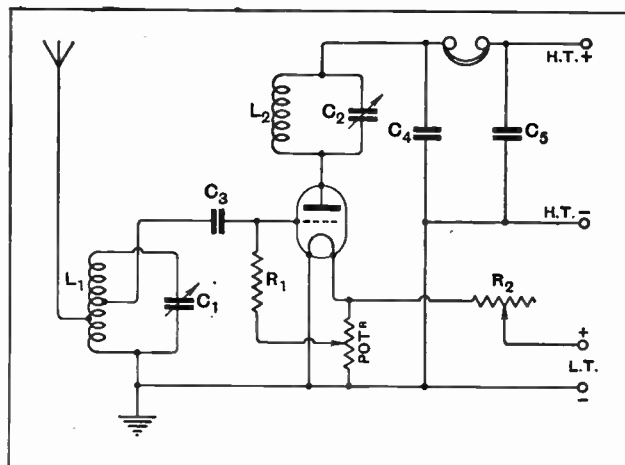

Fig. 1.—The theoretical circuit.  $C_1, C_2 = 0.0005$  mfd.;  $C_3 = 0.0003$  mfd.;  $C_4 = 0.0005$  mfd.;  $C_5 = 1$  mfd.;  $R_1 = 1$  megohm;  $R_2 = 6$  ohms.

**Tuned-anode Single-valve Receiver.—**

and can very cheaply construct our own tuning coils. No expensive L.F. transformers are required, whilst really good variable condensers, valve holders, and other small components which we shall require can be obtained quite cheaply.

As for results, of course it depends on the soundness or otherwise of the receiver design, upon the workmanship put into the instrument, and lastly upon the skill of the operator. The first-named requirement the writer hopes to supply forthwith, the second need cause no alarm as

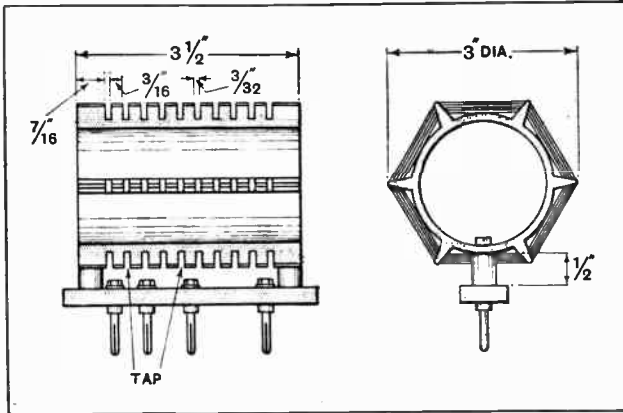

Fig. 2.—Details of the long-wave coil former.

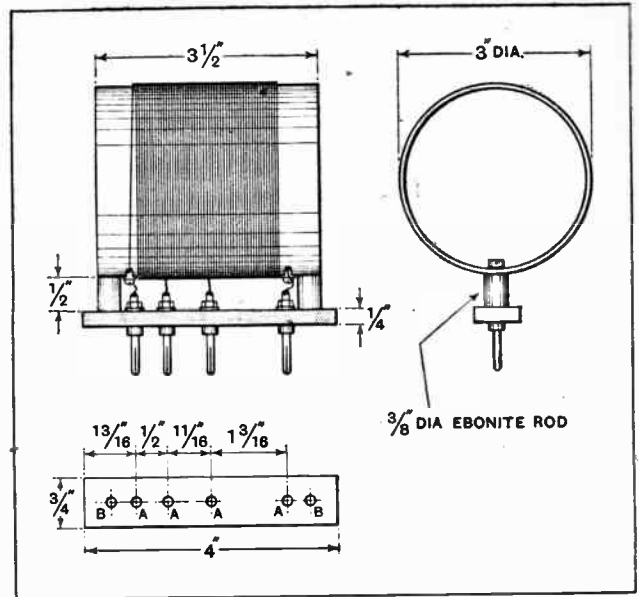

Fig. 3.—Details of the coil for the lower B.B.C. wavelengths. A = 5/32in. dia.; B, drilled and tapped No. 4 B.A.

the construction of a one-valve receiver is so simple that anybody capable of hanging a picture straight should be able to tackle it, whilst operating skill is quickly acquired by a very small amount of practice.

We will proceed straightway to examine the circuit diagram, and it will at once be seen that the method of reaction employed and the method of connecting the valve to the tuned-circuit appears rather unusual.

The simplest type of reaction arrangement is that in which a coil is inserted in series with the external plate circuit of the detector valve, this coil being placed in proximity to the grid tuning coil, and its position relative to the grid coil made variable by mounting it and the grid coil in an ordinary moving coil holder. The H.F. energy present in the plate circuit passing through the reaction coil sets up a fluctuating magnetic field surrounding the coil, which by interlinking with the grid coil sets up corresponding H.F. oscillations in the grid coil, and so the original

H.F. oscillations set up in the grid coil by the incoming signals (which appear in amplified form in the plate circuit), are to some extent transferred back to the grid coil and again amplified, and if the transference of energy from plate to grid coil is sufficient entirely to overcome the resistance of the grid circuit, the valve will oscillate. It will be seen, therefore, that whether or no the valve may be made to oscillate depends on the grid coil resistance, and in the case of the old-fashioned but still greatly used direct-coupled aerial it will be obvious that the

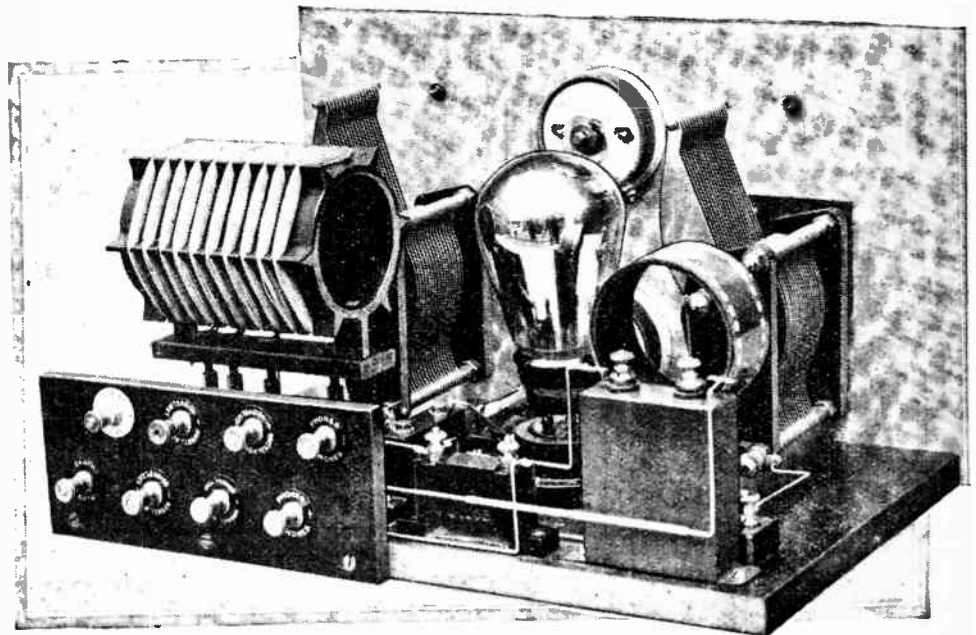

Rear view of the receiver showing the long-wave coil in position.

**Tuned-anode Single-valve Receiver.—**

resistance of the aerial must be overcome before the valve will oscillate. When the effect of the grid circuit resistance and the aerial resistance is reduced to zero, the valve will oscillate. It will be clear that the amount of energy actually fed back can be varied either by moving the reaction coil closer to the grid coil, and so obtaining a greater interlinkage of magnetic lines of force, or by increasing the size of the reaction coil and so actually increasing the number of lines of force surrounding the reaction coil. In each case, however, the amount of H.F. current actually passing through the coil is unaltered.

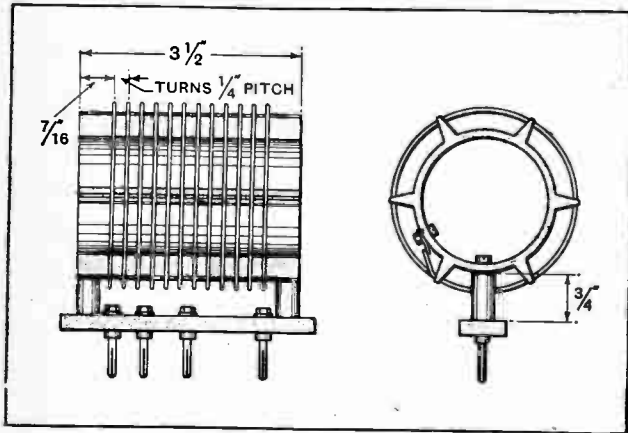

Fig. 5.—Details of the short-wave experimental coil. This is wound on a long-wave former with 10 turns of No. 18 tinned copper wire; aerial tapping at 2nd turn and grid tapping at 5th turn from low potential end.

The only difference between the moving coil method of controlling reaction and the Reinartz and similar methods, where a condenser is used to control reaction, is that in the latter method we keep the relative positions of the two coils constant, and, instead, vary the amount of H.F. current passing through the reaction coil, and thus, of course, vary the number of magnetic lines of force surrounding the plate coil. In both systems the method of transferring back the energy is by means of magnetic interlinkage between two coils. The Reinartz method, in which a condenser is used to control reaction is, therefore, just as much magnetic reaction as the moving coil method, and is not capacity reaction as many people erroneously think. It is merely capacitive control of magnetic reaction.

All experimenters know that if we connect a tuned circuit consisting of coil and

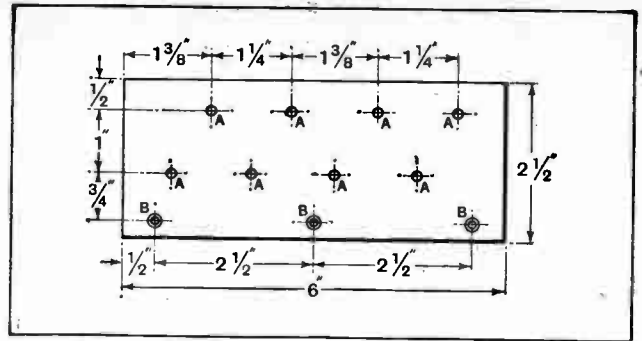

Fig. 4.—Details of the terminal panel. A = 5/32in. dia.; B = 1/8in., countersunk for No. 4 wood screws.

tuning condenser across the grid-filament path of a three-electrode valve, and a similar circuit across the plate-filament circuit, the result will be oscillation if there is no undue damping present to prevent it. Now this oscillation is not brought about by magnetic coupling between the plate and the grid coil, for it will still persist even if the two coils are screened from each other.

**Principle of Reaction Control.**

The reason for the valve oscillating is this. When the plate circuit is brought into resonance with the grid circuit, the effect is that the amplified H.F. energy on the plate (due initially, of course, to incoming signals setting up oscillations in the grid circuit) finds, as it were, that its way of escape round the plate circuit and H.T. battery to the valve filament is barred by the great opposition or impedance set up by the tuned plate circuit, for, as is well known, a tuned circuit offers a very high impedance to the passage of H.F. energy having the same frequency to which it is tuned. Baulked and chagrined, as it were, at this unfriendly opposition on the part of the tuned

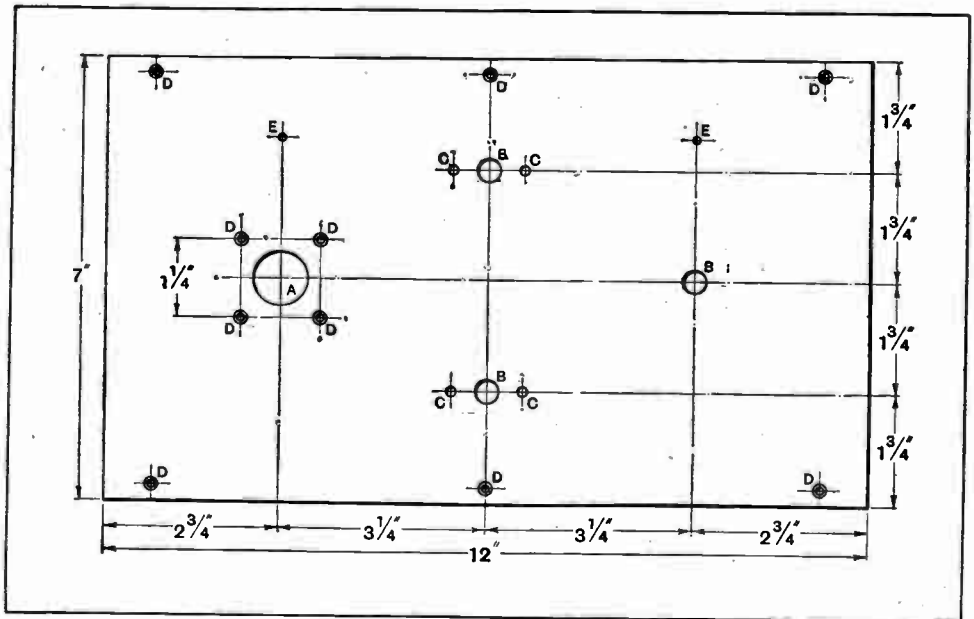

Fig. 6.—Dimensional details of the front panel. A = 7/8in. dia.; B = 3/8in. dia.; C = 5/32in. dia.; D = 1/8in. dia., countersunk for No. 4 wood screws and No. 6 B.A.; E = 1/8in. dia.

**Tuned-anode Single-valve Receiver.—**

plate circuit, a large part of the H.F. energy hops across the small condenser formed by the plate and grid of the valve, and has its revenge by causing the valve to oscillate, which, as even crystal users know, causes the valve under certain circumstances to give forth the familiar howl of anguish. Now in this case, the energy is fed back from plate circuit to grid circuit electrostatically through the valve capacity instead of electromagnetically, due to the coupling between two coils. This is true capacity reaction.

Now, as is well known, one of the most serious disadvantages of those methods of reaction in which a reaction coil is coupled to the grid coil, is that any alteration in the degree of reaction coupling greatly alters the tuning of the grid circuit, necessitating retuning every time the degree of reaction coupling is changed. The Reinartz and allied systems of capacity control of reaction in which the position of the two coils is fixed does much to overcome this evil, and at the same time gives a much smoother control of reaction, but still leaves much to be desired. The capacitative method of reaction which we have just been discussing, owing to the fact of there being no coil coupled

to the grid coil goes much further, as will have been anticipated by most readers, and although the system is by no means faultless, it is possible to vary the reaction control over wide limits without upsetting the tuning of the grid circuit. In addition to this, the method gives a much smoother control over reaction itself.

It is now high time that we pointed out the reason why this apparently excellent reaction system did not spring into popular favour when broadcasting first began in 1922. The reason is very simple. It just wouldn't work. Very many people tried it, and obtained little or no reaction effect whatever, and consequently gave it up in disgust. Now as is well known, practically all sets in the early days were very inefficient from all points of view, and the losses in the tuned grid circuit were high. First we had the almost universal direct-coupled aerial circuit with its high damping effect, and then, in addition, we had thoroughly bad tuning condensers, ebonite panels, and valve holders, etc., and the resultant damping was so high that quite a big reaction coil had to be used to get the set to oscillate; but still in most cases by the use of a big enough reaction coil the set could be made to oscillate. With the tuned plate system, however, the energy

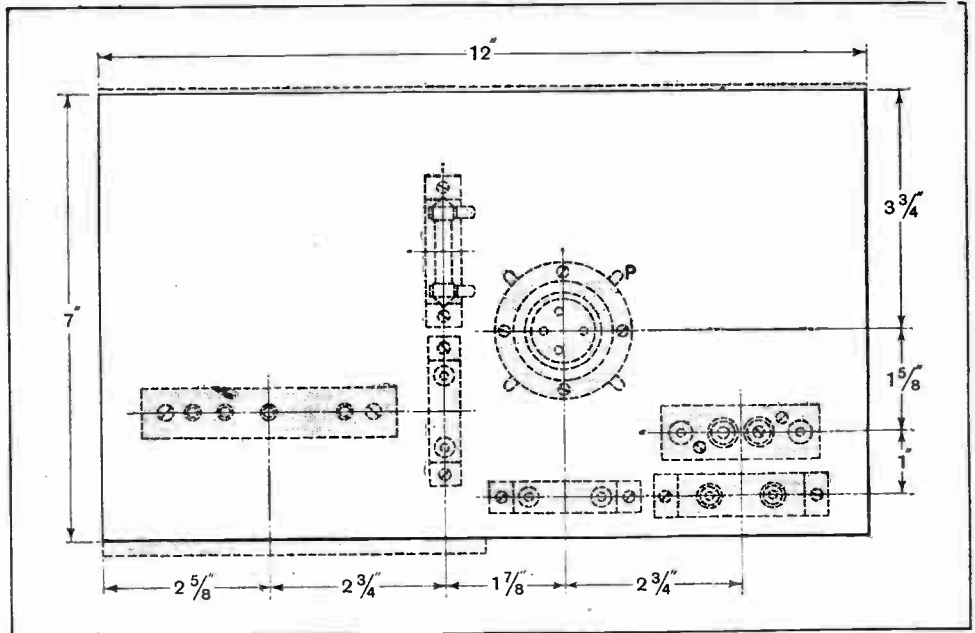
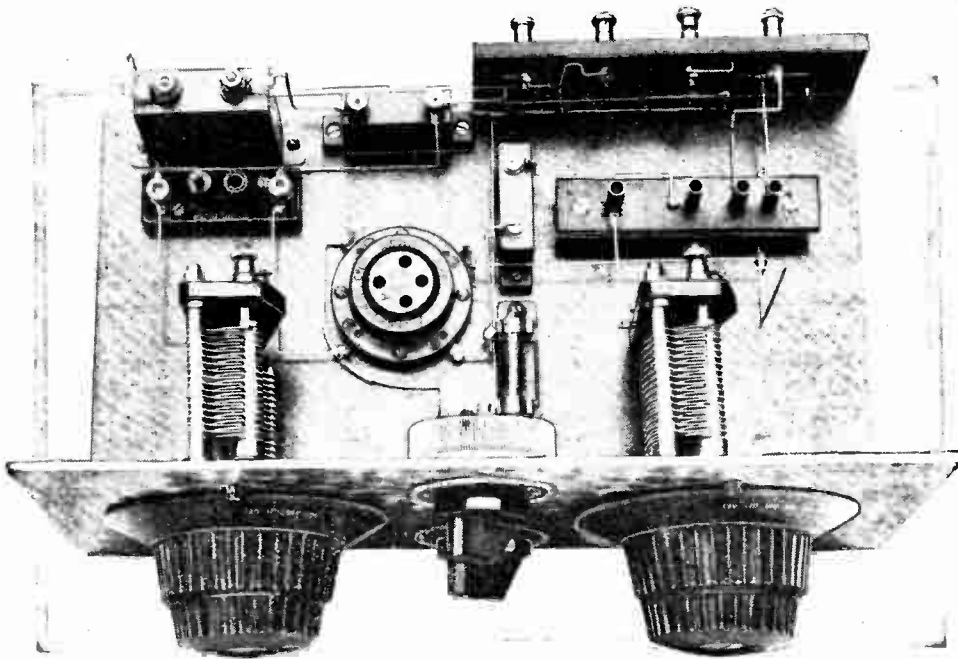

Fig. 7.—Dimensioned baseboard layout.



Plan view showing baseboard layout.

**Tuned-anode Single-valve Receiver.—**

feed back was nowhere near sufficiently great to overcome all this damping, and since there was no reaction coil, we could not increase its size. The system simply would not work with the inefficient methods of aerial coupling and the bad components of those days, however, and so came to be regarded as useless. In reality, as we now see, such a refusal to work is in reality a blessing in disguise, as it forces us to employ an efficient method of aerial coupling and to use good components. When this has been done no system could work better or more smoothly. It increases our selectivity not only in itself, but also by reason of the fact of it forcing us to use a lightly coupled aerial circuit and to use coils and other components of reasonably low losses.

**Tuning Coils.**

With regard to the construction of the tuning coils these are home-made and are rendered interchangeable by the use of plug and socket connections. They are similar in construction to the grid coils employed in *The Wireless World* "Regional Receiver, and since it was not found possible to improve upon them the design was adopted *in toto*, due acknowledgments being made to the designer of that receiver. Those who require further constructional details

of the formers should refer back to that article. The coil for the normal broadcasting wavelength band of 200 to 600 metres consists of a total of 72 turns of No. 24 D.C.C. wound on a 3in. diameter paxolin former having a length of 3½ inches. The method of attaching the four plugs to the paxolin former by means of two small ½in. lengths of ebonite tubing and ebonite strip, originally described in full and illustrated by sketches in the article dealing with the "Regional Receiver," are reproduced in the sketches accompanying this article with the necessary modifications for fitting an additional plug and socket. A tapping is made at the 12th turn from the low potential end of the coil for connection to the aerial

plug and at the 36th turn for connecting to the plug which will engage with the socket connecting to the grid condenser.

The long-wave coil is wound in sections on a ribbed ebonite former having the same overall dimensions as the paxolin former. Ten slots, having the dimensions indicated in Fig. 2, are cut in the ebonite ribs, and into each slot is wound 30 turns of No. 30 D.C.C., the winding being, of course, continuous. The aerial tapping is taken at the junction between the second and third slot connecting from the low potential end, the grid connection tapping being made between the third and sixth slots.

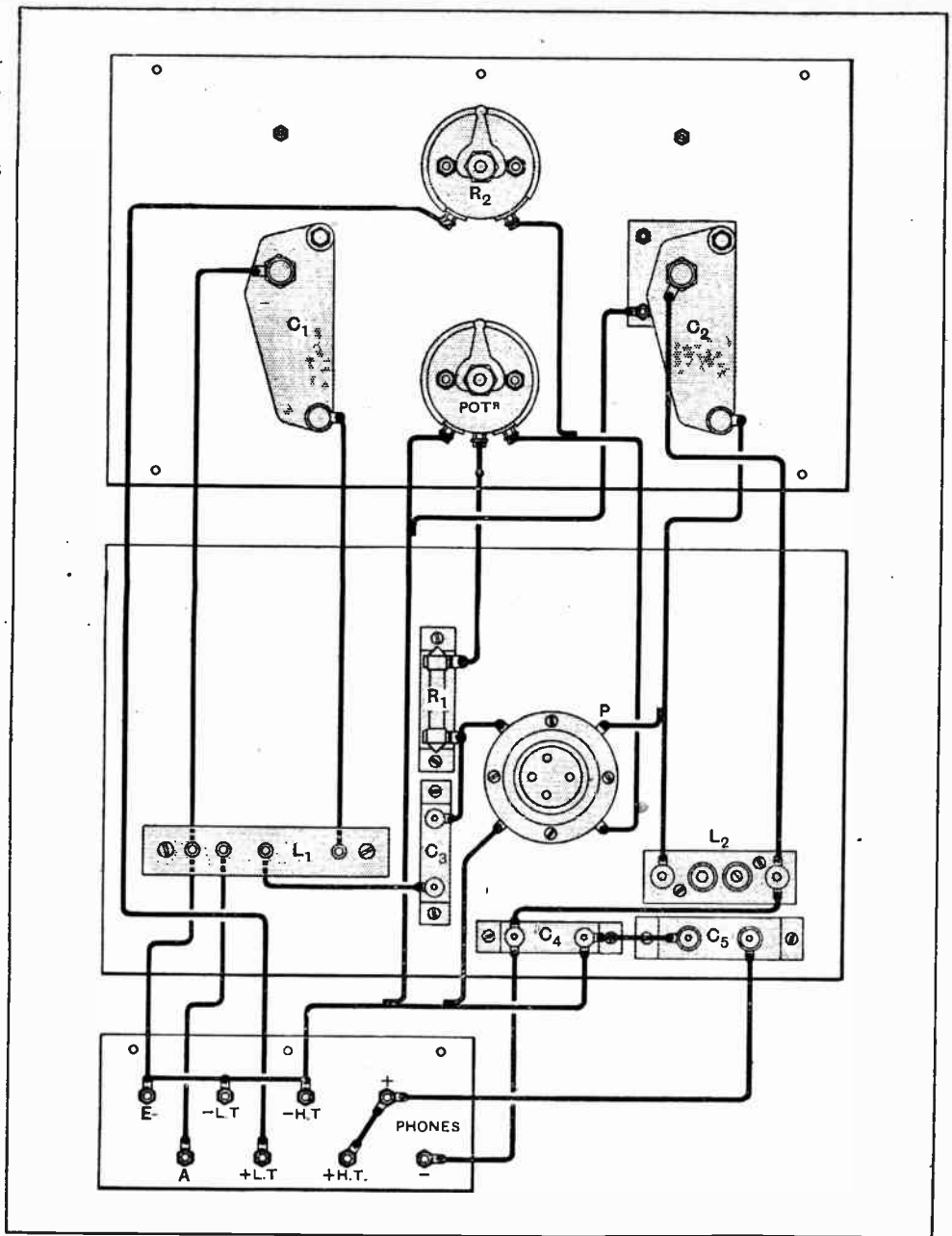

Fig. 8.—The practical wiring diagram.



LIST OF PARTS.

- 2 0.0005 mfd. condensers, with vernier (Ormond).
- 1 "Sorbo" valve holder (Sterling).
- 1 Paxolin former, 3½ in. × 3 in. diameter.
- 2 Ribbed ebonite formers (Becol).
- 4 Valve sockets.
- 12 Valve pins.
- 1 Single coil holder (Edison Bell).
- 1 1-mfd. fixed condenser (T.C.C.).
- 1 0.0005 fixed condenser (Dubilier).

- 1 0.0003 fixed condenser (Dubilier).
- 1 2-megohm grid leak (Dubilier).
- 1 6-ohm rheostat (Igranic).
- 1 400-ohm potentiometer (Igranic).
- 1 Aluminium panel 12 in. × 7 in. × 3/32 in.
- 1 Baseboard, 12 in. × 7 in. × ½ in.
- 1 Ebonite terminal panel, 6 in. × 2½ in. × ¼ in.
- 8 Terminals.
- 8 Terminal indicators.
- Ebonite strip and small screws, etc., for constructing coils.

Approximate Cost £3 3s. excluding cabinet.

In the "List of Parts" included in the descriptions of THE WIRELESS WORLD receivers are detailed the components actually used by the designer and illustrated in the photographs of the instrument. Where the designer considers it necessary that particular components should be used in preference to others, these components are mentioned in the article itself. In all other cases the constructor can use his discretion as to the choice of components, provided they are of equal quantity to those listed, and that he takes into consideration in the dimensions and layout of the set any variations in the size of alternative components he may use.

The assembly of the components on the panel and baseboard should be a perfectly straightforward matter. Actually an aluminium panel is used, and it will be realised therefore that it will be necessary to bush the anode tuning condenser in order to prevent short-circuiting the H.T. battery. There are various ways of doing this, and it is, of course, possible to obtain condensers complete with special bushes. In this actual receiver the problem was solved by drilling a circular hole in the panel of considerably greater diameter than the metal bush of the variable condensers, and then attaching, by means of four small nuts and screws, a rectangular piece of ½ in. ebonite to which the variable condenser is attached. Do not forget that it is the moving plates of the variable condensers which must be connected to the low potential ends of the circuit, which in the case of the grid tuning condenser will be the earth terminal, and in the case of the anode tuning condenser the H.T. + terminal. Do not forget also that the metal panel must be earthed. The position of the filament rheostat is important, and care should be taken that it must be connected in the positive filament lead as shown so that when turned to the "off" position the potentiometer is also disconnected from the filament battery.

With regard to operating the receiver we must first insert a suitable valve. It may be stated that almost any general purpose valve will give good results no matter whether it be of the 2-, 4-, or 6-volt class. A Mullard P.M.1 H.F., a Cossor 410 H.F., and a Marconi D.E.5B have all given good results. The value of H.T. used varied between 20 and 60 volts. With regard to the anode coil, this may be of the ordinary commercial type of plug-in instrument, or a home-made basket coil can be used. The value of the coil, of course, must be such that it will, in conjunction with the variable condenser, tune to the wavelength upon which it is desired to receive. A No. 50, 60, or 75 should be used on the normal broadcasting wavelengths, a No. 250 or No. 300 on the Daventry wavelength. Those who decide to experiment on the short wavelengths will have to equip themselves with a special short-wave plug-in coil such as is made by the Igranic Co., but do not forget that the set is, as might be expected, very inefficient on wavelengths below 100 metres, and is only intended for efficient reception on wavelengths above this value. Those who are seriously interested in short-wave work are referred to the June 29th issue, where they will find a real short-wave receiver.

In our issue of November 10th, 1926, we gave the interpretations of a number of the service code signals used in trans-oceanic traffic, and we are now able to supplement this list. There are probably a good many more of these intimate signals in use, some of which, we understand, will hardly bear literal translation without endangering the sale of *The Wireless World* to public reading rooms, but we believe the following list (for which we are largely indebted to our esteemed contemporary, the *Journal des 8*) gives those in general use.

- ZAP Acknowledge receipt.
- ZAN We can receive absolutely nothing.
- ZCO Send by code, each group once.
- ZCS Hold up your transmission.
- ZCT Send by code, each group twice.
- ZDD Make your dots and dashes thus . . . .
- ZDM You are missing your dots.
- ZDU We can work on Duplex.
- ZFA Automatic system out of order.
- ZFT What are the conditions for Triplex?
- ZGS Your signals are getting stronger.

INTERNATIONAL "Z" CODE.

- ZGW Your signals are getting weaker.
- ZHA What are the conditions for automatic reception?
- ZHC How are you receiving?
- ZHS Send at high speed.
- ZHY We have your . . . .
- ZKQ Let us know when you are ready to begin again.
- ZLB Make long intervals.
- ZLS We are disturbed by a storm.
- ZMO Wait a moment.
- ZMP Automatic transmission bad.
- ZMQ Wait.
- ZMR Your signals are moderately strong and readable.
- ZNB We are not receiving your interpolations, we will send twice.
- ZNG Conditions unfavourable for reception by code.
- ZNN Nothing more for you at present.
- ZOK We are receiving all right.
- ZPE Send everything in plain language.
- ZPO Send text in plain language, once.
- ZPP Send text only in plain language.

- ZPR Your signals are readable.
- ZPT Send text in plain language, twice.
- ZRO Are you receiving at normal speed?
- ZSA Stop automatic traffic.
- ZSB Your signals are not clear (sharp).
- ZSF Send faster.
- ZSG Stop automatic traffic and examine transmitter.
- ZSH Strong atmospherics here.
- ZSJ Stop automatic traffic because of jamming.
- ZSR Your signals are strong and readable.
- ZSS Send slower.
- ZSU Your signals are unreadable.
- ZSV Your speed is variable.
- ZSW Stop automatic traffic, signals are too weak.
- ZSX Stop automatic traffic, atmospherics too strong.
- ZTA Transmit automatically.
- ZTF Transmit twice quickly.
- ZTH Transmit by band.
- ZTV Transmit by rapid automatic.
- ZUA Conditions unfavourable for automatic reception.
- ZUB We cannot interpolate (break in upon) you.
- ZVF Variations of frequency in your transmitter.
- ZVP Please send V's.
- ZVS Variations in strength of your signals.
- ZWC Cracking atmospherics here.
- ZWD Send word.
- ZWO Send each word once.
- ZWT Send each word twice.

# NOVELTIES FROM OUR READERS

## VALVES FOR IDEAS

### Practical Wrinkles for the Wireless Workshop and Experimental Bench.

#### SHORT-WAVE RECEIVER CABINET.

Those living in the Colonies who wish to build the "Empire Broadcast Receiver" have the materials for building a screened cabinet already to hand in the form of the aluminium foil-lined 3-ply wood tea chests.

The aluminium foil should be placed between two pieces of 3-ply wood and secured by a brass wood screw at each corner. When the two sides, back, top, and bottom have been so prepared, they can be built into a firm cabinet by fixing sheet brass or copper corner pieces. The panel can be made by using one piece of 3-ply wood with aluminium foil stuck on with glue. The wood should be varnished to prevent absorption of moisture, and the whole then covered with one piece of black American cloth.—T. E. R. B.

#### PROTECTING L.T. LEADS.

The accumulator ends of L.T. battery leads very soon become damaged, the braiding and rubber being perished through coming in contact with acid.

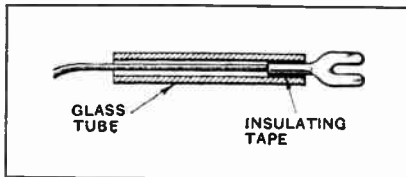

Glass tube to protect L.T. lead from accumulator acid.

A method of protecting them is to obtain two lengths of tube, about 2½ in. long (ebonite, glass, or other suitable material), and to fix in position with a strip of insulating tape ¼ in. inside wrapped round the body of the spade tag, the tube being forced on to this as shown in the sketch.—C. M. A.

#### NON-REVERSIBLE PLUGS.

Loud-speaker and other connections which are made through taper plugs and sockets may be made non-reversible by the method shown in the dia-

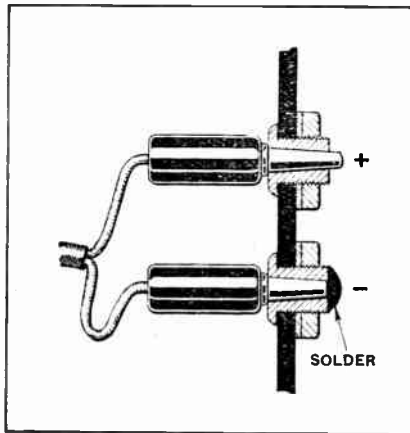

Non-reversible taper plugs and sockets.

gram if the plugs normally project for a short distance behind the sockets.

#### VALVES FOR IDEAS.

Readers are invited to submit brief details, with rough sketches, where necessary, of devices of experimental interest for inclusion in this section. A dull emitter receiving valve will be despatched to every reader whose idea is accepted for publication.

Letters should be addressed to the Editor, "Wireless World and Radio Review," Dorset House, Tudor Street, London, E.C.4, and marked "Ideas."

One of the plugs (the one marked negative in the diagram) should be filed down until it is slightly shorter than the depth of the corresponding

socket. The back of this socket is then filled up with solder so that if an attempt is made to insert the positive plug it would be impossible to make it bed down properly.—A. G. S.

#### CONE ANGLES.

When marking out the paper disc for constructing a cone diaphragm, a protractor is necessary in order to arrive at the correct angle for the V-shaped piece, which must be removed from the disc in order to form the cone. In the absence of a special protractor a condenser dial may be utilised.

Two types of dial are in general use, one marked with 100° and the other with 180°, and it is the latter type which should be employed. For a 120° cone the angle of the V-piece to be removed is 52°.

H. A. O'B.

#### VOLTMETER LEADS.

A popular type of voltmeter has two loose plugs for connection to H.T.+ and L.T.+ One plug has to be held in the hand when the other

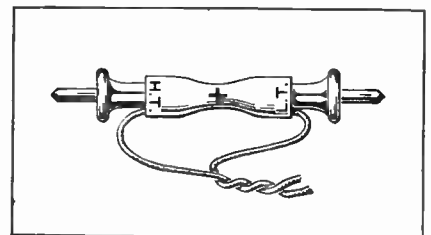

H.T. and L.T. voltmeter leads connected for rapid testing.

is used. If a piece of rubber tubing is fixed over the plug ends, handling is much easier, moreover, the rubber tube takes any sudden strain on the thin flex.—E. J. K.

# EVERY PART PERFECT NOT PARTIAL PERFECTION

**RELIABLE** valves must be perfect in every part. However long and strong a filament may be, it is not of much use if, owing to some defect in the electrode system or an imperfect vacuum, it does not function properly.



B.T.H. 2-volt Valves are good in every part, meticulous care having been exercised in the design and placing of filament, grid and anode. Equally close attention has been paid to the vacuum which in B.T.H. Valves is as perfect as it can possibly be made.

B.T.H. 2-volt Valves have a filament second to none in length, efficiency, long life and low current consumption, and it can be stated quite definitely that there is *no filament which lasts longer.*

There are no weak links in these valves—every point is a “strong point.” Whatever valves you may be using at the moment it is highly probable that the new B.T.H. 2-volt Valves are an improvement on them. They give instant and constant satisfaction.

ASK YOUR DEALER FOR THE NEW B.T.H. 2-VOLT VALVES.

Type	Purpose	Fil. Volts	Fil. Amps.	H. F. Batt. Volts	Ampl. Factor	Impedance	Price
B21	H.F.	2	0.1	40 to 150	16.0	32,000 ohms.	s. 10 d. 6
B22	G.P.	2	0.1	40 to 100	7.5	14,000 ohms.	10 6
B23	Power Amp.	2	0.2	40 to 100	6.0	8,000 ohms.	12 6
B8	Res. Coupl.	2	0.1	100 to 150	50.0	180,000 ohms.	10 6

The above prices are applicable in Great Britain and Northern Ireland only



A COMPLETE RANGE OF VALVES—

## 2 VOLT VALVES

FOR ALL SETS AND CIRCUITS

B21 {H.F. & DET}

B22 {General Purpose}

B23 {Loud Speaker}

B8 (R.C.)

2801

If you are interested in R.C. Coupling, write for a copy of the “RESISTOR” Booklet to Publication Dept., The British Thomson-Houston Co. Ltd., Rugby.

A21

Advertisements for “The Wireless World” are only accepted from firms we believe to be thoroughly reliable.

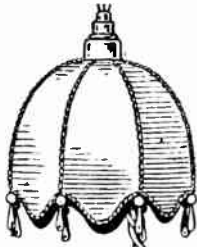

# For working entirely off the E.L. Mains

The illustration shows the new Met-Vick 5 with the eliminators contained in the side cupboards. It can be plugged into a lighting circuit just like any other Electric appliance. If used with H.T. and L.T. batteries these can be accommodated in the cupboards. The circuit employs two phase-balanced and stabilized H.F. stages before the detector, and two resistance coupled L.F. stages.

Operation is extremely simple, the local station can be easily cut out and a wide range of alternative programmes obtained.

Special attention has been paid to running costs which are remarkably low.

The Met-Vick 5 is a really beautiful instrument and while a distinct advance on any 1926 model it still remains at a reasonable price. Obtain Leaflet 4117/9 for complete range of prices.

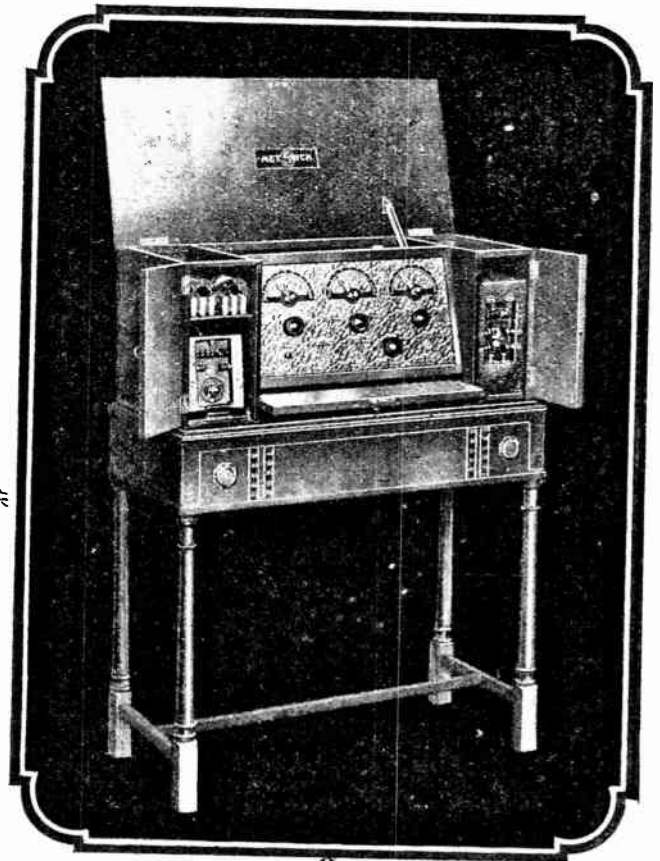

## Battery Eliminators

Met-Vick Battery Eliminators are supplied in two models, one for providing filament current and the other for anode and grid currents, by plugging in on electric light mains. The H.T.-G.B. Model provides a high voltage (up to 250 V.) for the last valve (ensuring a large volume without distortion). It is fitted with a switch, a protective fuse and a distributor panel enabling it to be used on various supply voltages of 40-100 periods. Grid Bias tappings at 5, 10, 15 and 20 volts.

The smoothing system is of exceptional efficiency. The eliminator can therefore be used successfully with multi-valve and the most sensitive sets even in districts where there are considerable irregularities in the electrical supply.

The L.T. Model gives an output of 5 amperes at 4 volts and a potentiometer ensures complete absence of hum. Obtain copy of List 7117/8.

# MET-VICK

(COSMOS)

## METRO-VICK SUPPLIES LIMITED

(Proprietors: Metropolitan-Vickers Elec. Co. Ltd.)

155 Charing Cross Road - LONDON, W.C. 2

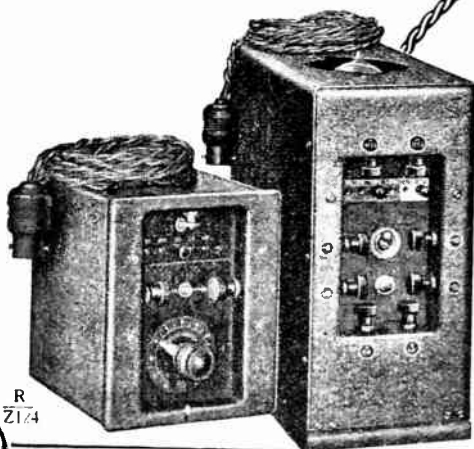

R  
Z1/4

DID YOU SEE THEM AT THE EXHIBITION?

Mention of "The Wireless World," when writing to advertisers, will ensure prompt attention.

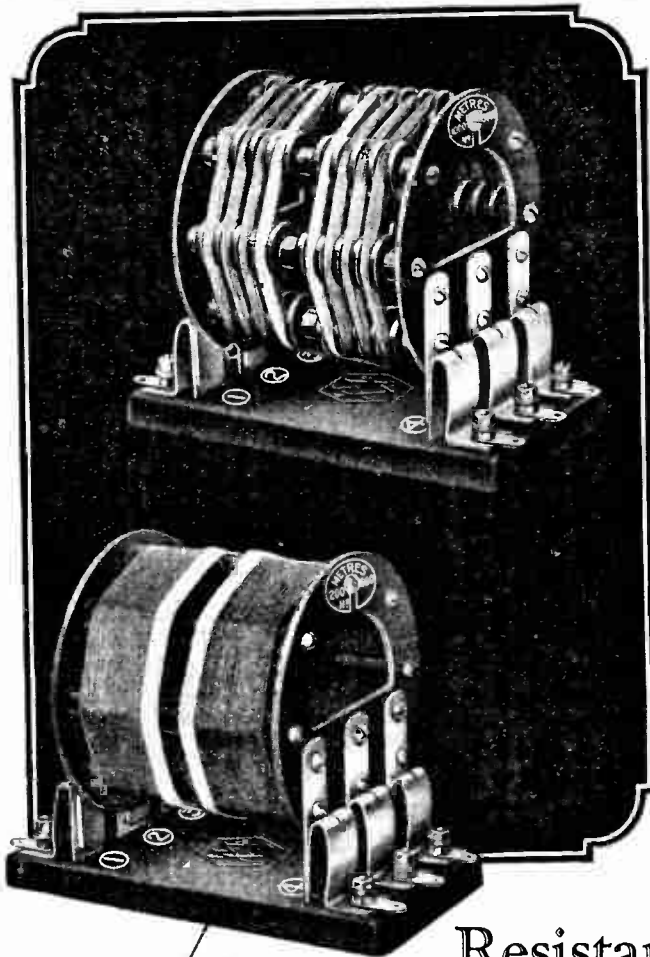

*Zz*

# A·N·P

(Astatic-Non-Parasitic)

# Coils

**A CLEVER SOLUTION OF A DIFFICULT PROBLEM.**

*Patents pending.*

Designed to overcome in a simple manner the three difficulties associated with high frequency amplification namely: Magnetic coupling between coils, Stabilisation, and Parasitic Oscillation. The first named is prevented by Astatic winding, obviating the necessity for metal screens with their disadvantages, the second is obtained by centre and quarter-tappings accommodating valves of various impedances, and the third is avoided by balanced self-damping windings, thus dispensing with the expensive double condenser and resistance method previously used.

*List 4117/8 gives full details and prices.*

## Resistance Coupling Units

Thousands of radio enthusiasts are loud in their praises of "Cosmos" (Met-Vick) Resistance Coupling Units. L.F. stages coupled by means of these Units result in clear Loud Speaker reproduction without distortion. The 'V' type unit can now be supplied fitted with the new 'Met-Vick' A.C. Valve Socket for use when building a set for working off the E.L. mains. The A.C. Valve-socket is also supplied separately for panel or baseboard mounting. *Obtain List 7117/8 for full details and prices.*

## MET-VICK

(COSMOS)

**METRO-VICK SUPPLIES LIMITED**

(Proprietors: Metropolitan-Vickers Elec. Co. Ltd.)

155 Charing Cross Road : : LONDON, W.C 2

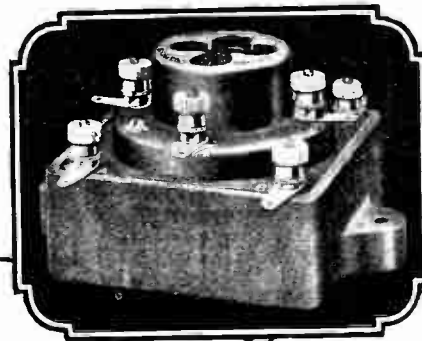

R  
P88

**DID YOU SEE THEM AT THE EXHIBITION?**

Advertisements for "The Wireless World" are only accepted from firms we believe to be thoroughly reliable

# NEW GENERAL RADIO SET CREATES SENSATION

Loud Speaker & all accessories built into one beautiful cabinet

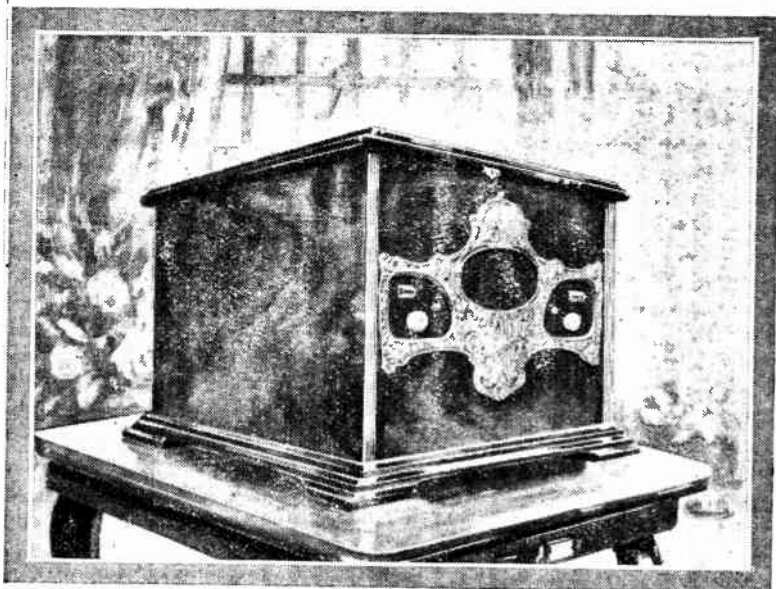

**NO ACCUMULATOR:  
NEW TYPE VALVES**

*Many other exclusive features*

*This is the new General Radio Set with its handsome cabinet of genuine hand-polished English walnut, the set is neat, compact, and easily transportable*

At the Radio Exhibition the centre of attraction was the New General Radio Set. This wonderful receiver had so many unique features that everyone was drawn to the General Radio Stand.

**NO MORE ACCUMULATORS TO CHARGE!** One of the most attractive features of this new set is the absence of the Accumulator. No longer will owners of General Radio Sets need to bother about having accumulators recharged. The General Radio *FILONATOR* (exclusive to General Radio Sets) can be recharged instantly in your own home simply by inserting special compressed tablets costing 1/-, a charge lasting six weeks with average use. It is much more reliable and efficient than the old style accumulator and lasts much longer. There is no acid in the Filonator, no fumes and no danger.

**A TRULY REMARKABLE LOUD-SPEAKER** Another feature of this new receiver is the patent "Magnetic-Cone" Loud Speaker. Although measuring only six inches across it gives remarkable volume with an exceptional sweetness of tone and a fidelity of reproduction so outstanding that the music or singing could be in the room beside you. The old horn type of speaker has been done away with and this new loud speaker is built into the cabinet. This big step forward is to a great extent responsible for the very handsome appearance of the new General Radio Cabinet Set.

**UNUSUALLY EASY TUNING** Tuning-in on the new General Radio Set has been made so easy by the new patent "Astatic" vario-coupler that only one control is

needed, this tuning gives so fine an adjustment that you can get the station you want at maximum strength without the slightest trouble. The tuning of the set covers all the European stations *without* additional coils.

**SUPER QUALITY VALVES** The new General Radio Set is fitted with special new type 1.4 volt valves designed specially by the leading Valve Manufacturers to give maximum efficiency with the General Radio Filonator. They have two filaments so that should one eventually burn out they continue to work on the second filament. This ensures *double life* for each valve.

**NO INCREASE IN PRICES**

The set complete costs only £12. The royalty is paid and there is *nothing* else to buy. If desired, easy payment terms of 20/- a month for twelve months are available. In every case, and which ever way you buy, all General Radio Sets are

**INSTALLED FREE**

in your home by our own engineer, in any part of the country. The Set is left playing perfectly for you, and free service calls are given after installation. Never before has so remarkable a set been offered to the public at so low a price and with so much service.

# GENERAL RADIO

**SEND TO-DAY FOR  
FULL PARTICULARS**

*Say Catalogue 4C—on a postcard with your name and address—or cut out this advt., write your name and address in the margin and put in open envelope (½d. stamp).*

GENERAL RADIO CO., LTD., 235 REGENT STREET, LONDON, W.1 SHOWROOMS: 105 REGENT STREET, LONDON, W.1

*Mention of "The Wireless World," when writing to advertisers, will ensure prompt attention.*

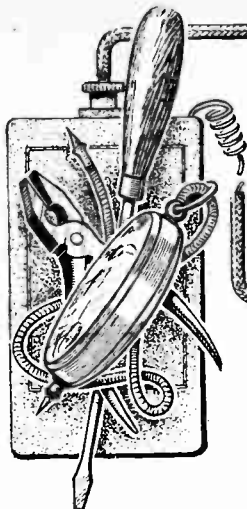

### THE "EVERYMAN FOUR" AND SELECTIVITY.

THIS popular receiver has but two tuned circuits, so, in spite of the fact that they are of the lowest resistance which is possible, or, rather, practicable, to obtain, it is hardly to be expected that a powerful near-by station can be completely eliminated at distances of a mile or two in favour of other transmissions on a neighbouring wavelength. Conditions improve rapidly with an increase of distance, and at three miles it should be found that the part of the scale occupied by the local station is sufficiently restricted to allow reception of a number of other stations. It may be repeated that selectivity is always improved by using as an H.F. amplifier a valve having a high impedance (in the order of 60,000 ohms), with, of necessity, a lower grid bias than usual; about  $\frac{1}{2}$  or  $\frac{3}{4}$  volt is generally sufficient, and may often be obtained by making use of the drop in potential across the filament resistance. It should be observed that, unless high valve impedance is accompanied by a commensurate increase in amplification factor (up to 35 or 40), the overall high-frequency magnification obtainable will be disappointingly low, and, while the local station may be eliminated, other signals may be too weak for good reproduction.

There is another method of getting rid of signals from a local station which will always effect an improvement, provided that the user is willing to sacrifice a certain band of

## PRACTICAL HINTS AND TIPS

### A Section Mainly for the New Reader.

wavelengths; the width of this band need not be very great unless interference is particularly severe. Referring to Fig. 1, it will be seen that an extra tuned circuit ( $L_1$ ,  $C_1$ ,  $C_2$ ) is coupled to the low potential end of the aerial-grid transformer secondary; if this is suitably proportioned and its coil correctly coupled to the main coil, it has the property of "absorbing" oscillations at the frequency to which it is tuned.

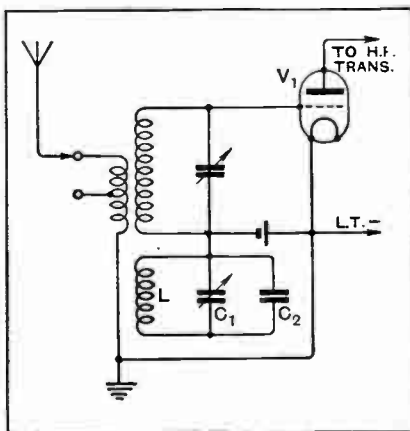

Fig. 1.—Adding an effective wavetrap to the "Everyman Four" receiver.

For best results it is highly desirable both that the H.F. resistance of the absorption coil  $L$  should be low and that the capacity used to tune it should be large; these conditions are best met by a single layer winding of from twenty to thirty turns (depending on the wavelength to be eliminated) of 27/42 Litz or No. 24 solid wire on a 3in. former. The necessary large capacity may be obtained by connecting a fixed air-dielectric condenser of about 0.005 mfd. in parallel with a similar variable, which must be mounted outside the containing cabinet. A semi-ad-

justable coupling between the coils must be provided; a separation of about one inch should be tried as a start. The absorption of local signals will be more thorough as coupling is tightened, but the waveband eliminated may be unnecessarily wide.

To operate the device, the absorption condenser is set at zero, and the local station should be tuned-in to maximum volume (with a very short aerial, if signals are excessively strong). The absorption circuit is now carefully tuned, so that signals vanish completely; or, at any rate, are reduced to minimum strength. After carrying out this operation, the receiver is operated in the usual manner; but, as suggested above, it will be as well to experiment with the coupling between coils.

o o o o

### BUILDING A LOUD-SPEAKER.

IT is impossible to over-emphasise the necessity for mechanical rigidity in the construction of a loud-speaker, whether it is of the horn or cone type. In other words, every care should be taken that movement or vibration can only be imparted to those parts which are intended to move. The need for good workmanship is most insistent when large amplitudes, as provided by a super-power output valve, are to be handled.

As an instance of what may happen, and as a guide to where to look for trouble, it may be mentioned that an annoying "comb and tissue paper" resonance, clearly evident on certain notes, was traced in a cone loud-speaker to lack of adhesion between three of the flaps cut in the edge of the cone and the supporting membrane.

## LOUD-SPEAKER MAGNETS.

THE magnetic field required for the successful operation of a moving coil loud-speaker is so intense that users of these instruments are recommended to remove their watches when carrying out preliminary adjustments; there is a certain amount of risk that the spring may be magnetised if the watch comes into close proximity to the "pot."

o o o o

REACTION AND  
H.F. AMPLIFICATION.

THOSE who have followed carefully the recent constructional articles appearing in this journal will have noticed that in a large number

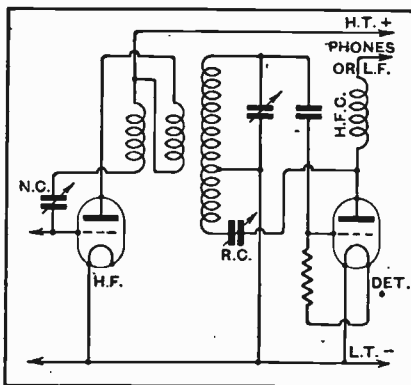

Fig. 2.—Reaction between plate and grid circuits of a detector valve following an H.F. amplifier.

of receivers, including H.F. amplification, there is no provision for reaction other than that obtainable by

partial denaturalisation. If the matter is gone into more thoroughly, it will be observed that the sets without reaction almost invariably make use of an anode bend detector, which does not introduce serious losses into the circuits. Indeed, it is possible to formulate a rough-and-ready rule to the effect that reaction should be used with leaky grid condenser detection, but may safely be omitted when the rectifier operates on its lower bend.

Many readers will no doubt be desirous of adapting recently published transformer designs to grid detection circuits, and a few hints on the most convenient method of procedure may be of interest. Generally speaking, reaction may be most easily controlled by means of capacity, as this system does not call for any mechanical arrangement for swinging a coil. A circuit diagram, showing the connections, is given in Fig. 2; it will be seen that an H.F. choke is inserted in series with the anode of the detector, in order that oscillating currents may be deflected through the reaction condenser (R.C.) and the reaction coil, which is wound as an extension to the secondary winding of the H.F. transformer. To economise in space, it is suggested that a maximum capacity of some 40 micro-microfarads (0.00004 mfd.) should be used for the controlling condenser; a neutralising condenser will do.

The position of the extra reaction winding with relation to the other

transformer coils is shown in Fig. 3. As the space available will generally be small, fine double silk-covered wire may be used. The necessary number of turns for the 250-550 metre waveband is not likely to exceed 25 (depending on the amount of damping present), so the length of winding will be only slightly over  $\frac{3}{4}$  in. with No. 42 gauge wire. For the long waves about 75 turns of similar

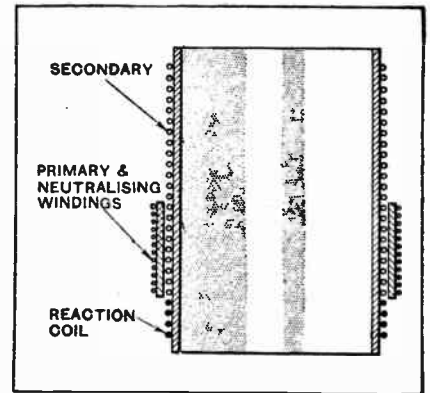

Fig. 3.—Section through a typical H.F. transformer, showing disposition of reaction coil (in black) with relation to other windings.

wire is sufficient; this may be "pile" wound. The reaction winding must be in the same direction as the secondary coil.

A consideration of the diagram will show that there are six external connections to the H.F. transformers; thus, if they are to be interchangeable, a base with the same number of pins must be provided.

## PCJJ's October Schedule:

Messrs. Philips Lamps, Ltd., advise us that the following schedule will be observed by the Eindhoven short-wave telephony station, PCJJ, during October.

	G.M.T.
Thursday, October 13th .. .. .	0.3
Thursday, " 13th .. .. .	17.21
Tuesday, " 18th .. .. .	19.22
Thursday, " 20th .. .. .	19.22
Tuesday, " 25th .. .. .	19.22
Thursday, " 27th .. .. .	19.22

Owing to the experimental character of PCJJ it is possible that the above times may be subject to alteration without notice.

o o o o

## Belgian Amateurs.

M. Louis Era (EB4BC) has been spending the summer at Bois de Villers, near Namur, and sends us an interesting comparison of the reception, on a three four-electrode valve set, of various European broadcasting stations.

He did not find much difference in the strength of long-wave stations, such as Hilversum and Daventry 5XX, as compared with that usually experienced in

TRANSMITTERS' NOTES  
AND QUERIES.

his station at Antwerp, though Radio-Paris and the Eiffel Tower were slightly stronger. With the shorter-wave stations the difference was more marked, Langenberg being very strong and constant, while Brussels was almost inaudible. Daventry, 5GB, came in on its opening night at good strength, very steady, and with excellent modulation. On subsequent days fading and slight distortion were observed. Mr. Era expects to return to Antwerp at the end of this month, and can then compare the reception at his home station with that observed while on his holiday.

o o o o

The Belgian station A11 is testing on telephony every day except Sundays between 16.30 and 17.30 and between 20.00 and 25.00 G.M.T. on 33 metres.

Reports will be welcomed by M. de Burlet, 5, Rue de la Linie, Brussels.

o o o o

Mr. G. Regnier (EB4WW) was in two-way communication on August 7th for three-quarters of an hour with OH 6BDL in Hawaii. This is claimed to be the first direct communication by amateurs between Belgium and the Hawaiian Islands. Mr. Regnier was using the Levy aerial which is now so popular in Belgium, and signal strength was reported good at both ends.

o o o o

## Short Waves from Troopship.

Reports on his signals on 41.7 and 24 metres are asked for by Mr. Thompson, ex GFY and GFR, now on board the troopship *Dorsetshire*, bound for Basra and Karachi. He intends to communicate with British amateurs after service work. His call-sign is GDKB.

Mr. T. P. Allen (Gi 6YW), of Belfast, to whom we are indebted for the above information, states that at 00.00 B.S.T. on September 29th signals were heard at R6 on approximately 45 metres.





## Multi-stage H.F. Amplification.—“Period” Cabinet Furniture.—The Patent Situation

By A. H. MORSE, A.M.I.E.E.

THE fourth annual Radio World's Fair opened at the New Madison Square Garden, in New York, on September 19th, the opening being preceded by a Mayoral proclamation inviting popular concentration upon the importance and beneficence of the new industry.

The stability which, since its inception, the radio industry has coveted, seems now to be in sight, and is reflected in the exhibits. Organised and efficient government control of broadcasting, the clearing up of the patent situation—which is still proceeding—and the mortality among irresponsible manufacturers, are the main factors working to this end. However, it is only within the last few weeks that many of the important manufacturers have acquired licences under the patents of the R.C.A., the Hazeltine and Latour Corporations, etc.; and there can be little doubt that in the intervening time few of these licences have been able to modify their products in accordance with their new scope and freedom in the matter of design. Nevertheless, all the exhibits are of a high order of interest and merit; all mark a distinct advance on the models of 1927; and very few show any sign of the disability which has been indicated.

The metamorphosis from apparatus to furniture is complete, and “period” cabinets abound. There is everything from “William-and-Mary” to “Lenin-and-Trotsky,” but in most cases the taste is excellent and the finish superb.

### Trend of Circuit Design.

The technical objectives have obviously been simplicity, selectivity, and quality of reproduction. Range is no longer a prime consideration.

License or no license, three stages of neutralised and tuned radio-frequency amplification, followed by a leaky grid detector and two stages of transformer-coupled audio-frequency amplification, seems to be the basis of almost all the sets exhibited. Here and there, there are four stages of radio and three of audio amplification, but they are rare. Resistance-capacity coupling seems to be most popular in kits, and a “Pierce-Airo” receiver is exhibited with a combination of resistance-capacity and transformer coupling in the audio stages. About 30 per cent. of the sets make use of the new A.C. valves, and are independent of batteries. Honours seem to be divided between

the “heater” A.C. valve (in which the filament heats but is not itself the cathode) and that in which the filament

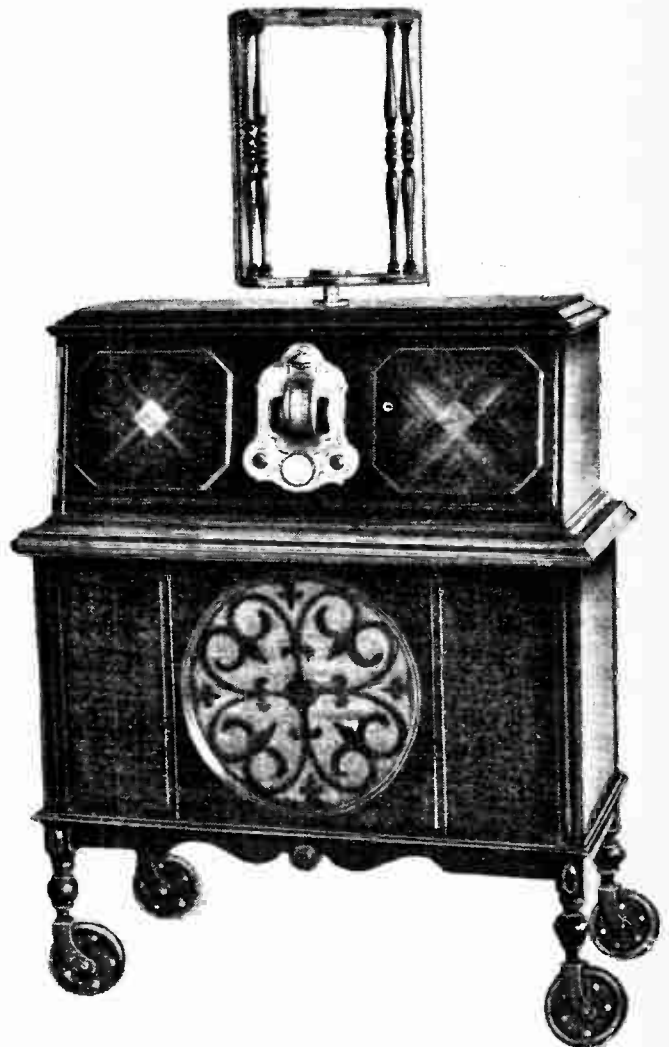

Fig. 1.—Freed-Elseman eight-valve frame aerial receiver operating from the mains.

**New York Radio Fair.—**

takes "raw A.C." The former, however, is preferred for detection, but does not become operative for some seconds after the current is turned on.

All circuits are screened, and in several cases the radio stages are doubly screened; and there is invariably provision for one or two power tubes in the audio stages. There are a few sets with single tuning control, but most have two. Filament rheostats have in some cases disap-

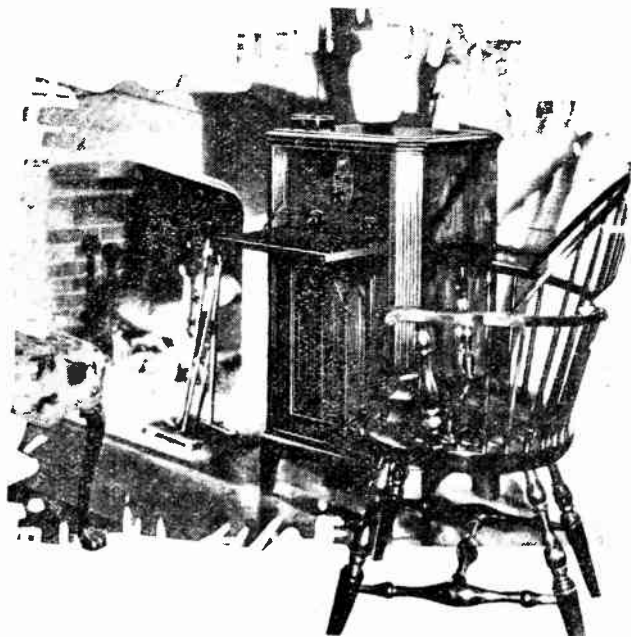

Fig. 2.—An excellent example of the trend of design in America; the Bosch Model 76 mains-operated receiver.

peared; provision for logging stations on tuning dials has almost completely gone; and volume control is general. Plate rectification is noted in one set (Stewart-Warner), and most sets are equipped with R.C.A. valves, as is said to be obligatory on the part of R.C.A. licensees. (Incidentally there are about twenty independent valve manufacturers in America.)

Many manufacturers offer specially designed consoles to accommodate their table models, loud-speakers, and accessories, so that a purchaser may acquire a De Luxe set on the instalment plan. Much ingenuity has been shown in facilitating this combination.

**Loud-speakers and Gramophone Reproducers.**

The horn type of loud-speaker has given way to the cone, a number of which are oval, or eccentrically driven. There is also the Balsa-Wood loud-speaker, which seems to be gaining in popularity and which certainly lends itself to novel and decorative treatment. The exponential horn is a feature of the Kellogg console (Fig. 4), and models are exhibited by the Baldwin and Racon companies. Of freakish loud-speakers the most sensible are those incorporated in useful tip-tables.

The combined radio receiver and gramophone is not a novelty, but the combination is novel as a product of the radio factory, and there are three such in the Fair. Each is equipped with a magnetic pick-up for the gramophone and so adapted that the audio-frequency amplifier and

loud-speaker is used in reproduction from either part of the combination.

There are about half-a-dozen magnetic gramophone pick-up devices adapted to feed through the audio stages to the loud-speaker of any radio receiver. The improved reproduction resulting from the use of these devices is putting new life into the gramophone trade, which is thus getting a hair of the dog that bit it. Still closer co-operation between the radio and gramophone trades seems therefore to be imminent, and certainly there will be radio exhibits at all subsequent gramophone shows.

Freed-Eisemann exhibit a Simon marine radio direction finder of very efficient appearance, indicating further competition in the marine field; and the R.C.A. exhibit a machine which automatically tests the characteristics of valves and passes on to a packing table only those which are up to specification.

**Typical Designs.**

Among so much excellence it is difficult to select models for special mention, but the following each have some special interest amongst the consoles.

Fig. 1 is a Freed-Eisemann socket-power, eight-valve (4-v-3) neutrodyne, loop-operated, tea-wagon model. The list price of this set is £98 10s., complete with power unit and loud-speaker; and it is likely to be popular for apartment-house use, for which it is obviously primarily intended.

Fig. 2 illustrates the Bosch Model 76. It is a six-valve (3-v-2) set of excellent design and performance. The chassis is of pressed steel, and the tuning dial is cali-

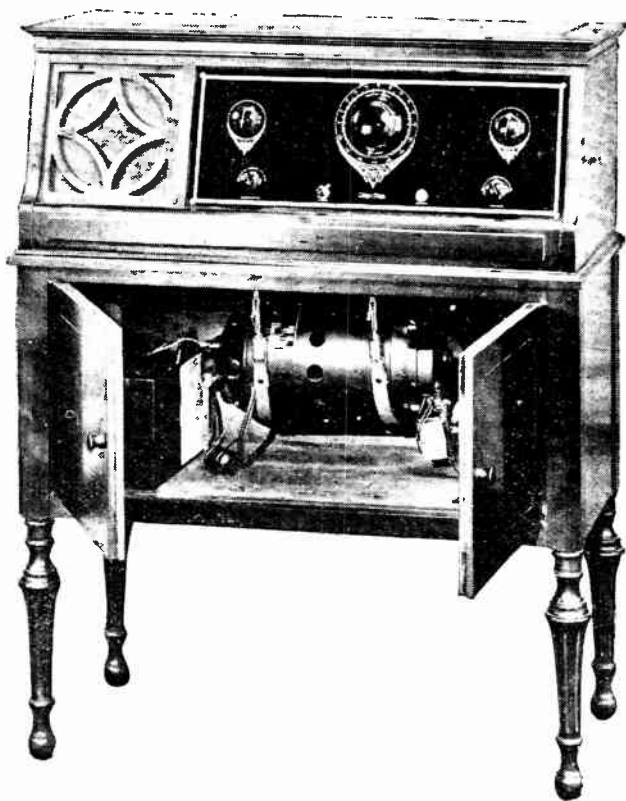

Fig. 3.—A motor generator is incorporated in the Day-Fan console. The total power supplied to the set is 300 watts.

**New York Radio Fair.—**

brated arbitrarily and in kilocycles. The aerial is separately tuned by the lower left-hand knob. Complete with power unit for socket operation, and built-in loud-speaker, this set sells for £59.

Fig. 3 is the Day-Fan motor-generator operated,



Fig. 4.—The Kellogg Model 510 working from A.C. mains incorporates a built-in loud-speaker horn of exponential type.

six-valve (3-v-2) console. It is claimed that the maximum power taken by this set is 300 watts. Filaments are in series. The list price complete is £70.

Fig. 4 shows the Kellogg Model 510. This is an all-A.C. set using seven McCullough valves (4-v-2) and equipped with a built-in exponential horn. It is inductively tuned, each of the four radio stages having a five-tapped inductance whereby the required waveband is selected, and a few variometer turns for precision tuning. The tapping and variometer adjustments are respectively ganged into two controls, and the operation is very simple. Overlap is negligible, and the quality of reproduction is particularly good. The front of the console (which is open in the illustration) is closed by means of sliding doors, an arrangement which not only makes for beauty but effects an economy of room space. The set retails for £99 complete.

Fig. 5 illustrates the Radio Corporation's Radiola 32, which embodies an eight-valve superheterodyne, a Type 104 (haffleboard) loud-speaker, a rotatable loop aerial, and a power-amplifier unit designed to operate off the lighting current (A.C. or D.C. as may be specified). The woodwork is exceptionally beautiful, and the set retails for £179 complete.

▲ 29

Fig. 6 illustrates the Stromberg-Carlson radio-gramophone Model 744. This set is equipped with a concealed loop aerial and seven valves (4-v-2). The gramophone is fitted with a magnetic pick-up which feeds through the audio stages of the radio set into the loud-speaker. A key is provided on the front of the panel for switching from radio to records. The complete set, with built-in socket-power unit and separate loud-speaker, lists at £249. It constitutes an excellent and extremely useful piece of furniture. (The Freshman Co. exhibit and offer a less elaborate but similar combination for £70.)

The most interesting table models are perhaps the Radio Corporation's Radiola 17 (Fig. 7) and the Crosley "Bandbox." The former is the ultimate in compactness and neatness. It contains six A.C. valves (3-v-2) and a H.T. and grid bias battery eliminator, and its overall dimensions are  $7\frac{7}{8} \times 8\frac{1}{2} \times 25\frac{5}{16}$  in. The list price, without valves, is £26, a price to conjure with.

The Crosley "Bandbox" has substantially the same radio circuit as Radiola 17, but has added "Acuminators" (cam-adjustable book-condensers for precise tuning of two of the radio stages), and has no battery eliminator. Its dimensions are  $5\frac{1}{2} \times 7\frac{7}{8} \times 17\frac{1}{4}$  in., and it sells for £11 (or £13 for A.C. operation) without valves. An appropriate 25- or 60-cycle H.T. and grid bias eliminator is offered for £12, so that a socket-power, six-valve (A.C.) combination may be obtained for £25 without valves.



Fig. 5.—Radiola eight-valve superheterodyne designed for A.C. or D.C. mains.

**New York Radio Fair.—**

There is a good display of well-made parts, accessories, and kits, including about a score of the last at prices from £7 to £17 per kit. British prestige is well maintained by the Amplion and Ferranti exhibits.



Fig. 6.—The Stromberg-Carlson combined gramophone-receiver which sells at the equivalent of £249.

A clever remote-control device for single tuning dial socket-power sets is exhibited by the Algonquin Electric Co. It consists of two units connected by a seven-wire cable. One unit rests on the receiver, and contains a small motor, etc. The motor is geared to the tuning spindle of the set by means of a chain and sprocket wheels. The other unit, which may be disposed where most convenient, is equipped with a voltmeter calibrated in wavelengths, two push-buttons for controlling the clockwise or counter-clockwise motion of the motor, and a rheostat switch whereby the volume is controlled and the power switched on or off.

**New "Osram" Valves.**

The two new "Osram" valves, namely, S625 and KHI, are fully described and their characteristics explained in the current number of the "Osram" G.E.C. Bulletin, published by the General Electric Co., Ltd., Magnet House, Kingsway, W.C.2.

o o o o

**"Standard" Broadcasting Booklet.**

An exhibit which attracted a large amount of attention at the National Radio Exhibition was the "Standard" broadcasting equipment on the B.B.C. stand. An interesting booklet has now been issued by Messrs. Standard Telephones and Cables, Ltd., the manufacturers of the transmitter, giving illustrated particulars, not only of the equipment on view at Olympia, but of several other types of

The way in which the wavelength is indicated on the remote-controller is very ingenious. The sliding contact of the potentiometer is attached to a worm which is driven by the motor, and by adjustment the receiver dial and the potentiometer are at zero at the same time. The potentiometer slider is electrically connected to the remote voltmeter, which is so calibrated and adjusted that it indicates the wavelength to which the receiver is tuned. On the correct adjustments are made they are said not to vary.

A simple model for battery sets is also shown. In this remote control is effected through a sort of Bowden wire to a worm drive on the tuning dial. Remote control of the volume and power is effected as in the more elaborate instrument.

**The Patent Situation.**

From the point of view of the broadcast listener, the engineer, the artist, or the large manufacturer, the Fair and its implications are eminently satisfactory. To the small set manufacturer, who is unable to guarantee a minimum yearly royalty of \$20,000—which, according to reports, is what the R.C.A. demand for a licence—they may not look so good. In order to meet the situation five of the latter have already merged their resources, and others may follow suit. Upon those who cannot or will not depend very largely the continuance of the present trend towards trade stability, and there is some ground for their argument that this large minimum royalty discriminates

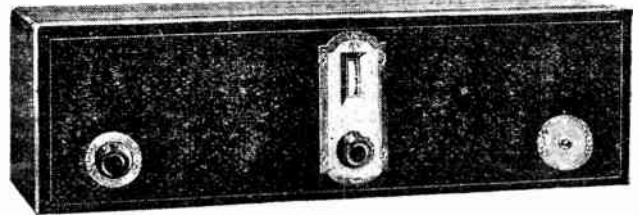

Fig. 7.—The Radiola No. 17 "table model"—a six-valve set with built-in A.C. battery-eliminator.

against them. Meantime there are still a number of set manufacturers who claim to be independent of R.C.A. and other patents, and the chairman of the Government Radio Commission's reported leaning towards crystal-controlled receivers is already having an unsettling effect.

**TRADE NOTES.**

"Standard" equipment installed in different parts of the world. The description deals with the whole of the instrument, from the microphone in the studio to the aerial tuning unit. We understand that interested readers can obtain a copy of the booklet on application to the company at Bush House, Aldwych, London, W.C.2.

o o o o

**The Amplion Junior Cone Speaker.**

We regret that the loud-speaker illustrated on page 423 of our issue of September 28th was erroneously described as a G.E.C. product. The instrument will

be easily recognised as the popular Amplion Junior Cone Speaker, A.C.1, which has been fitted with a hinged piece so that it can stand either vertically or hang from a picture rail.

o o o o

**Catching Whales by Wireless.**

Wireless under novel conditions is described in a new pamphlet, No. 239, issued by the Marconi Co., dealing with Marconi wireless telephone equipments designed for whalers and trawlers. Many photographs are included, showing whaling vessels at work, and they go to show how invaluable wireless has become in securing intercommunication in whaling fleets. The important feature of the Marconi apparatus is that it can be operated without any skilled attention whatever.



Events of the Week in Brief Review.

**INTERNATIONAL BROADCASTING SHOW IN MARCH.**

An International Broadcasting Exhibition is to be held in the Palace of Arts in Liège from March 10th-25th, 1928.

o o o o

**CANADIAN TELEPHONY SERVICE OPENED.**

Great Britain and Canada became linked by beam telephony on Monday, October 3rd, when the Prime Ministers of the two countries exchanged greetings between London and Ottawa.

No suitable beam station yet exists in Canada, and communication is therefore carried out from Canadian cities via land-line to New York and Rocky Point.

The service is available between 12.30 p.m. and 11 p.m. (G.M.T.), and the charge is the same as that for calls between this country and America, viz., £15 for three minutes. To call Canada it is merely necessary to ask the exchange for "Canadian Service."

o o o o

**NOT LUXURIES.**

Anxiety is being manifested in Australia over the growth in "luxury" imports, one of the items coming under review being wireless receiving sets and valves. But these are necessities, not luxuries!

o o o o

**MAGISTRATE AND THE WIRELESS ACT.**

An interesting magisterial interpretation of the Wireless Telegraphy Act occurred last week when Mr. Gattie, at the Tower Bridge Police Court, ordered William Trinder, of Bermondsey, to pay a fine of £5 and £2 2s. costs on a summons of installing a wireless set without a licence, but dismissed on payment of 2s. costs a second summons for working the set without a licence.

The defendant admitted that the set had been installed since Easter, and that he had been testing sets for two years. Many people must have wondered why the law makes it a double offence to instal and operate an unlicensed receiver, seeing that the operation of a set follows the installation of that set as night follows day.

**BOTH TO BLAME?**

The bad weather is now being blamed for causing poor wireless reception. This is in pleasing contrast to the off-repeated charge that wireless is responsible for the bad weather.

o o o o

**ARTIST'S WIRELESS PHILANTHROPY.**

Mrs. W. H. Travis, a Manchester artist, is offering for sale a selection of her water-colour paintings at the Collectors' Gallery, Mount Street, for the purpose of providing wireless sets for impoverished and bedridden people in the Manchester and Salford districts.

o o o o

**NEW BELGIAN WIRELESS STATION.**

An interesting new station was opened last week at Ruysselede, near Bruges, by means of which Belgium is able to communicate directly with the Congo and America. Both long and short wavelengths are used. The station covers an area of 358 acres, says *The Times*, and the aerials are slung between eight pylons each 930ft. in height.

The first message transmitted was one from the King of the Belgians to the U.S. President, assuring him of the friendship of the Belgian people for the United States.

o o o o

**HIGHER POWER. AMERICAN VIEWS.**

The movement in favour of higher power for broadcasting stations is finding an advocate on the other side of the Atlantic in Admiral W. H. G. Bullard,

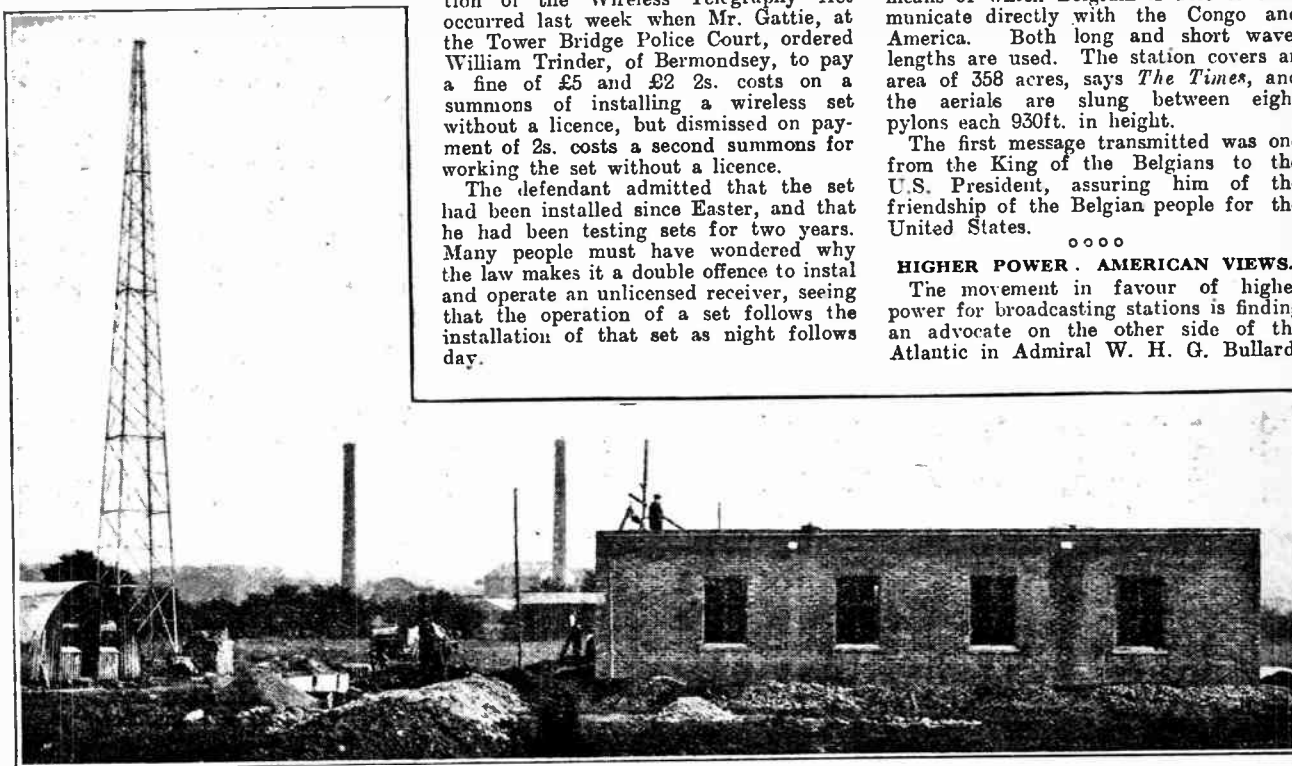

LONDON'S NEW WIRELESS STATION. Work is rapidly proceeding at Mitcham Common on the erection of a new station for the Air Ministry.

chairman of the U.S. Federal Radio Commission.

"I have got it into my head," said Admiral Bullard recently, "that the power of all stations could be increased 100 per cent., provided that the location of the station frees it from local troubles, that frequencies are kept constant, and that the character of the wave is pure."

Another view was expressed by a Chicago resident who wrote contending that all disturbance in the ether would be dispelled instantly if every station were limited to a power of 5 watts!

o o o o

#### TASKS BEFORE THE WASHINGTON CONFERENCE.

The International Radio Telegraph Conference was opened at Washington on October 4th by the President of the United States. Mr. Hoover, U.S. Secretary of Commerce, was elected to the chair.

It is expected that the deliberations of the conference will last several weeks. A very large agenda has to be tackled, the questions under consideration including 1,800 separate items.

Among the proposals made by Great Britain is the limitation of the use of damped waves by ships to those of 600 and 800 metres.

o o o o

#### TESTING WITH 60,000,000 CYCLES PER SECOND.

Experiments in 5-metre transmission and reception are being conducted by the engineers of W.G.Y., Schenectady.

In the next test, to be carried out between Schenectady and New York, the transmitter will be situated at a height of 300 feet within sight of the Woolworth Building, on the roof of which the receiver will be located. The transmitter

embodies two new four electrode air-cooled valves in the special oscillator circuit connected directly to the eight-foot aerial. It is tuned at a distance of 300ft. by means of a rope-drive vernier control.

#### FORTHCOMING EVENTS.

**WEDNESDAY, OCTOBER 12th.**  
*Stretford and District Radio Society.—At 8 p.m. At 6a, Derbyshire Lane. Question Night.*

*Tottenham Wireless Society.—At 8 p.m. At 10, Bruce Grove, N.17. Lantern Lecture: "Across Europe with a Radio-equipped Car," by Capt. L. F. Plugg. (Special invitation extended to local branch of Wireless League.)*  
*Muswell Hill and District Radio Society.—At 8 p.m. At Tollington School, Tetherdown. Lecture and Demonstration: "Liquid Air," by Mr. Allen J. Bremner, B.Sc.*

**FRIDAY, OCTOBER 14th.**  
*Radio Society of Great Britain.—Informal Meeting. At 6 p.m. At the Institution of Electrical Engineers, Savoy Place, W.C.2. Discussion: "Short Wave Aerial Systems."*

**MONDAY, OCTOBER 17th.**  
*Hackney and District Radio Society.—At 8 p.m. At Hackney Electricity Halls, Lower Clapton Road, E.5. Discussion on "Utilising D.C. Mains for H.T. Supply."*

**WEDNESDAY, OCTOBER 19th.**  
*Golders Green and Hendon Radio Society.—At 8 p.m. At the Club House, Willifield Way, N.W.11. Lecture: "Perfect Reproduction (with special reference to Transformers)," by Mr. R. Garside (of Messrs. Ferranti, Ltd.).*

#### INTERNATIONAL EXHIBIT OF WIRELESS APPARATUS.

Reference was made in our issue of September 28th to an interesting exhibit of British and foreign wireless apparatus on show at Messrs. Whiteley's, Queen's Road, Bayswater. We now learn that the exhibition will remain open until Saturday next, October 15th.

The display, which will be found on the third floor of the store, includes British valve-testing apparatus in operation. Entrance to the exhibit is free.

o o o o

#### THE EXHIBITION SEASON.

The past week has seen two successful wireless exhibitions, at Belfast and York respectively. The Belfast show was held in the Ulster Hall, and an interesting feature was the broadcasting of the Children's Hour by the B.B.C. in a small hall adjoining.

The York exhibition was held under the auspices of the York and District Radio Society, and was notable for a display of amateur-built apparatus.

o o o o

#### AN IMPORTANT BOOKLET.

"What is Amateur Radio?" is the title of an important booklet just issued by the Incorporated Radio Society of Great Britain from their offices at 53, Victoria Street, S.W.1. The many and varied activities of the Society are set forth in a manner which cannot fail to interest even the casual reader, who may learn for the first time that the "R.S.(A.B.," as it is familiarly called, includes in its membership nearly all the amateur transmitters in the country, possesses a special section for the development of wireless in schools, and has a history dating back to 1913.

Copies of "What is Amateur Radio?" can be obtained direct from the Society, price 1d. to cover postage.

o o o o

#### 60-MILE INAUGURAL SPEECH.

A science exhibition held at the White Rock Pavilion, Hastings, last week, was opened by Sir Henry Lunn in a speech from London conveyed by landline and distributed by loud-speakers.

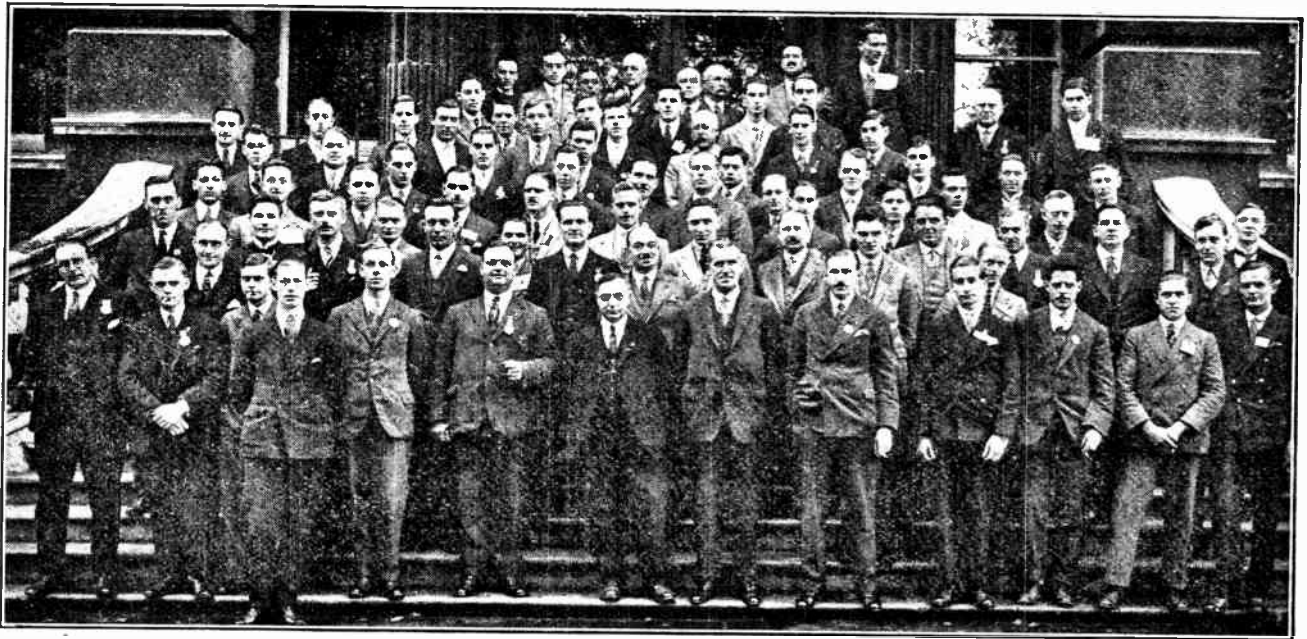

TRANSMITTERS ALL. Members of the Transmitter and Relay Section of the Radio Society of Great Britain photographed on the occasion of their annual convention, held at the Institution of Electrical Engineers on September 30th and October 1st.

# H.F. AMPLIFICATION ON SHORT WAVES.

## A Practical Three-valve Receiver with One H.F. Stage.

By F. CHARMAN.

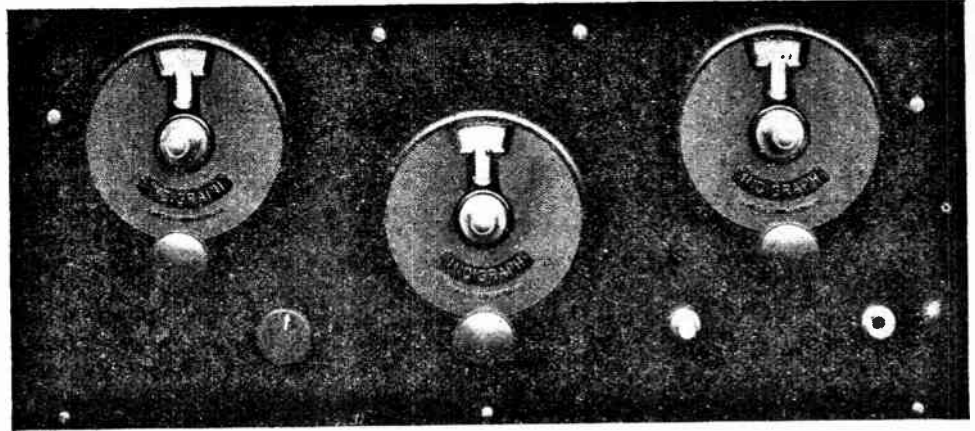

THE recent development of short waves has brought forward the need for a really sensitive receiver for these waves. Remarkably strong signals may be obtained with a plain detector and one L.F. stage at times when atmospheric conditions are favourable, but at other times, especially when it is desired to receive telephony, one feels the need of something more sensitive than the two valves. Another stage of L.F. amplification on the receiver is not a satisfactory solution of the difficulty, as the reception of telephony still entails very careful adjustment of the reaction control. A carefully designed superheterodyne receiver employing six or seven valves will perhaps be satisfactory, but it is expensive to build and expensive to maintain. A stage of high-frequency amplification before the detector will, however, provide much stronger signals to the detector valve, thus

efficiency of the aerial system at high frequencies, are liable to be heard over much greater distances.

The difficulties of providing H.F. amplification on wavelengths below, say, 75 metres have up to the present been insuperable, if one may judge by the obvious widespread desire for a short-wave H.F. amplifier and the lack of published contributions on this subject. It has always appeared to the writer that with a thorough understanding of the principles of neutralisation of valve capacities, the main difficulty of constructing a short-wave H.F. amplifier would be overcome. Perhaps, therefore, a brief reference to these principles would be advisable before proceeding with the description of a type of receiver which has been developed in the laboratories of the Igranic Electric Co., Ltd.

### Neutralising Valve Capacity.

In such a circuit as that shown in Fig. 1, which represents a single stage of H.F. amplification, the capacity in the valve between the plate and grid (shown dotted) produces two undesirable effects. The first is that a coupling exists between the two tuned circuits, plate and grid, which occasions an alteration of the tuning of one circuit as the other is brought toward resonance with it. The other undesirable effect is a feed-back of a fraction of the oscillating voltage on the anode to the grid, and the voltage fed back may, at certain tunings, arrive at the grid in such a phase as to encourage the generation of oscillations in the circuit. Both effects become increasingly great as the wavelength becomes shorter, and on the

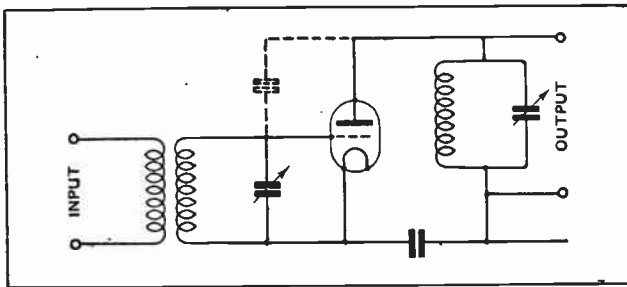

Fig. 1.—Single stage of tuned anode H.F. amplification showing valve capacity.

giving more latitude of reaction control, the advantage of which should outweigh the disadvantage of having another circuit to tune. Actually this has been found to be the case in practice.

Moreover, it must be borne in mind that the addition of a good H.F. stage to the receiver lessens the amount of radiation from the oscillating detector valve, which has become a growing nuisance with the rapidly increasing number of short-wave receivers. The oscillation problem is even more difficult on short waves than on broadcast waves, as the oscillations radiated, due to the increased

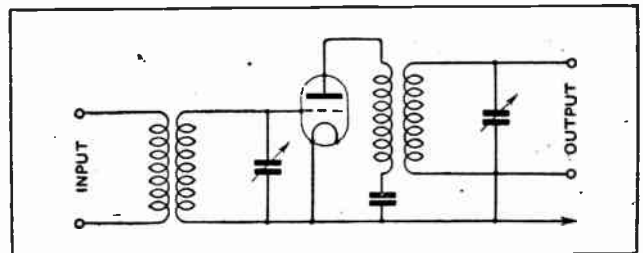

Fig. 2.—H.F. stage with transformer coupling (tuned secondary).

**H.F. Amplification on Short Waves.—**

wavelengths we are considering the first is so great as to render it almost impossible to tune-in a signal, whilst the oscillations generated by the valve are so strong that the valve assumes a condition which is extremely unfavourable for its operation as an amplifier.

It may be argued that, as the receiver is required to work on the threshold of oscillation, or even in an actual oscillating condition, it does not matter whether it is neutralised or not, provided that it is controllable. Both theory and practice condemn this view, inasmuch as what is required is that the damping effect of the H.F. valve should be removed from the anode circuit. This is not possible unless neutralisation is resorted to, since the aerial circuit

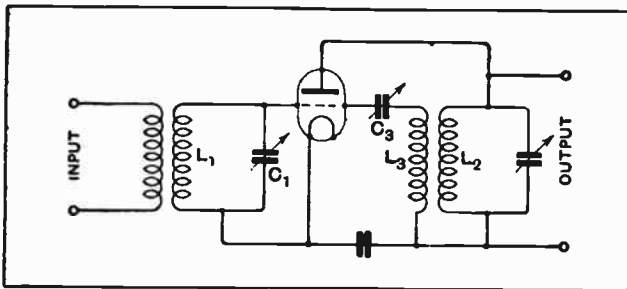

Fig. 3.—Neutralised tuned anode circuit.

goes into oscillation before sufficient reaction can be applied to reduce the damping imposed upon the anode circuit by the H.F. valve.

If, instead of the "tuned anode" arrangement of Fig. 1, one substitutes an H.F. transformer, as in Fig. 2, matters are very much the same as before. Unless coupling between the primary and secondary of the transformer is very loose, the electrical constants of the secondary are effectively transferred to the primary, and *vice versa*, in such a manner that the whole transformer behaves as a tuned anode system, and the condensers still exercise a distuning effect on each other, and the considerations of the previous paragraph still apply. To loosen the coupling would reduce the distuning effect, but to loosen it sufficiently to minimise the effect would involve such a loss of voltage on the secondary that the amplification of the stage would be completely lost. Also, even with the loosest coupling, the inductance of the primary is still sufficient on short waves to maintain the reaction effect in the H.F. amplifier.

**The H.F. Transformer.**

Both troubles may be overcome by ordinary neutralisation of the valve capacity, and a typical circuit for this is shown in Fig. 3. Here a coil  $L_3$  is coupled to the anode coil  $L_2$  so as to form a voltage transformer, and the two coils are arranged so that the oscillatory voltage supplied to the neutralising capacity  $C_3$  at the end of  $L_3$  is opposite in sign to that of the anode of the valve. Now if the transformer  $L_2 L_3$  has 1-to-1 ratio, and  $C_3$  is made equal in value to the grid-plate capacity of the valve, then the winding  $L_3$  will supply to the grid a voltage equal and opposite to that fed back to the grid *via* the inter-electrode capacity. There is thus effectively no feed-back, and the

circuit cannot generate oscillations due to this cause. Also, for the same reasons, the anode and grid circuits do not now distune each other. The voltage may be stepped either up or down from  $L_2$  to  $L_3$ , when  $C_3$  will be stepped down or up respectively in the same ratio. It is generally convenient to have some step down from  $L_2$  to  $L_3$ .

**Uniform Neutralisation.**

The commonest fault in the construction of neutralised receivers is the arrangement of the coils  $L_2$  and  $L_3$  so that they do not behave as a pure voltage transformer. In order to fulfil the requirements of neutralisation, the coupling between these coils must be very tight, that is to say, the coils must have a coupling coefficient of nearly unity, a condition very hard to realise in practice. Any lack of coupling is termed "magnetic leakage," and as far as neutralisation is concerned this can be represented by a so-called "leakage inductance," not coupled to  $L_2$  but in series with the condenser  $C_3$  and the coil  $L_3$ . As a result, less capacity is required to neutralise the valve capacity, and, unfortunately, since we are balancing a capacity against a capacity and an inductance in series, the value of neutralising capacity,  $C_3$ , required will alter with change of wavelength. This means that if we adjust the neutralisation for, say, the maximum wavelength of the range of the coils and tuning condensers, when we tune about half-way down the receiver will probably be badly denaturalised and go into oscillation, and the less tuning condenser one has in circuit the worse will the trouble become. The value of  $C_3$  required decreases with wavelength, the change in value being most rapid on the lower wavelengths of the tuning range.

In practice, due to the resistance in the grid circuit, a certain amount of denaturalisation is permissible without loss of efficiency, and one is therefore allowed a small

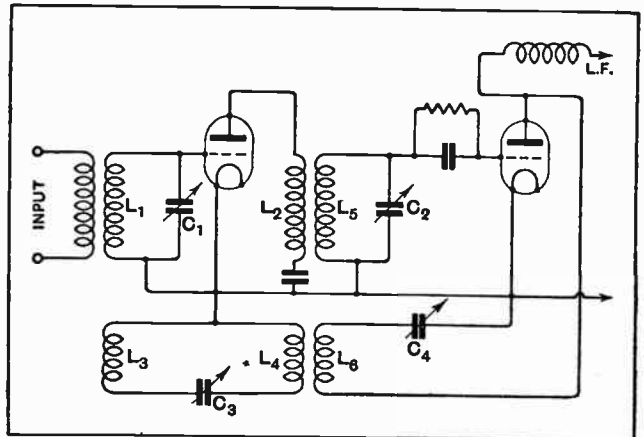

Fig. 4.—A system of neutralisation giving good results on short wavelengths.

amount of leakage inductance, provided it does not throw the neutralisation out beyond this limit. However, if the receiver is being used with reaction to receive C.W. signals, one can hear the distuning effect between anode and grid circuits as a change in the beat-note, unless the receiver is exactly neutralised, and on short waves this distuning, although amounting to only a small percentage of wavelength, may be sufficient to change the beat note



**H.F. Amplification on Short Waves.—**

beyond the limits of audibility. This effect must be reduced within reasonable limits if we are to have a receiver which is comfortable to handle. As will be shown later, the fulfilment of this need calls for special care in the design and layout of the receiver.

In the first experiments with H.F. amplifiers on short waves several neutralising arrangements were tried, and the circuit which showed most promise is that given in Fig. 4.

The circuit represents a transformer-coupled H.F. amplifier, with reaction applied to the detector valve in the most popular manner. It will be seen that the neutralising winding  $L_3 L_4$  is divided between the grid coil  $L_1$  and the plate coil  $L_2$  of the amplifier.

**Keeping H.F. out of the Batteries.**

Experiments with a receiver of this type indicated some interesting points. First, it is essential to keep H.F. currents from entering the H.T. battery, and this is done with the aid of H.F. chokes, as shown in the complete circuit diagram (Fig. 5). The two chokes in the detector plate circuit, together with the two 0.0005 mfd. condensers shown, represent a good H.F. filter, which has been found essential at this point, to overcome the annoying L.F. howl at the threshold of oscillation, so common in short-wave receivers.

Another point of great importance is the careful exclusion of H.F. currents from common paths. As shown in Fig. 5, the closed circuits  $L_1 C_1$  and  $L_3 C_3 L_4$ , are wired up as such, the coil  $L_1$  being connected straight across the tuning condenser  $C_1$ , and the leads to grid and filament are taken off this circuit afterwards. The length of the leads shown in thin lines in Fig. 5 is not important, as these carry practically no H.F. current, and there is not

likely to be any appreciable H.F. voltage drop along them. The same is done with  $L_3 C_3 L_4$ , and all leads returning to the filament of the amplifier valve are connected straight to the valve-holder, and not to the nearest point in the filament lead. This makes the amplifier a separate entity not mixed up with the detector circuit. The same considerations are given to the detector to make it exclusive of the L.F. amplifier.

**Layout and Wiring.**

A third point of great importance is also concerned with the layout and wiring. For the reception of short waves it is necessary to use coils of only a few turns, and the reader will see that if we have a coil of only two turns, connected to the remainder of its closed circuit by about a foot of leads, then the leads will embody a considerable portion of the inductance of the closed circuit. Now it has been pointed out that certain couplings must be very tight if one is to have a nicely neutralised receiver. This applies to  $L_1 L_3$  and  $L_2 L_4$  (Fig. 5), and if we wish reaction control to remain fairly constant over the whole tuning range it also applies to  $L_3 L_6$ .

Now with care neutralising coils can be made to couple very tightly with their tuned windings; but the inductance of the leads joining  $L_1$  to  $C_1$ ,  $L_2$  to valve and L.T. — through the by-pass condenser shown, and  $L_3$  to  $L_4$  represent leakage inductance as described earlier, and hence, to make the receiver such that no attention to the neutralising condenser is necessary during tuning, one must wire it with leads of very low inductance. This may be achieved to a sufficient extent by running the

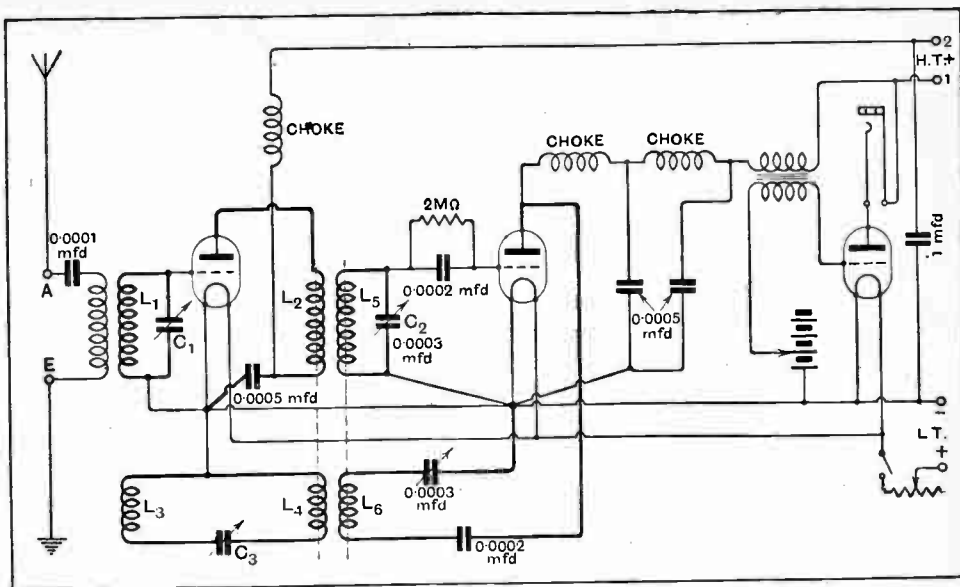

Fig. 5.—Complete circuit diagram of three-valve short-wave set with one stage of H.F. amplification.

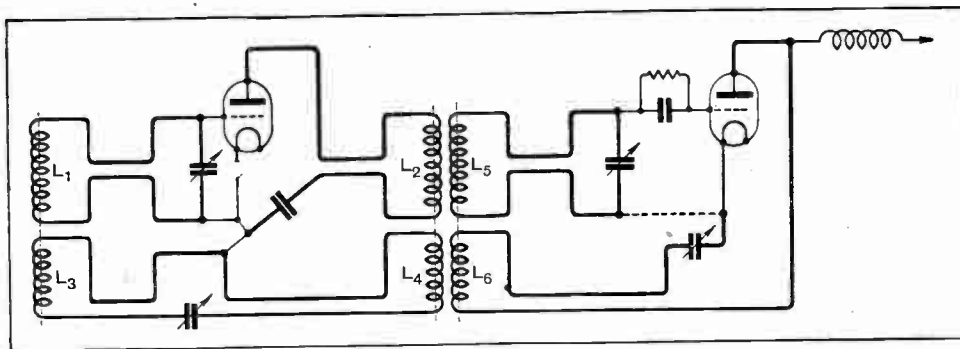

Fig. 6.—Connecting leads from closed H.F. circuits are run parallel and close together to avoid leakage inductance.

**H.F. Amplification on Short Waves.—**

connecting leads of all closed circuits parallel and close together, as indicated in Fig. 6, which shows the method of wiring in schematic form, closed circuits being in heavy lines. This does not give perfect neutralisation, but gives

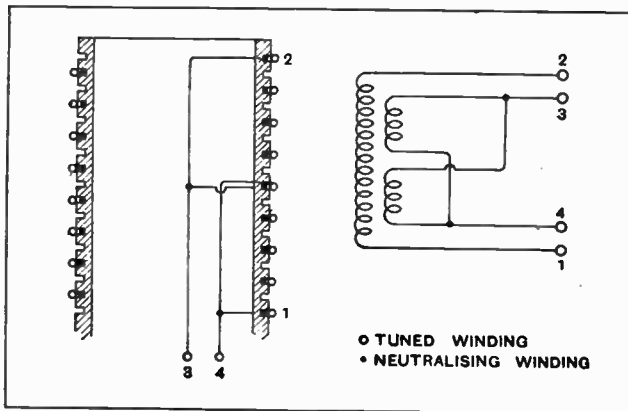

Fig. 7.—Section through coupling coils showing tuned circuit and neutralising windings and method of connection.

a near enough compromise to allow of comfortable use of the receiver without any other attention to the neutralising condenser than the initial adjustment.

As regards the L.F. stage, if it is desired to receive telephony it is advisable to use a transformer with a very high primary impedance, such as the Igranic "G" type  $3\frac{1}{2} : 1$ , to suit the high filament-plate resistance of the detector valve. However, for the reception of Morse signals from a congested ether, it may prove more advisable to employ a L.F. amplifier which has a peaky characteristic, with a much greater amplification at one frequency than at others. In this way a slight extra selectivity is obtained. To obtain this condition an Igranic "G" type  $7 : 1$  transformer has been used in the plate circuit of the high-impedance detector valve, which combination would, of course, be entirely wrong for broadcast reception, as the  $7 : 1$  transformer is intended to follow a low-impedance valve.

An extra stage of L.F. amplification may be added to the receiver without the introduction of any harmful effects, since, with the careful filtering arrangement shown in Fig. 5, and with isolation of the stages, no H.F. enters the L.F. amplifier.

Any stray capacities between parts of the plate and grid circuits of the detector and the input of the amplifier are not completely balanced out by the neutralisation of the amplifier, and the result is peculiar. The detector is set just on the

threshold of oscillation, and the circuit  $L_1 C_1$  is tuned through resonance with the detector circuit. As  $L_1 C_1$  passes through resonance with  $L_5 C_2$ , the receiver exhibits a tendency to pass over the threshold of oscillation, in the direction of either increased or decreased strength of oscillation, according to the phase of the resultant voltage fed back to the amplifier by the various stray capacities.

For example, it was found with one receiver built up in which the reaction condenser was within fair proximity (about 8 in.) to the condenser  $C_1$ , that when the amplifier was properly neutralised the reaction effect of the feedback was equivalent to several degrees of rotation of the reaction condenser. The detector was set on the threshold of oscillation, with  $C_1$  off tune, and when  $C_1$  was tuned in to resonance with the detector oscillation built up strongly, and it was necessary to decrease the reaction control by about 10 per cent. When the mutual inductance between the primary and secondary of the transformer  $L_2 L_5$  was reversed, by reversing the direction of one of the windings, the "peak" effect of the tuning of  $L_1 C_1$  upon the reaction became a "valley," so that more reaction was required to produce oscillation when the two tuned circuits were in resonance than when they were tuned to different wavelengths. In either of these conditions the receiver was not comfortable to handle, owing to the difficulty involved in tuning.

**Screening Essential.**

The effect just described can, however, be controlled to any degree by careful screening of the various parts of the receiver, and it has been found of advantage to arrange for the tuning of  $L_1 C_1$  into resonance with  $L_5 C_2$  to bring a very slight increase in the strength of self-oscillation of the receiver, and a great deal of time was spent, and several receivers built up, to determine the simplest way of controlling the amount of "peak" to the desired extent, at the same time using the minimum amount of screening.

It will have been appreciated from the remarks on the

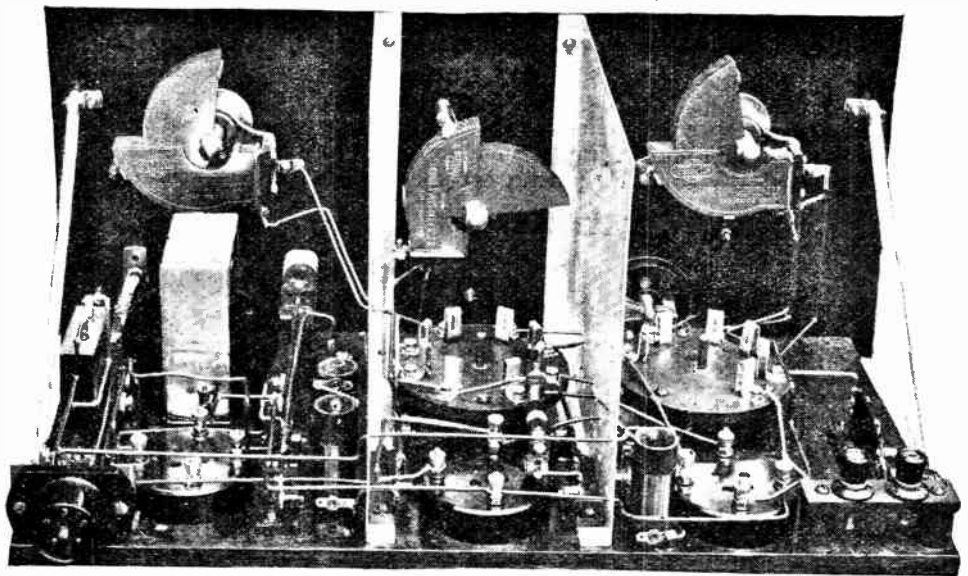

Fig. 8.—Experimental Igranic short-wave receiver with one stage of H.F. amplification.

**H.F. Amplification on Short Waves.—**

subject of leakage inductance that some very special construction is necessary for the transformers employed in a receiver of this type. As a result of considerable experiment a novel form has been adopted, the principle of which is illustrated in Fig. 7. The windings of the transformers, as will be seen from this figure, are supported on a cylindrical former in which is cut a screw thread the depth of which is about twice its width. In the base of this thread a wire of narrow gauge is situated; this is the neutralising winding, and since it carries no appreciable high-frequency current it is advantageous to keep the gauge of wire down to a low value. On the top of this winding, and supported by the sides of the groove, the main winding is situated, the gauge of wire being so chosen that there is adequate spacing between the two windings. A transformer of this type gives a very good approximation to unity coupling and at the same time little mutual capacity.

As it is desirable to employ a step-down arrangement for the neutralising transformers, the inner windings have been constructed in two halves, which are connected in parallel. This has the advantage of reducing the stray voltages on leads, etc., and making the neutralising condenser of a conveniently large value to handle.

Fig. 8 shows a receiver which has been built up by the Igranic Electric Co., as the outcome of this experimental work, and which has the commercial advantages of simplicity of construction and comparatively low cost. It is built up to the complete circuit shown in Fig. 5, and is at

present provided with two ranges of coils, to cover approximately 15 metres to 70 metres, but there is nothing to prevent the extension of the range of the receiver by the addition of extra ranges of coils, so as to bring it up to the broadcast wavelengths. Fig. 9 shows another similar receiver, complete with coils.

With such a receiver it has been possible to receive loud-speaker telephony from WGY on 32.7 metres and KDKA on 63, and also, at 3 p.m., from 2XG on 17 metres. Also, on a night when reception was so poor that on a single

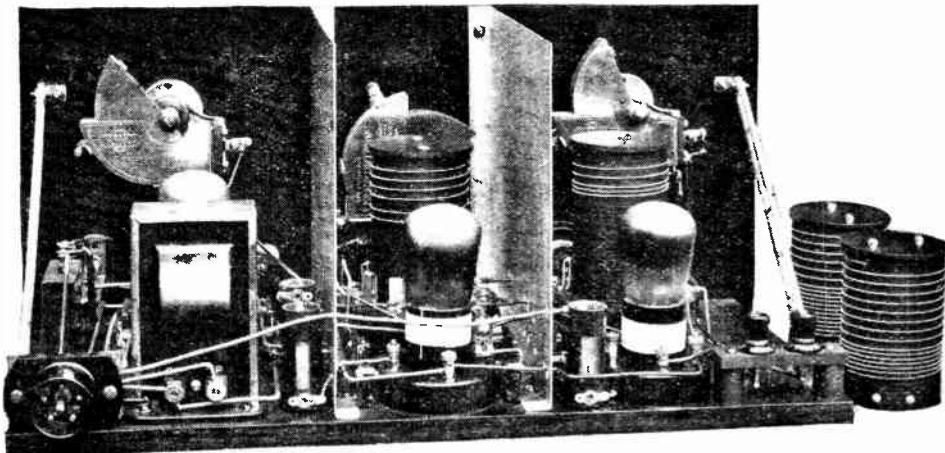

Fig. 9.—Another experimental set with valves and coils in position.

detector and one L.F. it was not possible to resolve the telephony from the carrier waves of WGY and KDKA, full loud-speaker volume has been obtained with the addition of one extra stage of L.F. to the receiver illustrated in this article.

In conclusion, the writer wishes to express thanks to the Igranic Electric Company for permission to publish the experimental work described above, which has been carried out in their laboratories.

**Loud-speaker Results with a Crystal.**

Although the recent Radio Exhibition demonstrated the decline in the popularity of the crystal receiver a number of people still object to the work entailed in the supervision of batteries in a valve set. It was with interest, therefore, that members of the Tottenham Wireless Society listened to a lecture by Mr. G. F. Taylor, of the New Wilson Electrical Manufacturing Co., on the Magnetic Bar Amplifier, a device for obtaining loud-speaker results from a crystal set without the use of valves. Its construction was fully explained by the lecturer, who then demonstrated, first with a crystal receiver and later with a single valve set. With good crystal strength, quite comfortable volume was secured on the loud-speaker.

The Society has prepared an interesting syllabus for the ensuing months. At this evening's (Wednesday's) meeting, to be held at 8 o'clock, Capt. L. F. Plugge will give a lantern lecture describing his journey across Europe with a radio-equipped car.

**CLUB NEWS.**

Hon. Secretary, Mr. A. G. Tucker, 42, Drayton Rd., Tottenham, N.17.

o o o o

**The Western Metropolitan Rally.**

Through the kindness of the Lyons Sports Committee, an interesting gathering recently took place of over 100 members from the following radio societies:—Golders Green and Hendon, Kensington, Lyons, Muswell Hill, Selfridges, Tottenham, Western Postal District. The gathering was organised by the Group Representative, Lt.-Col. H. Ashley Scarlett, D.S.O., and was held on the athletic grounds of Messrs. Lyons and Co. at Sudbury. After an exciting mixed double tennis tournament a dance took place in the ball-room, the proceedings suddenly developing into unexpected large proportions by the arrival of 200 guests

from the South Coast. Music was supplied from a gramophone using a Woodruffe pick-up followed by three stages of R.C. amplifiers making use of "Osram" LS5B valves and two "Osram" LS5A valves in parallel, 400 volts from the C.A.V. high-tension units and two ball-room Celestion loud-speakers. The results demonstrated the fact that such an installation is capable of splendid effects. Thanks are due to the following firms for their generosity in presenting prizes:—Messrs. Graham and Co., British Thomson-Houston, C.A.V., G.E.C., and McMichael, Ltd.

o o o o

**New Apparatus Demonstrated.**

New wireless apparatus by one of the leading manufacturers will be demonstrated by the Muswell Hill and District Radio Society at 8 p.m. at Tollington School, Tetherdown, N.10, on Wednesday next, October 19th. Hon. Secretary, Mr. Gerald S. Sessions, 20, Grasmere Rd., Muswell Hill, N.10.

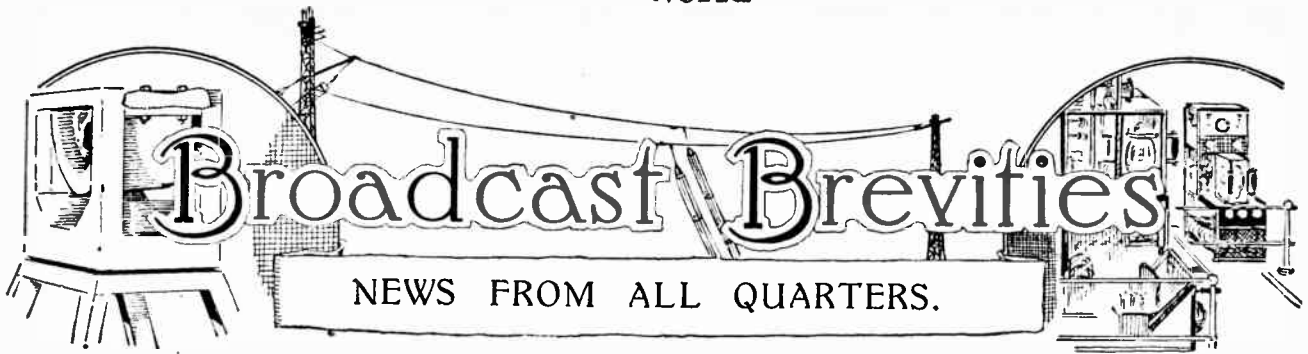

By Our Special Correspondent.

**About Licences.—Lessons from Olympia.—Prince of Wales to Broadcast.—Schools and Wireless.—Internationalised Broadcasting.**

**A Licence Controversy.**

A statistically-minded friend told me a few days ago that, having examined the receiving licence figures for the last four years, he had come to the conclusion that we have neared saturation point. I begged leave to differ.

Since then I have plunged into a study of the subject, and I have emerged without damage to my convictions. We are not near saturation point.

o o o o

**Figures for Four Years.**

At first glance the following figures, which show the number of licences extant during the month of August in each of the last four years, go to support my friend's contention.

August, 1924 ...	914,738
" 1925 ...	1,422,603
" 1926 ...	2,101,968
" 1927 ...	2,315,722

From this it would appear that we have passed the "straight portion" of the curve and are meandering along a slightly rising but not exciting plateau.

o o o o

**Lessons from Olympia.**

To be influenced by these figures, however, is to ignore not only the lessons of Olympia, but several other important factors, including the development of the broadcasting service.

Why was the wireless exhibition a greater success this year than ever before, if not for the reason that the regional scheme has awakened the public to the possibilities of alternative programmes; that the Promenade Concerts have enlisted the sympathies of the musical aristocracy whose former acquaintance with wireless was limited to the bleatings of shop-door loud-speakers; and that improvements in receiver design—technical and artistic—have seized upon popular imagination to a degree hitherto unrealised?

o o o o

**A Low Ratio.**

Estimates based on the licence figures go to show that in urban districts at the present moment there is still only one wireless set to every four or five houses. In the country the average of unequipped houses is probably higher, and it must not be forgotten that the completion of the regional scheme will bring in several

**FUTURE FEATURES.**

**London and Daventry (5XX).**

OCTOBER 16TH.—Orchestral and Vocal Programmes.

OCTOBER 17TH.—"Faust," a dramatic mystery by Wolfgang von Goethe.

OCTOBER 18TH.—Easthope Martin Programme.

OCTOBER 19TH.—"Tannhauser," by Richard Wagner.

OCTOBER 20TH.—Variety Programme.

OCTOBER 21ST.—National Concert relayed from the Queen's Hall, conducted by Sir London Ronald.

OCTOBER 22ND.—Ballad Concert.

**Daventry (5GB).**

OCTOBER 16TH.—"The Creation," an Oratorio by Haydn.

OCTOBER 17TH.—Variety Programme.

OCTOBER 18TH.—"Tannhauser," by Richard Wagner.

OCTOBER 19TH.—Tottenham Hotspur Football and Athletic Co., Ltd., Concert.

OCTOBER 20TH.—Symphony Concert.

OCTOBER 21ST.—Military Band Concert.

OCTOBER 22ND.—Popular Light Musical Programme.

**Bournemouth.**

OCTOBER 19TH.—Speech by H.R.H. the Prince of Wales at the Civic Reception at the Town Hall.

OCTOBER 22ND.—The Nightjars, the Station Concert Party.

**Cardiff.**

OCTOBER 18TH.—Welsh Orchestral Programme.

**Manchester.**

OCTOBER 20TH.—Blackpool Musical Festival Prize Winners' Concert.

**Newcastle.**

OCTOBER 22ND.—Variety Programme.

**Glasgow.**

OCTOBER 17TH.—The Radiotimists.

**Aberdeen.**

OCTOBER 20TH.—"The Eve of Trafalgar": Music of the Sea.

areas which still await a 100 per cent. broadcasting service.

o o o o

**The Four Million Mark.**

It will be time to consider whether we have reached saturation point when 4,000,000 licences have been issued. This figure will be attained if the B.B.C. play their part by providing entertaining programmes and by developing the regional scheme to give a 100 per cent. alternative service to all parts of the country.

o o o o

**Still Waiting.**

By the way, the patience of the British nation was never displayed to better effect than by the circumstance that there are still populous areas unserved by a 100 per cent. *single* programme service—after five years of broadcasting!

o o o o

**Prince of Wales at the Microphone.**

The Prince of Wales's speech in connection with the opening of the new extension of the Royal Victoria West Hants Hospital, Boscombe, will be broadcast from the Bournemouth station on October 19th.

o o o o

**New Play by Author of "The Liars."**

A new comedy in one act by Henry Arthur Jones will have its first production on October 20th, when it will be broadcast from 5GB. It is entitled "Her Tongue," and tells how the lady with the tongue nearly lost a husband.

o o o o

**Tired of Listening?**

There seems to be frank surprise at Savoy Hill over the complaint received from a Nottingham school that the children are growing tired of listening to broadcast lessons. The official interpretation of the case is that the set is giving poor results. An engineer is being sent to inspect the apparatus.

Whatever opinion the layman may hold as to the value of lessons by wireless, the majority of schools appear to be highly satisfied with the B.B.C. efforts in this direction. Last term 3,000 schools were taking the afternoon talks from London and Daventry; this term the number has increased to 3,500.

**B.B.C. as Publishers.**

Much of the success must surely be ascribed to the excellent series of booklets issued by the B.B.C. Publishing Department, each dealing in outline with the subject matter of a particular course. Some of these booklets are textbooks in themselves and must lessen very considerably the lecturer's task by supplying an atmosphere conducive to concentration.

o o o o

**Temptations for Teachers.**

It is a pity that the size of staff required precludes any attempt on the part of the B.B.C. to carry out a thorough inspection of school receivers. Some minor tragedies would probably be discovered. Tales would leak out of wasted afternoons, of children condemned to inactivity while teacher tries to bring in "a real German station" on a set intended solely for local reception.

Teachers are human, and the temptation to introduce Continental variations on "Half Hours with the Bugs, Fleas and Beetles" must be very strong.

o o o o

**International Programmes.**

There is much to be said for an Etheric League of Nations, which is now the avowed aim of the Union Internationale de Radiophonie. It may not be a Utopian dream to suppose that international amity can be fostered just as well by a common interest in the universal arts as by solemn conclave round a conference table.

With a view to closer collaboration between the broadcasting stations of Europe, the Council of the Union has decided to unite programme directors to participate in certain schemes for developing the "national programme" idea. The new movement is worth watching.

o o o o

**Frae Aberdeen Awa'.**

Mr. Angus McHaggis, of Aberdeen, writes:—

"It gives me the fair scunner—in fact, it makes my blood boil—to hear of all these folk at the Washington Conference fashin themselves about wavelengths when one of the most important questions remains unanswered. That question is this: Why do the Continental wireless papers, when printing programmes, continue to include Aberdeen under the general title 'England'? It makes one want to—to—och, awa' wi' ye!"

o o o o

**Sensation Without Shock.**

It was sheer imaginative enterprise on the part of the B.B.C. to let us hear from Dundee the other evening two eye-witnesses' accounts of the Scottish train mishap. The speakers had been passengers on the express, and their simply worded descriptions of the ghastly minute and a half before the darkened and jolting train came to a standstill were more thrilling in their vividness than many a newspaper "story."

If disaster had actually occurred no eye-witness account would have been broadcast. Just because broadcasting has power over the emotions of the listener far more than has the printed word, it is

not considered advisable to transmit anything of a harrowing nature. All sorts and conditions of men and women may be listening at any given moment, and there are hospital patients to be considered.

o o o o

**They Don't.**

The programme director of WLW, Cincinnati, Ohio, in planning special broadcasts for women, asks: "When will women listen?" It's plain that he's a bachelor.

o o o o

**G.B.S. versus G.K.C.**

A debate between those doughty opponents, George Bernard Shaw and G. K. Chesterton, is to be relayed from the Kingsway Hall to 2LO on October 28th.

o o o o

**In Memory of Easthope Martin.**

A programme of Easthope Martin's works will be broadcast on October 18th in commemoration of the death of this one of the best known of the younger school of modern British composers. Shortly before Easthope Martin died in 1925 he conducted at 2LO, and was becoming a familiar name to listeners.

o o o o

**Irish Comedian on Tour.**

Talbot O'Farrell is doing a week's tour for the B.B.C., commencing on October 24th. He appears on 5GB that night, and on 2LO on the 29th.

o o o o

**Portuguese Programme To-night.**

A Portuguese programme relayed from Radio-Belgique, Brussels, will be broadcast from 2LO this evening (Wednesday). It will include a speech by His Excellency Alberto d'Oliviera, the Portuguese Minister in Brussels.

**A Notable Variety Night.**

Flotsam and Jetsam will broadcast on October 15th from 2LO. Two other artistes who will help to make this a strong variety programme are Ada Reeve and Ethel Hook; the latter is Dame Clara Butt's sister, and listeners may remember that in their early professional days together their partnership was irreverently termed the "Butt-on-Hook."

o o o o

**A Sutro Play.**

A one-act play with a Great War setting, entitled "The Marriage will not take place," is to be broadcast to-morrow evening (Thursday). It is by Alfred Sutro.

o o o o

**Sir Landon Ronald.**

Sir Landon Ronald will conduct the B.B.C. National Concert at the Queen's Hall on October 21st.

o o o o

**Organ and Bells from Manchester Cathedral.**

Dr. R. G. Parsons, Bishop of Middleton, will give an address at the special service to be broadcast from Manchester Cathedral on October 16th. Listeners throughout the country will be able to hear this speaker, and also the beautiful bells and organ of the Cathedral, for the service will be relayed to London and Daventry, as well as Manchester.

o o o o

**A Rugger Broadcast.**

From Twickenham, on October 22nd, a description of the second half of the New South Wales v. London Rugby match will be relayed to 2LO and 5XX. Capt. H. B. T. Wakelam will be responsible for this broadcast.

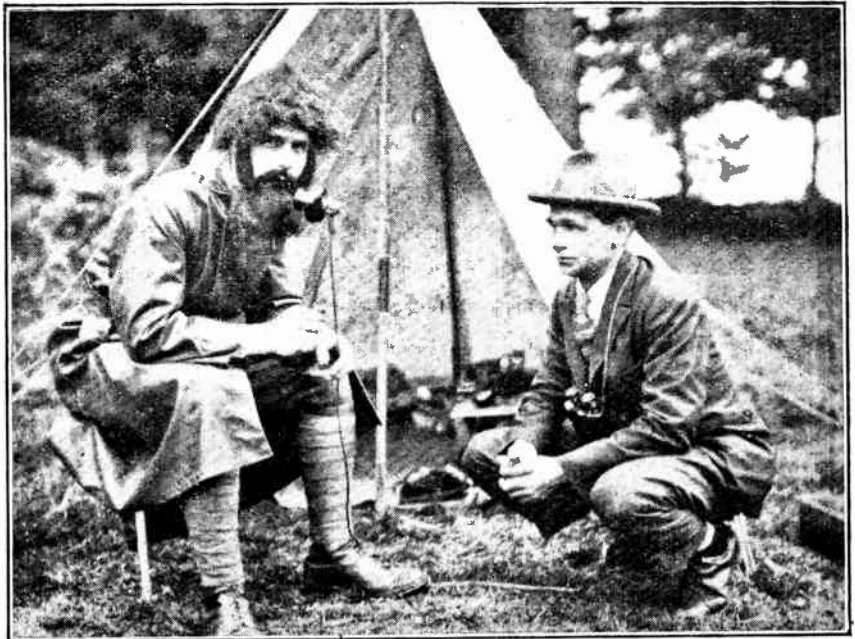

**RUN TO EARTH.** A peculiar species of wireless fugitive (on left) whose capture ended a "D.F. hunt" recently organised by the Wimbledon Wireless Society. The tracking party employed portable sets with frame aerials.

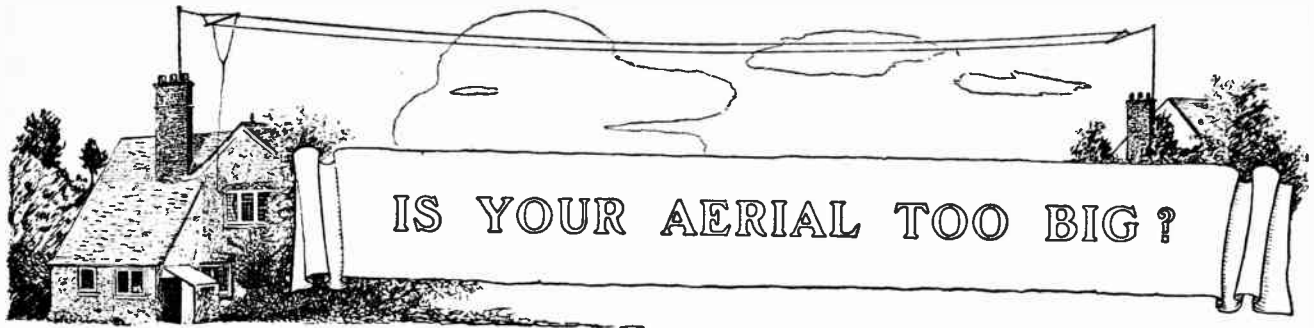

## Dimensions of the Aerial in Relation to Selectivity.

By A. L. M. SOWERBY, B.A.

THESE must be many experimenters who, during the last year or two, have built for themselves imposing multi-valve receivers with two or even three stages of tuned high-frequency amplification and have then, on putting the instrument into use, been woefully disappointed at the poor selectivity obtained. In most cases this failure to reach the high standard expected is in no way attributable to the receiver itself, but to the aerial-earth system with which it has been used; and, paradoxically enough, the better the aerial, according to ordinary standards, the more unsatisfactory it is likely to be with a big and powerful receiver.

It is usually preached that the best possible aerial is one that is erected on an open site, unshielded on all sides, and which is both high and as long as local conditions and the official restrictions permit. For a receiver for the local station only, this is no doubt true, but it is the purpose of this article to emphasise that both the distance from the nearest station and the type of receiver to be used should play a far greater part in the design of the aerial than is usually recognised. To erect an aerial with no further thought than to ensure the largest possible "collecting power" for wireless signals is far too crude a proceeding for modern conditions.

### Suiting the Aerial to the Set.

Perhaps it would be clearer to say that the aerial and the set must be designed as a single whole to perform the work that is required of them. Too many people possess an aerial erected, perhaps, in the first place to obtain maximum strength on a crystal set from the local station, and then use it indiscriminately with long-distance valve receivers of all types. The thought never occurs to them that each receiver requires a different aerial if full use is to be made of its powers.

What, then, are the qualities of an aerial that interest us from our present point of view?

The first of these, which is almost impossible to define quantitatively, may be called the "picking-up power," or sensitiveness, and may be taken to represent the total amount of power collected by the aerial. This collecting

power is a quality that is very largely under the control of the owner of the aerial, for it can always be decreased by lowering it, or by lopping off part or all of the horizontal portion, although the maximum that can be attained is to some extent dependent upon local conditions. It is with the aim of increasing this elusive quality of collecting power that aerials are periodically overhauled, re-insulated, and increased in height.

### H.F. Resistance and Aerial Dimensions.

The second interesting property of an aerial is its high-frequency resistance. This *can*, of course, be definitely measured for any particular case, and expressed as some number of ohms, but from the standpoint of the ordinary user of the aerial, even if he be experimentally inclined, the resistance is usually almost as vague a property as the collecting power. It may, however, be taken as axiomatic that the smaller the aerial the less will be its resistance, so that a small aerial will tend to give, on this score alone, greater ease in tuning out the local station.

A low-resistance earth connection, too, is of great importance, but it is taken for granted that the best in this direction has already been attained.

The loudness of signals obtained from an aerial depends on both collecting power and resistance, being greatest, of course, when the former is high and the latter low, so that if any alteration is made to the aerial it is not easy to say, at first sight, whether any improvement that may result is due to an increase in collecting power or to a decrease in resistance. One may make a shrewd estimate by observing the tuning characteristics of the aerial circuit. If the improvement is accompanied by a decided "spreading" of the local station over the dial, so that the circuit must be detuned farther than before to eliminate it, we may conclude that the collecting power of the aerial has been improved by the alteration made, but that the resistance is either unaltered, or, more probably, is greater. If, on the other hand, the increase in volume from the local station is accompanied by a sharpening of tuning in the aerial circuit, so that it is heard over no more degrees on the dial, and yet is louder when

*The large outdoor aerial was a necessity in the days when crystal sets were suitable for broadcast reception, but now that selectivity is demanded by the proposed Regional Scheme the high effective resistance of the large aerial is detrimental. Shorter aerials would therefore seem to be indicated for 1928, particularly in view of recent advances in the technique of H.F. amplification.*

**Is Your Aerial Too Big?—**

fully tuned in, it is safe to assume that the improvement is mainly due to a diminution of resistance.

These examples serve to illustrate another point—that all increase of signals due to a decrease of resistance is clear gain, since at the same time selectivity is improved. No extra power is collected, in fact, but better and more efficient use is being made of the original supply. On the other hand, an increase of signals due solely to improved collecting power carries with it, at best, some decrease in effective selectivity, since the extra power picked up from the local station causes it to be heard over a greater tuning range, and this loss of selectivity is made even more marked by the fact that the increased collecting power (probably attained by raising or lengthening the aerial) usually carries with it an automatic increase in resistance.

**Collecting Power and Selectivity.**

In erecting an aerial we must therefore keep in mind not only the question of collecting power, which is usually the only factor considered, but also the effective selectivity that is required, remembering that high selectivity can only be attained at the sacrifice of collecting power.

Further, since spark Morse, mush, and interference from tramways and electric machinery cannot be tuned out in any case, so that increased selectivity does not help us against them to any very great extent, we must assume that practically all interference arises from the local station. One of the determining factors in aerial design must therefore be the distance from the local station, for the ease or difficulty of tuning this out will fix the degree of selectivity required in the installation as a whole, the greatest selectivity naturally being required at the shortest ranges.

Clearly, if the aerial is large and high, having a big collecting power, a very considerable amount of power from the local station will be brought to the receiver, so that a number of tuned circuits will be needed to enable a distant station on a neighbouring wavelength to be heard without interference. Conversely, if the aerial is quite small, the amount of power from the local station delivered to the set will also be small, so that there will be much less difficulty in tuning it out to receive other stations. At the same time, this decrease in the size of the aerial will also lessen the power picked up from the distant station, so that it will be necessary to increase the sensitivity of the receiver.

**H.F. Amplification with Short Aerials.**

Now the most usual means of increasing the sensitivity of the receiver is to add to it one or more stages of high-frequency amplification, which necessarily involves the use of additional tuned circuits, so that selectivity is improved at the same time as sensitivity.

In designing an installation, then, the first consideration must be the degree of sensitivity expected of it; it is usual nowadays to demand that all European stations whose transmissions are sufficiently above the normal level of "mush" and general noise to be capable of affording entertainment shall be readily received after dark without the use of reaction in any form. This standard can be reached by a receiver with one efficient stage of high-

frequency amplification, together with a high and un-screened aerial. At a considerable distance from the nearest transmitting station, or if the degree of selectivity required is low, this installation will prove thoroughly satisfactory.

If a higher standard of selectivity is required, a further stage of high-frequency amplification, with its additional tuned circuit, may be added. If the original aerial is kept, it will normally be found, provided that the receiver is reasonably efficient, that the sensitivity of the installation as a whole is now considerably too high and that it is necessary to dim the filaments of the high-frequency amplifiers to prevent the detector from being overloaded with signals from all but the most distant stations. Furthermore, the local station will still be heard over quite a band of wavelengths. Additional selectivity may therefore be obtained by decreasing the size of the aerial until the original standard of sensitivity is regained, and it again becomes necessary to work the set at its fullest power, but without reaction, for the reception of the average distant station.

The net result of this change from, perhaps, 1-v-2 with full aerial to 2-v-2 with small aerial is then simply and solely a gain in selectivity, but this gain, by being due to two factors working together, is very large indeed. If still further selectivity is required, three H.F. stages may be attempted, together with a frame aerial, but the writer would warn any who may feel inclined to venture that the design of an *efficient* installation to this specification is a very tall order indeed. A more practical alternative is to retain the small aerial and the 2-v-2 receiver, but to introduce a separately tuned aerial circuit, loosely coupled to the grid circuit of the first valve. Though the gain in selectivity obtained in this way is not nearly so great, still it is by no means to be despised.

**Some Practical Observations.**

In order to fix more or less definitely the effective selectivity of various types of receiver on different aerials, some of the writer's recent experiences may be of interest.

With an aerial 4ft. high and about 9ft. long, combined with four tuned circuits in the receiver, 2LO, one and a half miles away, does not interfere when receiving stations separated from it by 30 kilocycles frequency difference, while the sensitivity of the complete installation, using three H.F. valves, is very considerably higher than is strictly necessary. The same receiver, when removed to a distance of eight miles from 2LO, but connected to a full-size outdoor aerial, will not tune that station out under 40 kilocycles difference, and practically every station received overloads the detector valve by many hundreds per cent. To obtain the required selectivity on this aerial, yet another tuned circuit would have to be added, while more than adequate sensitivity would still be obtained if one H.F. valve were removed. This aerial, in fact, is absurdly large for any receiver aiming at so high a degree of selectivity.

On a full-size aerial forty miles from the Bournemouth station the selectivity is such that that station is just inaudible when one 10 kilocycles away is being received. The selectivity here is ideal, but the sensitivity remains excessive. One H.F. stage less, and an aerial consisting of some 20ft. of wire run vertically upwards

**Is Your Aerial Too Big?—**

would just about meet the case, retaining a 20-kilocycle elimination of Bournemouth, together with sufficient sensitivity to receive any station whose signals are louder than the general level of stray noise.

Using a single stage of H.F. amplification, on the other hand (two tuned circuits), a full-size aerial is necessary if Continental stations are to be received at good strength, and the combination of a large aerial with only two tuned circuits results in extremely poor selectivity, it being difficult to separate stations 90 or 100 kilocycles from the local at a distance of a dozen miles. If any attempt is made to improve selectivity by cutting down the aerial, then the comparative insensitiveness of the receiver makes the reception of distant stations impossible (unless, of course, reaction is used; but we are considering modern receivers only). At forty miles out, however, such a receiver is extremely useful and gives a 40 or 50 kilocycle separation of the local without much difficulty, employing a full-size aerial.

**Loose-coupled Aerial Tuner.**

As an economical compromise, a loose-coupler may be added to such a set, thus adding a tuned circuit without increasing the number of valves in the receiver. Since this does not increase the sensitivity in any way, it does not enable us to diminish the size of the aerial and so does not confer quite all the extra selectivity that may be obtained by adding an H.F. stage, but for those who do not live within ten miles or so of the local station and who do not insist on tuning within 40 or 50 kilocycles of it, it can be strongly recommended.

These results are summarised in the table, in which the column headed "Selectivity" gives the separation, in kilocycles, between the local station and the distant station nearest in wavelength that can be heard without interference. The smaller this number, the greater the selectivity obtained. The number is, in fact, an indication of the number of distant stations blotted out by the local. If 20 kilocycles is the nearest possible approach to the local station's wavelength, then two stations, one on either side of it, cannot be heard through it. The number of stations lost in this way is given in the last column, headed "Stations Lost."

The figures given in the table must not be taken too literally, for they must inevitably depend, not only on the site on which the aerial is erected, but on innumerable small details of the receiver in use. But it will add some definiteness to state that they were obtained from receivers using Litz-wound coils of very low resistance, the transformer windings being proportioned for maxi-

mum amplification. Each tuned circuit was contained in a separate copper box, except in the case where two tuned circuits only were used. The receiver in this case was built on the lines of the "Everyman Four."

It must be the reader's task to use the data here given as a basis for the choice of a receiver to suit his own requirements in the way of selectivity. On the assumption that one H.F. stage is used for a full-sized aerial, two for a 20ft. vertical aerial, and either two or three for a wire strung across the room, the sensitivity should be quite adequate in all cases.

For satisfactory sensitivity, combined with selectivity of a high order, the writer would suggest the following combinations:—

Distance from Local Station.	Aerial.	Receiver.
Over 40 miles.	Full-size.	1 H.F.
15 to 40 miles.	Full-size.	1 H.F., with loose-coupler.
10 to 15 miles.	20ft. vertical.	2 H.F.
4 to 10 miles.	20ft. vertical.	2 H.F., with loose-coupler.
Under 4 miles.	Across room.	2 H.F., with loose-coupler, or 3 H.F. if required.

It must be emphasised that these suggestions are only valid if the design of the receiver is up to the highest modern standards, including Litz-wound coils, aerial tapped correctly into its tuning circuit, an anode rectifier, and the most efficient valves obtainable, the H.F. transformers being designed to extract the uttermost amplification from them. Adequate screening is also necessary where more than two tuned circuits are employed, or the selectivity will fall far below the standards given.

Aerial.	Distance in Miles.	Number of Tuned Circuits.	Selectivity (Approx.).	Stations Lost.
Full-size .....	40	2	40	6
Full-size .....	40	3	10 to 20	2 to 4
Full-size .....	40	4	10	0
Full-size .....	8	2	100	18
Full-size .....	8	3	50	8
Full-size .....	8	4	40	6
25ft. vertical .....	40	3	20	2
25ft. vertical .....	40	4	10	0
25ft. vertical .....	8	3	50	8
25ft. vertical .....	8	4	30	4
Across room .....	8	4	20	2
Across room .....	1½	4	30	4

General Electric Co., Ltd., Magnet House, Kingsway, W.C.2. New *Gecophone* Wireless Art Brochure in two colours, covering the *Gecophone* range of receivers, loud-speakers, gramophone reproducers, and H.T. battery eliminators. o o o o

Brown Brothers, Limited, Great Eastern Street, London, E.C.2. 200-page catalogue, covering leading lines of wireless sets, accessories, and components. (For *bona-fide* traders.)

**CATALOGUES RECEIVED.**

Metro-Vick Supplies, Ltd., 155, Charing Cross Road, London, W.C.2. Special Publication 7117/8, dealing with operation of radio sets direct from A.C. mains, with particulars of "Met-Vick" A.C. valves, rectifying valves, battery eliminators, etc.

Hart Accumulator Co., Ltd., Marshgate Lane, Stratford, London, E. 15. "Eminent Users of Hart Batteries," a pamphlet illustrated with portraits of celebrities who have chosen Hart batteries for H.T. and L.T. supply. o o o o

A. J. Dew and Co., 33 and 34, Rathbone Place, Oxford Street, London, W.1. 252-page catalogue of leading lines of radio apparatus and accessories, season 1927-28. (For *bona-fide* radio traders.)





## The CASE for the L.T. DRY BATTERY

- 1 The L.T. Dry Battery may be disregarded altogether until such time as it requires to be renewed.
- 2 The recharging bug-bear, inseparable from accumulators, is completely overcome by the use of a L.T. Dry Battery.
- 3 The exceptionally low internal resistance of the Siemens L.T. Dry Battery ensures that the voltage drop during normal daily use is negligible.
- 4 L.T. Dry Batteries are very suitable for use with high efficiency 0.1 ampere or 0.075 ampere valves:  
 The small sizes are suitable for use with one or two valves.  
 The larger sizes with up to 4 valves.  
 but more definite information is given in our Catalogue No. 650.
- 5 A combination of fixed resistors, with a Master variable resistance, gives the best results and is simple to operate.
- 6 The Siemens L.T. Dry Battery does not give out suddenly at inopportune moments, exhaustion being a gradual process giving ample warning of its approach. Users are delighted with the steady persistent service which they secure from these batteries.

WRITE FOR CATALOGUE No. 650.

# SIEMENS

## RADIO BATTERIES

SIEMENS BROTHERS & Co. Ltd., WOOLWICH, S.E.18.



# MARCONIPHONE

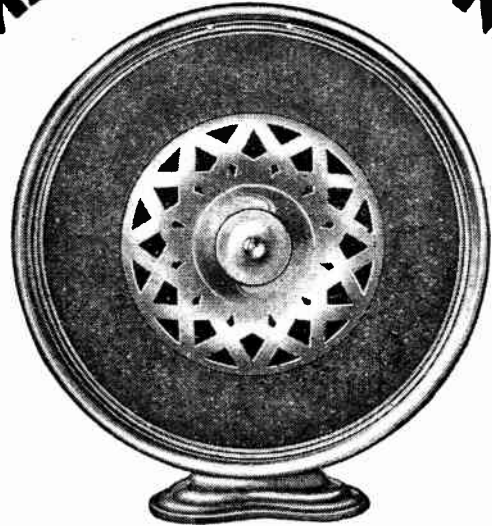

YEARS of patient research; of active experiment and then—the evolution of the New Marconiphone Cone Speakers. Nothing so strikingly distinguished, so perfect in performance, has ever appeared in loud speaker design. Never before has the acute sensitivity of the horn type speaker been combined with the greater attractiveness of the cone. For the first time, a loud speaker has been created, near enough to perfection, to honour it with the name Marconiphone.

### Marconiphone Model 175 Cone Speaker

Presents a sensitivity as acute as any horn type speaker, as well as a design of unusual distinction. A feature of no little value is the ease with which it may be kept free from dust.

75/-

### Marconiphone Model 105 Cabinet Cone

Stands out even amongst the list of triumphs achieved by the vast Marconiphone organization. Sound emission is from both sides, and whichever way the cone is turned, the entire musical scale is heard to perfection.

105/-

Full particulars from:

THE MARCONIPHONE COMPANY LTD.  
(AND REDUCED).

Head Office: 210-212, Tottenham Court Rd., W.1.  
Regd. Office: Marconi House, Strand, W.C.2.

THE CONE OF SUPERIOR PERFORMANCE.

# CONE SPEAKER

1167 E.

EVERYTHING



ELECTRICAL

**Super Power  
for Your Set!**

# DEP 240

The New Osram  
Super Power  
**2 Volt Valve**

To those who use a 2-volt (one-cell) accumulator this wonderful new valve comes as a unique opportunity for improvement of loud speaker reproduction—particularly with cone speakers.

Its use in the last stage of your set will give a new idea of the delights of perfect broadcast reception.

**CHARACTERISTICS.**

Filament Volts 2.0 max. Amplification Factor 3.5.  
Filament Current 0.4 amp. Normal Slope 1.16 ma/volt.  
Impedance 3,000 ohms.

**PRICE 20/-**

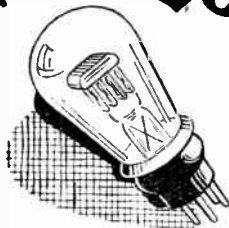

*A noteworthy addition  
to the range of*

**New  
Osram  
Valves**

*with the New Filament  
Your Dealer can Supply!*

**MADE IN ENGLAND**

*Advt. of The General Electric Co., Ltd., Magnet House, Kingsway, London, W.C.2.*

*Mention of "The Wireless World," when writing to advertisers, will ensure prompt attention.*

*Certainty!*  
**5GB - 2LO - 5XX  
& OTHERS**

with

**BRITISH GENERAL**

**AERIAL TUNING UNIT**

STANDARD  
MODEL

**18/6**

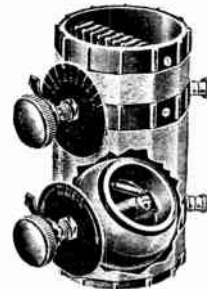

DE LUXE  
MODEL

**30/-**

Any wavelength from 250-2,000 metres by means of a simple 10 Stud Tapping Switch. No plug-in coils required; reaction smooth over entire wave-band. Simple two-hole fixing.

Can be obtained from all reputable dealers or direct from:—

**BRITISH GENERAL MANUFACTURING Co. Ltd.,  
BROCKLEY WORKS, LONDON, S.E.4.**

**CHOSEN FOR EVERY CIRCUIT  
IN "RADIO FOR THE MILLION"**

This statement speaks for itself. Belling-Lee Terminals are a perfect combination of Beautiful Finish and First class Workmanship. Bakelite insulated and made in 30 different engravings.

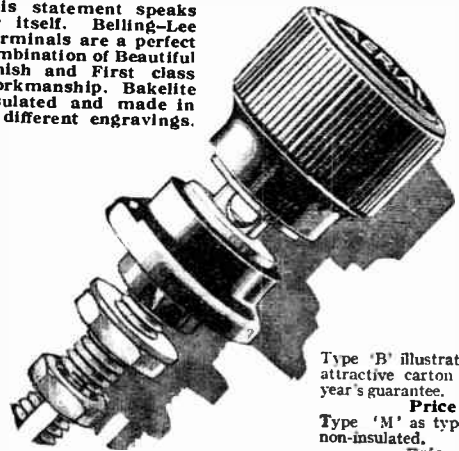

Type 'B' illustrated, sold in attractive carton carrying a year's guarantee.

**Price 9d. each.**

Type 'M' as type 'B' but non-insulated.

**Price 6d. each.**

Patented.

*Illustrated catalogue free on request.*

**BELLING-LEE  
TERMINALS**

*Belling & Lee, Ltd., Queensway Works, Ponders End, Middlesex.*



The following abstracts are prepared, with the permission of the Controller of H.M. Stationery Office, from Specifications obtainable at the Patent Office, 25, Southampton Buildings, London, W.C.2, price 1s. each.

**Directional Aerials.**  
(No. 263,753.)

Convention date (Japan): December 29th, 1925.

Directional transmission and reception is secured by means of an aerial combination of reflectors and "directors." As shown in plan in the figure, an energised

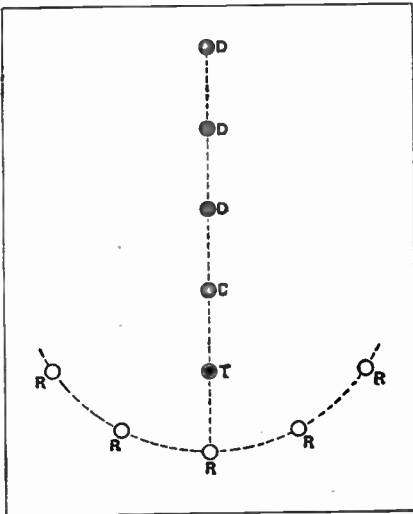

Beam transmitter with reflector and "director" elements. (No. 263,753.)

transmitting aerial T is backed by a series of conductors R, which are tuned to a frequency equal to or less than that of the signalling wave. They therefore act as reflectors. A second series of conductors marked D are arranged along the desired path of wave propagation. These are tuned to a frequency greater than that of the signalling wave, and are stated to act collectively as a wave duct or channel for the radiated energy. The phase of the current induced by the transmitter T in the conductors D "leads," whilst the current in the conductors R "lags" the induced voltage. This is stated to be the reason of the conductors D and R functioning as "directors" and reflectors respectively. Patent issued to Hidetsugu Yagi.

▲ 45

**Ultra High-frequency Generator.**  
(No. 274,183.)

Application date: April 13th, 1926.

The production of high-frequency oscillations of the order of a hundred million cycles a second, or more, involves peculiar and special problems of design. The figure illustrates a multiple-electrode generator comprising two sets of filament-grid-plate electrodes coupled together in pairs by straight wires symmetrically arranged. Certain of these rods form part of the aerial system from which the ultra-short waves are radiated. The whole system is enclosed inside an evacuated vessel.

The two sets of electrodes P, F, G are mounted at opposite ends of a sealed tube T, the symmetrical rod connectors and radiators being shown at R. Preferably the anodes are water-cooled, the liquid circulation passing through pipes W. A central steatite member S supports the rod connectors, and constitutes the point at which the low-tension voltage is applied through certain of the rods R to the two filaments. The high-tension supply to the plates passes through the water mains W.

Guard rings MM relieve the high-frequency electric stress set up in the insulating material forming the evacuated container T. The generated oscillations flow partly through the rods R connecting the two grids, and partly through the tubes W connecting the plates. The output may be radiated directly from the tube system, or the latter may be inductively coupled to a separate tuned cou-

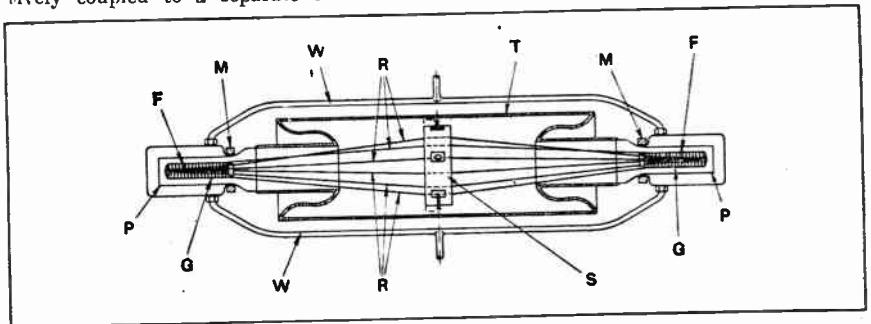

Oscillator valve for ultra high-frequency oscillations. (No. 274,183.)

ductor. Patent issued to W. J. Brown and Metropolitan Vickers Co.

o o o o

**Winding Inductances.**  
(No. 274,160.)

Application date: March 19th, 1926.

A moulded ebonite former is made in the form of a cylinder having axial ribs R out of which portions Q are cut away at intervals to take the windings. The unflattened parts of the ribs therefore project above the windings and protect

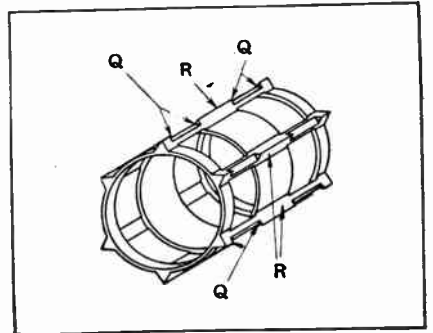

Moulded former for single-layer coils. (No. 274,160.)

them from damage should the component be dropped. The portions of the cylindrical core lying underneath the parts Q are also cut away into skeleton form as shown, so as to improve the overall efficiency of the coil. Patent issued to B. Hesketh.

**Non-radiating Receivers.**  
(No. 273,817.)

Application dates: 10th April and 20th October, 1926.

This specification is a development of previous patents taken out by Sir Oliver Lodge and his collaborators to cover what has been termed the N-circuit receiver. The basic circuit is shown at the top, and consists of an aerial connected through a choke or aperiodic coil L to earth. A single-point tapping is taken from a point *d* through a low-resistance tuned circuit (the N-circuit) to the grid of the valve. An alternative on a derived circuit is shown in the middle diagram, in which the earthed choke L is connected to the anode of the valve V, and a small blocking condenser C is inserted between the N-circuit and the single-point tapping to the aerial, the filament system being left unearthed. The earthed anode is connected through a pair of telephones, or the primary windings of a transformer or choke, to the high-tension battery.

It is stated that incoming signals periodically raise and lower the potential of each point in the aerial over which they pass, so that the point *d* will supply impulses to build up oscillating voltages

in the low-resistance N-circuit. The object of the choke coil L is to divert only sufficient energy from the aerial to stimulate the N-circuit. It must not be tuned to the incoming signals, and certainly not to the N-circuit, otherwise undesirable re-radiation will occur. The earthing of the anode shown in the middle diagram provides a certain degree of regeneration and assists to stabilise the circuit as a whole.

The lower diagram illustrates a practical receiving circuit embodying the above principles, in which, however, a connection O between earth and filament is shown. The blocking condenser C is here inserted between the N-circuit and grid, whilst reaction is provided by a condenser C<sub>1</sub> connecting the anode of the valve to the tapping point *d*. A switch S allows a choice of by-pass condenser across the low-frequency transformer T according to whether long- or short-wave signals are being received. N-circuits may also be inserted in the intervalle couplings, and high-frequency stages may be added. The same principle is also described as applied to a crystal receiver. Patent issued to Sir O. J. Lodge, E. E. Robinson, and M. M. Melinsky.

**Smoothing Units.**  
(No. 273,798.)

Application date: 6th April, 1926.

In order to reduce the risk of short circuit where smoothing condensers are inserted directly across the high-tension mains, the latter are first bridged by a resistance R, and auxiliary by-pass condensers C are then shunted across the various tapping points T. One or more chokes K, and an additional series resist-

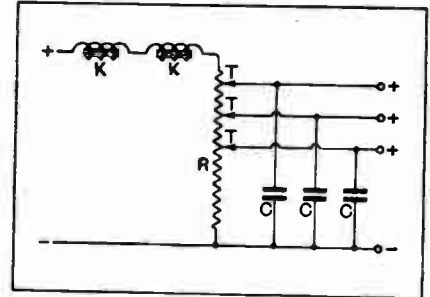

**Protected smoothing circuit.**  
(No. 273,798.)

ance if necessary, are inserted in the positive lead from the mains. For alternating current a suitable rectifier of the chemical, mechanical, or valve type is incorporated. The condensers are automatically discharged through the bridging resistance R when the supply is cut off, thus preventing any risk of shock from residual charges. Patent issued to F. Thornton, Ltd.

**BOOKS RECEIVED.**

*The Thermionic Valve*, its construction, action and control, by Fred Goddard, pp. 192, with 86 diagrams and appendix containing short glossary of technical terms, values of standard coils, Morse code, and selected call signs of broadcast-stations.

*The Four-Electrode Valve*, by Fred Goddard. Pp. 105, with 64 diagrams. Both the above published by Mills and Boon, Ltd., London. Price 3s. 6d. each, net.

*Transformatoren Verstärker*. Theory and practice of transformer design, by Dr. Ing. Ludwig Müller and Manfred von Ardenne. Pp. 137, with 66 illustrations and diagrams. Published by R. C. Schmidt and Co., Berlin. Price Rm. 4.

*On the Air*. A collection of short stories based on wireless subjects, by Paul Deresco Augsburg. Pp. 274. Published by D. Appleton & Co., New York and London. Price \$2.

*Wireless Loud-Speakers*. A practical manual describing the principles of operation, performance and design (2nd edition revised and enlarged), by N. W. McLachlan, D.Sc., Eng. (London), M.I.E.E., F.Inst.P. Pp. 139, with 86 illustrations and diagrams. Published by Iliffe and Sons Ltd., London. Price 2s. 6d. net.

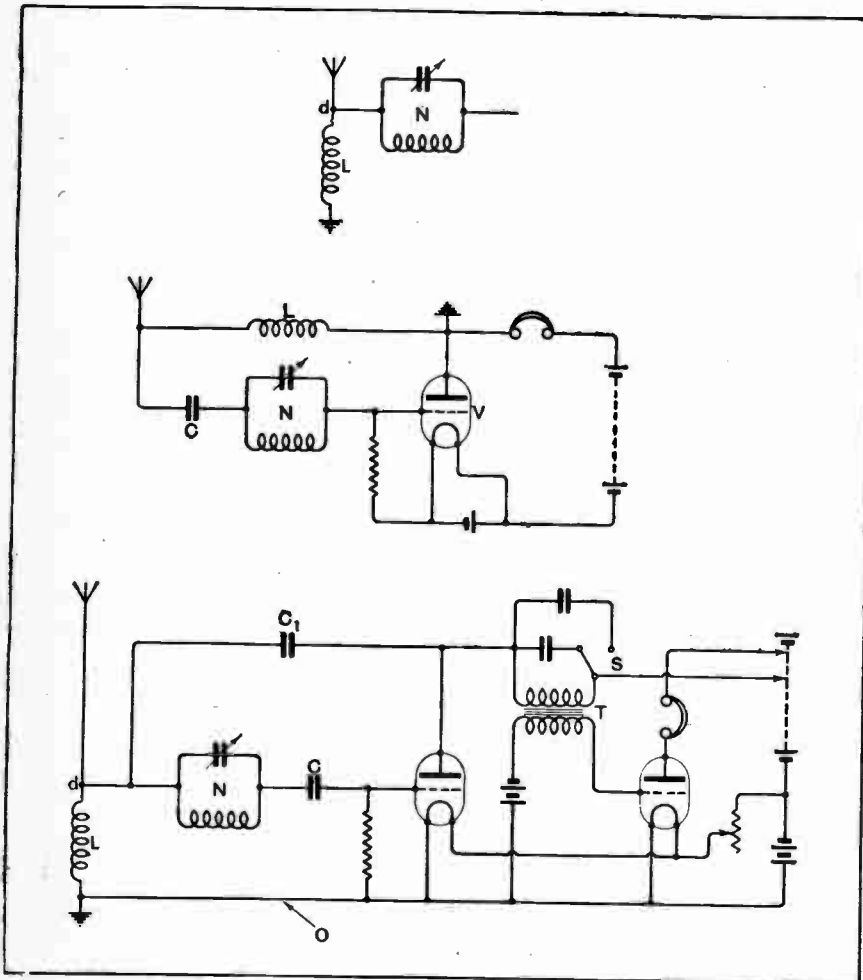

**The Lodge "N"-circuit.** (No. 273,817.)

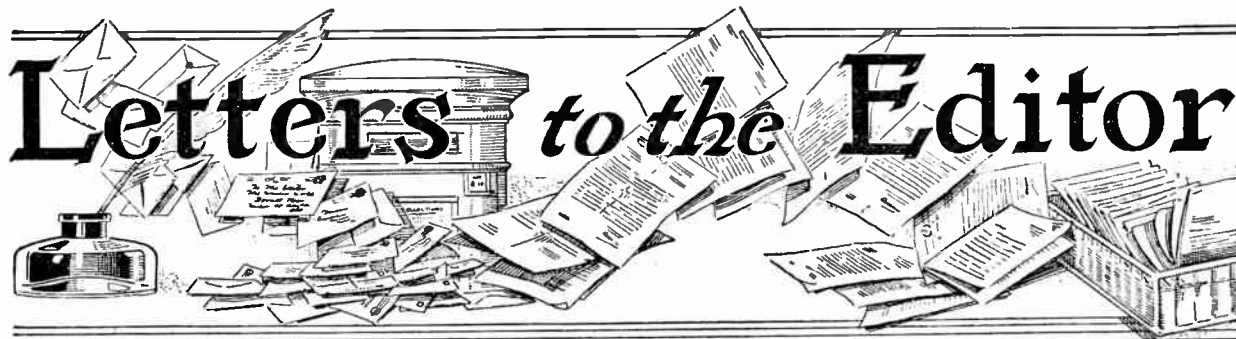

# Letters to the Editor

The Editor does not hold himself responsible for the opinions of his correspondents.

Correspondence should be addressed to the Editor, "The Wireless World," Dorset House, Tudor Street, E.C.4, and must be accompanied by the writer's name and address.

## THE PROBLEM OF H.T. UPKEEP.

Sir,—May I be permitted to comment on your correspondent's letter concerning H.T. upkeep?

He suggests that a saving in H.T. upkeep might be effected by the development of an improved double-grid valve, but is it not a fact that such valves are designed to have a specially low anode impedance and consequently, with the additional current taken by the second grid, throw an enormous load on the H.T. battery?

In a typical modern multi-valve receiver all the valves except the last may consume only a fraction of a milliamp. each. It is the last valve which takes the heavy anode current, since it has to supply a certain output of power.

Now, it seems to me that, with dry batteries, at any rate, the requisite power is more economically obtained by applying the maximum permissible voltage to an ordinary power valve, rather than by increasing the already heavy anode current to the last stage by using a four-electrode valve. The principal fault lies with the loud-speaker, and until we can induce this instrument to utilise more than a few per cent. of its input we must continue to supply it with power on an extravagant scale—and this from the H.T. battery. Of course, we may supply the last stage from an H.T. accumulator or, better still, from the mains. This last possibility suggests that the most profitable line of development of four-electrode valves lies in the direction of evolving a valve to work off, say, 200 volts H.T., and with an output equal to a bank of L.S.5A's supplied with several hundred volts H.T.!

The development of the independently heated cathode may make this possible, and a valve with such a "punch" would be a real boon to those experimenters whose ambition is to be able to fill the Albert Hall with the output from a coil-driven cone. It would be interesting to hear the opinions of others on the above points.

H. P. MARKS.

London, N.10.

September 22nd, 1927.

## LEGISLATION FOR AMATEUR TRANSMITTERS.

Sir,—Mr. E. A. Dedman's anxiety for the future of the British amateur short-wave transmitter is surely unnecessary. In Continental countries, where any expression of individualism is vigorously discouraged, the cause of "ham radio" may hang in the balance. But in the British Empire and the U.S.A., where "Liberty" is the watchword, shall this fine brotherhood of transmitters be suppressed?

The business is a question of reconciling the interests of an enthusiastic minority with the interests of an apathetic majority. There are only two arguments against amateur transmission: (1) That private stations may engage in the exchange of private messages against the interests of the State, which in this country has the monopoly of communication. (2) That private stations may interfere with the reception of broadcasting stations and the working of commercial and service stations.

It is a matter of honour with all British transmitters that they adhere to the terms of their licences; and a matter of honour with transmitters of every country that their interests

are unselfishly subservient to the interests of broadcast listeners. Thus, those two objections are immediately refuted.

There remains a long list of pros: the splendid international fellowship of amateur transmitters; the development of a trained band of technical and telegraphic experts whose experience is gladly at the disposal of Government and "B.C.L." alike; the enlarged field of opportunity for invention and discovery, for the amateur transmitter is *the experimenter par excellence*.

There is plenty of room for commercial, service, broadcast and amateur interests on short waves, and a British amateur can trust *his* Government to play fair with him. QRX.

September 28th, 1927.

## TELEVISION IN 1925.

Sir,—With reference to the letter on this subject, published in the September 28th issue, Mr. John Hays Hammond, jun., does not appear to be aware that Mr. Jenkins' experiments have not progressed further than the transmission of moving pictures, using a cinematograph film at the transmitter.

There is a vast difference between the transmission of motion pictures and television. In the former case results are achieved by means of a powerful light beam shining directly on the light-sensitive device through the film, *i.e.*, by transmitted light. In the latter case the images of actual living scenes are transmitted from one place to another by means of light *reflected back* from the scene on to the light-sensitive device.

The importance of the difference lies in the fact that reflected light is always many hundreds of times weaker than directly transmitted light, requiring the use of a vastly more sensitive light-sensitive device.

A. DINSDALE.

Evanton.

September 29th, 1927.

## EMPIRE BROADCASTING.

Sir,—You will be interested to hear that I have built the short-wave set described in your issue of June 29th, and that yesterday I heard quite clearly an excellent concert transmitted from Eindhoven. This is good work for two valves at 5,000 miles, and I congratulate and thank the designer of the set.

I have made only a few very minor modifications of the design, just different spacing owing to the fact that the particular components recommended were not available here, and a copper-lined wooden box instead of the aluminium cabinet.

How soon may we expect to hear an English station?

Mungpo, Bengal,

B. E. SHAW.

August 31st, 1927.

Sir,—As an old reader of six years' standing, may I say a few words on Empire broadcasting?

I fear that for once your extraordinary (and almost inexplicable) enthusiasm for Empire broadcasting has overweighed your usual dignified, calm and moderate views and opinions.

I agree with Capt. Eckersley and the B.B.C., that the time is not yet ripe for the B.B.C. to launch a 24-hour service on

short waves. Being the owner for over twelve months of a high-grade short-wave set (and being a more or less handy constructor) I really fail to see what chance there is of getting a really stable service over such enormous distances on such tricky wavelengths.

After a week of late nights pottering about with a short-wave set every Colonial will seek his sleepless couch and wish the British short-wave station further. The tuning is far too critical for ninety-nine people out of a hundred, and the static is usually greater than signal strength. I find distant listening interesting but extremely fatiguing and nerve racking.

So if you persist in your present policy you will soon have the short-wave enthusiasts of the British Empire suffering from acute neurasthenia.

If they want decent broadcasting, let them have a station of their own. No short-wave broadcasting is worth listening to from a musical point of view—it is simply abominable.

I only wish, instead of urging for an Empire short-wave station, you would urge for a crystal service for poor old Cornwall and Devon. Daventry Senior varies here, and Daventry Junior fades badly and is interrupted by Morse.

Give us a crystal service and let the British Empire look after itself. It is quite capable of it. GEO. LAITY.

St. Columb, Sept. 17th, 1927.

Sir,—My congratulations upon the splendid stand you have made in the interests of Empire broadcasting and to Gerald Marcuse for the excellent transmissions, restricted though they may be.

I sincerely hope that as a result of this the British public will give the credit, which is admittedly due, to the splendid band of amateurs who, in spite of bureaucratic red tape, are doing their bit to keep alive that fine British pioneering spirit.

One wonders whether, had there been a body like the B.B.C. in control of this country's destiny for centuries past, if such a thing as the British Empire would have existed.

We receive 2FC on the short waves—truly an instance of the children bringing up the parents.

To prate about quality is to flounder in seeking an excuse or perhaps a nice way of climbing down without a sacrifice of dignity. No amateur listener ever expects to obtain the same quality of reception over long distances as from the local station.

Let the B.B.C. highbrows and "nobrows" listen to PCJJ's radio acknowledgments of regular reception by Britishers in the Antipodes—that should convince them that Empire broadcasting is possible. Were this the only blunder of the B.B.C.

one might be tolerant in this matter. British broadcasting brought up within the protective shadow of a State monopoly has been nothing but a series of blunders. First the licence question, then the programmes, followed by "ducks and drakes" with the wavelengths; and finally, a refusal to consider Empire broadcasting.

ARNOLD J. I. BRADLEY.

Walsall,  
September 24th, 1927.

MORSE ON THE SOUTH COAST.

Sir,—I have always heard that Morse interference was bad on the coast, but I doubt whether anyone who has not experienced it can have any conception how bad it is. I have recently moved from London to Brighton, and it is no exaggeration to say that it is useless to try to listen to anything on the medium waves, for the programmes are utterly ruined by a continual undercurrent of Morse from ships in the English Channel.

I wrote to the B.B.C. and received a courteous letter in reply stating that they knew of the Morse interference, and that they were compelled to ask those who lived outside the service area of a main station to listen to 5XX. I can only say that there is a Morse station close by here operating on practically the same wavelength as Daventry.

It seems to me that it is useless to think about regional schemes, Empire broadcasting, etc., until the home listener is given value for his money. The whole energies of those connected with wireless should be employed in clearing the Morse off the broadcast wavelengths. Until that is done one might as well scrap one's set and go in for some other form of amusement.

A. H. B.

September 3rd, 1927.

BATTERY ELIMINATOR OF A.C. AND D.C.

Sir,—Herewith I am enclosing a circuit diagram of my "All Mains H.T. and L.T. Battery Eliminator," which I hope will be of some interest to your readers. In the issue of your journal for August 17th, 1927, the "Information Department" gave a circuit diagram, in reply to a question, of the "B.B.C. Two-valve Receiver" drawing both H.T. and L.T. current from D.C. mains. As circumstances compel me to change my residence frequently, where I would sometimes meet with A.C. mains and sometimes with D.C. mains, I experimented with the circuit enclosed, and it solved all my difficulties with regard to current supply.

It will be seen from the diagram how this is done, by means of an ordinary double-pole, double-throw switch (S<sub>1</sub>). I have with D.C. mains. The rest of the circuit is quite simple and straightforward, using a full-wave transformer and Marconi U.5 valve for rectification of the A.C. mains. It will be noticed that I have employed ordinary lamps for resistance, similar to your circuit of the "B.B.C. two-valve receiver," but I have arranged also inserted a "break" switch (S<sub>2</sub>), which is kept open when using the unit them in a slightly different manner, since no possible harm can be done by "shorting" the H.T. terminals. Of course, fuses may be inserted. Also, by plugging in different wattage lamps, one may obtain any voltages one requires. The same applies to the L.T. voltage; but this is mainly controlled by the resistance, R<sub>2</sub>.

R. N. CARTER.

London, W.9,  
August 25th, 1927.

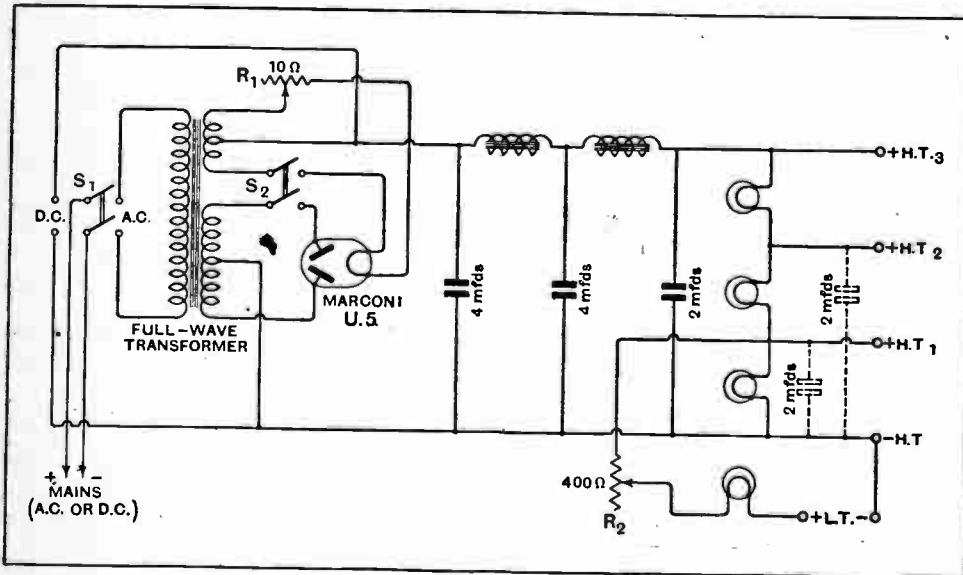

Circuit diagram of combined A.C. and D.C. battery eliminator constructed by Mr. Carter.

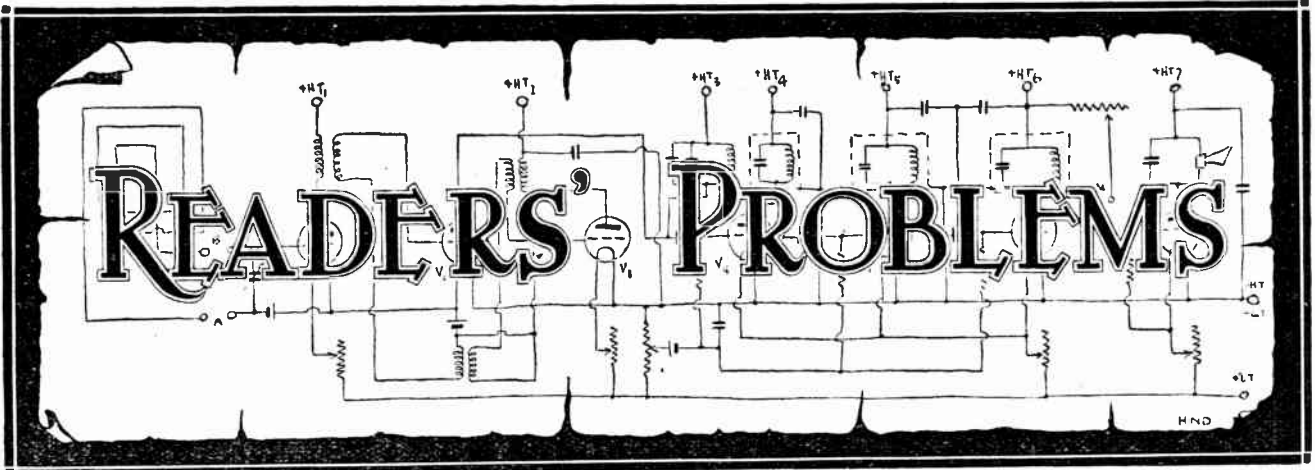

"The Wireless World" Information Department Conducts a Free Service of Replies to Readers' Queries. Questions should be concisely worded, written on one side of the paper, and headed "Information Department." One question only should be sent at a time, and must be accompanied by a stamped, addressed envelope for postal reply. Any diagram accompanying the question should be drawn on a separate sheet. No responsibility will be accepted for questions sent in which do not comply with these rules.

**Reducing Capacity of Variable Condensers.**

I have a 0.0005 mfd. variable condenser and now desire to reduce the maximum capacity to 0.0003 mfd. I understand that to do this it is necessary to connect a fixed condenser in series with the variable. Can you tell me the value of the fixed condenser required? M. E. D.

If you connect a fixed condenser of 0.001 mfd. in series with your 0.0005 mfd. variable condenser, the effective maximum capacity of this will now be reduced to 0.0003 mfd. This will be sufficiently near to the value required for all practical purposes. The method of calculating the resultant capacity when two or more condensers are connected in series, or parallel, was explained to a reader, "P. R. E.," on page 574 in our issue of May 4th last.

**Necessity for Choke-capacity Output.**

I have recently purchased a battery eliminator to replace my dry batteries (H.T.), but unfortunately cannot get this to function in a satisfactory manner. The receiver used is a "straight" detector and 2 L.F. The first L.F. stage is resistance-capacity-coupled and the second transformer-coupled. When the eliminator is switched on a "popping" noise is heard and signals are very distorted. This "popping" cannot be cured by adjustment of H.T. or grid bias, and I should be obliged if you can suggest a cure. R. J. C.

Your trouble is due to low-frequency oscillation of the L.F. portion of the receiver, and is brought about owing to a feed-back of energy from the output of the receiver to the detector valve. This takes place via a resistance which is common to the various H.T. leads and is represented by either the potential divider or series resistances in the battery eliminator, these being necessary to enable a

lower voltage than the mains voltage to be available at the output end for receiving purposes. This feed back can be overcome by making use of a choke-capacity output circuit, as shown in Fig. 1, from which it will be seen that the low-frequency oscillations pass from the anode of the output valve via the 4 mfd. condenser to the loud-speaker and thence direct to L.T.—. If the loud-speaker was connected in the anode circuit of this valve, the oscillations would then have to pass through the H.T. unit before returning to L.T.—, and owing to the common resistance a portion of these oscillations would be fed back to the detector stage.

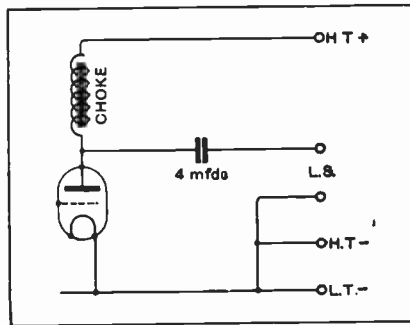

Fig. 1.—Typical choke-capacity output circuit.

Where an L.F. transformer is employed in the second stage, this tendency to low-frequency oscillation can, in some cases, be combated by reversing the secondary connections to the transformer. Although this reversal of connections may lead to a cure, it is nevertheless recommended that choke-capacity filters should be used when battery eliminators are employed. Apart from acting as a safeguard for the loud-speaker windings, the filter circuit localises the H.T. supply and obviates the necessity of passing this through long lengths of flex, as would be the case when the loud speaker is located at a distance.

**Testing a Valve.**

I understand that a valve which is believed to be faulty can be checked by an emission test. Could you give me any information on the method to adopt in a test of this nature? B. H. S.

Present-day valves of the dull emitter type may lose their emission if an excessive voltage is connected across the filament or a very high value of H.T. applied to the anode, with an inadequate value of negative bias on the grid. The method of checking the emission of a valve and a suitable test board for this purpose was described by "Empiricist" on page 695 in our issue of June 1st last, and we suggest you refer to this for the desired information.

o o o o

**A Case for Experiment.**

I am about to construct a battery eliminator for use with a five-valve receiver. The supply is 240 volts D.C., and I propose to connect the filaments of the valves in series, using 0.1 amp. valves in the first four positions, and a super-power valve taking 0.25 amps. on the filament as an output valve. Can you give me a complete circuit diagram, including at least two H.T. voltage output terminals? D. S. G.

We think that your project is an ambitious one, and not to be undertaken without full realisation of some of the difficulties likely to be encountered. It will be necessary to connect resistance of suitable value across the filaments of those valves taking 0.1 amp., and these valves must be so chosen that 0.1 amp. only passes through the valve. You could, of course, adopt a system of series-parallel connections for the valves. The filaments of the first two valves could be connected in parallel, and these connected in series with the third and fourth valves, these also having their filaments in parallel.

With the above arrangement it will still be necessary to have resistances across the valves taking less than 0.25 amps., but in this case their value need not be so high as when all valves are connected in series.

In view of the above, we would not feel justified in giving a circuit diagram without previously carrying out experiments on the lines indicated, for the reason that it would be difficult to foresee, from the theoretical circuit, all the "snags" that might be encountered.

o o o o

**Short-wave "Super" Sets.**

*I understand that it is possible to connect a short-wave receiver to the input terminals of a good broadcast receiver such as the "Wireless World Five," and so obtain vastly increased range and signal strength. Is this so, and, if it is, would you tell me exactly how to connect up?*

P. R. G.

If you mean that you have been told that you can connect up an ordinary type of short-wave receiver in the manner described, your informant is totally wrong. We think, however, that your informant was meaning that it is possible to connect a short-wave detector, and an oscillator valve in front of a receiver such as the "Wireless World Five," and so produce a short-wave superheterodyne by using the tuned H.F. stages of the broadcast receiver as an intermediate amplifier. This idea is by no means a new one, and has been exploited on many occasions. In order to achieve success the short-wave detector and oscillator unit must be very carefully designed. It is often found, however, that with a really good two-valve short-wave receiver, such, for instance, as the one described in our June 29th issue, it is possible to obtain results which are fully as good as those obtainable with the much more complicated and expensive apparatus which we have mentioned.

o o o o

**Batteries Abolished.**

*Some time ago you published in your journal a description of an instrument for obtaining all power from the mains, the instrument being either suitable for D.C. or A.C., a photograph of the instrument also being published. Could you explain to me how this instrument worked, and whether I can obtain one?*

T. F. C.

The instrument to which you refer was called the "Thermoformer," and was described in our issue of November 26th, 1924, it being marketed in America by the Sabin Electrical Products Co., Jersey City, U.S.A. It depended for its action upon the fact that if two metals are joined together and the junction heated in some manner, a difference of electrical potential will be set up between the far end of one metal and the far end of the other. We illustrate this clearly in Fig. 2 (a). Bismuth and antimony are the most common metals used in thermocouples, although various other metals and alloys will give results. The differ-

ence of potential is small, but it is possible to use several couples in series, such as we illustrate in Fig. 2 (b), it being necessary to heat each alternate junction, the other junctions being kept comparatively cool with respect to the hot junctions. This resulted in a battery of thermocouples, and an unlimited number of couples could be connected up in this manner to give a large voltage. The method of applying the system to a wireless receiver is clearly shown in Fig. 2 (c), which we think scarcely needs explanation. It is shown in conjunction with a single valve set just for explanatory purposes. In the "Thermoformer" the hot junctions were kept hot by means of electrical heating, but as will be seen from our sketch, there was no electrical connection whatever between the electrical heater attached to the house

it is obvious that the system could be arranged to operate from oil heaters for remote country districts where neither gas nor electricity was available.

It will be seen that we appear to have got an almost perfect battery eliminator, and in theory this is true, but in practice the prospects of this system becoming universal are by no means very bright at the present moment. It will be realised that there must be a very great energy lost in the heater, and the power, for instance, which was drawn from the mains to operate the heater is out of proportion to the output given, and consequently, from a purely economical point of view, the scheme could not at present become a really practicable one. In the actual "Thermoformer," which was designed solely for the electric mains, special arrangements were

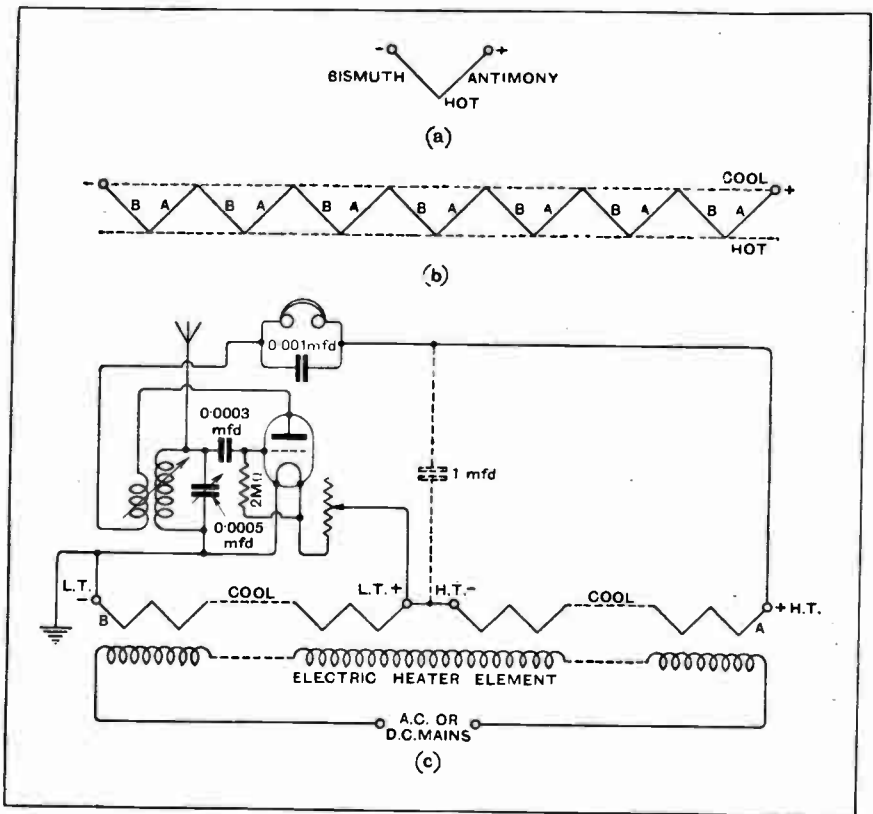
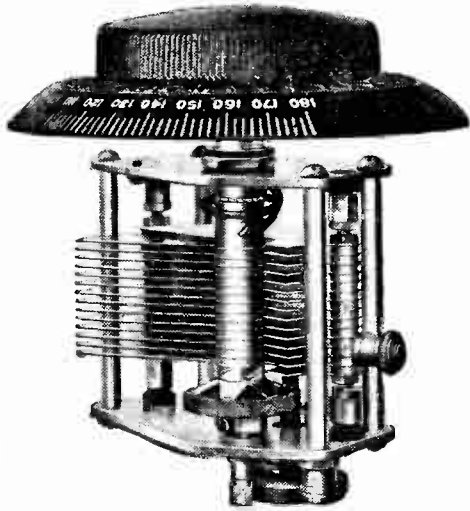

Fig. 2.—This type of H.T. and L.T. battery eliminator has the advantage of requiring no smoothing circuit.

lighting mains and the circuits of the receiver. Consequently no smoothing circuits whatever were needed, and, moreover, the instrument could be equally well plugged into A.C. or D.C. mains, since the mains merely heated the ordinary heater element. It will be appreciated that this system could also be applied with equal effect to the gas mains, and so we might have what could be called a battery eliminator for gas mains, it being merely necessary to build an instrument so that special gas burners were arranged to heat the hot joints. To carry the point further still,

made so that the heater element was very close indeed to the joints which had to be heated, and the whole instrument was arranged to give as small a loss of energy in the form of heat as possible. Although, therefore, at present this form of complete battery eliminator (for grid bias could, of course, also be taken in this manner) is not likely to make its appearance as a practicable proposition in this country, undoubtedly the idea has great possibilities for keen experimenters. It should be pointed out that sometimes these instruments are known as "Thermopiles."





**Brandes Variable Condenser  
'0003 at 15/- '0005 at 15/6**

(Continued)

retaining the compactness so essential in an instrument at the back of the panel.

A positive movement for approximate setting is obtained by turning the 4-inch diameter dial, which is provided with finger grips for this purpose. The final critical setting is obtained by turning the 2½-inch knob which actuates the slow-motion mechanism. Low di-electric losses and the complete absence of backlash are ensured.

**OTHER BRANDES PRODUCTS :**

- The Brandeset IIIa .. £6 : 15 : 0
- The Ellipticon .. .. 4 : 15 : 0
- The Brandola .. .. 2 : 17 : 6
- The Table-Talker .. .. 1 : 10 : 0
- The Table Conc. . . . 1 : 19 : 6
- The Audio Transformers 15/- & 15/6
- The Matched Tone Headphones 13/6

Send coupon for full information.

# Brandes

*the name to know in radio.*

*—fine critical setting  
& uniform separation*

The Brandes Variable Condenser brings the most nerveless hand a faculty for expert delicacy over the sensitive spots.

It is sturdily built and gives clear-cut tuning and precise operation. It is obvious that a condenser in which the dial reading varies directly as the frequency will give a more uniform separation of stations than one in which the dial reading varies directly as the wave-length. This is particularly apparent in the Brandes Condenser, and is most pronounced in the lower wave-lengths.

This condenser has been specially designed to provide a straight-line frequency tuning characteristic and to bring in the B.B.C. Stations well spaced out over the major portion of the dial, at the same time

A typical tuning curve is shown below:—

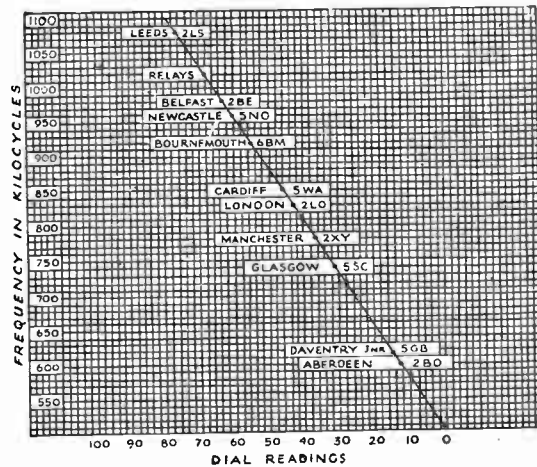

Actual curve of Brandes '0005 mfd. S. L. F. Slow Motion Condenser used with a loose-coupled circuit comprising No. 35 untuned aerial coil and No. 50 tuned secondary coil.



Brandes Ltd.,  
2/3, Norfolk St., Strand,  
W.C.2

Please send me your free  
illustrated catalogue.

Name.....

Address .....

W.W.2

Brandes products are only obtainable where you see this sign.

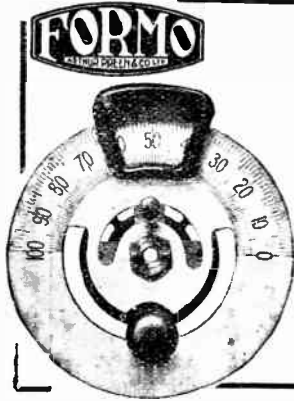

**ILLUMINATED DIAL**

**9/6**

Complete with Bulb.

An elegant and perfectly made Dial for mounting behind the Panel. Push-Pull Switch controls lighting. Easy to mount, and can be fitted to any Standard Condenser.

**THE FORMO COMPANY,**  
Crown Works, Cricklewood, N.W.2.

Phone: Hampstead 1787.

Full Catalogue Free on Request.

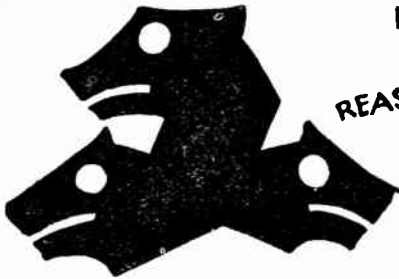

**EXTRAVAGANT  
QUALITY  
REASONABLE PRICES**

No money and no pains have been spared to make Hydra Condensers "the Zenith of Quality" yet owing to modern methods of manufacture and a great demand the prices are exceedingly reasonable. Aren't they?—

Prices: Tested on 500 volts D.C.  
1 mfd., 2/6 2 mfd., 3/6 4 mfd., 5/3

Prices: Tested on 750 volts D.C.  
equal to 500 volts A.C.

1 mfd., 3/- 2 mfd., 4/6 4 mfd., 6/9

Inquire for prices of Condensers tested at 1,000, 2,000, 4,000 and 6,000 volts D.C.

From all good dealers or direct from

**LOUIS HOLZMAN**

109 Kingsway, London, W.C. 2.

Telephone: Holborn 6209.

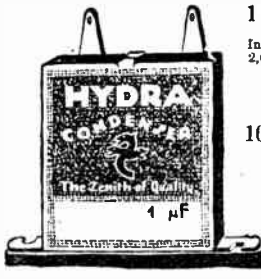

**HYDRA**

**OVERNIGHT**  
BATTERY CHARGER



LET the world famous OVERNIGHT battery charger rid you of all L.T. problems. It is made for and supplied complete with the equally world famous Philips Valves.

Model A.1. L.T. & H.T. 55/-  
Model A.2. L.T. only - 42/6

Obtain your OVERNIGHT to-day and your batteries will be charged to-morrow. Guaranteed absolutely silent, safe, and self-regulating.

Full particulars of OVERNIGHT Chargers, SUPRECISION A.C. Eliminator Components, and Measuring Instruments of every description from:—

**F. C. HEAYBERD & CO.**  
8/9, Talbot Court, Eastcheap, E.C.3  
(One minute from Monument Undg. Station)



**BRASS PULLEYS**

with close fitting wheels so that halyard cannot jam, straining screws rust-proofed all over, including thread. Pulleys at

1/- each. Straining screws at 1/6 each, post free.

Trade Enquiries Solicited.

**HILDICK & HILDICK,**

PLECK ROAD, WALSALL.



**CONDENSERS SPECIFIED IN**

**"RADIO for the MILLION"**

The experts who compile the famous P.M. publication "Radio for the Million" specify J.B. S.L.F. Condensers for their Star Receiver, the Nelson P.M. This must be of the greatest interest to all Radio enthusiasts, who realise that the designers of these sets specify nothing but the best.

Be guided by the expert, and ask your dealer for the Condensers which bear the Trade Mark J.B.

**THE PERFECT FIVE.**

1. J.B., S.L.F. Slow Motion. (J.B. True Tuning S.L.F.) Double Reduction Friction Drive. Ratio 60-1. Prices, complete with 4" Bakelite Dial for coarse tuning and 2" Bakelite knob for Slow Motion Device. '0005 mfd. 16/6; '00035 mfd. 15/6; '00025 mfd. 15/-; '00015 mfd. 15/-.
2. J.B., S.L.F. Prices, complete with 4" Bakelite Dial. '0005 mfd. 11/6; '00035 mfd. 10/6; '00025 mfd. 10/-; '00015 mfd. 10/-.
3. J.B. Log. Plain. Prices, complete with 4" Bakelite Dial. '0005 mfd. 11/6; '00035 mfd. 10/6; '00025 mfd. 10/-; '00015 mfd. 10/-.
4. J.B. Log. Slow Motion. Double Reduction Friction Drive. Ratio 60-1. Prices, complete with 2" Bakelite knob for vernier control and 4" Bakelite Dial for main control. '0005 mfd. 16/6; '0003 mfd. 15/6; '00025 mfd. 15/-; '00015 mfd. 15/-.
5. J.B. Neutralising Condenser. Price 3/6.

**JACKSON BROS**  
8, POLAND ST- OXFORD ST  
LONDON - W 1 Telephone - GERRARD 7414



**THE 'DYNIC' D.C.**

**REGULATOR**

for using current from D.C. mains

**DOES AWAY WITH THE NECESSITY FOR HT BATTERIES**

Single tapping models, price	£2. 7. 6
5 " " " from	£3. 0. 0
10 " " " " " "	£3. 10. 0
Super Heterodyne " " " "	£5. 15. 0
Special Model for Marconi- phone Straight Eight, price	£6. 10. 0

(Postage 1/-)  
Infinitesimal running costs.  
**JONES & STEWART,**  
247a, St. Vincent Street, GLASGOW, G2.

Phone: Cent. 4392. Telegrams: "Gadgets."



Mention of "The Wireless World," when writing to advertisers, will ensure prompt attention.

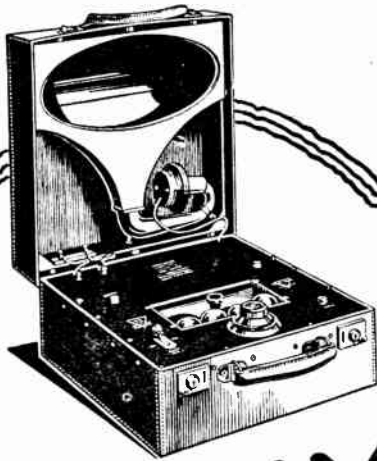

# THE ONLY PORTABLE-

The Langham Portable is the only portable of its kind. There is no aerial, no earth, and only one tuning control—everything is contained in one solid leather case. The model illustrated has a full continental range up to 1,000 miles and gives perfect loud speaker reproduction anywhere.

A week's free trial, 12 months' guarantee. Yours for only £5 deposit. Balance by small monthly instalments.

**WRITE FOR FULL PARTICULARS.**

The new Langham Transatlantic Portable exhibited at the Radio Exhibition is the talk of two continents. It is the only portable in the world that has received the United States on 'phones and loud speaker.



Langham Radio, Albion House, 59, NEW OXFORD St., W.C.1.  
Telephone: Museum 2878 & 8293.

T.M.C.D.  
48

DO YOU

??  
SAVE MONEY?

DO YOU SAVE MONEY BY USING

“**VARTA**”  
MONOBLOCKS  
FOR  
RADIO H.T. SUPPLY



“VARTA” 20 VOLT H.T. MONOBLOCK TYPE “WA” (with one tapping at 10 volts).

PRICE NOW REDUCED TO  
**9/-**

THUS A 60 VOLT BATTERY OF 3 “VARTA” MONOBLOCKS COSTS 27/-, JUST 3 TIMES AS MUCH AS A DRY BATTERY,

AND LASTS INFINITELY LONGER.

“Don't scrap—recharge.”

WRITE FOR LIST Nos. 1, 2 & 3 to

A.F.A. ACCUMULATORS LTD., 120, Tottenham Ct. Rd., W.1

**EVERYMAN FOUR COILS.**

There is no need to wait days for the correct coils for this popular and highly efficient receiver.

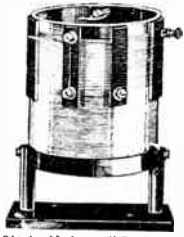

"FINSTON" Coils are wound exactly to designers specification, with 27/42 wire and are supplied complete with Ebonite Supports and Base.

**AERIAL COILS 14/- TRANSFORMER 15/-**  
Complete Set 28/-.

If your Dealer is sold out tell him we guarantee to supply by return of post.

We supply Coils and Transformers for all "Wireless World" sets.

Full details will be sent free on request.

Obtainable from all Dealers or

**FINSTON MFG. CO., LTD.,** 45, HORSEFERRY ROAD, LONDON, S.W.1.

# Trelleborgs

**GUARANTEED GENUINE EBONITE**

THE FINEST QUALITY PANEL OBTAINABLE.

**ONLY 1/2d.** Retail Price per square inch.

STANDARD GLOSSY FINISH 3/16" THICKNESS.

Other prices:— $\frac{3}{8}$ " Highly Polished, 3d. per sq. in.;  $\frac{1}{4}$ " Standard Glossy, 2d. per sq. in.;  $\frac{1}{2}$ " Highly Polished, 1d. per sq. in.

**MAINS POWER AT A TOUCH FROM THE NEW**

# EKCO

**ONLY 17'6**

Most reliable, most compact, and the cheapest form of H.T. supply on the world's markets. Suitable for 1 to 3 Valve Sets only. Operates on all D.C. Mains from 100 to 250 volts.

Model M.1  
D.C.  
17 6



Write for full details of Ten New "EKCO" Models.

**E.K. COLE LTD** DEPT. W., "EKCO" WORKS, LONDON RD., LEIGH-ON-SEA

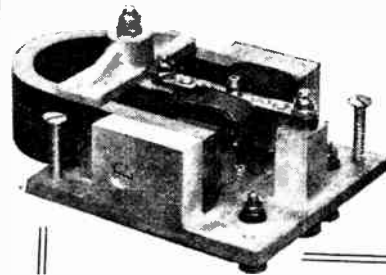

The New "ZAMPA" CONE MOVEMENT

for **HOME CONSTRUCTORS**

The new "Zampa" Cone Movement for Home Constructors gives a larger movement for the new 3 feet Cone than any on the present market—enables you to make a reliable 3 feet Cone Loud Speaker at home.

Movement and complete materials for making the 3 feet Cone **£3-10-0**

"Zampa" Cone Movement only - **£2-5-0**

No cheaper or easier way of building a Cone.

Catalogue Free.

**MIC WIRELESS CO.,** MARKET STREET, WELLINGBORO'.

*The right place for the*

# Watmel

**H.F. CHOKE**

**PRICE 5/-**

The special method of cross winding the double silk covered wire in four accurately balanced sections reveals the superiority of the Watmel and the extreme scientific care taken in its manufacture. Low self-capacity—constant impedance and small external field are features which no other H.F. Choke can as truly claim as the Watmel. Windings protected by transparent cover. Mounted in bakelite base with nickel-plated terminals. The right place for the Watmel H.F. Choke is in every circuit where radio frequency chokes are specified. Write for particulars stating requirements for coil drive Loud Speakers.

**WATMEL WIRELESS CO. LTD.,** Imperial Works, High Street, Edgware, Middlesex.

# W.B.

**ANTI-PHONIC LOW-LOSS VALVE HOLDER**

Cut open for your inspection.

Notice that—

- 1.—Floating springs and valve sockets are riveted and soldered.
- 2.—Springs are at right angles to valve sockets, avoiding side strain and snapping.
- 3.—The price is only **18** each without terminals, or **19** each with terminals.

Supplied by all good class dealers from stock.

In case of difficulty write to the makers—

**WHITELEY, BONEHAM & CO., LTD.,** Duke Street, Mansfield, Notts.

Mention of "The Wireless World," when writing to advertisers, will ensure prompt attention.

# MISCELLANEOUS ADVERTISEMENTS.

**NOTICES.**

**THE CHARGE FOR ADVERTISEMENTS** in these columns is :

12 words or less, 1/- and 1d. for every additional word, e.g., 18 words, 1/8; 24 words, 2/-. Name and address must be counted.

**SERIES DISCOUNTS** are allowed to Trade Advertisers as follows on orders for consecutive insertions, provided a contract is placed in advance, and in the absence of fresh instructions the entire "copy" is repeated from the previous issue : 13 consecutive insertions, 5% ; 20 consecutive, 10% ; 52 consecutive, 15%.

**ADVERTISEMENTS** for these columns are accepted up to **FIRST POST** on **THURSDAY MORNING** (previous to date of issue) at the Head Offices of "The Wireless World," Dorset House, Tudor Street, London, E.C.4, or on **WEDNESDAY MORNING** at the Branch Offices, 19, Hertford Street, Coventry; Guildhall Buildings, Navigation Street, Birmingham; 199, Deansgate, Manchester.

Advertisements that arrive too late for a particular issue will automatically be inserted in the following issue unless accompanied by instructions to the contrary. All advertisements in this section must be strictly prepaid.

Postal Orders and Cheques sent in payment for advertisements should be made payable to **ILLIFE & SONS Ltd., and crossed & Co. Treasury Notes, being untraceable if lost in transit, should not be sent as remittances.**

All letters relating to advertisements should quote the number which is printed at the end of each advertisement, and the date of the issue in which it appeared.

The proprietors are not responsible for clerical or printers' errors, although every care is taken to avoid mistakes.

**NUMBERED ADDRESSES.**

For the convenience of advertisers, letters may be addressed to numbers at "The Wireless World" Office. When this is desired, the sum of 6d. to defray the cost of registration and to cover postage on replies must be added to the advertisement charge, which must include the words Box 000, c/o "The Wireless World." Only the number will appear in the advertisement. All replies should be addressed No. 000, c/o "The Wireless World," Dorset House, Tudor Street, London, E.C.4. Readers who reply to Box No. advertisements are warned against sending remittance through the post except in registered envelopes; in all such cases the use of the Deposit System is recommended, and the envelope should be clearly marked "Deposit Department."

**DEPOSIT SYSTEM.**

Readers who hesitate to send money to unknown persons may deal in perfect safety by availing themselves of our Deposit System. If the money be deposited with "The Wireless World," both parties are advised of its receipt.

The time allowed for decision is three days, during which time, if the buyer decides not to retain the goods, they must be returned to the sender. If a sale is effected we remit the amount to the seller, but, if not, we return the amount to the depositor. Carriage is paid by the buyer, but in the event of no sale, and subject to there being no different arrangement between buyer and seller, each pays carriage one way. The seller takes the risk of loss or damage in transit, for which we take no responsibility. For all transactions up to £10, a deposit fee of 1/- is charged; on transactions over £10 and under £50, the fee is 2/6; over £50, 5/-. All deposit matters are dealt with at Dorset House, Tudor Street, London, E.C.4, and cheques and money orders should be made payable to Illife & Sons Limited.

**THE SALE OF HOME-CONSTRUCTED UNLICENSED APPARATUS.**

**A New Service to our Readers.**

We have made an arrangement with the Patentees whereby readers who wish to dispose of a home-constructed receiver not licensed under the patents made use of, can license the set by means of the Deposit System referred to above.

The person desiring to sell, in sending us particulars for his advertisement, will in every case make use of a Box No., and should add to the price which he requires the amount of royalty customarily paid by manufacturers, viz., in the case of Marconi Patents the amount should be calculated at 2/6 per valve holder.

If the purchaser is satisfied with his purchase, the sum realised will be forwarded to the seller, less the amount due in respect of royalties, which amount will be paid by "The Wireless World" to the owners of the patents concerned, and a certificate will be handed on to the purchaser of the set.

**SPECIAL NOTE.**

Readers who reply to advertisements and receive no answer to their enquiries are requested to regard the silence as an indication that the goods advertised have already been disposed of. Advertisers often receive so many enquiries that it is quite impossible to reply to each one by post.

## WONDERFUL WIRELESS OFFER

**THE Graves Two-Valve Loud Speaker Wireless Set offered to you on Easy Payment Terms will compare for VALUE and EFFICIENCY with any £10 Wireless Set offered by any other firm in the World.**

It is no use trying to accurately illustrate or even describe the Graves Set in a small advertisement, but a post card will bring you a fully illustrated descriptive catalogue which gives you exact and truthful details.

**BRIEF SPECIFICATION:** The Cabinet is of polished Oak and all components of highest quality. Mullard Dull Emitter Valves with patent Valve holders etc.; H.T. Battery, 2-Volt Accumulator and complete Aerial Outfit. Loud Speaker of exclusive design to match the Cabinet, with unique magnetic system and improved diaphragm **£7:17:6**

**TERMS.**—Our Bargain Price is for Easy Terms. Send 10/6 now, & complete purchase in 14 monthly payments of 10/6. Five per cent. discount for cash. Fullest approval in your own home.

Write for Free Catalogue.

Unchallengeable values in up-to-date Wireless Sets.

**J. G. GRAVES Ltd. SHEFFIELD.**



**GAMBRELL**  
Centre-Tapped Coils not only give the best results, but are unlimted in use, as they can be employed in any circuit, centre-tapped, or otherwise. Standard fitting to all coil sockets, and occupy minimum Baseboard space

SIZE.	PRICE.	Approx. No. of Turns.
a3	4/10	18
a	4/10	25
A	5/-	30
B1	5/3	40
B	5/6	50
C	5/9	75
D	6/3	100
E1	6/9	150
E	7/3	200
F	8/6	300
G	10/-	500

There is a Gambrell Coil Holder specially designed for use with above coils, and which does away with all fivible leads. Price 1/9 each.

**GAMBRELL BROS. Ltd.**  
76, VICTORIA ST., LONDON, S.W.1.

**'L&H' SHORT WAVE COIL**  
20 to 70 metres.

This coil is specially designed for Empire Broadcast Reception. For full particulars see *Wireless World*, June 29, 1927. Price complete with base **6/-**

**LAWRENCE & HULL**  
29 Parkhouse St., Gamberwell, S.E.5  
Phone: Rodney 3810.

**RECEIVERS FOR SALE.**

**ALL-WAVE Four** and the Famous Everyman Four; high-class sets only, giving maximum efficiency; full particulars and prices on application.—H. Goodwin, Woodcock Hill, Elstree. [0050]

**RADIO by Post.**—We can save you money. We supply complete sets, also component parts for all advertised circuits at minimum prices; send us your enquiry or let us suggest the best set for your personal need; no obligation.—Radio Postal Service, 66, Burnaston Rd., Hall Green, Birmingham. [5713]

**MARCONI Offer 12/6** a Valve if You Exchange your Set. We offer to double the allowance in part exchange for any new set.—Chas. Rodwell, Ltd., London Bridge, S.E., or branches at Waterloo Station, S.E.; 785a, Commercial Rd., E.14; 56, The Mail, Ealing, W.5; 31, Walbrook, E.C.4. [0087]

**SOME of Our Sets Please the Rich Man**—some of our sets please the poor man; our deferred payments system pleases every man.—Write to desk W, New Times Sales Co., 77, City Rd., London, E.C.1. [0080]

**REINARTZ 3-Valve**, complete with valves in pedestal cabinet, £8; with H.T., L.T., and L.S., £12; set of Igranic coils, 10/-, or offers?—N. G. Wertheim, 5, Cleve Rd., Hampstead. [5907]

**SUPERB Attwater-Kent 5-Valve Set** in Beautiful Polished Cabinet; £5; components alone worth double.—Player, Burcot, near Bromsgrove. [5908]

**A 2-Valve L.S. Set**, in excellent oak cabinet, Marconi royalty paid; constructed from best components, including Marconi Ideal transformer, Dubilier condensers, etc.; £5/10; send for particulars and photo.—Box 3863, c/o *The Wireless World*. [5913]

**PAY Later**, buy now: Wireless sets, components, loud-speakers, etc., for deferred payments. Write or call for terms.—Ellis Nicholls & Co., 132, Caledon Rd., East Ham, London, E. [5914]

**7-VALVE Super Heterodyne**, complete with valves, batteries, and loud-speaker; £25. Bracey, T, Graham Rd., Mitcham, Surrey. [5931]

**4-VALVE Neutrodyne Set for Sale**, complete with following: Brand new G.E.C. cone loud-speaker, £6/6 model; Lucas low tension battery 6 volt 50 a.h. actual and 135 volts high tension accumulators, 4 6v. power valves; guaranteed perfect in every detail; cost over £40, accept £25.—Hopkins, 126, Long Street, Birmingham. [5934]

**LEWIS and THOM for Receivers of L** Quality and Distinction; guaranteed exactly to author's specification in every case. Exhibition Five, £14; All-Wave Four, £12/10; Everyman's Four, £12/10; Long Range Five ("Modern Wireless") £15; Solodyne, £17; All-Wave Two, our own design, covering all wavelengths from 20 to 2,000 metres, metal panel, £6; All-Wave Three as above, but with extra L.F. stage, £7.

**QUOTATIONS** Given for Everman's Q Series of Coils, or any receiver described in technical Press.

**LEWIS and THOM**, Radio and Electrical Engineers, 24, Clarendon Rd., Whalley Range, Manchester. Phone: Chorlton 1527. [5910]

**Receivers for Sale.—Contd.**

**SUPERSONIC** 6-valve with 2-valve Amplifier, plus valves and frame; £20.—Box 3856, c/o *The Wireless World*. [5898]

**EVERYMAN** Four, Mullard 6 volt .1 amp. valves and Speravox cone speaker; first £10.—Irving, 33, Shernhall St., E.17. [5943]

**3-DRAWER** Foolscap Letter-filing Cabinet on Base; unused R.I. tuner; Lissen eleven-way reactance; ten Igranic coils; 3 or 4-valve receiver, Daventry and Continentals on loud-speaker, remarkable clarity; sale, cheap, or negotiate exchange M.C. Westons, Sifams, Sullivans, or 200 H.T. unit, 50 cycles.—Box 3912, c/o *The Wireless World*. [5977]

**THE Londbird** Three.—The finest 3-valve set on the market to-day at the price; simplicity, selectivity, purity and volume; no coil changing; long and short waves; price, including all accessories and speaker and royalties, £13/10; everything best quality; money-back guarantee.—Particulars from Browne, 65, Sinclair Rd., W.14. [5940]

**EPOCH Electrical Society.**—Before you buy your new set visit our Demonstration Room and hear the latest and most popular makes of sets side by side; largest number of sets in London to select from; prices from 5/9 to £100.

**EPOCH Electrical Society.**—Bring your old set in part payment for a new set.

**EPOCH Electrical Society.**—Installments may be arranged on all sets of £10 upwards.

**EPOCH Electrical Society.**—Let us build your sets to any published or special circuit; large selection of cabinets; lowest charges.

**EPOCH Electrical Society, Ltd.**, 53, Gracechurch St., E.C.3. Call, write, or 'phone Royal 8570, twenty yards from Monument Station. [5864]

**F. W. SMURTHWAITE**, Radio Engineer, for beautifully made radio apparatus at reasonable prices. Every instrument is personally tested by me and guaranteed for 12 months.

**THE Shielded Five**, the finest long range receiver on the market to-day; a handsome set, simple to tune, with such power that any signal above the "noise level" will come in at full L.S. strength, and most important of all, with perfect quality. Perfect reproduction is guaranteed, the amplification being even right down to 50 cycles, whilst volume is under complete control. For the local station three valves only are used. Everyone interested in better wireless reception is invited to investigate the merits of this instrument; the value is incomparable; price £20.

**EVERYMAN** Four, both types, All-Wave Four, Regional receiver, etc.; all beautifully made in seasoned oak or mahogany cabinets; finest possible components throughout.

**SHORT-WAVE** Receiving and Transmitting Apparatus of Every Kind; your enquiries will have my personal attention.

**SPECIAL Bargains.**—2-valve Gecophone cabinet receiver, with doors and battery compartment, complete with valves; guaranteed indistinguishable from new; £6.

**ERLA** 5-Valve Receiver, factory made set; with 5 D.E. valves; £12.

**F. W. SMURTHWAITE**, 15A, Onslow Gardens, Wallington, Surrey. 'Phone: Wallington 1982. [5942]

**ORMISTON'S LITZEN WIRE**  
No. 27/42 S.W.G.

is the best for Tuning Coils, Variometers, and H.F. Transformers.

Each individual strand is silk covered with an overall covering of silk.

THE "WIRELESS WORLD" USES IT.

PRICES:

20 yds. .... 5/6	50 yds. .... 12/-
25 yds. .... 6/6	60 yds. .... 14/6
150 yds. 9/40 Litzen Wire at 15/-.	

**P. ORMISTON & SONS, LTD.,**

Electric Wire Manufacturers,

79, CLERKENWELL RD., LONDON, E.C.1

Trade Terms on application.

**"SEVA" ELECTRIC SOLDERING IRONS.**



Special Radio and Telephone Model ..... 30/-  
Used in hundreds by the leading manufacturers 8 hours a day and every day. Satisfaction guaranteed.  
**G. H. HADLEY, Norwich Union Chambers, Birmingham**

**REPAIRS**

to HEADPHONES, LOUDSPEAKERS, TRANSFORMERS, COILS.

First-class workmanship only. This is just the vital difference. We are specialists with almost 30 years' experience in every form of intricate and accurate coil winding, and we guarantee that work entrusted to us will be returned to you as good as new, if not better. This is no idle claim, but the unsolicited opinion of scores of satisfied clients.

**THE VARLEY MAGNET COMPANY**  
(Proprietors Oliver Pell Control, Ltd.),  
BLOOMFIELD ROAD, WOOLWICH, S.E.18.  
Telephone: Woolwich 0495.



**A FREE Booklet for YOU**

Here is a free offer to all Battery users which shouldn't be missed. Just send a 1/4d. stamp to the address below and receive by return a valuable 20pp. booklet dealing with the wonderful ETON primary H.T. Battery. This offer is only for a limited period so write off for it TO-DAY to the **ETON GLASS BATTERY CO.**, 46, St. Mary's Road, Leyton, E.10.



**MICROSTATS**

Sales approaching 1,000,000

SILENT Long Lived

SUITABLE FOR ALL VALVES.

The "V.F.R.," without change of Resistor Element, will govern the Filament Temperature of any Valve perfectly. There is, therefore, no need to possess a multitude of Resistor Elements—one simple Component, the "MICROSTAT" suits all Valves, 1 to 80-ohms.

**V.F.R. MODEL**, Baseboard Mounting 3/- Post Free For Satisfaction fit "Microstats."

Send for Sample to Manufacturers:  
**LIFFORD Eng. Co., Kings Norton, Birmingham**

**Receivers for Sale.—Contd.**

**GECOPHONE** 8-valve Super-het with 6 Valves, coils and frame aerial; perfect condition; absolute bargain at £22/10.—Demonstration at Bolus, 5, Friar's Rd. Coventry. 50 stations on L.S. [5933]

**NEW Everyman** Four, complete with valves, in mahogany cabinet, £12.—T., 37, Brigstock Rd., Thornton Heath, Surrey. [5801]

**BATTERIES.**

**ACCUMULATORS**, all sizes in stock, from A 3/9; send for complete list.—Bright and Hayles, 78, Church St., Camberwell, London, S.E.5. [0079]

**WET H.T.**, the coming battery; doz. cells, 18 volts, easy to assemble, 3/3, post 9d., 3 doz. post free.—Matthews, 112, Maygrove Rd., Kilburn, London. [5965]

**WET H.T. Batteries.**—Jars, 2 1/4 x 1 1/2 x 1 1/3 doz.; zincs, 1/- doz.; sacs, 1/6 doz.; dozen cells complete (18 volts), 3/6; post 9d. extra. High efficiency, long life, upkeep practically nil. Orders for 3 dozen or over post free, packed in special carton with divisions for each cell, usable as container for complete battery. Send 6d. for sample complete unit with instructions. Write for free lists of wireless bargains.—W. Taylor, 57, Studley Rd., Stockwell, London. [0030]

**"A.B." Dry H.T. Batteries** Cost Less Than A Many other makes. The fact that they are manufactured by Messrs. Thomson Houston et Cie., of Paris, is proof of their high quality. Further, every battery carries a full and generous guarantee. Usual sizes stocked; 60 volt, 100 volt, and grid bias, etc. Ask your dealer for same. If he cannot supply you write us direct. Trade enquiries specially invited.—G. E. Ambatiello & Co., Ltd., Ambatiello House, Farringdon Road, E.C.1. Telephone: Clerkenwell 7440. [0063]

**WET** (sac Leclanche) H.T. Batteries, latest booklet on how to make and maintain these economical and simple batteries; give perfectly silent and smooth reception with unlimited power; suitable for small or multi-valve sets of all sizes; information also on L.T. batteries free; enclose postage, 1/4d.—Taylor, 57, Studley Rd., Stockwell, London. [0077]

**WHY Buy Wireless Accumulators?**

London's Leading Hire Service improves reception. Saving time, trouble, and money. No big outlay. No deposit. Pay carman on each delivery. Low tension service from 1/3 per week. Fully charged and delivered free within 12 miles of Charing Cross. Explanatory folder post free.—Radio Serv., 105, Torriano Av., N.W.5. 'Phone: North 0623/4/5. [5587]

**H.T. Accumulators**, Exide W.T. 7-20 volt units in case, £3/10, or might sell separately at 9/6 each. E. Edwards, 15, Achilles Rd., West Hampstead, London, N.W.6. [5966]

**CABINETS.**

**DIGBY'S Cabinets.**—Table models in solid oak and mahogany from 11/6 to 71/-.

**DIGBY'S Cabinets**, fitted with Radion or Resistor ebonite if required.

**DIGBY'S Cabinets.**—Pedestal model, with separate battery compartment, from 56/- to £12.

**DIGBY'S Cabinets** Made to Customers' own designs.

**DIGBY'S Cabinets.**—Write for new 16-page art catalogue.—F. Digby, 9, Banbury Rd., South Hackney, London, E.9. 'Phone: Clissold 5458. [5979]

Mention of "The Wireless World," when writing to advertisers, will ensure prompt attention.

**Cabinets.—Contd.**

**ARTCRAFT** Radio Cabinets and Panels for all "Wireless World" sets.  
**ARTCRAFT** Cabinets made in Oak and mahogany, properly french polished, and are priced at 6/- to £11/11.  
**ARTCRAFT** Cabinets made to any specification or design. Estimates by return.  
**ARTCRAFT** Illustrated Catalogue Free.—The Artcraft Co., 156, Cherry Orchard Rd., Croydon. 'Phone: Croydon 1981. [0040]  
**FIRM** Able to Take Contracts for Wireless Cabinet Work; quotations on receipt of particulars or quantities.—196, Lewisham Rd. See Green 1206. [5719]  
**AMERICAN** Type Cabinets, with hinged top and baseboard; in hand polished oak, 12in. x 8in., 10/6, post free; any size supplied.—Phœnix Wood Engraving Co., 28, Market St., Manchester. [5870]  
**DEDESTAL** Cabinets in Massive Oak Jacobean Finish (as illustrated in *The Wireless World*, May 4 issue), for Everyman four or any set with panel up to 26 x 8in., stands 3ft. high, 15in. deep, 10in. baseboard included; £5. carriage paid; may be inspected on van before acceptance; fully illustrated folder gives every detail; write to-day.—G. E. Ambatiello and Co., Ltd., Ambatiello House, Farringdon Rd., London, E.C.1. 'Phone: Clerkenwell 7440. Telegrams: Ambatiello, London. [0055]  
**MAKE** Your Own Cabinet.  
**EVERYMAN** Four Cabinet, 26 x 8, packed flat ready for assembling, 18/6, in oak or mahogany.  
**READY** for Assembling Means all Joints, mouldings, etc., hand finished and sanded papered smooth as glass by competent cabinet makers.  
**JUST** a Touch of Glue and you have constructed a cabinet guaranteed to equal the work of a master craftsman.  
**SEND** a p.c. at once for full particulars, stating requirements.  
**THE R.F.A. CABINET CO.**, 37, Brigstock Rd., Thornton Heath, Surrey. [5804]  
**LOUD-SPEAKERS.**  
**REED** Movements.—Double Acting Reed cone movements specially designed to operate cone and other large diaphragms; extremely sensitive on small input, yet capable of enormous volume with sufficient input. Will work up to a 3ft. cone with ease. No rattle or distortion; 27/6 each. Fair allowance on Brown A earpieces, or Lissenolas and other units in part exchange. Send stamp for illustrated Lists of these and Seamless Cones.—Goodmans, 27, Farringdon St., E.C.4 [0066]  
**MIRROVOX** Loud-speaker, oval pleated mahogany mounted, looks like a mirror; perfectly wonderful reproduction, equal to any speaker double the price; try one on 7 days' approval; satisfaction or money refunded; £2/10 post free.—A. Brixey, Coldharbour Lane, Hayes, Middlesex. [5579]  
**COIL** Drive Loud-speaker Parts to suit your requirements, manufactured under the personal supervision of W. J. Turberville-Crewe, M.Inst.R.E.; lists free.—J. Glasscoe and Co., 49 Eastcheap, E.C.3. [5826]  
**REPAIRS.**—All loud-speakers repaired and maximum efficiency attained, 4/- post free; every repair is accompanied with a three months' guarantee; don't discard if burnt out; trade invited.—Transform, 115, Links Rd., Tooting, London, S.W.17. [0084]

**More Power to your Wireless!**

**"LEION" RADIO POWER UNIT**

(See "Wireless World," May 4, 1927)  
 It gives steady, silent power—volume without background.  
 To B.E.S.A. Specifications.  
 5 years Guarantee.  
**MAKERS:**  
**P. B. G. Ltd.,**  
 10, Vyse St., BIRMINGHAM.



H.T. & Charger. Agencies Vacant.

**Loud-speakers.—Contd.**

**UNITS** for Cone Speakers.—Highly efficient. Patented, double acting reed movement, the result of years of experimenting. Very sensitive to small impulses, but capable of handling enormous power without overloading; special resonance damping device; high class workmanship and keenest value yet offered; complete with fixings for attaching cone. Fuller details, list of cones, complete speakers, etc., post free.—Everyman's Radio Service, Brent St., Hendon, N.W.4. 'Phone: Hendon 2378. [5105]  
**KONEDOPE** Makes Home Constructed Diaphragms Air- and Damp-proof. Tins sufficient for 2 large cones, 1/8, post free.—Everyman's Radio Service, Brent St., N.W.4. [5851]  
**DID** You See the Moving Coil Loud-speaker built with Webson parts, manufactured by Star Engineering, on Stand No. 103 at Olympia Exhibition?  
**IF** So, you would appreciate the high class workmanship and finish, which is the standard for all Webson parts manufactured by Star Engineering.  
**WHEN** You Order Webson Parts you obtain goods made by engineers and recommended by the principal wireless journals. See *Wireless World*, Sept. 28; "Amateur Wireless," Sept. 24 and Oct. 1.  
**FOR** Highest Efficiency build your moving coil loud-speaker with Webson parts, manufactured only by Star Engineering, Didsbury, Manchester.  
**YOUR** Name and Address in block letters will ensure you free lists per return post.—Star Engineering, Didsbury, Manchester. 'Phone: Didsbury 1785. [5878]  
**STERLING** Baby Loud-speaker; 28/-.—J. Maylin, 14, Love Lane, Tottenham, N.17. [5921]  
**GRAMOPHONE** Pick-up, any make supplied; gramophones from £2.—Browne, 65, Sinclair Rd., W.14. [5941]  
**AMPLION** Dragon, brand new; £2.—Write Sanger, 50, Fordingley Rd., Paddington, W.9. [5957]  
**MAGNAVOX** Senior, perfect condition. Complete, £3/10.—A. Bean, 12, Park Avenue, Burnley. [5958]  
**BRANDE'S** Table Talker, fortnight old, unsoiled, 19/6.—Russell, "Oakdene," Oxford St., Landon. [5959]  
**AMPLION** Attachment, cheap, best offer.—Write B., 50, Highbury New Park, London. [5960]  
**BIRMINGHAM** and Midlands.—To retailers, gramophone demonstrators, and all open to improve their reception, before committing yourselves to the slightest extent on any speaker, come and hear the most efficient coil drive instrument yet devised.—Marlow, 1, Church St., Lozells, Birmingham. [5961]  
**MOVING** Coil Loud-speakers.—Purchase your parts from Baker's Selhurst Radio and obtain the best results. We manufacture every part in our works from the castings to the moving coil, and we are therefore enabled to sell to the public a superior article at a reasonable price. We shall be glad to show you all parts at our works, 42, Cherry Orchard Rd., East Croydon. [5980]  
**42**, Cherry Orchard Rd., East Croydon.—All moving coil loud-speaker parts made here, by Baker's Selhurst Radio. [5981]  
**MOVING** Coil Loud-speakers.—All parts available at Baker's Selhurst Radio, 89, Selhurst Rd., S. Norwood, S.E.25. [5982]

*Put it there!*



Get the best out of your valves with the New AERMONIC no-loss, no-vibration holder. Anti-capacity because minimum di-electric between sockets. Anti-phonetic because properly sprung. (Valves don't wobble all over the place with Model K.)

**AERMONIC ANTI-CAPACITY ANTIPHONIC VALVE HOLDER 2/3**

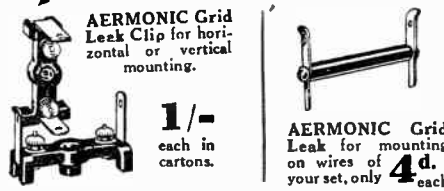

**AERMONIC** Grid Leak Clip for horizontal or vertical mounting. 1/- each in cartons.  
**AERMONIC** Grid Leak for mounting on wires of your set, only 4d. each

If any difficulty write to either address below:  
**JAMES CHRISTIE & SONS, LTD.,**  
 246, West Street, SHEFFIELD.  
 London Agents: A. F. BULGIN & CO., 10, Cursitor St., London, E.C.4

Advertisements for "The Wireless World" are only accepted from firms we believe to be thoroughly reliable.

**Loud-speakers.—Contd.**

**WOOD Horns.**—Illustrated list of new models ready. There's one for every speaker base and gramophone attachments.—Maddison, Manufacturer of the Allwoodorn, 2a, Ronalds Rd., N.5. [5845]

**VALVES.**

**SCREENED Grid Valves.**  
**THE A.P. 412 S.G.** for non-neutralised H.F. amplification and super R.C. amplification, amplification factor 110, standard 4-pin base; write to-day for full data of all the A.P. 4 electrode valves.—Aneloy Products, 36, Hindmans Rd., E. Dulwich, London, S.E.22. [5589]

**DO You Know That —**

- (a) the greatest item in your running costs is your bill for H.T. supply?
  - (b) Your power valve probably takes about 8ths of this? Thus resistance-capacity will not help you here, for you will still need a power valve.
  - (c) An A.P. 4 electrode valve in place of your present power valve will work as well on less than half the H.T. voltage.
  - (d) You will thus save 8ths, say 1/3, of your present H.T. costs, on the power valve alone. **WORK it Out and See What it Comes to in Your Case!**
  - (e) If your set is used at all you are probably spending from £3 to £6, at the least, and so you will save from 15/- to 30/- annually, i.e., the cost of one or two A.P. valves.
- A.P. 4 Electrode Valves Can be Used in Conjunction with Existing 3 Electrodes.**  
**THE A.P. Range Includes a Valve for Every Position and new Types for Super Amplification, super power, and screened grid work.**  
**WRITE To-day for X-ray Photographs of the A.P. Range, together with other A.P. 4 electrode facts and data.**  
**ANELOY PRODUCTS, 36, Hindmans Rd., East Dulwich, S.E.22. 'Phone: New Cross 4074. [5916]**

**CHARGERS & ELIMINATORS.**

**ACCUMULATOR Chargers (A.C.), 45/- complete.** Post free. Also components for same and for A.C. battery eliminators; fully guaranteed.—Stafford O'Brien and Partners, Ltd., 66, Victoria St., S.W.1. [0052]

**ALTERNATING and Direct Current problems.**—Kaynite components will solve them.—Call at The Lisle Radio Co., 37, Lisle St., W.C.2. [5686]

**LEWIS and THOM for Radio Instruments of Precision.**

**ABOLISH Both High and Low Tension Batteries.**—Our All Mains units enables you to work your set entirely from electric light plug. D.C. models: Standard, £4/10; De Luxe, £6. A.C. models: Standard, £7/10; De Luxe, £9; suitable for almost any receiver.

**HIGH Tension Eliminators.—D.C. models:** Junior, giving 6 positive tappings, 35/-; Standard, 55/-; De Luxe for Super Het or Straight Eight receivers, £3/10.

**H.T. Eliminators.—A.C. models:** Standard, £4/15; De Luxe, £5/10; please state mains and voltages when ordering.

**LEWIS and THOM, Radio and Electrical Engineers, 24, Clarendon Rd., Whalley Range, Manchester. 'Phone: Chorlton 1527. [5912]**



ONE, TWO, THREE, FOUR FIVE, SIX Valves perfectly and independently controlled by one unit.

**THE LORIOSTAT**  
 as used in the  
**"Wireless World Regional Receiver."**

A multiple unit superseding the fixed Resistor. Can be used in any circuit to control any number of valves. For own requirements as follows:—  
 1 way 2/- 2 = 3/9 3 = 5/6  
 4 = 7/6 5 = 9/- 6 = 10/3  
 Colours: 1. 2. 3. 4. 5. 6.  
 case a LORIOSTAT in your set.  
 6, 15 or 30 ohms.

**A. W. STAPLETON,**  
 19a, Lorrimore Buildings, Lorrimore St., Waltham, S.E.17

**Have YOU tried PERTINAX?**

3, 10" thick, cut standard sizes, in neatly labelled envelope, or cut to your own requirements at 1d. per square inch. Colours: Natural brown, mahogany, walnut and black. Send 1d. stamp for 1" sq. sample, stating colour, to Geo. L. SCOTT & Co., Ltd., 69, Fleet St., E.C.4.

Dependable Mains Units

**REGENTONE**  
 For A.C. & D.C.

**BEHIND EACH REGENTONE INSTRUMENT THERE LIES 4 YEARS' SPECIALISED EXPERIENCE.**

**MAINS UNITS, MAINS RECEIVERS, COMPONENTS.**  
 SEND FOR ILLUSTRATED CATALOGUE.

**REGENT RADIO SUPPLY CO.**  
 Offices and Demonstration Rooms:  
 21, BARTLETT'S BLDGS., HOLBORN CIRCUS, E.C.1. CENT. 9661.

**DAREX "Safety First" TERMINALS**

SAVE VALVES and Batteries. Accidental Damage avoided. Descriptive List free on request.

**DAREX RADIO CO.,**  
 Waldram Rd., Forest Hill, London, S.E.23  
 TRADE SUPPLIED

**RELIABILITY S.L.F. CONDENSER**  
 with ebonite ends and 4" Trolite Dial.  
 '0005 5/9. '0003 5/6. Vernier Dial 1/6 extra. Post Free.

Further Attractive Items in Miscellaneous Columns. Send for FREE Guide now. Trade Enquiries Solicited.

**J. H. TAYLOR & CO**  
 2 RADIO HOUSE, MACAULAY ST. HUDDERSFIELD.

**BOWYER-LOWE**  
 APPARATUS

**BOWYER-LOWE CO. LTD., LETCHWORTH**

**Chargers & Eliminators.—Contd.**

**COMPACTO Accumulator Charges 100 A.C.** with Ten Sets of Electrodes, amp. meter attached; cheap for quick sale.—91, Paris Lane, Penge. [5903]

**FOR Sale, A.C. Rectaloy charger,** as new £2 or nearest offer.—D. Mann, Weymouth College, Dorset. [5962]

**MAINS Transformers for H.T. Trickler** chargers from A.C. mains, as described in *The Wireless World*. State voltage and periodicity; price 10/6 each post free.—Full particulars from Garrett and Spawforth, 92, Great Russell St., London, W.C.1. [5971]

**EKCO. H.T. Eliminator for 200 v. 0-50** cycles mains, tapped 60-120, DU5 valve, 1-6 valves; 1 year's guarantee, used once only, owner going north, £6/5.—S. Daniel, 10, Waringham Rd., Thornton Heath, Surrey. [5971]

**COMPONENTS, ETC., FOR SALE**

**BELLING-LEE Panel Fittings** are designed to give an expert finish to any home constructed set. Catalogue post free.—Belling and Lee, Ltd., Queensway Works, Ponders End, Mex. [0018]

**AERIAL Grid Coils and H.F. Transformers for Everyman Four,** with chart showing over 40 stations (on L.S.), price 17/6 each; H.F. transformers for the All-Wave Four, high and low wavelengths, set of two and base 35/-; all coils of highest quality materials and finish.—H. Goodwin, Woodcock Hill, Elstree. [0051]

**REED Movements.—Double Acting Reed** movements specially designed to operate cone and other large diaphragms; extremely sensitive on small input, yet capable of enormous volume with sufficient input. Will work up to a 3ft. cone with ease. No rattle or distortion; 27/6 each. Fair allowance on Brown A earpieces, or Lissenolas and other units in part exchange. Send stamp for Illustrated Lists of these and Seamless Cones.—Goodmans, 27, Farringdon St., E.C.4. [0047]

**DECKOREM Components** are the finest you can include in any set you build. Write for free catalogue.—A. F. Bulgin & Co., 9-11, Cursitor St., London, E.C.4. [5881]

**ALL-WAVE Coils (May 11th),** pair with 6-pin base; 42/6.—Jennens, below.

**EVERYMAN Coils, 3, 4, 5,** on ebonite E bases; 15/- each.—Jennens, below.

**TUBES, 3in. x 3 1/2in.,** genuine Mikopac; 1 1/4; 2 2/6; 3 3/6.—Jennens, below.

**SPACERS, grooved,** with screws, 8 aerial S or anode, 1/-; All-wave 6 short, 1/-; 12 long, 2/6.—Jennens, below.

**LITZEN Wire (Lewcos 27/42),** to wind 70 L turns; 4/8.—Jennens, below.

**WYCHE Switch, 2-way, 1/3;** both battery, 1/6.—Jennens, below.

**LEOWE Multiple Valves, 3 L.F. and 2** L.H.F.; write for price and particulars; trade enquiries invited for all above.—Jennens Radio, 30, Chapel St., Birmingham. [0075]

**RELIABILITY WIRELESS GUIDE.—** New edition, No. 99A, just issued. Free upon request.

**RELIABILITY GOODS AND SERVICE.**—only obtainable from J. H. Taylor and Co., 15, Radio House, Macaulay St., Huddersfield. Trade supplied. Send for free Guide now. [0028]

**TANTALUM.—Tantalum metal sheet for** A.C. rectifiers.—Blackwell's Metallurgical Works, Liverpool. [5745]

Mention of "The Wireless World," when writing to advertisers, will ensure prompt attention.



**Components, Etc., for Sale.—Contd.**

**RITISH and Best.**—High tension accumulators, pure reception and constant voltage; Ediswan 4-5,000 m.a.h. capacity, 20 volt units, 16/8; Exide 2,500 m.a., 10 volt units, 5/-; Oldham 20 volt units, 12/6 each; Carrier and lid Oldham, extremely neat, 4/6 each; all above 80 volts or more carriage paid U.K.—Radio Service Depot, 678, Washwood Heath Rd., Birmingham. [5447]

**J.S. Headphones**, light, strong, adjustable Headanos, perfectly clear and comfortable; full maker's guarantee (list price 15/-) in 7 days' approval; satisfaction or money refunded; 10/6 post free.—A. Brixey, Coldharbour Lane, Hayes, Middlesex. [5578]

**BROWN A's.**—A large purchase, on favourable terms, of these genuine original A type earphones enables us to offer them at 25/- each, 2,000 ohms, or complete with headphones, in original boxes, 30/- per pair; fully guaranteed (unused); trade supplied; this type Brown A is specially suitable for gramophone pick-ups, as described by G. W. Sutton in *The Wireless World*, July 20th issue.—Goodman's, 27, Farringdon St., E.C.4. [0067]

**MATEUR'S Surplus Components**; send for list.—Howarth, 59, Green Rd., Colne, Lancs. [5749]

**ARMONIC Valve Holders** are the finest value in British made components; model H antimicrophonic, 1/6 each.

**RID Leak Holders** for Vertical or Horizontal mounting; Bakelite mouldings with adjustable springs, fitted terminals, Aeronic No. 1, 1/-.

**NGLE Bending Pliers**, Aeronic; one nip of the jaws bends wire to a right angle; dispensable for workmanlike wiring. Price 1/- each.

**RID Leak Clip** for Mounting direct on the wires; Aeronic No. 2, 4d.; if your dealer does not stock, write to the manufacturers, James Christie & Sons, Ltd., West Hill, Sheffield. [0078]

**MORE Storry Specialities.**—Reliable pocket voltmeters, double reading, 0-6, 0-120, 6; C.E.B. headphones, very sensitive, etherette headbands, 6/6, usually 12/6; antimicrophonic valve holders, well designed, 3; post paid and guaranteed.—Storry's Ltd., Eastbank St., Southport. [5742]

**. & J. Everyman Coils**, new and old type, 15/- each; guaranteed to specification; made under personal supervision.

**. & J. Mottled Aluminium Screens**; 4/- each.

**. & J. Porcelain Panels**, see Sept. 7th issue, page 298; any size cut and drilled to template; Everyman Four panel drilled 11 holes, 1/3.

**. & J. Screened Grid Valve Holders** in polished ebonite, rigid each end and nicely detachable, no flex leads; 3/6.

**. & J. Keen Prices to Trade and Factors.**

**. & J. Wireless Co.**, 2, Athelstane Mews, London, N.4. Mountview 1695. [0043]

**ECKOREM Components** are the finest you can include in any set you build. Write for free catalogue.—A. F. Bulgin & Co., 9-11, Pursitor St., London, E.C.4. [5882]

**SHORT-WAVE** wavemeters, 18-70 metres, every instrument individually calibrated by hand; enables any required station to be found immediately. In upright mahogany cabinet, complete with full instructions, 30/-, cash or o.d.—Deepees, 22, Ganton St., Regent St., W.1. [5894]

**Proof of its excellence**

**RESISTON PANELS**

and **Terminal Strip**

are used in the

**Cossor Melody Maker Receiver**

Panel: (in black), - - - 9/3  
" (mahogany grained), 11/6  
Terminal Strip, 2/-

**Get them from your Dealer**

American Hard Rubber Co. (Brit) Ltd., 13a Fore St., London, E.C.2  
[9683]

**"Radielle"**

**H.T. BATTERY ELIMINATORS**  
for A.C. and D.C. Mains.

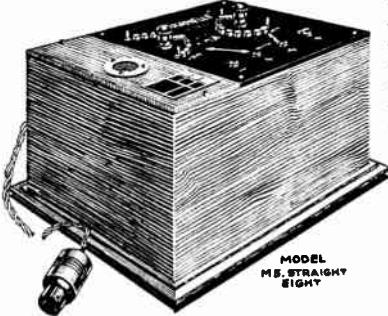

**Model M.5 Straight 8 for A.C. Mains, full wave rectification, specially adapted for Super-Heterodyne sets.** Plus 12/6 Royalty.

Output at 140 Volts, 25 m.a. 3 Tappings, one fixed at 140 Volts, and two independently variable from 21 to 140 Volts, total output regulated by master control. Other Models from £3-13-0.

Instruments for A.C. Mains complete with Valves. British Manufacture. Guaranteed for One Year. If your dealer cannot supply, write direct to us and we will send on seven days' approval. Cash with order (carriage and packing 1/6). State voltage of your mains, and whether A.C. or D.C.

SEND P.C. FOR LIST

**HAWKINS & SOFFE,**  
Electrical Instrument Makers,  
56, Crogsland Road, Chalk Farm, N.W.1.  
Telephone: Hampstead 1934.

**Components, Etc., for Sale.—Contd.**

**COUNTRY Listeners.**—Time is money, order from your fireside and save both; all products displayed in this issue supplied at advertised prices, post free; special coils for screened H.F. Everyman Four, exactly to specifications; 30/- per pair; prompt, reliable, economical.—The Ready Radio Supply Co. (the radio house for the amateur constructor), 41, Newcomen St., London Bridge, S.E.1. [5668]

**CHAKOPHONE** Tuning Unit with Reaction, 300-2,000 metres, complete with instructions, 8/-; Everyman Four coils (Chakophone), boxed with "Wireless World" Booklet, 31/-.

**TUNEWELL Coils**, 25, 35, 50, 75, 1/6 each, 100, 1/8; 150, 2/3; 175, 2/6; 200, 2/9; 250, 3/3; air spaced, robust, efficient. Special Lines.—Wanderplugs, 1/3 doz.; terminals, with nut washer and indicating label, 2 B.A. pillar, 4 B.A. W.O., 2 and 4 B.A. phone, 2/- doz.; plated, 2/6 (state markings); coil holders, 2-way B.bd. 2/6, geared 2/9; switches, push pull, 11d.; S.P.D.T. on ebonite or porcelain, 9d.; D.P.D.T. on porcelain, 1/6; red and black flex, 1/6 doz. yds.; R.C. cable, 2 mm. 1/-, 4 mm. 1/9, 5 mm. 2/3 doz. yds.; insulated staples, 1/9 100.

**POSTAGE** up to 5s., 6d.; over 5s., free; Send us your enquiries.—Radio Supplies Co., 37, Bedford St., Leamington Spa, Official Traders and Repairers to Radio Society of G.B. and Wireless League. [5685]

**REPAIRS.**—All transformers repaired and maximum efficiency attained, 4/- post free; every repair is accompanied with a three months' guarantee; don't discard if burnt out; trade invited.—Transform, 115, Links Rd., Tooting, London, S.W.17. [0083]

**SPECIAL Offer of Famous Burndept Goods,** now deleted from catalogue. Burndept Peter Pan Loud-speakers, 2,000 ohms. bargain price 12/11; Burndept crystal detectors, originally 4/-, bargain price, 2/6; Burndept hot wire ammeters, originally 25/-, bargain price 4/11; Burndept .0002 condensers, bargain price 3/11; Burndept 3-way coil holders (geared), bargain price 5/11; Burndept 2-way ditto, bargain price 5/11; Dubilier grid leaks (1 meg. and 3 meg.), bargain price 1/3; Burndept concert coils (set of 4), bargain price 5/6; Burndept rheostats, bargain price 1/11; Burndept vernier condensers, bargain price, 1/11; Burndept valve holders, bargain price, 6d.; Burndept fixed resistors, bargain price, 9d.; Burndept anode condensers, .0002 low loss, bargain price 5/11; ditto, with vernier, bargain price, 8/11; Burndept Ethodyne, originally £75, bargain price £35; Burndept 5-valve Ethophone Grand, originally £75, bargain price £22/10; Marconi 2-valve amplifiers, bargain price 52/11; Marconi 1-valve amplifiers, bargain price 32/11; T.M.C. headphones, originally 17/6; bargain price 10/11; T.M.C. 3-valve sets with internal loud-speaker, bargain price £4/17/6. All the above Burndept goods are in original packages, and undamaged goods will be exchanged for any others, if purchaser wishes, within seven days. Enquiries from traders invited for quantities. Obtainable only from Chas. H. Rodwell, Ltd., London Bridge, S.E.1, and at the following branches: 31, Walbrook, E.C.4; 785a, Commercial Rd., E.14; 56, The Mall, Ealing, W.5; Waterloo Station (Main Entrance), Waterloo Rd., S.E. [0086]

**Components, Etc., for Sale.—Contd.**

**REPAIRS.**—All headphones repaired and maximum efficiency attained, 4/- post free; every repair is accompanied with a three months' guarantee; don't discard if burnt out; trade invited.—Transform, 115, Links Rd., Tooting, London, S.W.17. [0085]

**BARGAIN.**—Send for a parcel of new wireless parts; 4/6, post 6d.; value guaranteed; sent c.o.d. if desired.—Box 3784, c/o *The Wireless World*. [5832]

**EPOCH Electrical Society.**—All standard lines and best foreign components in stock; mail orders despatched same day.

**EPOCH Electrical Society.**—Constructors' requirements specially catered for; let us quote for your kit.

**EPOCH Electrical Society.**—If you experiment for enjoyment's sake, buy your parts from us. If you want a guaranteed set, let our experienced engineers build it for you.

**EPOCH Electrical Society.**—Bring your old components in part payment for new ones.

**EPOCH Electrical Society, Ltd.,** 53, Gracechurch Street, E.C.3. Call, write, or phone Royal 8570, twenty yards from Monument Station. [5883]

**DECKOREM Components** are the finest you can include in any set you build. Write for free catalogue.—A. F. Bulgin & Co., 9-11, Cursitor St., London, E.C.4. [5883]

**CONSTRUCTORS.**—Fit the Delophone aerial tuner and dispense with plug-in coils; special model made for baseboard mountings, 250-4,000 metres; price 22/6; send for descriptive leaflet.—E. & F. Deal, 283, Shirley Rd., Southampton. [5844]

**RADIO Engineer Giving up Business** Disposing of stock, send P.C. stating your requirements for estimate by return.—T., 37, Brigstock Rd., Thornton Heath, Surrey. [5802]

**ARE You Wanting the Newest Components** in the Following Brands: R.I. Varley, Ormond, Cyldon, Igranic, Colvern, Ferranti, Lewcos, Marconiphone and G.E.C.; I can deliver by return; post free over £1.—Weider, 107, Cannon St. Rd., London, E.1. [5902]

**SCREEN Coils.**—Split primary aerial, 250-550, 1,000-2,000, 5/6; split primary H.F., 250-550, 7/6; 1,000-2,000, 7/6; split secondary H.F., 250-550, 7/6; 1,000-2,000, 11/-; six-pin Bakelite base, 2/- each.—Below.

**EVERYMAN Four Coils,** complete with base: aerial, 15/-; transformers, 15/-; 28/- set.—Below.

**HYDRA Fixed Condensers,** tested 500 volts: .25 M.F., 2/-; .5 M.F., 2/3; 1 M.F., 2/6; 2 M.F., 3/6 each; other capacities in stock.—Below.

**VARIABLE Condensers.**—S.L.F. .0003, .0005, 7/6 each; L.M.L. .0005, .00035, .00025, 10/6.—Below.

**SUPER Filament Resistances,** 7, 15, 30 ohms, panel or baseboard types; 2/6 each.—Below.

**VALVE Holders,** Antimicrophonic; 1/6 each.—Below.

**H.F. Chokes and Anode Resistances,** 60,000, 80,000, 10,000 ohms; 5/- each.—Below.

**LITZ Wire,** 27-42, 20 yds., 5/-; 50 yds., 12/-; 9-40, 150 yds., 9/6; other lengths pro rata.—Below.

**PAXOLIN Tubes,** 3in. x 2½in., 1/6 each; ebonite spacers and screws complete, 2d. each.—Obtainable all dealers or Stone Mfg. Co., 108-9, Great Saffron Hill, London, E.C.1. [0068]

**Components, Etc., for Sale.—Contd.**

**DO What You Will,** how you will, the most economical way of buying is part exchange.

**BEAT It!**—You can't beat it; you get part of what you want for something you do not—and when the deal is over—it is over. It is not like the proverbial bad penny.

**APPLEBY'S** Inaugurated Part Exchange by Mail in the early part of the year—as an experiment. The experiment has satisfied some hundreds of *Wireless World* readers. It will satisfy you too.

**IF** you are not aware of the details, here is a brief outline: Simple—straightforward—fair.

**WE** Supply all the Leading Lines of Radio Apparatus at Current List Prices, and make no carriage charges except on accumulators and batteries.

**IN** Part Exchange Will Take any Component or Loud-speaker for which you have no further use.

**TO** Make Fair Offers we Must See the Material—so excepting large loud-speakers—send your gear to us to value; do not send burnt-out valves, transformers, etc. In the unlikely event of no agreement being reached we will return your material carriage paid.

**INCLUDE** with Your Parcel a List of Contents and a List of New Requirements. For economical reasons, and to allow fair offer, we cannot execute part exchange orders of less than 10/- nett value; also any offer made is an allowance from order of not less than twice the allowance—but it is fair.

**APPLEBY'S.**—Specialists in and originalators of square deal part exchange.—Appleby's, The Croft, Willesden, London, N.W.10. [5900]

**COMPLETE** Set of Components for New Everyman Four including valves (one shielded grid, one R.C. and 2 L.F.) and mahogany cabinet, £10.—T., 37, Brigstock Rd., Thornton Heath, Surrey. [5803]

**2-COIL** Screens and Bases, 5/6 each; neutralising condenser, 2/6; R.I., L.F. transformer, 10/6; 2-way coil holder, 2/6; Peerless rheostats, 2/- each; postage 6d. extra.—Pulleyn, St. John's Ave., Bridlington. [5905]

**STERLING** Anode Reaction Units (Davenport and ordinary), with adapter; Sterling variometer (21/- model), as new; lot, 30/-; offers?—Oscar Kaye, Tanfield Terrace, Birkby, Huddersfield. [5915]

**COLVERN,** 3 screens and bases, 1 aerial coil, 1 split primary coil; 21/- lot; Lewcos, Solodyne coils, 2 aerial, 4 split primary, long and short waves; 40/- lot.—Glass, 9, Campden Rd., South Croydon. [5919]

**EXPERIMENTER** Has the Following Parts for Sale: 4 Success intermediate super het. transformers, 40/-; Burndept trickle charger, 42/-; Marconiphone volume control, 4/-; Igranic volume control, 3/-; Burndept slow motion dial, 4/-; Utility 3-pole change over switch, 2/6; Atlas aperiodic coupler, 2/-; Polar coil unit, 4/-; Magnum tapped trap coil with switch, 8/6; A.J.S. choke unit, 1st stage, 9/-; Igranic potentiometer, 300 ohms, 2/-; Igranic high resistance potentiometer, 2/6; Lissen potentiometer, 400 ohms, 1/6; Lissen vernier condenser, 1/6; 2 Lissenstat majors, each 2/-; Cosmos H.F. choke, 3/-; Success L.F. Choke, 5/-.—Write Duncan, Killyneil, Farrar Lane, Lawnswood, Leeds. [5920]

**Components, Etc., for Sale.—Contd.**

**BOWYER-LOWE** and Intermediates and broadcast coupler, £2/10; Sifam 0-6 0-120, moving coil, panel mounting voltmeter (new), list 27/6, £1; 3 R5V valves, 3/ each; Sopranoist .0005 S.L.F. condenser, 4/-; Lissenagon X coil 50, 3/6.—E. Passingham, Boxgrove Rd., Guildford. [5921]

**DECKOREM** Components are the finest you can include in any set you build. Write for free catalogue.—A. F. Bulgin & Co., 9-11, Cursitor St., London, E.C.4. [5883]

**A MATEUR'S** Surplus.—Duvolcon, 4/6 Mullard 100,000 resistances, 3/-; 3 square law .0005 and .0003 variables, 2/6 each; T.C.C. .01, 1/3; plug-in coils, 6d. to 1/- each; new D.E.5, D.E.5B, 6/- each; Success choke, 5/-.—D., 16, Emanuel Ave., Acton, W.3. [5922]

**GECOPHONE** S.L.F. .0005, 14/-; .0007, 12/-; Colvern S.P. short and Daventry ditto S.S., 5/6 each, £1 the four; 2 bases, 9/- each; Loriostat, 6 ohm 1-way, 1/-; Watman 11.F. choke, 3/6; Carburundum crystal unit, 7/-; Dubilier 100,000 ohms and base, 3/6; neut. cond., Gambrell, 3/-; McMichael, 2/6; R.I. multi, 15/-; 2 Lotus holders, 2/6; perfect order, new May.—Waterman, Elim Lodge, Solent Rd., Drayton, Cosham, Hants. [5923]

**BARGAINS**—Igranic pattern variometer, 7/6; Carburundum detector unit, 10/-; Peto-Scott condenser, 4/6; Xtratone amplifying unit, 17/-; Finiston H.F. S.P., 6/- base, 1/-; P.M.1 valve (new), 7/6; Dubilier Mansbridge condensers, 2 w., 4/-; Ormon variable condenser, .0003, 2/6; .0002 with vernier, 2/6; Gambrell B coil, 4/-; Igranic jack and plug, 3/6; Atlas aperiodic coupler, 4/-; M.H. H.F. transformers, B.B.C. arrangement, 5/- each; R.I. multi-ratio transformer, 17/6; midget condenser, 1/6; mounted D.P.D.A. switch, 1/6; Detex S.M. dial, 3/6; Polar 2-way coil holder, 3/6; Atlas vernier dial, 6/- Wanted: A.F.3 and Marconi Ide transformers, logarithmic condensers, short-wave set.—Burton, Bury Old Rd., Heywood, Lancashire. [5924]

**R.I. Reactive Anode Unit,** H.F., unused, 12/6; T.B., .00015 S.L.F. true tuning variable condenser, unused, 8/6.—Fred Smith, 1, Baiter Terrace, Bicester, Oxon. [5925]

**EVERYMAN** Four Coils and Transformer for Standard 6-pin Bases, 30/- pair; pairs of coils covering B.B.C. and Daventry wavebands, complete with 2 6-pin bases; £4.—Below.

**LITZ** Wire (Lewcos 27-42), any length 1d. per foot.—All above post free from Stoner's Radio Service, 42, Wellesley Rd., Wanstead, E.11. [5926]

**A MATEUR'S** Surplus.—Send stamped envelope for list.—Tarr, 118, Waterloo Rd., Southampton. [5927]

**GRAMOPHONE** Pick-up G.E.C., new, 30/-; 2 R.I. Varley R.C.C. units; 14/- each.—Box 3911, c/o *The Wireless World*. [5928]

**MEASURE** the Received Current in Your Aerial.—Highly sensitive galvanometer reading in ½ microamps, a lovely instrument, practically unused, guaranteed £2; Navy type Weston relay; 15/-.—Send cash to P. H. Windsor, Fern Hill, Horley, Sussex. [5929]

**EVERYMAN** Four Coils Exact to Specification, 22/6 pair post paid, 23/- c.o.d. approval against cash.—H. Freeman, 4 Tenbury Rd., King's Heath, Birmingham. [5930]

Mention of "The Wireless World," when writing to advertisers, will ensure prompt attention.

**Components, Etc., for Sale.—Contd.**

(Continued from first column.)

condensers only require affixing to panel and the leads screwed down to make the set a complete receiver ready for immediate listening-in. We should like to emphasise that the above set is the last word in radio technique, and remarkable results are obtainable with it, far in advance of anything hitherto obtainable with four valves. Part kits as above are in stock, ready wired up, and can be despatched same day as order received. We offer this service with any sets published in *The Wireless World*. Details sent of Mr. W. James' "Long Range Five" ("Modern Wireless"), or of *Wireless World* Short Wave I., II., or III. sets, or of "Amateur Wireless" Shielded Valve Three (between 20 to 30 stations on loud-speaker with three valves). May we emphasise that these particular sets are equal to the best, and better than most, of the commercial sets on the market to-day. All enquiries and remittances to Cambrian Electric, Ltd., 14, Regent Street, Wrexham. [5827]

**DECKOREM** Components are the finest you can include in any set you build. Write for free catalogue.—A. F. Bulgin & Co., 9-11, Cursitor St., London, E.C.4. [5885]

**IGRANIC** New 6-400 ohm Potentiometers, 1.50 ohm, 1/6 each; Marconi Ideal, 4 to 1, 15/-; 1 Lissenola unit, 7/6; 2 Mullard 100,000 ohm with bases, 3/- each; valves, P.M.3.A., 7/-; S.T.21, 7/-; D.E.R., 5/-; 2 good .0005 square law, 2/6 each.—Sayers, 32, Larnach Rd., London, W.6. [5955]

**SIMMONDS BROS.**, Shireland Rd., Smethwick.

**COIL** Prices.—Everyman Four, 33/- pair; Everyman Three, 35/-; All-wave Four, 42/6; New Everyman Four, 33/-; "Wireless World" Five, 50/6 set of 3; Regional short-wave, 34/6 pair, long wave, 48/6 pair, bases, 6/- the two; Empire broadcast coil, mounted, 8/6; chokes, 7/6 pair; Quality Three coil, 16/6.

**SCREEN** Prices.—Everyman Four, 40/-; Everyman Three, 4/-; All-Wave Four, 5/-; New Everyman Four copper box, 17/6; Empire broadcast cabinet, £2.

**BERCLIF** Valve Holder is Essential for all high-frequency valves and short-wave work; approved by the experts, price 2/9, dealers please send for sample c.o.d. Readers and the trade supplied with all above; component lists and test report on coils free from the original Everyman specialists.

**SIMMONDS BROS.**, Shireland Rd., Smethwick. [5954]

**FERRANTI** A.F.3 Transformer, 16/6 - Rennie, 546, New Chester Rd., Rock Ferry, Birkenhead. [5947]

**ARNEL** Bargains.—T.M.C. loud-speakers, All new and perfect, only a few left; Junior model, usual price 30/-, our price 16/-; Standard model, usual price 85/-, our price 40/- carriage free.—Below.

**DEMPSEY-TUNNEY** Fight was Received perfectly in Manchester, direct from New York on a 2-valve set using one of our 6/- L.F. transformers; nothing to beat them at double the price; try a sample; stocked in 2 ratios, 3-1 and 5-1.

**SCORES** of Other Bargains.—All carriage paid cash with order.

**ARNEL MANUFACTURING Co.**, Arnel Works, Gun St., Ancoats, Manchester. [5957]

# "Layerbilt"

**EXTRAVAGANT DEMANDS.**

"They will supply without faltering the most extravagant demands of modern receivers and still give a long life."

**UNFAILING SERVICE.**

"In this laboratory a load of 20 milliamps has been frequently taken for hours on end from these batteries and in no case have they failed to do their duty."

**SUPER POWER-VALVES.**

"Two or three 'Layerbilt' 45 volt units have been in continuous use for the last three months on a set using a super power-valve in the output stage, and as they still show a voltage of 43 each we have no hesitation in recommending them to readers."

Quotations from article in "WIRELESS CONSTRUCTOR."

## Columbia

### High Capacity Batteries

Full particulars from

**J. R. MORRIS,**  
15, Kingsway, London, W.C.2.

If you did not see this at the Show obtain full particulars from your dealer.

**PANEL PLATE TUNER UNIT**

**35/-**

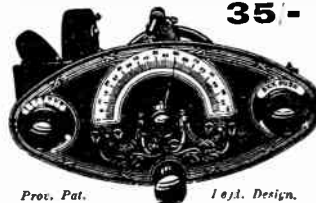

Proc. Pat. 1921. Design.

More than half a set. No Ebonite Panel required. Can be fitted to any form of Cabinet.

Complete wiring diagrams for building 2 or 3 valve Loud-Speaker sets.

No coils to change. Davenport, 5GB and all local stations at 600 loud-speaker strength.

Black and Gold or Black and Silver finish.

# LAMPLUGH

## BRITAIN'S BEST RADIO

S. A. LAMPLUGH LTD., King's Rd., Tyseley, BIRMINGHAM.  
Distributors for London and Southern Counties:—J. C. Shore & Co., 28, Newman Street, Oxford Street, W.1.

**Components, Etc., for Sale.—Contd.**  
**CAMBRIAN ELECTRIC LTD.,** Wrexham.

**THE** Amateur Radio Enthusiast is usually at a serious disadvantage as regards facilities and equipment when it comes to wiring up a valve set. In the ordinary household space is generally restricted. Soldering has to be done under difficulties, and this is an art many amateurs have not mastered yet. Authors' designs should be meticulously adhered to as far as drilling and component mounting are concerned if the fullest limit of success is to be achieved in set building. The amateur too often overlooks these important items, and dry joints, incorrect spacing, wrong disposition of components and other faults mar his work. It will be conceded that the professional has several advantages over the amateur, and success often attends his efforts far and away above those of the man who builds perhaps one set in twelve months. The snag usually is the professional's charge for assembling and wiring up a set. This is usually more than it is considered worth while by the amateur. This is where we strike a new line, and offer real and sterling

**SERVICE** and at a very moderate consideration. Briefly, we offer to all amateurs who order the necessary components from us to wire up their sets. This work is guaranteed to be strictly in accordance with the original set even to the smallest detail. The introduction of electric soldering, power drilling, and what will be practically mass production of sets, enable us to do this at the rate offered. For example, if a complete kit of components is ordered (and in this case a royalty of 12/6 per valve is payable to the Marconi Co.) these are mounted in a strictly accurate manner on the baseboard, and panel fixed, and the set wired up exactly as originally done by the author. If a part kit of components is ordered, the same meticulous care is taken, our fee being merely 2/6 per valve. The charge, therefore, for wiring up the

**NEW** Everyman four is 10/- only. The following are the components required for this excellent set:—2 Ethovernier dials, 18/- (cheaper can be substituted); 3 valve holders (B. Lowe), 9/-; 1 valve holder (Athol), 1/-; 1 rheostat, 10 ohms (Burndept), 5/-; 1 rheostat, 2 ohms (Burndept), 5/-; 4 fixed condensers, 1 mfd. T.C.C., 15/4; 1 fixed condenser, 2 mfd. T.C.C., 4/8; 1 fixed condenser, .0005 (Dubilier), 2/6; 1 L.F. transformer, 3 1/2-1 (Ferranti, Ltd., A.F.3), £1/5; 1 16-volt grid battery, 3/6; 1 bi-duplex wire-wound R.C. coupler, Type B (R.I. & Varley), £1/2/6; aerial coil and H.F. transformer, best quality, £1/11; 1 shielding box, 7/6; 12 tapped valve supporting legs, 3/-; terminal strip, 2/-; 12 shrouded terminals (Belling Lee), 9/-; panel, best ebonite, 26x8x1/4, 17/6; 1 on and off switch, 1/6; tapped supports for Athol V-holder, 1/-; £9/4. Mounting components, drilling panel, and wiring up, 10/- Total, £9/14. Other components are as follows:—cabinet, best make, mahogany (baseboard free), £2; Marconi shrouded valve, £1/2/6.

**THE** above is, of course, a part kit of components, and two .0005 variable condensers have been omitted, as it is found that most amateurs have these in their possession already, and as the leads to the condensers are already in position in the set, the variable

(Continued third column.)

**Components, Etc., for Sale.—Contd.**

**F**OR Sale.—50/- brand new Amplion A.R.65, cost £3/5; also Brandes 3:1 and 5:1 and Royal 5:1 transformers, 10/- each; Lissenola, 8/-; Varley 250,000 resistance, 5/-; Ormond .0003, 4/-, and friction dial, 3/-; McMichael neodyne condenser, 2/-; all perfect.—Box 3914, c/o *The Wireless World*. [5953]

**S**ELBY and Co. Have a Further Limited Supply of the famous Burndept Supervernier Friction Drive Dials at 2/9, 2 for 5/-, post free; guaranteed perfect; not suitable for one-hole-fixing components without adaptation; bargain list free.—6, Hauberk Rd., Lavender Sweep, S.W.11. [5944]

**P**ICK-UP, latest used by 2LO for perfect gramophone reproduction; demonstrations daily by W. J. Turberville-Crewe, M.Inst. R.E., £4/4.—J. Glasscoe & Co., 49, Eastcheap, E.C.3. [5945]

**E**XPERIMENTER'S Surplus For Quick Sale: Sterling Audivox speaker, 40/-; Brandes ditto, 15/-; 2 Ediswan low frequency amplifiers, 18/- each; 1 broadcast split primary transformer, 1 Daventry Lewcos Finstar ditto, 6/- each; 2 screens and bases, 5/- each; 1 A.F.3 transformer, 17/6; 11 V24 valves, 3/- each; Igranic or Lissen coils, all sizes, one-third cost; first cash or c.o.d.; all above as new.—Johnston, Auchin Campbell Rd., Hamilton. [5946]

**C**OILS Wound for any Special Circuit Exact to Specification: Everyman's Four, 25/-; *Wireless World* Five, 38/-; Everyman's Three 27/-; All-Wave Four, 35/6; screen and base 6-pin, 7/6; spacers, grooved, with screws, set of 8, 1/-; All-Wave long, 2/-; short, 1/-; tubes, 3in. x 3 1/2 in., 1/3; discount to trade; agents wanted in several districts.—Norton Bannerman & Co., Bradfield Works, Hawksley Ave., Sheffield. [5948]

**A** NUMBER of Telephones, transformers, valves, ebonite panels, brass parts, crystal detectors, variable condensers, dials, 2 and 3 coil holders, etc., for sale, also electric drill; no reasonable offers refused.—Box 3913, c/o *The Wireless World*. [5949]

**E**VERYMAN Four and Three, "W.V." five coils, genuine specified materials; 11/- each coil with base; post free; many testimonials proving superior results.—B. Rushton, 50, Humber Rd., Wolverhampton. [5950]

**D**ECKOREM Components are the finest you can include in any set you build. Write for free catalogue.—A. F. Bulgin & Co., 9-11, Cursor St., London, E.C.4. [5886]

**E**XPERIMENTER Has for Sale Cheaply Quantity of Wireless Components; list sent.—Wrigley, 260, Portland St., Southport. [5951]

**2** PAIRS English Phones, 8/6 pair; Six-Sixty 2v. D.E., 4/-; C.T. .08, 5/-; 2 B.E.s, 1/6 each; Burndept 4-way switch, 3/-; Lamplugh 2-coil holder, 2/-; all guaranteed.—P. Sadler, The Larches, Four Oaks, Warwickshire. [5956]

**M**OVING Coil Loud-speakers.—All parts available at Baker's Selhurst Radio, 80, Selhurst Rd., S. Norwood, S.E.25. [5983]

**MISCELLANEOUS.**

**E**ASY Payments.—We supply, by easy payments, components, accessories and sets; any make; 10 per cent. down, balance spread over 10 months; send list of requirements to London Radio Supply Co., 11, Oat-la., London, E.C.2. [5591]

**Miscellaneous.—Contd.**

**T**HE Wireless Doctor Will Call (London and Home Counties) if your set is troublesome; no cure, no charge; Wireless Association registered repairer; sets installed, maintained, and brought up to date; experiments and testing undertaken; Solodyne demonstrated.—Alexander Black, 2A, Woodville Grove, N.16. Clissold 3687 and Victoria 6215. [3841]

**M**R. CLAUDE LYONS, M.I.R.E., will advise all constructors of supersonic-heterodyne receivers, without charge; if you have trouble with your present superhet, or contemplate building this most efficient form of receiver, write him, c/o Messrs. Claude Lyons, Ltd. (G.R. Quality Parts), 76, Oldhall St., Liverpool. [0065]

**W**IRELESS Doctor Touring Midlands and South Coast.—Ernest J. Baty, B.Sc., Luton. [5464]

**T**HE Little Imp.—Combination gas blow pipe; indispensable to wireless workers, jewellers, opticians, amateurs, etc.; simplifies small soldering; fine intense flame; does away with soldering iron and blow pipe; marvellous invention; 2/6 post free; approval willingly.—Hammond, Market Hall, Burnley. [5563]

**S**COTLAND'S First Radio Doctor (Glasgow and District) will call if your set is troublesome; no cure, no charge; sets installed, maintained and modernised; Everyman Four specialist; fees moderate; a postcard brings me.—"Radio," 74 1/2 New City Rd., Glasgow. [5680]

**S**COTT SESSIONS, the radio doctor (London and environs); any set or component supplied, installed, repaired, modernised; "Wireless World" set specialist; officially approved as radio repairer and trader by the Radio Society of Great Britain and the Wireless League; no work too big or too difficult! Hill Top, Muswell Hill, N.10. 'Phone: Mountview 4928. [5671]

**W**IRELESS Doctor (Croydon, Redhill, Dorking district) will call; send postcard; sets installed and repaired; and component supplied.—T. White, 8, Clarendon Rd., Redhill. [5708]

**W**IRELESS Doctor, Plymouth district, will call, send postcard; sets modernised, all classes of repairs undertaken; terms moderate.—W. Rose, Panmure, Wilderness Rd., Mannead, Plymouth. [5854]

**L**EEDS and 25 Miles Radius.—Wireless doctor attends on receipt of postcard; definite results guaranteed; moderate charges.—Wilson, 21, Roberts Ave., Harehills Lane, Leeds. [5868]

**M**ANCHESTER.—Can you get 5GB? If not, your set is a case for the wireless doctors; get in touch with Lewis and Thom, Radio Engineers, 24, Clarendon Rd., Whalley Range. 'Phone: Chorlton 1527. [5911]

**F**ILMS and Home Cinemas.—Price list free.—London's Cheapest Cinema Market, 25a, St. Ann's Rd., Brixton. [5909]

**A**NY Set Build for Cost of Components and Royalties; really good workmanship; maintenance and satisfactory repairs undertaken; distance no object.—Write or call, Lieut. E. M. Eldred, R.N. 839, London Rd., Westcliff-on-Sea. [5917]

**E**XPERIMENTER'S Must Have Reliance in their Accumulators; test with a Utility syringe hydrometer for certainty; post free, 4/6, with full instructions; satisfaction guaranteed.—The Utility Syringe Hydrometer Co., Dept. D, 16, Howard Rd., Ilford, Essex. [0059]

**Miscellaneous.—Contd.**

**W**IRELESS Doctor will Call South London, Kent, Surrey; repairs, renovations, installation advice, any type of set. G. W. Adams, 27, Cottingham Rd., Anerley, S.E.20. [5914]

**O**THER Systems are Superseded by Eelex Plugs and Sockets.—Ask your dealer, or Easticks, 118, Bunhill Row, E.C.1. [0022]

**W**IRELESS Doctor.—Your set altered and improved quickly and efficiently; portable sets and Solodynes expertly tested and repaired.—Write Morley, 18, Grangemill Rd., Catford. [5967]

**1,500** Volt Mackie Generator, 150 watts complete with shunt regulator and H.T. voltmeter; also 1/2 h.p. 240-volt D.C. high-speed Verity motor and starter, £14; Western Electric 2-valve power amplifier with valves and balanced armature loud speaker, £10; wavemeters, Mark II station tester, 100-3,000λ, good condition, £3/10; Admiralty by Gambrell, 120-8,000λ, £2/10.—Box 3918, c/o *The Wireless World*. [5968]

**D**.Y.P.—Decorate your panels with our art panel decorations and centrepiece; they develop your personality and are easy to fix. 1/- per packet post free; gold, silver or white word transfers, 6d. packet.—The D.Y.P. Co., 14, Daffodil St., London, W.12. [5969]

**H**OME Cinemas.—Films; free lists.—Kinema Salesmen, 4, Kingsley House, Harp Lane, London, E.C.3. [5970]

**M**OVING Coil Loud-speakers.—All parts available at Baker's Selhurst Radio, 80, Selhurst Rd., S. Norwood, S.E.25. [5981]

**PATENT AGENTS.**

**P**ATENTS and Trade Marks.—British and Foreign.—Gee and Co. (H. T. P. Gee—Member R.S.G.B. and A.M.I.R.E.), 51-52, Chancery Lane, London, W.C.2. 'Phone Holborn 1525. [0000]

**REPAIRS.**

**A**LL L.F. Transformers, 4/-; headphones 4/-, loud-speakers 4/- post free; maximum efficiency attained; every repair is accompanied with a three months' guarantee don't discard if burnt out; trade invited.—Transform, 115, Links Rd., Tooting, London, S.W.17. [0010]

**L**OUND-SPEAKERS, headphones rewound to any resistance and remagnetised, 3/- transformers rewound, 4/-; sets constructed and overhauled, work guaranteed.—Leeds Wireless Repair Service, 5, Boston Place Green Rd., Leeds. [5810]

**H**EADPHONES and Loud-speakers Rewound, remagnetised and overhauled 4/-; transformers rewound, from 5/-; sent to our agents or direct to us.—Repairs fully guaranteed by M.I. Vaughton, 88, Vyse St. Birmingham. Tel.: Mivysse, Birmingham. [5830]

**H**EADPHONES and Loud-speakers rewound, remagnetised and overhauled, 3/- post free; guaranteed; Brown's A type 4/-; established 1923.—Bradford & Co., 16 Prospect St., Plymouth. [5860]

**2**LO, 5XX, 5GB All Calling! for the name and address of a reliable valve repairing company. Here it is: The North London Valve Co., Ltd., 22 1/2, Gazenove Rd., London N.16. Repair prices: B.E., 3/-; D.E. 2v.3 5/9; D.E. .06, 6/-. Write for full price list [5960]

Mention of "The Wireless World," when writing to advertisers, will ensure prompt attention.

**Repairs.—Contd.**

LOUD-SPEAKERS, headphones, guaranteed repairs; any make or type rewound, demagnetised and adjusted by experts; best materials only used; post free, 4/-.—Howell, 2, Fotheringham Rd., Enfield, Middlesex. [5964]

**WANTED.**

EKO Junior Speaker, blue print of (all endorsed super het. by Kendall), "Modern Wireless," July, 1925; Magnum or old Bowyer-Lowe 6 terminal coupler; exchange new Bowyer-Lowe 4-pin oscillator which suited Kendall's set.—Cavendish, 49, Upper Berkeley Street, London, W.1. [5899]

WANTED, Selective 2- or 3-Valve Set, Marconi V2, or similar; cheap; approval.—BM/ESNT., London. [5932]

WANTED, set 3 transmitting inductances, Peto-Scott; potential divider, 10 tapings, 10,000 ohms; L.F. chokes for eliminators, 2 amp. aerial ammeter, Ormond Straight Line condensers, friction dials, .00035 set short wave coils, Lissen short wave choke, split primary and secondary transformers, 6-pin.—Box 3910, c/o The Wireless World. [5936]

BROWN Gramophone Attachment Reed movement wanted.—59, Sternhold Avenue, W.2. Phone: Streatham 6315. [5972]

VERRANTI A.F.3 Transformer; reasonable.—Moore, 136, Leam Terrace, Leamington. [5904]

**EXCHANGE.**

LEEPER Monotrol 4-Valve Reflex Set for good portable gramophone, or sell.—K, 22, Albacore Crescent, S.E.13. [5985]

BROWN Microphone Amplifier (listed £5/19/6); will exchange for good loud-speaker or good wireless parts, or will sell or 45/-.—C. Amos, 36, Albany St., Regents Park. [5923]

**AGENCIES.**

AGENTS Wanted for Cheapest and Safest Non-pumping Petrol-gas Lamps; good saving made converting all paraffin lamps into 50 c.p. Titus light; particulars, Titus, Kingston, Brighton. [5240]

**SITUATIONS VACANT.**

DESIGNS Engineer Wanted for the Design of Radio Broadcast Receivers, etc.; first-class qualifications and experience essential.—Apply, stating qualifications and salary desired, to Box 3862, c/o The Wireless World. [5906]

TRAVELLERS Having First-class Connection amongst Leading Wireless Trade offered liberal commission to introduce good selling line.—Apply by letter, stating ground covered, etc.—Box 3909, c/o The Wireless World. [5935]

**SITUATIONS WANTED.**

YOUNG Man (22), 5 years' technical college training, 2 years manager of large city wireless shop, experienced in design, making and selling of radio apparatus, seeks progressive position; S.E. Lancs. district preferred.—Box 3906, c/o The Wireless World. [5933]

SALES Demonstrator, keen, practical knowledge, good personality, own car, wants appointment.—Phone: Woolwich 0123. J. C., 67, Bostall Hill, S.E.18. [5975]

RADIO Engineer, late R.N. (Warrant Officer) and Marconi Co. needs employment (London or near); experienced retail management; practical and technical man; highest references.—Box 3916, c/o The Wireless World. [5974]

**Situations Wanted.—Contd.**

EXCEPTIONAL Man.—Trained salesman with seven years' experience sales development, B.Sc. and B.Com. (London); Position that leads somewhere required, preferably with wireless or electric manufacturer; disengaged shortly.—Write Box 3917, c/o The Wireless World. [5973]

**BOOKS, INSTRUCTION, ETC.**

THE ABC of the Superhet," by Mr. Claude L. Lyons, M.A.R.E., 88 pages, 17 explanatory diagrams or photographs, and including complete schematic and point-to-point wiring plan of the famous *Evening Chronicle* 8-valve superheterodyne receiver. The only book of its kind at present in existence; recently described by the Editor of *The Wireless World* as "A fascinating booklet. . . . A lucid description of the operation of the superhet receiver. . . . With constructional details and useful hints and for the home constructor." Only 8d. complete, post free, from Claude Lyons, Ltd. (G.R. Quality Parts), 76, Oldhall St., Liverpool. [0064]

SEND Sixpence for the well-illustrated booklet giving comprehensive and constructional details of successful high tension battery elimination from alternating current.—A. W. Knight & Co., 180, Tower Bridge Rd., S.E.1. [5687]

**MAKE YOUR OWN HIGH TENSION ELIMINATORS & BATTERY CHARGERS**

THE "Sensitite" High Tension Eliminator, complete kit of parts contains Super-Power Transformers, Chokes, Variable Wire Wound Tapped Resistances and necessary Condensers, all fully guaranteed. Prices from 18.6. Wiring diagrams and blue prints free. Write to-day stating A.C. or D.C. Mains.—

The WHOLESALE WIRELESS Co., 103, Farringdon Road :: London, E.C.1.

Anything for Wireless sent C.O.D.

Send a note of your requirements to YOUNG'S (GLASGOW) LTD., 40, Stockwell St., GLASGOW.

**DIX-ONEMETERS**

are the best Bargain ever offered to Radio users. £10 worth of precision, Multi-range Mirror scale, Jewelled knife-edge Instrument for 55/-



Have you a copy of the "CATALOGUE THAT SAVES YOU POUNDS."

Dynamos, 50/-; Alternators, 70/-; Cabinet Violina Loud Speakers, 25/-; Weston Relays, 25/-; Gyroscopes, 15/-; Micro-Ammeters to 1/2 micro-amp, 60/-; Fire-side Auto. Fila. Switches, 10/- & 15/-; X-Ray Tubes and Coils cheap; Frame Aerials 10/-; H.T. Eliminators, 30/-; 34" Paxolin Tubes, 6d.; G.P.O. Galvos, 7/6; Marconi Valve-Crystal Sets, 27/6; 2-Valve, 45/-; Sterling 3-Valve, 25 10s. 0d.; 5-Valve R.A.F., 25. 6-Valve Marconi, 21s.

**ELECTRADIX RADIOS for Everything**

Send your enquiries and 4d. for Illustrated Catalogue, or call at 218, Upper Thames Street, E.C.4.

**A CORRECTION**

Owing to a printer's error in our advertisement on page 9 last week, the filament voltage of the

**CLEARTRON VALVE CT 215 H°**

was given as 5 volts. This should read 2 VOLTS.

SELFRIDGE'S RADIO DEPT., FIRST FLOOR, OXFORD ST., LONDON, W.1.

**EBONITE BUSHES**



FOR MOUNTING ON METAL OR WOOD.

Orders under 1/- send 1/2d. Postage

NUMBER	0	1	2	3	4	5	6
Hole in Bush	6BA.	4BA.	2BA.	1/2"	5/16"	1/4"	7/16"
Price each :	1d.	1d.	1d.	1d.	2d.	2d.	2d.

(Complete List of sizes free on application.)  
DAREX RADIO CO.,  
Waldram Rd., Forest Hill, London, S.E.23.  
TRADE SUPPLIED

**The H.T.C. TWIN RECEIVER**

A complete up-to-date set, including loud speaker and all accessories, as shown at Olympia.

Seven days' trial and initial payment refunded if not entirely satisfactory.

H.T.C. ELECTRICAL CO. LTD., 2, Boundaries Rd. Balham, S.W.12.



Immediate delivery for Balance 2/6 per week or 10/- per month. Total cost £6.10.0.

5/-

Cash Price 23 4 0  
Royalty Paid.  
3 valve set. Cash Price 23 8 0  
Deferred Terms 23 16 0

As near perfection as possible

Coefficient of coupling for first stage is .982. For a perfect transformer this should be 1. This means a loss of only .018 or 1.8 per cent.

The Power Equipment Co. Ltd. Kingsbury Works, The Hyde, HENDON, N.W.9.

**POWQUIP TRANSFORMERS**

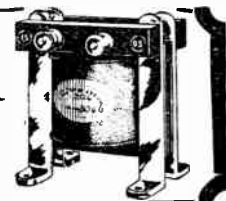

**The TANNON H.T. UNITS FOR D.C. MAINS**

KIT OF PARTS from 25/- COMPLETE UNITS from 2 Gns.

WRITE FOR LISTS OF COMPONENTS, ETC.

TULSEMERE MANUFACTURING CO.,

Tulsemere Road, West Norwood, S.E.27. Phone: Streatham 6781

INDEX TO ADVERTISEMENTS.

Accumulators Elite	PAGE 32	Gambrell Bros., Ltd.	PAGE 23	P.B.G., Ltd.	PAGE 25
A.F.A. Accumulators, Ltd.	21	Garnett, Whiteley & Co., Ltd.	10	Power Equipment Co., Ltd.	31
American Hard Rubber Co. (Brit.), Ltd.	27	General Electric Co., Ltd.	Cover ii & 18	Pye, W. G., & Co.	10
Batteries, Ltd.		General Radio Co., Ltd.	16	Radio Service (London), Ltd.	32
Belling & Lee, Ltd.	18	Graham Amplion, Ltd.	Cover ii	Redfern's Rubber Works, Ltd.	10
Benjamin Elec. Co., Ltd.		Graves J. G., Ltd.	23	Regent Radio Supply Co.	26
Bowyer-Lowe Co., Ltd.	26	Hadley, G. H.	24	R.I. & Varley, Ltd.	5
Brandles, Ltd.	19	Hawkins & Sofie	27	Scott, G. L., & Co., Ltd.	26
British General Manf. Co., Ltd.	18	Hayberd, F. C., & Co.	20	Siemens Bros. & Co., Ltd.	31
British Thomson-Houston Co., Ltd.	13	Hildick & Hildick	20	Sifam Electrical Inst. Co.	17
Brown, S. G., Ltd.	3	Holtzman, L.	31	Simmonds Bros.	6
Burndopt Wireless Apparatus	4	H.T.C. Electrical Co., Ltd.	6	Stapleton, A. W.	26
Carborundum Co., Ltd.		Hunt, A. H., Ltd.	11	Taylor, J. H., & Co.	26
Christie, Jas., & Sons, Ltd.	25	Igranic Electric Co., Ltd.	20	Tulsemere Manf. Co.	22
Colc, E. K., Ltd.	22	Jackson Bros.	20	Tungston Accumulator Co., Ltd.	31
Collinson Precision Screw Co., Ltd.		Jones & Stewart	29	Vandicrevell, C. A., & Co., Ltd.	8
Cossor, A. C., Ltd.	12	Lampugh, S. A., Ltd.	21	Varley Magnet Co.	24
Darex Radio Co.	26 & 31	Langham Radio	23	Walker Bros. (Guildford), Ltd.	6
Digby, F.		Lawrence & Hull	23	Walton Wireless Co., Ltd.	22
Dubilier Condenser Co (1925), Ltd.	7	Lifford Engineering Co.	24	Weston Elec. Instrument Co., Ltd.	4
Eagle Engineering Co., Ltd.		Lyons, Claude, Ltd.	17 & Cover iv.	Whiteley, Boneham & Co., Ltd.	22
Edison Swan Electric Co., Ltd.	31	Mareoniphone Co., Ltd., The	2	Wholesale Wireless Co.	31
Electradix Radios	8	McMichael, L., Ltd.	14 & 15	Williams & Moffat	32
Electron Co., Ltd.	24	Metro-Vick Supplies, Ltd.	22	Wingrove & Rogers, Ltd.	31
Eton Glass Battery Co.	9	Mic Wireless Co.	1	Wright & Weaire, Ltd.	31
Ferranti, Ltd.	22	Morris, J. R.	24	Young's (Glasgow), Ltd.	32
Finston Manf. Co., Ltd.	20	Mullard Wireless Service Co., Ltd.			
Formo Co.		Ormiston, P., & Sons, Ltd.			

**THE NEW [LOW LOSS. LOG LAW.] SIMPLICON-4.L.**

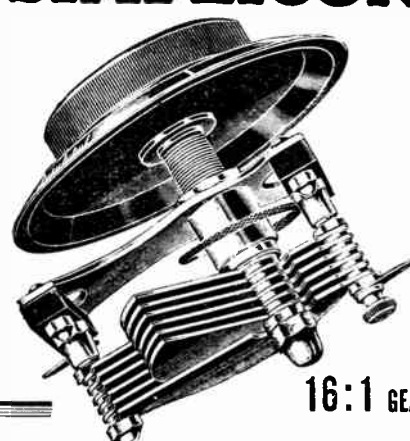

**13/-**  
·0003.  
Other Capacities:  
**13 6 ·0005.**  
**12 9 ·00025.**  
**12 6 ·00015.**

**16:1 GEAR WITH KNOB AND DIAL.**

**THE CONDENSER THAT CAUSED THE SENSATION AT OLYMPIA.**

**THE ONE THAT IS DIFFERENT.**  
Those who could not see it send for leaflet.

**A precision made Instrument fully guaranteed.**  
*The ideal Condenser for Portables.*

Sole Manufacturers: **WILLIAMS & MOFFAT, Ltd.**  
Grange Road, Small Heath, BIRMINGHAM.

The **Wireless World** AND RADIO REVIEW

**EVERYMAN FOUR**

A 36-Page Booklet giving full Constructional Details of a remarkably efficient "Two-Control" Receiver for Long or Short Waves.

By W. JAMES.

The "EVERYMAN FOUR" attracted widespread attention when it was first described in "The Wireless World." It is a very sensitive set and has a high degree of selectivity. The local station is perfectly received, and during a normal evening at least fifteen different stations may be received clearly at good loud-speaker strength. (Constructors claim up to twenty-eight stations.) An additional long-wave attachment for Daventry is described in the booklet.

Price 1/- net By post 1/2

From the offices of "THE WIRELESS WORLD," Dorset House, Tudor Street, London, E.C.4. w.w.59

**LONDON LISTENERS!**  
—improved reception ensured

if you have your accumulators correctly charged by our skilled maintenance service. We collect weekly, fortnightly or monthly within 12 miles of Charing Cross, and exchange your accumulator (H.T. or L.T.) for one fully charged. **If yours are not serviceable, you can hire ours.** Both trouble-free, money-saving services. Terms—weekly, fortnightly, monthly or quarterly—no deposit required. And you can depend on our service for a solution in every wireless trouble.

*Our service—the speciality of experts*  
Write for full details and terms:  
**RADIO SERVICE (London) Ltd.,**  
105 Torrione Avenue, and 22 E2., N.W.5. Phone: 1 111 083 (4 lines)



**ACCUMULATORS "ELITE"**  
— The Elite of all —

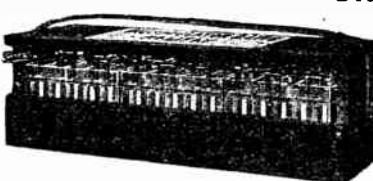

**H.T. ACCUMULATORS, 80 volts type, 02, Semi-oil Submerged. Complete, as illustrated. Price 22/-**

The World's Best High Tension Accumulator and of Brit Manufacture. The Unique Semi-Oil Submerged feature of Elite, absolutely prevents surface leakage losses. The battery lasts a life-time. Write for lists.

**ACCUMULATORS ELITE Bedford Street, HALIFAX**  
Telephone: 4304. Telegrams: Elite Halifax

London Distributor:—**CECIL POHLMAN, 77, Great Portland Street, LONDON, W**

Mention of "The Wireless World," when writing to advertisers, will ensure prompt attention.

THIRD YEAR OF PUBLICATION

The **Wireless** **DIARY**  
AND RADIO REVIEW **World for 1928**

AN INVALUABLE LITTLE BOOK FULL OF USEFUL INFORMATION FOR EVERY WIRELESS ENTHUSIAST.

IN previous years "The Wireless World" Diary has proved of so much value to wireless users that the 1928 Edition will undoubtedly be welcomed by a wide circle of radio enthusiasts.

This little book contains, in convenient compass, items of information which are frequently required, and the Diary pages provide ample space for notes concerning individual sets and other wireless matters.

**Brief List of Contents :**

Convenient Diary: Glossary of Technical Terms: Broadcasting Stations of Europe: Tables of Wavelength, Frequency and L.C. Values: Wireless Symbols: Circuit Diagrams: Wireless Notes for Amateurs: Valve Data: Coils for Broadcast Wavelengths: etc.

NOW  
READY

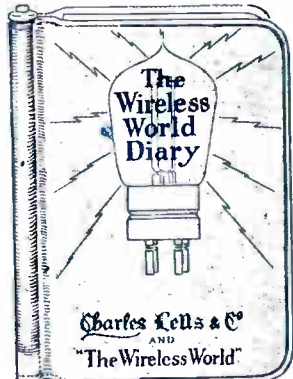

Charles Kells & Co.  
AND  
"The Wireless World"

**PRICES:**

Cloth Edition, 1 - net. By post, 1/11. Leather Case, with pockets, pencil and season-ticket window, 2/6 net. By post 2/8.

*From all booksellers and stationers, or direct from the Publishers:*

ILIFFE & SONS LTD., DORSET HOUSE, TUDOR STREET, LONDON, E.C.4.

W.W. 34

**NOW READY**  
**WIRELESS**

**Second Edition (Revised) of**  
**LOUD SPEAKERS**

By N. W. McLACHLAN, D.Sc.

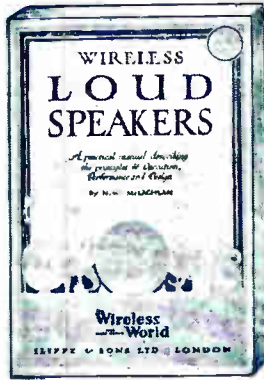

A Practical Manual describing the Principles of Operation, Performance and Design.

THE purpose of this book, now in the second edition, revised throughout by the author, is to describe in a simple manner the major principles of the design of modern loud-speakers—chiefly of the large diaphragm type—and some associated circuits. Throughout the volume the author has refrained from a too technical treatment of the analytical side of the subject. The book is clearly written and fully illustrated by numerous diagrams and photographic reproductions. A chapter showing how to construct a loud-speaker will appeal to many amateurs.

**A Résumé of the Contents :**

GENERAL ACOUSTIC PRINCIPLES: LOUDNESS OF REPRODUCTION AND ITS INFLUENCE ON QUALITY: RESONANCE CAUSING BLURRING OF COMPLEX SOUNDS: PRINCIPLES AND DESCRIPTION OF HORN-TYPE LOUD-SPEAKERS: LATERAL MOTION OF AIR EFFECT OF HORN LENGTH: PRINCIPLES OF LARGE DIAPHRAGM SHAPE: CONE DIAPHRAGMS: REFLECTORS: ROOM RESONANCES: STANDING WAVES: ACOUSTIC SHADOWS ETC., ETC.

Price 2/6 net. By post, 2/8.

*From all booksellers or direct from the Publishers:*

ILIFFE & SONS LTD., Dorset House, Tudor Street, London E.C.4.

W.W. 54.

*Advertisements for "The Wireless World" are only accepted from firms we believe to be thoroughly reliable.*

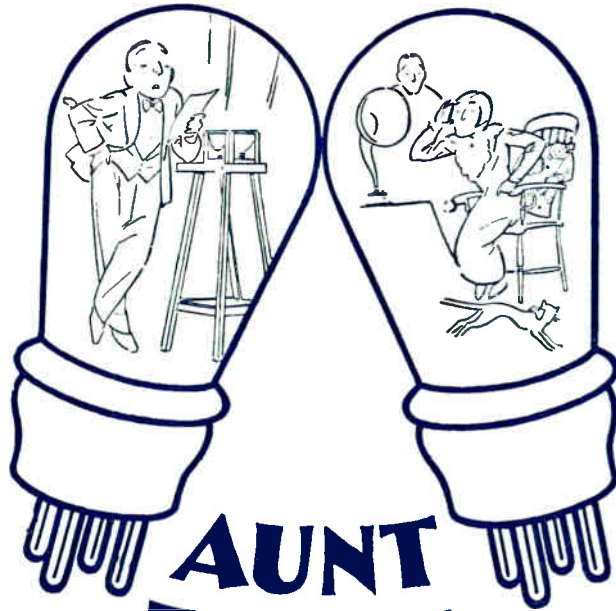

# AUNT ETHEL SAID IT WAS LIBEL

George is an announcer. At Binghampton, we believe. He's Aunt Ethel's favourite nephew. When she heard him on Cousin Dick's set one evening she said, first of all, that George had croup. Then she said it was a scandal.

And after that she talked a lot about solicitors and libel actions and things.

For George, as you've probably gathered, was a victim of "valve distortion." When Aunt Ethel told him what he sounded like on Cousin Dick's set, he said that was the *worst* of Dick, he would go experimenting, and that Marconi Valves ought to be made compulsory by law . . . .

Seriously, though, that is one outstanding thing about Marconi Valves. They don't "twist." Moreover, they're very economical on power and they last a tremendously long time. You see, they're MARCONI, which means that everything—filament, grid, plate, vacuum, *everything*—is designed for the purpose of a making better VALVE.

You have a 2-volt accumulator?—then these are the Marconi Valves you need :—

Marconi D.F.H. 210—for the H.F. stage (Price 10/6)

Marconi D.E.L. 210—for the detector stage  
(also for 'general purposes') " 10/6

Marconi D.E.P. 210—for the Power stage " 12/6

Full particulars of all Marconi Valves and all Marconi Sets are to be found in an amusing and informative free booklet called "Back Chat." Secure your free copy by sending off the coupon (below) Now.

# MARCONI VALVES

-do everything that a valve should do'

The Marconiphone Co. Ltd. (and reduced)  
210-212, Tottenham Court Road, London, W.1.

Please send me copy of "Back Chat."  
Thank you.

Name.....  
Address.....  
WW 3 #d stamp if unsealed

Printed for the Publishers, ILIFFE & SONS LTD., Dorset House, Tudor Street, London, E.C.4, by The Cornwall Press Ltd., Paris Garden, Stamford Street, London, S.E.1.

Colonial and Foreign Agents:  
 UNITED STATES—The International News Co., 131, Varick Street, New York. FRANCE—W. H. Smith & Son, 249, Rue Rivoli, Paris; Hachette et Cie, Rue Beaumart, Paris.  
 BELGIUM—W. H. Smith & Son, 78, Marche aux Herbes, Brussels. INDIA—A. H. Wheeler & Co., Bombay, Allahabad and Calcutta. SOUTH AFRICA—Central News Agency, Ltd.  
 AUSTRALIA—Gordon & Gotch, Ltd., Melbourne (Victoria), Sydney (N.S.W.), Brisbane (Queensland), Adelaide (S.A.), Perth (W.A.) and Launceston (Tasmania).  
 CANADA—The American News Co., Ltd., Toronto, Winnipeg, Vancouver, Montreal, Ottawa, St. John, Halifax, Hamilton; Gordon & Gotch, Ltd., Toronto; Imperial News Co., Toronto; Montreal, Winnipeg, Vancouver, Victoria. NEW ZEALAND—Gordon & Gotch, Ltd., Wellington, Auckland, Christchurch and Dunedin.



3<sup>D</sup>

# The Wireless World

AND RADIO REVIEW

*The Paper for Every Wireless Amateur*

Wednesday, October 19th, 1927.

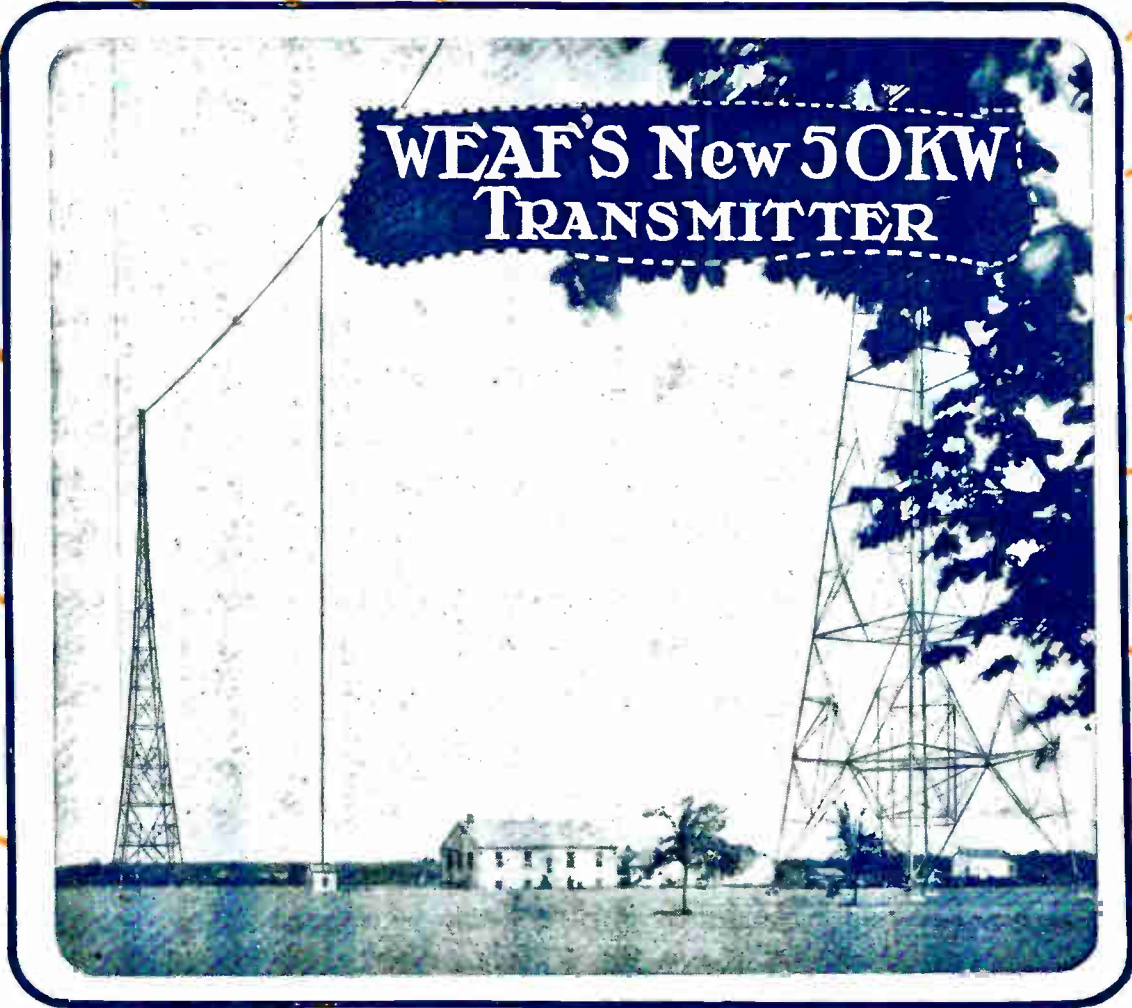

## Condensers and Resistances



Type 620 Mica Receiving Condenser. 21 standard capacities from 0.00005 to 0.015 mfd.



Dubilier Resistors made in 21 standard values up to 50 ohms, to fit Dumetohm holders.



The Duwirohm wire-wound Anode Resistance made in 14 standard values.

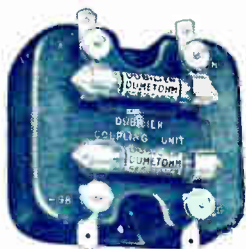

The Dubilier R.C. Coupling Unit for use with high amplification factor valves.

**D**UBILIER Condensers and Resistances are the outcome of a highly specialised experience.

They are designed with a thorough understanding of the functions which each is expected to perform and their unfailing accuracy and reliability have made them famous wherever the science of radio is known.

Use Dubilier Condensers and Resistances in every radio set you build and be assured of the satisfactory results which only carefully chosen components can give.

**Type 620.**—This is the famous fixed mica condenser which is the vertical counterpart of the type 610. It is suitable for use as a grid condenser, by-pass condenser, etc., etc. Both types 610 and 620 are made in 21 different standard capacities between 0.00005 and 0.015 mfd., and are supplied with the necessary clips for series and parallel mounting of the Dumetohm between 0.00005 and 0.0005 mfd. capacities.

Prices from 2/6 to 4/6, according to capacity.

**Dubilier Filament Resistors.**—We supply a complete range of accurate Filament Resistors which clip into the Dumetohm holder as shown. By employing the correct value of resistor you are enabled to obtain the drop in voltage necessary when using say, 2-volt valves with a 6-volt accumulator.

We shall be pleased to forward a chart enabling you to determine the correct resistor to use in any given case.

**Dubilier Resistors, 1/- each.  
Dumetohm Holders, 1/- each.**

**The Duwirohm,** a Dubilier wire-wound Resistance, is constructed with a special form of non-inductive winding enabling the Resistance to carry a potential of several hundred volts in safety. Graded to a close degree of accuracy, it is guaranteed to remain constant indefinitely. Standard Resistances are 10, 20, 30, 40, 50, 100, 70, 80, 90, and 100 thousand ohms at 5/- each, 150 and 200 thousand ohms at 8/- each, 250 thousand ohms at 9/9 each and 300 thousand ohms at 11/6 each. Holder as shown 1/6 extra.

**The Dubilier R.C. Coupling Unit.**—In this unit is combined our unique experience in the manufacture of Condensers and Resistances. The condenser element contains dielectric of the best India Ruby Mica, the resistances being the famous Dumetohms which, it will be noticed, can be interchanged for values to suit your own requirements. Many thousands of these units are giving excellent reproduction all over the country. Price 7/- each.

**Your  
Dealer  
Stocks**



**Products  
—Ask  
Him**

Advt. of The Dubilier Condenser Co. (1925) Ltd., Ducon Works, North Acton, W.3.

T.C.53

IT COSTS YOU LESS  
TO USE MULLARD  
0.075 VALVES

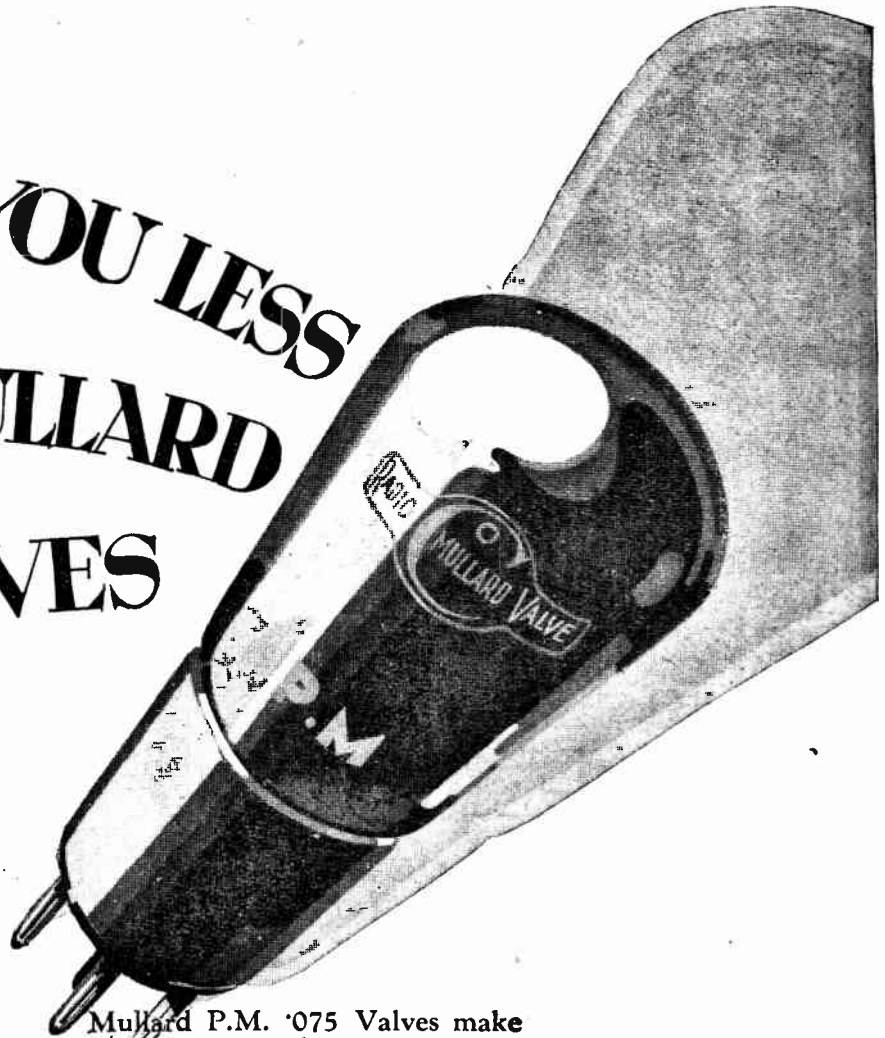

Mullard P.M. '075 Valves make  $1/10$  ampere valves extravagant. They give the ample power you want from your receiver, last long and stand hard service ... provide pure tone and true reproduction, all with reduced running cost.

These are some advantages of valves with the wonderful Mullard P.M. Filament, the filament that is robust and tough, the filament with great emission surface.

Depend on Mullard to improve your radio reception.

**Mullard**  
**THE MASTER VALVE**

# SEFRIDGES

and the Famous  
**"CLEARTRON" VALVES**

**T**HE famous "Cleartron" Valve has during a usually quiet summer season created, what we believe to be, a record for the sale of Radio Valves in this country. "Ring" prices are still much higher than is economic. Compare them with those fixed for the coming season for "Cleartron"—British made and standard. The famous "Cleartron" Valve is now 3/9 for ordinary type and 6/6 for power and R.C.C. types. Every valve is a dull emitter, and fresh supplies are sent weekly from the Birmingham Factory.

**SPECIFICATION OF THE FAMOUS "CLEARTRON" VALVES:**

Valve.	Filament Volts.	Filament Amps.	Impedance Ohms.	Amplification Factor.
CT10	3·8	0·1	15,000	7·5
CT10*	3·8	0·1	8,000	3·8
CT15	1·8-2	0·15	18,000	7·5
CT15*	2·0	0·3	7,500	4·5
CT25	5·0	0·25	10,000	9·0
CT25B°	5·0	0·25	20,000	20·0
CT25*	5·0	0·5	4,000	5·0
CT215H°	2·0	0·15	100,000	45·0

\*Valves are Power Valves.  
 °Valves are Special Valves for resistance capacity amplification.

<b>General Purpose VALVES</b>	<b>British VALVES</b>	<b>Power VALVES</b>
Ruling "Ring" Price 10/6	Ruling "Ring" Price 12/6	Ruling "Ring" Price 6/6
<b>SEFRIDGE 3/9</b>	<b>SEFRIDGE 6/6</b>	
Price, each	Price, each	

Postage 3d. extra. Postage 3d. extra.

Radio Department, First Floor.

## "CLEARTRON" Famous "Di-Kast" Condensers

These are variable Air-Dielectric Condensers, with both Rotor and Stator cast in one piece. They were manufactured under direct licence from the Western Electric Co. Ltd., and under the registered design of Lamplugh of Birmingham. Specially designed vanes provide straight line readings and are very suitable for short wave work. Capacities '0005, '0003 and '0002 only. Complete with Detex 2½ inch slow-motion dial. Former Price 13/6 **SEFRIDGE PRICE, each 4/3**

Or complete with 4-inch Detex dial, Former Price 14/6 **SEFRIDGE PRICE, each 4/9**

Condensers only, **SEFRIDGE PRICE, each 2/6**

Postage 6d. each extra.

Radio Department, First Floor.

Selfridge & Co., Ltd., Oxford St., London.

Phone—Mayfair 1234

Mention of "The Wireless World," when writing to advertisers, will ensure prompt attention.

DO YOU  
  
 SAVE MONEY?

DO YOU SAVE MONEY BY USING

# "VARTA" MONOBLOCKS

FOR  
 RADIO H.T. SUPPLY



"VARTA" 20 VOLT H.T. MONOBLOCK TYPE "WA" (with one tapping at 10 volts).

PRICE NOW REDUCED TO  
**9/-**

THUS A 60 VOLT BATTERY OF 3 "VARTA" MONOBLOCKS COSTS 27/-, JUST 3 TIMES AS MUCH AS A DRY BATTERY,

AND LASTS INFINITELY LONGER.

*"Don't scrap—recharge."*

WRITE FOR LIST Nos. 1, 2 & 3 to

A.F.A. ACCUMULATORS LTD., 120, Tottenham Ct. Rd., W.1

A  
Perfect  
Job.

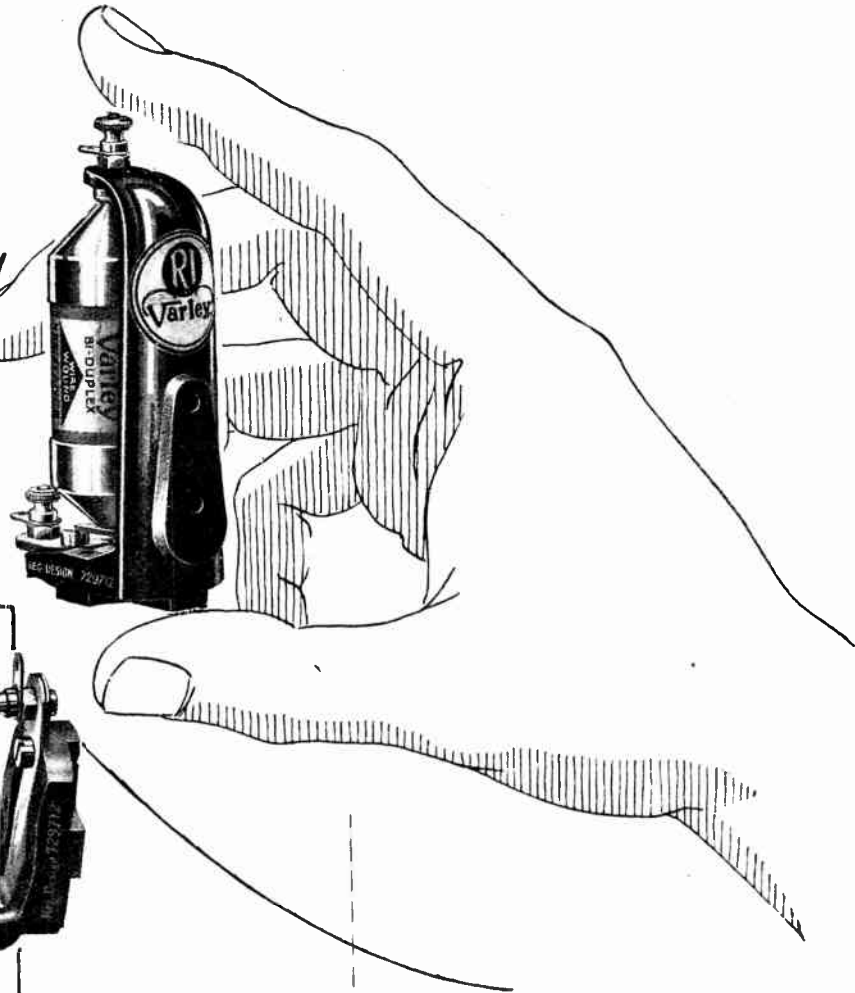

FOR  
HORIZONTAL  
MOUNTING

## IT'S BI-DUPLEX WIRE-WOUND

Only those who have actually used Bi-duplex wire-wound components can appreciate the real significance of this famous winding.

To begin with, every turn of bare wire is separated from the next by specially spun silk and, in addition, each layer of wire and silk is separated from the next by micanite paper. This method of winding ensures absolute constancy under all conditions; the possibility of shorted or leaking turns is eliminated, the slightest generation of heat is quickly and evenly distributed, and maximum air spacing consistent with mechanical stability is assured.

All resistances are non-inductively wound with a special alloy wire, which has a large factor of safety in current-carrying capacity.

The finished touch to these perfect components is the new **UNIVERSAL HOLDER**, which makes them suitable either for **VERTICAL** or **HORIZONTAL MOUNTING**.

Made in a complete range of sizes up to 500,000 ohms.

Prices **5/6** to **17/6**

Leaflet C.16 with full particulars, including Power Types, Tapped Resistances, and Variable Resistances, on application.

*Other famous Bi-duplex Wire-Wound components are our new Resistance Capacity Coupler and Multi-Cellular H.F. Choke.*



# THE MARK OF BETTER RADIO

Kingsway House, 103, Kingsway, London, W.C.2.

Telephone: Holborn 5303.

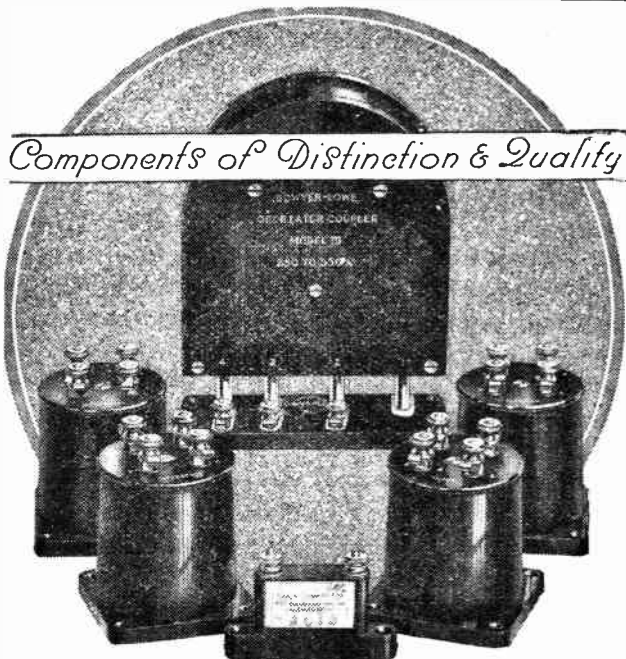

*Components of Distinction & Quality*

Constructor's Kit containing principal components for building a Seven Valve Set, £10. Three Transformers, one Filter, and fixed Condenser, £4. Interchangeable Oscillator Couplers: 250-550 metres, £1. 550-2000 metres, £1. Base for same, 4s.

# Pioneers in Super-Het Components

The world-wide success of BOWYER-LOWE Super-Het Components and Receivers has not been due to chance. BOWYER-LOWE were Super-Het pioneers. Long before other manufacturers had begun to think of Super-het production, BOWYER-LOWE designers were at work. Laboratory research was followed by elaborate and exhaustive testing and no component was introduced until it had satisfied the high standards of BOWYER-LOWE performance.



THE "WHITELINE" VALVE HOLDER 2/3



"POPULAR" CONDENSER  
0003 .. 10/-  
0005 .. 10/6

WRITE TO-DAY for a COMPLETE LIST of OUR PRODUCTIONS.



BOWYER-LOWE CO. LTD., LETCHWORTH



A BOOK THAT EVERY EXPERIMENTER SHOULD HAVE: "The Bowyer-Lowe Standard 7 and 8-valve Super-Heterodyne"

How to Build and Operate. By A. E. BOWYER-LOWE.

PRICE - - - 2/-

Send your remittance for a copy to-day.

IGRANIC TRIPLE HONEYCOMB INDUCTANCE COILS.

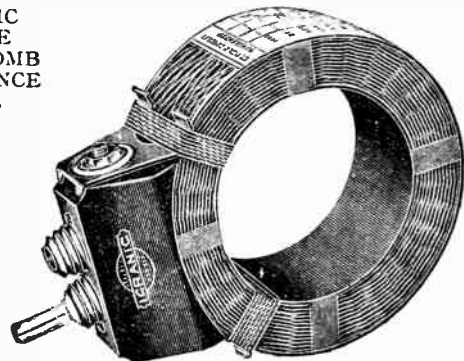

## IGRANIC COILS set

a new and higher standard

Always since radio became popular IGRANIC COILS have led the way. With this new radio season still more exclusive features have been incorporated in IGRANIC TRIPLE HONEYCOMB INDUCTANCE COILS to keep them well ahead of competition.

Here are the three new features of importance to all radio enthusiasts :-

- 1 Self-capacity much lower.
- 2 High frequency resistance decreased.
- 3 Adjustable extra low loss plug and socket mounting.

The IGRANIC TRIPLE HONEYCOMB INDUCTANCE COIL is obtainable in seventeen different sizes giving a wave-length range of 100 to 25,000 metres. Prices from 2/9 for a No. 25 to 16/- for a No. 1,500. Ask your dealer about them.

The Igranic range of Coils includes Tapped Triple Honeycomb Coils, XLLOS (Extra Low Loss) and Centre Tapped XLLOS Coils, Short Wave Coils and the Unitune Aperiodic Fixed Coupler.

Write for publication U.225 which describes the entire range.



149, Queen Victoria Street, London, E.C.4  
WORKS: BEDFORD

BRANCHES: BIRMINGHAM, BRISTOL, CARDIFF, GLASGOW, LEEDS, MANCHESTER, NEWCASTLE.

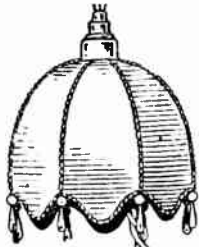

# For working entirely off the E.L. Mains

The illustration shows the new Met-Vick 5 with the eliminators contained in the side cupboards. It can be plugged into a lighting circuit just like any other Electric appliance. If used with H.T. and L.T. batteries these can be accommodated in the cupboards. The circuit employs two phase-balanced and stabilized H.F. stages before the detector, and two resistance coupled L.F. stages.

Operation is extremely simple, the local station can be easily cut out and a wide range of alternative programmes obtained. Special attention has been paid to running costs which are remarkably low.

The Met-Vick 5 is a really beautiful instrument and while a distinct advance on any 1926 model it still remains at a reasonable price. Obtain Leaflet 4117/9 for complete range of prices.

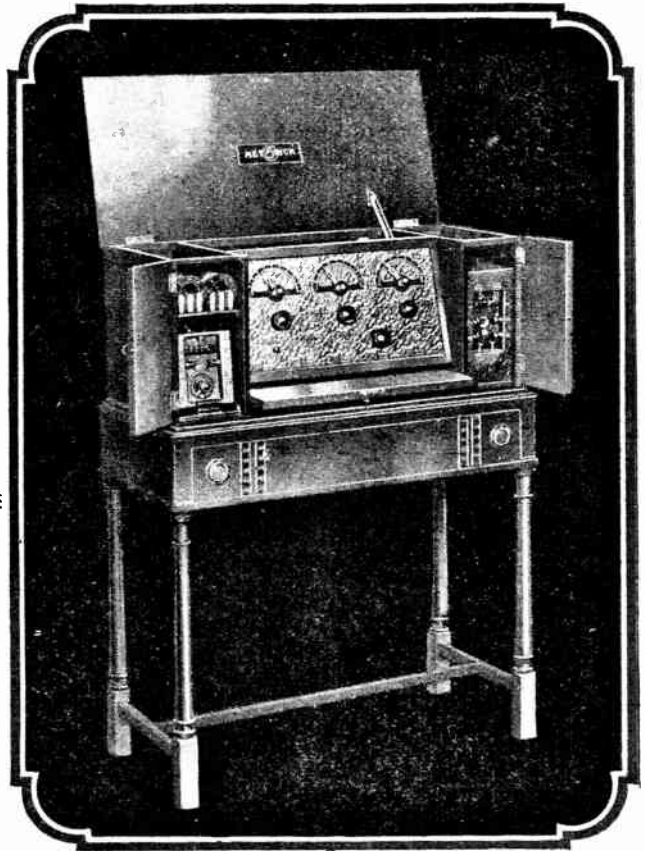

## Battery Eliminators

Met-Vick Battery Eliminators are supplied in two models, one for providing filament current and the other for anode and grid currents, by plugging in on electric light mains. *The H.T.-G.B. Model* provides a high voltage (up to 250 V.) for the last valve (ensuring a large volume without distortion). It is fitted with a switch, a protective fuse and a distributor panel enabling it to be used on various supply voltages of 40-100 periods. Grid Bias tapings at 5, 10, 15 and 20 volts.

The smoothing system is of exceptional efficiency. The eliminator can therefore be used successfully with multi-valve and the most sensitive sets even in districts where there are considerable irregularities in the electrical supply.

*The L.T. Model* gives an output of 5 amperes at 4 volts and a potentiometer ensures complete absence of hum. Obtain copy of List 7117/8.

# MET-VICK

(COSMOS)

## METRO-VICK SUPPLIES LIMITED

(Proprietors: Metropolitan-Vickers Elec. Co. Ltd.)

155 Charing Cross Road - LONDON, W.C. 2

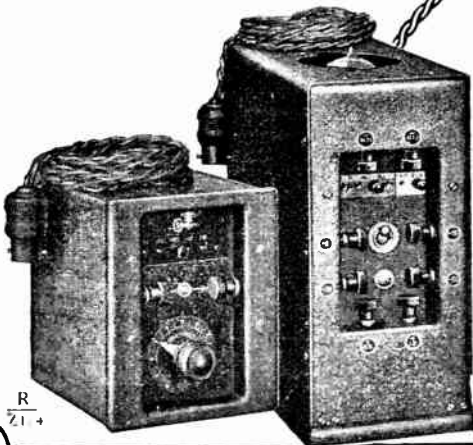

R  
Z.T. +

**As correct as  
the plumb line**

**T**HE shortest distance between two points" our old friend Enclid tells us, "is a straight line." The plumb line always registers the shortest distance between two points. It is correct—to a minute degree.

So is the T.C.C. Condenser. The strenuous tests through which every T.C.C. passes, ensure that. When you buy a T.C.C. you know that its capacity is identical with that stamped on the side of its green case. In its insulation, too, you can have the same complete faith. Remember: you get a square deal when you buy T.C.C. Mansbridge Condensers. All capacities from .005 mfd. price 1/8d.



**T.C.C.  
Condensers**

3d.

and Coupon  
brings copy of  
"How to build  
your own H.T.  
Eliminator."

To the Telegraph Condenser Co. Ltd., Wales Farm Road., N. Acton, W. 3.  
I enclose 3d. in stamps. Please send me a copy of "How to build your own H.T.  
Eliminator for A.C. or D.C." W.W. Oct. 19

Name..... Address.....



Mention of "The Wireless World," when writing to advertisers, will ensure prompt attention.



**RECUPERATING AGENT  
IN THE  
HELLESEN  
DRY BATTERIES.**

**T**he proof of a Dry Battery is the number of hours of efficient service you get out of it for the money you spend. We are confident of the result if you rely on a Helleesen Dry Battery for your H.T. Supply. Get a smooth uniform H.T. Supply at the minimum cost per hour from a sealed genuine Helleesen H.T. Battery with the quadruple insulation and the No. 7 Recuperating Agent.

60-volt "WIRIN" 12/6  
99-volt "WIRUP" 21/-  
(Postage Extra.)

All types, voltages, etc., in Double and Treble capacities for H.T. and L.T. Supply. Ask your dealer for the type to suit your set and get the maximum service, or write us for full particulars.

Obtainable at all Radio, Electrical and General Stores Harrods, Selfridges, etc., or direct from

A. H. HUNT, Ltd. (Dept. 1), CROYDON, SURREY.







**SAY WHAT SET YOU HAVE-AND WE'LL TELL YOU WHAT VALVE TO USE**

There are over twenty Ediswan valves—each different—each specifically designed to do a certain thing and do it well.

Choosing valves for your set is like choosing instruments for a band. Each must perform in harmony with the other.

Let us help you to get the best out of your set. Describe the set you have (or the set you're going to build) and post it to us with the coupon below. We will send you a copy of the Ediswan Range booklet with the valves you require specially marked. *Just post the coupon.*

*See that little window in the Ediswan Valve?*

*Here's the reason.*

*The low-current consumption of Ediswan valves (and especially the Quarter-Watt Point One Economy types) is so low and the glow is so dull, that a window is necessary to tell you if the valve is really operating: Ediswan valves will bring immediate improvement to a set which is already good. Ediswan valves in many sets will bring enchantment out of chaos. Prove for yourself how true is the famous Ediswan Slogan:—*

**“Clearest, strongest, last the longest”**

**EDISWAN**



V.61

To The Edison Swan Electric Co., Ltd. W.W. 19-10-27  
 (Publicity), 123/5 Queen Victoria Street, LONDON, E.C.4.

Particulars of my set are attached. Send your valve booklet marked up with valves you recommend.

NOTE. If you would like a copy of the "R.C. Threesome" Book and Blue Print also, place a cross here.....

Name .....

Address .....





**Same price—only cheaper**

Whilst the prices of Daimon 60 and 100 volt batteries are the same as other makes, Daimon are in reality cheaper because they are better. Daimon batteries are made by the oldest battery manufacturers in Europe, and each battery produced has in it all the finer points that make for improved reception.

**DAIMON JUNIOR**  
60 volts .. 7/11, 100 volts .. 12/11.

See us at the Manchester Exhibition, October 24—November 5. **STAND 67.**

From all good dealers or direct  
**S.D.H. Manufacturing Co.**  
Collindale Avenue,  
Hendon, London, N.W.9.

**daimon**  
**BATTERIES** 7/11

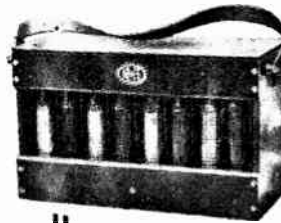

**Why do Imperial Airways use "NIFE" Accumulators only?**

**Absolute reliability is essential.**

*You will be interested in the new models of the "NIFE" Steel Plate H.T. Batteries.*

**Send for leaflets now.**

**Batteries Ltd., Redditch, Eng.**  
220 Shaftesbury Avenue, London, W.C.2



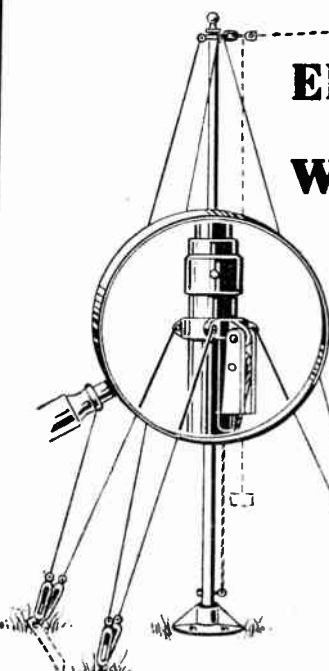

**A GOOD ENGINEER'S TELESCOPIC WIRELESS MAST**

(Patent Nos. 233035 & 244883.)  
Note:— Enlarged view of catch to support top section when extended. Tubular, 17 ft. when telescoped, complete with guy wires, straining screws, base plate and ground pegs. The whole galvanised except ground pegs.

**LASTS A LIFETIME**

**34 Feet**  
**£3 - 15 - 0**

**50 Feet**  
**£7 - 5 - 0**

**HILDICK & HILDICK,**  
**PLECK ROAD, WALSALL.**

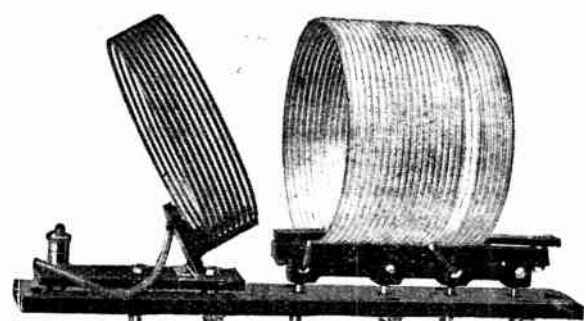

**Interchangeable . . . .**

Supplied in a set of four, with one suitable aerial coil covering the full wave-band. Mounted on low dielectric strip, fitted with six pins. A base is provided carrying six spring contacts.

**PRICE 35/-**

Approximate tuning range with .00015 mfd. condenser:

Coil A: 10 to 17 meters  
Coil B: 17 to 34 meters  
Coil C: 34 to 70 meters  
Coil D: 60 to 130 meters

**C**OLVERN short-wave coils fulfil all the requirements for highly efficient functioning at the extreme higher frequencies. The coils are robust, turns are air-spaced and are supported by the minimum of dielectric material. The leading-out wires pass outside the coil, and are soldered direct to pin contacts.

**COLVERN VALVE HOLDERS** for the new Screened-grid Valves . . . give a choice of four positions - - **4 6**

**THE COLLINSON PRECISION SCREW CO. LTD.**  
PROVOST WORKS, MACDONALD ROAD, WALTHAMSTOW, E.17

Mention of "The Wireless World," when writing to advertisers, will ensure prompt attention.

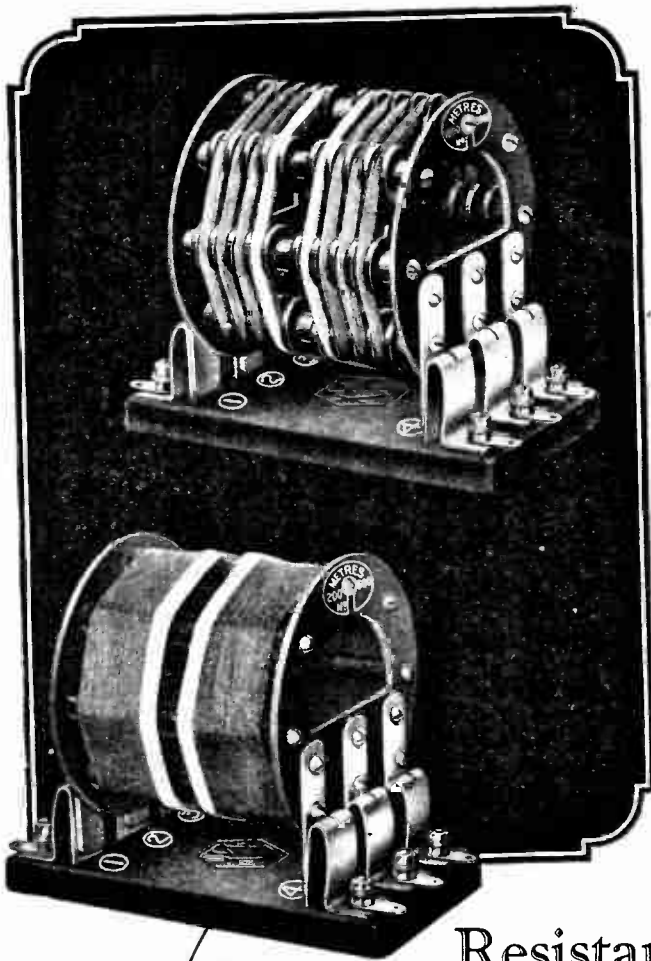

*Zz*

# A·N·P

(Astatic-Non-Parasitic)

# Coils

A CLEVER SOLUTION OF A DIFFICULT PROBLEM.

*Patents pending.*

Designed to overcome in a simple manner the three difficulties associated with high frequency amplification namely: Magnetic coupling between coils, Stabilisation, and Parasitic Oscillation. The first named is prevented by Astatic winding, obviating the necessity for metal screens with their disadvantages, the second is obtained by centre and quarter-tappings accommodating valves of various impedances, and the third is avoided by balanced self-damping windings, thus dispensing with the expensive double condenser and resistance method previously used.

List 4117/8 gives full details and prices.

## Resistance Coupling Units

Thousands of radio enthusiasts are loud in their praises of "Cosmos" (Met-Vick) Resistance Coupling Units. L.F. stages coupled by means of these Units result in clear Loud Speaker reproduction without distortion. The 'V' type unit can now be supplied fitted with the new 'Met-Vick' A.C. Valve Socket for use when building a set for working off the E.L. mains. The A.C. Valve-socket is also supplied separately for panel or baseboard mounting. Obtain List 7117, S for full details and prices.

## MET-VICK

(COSMOS)

METRO-VICK SUPPLIES LIMITED

(Proprietors: Metropolitan-Vickers Elec. Co. Ltd.)

155 Charing Cross Road : : LONDON, W.C 2

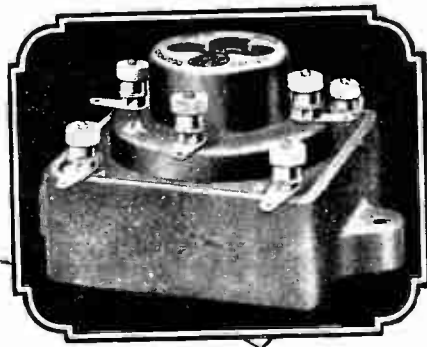
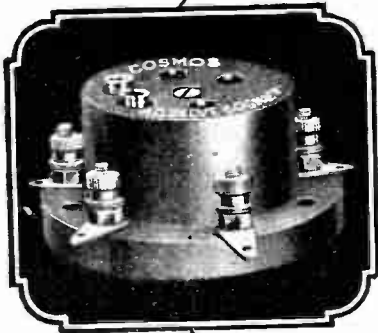

R  
F88

B5

Advertisements for "The Wireless World" are only accepted from firms we believe to be thoroughly reliable.

**100% IMPROVEMENT IN QUALITY WITHOUT LOSS OF VOLUME WITH THE SUCCESS SUPER CHOKE**

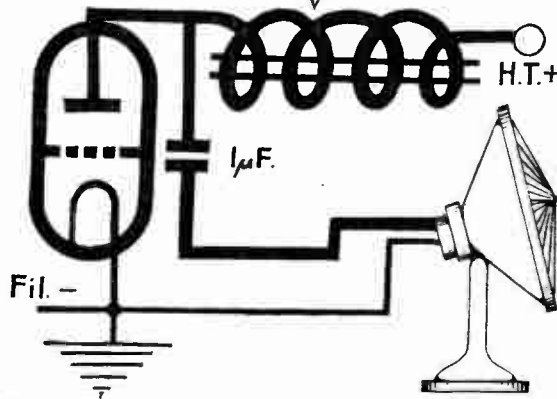

USE A FILTER CIRCUIT WITH THE ONLY CHOKE DESIGNED FOR THE PURPOSE - **14/-** ea.

Sole Manufacturers: **BEARD & FITCH,** 34, AYLESBURY ST., E.C.1.

**Building a set this Winter? Here is the CABINET for it!**

The W.B. Range of Cabinets for Constructors provides 7 Stock sizes in Polished Oak or Mahogany. Highly finished Ebonite panels can be supplied for each size at standard prices. The Cabinets are produced only in a high class finish, each being an article of furniture. We have kept our prices as reasonable as possible, but in reviewing them it will be appreciated that we are not aiming to cater for any but those requiring the best. We believe that this class of customer is prepared to pay a reasonable price for really good quality; compare W.B. Cabinets and their prices—and your choice will certainly be in their favour.

**PRICES.**

	Oak.	Mahogany.		Oak.	Mahogany.
12" x 7" x 7"	15-	17 6	21" x 7" x 7"	24-	28/-
14" x 7" x 7"	18 6	21-	24" x 7" x 7"	30-	35-
16" x 8" x 7"	20-	23-	26" x 8" x 7"	32 6	37 6
18" x 7" x 7"	21-	25-			

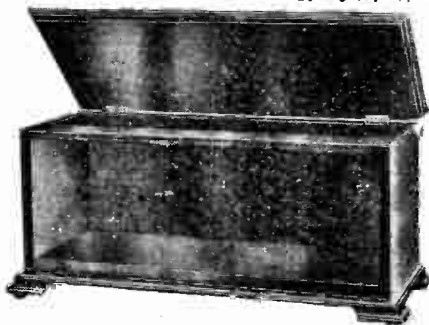

Every up-to-date Dealer has a range of these Cabinets to show you.

**WALKER BROS. (GUILDFORD) LTD.**  
BRAMLEY - GUILDFORD  
Telephone: Bramley 117.

**PERFECT TERMINALS**

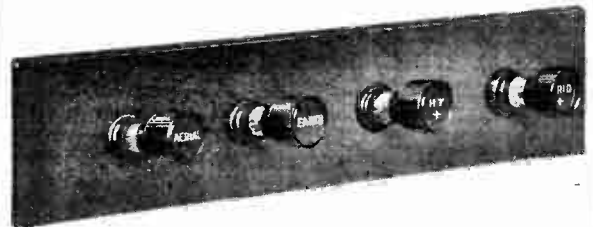

Make your set distinctive by fitting Belling-Lee Terminals. Recommended and used by all the leading Radio experts, and by manufacturers of the best battery eliminators, the Belling-Lee patented terminal has long since proved itself to be the best designed terminal for Radio. Following are a few of its unique features:—

- Insulated Non-Rotating engraved top.
- Highly finished screw action insulated head.
- Non-threaded stem and cross-hole connection.
- Shielded metal clamping faces.
- Highly finished insulated collar.
- Metal parts nickelled.
- Transverse slot with clamping nut eliminating soldering.

Prices: Type 'B.' Standard large insulated and guaranteed model. (Polished black bakelite) 9d. each.  
Type 'M.' As type 'B.' but smaller and with only the engraved top insulated. Best nickel plate brass. 6d. each.  
Made with 30 different engravings.  
Send for attractive illustrated brochure.

**BELLING-LEE TERMINALS**

Belling & Lee, Ltd., Queensway Works, Ponders End, Middlesex.

Mention of "The Wireless World," when writing to advertisers, will ensure prompt attention.



# THE ONLY PORTABLE-

The Langham Portable is the only portable of its kind. There is no aerial, no earth, and only one tuning control—everything is contained in one solid leather case. The model illustrated has a full continental range up to 1,000 miles and gives perfect loud speaker reproduction anywhere.

We offer you a week's free trial, and a definite 12 months' guarantee.

Yours for only £5 deposit. Balance by small monthly instalments.

**WRITE FOR FULL PARTICULARS.**

The new Langham Transatlantic Portable exhibited at the Radio Exhibition is the talk of two continents. It is the only portable in the world that has received the United States on 'phones and loud speaker.

*The*  
**LANGHAM**  
*Portable Radio*

Langham Radio, Albion House,  
59, NEW OXFORD St., W.C.1.

Telephone: Museum 2878 & 8293.

T.M.C.D.  
48

EVERYTHING **The G. E. C.** ELECTRICAL  
*your guarantee*

*Perfect at Every Point*

*New*

# Osram Valves

*with the New Filament*

## The Perfect Anode

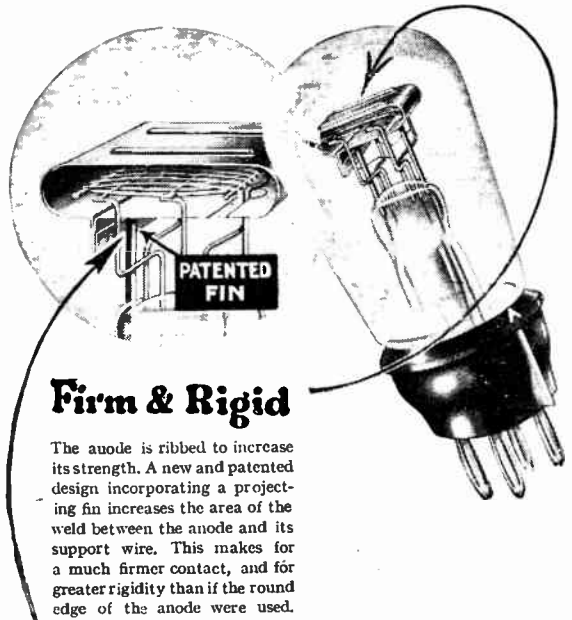

### Firm & Rigid

The anode is ribbed to increase its strength. A new and patented design incorporating a projecting fin increases the area of the weld between the anode and its support wire. This makes for a much firmer contact, and for greater rigidity than if the round edge of the anode were used.

### Generous Proportions

The OSRAM anode is large enough to collect every electron that leaves the filament. It totally encloses the active portion of the filament, reducing valve resistance and increasing the undistorted volume of output given to your loud-speaker.

**MADE IN ENGLAND**

**VALVES TO IMPROVE YOUR LOUD-SPEAKER REPRODUCTION**

OSRAM	2-volt	4-volt	6-volt	
	D.E.P. 215	D.E.P. 410	D.E.P. 610	Price 12/6 each
	D.E.P. 240		D.E. 5a.	Price 20/- each

Made at the factory with the greatest experience in valve manufacture in the British Empire.

Manufactured from raw material to finished product by the same British Organisation.

Advt. of The General Electric Co. Ltd., Magnet House, Kingsway, London, W.C.2

# Forging ahead

Cossor introduces  
**2 Volt**  
 Screened Grid Valves

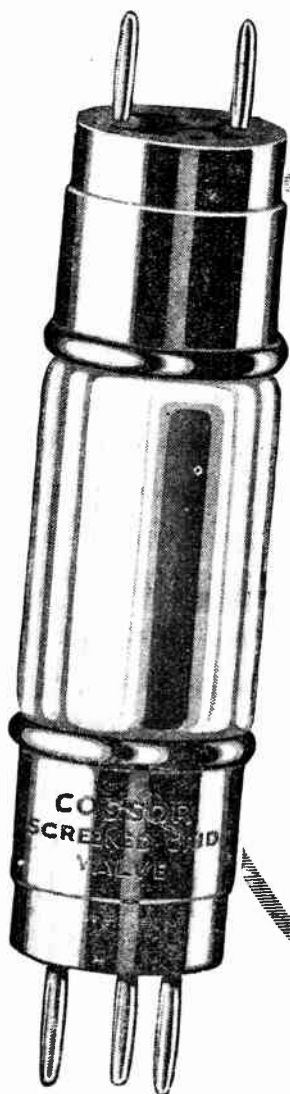

Cossor 2-volt Screened Grid. Consumption 1 amp.

22/6

Also 6-volt type. Consumption 1 amp.

22/6

**A** GAIN Cossor leads the way. Hitherto only 6-volt Screened Grid valves have been available. Now the exceptional efficiency and the enormous emission given off by the Kalenised filament has made possible the production of a 2-volt Cossor Screened Grid valve giving a far higher standard of performance. Current consumption has been reduced to one tenth of an ampere.

Use this wonderful new Cossor Valve in any Set where screened grid valves are specified—you'll get better results, increased amplification, improved stability with a considerable economy in maintenance. All Cossor Screened Grid Valves are fitted with standard double-ended caps. Build up a Receiver to utilise these new Cossor Valves now—you'll be thrilled at the ease in which you'll be able to pick up distant Stations at tremendous volume. The new Cossor Screened Grid Valve is Radio's latest—and greatest—development.

# Cossor

Advl. of A. C. Cossor Ltd., Highbury Grove, N.5

Mention of "The Wireless World." when writing to advertisers, will ensure prompt attention.

GA 9730  
 B8

# The Wireless World

AND  
RADIO REVIEW  
(15<sup>th</sup> Year of Publication)

No. 425.

WEDNESDAY, OCTOBER 19TH, 1927.

VOL. XXI. No. 16.

Editor : HUGH S. POCOCK.

Assistant Editor : F. H. HAYNES.

Editorial Offices : 139-40, FLEET STREET, LONDON, E.C.4

Editorial Telephone : City 4011 (3 lines).

Advertising and Publishing Offices : DORSET HOUSE, TUDOR STREET, LONDON, E.C.4.

Telephone : City 2847 (13 lines).

Telegrams : "Ethaworld, Fleet, London."

COVENTRY : Hertford Street.

BIRMINGHAM : Guildhall Buildings, Navigation Street.

MANCHESTER : 199, Deansgate.

Telegrams : "Cyclist Coventry."  
Telephone : B210 Coventry.

Telegrams : "Autopress, Birmingham."  
Telephone : 2970 and 2971 Midland.

Telegrams : "Illife, Manchester."  
Telephone : 8970 and 8971 City.

Subscription Rates : Home, 17s. 4d. ; Canada, 17s. 4d. ; other countries abroad, 19s. 6d. per annum.

As many of the circuits and apparatus described in these pages are covered by patents, readers are advised, before making use of them, to satisfy themselves that they would not be infringing patents.

## RADIO AND SATURATION.



HERE have been a number of expressions of opinion published recently on the question of when we shall reach the saturation point in wireless ; that is to say, when will the demand for wireless receiving sets have been so far met that sales will substantially fall off.

A recent article in *The New York Times*, published about the time of the New York Radio Fair, gave some interesting figures. An expert on foreign trade had taken on himself the rather ambitious task of approximating the number of receivers in use throughout the world, and his estimate gave the number located in zones where satisfactory reception could be depended upon as 18 million. In the United States alone there were 700 licensed transmitting stations, and he regarded the entire United States as a zone of constant reception, whilst in Europe the constant reception zone extended only to the border line of Russia.

### Supplying the World with Sets.

A rough estimate of the population of the world was taken at 1,748 millions, and, assuming an average of five listeners to every receiving set, it was estimated that 90 million people in the world were enjoying receiving facilities, or 9 per cent. of the total population in zones which to-day enjoy a reliable broadcasting service. To put a wireless receiver in a sufficient number of homes to enable everyone located within a zone of dependable reception to listen, 200 million sets would have to be provided, and if broadcasting facilities were extended throughout the world nearly 350 million sets would be required.

We have made no attempt to check these figures given in *The New York Times*, but we have no reason to suppose that they fall far short of a reasonable approximation. Broadcasting transmitters will naturally be erected wherever the demand is sufficient to justify the expense, and although the demand is undoubtedly steadily increas-

ing, it will take a long while before all the countries of the world will enjoy the advantages of a satisfactory service. The demand for sets must increase steadily whenever a new station comes on the air, and long before the world's manufacturers of radio sets established to-day can even meet the requirements of areas at present serviced, old sets will require replacement and so the demand will be extended.

o o o o

## 5XX AND THE REGIONAL SCHEME.

IN a letter published elsewhere in this issue a correspondent makes the point that, in his opinion, with the introduction of the regional scheme the Daventry 1,600 metre station 5XX should be abolished. He rightly remarks that we have repeatedly drawn attention to the difficulty of designing satisfactory sets for the reception of both Daventry and the ordinary broadcast band. Our correspondent, however, does not point out that these criticisms were levelled at the time Daventry was contemplated, and that since that date we have also emphasised what we consider to be still more important, viz., that the B.B.C. should cease to chop and change with wavelengths and make alterations in other directions which necessitate modification in the design of receivers. In America the wavelength band has not altered since the introduction of broadcasting, and the wavelengths are all of much the same order, so that the manufacturer and designer are in a position to get down to mass production methods without fear of any serious changes.

Now that 5XX is an established station we think it would be grossly unfair both to the public and to the manufacturer to make that station any less important a part of the broadcast scheme than it is to-day. Many listeners' sets are designed for reception of Daventry wavelengths only, whilst to many coast dwellers Daventry is likely to continue to be the station normally received even after the regional scheme is in operation.

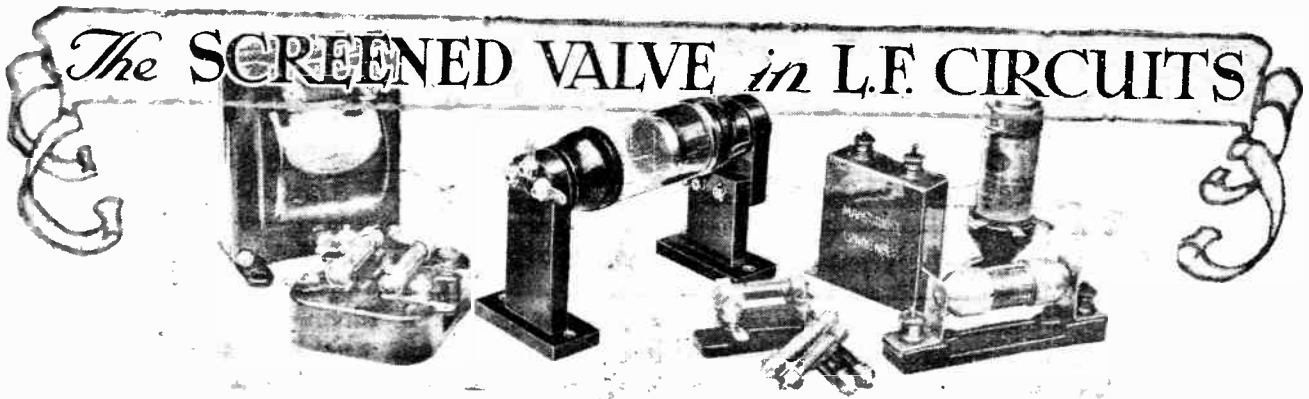

## Experiments with Resistance=capacity and Iron=cored Transformer Coupling.

By N. W. McLACHLAN, D.Sc., M.I.E.E.

IN the previous articles<sup>1</sup> we saw that, provided the impedance or load in the anode circuit had a relatively small D.C. resistance, a screened valve could be regarded as a three-electrode valve having a high internal resistance and a large magnification factor. Starting with this as a basis, we shall examine the action of the valve as a note magnifier. A well-known form of coupling is by means of an iron-cored intervalve transformer. The performance of a 2.7/1 transformer with a three-electrode valve of low A.C. resistance is shown by the curve of Fig. 1. If now we take the performance of the same transformer with a valve of high internal resistance, we have the case of the screened valve. In *The Wireless World*, January 20th, 1926, I gave a characteristic curve for a 2.7/1 transformer with a D.E.Q. of internal resistance  $3.7 \times 10^5$  ohms. This is about the value to be expected for a screened valve with a grid bias of -2.5 to -4.5 volts, so that the performance of this transformer with such a valve is indicated by

the curve of Fig. 2. The explanation of the curve is on the same lines as that given in connection with the selectivity of a tuned anode. The transformer can for simplicity be replaced by an LC circuit, in which the A.C. resistance is fairly high (Fig. 3). Now, with such

<sup>1</sup> *The Wireless World*, August 1st, September 7th, and September 14th, 1927.

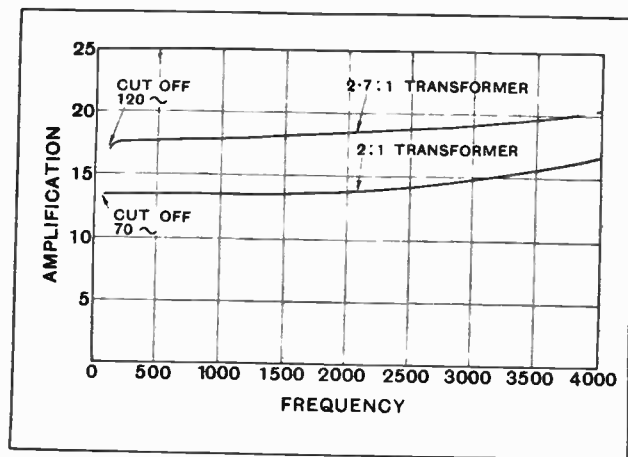

Fig. 1.—Frequency characteristics of 2.7:1 (50-henry primary) and 2:1 (100-henry primary) transformer with D.E.S valve (anode volts, 160, grid bias - 7.5 volts).

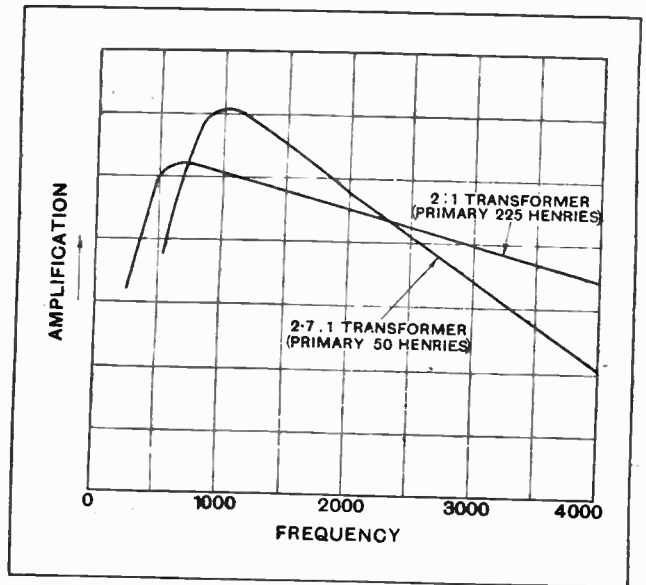

Fig. 2.—Transformer characteristics with D.E.Q valve (A.C. resistance 370,000 ohms) operating as anode rectifier. The amplification scale is arbitrary.

a circuit the inductive reactance below resonance and the capacity reactance above resonance are small compared with the valve resistance. Thus the greater part of the A.C. voltage is spent on the valve, thereby giving a reduction in magnification. At resonance, which for the 2.7/1 transformer is in the neighbourhood of 900 to 1,000 cycles, the impedance is essentially a dynamic resistance whose value is comparable with the reactance of the transformer on each side of resonance. Thus, owing to the high A.C. valve resistance, an iron-cored transformer acts as a low-frequency tuned circuit. The damping



**The Screened Valve in L.F. Circuits.—**

action of the valve which may be considered to be a leak across the transformer, as shown in the first article, is not sufficient to flatten the tuning to any extent (Fig. 4). I have tried the screened valve with a transformer of 225 henries primary inductance and resonant frequency in the neighbourhood of 700 cycles. Although this inductance is three or four times that of the average high-inductance transformer, the quality of broadcast reception reminded me of the results obtained some four years ago when the radio art was in its embryo stage. The effect was according to theory, and is indicated by the curve of Fig. 2. The bass disappeared, likewise the upper register leaving a kind of moan about an octave and a half above middle C. This could be simulated by using a three-electrode detector with low-inductance choke, and by removing the upper register with the aid of a condenser across the choke. The circuit apart from this was quite normal, *i.e.*, a low resistance three-electrode valve was used with the transformer, which gives uniform amplification down to 40 cycles.<sup>2</sup>

**Note Filters for Radiotelegraphy.**

Since the screened valve has such a high internal resistance, thereby rendering iron-cored apparatus comparatively selective, it is natural that we should enquire whether it can be applied to note filters in radiotelegraphy. In the recording of radio signals it is usual, but by no means imperative, to heterodyne the incoming signals until a beat note is secured in the detector circuit. This note is amplified and passed through a series of valve-coupled tuned circuits as indicated in Fig. 6, the reason being to secure additional immunity from interference. The incoming radio signals are received in the usual way on an aerial (usually diagram) and then passed through a series of high-frequency filter circuits of low A.C. resistance. Then follows some H.F. amplification, the detector and the note magnifiers. Extensive filtering with long radio waves had drawbacks owing partly to lack of selectivity

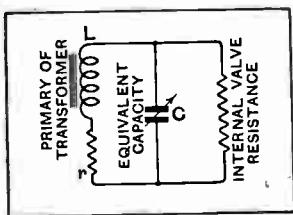

Fig. 4.—Circuit illustrating damping or leak effect of valve on the primary circuit of transformer. With a screened valve the damping is relatively small since the resistance is high.

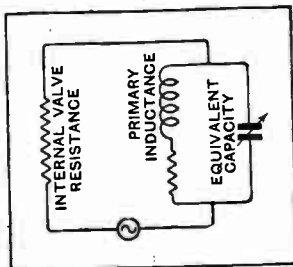

Fig. 3.—Approximate circuit for primary of intervalve iron-cored circuit. The primary inductance has a fairly high A.C. resistance.

when valve coupling was used and to the expense of large stranded wire coils. The screened valve may remove this disability to some extent and at the same time eliminate the necessity for neutrodyne. Filtering at note frequencies is relatively cheaper and easier. The screened valve will by virtue of its low capacity and high A.C. resistance give greater stable magnification and selectivity per stage than the three-electrode valve, and should be a boon. As a case in point, take a radiotelephone system in which the receiving station is called by using a note frequency to modulate the transmitter. The additional selectivity and magnification of the screened valve will make for greater immunity from jamming and enhanced stability for equal signal strength as received by the aerial.

**Superheterodyne Circuits.**

It is interesting to discuss the case of intermediate stages in a superheterodyne receiver. In an extensive article dealing with supersonic iron-cored intervalve transformers<sup>3</sup> it was shown that the so-called input impedance of a valve (due to anode to grid capacity) following transformer virtually increased its self capacity, thereby altering the optimum wavelength. Also that unless the capacity added to a transformer preceding or succeeding the aforementioned was identical, the two transformers worked on different optima wavelengths.

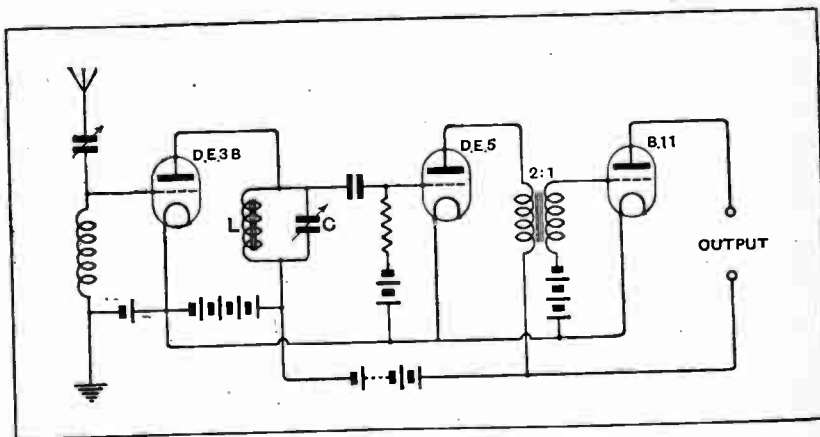

Fig. 5.—Circuit for simulating action of transformer with screened valve. L is an inductance of 20 henries, and C a variable 0.005 mfd. condenser.

The result was a loss in amplification and in selectivity. Now this increase in capacity was mainly due to the electrostatic capacity between grid and anode. In the screened valve, since the capacity is negligible, one immediately jumps to the conclusion that such valves will be beneficial in the intermediate stages of a supersonic amplifier. Let us examine the case of a screened valve and one of the transformers described in the above article. Transformer No. 1 had a natural wavelength of 4,400 metres (when the capacity effect of the following valve was absent; see *The Wireless World*, January 5th, Table 12). This is about the favourite wavelength region for supersonic circuits. Following the same line of argu-

<sup>2</sup> The amplifier and transformer used were described in *The Wireless World*, January 13th, 1926

<sup>3</sup> *The Wireless World*, November 10th, 17th, 24th, December 8th, 1926; January 5th, 1927.

**The Screened Valve in L.F. Circuits.—**

ment regarding tuned circuits as we pursued in the first article on screened valves, the transformer at its resonance frequency can be regarded as a dynamic resistance. On this hypothesis it is easy to calculate the magnification obtained from the transformer used in conjunction with a screened valve. For the screened valve whose characteristics we have given the internal resistance is about  $2 \times 10^5$  ohms and the magnification factor 80 at  $-1$  grid bias. The dynamic resistance of transformer No. 1 referred to the primary circuit is approximately

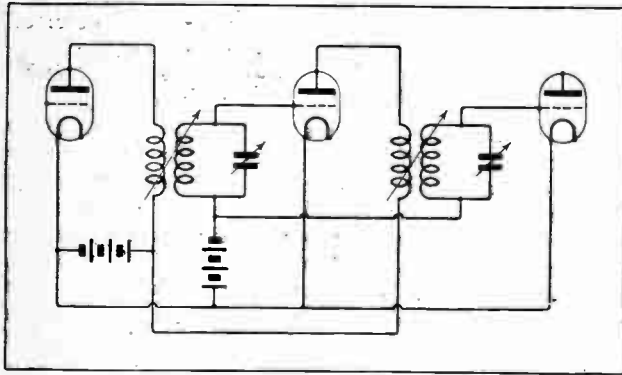

Fig. 6.—Tuned plate filter circuit with neutralising connections omitted.

$4 \times 10^4$  ohms, and the amplification with this resistance in the circuit of our screened valve would be

$$\left[ \frac{4 \times 10^4}{2 \times 10^5 + 4 \times 10^4} \right] \times 80 = \frac{4}{24} \times 80 = \frac{80}{6}$$

But the ratio  $\frac{\text{secondary turns}}{\text{primary turns}} = 3$ , so that the voltage magnification to the grid of the next valve would be  $\frac{80}{6} \times 3 = 40$ . This is an improvement on the actual value of 22 with D.E. 5B and an undesired wavelength increase from 4,400 metres to 7,000 metres due to the input impedance of the next valve. In practice owing to the filament and grid capacity of a screened valve there would be an increase in wavelength but not nearly so much as that indicated above. The increase in wavelength with the screened valve would not cause any serious drop in magnification. Thus it appears that despite their high internal resistance, screened valves will be useful for iron-cored supersonic transformers so far as magnification is concerned. For greater magnification the transformer would have to be designed to fit the valve. It is of interest to remark in passing that the best condition prevails when the dynamic resistance of the transformer referred to the primary winding is equal to the internal valve resistance. In our case cited above, it was a long way from this, the valve resistance being five times that of the transformer. Keeping the secondary winding the

same the necessary condition would be secured by increasing the number of turns on the primary, *i.e.*, reducing the transformation ratio. With the proper turns ratio the amplification would be in the neighbourhood of 60. It is difficult to calculate this figure accurately owing to the alteration in the mutual capacity between the windings when the primary turns are increased. The mutual capacity should be reduced to a minimum. I imagine someone saying to himself, What about supersonic tuned anodes? This is the case of the transformer with no primary, the secondary being placed straight in the valve circuit. I hope to deal with this question later, but so far as can be seen without going deeply into the matter the elimination of both primary and mutual capacity will increase the dynamic resistance and, moreover, with an iron-cored choke (assuming the D.C. feed is not large enough to do harm to the iron) in which the iron loss is appreciable there may be little magnification gain in using a transformer with a screened valve, although there is a gain in selectivity, particularly if a large ratio is used. We may interpolate the remark that where H.F. circuits are concerned, on the broadcast wavelengths from 300 to 500 metres, the best transformer<sup>4</sup> has an advantage over the tuned anode of only 8 per cent. in magnification when using an average low-loss coil. When air-cored coils are used for supersonic circuits it is possible, by using stranded wire, to enhance the dynamic resistance at resonance. The result is obtained by using a more expensive and bulky article, and since there is no closed magnetic field, unless a toroidal construction is adopted, the stray field may be a nuisance. I do not, however, imply that air-cored coils should be summarily dismissed.

The above discussion has dealt mainly with the amplification side of the problem. In supersonic amplifiers there is also the question of selectivity. It follows from all we have said previously on the subject that the screened valve will enhance the selectivity of supersonic coupling units just as it does those of the shorter waves, by virtue of its large internal resistance. As with the short-wave tuned anode, increased selectivity is obtained by reducing the inductance and coil resistance and increasing the capacity at any given wavelength. Magnification is augmented by keeping the capacity and resistance as small as possible and increasing the inductance. The stability of the system is far less acute with wavelengths of 4,000 metres or more than at the broadcast band. Provided the system has no modes of oscillation of higher frequency than the working frequency, much greater stable amplification can be secured at 4,000 than at 400 metres. This is due to the fact that the impedance of the electrostatic valve capacity is ten times as large as the former as at the latter frequency.

(To be concluded.)

<sup>4</sup> Valve resistance = dynamic resistance of transformer at resonance.

### MANCHESTER RADIO EXHIBITION.

The fourth Wireless Exhibition organised by the "Evening Chronicle" will be held at the City Hall, Deansgate, Manchester, opening on Monday, 24th October, and continuing till Saturday, 5th November.

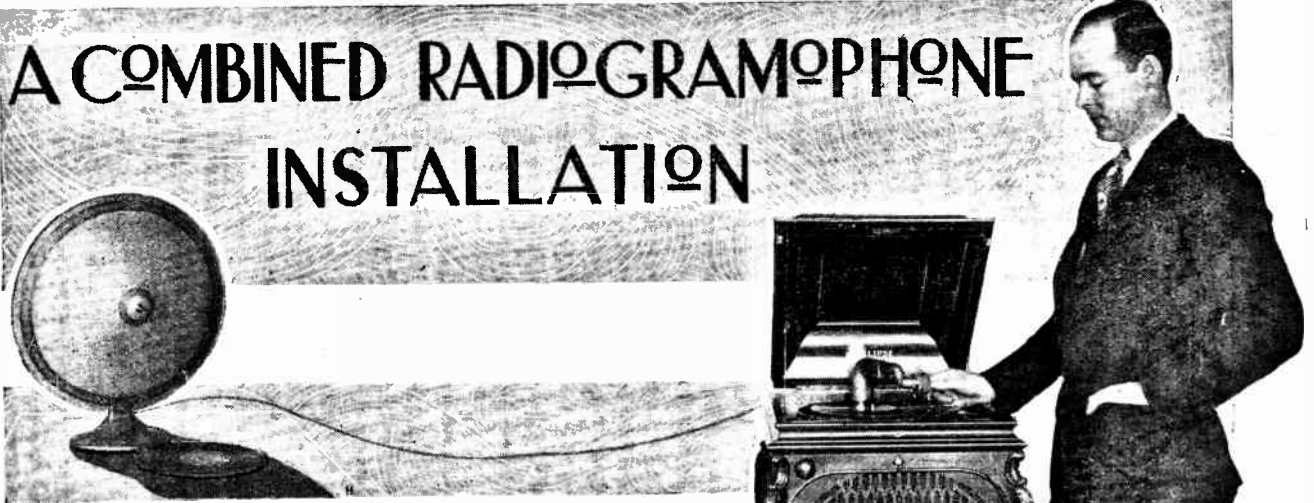

# A COMBINED RADIOGRAMPHONE INSTALLATION

An Electrostatic Pick-up Energised  
with H.F. Oscillations from the  
Broadcast Receiver.

By A. DINSDALE.

SINCE the introduction of broadcasting we have become accustomed to endless arguments as to the relative merits of a broadcast receiver when compared with a good gramophone as a means of entertainment.

Gramophones have been vastly improved of late, and so have broadcast receivers and their associated equipment, so that to-day there is very little to choose between high-grade representative instruments of both methods of reproducing musical entertainment.

The modern improved gramophone owes much to the apparatus and methods which have been developed for the conduct of broadcasting, as shown by the present writer in a previous article in this journal.<sup>1</sup> In one or two instances thermionic valve amplifiers and loud-speakers have been incorporated with the gramophone, for the purpose of giving to the reproduction increased volume and purity.

In the present article it is proposed to describe an example of the latest development in this direction, a development which goes a step further, inasmuch as the amplifier and loud-speaker equipment in this case can be used either to reproduce music impressed upon gramophone records, or it can be connected to an aerial in the usual way and used as a broadcast receiver.

Thus, if the user of this combination equipment tires of the broadcast programme, and there is no satisfactory alternative, he can switch his receiver over to the gramophone and become his own broadcaster, choosing a suitable programme from the records available.

The designer of the particular system under review is Mr. F. A. Jewell, consulting engineer to the Adams-Sibley Developing Corporation, of New York, to whom the writer is indebted for permission to publish this description.

"Pick-up" Devices.

### "Pick-up" Devices.

In any method which has for its object the electrical reproduction of gramophone records the usual sound box, which translates the indentations of the record into mechanical sound waves, must be replaced by an electrical device which will turn the mechanical vibrations of the gramophone needle into electrical impulses. Such an electrical device is known as a "pick-up."

It will immediately be realised that the quality of sound in electrical reproduction can be no better than the loud-speaker and the amplifier that feeds it, and both in turn depend upon the efficiency of the pick-up. It is apparent, therefore, that when tackling the problem of improving electrical reproduction we must commence with the pick-up, which has received less attention than has the rest of the equipment.

A disadvantage of the gramophone which has not, so far, been entirely overcome, either in mechanical or electrical reproduction, is the objectionable scratching noise made by the needle as it passes over the revolving record. It has been ascer-

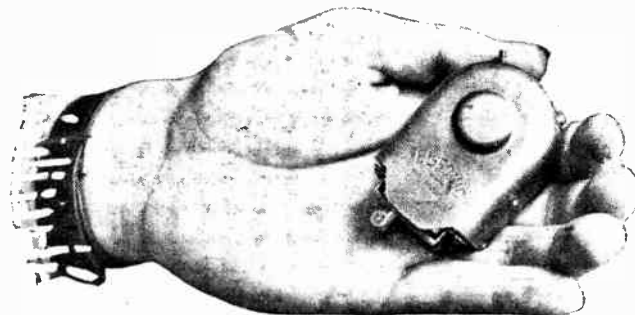

Fig. 1.—Showing the relative size of the El Fonic pick-up.

<sup>1</sup> "Wireless and the Gramophone," *The Wireless World*, September 15th, 1926.

**A Combined Radio-gramophone Installation.—**

tained that 80 or 90 per cent. of this noise is due to the needle scraping along the bottom of the groove of the record, causing *vertical* movement, whereas the sound waves are cut *laterally* in the sides of the groove. The needle thus has two movements imparted to it, one lateral and one vertical. The problem is to prevent the vertical movement affecting the reproducing mechanism.

In the type of pick-up designed by Mr. Jewell, vertical movement of the needle will not cause any electrical change in the output circuit, and the remaining 10 to 20 per cent. of scratch, known as "side-wall scratch," is damped out to a negligible point.

This new type of pick-up makes use of the principle of the electrostatic, or condenser, microphone, a type of microphone which is more commonly found abroad than in this country. The device, which has been called the El Fonic pick-up, is shown in Fig. 1. Fig. 2, which is a back view, shows the socket into which the tone arm of the gramophone fits. The details of the device can clearly be seen in Fig. 3. It consists essentially of two very small condenser plates, one of which is fixed and the other movable. To the latter is attached the gramophone needle, so that the mechanical vibrations communicated to the needle by the sound waves cut in the record cause the distance between the fixed and movable plates of the condenser to vary.

**Action of Capacity-type Pick-up.**

This system of gramophone reproduction may be said to make use of the principles of radio throughout, for the record is made to modulate a high-frequency carrier wave just as does the output of the microphone in a broadcasting station. This record-modulated carrier wave is then rectified, amplified, and fed to a loud-speaker.

The diagram in Fig. 4 will assist the reader to understand the action of the system. The valve *V* is arranged as an oscillator, its frequency of oscillation being controlled by the inductances  $L_1$  and  $L_2$ , and the condenser *C*. Coupled to the oscillator coil is a small pick-up coil,

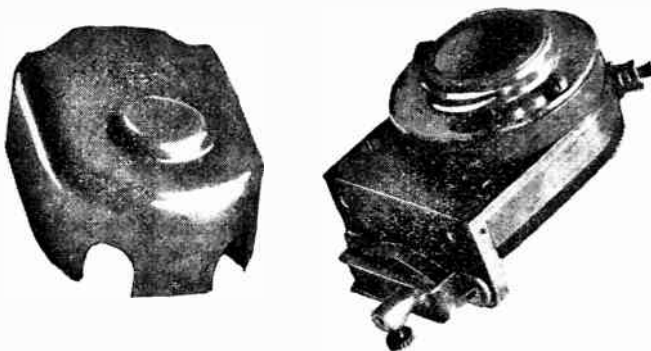

Fig. 2.—Back view of pick-up with cover removed, showing socket for attachment to gramophone tone arm.

$L_3$ , which is in series with the capacity-type gramophone pick-up,  $C_1$ ,  $C_2$ , and an H.F. transformer, which is broadly tuned to the frequency of oscillation of *V*.

Now, the amount of H.F. energy which will reach the primary of the H.F. transformer is dependent upon the degree of coupling between it and the oscillator coil. The

coupling between  $L_2$  and  $L_3$ , once determined, remains fixed, so that the only remaining variable is the distance between the plates of the condenser  $C_1$ ,  $C_2$ . That is to say, the amplitude of the H.F. current in the primary of the H.F. transformer is dependent upon the capacity of the pick-up device, and this varies exactly in accordance with the mechanical vibrations communicated to the movable plate by the needle travelling in the undulating groove of the record.

**Rectifying the Modulated H.F. Currents.**

The varying H.F. current is transferred to the secondary winding of the transformer and thence to any con-

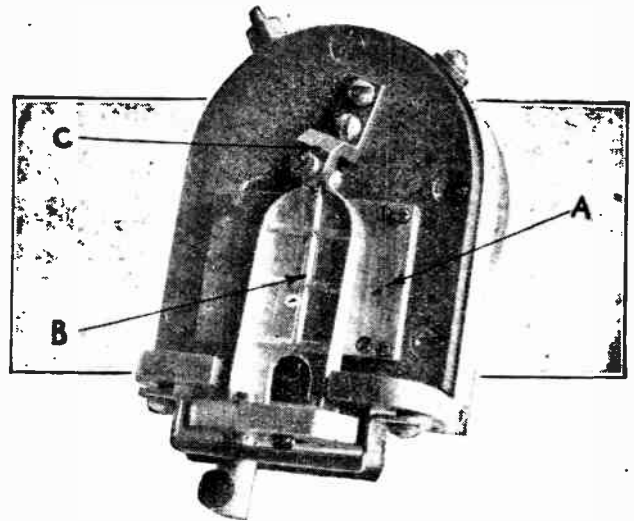

Fig. 3.—Details of the El Fonic pick-up. A is the fixed plate, B the moving plate, and C a damping device.

ventional detector circuit, the output of which is passed through an H.F. choke and then on to a suitable L.F. amplifier and loud-speaker.

Since the frequency of the current passing through  $C_1$ ,  $C_2$  is very high, the plates are very small. The vibrating member,  $C_2$ , is made of aluminium, and is therefore extremely light. Furthermore,  $C_2$  does not have to perform any mechanical work, such as moving an air column, or moving an armature against a heavy spring tension, as in the magnetic type of pick-up, so it is allowed to float freely in the record groove.

In such circumstances the vibrating plate has negligible inertia, so that it can respond to all the delicate overtones, as well as to all the fundamentals. Also, as there is only one frequency to contend with, that of the oscillator, and since the only function of the pick-up is to vary the amplitude of a current at this frequency, no difficulty is encountered in designing a circuit to respond to it.

It will now be readily understood how that amount of needle scratch which is due to vertical movement of the needle cannot affect the capacity of  $C_1$ ,  $C_2$ .

**A Combination Radio-gramophone Set.**

The designer of the El Fonic pick-up is also responsible for the design of a suitable distortionless amplifier, details of which will be given later. Having thus designed the complete equipment for the perfect reproduction of gramophone

**A Combined Radio-gramophone Installation.—**

phone records, it occurred to him that since this equipment makes use of standard radio apparatus, it would be an excellent thing to arrange matters so that music could be reproduced either from records or from a broadcasting station at will, and without the use of any more apparatus.

The complete circuit for this purpose, employing five valves, is given in Fig. 5, from which it will be seen that by simply throwing two switches either ordinary broadcasting can be received and reproduced, or the music from a gramophone record.

When switch J is thrown to the left and switch J<sub>1</sub> down the set is ready to receive broadcasting, and the first valve acts as an H.F. amplifier, so that there is one stage of H.F. amplification, a detector operating on the anode bend principle, and a special 3-stage L.F. amplifier. All the tuning is accomplished by the single condenser C<sub>1</sub>, which controls the input circuit. The resistance R<sub>2</sub> acts as a reaction control, while R<sub>3</sub> acts as a volume control.

With switch J thrown to the right, and switch J<sub>1</sub> in the up position, the equipment is ready for gramophone reproduction, and the first valve then functions as an oscillator.

When the set is switched for broadcast reception the coil L<sub>2</sub> functions as the primary, or aerial coil, and the coil L<sub>1</sub> as the secondary, or grid coil of the H.F. stage. Across this coil is a 0.0005 mfd. condenser, which is the only tuning control. The variable resistance R<sub>2</sub> controls the degree of reaction by varying the potential impressed upon the plate of the first valve, V. Coil L is out of circuit.

When the switches are thrown so that the set is ready

for gramophone reproduction, coil L comes into use as the reaction coil, and the first valve, V, becomes an oscillator; L<sub>1</sub> becomes the oscillator coil and L<sub>2</sub> becomes the coupling, or pick-up, coil. R<sub>2</sub> is turned so that all the resistance is cut out of circuit, and the condenser C<sub>1</sub> is so adjusted that the frequency of oscillation of the circuit best suits the constants of the untuned H.F. transformer, L<sub>3</sub>. Once this adjustment has been found it remains the same every time the gramophone combination is used.

**Constructional Details.**

The coupler unit, L, L<sub>1</sub>, L<sub>2</sub>, is one of the most important parts of the circuit, and must therefore be very carefully constructed. The three coils are of the basket weave type of winding, and their internal diameter is 1½ in. Coil L has 25 turns of No. 24 D.S.C. wire, coil L<sub>1</sub> has 52 turns of similar wire, and L<sub>2</sub> has 10 turns. All three coils are wound in the same direction, and are mounted on an ebonite former, so that they can be slid along the former to find the best coupling position. Once found this position is left untouched.

As already mentioned, the H.F. transformer L<sub>3</sub> (Fig. 5) is of the untuned type, and should cover the band of wavelengths between 200 and 500 metres.

Before proceeding to describe the amplifier in detail, it should be stated that it was developed for use with American valves, the first three being the American 201-A type, the fourth a semi-power valve, and the fifth a power valve.

Mr. Jewell, the designer of the amplifier, lays great stress on the fact that the L.F. transformer, T in Fig. 5, must have a low-impedance primary; it must therefore

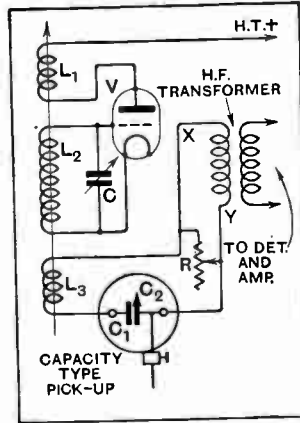

Fig. 4.—Schematic diagram of capacity type pick-up and its associated oscillator.

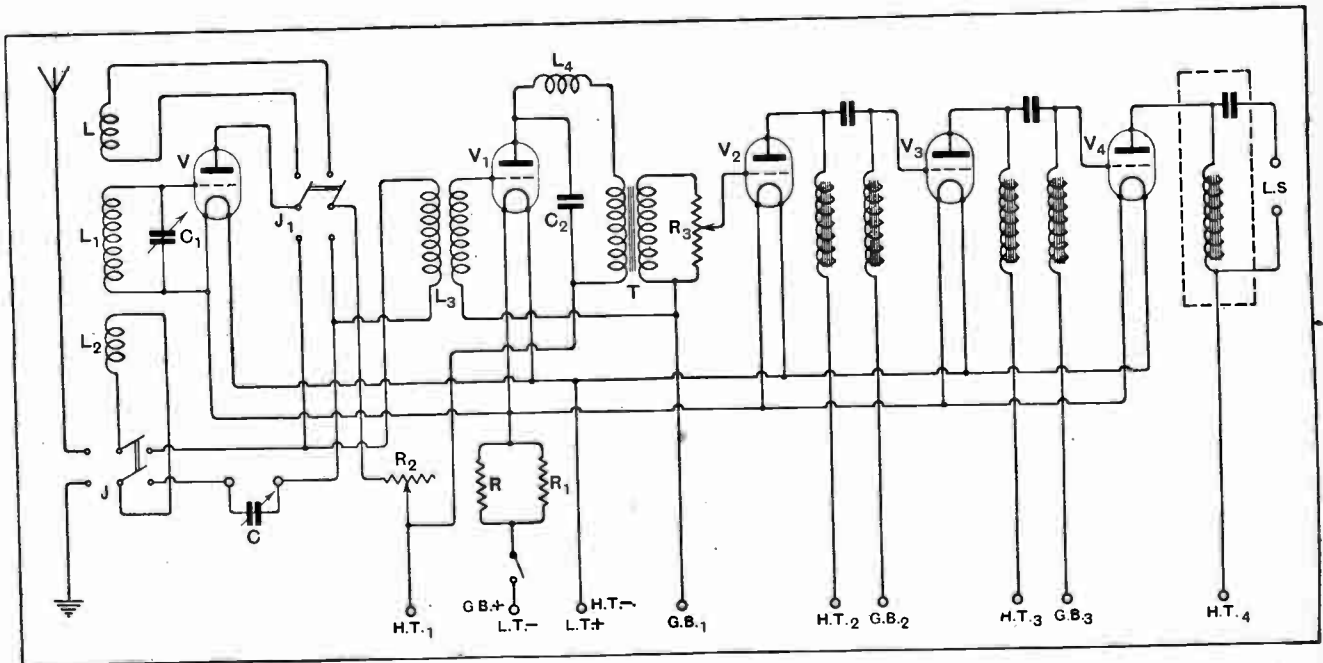

Fig. 5.—Complete circuit diagram of radio-gramophone installation.

**A Combined Radio-gramophone Installation.—**

be one of the old type. It should have a ratio of  $4\frac{1}{2} : 1$  and be high pitched. With a transformer of this type in circuit, there will be no danger of over-accentuating the low bass notes.

The above statements may seem strange to our readers when so much emphasis has been laid lately upon the necessity for transformers with a high-impedance primary so that the low notes may be brought out. However, Mr. Jewell states that if a high-impedance transformer is used, the bass notes will be so loud and overpowering that they will drown out the rest of the harmony!

Across the secondary of the transformer is a 500,000-ohm variable resistance which acts as a volume control, both for radio reception and for gramophone reproduction.

The remainder of the amplifier is of somewhat unusual design. The values of the plate chokes are given as 200 henries, whilst the values of the grid chokes are stated to be 2,000 henries! Mr. Jewell explains that he has purposely chosen this high value for the grid chokes so that there shall be no danger of audio-frequency oscillations being set up owing to the close proximity of grid and plate chokes of the same value. With a difference between them of 1,800 henries, all danger of oscillation is removed.

As there is no load in the grid circuits of the amplifier valves, the value of 2,000 henries is obtained by the use of a closed core, thus eliminating the necessity for an excessively large winding. It is stated that, as the D.C. resistance of the choke is comparatively low, due to the relatively small amount of wire used in the coil, it is impossible for any appreciable charge to accumulate on the grid of the valve. This also permits the use of a coupling condenser of comparatively high capacity (1 mfd.).

**Adapting to Existing Receivers.**

For experimental purposes, there is no need to build this special amplifier, for any broadcast receiver using valves can easily be adapted to give satisfactory results, provided it is capable of giving good reproduction of broadcasting, and those possessing both a gramophone and a good wireless set may like to try a combination of the two, especially if the gramophone is several years old and therefore not designed along modern lines. The result will be a vast improvement of the gramophone reproduction.

Besides the El Fonic pick-up, all that is necessary is an oscillator unit, and this can easily be made up in accordance with the specifications given above. It is advisable to put the unit in a metal screened case to prevent the radiation of oscillations, which might disturb listeners in the vicinity.

The unit need not be fitted with the H.F. transformer shown in Fig. 4. Instead, the leads which go to the primary of it are taken to the aerial and earth terminals of the wireless set. If this happens to have one or two stages of H.F. amplification before the detector it simply means that the input modulated H.F. currents from the oscillator and El Fonic pick-up combination will be amplified before they are rectified, and in that case it will be advisable to include in the oscillator unit a variable resistance connected as shown at R in Fig. 4.

This will enable the input volume to be controlled so that the H.F. valves will not be overloaded.

For quick change-over purposes the wireless set might very well be fitted with a jack connected to the aerial and earth terminals. The aerial and earth leads could then be connected to a plug, and the leads X and Y in Fig. 4 to another plug, so that a change from radio reception to gramophone reproduction could be effected simply by changing plugs and starting up the gramophone.

It should be pointed out that the oscillator operates at a frequency within the broadcast waveband; hence the advisability of screening it. Furthermore, if the user of the combination is very close to a broadcast station, a whistle may be heard when running the gramophone. This is due to the oscillator heterodyning with energy picked up by the receiver itself from the broadcasting station's carrier wave. Altering the adjustment of the oscillator tuning condenser will cure this.

When running the gramophone it will be necessary to tune the wireless set to the wavelength upon which the oscillator unit is operating.

The wireless set, or amplifier equipment, can very conveniently be placed, in the case of a cabinet-type gramophone, in the space usually devoted to the storage of records.

**The System in Operation.**

Whilst in New York recently the writer was fortunate enough to be able to attend a demonstration of the El Fonic pick-up and its associated equipment. First of all, the device was demonstrated in conjunction with an amplifier built as indicated diagrammatically in Fig. 5, a large cone speaker being used. The improvement over the average gramophone, even of fairly modern design, was truly astonishing. All musical notes, from the lowest to the highest, appeared to be amplified to an equal extent and were reproduced with a brilliance and clarity seldom heard on any gramophone.

On broadcasting, the results were not quite so good, but, even so, they were better than one hears from the general run of broadcast receivers. No doubt the inclusion of the old-fashioned type of L.F. transformer prevented the broadcast reproduction from equalling that of the gramophone and amplifier combination.

During gramophone reproduction the extreme quietness of background was remarkable. At a distance of about ten feet from the loud-speaker, needle scratch was not discernible, even at the commencement of a record, before the music started. As is fairly well known, modern electrically cut records have an enormous range of volume, which the ordinary type of gramophone is totally incapable of handling. The system under review handled equally well either the softest pianissimo passages or the loudest passages of a full orchestra, during which the output volume of the loud-speaker was enormous, and gave an extremely realistic effect.

By way of comparison, a standard five-valve neutrodyne set was next connected up with an adaptor unit, and gramophone records reproduced by means of it. The results were not nearly so good, of course, but they were considerably better in quality than could be obtained from the same gramophone, playing the same records, and using its ordinary mechanical sound-box and horn.

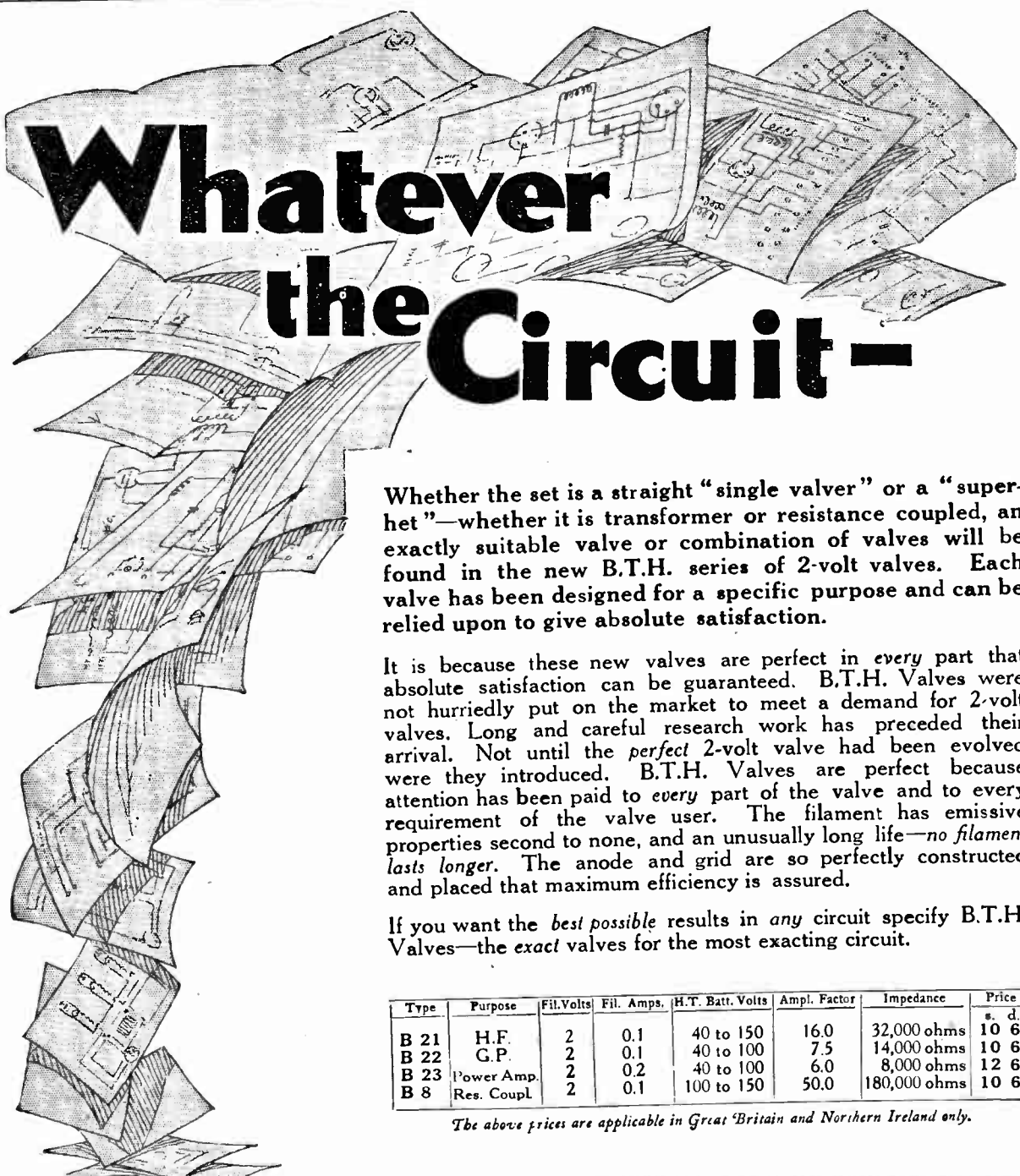

# Whatever the Circuit—

Whether the set is a straight "single valver" or a "super-het"—whether it is transformer or resistance coupled, an exactly suitable valve or combination of valves will be found in the new B.T.H. series of 2-volt valves. Each valve has been designed for a specific purpose and can be relied upon to give absolute satisfaction.

It is because these new valves are perfect in every part that absolute satisfaction can be guaranteed. B.T.H. Valves were not hurriedly put on the market to meet a demand for 2-volt valves. Long and careful research work has preceded their arrival. Not until the perfect 2-volt valve had been evolved were they introduced. B.T.H. Valves are perfect because attention has been paid to every part of the valve and to every requirement of the valve user. The filament has emissive properties second to none, and an unusually long life—no filament lasts longer. The anode and grid are so perfectly constructed and placed that maximum efficiency is assured.

If you want the best possible results in any circuit specify B.T.H. Valves—the exact valves for the most exacting circuit.

Type	Purpose	Fil. Volts	Fil. Amps.	H.T. Batt. Volts	Ampl. Factor	Impedance	Price s. d.
B 21	H.F.	2	0.1	40 to 150	16.0	32,000 ohms	10 6
B 22	G.P.	2	0.1	40 to 100	7.5	14,000 ohms	10 6
B 23	Power Amp.	2	0.2	40 to 100	6.0	8,000 ohms	12 6
B 8	Res. Coupl.	2	0.1	100 to 150	50.0	180,000 ohms	10 6

The above prices are applicable in Great Britain and Northern Ireland only.



A COMPLETE RANGE OF VALVES—

## 2 VOLT VALVES

FOR ALL SETS AND CIRCUITS

B21	{ H.F. & DET }
B22	{ General Purpose }
B23	{ Loud Speaker }
B8	{ R.C. }

If you are interested in R.C. Coupling, write for a copy of the "RESISTOR" Booklet to Publication Dept., The British Thomson-Houston Co., Ltd., Rugby

2804.

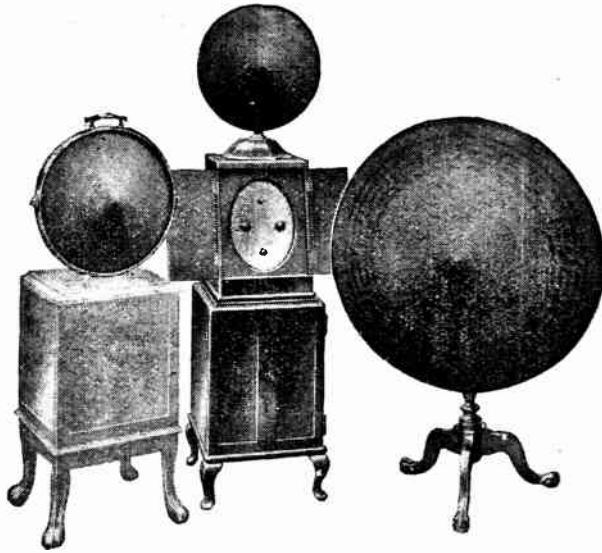

## Even Distribution

The B.S.A. Kone Loud Speaker is non-directional in character and consequently there is no need for listeners to be grouped before the instrument in order to hear the programme satisfactorily. This property of even distribution of sound, together with the wonderful reproducing qualities of the B.S.A. Kone Loud Speaker, gives perfect reception when used with a good receiving set. Ask the B.S.A. Agent in your town for a demonstration NOW.

### B.S.A. Radio Sets

include 2-valve, 3-valve, 4-valve, 4-valve de Luxe, 7-valve Universal and 8-valve de Luxe receivers.

Prices from **£6 15s.**

Set only.

Royalties and accessories extra.

# B.S.A.-KONE Loud Speakers

from **£3.3s.**

Catalogue Post Free from

B.S.A. Radio Ltd.,  
21, Small Heath, Birmingham.  
Proprietors: The Birmingham Small Arms Co., Ltd.



EVERYTHING

The **G. E. C.**  
your guarantee

ELECTRICAL

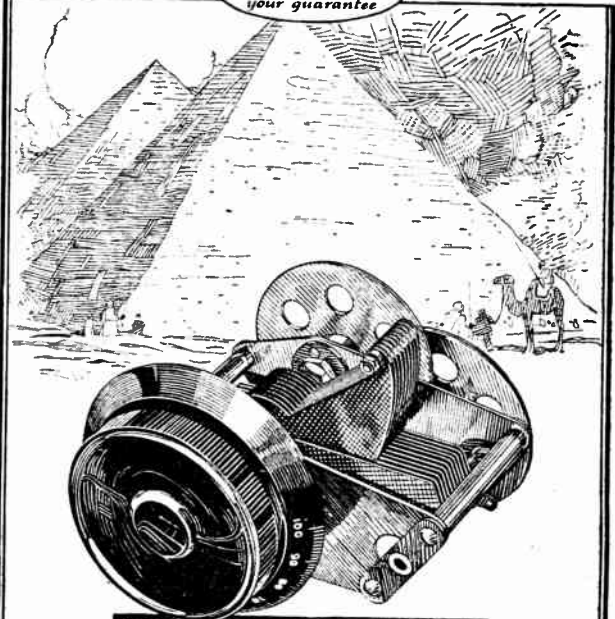

## GECOPHONE CONDENSERS

for **LONG LIFE**

because the "GECOPHONE" Condenser is a heavy, precision-built instrument, able to take a lot of mishandling without grumbling. It is the smoothest, sweetest running condenser, and the finest engineering job in the wireless industry.

### Reduced Prices

Square Law Type		Straight Line Frequency Type	
·0001	· 17/6	·0003	· 17/6
·0002	· 17/6	·0005	· 19/6
·00025	· 17/6	·001	· 27/6
		·0003	· 19/-
		·0005	· 22/-



Advt. of The General Electric Co. Ltd., Magnet House, Kingsway, London W.C.2

Mention of "The Wireless World," when writing to advertisers, will ensure prompt attention.



# INTERESTING FOREIGN APPARATUS.

## Selected New Sets and Components.

**F**OLLOWING immediately on the all-British wireless show at Olympia was an exhibit organised by the wireless departments of Selfridge and Whiteley at the premises of the latter store. Although many of the exhibitors were to be found at Olympia, the Whiteley Exhibition included apparatus of foreign manufacture, and in this respect attracts the interest of the amateur by affording him an opportunity of inspecting imported instruments. The foreign apparatus was limited almost entirely to American and German manufacture, except in



Progress in receiver design as illustrated in this compact six-valve set—the Rothermel-Crossley Band Box.

the case of a few small meters and inexpensive battery eliminators, some of which came from France.

British exhibitors included Hart Collins, showing the making up of self-contained sets; Igranic, principally components; Marconiphone, Marconi sets and valves; McMichael, sets and components; Ormond, variable condensers and a portable set; General Electric Company, sets, battery chargers and eliminators, and Osram valves; Mullard, the P.M. valves; Wingrove and Rogers, Polar components. The apparatus exhibited by these firms has been fully described in recent issues.

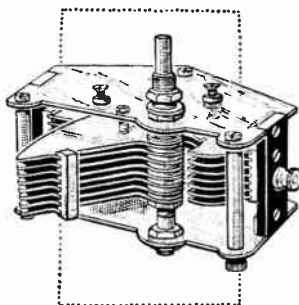

The Saba S.L.F. condenser.

B 19

Foreign apparatus was shown by the Continental Radio Import Company, Saba Radio Products, Rothermel, Heayberd, Freed Eisemann, Hydeleman, Louis Holzman, and Leslie Dixon, though the latter was showing apparatus mainly of interest to the transmitting amateur, including some new and modified ex-Government material.

There need no longer be any doubt that foreign radio apparatus is already available in considerable quantity in this country. American apparatus, extensively handled by the Rothermel Corporation, is already well known, though mostly restricted to component parts. At their stand, however, at least two of the latest type of American receiving sets were examined—the Synchrophase, by Grebe, and the Rothermel-Crossley Band Box. The former embodies a multi-stage H.F. amplifier, with binocular coil intervalve couplings. The tuning dials are horizontally edgewise operated, with condenser spindles standing vertically and provision for linking them together for one-dial control. Two other controls are fitted to the Grebe sets: one a volume control, which appears to be a double-wound rheostat, and the other called "tone color" and stated to be a control for adjusting the input to the loud-speaker to compensate for its uneven response characteristics.

### American Receiver Designs.

The Grebe Consoles make use of the standard tuner-receiver unit, and several models are fitted with two or more loud-speakers as well as battery compartment.

The Crossley Band Box is an exceedingly compact design, being a six-valve receiver in a well-finished metal case, measuring only  $17\frac{1}{4}$  in.  $\times$   $7\frac{1}{2}$  in.  $\times$   $5\frac{1}{2}$  in. Its one-dial tuning and operating controls are inconspicuous, and are surrounded by a fascia plate with aperture through which is viewed a finely divided illuminated scale. Again, it is a receiver with a multi-stage H.F. amplifier using neutralised inter-valve couplings, with tuning adjustments

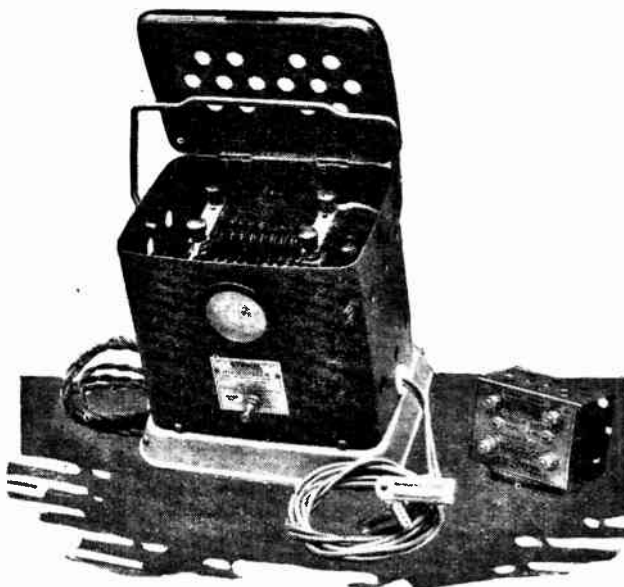

The Kuprox battery charger fitted with dry Kodel rectifying unit. The rectifier is supplied separately for building into a home-constructed battery charger.

**Interesting Foreign Apparatus.—**

linked together to a common control. Assuming that it fulfils the requirements of a long-range loud-speaker set it represents a remarkable advance in home receiver construction. A feature of the design is its ready adaptation for fitting in a console cabinet. A special model is available for use with a Crossley A.C. power unit, so that the entire outfit is batteryless and derives its current from the public supply.

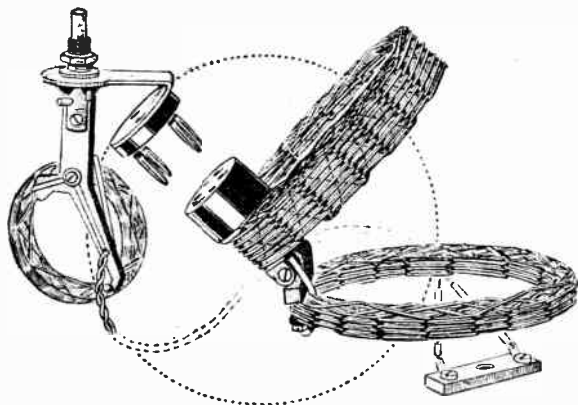

Saba basket tuning coils fitted with four-pin mounts.

Another item of new interest shown by Rothermel was the Kodol rectifier, a small and entirely dry unit for battery charging from A.C. supply, selling at 25s. Although too new to form the subject of technical comment, it is undoubtedly more convenient than any other form of small rectifier, is stated to last indefinitely, and, subject to its rectifying properties being found satisfactory, may replace other rectifying devices and battery chargers.

**Imported Components.**

The presence of a comprehensive range of components of German manufacture was an innovation, and a few specimens have been selected for comment here as typifying the general design and quality. Other than the already well-known compact receiver making use of the Loewe multi-electrode valve, no complete sets of German manufacture were to be seen. The components include variable condensers, intervalve transformers, tuning coils, telephone receivers and loud-speaker movements, small fixed-capacity condensers, grid leaks, meters, plugs, and jacks.

The Saba range, shown by the Services Shipping Co.,

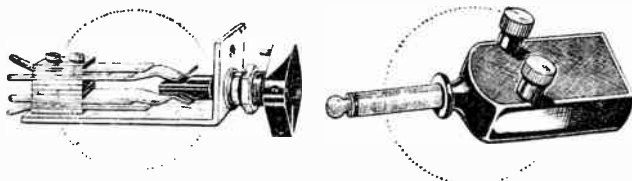

Key switch and plug included in the Saba range of components.

Ltd., were probably the most complete. Saba variable condensers are made in several types—a cheap square law model, a good quality S.L.F., as well as an S.L.F. with reduction gearing. All models include such features as "one-hole," as well as "three-screw," fixing, long and well fitting top bearing, neatly fitted pig-tail connector, slotted bar mounting for the fixed plates, and strip ebonite insulating supports. The cheap model with a capacity of 0.0005 mfd. is offered at 7s.; and is fitted with metal end plates with crystallate finish, tuning plates of aluminium, and provided with the flat form of spring washer to friction the spindle and keep it in correct setting. The more expensive model has nickel-plated end plates and pillars, silver-plated and transparent lacquered fixed and moving plates, the latter being stiffened by a substantial bar near their extremity and shaped to follow the S.L.F. law. Absence of spring washer, clean machining of parts, and the use of fine pitched screw threads in this model all evince instrument-making perfection. Both grades are available with 100 to 1 reduction gearing arranged in the familiar manner as a double train of pinions near the base of the condenser, the better quality model selling at 14s. The use of toothed pinions arranged to give considerable reduction ratio calls for comment, though in actual handling backlash cannot be observed, due to the fact that the teeth are cut deep and meshed tightly though without causing the action to bind. Concentric controls give fine and rough adjustment.

As to tuning coils, these are entirely unorthodox. Of cylindrical basket construction, all types are fitted with four-pin mounts for changing the tuning range, the base

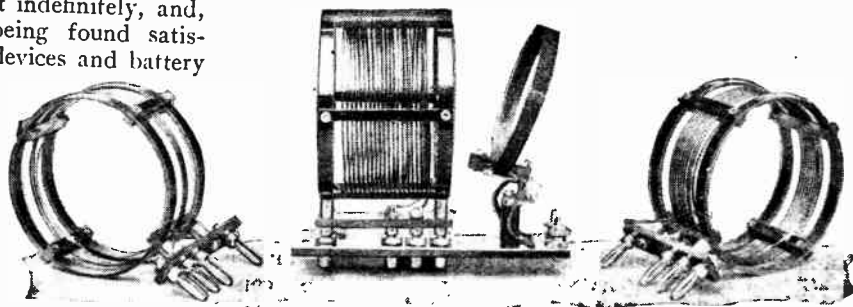

Aero short-wave tuning equipment covering a wave range of 15 to 130 metres shown by the Rothermel Corporation.

and mounting bracket being arranged so that the coil is tilted over at 45°. The range includes aerial and reaction couplings, H.F. intervalve transformers, and an H.F. choke, but owing to their peculiar construction it is doubtful if they will become popular in this country.

Break jacks and key switches built with bent metal frames may make an appeal where really low-priced articles are required. These are available for either key, plug, or two-position plunger operation. The intervalve L.F. transformers by Saba will appeal where low price is the first consideration.

Trickle chargers with arc rectifying valves were shown by Heayberd, together with a variety of French measuring instruments. In addition to Hydra condensers, shown by Louis Holzman, was to be observed a cheap-pattern two-range voltmeter of small rectangular design.

BROADCAST  
RECEIVERS:

## Lamplugh "Quality Two"

A Two-valve  
Loud-speaker  
Receiver with  
Enclosed Batteries.

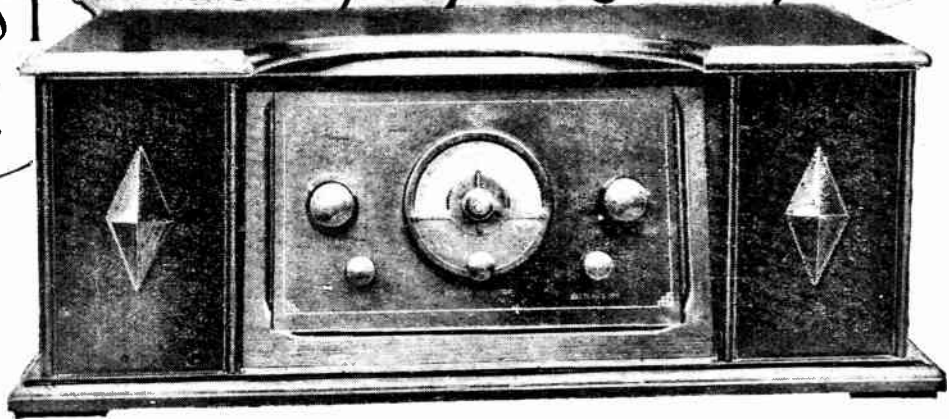

THERE was ample evidence at this year's Show of the modern tendency to clean up the appearance of wireless gear by accommodating the batteries inside the receiver cabinet, suitable precautions being taken to partition off the battery cells from the remainder of the circuit. The Lamplugh "Quality Two," introduced at Olympia last year, is a notable example of this form of construction, the H.T. and L.T. batteries being housed in separate compartments at each side of the instrument panel. The only external wires are therefore the loud-speaker and aerial and earth leads. Both sets of leads are taken from the back of the cabinet and can be easily arranged in a neat and inconspicuous manner so that the receiver does not look out of place in the most tastefully furnished room.

#### The Circuit.

A conventional circuit has been adopted, consisting of a reacting detector followed by a low-frequency amplifier with transformer coupling. The tuning coils are built in the form of a separate unit, and are wound in

slots in ebonite formers, the aerial coil being fixed and the reaction movable. The aerial circuit is tuned by a Lamplugh straight-line condenser—the type with spear-shaped vanes—and an optional series aerial condenser is provided. The latter is brought into action by a system of three sockets with triangular spacing. Aerial and earth are connected to a two-pin plug, and two alternative methods of insertion in the sockets are possible, giving direct or condenser coupling for the aerial.

#### Components.

The new Lamplugh "Quality" transformer is now used to couple the detector to the last valve. Grid bias for this valve is provided by a 4½-volt battery clamped to the back of the cabinet inside. The detector valve is a P.M.1 H.F., and the amplifier a P.M.2 with 60 volts H.T. The loud-speaker is connected directly in the plate circuit of the last valve through a plug and socket at the back of the cabinet.

The controls are centred on a sloping panel of figured ebonite mounted between the battery compartments. On the left of the large central tuning dial is the reaction coupling control, and on the right the filament rheostat. Immediately below the rheostat is the on-and-off switch, and the corresponding switch in the left-hand bottom corner short-circuits a portion of the aerial inductance, thus giving a choice of the lower broadcast band of wavelengths or the higher wavelengths around 1,600 metres.

On test in London, Daventry (5XX) and Radio Paris were received on the loud-speaker on the upper wave range with a standard roof-top aerial, and 2LO and 5GB

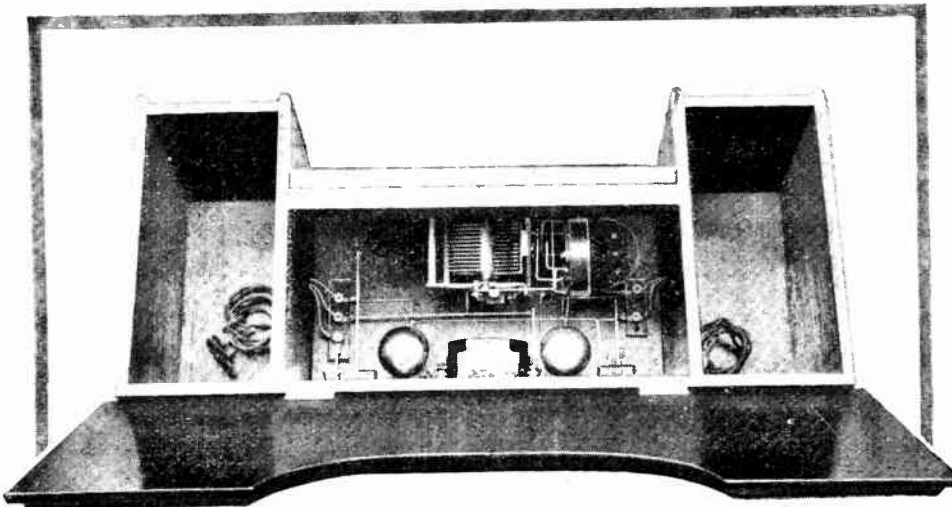

Plan view of interior showing battery compartments.

**Broadcast Receivers.**—

could be just separated at  $3\frac{1}{2}$  miles from the former station by making full use of reaction; without reaction the tuning was somewhat flat, but this may have been due to an intermittent wave-change switch, which was subsequently rectified.

The receiver is made by S. A. Lamplugh, Ltd., King's Road, Tyseley, Birmingham, and the price with standard equipment, which includes a Lamplugh loud-speaker, P.M. valves, H.T., L.T., and grid bias batteries is £16 14s. The receiver alone costs £10, exclusive of royalty.

## PRACTICAL HINTS AND TIPS.

A Section Devoted to the Practical Assistance of the Beginner.

### SIMPLIFYING H.F. TRANSFORMER CONSTRUCTION.

IT seems probable that the difficulty (generally more apparent than real) of winding primary and neutralising sections of the high-magnification H.F. transformers, described in connection with a number of *Wireless World* receivers, is responsible for the fact that they are not even more widely used. It may be recalled that the primary turns (spaced from the secondary by insulating strips in order that capacity may be reduced by ensuring that the dielectric is, practically speaking, of air) are spaced from each other by  $\frac{1}{16}$  in. The neutralising section is wound between these turns; consequently the capacity of this winding with respect to the primary is also reduced to a minimum, as air is again largely the insulating medium.

Now it will be found that, unless properly grooved ebonite spacing strips are available, a good deal more patience than that with which the majority of us are gifted will be required to wind these two sections in a reasonably regular manner. Fortunately for those whose workshop equipment is limited, ready-made spacers are obtainable commercially, but as they are not always available, another method of construction may be described. This is shown in the sectional sketch given in Fig. 1, from which it will be seen that the neutralising coil, instead of being between the primary turns, is wound over them on a second set of spacing strips. This is an arrangement first adopted for long-wave transformers, in which the "side-by-side" method is generally impracticable, due to the greater winding length required; it is, however, quite suitable for couplings designed to operate on the normal broadcast waveband.

The first set of spacers (between primary and secondary) should be of

the length and thickness specified for the transformer which is to be constructed; grooves are not essential, as it is possible to judge the positions between adjacent turns of a single-layer coil with sufficient accuracy. The length of the complete winding should, however, be approximately that laid down in the instructions which are being followed. The neutralising section must be completely coupled to the primary, so the strips separating these two windings should be not thicker than  $\frac{3}{32}$  in.; they may be made of Paxolin, Pertinax, or waxed cardboard, and should be bent to have a cross-section in the form of an open "V" or an arc, in order that they may fit closely over the angle formed by the primary in passing over its spacers.

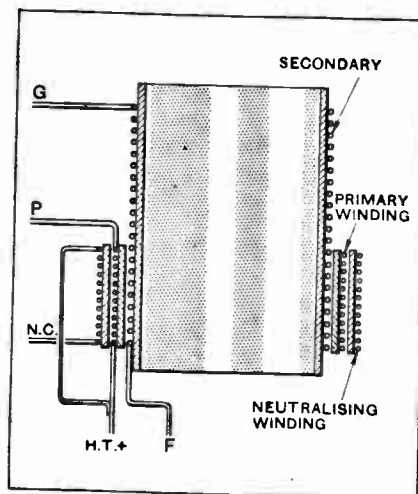

Fig. 1.—Modified H.F. transformer, with neutralising coil wound over the primary.

In order to avoid the necessity for fitting terminal screws for anchoring the ends of the primary and neutralising coils, these may be secured to the strips by a trace of some adhesive such as Chatterton's Compound, although this plan is in the nature of a makeshift.

### TESTING FOR QUALITY.

IT should be needless to say that the task of making a comparative test between the relative quality of reproduction of various loud-speakers and amplifiers should be approached with an open mind and a completely impartial attitude. This is because the human ear is notoriously unreliable; if we start operations with the preconceived notion that a certain arrangement is bound to be better than another against which it is to be tested, it is fatally easy to deceive ourselves into reaching a false conclusion.

The type of transmission on which tests are to be made should also be chosen with some discrimination. As a rule, "outside" broadcasts should be avoided, as the placing of the microphone and control of amplification is seldom under such perfect control as in the studio. Again, no attempt should be made to compare quality on ambitious broadcasts of full orchestral items, unless the listener has something more than the average amount of musical knowledge; the majority of us are better capable of forming a reliable opinion of some simpler transmission, such as an instrumental solo or perhaps a trio or quartette. It must not be forgotten that piano music is excellent as a medium for making comparative tests, partly because this instrument covers a very wide range of frequencies; in particular, the shortcomings of many receivers and loud-speakers in the matter of reproduction of the upper register are often shown up by the production of a "wooden" click instead of the note itself.

As an example of the pains which may be taken in the search after high-quality reproduction, one may instance a certain keen experimenter who makes a practice of attending public lectures and concerts at which

speakers or artists due to broadcast in the immediate future are "billed" to appear. He is thus able to get first-hand knowledge of peculiarities and inflexions of their voices or styles as musical executants. Few of us are likely to go to such lengths, but those who do so can flatter themselves that they are bearing a worthy part in the campaign for better quality, and, with an increase in their numbers, we shall hear fewer such statements as "my receiver is perfect on music, but speech is almost unintelligible." A little consideration will show that such a state of affairs is quite impossible, as speech frequencies are also present in music.

o o o o

**PUSH-PULL AMPLIFICATION.**

THE input required to obtain life-like reproduction from a modern loud-speaker is very large, and is, in fact, measurable in watts. It has been the practice of advanced experimenters requiring several watts output to employ very high anode voltages on the valve or valves in the last stage of the receiver; in fact, several sets have been described in this journal which have been designed to take from 300 to 500 volts H.T.

Now these voltages are costly to generate and are somewhat dangerous to handle, and further, the choice of valves which will withstand such pressures is strictly limited; in fact, were it not for the large grid swing on the input side of the last stage, more normal methods would be adopted.

There is, happily, another method of achieving the same end, *i.e.*, several watts distortionless output from the set without resort to such high voltages, and for which quite ordinary "super power" valves are suitable. This method is known as push-pull amplification, the connections for which are given in Fig. 2. A special intervalve transformer with a centre-tapped secondary and a special output transformer with a centre-tapped primary are usually employed for this work, but are not absolutely necessary, since each of the transformers could be replaced by two ordinary instruments in series.

Coming at the opposite ends of a centre-tapped winding, each of the valves in the last stage deals with

only one-half of the input wave, and so the effective grid swing to that stage may be doubled without increasing the H.T. voltage necessary. The anode current is, of course, doubled, but in these days of mains units there should be no difficulty in obtaining the extra current required.

Two incidental advantages accrue from the use of push-pull amplification, the first of which is that if matched valves are used the whole family of even harmonics, which are always present in the output of an ordinary straight amplifier to a greater or lesser extent owing to valve

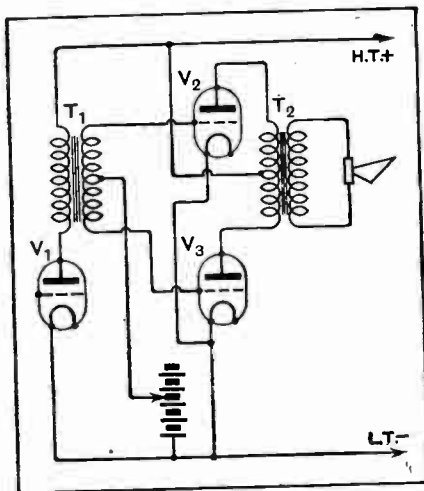

Fig. 2.—The connections of a push-pull amplifier. V<sub>1</sub> is the penultimate L.F. amplifier, V<sub>2</sub> and V<sub>3</sub> are parallel output valves. T<sub>1</sub> and T<sub>2</sub> are, respectively, intervalve and output transformers.

curvature, disappear; and the second is that the effect on the core of the output transformer of the steady anode current to each of the valves cancels out, making a small transformer possible as there is no polarising flux to reduce the scope of the iron. This latter advantage is, of course, lost if two ordinary transformers are used in series for the work.

Some of the makers of the better-class transformers are now producing special models with the necessary centre tappings, and it is safe to say that push-pull amplification will become more and more popular.

o o o o

**AERIALS—INTENTIONAL AND OTHERWISE.**

THE observant experimenter will often notice quite remarkable effects due to the proximity of an

aerial not actually connected to the receiver. At one time it was usual to boast that one's set would receive certain stations without an aerial, and possibly without even an earth.

Such a test carried out under home conditions probably involved disconnecting the aerial wire from the set and leaving it lying on the table near by, or at the most disconnecting the wire from the inside end of the lead-in terminal. In both these cases more careful experiments will show that the aerial is still influencing reception, and it has even been noticed that an aerial is not quite inert if connected to an earth separate from that used by the set.

Receivers are frequently tested nowadays to ensure that they will not receive even a powerful local station without an aerial. This serves as a test of the efficiency of screening boxes. To be quite fair to the set, however, it is important that there should be no aerial, either of the frame or open type, near by.

Other sources of unwanted reception are to be found in long H.T. and loud-speaker leads, particularly the former if a mains unit situated at some distance from the set is being used. The blocking condenser within the set between each H.T. tapping and earth should not be omitted even though there is a full set of condensers in the eliminator; and again, if long loud-speaker leads are to be used, it is desirable that an output transformer, the core and secondary of which are earthed, should be employed in the plate circuit of the last stage in the set.

The use of a frame aerial will endow most receivers with a marked degree of selectivity, which is in no small degree due to the directional property of the frame; but here, again, care should be taken to ensure that there is not a lead-in from an open aerial close by, or persistent jamming by the local station may be experienced.

It is a good plan to mount coils with their axes vertical wherever possible, as, if otherwise placed, they may be acting as miniature frame aerials within the set. Certain special arrangements of windings, such as the toroids and the binocular coils, tend to prevent trouble from this source.

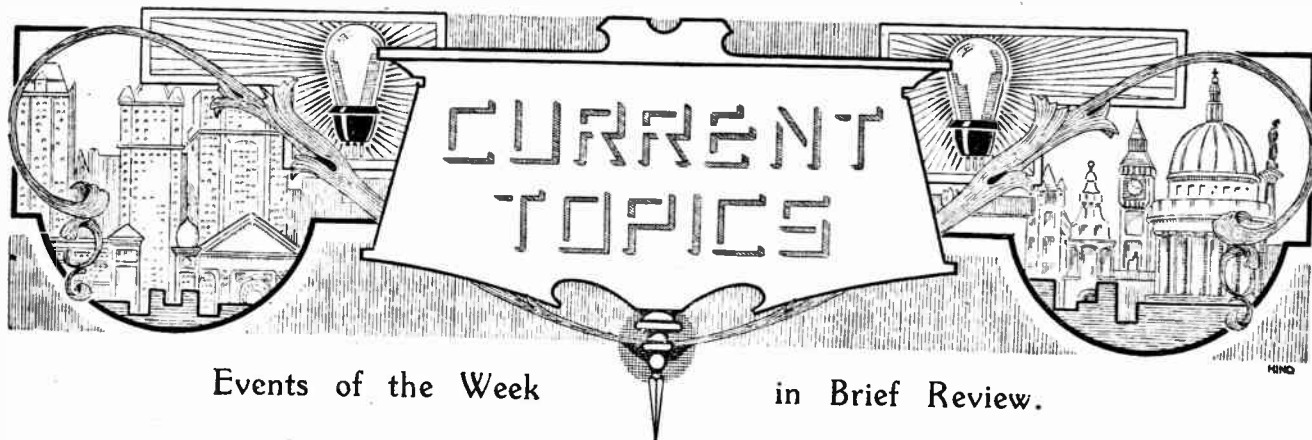

Events of the Week

in Brief Review.

**MAKING HOUSES COMPLETE.**

Greenford housing authorities are following the example set by other districts by installing indoor aerials in three hundred new houses.

○○○○

**LOUD-SPEAKERS ON THE RAILWAY.**

Train travellers at Newcastle Central Station witnessed an interesting experiment on Saturday, October 8th, when six loud-speakers fixed at strategic points were used to announce the arrival and departure of trains. The microphone and amplifiers, supplied by Standard Telephones and Cables, Ltd., were situated in No. 2 signal box.

The volume of speech easily overcame the hubbub of the station.

○○○○

**A DECEPTIVE LIGHT.**

A mistake as to the function of a lamp had an important sequel at the Southend Police Court last week, when a Leigh resident was summoned by the corporation for improperly using electricity. It was stated that the defendant had two meters, one for lighting at 6½d. per unit and the other for heating at 2½d. He had charged a high tension accumulator on the heating supply and a light was seen burning while this was being done.

As having been explained that the lamp was not being used for purposes of illumination but simply as a resistance, the chairman said that the Bench thought it would be dangerous to convict, and the summons was dismissed.

○○○○

**MR. WILLIAM LE QUEUX.**

Mr. William le Queux, the well-known author, whose death at the age of 63 occurred in Belgium on October 13th, could be numbered among the pioneers of amateur wireless. For some time prior to the war he included the study of wireless problems among his many activities, becoming a member of The Wireless Society of London soon after its foundation in 1913.

After the war Mr. le Queux turned his attention to transmission, and was one of the first amateurs to experiment in wireless telephony. He worked in collaboration with Mr. W. W. Burnham (2FQ), of Blackheath, his own call-sign being 2AZ. He was a member of the Radio Society of Great Britain.

**WIRELESS SHOW AT GUILDFORD.**

The Guildford Wireless Society is holding an exhibition from October 26th-29th.

○○○○

**A BIG SET.**

A new wireless set installed in Lambeth Hospital is capable of operating eleven hundred pairs of head phones and over seventy loud-speakers.



Photo: Elliott and Fry.

**AN AMATEUR TELEPHONY PIONEER.**

Mr. William le Queux, the noted novelist, whose death occurred last week. He included wireless telephony experiments among his many activities.

**BROADCAST BEFORE BREAKFAST.**

So great was the demand for stands at the Copenhagen wireless exhibition, which has just taken place, that the organisers were compelled to refuse many applications for space. The number of licensed listeners in Copenhagen now totals 160,000, writes a correspondent, and some Danish listeners are such avid enthusiasts that regular transmissions are given from the Copenhagen station at 6.30 a.m. consisting of physical exercises.

Sweden possesses thirty broadcasting stations, all in regular operation.

**WIRELESS AIDS SICK MAN.**

The serious illness of the principal keeper at the Sule Sherry Lighthouse, Orkney Islands, was diagnosed last week by a doctor on the mainland by means of wireless reports. Thanks to the agency of wireless a steamer was sent immediately and the sick man removed to hospital.

○○○○

**ENCOURAGING CRYSTALS IN JAPAN.**

A decision to increase the use of crystal receivers has been taken by the Japanese Broadcasting Association, which is embarking on a scheme for increasing the power of present stations from one to ten kilowatts and for establishing of new stations.

The association has three branches, comprising the Kwanto branch in Tokio, the Tokai branch in Nagoya, and the Kansai branch in Osaka. Japanese listeners are placing great confidence in the abilities of the association to secure the utmost development of broadcasting for the benefit of all.

○○○○

**ALL ROADS LEAD TO MANCHESTER.**

Manchester amateurs are eagerly looking forward to the opening of the Fourth Annual Wireless Exhibition, organised by the *Evening Chronicle*, which will open at the City Exhibition Hall on Monday next, October 24th.

In many respects the exhibition promises to be a worthy understudy to the recent Olympia Show, many of the leading firms who displayed their latest products at Olympia having transferred their exhibits to Manchester.

One of the most important features of the Show will be the staging of amateur apparatus constructed by entrants in the *Evening Chronicle* series of competitions. The work of judging the entries is in the hands of the Manchester and District Radio Societies. Another competition, for the compilation of the best two contrasting programmes, has also brought a large entry; two of the winning programmes will be broadcast.

The Exhibition will remain open until Saturday, November 5th.

○○○○

**TELEPHONY TO CANADA.**

Our attention has been drawn to a slip which occurred in these columns last week

in a reference to the newly-opened official telephone service between this country and Canada. The system used is, of course, the same as that employed in the other Transatlantic telephone services from Rugby, and not "beam," as stated in the paragraph in question.

**FORTHCOMING EVENTS.**

**WEDNESDAY, OCTOBER 19th.**

*Radio Society of Great Britain.*—At 6 p.m. At the Institution of Electrical Engineers, Savoy Place, W.C.2. Lecture: "The Balanced Colpitts Oscillator," by Mr. E. H. Robinson.  
*Golders Green and Hendon Radio Society.* At 8 p.m. At the Club House, Willifield Way, N.W.11. Lecture: "Perfect Reproduction (with special reference to Transformers)," by Mr. R. Garside (of Messrs. Ferranti, Ltd.)  
*Muswell Hill and District Radio Society.*—At 8 p.m. At Tollington School, Tetherdown. Demonstration of New Apparatus by a leading manufacturer.  
*Tottenham Wireless Society.*—At 8 p.m. At 10, Bruce Grove, N.17. Lecture: "Litzendraht Coils and H.F. Screens," by Mr. Powell (of Messrs. Wright and Pearce).

**THURSDAY, OCTOBER 20th.**

*Institution of Electrical Engineers.*—Opening Meeting of Session. At 8 p.m. (light refreshments at 5.30). At the Institution, Savoy Place, W.C.2. Inaugural address by Mr. Archibald Page, President.  
*Stretford and District Radio Society.*—At 8 p.m. At 6a, Derbyshire Lane. Lecture: "Set Maintenance," by Mr. Grant.  
*Radio Experimental Society of Manchester.*—Lecture: "Modern Loud-speakers," by Dr. S. Hodgson, B.Sc., M.B.C.S., L.R.C.P.  
**MONDAY, OCTOBER 24th.**  
*Hackney and District Radio Society.*—At 8 p.m. At the Electricity Halls, Clapton Road, E.5. Lecture and Demonstration on the New Screened Valves.

**SET CONSTRUCTION IN SCHOOLS.**

Schools in Leeds, which were among the first to introduce wireless sets, are carrying out tests to discover the most suitable "all-round" type of set for

school work. The schools involved are the Blenheim Girls' School, the Brudenell Road Boys' School, the Thoresby High School for Girls, and the West Leeds High School for Boys. As the set is found which will give the most perfect reception each school, with technical help, will make its own set. Four-valve receivers are most favoured.

**RADIO WEEK FOR BRISTOL.**

A Bristol Radio Week has been fixed for November 20th to November 26th, during which period a special effort will be made by the local wireless interests as well as the B.B.C. to cultivate a greater public regard for broadcasting and wireless generally.

The plans already made provide for, first, a week of special broadcast programmes with a "Bristol flavour"; secondly, an exhibition of wireless sets and technical matter in simplified form for school teachers and others; and, thirdly, a number of lectures to the Bristol public on the gentle art of listening-in.

**KITE AERIALS FOR AIRCRAFT.**

Interesting kite wireless experiments with the object of assisting air pilots who have crashed in lonely districts are being carried out by the U.S. Navy Bureau, according to reports from Washington.

The kites employed use thin wire instead of the usual cord, and are designed for use when the aeroplane aerial has been smashed. These kite aerials fulfil a double purpose, for, besides acting as efficient wireless aerials, they make useful visual distress signals. Very probably kite aerials will become a standard fitting on U.S. naval planes.

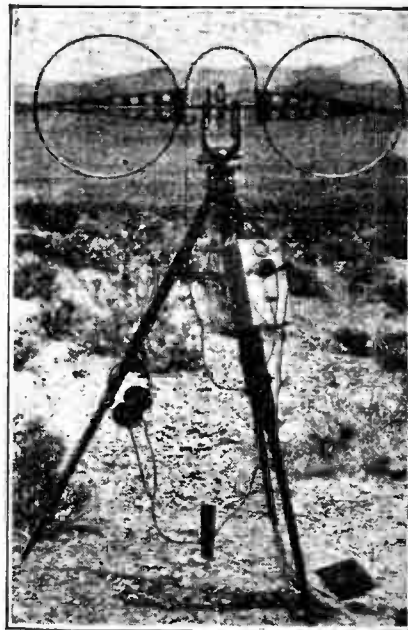

**PROSPECTING BY WIRELESS.** The short-wave receiver, fitted with directional loops, used in conjunction with the transmitter seen below.

**BOOKS AND CATALOGUES RECEIVED.**

*The Motor Cycle Book for Boys*, by the Editorial Staff of *The Motor Cycle*. Pp. 195, profusely illustrated; with five coloured plates and historical end-papers. Published by Iliffe and Sons Ltd., London. Price 6s. net.

Philips Lamps, Limited, 145, Charing Cross Road, London, W.C.2. Leaflet describing and illustrating Philips rectifiers for radio and car purposes.

Benjamin Electric, Ltd., Brantwood Works, Tottenham, London, N.17. "Still Rising," a pamphlet illustrating the growth in the sales of Benjamin radio accessories.

The D.P. Battery Co., Ltd., Bakewell, Derbyshire. "A Century of Power"—an art brochure describing the growth of the D.P. Battery Company's works in the Peak District of Derbyshire.

The Marconiphone Co., Ltd., 210-212, Tottenham Court Road, London, W.1. Publication No. 453a, being an illustrated 78-page catalogue of Marconiphone receivers, accessories, and components.

Sydney S. Bird and Sons, "Cyldon" Works, Sarnesfield Road, Enfield Town, Middlesex. "Concerning Variable Air-spaced Condensers," a booklet by Sydney S. Bird describing the construction of the "Cyldon" condensers, and giving comparative graphs showing variation in curves between Cyldon Square Law, Straight Line Frequency, and Logarithmic Mid-line Condensers.

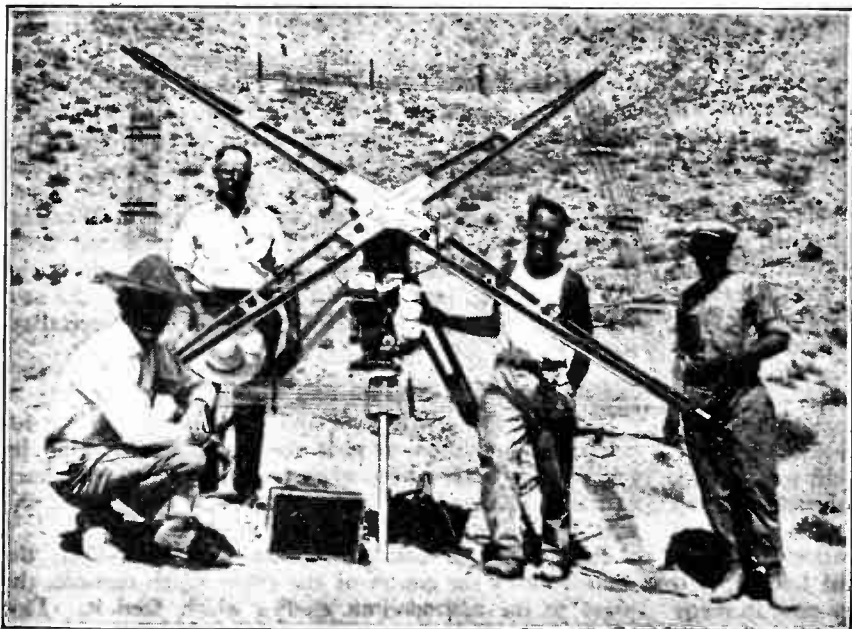

**PROSPECTING BY WIRELESS.** party of mineral prospectors in southern California with a frame aerial short-wave transmitter devised to locate mineral deposits. The strength of high-frequency signals is affected by passage over metallic and other deposits, which can thus be traced with the aid of a directional short-wave receiver.

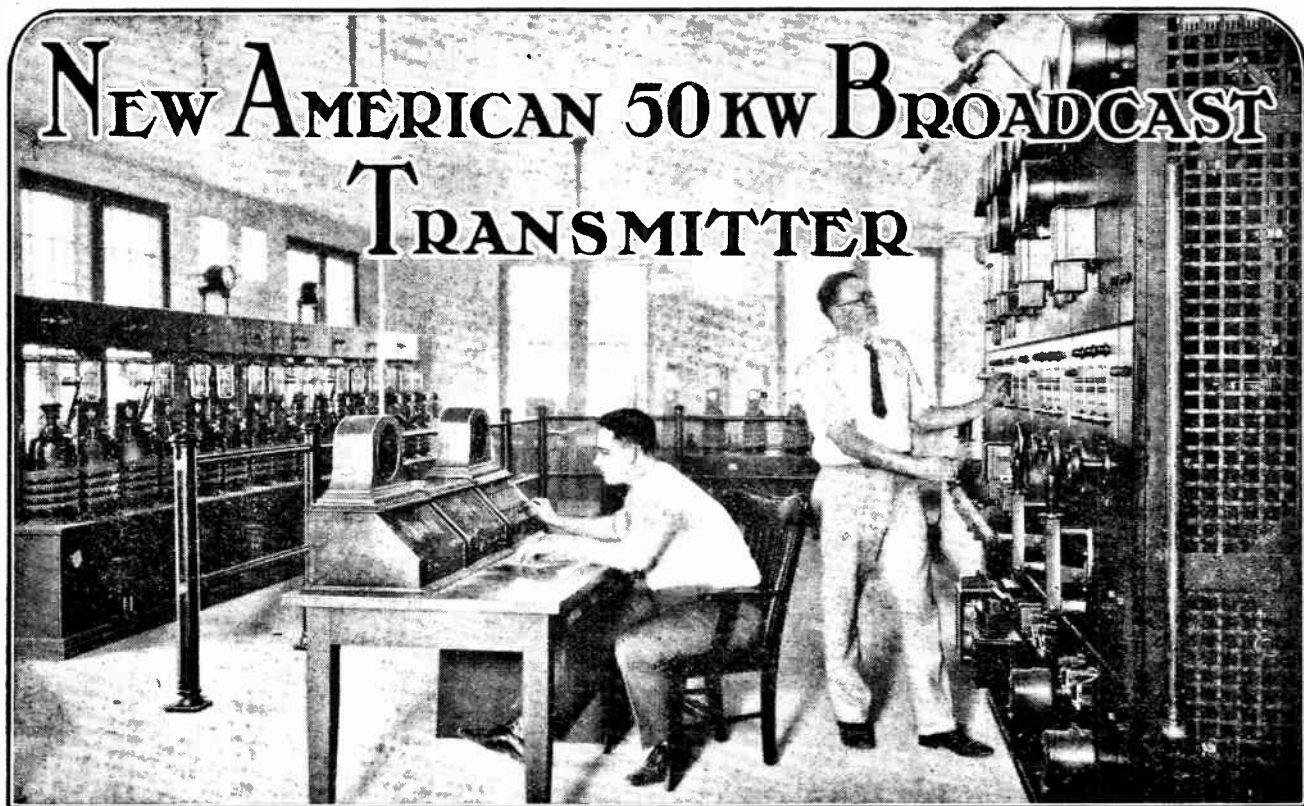

# NEW AMERICAN 50 KW BROADCAST TRANSMITTER

## A Description of the Plant at WEAJ, Bellmore, Long Island.

By OUR NEW YORK CORRESPONDENT.

FOR some time past the tendency of American broadcast stations has been towards the use of increasingly high power, and as a result there are in daily operation two stations (WJZ and WGY) already using an output power of 50 kW. The latest graduate to the 50 kW. class is station WEAJ, of New York City, owned and operated by the National Broadcasting Company, and the key station of one of that company's extensive S.B. networks.

When the National Broadcasting Company was first formed, in November, 1926, WEAJ was handed over to it by the Radio Corporation of America, which had just purchased it from the American Telephone and Telegraph Co. for one million dollars. This original transmitter has an output power of 5 kW., and is situated on the roof of the Bell Telephone Laboratories, in the heart of New York.

After the formation of the N.B.C., plans were immediately started upon for the erection of a new and more powerful station to take the place of the old transmitter, which, though it represented the peak of development by the A.T. and T., as regards equipment, was not in an ideal location. For one thing, its operation interferes with other research work being conducted by the Bell Laboratories; and reception from it is very poor in many parts of New York on account of the high absorption due to the close proximity of high steel-framed buildings.

Thus the site for the new station was chosen at Bellmore, Long Island, which is about thirty miles from New York.

Specifications for the entire plant were drawn up by the National Broadcasting Co.'s Board of Consulting Engineers, composed of the following: Dr. Alfred N. Goldsmith, Chief Broadcast Engineer of the Radio Corporation of America, Chairman; Dr. E. F. W. Alexander, Consulting Engineer, General Electric Company; and Frank Conrad, Consulting Engineer, Westinghouse Electric Company. The above-mentioned three companies are the parent companies from which the N.B.C. sprang, and supplied the equipment for the new station in accordance with their particular specialisations.

### Towers and Aerial.

Through the courtesy of the N.B.C., the writer received an invitation to visit the new station during its preliminary tests, which were made under the temporary call sign 2XZ. Long before these lines are in print the new WEAJ will be in regular operation.

Proceeding by motor 'bus from New York City, the route follows the course of the cable which connects the plant to the metropolitan studios which feed it. This cable passes through three telephone exchanges, Prospect, Jamaica, and Lynbrook, at each of which points repeaters.



**New American 50 kW. Broadcast Transmitter.—**

or amplifiers, are inserted to keep the signal well above line and other disturbances.

The two self-supporting steel towers of the station, each 300 feet in height, are visible for a considerable distance over the flat Long Island country, and as one approaches the eight-acre site the aerial becomes visible. This latter is merely a single  $\frac{3}{8}$ -inch wire suspended between the towers, with the down-lead in the middle, forming a T-shaped antenna of great mechanical strength.

This great mechanical strength is of particular importance in the vicinity of New York because of the so-called sleet storms which occur frequently in winter. During these storms heavy rain falls, which immediately freezes on encountering any object. Thus one may frequently see wires, trees, buildings, streets, etc., encased in a heavy coating of ice to a depth of one or two inches.

The horizontal section of the aerial is 250 feet long, affording ample clearance from the towers, which are spaced 600 feet apart. The towers are supported on heavy, glazed porcelain insulators, and, under normal circumstances, remain insulated from earth. This type of aerial has a high effective height and radiates efficiently in all directions. Its natural wavelength is well over 600 metres, necessitating the use of a series condenser to tune the system to 491.5 metres, corresponding to the frequency of 610 kC. assigned to the station.

In order to ensure the safety of aircraft, and also to

act as a guide, the towers are painted in alternate twelve-foot bands of black and yellow. At night they are illuminated by flood lights.

The earthing arrangements consist of a system of buried wires.

The station building is a one-storey-and-basement stucco structure set about midway between the towers. The architecture might be described as a compromise between the residential and the style usual in power plants. The photograph reproduced on the front cover gives a comprehensive view of the building, the towers, aerial, and (at the left of the building) the little tuning hut, to which reference will be made later.

**Input and First Amplifier.**

Entering the station by a short flight of steps leading to the main floor, the visitor passes through the engineer's office to a control room on the right, where the incoming lines terminate. Here are installed the preliminary input amplifiers of the station and the monitoring panels.

The monitoring and switching panels comprise apparatus such as small amplifiers and volume indicators. The purpose of this equipment is to measure the strength of incoming currents and to equalise or correct any loss of high musical frequencies along the line. Signal lights are also provided to indicate the condition of the various circuits, and a compact form of oscillograph indicates the depth of modulation of the carrier.

In addition to these visual checks, there is a high-quality cone speaker fed from a radio-frequency rectifying system, which is used for "monitoring" the output of the station aurally. On these panels also there are jack panels and switching facilities for conveniently changing lines, etc.

The first speech amplifier in the actual broadcasting circuit within the station building consists of a UV211 valve with a 50-watt oscillator rating. This is resistance-coupled to another valve of the same size. The next unit is a 1 kW. UV851 air-cooled valve which energises the grids of the modulators, connection being effected through a low-capacity cable.

These three valves derive their filament current from an accumulator, while the plates are fed from D.C. generators. The complete amplifier is mounted in a metal case about seven feet high, suitable meters being mounted on the face of the panel. It is provided in duplicate, with a power con-

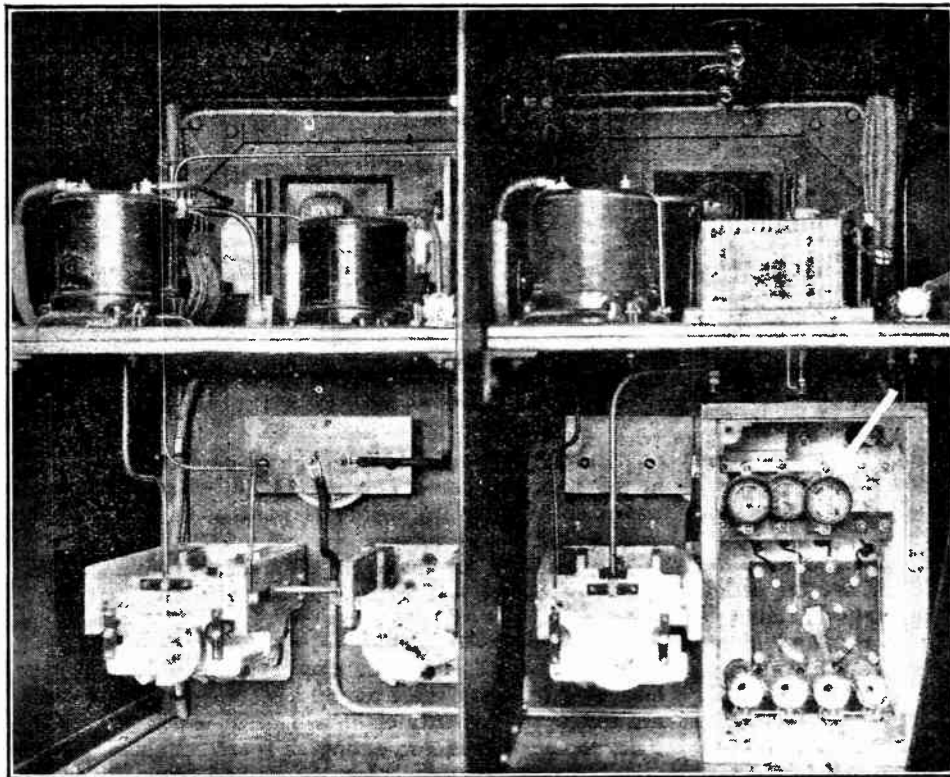

Back view of crystal-controlled oscillator. The arrow indicates the crystal in use, two spares being available. The temperature of the oscillator is maintained constant by electrical thermostats.

**New American 50 kW. Broadcast Transmitter.—**

trol and change-over panel set between the two amplifier units.

The main transmitter room of the station contains the following units: Main power switchboard, crystal-controlled low-power oscillator, intermediate power amplifier, 50 kW. power amplifier, modulator for 50 kW. amplifier, rectifier, tuning apparatus, and operator's control desk. With all this apparatus arranged round the walls, the room, which measures 70 feet by 30 feet, is by no means crowded. High-tension sections are barred by a wooden railing.

**Radio-frequency Apparatus.**

The radio-frequency (610 kC.) section of the equipment begins with the crystals, of which there are

size, which, in turn, is followed by stages employing one and then two UV211 (50 watt) valves. At the next stage the level becomes formidable, and a 1 kW. valve is required to handle it. Up to this point all the valves are air-cooled, but in the next stage a single 20 kW. water-cooled valve is employed. This latter constitutes the intermediate power amplifier, and is on a separate panel, with its own meters and controls.

The water-cooled valves used in this installation are of the usual type in which the grid and filament are enclosed in a metal cylinder which acts as the plate, and which is also in direct contact with the cooling water. The amount of energy conveyed to this plate may be of the order of 30 kW., at a voltage of perhaps 15,000. The efficiency of the device is estimated at 60 or 70 per cent., so that some 20 kW. may be withdrawn in the form of useful



General view of valve panels: on the extreme left, the radio-frequency amplifier; in the centre, the modulator; and on the extreme right, the high-power rectifier.

three, housed in a metal box, the temperature of which is thermostatically controlled. Any crystal may be selected by means of a switch on the face of the panel.

The function of the crystals is, of course, to keep the station on its assigned frequency. Their natural period varies slightly with variations in temperature, and it is planned to keep the heating current on day and night, whether the station is in operation or not, in order to maintain perfectly equable physical conditions for this delicate equipment.

The first valve controlled by the crystal is a UV210 of 7.5 watts rating, a valve commonly found in the last audio stage of many high-quality American receivers. This valve is R.F. coupled to a second valve of the same

oscillations, leaving 10 kW. to be dissipated at the anode in the form of heat. This energy heats up the cooling water, which circulates round the plate at the rate of two or three gallons per minute.

The filaments of these 20 kW. valves consume over 1 kW. of energy—52 amperes at 22 volts.

**High-power Amplifier and Modulator.**

In the 50 kW. 610 kC. amplifier which follows the intermediate power stage ten 20 kW. water-cooled valves are employed, but only eight will be in use at any given time, the remaining two acting as spares. These valves are all run very much below their rated power in order to avoid any possibility of overload (blasting), and to prolong their life. This unit, which is about 20 feet

**New American 50 kW. Broadcast Transmitter.—**

long, is built in open fashion; most conspicuous on the panel are the ten hose coils wound on insulating cores into which the anodes of the valves themselves fit. These coils ensure a water column sufficiently long to insulate the plates, with their 10,000- to 15,000-volt high-tension supply, from earth.

livering 12 amperes D.C. at 15,000 volts, or 180 kW

The main switchboard of the station is similar in appearance to that of any good-sized electric sub-station, with the same circuit breakers, meters, relays, signal lights and controls. The equipment for starting and stopping the various machines and energising the different valve panels is mounted on this board.

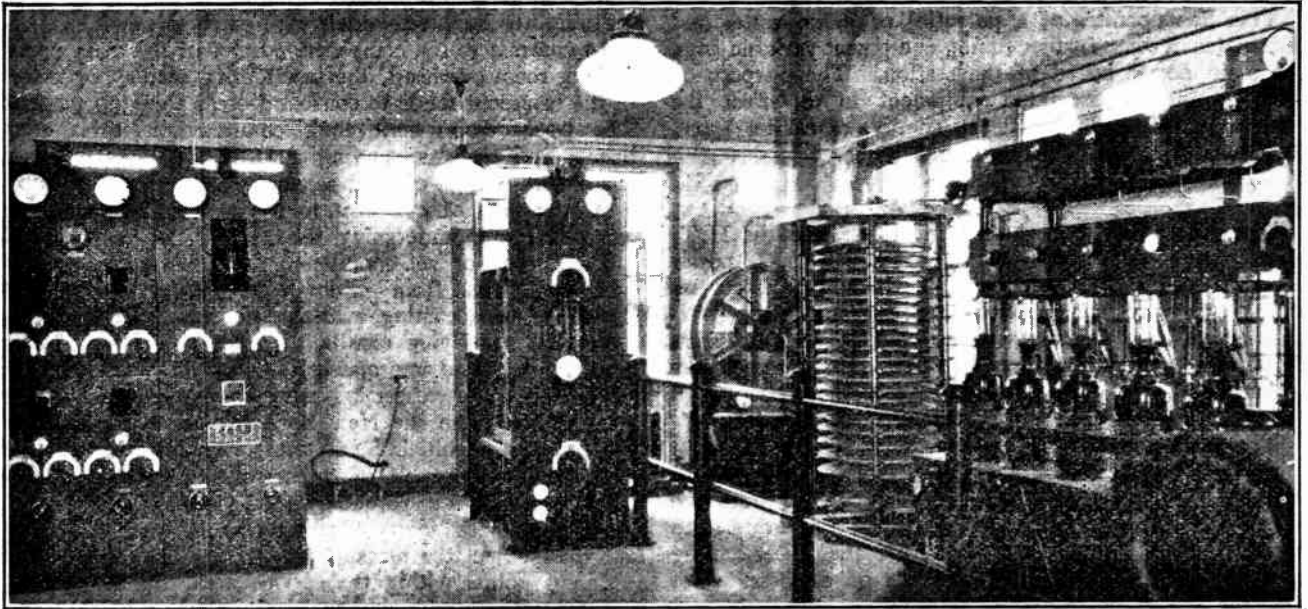

Radio-frequency circuits of the power amplifier. On the extreme left will be seen the crystal control panels.

Below each water coil there is a pressure-actuated relay which prevents the high-tension being applied to the plates of the valves when the water is not flowing at a safe rate. With twenty-seven water-cooled valves in use, in the absence of such automatic protection an operator's mistake might cost the station upward of \$10,000 (£2,000) in a few seconds!

The superstructure of the 50 kW. amplifier carries meters, individual choke coils, indicating-relays, switches, and other equipment required in the operation of high-power transmitting valves.

The modulator, which moulds the amplitude of the 50 kilowatts of radio-frequency energy in accordance with the speech or music of the programme, is a similar unit in appearance.

There are sixteen high-power valves in the modulator—twelve in use and four spares. These are connected and disconnected in groups of two, but the grid bias may be individually adjusted. This bias voltage is provided by a pair of small generators situated, together with the rest of the running machinery, in the basement, which we shall visit later on. The bias voltage is not much below 1,000, so that there is some danger of electrocution on any of the Bellmore frames, even if one does not come in contact with the plates of the valves.

At the far end of the room is the high-power rectifier, which supplies plate power for all the three-electrode valves. This is a relatively small frame, mounting six water-cooled two-electrode valves, but it is capable of de-

Once the station is running, however, it may be shut down instantly by means of a small tumbler switch on the operator's control unit. This table also holds the 600-metre receiver and loud-speaker which American law requires every broadcasting station to have in constant operation on marine wavelengths while the station is broadcasting. An operator sits at the table, and in the event of an S O S call being picked up from a ship in distress far out at sea, the station is immediately closed down, after a short explanatory announcement has been made. In this way interference with distress working is avoided.

If an amplifier or modulator valve should break down in operation, the operator is also in a position to cut it out of circuit and replace it with one of the spares. This is done by throwing two tumbler switches on the control unit. These actuate solenoid-operated switches which perform the operations required. Such automatic controls, while complicated and costly, ensure the continuity of service which is vital to a first-class broadcasting station.

Failure of a valve is immediately indicated to the operator by the dropping of a small white disc, when the solenoid switch controlling a burnt-out valve automatically opens as the result of the failure. From his place at the control table the operator has a clear view of all the valve equipment.

Near the radio-frequency amplifier, on the opposite side of the room to the rectifier, there is situated a huge,

**New American 50 kW. Broadcast Transmitter.**—

hollow plate condenser, which stands well over the height of a man's head, and which is variable by means of an electric motor. This, in conjunction with an equally large pair of flat spiral inductances, constitutes the 610 kC. closed circuit which delivers the modulated radio-frequency energy to a transmission line which runs some 30 feet out to a small tuning house built directly under the aerial down-lead.

This line operates at a potential of 5,400 volts, and terminates in some further tuning equipment variable from the main power board of the station. The purpose of this line and its associated equipment is to effect the transfer of the radio-frequency energy, or carrier wave, to the aerial, which radiates it into space.

**The Basement.**

Descending now into the basement, we find the H.T. transformers which step up the 2,300-volt A.C. power supply received from the Long Island Lighting Company to the 15,000 volts required to feed the high-power rectifiers. Here also are the immense chokes and condensers required to smooth out the rectified A.C., the speech choke which couples the 50 kW. amplifier to the modulator, and the running machinery of the station.

The running machinery includes three 25 kW. filament motor-generators, four 3 kW. plate motor-generators for supplying H.T. to the lower-powered valves, and two 0.55 kW grid bias motor-generators. In a separate room there is also pumping equipment for the water-cooling system, which handles 4,000 gallons of distilled water per hour while the station is in operation. Distilled water is used for cooling purposes because ordinary water leaves

a deposit on the plates of the valves, and in this connection the interesting fact, not entirely devoid of humour, is revealed that the National Broadcasting Co. applied to the Bureau of Prohibition at Washington for permission to use a small still for the purpose of making three gallons of distilled water per hour!

In the basement also there is an accumulator room, heating apparatus, and a vault for spare valves. The floors, ceilings, walls and windows of the entire plant building are double-shielded with earth screens.

In contrast to the comparative quiet of the main transmitting room overhead, the bewildering medley of noises in the basement tends to confound one's thinking powers. The transformers emit their characteristic threatening drone, and the fast-running generators fill the enclosed space with a high-pitched scream.

At the time of our visit to the new Bellmore station the plant was undergoing tests which, at the time of writing, are not yet completed. A continuous twelve-hour test, run from midnight to midday, the longest period of broadcasting available for continuous testing, gave very gratifying results, no part of the transmitter having functioned improperly. During this test—the first other than pure carrier wave tests—gramophone records were played from the New York studios, and tone tests were also sent out. These latter tests showed that the new station is capable of transmitting satisfactorily frequencies from 30 to 10,000 cycles.

After the satisfactory conclusion of further tests having for their object the measurement of the field strength at different points within the service area, the old 5 kW. WEAF will be closed down and its place in the ether taken by the new 50 kW. transmitter.

**Z Codes.**

With reference to the International "Z" Code which we gave on page 509 of our issue of October 12th, we must frankly admit that the translations of some of the code letters taken from different sources are not always entirely in agreement. For example, the translation of ZFA is given by one authority as "Your transmission is fading out," and by another as "Automatic transmission out of order." ZPT is also translated alternatively as "Send text in plain language twice," and "Send twice quickly." We shall therefore welcome any authoritative information correcting or supplementing the list.

○○○○

**The Mysterious HJG.**

We learn that the station HJG, which has puzzled so many of our readers, and, incidentally, has rather interfered with the reception of U2XAD, is the Marconi Company's 25 kW. station at Bogotá, Colombia, transmitting on 22 metres. Commercial stations in the Republic of Colombia are allotted the call-signs HJA to HKZ. At present there are seven Marconi stations working: HJA, San Andres Island, 5 kW. spark; HJB, Puerto, Colombia, kW. spark; HJC, Barranquilla, 6 kW C.W.; HJD, Medellin, 6 kW. C.W.; HJE, Cali 3 kW.

**TRANSMITTERS' NOTES**

C.W.; HJF, Cucuta, 3 kW. C.W.; and HJG, Bogotá.

The interference from HJG appears to be lessening, or possibly listeners may have become more accustomed to tuning him out, as we hear of a reader at Newark who was able to receive both 2XAF and 2XAD at 8.45 p.m. on October 5th without experiencing any trouble. He reports that both stations were transmitting simultaneously, and that 2XAD on 22 metres was slightly the stronger. After these stations had closed down he was able to pick up HJG sending a succession of Vs.

○○○○

**Anglo-Canadian Beam Stations.**

Through the courtesy of Marconi's Wireless Telegraph Co., Ltd., we are now able to give the amended wavelengths of the following Beam stations:—

GBK—Bodmin, 16.574 and 32.397 metres.

CG—Drummondville, Canada, 16.501 and 32.128 metres.

○○○○

**Belgian Amateurs.**

Two new official relay stations have been established by the Reseau Belge:

EB 4XS (Mr. R. Parent, Verviers) will listen on Tuesdays from 18.00 to 20.00 G.M.T. and Saturdays from 18.00 to 19.00 G.M.T. on 44 metres and on Wednesdays from 23.00 to 24.00 G.M.T. on 19.50 metres. EB 4FN (Mr. C. Hauman, 187, Avenue Albert, Brussels) will listen on Thursdays between 18.30 and 19.30 G.M.T. on 45 metres.

○○○○

**A Correction.**

We regret an error in the call-sign of Mr. A. G. Watkins, as printed on page 282 of our issue of August 31st. This should be 6WX and not 5WX. We trust that neither Mr. Watkins nor Mr. R. Hallam, the rightful owner of 5WX, has been inconvenienced by our mistake.

○○○○

**New Call-signs and Stations Identified.**

5 GR (ex 2 BPI) Leslie W. Gardner, 10, Ludlow Rd., Coventry.  
5 UM (ex 2AJI), J. Hum, 17, Eastwood Rd., Muswell Hill, N.10: transmits on 150-200 metres and welcomes reports.  
6 MG J. Montgomery, 147, Royal Avenue, Belfast, transmits on 23, 45, 90, and 150-200 metres. (This call-sign was formerly held by Mr. B. W. D. D. Lacey in Birmingham.)  
6 NW J. G. Newell, "Fairlight," Waterworks Rd., Eastwood, Southend-on-Sea: transmits on 180 metres and will welcome reports.  
6 UC A. C. Chatwin, 1, York Rd., Edgbaston, Birmingham. (Change of address after November 11.)  
6 YG F. W. Goff, 15, Melbourue Parade, Palmers Green, N.13.

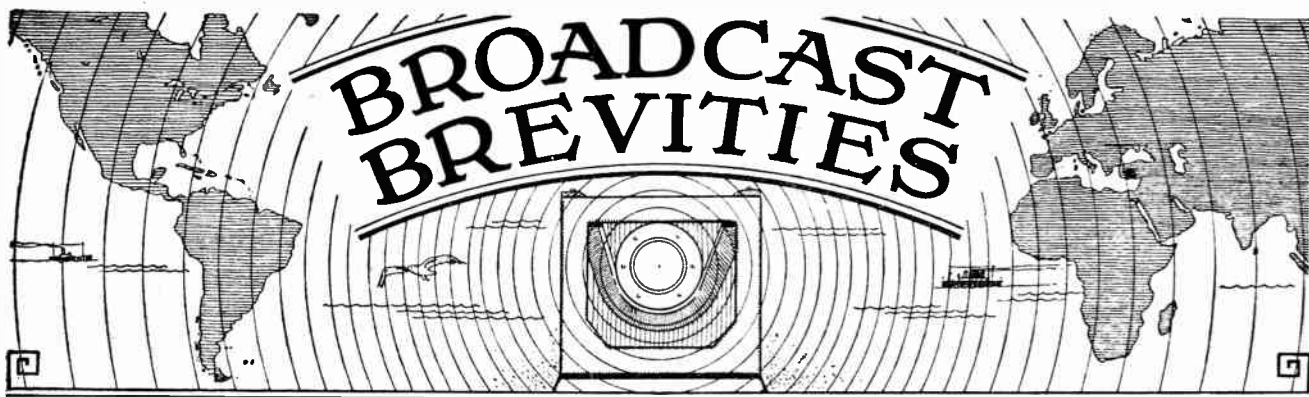

By Our Special Correspondent.

**Weakening of 5GB.—Captain Eckersley and Transatlantic Programmes.—The Enduring Oscillator.—Hot Studios.—National Concert on Friday.**

**The Daventry Diminuendo.**

A topic of debate in many railway carriages these October mornings is the Daventry Diminuendo, or, more bluntly, the decline in power of 5GB. Everywhere it is being noticed.

A month ago the station was reputed to be putting out 20 kilowatts from the aerial; the figure then dropped to 14 kilowatts, and now, from the sound of things, that figure has been halved.

This is all to the good from the point of view of the Daventry townsman, who probably hears the station on the bed-springs while he sleeps. but it has its discouraging side for Birmingham and London.

o o o o

**Masts Everywhere.**

The real cause of the power decline can probably be traced to the new 325ft. masts, one of which is already in position. At the time of writing I understand that the other is suspended precariously by the eyebrows at an angle of 45°. These metal structures are helping the giant masts of 5XX to absorb as much as possible of the energy radiated from the puny little aerials at present serving the experimental station.

When new mast No. 2 reaches the vertical we may expect another drop in the strength of 5GB.

o o o o

**Tests with the New Masts.**

Another contributory cause to the present unsatisfactory conditions is the delay in the delivery of a number of new water-cooled valves.

Before the new masts supersede the old some very thorough tests will be carried out after ordinary broadcasting hours. The engineers are determined to score a success if it is humanly possible; so we can be prepared for some interesting ether-shaking in the very near future.

o o o o

**"Please to Remember . . ."**

The variety programme on November 5th from 2LO and 5XX will include a "Guy Fawkes" sketch.

**FUTURE FEATURES.**

*Important items for week ending October 29th.*

**London and Daventry (5XX).**

23RD.—Albert Sandler and the Grand Hotel, Eastbourne, Orchestra.

24TH.—Military Band Programme.

25TH.—Variety Programme.

26TH.—"La Traviata" (Verdi). S.B. from Manchester.

27TH.—Orchestral Concert by the Hallé Orchestra, relayed from Manchester.

28TH.—Debate between G. Bernard Shaw and G. K. Chesterton, relayed from the Kingsway Hall.

29TH.—Light Music by Paul Lincke, the Wireless Orchestra conducted by the composer.

**Daventry (5GB), experimental.**

23RD.—Light Symphony Concert.

24TH.—Variety Concert.

25TH.—Ballad Concert.

26TH.—Orchestral Concert.

27TH.—Symphony Concert, relayed from the Winter Gardens, Bournemouth.

28TH.—Symphony Concert.

29TH.—Popular Programme.

**Bournemouth.**

28TH.—"Wine, Women and Song." Cardiff.

24TH.—"A Disturber of Traffic," play in three acts by Herbert Swears.

**Manchester.**

24TH.—Speeches at opening of fourth Manchester Wireless Exhibition, relayed from the City Hall.

**Newcastle.**

25TH.—The Hepburn Colliery Prize Band and Vocalists.

**Glasgow.**

29TH.—"A Man of Ideas," a play by Miles Malleston.

**Aberdeen.**

24TH.—"The Return," a play of Russia by Gertrude Robons.

**Why Daventry Broke Down.**

5XX broke down for ten minutes one evening recently. The stoppage was due, says the B.B.C., to "high resistance on the grid mat of the automatic negative of the sub-sub-control."

The general public will be glad to know this.

o o o o

**"P.P." at Washington.**

Captain P. P. Eckersley, who is representing the Bureau Internationale de Radiophonie and the B.B.C. at the Washington Conference, will not have concluded his work in America when the last meeting has been held. I understand that, prior to his return, he intends to discuss arrangements with the National Broadcasting Company for the interchange of British and U.S. programmes on a regular basis.

Within limits there can be no objection to schemes of this sort, even if the value of American programmes as programmes may be overrated; moreover, the experience gained in the reception of the transmissions over here should provide useful data for the use of the Dominions when setting up their stations to receive British short-wave programmes.

o o o o

**Defeating Fading and Atmospherics.**

The B.B.C. engineers stick to the idea that the problem of short-wave broadcasting is one of reception rather than transmission. To ensure the best possible reception from America this winter a number of separate receivers are to be used, with filter circuits, to eliminate atmospherics and to overcome fading, which is often peculiar to certain districts and receiving-set conditions.

As demonstrating the nature of the short wave it is significant that the Eindhoven relay of the Baldock-Smith fight at the Albert Hall was an almost complete failure so far as South Africa was concerned. Yet South Africa had often listened to PCJJ on former occasions, and in this case there was no dearth of amateur receiving talent.

**Wireless Publicly Damned.**

Wireless seems to be having a bad time in the Caucasus, according to a writer in "St. Martin's-le-Grand." A broadcast receiver was recently taken to the almost inaccessible region of Svanetia, on the southern slopes of the Caucasian Mountains, where the mullahs are reported to be indulging in fiery diatribes against the devilish invention. Here the radio set was publicly damned before a huge crowd of onlookers and then thrown down a precipice.

In this country the ceremony is generally carried out privately, the wife being the sole onlooker.

**"A.G.G." Discusses Mr. J. H. Thomas.**

There must be thousands of listeners who, over the past quarter of a century, have read Mr. A. G. Gardiner's sketches of men and matters in the Press. On October 20th he will broadcast the second in the "personal sketches" series which he is doing, and his subject will be Mr. J. H. Thomas.

**The Enduring Oscillator.**

How often in wireless the wish is father to the thought! A new station will make all other stations look silly—until it is tried; an unheard-of broadcast entertainer will put his predecessors into the ranks of mumbling mummies—until he is heard; the carefully heated soldering iron will put the finishing touch to the set—until, alas, it does, in the wrong fashion!

The thought that oscillation is on the decrease must, I fear, own up to the same parentage. A report that the Nottingham area is now freer from oscilla-

tion than ever before has been interpreted as an indication that oscillators all over the country are queuing up for the stool of repentance. A fine thought!

**A Beautiful Thought.**

Unfortunately there is nothing in it, according to Savoy Hill. That the oscillator is unabashed by regional schemes, the return to G.M.T., the weather or anything else is shown by the weekly list of complaints, which is still up to its usual average.

**Turn Out the Lights.**

A blind detective is an unusual factor in the solving of crime problems, but Aberdeen station is giving on November 2nd a play entitled "In the Dark," by Gilbert Heron, in which the mystery is unravelled by a sightless detective.

**"Tannhauser" To-night.**

A strong cast has been engaged for the 2LO and 5XX broadcast of "Tannhauser" this evening (Wednesday). Walter Widdop takes the name part, Foster Richardson is the Landgrave, and Miriam Licette is Elizabeth. Other singers to be heard are Harold Williams, Leonard Gowings, Herbert Simmonds, Sam Harrison, Mavis Bennett, and Stiles Allen.

**Noise Between Studios.**

A rather annoying form of mutual inference between 2LO and 5GB has been traced to sound communication from studio to studio at Savoy Hill. The ventilation of studios is not all it should be, and on recent occasions it has happened that studio doors have been left open, with results which have speedily been apparent via telephone and corre-

spondence. The nuisance has been overcome by a stronger insistence on closed doors, but this has not removed the prime trouble, viz., poor ventilation.

This remains a special trial to unfortunate performers, particularly on wind instruments, who have to sit out a two-hour symphony concert in an illuminated "Black Hole of Calcutta."

**Why Not in the Others?**

The only studio at Savoy Hill which remains fairly habitable after a couple of hours is No. 7. This possesses special ventilating apparatus which was included in the structural alterations when the studio was first built.

**Friday's National Symphony Concert.**

Myra Hess will be the soloist in the National Symphony Concert at the Queen's Hall on Friday evening next, and will play Schumann's pianoforte concerto in A minor as well as three pieces by Granados. The National Orchestra, conducted by Sir Landon Ronald, will contribute to the programme as follows: Overture, "Oberon" (Weber); Suite, "English Pastoral Impressions" (Farra); Episode, "Carnaval in Paris" (Svendsen); Symphony No. 2 in E Flat (Elgar).

**On the Long Side.**

By the time these lines are read Mustapha Kemal, President of the Turkish Republic, will, according to present arrangements, have completed a broadcast speech lasting four days and containing 400,000 words. I hope this feat of endurance will not be accepted as a challenge by the B.B.C. Educational Department.

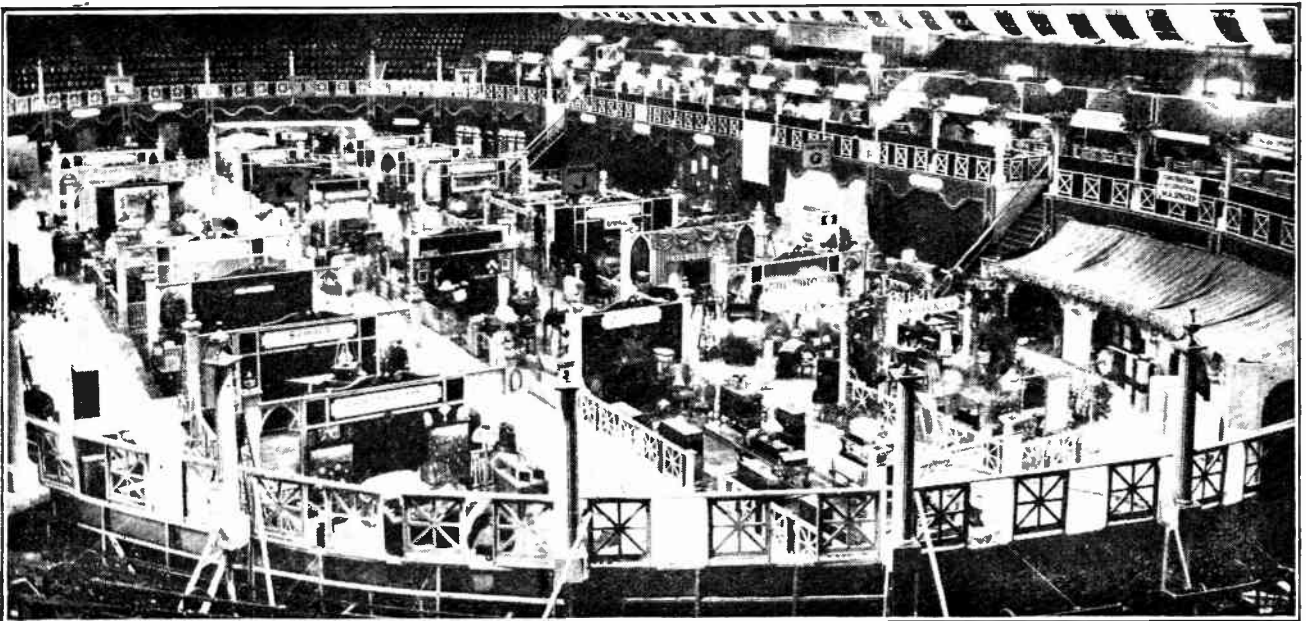

EXHIBITION FEVER IN NEW YORK.—A gallery view of last month's "Radio World's Fair," as the American annual wireless exhibition is called. The exhibition, which was held in the Madison Square Gardens, New York, attracted wireless enthusiasts and traders from all over the United States.

# The Experimenters' Notebook



## Directional Reception.

By "EMPIRICIST."

HERE is no doubt that one of the most powerful methods for the elimination of interference in wireless reception is provided by the directional properties of various forms and combinations of aerial systems. Apart from the elimination of interference from a specific source, it is clear from a statistical point of view that there is less likelihood of interfering stations being picked up when the aerial is non-receptive in certain directions than when it is entirely non-directional. Furthermore, in the case of certain types of interference referred to in a previous article,<sup>1</sup> a directional aerial system is the only hope of securing a satisfactory result, since tuning methods in such cases are entirely useless.

### Directional Receivers.

In considering ways and means in this respect it is necessary to draw a distinction between direction-finders and directional receivers. In the case of the former, more exact care in design and more careful analysis of errors is necessary; in respect of the latter we only require to know that it is "blind" to signals from certain directions, and it is not necessary to know with great accuracy what these directions are.

The fundamental element in practically all directional receivers is a frame or loop aerial, and it is of the first importance to appreciate how an aerial of this kind works. At the risk, therefore, of wearying some readers who are already quite familiar with the subject, we propose to devote some space to analysing the operation of a typical loop

voltages induced in the horizontal parts of the frame will be zero, and will have no effect in the circuit. It is clear from the figure that, because  $v_1$  and  $v_2$  are in the same direction in space, they oppose one another as far as any effect within the circuit is concerned, and it is only the small difference between these two voltages that constitutes the electromotive force within the circuit. The reason for this difference is found in the nature of a wireless wave, the wave corresponding to the far side of the frame reaching its crest a fraction of a second later than that corresponding to the near side. The wave corresponding to  $v_2$  is thus always lagging slightly behind that corresponding to  $v_1$ , and the voltages, as previously stated, are unequal in consequence.

If we now draw graphs of the voltages  $v_1$  and  $v_2$

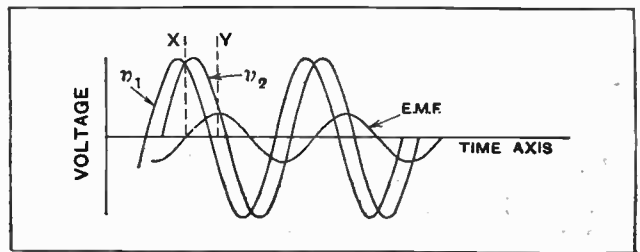

Fig. 2.—Graph of voltages in frame aerial showing resultant E.M.F.

against time, they will take the form of Fig. 2,  $v_2$  lagging behind  $v_1$ . It will be noted that these curves cut each other at points very near their crests; at the points of intersection the effective E.M.F. in the circuit is zero. At points equidistant from these the effective E.M.F. is a maximum, and its graph takes the form shown in the diagram.

### Phase of Resultant E.M.F.

If, as is the case in practice, the two voltages  $v_1$  and  $v_2$  are very nearly equal to each other, we may say that the E.M.F. attains its crest value when the voltages  $v_1$  and  $v_2$  are zero, and *vice versa*; in other words, the effective E.M.F. in the loop is *in quadrature with the signal E.M.F.* This point is extremely important to bear in mind.

Let us now consider a signal emanating from a source perpendicular to the plane of the paper; then the waves will hit the two sides of the frame simultaneously, and the voltages on opposite sides will be exactly equal in

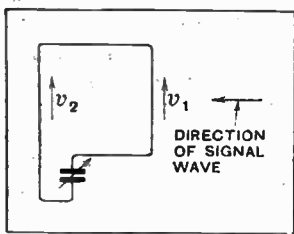

Fig. 1.—Direction of voltages induced in vertical sides of a frame aerial.

aerial and comparing it with an open aerial of the ordinary kind.

Referring to Fig. 1 let us imagine the frame aerial to be of square section and to lie in the plane of the paper; let us also consider a signal to be transmitted from a source in the same plane, in a direction from right to left. Then, if the frame is of small dimensions in comparison with the wavelength of the signal, the voltages  $v_1$  and  $v_2$  induced in opposite sides of the frame will be very nearly equal, and in the same sense the

<sup>1</sup> The Wireless World, June 29, 1927.

**The Experimenter's Notebook.—**

value. There will be thus no resultant E.M.F. in the circuit at all, and the signal will not be received. The minimum is critical, as anybody who has handled frame aerials will appreciate; by this we mean that a small displacement of the frame in either direction will result in the signal E.M.F. being again effective in the circuit, and its sense will be opposite on either side of the position of zero receptivity.

In Fig. 3 is an attempt to represent this graphically. O is the position of a frame aerial, the plane of which points North and South, and is perpendicular to the plane of the paper, the latter being assumed horizontal.

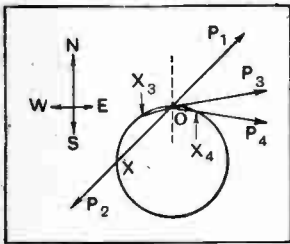

Fig. 3.—Diagram showing variation of signal strength in frame aerial at O with the bearing of a station P.

Let us imagine a station P always equidistant from O and of equal strength taking up various positions lying in directions  $OP_1$ ,  $OP_2$ , etc. Then we know from the foregoing that when OP lies East and West, *i.e.* perpendicular to the frame aerial, the E.M.F. in the circuit is zero, and when it lies North and South it is a maximum. Calculation shows that the strength of the E.M.F. can be represented by a straight line OX, where X is the intersection of OP with a circle on which O lies, and which has a diameter pointing North and South.

A convention as regards the sign of the E.M.F. is necessary. If it is assumed that a station in a southerly direction generates a positive E.M.F. in the frame, then a station in a northerly direction generates a negative E.M.F. This is represented in the graph by the convention that if X lies in the line OP the E.M.F. is positive, but if in OP produced then it is negative. Thus, referring to the figure, the same intercept OX is positive if the direction of the signal is  $OP_2$ , but negative if the direction is  $OP_1$ . It seems of importance to bear this point in mind, and the diagram given here, consisting of a single circle, appears to be preferable to the customary figure of eight diagram in which the convention of sign is ignored.

**The Minimum Position.**

The critical nature of the minimum position may be appreciated from the diagram in the light of the explanation just given. If  $OP_3$  and  $OP_4$  are two positions of OP, one just north and the other just south of the east-west line, it will be seen that the corresponding intercepts  $OX_3$  and  $OX_4$  are opposite in sign. There is, therefore, no "dead point" of E.M.F., but a sudden disappearance and reappearance of the signal.

The characteristics of the ideal frame aerial may thus be summarised by saying that it is "blind" to signals in a direction perpendicular to its plane, and receives with maximum efficiency signals in a direction lying in its plane. Furthermore, under all conditions, the effective E.M.F. is in quadrature with the field.

Practical frame aerials are frequently not as regular in their performance as the above summary would indi-

cate. The most important defect from which they suffer is a blunt minimum, and this defect may be due either to the frame aerial or the apparatus with which it is associated. The minute character of the E.M.F.s within a frame has been emphasised, and it is often found in practice that the electrostatic field of the transmitting station produces a powerful enough effect on the "live" elements of the frame circuit to make the frame aerial behave as if it were an open aerial. Since the E.M.F. in this case is in phase with the field it cannot be balanced out by a displacement of the frame, and the result is a blunt minimum. This is a serious defect when reception takes place from a near-by station, as it allows interference to be introduced which may completely swamp the distant signals which it is desired to receive.

The cure of this defect, if it is sufficiently serious to necessitate special steps being taken, lies either in preserving electrostatic symmetry in the frame windings or else actually screening them electrostatically. Associated apparatus, such as condensers, may, of course, be screened, and this will frequently prove a good-enough remedy. The employment of a frame aerial earthed at its centre point will ensure that no frame currents are directly induced by the electrostatic field of the signal, and will also provide a convenient means of neutralisation should this be required. The inclusion of the windings within a screening cage has recently been adopted by the N.P.L., and this has the additional advantage of counteracting what is known as "vertical" or "antenna" effect, about which a few remarks must now be made.

Referring to Fig. 4, the frame aerial AB is tapped in its centre point at C, and all associated apparatus is screened. The direct electrostatic field due to a signal will thus produce equal voltages  $v$  in the two halves CA and CB of the frame, which, owing to their opposition, will not set up any current in the frame circuit. If, however, the terminals C and A are connected to the grid and filament of the first receiving valve, the voltage  $v$  will appear across these terminals and will be combined with the voltage set up in the frame windings by the operation of the latter as a normal frame aerial. Since the voltage built up in the frame aerial is in quadrature with the driving E.M.F., which is itself in quadrature with the field, the voltage across the frame is in phase with  $v$ , and will, therefore, combine with it. The result will be that the minima produced by the action of the frame will, except in extreme cases, be as sharp as ever, but they will be displaced in position, and the two maxima will be of unequal strength. If the vertical effect is of sufficient intensity a "polar diagram" will be obtained which yields a single "blunt" minimum in one direction and a broad maximum in the opposite direction; this is the well-known "heart-shaped" or cardioid diagram which forms practically the most useful basis for directional reception.

(To be continued.)

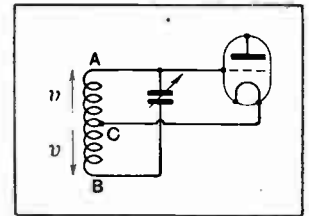

Fig. 4.—Illustrating the "antenna" effect of a frame aerial.





The Editor does not hold himself responsible for the opinions of his correspondents.

Correspondence should be addressed to the Editor, "The Wireless World," Dorset House, Tudor Street, E.C.4, and must be accompanied by the writer's name and address.

#### B.B.C. RECEPTION IN SCOTLAND.

Sir,—With reference to "A Sad Business" ("Broadcast Brevities," September 28th issue), it may interest your correspondent to learn that not only the "Highlanders" but quite a large proportion of the "Lowlanders" also are reduced to listening to his equivalent to Salamanca—otherwise Daventry. At the present moment—Monday evening—5XX has faded away, and we are left with nothing else good enough to tune in on the loud-speaker and *sit down* to listen to. On running round the dial from 250-600 metres there are about five fairly strong and *steady* stations (all foreigners), and somewhere in the background are our precious stations. Yes, it is indeed "a sad business," as we had fondly hoped to have an alternative to 5XX, which at present we have not. This state of affairs exists over a great portion of Scotland, in some places at thirty miles from our main stations, I believe.

We are wireless dealers, and here we are, at the beginning of the season, almost dreading a request for a demonstration at a client's home in case it happens to be an evening such as to-night, when 5XX is fading badly. It is impossible to sell to customers whose only interest is in the music itself.

So now perhaps your correspondent will understand why Highland (and Lowland) listeners had such an interest in 5GB and why they are voicing their great disappointment at its failure to reach them. Let us hope that the new aerial, etc., may bring it to them at something like the strength at which they receive Langenberg.

As a short-wavelength enthusiast, I am interested in the proposed short-wave station, but as an ordinary listener I am more interested in getting at least *one* station satisfactorily, and preferably a Scottish programme at that, and so am just a little jealous of the enthusiasm shown in "our" paper for the erection of a short-wave station, while our own country is so badly covered.

THOS. C. HORNE.  
(James Murdoch and Co.)

Hawick, N.B., October 3rd, 1927.

#### TELEVISION IN 1925.

Sir,—Why has Mr. Hutchinson, no doubt quite unintentionally, "cooked" his argument (in his letter of September 28th, 1927) by the omission of the word "normally" from his translation of M. Dauvillier's statement in *Comptes Rendus*?

I am open to correction—indeed, I hope that I am wrong—but, in so far as I have been able to follow the progress of Mr. Baird's experiments in the technical Press, it would seem that the transmission of *normally* illuminated subjects has yet to be achieved.

M. J. C. DENNIS.

Baltinglass, October 7th, 1927.

#### EMPIRE BROADCASTING.

Sir,—In your Editorial of September 14th you write: "Under 'Correspondence' in this issue we publish a letter from a reader in Cape Town. This letter is, perhaps, somewhat bitter in its attack on our lack of enterprise. . . ."

May I say the reader in Cape Town does not stand alone in any of his sentiments, for they find an echo in the hearts of many Britishers overseas. It is quite patent that we have been let down by the Old Country, and badly at that.

I recently built an eight-valve short-wave super-het. for the entertainment of the personnel of this station. Reception from PCJJ (including relay of 5XX), 2XAF, 2XAD (as early as 8.30 p.m. local on L.S.), 2XG, and others is absolutely first-class. The Dempsey-Tunney fight from 2XAF was followed by thirty people, blow for blow, on the loud-speaker.

Eindhoven has undoubtedly stolen the B.B.C.'s powder, and, as some one put it, the B.B.C. has been caught out, and is trying to explain it all to the umpire.

Can you wonder why we are bitter?

DUM SPIRO, SPERO.

Helwan, Egypt, September 28th, 1927.

Sir,—Amidst all this controversy concerning the B.B.C. and short waves, it is as well to bear in mind that they, under the *role* of the British Broadcasting Company, associated themselves with short-wave transmission nearly four years ago. This was conducted from the Old Vic Theatre on a wavelength of 60 metres, and was used as a radio link to 2LO. I believe this same method has been used for other O.B. work as well.

At the time of the inauguration of the radio link only a few of us could boast of short-wave receivers, so really we are in the dark as far as the B.B.C.'s capabilities of short-wave broadcasting is concerned.

G. F. KITCHEN.

Epsom, October 9th, 1927.

#### TRANSMISSIONS FROM RADIO MALABAR, JAVA.

Sir,—With reference to ANH, Radio Malabar, Java, I picked up that station at 14.00 G.M.T., October 8th, 1927, on 17 metres, and I heard it announced in English, French, and Dutch that Radio Malabar was now broadcasting on a wave of 270 metres and relaying on 17 metres, and that reports would be welcome of both wavelengths, also that transmission would be made as usual. The strength was R4 on 0-v-1. I think that ANH closed down on 17 metres while a 270-metre transmitter was being rigged up, which, if correct, would explain why Mr. Somerset did not get ANH.

J. W. HAMILTON.

Sandhurst, October 10th, 1927.

#### THE B.B.C. REGIONAL SCHEME.

Sir,—There is one point to which no attention appears to have been given and which seems to require careful consideration and an early decision.

You have repeatedly drawn attention to the difficulty of designing satisfactory sets for the reception of both Daventry and the 250-500-metre band, particularly where selectivity is required. This difficulty is a serious matter for the amateur, and even more serious when commercial sets are concerned. I think there can be no doubt that immediate progress in

the design and efficiency of commercial sets would result from the abolition of 5XX.

So far as can be foreseen the *raison d'être* for the establishment of Daventry will have disappeared when the regional scheme is complete, because each station will have a greater range than the present low-wave stations. There is little doubt that Capt. Eckersley will be reluctant to abandon the 1600-metre wave, but I venture to suggest that under the new scheme it will be entirely out of place and unnecessary. If a wide-range station is necessary, then I suggest better results would prob-

ably be obtainable on a relatively short wave well under 200 metres. It seems to me the point ought to receive immediate consideration and be the subject of an early announcement.

May I take this opportunity of complimenting the B.B.C. on the soundness of the ideas underlying the alternative programmes as evidenced by 5GB. The "late news" an hour later and no talks will enable us to obtain entertainment at times when we were formerly denied it, and this is one very considerable advantage of the new scheme.

Prenton, September 12th, 1927.

D. R. WHITE.

#### Southend Society Begins Session.

Mr. H. Dent, of the Editorial Staff of *The Wireless World*, was the lecturer at the first winter meeting of the Southend and District Radio Society. Mr. Dent took as his subject "Improvement of Reception" and provided much valuable information. The causes of various faults arising in receivers were dealt with, the recommended cure being given in each case, while circuits embracing the results of the latest researches and experiments were dealt with in detail.

A most attractive list of lectures has been arranged for the ensuing session.

Hon. Secretary, Mr. F. J. Waller, Eastwood House, Rochford, Essex.

o o o o

#### "The Tickler."

The above is the title of a breezy little monthly magazine which is the official organ of the Stretford and District Radio Society. The first issue promises a bright future. Mr. A. Nixon is to act as technical adviser and will supply technical contributions, while "5YD" will contribute monthly problem articles. The most interesting lecture of the month will also be reported in the paper.

Hon. Secretary, Mr. W. Hardingham, 6a, Derbysire Lane, Stretford.

o o o o

#### The Year's Best Lecture.

The President's Cup for the best lecture given by a member of the Tottenham Wireless Society during the last season was awarded to Mr. R. F. G. Holness, at the 5th Annual General Meeting of the Society held on October 5th, when Prof. A. M. Low occupied the chair. The Committee's report, briefly reviewing the work of the past year, showed that the Society had been active in many directions, special success having been attained in the direction of field days, social outings, and visits to places of wireless interest. The Treasurer's report showed that the Society was in a highly satisfactory position both as regards membership and finance. The Technical Officer's report made reference to the work of his Committee in constructing a first-class transmitter.

Hon. Secretary, Mr. A. G. Tucker, 42, Drayton Road, Tottenham, N.17.

o o o o

#### Taking Out a Patent.

The subject of patents was dealt with in a lecture by Prof. A. M. Low at the meeting of the Tottenham Wireless Society on Oct 5. After reviewing the patent law in the chief foreign countries subscribing to the convention, Prof. Low dealt in detail with the rules governing

## NEWS FROM THE CLUBS.

the issue of a patent in this country. He pointed out that a patent was not a Government guarantee of originality, but it enabled one to fight for one's rights in the Courts. The three essential necessities were novelty, utility and subject matter.

o o o o

#### Listening to 2LO at Lisbon.

An illustration of the efficacy of broadcast S.O.S. messages was provided by Capt. L. F. Plugge in his lecture describing a European tour with a radio-equipped car before the Wembley Wireless Society on October 7. Capt. Plugge's party were at supper on the outskirts of Lisbon when 2LO was tuned in. An S.O.S. was broadcast requesting Miss Woodhall, a member of the party, to return immediately to England to her father's bedside.

Nearly 200 persons were present at this, the first winter meeting of the Wembley Wireless Society, and it is regarded as a good send-off for the new session.

o o o o

#### Overcoming Difficulties in Swansea.

The Swansea Radio Society, which has been passing through "lean years," has decided to continue activities despite certain recommendations that the Society should close down. At the annual meeting held on Oct. 3, it was decided to reduce the subscription to 5/-. It was the feeling of the meeting that a happy and successful session could still be looked forward to, given the support of the members and the wireless public of Swansea.

Hon. Secretary, Mr. E. H. White, 100, Bryn Rd., Swansea.

o o o o

#### Manchester Society Resumes Meetings.

A practical demonstration on various topics took place at the opening meeting of the winter session of the Radio Experimental Society of Manchester. The discussion was opened by the Hon. Secretary who illustrated a practical circuit, explaining how to overcome the various "snags" in operating oscillating crystal circuits. Mr. A. K. Bentley, of the Manchester Technical College, then expounded the "arc theory" of the oscillating crystal. Mr. R. M. Kay, who has recently returned from Canada, spoke on "Recent American Ideas and Discoveries," while Messrs. Hulme and

Walmsley gave their experience with H.T. eliminators.

The Society will take an active part in the Manchester Wireless Exhibition at the end of the month.

Hon. Secretary, Mr. J. Levy, 19, Lansdowne Rd., West Didsbury, Manchester.

o o o o

#### Hackney Society's Annual Dinner.

The fifth annual dinner of the Hackney and District Radio Society was held on Thursday, Oct. 6, at the Talbot Restaurant, London Wall, E.C., the occasion being made a "Ladies Night." The toast of the King having been loyally given, the silver Cunningham Challenge Cup, given by the Chairman, was presented to Mr. W. Samson, Vice-Chairman, for the best performance of a wireless set at the annual outing held in July.

Hon. Secretary, Mr. G. E. Sandy, 48, Melrose Ave., Wimbleton Park, S.W.19.

o o o o

#### Wireless at Croydon Aerodrome.

The members of the Golders Green and Hendon Radio Society recently paid a visit to Croydon Air Port. Most efficient arrangements had been made by the Air Ministry to increase the interest of the visit and the fullest advantage was taken of the facilities offered. After the party had witnessed the arrival and departure of various air liners, a visit was paid to the wireless station. The staff were most hospitable and spared no effort to explain every detail. It was noted that much of the apparatus seemed somewhat antiquated for the highly important work undertaken, but it is understood that this fault will be remedied when the station shortly undergoes removal.

The party was shown how a pilot was brought to his station solely by the aid of the wireless direction finder. A notable feature was the apparent ease with which communication was maintained with the various air liners on route.

Hon. Secretary, Lt.-Col. H. A. Scarlett, D.S.O., 357a, Finchley Rd., N.W.3.

o o o o

#### Wireless at Hastings.

The Hastings, St. Leonards and District Radio Society took a prominent part at the recent Hastings Science Exhibition, being responsible for the wireless section. An interesting lecture on television by Mr. J. L. Baird drew a large attendance. Among the most interesting exhibits in the section were Prof. Vinnycombe's Wave Motion Model, B.T.H. Oscillating Valve Model and a 45 metre transmitter.

Hon. Secretary, Mr. N. G. Nye, 9, Stockleigh Rd., St. Leonards-on-Sea.

READERS' PROBLEMS ANSWERED

Queries should be concisely worded, written on one side of the paper, and headed "Information Department." Only one question (which should deal with a specific

point) can be answered. A stamped addressed envelope must be enclosed for reply. Letters which do not comply strictly with these rules cannot receive attention or acknowledgement

"The Wireless World" Information Department Conducts a Free Service of Replies to Readers' Queries.

Correct Condenser Values.

I am building a "Reinartz" receiver from spare parts which I have by me. I find that I have one 0.0005 mfd. variable condenser, and one 0.0003 mfd. instrument. Which should I use for tuning the grid coil? R. G. A.  
We should advise that you use the 0.0005 mfd. variable condenser for tuning the grid coil, and the 0.0003 mfd. condenser for the purpose of reaction.

Multiply by Four.

I possess a milliammeter reading 0.5 milliamps., but I find that this is not suitable for testing the anode current of super-power valves. Can you please suggest an easy and inexpensive method of modifying this instrument so that it will read about 20 milliamps. full-scale deflection? M. T.

Provided your meter is one of well-known make and working on the moving-coil principle, it will not be at all difficult to increase the range of the instrument, at the same time maintaining the accuracy of the readings. You are recommended to make up a resistance shunt which can be connected across the terminals of the instrument, and the value so chosen that the scale reading is reduced by one-quarter. Alternatively, a variable rheostat could be employed, and this would overcome the necessity for making up a fixed resistance. The meter, a variable resistance of high order, and a two-volt cell should be connected in series with the resistance adjusted until the meter reads 4 milliamps. A rheostat should now be connected across the meter terminals and adjusted until the meter indicates a current of 1 milliamp. The rheostat should be disconnected and the reading checked to ascertain that no variation has taken place during the foregoing. If the reading is now found to be as formerly, namely, 4 milliamps., the rheostat should be again connected in circuit, and, if no change has taken place, should reduce the meter reading to 1 milliamp.

The full-scale deflection of the meter will now be 20 milliamps., or four times its original reading. When readings are taken with the shunt in position it will be necessary to multiply the indicated reading by four to obtain the correct current.

A Supersonic Difficulty.

I have added a stage of H.F. amplification before the first detector valve of my supersonic heterodyne receiver, but cannot stabilise this circuit by the usual neutrodyne method. The H.F. transformer is the "All-Wave Four" type, and functioned quite satisfactorily in a "straight" circuit. The H.F. stage is completely screened in a copper box of ample dimensions and the screen connected to earth in the usual manner. Can you suggest an explanation for this and indicate how I can overcome my difficulties?

F. H. B.

There are a number of causes which may account for the inability to stabilise the H.F. circuit, and we will consider these separately and suggest a possible cure. In the first case one or more of the pins on the case of the transformer may not be making contact with their respective sockets on the base mounting, or they may be dirty and resulting in a high-resistance contact. The pins should be examined, cleaned, and if of the "split" variety splayed open to ensure good elec-

trical contact. Should this not lead to a cure, attention must be turned to another possibility. In a similar case previously encountered the cause for this effect was traced to the presence of high-frequency oscillations in the L.F. amplifier, and the receiver was rendered stable by the insertion of H.F. chokes in the anode circuit of the second detector valve. In view of the complicated nature of the H.F. component in the I.F. amplifier, a more complete system of filtering than that usually adopted was found necessary, and the circuit employed is given in Fig. 1. It will be seen that two chokes are connected in series, and by-pass condensers, each having a capacity of 0.0001 mfd., connected between the points shown. If this does not completely overcome the difficulty, the capacity of these condensers should be increased, but it is not recommended to go beyond 0.0002 mfd. in each case, otherwise quality may suffer.

In superheterodyne circuits it is recommended that the intermediate amplifier should be screened, and although it is not essential that the valves be included in the screened compartments, the stability of the receiver is greatly improved if the I.F. transformers or reactances are screened.

Advantages of a Separate Reactor Valve.

I propose to add a separate reactor valve to my existing detector and two L.F. receiver, as I have been told that I should be able to obtain much better results. Can you explain to me exactly what improvement this addition will effect? I should specially like to know whether quality would be in any way improved.

L. B. A.

The advantage of a separate reactor valve is that the detector valve no longer has to perform the dual office of regenerating and rectifying, as in the case of the ordinary arrangement of regenerative receiver, the reactor valve taking on the function of providing regeneration. Since this valve is to be used solely for reaction purposes, it may be operated upon the straight portion of its characteristic instead of on the bottom end of its grid-volts anode-current curve, as for instance when anode bend rectification is used.

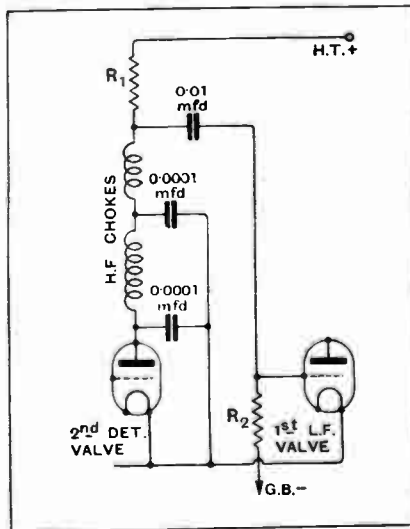

Fig. 1.—Filter circuit for keeping H.F. out of the L.F. amplifier in a superheterodyne receiver.

The advantage of being able to use the valve adjusted to this portion of its characteristic is that smoother reaction control is obtained, and therefore, of course, the getting of distant stations by delicate adjustment of reaction is considerably easier. However, if too great a degree of reaction is used, quality reproduction will be marred no less than if a separate reactor valve were not used.

o o o o

#### A New Use for Bright Emitters.

I have constructed the trickle charger described in "The Wireless World" of August 3rd last, but having two R5V bright emitter valves not being used I wish to employ these in place of the special rectifying valve recommended. Do you think that these will pass sufficient milliamps. for the purpose?

L. H. S.

The two valves mentioned by you could be employed as rectifiers in the battery charger, and we suggest that you connect the filaments in parallel and use the 8-volt tapping on the bell-ringing transformer. It will be necessary to include a resistance of 2.5 ohms in the filament

Wave Four" receiver was to enable an overlap between long- and short-wave transformers to be obtained. If you are prepared to forgo the capability of tuning in stations working on wavelengths between 550 metres and about 700 metres you could use your 0.0003 mfd. variable condensers without alteration to the numbers of turns recommended. A little difficulty may be experienced in tuning in Daventry and Radio Paris with the smaller capacities, but this could be overcome by the addition of about 20 turns to the secondary of the long-wave transformer. To increase the tuning range of the transformers beyond about 550 metres with a 0.0003 mfd. condenser, it will be necessary to add turns to the secondary windings, and this will result in the lowest wavelength tunable being proportionately lengthened. We think it would be advisable to forgo the advantages of an overlap and use your condensers without any alteration in the number of secondary turns on the short-wave transformer. There are very few worth-while stations working between 550 metres and 700 metres receivable in this country without being accompanied by severe Morse

far the most economical and satisfactory process would be to invest 12s. 6d. in the purchase of a proper half-wave rectifying valve.

o o o o

#### The Range of the "Regional."

Having in the past experienced trouble from L.F. oscillation (both actual and incipient) in two-stage low-frequency amplifiers, I am attracted by the "Regional Receiver," described in your issues of August 17th and 24th. I note, however, that the author of the article in question suggests a loud-speaker range of 60 miles on signals from the new high-power stations. If this is to be taken as a maximum, I am afraid the set is unsuitable for me, as reception of 5GB is essential. As you will see from my address, I am situated in North London, at a distance from Daventry which is greater than 60 miles. My aerial is slightly better than the average, and my results as far as range is concerned have always been considered as good; do you consider that the receiver in question could be guaranteed to be sufficiently sensitive?

A. P.

Without an intimate knowledge of local receiving conditions it is impossible to make definite statements regarding the range to be expected from any receiver. It may be stated, however, that range is always estimated conservatively in articles appearing in this journal, and even if your conditions were no better than the average we should have little hesitation in saying that 5GB ought to be well received on the loud-speaker in London.

o o o o

#### Using a Frame Aerial with the "Everyman Four."

I am constructing the frame aerial for long and short wavelengths described in your July 27th issue, and propose to use it in conjunction with the "Everyman Four" by substituting it in place of the secondary of the aerial-grid transformer. I shall, of course, take all precautions by suitable positioning of the frame to prevent magnetic interaction between it and the intervalve transformer. Will my proposals be quite in order?

J. R.

There is no reason why you should not use a frame aerial in conjunction with the "Everyman Four" receiver as you suggest, but although the frame aerial is designed for long and short wavelengths, you must not suppose that you will be able to receive long-wave stations on the "Everyman Four" by using it. The H.F. intervalve transformer in the "Everyman Four" is designed solely for the 200- to 600-metre wavelength band, and of course for long-wave reception of Daventry the H.F. stage in the "Everyman Four" is not used, and the receiver is a plain detector and two L.F. set without either reaction or an H.F. stage. The frame aerial, therefore, will be perfectly suitable for the normal broadcasting band, but will be of no avail on the long wavelengths.

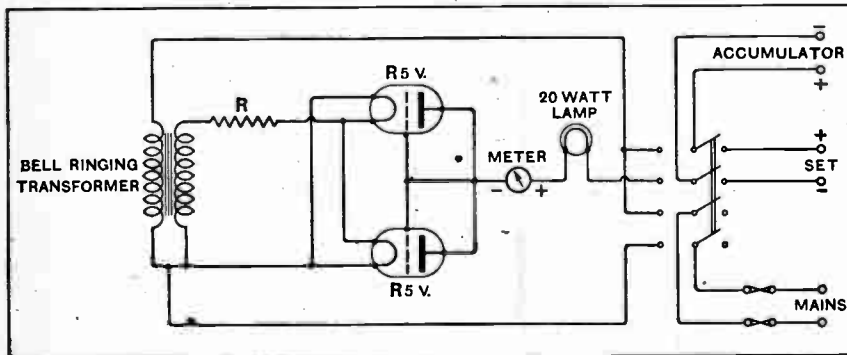

Fig. 2.—Modified trickle charger circuit for use with bright-emitter receiving valves.

circuit to reduce the voltage to 5.5. This is shown in the circuit diagram, Fig. 2, at R, and can be made by winding 7 feet of No. 22 S.W.G. Eureka wire on a suitable former. The grids and anodes of the two valves must be connected together in the manner shown, and thence via the meter to the lamp, which should not exceed a 20-watt rating. Apart from the slight modification to the filament circuit, the general arrangement will not require alteration, and should be carried out in accordance with the instructions given in *The Wireless World* of August 3rd last.

o o o o

#### An "All-Wave Four" Tuning Problem.

I propose building the "All-Wave Four" receiver, and among the components I have available are three 0.0003 mfd. variable condensers with slow-motion dials. I do not desire to incur unnecessary expense, and should like to employ these in the set. Can you tell me what alteration in the winding of the H.F. transformer secondary will be necessary?

D. H. R.

The main reason why 0.005 mfd. variable condensers were used in the "All-

interference from ships and ship stations, and we do not think the loss of this waveband need be regretted.

o o o o

#### False Economy.

I am constructing the H.T. trickle charger described in your August 3rd issue. I notice that by using two ordinary power valves in parallel it is possible to easily obtain a charging current of 20 milliamperes. Since I have several spare valves of this type, I should like to know whether I could use them and thus save the expense of purchasing a proper rectifying valve.

F. R. L.

Although, as you state, the charging current could be obtained from two parallel valves of the low-impedance type, with their grids and anodes joined together, it must be remembered that the life of the valves under these conditions would be far less than when used normally in a receiver, and as each valve is more expensive than a good half-wave rectifying valve, we think that it would really be false economy for you to carry out your proposal. In the long run, by

**Never Forget!**



*The Way to Ensure  
Better Reception,  
Greater Volume &  
Purer Tone*

is by using

# HART BATTERIES

**FOR ALL WIRELESS CIRCUITS**

There are sizes and types suitable for every kind of Valve Receiver.

Write Dept. W.W. to-day for price list and FREE illustrated Booklet of interest to all wireless users.

HART ACCUMULATOR CO. LTD., STRATFORD, LONDON, E.15.  
BIRMINGHAM: 165 Edmund Street. BRISTOL: 37 Victoria Street.  
CARDIFF: 50 Charles Street. GLASGOW: 107 Wellington Street. MANCHESTER: 88 Chapel Street. WESTMINSTER: 36 Victoria Street, S.W.1. YORK: 6 Bridge Street.

## TEST IT WITH CRESCENT



**CRESCENT MOVING COIL METERS**

A new line marketed by us to give satisfaction first and foremost.

Volt Meters are guaranteed to have a resistance of 200 ohms per Volt and a consumption of only 4 to 5 Milliamps on full scale deflection.

Precise within 1%.  
Milliamp Meters Sh. 17/6 ea.  
Single-Reading Volt Meters ..... 17/6 ea.  
Double-Reading Volt Meters, reading 6 and 120 Volts ..... 20/-

If unobtainable from your dealer apply to

**LOUIS HOLZMAN,**  
109, KINGSWAY, LONDON, W.C.2

Telephone: HOLBORN 6209.

See us at the Manchester Chronicle Radio Exhibition,  
Oct. 24 - Nov. 5, Stand 67.

# Perfect in every way

-in design,  
clarity,  
sensitiveness  
& comfort.  
They cost only

# 15/-

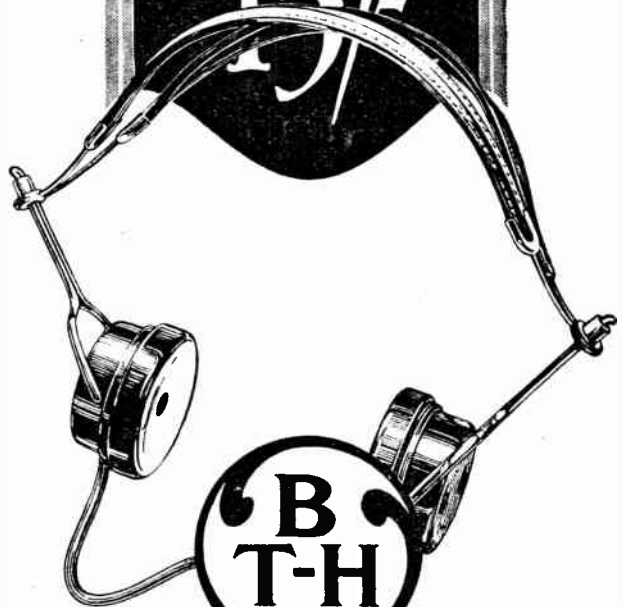

## HEADPHONES

The above price is applicable in Gt. Britain and Northern Ireland only.

The British Thomson-Houston Co., Ltd.

2849

**HIGH CLASS PATENT  
CONE LOUD SPEAKERS**

at Popular Prices

These Loud Speakers are fitted with a patent cone giving perfect reproduction and efficiency.

**Oak Cabinet Model £3. 0. 0**

**The Junior Model**  
(Suitable for portable sets)  
**£2. 10. 0**

Why pay more? when the W.B. Valve Holder, complete with terminals, is used in all modern sets, including the "Cossor Melody Three" and the "Wireless World Exhibition Five."

Stocked by all high-class Radio Dealers. If unable to obtain quick supplies please write direct.

Manufactured and guaranteed by:

**WHITELEY, BONEHAM & CO., LTD.,**  
NOTTINGHAM ROAD,  
MANSFIELD, NOTTS.



The all-Bakerlite Cabinet Model Cone Loud Speaker  
**£4. 4. 0**



The W.B. anti-phonous Low Loss Valve Holder  
**1/9 each**

**EVERYMAN FOUR COILS.**  
There is no need to wait days for the correct coils for this popular and highly efficient receiver.

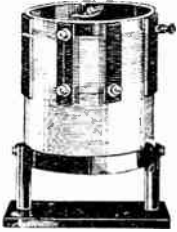

"FINSTON" Coils are wound exactly to designers specification, with 27/42 wire and are supplied complete with Ebonite Supports and Base.

**AERIAL COILS 14/- TRANSFORMER 16/-**  
**Complete Set 28/-.**

If your Dealer is sold out tell him we guarantee to supply by return of post.  
We supply Coils and Transformers for all "Wireless World" sets.  
Full details will be sent free on request.

Obtainable from all Dealers or  
**FINSTON MFG. CO., LTD.,** 45, HORSEFERRY ROAD, LONDON, S.W.1.

**REFUSE IMITATIONS**



New Standard Sizes in three finishes. The Guaranteed panels made by Ebonite experts at low prices.

Make sure of having the prize-winning original Former by buying only Formers bearing Trade Mark "Becol."



**RADIO BECOL PANELS**  
Genuine **EBONITE** MAKE

The BRITISH EBONITE Co., Ltd., HANWELL, LONDON, W.7

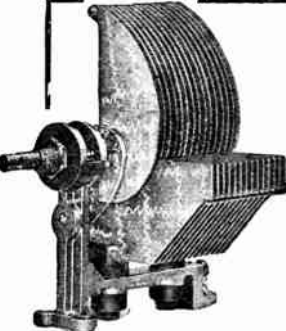

**FORMO**  
LOG (or Mid-line) CONDENSER  
The most scientific Condenser ever produced.  
Perfect in every detail of construction and performance.  
For mounting either Panel or Baseboard.

**THE FORMO COMPANY,**  
Crown Works, Cricklewood Lane, N.W.2.  
Telephone: Hampstead 1787.

'00035. '00025. '0005  
Price 10/6 each. Full Catalogue Free on Request.

The right place for the **Watmel** H.F. CHOKE



PRICE **5/-**

The special method of cross-winding the double silk covered wire in four accurately balanced sections reveals the superiority of the Watmel and the extreme scientific care taken in its manufacture. Low self-capacity—constant impedance and small external field are features which no other H.F. Choke can as truly claim as the Watmel. Windings protected by transparent cover. Mounted in bakelite base with nickel-plated terminals. The right place for the Watmel H.F. Choke is in every circuit where radio frequency chokes are specified. Write for particulars stating requirements for coil drive Loud Speakers.

**WATMEL WIRELESS CO. LTD.**  
Imperial Works, High Street, Edgware, Middlesex.

**CUT THIS OUT FOR CABINETS**



and post to us for new FREE list illustrating Cabinets as shown in "Wireless World," etc., etc.

NAME .....

ADDRESS .....

(Write in block letters please.)

**CARRINGTON Mfg. Co., Ltd.,**  
CAMCO WORKS, Sanderstead Road,  
South Croydon.  
Telephone : Croydon 0823 (2 lines).



**Trelleborgs**  
GUARANTEED  
**GENUINE EBONITE**  
THE FINEST QUALITY PANEL OBTAINABLE.  
**ONLY 1/2d.** Retail Price per square inch.  
STANDARD GLOSSY FINISH 3/16" THICKNESS.  
Other prices:—3/8" Highly Polished, 3d. per sq. in.; 1/2" Standard Glossy, 4d. per sq. in.; 3/4" Highly Polished, 1d. per sq. in.

Mention of "The Wireless World," when writing to advertisers, will ensure prompt attention

# MISCELLANEOUS ADVERTISEMENTS.

**NOTICES.**

**THE CHARGE FOR ADVERTISEMENTS** in these columns is:

12 words or less, 1/- and 1d. for every additional word, e.g., 18 words, 1/6; 24 words, 2/-.

Name and address must be counted.

**SERIES DISCOUNTS** are allowed to Trade Advertisers as follows on orders for consecutive insertions, provided a contract is placed in advance, and in the absence of fresh instructions the entire "copy" is repeated from the previous issue: 13 consecutive insertions, 5%; 28 consecutive, 10%; 52 consecutive, 15%.

**ADVERTISEMENTS** for these columns are accepted up to **FIRST POST ON THURSDAY MORNING** (previous to date of issue) at the Head Offices of "The Wireless World," Dorset House, Tudor Street, London, E.C.4, or on **WEDNESDAY MORNING** at the Branch Offices, 19, Hertford Street, Coventry; Guildhall Buildings, Navigation Street, Birmingham; 199, Deansgate, Manchester.

Advertisements that arrive too late for a particular issue will automatically be inserted in the following issue unless accompanied by instructions to the contrary. All advertisements in this section must be strictly prepaid.

Postal Orders and Cheques sent in payment for advertisements should be made payable to **ILLIFFE & SONS Ltd., and crossed & Co. Treasury Notes**, being untraceable if lost in transit, should not be sent as remittances.

All letters relating to advertisements should quote the number which is printed at the end of each advertisement, and the date of the issue in which it appeared.

The proprietors are not responsible for clerical or printers' errors, although every care is taken to avoid mistakes.

**NUMBERED ADDRESSES.**

For the convenience of advertisers, letters may be addressed to numbers at "The Wireless World" Office. When this is desired, the sum of 6d. to defray the cost of registration and to cover postage on replies must be added to the advertisement charge, which must include the words Box 000, c/o "The Wireless World." Only the number will appear in the advertisement. All replies should be addressed No. 000, c/o "The Wireless World," Dorset House, Tudor Street, London, E.C.4. Readers who reply to Box No. advertisements are warned against sending remittance through the post except in registered envelopes; in all such cases the use of the Deposit System is recommended, and the envelope should be clearly marked "Deposit Department."

**DEPOSIT SYSTEM.**

Readers who hesitate to send money to unknown persons may deal in perfect safety by availing themselves of our Deposit System. If the money be deposited with "The Wireless World," both parties are advised of its receipt.

The time allowed for decision is three days, during which time, if the buyer decides not to retain the goods, they must be returned to the sender. If a sale is effected we remit the amount to the seller, but, if not, we return the amount to the depositor. Carriage is paid by the buyer, but in the event of no sale, and subject to there being no different arrangement between buyer and seller, each pays carriage one way. The seller takes the risk of loss or damage in transit, for which we take no responsibility. For all transactions up to £10, a deposit fee of 1/- is charged; for transactions over £10 and under £50, the fee is 2/6; over £50, 5/-. All deposit matters are dealt with at Dorset House, Tudor Street, London, E.C.4, and cheques and money orders should be made payable to Illiffe & Sons Limited.

**THE SALE OF HOME-CONSTRUCTED UNLICENSED APPARATUS.**

**A New Service to our Readers.**

We have made an arrangement with the Patentees whereby readers who wish to dispose of a home-constructed receiver not licensed under the patents made use of, can license the set by means of the Deposit System referred to above.

The person desiring to sell, in sending us particulars for his advertisement, will in every case make use of a Box No., and should add to the price which he requires the amount of royalty customarily paid by manufacturers, viz., in the case of Marconi Patents the amount should be calculated at 12/6 per valve holder.

If the purchaser is satisfied with his purchase, the sum realised will be forwarded to the seller, less the amount due in respect of royalties, which amount will be paid by "The Wireless World" to the owners of the patents concerned, and a certificate will be handed on to the purchaser of the set.

**SPECIAL NOTE.**

Readers who reply to advertisements and receive no answer to their enquiries are requested to regard the silence as an indication that the goods advertised have already been disposed of. Advertisers often receive so many enquiries that it is quite impossible to reply to each one by post.

## WONDERFUL WIRELESS OFFER

**THE Graves Two-Valve Loud Speaker Wireless Set offered to you on Easy Payment Terms will compare for VALUE and EFFICIENCY with any £10 Wireless Set offered by any other firm in the World.**

It is no use trying to accurately illustrate or even describe the Graves Set in a small advertisement, but a post card will bring you a fully illustrated descriptive catalogue which gives you exact and truthful details.

**BRIEF SPECIFICATION:** The Cabinet is of polished Oak and all components of highest quality. Mullard Dull Emitter Valves with patent Valve holders &c.; H.T. Battery, 2-Volt Accumulator and complete Aerial Outfit. Loud Speaker of exclusive design to match the Cabinet, with unique magnetic system and improved diaphragm. **£7:17:6**

**TERMS.**—Our Bargain Price is for Easy Terms. Send 10/6 now, & complete purchase in 14 monthly payments of 10/6. Five per cent discount for cash. Fulllest approval in your own home.

Write for Free Catalogue.

Unchallengeable values in up-to-date Wireless Sets.

**J. G. GRAVES Ltd. SHEFFIELD.**



## WEARITE COMPONENTS

**NEW EVERYMAN FOUR**

COILS and BASES 35/- per set.

EVERYMAN FOUR and EVERYMAN THREE

COILS & BASES 37/6 per pr.

H.F. CHOKE . . . 6/6

**REGIONAL RECEIVER**

B.B.C. COILS with bases 18/9 each

5XX COILS " " 22/6 each

Genuine Paxolin Formers 3x3 1/2 each

**MELODY MAKER-4 COIL 8/6**

on GENUINE PAXOLIN.

LOOK FOR TRADE MARK

Send 'or illustrated lists.

**WRIGHT & WEARE LTD.,**

740, HIGH ROAD, TOTTENHAM, N.17.

PHONE: Tottenham 3132.

## RECEIVERS FOR SALE.

**ALL-WAVE** Four and the Famous Everyman Four; high-class sets only, giving maximum efficiency; full particulars and prices on application.—H. Goodwin, Woodcock Hill, Elstree. [0050]

**MARCONI** Offer 12/6 a Valve if You Exchange your Set. We offer to double the allowance in part exchange for any new set.—Chas. Rodwell, Ltd., London Bridge, S.E., or branches at Waterloo Station, S.E.; 785a, Commercial Rd., E.14; 56, The Mail, Ealing, W.5; 31, Walbrook, E.C.4. [0087]

**PAY** Later, buy now: Wireless sets, components, loud-speakers, etc., for deferred payments. Write or call for terms.—Ellis Nicholls & Co., 132, Caledon Rd., East Ham, London, E. [5914]

**7-VALVE** Super Heterodyne, complete with 7 valves, batteries, and loud-speaker; £25. Bracey, T, Graham Rd., Mitcham, Surrey. [5931]

**NO. 81** Marconiphone Straight Eight Receiver, complete with accessories and long and short wave coils, instrument just returned by makers, having been thoroughly overhauled and case repolished; price £45, or would exchange for No. 51 Marconiphone receiver complete with D.C. equipment and extras.—Box 3942, c/o The Wireless World. [5997]

**5 V. B.T.H. R.C.** Receiver, new, wavetrap, 5 series parallel switches fitted to panel, Mag. cabinet, 20 stations L.S. two miles 2L0; £9; letters only.—51, Earl's Court Sq., S.W.5. [6020]

**SILVER** Marshall 7-Valve All-wave Super Heterodyne, in polished walnut case, superbly expert built, licensed, complete with couplers 50 to 2,500 metres, highest grade American and English components, with frame aerial; £25.—Redway, Point, Exmouth. [6015]

**4-VALVE** B.S.A. Receiver, complete with 4 valves, only used two or three times; £16, original cost over £30.—P. Powell, 54, High St., Tunbridge Wells. [6021]

**5-VALVE** Cosmos Receiver in Mahogany Floor Pedestal Cabinet, purchased less than a month ago, complete with five 2-volt valves, absolutely brand new; first offer over £17 secures.—P. Powell, 54, High St., Tunbridge Wells. [6022]

**PUBLISHED** Sets Built to Specification, I tested, and guaranteed, at cost of parts only.—Write requirements for particulars to Box 3993, c/o The Wireless World. [6034]

**SETS,** components, accessories—choose what you want and pay as you use; the New Times way makes radio purchases easy. Write for catalogue and particulars of easy payment plan to Desk W. New Times Sales Co., 77, City Road, London, E.C.1. [0080]

**GENUINE** Bargains!—3-valve set, finest G components; in mahogany cabinet 26in. x 8in., complete with valves, accumulator, and pair Gecophone headphones; as new, £5/10; also two-valve Marconiphone power amplifier, two L.S.5 valves and 6 v. 40 amp. hour (actual) accumulator, brand new, unsoiled; cost £14, sacrifice, £6/10 or offer.—Box 4007, c/o The Wireless World. [6037]

**4-VALVE** Receiver, H.F., Det., 2L.F. screened coils.—Box 4009, c/o The Wireless World. [6038]

## Receivers for Sale.—Contd.

**5-VALVE** Freed-Eisemann Neutrodyne, complete kit of parts with instructions ready for assembly; very selective, brand new; cost £14, accept £7/15; a bargain.—Tofield, 99, Trafalgar Rd., Moseley, Birmingham. [6019]

**SHIPS' Wireless Equipment for Disposal.**—Marconi Co.'s 31 crystal receivers, 300-2,000 metres, good condition, price £1, carriage forward; Marconi 3-valve receivers, 30/-, postage and packing, 1/3; Marconi 1-valve receivers, £1, postage and packing, 1/3; Marconi L.F. transformers, 7/6, postage, 6d.; Marconi galvanometers, 4/6, postage, 6d.; Marconi buzzers, 3/6, postage, 6d.; useful parcels of sundry Marconi material, 10/-, postage and packing, 1/3; two only Marconi tuning panels with variable reaction and billi-condenser, 12/6; a bargain, postage 1/-; three only Marconi variometer panels, 5/- each, postage and packing, 1/-; Fuller Sparta 19/6 headphones, 4,000 ohms, brand new and fully guaranteed, 6/6 per pair, postage, 6d., cash with order.—J. B. Humphreys & Co., Marine Wireless Telegraph Engineers, Bombay St., Bermondsey, London, S.E.16. Telephone: Hop 3404. [6039]

**GRANIC** Neutrosomic Seven Portable Receiver de Luxe, complete with separate frame aerial, loud-speaker and battery box; all as new; cost over £55, take £30.—33, Beechcroft Avenue, Golders Green, N.W.11. [6040]

**SUPERHETERODYNE**, by Lumiere, of Paris, 8 valves, aluminium panel in walnut cabinet, extremely compact, high and low wavelengths; cost £40, accept £17/10, including 8 matched valves; demonstrations at evening after 7 o'clock by appointment. 'Phone: Royal 3654.—Benham, 19, Bernard Gardens, Wimbledon.

**EPOCH Electrical Society.**—Before you buy your new set visit our Demonstration Room and hear the latest and most popular makes of sets side by side; largest number of sets in London to select from; prices from 5/9 to £100.

**EPOCH Electrical Society.**—Every set bought from Epoch carries a guarantee of full satisfaction, with service after purchase. Sets delivered anywhere in G.B. Free installation within 25 miles.

**EPOCH Electrical Society.**—Bring your old set in part payment for a new set.

**EPOCH Electrical Society.**—Installments may be arranged on all sets of £10 upwards.

**EPOCH Electrical Society.**—Let us build your sets to any published or special circuit; large selection of cabinets; lowest charges.

**EPOCH Electrical Society, Ltd.,** 53, Gracechurch St., E.C.3. Call, write or 'phone Royal 8570, twenty yards from Monument Station. [6064]

**4-VALVE Set (A.J.S.),** handsome mahogany cabinet, table grand model, new condition, complete with full size (A.J.S.) oak loud-speaker, high- and low-tension accumulators (Exide), dull emitter valves, set of coils; cost over £30, accept £18/18; appointment by letter, London, S.E. district.—Apply Box 4010, c/o The Wireless World. [6065]

**THE Londberg Three,** finest 3-valver made; See previous advert.—Write for particulars to Browne, 65, Sinclair Rd., W.14. [6069]



**Run for the bus...  
it's all right...**

**BENJAMIN**

Portable Set . . . jolting damage the valves? . . . not likely! . . . Benjamin Anti-Microphonic Valveholders fitted . . . Soak up all the jolts and bumps . . . carry the set about like an attache case—run for the bus—Valves O.K.

Fit Benjamin Anti-Microphonic Valveholder to your portable set. No other valveholder will screen your valves from shock and vibration so well. **The Secret is in the one-piece springs.**

These 5 necessary vital features are only found in Benjamin Valveholders:—  
1. Valve sockets and springs are made in one piece with no joints or rivets to work loose and cause faulty connections.  
2. Valves are free to float in every direction.  
3. Valves can be inserted and removed easily and safely.  
4. Valve legs cannot possibly foul the base-board.  
5. Both terminals and soldering tags are provided.

**BENJAMIN**

CLEARER-TONE ANTI-MICROPHONIC VALVEHOLDER.

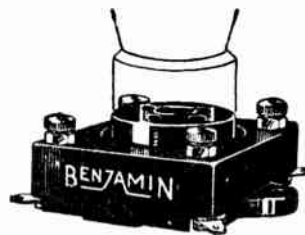

**PRICE 2/-**

**Benjamin Battery Switch**  
A sturdy positive action switch for high or low tension. It's OFF when it's IN, thus preventing the accidental turning on of current. Single contact. One-hole fixing.

**THE BENJAMIN ELECTRIC LTD.**

Brantwood Works,  
Tariff Road,  
Tottenham, N.17.

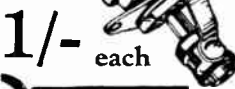

**1/- each**

**BATTERIES.**

**ACCUMULATORS**, all sizes in stock, from 3/9; send for complete list.—Bright and Hayles, 78, Church St., Camberwell, London, S.E.5. [0079]

**WET H.T. Batteries.**—Jars, 2½ x 1½ x 1½, 1/3 doz.; zincs, 1/- doz.; sacs, 1/6 doz.; dozen cells complete (18 volts), 3/6; post 9d. extra. High efficiency, long life, upkeep practically nil. Orders for 3 dozen or over post free, packed in special carton with divisions for each cell, usable as container for complete battery. Send 6d. for sample complete unit with instructions. Write for free lists of wireless bargains.—W. Taylor, 57, Studley Rd., Stockwell, London. [0039]

**"A.B." Dry H.T. Batteries Cost Less Than** Many other makes. The fact that they are manufactured by Messrs. Thomson Houston et Cie., of Paris, is proof of their high quality. Further, every battery carries a full and generous guarantee. Usual sizes stocked; 60 volt, 100 volt, and grid bias, etc. Ask your dealer for same. If he cannot supply you write us direct. Trade enquiries specially invited.—G. E. Ambatiello & Co., Ltd., Ambatiello House, Farrington Road, E.C.1. Telephone: Clerkenwell 7440. [0063]

**WET (sac Leclanche) H.T. Batteries**, latest booklet on how to make and maintain these economical and simple batteries; give perfectly silent and smooth reception with unlimited power; suitable for small or multi-valve sets of all sizes; information also of L.T. batteries free; enclose postage, 1½d.—Taylor, 57, Studley Rd., Stockwell, London. [0077]

**WHY Buy Wireless Accumulators?** London's Leading Hire Service improves reception. Saving time, trouble, and money. No big outlay. No deposit. Pay carman on each delivery. Low tension service from 1/3 per week. Fully charged and delivered free within 12 miles of Charing Cross. Explanatory folder post free.—Radio Service, 105, Torrion Av., N.W.5. 'Phone: North 0623/4/5. [5587]

**B.B.C. H.T. Batteries.** See advertisement. page 22.—British Battery Co., Ltd., Clarendon Rd., Watford, Herts. [0048]

**EXPERIMENTERS** Must Have Reliance in their Accumulators; test with a Utility syringe hydrometer for certainty; post free, 4/6, with full instructions; satisfaction guaranteed.—The Utility Syringe Hydrometer Co., Dept. D, 16, Howard Rd., Ilford, Essex. [0060]

**5** 20-volt Exide H.T. Accumulators for Sale, good condition; £2 or nearest offer.—Dickson, 37, Victoria Buildings, Manchester. [6036]

**CABINETS.**

**ARTCRAFT** Radio Cabinets and Panels for all "Wireless World" sets.

**ARTCRAFT** Cabinets made in Oak and mahogany, properly french polished, and are priced at 6/- to £11/11.

**ARTCRAFT** Cabinets made to any specification or design. Estimates by return.

**ARTCRAFT** Illustrated Catalogue Free.—The Artcraft Co., 156, Cherry Orchard Rd., Croydon. 'Phone: Croydon 1981. [0040]

**FIRM** Able to Take Contracts for Wireless Cabinet Work; quotations on receipt of particulars or quantities.—196, Lewisham Rd. Lee Green 1206. [5719]

**BEAUTIFUL** Carved Cabinet; cost £2, accept 15/6; particulars.—Santler, Bosbury, Howsell, Malvern. [6010]

Mention of "The Wireless World," when writing to advertisers, will ensure prompt attention.



**Cabinets.—Contd.**

**D**IGBY'S Cabinets.—Table models in solid oak and mahogany from 11/6 to 71/-.

**D**IGBY'S Cabinets, fitted with Radion or Resiston ebonite if required.

**D**IGBY'S Cabinets.—Pedestal model, with separate battery compartment, from 56/- to £12.

**D**IGBY'S Cabinets Made to Customers' own designs.

**D**IGBY'S Cabinets.—Write for new 16-page art catalogue.—F. Digby, 9, Banbury Rd., South Hackney, London, E.9. 'Phone: Clissold 5458. [5979]

**A**MERICAN Type Cabinets, with hinged top and baseboard; in hand polished oak, 12in. x 8in., 10/6, post free; any size supplied.—Phoenix Wood Engraving Co., 28, Market St., Manchester. [5870]

**M**AKE Your Own Cabinet.

**E**VERYMAN Four Cabinet, 26 x 8, packed flat ready for assembling, 18/6, in oak or mahogany.

**R**EADY for Assembling Means all Joints, mouldings, etc., hand finished and sanded smooth as glass by competent cabinet makers.

**J**UST a Touch of Glue and you have constructed a cabinet guaranteed to equal the work of a master craftsman.

**S**END a p.c. at once for full particulars, stating requirements.

**T**HE R.F.A. CABINET CO., 37, Brigstock Rd., Thornton Heath, Surrey. [5804]

**A**GAR for High-class Cabinets to customers' requirements from selected seasoned timber by competent craftsmen; maker of cabinets for P.M. series and other high class sets.—W. H. Agar, 19, Whitecross Pl., E.C.2. London Wall: 3305. [6061]

**M**ASSIVE Oak Pedestal Cabinets, Jacobean finish (as illustrated in *The Wireless World* in May 4th issue), new, improved and very substantial model now ready, stands 3ft. high, 2ft. 9in. wide, 15in. deep, for panel up to 26in. x 8in. These cabinets are built to one standard size and will house almost all the best known and latest sets and circuits, including Everyman Four and Five, B.B.C. 3 and 4 valve sets. Simple adjustable fittings permit any length of panel up to 26in. to be fitted. £5 carriage paid, or free delivery by our own van London and suburbs. May be inspected on van before acceptance. Illustrated folder gives all details. Write to-day.—G. E. Ambatiello and Co., Ltd., Ambatiello House, Farringdon Rd., E.C.1. 'Phone: Clerkenwell 7440. Telegrams: Ambatiello, London. [0056]

**LOUD-SPEAKERS.**

**M**IRROVOX Loud-speaker, oval pleated polished aluminium diaphragm, mahogany mounted, looks like a mirror; perfectly wonderful reproduction, equal to any speaker double the price; try one on 7 days' approval; satisfaction or money refunded; £2/10 post free.—A. Brixey, Coldharbour Lane, Hayes, Middlesex. [5579]

**R**EPAIRS.—All loud-speakers repaired and maximum efficiency attained, 4/- post free; every repair is accompanied with a three months' guarantee; don't discard if burnt out; trade invited.—Transform, 115, Links Rd., Tooting, London, S.W.17. [0084]

**G**OODMANS Can Give Prompt Delivery of Moving Coil Units. The lowest prices consistent with highest possible grade workmanship; list MC3 on request.—Goodmans, 7, Farringdon St., E.C.4. [0080]



**Ask for them by NAME  
—and don't be misled.**

"Utility" designs are correct, materials good, finish perfect!—moreover should any defect develop under reasonable treatment, we will remedy it at once under the "Utility" Guarantee. Incorporate these components in your own set and note the all-round immediate improvement.

**Your local DEALER can supply.**



**"Utility" MICRO-DIAL**  
A new model, improved by the addition of an easy-read aluminium dial and hair-line cursor. Adjustments can be read in a clockwise or anticlockwise direction. (This is a special model not intended to displace our popular plain dial.)  
**Price 7/6 each**



**"Utility" LOGARITHMIC CONDENSERS**  
Light thimble insulators with walls only 1/16 in. thick have minimised the solid dielectric. Vernier pattern fitted with our Micro-Dial (ratio 70-1). Capacities .0002 to .0005 at prices from 7/6 up.



**"Utility" NEUTRODYNE CONDENSER**  
Mounts above or below the baseboard of the set. Rigidly made, ball bearing spindle, and sufficient tension to prevent accidental misadjustment. Detachable key-handle.  
**Price 5/-**



These no-capacity switches have been made extremely compact. Rubbing-action, self-cleaning contacts. Six sizes supplied, 1, 2, 3, 4, 5 or 6 change-over. Prices: Lever patt. from 3/6 each. Knob patt. from 8/-. [5579]



Write for Lists—  
**WILKINS & WRIGHT Ltd.,**  
*Utility Works, Kenyon Street,*  
**BIRMINGHAM.**

**Loud-speakers.—Contd.**

**R**EED Movements.—Double Acting Reed movements specially designed to operate cone and other large diaphragms; extremely sensitive on small input, yet capable of enormous volume with sufficient input. Will work up to a 3ft. cone with ease. No rattle or distortion; 27/6 each. Fair allowance on Brown A earpieces, or Lissenolas and other units in part exchange. Send stamp for illustrated Lists of these and Seamless Cones.—Goodmans, 27, Farringdon St., E.C.4 [0066]

**D**ID You See the Moving Coil Loud-speaker built with Webson parts, manufactured by Star Engineering, on Stand No. 103 at Olympia Exhibition?

**I**F So, you would appreciate the high class workmanship and finish, which is the standard for all Webson parts manufactured by Star Engineering.

**W**HEN You Order Webson Parts you obtain goods made by engineers and recommended by the principal wireless journals. See *Wireless World*, Sept. 28; "Amateur Wireless," Sept. 24 and Oct. 1.

**F**OR Highest Efficiency build your moving coil loud-speaker with Webson parts, manufactured only by Star Engineering, Didsbury, Manchester.

**Y**OUR Name and Address in block letters will ensure you free lists per return post.—Star Engineering, Didsbury, Manchester. 'Phone: Didsbury 1785. [5878]

**B**IRMINGHAM and Midlands.—To retailers, gramophone demonstrators, and all open to improve their reception, before committing yourselves to the slightest extent on any speaker, come and hear the most efficient coil drive instrument yet devised.—Marlow, 1, Church St., Lozells, Birmingham.

**H**OME Constructors, see next week's advertisement for most complete kit parts suitable home construction yet offered.—Marlow, above. [5961]

**W**OOD Horns.—Illustrated list of new models ready. There's one for every speaker base and gramophone attachments.—Maddison, Manufacturer of the Allwoodorn, 2a, Ronalds Rd., N.5.

**P**ICK-UP.—No need to buy a gramophone! Get a motor and tone arm from H. Maddison, manufacturer of gramophones and the famous wood horn for loud-speakers.—The Allwoodorn, 2a, Ronalds Rd., N.5. [5845]

**V**AUGHTON.—Guaranteed parts for coil drive loud-speakers described in *The Wireless World*, Sept. 28th.

**V**AUGHTON.—Accurately machined magnet pot casting, 17/6; frame, 17/6; moving coil, 7/6.

**V**AUGHTON.—Brass bobbins exact to specification, 5/6; plywood rings, 2/-; ebonised ditto, 2/6.

**V**AUGHTON.—Wire (D.C.C.) for above: 14 S.W.G., 2/-; 16 S.W.G., 2/2; 18 S.W.G., 2/5; 20 S.W.G., 2/10; 22 S.W.G., 3/4; 24 S.W.G., 4/-; 26 S.W.G., 4/10; 28 S.W.G., 5/6; 30 S.W.G., 7/3; 34 S.S.C., 10/2; 38 S.S.C., 17/6 per lb.

**V**AUGHTON, 88, Vyse St., Birmingham. Tel.: Mivvise, Birmingham. [5994]

**F**REED-EISMANN Latest Cone Loud-speaker, 15in. diameter, 18in. high, new condition; cost £5/15, accept 75/-.—Tofield, 99, Trafalgar Rd., Moseley, Birmingham. [6018]

**I**F You are in London Call and See Goodmans' Coil Drive and Reed Units before purchasing elsewhere.—Goodmans, 27, Farringdon St., E.C.4. [0090]

**Loud-speakers.—Contd.**

**M**OVING Coil Loud-speaker Parts.—I have been asked by everyone, including a representative of the "W.W." (who has heard my results) how it is obtained without impetuous valves, stages of push, pull, and output transformer, and additional amplifier. etc. The result is that of many years experience with magnetic flux and 4 years with this type of speaker. The pot is of a grade of steel which I have used for the past 35 years with, of course, the required gauge and quantity of wire to suit the voltage and on a suitable high resistance coil of 2,000 turns 47G. wire (having designed and built a machine for winding same) mounted on a well-thought-out diaphragm (patents pending). When ordering coil give outside and inside dimensions and depth of gap.—Chas. Andrews, Hunton House, Hunton Hill, Erdington ('Phone: 203) Birmingham. [5995]

**U**NITS for Cone Speakers.—Highly efficient, patented, double acting reed movement, the result of years of experimenting. Very sensitive to small impulses, but capable of handling enormous power without overloading; special resonance damping device; high class workmanship and keenest value yet offered; complete with fixings for attaching cone. Fuller details, list of cones, complete speakers, etc., post free.—Everyman's Radio Service, Brent St., Hendon, N.W.4. 'Phone: Hendon 2378. [6026]

**C**OIL Drive Units from Stock, the usual high standard of workmanship associated with the name of Goodmans, 27, Farringdan St., E.C.4. [6009]

**B**ROWN Disc Silver, like new, works beautifully; cost £8/8, accept £6.—Bentham, 19, Bernard Gardens, Wimbledon, for appointments after 7 o'clock. 'Phone: Royal 3654. [6042]

**G**RAMOPHONE Pick-up and Plug Adaptor, wonderful value; no separate amplifier required; price £6.—Browne, 65, Sinclair Rd., W.14. [6067]

**B**AKER'S "Selhurst" Radio for Coil Drive Speaker Parts; immediate delivery of magnet units with field windings for use with accumulators or D.C. mains as required.

**B**AKER'S "Selhurst" Radio for 2 in. Moving Coils; lightest made.

**F**RAMES and Cradles specially constructed to enable unit to be assembled in a few minutes without tools; from Baker's "Selhurst" Radio; immediate delivery.

**I**MPORTANT.—All coil drive speaker parts supplied by us are constructed by highly skilled engineers of the best possible materials; as we do not depart from specifications given in *The Wireless World* you are assured of good results. We manufacture everything, from the pot castings to the finished article.

**W**E have received testimonials from all over the country and also from Belgium, Holland and Italy, expressing complete satisfaction with the parts, and surprise at the wonderful results obtained.

**W**E shall be glad to show you all our coil drive speaker parts at our works at Croydon at any time.—Baker's, "Selhurst" Radio, 89, Selhurst Rd., South Norwood, S.E.25. Works: 42, Cherry Orchard Rd., East Croydon. Telephone: Thornton Heath 1488. [6044]

**E**XCHANGES.—Any make of speaker or component taken in part exchange for new, and up to 60 per cent. of new prices allowed for old parts.—Write Talbots, 97, Highfield Rd., Blackpool. [6045]

**A Real Boon to the Amateur Constructor**

**PANEL PLATE TUNER UNIT 35/-**

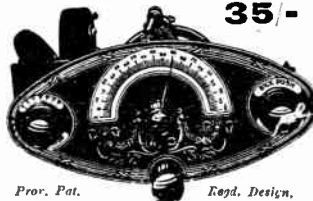

Prov. Pat. Regd. Design.

**More than half a set**  
No Ebonite Panel required. Can be fitted to any form of Cabinet. Complete wiring diagrams for building 2 or 3 valve Lou 1-Speaker sets. No coils to change. Daventry, 5GB and all local stations at good loud-speaker strength. Black and Gold or Black and Silver finish. Will give your set the true professional appearance.

**LAMPLUGH**  
*BRITAIN'S*  
**BEST RADIO**  
(LAMP-LOO)

S. A. LAMPLUGH LTD., King's Rd., Tyseley, BIRMINGHAM.  
Distributors for London and Southern Counties:—J. C. Shore & Co., 28, Newman Street, Oxford Street, W.1.  
**SEND FOR LISTS.**

**Loud-speakers.—Contd.**

**B**.T.H. Rice-Kellog, as new; cost £60; B owner going abroad; £36.—M., Witten Lodge, Stoke Green, Coventry. [5998]

**K**ONEDOPE Makes Home Constructed Diaphragms Air- and Damp-proof. Tins sufficient for 2 large cones, 1/8, post free.—Everyman's Radio Service, Brent St., N.W.4. [5851]

**B**ARGAIN, £4/10; Brown II.Q. model loud-speaker, brand new and unused; cost £6/6.—Thomas, 5, The Gables, Hampstead, N.W.3. [5999]

**L**OUND-SPEAKER Units, very substantial and well designed, post paid 10/-; money back if not satisfied.—Storrays', Ltd., Eastbank St., Southport. [6004]

**G**RAMOPHONE Motors, turntables, pick-ups, lowest prices.—Browne, 65, Sinclair Rd., W.14. [6068]

**T**HE New Goodman Junior Reed Movement, 14/6. The finest unit, at anywhere near the price, for driving cone and other large disc type speakers. This unit should not be confused with converted earpieces or gramophone attachments. Second only in efficiency and performance to our Double Acting Reed Movement. Full descriptions in our illustrated lists, free on request.—Goodmans, 27, Farringdan St., E.C.4. [6002]

**A**MPLIONS.—Large Dragon, oak flare, £5/5 model, £3; special Dragon pattern mahogany flare, beautiful instrument, as new, £4; swan-neck pattern, oak flare; all perfect, £3/10.—Box 3984, c/o *The Wireless World*. [6007]

**VALVES.**

**S**CREENED Grid Valves.

**T**HE A.P. 412 S.G. for non-neutralised H.F. amplification and super R.C. amplification, amplification factor 110, standard 4-pin base; write to-day for full data of all the A.P. 4 electrode valves.—Aneloy Products, 36, Hindmans Rd., E. Dulwich, London, S.E.22. [5589]

**D**O You Know That —

- (a) the greatest item in your running costs is your bill for H.T. supply?
- (b) Your power valve probably takes about 5/8ths of this? Thus resistance-capacity will not help you here, for you will still need a power valve.
- (c) An A.P. 4 electrode valve in place of your present power valve will work as well on less than half the H.T. voltage.
- (d) You will thus save 5/8ths, say 1/3, of your present H.T. costs, on the power valve alone.

**W**ORK it Out and See What it Comes to in Your Case!

(e) If your set is used at all you are probably spending from £3 to £6, at the least, and so you will save from 15/- to 30/- annually, i.e., the cost of one or two A.P. valves.

**A**.P. 4 Electrode Valves Can be Used in A Conjunction with Existing 3 Electrodes.

**T**HE A.P. Range Includes a Valve for Every Position and new Types for Super Amplification, super power, and screened grid work.

**W**RITE To-day for X-ray Photographs of the A.P. Range, together with other A.P. 4 electrode facts and data.

**A**NELOY PRODUCTS, 36, Hindmans Rd., East Dulwich, S.E.22. 'Phone: New Cross 4074. [5916]

**T**RIOTRON Dull Emitter Valves, 2 volt, 4/6, power 7/6; highly recommended; guaranteed and post paid.—Storrays', Ltd., Eastbank St., Southport. [6003]

**Polar Components are guaranteed**

**The Coil Unit**

Twelve coils of uniform size available, 3/- each. Wavelengths 170 to 4,720 metres. Fits valve socket. Unit carrier and two coils, 9/- Carriers, 3/-



Full List and wave length table on application.

**Neutralising Condenser**

Single hole fixing, push-pull and tuning motion, fitted with locknut, dust and damp proof. PRICE 4/- EACH.

Ask your dealer to show them.

**WINGROVE & ROGERS, Ltd.**  
Proprietors of the Broadcasting Business of the Radio Communication Co., Arundel Chambers, 188, Strand, LONDON, W.C.2.

Mention of "The Wireless World," when writing to advertisers, will ensure prompt attention.

**Valves.—Contd.**

**MARCONI**, 3 D.E.5s, 2 D.E.8H.F.s., a D.E.5B., and a D.E.5A.; Mullard, 2 P.M.2s, and 1 P.M.1 L.F.; all recent, full emission, £6 or nearest offer.—E. K. Atkins, Jr., Abbey Fields, Rochester, Stafford. [6011

5/—British valves: 2 volt .06 H.F. and L.F., 2 volt .1 H.F. and L.F., 2 volt .25 P.V., 4 volt .06 H.F. and L.F., 4 volt .1 H.F. and L.F., 4 volt 12 P.V., 6 volt .1 H.F. and L.F., 6 volt .25 P.V.; all one price, 5/- each, and all guaranteed; trade supplied; write your name and address clearly.—H. Howarth, British Valve Depot, 288, Deansgate, Manchester. [5987

**CHARGERS & ELIMINATORS.**

**ACCUMULATOR** Chargers (A.C.), 45/- complete. Post free. Also components for same and for A.C. battery eliminators; fully guaranteed.—Stafford O'Brien and Partners, Ltd., 66, Victoria St., S.W.1. [0052

**FOR** Sale, A.C. Rectaloy charger, as new £2 or nearest offer.—D. Mann, Weymouth College, Dorset. [5962

**PHILIPSON'S** Safety High Tension Eliminator for D.C. Mains, 200 to 250 volts, no hum or ripple, gives 7 voltages from 60 to 135 volts, maximum output 38 M.A.; fitted in well-finished oak cabinet, price £2/19/6, carriage paid.

**PHILIPSON'S** Safety High Tension Battery Eliminator for A.C. Mains, 200-250 volts, gives voltages from 20 to 120 volts at 20 M.A. discharge, and grid bias 5 voltages from 2 to 12 volts, maximum current output 50 M.A.; fitted in well-finished oak cabinet, £5/19/6, royalty 12/6; 12 months' guarantee given.

**PHILIPSON and Co., Ltd.**, Radio Engineers, Holland St. Works, Astley Bridge, Bolton. 'Phone: 2038 Bolton. Telegrams: "Safety," Bolton. [0081

**MAKE** Your Own High Tension Eliminators and Battery Chargers, using Croix super-power transformers and filter chokes, guaranteed for one year; wiring diagrams free; set of parts from 16/6; write today, stating A.C. or D.C. Mains.—The Wholesale Wireless Co., 103, Farringdon Rd., London, E.C.1. [0088

**A.C. Battery** Charger, complete with transformer, auto-cut-out, fuses, double contact vibrator, condenser, regulating resistance and ammeter; £2.

**POWER** Transformer, 220-240 volts to 8 volts 6 amperes, complete in Ironclad case; £2.

**POWER** Transformer, Ediswan, 200 volts to 50 volts 20 amperes, 1 k.w., complete in Ironclad case; £3/10.

**1/16** H.P. A.C. 200 Volt Single Phase Motor, fitted with Auto starting coils; £2/5.

**MAJOR SMITH**, 16, The Mall, Surbiton. [6000

**RADIELLE** M5 Straight Eight Model, output 140 volts, 25 m.a. for A.C. mains, 200 volts, 50 cycles; guaranteed; cost £6/17/6, accept £5.—Benham, 19, Bernard Gardens, Wimbledon; appointments after 7 o'clock. 'Phone: 3654 Royal. [6043

**CHARGER** for 20-200 Volt H.T. Accumulators from A.C. Mains, 200/20 volts 50 periods, complete; £2/10.—E. Edwards, 15, Achilles Rd., West Hampstead, London, N.W.6. [6024



**BRIGHT OR DULL—**  
*The* **PEERLESS**  
**DUAL RHEOSTAT**  
**AFFORDS**  
**PERFECT**  
**CONTROL!**

The Peerless Dual Rheostat is specially made to meet the demand for a Rheostat covering needs of both bright and dull emitter valves. Has two windings, a resistance of 6 ohms, with a continuation on to a 30 ohm strip winding. Resistance wire wound on hard fibre strip under great tension and immune from damage. One-hole fixing, terminals conveniently placed. Contact arm has smooth, silky action. All metal parts nickel-plated. Complete with ebonite knob and dial.

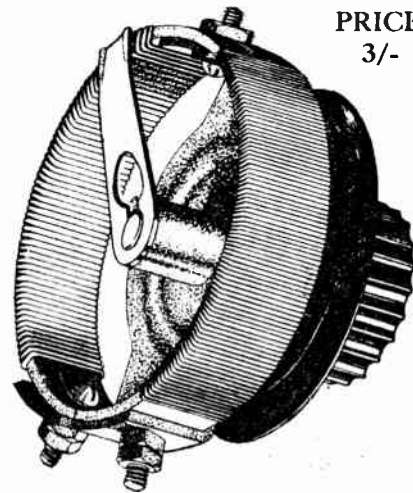

**PRICE**  
3/-

**THE BEDFORD ELECTRICAL & RADIO CO., LTD.,**  
22, Campbell Road, Bedford.

**Chargers & Eliminators.—Contd.**

**HOME** A.C. Charger, *Wireless World*, Oct. 5th; angle iron uprights, 1/3 per set; angle iron feet. 6d. per pair; wire, 26 D.S.C., per lb. 8/-; wire, 22 D.S.C., per 1/2 lb., 3/6; wire, 16 D.S.C., per 1/4 lb., 1/3; base-board mounting valve holders, 1/- each; wire, soldering tags, screws and nuts, Sankey laminations, etc., prices on application.—Vaughton, 88, Vyse St., Birmingham. Tel. Mivyse, Birmingham. [5993

**COMPONENTS, ETC., FOR SALE.**

**BELLING-LEE** Panel Fittings are designed to give an expert finish to any home-constructed set. Catalogue post free.—Belling and Lee, Ltd., Queensway Works, Ponders End, Mss. [0018

**AERIAL** Grid Coils and H.F. Transformers for Everyman Four, with chart showing over 40 stations (on L.S.), price 17/6 each; H.F. transformers for the All-Wave Four, high and low wavelengths, set of two and base 35/-; all coils of highest quality materials and finish.—H. Goodwin, Woodcock Hill, Elstree. [0051

**DECKOREM** Components are the finest you can include in any set you build. Write for free catalogue.—A. F. Bulgin & Co., 9-11, Cursitor St., London, E.C.4. [5881

**REED** Movements.—Double Acting Reed R movements specially designed to operate cone and other large diaphragms; extremely sensitive on small input, yet capable of enormous volume with sufficient input. Will work up to a 3ft. cone with ease. No rattle or distortion; 27/6 each. Fair allowance on Brown A earpieces, or Lissenolas and other units in part exchange. Send stamp for Illustrated Lists of these and Seamless Cones.—Goodmans, 27, Farringdon St., E.C.4. [0049

**ALL-WAVE** Coils (May 11th), pair with 6-pin base; 42/6.—Jennens, below.

**EVERYMAN** Coils, 3, 4, 5, on ebonite bases; 15/- each.—Jennens, below.

**TUBES**, 3in. x 3 1/2in., genuine Mikopac; 1 1/4; 2 2/6; 3 3/6.—Jennens, below.

**SPACERS**, grooved, with screws, 8 aerial S or anode, 1/-; All-wave 6 short, 1/-; 12 long, 2/6.—Jennens, below.

**LITZEN** Wire (Lewcos 27/42), to wind 70 turns; 4/8.—Jennens, below.

**WYCHE** Switch, 2-way, 1/3; both battery. 1/6.—Jennens, below.

**LEOWE** Multiple Valves, 3 L.F. and 2 H.F.; write for price and particulars; trade enquiries invited for all above.—Jennens Radio, 30, Chapel St., Birmingham. [0075

**LAKER** 30ft. Handsome Steel Mast, 22/6. See descriptive advertisement, page 24. Easily erected. [0021

**TANTALUM**.—Tantalum metal sheet for A.C. rectifiers.—Blackwell's Metallurgical Works, Liverpool. [5745

**BRITISH** and Best.—High tension accumulators, pure reception and constant voltage; Ediswan 4-5,000 m.a.h. capacity, 20 volt units, 16/8; Exide 2,500 m.a., 10 volt units, 5/-; Oldham 20 volt units, 12/6 each; carrier and lid Oldham, extremely neat, 4/6 each; all above 80 volts or more carriage paid U.K.—Radio Service Depot, 678, Washwood Heath Rd., Birmingham. [5447

**SHORT-WAVE** wavemeters, 18-70 metres, every instrument individually calibrated by hand; enables any required station to be found immediately. In upright mahogany cabinet, complete with full instructions, 30/-, cash or c.o.d.—Deepees, 22, Ganton St., Regent St., W.1. [5894

**Components, Etc., for Sale.—Contd.**

**A** J.S. Headphones, light, strong, adjustable; Headanos, perfectly clear and comfortable; full maker's guarantee (list price 15/-) on 7 days' approval; satisfaction or money refunded; 10/6 post free.—A. Brixey, Coldharbour Lane, Hayes, Middlesex. [5578]

**A** MATEUR'S Surplus Components; send for list.—Howarth, 59, Green Rd., Colne, Lancs. [5749]

**A** ERMONIC Valve Holders are the finest value in British made components; model H antimicrophonic, 1/6 each.

**G** RID Leak Holders for Vertical or Horizontal mounting; Bakelite mouldings with adjustable springs, fitted terminals, Aeronomic No. 1, 1/-.

**A** NGLE Bending Pliers, Aeronomic; one nip of the jaws bends wire to a right angle; indispensable for workmanlike wiring. Price 2/- each.

**G** RID Leak Clip for Mounting direct on the wires; Aeronomic No. 2, 4d.; if your dealer does not stock, write for free list to the manufacturers, James Christie & Sons, Ltd., West St., Sheffield. [0078]

**R** EPAIRS.—All transformers repaired and maximum efficiency attained, 4/- post free; every repair is accompanied with a three months' guarantee; don't discard if burnt out; trade invited.—Transform, 115, Links Rd., Tooting, London, S.W.17. [0083]

**R** EPAIRS.—All headphones repaired and maximum efficiency attained, 4/- post free; every repair is accompanied with a three months' guarantee; don't discard if burnt out; trade invited.—Transform, 115, Links Rd., Tooting, London, S.W.17. [0085]

**L** AKER 30ft. Handsome Steel Mast, 22 lb. See descriptive advertisement, page 24. Easily erected. [0022]

**B** ARGAIN.—Send for a parcel of new wireless parts; 4/6, post 6d.; value guaranteed; sent c.o.d. if desired.—Box 3784, c/o The Wireless World. [5832]

**S** CREEN Coils.—Split primary aerial, 250-550, 1,000-2,000, 5/6; split primary H.F., 250-550, 7/6; 1,000-2,000, 7/6; split secondary H.F., 250-550, 7/6; 1,000-2,000, 11/-; six-pin Bakelite base, 2/- each.—Below.

**E** VERYMAN Four Coils, complete with base: aerial, 15/-; transformers, 15/-; 28/- set.—Below.

**H** YDRA Fixed Condensers, tested 500 volts: .25 M.F., 2/-; .5 M.F., 2/3; 1 M.F., 2/6; 2 M.F., 3/6 each; other capacities in stock.—Below.

**V**ARIABLE Condensers.—S.L.F. .0003, .0005, 7/6 each; L.M.L. .0005, .00035, .00025, 10/6.—Below.

**S** UPER Filament Resistances, 7, 15, 30 ohms, panel or baseboard types; 2/6 each.—Below.

**V**ALVE Holders, Antimicrophonic; 1/6 each.—Below.

**H**.F. Chokes and Anode Resistances, 60,000, 80,000, 10,000 ohms; 5/- each.—Below.

**L** ITZ Wire, 27-42, 20 yds., 5/-; 50 yds., 12/-; 9-40, 150 yds., 9/6; other lengths pro rata.—Below.

**P**AXOLIN Tubes, 3in. x 2½in., 1/6 each; ebonite spacers and screws complete, 2d. each.—Obtainable all dealers or Stone Mfg. Co., 108-9, Great Saffron Hill, London, E.C.1. [0068]

**D**ECKOREM Components are the finest you can include in any set you build. Write for free catalogue.—A. F. Bulgin & Co., 9-11, Cursitor St., London, E.C.4. [5882]

**H. T. BATTERIES**  
British and Better than slightly cheaper Foreign made goods.



You do get full value from H.T. Batteries. Reliability with ultimate economy too. This is our CABINET TYPE with full size cells, perfect insulation, highest efficiency. Best materials only used.

60 VOLTS Tapped 5, 10, 15, 30, 45, 60 .. .. 9/6  
100 VOLTS Tapped every 15 Volts .. .. 16/-  
(All Carriage Paid)

**There are many uses for these No. 1 W 4½ volt Batteries—Standard Pocket Lamp Size. Patent Spiral Wire Terminals and Wander Plug Sockets. Permanent connections without soldering. Illustration shows how to connect in series. Build up the voltage you need. 7/- Per doz. with plug. Carr. Paid.**

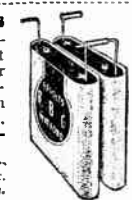

We supply all standard types and voltages. Write for Details. Made at our Watford Works.  
**BRITISH BATTERY CO., LTD.**  
Telephone—Watford 617.  
Clarendon Road, Watford, Herts.

**We would like you to hear the**

**TRIX**

**PORTABLE FOUR**

We will gladly send a demonstrator with the set to any address in the London area, without cost or obligation. The TRIX Portable Four represents the 18-guinea model with the 50-guinea tone. Send for full details to Eric J. Lever, Clerkenwell Green, London, E.C.1.  
Phone: Clerkenwell 3014/5.

**LORIOSTAT**  
as used in the  
"Wireless World Regional Receiver."

A multiple unit superseding the fixed Resistor. (Can be used in any circuit to control any number of valves. For downright efficiency use a LORIOSTAT in your set.)

1 way 2/- fixed Resistor. (Can be used in 4 way 7/3  
2 " 3/8 any circuit to control any number 5 " 8/-  
3 " 5/6 of valves. For downright efficiency 6 " 10/3  
use a LORIOSTAT in your set.)

6, 15 or 30 ohms.

**A. W. STAPLETON,**  
19a, Lorrimer Buildings, Lorrimer St., Waltham S.E.17

**Components, Etc., for Sale.—Contd.**

**E** VERYMAN Four Coils Exact to Specification, 22/6 pair post paid, 23/- c.o.d., approval against cash.—H. Freeman, 47, Tenbury Rd., King's Heath, Birmingham. [5952]

**C** ONSTRUCTORS.—Fit the Delophone aerial tuner and dispense with plug-in coils; special model made for baseboard mountings, 250-4,000 metres; price 22/6; send for descriptive leaflet.—E. & F. Deal, 283, Shirley Rd., Southampton. [5844]

**D** ISTANCE Control.—A few Siemen's 200 ohm line relays for sale; an infallible unit for remote control; mounted in teak case with connecting terminals, 17/6; unmounted for fixing in set, 12/6, post free.—W. H. Agar, 19, Whitecross Pl., E.C.2. [6060]

**P** ICK-UP, latest used by 2LO for perfect gramophone reproduction; demonstrations daily by W. J. Turberville-Crewe, M.Inst. R.E., £4/4.—J. Glasscoe & Co., 49, Eastcheap, E.C.3. [5945]

**E** VERYMAN Four and Three, "W.W." five coils, genuine specified materials; 11/- each coil with base; post free; many testimonials proving superior results.—B. Rushton, 50, Humber Rd., Wolverhampton. [5950]

**R** ELIABILITY WIRELESS GUIDE.—New edition, No. 99A, just issued. Free upon request.

**R** ELIABILITY GOODS AND SERVICE.—Only obtainable from J. H. Taylor and Co., 15, Radio House, Macaulay St., Huddersfield. Trade supplied. Send for free Guide now. [0028]

**C** HAKOPHONE Tuning Unit with Reaction, 300-2,000 metres, complete with instructions, 8/-; Everyman Four coils (Chakophone), boxed with "Wireless World" Booklet, 31/-.

**T** UNEWELL Coils, 25, 35, 50, 75, 1/6 each, 100, 1/8; 150, 2/3; 175, 2/6; 200, 2/9; 250, 3/3; air spaced, robust, efficient. Special Lines.—Wanderplugs, 1/3 doz.; terminals, with nut washer and indicating label, 2 B.A. pillar, 4 B.A. W.O., 2 and 4 B.A. phone, 2/- doz.; plated, 2/6 (state markings); coil holders, 2-way B.bd. 2/6, geared 2/9; switches, push pull, 11d.; S.P.D.T. on ebonite or porcelain, 9d.; D.P.D.T. on porcelain, 1/6; red and black flex, 1/6 doz. yds.; R.C. cable, 2 mm. 1/-, 4 mm. 1/9, 5 mm. 2/3 doz. yds.; insulated staples, 1/9 100.

**P** OSTAGE up to 5s., 6d.; over 5s., free; Send us your enquiries.—Radio Supplies Co., 37, Bedford St., Leamington Spa, Official Traders and Repairers to Radio Society of G.B. and Wireless League. [5685]

**S** TORRY BARGAINS.—Amplion Siftron loud-speaker filters, protects loud-speaker windings, improves tone; usual price 33/-, offered at 12/6; Cleartron variable condensers, 4/11; post paid and guaranteed.—Storrays, Ltd., The Wireless Mart, Eastbank St., Southport. [6002]

**C** OILS Wound for any Special Circuit Exact to Specification: Everyman's Four, 25/-; Wireless World Five, 38/-; Everyman's Three 27/-; All-Wave Four, 35/6; screen and base 6-pin, 7/6; spacers, grooved, with screws, set of 8, 1/-; All-Wave long, 2/-; short, 1/-; tubes, 3in. x 3½in., 1/3; discount to trade; agents wanted in several districts.—Norton Bannerman & Co., Bradfield Works, Hawksley Ave., Sheffield. [5948]

Mention of "The Wireless World," when writing to advertisers, will ensure prompt attention.

**Components, Etc., for Sale.—Contd.**

**SIMMONDS BROS.**, Shireland Rd., Smethwick.

**COIL** Prices.—Everyman Four, 33/- pair; Everyman Three, 35/-; All-wave Four, 42/6; New Everyman Four, 33/-; "Wireless World" Five, 50/6 set of 3; Regional short-wave, 34/6 pair, long wave, 48/6 pair, bases, 6/- the two; Empire broadcast coil, mounted, 8/6; chokes, 7/6 pair; Quality Three coil, 16/6.

**SCREEN** Prices.—Everyman Four, 4/6; Everyman Three, 4/-; All-Wave Four, 5/-; New Everyman Four copper box, 17/6; Empire broadcast cabinet, £2.

**BERCLIF** Valve Holder is Essential for all high-frequency valves and short-wave work; approved by the experts, price 2/6. Dealers please send for sample c.o.d. Readers and the trade supplied with all above; component lists and test report on coils free from the original Everyman specialists.

**SIMMONDS BROS.**, Shireland Rd., Smethwick. [5954]

**ANY** Radio Component Supplied from Stock at list price; no extra charge for postage, advice given.—Storrys', Ltd., The Wireless Mart, Eastbank St., Southport. [6005]

**DECKOREM** Components are the finest you can include in any set you build. Write for free catalogue.—A. F. Bulgin & Co., 9-11, Cursitor St., London, E.C.4. [5883]

**BARGAIN** Offer.—Parcels of new wireless components, 2/6 and 5/- each, post free, value guaranteed.—Fairhaven, Victoria Avenue, Hunstanton. [6016]

**B. & J.**—Everyman coils, new and old type, 15/- each.

**B. & J.**—We still guarantee that all our Everyman coils are exact to specification in every detail.

**B. & J.**—Mottled aluminium screens, 4/- each; plain, 2/6.

**B. & J.**—Screened grid valve holder, in polished ebonite, 4/6, matt 3/6.

**B. & J.**—Short wave coils, set of five interchangeable coils with bases; maximum air spacing, 16 gauge wire, 15/- per set.

**B. & J. Wireless Co.**, 2 & 3, Athelstan Mews, London, N.4. [0043]

**DIAPHRAGM DRESSING**, which has stood the test of over two years and given universal satisfaction. See you get "Dilac." It is not the usual amyl acetate 7 celluloid medium: 1/3 and 1/9 per jar post free; bronze, gold, or silver stocked.—Goodmans, 27, Farringdon St., E.C.4. [0067]

**LAKER** 30ft. Handsome Steel Mast, 22/6. See descriptive advertisement, page 24. Easily erected. [0023]

**AMATEUR'S** Surplus.—30 plug-in coils, 30/-; set 7 H.F. transformers, lot 7/6; 4 McMichael ditto, lot 12/6; set 8 Igranic gimbal coils, 7/6; set 4 Burndept short-wave coils, 5/-; 2 Igranic unshrouded L.F. transformers, 10/-; pair Western ditto, 17/6; 2 Cosmos ditto, 5/-; Polar 3 coil-holder, 2/-; A.J.S. 2 coil-holder, 2/-; Polar R.C.C. unit, 4/6; Cosmos ditto, 5/-; Lissen I.F. choke, 4/6; 2 Ormond S.L. .00025, each 2/6; Sterling phones, 5/6; Amplion A.R.15, oak, 50/-; Amplion 3 guinea attachment, 17/6; Western phone transformer, 5/-; Sparta ditto, 3/6; Cosmos ditto, 2/6; 6 Dewar switches, lot 5/-; 6 Lissen switches, lot 4/-; all good condition.—Box 3936, c/o The Wireless World. [5980]

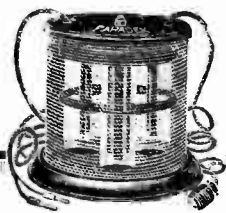

Patents Pending.

**LOW INITIAL COST RUNNING COST NO TROUBLE**

For charging H.T. Accumulators from A.C. Mains. This charger, the result of years of Scientific research, embodies a new form of electrode and electrolyte. Can be used on any voltage. No trouble, no fumes, no overheating, no waste or corrosion of electrode. Simple and safe. Model F.G.1. 30/- L.T. Trickle Charger, Model F.G.2. 45/-; packing and carriage 1/6 extra in both cases.

Full particulars on request.

**Faradex RECTIFIERS**

**ROOKE BROS. LTD.**, 55, Cardington Street, Euston, N.W.1.

**E E L E X.**

The Elex System of Standardised Plugs and Sockets is complete. No other system is so adaptable or comprehensive in its uses. Recommended and used by the "Wireless Magazine," "Popular Wireless," "Modern Wireless," "Amateur Wireless," etc., etc., etc.

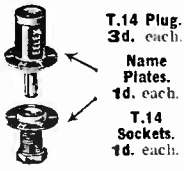

**T.14 Plug.** 3d. each.  
**Name Plates.** 1d. each.  
**T.14 Sockets.** 1d. each.



**Baseboard Coil Mount.** 1/3 each.



**E E L E X TREBLE DUTY TERMINAL.** Nickel Plated, 4/6 each. 36 Indicating Tops.

**MOISTURE RETAINING EARTH** A more effective area than an earth tube. 9" in diameter, with about 6 ft. copper lead and brass Terminals.

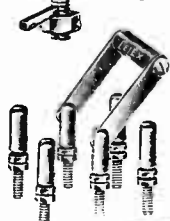

**MINIATURE SWITCH.** D.P. c/o, 1/6 each.



Complete free List W15, showing Wireless Accessories in full size, upon application.

**J. J. C. & SONS**, 118, Bunhill Row, E.C.1. Phone: Clerkenwell 9232-3.

**Components, Etc., for Sale.—Contd.**

**QUICK** Sale.—Bowler-Lowe Super Het. transformers and coupler, £2/10; R.I. 7 ratio transformers, 12/6 each; A.J.S. hexagonal frame, as new, £2; 2 Mullard D.E.3 2-volt valves, 5/- the pair; Transatlantic 5-valve transformer, coupled L.F., £7/10 (complete with valves).—BM/EXN9, W.C.1. [5990]

**ALWAYS** use Always Resistances in your sets.

**ALWAYS** Constant Patent Resistances are supplied in all values from 1,000 ohms to 30 megohms.

**ALWAYS** Resistances are guaranteed silent and constant under all tensions up to 200 volts.

**ALWAYS** Resistances have been awarded Certificate of Merit by Radio News, of New York.

**ALWAYS** Resistances are priced at 1/9 a retail.

**SEND** To-day and Try an Always in that new circuit.

**POST** Free from Abingdon Wireless Supplies, 20, Lombard St., Abingdon, Berks. [5991]

**EXPERIMENTER'S** Surplus.—R.I. aerial tuning inductance, 30/-; R.I. tuned anode, 17/6; Varley anode (80,000), 5/-; two Elite 60-volt accumulators, 17/6 each.—Nixon, 16, Padoga Avenue, Richmond, Surrey. [6001]

**DECKOREM** Components are the finest you can include in any set you build. Write for free catalogue.—A. F. Bulgin & Co., 9-11, Cursitor St., London, E.C.4. [5884]

**SPECIAL** Offer of Famous Burndept Goods. Now deleted from catalogue. Peter Pan loud-speakers, 2,000 ohms, bargain price 12/11; crystal detectors, originally 4/-, bargain price 2/6; hot wire ammeters, 0-1.5 amp., bargain price 8/11; .0002 condensers, bargain price 3/11; 3-way coil holders (geared), bargain price 5/11; 2-way ditto, bargain price 5/11; Dubilier grid leaks (1 meg. and 3 meg. only), bargain price 1/3; concert coils (set of 4), bargain price 5/6; rheostats, 1.4 ohms to control 3 valves, bargain price 1/11; vernier condensers, bargain price 1/11; valve holders, bargain price 6d.; fixed resistors, bargain price 9d.; dual anode condensers, .0002 low loss (coupled up, these get 5GB), bargain price 5/11; ditto, with vernier, bargain price 8/11; Ethodyne, originally £75; bargain price £35; wavemeter rejector, a carefully designed wave trap or filter, originally £4/5, bargain price 22/6; telephone transformers, bargain price 8/11 each; Ethophone V (4-valve set), originally £30, bargain price £12/12 (1 only to offer); loud-speaker wall brackets in oak or mahogany, bargain price 4/6. All the above Burndept goods are in original packages, and undamaged goods will be exchanged for any others, if purchaser wishes, within 7 days. We also offer Marconi 2-valve amplifiers, bargain price 52/11; Marconi 1-valve amplifiers, bargain price 32/11; T.M.C. headphones, originally 17/6, bargain price 10/11; T.M.C. amplifying panels, bargain price 14/11; T.M.C. detector panels, bargain price 12/11. Enquiries from traders invited for quantities. Obtainable only from Chas. H. Rodwell, Ltd., London Bridge S.E.1, and at the following branches: 31, Walbrook, E.C.4; 785A, Commercial Rd., E.14; 56, The Mall, Ealing, W.5; Waterloo Station (Main Entrance), Waterloo Rd., S.E. [0086]

**Components, Etc., for Sale.—Contd.**

**USE** the A.W.S. Permanent Detector for better crystal reception, the only crystal detector that is absolutely stable when used in conjunction with valve amplification. *The Wireless Trader* says: "Equal to a first-class Galena." A real permanent detector at last, no adjustment required; hundreds of dealers stock them, but if yours does not, send direct, and detector will be sent post free; price 3/- retail.—Abingdon Wireless Supplies, 20, Lombard St., Abingdon, Berks. [5992]

**TELETRON.**—The simplest remote control. A central receiver can be controlled from any distance and from any number of points. Teletrol can be applied to both direct and choke capacity outputs, and takes only 2 ma. to operate. Invaluable for use in private houses, country estates, institutions, etc., price 35/-.—Baily, Grundy & Barrett, Ltd., 2, St. Mary's Passage, Cambridge. [6028]

**LAKER** 30ft. Handsome Steel Mast, 22/6. See descriptive advertisement on this page. Easily erected. [0035]

**ARNEL MANUFACTURING Co., Arnel Works, Gun St., Ancoats, Manchester.** [6049]

**BURTON** 6-pin Bases with Screen, 5/- each; Lewcos split primary H.F. transformer, 5/6; Varley H.F. choke, 4/6; Bowyer-Lowe barrel type H.F. transformer, 2/6; lot 21/-; pair Brandes headphones, 7/6.—Advertiser, "Stanville," Cumnor Hill, Oxford. [6032]

**TRANSFORMERS.**—McMichael Daventry and 550, 5/- each; Eureka reflex L.F., 7/-; Cleartron condenser dial, 4/6; coils, 300 and 150, and 3 condenser dials, 3/6; all as new.—Heydon, Redruth. [6033]

**CYLDON** Dual Condensers, .0005, 3 split secondary Lewcos coils broadcast and 3 ditto higher wavelengths, three bases and screens.—Forwood, Limpfield, Surrey. [6009]

**EPOCH Electrical Society.**—All standard lines and best foreign components in stock; mail orders despatched same day.

**EPOCH Electrical Society.**—Constructors' requirements specially catered for; let us quote for your kit.

**EPOCH Electrical Society.**—If you experiment for enjoyment's sake, buy your parts from us. If you want a guaranteed set, let our experienced engineers build it for you.

**EPOCH Electrical Society.**—Parts for all wireless Press circuits at lowest prices.

**EPOCH Electrical Society.**—Repairs, re-wiring, modernising, etc., carried out by real experts. Consult our experts upon your problems. No charge or obligations whatever.

**EPOCH Electrical Society.**—A few Epoch bargains: .0005 S.L.F. condensers, 3/3; ebonite grid-leak clips, 4½d.; slow motion dials, 2/6, 3/-, 3/6; American grid leaks, 6d.; double-reading voltmeters, 4/3; hydrometers, 2/-; Jacobean oak pedestal cabinets, 35/-; push-pull switches, 7½d., etc.

**EPOCH Electrical Society, Ltd.,** 53, Gracechurch St., E.C.3. Call, write or 'phone Royal 8570, twenty yards from Monument Station. [6063]

**WAVEMETER, R.A.F.** buzzer, 300 to 4,000, good order; best offer over 25/-.—H. Batley, Corsham, Wilts. [6047]

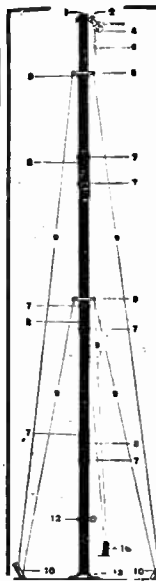

**LAKER STEEL MASTS**

are 100% efficient—

They are made by engineers and supplied to H.M. Government, the B.B.C., and to Colonial and foreign stations throughout the world.

There are 50,000 "Laker" masts in daily use.

By mass production we are able to offer a wonderfully efficient and handsome steel mast at the extraordinarily low price of

**30ft. 22/6**

Complete as Illustrated

Read 1/- extra for par carriage. We pay the rest.

Always bear in mind that an efficient aerial is the most important factor in good radio reception.

**J. & J. LAKER CO.,**  
Engineers,  
Beckenham, Kent

**THE DIX-ONEMETER**

is a precision instrument of universal use, with an ingenious system of Multipliers which enable full scale readings of any value to be made over a wide range. 1 Millivolt to 2,000 volts, 50 ohms to 50 megohms, Mirror Scale. Jewelled knife-edge. A £10 de Luxe Model for 55/-



**The Viola Loud Speaker** is constructed on cabinet lines, and gives wonderful reproduction over the complete tonal range. This loud speaker De Luxe is of beautifully polished mahogany. Price, complete with Reed producer and cord, 25/-

**Distant Control Switch Relay.** This is the most efficient method of Distant Control for all who use valve receivers. Simple to connect up and easy to operate, only two connections to L.T. Battery and two to control circuit. Can be used in all L.T. circuits of 2 to 8 volts up to 5 amps. Indoor type, which is enclosed in a fine polished oak case 15/-

Outdoor type in watertight brass case 17/6.

Our NEW 72-PAGE CATALOGUE is now ready! Over a 1,000 bargains are listed and hundreds illustrated. Send 4d. in stamps to

**ELECTRADIX RADIOS,**  
218, Upper Thames Street, London, E.C.4.



**MICROSTATS**

Sales approaching 1,000,000

SILENT. LONG LIVED.

SUITABLE FOR ALL VALVES.

The "STANDARD MODEL" without change of Resistor Element, will govern the Filament Temperature of any Valve perfectly. There is, therefore, no need to possess a multitude of Resistor Elements—one simple Component, the "MICROSTAT" suits all Valves, 1 to 80 ohms.

**STANDARD MODEL** for Panel Mounting 2/9 Post Free For Satisfaction fit "Microstats."

Send for Sample to Manufacturers:

**LIFFORD Eng. Co., Kings Norton, Birmingham**

**Components, Etc., for Sale.—Contd.**

**DECKOREM** Components are the finest you can include in any set you build. Write for free catalogue.—A. F. Bulgin & Co., 9-11, Cursitor St., London, E.C.4. [5885]

**MACHINE** Grooved Ebonite Coil Spacers, for Everyman Four Coils, etc., 2/6 per set of 16, post free.—Gordon's Wireless Depot, Findon St., Hillsborough, Sheffield. [6017]

**FULLER B.P.80** 2 volt 120 amp., 13/6; Amplion Radiolux, oak (£6/6), £4; Amplion Junior Dragon, 25/-; Hart accumulator, H.T., 120 volts, 27/6; Exide H.T. 140 volts, 8/6 per 20-volt crate; Everyman Four in 3-foot oak writing bureau with Weston milliampmeter and double-range voltmeter on panel, what offers? also quantity of spares.—27, Dawnay Rd., Earlsfield, S.W.18. [6070]

**SMALL** Power Transformers Made to Customers' own Requirements; cut prices, best materials.—Maddick, Rostrevor, Church St., Staines. [6071]

**MATEURS!** Block and Mansbridge Condensers, guaranteed 600 volts A.C. or D.C. 4 mfd., 4/11; 2 mfd., 2/11; and many other bargains in coil-driven cone loud-speakers, transformers; S.L.F. condensers; meters; and H.T. accumulators; all new. Send for list, post free.—Mr. T.M.L., City and Guilds College, S.W.7. [6050]

**MORE** Arnel Bargains.—Phones, 4,000 ohms, double earpiece, price 12/6, our price 6/-; double reading pocket voltmeters, 0-6 and 0-120 volts high resistance, dead beat, usual price 7/6, our price 5/8; H.T. batteries, 60 volts, reliable and guaranteed, usual price 6/0, our price 6/-; anti-microphonic valveholders with terminals, 1/3 each.—Below.

**SPECIAL** Arnel Offer.—Still a few T.M.C. loud-speakers left at 16/- and 40/- each; all goods new and perfect, and sent post paid for cash with order.

**MULLARD P.M.254**; 15/-; month old; Hart R.A.O. H.T. accumulator, 90 volts, 35/-.—Evans, 8, Shrublands Avenue, Berkhamsted, Herts. [6048]

**LAKER** 30ft. Handsome Steel Mast, 22/6. See descriptive advertisement on this page. Easily erected. [0036]

**PAIR** Brown's F Headphones, 15/-; Polar Junior 3-way vernier coil-holder, 5/-; both hardly used.—Walton, Cecil Avenue, Cathcart, Glasgow. [6046]

**AEROPLANE** Quality, submarine prices, power transformers, output 150-0-150 v. 50 m.a. and 5 v. L.T., 17/6; chokes, 5/6; kit of components for H.T. eliminator, full wave rectification, output 150 v. 50 m.a., 52/6; send p.c. for full lists.—Simpson, Jesmond Place, Leeds. [6012]

**DECKOREM** Components are the finest you can include in any set you build. Write for free catalogue.—A. F. Bulgin & Co., 9-11, Cursitor St., London, E.C.4. [5886]

**SPECIAL** Offer of Famous Burndept Goods, now deleted from catalogue. Transmitting leaks, our price 7/6; transmitting power unit (1 only), converts alternating current, input 200-220 volts 50 cycles, output 75 milliamps of rectified smooth D.C. at 500-1,000 or 1,500 volts; list price £75, our price £24/10; transmitting inductor (1 only), 100-130 metres; list price £35, our price £12/10.—Chas. H. Rodwell, Ltd., London Bridge, S.E.1. [0094]

Mention of "The Wireless World," when writing to advertisers, will ensure prompt attention.

MISCELLANEOUS.

**E**ASY Payments.—We supply, by easy payments, components, accessories and sets; any make; 10 per cent. down, balance spread over 10 months. Send list of requirements to London Radio Supply Co., 11, Oat Lane, London, E.C.2. [5591]

**T**HE Wireless Doctor Will Call (London and Home Counties) if your set is troublesome; no cure, no charge; Wireless Association registered repairer; sets installed, maintained, and brought up to date; experiments and testing undertaken; Solodyne demonstrated.—Alexander Black, 2A, Woodville Grove, N.16. Clissold 3687 and Victoria 6215. [3841]

**L**AKER 30ft. Handsome Steel Mast, 22/6. See descriptive advertisement, page 24. Easily erected. [0037]

**M**R. CLAUDE LYONS, M.I.R.E., will advise all constructors of supersonic-heterodyne receivers, without charge; if you have trouble with your present superhet, or contemplate building this most efficient form of receiver, write him, c/o Messrs. Claude Lyons, Ltd. (G.R. Quality Parts), 76, Oldhall St., Liverpool. [0065]

**W**IRELESS Doctor Touring Midlands and South Coast.—Ernest J. Baty, B.Sc., Luton. [5464]

**S**COTT SESSIONS, the radio doctor (London and environs); any set or component supplied, installed, repaired, modernised; "Wireless World" set specialist; officially approved as radio repairer and trader by the Radio Society of Great Britain and the Wireless League; no work too big or too difficult! Hill Top, Muswell Hill, N.10. Phone: Mountview 4928. [5671]

**L**AKER 30ft. Handsome Steel Mast, 22/6. See descriptive advertisement, page 24. Easily erected. [0046]

**E**LEX Standardised Plug Socket System will improve your set; lists free.—Ask any trader, or Easticks, 118, Bunhill Row, E.C.1. [0025]

**S**PRING Gramophone Motors with Turntable for Electrical Pick-ups; from 19/6.—Shaw, Skipton Rd., Trawden, Colne. [5996]

**M**ARCONI H.T. Generator, plus smoothing condenser, output 1,200 volts 12 milliamps., perfect condition; £6; offers.—Kaye, 48, Westover Rd., Bramley, Leeds. [6029]

**L**AKER 30ft. Handsome Steel Mast, 22/6. See descriptive advertisement, page 24. Easily erected. [0047]

**F**ULL Wave Rectifying Unit, 30 watts. mounted with rheostats; 2 new U.3 rectifiers, holders, etc. £2 5; 40 watt French Xtg. valve, new (6 v. 2 amp.), £1/15; Exide 24 v. acc., type W.H., as new, 15/-; 90 glass tubes, 3in. x 1in., flat bottom, 10/-; Westinghouse v.-meter, 9in. dial, 0-150 and 0-300 (wants extra res. for latter voltage), £1; 1/2 kw. step-down transformer, 240-100, by Foster, £2; Spark Xr., intact in case, £1.

**M**H., H.F. Transformer, 300-600, new: 4/6; M.H. dimics and bases, S.W.1 and 2, new, 5/- each; 4 Bretwood A.F. amplifiers, new, 5/- each; variable anode res. and American grid leak, 3/6 pair; spark coil, ex. Xr., 5/-; telephone hand magneto, 5/-; Bretwood variable S.L.F., .0005, new, 7/6; D.E.Q. valve, new, 10/-; D.E.V. valve, new, 10/-.—Box 3983, c/o The Wireless World. [6006]

The NEW "ZAMPA" CONE MOVEMENT  
A 3-foot Cone for HOME CONSTRUCTORS

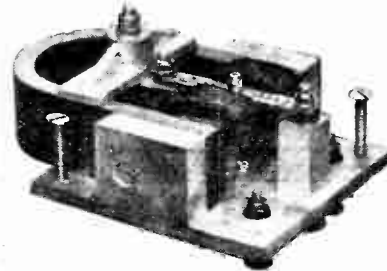

The new "Zampa" Cone Movement for Home Constructors gives a larger movement for the new 3-foot Cone than any on the present market—enables you to make a reliable 3-foot Cone Loud Speaker at home.

Movement and complete materials for making the 3-foot Cone... £3 : 10 : 0

"Zampa" Cone Movement only £2 : 5 : 0

No cheaper or easier way of building a Cone.

Stand 91, Manchester Exhibition.

Catalogue Free.

MIC WIRELESS CO., MARKET ST., WELLINGBORO.

C.D.M.

FIXED CONDENSERS

Manufactured under true scientific principles, are being incorporated in many sets requiring components of good British make.



Patent No. 275809.

Outer cases are of best Brown Bakelite, fitted with two convenient sized terminals and solder tags for making connections. Best Ruby Mica used for insulation, and one-hole fixing for which screw is provided. Each Condenser is tested and we guarantee to be correct to within 5%.

Above reproduction is the actual size.

QUALITY TELLS!

- .00005 to .002 - - - - 2/- each.
- .0025 to .006 - - - - 2/6 "
- Grid Condenser and 2 meg. leak - 2/6

If your dealer does not stock, write direct to the sole manufacturer:

C. D. MELHUIISH,

(Late Director and Works Manager Watnet Wireless Co. Ltd.)

8, Gt. Sutton St., Goswell Road, E.C.1.

Phone: Clerkenwell 7494.

Send for catalogue of our guaranteed products.

Miscellaneous.—Contd.

**L**AKER 30ft. Handsome Steel Mast, 22/6. See descriptive advertisement, page 24. Easily erected. [0061]

**L**ITZ Wire (Lewcos 27-42): any length at 1d. per foot, 50 yds. 11/6; 9-38s., 4/- per 50 yds.—All above post free from Stoner's Radio Service, 42, Wellesley Rd., Wanstead, E.11. [6006]

**W**IRELESS Doctor.—Your set altered and improved quickly and efficiently; portable sets and Solodynes expertly tested and repaired.—Write Morley, 18, Grangemill Rd., Catford. [5967]

**A**GAR'S Resin Cored Solder Should Always be used for making radio and electrical connections; it is non-corrosive and clean to handle; it has been tested and recommended by The Wireless World; 1/- per carton, post free.—W. H. Agar, 19, Whitecross Pl., E.C.2. [6062]

**H**IGH Tension Generator Unit, ball bearing motor, all carbon brushes, three-way resistance control switch, input 12 v. 5 amp. (Max), output 500 v. 100 m.a., transformer, D.C. output, in good condition and working order; 30/-.—Below.

**2** INCH Spark Coil, heavy discharge, 2 high-speed trembler, good joints, 17/6; 1 inch spark coil in case, with Morse key, 8/6; 1,000 ohm choke coils, 1/-; 500 ohm choke coils, 1/-; 120 ohm earphones, 1/6; good sensitive microphones, 1/6; transformers to suit, 2/6.—Below.

**S**KINDERVIKEN Microphone Buttons, 2 new, 2/-; 2 M.F. Mansbridge condensers, 2/-; 1-36 Mansbridge, 6d.; G.P.O. galvanometer, as new, 12/6; Silvertown magnetic galvo; full scale, 20/-; multiple Dewar switches, 1/-; good buzzers, 1/-; good fan motors, 110 volt D.C., large, 12/6; 1/4-h.p. D.C. motor, as new, ball bearing, 45/-.—Below.

**H**AND Telephones, complete with earphone and microphone, 3/6; good rin. spark coils, 5/-; Marconi variable condensers, .01, 6/-; G.P.O. receivers, 2/6; L.F. transformers, new, 4-1, 7/6; charging resistance, 2 amp., 6/-; all above guaranteed, 3 days' approval from date of delivery; cash with order.—Galpin, Binfield Heath, near Henley-on-Thames. [6066]

**L**AKER 30ft. Handsome Steel Mast, 22/6. See descriptive advertisement, page 24. Easily erected. [0062]

**B**BROWN'S 40/- Gramophone Unit, new; offers.—W. H. B., 19, Baldry Gardens, London, S.W.16. [6058]

**H**OME Cinemas.—Films; free lists.—Kinema Salesmen, 4, Kingsley House, Harp Lane, London, E.C.3. [6057]

PATENT AGENTS.

**P**ATENTS and Trade Marks.—British and Foreign.—Gee and Co. (H. T. P. Gee, Member R.S.G.B. and A.M.I.R.E.), 51-52, Chancery Lane, London, W.C.2. Phone: Holborn 1525. [0001]

**K**ING'S PATENT AGENCY, LTD. (B.T. King Registered Patent Agent, G.B., U.S., and Can.). Free "Advice Handbook" and consultations; 40 years' references.—146a, Queen Victoria St., London, E.C.4. [0002]

EXCHANGE.

**B**IRMINGHAM Reader will Exchange Radio Tools, etc., for gramophone.—Lawson, 13, Francis Rd., Edgbaston. [603]

**REPAIRS.**

**A**LL L.F. Transformers, 4/-; headphones, 4/-, loud-speakers 4/- post free; maximum efficiency attained; every repair is accompanied with a three months' guarantee; don't discard if burnt out; trade invited.—Transform, 115, Links Rd., Tooting, London, S.W.17. [6011]

**L**LOUD-SPEAKERS, headphones rewound to any resistance and remagnetised, 3/-; transformers rewound, 4/-; sets constructed and overhauled, work guaranteed.—Leeds Wireless Repair Service, 5, Boston Place, Green Rd., Leeds. [5811]

**H**EADPHONES and Loud-speakers Rewound, remagnetised and overhauled, 4/-; transformers rewound, from 5/-; sent to our agents or direct to us.—Repairs fully guaranteed by M.I. Vaughton, 88, Vyse St., Birmingham. Tel.: Mivyse, Birmingham. [5831]

**H**EADPHONES and Loud-speakers re-wound, remagnetised and overhauled, 3/- post free; guaranteed; Brown's A type, 4/-; established 1923.—Bradford & Co., 16, Prospect St., Plymouth. [5861]

**L**LOUD-SPEAKERS.—Headphones, guaranteed repairs; any make or type re-wound, remagnetised and adjusted by experts; best materials only used; post free, 4/-.—Howell, 42, Fotheringham Rd., Enfield, Middlesex. [6025]

**A**LL Agree that We are the Leading Doctors of Valves. No matter whether your valves are dead or alive.—Send them to us and we will let you know the cost to renew their original energy, or send for Price List to The North London Valve Co., Ltd., 22½, Cazenove Road, N.16. B.E., 3/-; D.E. .25, 5/9; D.E. .06, 6/- [6059]

**WANTED.**

**T**RANSFORMERS.—3 Litzen (aerial and 2 split primary), 1 Ideal 6: 1.—Ashworth, 102, Alexandra Rd., Plymouth. [5989]

**W**ANTED, Marconiphone long range V.2 range blocks and regenerators.—Eveleigh, 60 Oscar St., St. John's, S.E.8. [6014]

**W**ANTED, D.E.T.1 transmitting valve for cash, or exchange new 0/30 A valve and cash adjustment.—Woodcock, 8, George Street, Bridlington, Yorks. [6056]

**2** DIMIE 3A, 1 S.W.3, 1 No. 5, 50, and 150 Unimic coil, 1 D.E.5A.—Smith, Fairy Lane, Sale. [6055]

**TUITION.**

**I**NSTRUCTION in Morse, day or evening, easy terms.—Telegraph School, 29, Talfourd Rd., Peckham, S.E. [6013]

**AGENCIES.**

**A**GENTS Wanted for Cheapest and Safest Non-pumping Petrol-gas Lamps; good living made converting all paraffin lamps into 150 c.p. Titus light.—Particulars, Titus, Kingston, Brighton. [5240]

**SITUATIONS VACANT.**

**Y**OUNG Assistant Required for Wireless Department by old-established retail City firm, gentlemanly appearance and address.—Apply with particulars of experience and salary required to Box 3990, c/o The Wireless World. [6023]

**Y**OUTHS Required for Assembling and wiring.—Apply Eastern Wireless Co., Ltd., Collingwood Rd., Sutton. [6053]

Mention of "The Wireless

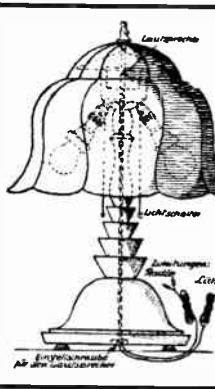

**TWO HITS OF BERLIN RADIO SHOW**  
are the  
**"DIHAG" LOUD-SPEAKER TABLE LAMP**  
**£6.00**  
with silk-shade and the  
**"DIHAG" CABINET LOUD SPEAKER**  
(13" high), Mahogany polished. **£3.15.0**  
Apply to:—**DIHAG, Hamburg, 5, Germany.**  
Agents required!!!

**TANNOY COMPONENTS**  
for  
**MAINS UNITS**

Transformers, Chokes, High-Voltage Condensers, Potential Dividers, Rectifiers, etc.

Write or 'phone for particulars.  
**TULSEMERE MANUFACTURING CO.**  
Tulsemere Road, West Norwood, S.E.27.  
Phone: Streatham 6731

**LONDON LISTENERS!**  
—Improved reception ensured if you have your accumulators correctly charged by our skilled maintenance service. We collect weekly, fortnightly or monthly within 12 miles of Charing Cross, and exchange your accumulator (H.T. or L.T.) for one fully charged. If yours are not serviceable, you can hire ours. Both trouble-free, money-saving services. Terms—weekly, fortnightly, monthly or quarterly—no deposit required. And you can depend on our service for a solution in every wireless trouble.

Our service—the speciality of experts  
Write for full details and terms:  
**RADIO SERVICE (London) Ltd.**  
105 Torriano Avenue, am'ln Rd., N.W.5. Phone: North 0828 (3 lines)



**Anything for Wireless sent C.O.D.**

Send a note of your requirements to  
**YOUNG'S (GLASGOW) LTD.,**  
40, Stockwell St., GLASGOW.

**DAREX**  
**"Safety First"**  
Accidental Damage avoided  
**TERMINALS**  
Descriptive List free on request.

**DAREX RADIO CO.,**  
Waldram Rd., Forest Hill, London, S.E.23  
TRADE SUPPLIED

**NO MORE CORRODED TERMINALS.**  
The priceless boon to all electrical battery users.  
**ANTYSULPH**  
Guaranteed to kill existing and prevent future corrosion.  
PRICE 13 POST FREE.

Manufactured only by **BRITISH ELECTRIC G.I. Ltd.,**  
Strand House, Willesden Lane,  
Park Royal, N.W.10.  
Trade enquiries welcomed

**Situations Vacant.—Contd.**

**E**XPERIENCED Salesman-Demonstrator Required, practical man with up-to-date knowledge of the latest sets and components, good salesmanship essential, London district; state age, experience, salary required.—BM/FHAR, W.C.1. [6027]

**W**IRELESS Engineers Wanted in all Parts of the Country for Full or Spare Time Work.—Write for particulars, Box 3992, c/o The Wireless World. [6031]

**F**IRM of Radio Manufacturers Making Sets, battery eliminators, loud-speakers and components, require the services of a chief draughtsman, able to turn out neat final designs of apparatus from technical laboratory data; applicant must have good knowledge of production and be a qualified designer and draughtsman.—Write, stating nationality, age, experience, and salary required, together with photograph, to Box 4004, c/o The Wireless World. [6054]

**SITUATIONS WANTED.**

**E**X P.O. Telegraphist, 30, 13 years' arc, spark, valve, short wave, fitting, care maintenance machinery batteries.—Box 4006, c/o The Wireless World. [6051]

**A**DVERTISER, aged 27, well educated, 5 years' experience modern receivers, desires spare time installation, construction, or sales demonstration; own car; permanent post considered.—Box 4005, c/o The Wireless World [6052]

**R**ADIO Engineer and Draughtsman Seeks Situation, 5 years' experimental experience installation, construction, repairs.—Box 4008, c/o The Wireless World. [6072]

**S**ITUATION Required, wholesale or retail wireless business, age 35; 12 years' experience wireless; moderate salary.—Box 4015, c/o The Wireless World. [6073]

**BOOKS, INSTRUCTION, ETC.**

**"THE ABC of the Superhet,"** by Mr. Claude L. Lyons, M.A.R.E., 88 pages, 17 explanatory diagrams or photographs, and including complete schematic and point-to-point wiring plan of the famous *Evening Chronicle* 8-valve superheterodyne receiver. The only book of its kind at present in existence; recently described by the Editor of *The Wireless World* as "A fascinating booklet. . . . A lucid description of the operation of the superhet receiver. . . . With constructional details and useful hints and for the home constructor." Only 8d. complete, post free, from Claude Lyons, Ltd. (G.R. Quality Parts), 76, Oldhall St., Liverpool. [6064]

**3-VALVE Receiver for 30/-**—Write now for booklet on how to build the L.R.C.3 valve set for 30/-, from guaranteed parts only—the ideal loud-speaker set.—1/-, post free, from H. Howarth, Lustrulux Depot, 288, Deansgate, Manchester. [5988]

**"WIRELESSWORLD" COILS**  
"L & H" Everyman Four.  
Exactly to specification. Fully Guaranteed. Price per pair including 30/- Bases . . . . . 23  
"All-Wave Four" H.F. Transformers Short or Long Wave . . . . . 16/- each 6 Pin Base . . . . . 23  
"Regional" Coils Including Bases Short Wave . . . . . 35/- per pair Long Wave . . . . . 42/-

**LAWRENCE & HULL, 29, Parkhouse Street, S.E.5. Phone: Rodney 3810.**





**RELIABILITY S.L.F. CONDENSER**  
with ebonite ends and 4" Trollic Dial.  
0005 5/8. 0003 5/8.  
Verrier Dial 1/6 extra.  
Post Free.

Further Attractive Items in Miscellaneous Columns. Send for FREE Guide now.

**J. H. TAYLOR & CO**  
2 RADIO HOUSE,  
MACAULAY ST. HUDDERSFIELD. Trade Enquiries Solicited.



**"COLLETT" PANEL BRACKETS**

PRICES  
No1 (6x6) 19 PER PAIR  
No2 (3 1/2 x 3 1/2) 13 PER PAIR

Specially designed to give CORRECT PROPORTION and BALANCE "COLLETT" Brackets will support panels no matter how heavily loaded with components. Strong and light. A refinement to any set.

From all good dealers.  
**S. H. COLLETT MFG. COMPY.**  
60, Pentonville Road, N.1.

**Have YOU tried PERTINAX?**

3 1/2" thick cut standard sizes, in neat envelope natural brown, 10 sq. in. mahogany, walnut or black 5 8 sq. in. Cut to own requirements. Natural brown 5 8 sq. in.; wood finishes 10 sq. in. Send 1/4d. stamp for 1" sq. sample stating colour, to Geo. L. Scott & Co., Ltd., 68, Fleet St., E.C.4



**The ETON Porous Pot**

is a neat porous jar 1 in. in diameter and 2 in. in height. The pot is filled with high-grade chemicals, principally black manganese dioxide, packed closely round the positive carbon rod. This rod is capped by a split brass base which carries the terminal proper. The thread of the terminal is long enough to permit the plug socket supplied (one with each 6 cells purchased) to be screwed on any pot. This socket takes the standard wander plug.

Complete instructions and other information are contained in our 6d. manual, which will be forwarded to you free on receipt of 1/4d. stamp. Send to-day to—

**The ETON GLASS BATTERY Co.,**  
46, St. Mary's Road, Leyton, E. 10.



For use with the Eton Primary H.T. Batteries.

**For utmost efficiency**

The C.E. PRECISION FLOATING VALVE HOLDER maintains the high standard of efficiency and value associated with the name. It is anti-capacity and non-microphonic, and judged by the ever-increasing demand, it is preferred by radio enthusiasts. Comparison is the only real test and you will find by actual comparison that this valve holder shows obvious points of superiority.

There are also the famous C.E. PRECISION Rheostats, Sectionally Wound Fixed Resistors, H.F. Chokes, etc., etc. Write for full list of components.

If unobtainable, please send us the name of your dealer.

**C. EDE & CO., LTD.,**  
BYFLEET, SURREY.  
2/3 each  
Telephone: Byfleet 226.  
Telegrams: "Cepreist, Byfleet."



**EBONITE BUSHES**

FOR MOUNTING ON METAL OR WOOD.

PERFECT INSULATION  
Two required for each hole.

Orders under 1 - send 1/4d. Postage

NUMBER	0	1	2	3	4	5	6
Hole in Bush	6BA.	4BA.	2BA.	1", 5/16", 1", 7/16"			
Price each	1d.	1d.	1d.	1 1/4d.	2d.	2d.	2d.

(Complete List of sizes free on application.)  
**DAREX RADIO CO.,**  
Waldran Rd., Forest Hill, London, S.E.23.  
TRADE SUPPLIED



As near perfection as possible

Coefficient of coupling for first stage is .982. For a perfect transformer this should be 1. This means a loss of only .018 or .1% per cent.

**- POWQUIP -**  
**TRANSFORMERS**

The Power Equipment Co. Ltd.  
Kingsbury Works, The Hyde,  
HENDON, N.W.9.

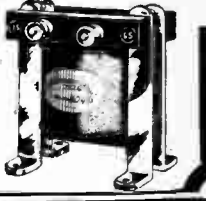

**Short & Long Wave Transformers. Coils & Formers**

ABOVE ARE RADIAX Regd. DESIGNS.

Filled Formers, 3in. diam. 3in. 4 1/2 3 1/2in. 4 8	Base,	2 6
Low Loss, for same		
All-Wave Four Coils, 1,000 2,000, 17 8 ; 200 500, 15"		28-
Everyman-Four Coils, the pa-r.		12 6
Monotone-3 Coils, 200,600, 10 6 ; 1,000 2,000		
Radiax H.F. Choke (tested and favourably reviewed by "Wireless World") aids perfect react on and obviates troubles due to resonance. 8 8 ; Special Short Wave		5 6
Radiax Anode Resistance for L.F. Amplification		4 6
Resolin Tubes, 3in. x 3 1/2in. for Everyman-Four, etc.		1 3
Neutralising Condensers, 3 - . Baancing Condensers, 3 - .		
Reaction Condensers, 3 9. Push-Pull Switches		1-

The New Bennett Coil and Transformer Set. Radiax Low Loss design, with Auto Coupled helical aerial coil, and Primary neutralising secondary and reaction Transformer. A perfectly turned-out job, ensuring magnificent results. Circuit diagram and information on building into your set with ease; pair 250 500. Price for pair with case. . . . . 27 6

Coils wound to specification. All components for All-Wave Four—Empire Short Wave—Monotone-3, etc. Leaflets stamp. Full catalogue 2d.

**RADIAX LTD.** 30, Accessory House, Palmer Place, Holloway Rd., N.7

**The H.T.C. TWIN RECEIVER**

A complete up-to-date set, including loud speaker and all accessories, as shown at Olympia.

Seven days' trial and initial payment refunded if not entirely satisfactory.

**H.T.C. ELECTRICAL CO. LTD.,**  
2, Boundaries Rd., Balham, S.W.12.

Set and accessories sent, carriage paid, on 7 days free trial, against signed agreement and a deposit of.....

**5/-**

Cash Price £6 4 0  
Royalty Paid.  
3 valve set, Cash Price £8 8 0  
Deferred Terms £8 16 0

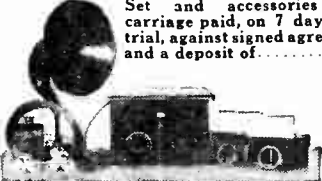

**ACCUMULATORS "ELITE"**

— The Elite of all —

**H.T. ACCUMULATORS, 60 volts 22/6**  
type, 02, Semi-oil Submerged. Price Complete, as illustrated.

The World's Best High Tension Accumulator and of British Manufacture. The Unique Semi-Oil Submerged feature of the Elite, absolutely prevents surface leakage losses. The battery lasts a life-time. Write for lists.

**ACCUMULATORS ELITE** Bedford Street, HALIFAX.  
Telephone: 4304. Telegrams: Elite Halifax.

London Distributor:—**CECIL POHLMAN, 77, Great Portland Street, LONDON, W.1**



**Insist on Parfait Brand**

**THE PERFECT EBONITE**

**FROM YOUR DEALER**

In Four Qualities: Matt, Semi-Polished Mahogany, Hand-Polished

Sole Manufacturers:—  
**H. B. POTTER & CO., LTD., Station Buildings, ROCHDALE.** Phone: 1485.

INDEX TO ADVERTISEMENTS.

Accumulators Elite .. .. .	27	Ede, C. E., & Co. .. .. .	27	Mic Wireless Co. .. .. .	25
A.F.A. Accumulators, Ltd. .. .	2	Edison Swan Electric Co., Ltd. .. .	7	Mullard Wireless Service Co., Ltd. .. .	1
Artic Fuse & Electrical Mfg. Co., Ltd. .. .	28	Electradix Radios .. .. .	24	Potter, H. B., & Co., Ltd. .. .. .	27
Batteries, Ltd. .. .. .	8	Ericsson Telephones, Ltd. .. .. .	Cover iii.	Power Equipment Co. .. .. .	27
Beard & Fitch .. .. .	10	Eton Glass Battery Co. .. .. .	27	Pye, W. G., & Co. .. .. .	27
Bedford Elec. & Radio Co., Ltd. .. .	21	Finston Manf. Co., Ltd. .. .. .	16	Radiax, Ltd. .. .. .	27
Belling & Lee, Ltd. .. .. .	10	Formo Co. .. .. .	16	Redfern's Rubber Works, Ltd. .. .	Cover iii.
Benjamin Elec. Co., Ltd. .. .. .	18	Garnett, Whiteley & Co., Ltd. .. .	Cover iii.	Radio Service (London), Ltd. .. .	26
Bowyer-Lowe Co., Ltd. .. .. .	4	General Electric Co., Ltd. .. .. .	11 & 14	R.I. & Varley, Ltd. .. .. .	3
British Battery Co., Ltd. .. .. .	22	Graves, J. G., Ltd. .. .. .	17	Rooke Bros., Ltd. .. .. .	23
British Ebonite Co., Ltd. .. .. .	16	Hart Accum. Co., Ltd. .. .. .	15	Scott, G. L., & Co., Ltd. .. .. .	27
British Electric G.I., Ltd. .. .. .	26	Hildick & Hildick .. .. .	17	Selfridge & Co., Ltd. .. .. .	22
British Thomson-Houston Co., Ltd. .. .	13 & 15	Holzman, L. .. .. .	8 & 15	Stapleton, A. W. .. .. .	2
Brown, S. G. .. .. .	14	H.T.C. Electrical Co., Ltd. .. .. .	27	Taylor, J. H., & Co. .. .. .	27
B.S.A. Radio, Ltd. .. .. .	14	Hunt, A. H., Ltd. .. .. .	6	Telegraph Condenser Co., Ltd. .. .	6
Caxton Wood Turning Co. .. .. .	28	Igranic Electric Co., Ltd. .. .. .	4	Trelleborg's .. .. .	16
Carrington Manf. Co., Ltd. .. .. .	28	Jewel Pen Co., Ltd. .. .. .	28	Tulsemere Manf. Co. .. .. .	28
Christie, Jas., & Sons, Ltd. .. .. .	28	Laker, J., & J., Co. .. .. .	24	Walker Bros. (Guildford), Ltd. .. .	10
Collett, S. H., Manf. Co. .. .. .	27	Lamplugh, S. A., Ltd. .. .. .	20	Watmel Wireless Co., Ltd. .. .. .	16
Collinson Precision Screw Co., Ltd. .. .	8	Langham Radio .. .. .	11	Wet H.T. Battery Co. .. .. .	18
Coscor, A. C., Ltd. .. .. .	12	Lawrence & Hull .. .. .	26	Whiteley, Bournemouth & Co., Ltd. .. .	16
Darex Radio Co. .. .. .	26 & 27	Lever, Eric J. .. .. .	22	Wilkins & Wright .. .. .	19
Dihag .. .. .	26	Lifford Engineering Co. .. .. .	24	Wingrove & Rogers, Ltd. .. .. .	20
Dubliler Condenser Co. (1925), Ltd. .. .	Cover ii.	Marroniphone Co., Ltd., The .. .	Cover iv.	Wright & Weaire, Ltd. .. .. .	17
Eastick & Sons, J. J. .. .. .	23	Melhuish, C. D. .. .. .	25	Youngs (Glasgow), Ltd. .. .. .	26
		Metro-Vick Supplies, Ltd. .. .. .	5 & 9		

**Startling Reduction**  
from **3/9** to **2/3** EACH POST FREE



THE MASTER NON-VIBRATORY VALVE-HOLDER

**NOW BEING SOLD DIRECT TO THE PUBLIC**

By cutting out the middleman, by initiating more efficient methods of manufacture, and being aided by the already large demand for this super Valve-Holder, we have pleasure in announcing that from SEPT. 21st The "ARTIC" Valve-Holder has been reduced in price from 3/9 to 2/3 each, POST FREE. Its superiority as a valve-holder has always been admitted, and this astounding reduction places it within the reach of EVERY valve user. Quality and construction have not been altered in the slightest degree.

The "ARTIC" principle guarantees perfect steadiness under all conditions of shock and vibration. Even when the valve is moved directly, it just sags back into position. No springs or rubber are employed—these are but makeshifts and success can never be possible with such mediums.

**DIRECT FROM US TO YOU MEANS A CHEAPER VALVE-HOLDER FOR YOU.**

2/3 each POST FREE with P.O. remittance or C.O.D. with C.O.D. charge extra.

MAKES A GOOD VALVE BETTER AND A BAD VALVE GOOD.

WORLD PATENTS.  
NO SPRINGS.  
NO RUBBER USED.



**CAXTON WIRELESS CABINETS**

THOUSANDS OF SATISFIED CUSTOMERS.

All Polished with new enamel that gives a glass hard surface that cannot be soiled or scratched. Ebonite or Radion Panels Supplied and Perfectly Fitted at low extra cost. SENT FREE—Catalogue of Standard Wireless Cabinets in various sizes and woods.

Elstree "Solodyne"

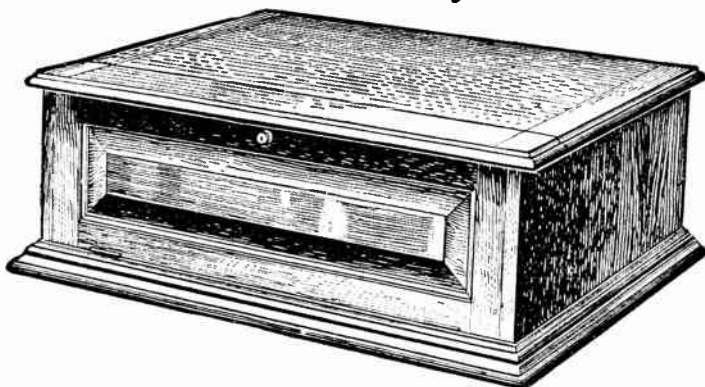

Specially designed for this famous Radio Press Circuit. All details and dimensions conform to their specification, enabling constructors to follow the layout without difficulty.

PRICES:

Light Fumed Oak 66/- Dark or Jacobean Oak 70/- Real Mahogany 73/-

Prices include either "fall front" with handsome solid raised panel, as illustrated, or beaded doors, allowing ample space for tuning controls, etc. Glass panelled doors can also be supplied at 3/- extra.

CASH WITH ORDER. CARRIAGE PAID U.K. PROMPT DELIVERY.

Packing Case 5/- extra repaid if Case returned within 14 days Carriage paid to Works.

**CAXTON WOOD TURNERY CO., MARKET HARBOROUGH.**

Mention of "The Wireless World," when writing to advertisers, will ensure prompt attention.

Put it there!



Get the best out of your valves with the New AERMONIC no-loss, no-vibration holder. Anti-capacity because minimum di-electric between sockets. Anti-phonics because properly sprung. (Valves don't wobble all over the place with Model K.) Price 2/3 Write for free list. If any difficulty write to either address below:

**JAMES CHRISTIE & SONS, LTD.,**  
246, West Street, SHEFFIELD.  
London Agents:  
**A. F. BULGIN & CO.,** 10, Cursitor Street, London, E.C.4.

TRADE MARK "RED DIAMOND" THE RECOGNISED DETECTOR FOR ALL CIRCUITS USING CRYSTAL RECTIFICATION.



RD 40 2/- SHIELD FOR SAME 6d.

By Insured Post 2/3 or 2/9 with shield. Can be mounted on brackets or through panel. Once set always ready. Not affected by vibration. Each one is tested on broadcast before despatch, and is perfect. Of all high class Radio Dealers or Sole Makers :-

**JEWEL PEN CO. LTD.,** (Radio Dept. 14) 21-22, Gt. Sutton St., LONDON, E.C.1

**WAS  
£1  
NOW**

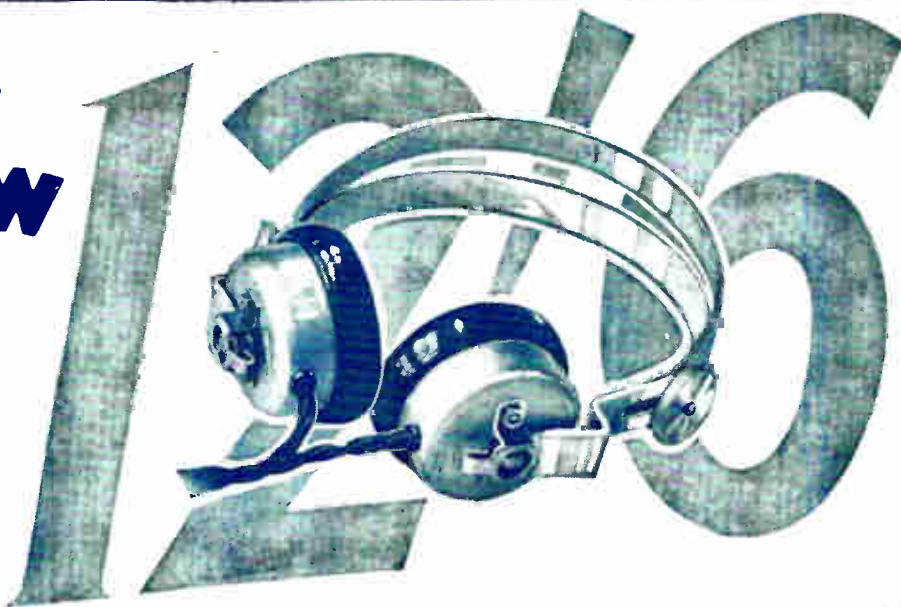

Even if you have a multi-valve set, now and again you'll need a good crystal set. Buy an Ericsson Crystal Set today. Sturdily and handsomely made and a really sensitive instrument. Tunes up to 5 G.B. and has a loading coil plug for 5 X.X. A real snip at 15/-

The famous Ericsson Super Sensitive Telephones are reduced to 12/6 a pair! Adopted by the B.B.C. for use in their studios. Used by most D.X. experimenters. Adopted as standard in 1909 by the Admiralty and in 1917 by the Air Board. Three resistances, 120, 2000, and 4000 ohms—one price, 12/6. Get your pair to-day.

At all our agents or direct from the Company.  
ERICSSON TELEPHONES LTD., 67/73, Kingsway, London, W.C.2.

**Ericsson**  
SUPER SENSITIVE TELEPHONES

se **REDFERN'S**  
REG. NO. 469456  
**Ebonart**  
NON-METALLIC SURFACE EBONITE  
**RADIO PANELS**  
for

easy working, positive insulation, beautiful appearance, and an entire freedom from surface leakage. In black and a beautiful mahogany grain, in nine standard sizes and prices. The "Ebonart Station Log Chart" given with each panel.

**Redfern's**  
**FERNOLITE (Regd.) DIAL KNOB.**

A beautifully-finished moulded 4-in. dia. knob, scale 0° to 180°, complete with fixing screw. This dial knob is made in black for use with black panels, and in mahogany for use with mahogany panels.

Black - - - - 2/- each  
Mahogany - - - - 2/3 each

Send for the Book of Ebonart.

Obtainable from all reputable dealers.

**REDFERN'S RUBBER WORKS, LTD.,**  
HYDE, CHESHIRE.

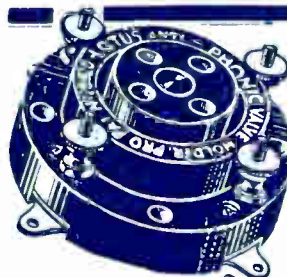

**No fading away—  
No microphonic  
noises—**

Use Lotus Coil Holders and Valve Holders in YOUR set. They ensure perfect, uninterrupted reception.

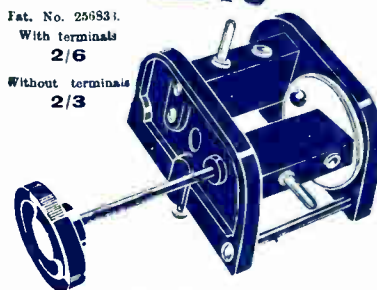

There will be no more fading away of volume, no more breaking of valves and disturbing microphonic noises once you have fitted your set with Lotus Coil Holders and Valve Holders.

Pat. No. 256831.  
With terminals 2/6  
Without terminals 2/3

From all Radio Dealers.

Two Types :	
For outside panel mounting.	
Two-way	7/-
Three-way	10/6
For inside baseboard mounting with 6in. handle.	
Two-way	8/-
Three-way	12/6

**LOTUS**  
COMPONENTS.

**GARNETT, WHITELEY & CO., LTD.**  
Lotus Works, Broadgreen Road, LIVERPOOL.

You can easily build the D.P.1 Receiver shown here from the FREE constructional booklet provided. A 3-valve, operating direct from D.C. mains, it combines the simplicity of the battery-less receiver with superlative performance.

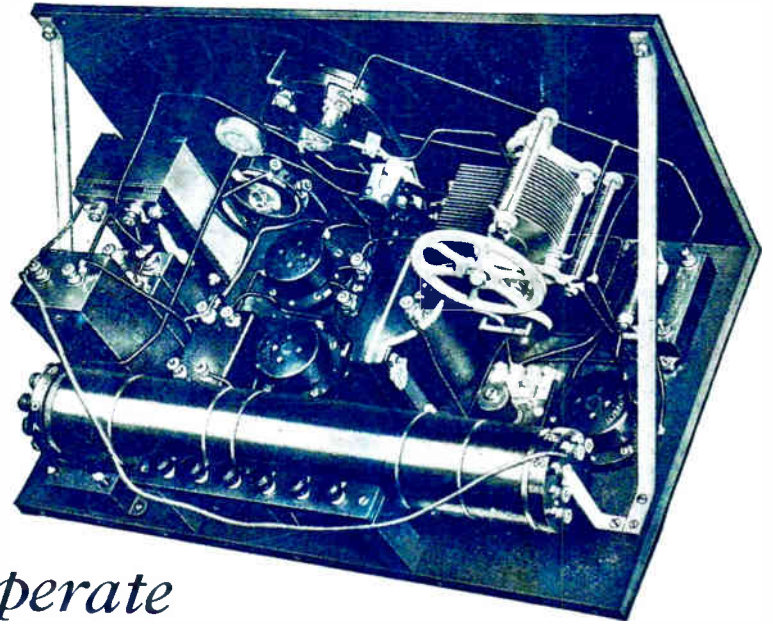

You can easily build a receiver to operate direct from the mains

Marconiphone have evolved it—you can build it—the perfect battery-less receiver for the home constructor. Simple to build, simple to operate, completely trouble-free and amazingly economical in running costs. There are four circuits from which to choose, two for D.C. and two for A.C. Mains, and every receiver in addition to its simplicity, presents superlative qualities of reproduction and tone. Send now for your FREE constructional booklet.

FREE CONSTRUCTIONAL BOOKLET,

including blue print and full details will be supplied for any one of these receivers. Booklets, including blue print of the other five receivers, 6d. each.

For A.C. Mains

- K.1. 3-valve receiver employing the famous K.L.1. valves
- K.2. Similar to K.1, but in addition incorporates an H.F. stage.

For D.C. Mains

- D.P.1. 3-valve receiver - simple to construct.
- D.P.2. Similar to D.P.1, but gives greater range and selectivity by means of a neutralised H.F. stage

If you want distance, there are two special circuits incorporating the Marconi S625 Shielded Valve.

T.1. 4-valve receiver, including 1 H.F. stage, with S625 valve.

T.2. 5-valve. Two H.F. stages, with S625 valves. Stations hundreds of miles away can be tuned in with complete stability.

# MARCONIPHONE

To the MARCONIPHONE CO. LTD. (AND REDUCED) 210-212, Tottenham Court Road, London, W.1.

Please send me free constructional booklets, including blue-print for circuit.....

I am also enclosing.....for the following booklets.....

NAME..... TOWN.....

ADDRESS..... COUNTY.....

3<sup>D</sup>

# The Wireless World

AND RADIO REVIEW

*The Paper for Every Wireless Amateur*

Wednesday, October 26th, 1927.

## TWO IN EVERYMAN RECEIVER



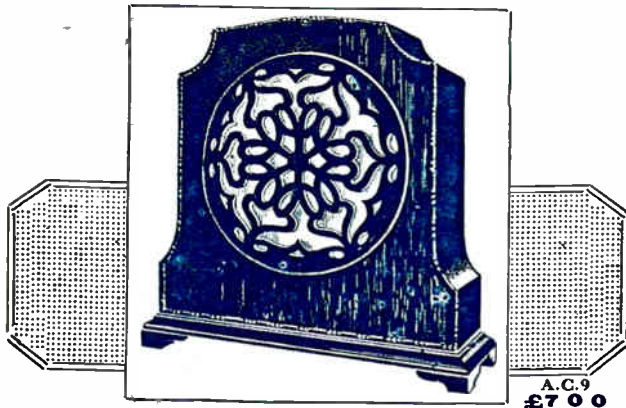

A.C.9  
£7 0 0



A.C.1 52/6



A.C.3 75/-



A.C.4 £4 0 0



A.C.5 £6 0 0



A.C.7 £6 10 0

*What do  
you hear?*

You need not—should not—suffer poor quality from a loud-speaker. With a reasonably good set, the right valves, sufficient H.T., and—above all—an AMPLION you will enjoy reception such as you never imagined possible.

*The  
Natural  
Tone*

**AMPLION  
CONE  
SPEAKER**



Announcement of Graham Amplion, Ltd., 25, Savile Row, London, W.1.

Mention of "The Wireless World," when writing to advertisers, will ensure prompt attention.



## EFESCA REGENERATIVE AERIAL TUNER

The Efesca Regenerative Aerial Tuner comprises a coil wound on a cylindrical former having an induction equal to a whole range of plug-in type coils, from No. 30 to No. 300, and by using a .0005 Variable Condenser in parallel all wavelengths are covered from 200 metres to 2,600 metres.

A single unit with the tuning range of a whole set of coils.

Ask for free blue print of an easily made 2-valve set employing the above. Price 25/-



### NEW TYPE Reactive AERIAL TUNER

The "DUOTAP," with only two tappings enabling selection of low or high wave stations by just changing a plug into alternative tappings.

Price 15/- each.

EFESCA (Junior) H.T. BATTERY ELIMINATORS for giving H.T. supply direct from the electric mains where direct current is available.

Price £1 15 0

EFESCA VARIFORM L.F. transformer. With four interchangeable primary bobbins enabling impedance to be matched with any valve.

Price £1 5 0

FALK, STADELMANN & CO., LTD.

EFESCA ELECTRICAL WORKS,  
83/93, Farringdon Road, London, E.C.1.

And at Glasgow, Manchester, Birmingham  
Dublin, Newcastle and Cardiff.

# EFESCA

**FOR FULL MEASURE—  
THE MULLARD  
FULL WAVE**



## H.T. UNIT

Be sure of these facts when you buy your H.T. Supply Unit—that it is a full wave unit, and that it is made by Mullard. The Mullard Full Wave H.T. Unit makes the most of your mains supply—therefore it is economical.

It is steady. It is silent in action and there is a large output available from four tapings, up to 150 volts—therefore it is efficient.

There are no controls and it requires no attention—therefore it is simple.

Remember — Full Wave for Full Measure—and ask for Mullard.

For A. C. Mains  
Price Complete

**£7 · 10 · 0**

# Mullard

## MASTER · RADIO

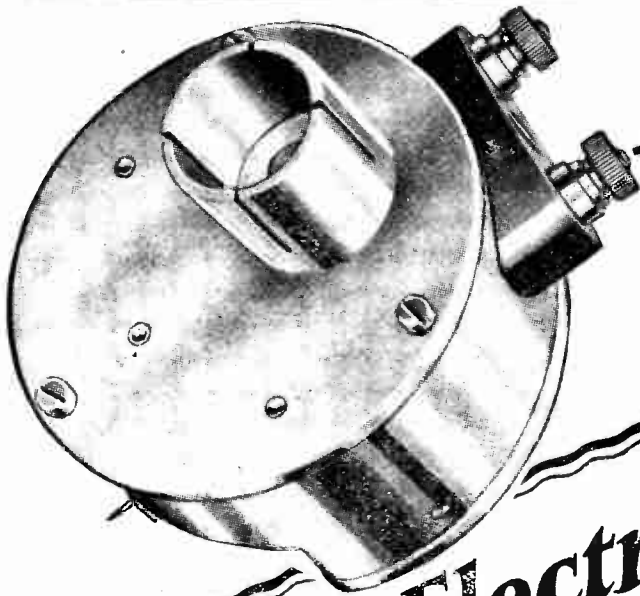

# Let Electricity improve your gramophone

**B**E your Gramophone old or new, electricity can improve it. The Brown Electrical Pick-up, when fitted in place of the ordinary sound box and connected to an amplifier and loud speaker, will give you four much-sought gramophone improvements. It will give purer, more mellow, more life-like tone. It will give far greater, more majestic volume. It will give that much-needed effective control of volume. It will almost completely eliminate the bug-bear of needle scratch. In short, the Brown Electrical Pick-up brings gramophone performance streets nearer the ideal. Ask your Dealer to prove this to you by showing you how the Pick-up can improve your gramophone. Price **£4**

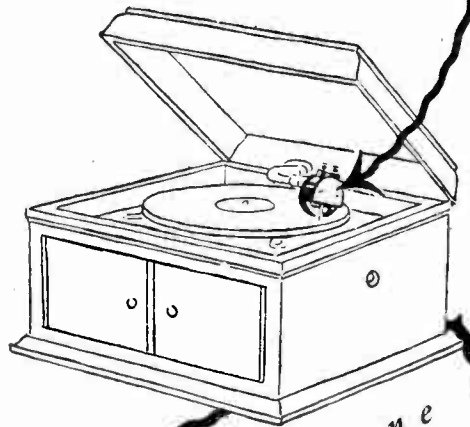

*The*  
**Brown**

**ELECTRICAL PICK-UP**

Purify its tone  
Increase its volume  
Reduce its needle scratch  
Control its volume

*will*

Advt. S. G. Brown, Ltd., Western Ave., North Acton, London, W.3.

Mention of "The Wireless World," when writing to advertisers, will ensure prompt attention.

9772

A2



# "heard every round of the Tunney-Dempsey fight!"

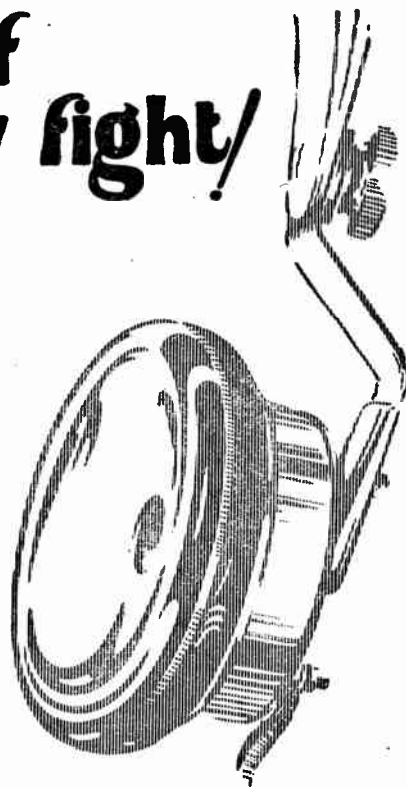
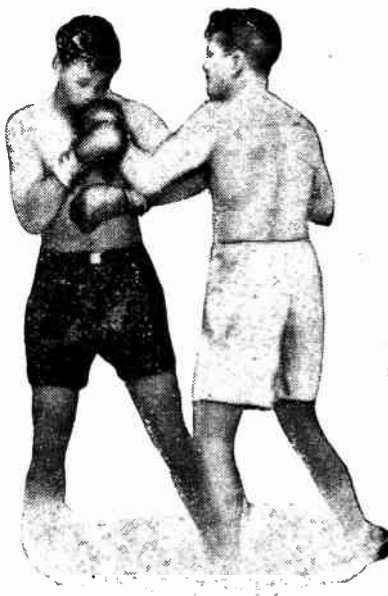
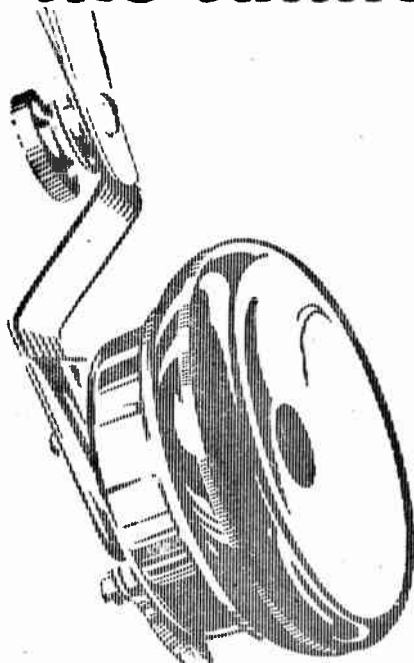

**A word about the Ediswan Local Station Eliminator.**

No set is complete without this new Ediswan wavetrap. It cuts out the local station sharply and totally and allows you to reach out for other stations within the capabilities of your set.

Your local dealer can now supply.

25/-

## WHAT SET? WHICH VALVE?

Say what set you have—or the set you are going to build—and we will tell you what valves to use. Post the description to us with the coupon—TO-DAY.

W.W. 26-10-27

To The Edison Swan Electric Co. Ltd.,  
(Publicity), 123/5 Queen Victoria Street,  
LONDON, E C 4.

Particulars of my set are attached. Send me your valve booklet marked up with the valves you recommend.

NAME .....

ADDRESS .....

V. 62

## Read this remarkable testimony to— EDISWAN VALVES!

"I constructed a four valve short wave receiver and purchased four Ediswan valves . . . Since then I have tuned in 2XAF on fourteen out of fifteen attempts.

This morning, using three pairs of headphones, I again tuned in 2XAF and heard every round of the Tunney-Dempsey fight the reception of which was clear, loud and absolutely excellent and the best I have received, and I should like you to know that this result lies in the functioning of your Ediswan valves."

W. J. B.

During October, LAST YEAR, a similarly remarkable testimonial to Ediswan Valves was published from Mr. C. L. Ashhurst, Norwich, and two friends, who heard every detail, round by round, of the great Dempsey v. Tunney fight.

Letters like this speak more than pages of advertising.

# EDISWAN VALVES

### Clearer, Stronger, Last the Longest

# Your Choice

## CAV

# RADIO BATTERIES

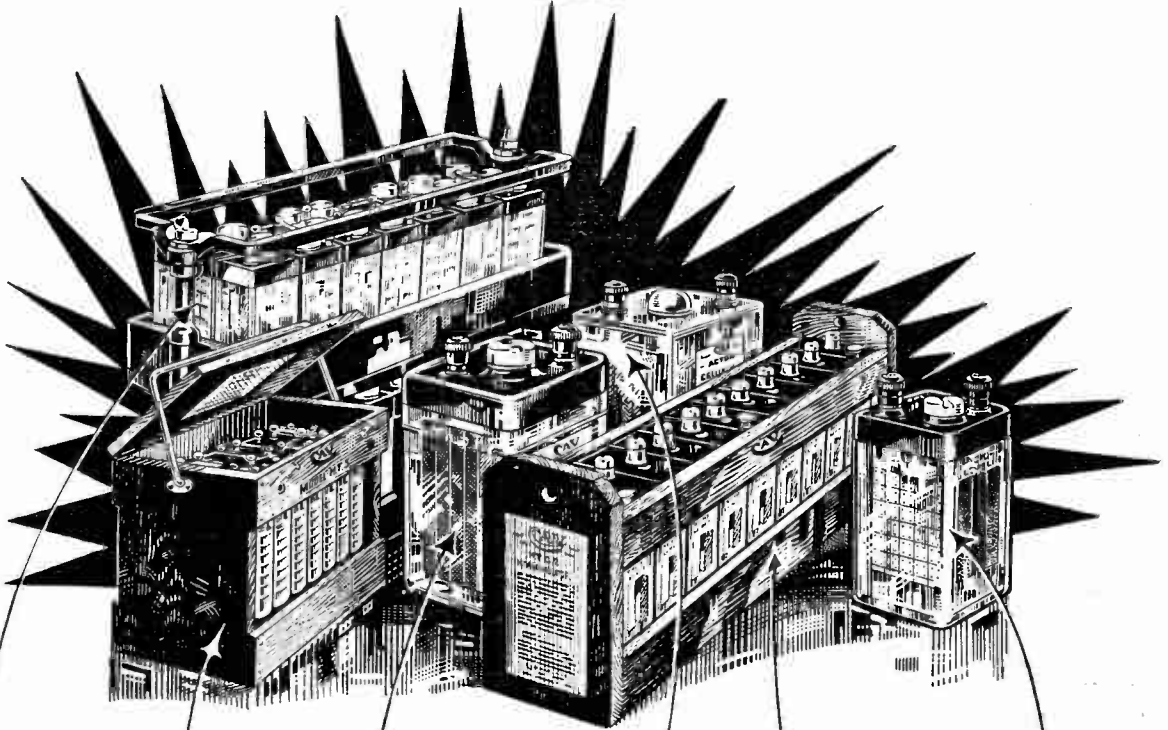

**THERE IS A TYPE FOR EVERY RADIO USER**

**60-volts. H.T.3. 2500 Millamp hrs.**  
 The original H.T. Accumulator of compact design. Every cell air spaced and embedded in hard wax. Tappings can be taken from any cell. Obtainable in 30, 60 and 90-volt units.  
 60-volt. Fully charged. £3 : 0 : 0

**42-volts H.T.18. 5000 Millamp hrs.**  
 A large capacity battery of sound constructional design. Suitable for large receiving sets, public address systems and small transmitters.  
 £3 : 17 : 6

**ACTON CELLULOID.**  
 Supplied in all capacities, this range of low tension batteries is offered at competitive prices, while the quality is in every way representative of our 36 years experience in battery manufacture.  
 2-volt. 30 amp. actual. 13/6

**ACTON GLASS.**  
 The "Acton Glass" low tension range provide an alternative to the celluloid cased battery, and is also suitable for tropical climates. All capacities supplied.  
 2-volt. 48 amp. actual. 16/-

**A.G.M. MASS PLATE.**  
 This 20 amp. 2-volt mass plate cell is ideal for Sets not taking more than 1 ampere. The charge can be spread over months without danger of sulphation.  
 Supplied dry charged 5/-

**20-volts H.T.G.2. 2500 Millamp hrs.**  
 The ideal High Tension supply for the average Broadcast Receiver. Any voltage obtained by coupling a suitable number of units. A 10-volt tapping point provided.  
 Supplied dry charged 15/-

FREE COPY OF BATTERY CHARGING INSTRUCTION BOOKLET SUPPLIED ON APPLICATION.

**CAVandervell & Co., Ltd.**  
 ACTON, LONDON, W 3

Depots at BELFAST, BIRMINGHAM, BRISTOL, COVENTRY, DUBLIN, GLASGOW, LEEDS, MANCHESTER & NEWCASTLE  
 Service Agents throughout the Country.

Mention of "The Wireless World," when writing to advertisers, will ensure prompt attention.

# Press Opinions!

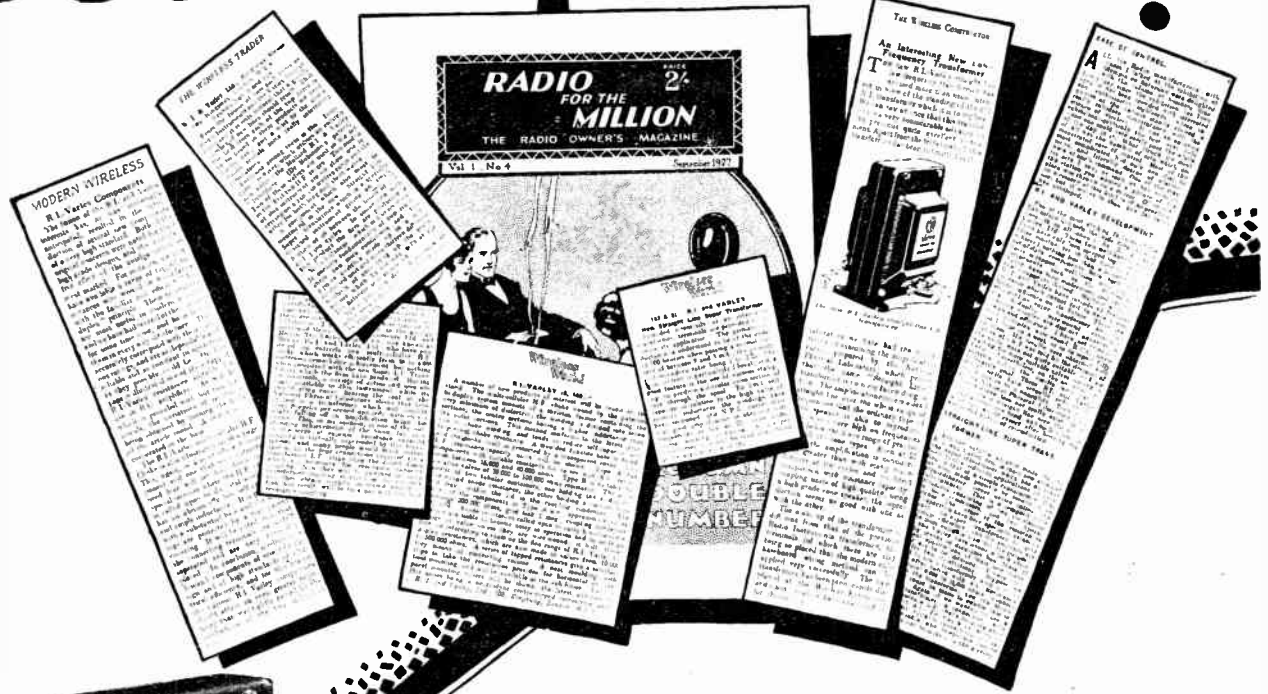

25/-

TYPE A .. 20/-  
TYPE B .. 22/6

The General Public Press, the Wireless Technical Press, the Trade Press—all refer to the new R.I. and Varley Straight Line Super Transformer and Resistance Capacity Coupler as two of the big radio achievements of the year. "Radio for the Million" published "A Remarkable Curve" showing the wonderful "uniform frequency response over an extremely wide frequency range" obtained with our Resistance Capacity Coupler Type B, and the Mullard P.M. 5B Valve.

In doing so these various wireless authorities have behind them the independent support of the National Physical Laboratory, whose curves show a remarkable degree and constancy of amplification over a very wide wavelength band. Some idea of the success achieved with the new Super Transformer can be gauged from the fact that the inductance at 50 cycles is 122 henries, and at 500 cycles 123 henries. It is interesting to note that this transformer has twelve different uses in addition to that of a simple transformer, full particulars of which are published in our transformer leaflet (free on application).

The new Bi-duplex wire-wound Resistance Capacity Coupler gives absolutely uniform amplification from 20 to 6,000 cycles (as shown by the National Physical Laboratory curve), and ensures a degree of amplification and purity of tone hitherto unknown.

We are in the unique position of being specialists in every form of Low Frequency Amplification, and our booklet "Low Frequency Amplification"—just published (price 1/-)—contains a wealth of new and valuable information which will enable you to improve to a remarkable degree the quality of your reproduction.

Leaflet C 17—free on application—gives full particulars of Transformers, L.F. Choke, etc.  
Leaflet C 14—free on application—gives full particulars of Resistance Capacity Couplers.

**THE MARK OF BETTER RADIO**

Kingsway House, 103, Kingsway, W.C.2. Telephone: Holborn 5303



Advertisements for "The Wireless World" are only accepted from firms we believe to be thoroughly reliable.

# Not Necessary to buy a TUNGSTONE TWICE IN A LIFE TIME

FIRST CHARGING RISKS ENTIRELY ELIMINATED.

*Battery Troubles Solved*

**10 HORSE POWER STARTER KICK**

The ONLY Car Starting Portable Storage Battery in the World

**TUNGSTONE**

With Plate Grids and Paste made of Pure Lead

**Accumulator**

Telephone Central 8926 (4 Lines) London E.C.4  
3, ST. BRIDE'S HOUSE, SALISBURY SQ., FLEET ST., LONDON E.C.4

*Revolution after 50 years Stagnation*

OF THE World's Battery Practices

NO SULPHATION. All Parts Replaceable

FIRST CHARGE ONLY

**Four Hours**

For any STORAGE BATTERY from 6 to 5,000 amps.

Because Standardised and Interchangeable renewable Die Cast and Machine Pasted Plates PERPETUALLY replace a Set of Used Plates. Dry Plates partially first charged are ready for immediate use. Can be stocked for unlimited period in dry place. Spare Plates sold at reasonable prices with allowance of 4d. per lb. for returned disused plates. Anyone can quickly and easily slip a Set of New Plates into the Indestructible Guaranteed Metal Containers in use.

## FREE for the ASKING

*Illustrated Battery Pocket Guide  
containing Special Articles on*

## MODERN BATTERY FAILURES

### HIGH TENSION PLATES. EXCLUSIVE FEATURES NEVER BEFORE ACHIEVED BY ANY OTHER MAKER

Tungstone, with its two Perfectly Scientifically Balanced H.T. Plates, without Wood Separators, is far more efficient and steadier in working with assured longer life than when three unbalanced Plates are used necessitating Wood Separators.

All Tungstone High Tension Plates are SCIENTIFICALLY BALANCED in correct weight proportions of the Grid and Pure Lead Paste, so that the Ampere Hour Capacity is evenly used up by an automatic proportional discharge of current from Positive and Negative Plates securing steady voltage. No abrupt changes in the potential. The drop slow and imperceptible. No Wood Separators prevent Voltage fluctuations due to polarization and internal resistance which is negligible. No frothing or foaming. No Sulphation. No Parasitical Noises in Phones or Loud Speaker. No sudden Plate failure at a critical moment demanding Voltage adjustments. The respective Plates are Certain to get their required proportionate charge of current. If correctly first charged is a guarantee against uneven strain and irregular drain on Plates on Charge and Discharge, and there is no chance of a separate Cell discharging and reversing long before the others. The loss of charge on standing is low and the local action small.

The open Circuit Voltage will give due warning of the approach of the Battery to a discharged state. As H.T. Cells are small it is difficult to test the Specific Gravity. Balanced Plates allow greater dependability to be placed on voltage readings. Cells are not permanently ruined by being left standing for months.

### A FULL CHARGE IS ALWAYS SECURED IN SHORTER TIME AT LESS COST

All De Luxe H.T. 3 a.h. Tungstone Accumulators from 12 to any Volts are fitted with a Patent Charging Equipment whereby each series of 12 Volts can be coupled in parallel so that they can be charged to the full on a 12-16 Volt Charging Plant.

EASY TERMS OF PAYMENT.—Sold in U.K. on Monthly Payments extended over a period. Apply for particulars.

**TUNGSTONE ACCUMULATOR CO., LTD.,** The Independent Battery of the British Empire,  
3, St. Bride's House, Salisbury Square, London, E.C.4.

Mention of "The Wireless World," when writing to advertisers, will ensure prompt attention.

G

B4

# THE FERRANTI SPEAKER



**PRICE £3-3-0**

**THE SPEAKER WITH THE EXPONENTIAL HORN  
MANCHESTER RADIO EXHIBITION—STANDS 59 and 60**

**FERRANTI ELECTRIC  
LIMITED,  
TORONTO, CANADA.**

**FERRANTI LTD.,  
HOLLINWOOD,  
LANCASHIRE.**

**FERRANTI INC.,  
BUSH TERMINAL BUILDING,  
N.Y. CITY, U.S.A.**



*Prices :*

Without Terminals 2/3

With Terminals 2/6

Combined Grid Leak and Terminal Valve Holder 3/9

# Look to your Valve Holders !

**I**F your reception is unsatisfactory or weak, if it is spoiled by constant irritating noises, look to your Valve Holders.

See that they are guaranteed to absorb shock and eliminate all microphonic noises, because that IS where the fault lies.

The Lotus Valve Holder is constructed to give immediate and lasting connection when the valve pins enter the valve sockets. The leg sockets expand and automatically lock, and the floating platform in which they are fixed is suspended by four phosphor bronze springs, which have great mechanical strength and at the same time are sufficiently resilient to absorb any external shock that would cause damage to the valve.

Carefully made from the finest bakelite mouldings, with phosphor bronze leg sockets, every Lotus Valve Holder undergoes strict tests before leaving the factory, and can be relied on to withstand a great deal of rough usage.

**LOTUS**  
BUOYANCY  
**VALVE HOLDER**  
ANTI-MICROPHONIC

Made by the makers of the famous Lotus Remote Control, Vernier Coil Holders, Jacks, Switches and Plugs.

GARNETT, WHITELEY & CO., LTD.

"Lotus Works" - Broadgreen Road, Liverpool

**ABSORBS SHOCK—ELIMINATES MICROPHONIC NOISES**

CAUSTON.

*Mention of "The Wireless World," when writing to advertisers, will ensure prompt attention.*

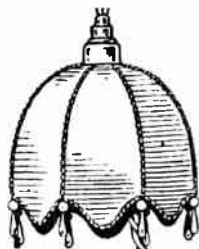

# For working entirely off the E.L. Mains

The illustration shows the new Met-Vick 5 with the eliminators contained in the side cupboards. It can be plugged into a lighting circuit just like any other Electric appliance. If used with H.T. and L.T. batteries these can be accommodated in the cupboards. The circuit employs two phase-balanced and stabilized H.F. stages before the detector, and two resistance coupled L.F. stages.

Operation is extremely simple, the local station can be easily cut out and a wide range of alternative programmes obtained. Special attention has been paid to running costs which are remarkably low.

The Met-Vick 5 is a really beautiful instrument and while a distinct advance on any 1926 model it still remains at a reasonable price. Obtain Leaflet 4117/9 for complete range of prices.

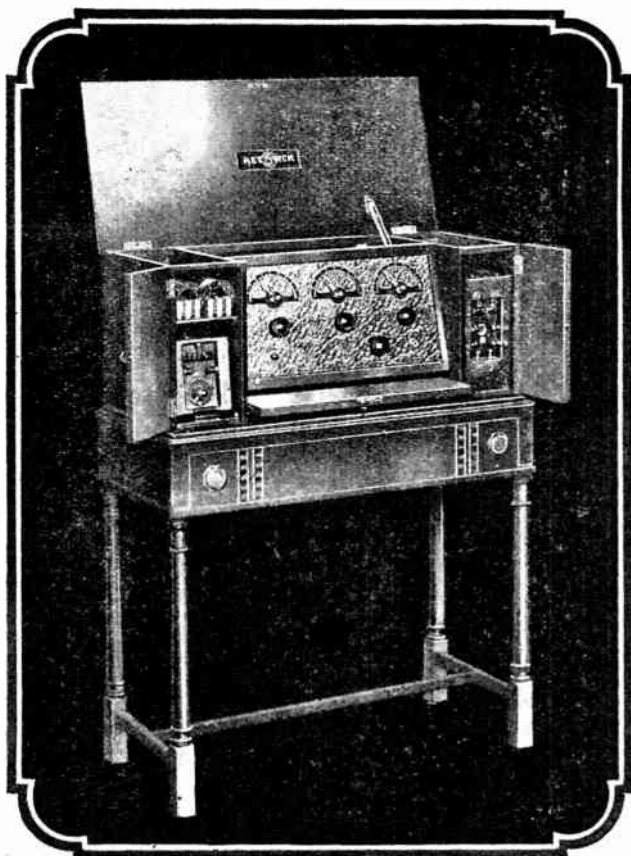

## Battery Eliminators

Met-Vick Battery Eliminators are supplied in two models, one for providing filament current and the other for anode and grid currents, by plugging in on electric light mains. *The H.T.-G.B. Model* provides a high voltage (up to 250 V.) for the last valve (ensuring a large volume without distortion). It is fitted with a switch, a protective fuse and a distributor panel enabling it to be used on various supply voltages of 40-100 periods. Grid Bias tappings at 5, 10, 15 and 20 volts.

The smoothing system is of exceptional efficiency. The eliminator can therefore be used successfully with multi-valve and the most sensitive sets even in districts where there are considerable irregularities in the electrical supply.

*The L.T. Model* gives an output of 5 amperes at 4 volts and a potentiometer ensures complete absence of hum. Obtain copy of List 7117/8.



# MET-VICK

(COSMOS)

METRO-VICK SUPPLIES LIMITED

(Proprietors: Metropolitan-Vickers Elec. Co. Ltd.)

155 Charing Cross Road - LONDON, W.C. 2

See them on the Met-Vick Stands Nos. 34 and 35 Manchester Radio Exhibition October 24 to Nov. 5



**It's an Easy Step - from Workbench to Drawing Room!**

**We supply the  
MH DIMIC THREE**

Complete in Mahogany Case at the special price of

**£11**

Royalties 4s. 17d. extra.

**THE MH 1928  
DIMIC FOUR RECEIVER**

The 1928 Dimic Four (one H.T., one det., two L.F.) embodies many marked improvements. The Components have now been arranged in a dust-proof compartment underneath the baseboard, the upper range coils (Davenport, Radio Paris, etc.) being fixed permanently, but the lower range Dimic Coils being plugged in as required on the upper surface of the baseboard.

The redesigned dark oak cabinet contains space for H.T. and grid bias batteries, while two handy terminals connect easily to an exterior accumulator. Extra terminals facilitate connection with a gramophone pick-up attachment, utilising the amplifying valves to reproduce records on the loud speaker.

**PRICE 17 GNS.**

Royalties  
4s. 17d. Extra.

The simplicity in building this fine receiving set is a joy, equalled only by the pride you will take in the finished article.

Its handsome exterior is an ornament to the Drawing Room—its capabilities in point of Tone, Power and Range will meet with rapturous praise from friends and family alike.

**THE MH HOME ASSEMBLY  
'DIMIC THREE'**

Complete working instructions for the construction of this unique Three-Valve Receiver, together with Diagrams, Illustrations and Full-sized Blueprint Layout of Components, will be supplied on request, price 1.-.

The Home Constructor, following out the details and instructions contained therein, will be possessed of a first-grade set, giving alternative programmes from distant stations, with ease of control, simplicity in wave-length change, and built with components of distinction, of British manufacture and carrying a definite guarantee.

We supply the complete set of parts, including Panel (polished, engraved and drilled), all screws, terminals and connecting wire for the price of

**£7 : 8 : 6**

Cabinet from **£1 : 6 : 6.**

Baseboard only (if desired), 3s. 6d.

Telephone:  
SLOUGH  
441-442

**L.M. MICHAEL LTD**

Manufacturers of Wireless and Scientific Apparatus  
**WEXHAM ROAD, SLOUGH, BUCKS**

Irish Agents: B.N.B. Wireless Ltd., Dublin & Belfast.

Telegrams:  
Radiether,  
SLOUGH

**WE ARE EXHIBITING AT THE MANCHESTER RADIO EXHIBITION, OCT. 24-NOV. 5.**



# At Manchester be sure and see—

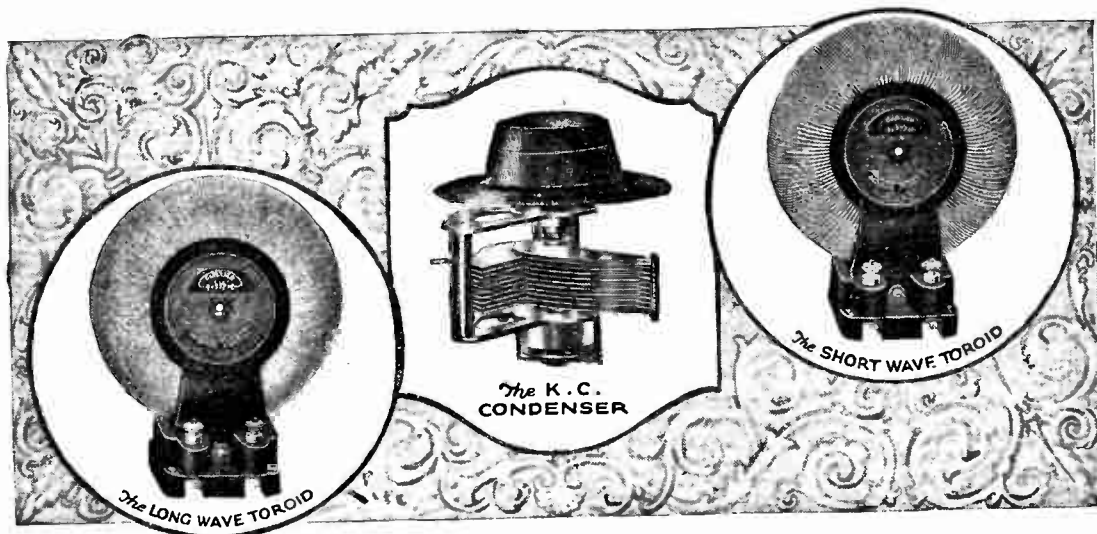

## the Toroids and the K.C

**T**HE Dubilier Stands at the Manchester Exhibition (October 24th to November 5th) are Numbers 69 and 70. Here will be seen all the new Dubilier Products which attracted so much attention at Olympia. The K.C. Variable Condenser, stated by many to be the 'finest variable wireless has ever seen,' and selling at **12/-** complete with 200 to 1 slow motion drive, will be shown. So will be wonderful 'fieldless' Toroids which make highly selective tuning couplers, which, when used as H.F. Transformers, eliminate all necessity for screening and give utmost stability on account of their non-pickup qualities. They cost **10/6** each complete with terminal base.

Then there are the Dubilier R.C. Coupling Unit at **7/-**, a complete range of H.T. Supply Units to suit various voltages and frequencies as well as for D.C. Mains, the unique Dubilier electrostatic Gramophone pick-up at **35/-**, a range of Filament resistors, and, finally, the Dubilier Mansbridge and Mica Condensers and the Dubilier Resistances which are famous wherever Radio is known.

Do not miss an opportunity to see this most comprehensive exhibit, but if you are unable to get to Manchester, a postcard to us will bring you our new Catalogue in which all these products are fully described—may we send you a copy?

Your Dealer  
Stocks



Products—  
Ask him.

*Advt. of The Dubilier Condenser Co. (1925) Ltd., Ducon Works, North Acton, W.3.*

TC 57

# Successful H.F. Amplification on 15 metres!

## A remarkable IGRANIC achievement.

Although wonderful reception on short waves has been obtained with simple receivers employing a detector in conjunction with an L.F. amplifier, it has long been realised that if it were possible successfully to employ H.F. amplification on very short wavelengths, reception of short wave signals over very great distances could be accomplished with a greater degree of certainty.

Igranic Radio Engineers have, after considerable research and experiment, succeeded in overcoming the difficulties associated with H.F. amplification of short waves, and it is now possible to employ H.F. amplification on wavelengths as low as 15 metres with complete efficiency. What is more important, these results are not confined to laboratory experiments conducted by expert radio engineers, but can be repeated by any radio constructor with the aid of the Igranic Neutro-regenerative short wave amplifier and other standard radio components.

The Igranic Neutro-regenerative Amplifier Outfit is unique in that it is the first outfit of parts offered to the public which permits of successful H.F. amplification on very short wavelengths.

The secret of the remarkable results which are made possible by the use of this outfit lies in the specially-designed H.F. Transformers, Chokes and Screens, and provided that the constructor follows carefully the instructions which are issued with each outfit, he may build himself a three-valve or four-valve receiver capable of giving efficient H.F. amplification on wavelengths from 15 to 70 metres approximately.

The Igranic Neutro-regenerative Short Wave Amplifier Outfit comprises the following components:—

- 2 Special H.F. Transformers (15-40 metres).
- 2 Mounting Bases for same.
- 2 Aluminium Screening Plates.
- 2 Special Short Wave H.F. Chokes.

Excellent loud-speaker reception has been obtained from various American Short Wave Broadcasting stations and the recent experimental transmission from 2 FC Sydney, Australia, was picked up direct by a receiver incorporating the Igranic Neutro-regenerative Amplifier Outfit with very gratifying results. Further, it is quite possible to receive at good loud-speaker strength over great distances, short wave broadcasting stations which cannot be received satisfactorily on an ordinary short wave receiver.

For full particulars of this wonderful new Igranic Outfit, write for a copy of Leaflet U226, which describes it.



**IGRANIC NEUTRO-REGENERATIVE  
SHORT WAVE AMPLIFIER OUTFIT.**

Complete with H.F. Transformers for wave- lengths from 15-40 metres approx ..... **£2 5s.**

**ADDITIONAL H.F. TRANSFORMERS**

for wavelengths from 30-70 metres approx. .... **19/-**  
per pair.

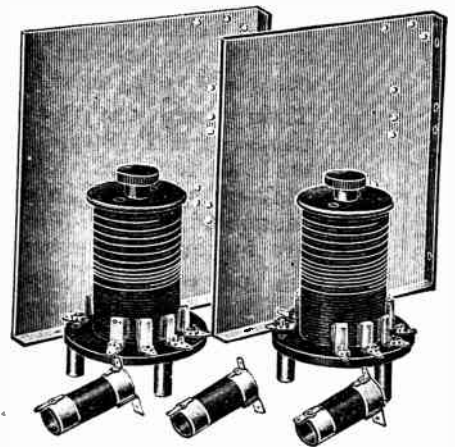

**THE PARTS COMPRISED IN THE OUTFIT.**

**IGRANIC ELECTRIC CO., LTD.,**  
149, Queen Victoria Street, London, E.C.4.

Works: BEDFORD.

Branches: **BIRMINGHAM, BRISTOL, CARDIFF, GLASGOW, LEEDS, MANCHESTER, NEWCASTLE.**

Mention of "The Wireless World," when writing to advertisers, will ensure prompt attention.

# TWO WONDERFUL BULLPHONE UNITS AT 15/- Each.

## EACH A MASTER OF ITS KIND

Firstly the Gramophone Unit which is reduced from 32/6 to meet a public demand, and secondly the

### NEW WONDER CONE UNIT

with Balanced Armature. A great surprise awaits you!

Purchase a sheet of 3-ply 3ft. square. Cut a hole in centre 12½" in diameter and make your own cone from instructions supplied with each unit or send 2/- for the Bullphone Paper Cone as fitted to our own speakers.

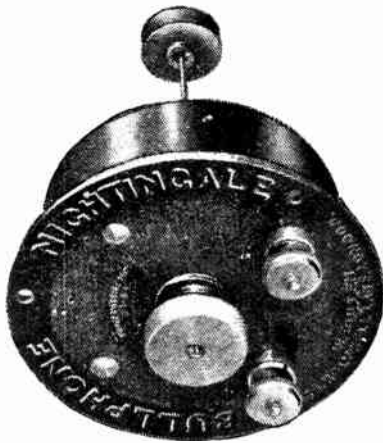

AS FITTED TO OUR CABINET CONE

This unit has a 4" diaphragm and is fitted with laminated pole pieces and cobalt magnet, the magnetism of which is guaranteed for all time, no matter how frequently it may be dropped or how roughly treated.

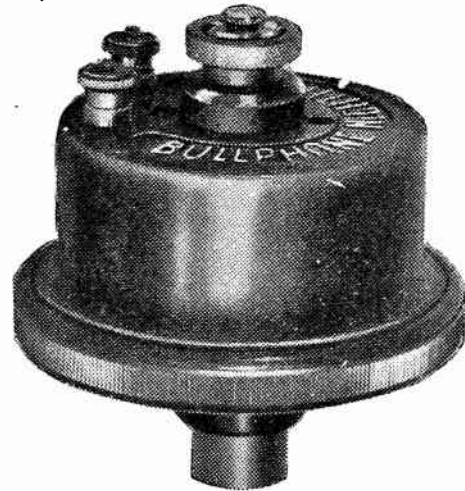

AS FITTED TO OUR £6 POST HORN



26" HIGH  
BELL MOUTH 14½"  
INSHEED IN  
MAHOAGANY

SOUND CONDUIT & TONE ARM

GUARANTEED FREE FROM METALLIC RESONANCE

SUPER

63/- cash, or EASY TERMS  
7/6 deposit and 12 monthly payments of 5/-



CABINET CONE

77/6 cash, or EASY TERMS  
12/- deposit and 12 monthly payments of 6/-



DE LUXE

57/6 cash, or 5/- deposit and 12 monthly payments of 5/-

Deferred Payments. All Speakers supplied on first payment. No references required.

Send your deposit now to your local dealer or direct to

BULLPHONE, 38, HOLYWELL LANE, LONDON, E.C. 2.

EVERYTHING **The G. E. C.** ELECTRICAL  
your guarantee



**L.F. TRANSFORMER FACTS**  
*Performance*

GECOPHONE L. F. TRANSFORMERS give results as neat perfect as it is possible to obtain. With a good loud-speaker such as the GECOPHONE CONE, the purity and natural tone is amazing, and sets using them have been given unstinted praise by such famous artistes and musicians as Dame Clara Butt, Miss Edith Day, Albert Sammons, De Groot and many others.

**Reduced Prices**  
Ratio 2-1 ... 17/6      Ratio 4-1 ... 20/-  
MADE IN ENGLAND

**GECOPHONE**

**L.F. TRANSFORMERS**  
*for volume and purity*  
Sold by all Wireless Dealers and Stores.

Agents of The General Electric Co., Ltd., Magnet House, Kingsway, London, W.C.2.

Mention of "The Wireless World," when writing to advertisers, will ensure prompt attention.

**WESTON**

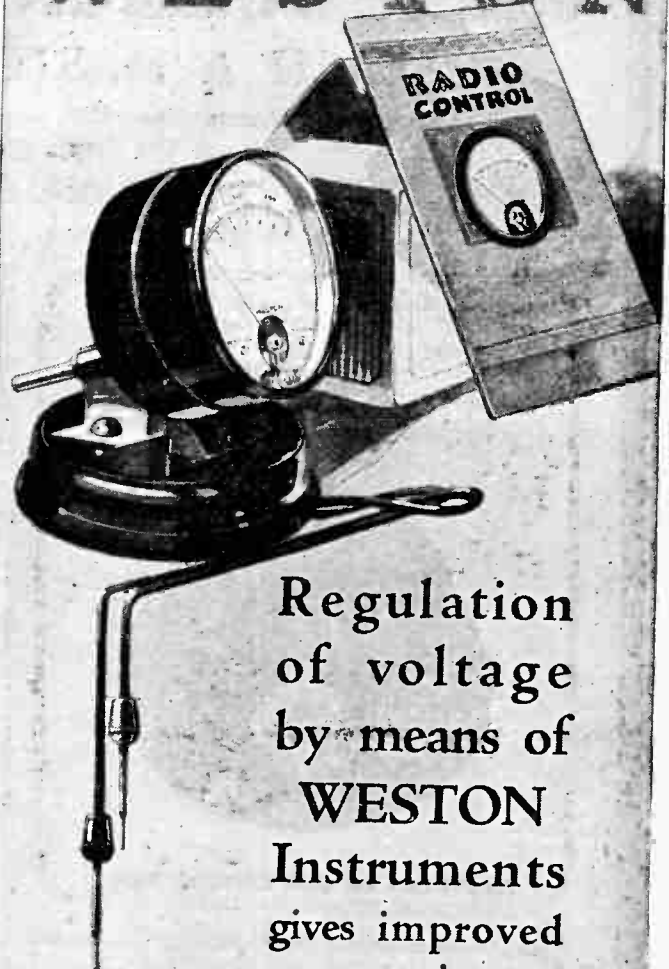

Regulation of voltage by means of **WESTON** Instruments gives improved reception

To obtain maximum results from your receiver you must be sure that the H.T., L.T. and G.B. voltages are regulated correctly. For an exact measurement of these variable voltages use a Weston Pin-Jack Voltmeter with high-range stand. Only the Weston standard of accuracy and reliability is sufficiently fine to be of any use for such measurements.

The Weston free booklet "Radio Control" explains the necessity for accurate electrical control of your radio receiver and gives much helpful advice. Let us have your name and address.

**MODEL 506 Pin-Jack Voltmeter complete with high range stand and testing cables £2:10:0**

**WESTON**

STANDARD THE WORLD OVER

Pioneers since 1888

Weston Electrical Instrument Co. Ltd.  
15, Gr. Saffron Hill,  
London, E.C. 1

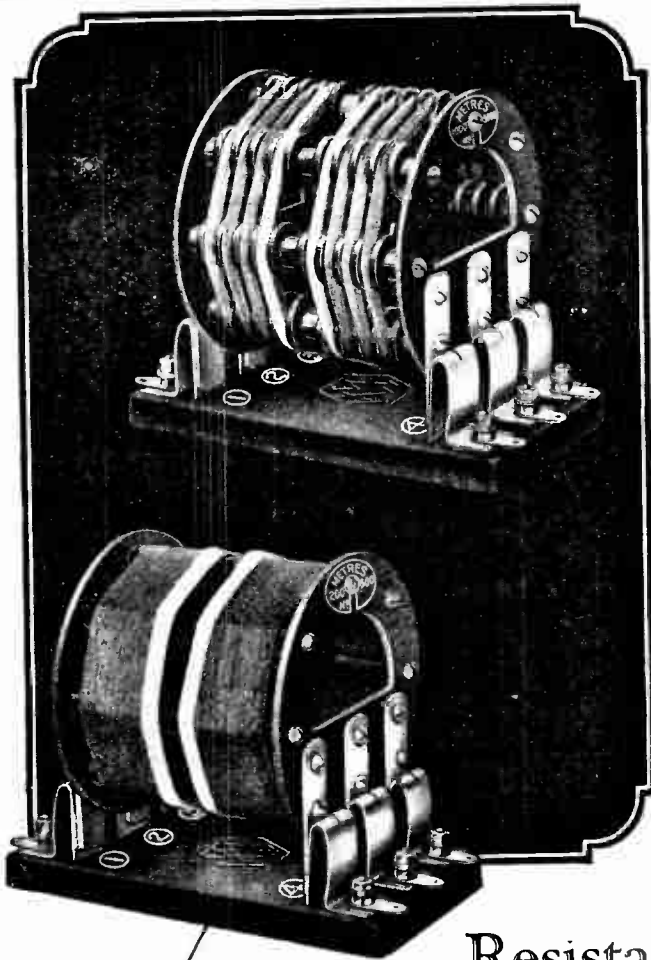

# A·N·P (Astatic-Non-Parasitic) Coils

A CLEVER SOLUTION OF A  
DIFFICULT PROBLEM.

Patents pending.

Designed to overcome in a simple manner the three difficulties associated with high frequency amplification namely: Magnetic coupling between coils, Stabilisation, and Parasitic Oscillation. The first named is prevented by Astatic winding, obviating the necessity for metal screens with their disadvantages, the second is obtained by centre and quarter-tappings accommodating valves of various impedances, and the third is avoided by balanced self-damping windings, thus dispensing with the expensive double condenser and resistance method previously used.

List 4117/8 gives full details and prices.

## Resistance Coupling Units

Thousands of radio enthusiasts are loud in their praises of "Cosmos" (Met-Vick) Resistance Coupling Units. LF stages coupled by means of these Units result in clear Loud Speaker reproduction without distortion. The 'V' type unit can now be supplied fitted with the new 'Met-Vick' A.C. Valve Socket for use when building a set for working off the E.L. mains. The A.C. Valve-socket is also supplied separately for panel or baseboard mounting. Obtain List 7117/8 for full details and prices.

## MET-VICK

(COSMOS)

METRO-VICK SUPPLIES LIMITED

(Proprietors: Metropolitan-Vickers Elec. Co. Ltd.)

155 Charing Cross Road : : LONDON, W.C 2

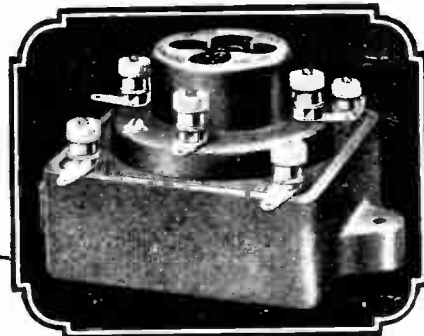
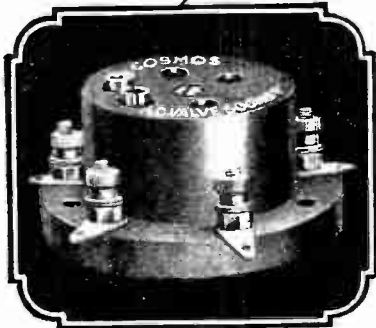

R  
P88

See them on the Met-Vick Stands Nos. 34 and 35 Manchester Radio Exhibition October 24 to Nov 5

# free

Cossor's great scheme  
to bring Alternative  
programmes to all

THE new B.B.C. Alternative programmes demand a new standard in Receiver performance. Only the Receiving Set which is 'Razor-sharp' in tuning will be sufficiently selective to tune out the unwanted local station in favour of the one which is required. Appreciating this the makers of Cossor Valves have made it easy for everyone to own a Receiving Set which has been specially designed to meet these new conditions of Radio. The wonderful new Cossor 'Melody Maker' is not only highly selective but, as its name implies, it gives amazingly clear and true to life reproduction. It is a real 'alternative programme' Receiver, for if its owner is dissatisfied with B.B.C. programmes a large number of Continental Stations in France, Holland, Germany, Italy, Spain and Switzerland are always available at full loud speaker strength.

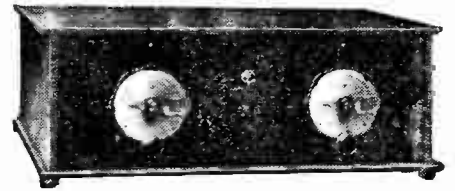

The wonderful  
Cossor "Melody Maker"

Build the  
wonderful

# COSSOR "Melody Maker"

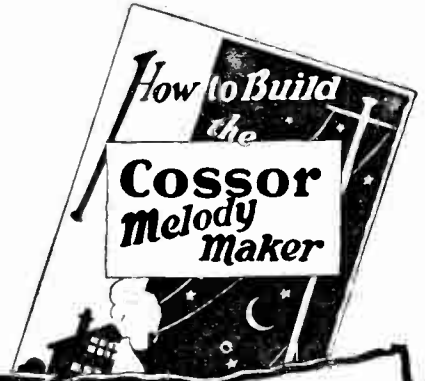

To A. C. Cossor Ltd., Highbury Grove, London, N. 5  
Please send me free of cost your constructional system  
"How to build the Cossor "Melody Maker."

Name .....

Address .....

W.W. ....

Advt. of A. C. Cossor, Ltd., Highbury Grove, N. 5.

Mention of "The Wireless World," when writing to advertisers, will ensure prompt attention.

# The Wireless World

AND  
RADIO REVIEW  
(15<sup>th</sup> Year of Publication)

No. 426.

WEDNESDAY, OCTOBER 26TH, 1927.

VOL. XXI. No. 17.

Editor : HUGH S. POCOCK.

Assistant Editor : F. H. HAYNES.

Editorial Offices : 139-40, FLEET STREET, LONDON, E.C.4

Editorial Telephone : City 4011 (3 lines).

Advertising and Publishing Offices : DORSET HOUSE, TUDOR STREET, LONDON, E.C.4.

Telephone : City 2847 (13 lines).

Telegrams : "Ethaworld, Fleet, London."

COVENTRY : Hertford Street.

BIRMINGHAM : Guildhall Buildings, Navigation Street.

MANCHESTER : 199, Deansgate.

Telegrams : "Cyclist Coventry."  
Telephone : 8210 Coventry.

Telegrams : "Autopress, Birmingham."  
Telephone : 2970 and 2971 Midland.

Telegrams : "Iliffe, Manchester."  
Telephone : 8970 and 8971 City.

Subscription Rates : Home, 17s. 4d.; Canada, 17s. 4d.; other countries abroad, 19s. 6d. per annum.

*As many of the circuits and apparatus described in these pages are covered by patents, readers are advised, before making use of them, to satisfy themselves that they would not be infringing patents.*

## TRESPASSING.

MINOR matter, perhaps, but, nevertheless, one which we feel should not be allowed to pass without comment, relates to the attitude of the B.B.C. towards school radio and the undoubtedly well-intentioned efforts of the technical staff of the Corporation to improve reception conditions in educational centres. Some time back the B.B.C. demonstrated and described receivers of their design which they explained were typical sets suitable for reception under different conditions, and these sets, we understand, are those which they have recommended for use in schools. A pamphlet for the use of schools has recently been put out by the B.B.C., in which much helpful information on reception is given, and this is useful, but the B.B.C. has taken on itself to give estimates in the pamphlet of what should be the cost to a school of suitable equipment for reception. There is, perhaps, no particular objection to the B.B.C. giving this advice in this instance, but, if pushed to its logical conclusion, this attitude really amounts to an attempt on the part of the B.B.C. to dictate to the manufacturer the price at which he should sell his sets; and this surely is not a legitimate extension of the activities of the B.B.C.

Again, still considering the relation of the B.B.C. towards school reception, we find that the B.B.C. has been involved in the setting up of a small new department in order to advise on the apparatus for schools to use and with travelling engineers available to visit schools where educational transmissions are received. No doubt, this is an admirable service in its way, but is it right that the B.B.C. should so lay itself open to criticism for coming directly across the path of the legitimate services which have been established by skilled wireless men all over the country to earn a living by attending to faults in receivers and acting as consultants where improvements in reception are desired? We know the reply could be that the B.B.C. cannot trust many of the local service agencies to do the job properly, and we suppose they

will also prefer that sets of their own design should be installed rather than those supplied by manufacturers, but these arguments are beside the point; it is just a question of principle where we think the B.B.C., no doubt inadvertently, have overstepped the bounds.

That the B.B.C. is conscious of the position when attention is drawn to it was indicated only recently when, replying to a correspondent's letter published in *The Wireless World*, the B.B.C. expressed the view that they should never enter into competition with the legitimate manufacturer of sets by undertaking to manufacture sets themselves.

The whole question of what limits should be put on the encroachments of the B.B.C. into the preserves of the industry is an important matter which could usefully form the subject of correspondence from our readers, whose views would be welcomed.

o o o o

## EMPIRE BROADCASTING.

THE interest in Empire broadcasting remains as keen as ever, although since the assurance given by the B.B.C. that they would have a station ready for tests in October there has been a truce, as it were, to give the B.B.C. a chance of demonstrating their good intentions. There is still, however, a feeling of mistrust of the B.B.C., in spite of their assurances as to the genuineness of their desire to conduct a service, and this feeling, we are afraid, was enhanced by the ill-success of the Australian re-broadcast attempt recently, which was discontinued just at the time that reception conditions began to improve to such an extent that had the B.B.C. continued for another half-hour the re-broadcasting could then have been regarded as a success rather than a failure. Failures, of course, go to support the pessimistic attitude which the B.B.C. has adopted all through in regard to Empire broadcasting; a really successful re-broadcast, on the other hand, might be construed as an unfortunate piece of evidence in support of the arguments of those who persist in demanding that an Empire broadcasting station should be established.

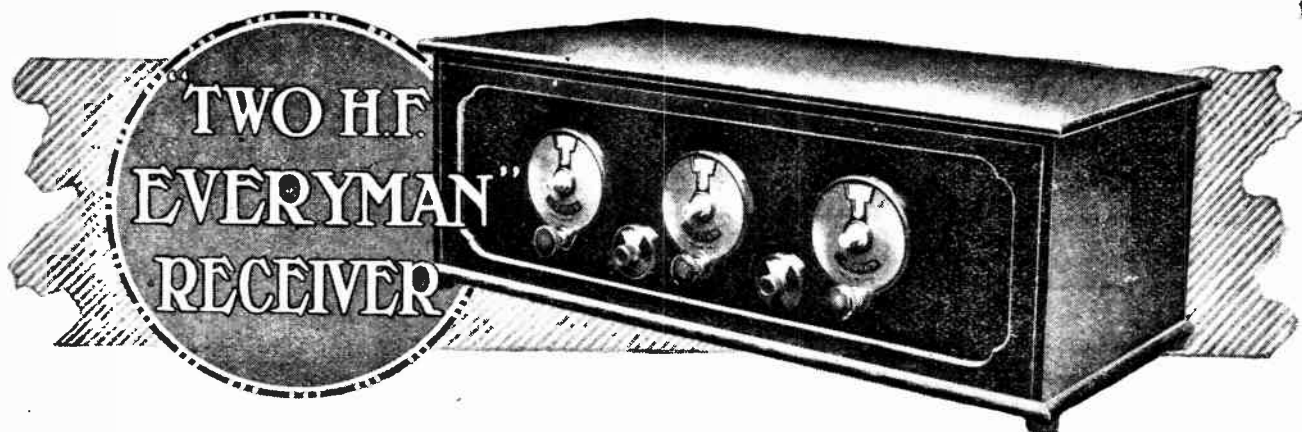

## A Broadcast Receiver for the Long and Short Wavelengths.

By W. JAMES.

**A**BOUT fifteen months ago the writer described the "Everyman Four" receiver in this journal. The set was built to give the utmost magnification from four valves with ease of control and a quality of reproduction acceptable to the careful listener. Every part used in the set was examined, and every factor then known to the writer as likely to influence the magnification was considered, with the result that even to-day the set has few rivals. Particular interest attaches to the unique construction of the high-frequency transformers used. These had a secondary of high-frequency cable, with fine wire primary windings wound over strips of ebonite laid on one end of the surface of the secondary.

Everything was done to ensure the success of these transformers. They were fixed in the set with an adequate shield. Losses were reduced to the practical minimum, and under the conditions specified they gave so much magnification that adjustable reaction was not required. The set will receive a large number of distant stations. But it has one drawback: it covers only the 200 to 550 metres band of wavelengths. The high-power stations working between 1,000 and 2,000 metres cannot be received. Listeners living in coastal districts cannot use this powerful set to the best advantage because of spark station interference, and amateurs who have built the set and learned what a carefully designed four-valve receiver will do now wish to cover all broadcast wavelengths with equal effectiveness.

The problem of how best to build a receiver tuning over the two broadcast bands was therefore considered. The simple expedient of fitting the "Everyman Four" type of high-frequency transformer with plugs, and providing a base with sockets, was regarded in the light of a compromise. For this involves the use of an ebonite support for the plugs with a similar support for the sockets of the base. This introduces losses which reduce their efficiency, besides which, the fragile construction of the transformer renders them not suitable to be handled, as they

must be when they are made changeable. The transformers were intended to be mounted in a set where their delicate construction would be no handicap, and, in fact, electrical efficiency alone was considered when arriving at the final design.

When it was decided to build an all-wavelength broadcast receiver, the writer thought it desirable to begin afresh. He had to face a new set of conditions. To cover all broadcast wavelengths, changeable coils are necessary; therefore they must be strong enough safely to withstand pushing, pulling and knocking about. The circuit, too, must be a safe one, with no high tension on the coils to give trouble; and the fact that the balancing condenser of the "Everyman Four" sometimes short-circuits, with disastrous effects to the fine windings, was remembered.

The new conditions of broadcasting demand a set having rather better selectivity than has the "Everyman Four." It was therefore decided to use two completely shielded stages of high-frequency amplification and to

design coils which, whilst mechanically sound, would result in the overall selectivity being better than that of the "Everyman Four" for about equal amplification, as it was felt that the magnification given by an "Everyman Four" was all that is necessary for modern conditions. But, as a matter of fact, distant stations are heard louder with the new set; they are clearer, and the more powerful stations are received at such strength as to overload the output power valve unless the volume control is turned well down.

The new receiver is therefore definitely better than the "Everyman Four," although it costs a little more to make and is not quite so easy to tune. It also receives five or six long-wave stations at good loud-speaker strength, and the circuit is so designed that once the balancing condensers are set on the short waves they do not have to be touched when the long-wave coils are plugged in.

*The "Two H.F. Everyman" Receiver has four valves, and tunes from 240 to 600 metres with one set of coils, and from 1,000 to 2,000 metres with the second set. High amplification, with good selectivity and perfect stability, are the features of the set. It is very easily constructed, and uses a new design of high-frequency transformer which gives high amplification, whilst being sufficiently robust for plugging-in.*



"Two H.F. Everyman" Receiver.—

The circuit finally arrived at is given in Fig. 1. An aerial-grid high-frequency transformer  $L_1$  is used to couple the aerial and the grid of valve  $V_1$ . Its primary winding is tapped and connected to terminals  $A_3$  and  $A_2$ . Aerial terminal  $A_1$  is connected to the tap on the coil through the fixed condenser  $C_1$ ; this is therefore the most selective connection. With these three alternative aerial connections the input transformer can be used to best advantage with long and short aerials and when the set is used near a broadcast station or a long way from one. The secondary winding of this transformer is tuned by

$NC_1$  is mounted on the panel, but insulated from the copper box. Transformer  $I_2$  therefore has three windings, three ends of which are connected together and to negative L.T., while the other three ends go to the grid, anode condenser and balancing condenser. The circuit is therefore so arranged that no high-tension current passes through the coils and none is applied to the balancing condenser. The second stage is made up in the same way as the first, except that valve  $V_3$  is the detector and has a grid condenser and leak  $C_7, R_2$ . To the anode of the detector the primary winding of transformer  $T_1$  (having a built-in by-pass condenser) is connected, and its

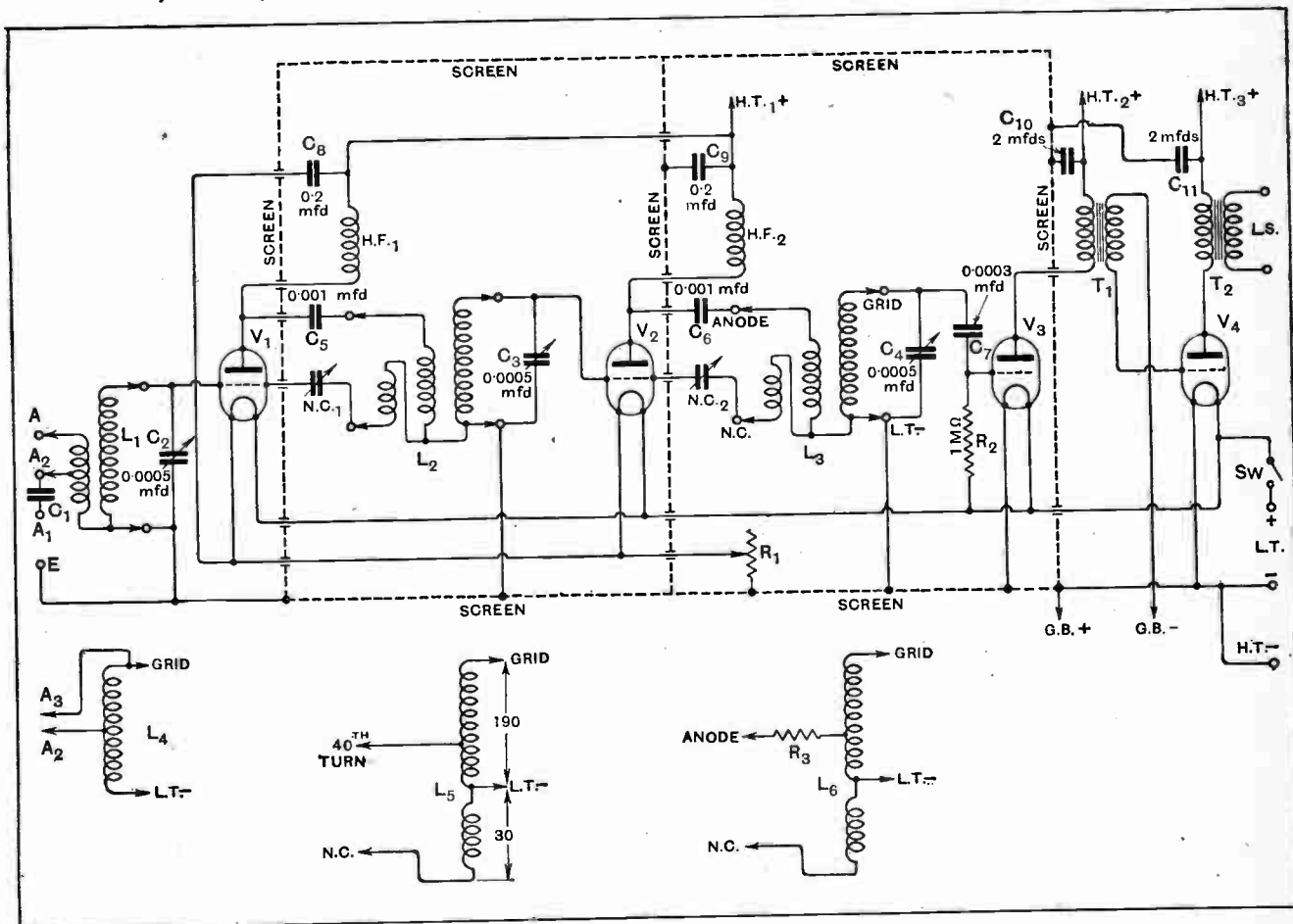

Fig. 1.—Circuit of the receiver showing the lower broadcast wavelength coils connected. The three long-wave coils are shown below. The following parts are used:  $C_1$ , .001 mfd. fixed condenser;  $C_5$ , .001 mfd.;  $C_6$ , .001 mfd.;  $C_7$ , .0003 mfd.;  $C_8$ , .2 mfd.;  $C_{10}$ , 2 mfd.;  $C_{11}$ , 2 mfd.;  $C_2, C_3, C_4$ , .0005 mfd. tuning condensers;  $R_1$ , 30-ohm rheostat;  $R_2$ , 1-megohm grid leak;  $R_3$ , 2000-ohm non-inductive resistance;  $T_1$ , 3.5 to 1 transformer with built-in condenser;  $T_2$ , output transformer.

a .0005 mfd. condenser and has its ends joined to the grid and negative L.T., the grid being biased negatively by an amount equal to the fall in voltage over the volume control rheostat  $R_1$ .

To the anode of the first valve is connected a high-frequency choke coil  $HF_1$  and by-pass condenser  $C_8$ , and also the coupling condenser  $C_5$  and the primary winding of transformer  $L_2$ . This transformer and valve  $V_2$  is included in the first section of the copper box. The transformer has a balancing winding connected through a balancing condenser  $NC_1$  to the grid of the first valve;

secondary is joined to valve  $V_4$ . This valve has a loud-speaker transformer  $T_2$ .

Volume is controlled by the rheostat  $R_1$ . When more resistance is put in the circuit the current through the H.F. valve filaments is reduced and the negative grid bias is increased, with the result that the impedance of the two H.F. valves goes up. The amplification is therefore reduced, and can be very nicely varied by this simple means.

The leaky grid method of rectification was used in order that a high-impedance detector valve could be

**"Two H.F. Everyman" Receiver.**

employed with transformer coupling. The new type Ferranti transformer has a primary inductance of about 140 henries under working conditions, and at fifty cycles its impedance is over 44,000 ohms. An RC type of valve used as a grid rectifier with ample H.T. has an A.C. resistance of about 50,000 ohms; a 50-cycle note is therefore amplified nearly 70 per cent. of the full amount, which is very satisfactory. Incidentally, such a valve has an amplification factor of about 50, and the stage magnifies 175 times. It is therefore very easy to obtain full loud-speaker strength with the one stage of L.F. amplification.

A leaky grid rectifier also has the advantage that it is more sensitive to weak signals than an anode bend detector, and it cannot be said to distort very much because of the values of fixed condenser and grid leak used. These are .0003 mfd. and 1 megohm, with the return end of the grid leak connected to positive L.T. The tuning of the third high-frequency circuit is, of course, made broader by the leaky grid rectifier, but this is an advantage as it makes tuning easier. Transformers  $L_1$  and  $L_2$  are so sharply tuned that with the extra tuning provided by  $L_3$  the set is quite selective enough for ease of handling.

The three coils are provided with four contact pins, three being mounted at one end of the tube carrying the windings, with the fourth contact at the other end. This last contact fits in the socket which is connected to the grid and is therefore well spaced from the other contacts which fit in sockets connected to the filament, anode condenser and balancing condenser. Negligible loss is introduced by having these three contacts near one another, for only a fraction of the full high-frequency voltage developed across the secondary is between them. In the same way, the high-frequency choke which shunts the primary winding does not cause an appreciable loss, because its impedance is high compared with the effective resistance of the primary winding.

The form of construction adopted has therefore the advantage of requiring four contacts instead of the usual five, and since no high tension is applied to any of the windings the circuit is a perfectly safe one.

**Long-wave Circuit.**

The long-wave coils are rather different in construction, although they have much the same external appearance. These coils are shown below the circuit of Fig. 1. That on the left is the long-wave aerial coil and is marked  $L_4$ . It has a single winding with a centre tap which connects to  $A_2$ , while terminal  $A_3$  goes direct to the grid end. Transformer  $L_5$  is a single-layer winding with a tap for the primary and balancing circuits. The last long-wave transformer,  $L_6$ , is the same as  $L_5$  except that it has a non-inductive resistance,  $R_3$ , connected between the tap on the coil and the anode contact. This resistance is therefore in series with the primary portion of the winding.

During the course of experiments with the long-wavelength coils it was found that the amplifier tended to oscillate at a very high frequency; with one form of construction violent oscillations of about 5,000,000 cycles were gener-

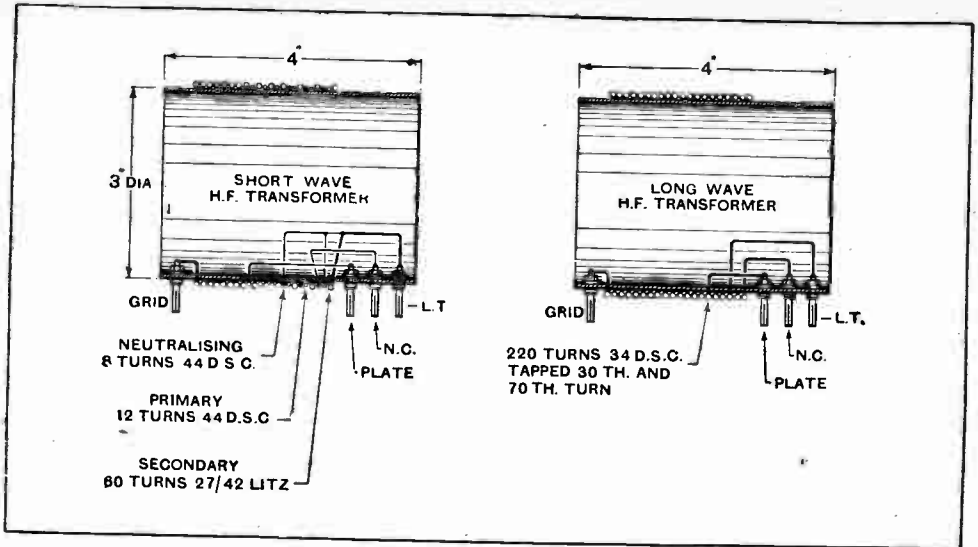

Fig. 2.—Construction of the long and short wave transformers. Two each are required, with formers of Radlon or Paxolin tube.

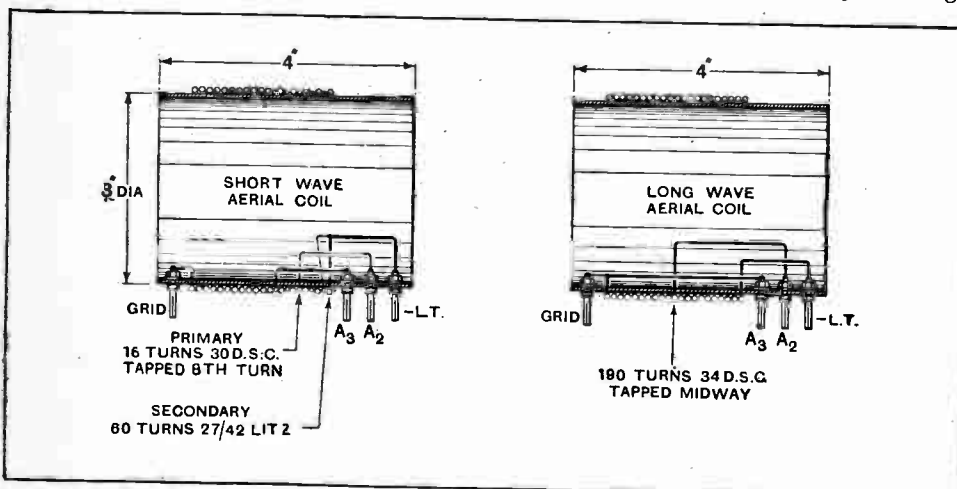
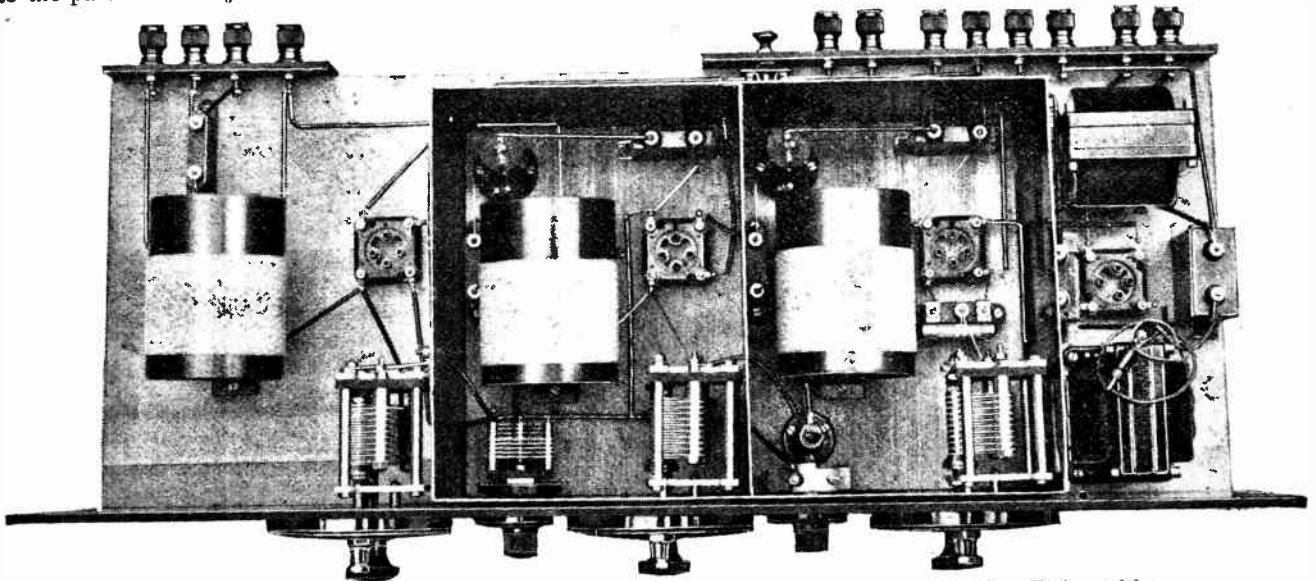

Fig. 3.—The aerial-grid coils for long and short wavelengths.

**"Two H.F. Everyman" Receiver.—**

ated. This was due to the circuit formed by the primary portion of the coil, the balancing winding and the neutralising condenser, and the frequency was controlled to some extent by the setting of the balancing condenser. To prevent these spurious oscillations it was found necessary to include a resistance in series with either the primary or the balancing windings, and it was decided to connect it as indicated in the diagram. This has the effect of stopping these spurious oscillations, but does not materially affect the working of the transformer, for the resistance used, 2,000 ohms, is small compared with the anode impedance of the valve with which the transformer is associated and also the working impedance of the primary of the transformer. This resistance was not found necessary when using the short-wavelength coils, and for this reason was not included in the set itself; it is arranged to the part of coil  $L_6$ .

sacrificing amplification and selectivity, but it has been done. When designing these transformers it was soon found that better results were obtained with this form of construction by using a smaller secondary coil and a larger tuning condenser, for the shunting effects of the material used in the coil base and for the former then has less effect, while the formation of the windings tends to give a uniform amplification-frequency curve. In the original "Everyman Four" transformer the writer spread the primary and balancing windings over a comparatively large part of the secondary in order to obtain the optimum magnetic coupling, and this made it necessary carefully to space the windings in order to make capacitative currents as small as possible. In the new design the primary is wound with its turns touching the turns of the secondary. In effect, the primary is one of the wires of the stranded conductor itself, with the result that there is no capacity current. The difficulty, of



Plan view of the set with the lid of the copper box removed to show the short-wave plug-in coils in position.

The most interesting feature of this receiver, no doubt, is the high-frequency transformers. These were designed to be mechanically sound, and at the same time to have a high electrical efficiency. The capacity between the balancing and other windings has been minimised by the use of a very fine wire, gauge No. 44 D.S.C., and instead of the 1 to 1 turns ratio of primary and balancing windings, the ratio has been made  $1\frac{1}{2}$  to 1 for the short-wave coils. This can be done with very satisfactory results in this new form of construction because the primary and balancing windings are so tightly coupled, and the whole transformer has been so designed that perfect stability with high amplification is assured.

**Construction of the Coils.**

The new construction has many advantages over the old; not only are the new coils robust and capable of withstanding without damage a good deal of handling, but they are much more easily made than the original "Everyman Four" coils. It was quite a nice problem as to how best to arrange the windings without materially

course, is the balancing winding which has to be connected in the reverse direction, but the loss due to this has been made very small by using a few turns of very fine wire.

The short-wave aerial coil is constructed as shown in Fig. 3. A tube of Paxolin (Wright and Weaire) or Radion (American Hard Rubber Co.), 4 inches long and 3 inches in diameter (the Radion is  $3\frac{1}{8}$  inches outside diameter), has four valve pins mounted on it as shown; 60 turns of  $27/42$  Litz wire are then wound on and the ends connected to the outer pins. One end of a length of No. 30 D.S.C. wire is now passed through the same hole in the former as the earth end of the Litz wire, and is soldered to the same contact as the Litz; 8 turns are then wound on, the wire being laid turn by turn between the turns of the Litz. At the eighth turn a tap is taken to one of the pins as shown, the wire being passed through a hole in the former. The next 8 turns are then put on and the end passed through a hole in the former to the remaining contact.

The two short-wave high-frequency transformers are of identical construction, Fig. 2, the secondaries having 60

LIST OF PARTS.

- 1 panel, 26in. × 8in. × 3/16in.
- 1 Baseboard, 26in. × 10in. × 1/4in.
- 1 Cabinet, 26in. × 8in. × 10in. deep (Unitca Cabinet Co.).
- 1 Copper box, 13in. × 8 1/2in. × 6 1/2in. high.
- 1 Fixed condenser, 0.0001 mfd. (T.C.C.).
- 2 Fixed condensers, 0.001 mfd. (T.C.C.).
- 1 Fixed condenser, S.P. 0.0003 mfd. (T.C.C.), with clips.
- 2 Fixed condensers, 2 mfd. (T.C.C.).
- 2 Fixed condensers, 0.2 mfd. (T.C.C.).
- 1 "Ediswan" grid leak, 1 meg. (Edison Swan Elec. Co., Ltd.).
- 2 H.F. chokes (Wright & Weaire).
- 1 Special neutralising condenser (Bulgin).
- 1 "Peerless" rheostat, 30 ohms (Bedford Elec. Co.).
- 3 "Cylodon" Log Mid. Line Condensers, 0.0005 mfd. (Sydney S. Bird & Sons).
- 4 Whiteline valve holders (Bowyer-Lowe).
- 1 A.F.5 transformer (Ferranti, Ltd.).
- 1 O.P.1. transformer (Ferranti, Ltd.).
- 1 "On and Off" switch (Bulgin).
- 1 Neutrovernier (Gambrell Bros.).
- 12 Ebonite shrouded terminals (Belling & Lee).
- 3 Indigraph vernier dials (Igranic).
- 2 2-inch dials (Igranic).
- 6 Coils, comprising tubes 3in. dia. × 4in. length.
- 24 Pin connectors, primary wire and Litz.
- Material for Coil bases..

turns of 27/42 Litz. The end 12 turns next to the 3 pins should then be spaced slightly by wrapping a No. 30 gauge wire in the space between each of the turns. This wire is then removed and the primary proper consisting of 12 turns of No. 44 D.S.C. is wound on. The beginning end is passed through the hole in the former with the Litz and soldered to the same tag, and the 12 turns are put on in the space between each of the 12 turns of the Litz. This end is then passed through the former and soldered to one of the pins, as shown. The balancing winding is now commenced and consists of 8 turns of the No. 44 D.S.C., which is wound on top of the primary, but the beginning end is taken to one of the pins, and the finishing end to the pin having the Litz and primary connected to it.

The long-wave coils are wound with No. 34 D.S.C. For the aerial coil wind on 190 turns and take a tapping at the centre point, as shown in the sketch of Fig. 3. For the long-wave high-frequency transformers (Fig. 2) 220 turns of the No. 34 D.S.C. must be wound on with a tapping at the 30th turn for the earth connection, and at 40 turns further on for the anode connection. The winding of 30 turns is for balancing. Reference to wire tables will show that, theoretically, it is not possible to put this

number of turns in the length available, but yet the London Electric Wire Co.'s wire fits in with an eighth of an inch to spare. These transformers tune to over 2,000 metres, and if the reader should find that the wire he is

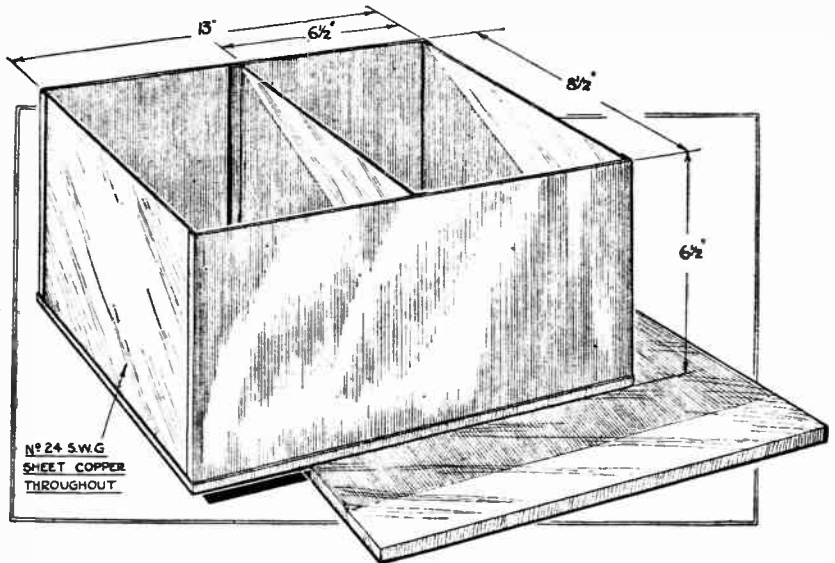

Fig. 5.—The copper box which is used to shield the two high-frequency stages.

using is rather thicker than that used by the writer, he can leave off 10 turns, which will reduce the maximum wavelength to a little below 2,000 metres.

The stabilising resistance may be wound with any convenient gauge of Eureka wire, and, provided it is reasonably non-inductive, will be perfectly satisfactory. When the coil is constructed it will be seen that this resistance wire can be put inside the coil former. The resistance wire can be wrapped on a small piece of tube about the size of a grid leak in the form of two small piles wound in opposite directions. No. 40 Eureka wire has a resistance of about 37 ohms per yard; No. 42, 53, and No. 44, 84 ohms per yard.

Fig. 4 shows the construction of the particular coil base used by the writer, but the reader can, of course, modify this construction to suit the sockets which he has on hand. Fig. 5 is a sketch of the copper box, which can be of any convenient gauge.

(To be concluded.)

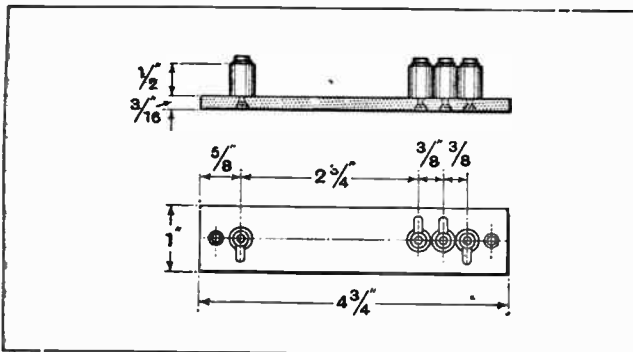

Fig. 4.—Details of the coil base

# PRACTICAL HINTS & TIPS

A Section Devoted to the Assistance of the Beginner.

### STAGE-BY-STAGE TESTS.

THE best advice that can be given to the amateur in trouble with a receiver is that systematic stage-by-stage and point-to-point tests should be carried out. It is always a matter of chance if a fault is located by haphazard methods; as a rule, the adoption of a definite method of procedure will lead most quickly to the isolation of the trouble. It is a good plan, in the first place, to assure oneself if it lies in the H.F.-detector portion or in the L.F. amplifier; to do this, the phones should be inserted in the anode circuit of the detector valve. In certain cases a difficulty arises at this stage, because in several modern receivers a high ohmic resistance is used for coupling this valve to the next, and, consequently, as full emission is not required, the filament is run at less than normal brilliancy. When phones are substituted for the resistance, however, conditions are altered, and full filament voltage should be applied. At the same time, some variation in detector bias (for anode bend rectification) will probably be necessary, as the change in anode load will alter the characteristics of the valve.

o o o o

### H.T. AND L.T. FROM D.C. MAINS.

IT is always recommended, when valves are to derive their L.T. supply from D.C. mains, that filaments should be connected in series; the usual parallel arrangement, which is standard when current is supplied by a battery, becomes wasteful and inefficient when there is a large surplus voltage to be dissipated, as there always is with ordinary supply pressures. Series connection of filaments

will in turn necessitate the use of valves having the same current consumption; this is not a real disadvantage at the present time, as valves with characteristics suitable for almost every function with filaments taking 0.1 ampere are produced by a number of manufacturers.

It is convenient to use the resistance necessary for "breaking down" filament voltage as a potential divider for reducing H.T. pressure; this arrangement is shown in Fig. 1, in which  $R_1$  is the main resistor and  $R_2$  is an auxiliary rheostat for final adjustment. The total resistance required may be easily calculated; the first step is to ascertain

"dropped" by "current taken by the valves" (in amps). In this case, our figures are  $222 \div 0.1$ , giving a total required resistance of 2,220 ohms; thus  $R_1$  may be of 2,000 ohms, and  $R_2$  of some 400 ohms, giving a reasonable margin for fine adjustment. A potentiometer, with connections made to one end of its windings and to the slider, will serve as the latter resistance, as the majority of commercial types will carry a greater current than that under consideration without undue heating.

We have so far ignored the D.C. resistance of the L.F. choke; in this matter we must be guided by the manufacturer's published data, and

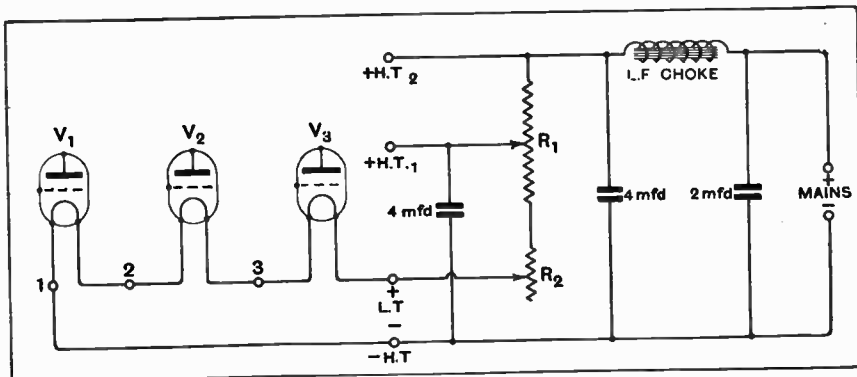

Fig. 1.—Filament and anode current from D.C. mains, showing filaments connected in series.

the total rated voltage of the series-connected filaments; assuming there to be three of these, each rated at 6 volts, we get a total of 18. The voltage to be dropped is obtained by subtracting this figure from that of the mains; which, for the sake of illustration, will be taken as 240, giving a surplus voltage of 222. The required resistance (in ohms) is obtained by dividing "voltage to be

if it does not exceed some 200 ohms the figures given above will still hold there good. If it does, a corresponding reduction must be made in  $R_1$ . The choke must be carefully chosen; to be on the safe side, its inductance should not be much less than 15 or 20 henries, although a considerably lower value may give satisfactory results if the supply current happens to be free of serious irregularities.

Its current-carrying capacity is a matter of considerable importance, so definite information on this subject should be obtained before purchase. A consideration of the circuit diagram will show that the anode current, as well as that for the filaments, passes through the choke; it would be as well to allow for a total current of 130 milliamperes.

It is suggested that the full H.T. voltage of the mains (less any small "drop" in the choke) should be applied to the last valve. It is realised that this procedure will result in some reduction in its useful life, but this will not be serious if bias is increased to such an extent that the anode current of a 7,000-ohm valve is reduced to some 8 milliamps. This plan is recommended partly because there are a very limited number of o.1 amp. valves capable of handling a large input with anode voltages of the usual value of 120; by applying an excess voltage, we obtain very much the effect of a super-power valve, without adding to the complexity of the receiver; and, even allowing for decreased valve life, maintenance cost will probably be less than that obtaining when a super-power valve is used with ordinary voltages. A consideration of the circuit diagram will show that no part of the potential-dividing resistance  $R_1$  is in series with the H.T. + 2 terminal, so a by-pass condenser across this supply, other than that across the smoothed output, will be unnecessary.

When using D.C. mains in this way, it is highly desirable that there should be no difference of potential between the "mains earth" and the "set earth"; it is, therefore, recommended that a coupled aerial circuit (which may be tuned or "untuned") should invariably be used. If a published design is being followed, the connection generally shown between I.T. negative and earth should be omitted; this point is made clear in Fig. 2.

A certain amount of confusion seems to exist as to the points to which the various grid circuits should be returned when filaments are connected in series; an attempt is made to elucidate this in Fig. 1, in which the points associated respectively with  $V_1$ ,  $V_2$ , and  $V_3$ , are marked 1, 2, and 3.

Finally, a word of warning should be given against attempting to adapt this supply system to sets including complex circuits; all the troubles nor-

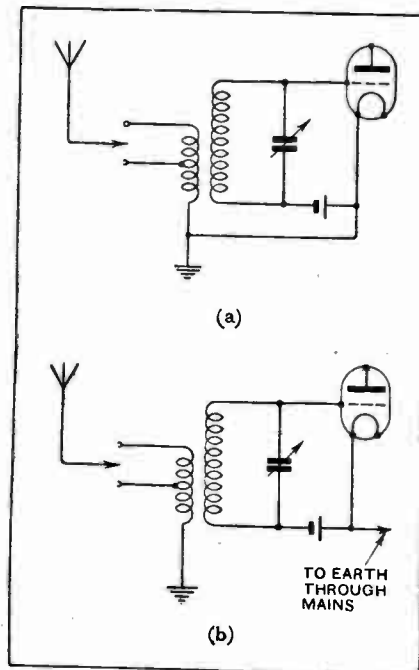

Fig. 2.—When H.T., L.T., or both are obtained from D.C. mains, the usual connection between filaments and earth should be removed.

mally encountered are intensified when high- and low-tension voltages are taken from the mains.

o o o o

#### AERIALS AND EARTHS.

WHEN one looks at the aerials in the gardens adjoining a row of suburban villas, one is struck by the number of cases in which minor transgressions of the recognised principles of aerial construction are made for no apparent reason whatever. The results of such errors must vary from slight loss of efficiency in some cases to really gross shortcomings in others.

Take the case of the inverted "L" aerial for example; the most common error is to attach the down-lead to a point some feet along the aerial from the insulator at the end nearer the house instead of right at the insulator. Because of this fault the aerial is no longer a true inverted "L" nor is it a "T," which has equal lengths on each side of the down-lead. The result is a certain loss of signal strength and selectivity, since the aerial tends to be-

have as two separate aerials having dissimilar constants.

For a given span the natural wavelength of the "T" aerial is only about one-half that of an inverted "L," and, as the full length of wire permitted by the P.M.G. makes an "L" aerial which is barely long enough for the best reception of the usual broadcast wavelength, it follows that the same amount of wire used in a "T" aerial is likely to give appreciably inferior results.

Then, again, there is the question of height. A few simple experiments will demonstrate that every foot or two gained in the average height of an aerial makes an appreciable improvement in reception, and, further, it is generally agreed that for a given total length of wire in the aerial a short, high one will be more suited to distant reception than a long, low one. The short, high aerial is more selective. Quite apart from the question of obtaining higher masts, it is surprising to notice in how many cases aerials are not rigged to the top of those already available.

Earths have often been discussed; to make a really good one represents one of the regular problems of wireless. Buried conductors running underneath the whole length of aerial probably represent the best possible arrangement, but, owing to the work and general dislocation that the installation of such an arrangement tends to cause, it is seldom carried out. The next best earth is probably an old dustbin, water-tank, or other galvanised article of considerable area buried *at least* three feet deep (and this depth should be measured, or, if estimated by the digger, the estimate should be divided by two!) at a point which will give a good, short connection to the set. A joint to such an earth should be made by soldering on the wire in several places and painting the joints over to retard electrolysis.

The chief point to remember about earths, however, is that they do not usually mix well. For instance, it is just about as bad to use a buried earth and a water-pipe earth connected together to form one earth for the set as to try to use two aerials simultaneously. Each earth requires separate tuning, and for general purposes it is much better to use one earth only.

# A REVOLUTIONARY DISCOVERY

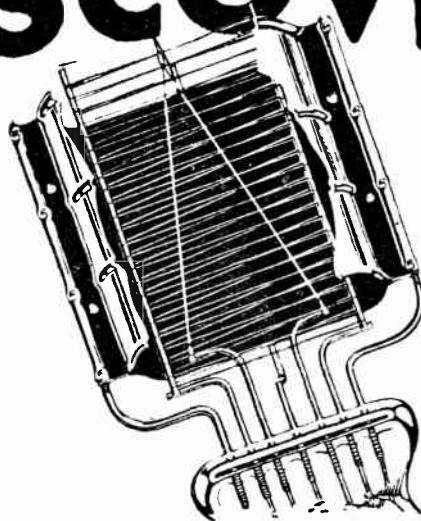

WE are now in a position to announce the successful development of an entirely new series of B.T.H. 2-volt valves. The filaments of these valves are made of *nickel*, a material (never before used for this purpose) which we have found to possess, to an astonishing degree, certain properties and characteristics essential to the production of valves of the highest efficiency.

These new valves—known as B.T.H. Nickel Filament Valves—are definitely superior to all previous 2-volt valves.

Briefly, the use of nickel, together with new methods of treating the filament during manufacture, has enabled us to produce

a valve possessing the following advantages :

The filament is very much longer than that of any other valve of corresponding type.

As a result the emission is considerably greater, giving a longer useful life than any other valve.

These claims may not convey much to you. You can only *prove* the superiority of B.T.H. Nickel Filament Valves by substituting them for the valves you are now using. The difference, however, will astonish and delight you, and is out of all proportion to the cost of the change-over.

B.T.H. Nickel Filament Valves are at present available in three types—all 2-volt—as listed below. Each of these valves will give you better results, and for a longer period, than any other make of 2-volt valves.

Ask your dealer for full details.

## B. 210 H

*High Frequency*

Filament Voltage . . . . . 2  
 Filament Amps . . . . . 0.10  
 Max. H.T. Voltage . . . . . 150

10s 6d

## B. 210 L

*Detector*

Filament Voltage . . . . . 2  
 Filament Amps . . . . . 0.10  
 Max. H.T. Voltage . . . . . 120

10s 6d

## B. 215 P

*Power Amplifying*

Filament Voltage . . . . . 2  
 Filament Amps . . . . . 0.15  
 Max. H.T. Voltage . . . . . 120

12s 6d

*The above prices are applicable in Great Britain and Northern Ireland only.*



# VALVES

NICKEL FILAMENT

*The British Thomson-Houston Co., Ltd*

2840

# THE REAL SOLUTION

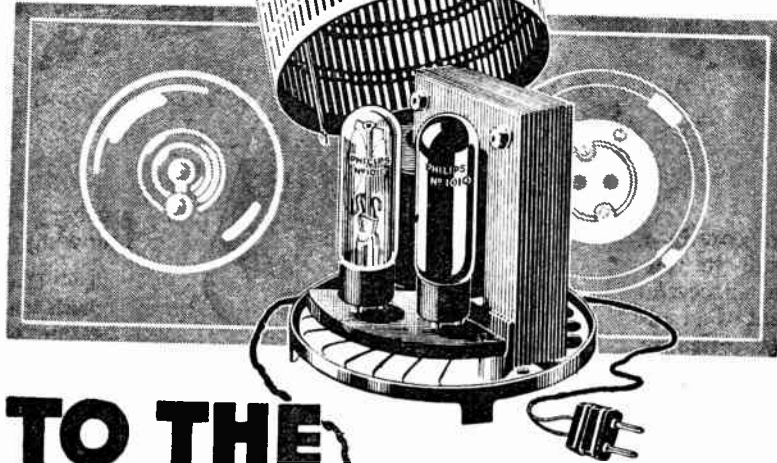

## TO THE BATTERY CHARGING PROBLEM

Philips Battery Charger Type No. 1009 ensures accumulators being maintained at full capacity from the electric light mains.

There is no complicated mechanism. A small control in the output lead enables either H.T. or L.T. accumulators to be charged.

The Unit is quite simple to use, and there is no fear of overcharging, with consequent damage to the plates. Philips Battery Charger Type No. 1009 is supplied for any voltages from 100 to 260.

See Stand No. 24,  
Manchester Radio Exhibition.

# PHILIPS

*For Radio*

Advt. PHILIPS LAMPS LTD., Philip House, 145 Charing Cross Road, London. W.C. 2.  
Mention of "The Wireless World," when writing to advertisers, will ensure prompt attention.



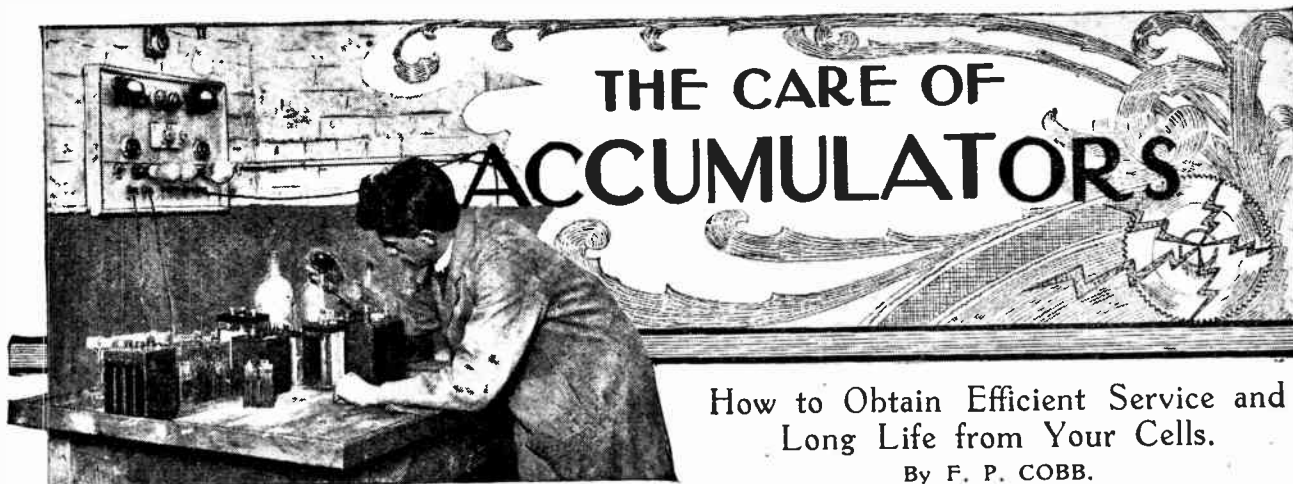

## How to Obtain Efficient Service and Long Life from Your Cells.

By F. P. COBB.

THE average radio user does not seem to appreciate the fact that storage batteries require a reasonable amount of care and attention to get the best results out of them, and in many cases they are looked upon as a kind of tank for storing electricity.

The life of an accumulator should be four or five years, but this may easily be reduced to the same number of months if reasonable and proper care is not given.

The one chief thing is to see that the cells are *never* run right down, *i.e.*, that the voltage of *each* cell never drops below 1.8 volts, and it is well to remember that any one cell, no matter how large, will give no higher voltage than the smallest made.

There are three voltages of valves in general use, *viz.*, those taking approximately 2 volts, 4 volts, and 6 volts, and in the first case one cell only is used; in the second and third cases two- and three-cell batteries are required respectively. These may appear at first sight to be one large cell, but on a closer examination the four- and six-volt batteries will be seen to be composed of two and three cells respectively, each in separate containers. For radio work, glass or celluloid containers are superior to ebonite, as with these the actual plates of the battery can be seen.

Let us examine one of these batteries carefully, and for this we will choose a four-volt accumulator.

We see that we have inside each case some plates set closely together, but not touching, and we also notice that these are of two kinds, the first being a reddish colour and thicker, and the second kind being grey and thinner, and we note that these are set alternately—grey, red, grey, red, grey.

### Colour of Plates.

A careful examination will show that, at the top of the cell all the red, thick plates are joined together and taken to the positive (+) terminal, and all the thin grey plates likewise joined are taken to the negative (-) terminal, which, in the case of the four-volt battery, are united to the positive red plates in the next cell, leaving the red terminal of the first cell and the grey terminal of the second cell for our connections, the cells being separated by a partition, if in celluloid, or being in two containers if glass.

The plates are covered with a clear liquid to about  $\frac{1}{4}$  in. above the tops. This liquid, called the electrolyte, is diluted sulphuric acid, and, as such, should be treated with respect, as it will have none for the owner's clothes or hands if spilt on them.

If the cell is fully charged, and in good condition, the positive plates should be a reddish chocolate colour, and the negative plates a light bluey-grey, and this colour alone is an indication of the condition of the cell, but keen observation and the constant care of accumulators is necessary before too much reliance can be placed in this test.

As the cell runs down in use, the positive plates lose their darker brown colour, and attain a brighter colouring, the grey plates also losing a little of their blueness.

### Charged and Discharged Voltages.

As mentioned before, the voltage of a cell should never be less than 1.8 volts. A charged cell, just taken from charging, may show for a short time as much as 2.25 volts or a little more, but on standing it rapidly drops to 2.2 volts, and your battery should show this value *per cell* when connected to your set. In discharging, the voltage drops gradually from 2.2 to 2 volts, remains constant at that figure for a fairly long period, and then drops to 1.8 volts. If discharged after this the drop to 0.5 volt is very rapid.

We have noticed the change which has taken place in the colour of the plates during the discharge to 1.8 volts; now let us consider the electrolyte, *i.e.*, the acid. This appears to have undergone no change, but if we test this by means of a hydrometer we shall find that the specific gravity of the acid is much lower.

Now, on every cell there are certain mysterious particulars and instructions given by the makers, such as this:—“Capacity (intermittent discharge), 45 amp. hours; normal charging rate, 1 amp.; fill with accumulator acid of 1.240 specific gravity; if specific gravity falls to 1.100 the cell requires recharging.”

The chief trouble here is:—What is specific gravity or sp. gr.?

All liquids vary in density, *i.e.*, weight per given measure. If you fill a petrol can with water you will find it heavier than a similar can filled with petrol, and in the same way you would find, speaking metaphorically,

**The Care of Accumulators—**

that a petrol can filled with strong sulphuric acid would be roughly three times as heavy as the same can filled with water. If we take the sp. gr. of water as 1, we should say that the sp. gr. of petrol was about  $\frac{1}{3}$ , and that of pure strong sulphuric acid about 3.

Obviously, if we mix the acid and water, the more water we add to the acid the less dense or heavy would be any given measure of bulk. Let us take a pint as our measure. A pint of pure strong sulphuric acid weighs roughly  $3\frac{1}{2}$  lb., and a pint of water weighs  $1\frac{1}{2}$  lb. Now, if we take  $\frac{1}{2}$ -pint of acid and add  $\frac{1}{2}$ -pint of water, we shall have 1 pint of a diluted solution of acid, weighing half of  $3\frac{1}{2}$  lb. plus half of  $1\frac{1}{2}$  lb., *i.e.*,  $2\frac{1}{2}$  lb.

Now, the sp. gr. of this solution would be the weight of this, compared with the weight of an equal measure or volume of water; or the ratio of the weight of the acid solution to that of the water; in this case the ratio of  $2\frac{1}{2}$  to  $1\frac{1}{2}$ , which gives us a sp. gr. of 2, *i.e.*, that a pint of a solution made up of equal parts of acid and water would weigh twice as much as a pint of pure water, or, in other words, this acid solution is twice as dense or thick



A bad case of disintegration of the positive plates due to overcharging.

as the pure water. To measure this density we use an instrument called a hydrometer, which consists of a glass tube, blown out and usually flattened at one end, weighted, so that it floats upright, and carrying a scale inside the upper portion.

If this is so weighted that it will just float in pure water, it is obvious if placed in a liquid thicker or denser than water it will float higher, and so, if the scale is read at the level of the liquid the density can be found at a glance.

In the case of one cell, however, it is impossible to get the hydrometer into the acid, on account of the pitch seal, or celluloid top, so an instrument has been designed

to overcome this difficulty, and is sold by several accumulator manufacturers, the cost being about 4s.

It consists of a wide glass tube, in which the smaller hydrometer is placed, and at one end of the large tube is a rubber bulb, and at the other a rubber plug attached to a length of narrow rubber tubing, which is inserted into the cell under the test, through the vent hole, and sufficient acid is sucked up by means of the bulb to take a reading off the floating hydrometer, the acid then being replaced in the cell. This instrument resembles an enormous fountain pen filler, with the actual hydrometer inside. If we take this test with the cell fully charged and another test when it is run down, we shall get very different readings.

This is due to the action of the cell itself, which really does not store electricity at all.

What happens is this:—If we place two sheets of lead in a diluted solution of sulphuric acid and pass a current of electricity through them, one plate will change gradually to a red colour and the other remain as before. A chemical change has taken place by the action of the flow of electricity, and a portion of the water in the acid solution has been removed from it partly to be combined with the lead of the red plate.

If we remove water from the acid solution, and do not take away any acid, it is obvious that the remaining solution must be more acid, *i.e.*, denser than at the commencement. If after charge we join the two lead plates a current of electricity will flow from the red to the grey one, and a reverse chemical change take place, water being returned to the acid, and so the density or sp. gr. is lessened.

**Sulphating.**

In commercial cells the plates are "formed," *i.e.*, chemically treated before assembly, and therefore have a greater capacity, and are more active than the plain lead, and a certain lowering of the sp. gr. is normal in the discharging of the cell; but if the sp. gr. is lowered too much by undue discharging, another chemical change takes place called "sulphating." This can easily be seen in the form of a hard white deposit or film on one or both plates, and is most injurious to the cell, and if allowed to persist and increase will utterly ruin the best battery made by making it unable to hold its charge. Sulphating is also caused by allowing the level of the acid to fall below that of the plates, thus exposing them to the air. Should a cell get slightly sulphated, this can often be remedied by giving a long, slow charge, *i.e.*, below the normal charging rate, when the sulphated particles will gradually loosen and fall to the bottom of the container, and in most cases two or three charges and discharges are necessary to clear the plates thoroughly. If the cell is so badly sulphated that it will not answer to this treatment, it is better to buy a new one than to try to remove the plates and scrape the deposit off, but this can be done if the plates will hold together for the operation. There is also an electro-chemical method, but it is impracticable for the amateur without a fair knowledge of chemistry and a means of charging.

In many cells the plates are divided from one another by separators. These may be of thin wood specially treated, perforated corrugated celluloid, or, in large cells,

**The Care of Accumulators—**

glass tubes. Where these are not provided, a bad short-circuit will often cause the red plates to bulge and to touch the grey ones. If this only takes place in one spot, an internal short-circuit is set up in the cell itself, and sulphating begins almost at once. The only remedy for this is the separating of the touching plates, a nasty job, as in nine cases out of ten the whole lot have to be removed from the container, and the buckled plates straightened by gentle blows with a mallet. If plates are removed from a cell these should always be protected from air contact as much as possible, the plates not actually being handled should be kept covered with acid or water, and the two sets should not be put in the same temporary container.

Should the acid level get too low, and the top of the plates begin to get dry, pure (distilled or clean rain) water only should be added to raise the level, as this loss will have been caused by evaporation. Acid of correct sp. gr. should only be added when a part of the contents have been spilled or very occasionally to bring the sp. gr. up when the cell is known to be fully charged, and about once a year the acid should be emptied out, the cell washed with clean acid, and refilled at once. This is to remove any sediment which always collects at the bottom of the container.

If this were allowed to remain too long, it would in time bridge the plates, thus short-circuiting them.

This sediment comes mainly from the positive or red plate, and the deposit is much hastened by overcharging, *i.e.*, charging for too long a time and, or at too high a rate, consistently.

**Charging Rate.**

The charging itself is a very important matter, as the life of the cell is often governed by this, and too much care cannot be exercised in finding a man who will do this work properly. The charging station which advertises to charge a cell in half a day, or which returns cells warm, is to be avoided, and also the man who tells you that the charging rate "does not matter."

This charging rate is given on the maker's label on each cell in amperes or for short amps., and should not be exceeded by more than 5 per cent. at the most, and from this the number of hours' charge required to fill the cell can be easily calculated. Suppose the label states that the capacity is 45 amp.-hours, and the charging rate 1 amp., then if the cell is fully discharged one amp. must be passed through it for 45 hours. Allow a little extra for the efficiency not being 100 per cent., and say that one amp. must be passed for 48 hours to charge fully this cell, *i.e.*, two days' charging continuously, but as many charging stations do not charge during the night, it means that four days will be required to complete the charge.

It is, of course, absolutely essential that the cell should be properly connected to the source of supply, *i.e.*, the positive main to the positive terminal, and that some means of regulating the current is available, as the voltage of the cell rises as it is getting charged, and so the charging voltage must be increased to keep it up to the normal charging rate.

When first connecting up no change is seen, but gradu-

ally, say, when half charged, small bubbles will be seen to be rising from the plates, and these increase in number till the acid appears to be quite milky, which shows that everything is in order. Later, this milkiness disappears altogether, and large clear bubbles rise to the surface, giving the appearance of boiling, showing that the cell is nearly charged. In the earlier stage the cell is said to be "milking," and in the later stage "gassing." When "gassing" is taking place freely a voltage and sp. gr. reading should be taken, and in an hour or two should be repeated. This is continued till the last readings correspond with the previous ones, when the cell is fully charged. These readings should be taken while the charging current is flowing, and the voltage across a cell fully charged will be 2.45 to 2.5 volts. but, of course, this drops at once to 2.25 or so as soon as the charging current is cut off.

The writer has seen a case where the acid turned a rich purple when charging was in progress, and this was due to an impurity (manganese) in the acid, which he was assured did no damage, a statement "to be taken with a grain of salt." It is most important that the electro-

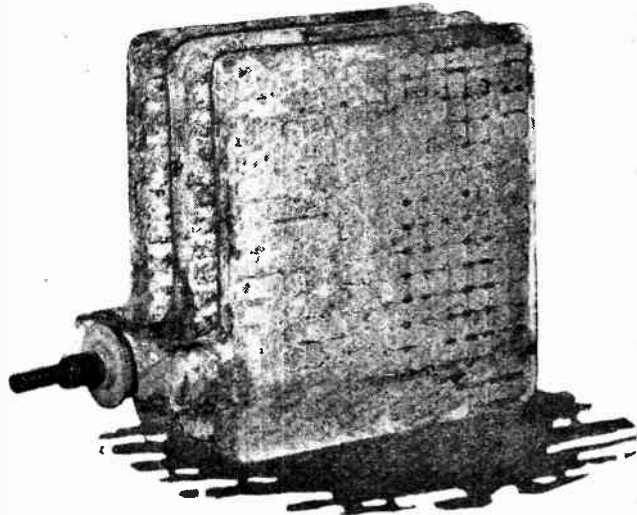

Sulphating of the negative plates is due to weak electrolyte or discharging below 1.8 volts per cell.

lyte should be pure brimstone sulphuric acid, diluted with distilled water. If distilled water is not obtainable, clean rain-water is next best, but it should not have been stored in an iron tank, and should be boiled and allowed to cool before using. In some places tap-water may be used, but the makers of the cell should be consulted beforehand.

If you wish to dilute or "break down" your own acid great care is needed. The pure, strong acid known as C.O.V. (concentrated oil of vitriol) must be added slowly to the water, stirring all the time. In any case this will give rise to heat, and the solution will become quite hot. If the water is added to the acid, steam will be formed and the acid blown over the person adding the water. It is necessary that the solution be quite cold before taking the final sp. gr. reading, as the density of liquids increases on cooling, and on no account must hot solution be put in the cell. Finally, a glass rod should be used

**The Care of Accumulators—**

for stirring, and the acid "broken down" in a glass jar, and no metal of any kind allowed to come in contact either with the strong acid or the dilute solution.

If a cell is to stand for a period of time, say about a month, without use, the best plan is to send it to be charged, asking to have the cell fully charged and to put on charge again for about one hour per week till you are ready for it.

If a cell is not required for a long period, say, six months or so, charge fully, empty acid, and wash the plates thoroughly with pure water, changing it frequently for several days. The usual practice is then to empty the cell and store dry, but it is most important that the acid is all removed from the spongy plates before, as "sulphating" will occur if merely swilling is employed. To bring into use, fill with acid at the proper sp. gr. (about 1.240), charge for an hour or so, and connect up.

It is quite easy to calculate how long your battery will run without requiring recharging. Each valve box you have will tell you the filament current your valves take, which may be from 0.06 amps. to 0.3 amps., according to the make. For this purpose the anode voltage, given in milliamperes, does not enter into consideration, and may be neglected.

If you have three valves taking 0.1 amp., 0.1 amp., and 0.15 amp., you will have a total consumption of the sum of these, viz., 0.35 amp. per hour. Thus in ten hours you will have used  $10 \times 0.35 = 3.5$  amp.-hours of your battery capacity. Should your battery give a capacity of 45 amp. hours, 45 divided by 0.35 will give you the *maximum* hours you may use your set to run your battery right down, i.e., 129 hours. This is the theoretical maximum, and it would be well to test your cell at the end of 120 hours' use.

In any case the battery should be charged at intervals not exceeding three weeks, unless especially shown to the contrary on the maker's label.

The capacity of a battery of cells, connected in *series*, is equal to the capacity of the smallest cell, and the voltage will be equal to the number of cells multiplied by the voltage of each cell, i.e., 2.2 volts for a short time, and then 2 volts. A battery is connected in *series* when the positive of one cell is connected to the negative of its neighbour, and so on, leaving the connecting wires to be fastened to the unused terminals, one at each end of the battery.

**Cells in Series and Parallel.**

The capacity of a battery of cells, connected in *parallel*, is equal to the sum of the individual capacities, and the voltage will be equal to that of one cell. A battery is connected in parallel when all the positive terminals are connected to each other, and all the negative terminals joined together, and a pair of wires taken, one from the positive side and one from the negative side.

The size of the plates will not affect the voltage, but the larger the plates the larger the capacity of the cell.

Should a four-volt battery cease to give its true voltage, and only yield two volts, the container being of celluloid, and the plates appear of good colour and not

shorted, it is possible that a pin-hole has appeared in the dividing wall, thus allowing the battery to become one cell instead of two. To test for this, empty of acid and fill up one cell only, and if the partition is perforated the level in the filled cell will be lowered. To repair this the plates must be removed from each cell, the container thoroughly washed and *dried*, and celluloid cement put liberally along all joints of the partition on each side, not forgetting the bottom joint. Let this set for five or six hours, test again with water, and if good replace the plates and acid, and charge, making the joints on the top with celluloid cement.

To make the cement a 1 oz. bottle of amyl acetate is obtained from a chemist, and a few shreds of celluloid placed in the liquid. Cork well, and in about twelve hours the celluloid will have dissolved. Do not half-fill the bottle with the shredded celluloid, or you will have a jelly too thick to use.

**Summary.**

- (1) Note the colour of the plates.
- (2) Test with voltmeter and hydrometer, bearing in mind that the state of the sp. gr. is the only true indication of the condition of the cell.
- (3) If "sulphating" appears, send battery to be charged at once, and look for the cause, e.g., short-circuit in the cell itself or in the L.T. leads in the set. Possibly your valve rheostat has not been turned fully off, or may not completely cut the cell out of circuit when in "off" position.
- (4) Do not wait till your reproduction fades away before testing and examining your L.T. battery.
- (5) Keep a spare L.T. battery at your charging station. This need not be as large as your main battery, but large enough to run your set for a week, while the large battery is being charged.
- (6) If a cell is returned to you warm, change your charging station.
- (7) Do not expect your battery to be charged in half a day. It cannot be done if your cells are to give you a reasonable life.
- (8) Keep the plates well covered, and keep your battery in a reasonably cool place.
- (9) Never store an accumulator in a discharged or partly discharged condition.
- (10) Disconnect and clean *all* connections on battery, using a little vaseline once in six months.

The writer hopes that these few notes will cause a little more interest to be taken in that essential portion of a wireless set which is so often neglected.

**THE WEAKEST LINK.**

IT is not generally realised by beginners that the maximum undistorted volume which any set is capable of delivering is determined by the voltage-handling capacity of the output valve. Thus a two-valve set, provided, of course, that a sufficient input can be obtained from the aerial, will give signals of precisely the same strength without overloading as will a five-valve receiver having the same valve, operated under similar conditions as regards anode voltage, etc.

**RECEIVER WITH OVER  
2000  
LISTENING POINTS**

An Automatically Controlled Installation,  
without Batteries, Capable of Working  
2,000 Pairs of Headphones and 80 Loud-  
speakers Simultaneously.

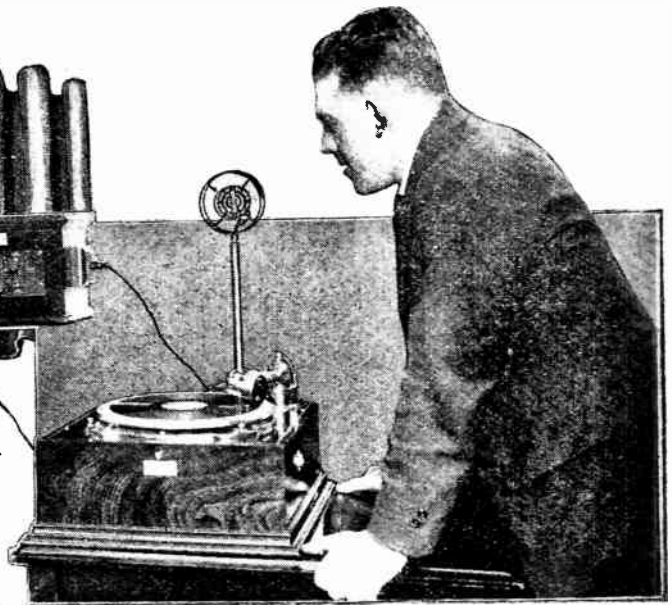

**T**HE Marconiphone Company are to be congratulated on designing and manufacturing a receiving installation for Lambeth Hospital which is probably more comprehensive in its conception and has a greater number of listening points than any other set existent. The more important problems involved in hospital installations have been discussed at some length in an article<sup>1</sup> written in this journal earlier in the year; it will therefore be sufficient to describe the salient features and

innovations which will be of interest from a purely wireless point of view, since the increasing importance of distribution from a centralised receiver in flats and hotels, etc., renders necessary a general knowledge of the underlying principles.

**Two Independent Receivers.**

To take full advantage of alternative programmes under the regional scheme it was decided to design the set to receive either 2LO or 5GB at will, and rather than have an automatic selection of these two stations by alteration of tuning it was found advisable to erect two separate aerials connected to two separate receivers with fixed tuning; the proximity of 2LO to Lambeth, however, necessitated the incorporation of a series rejector and one stage of high-frequency amplification with loose coupling to the 5GB set in which leaky grid detection is used. The 2LO receiver contains no rejector circuit, but has a high-frequency stage coupled to an anode bend detector by the neutralised tuned anode method. After detection, the rectified signals from either receiver are passed into a common transformer-coupled I.F. stage, which is also wired to accept signals from a gramophone pick-up or a local microphone placed in the steward's room, and after further amplification by resistance coupling the impulses are applied to a bank of power valves, each of which feeds a fixed number of listening points. Seven valves of the DE5A class are used for reception on 2,000 phones, and five LS5As are used for the 80 loud-speakers. While the grids of the power-amplifying valves are connected to a common grid bias battery, their anodes each supply a separate circuit through their own step-down line transformer, thus ensuring full operating efficiency by matching the output impedances and enabling the load to be balanced evenly. An additional advantage is that the high-tension current does not reach the line, and listeners are therefore protected from the possibility of shock.

It will be seen that each valve in the lower two panels on Fig. 1 is associated with two sockets for testing

<sup>1</sup> June 22nd, 1927.

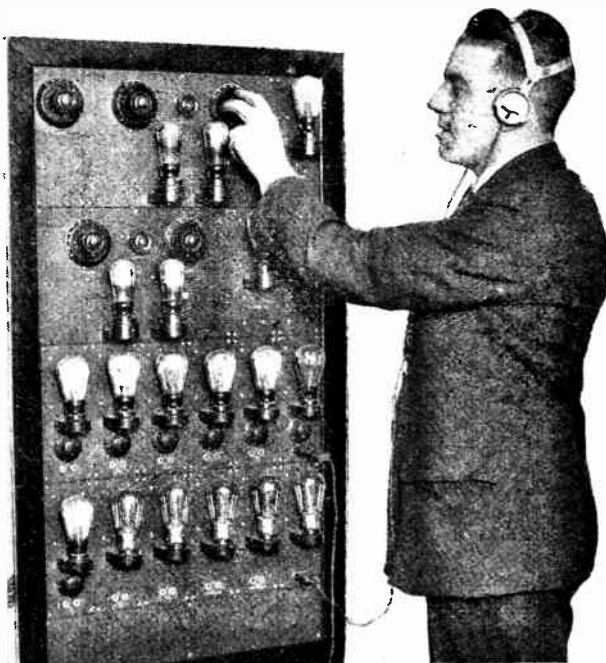

Fig. 1.—The top panel contains the 5GB receiver incorporating a rejector circuit. The next panel contains the 2LO receiver. On the third panel are six DE5A output valves with volume controls for phone reception, while on the bottom panel are the LS5A output valves for loud-speaker reception.

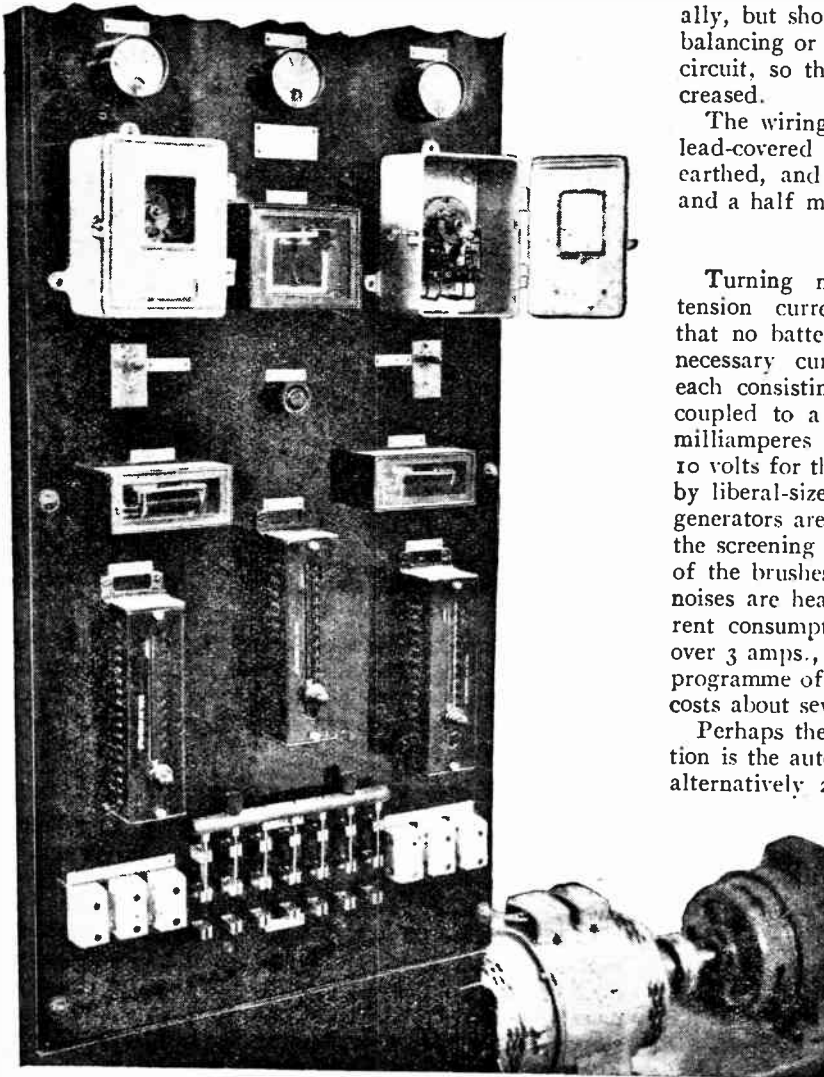

Fig. 2.—The generator and time switch control board. Note the throw-over switch at the bottom for bringing in the duplicate generator in the event of breakdown.

quality and strength of signals by plugging in a loud-speaker; it will also be noticed that in the case of the first seven amplifying valves for phone reception a volume control is provided. Since the number of telephones in use is always large, there is no necessity to compensate for any which may be disconnected individu-

ally, but should a nurse wish to cut off a whole ward, a balancing or equivalent resistance is automatically put in circuit, so that the output from other feeders is not increased.

The wiring to the various wards is carried out in twin lead-covered cable throughout, the casing is bonded and earthed, and the total length of wire used exceeds nine and a half miles.

#### Power Supply.

Turning now to the supply of high and low tension current, it is extremely interesting to find that no batteries are used. The equipment derives the necessary current from duplicate motor generator sets, each consisting of an A.C. self-starting motor directly coupled to a double-output D.C. generator giving 200 milliamperes at 310 volts for H.T., and 10 amperes at 10 volts for the filaments; the output is suitably smoothed by liberal-sized chokes and condensers, and although the generators are placed only a few feet from the receivers, the screening of the commutator housings and the design of the brushes is such that no hum, ripple or scratching noises are heard at the listening points. The total current consumption from the 220-volt A.C. mains is just over 3 amps., so that at a penny per power unit the daily programme of ten hours, enjoyed by nearly 3,000 people, costs about sevenpence.

Perhaps the most ingenious part of the whole installation is the automatic selection by Venner time switches of alternatively 2LO and 5GB programmes at appropriate times between 12 noon and 12 midnight. As soon as the time switch (there is one for each receiver) makes contact a relay is energised by an accumulator which is floated across the L.T. circuit and the motor generator is brought into action. Fig. 2 shows the control board, at the top of which are two indicating pilot lamps to show which receiver is in action; below these are three voltmeters, the first giving generator L.T. volts, the second the volts at the filament legs of the valves, and the third the H.T. volts. The rest of the panel supports the Venner time switches, the relays and the field regulator resistances for the generator.

It is a feat of no small magnitude that the only attention necessary for the maintenance of this large installation is the winding of the two time switches once a fortnight.

#### Ferranti Factory Developments.

The new works and drawing offices of Messrs. Ferranti, Ltd., of Hollinwood, Lancs, have been fitted with "Vita" glass to enable the workers to benefit from the influence of the ultra-violet rays.

On October 13th the Manchester branch of the Electrical Association for Women visited the Ferranti works during their conference meetings held in Manchester on that date. The party, which numbered about 140, evinced great interest in recent extensions to the factory, which covers an area of 8½ acres, and

#### TRADE NOTES.

employs a staff of over 3,500. Every effort is being made to maintain the health of the workers, and with this idea a special ambulance room has been fitted up.

o o o o

#### An "Ekco" Anniversary.

A staff visit to the National Radio Exhibition and an evening at the Coli-

seum celebrated the anniversary of the formation into a limited liability company of Messrs. E. K. Cole, Ltd., manufacturers of the well-known "Ekco" radio electrical products, whose works are situated at London Road, Leigh-on-Sea.

o o o o

#### Change of Address.

Messrs. H. W. Sullivan, Ltd., electrical, telegraph and radio engineers, have transferred their head office and works to new premises at 72, Leo Street, Peckham, S.E.15.

# THE SCREENED VALVE IN L.F. CIRCUITS.

## Resistance=condenser Coupling.

By N. W. McLACHLAN, D.Sc., M.I.E.E.

(Concluded from page 538 of previous issue.)

HAVING had no luck with screened valves and audio-frequency iron-cored apparatus—except to mis-shape the signals—we turn our thoughts elsewhere. The next field for exploration is resistance coupling.

We have already seen that the amplification factor of a screened valve is high. With a tuned circuit whose dynamic resistance is  $5 \times 10^5$  ohms, the amplification is nearly 60. It is natural, therefore, to imagine that the screened valve will be ideal for low-frequency resistance-condenser coupling. When the problem is examined analytically and tested practically, there are conditions which are against the use of the valve. The circuits considered hitherto have been sensibly free from D.C. ohmic drop, so that practically the whole of the H.T. battery voltage is on the valve. But let us connect a resistance of  $10^5$  ohms in series with the valve and assume the feed or anode current is 1.5 milliamperes. The drop in this resistance is 150 volts, leaving only 50 volts on the valve when the H.T. voltage is 200, which is a value likely to be used. Now if we glance at the curves of Fig. 7 we see that when the anode voltage is 50 the valve is being worked on the wrong part of its characteristic. The correct part of the characteristic lies above 100 volts, i.e., the actual volt drop on the anode of the valve due to the H.T. feed current must exceed 100. The valve will, of course, function after a fashion on almost any part of the characteristic, but to get the best results the above condition should be fulfilled. In order to operate on the working part of the characteristic, two courses are open: (1) to increase the battery voltage, (2) to increase the grid bias. The former expedient will in general be out of the question for the average experimenter. Hence we will choose the latter. The effect of increasing the grid bias is to reduce the anode feed current (see Fig. 7). Thus the volt drop on the anode resistance is reduced, and that on the valve increased. In practice, for 200 volts H.T. and  $10^5$  ohms resistance there is an optimum value of grid

bias at which the amplification is a maximum. For example, in a receiving set where the detector is resistance-condenser coupled to a screened valve which in turn is resistance-condenser coupled to the power valve, the optimum grid bias with 200 volts H.T. and  $10^5$  ohms in the anode circuit is about -4.5. Under these conditions the actual magnification is about 25. This comparatively low value is due in part to the anode resistance being relatively small, since it is less than the internal A.C. valve resistance. It is well known that, to secure satisfactory results, the anode resistance should be several times the internal valve resistance. With a screened valve this would necessitate a resistance of about 1 megohm when working with a bias of -4.5 volts, since the internal valve resistance for this value of bias is about  $3.5 \times 10^5$  ohms. Moreover, with this increased value of anode resistance (1 megohm) the H.T. voltage would require to be 300 volts or so to secure higher magnification.

### Comparison with Three-electrode Valves.

Now with a D.E.H.610 valve the "m" value is 40, and the internal resistance  $6.5 \times 10^4$  ohms. Furthermore—and this indicates the great drawback of the screened valve—the voltage on the three-electrode valve itself does not require to be nearly as much as 100 before the correct portion of the characteristic is obtained. This means that with a D.E.H.610 valve an anode resistance of  $2 \times 10^5$  ohms<sup>5</sup> and a H.T. of 200 volts we should get an amplification of 30, which is about the same order as that for a screened valve with anode resistance higher than  $10^5$  ohms and increased H.T. Thus for resistance-condenser coupling the screened valve does not possess any particular advantage in the way of amplification at normal H.T. volts.

To illustrate the action of a resistance-capacity screened valve more fully a series of characteristic curves of a

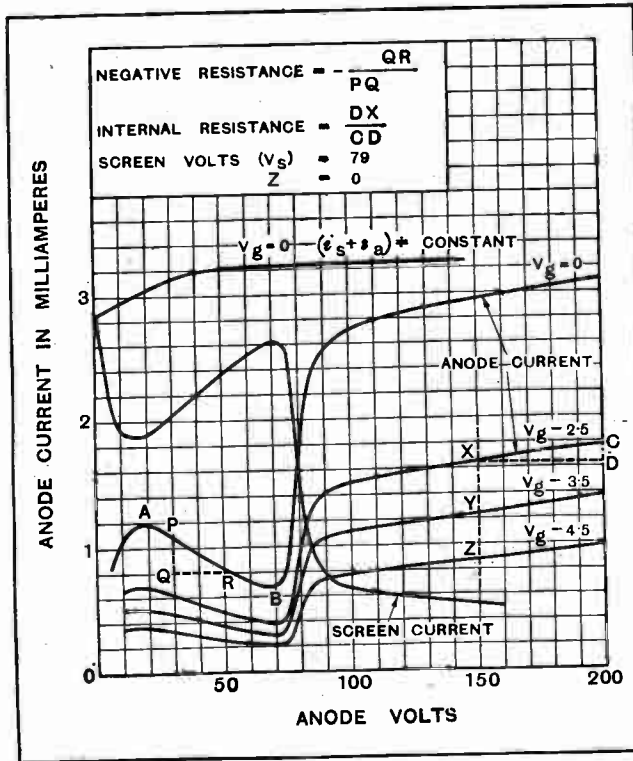

Fig. 7.—Characteristic curves of the S.625 valve.

<sup>5</sup> It is assumed, of course, that the value of the grid leak is at least 1 megohm. Otherwise the amplification would not be obtained.

**The Screened Valve in L.F. Circuits.—**

screened valve with  $10^5$  ohms in its anode circuit are given in Fig. 8. If these curves are compared with those of the same valve with no anode resistance (Fig. 7) it will be seen that they are all displaced bodily to the right. For example, where the anode resistance is zero and the grid bias  $-2.5$  the current attains a maximum value for a H.T. voltage of 17, whereas with  $10^5$  ohms in circuit this maximum occurs at a H.T. voltage 83. In other words, the drop in voltage across the resistance is  $83 - 17 = 66$ .

This corresponds to a current of  $\frac{66}{10^5} = 0.66$  milliamp.

From the curve of Fig. 8 and grid volts  $-2.5$  we find the actual current is 0.69 milliamp., so that there is a fair agreement between calculation and experiment. Incidentally, we may interpolate the remark that the quantity  $\frac{\text{volts}}{\text{current}}$  for the valve is only  $\frac{17 \times 10^3}{0.66} = 2.6 \times 10^4$  ohms,

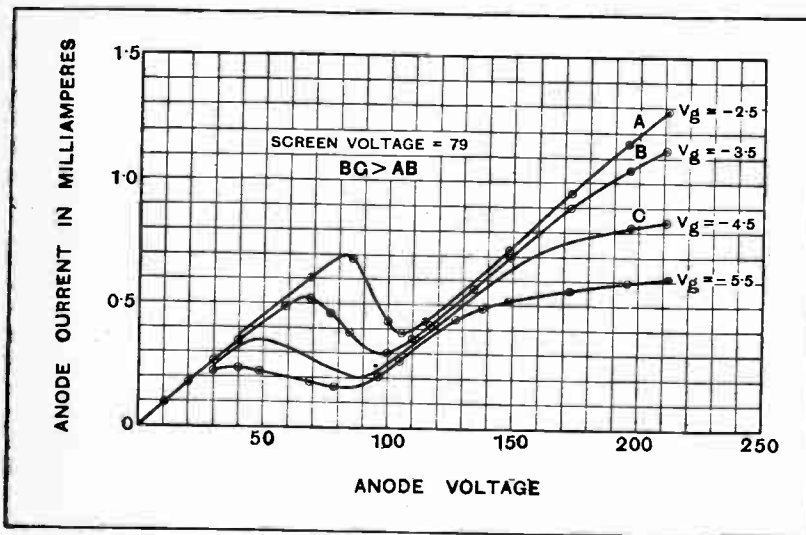

Fig. 8.—Curves of S.625 valve with 100,000 ohms in anode circuit.

which is much lower than the anode resistance  $10^5$  ohms. Now for present purposes we can conveniently regard this  $2.6 \times 10^4$  ohms as the D.C. valve resistance. If we take the corresponding value for a three-electrode valve with H.T. volts 17 we should find it much higher. For instance, in the case of a D.E.5B with a grid voltage of  $-2.5$  and anode voltage 17 it would amount to several megohms, because the valve would be at its rectifying point. Thus we see that what we can for convenience call the D.C. resistance of a screened valve is much lower than that of a three-electrode valve. Moreover, in a screened valve the volt drop on the anode resistance is much greater than it would be with a three-electrode valve. This means that the three-electrode valve has the advantage of a greater proportion of the H.T. volts on its anode than the screened valve.

Coming again to Fig. 8, we see that for an anode voltage of 200 the curves cannot be regarded as parallel lines. In fact, it is not until a voltage of 250-300 is reached that they approach parallelism. Furthermore, at 200 volts the current change from  $-3.5$  to  $-4.5$  volts is greater than that from  $-2.5$  to  $-3.5$ . Now, the amplifi-

cation of the valve is the change in anode voltage for a change of 1 volt on the grid. From  $-3.5$  to  $-4.5$  this is about 25, i.e.,  $BC \times$  anode resistance = 25. From  $-2.5$  to  $-3.5$  this is about 12, i.e.,  $AB \times$  anode resistance = 12, so that there is an appreciable alteration. This difference is very evident when we try an experiment with the valve in a radio receiver.

The greater amplification due to increased grid bias is due to the smaller anode current causing a reduced drop on the resistance, thereby leaving a greater voltage on the valve. When, however, the H.T. volts are increased, this difference in amplification with the above values of grid bias disappears. In Fig. 9 we have the characteristic curves for 200 to 300 volts H.T. The curves are sensibly linear and parallel. A further interesting point about the curves in the region between 150 to 200 H.T. volts is their lack of parallelism, which for a grid swing of 1 volt each side would introduce distortion.

The fact that the amplification from grid voltage  $-3.5$  to  $-4.5$  is twice that from  $-3.5$  to  $-2.5$  means that the negative halves of the waves are amplified twice as much as the positive halves. This is probably more serious than the lack of parallelism. If, however, we take the grid bias as  $-4.5$ , the amplification is sensibly equal for, say, 0.5 volt on each side, whilst at 200 volts H.T. the lack of parallelism is not so deadly. There would be distortion, but on trial I did not find it serious. The screened valve was resistance-coupled and connected between the detector and the power valve.

Although there is a possibility of distortion in a resistance-coupled amplifier using screened valves if the H.T. is too low and the grid swing too high, there are possibilities of enhanced stable magnification in this type of amplifier where it is desired to amplify very weak signals. We have seen that the stability of the system depends upon the magnification per stage, and that it is greater the lower the frequency. Now a resistance-coupled amplifier is usually employed for L.F. amplification, so that we should expect considerable magnification to be obtained without oscillation. It must be remembered that resistances usually have inductance and capacity, also there are stray capacities and inductance in the wiring. These make for inaudible oscillation unless due precautions are taken. Nevertheless, by careful design there ought to be greater stable magnification than is at present possible with the un-neutrolyned three-electrode resistance-coupled amplifier. It is found, however, that apart from self-oscillation limitations are imposed in low-frequency amplifiers due to the agitation of electrons in the conductors themselves.<sup>6</sup> I understand that a magnification of about  $10^5$  is the limit for low frequencies. At high frequencies the above effect is not felt, but another effect, known as the "shot" effect, is important. Electrons are not evaporated absolutely uniformly from a filament. The sudden shock which an occasional extra electron gives the valve circuit sets it into

<sup>6</sup> See "The Schottky Effect in L.F. Circuits," by J. B. Johnson, *Am. Phys. Rev.*, July, 1925.



**The Screened Valve in L.F. Circuits.—**

oscillation which, repeated often enough, ultimately culminates after amplification (large) and detection in the well-known noise of a H.F. amplifier. There is therefore a limit to the H.F. amplification beyond which the noise due to "shot effect" drowns the signals. This limit for radio frequencies is several million, but depends on the type of valve. If we assume a detector voltage of 1, the weakest signal which can comfortably be amplified is a fraction of a microvolt, say  $\frac{1}{4}$  to  $\frac{1}{2}$ .

In resistance-condenser coupling there is undoubtedly an issue which is of importance with good loud-speakers. I refer to the input impedance of the valves. It is easy to calculate the effect if we know the self-capacity of the anode-grid circuit of the valve and its magnification factor. To get the bass register and a large amplification per stage there is a tendency to use high anode resistances and large grid leaks. The input to the next valve is equivalent to a condenser across the anode resistance and leak in parallel.

At the higher frequencies of 3,000 cycles or more, this condenser may act as an appreciable drain on the grid leak anode resistance combination, thereby lowering its effective impedance, and with it the amplification. The effect of several stages is cumulative. For example, if the magnification at 500 cycles is 15 and at 5,000 cycles 12 per stage the respective magnification of three stages at these frequencies are 3,375 and 1,728, *i.e.*, the grid volt swing on the power valve at 5,000 cycles is half that at 500. This is readily detected by ear provided, of course, we have a standard of comparison. Now, with the screened valve this input impedance is small and sensibly that of the filament to grid capacity alone. Moreover, there will not be nearly so large a drop in amplification at the higher frequencies as with a three-electrode valve amplifier giving the same degree of overall magnification. On the other hand, one must be careful not to achieve the same result by enhanced H.F. selectivity, thereby cutting into the side bands.

**Summary.**

(1) The characteristic curve of an audio-frequency transformer used in conjunction with a screened valve is after the nature of a tuning or selectivity curve. This is a direct result of the high A.C. internal resistance of the valve. It follows, therefore, that the use of a screened valve in a L.F. amplifier with a transformer does not give equal magnification over a wide band of frequencies. The result, in practice, is to delete the upper and lower registers.

(2) The low self-capacity and high internal resistance of the screened valve makes it suitable for securing high magnification and enhanced selectivity in the intermediate stages of a superheterodyne receiver. Where iron-cored apparatus (either transformers or chokes) are used the relative absence of the input impedance of the valve curbs the tendency to self-oscillation. It also prevents the appreciable increase in wavelength concomitant with the use of a three-electrode valve by virtue of the input capacity added to the transformer or choke. This facilitates the operation of a cascade system of units to give maximum amplification on the same wavelength. It also enhances the selectivity of the system by allowing the units to have sensibly the same resonance frequency.

(3) There is little to be gained in amplification by using a high-frequency transformer on the waveband 300-500 metres, in association with a screened valve. This is due to the high internal valve resistance. By using a comparatively large ratio the stability and selectivity are enhanced.

(4) A screened valve can be used in a resistance-condenser amplification system provided the H.T. volts are adequate and the grid bias correctly adjusted. There is a possibility of distortion if the grid swing exceeds about 0.5 volt, unless the H.T. is sufficiently high. It is impracticable to use anode resistances several times the internal resistance of the valve, owing to the large value of

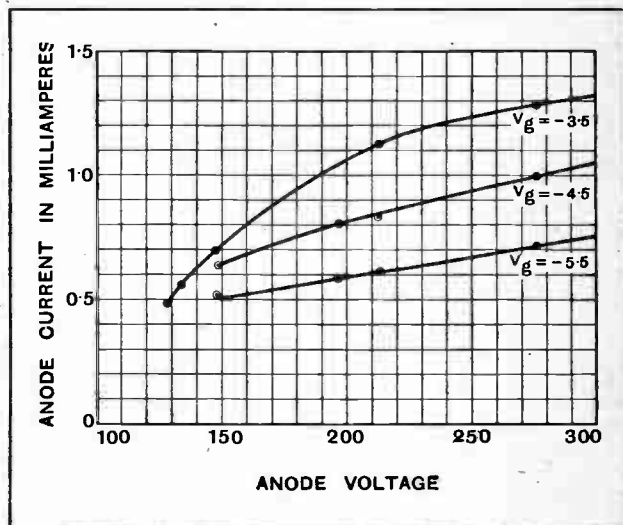

Fig. 9.—Characteristics of S.625 valve for anode voltages between 150 and 300 volts.

H.T. necessary to take the valve to the working part of its characteristic. In this respect the screened valve differs considerably from the three-electrode valve. For 200 volts H.T. a resistance of  $10^5$  ohms is quite large enough. The magnification per stage is then about 25, which is less than with a D.E.H.610, using an anode resistance of  $2 \times 10^5$  ohms and 200 volts H.T.

(5) The relative absence of grid-anode capacity reduces the input impedance of a screened valve to the filament to grid capacity. The small feed back ensures greater overall stable resistance-condenser amplification and much less reduction in the amplification of higher audio frequencies than is the case in a three-electrode valve amplifier.

(6) Owing to the promiscuous movement of electrons in audio frequency circuits there is a limit to the maximum magnification. This limit is controlled by the amount of noise or interference caused by these wandering electrons which impulse the circuits.

(7) The minute variation in anode feed due to irregularities in electron emission from a valve filament causes the radio frequency circuits to be impulsed. This phenomenon is termed the "shot effect," and the noise due to this limits high-frequency magnification to several million.

(8) The limit of audio-frequency magnification is less than that of radio-frequency magnification, since the agitation of electrons in a low-frequency conductor creates more "audible noise" than the shot effect.

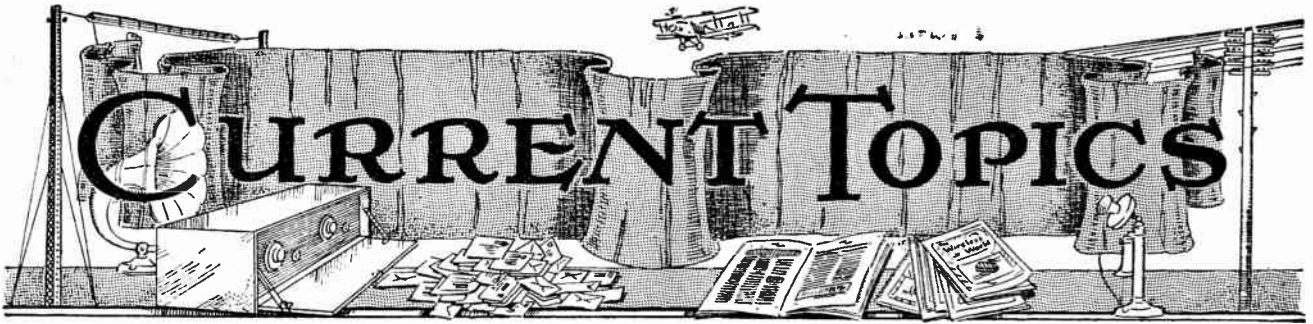

## Events of the Week in Brief Review.

### PRISON FOR "PIRATES."

Wireless "pirates" are to receive severe punishment in Bulgaria, according to that country's new wireless act. Those detected will be liable to twelve months' imprisonment, a heavy fine, and the confiscation of their apparatus.

○○○○

### NATIONAL WIRELESS WEEK.

National Wireless Week is to be held from November 13th to 20th, and during this period the B.B.C. will transmit special programmes.

The object of the "Week" is to encourage listeners to interest their friends in broadcasting.

○○○○

### LIFEBOAT WIRELESS.

Independent wireless transmitters for use on the lifeboats are a feature of the Marconi equipment installed on the *Laurentic*, the new triple-screw addition to the White Star Line. The *Laurentic* carries 1½ kilowatt spark and valve transmitter, and is fitted with a wireless direction-finder.

○○○○

### TRIUMPH FOR "WIRED WIRELESS."

The value of "wired wireless" was never demonstrated to better advantage than during a recent storm which broke down the trunk telephone line between Bombay and Poona. According to the *Times of India* the wires were useless for telephone communication, but engineers at the beam wireless station at Kirkee experienced no difficulty in putting through hundreds of words *via* the incapacitated wires by means of wired wireless. Using this system, the gap in the wires was effectually bridged, and the beam service remained unaffected.

○○○○

### MR. LEVINE'S WIRELESS WISDOM.

Mr. Charles A. Levine, the Atlantic flyer, stated when he returned to New York on October 17th that he hoped to make another flight to Europe next spring, but this time in a multi-engined machine with a good wireless apparatus.

○○○○

### TO SOOTHE THE TROUBLED MIND.

Various mental asylums in different parts of the country have installed broadcast receivers. In their recently published annual report the Commissioners of the Board of Control record that the

Nottingham City Mental Hospital has fourteen loud-speakers connected with a central receiving set. There are eighteen loud-speakers in use at the Rainhall (Lancs) Mental Institution. Other institutions equipped with receivers are those at Kesteven (Lincs), Hanwell, Netherlee, Derby, and the Yorkshire North Riding Institution.

### THE MANCHESTER SHOW.

The Manchester City Exhibition Hall is the scene this week of the Fourth Annual Wireless Exhibition organised by the *Evening Chronicle*. Prominent firms who exhibited at Olympia have transferred their displays to Manchester, so that in many respects Mancunians are enjoying the same benefits as did visitors to the London show.

Readers are cordially invited to *The Wireless World* stand, No. 27, on which will be found a number of receivers recently described in this journal.

An interesting feature of the show is the display of amateur-built sets. The Exhibition will remain open until Saturday, November 5th.

○○○○

### YOUR WIRELESS DIARY.

Handy information of the sort which the amateur experimenter often requires at a moment's notice will be found in the 1928 edition of "The Wireless World Diary and Notebook," just published. The special features include a Glossary of Technical Terms, a list of British and European broadcasting stations tabulated in order of wavelength and frequency, and a valuable collection of "Receiver Notes" in which will be found details, with circuits, of the principal receivers now in vogue. Valve data occupy 12 pages, and is given in tabular form for ready reference.

Copies are obtainable from the leading booksellers and stationers, or from the publishers, Iliffe & Sons Ltd., Dorset House, Tudor Street, London, E.C.4. The cloth edition is 1s., postage 1½d. extra; the leather case edition with pencil and season ticket holder is 2s. 6d., postage 2d. extra.

○○○○

### WIRELESS LESSONS IN SCHOOL.

How to secure maximum benefit from school wireless lessons was a point dealt with in a presidential address given by Mr. R. E. Sopwith, on October 8th, at the seventh annual meeting of the National Association of Inspectors of Schools and Educational Organisers. "It is already clearly evident," said the speaker, "that school wireless demands two teachers, one at the microphone, the other in the class-room. Moreover, not

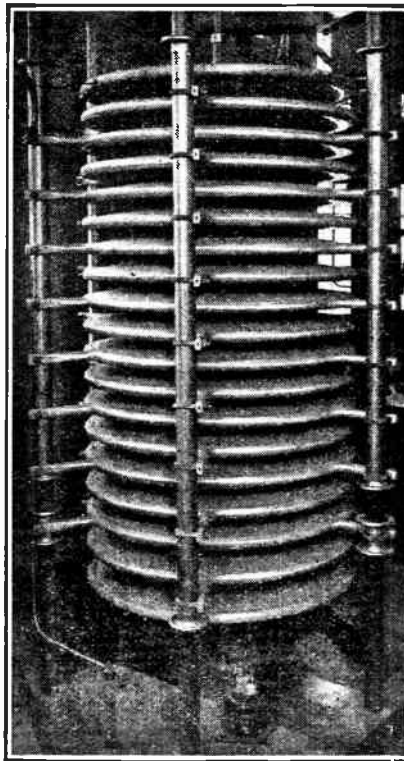

**A LARGE SIZE IN CONDENSERS.**  
One of the high capacity fixed condensers, seven feet high, in the new 50 kilowatt transmitting plant of WEA F, Bellmore, N.Y.

### IT DEPENDS ON THE SET.

"Everybody, sooner or later, becomes dissatisfied with the quality of reproduction put forth by his or her receiver."—Liverpool paper.

Is it really as bad as that?

only must the wireless lesson be prepared for, but it must be followed up if any real benefit is to be obtained from it."

o o o o

#### U.S. RADIO CENSUS.

Hitherto the domestic sales of radio equipment in the United States have only been calculated approximately. The Department of Commerce at Washington has now determined to obtain more definite figures of the turnover throughout the country.

Beginning with this month, and at the request of the radio industry itself, quarterly questionnaires will be sent out to all radio dealers, who will be asked to state the number of units on hand on the first day of the quarter, such as receiving sets, loud-speakers, batteries, and other accessories.

These returns will be pooled and com-

#### Guildford's First Wireless Exhibition.

To-day (Wednesday) will see the opening of the first radio exhibition to be held in Guildford. Organised by the Guildford and District Wireless Society, the exhibition will be open from 2.30 to 9 p.m. on October 26th, 27th, 28th and 29th at the Ward Street Hall. Among the attractions will be demonstrations of faithful broadcast reproduction.

The hon. secretary of the society is Mr. R. B. Leighton, Albury, Abbotswood, Guildford

o o o o

#### Selectivity with Liquid Air.

There was a radio flavour in the demonstration on liquid air given by Mr. Alan J. Bremner, B.Sc., at the last meeting of the Muswell Hill and District Radio Society. The demonstrator mentioned that he had immersed a crystal set inductance in liquid air, and while no increase in strength was noticed there had been an appreciable growth in selectivity. Among many other interesting experiments Mr. Bremner demonstrated the evacuation of an X-ray tube by means of liquid air.

The hon. secretary is Mr. Gerald S. Sessions, 20, Grasmere Road, Muswell Hill, N.10.

o o o o

#### "Wireless World" Five at South Croydon.

The "Wireless World" Five was used in a convincing demonstration of the reception of long-distance stations at the last meeting, on October 12th, of the South Croydon and District Radio Society, the demonstrator being Mr. Tozer. On the loud-speaker many European stations were clearly heard, specially notable being the reception of Prague and Vienna, which came in at remarkable volume. At the end of the meeting various members personally operated the set and learnt how simple it was to work.

Hon. Secretary: Mr. E. L. Cumbers, 14, Campden Road, S. Croydon.

o o o o

#### Lancaster Students' Wireless Club.

Two lady members were among those elected to serve on the committee of the

#### "W.W." SETS ON VIEW.

The set builder who meets with a constructional difficulty often wishes that an opportunity existed to inspect a completed receiver, which would make matters clear in a few moments. Such an opportunity is offered by the array of recent Wireless World sets which, owing to the success of the first display, are again on view for the benefit of the public at 116, Fleet Street, London, E.C.4.

A cordial invitation is extended to readers to visit this miniature exhibition, which is open daily from 10 to 6.

piled by the separate States, and it should then be possible to ascertain the total radio apparatus on hand in a given

area. After each census (says the *Manchester Guardian*), the returns on the fresh questionnaires will be compared with the previous returns, the stocks on hand deducted from the previous stocks, plus the manufacturers' shipments during the three-month period, and it should then be possible accurately to know the actual consumption of radio apparatus.

o o o o

#### AUTO ALARM ON SHIPS.

Eleven White Star liners are being fitted with the Marconi auto alarm apparatus. Similar equipment is being installed on twenty vessels of an associated company, Messrs. Shaw, Savill, & Albion Co., Ltd.

The auto alarm dispenses with the need for continuous watch, the reception of an S.O.S. message being sufficient to actuate a bell.

## NEWS FROM THE CLUBS.

wireless club attached to the Lancaster Storey Institute Students' Association at the first meeting of the session, held on October 12th. Other appointments included instructors in practical wireless and morse. A subscription list has been opened to provide the society with a new wireless set, and a useful feature of the winter activities will be a sale and exchange mart.

Hon. Secretary: Mr. W. Salt, 5, Coverdale Road, Lancaster.

#### FORTHCOMING EVENTS.

##### WEDNESDAY, OCTOBER 26th.

Muswell Hill and District Radio Society.—At 8 p.m. At Tollington School Tetherdown, N.10. Lecture: "The Uses of Neon Tubes," by Mr. Leonard Hirschfeld, B.Sc.  
Tottenham Wireless Society.—At 8 p.m. At 10, Bruce Grove, N.17. Lecture: "Osram Valves," by Mr. F. E. Henderson (of the G.E.C.).  
Stretford and District Radio Society.—At 8 p.m. At 6a, Derbyshire Lane. Demonstration on the Neutrosomic Seven, by a representative of Igranic Electric Co., Ltd.

##### THURSDAY, OCTOBER 27th.

Golders Green and Hendon Radio Society.—Club Dance. At 8 p.m. At the Club House, Willifield Way, N.W.11. Tickets 3s. 6d., from Mr. E. E. Marshall, Wayside, Golders Green Rd., N.W.11.  
Ilford and District Radio Society.—At the Wesleyan Institute. Talk on "Short Wave Transmitting Sets," by Mr. J. E. Nickless (2KT).

##### SATURDAY, OCTOBER 29th.

Stretford and District Radio Society.—Select Dance at the Conservative Club, King Street, Stretford

##### MONDAY, OCTOBER 31st.

Hackney and District Radio Society.—At 8 p.m. At the Hackney Electricity Hall, E.S. Talk on "Moving Coil Loud-Speakers," with demonstration, by Mr. G. V. Colle.

##### WEDNESDAY, NOVEMBER 2nd.

Institution of Electrical Engineers, Wireless Section.—At 6 p.m. (light refreshments at 5.30). At the Institution, Savoy Place, W.C.2. Inaugural Address by the Chairman, Lt.-Col. A. G. Lee, O.B.E., M.C., B.Sc.

#### Overhauling a Club Transmitter.

The City of Belfast Y.M.C.A. Radio Club is busily engaged in rebuilding the club's transmitter, GI-GYM, besides constructing a number of receivers. The morse class has been resumed, both for beginners and those who wish to maintain their speed. A series of interesting lectures is being arranged for the coming months.

Full particulars regarding membership can be obtained from the hon. secretary, Mr. J. J. Cowley, at the headquarters of the association, Wellington Place, Belfast.

o o o o

#### Improving the Quality of Reproduction.

The Golders Green and Hendon Radio Society is devoting special attention this session to the quality of reproduction, and at a recent meeting Mr. L. Franklin, of Metro-Vick Supplies, Ltd., gave the first of a series of talks on this topic. Mr. Franklin described certain methods of rectification and amplification, and put forward his opinion that resistance-coupling under proper conditions gave results which could not be bettered.

The first club dance will be held tomorrow evening (Thursday) in the ballroom of the club house at 8 o'clock. Tickets, 3s. 6d., inclusive, from Mr. E. E. Marshall, Wayside, Golders Green Road, N.W.11. The Georgian Dance Trio have again been engaged for the winter season.

Hon. Secretary: Lt.-Col. H. Ashley Scarlett, D.S.O., 357a, Finchley Road, N.W.3.

o o o o

#### A Northern Club.

In lecturing on "How a Valve Works" at the last meeting of the South Hetton and District Radio Society, Mr. J. W. Brown provided the members with much information of a kind which is frequently overlooked.

The encouraging attendance of 30 members gives promise that the society will enjoy a flourishing session.

Hon. Secretary: Mr. M. G. Hall, 33, Forster Street, South Hetton, Co. Durham.

# Some Recent Patents

The following abstracts are prepared, with the permission of the Controller of H.M. Stationery Office, from Specifications obtainable at the Patent Office, 25, Southampton Buildings, London, W.C.2, price 1s. each.

## Loud-speakers. (No. 273,658.)

Convention date (U.S.A.): July 3rd, 1926.

The diaphragm of a loud-speaker of the hornless type consists of a sheet of elastic material maintained under a permanent stress. For instance, a disc of sheet metal may be clamped in a suitable frame when red hot and then allowed to cool. In the process of shrinking, internal stresses are set up which are stated to improve the resonating qualities of the diaphragm. In the case of parchment, the material may be clamped in the holder whilst wet and then allowed to dry *in situ*. Additional layers are added to thicken the diaphragm around the central parts.

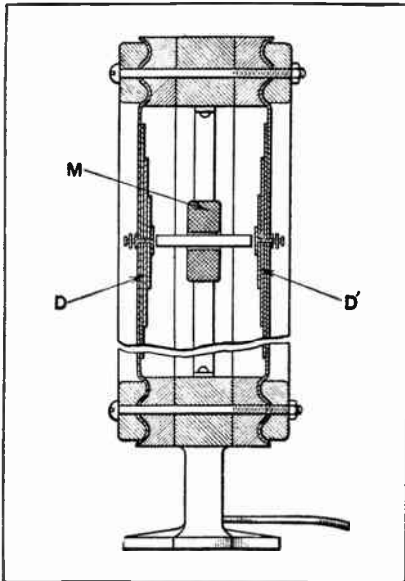

Loud-speaker with stretched laminated diaphragms. (No. 273,658.)

The high-powered speaker illustrated comprises two such stressed diaphragms D, D' mounted back to back, and energised by a central magnet M. Instead of being circular the diaphragms may be made of square outline, the operating magnet in this case being disposed to one side of the centre. This is stated to

produce a certain range of overtones which are pleasing to the ear. Patent issued to L. W. Staunton.

## Battery Eliminators. (No. 275,797.)

Application date: August 20th, 1926.

Alternating current from the mains energises a double-wound secondary supplying a full-wave rectifier W. After passing through a smoothing circuit S the output is utilised to provide the plate, filament, and grid-biasing voltages of a

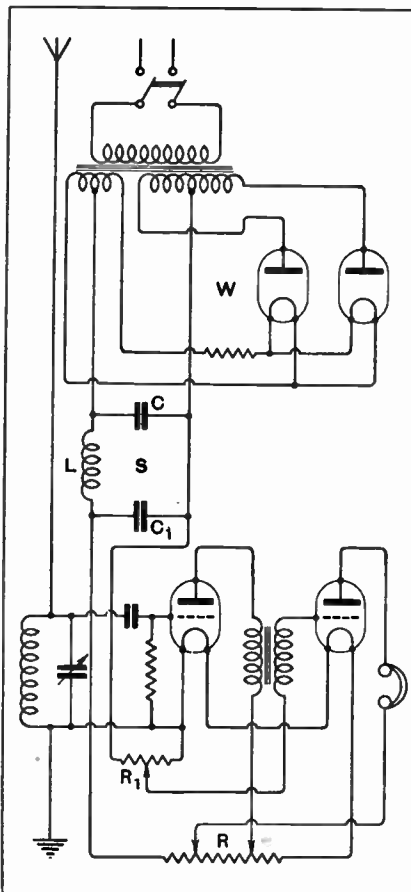

Receiving circuit operating from A.C. mains. (No. 275,797.)

multi-valve set. A series resistance R in the positive lead affords suitable tapping points for the high-tension, and also provides sufficient voltage drop to feed the valve filaments in series. The grid bias is derived from a second resistance R<sub>1</sub> inserted in the negative lead as shown.

For a 220-volt A.C. supply with a frequency of 50 cycles the choke L should have a resistance of 500 ohms and an inductance of 10 henries, whilst the shunt condensers C, C<sub>1</sub> should each have a capacity of 5 microfarads. The resulting direct-current pressure available for the set will then be in the neighbourhood of 140 volts. Patent issued to R. Anan.

## Telephony Transmitters. (No. 275,771.)

Application date: July 8th, 1926.

Modulating current from the microphone M is applied through a transformer across the grid and plate of an auxiliary valve V, which is in turn inserted between the grid and filament of the power

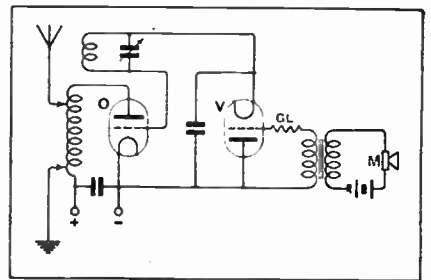

Grid modulation circuit. (No. 275,771.)

valve O. The latter generates the radio-frequency carrier wave. The arrangement is of the type known as grid control as distinct from the more usual plate modulation or choke control. The valve V functions as a variable grid leak to the power valve O, its impedance varying with the voltages applied from the microphone circuit. An additional resistance GL of 90,000 ohms is inserted in series with the grid of the valve V, as shown, for the purpose of controlling the mean operating potential throughout the full range of modulation. Patent issued to N. F. S. Hecht and G. Morton.

# The Experimenters' Notebook



## Directional Reception. (Continued from page 558 of previous issue.) By "EMPIRICIST."

WE may summarise the contents of the preceding instalment on directional receivers briefly in the following terms:—

(a) A loop aerial under ideal conditions receives signals at maximum strength from sources lying in its plane, but is blind to signals from sources lying perpendicular to its plane.

(b) The *effective* E.M.F. in an ideal frame aerial is in quadrature with that produced in an open aerial located in the same place as the frame aerial.

(c) The voltage built up across the terminals of an ideal frame aerial is thus in quadrature with the voltage built up across a tuning inductance connected to an open aerial.

(d) If a frame aerial is susceptible to the electrostatic wave of a transmitting station it will pick up partly as if were an open aerial, and rotation of the frame will only produce a minimum and not an extinction of signals.

(e) If the frame is centre-tapped, and care is taken to ensure perfect symmetry, currents will no longer be built up in it in response to the direct electrostatic field of a transmitting station and "clean minima" will result.

(f) Inasmuch as the actual electrostatic E.M.F. may exist separately in the two halves of the frame, though balanced out in the frame as a whole, there may be a secondary voltage present in the frame, even though no current is built up in the circuit as a result of it. Since the voltage produced in this manner is in phase with the electrostatic field, it will also be in phase with the voltage built up in the frame as a result of its normal operation. The two voltages will therefore combine, and the result will be a displacement of the position of zero receptivity. The effect of direct induction which gives rise to this secondary voltage in the frame has been termed "vertical" or "antenna" effect.

### Polar Diagrams.

The combination of open and loop aerials in various manners represents the handiest and most readily controllable means for taking advantage of directional methods of reception. It is first necessary

to postulate a receiver which is sufficiently sensitive to operate in conjunction with a loop aerial alone, since at the best we can only double the strength of reception from any given station if we wish our aerial arrangement to preserve its directional properties. In other words, we cannot regard the open aerial as anything but a means for controlling the nature of the "polar diagram," and we can never use it so as to give its maximum signal strength.

First of all, if we consider the problem of eliminating a strong interfering station, it is absolutely essential to get rid of "direct pick-up," since this will spoil the sharpness of the minimum. This may be effected most easily perhaps by the use of a centre-tapped frame, though in this case it is preferable for the tuning condenser to be screened, as otherwise asymmetry may result owing to one set of plates having more metal work connected to them than the other. When once care has been taken in this respect, "clean minima" will result, and the first step in building a receiver with satisfactory directional properties will have been accomplished. There will, however, still be "vertical effect" present in the frame aerial arrangement as it stands, and it will be necessary to consider how to deal with this.

Possibly the most satisfactory method in the case of an installation, in which no attention has to be paid to absolute direction but only to the possibilities of eliminating interference, is to ignore the "vertical effect" due to the frame itself and to provide means for combining an open aerial with the loop aerial in such a manner that a controllable amount of "vertical" can be introduced so as either to cancel out what the frame itself picks up, or else to make deliberate introductions of this effect in order to change the shape of the "polar diagram."

In Fig. 5 is shown a convenient arrangement for introducing "vertical" in a frame aerial circuit. Here a centre-tapped frame aerial is employed, as previously described, and it is assumed that care has been taken to eliminate direct "pick-up" by the means already suggested. A small coupling coil is introduced in the centre of

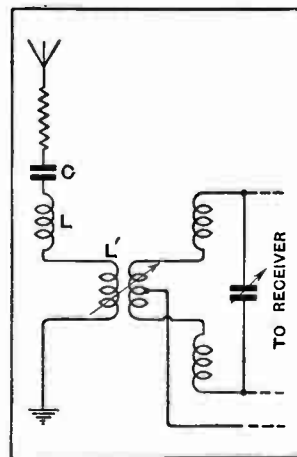

Fig. 5.—A periodic open aerial coupled to frame to introduce controllable "antenna" effect.

**The Experimenter's Notebook.—**

the frame windings; this, in order to preserve electrical symmetry, should be tapped in its centre and equal numbers of turns inserted in each half of the frame. A resistance is inserted in the aerial lead for the purpose of flattening the tuning as completely as possible. This should essentially be of low capacity, and may quite conveniently consist of a number of ordinary grid leaks connected in series, such an arrangement enabling adjust-

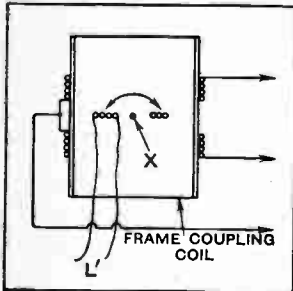

Fig. 6.—Coupler suitable for use in the circuit of Fig. 5. The centre coil is rotatable about the axes X, and is of basket coil form, the outer coil being wound as a single-layer solenoid.

ments for aerials of different sizes to be effected by alteration in coil L. and series condenser C in the aerial circuit will enable fine adjustment of phase to be easily carried out. A coupling coil L' should be mounted so as to be rotatable in relation to the coupling coil in the centre of the frame. An excellent construction which prevents asymmetrical effects is to make L' in the form of a flat coil rotatable inside a cylindrical former on which the frame coupling coil is mounted. Such an arrangement is shown in Fig. 6, and it will appear from consideration of this figure that the proximity of the high potential end of the coil L' (which we may assume to be the outer turn of this coil) to the respective extremities of the centre tapped frame coil is always the same. As a result there will be no direct pick-up in the frame introduced as a result of the frame aerial coupling. Experiments with basket formers will indicate the correct number of turns for L' to suit the particular case.

**The Cardioid Diagram.**

An arrangement of this sort will be found to give a "heart-shaped" polar diagram of reception with great ease, and also any desired shape intermediate between this and the ordinary circle. It will be found that the condenser C is not critical in its adjustment, and serves merely as a means for sharpening up the minima.

The procedure for testing and adjusting the apparatus is almost evident from what has been described. It will be found that if L' is set at the position of minimum coupling that the minima on rotating the frame are approximately equally disposed, so that the frame is non-responsive to signals from a source lying perpendicular to its plane. Rotation of the frame through 180° from one point of extinction of the signal will thus produce the second point, or very nearly so. If now the coupling is increased, a displacement of the positions of the two minima towards each other in either one sense or the other will be experienced, and also possibly a slight blunting of minima. Adjustment of the condenser C in conjunction with the correct value of inductance at L will suffice to sharpen up the minima, and no readjustment of C should be required for that particular wavelength. Rotation of the coil L' will then yield any required variety

of polar diagram. A number of different typical diagrams are shown in Fig. 7.

**Coastal Reception.**

The utility of such an arrangement when correctly set up, for the elimination of interference is almost unbelievable, and it constitutes practically the only satisfactory method of dealing with ship interference in locations near the coast. In cases of this sort it is usually desired to receive at optimum strength in a direction lying inland and to "blank out" as far as possible all signals coming from the sea. If the adjustment is made so that the two minima just coalesce into a single broad minimum it will be found that the frame can be rotated so that an angle of about 30° of practically zero reception is produced, a maximum signal strength resulting in a direction opposite to this, *i.e.*, directly inland.

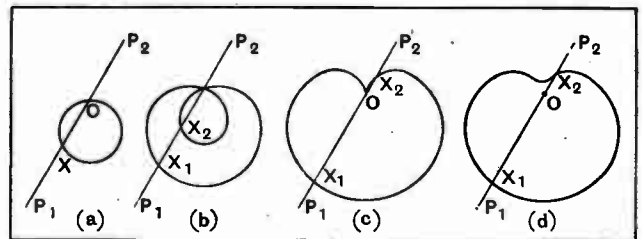

Fig. 7.—Polar diagrams corresponding to various combinations of loop and open aerial. (a) is loop alone; (b) loop combined with open aerial, signal strength due to the open aerial being less than that due to loop; (c) open aerial signal strength equal to that of loop; (d) open aerial signal strength greater than that of loop.

It is not, of course, possible to deal with all cases of interference in this manner, since one particularly strong aerial station may need all the directional properties of the aerial system concentrated on it, and the arrangement will then not be capable of adjustment so as to give a general non-receptive effect in a seaward direction. On the other hand, it is perfectly clear that by manipulating both the frame and the coupling coil L' two totally distinct sources of interference can be blotted out and reception effected from all other directions.

The writer is of the opinion that the possibilities of directional reception have not been properly exploited so far in connection with broadcast reception, and it would seem certain that experiments carried out on the lines of the foregoing remarks, while not necessarily simple, would give results of the greatest possible value and interest.

**BOOKS AND CATALOGUES RECEIVED.**

"The Interaction of Pure Scientific Research and Electrical Engineering Practice." A course of advanced lectures delivered before the University of London, October and November, 1926, by J. A. Fleming, M.A., D.Sc., F.R.S. Pp. 235 with frontispiece and 64 illustrations and diagrams. Published by Constable & Co., Ltd., London. Price, 15s. net.

"Television for the Home." The wonders of "Seeing by Wireless," by R. F. Tiltman, F.R.S.A., with introduction by Prof. A. M. Low. Pp. 106 with 8 illustrations. Published by Hutchinson & Co., Ltd., London.

Ferranti, Ltd., Hollinwood, Cheshire. Publication Wc401, describing Ferranti audio-frequency transformers, types AF-3 and AF-4. Publications dealing with Ferranti radio meters, trickle charger, loud speaker, etc.



News from All Quarters: By Our Special Correspondent.

**Improvements at 5GB.—A Telescopic Stunt.—Empire Broadcast Tests.—Separate Station for Education?—Armistice Day.—Honegger's "King David."**

**Louder Signals from 5GB.**

Some tense moments have occurred at Daventry during the last week or two during the raising of the two new 325ft. masts which, according to pious hopes, are going to show the world that 5GB is still a force to be reckoned with.

The masts are now in position, but the engineers have decided to ca' canny with the transmissions, the original little aerials still being in use. Some furtive nocturnal tests will be conducted with the new aerial before any announcements are made, though I expect that it will come into operation within the next fortnight.

o o o o

**Forgetting Wear and Tear.**

In view of these efforts to improve the radiation from Daventry Experimental, it is a little difficult to sympathise with those aggrieved crystal users of Birmingham who are reported to be refusing to renew their licences.

The experience of the past few weeks has shown that many sets are now either obsolete or the victims of wear and tear. In many cases of complaint the B.B.C. have given hints on overhauling the receiver, with the result that quite a number of people who have taken official advice report an astonishing improvement in their reception, and are now anxious to help their companions in distress!

o o o o

**Poor Old Aerial.**

How many good citizens ever overhaul their aerial system to repair the effects of smoke, dust, rust, and other enemies to efficient reception? Are you among them? I put this question to a friend: he replied: "I had a job putting the darn thing up three years ago, and I've let it stop there."

He will probably overhaul it when it drops.

o o o o

**Fatality at Daventry.**

The news of the first fatality in five years of British broadcasting will have occasioned general regret. Mr. W. E. Miller, whose tragic death occurred at Daventry last Thursday afternoon, was maintenance engineer of 5GB. It appears that Mr. Miller, after switching

on the high tension, was observed a few minutes later to lean over the guard rail apparently with the object of making an adjustment which should not have been undertaken with the switch "on."

Mr. Miller was twenty-nine years of age, and was unmarried. He had been with the B.B.C. two years.



**LISTENING IN BRAZIL.**—Mr. E. D. Wratten, a reader in Brazil, sends us this photograph of a fair listener at Rio de Janeiro. He has constructed *The Wireless World* "Empire Broadcast Receiver" and is now awaiting signals from 5SW!

**A Telescopic Stunt.**

Nowadays the Savoy Hill Stunt Department seems to have gone into comparative retirement; not so the officials in charge of this form of enterprise at station 5CL, Adelaide. The other day a "Special Radio Stunt" was organised in which Mr. Dodwell, Government Astronomer,

inspected the heavens from the telescope at the Adelaide Observatory and described to listeners what he could see. This stunt would be worth copying over here.

o o o o

**A Chance Missed?**

No doubt it will occur to some readers that the B.B.C. missed an opportunity of a similar stunt when the Baldock-Smith fight was broadcast. From the look of things Baldock could have described some interesting new constellations!

o o o o

**West Ham v. Cardiff City.**

The second half of the West Ham v. Cardiff City match on November 12th will be broadcast from 2LO.

o o o o

**First Signals from 5SW.**

The first whispers from the Empire short-wave station 5SW at Chelmsford will probably have gone out a few hours before these lines are read. At first the signals will be of a purely tentative nature, being mainly concerned with the testing of the apparatus as it is erected. No definite schedule has been arranged, but I understand that certain picked listeners in Australia and South Africa are already "on watch."

There is very little likelihood that the full power of 25 kilowatts will be used at first.

o o o o

**Another Relay from Sydney.**

Meanwhile the B.B.C. is not neglecting the other side of the short-wave question, i.e., reception from the Colonies. Following upon the partial success of the relay from 2FC, Sydney, on Sunday evening, October 16th, arrangements are being made for another special transmission from 2FC on Sunday next, October 30th, when it is expected that the Australian station will be relayed from 2LO 5XX, and 5GB between 6 and 6.30 p.m.

o o o o

**Keston's Bad Luck.**

It was apparently bad fortune which prevented the last effort from being a much greater success than it was. When Keston first attempted to pick up 2FC,

on 28.5 metres, atmospherics were so troublesome that 23 minutes elapsed before recognisable signals came through. This was at 6.8 p.m., when the relay began, but as conditions had not improved at 6.20 p.m. it was decided to abandon the re-transmission. Ten minutes later, by one of those freaks which always have to be reckoned with in wireless, Australia came through with better quality than ever before.

By that time the British listening public had shut down!

#### An Underground Aerial?

For short-wave relay work the Keston engineers are now using an eight-valve receiver and an aerial which can best be described as a development of the Beverage aerial. It runs along the ground at a height of only one foot. There is talk of employing a buried aerial; would this provoke the accusation that the signals were coming through the earth by land-line? The B.B.C. has to be so careful!

#### Separate Station for "Culture"?

It is extremely unlikely that the joint committee on educational broadcasting, appointed by the B.B.C. and the British Institute of Adult Education, will see its desires fulfilled by the establishment of a separate station for "cultural" broadcasts.

Much as the educationists would like a station all their own to dispense culture morning, noon, and night, the idea will hardly come into the realm of practical politics while the present Geneva wavelength scheme holds sway.

We have only nine wavelengths to play with; the regional scheme will absorb all these.

#### G.B.S. and G.K.C.

Ireland is taking an uncommon interest in the promised debate between Bernard Shaw and G. K. Chesterton, to be broadcast from the Kingsway Hall, London, through 2LO and 5XX on Friday next at 8 p.m. Both Dublin and Cork stations are relaying the debate, the former on 319.1 and the latter on 400 metres. No doubt Hibernian interest has been aroused by the fact that that distinguished Irishman, Mr. Shaw, is heard all too rarely in his own country.

The debate will centre on that weighty question: "Do we agree?"

#### Disguising the News Bulletin.

A laudable effort to dress up the broadcast news bulletin in a new guise is being made by the Montmartre station of *Radio Vitus*, Paris, which is now providing its adherents with "Le Journal Radio-phonique de France." This is a daily "spoken newspaper," transmitted from 6 to 7 p.m. G.M.T., and giving a review of scientific and literary topics and current affairs.

The B.B.C. once made an attempt in the same direction by broadcasting "Editorials," but their enterprise was suppressed because of the difficulty of eliminating controversial topics.

#### Armistice Day Programme.

The main evening programme on Armistice Day will be comprised in the National Symphony Concert which is to be conducted in the Queen's Hall by Sir Edward Elgar and Sir Henry Wood.

The items already arranged are Stan-

#### FUTURE FEATURES.

##### London and Daventry (5XX).

OCT. 30TH.—Symphony Concert to celebrate the fiftieth season of the People's Concert Society.

OCT. 31ST.—"Old Heidelberg," a play by Wilhelm Meyer-Forster.

NOV. 1ST.—English comic opera programme.

NOV. 2ND.—"King David" (Honegger).

NOV. 3RD.—Variety programme.

NOV. 4TH.—Symphony Concert. Bridge Hand.

NOV. 5TH.—Military Band Concert.

##### Daventry (5GB) experimental.

OCT. 30TH.—Religious service relayed from a Ward at the General Hospital (from Birmingham).

OCT. 31ST.—A Military Band Concert.

NOV. 1ST.—"Riders to the Sea," a play by J. M. Synge.

NOV. 2ND.—"The Way of an Eagle," an arrangement of the popular play by Ethel M. Dell.

NOV. 3RD.—"The Blue Peter," a comic opera in one act by A. P. Herbert.

NOV. 4TH.—Variety programme.

NOV. 5TH.—A Scots programme.

##### Bournemouth.

NOV. 5TH.—"Bombastes Furioso," a burlesque tragic opera in one act.

##### Cardiff.

OCT. 31ST.—"Hallowe'en," an orchestral and vocal concert.

##### Manchester.

NOV. 2ND.—"Manchester Evening Chronicle" programme.

##### Newcastle.

NOV. 3RD.—Variety programme.

##### Glasgow.

OCT. 31ST.—"Hallowe'en at Knockendoch."

NOV. 5TH.—A programme by blind artists.

##### Aberdeen.

NOV. 2ND.—"In the Dark," a detective play by Gilbert Heron.

##### Belfast.

NOV. 2ND.—Operatic Favourites.

ford's "The Last Post" (chorus and orchestra), "The Glories of our Blood and State," by Parry, and Elgar's "The Spirit of England," in which Miss Dorothy Silk, as soloist, will be assisted by chorus and orchestra.

"Let us now praise famous men," from

the Apocrypha, will be spoken by General Sir Ian Hamilton and Pericles' Funeral Oration by Lord Balfour.

#### A Shavian Retort.

Alan Griff, who will read one of his short stories, "The Kingdom," at Manchester station on November 4th, is yet another author who has passed under the fierce but friendly eye of Bernard Shaw. The introduction came about through a review which Mr. Griff wrote of "Back to Methuselah," and G.B.S. described as "Not bad. You can't see the wood for the trees; but your taste in trees is very good."

#### Talks for Rainy Days?

Diagnosis and treatment of common afflictions as well as more serious maladies are being dealt with in a course of broadcast lectures lasting for thirteen weeks which are now being given from WBZ at Springfield, Massachusetts. It is difficult to imagine anything more depressing.

#### A Gaelic Folk Opera.

The first broadcast performance of "The Seal Woman," a Gaelic folk opera in two acts by Margaret Kennedy Fraser and Granville Bantock, will be given from 5GB on November 8th. The cast will be the original cast which appeared at the first production of the opera at the Repertory Theatre, Birmingham, in 1924. Mr. Joseph Lewis, who conducted part of the original performance, is producing the opera under the supervision of the composer.

#### A Promising Variety Night.

A strong variety programme will go out from 2LO on November 5th. Neil Kenyon is to give listeners a repeat performance of "The Poet," one of his funniest numbers. Norman Griffin, who is to present the comedian in "Blue Skies," will also be heard on the same evening. He used to understudy Leslie Henson. Other artists in the same bill are Olive Kavann, Scott and Lanchester, and Wish Wynne.

#### Honegger's "King David."

One of the outstanding musical events of the season will be the performance by the Civil Service Choir, numbering 160, of Honegger's "King David," which takes place at the Central Hall, Westminster, on November 2nd, and is to be broadcast.

The Wireless Symphony Orchestra will take part under the conductorship of Mr. Stanford Robinson, of the B.B.C. The Corporation has also lent the services of Mr. A. S. Hibberd for this performance as Narrator, the function fulfilled by Mr. Robert Loraine when the B.B.C.'s National Orchestra gave a performance of the same work in March last at the Royal Albert Hall. The soloists on November 2nd are Elsie Suddaby, Dorothy D'Orsay, and Leonard Gowings.

Listeners will be able to obtain souvenir programmes from the Secretary of the Civil Service Choir, 84, Elers Road, Ealing, W.13, price sixpence post free.





# STERLING

MANSBRIDGE TYPE

## CONDENSERS

**LOWER PRICES**

The famous Sterling Mansbridge Type Condensers have been reduced in price. Now, your choice must inevitably lead you to the condenser that is protected against dielectric breakdown by the self-sealing device—is tested to 300 volts—is completely enclosed in a strong metal case.

Capacity.	Price.	Capacity.	Price.
	s. d.		s. d.
0.01 mfd. ..	1 9	5 mfd. ..	2 7
0.05 mfd. ..	1 9	1 mfd. ..	2 10
0.1 mfd. ..	1 10	2 mfd. ..	2 10
0.2 mfd. ..	2 3	4 mfd. ..	7 6
0.25 mfd. ..	2 3	6 mfd. ..	11 6
0.3 mfd. ..	2 3	10 mfd. ..	18 0
0.4 mfd. ..	2 7		

Full particulars on request.

THE MARCONIPHONE COMPANY, LTD.

(Sole Agents for Sterling Telephone and Electric Co., Ltd.)

Head Office: 210-212 Tottenham Court Road, London, W.1

Registered Office: Marconi House, Strand, London, W.C.2

M 9986

# BUSH HOUSE

The Largest Wireless Organisation  
in Great Britain.

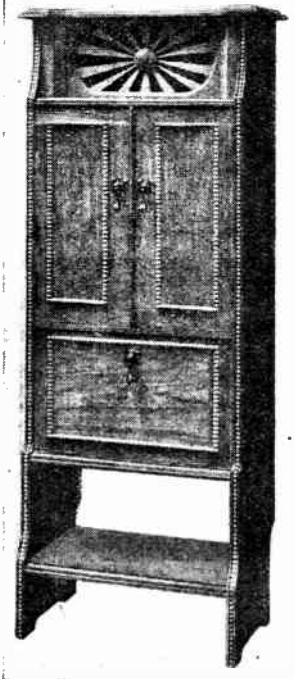

**ANSIL DE LUXE**  
Combined  
Cabinet and  
Speaker.

Price  
**£5 15 0**  
Solid Jacobean  
Oak. Mahogany  
10/- extra.

**ANSIL**  
**CABINETS, SETS**  
**AND COMPONENTS**  
direct from our factory to you.

Our branch at No. 40, Deansgate (corner of St. Mary's Gate), with its fine Demonstration Lounge, is certainly the most elaborate and best equipped in this country. Set manufacturers and Traders should not fail to call—the service from our Cabinet Factory supplies the long-felt want.

HART Battery Service Agents.  
Factors supplied.

VISIT THE PERMANENT EXHIBITION  
AND DEMONSTRATION LOUNGE AT

**40, DEANSGATE, MANCHESTER**



*Still* the only full-size, first quality instrument for £3.0.0

IN spite of the recent introduction of many new loud speakers, the B.T.H. Type C2 Loud Speaker still remains supreme in its class. There is not another loud speaker, at anywhere near the price, that will give such great volume and such faithful reproduction. It is still the only full-sized, first quality instrument for £3.

Ask your dealer to let you make a comparative test

The above price is applicable in Great Britain and Northern Ireland only.

The **B.T.H.** TYPE C2 LOUD SPEAKER

2796

The British Thomson-Houston Co., Ltd.

# CARBORUNDUM IN RADIO

## CARBORUNDUM STABILISING DETECTOR UNIT.

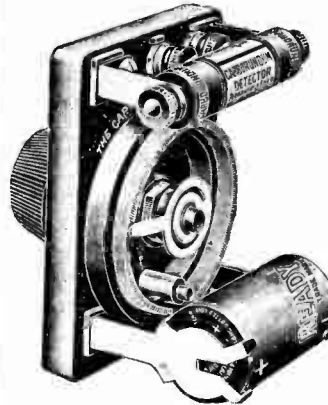

This Unit is an electrically controlled Carborundum Detector and is adaptable to all detector circuits. This is because of the resistance controlling feature whereby the Detector may be made to match the impedance of any circuit. The unit control is exceptionally fine and smooth, accurate to about 1/1000th of a volt. The Unit consists of a fixed detector high-resistance potentiometer, built-in mica condenser and

clips for the dry cell, all mounted on a low-loss base. Single hole mounting.

No. 32. Price - each 12/6

Dry Cell (price extra), each 5d.

No. 30. Carborundum Detector (without Stabilising Device). Price - each 5/-

## CARBORUNDUM RESISTANCE CAPACITY COUPLING UNIT.

This Unit is quite different from any other at present on the market, presenting as it does many distinct advantages over Units employing ordinary Grid Leaks and Anode Resistances. The Resistances used in the Carborundum Resistance Capacity Coupling Unit are solid rods of unbreakable Carborundum, which is created in the largest electric furnaces in the world, at the terrific temperature of 4000° F. They cannot burn out, present no capacity effects, and are absolutely non-microphonic. The Unit takes up far less room than the smallest L.F. transformer, and the complete absence of background noises enhances the already great possibilities of R.C. Coupling. Not being dependent on a metallic film, the resistances will not disintegrate and are unaffected by atmospheric changes. No. 73. Price 8/6.

CARBORUNDUM ANODE RESISTANCES AND GRID LEAKS in all standard values. Price - each 2/6.



SEE OUR EXHIBIT. "EVENING CHRONICLE" WIRELESS EXHIBITION,

STAND No. 16

Send for new 24-page Book containing Circuits and much useful information.

All Carborundum Radio Products are sold under our complete guarantee that they will operate satisfactorily in properly designed circuits.

THE CARBORUNDUM Co., Ltd., TRAFFORD PARK, MANCHESTER.

# NEW APPARATUS

A Review of the Latest Products of the Manufacturers.

**COLUMBIA LAYERBUILT BATTERY.**

An important departure in dry battery construction is to be found in the Columbia battery, obtainable from J. R. Morris, Imperial House, 15-19, Kingsway, London, W.C.2.

At one time all dry cell batteries consisted of an assembly of cylindrical cells, and consequently for a given overall size the capacity of the battery was somewhat less than could be obtained by the adoption of square section cells filling the

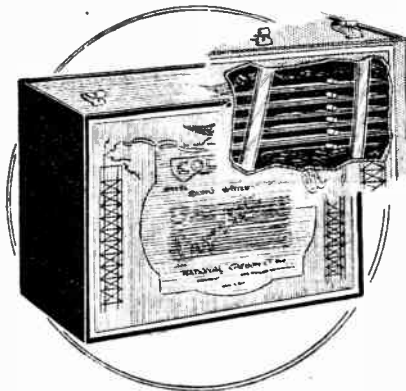

Novel super H.T. battery construction. The cells are assembled in the form of flat sections.

entire interior of the case. A modification from round to square cells gives a slight increase in the ampere-hour capacity of the battery, though the internal resistance is not materially reduced.

In the new Columbia battery not only is the entire interior of the container filled by the cells without the need for air gaps or insulating spacers, but the cells are modified in a manner which reduces the internal resistance, at the same time increasing the ampere-hour capacity. By removing the side of the battery and cutting through the insulating compound the plates are exposed and are seen to be in the form of flat zinc sheets with small carbon rods interposed between them and bedded into the carbon mass depolarising compound and electrolyte. A large area of negative plate is obtained, while the distance between the plates is small.

This original form of construction obviously calls for comment, though it is diffi-

cult to determine the precise method of internal assembly of the battery and many details of manufacture are, of course, not obvious from a destructive examination of the interior. The maximum discharge rate of a battery of this class is probably of the order of 20 mA., though for test purposes a current of between 40 and 36 mA. over a period of 50 hours was passed, after which the voltage declined rapidly. This continuous discharge test is, of course, unusually severe and does not indicate that the battery is exhausted after such a run, but rather that it is temporarily polarised. Ampere-hour capacity of a dry cell is, of course, a function of discharge rate, and even on this excessive discharge the capacity of the battery is shown to be unusually high.

Where mains supply is not available for operating a battery eliminator or for charging high tension accumulators the use of this type of battery can be recommended. The unit measures about 8x7x4 1/2 in., gives 45 volts, and costs 25s. The increasing use of power valves working in connection with the operation of moving coil loud-speakers is stimulating the demand for a heavy duty battery of this class.

o o o

**USEFUL BATTERY CLIPS.**

Rather than insert flexible leads under the terminals of accumulators when connecting them to the charging circuit, a more convenient method is to make use of clips for gripping the terminal of the

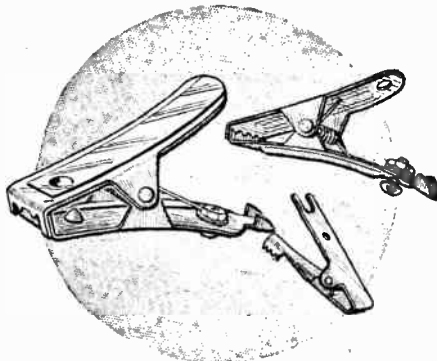

Lead-covered battery charging clips.

terminal stem. Certain types of batteries are, moreover, only fitted with lugs, in which cases the use of clip connectors becomes essential.

Messrs. Ward and Goldstone, Ltd., Frederick Road, Pendleton, Manchester, now offer a useful range of clip connectors specially made for this purpose carrying a special lead covering to prevent corrosion.

o o o

**THE CASON TOGGLE SWITCH.**

The majority of receiving sets are brought into operation by a single-pole switch fitted in the battery filament leads, and there is a demand for a simple

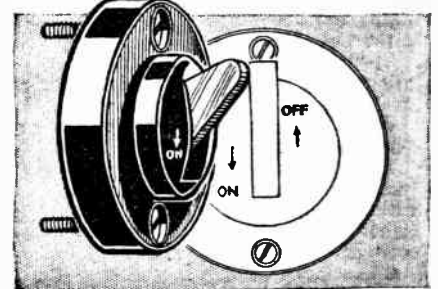

Cason Toggle switch.

form of switch of attractive appearance. A plunger switch is commonly used for this purpose, but cannot be always conveniently fitted owing to the need for a rather large hole in the panel, while there may not be sufficient accommodation for a projecting part behind the panel.

In such cases the new Toggle switch made by Cason Mouldings, Chiswick Road, Lower Edmonton, London, N.9, will be found suitable. It is simply attached to the panel by means of two small screws which serve also for making the necessary circuit connections. The lever moves with a good snap action, making a thoroughly good, reliable contact. The body of the switch is a clean black moulding of distinctive appearance, while the lever is moulded in a hard red material. The liberal current-carrying capacity of this switch renders it suitable for other purposes, such as breaking the primary circuit of a battery eliminator transformer.



The Editor does not hold himself responsible for the opinions of his correspondents.

Correspondence should be addressed to the Editor, "The Wireless World," Dorset House, Tudor Street, E.C.4, and must be accompanied by the writer's name and address.

#### EMPIRE BROADCASTING.

Sir,—It is a pity that the "powers that be" of the B.B.C. were in all probability sleeping the sleep of the just while the second part of the Australian Second Empire Programme was being broadcast from 6.30 this morning, so that the fervent appeal by the Lord Mayor of Sydney during this broadcast for a policy of reciprocation by the B.B.C. will be somewhat ineffective unless repeated through some other medium.

Boston Spa.

ERIC A. TOPHAM.

October 17th, 1927.

#### MORSE INTERFERENCE.

Sir,—May I be allowed to cover up one or two points raised in your Editorial under this heading in the October 12th issue.

Ships at sea carry wireless primarily for safety purposes, and it has always been recognised that spark or I.C.W. transmissions are peculiarly suited for this duty. The British proposals therefore do not contemplate C.W. transmission on 630 metres.

So far as I am aware the proposals are that six months after the Convention comes into force no new ship station shall use highly damped waves—they are referred to as type B waves—if the power exceeds 125 metre-amps., and from the same date no land station shall use type B wave—ships' emergency sets will remain as at present, mainly spark sets operating from an independent source of power.

With regard to the Auto-Alarm, this does not respond to SOS sent in Morse, but to a special "distress call."

This consists of a series of not fewer than three long dashes each of four seconds duration, separated by one second spaces, with certain tolerances for hand sending. The receiver is permanently adjusted in a non-oscillating condition with flat tuning between 585 and 615 metres.

Operators do not "search over the shipping band of wavelengths" for distress calls, they listen during their watch on 600 metres, on which wave all distress calls are transmitted.

The Auto-Alarm is no new thing, its advent was contemplated in the Merchant Shipping Rules of 1920, it was the subject of Admiralty tests in 1923 and 1924, and after considerable development and the expenditure of much time and money was finally approved by the Board of Trade in July this year. It is therefore an expensive piece of apparatus.

It is actuated simply by the starting and stopping of the received current—suitably amplified—in conjunction with a timing mechanism to test whether the signals being received conform to those laid down—if they do, the instrument rings a bell. The device is thus comparatively simple, and it seems unlikely that any system of note selection and filters could provide anything like the same degree of reliability even at prohibitive cost.

As the law stands, practically the whole of the British Mercantile Marine are compelled to fit the apparatus, and those not compelled will do so on the grounds of economy.

Many vessels are already at sea with the alarm, and it appears improbable both in view of the large interests involved and of the essential use in any case of spark or I.C.W. that any change can now be justified.

J. B. WILSON.

Liverpool,

October 13th, 1927.

Sir,—If your correspondent A. H. B., whose letter appears in the current issue, will "look to his set" he will probably

find that by making it more selective the Morse of which he complains will become less objectionable.

After moving down here from London I experienced a very similar feeling of annoyance, but after redesigning my set several times, and particularly after putting in a properly neutralised H.F. stage, I found that quite a considerable band of "medium waves" was almost entirely free from interference.

During the last few months matters have also improved and 2LO is very seldom interfered with during the evening, and when such interference occurs it is almost invariably caused by French ship and shore stations well off a nominal 300-metre wave. The bugbear of Newhaven GNV has been completely removed by its translation to another wave, while on Daventry there is only very occasional interference by Spanish coast stations. There is no British station anywhere near Daventry's wavelength during broadcasting hours on a reasonably selective set.

Daventry 5GB is badly interfered with, and the alternative programme is worthless to South Coast listeners, as also is Bournemouth on its new wave, but either 2LO or Daventry can be relied upon to give a proper evening's entertainment, and an alternative is provided by Radio-Paris or Langenberg. Other Continental stations are also frequently clear of nearby Morse.

One further hint: The excessive use of reaction, although theoretically sharpening the tuning, will bring in a host of spark stations all down the Channel, and freedom can only be obtained by using sufficient valves to enable London to be received at full loud-speaker strength without any reaction or denaturalising, intentional or otherwise.

Hove.

BM/MHNF.

#### REMOTE INDICATING AERIAL AMMETER.

Sir,—I have just had brought to my notice a letter from Mr. Aughtie in your issue of August 24th, in connection with an article by Mr. Castellain on a remote indicating aerial ammeter (August 10th issue).

Like Mr. Aughtie, I had difficulty in seeing how the so-called current transformer works, as there appears to be no coupling between the two circuits as shown in your contributor's article. For coupling the two conductors should be parallel, and in the original diagram given the conductors are at right angles. Your contributor is quite wrong in stating that the coupling is due to this coil as a coil.

The actual coupling is due to the fact that a coil may be considered to have two components at right angles, one parallel to the primary and one perpendicular, the parallel one only being effective.

The essential part is shown in the diagram, where  $b$  is a straight wire equal in length to his coil, running parallel to the primary at a distance  $a$  equal to the radius of his coil. All the coupling is due to the straight wire  $b$ , and so no turns are needed.

Wembley,

October 17th, 1927.

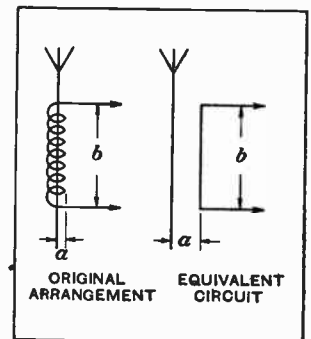

Equivalent circuit of aerial ammeter transformer as explained in Mr. Banner's letter.

# READERS' PROBLEMS

"The Wireless World" Information Department Conducts a Free Service of Replies to Readers' Queries.

Queries should be concisely worded, written on one side of the paper, and headed "Information Department." Only one question (which should deal with a specific point) can be answered. A stamped addressed envelope must be enclosed for reply. Letters which do not comply strictly with these rules cannot receive attention or acknowledgement.

## Obtaining Good Quality by Push-pull Amplification.

*I should be glad if you would give me the connections of a push-pull amplifier, and indicate to me the advantages of using such an arrangement. Will you please state also why using two valves in parallel in the last stage has the same effect as connecting them up in the push-pull manner?*

R. T. A.

Using modern valves, it may be said that the great advantage of a push-pull amplifier is that it is possible to operate a loud-speaker receiver on half the H.T. voltage required when not using this system. In other words, assuming that you have been running a loud-speaker receiver with a total of 120 volts on the output valve, you can reduce this voltage to 60 volts and obtain the same results from the point of view of quality as before. The reasons for this are as follows.

The effect of a push-pull amplifier, in which, of course, two valves are used in the output stage, is to double the permissible grid swing in the output stage for a given H.T. voltage. In the days before power valves became popular it was possible to use two general purpose valves in the output stage using this system, and obtain results approaching those obtainable with one power valve, as the straight line portion of grid volts anode current characteristic of one valve was added to that of the other valve, thus giving double the permissible grid swing. If we have an L.F. amplifier, using in the output stage a good power valve with, say, 120 volts on the plate, we get a certain permissible grid swing; now, if we reduce the H.T. voltage, we correspondingly reduce the permissible grid swing; but if we use two power valves on the push-pull system, with reduced H.T. voltage, and, therefore, with the permissible grid swing of each valve reduced, we shall obtain the effect of adding these two reduced permissible grid swings together with the result that we shall have more or less the same total permissible grid swing as was the case when we used one output valve with full H.T. voltage.

We have gained the advantage of using a lower H.T. voltage, therefore, which is a great consideration from the point of view of initial outlay in purchasing large capacity dry cell H.T. batteries or large capacity H.T. accumulators. When we reduce the H.T. voltage on a valve, all other things being equal, the plate

current is also reduced, and therefore the total plate current of our two valves arranged to work at reduced H.T. voltage on the push-pull system is no greater than the plate current of a single valve with normal H.T. voltage.

Possibly, the greatest advantage of the push-pull system, however, is not the possibility of using 60 volts H.T. instead of 120 volts, but the fact that by using two valves on the push-pull system on normal H.T. voltage we can obtain the same effect as if we had used a much bigger power valve of the L.S.5A type on a vastly increased value of H.T. voltage. Using ordinary power valves, therefore, with normal H.T., it is possible to obtain what we may term "L.S.5A results" without the necessity of increasing the value of our H.T. battery.

respect of the inner grid of the four-electrode valve.

Since modern and really well designed push-pull transformers are now available, this system has great possibilities to the quality seeker.

With regard to your other query, we would say that connecting two valves in parallel in the last stage does not have the effect of doubling the permissible grid swing, as in the case of push-pull amplification.

o o o o

## Frame or Indoor Aerial?

*Will you please tell me whether a frame aerial or an ordinary indoor aerial is the more effective, and also which is the most effective form of indoor aerial?*

M. F. M.

It may undoubtedly be said that the indoor aerial has a great advantage over the frame, from the point of view of pick-up properties, although, naturally, a frame aerial used with a highly sensitive receiver has the advantage from the point of view of selectivity. It is difficult to say what is the best form of indoor aerial, as it depends on local circumstances, but it should be erected as high in the house as possible, one of the best forms of it being a straight wire stretched along a lengthy passage or corridor. If the house possesses a loft, two or three wires stretched the full length of the loft gives excellent results. In the case of a picture-rail aerial, the wire should not be run several times round the room, and, indeed, should not even complete one circuit of the room, but should preferably be carried round three sides of the room only, and, if possible, stood out from the picture rail on one of the special devices now obtainable for this purpose.

o o o o

## Correct Condenser Values.

*I should be glad if you can tell me the correct value of condenser to use in a choke-filter output circuit.*

T. R. D.

The usual value given for use in this position is 2 mfd. By using a 4 mfd. condenser an improvement will usually be noticed in the matter of better reproduction of the lower musical notes, but there is little to be gained by exceeding a value of 4 mfd. In the case of most receivers, indeed, no gain at all will be noticed by using a larger condenser than 2 mfd. owing to the limitations of the average L.F. amplifier and loud-speaker.

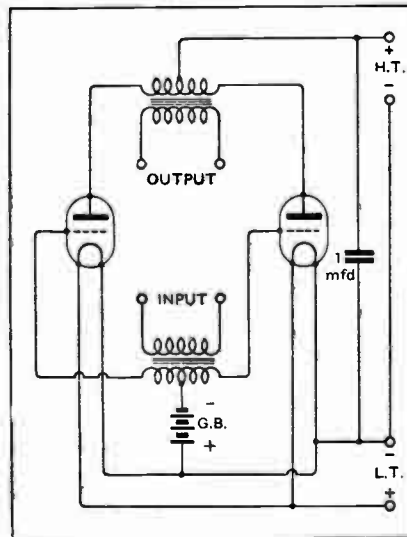

Fig. 1.—Connections of a push-pull amplifier.

To sum up, it may be said, therefore, that the push-pull system gives us the choice of obtaining the same results with reduced H.T. as we could obtain with the ordinary system, and normal H.T. values, or, alternatively, we can obtain vastly improved results with the same H.T. value. In one sense, therefore, the results obtainable are similar to those provided by four-electrode valves, where, as is well known, reduced H.T. values can be used, but without the necessity of using special valves or of drawing extra H.T. current from the H.T. battery in

**D.C. Supply Main Problem.**

*I have a D.C. lighting supply available and decided to construct a battery eliminator to replace my H.T. batteries. I have experimented with various arrangements, but the results obtained have not proved satisfactory. In the course of experimenting, I discovered that the positive of the supply is earthed, and I think that this may contribute largely to my failure. Can you suggest a circuit suitable for employment when the positive supply main is earthed?*

G. R. F.

It is quite possible that the positive supply main being at earth potential accounts for your failure to obtain a satisfactory H.T. supply from your eliminator. It has been found that under similar conditions the difficulties can be overcome by incorporating H.F. chokes in both supply mains, and the circuit in Fig. 2 shows the method of connecting these. A loosely-coupled aerial circuit is always recommended when a D.C. battery eliminator is used, and this should

be used to use anode-bend rectification, because the effect of grid current, if leaky-grid rectification were used, would be to set at naught all our efforts in eliminating H.F. transformer losses. In order to obtain maximum sensitivity with an anode bend rectifier, we almost invariably make use of a special valve having a fairly sharply defined bottom bend. Now, such a valve normally has a high impedance, and a very much higher one when the necessary grid bias has been applied to bring the working point down to the bottom bend. It is essential, therefore, if good quality is to be maintained, and the lower musical tones well reproduced, that a very high impedance be used in the external plate circuit, and so resistance coupling is adopted. The effect of using a transformer would be, among other things, seriously to impair quality. You will see, therefore, that if you put in an L.F. transformer it is necessary in the interests of quality to use leaky-grid rectification, and if this is done the efficiency of the receiver on the H.F. side is seriously reduced.

**A Point of Doubt.**

*With regard to the circuit of the "balanced crystal" receiver published on page 200 of your August 31st issue, I notice that you say that the two switches S<sub>2</sub> and S<sub>3</sub> are for the purpose of bringing either of the two crystals into circuit as desired, but I cannot see how the "balanced crystal" system works if only one crystal is brought into operation at a time. Can you explain this?*

F. E. G.

When first bringing this instrument into use, it is necessary to adjust each crystal individually. First the switch S<sub>2</sub> should be closed, and the corresponding crystal adjusted by means of its potentiometer, and then S<sub>2</sub> should be opened and S<sub>3</sub> closed, and its corresponding crystal adjusted as in the case of the other crystal. When this has been done, both switches should be closed, and the final adjustment made.

It should be pointed out, also, that either crystal may be used in the ordinary manner by merely closing its switch, and adjusting it with the potentiometer. The "balanced" system can only be used, of course, when both crystals are in operation.

**When "Anode-bend" Gives Poor Quality.**

*I have an ordinary type of receiver consisting of a leaky grid rectifier, followed by a stage of transformer-coupled L.F. I should like to experiment with anode-bend rectification without going to any great expense, and would appreciate details for altering my set experimentally for this purpose.*

P. S. T.

You may obtain anode-bend rectification by merely disconnecting the low potential end of your grid leak from L.T.+, and instead connecting it to a wander plug which should be inserted at 1½ volts negative of your grid battery. A better plan would be to connect the low-potential end of the grid leak to the negative terminal of a small dry cell, the positive terminal of the cell connecting to the slider of a potentiometer, which should be shunted across the filament battery. It is highly probable, however, that, instead of obtaining the anticipated increase in quality due to the use of anode-bend rectification, you would obtain greatly inferior quality. due to attenuation of the lower musical notes. The reason for this is that, when a valve is used as an anode-bend rectifier, its impedance rises very considerably, and renders it unsuitable for use in front of a transformer. You should, in reality, follow an anode-bend rectifier by a stage of resistance coupling, in order to counteract this effect. You will note that this is done in all modern receivers employing an anode-bend rectifier. Instances of such receivers are the "Everyman-Four," "All Wave Four," and the "Wireless World Regional Receiver." A second stage of L.F., of course, can be transformer-coupled in the ordinary way, as it is in the "Everyman-Four" receiver.

B 46

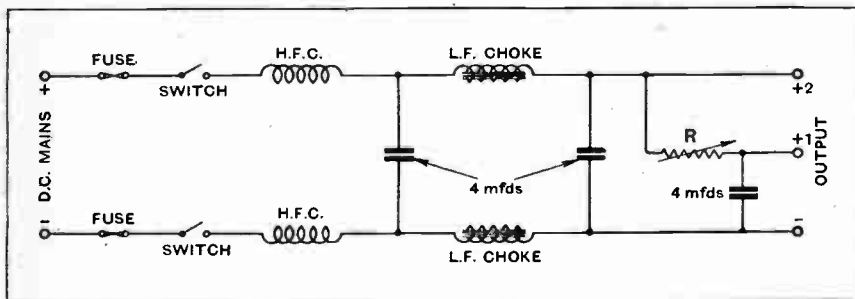

Fig. 2.—Smoothing circuit for use with D.C. mains when positive lead is earthed.

not be directly connected to the receiver. Further, it becomes necessary to maintain a high standard of insulation between the accumulator and earth, otherwise a short-circuit or partial short-circuit will develop. Under no condition should the accumulator terminals be touched without first switching off the eliminator.

o o o

**Departures from Author's Specification.**

*I propose to build an "Everyman-Four" receiver, but to depart from specifications with regard to a small point. I propose to use two L.F. transformers instead of using resistance coupling in one stage and transformer coupling in the other stage. I presume that as the alteration is only on the L.F. side of the receiver the sensitivity and selectivity will be in no way affected.*

A. S. R.

You are quite wrong in supposing that your proposed departure in specifications is unimportant, and that it will have no effect on the H.F. efficiency of the receiver. In this receiver special efforts were made to secure a very high degree of sensitivity and selectivity by designing special low-loss transformers with secondaries wound with Litz wire. Now, having taken the trouble to eliminate losses in the transformers and to wind the secondaries with Litz, it was impera-

This point strongly exemplifies the importance of not departing from the authors' specifications when building receivers without taking advice on the matter, for in this case, as you will see, an apparently minor departure from specifications on the L.F. side has a serious effect on the working of the H.F. side of the instrument.

o o o

**Connecting a Milliammeter.**

*I wish to make use of a milliammeter connected in the plate circuit of my last valve, and to have also a switch for cutting it out when not actually taking a reading. I make use of a choke-filter circuit, and am not certain how to connect it up using this device, and should be glad of your help.*

K. L. F.

It is only necessary to break the plate circuit of the last valve and insert the milliammeter in the correct order of polarity. The best method of connection is to connect a wire direct from the "H.T.+" end of the choke to the negative terminal of the milliammeter, the positive terminal of the milliammeter connecting to H.T.+. A simple short-circuiting switch may be connected across the milliammeter to cut it out when not desired, although no harm will be done by leaving it permanently operative.

*the perfect Cone Unit  
in the acoustically perfect  
cabinet—*

The performance of this Brandes Cone type loudspeaker is as near perfection as possible, and unequalled by instruments at double the price. It removes the last objection to an external loudspeaker. There is no horn, and the cone itself is effectively concealed in a handsome cabinet which is finely finished in either oak or mahogany. The tones are luxuriant and natural. Very low tones—the kind that were once muffled and lost—respond with accuracy and clarity. High soprano notes, once thin and metallic, are beautifully rounded and mellow. This faithful reproduction is due not only to the large vibrating area of the cone itself, but also to the driving unit of special Brandes design. This unit is of the balanced armature type which, whilst giving great volume, is extremely sensitive, and reacts to the faintest impulse. A special magnetic circuit is incorporated in the unit, increasing sensitivity. Very large magnets are employed, and the pole pieces are laminated. Height 13 ins., depth 7 ins., width 10 ins.



**GREATLY REDUCED PRICES**

for other Brandes Products

<i>The Brandeset 111a</i>	.. .. .	£6	15	0
<i>The Brandola</i>	.. .. .	2	17	6
<i>The Table-Talker</i>	.. .. .	1	10	0
<i>The Table Cone</i>	.. .. .	1	19	6
<i>The Matched Tone Headphones</i>	.. .. .		13	6
<i>The Variable Condenser</i>	.. .. .	15	0 and 15	6
<i>The L.F. Transformer</i>	.. .. .	15	0 and 15	6

★All our products are made of British materials by British workpeople, at our works at Slough, Bucks.

**The ELLIPTICON**

(Registered Trade Mark)

£4 : 15 : 0

(Reduced from £5 : 10 : 0)

*A Junior Model, the Table Cone,  
is also supplied*

£1 : 19 : 6

**Brandes**

*the name to know in radio.*

Post the Coupon for full information.

**Brandes**  
AUTHORISED  
RADIO DEALER

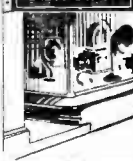

Brandes Ltd.,  
2/3, Norfolk St., Strand,  
W.C.2

Please send me your free  
illustrated catalogue.

Name.....

Address.....

.....

W.W.3

Brandes products are only obtainable where you see this sign.

# Anti-Microphonic at last!

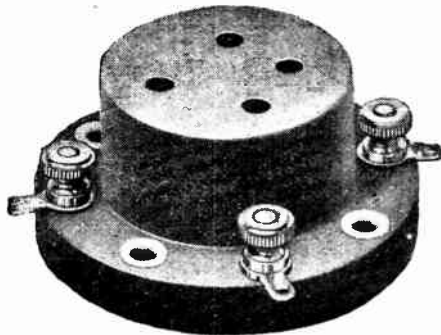

Patent No. 269,388

Recognise them by the Yellow Carton

Send for The Book of Ebonart, a useful guide for the wireless amateur.

## THE REDFERN Pneumatic Action VALVE HOLDER

This new invention positively eliminates microphonic noises.

Constructed without springs; it has no natural frequencies, therefore completely solves the problem of the proximity of loud speaker to valves. Sold everywhere at

PRICE **2/6** EACH

REDFERN'S RUBBER WORKS LIMITED, HYDE, CHESHIRE



### The Latest Radio Development **MAGNUM**

#### Gramophone Electrical Pick-up.

The Magnum is the latest and easily the lowest priced Pick-up. One of its unique features is its volume control. You can regulate its amazingly pure reproduction from a faint whisper to the maximum volume your wireless amplifier can give. Adapted to any gramophone instantly. You have merely to fit the Magnum Pick-up on to the tone-arm and connect to the amplifying side of your wireless set. Uses all types of needles.

**35/-**

Send stamp for particulars.

**BURNE-JONES**  
& CO. LTD.,  
MAGNUM HOUSE  
TELEPHONE: HOP 6257  
288, BOROUGH HIGH ST.  
LONDON. S. E. 1

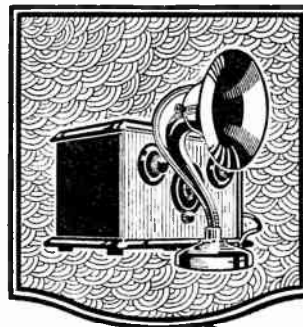

## IMPROVE RECEPTION WITH A **STANDARD** WET H.T. BATTERY

The one growing ambition of every wireless enthusiast is **BETTER RECEPTION** — YOU can realise yours by obtaining a **STANDARD SAC LECLANCHE WET H.T. BATTERY.**

**SILENT BACKGROUND—SIMPLE CONSTRUCTION—NO CREEPING—AMPLE POWER OVER LONG PERIODS—ECONOMICAL.**

**PRICES from 15/- according to capacity, voltage and life required. Deferred terms if desired.**

Send for the **STANDARD SAC LECLANCHE 20-page booklet.** It explains everything in detail for both H.T. and L.T.

When writing please state number and type of valves, and we will recommend a suitable battery.

Carriage paid on orders for 10/- and over. **STAND 74 MANCHESTER RADIO EXHIBITION.**

**THE WET H.T. BATTERY CO.**  
12-13, Brownlow Street, High Holborn, W.C.1.

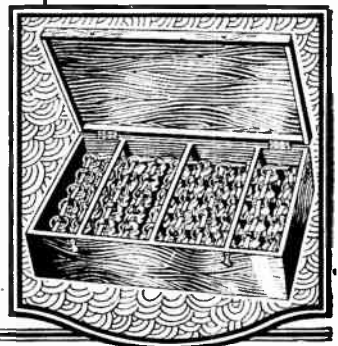



DO YOU  
 ? ?  
 SAVE MONEY ?

DO YOU SAVE MONEY BY USING

“**VARTA**”  
**MONOBLOCKS**  
 FOR  
**RADIO H.T. SUPPLY**



“VARTA” 20 VOLT H.T. MONOBLOCK TYPE “WA” (with one tapping at 10 volts).

PRICE NOW REDUCED TO  
**9/-**

THUS A 60 VOLT BATTERY OF 3 “VARTA” MONOBLOCKS COSTS 27/-, JUST 3 TIMES AS MUCH AS A DRY BATTERY,

AND LASTS INFINITELY LONGER.

“Don't scrap — recharge.”

WRITE FOR LIST Nos. 1, 2 & 3 to

A.F.A. ACCUMULATORS LTD., 120, Tottenham Ct. Rd., W.1

For “a round  
 £ 3.”

You can buy a loud speaker for a round £3 which, if your receiving set will work at loud speaker strength at all, will absolutely ensure the most perfect reproduction obtainable therefrom. It is the speaker which makes a poor set good and a good set better — it has a world-renowned name and a wonderful reputation. It is known as the

*Ethovox*  
 REC

You have heard its name of course—NOW HEAR IT. We will demonstrate it at any time at our showroom 15, BEDFORD ST., STRAND, LONDON, W. C., or if you will write us to Blackheath we will arrange a demonstration with your local dealer.



**BURNDEPT**  
 WIRELESS APPARATUS  
 BLACKHEATH  
 LONDON, S.E.3

## Building a set this Winter? Here is the **CABINET** for it!

The W.B. Range of Cabinets for Constructors provides 7 Stock sizes in Polished Oak or Mahogany. Highly finished Ebonite panels can be supplied for each size at standard prices. The Cabinets are produced only in a high class finish, each being an article of furniture.

We have kept our prices as reasonable as possible, but in reviewing them it will be appreciated that we are not aiming to cater for any but those requiring the best. We believe that this class of customer is prepared to pay a reasonable price for really good quality; compare W.B. Cabinets and their prices—and your choice will certainly be in their favour.

### PRICES.

	Oak	Mahogany.		Oak	Mahogany
12" x 7" x 7" ..	15/-	17/6	21" x 7" x 7" ..	24/-	28/-
14" x 7" x 7" ..	18/6	21/-	24" x 7" x 7" ..	30/-	35/-
16" x 8" x 7" ..	20/-	23/-	26" x 8" x 7" ..	32/6	37/6
18" x 7" x 7" ..	21/-	25/-			

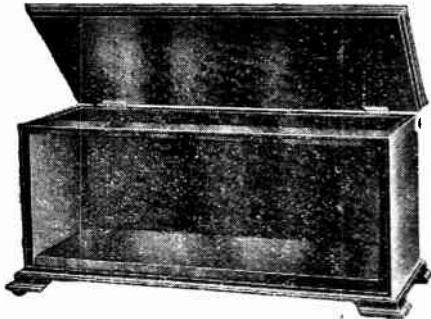

Every up-to-date Dealer has a range of these Cabinets to show you.

**WALKER BROS. (GUILDFORD) LTD.**  
**BRAMLEY GUILDFORD**  
Telephone: Bramley 117.

A  
**BURTON**  
PRODUCT  
ENTIRELY BRITISH

## THE BURTON PANEL RHEOSTAT



Panel Mounting Rheostat, 6, 10, 15, 30 ohms,  
**2/3**  
complete.

**C. F. & H. BURTON,**  
Progress Works,  
BERNARD STREET,  
WALSALL.  
Phone 560.



**EELIX TREBLE DUTY TERMINALS**—generously proportioned, of pleasing appearance, having almost unlimited number of uses. Supplied in Standard Nickel Plate finish, 36 varieties. Choice of six coloured tops or lettered Earth, Aerial, etc. Price 4½d. each. Illustration shows construction and ease of connections.

Complete List WW 14 on application.



VIEW OF TOP

**EELIX MOISTURE RETAINING EARTH.**  
(Pat. No. 256802.)  
Price 4/- each.

**EELIX VERNIER DIAL.**  
2/6 each.

**J. J. EASTICK & SONS**  
TELEPHONE: CLERKENWELL 9282/3  
EELIX HOUSE · 118 BUNHILL ROW · E.C1



## Interchangeable . . .

Supplied in a set of four with one suitable aerial coil covering the full wave-band. Mounted on low dielectric strip, fitted with six pins. A base is provided carrying six spring contacts.

**PRICE**  
**35/-**

Approximate tuning range with '00015 mfd. condenser:

Coil A: 10 to 17 meters.  
Coil B: 17 to 34 meters.  
Coil C: 34 to 70 meters.  
Coil D: 60 to 130 meters.

**COLVERN** short-wave coils fulfil all the requirements for highly efficient functioning at the extreme higher frequencies. The coils are robust, turns are air-spaced and are supported by the minimum of dielectric material. The leading-out wires pass outside the coil, and are soldered direct to pin contacts.

**COLVERN VALVE HOLDERS** for the new Screened-grid Valves . . . give a choice of four positions - - **4/6**

**THE COLLINSON PRECISION SCREW CO. LTD.**  
PROVOST WORKS, MAGDONALD ROAD, WALTHAMSTOW, E.17

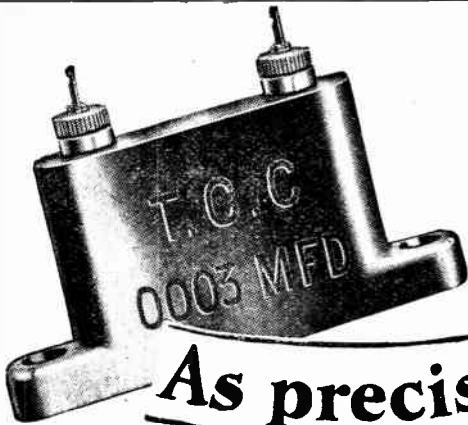

**As precise  
as the  
Standard Measure**

THE Standard Measure never varies. Its inch is an inch—always. It is precisely accurate. The T.C.C. Condenser, also, is precisely accurate. Its capacity never varies. If '001 is stamped on the side of its green case, its capacity is '001—always. That is one reason why T.C.C. Condensers are regularly used by all the leading Radio technicians. They know its capacity is accurate. And they know its insulation is perfect. They know, in short, that T.C.C. Condensers will never let them down.

Follow their lead. Use T.C.C. Mica Condensers in your next Set. All capacities—from '0001 mfd. price 2/4.

**T.C.C.  
Condensers**  
**Always dependable**

Adv. Telegraph Condenser Co., Ltd., Wales Farm Rd., N. Acton, W. 3.

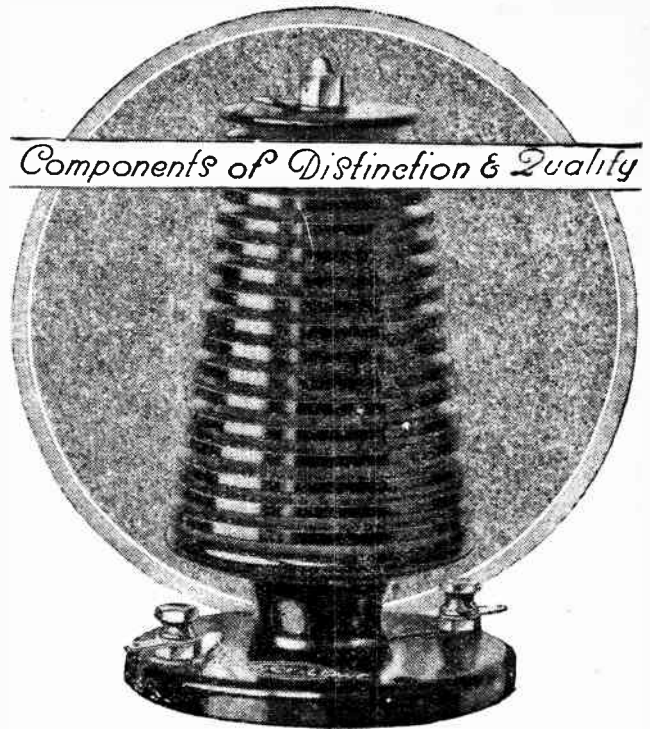

*Components of Distinction & Quality*

## Universal H.F. Choke

The ideal component wherever a H.F. Choke is indicated. By virtue of its special sectional winding not only is the distributed capacity kept at a minimum but it will efficiently operate over a very wide range of wave-lengths from the shortest to the longest.

LIST 288

**9/-**



VARIABLE RESISTOR

List 289 5 ohms 3/-  
List 290 30 ohms 3/-



TWO-SPEED DIAL  
Manufactured under  
Burndept patents.  
LIST 253 9/-  
(Complete with station  
recorder.)

Send 1½d. in stamps for the New Bowyer-Lowe Catalogue.



BOWYER-LOWE CO., LTD., LETCHWORTH

A BOOK THAT EVERY EXPERIMENTER SHOULD HAVE:  
"The Bowyer-Lowe Standard 7 and 8-valve Super-Heterodyne"  
How to Build and Operate. By A. E. BOWYER-LOWE.

PRICE - - 2/-

Send your remittance for a copy to-day.

*You must have a precision instrument*

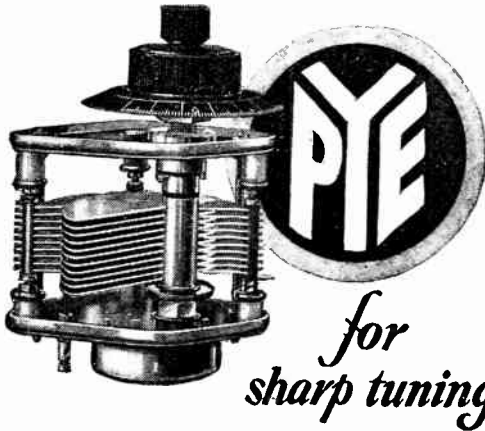

*for sharp tuning*

Modern radio circuits call for critical tuning—critical tuning demands precision condensers—precision condensers means Pye condensers for accuracy and reliability. Pye precision condensers are scientific instruments made one at a time with great care. You need them to get the best from your set.

PRICES—0001, '0002, '0003 Mfd. 17/6 each.  
 '0005 Mfd. 18/6 ..  
 '00075 Mfd. 22/6 ..



Write for illustrated list of components and sets (post free).

**W. G. PYE & Co.,**  
 "Granta Works," Montague Road,  
 CAMBRIDGE.

**THE FINISHING TOUCH**

Belling-Lee Terminals are the finishing touch to any receiver. They are a perfect combination of Beautiful Finish and First Class Workmanship. Bakelite insulated and made in 30 different engravings.

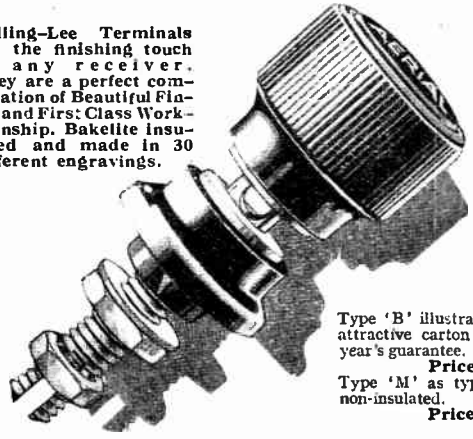

Type 'B' illustrated, sold in attractive carton carrying a year's guarantee.

Price 9d. each.

Type 'M' as type 'B' but non-insulated.

Price 6d. each.

Patented.

Illustrated catalogue free on request.



Belling & Lee, Ltd., Queensway Works, Ponders End, Middlesex.

**THE LAMPLUGH PANEL PLATE TUNER UNIT**

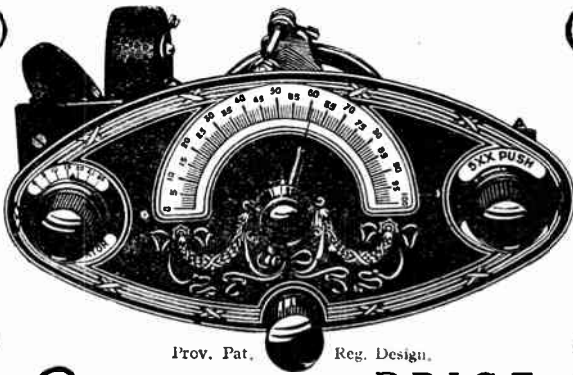

Prov. Pat. Reg. Design.

*The touch of the Craftsman*

**PRICE 35/-**

complete, as illustrated.

Simple and full diagrams and layouts for building two- or three-valve sets supplied with each Unit.

Inspect our **Stand 63**  
 Manchester Wireless Exhibition

This unit is half a Receiver and consists of 4 richly engraved metal panel in black and gold or black and silver, on which are mounted coils covering the broadcast wavelength, with a specially calibrated dial (250—2,000 metres), an S.L.T. Slow-motion condenser and a switch for changing from low to high wavelengths. No Ebonite panel is required and this Unit can be mounted to any form of Cabinet.

Simplicity is a feature, and any amateur can with the minimum of trouble, construct a super-efficient set with the appearance of the high-class factory production.

S. A. LAMPLUGH, Ltd., King's Rd., Tyseley, BIRMINGHAM

Representatives for London and Southern Counties:—  
 J. C. SHORE & CO., 28, Newman Street, Oxford Street, W.1.  
 Representatives for Lancashire and Yorkshire:—  
 H. DIGGLE, 19, Houghton Street Southport.



*Why do Imperial Airways use "NIFE" Accumulators only?*  
**Absolute reliability is essential.**

*You will be interested in the new models of the "NIFE" Steel Plate H.T. Batteries.*

**Send for leaflets now.**

**Batteries Ltd., Redditch, Eng.**  
 220 Shaftesbury Avenue, London, W.C.2



Mention of "The Wireless World," when writing to advertisers, will ensure prompt attention.



RECUPERATING AGENT  
IN THE  
**HELLESEN**  
DRY BATTERIES.

The proof of a Dry Battery is the number of hours of efficient service you get out of it for the money you spend. We are confident of the result if you rely on a Helleesen Dry Battery for your H.T. Supply. Get a smooth uniform H.T. Supply at the minimum cost per hour from a sealed genuine Helleesen H.T. Battery with the quadruple insulation and the No. 7 Recuperating Agent.

60-volt "WIRIN" 12/6  
99-volt "WIRUP" 21/-  
(Postage Extra.)

All types, voltages, etc., in Double and Treble capacities for H.T. and L.T. Supply. Ask your dealer for the type to suit your set and get the maximum service, or write us for full particulars.

Obtainable at all Radio, Electrical and General Stores Harrods, Selfridges, etc., or direct from  
A. H. HUNT, Ltd. (Dept.), CROYDON, SURREY.



EVERYTHING **The G. & C.** ELECTRICAL  
your guarantee

Perfect at Every Point

New **Osram**  
Valves

with the New Filament

The Perfect Filament

The OSRAM Valve filament is of entirely new construction and design.

1. It is Strong

It embodies a core of tungsten, one of the toughest metals known.

2. It has enormous electron emission

Specially selected materials giving extraordinary high electron emission at very low temperatures are chemically combined to this core. The operating temperature is so low that the filament cannot be seen glowing.

3. It is long

The filament length is greater than that of any other valve of equivalent class, ensuring the best operating characteristics.

4. It is anti-microphonic

The nature of its construction requires no spring suspension—spring suspension being always an undesirable feature. This provides freedom from microphonic noise troubles.

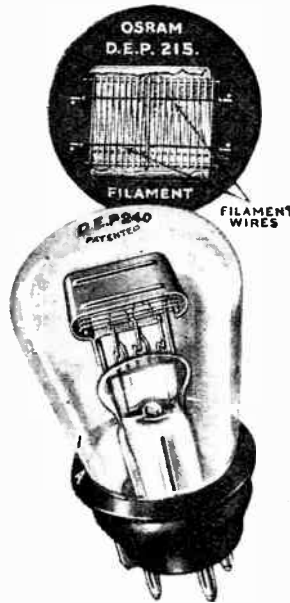

MADE IN ENGLAND

VALVES WITH THE NEW OSRAM FILAMENT FOR H.F. DET. & L.F. STAGES.			
2-volt D.E.L. 210	4-volt D.E.L. 410	6-volt D.E.L. 610	Price 10/6 each

Made at the factory with the greatest experience in valve manufacture in the British Empire.

Manufactured from raw material to finished product by the same British Organisation.

Act. of The General Electric Co., Ltd., Magnet House, Kingsway, London, W.C.2.



**Now Reduced from—**

**3/9 to 2/3**  
EACH POST FREE

**OUR DIRECT TO THE PUBLIC POLICY—**

This surprising reduction of 1/6 (which took place on Sept. 21st) was made possible by our new policy of selling direct to the buyer, by more efficient manufacturing methods, and by largely increased sales. The superiority of the "ARTIC" Valve-Holder has always been admitted, and its present price now places it within the reach of EVERY valve user. Quality and construction have not been altered in the slightest degree.

The "ARTIC" principle guarantees perfect steadiness under all conditions of shock and vibration. Even when the valve is moved directly, it just sags back into position. No springs or rubber are employed—these are but makeshifts and success can never be possible with such mediums.

**DIRECT from US to YOU.**  
**MEANS a CHEAPER VALVE-HOLDER for YOU.**  
2/3 each POST FREE with P.O. remittance or C.O.D. with C.O.D. charge extra.  
**MAKES A GOOD VALVE BETTER & A BAD VALVE GOOD.**

WORLD PATENTS.  
NO SPRINGS.  
NO RUBBER USED.



**ARTIC**  
FUSE & ELECTRICAL MFG. CO. LTD.  
BIRTLEY, Co. Durham

# "EKCO"

## H. T. UNITS

There is an "EKCO" for every purse and for every voltage in the British Isles.

The most comprehensive range in mains power radio units, sets and components—as fully detailed in the new "EKCO" Folders. We shall, if your dealer cannot supply you, be only too pleased to give you any information concerning "EKCO" Mains Power—the radio method of to-day and the future.

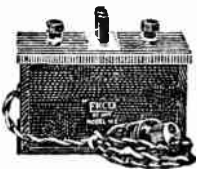

Model M.2. D.C.  
29/6

Two tappings. Suitable for 1 to 3 valve sets only.

Models range from 17/6 to £9 10 0, D.C. & A.C.



Model M.1. D.C.  
17/6

One tapping. Suitable for 1 to 3 valve sets only.

**E.K. COLE LTD**

DEPT. W., "EKCO" WORKS, LONDON RD., LEIGH-ON-SEA.

## "BERCLIF" QUALITY COILS

- |                |   |           |
|----------------|---|-----------|
| EVERYMAN FOUR. | } | 33 - SET. |
| Original type  |   |           |
| Regular type   |   |           |
| Long wave type | } | 42/6 SET. |
| ALL-WAVE FOUR  |   |           |
| REGIONAL       |   |           |
| Short wave     | } | 40/6 SET. |
| Long wave      |   |           |
|                | } | 54/6 SET. |
|                |   |           |

All other types supplied. Screens, Cabinets, Complete Sets, everything you want, from the original and leading specialists.

**SIMMONDS BROS.** Shireland Road, Smethwick, Staffs. New list ready shortly, sent post free. Trade supplied Home and Abroad. Watch our weekly small advertisements.



"HIGH WIRING" VALVE HOLDER.  
P. Pat. 22826.

2 9

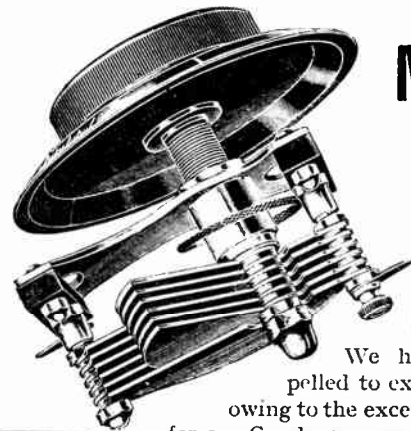

**MOVED!**

**BY ORDERS.**

We have been compelled to extend our Works owing to the exceptional demand for our Condensers, especially the new model, Ball-bearing, Nickel-plated, adjustable tension type—the 16:1 Ball-Geared, Guaranteed

## SIMPLICON-4.L.

Prices with 4" Dial & Knob  
 :0003 13/-      :00025 12/9  
 :0005 13/6      :00015 12/6

The Ideal Condenser for a Good Set, incorporated in several Portables at OLYMPIA.

Orders now to the new Address—

**WILLIAMS & MOFFAT, Ltd.,** Radio Dept., LADYPOOL ROAD, SPARKBROOK, BIRMINGHAM.

## A NEW BATTERY CHARGE INDICATOR

Chaslyn Vent Type Hydrometer (Patent applied for.)

For High and Low Tension accumulators (1250 S.G.). Can be left permanently on accumulator during discharge and will show at a glance the state of charge by the way the balls of different specific gravities sink or swim.

Always on View. No Mess. Checks Faulty Charging. Increases Life of Battery. Easy to see. Simple to read. No bothersome scales. No burden on memory.

PRICE 1/6 EACH Post Free

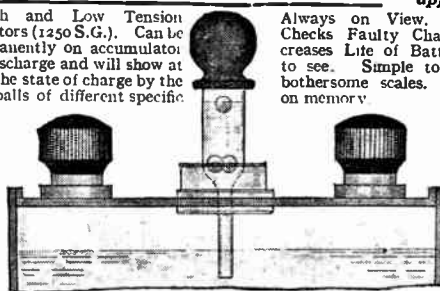

Full-size CHASLYN HYDROMETERS

Price each 3/- Post free

**J. H. COLLIE & CO., 10, Canning Place, LIVERPOOL**

# MISCELLANEOUS ADVERTISEMENTS.

**NOTICES.**

**THE CHARGE FOR ADVERTISEMENTS** in these columns is:

12 words or less, 1/- and 1d. for every additional word, e.g., 18 words, 1/6; 24 words, 2/-. Name and address must be counted.

**SERIES DISCOUNTS** are allowed to Trade Advertisers as follows on orders for consecutive insertions, provided a contract is placed in advance, and in the absence of fresh instructions the entire "copy" is repeated from the previous issue: 13 consecutive insertions, 5%; 26 consecutive, 10%; 52 consecutive, 15%.

**ADVERTISEMENTS** for these columns are accepted up to **FIRST POST ON THURSDAY MORNING** (previous to date of issue) at the Head Offices of "The Wireless World," Dorset House, Tudor Street, London, E.C.4, or on **WEDNESDAY MORNING** at the Branch Offices, 19, Hertford Street, Coventry; Guildhall Buildings, Navigation Street, Birmingham; 199, Deansgate, Manchester.

Advertisements that arrive too late for a particular issue will automatically be inserted in the following issue unless accompanied by instructions to the contrary. All advertisements in this section must be strictly prepaid.

Postal Orders and Cheques sent in payment for advertisements should be made payable to **ILIFFE & SONS Ltd.**, and crossed **& Co. Treasury Notes**, being untraceable if lost in transit, should not be sent as remittances.

All letters relating to advertisements should quote the number which is printed at the end of each advertisement, and the date of the issue in which it appeared.

The proprietors are not responsible for clerical or printers' errors, although every care is taken to avoid mistakes.

**NUMBERED ADDRESSES.**

For the convenience of advertisers, letters may be addressed to numbers at "The Wireless World" Office. When this is desired, the sum of 6d. to defray the cost of registration and to cover postage on replies must be added to the advertisement charge, which must include the words Box 000, c/o "The Wireless World." Only the number will appear in the advertisement. All replies should be addressed No. 000, c/o "The Wireless World," Dorset House, Tudor Street, London, E.C.4. Readers who reply to Box No. advertisements are warned against sending remittance through the post except in registered envelopes; in all such cases the use of the Deposit System is recommended, and the envelope should be clearly marked "Deposit Department."

**DEPOSIT SYSTEM.**

Readers who hesitate to send money to unknown persons may deal in perfect safety by availing themselves of our Deposit System. If the money be deposited with "The Wireless World," both parties are advised of its receipt.

The time allowed for decision is three days, during which time, if the buyer decides not to retain the goods, they must be returned to the sender. If a sale is effected we remit the amount to the seller, but, if not, we return the amount to the depositor. Carriage is paid by the buyer, but in the event of no sale, and subject to there being no different arrangement between buyer and seller, each pays carriage one way. The seller takes the risk of loss or damage in transit, for which we take no responsibility. For all transactions up to £10, a deposit fee of 1/- is charged; on transactions over £10 and under £50, the fee is 2/6; over £50, 5/-. All deposit matters are dealt with at Dorset House, Tudor Street, London, E.C.4, and cheques and money orders should be made payable to Iliffe & Sons Limited.

**THE SALE OF HOME-CONSTRUCTED UNLICENSED APPARATUS.**

**A New Service to our Readers.**

We have made an arrangement with the Patentees whereby readers who wish to dispose of a home-constructed receiver not licensed under the patents made use of, can license the set by means of the Deposit System referred to above.

The person desiring to sell, in sending us particulars for his advertisement, will in every case make use of a Box No., and should add to the price which he requires the amount of royalty customarily paid by manufacturers, viz., in the case of Marconi Patents the amount should be calculated at 12/6 per valve holder.

If the purchaser is satisfied with his purchase, the sum realised will be forwarded to the seller, less the amount due in respect of royalties, which amount will be paid by "The Wireless World" to the owners of the patents concerned, and a certificate will be handed on to the purchaser of the set.

**SPECIAL NOTE.**

Readers who reply to advertisements and receive no answer to their enquiries are requested to regard the silence as an indication that the goods advertised have already been disposed of. Advertisers often receive so many enquiries that it is quite impossible to reply to each one by post.

## WONDERFUL WIRELESS OFFER

**THE Graves Two-Valve Loud Speaker Wireless Set offered to you on Easy Payment Terms will compare for VALUE and EFFICIENCY with any £10 Wireless Set offered by any other firm in the World.**

It is no use trying to accurately illustrate or even describe the Graves Set in a small advertisement, but a post card will bring you a fully illustrated descriptive catalogue which gives you exact and truthful details.

**BRIEF SPECIFICATION:** The Cabinet is of polished Oak and all components of highest quality. Mullard Dull Emitter Valves with patent Valve holders &c.; H.T. Battery, 2-Volt Accumulator and complete Aerial Outfit. Loud Speaker of exclusive design to match the Cabinet, with unique magnetic system and improved diaphragm. **£7:17:6**

**TERMS.**—Our Bargain Price is for Easy Terms. Send 10/6 now, & complete purchase in 14 monthly payments of 10/6. Five per cent discount for cash. Fulllest approval in your own home.

**Write for Free Catalogue.**

Unchallengeable values in up-to-date Wireless Sets. **J. G. GRAVES Ltd. SHEFFIELD.**



**10/6 NOW**  
**OF PROVED EFFICIENCY**

**The 1928 "Allwoodorn" 30/-**  
*Loud Speaker Unit, Extra.*

**MODEL N°6.** We claim ALL WOOD because there are no metal pieces inside or outside of our wood horns or flairs. The joints are CORRECTLY GLUED and are not filled with a petroleum mixture, i.e. "plastic wood."

**THE ALLWOODORN** is the result of 20 years experience in the manufacture of wood horns.

The Model illustrated has a 14" mahogany bell-Height 19". Effective length 26". The neck is cast aluminium, making with the wood bell a perfect combination giving tone, volume, and clarity that are far superior to a horn made entirely of one material. ANY GRAMOPHONE UNIT will fit this horn.

**H. MADDISON, (Dept. W-W.)**  
2A, Ronalds Rd., Nr. Highbury, N.5.  
*Wholesale and Retail.*

**RECEIVERS FOR SALE.**

**ALL-WAVE** Four and the Famous Everyman Four; high-class sets only, giving maximum efficiency; full particulars and prices on application.—H. Goodwin, Woodcock Hill, Elstree. [0050]

**MARCONI** Offer 12/6 a Valve if You Exchange your Set. We offer to double the allowance in part exchange for any new set.—Chas. Rodwell, Ltd., London Bridge, S.E., or branches at Waterloo Station, S.E., 785a, Commercial Rd., E.14; 56, The Mall, Ealing, W.5; 31, Walbrook, E.C.4. [0087]

**PAY** Later, buy now: Wireless sets, components, loud-speakers, etc., for deferred payments. Write or call for terms.—Ellis Nicholls and Co., 132, Caledon Rd., East Ham, London, E. [5914]

**7-VALVE** Super Heterodyne, complete with valves, batteries, and loud-speakers; £25.—Bracey, 7, Graham Rd., Mitcham, Surrey. [5931]

**STOP Longing!**—Sets, loud speakers, accessories—get what you want now for small first payment. We arrange easy deferred terms on any order; buying made simple; the finest instruments now available to all.—For brochure send card to Desk "W." New Times Sales Co., 77, City Rd., London, E.C.1. [0080]

**4-VALVE** Family Receiver H.F. Det 2 L.F. Mullard Igranic Duetter Components, home constructed, including new 6 volt accumulator, H.T. batteries, all contained in handsome 3ft. 6in. polished walnut cabinet; also fine claritone loud speaker, £12 the lot.—Apply by letter or call on Saturdays only, Mr. Ward, 28, Moncrieff St., Peckham, London. [6076]

**M.C. 4**, with loud speaker and valves complete, 50 stations on L.S., £10.—A. H., 19, Priory Conrt, Mazend Ave., Quex Rd., N.W.6. Evening after 7. [6081]

**SHORT** Wave 6-valve super het, partly finished, offers wanted; also Burndept Trickle charger, new.—Box 4024, c/o Wireless World. [6082]

**MARCONI** Straight Eight, with valves, condensers and coils for Daventry, perfect condition, in fact, as new; first £35 secures.—Tye, 10, Eardley Rd., Sevenoaks. [6097]

**WIRELESS** Sets Constructed to Specification, designed, rebuilt and repaired; estimates on application.—Box 4060, c/o Wireless World. [6106]

**WIRELESS** World Five and 1927 Five, complete or components; also quantity modern spares, all cheap owing to tram interference.—Warmsley, 40, Ainsworth St., Blackburn. [6121]

**3-VALVE** Set in Pedestal Cabinet, complete with valves, H.T., L.T. and £5 Amplion loud speaker, perfect reception of 2LO and 5GB at Hampstead; offers, would sell separately.—Wertheim, 5, Cleve Rd., Hampstead. [6119]

**EVERYMAN** Four Receiver in Oak Cabinet to specification, complete with P.M. valves, royalty paid, £14.—Everyman Four coils, 25/- pair.—Warwick Radio Co., Warwick. [6151]

**4-VALVE** Screened Coil Neutrodyne, in Carrington mahogany cabinet, all best components, as new; £18.—Tel.: Sloane 2045. [6149]

**WESTERN ELECTRIC** 7-valve Superheterodyne, complete less batteries, £17; Western Electric 2-valve amplifier, £3, with valves; Burndept 2-valve short wave receiver, 30-100 metres, with valves, £6; Magnavox Senior loud-speaker, £3.—Long, Railway Rd., Bath. [6147]

**8-VALVE** Superhet., standing cabinet model, makers' price £38 set alone, 120 H.T., frame aerial, speaker, etc.; gift, £22.—Howard, 112, Asylum Rd., Peckham, London. [6143]

**3-VALVE** and Crystal (Trinadyne), any combination, useful with gramophone pick-up, Mahoganite panel, good components, £5/7/8; Auxiliary Super unit (detector, amplifier, or wavemeter), 4-electrode, with spare Thorpe K4 valve, 27/6.—Box 4076, c/o The Wireless World. [6142]

**3-VALVE** G.E.C., with speaker, cost £15, sell £4/10, 3 00025 condenser, cost 10/6, sell 3/6.—Lawson, Allandale Rd., Barnsley. [6139]

**EPOCH ELECTRICAL SOCIETY.**—Before you buy your new set visit our Demonstration Room and hear the latest and most popular makes of sets side by side, largest number of sets in London to select from; prices from 5/9 to £100.

**EPOCH ELECTRICAL SOCIETY.**—Every set bought from Epoch carries a guarantee of full satisfaction, with free service after purchase; sets delivered free anywhere in G.B.; free installation within 25 miles.

**EPOCH ELECTRICAL SOCIETY.**—Bring your old set in part payment for a new set.

**EPOCH ELECTRICAL SOCIETY.**—Installments may be arranged on all sets of £10 upwards.

**EPOCH ELECTRICAL SOCIETY.**—Let us build your sets to any published or special circuit; large selection of cabinets; lowest charges.

**EPOCH ELECTRICAL SOCIETY.**—Let us build your sets to any published or special circuit; large selection of cabinets; lowest charges. **EPOCH ELECTRICAL SOCIETY, Ltd 53, Gracechurch St., E.C.3.** Call, write, or phone Royal 8570. (Twenty yards from Monument S.W.) [6163]

**Receivers for Sale.—Contd.**

**7-VALVE Superhet.** (tuned American inter-frequency transformers, Cossor and Mullard valves, K.C. condensers (Dubilier), resistance and transformer (Ferranti), low-frequency metal panel, oak cabinet, tungstone H.T., and 110 amp. actual L.T. accumulators, £5/5 cone or £6/6 horn speaker, everything new; £25; demonstration.—Bennett, 20, Rowlands Rd., Becontree. [6140

**GILLAN** Portable 4-valve, in real leather case, new, Daventry and London, cost £25, £15 or near offer for quick sale.—H. Passmore, 8, Grosvenor Gardens Mews (North), Victoria, S.W.1. [6129

**BATTERIES.**

**ACCUMULATORS**, all sizes in stock, from 3/9; send for complete list.—Bright and Hayles, 78, Church St., Camberwell, London, S.E.5. [0079

**WET H.T. Batteries**.—Jars, 2 1/4 x 1 1/2 x 1 1/2, 13 doz.; zincs, 1/- doz.; snes, 1/3 doz.; dozen cells complete (18 volt), 3/6; post 9d. extra; high efficiency, long life, upkeep practically nil; orders for 3 dozen or over packed in special carton with divisions for each cell, usable as container for complete battery; send 6d. for sample complete unit with instructions; write for free lists of wireless bargains.—W. Taylor, 57, Studley Rd., Stockwell, London. [0039

**A.B. Dry H.T. Batteries** Cost Less Than Many Others. Make; in fact that they are manufactured by Messrs. Thomson Houston & Co., of Paris, is proof of their high quality; further, every battery carries a full and generous guarantee; usual sizes stocked; 60 volt, 100 volt, and grid bias, etc.; ask your dealer for same; if he cannot supply you write us direct; trade enquiries specially invited.—G. E. Ambatiello and Co., Ltd., Ambatiello House, Farringdon Rd., E.C.1. Telephone: Clerkenwell 7440. [0063

**WHY** Buy Wireless Accumulators? London's leading hire service improves reception; saving time, trouble, and money; no big outlay, no deposit, pay carman on each delivery; low tension service from 1/3 per week; fully charged and delivered free within 12 miles of Charing Cross; explanatory folder post free.—Radio Service, 105, Torrionia Av., N.W.5. 'Phone: North 0623-4-5. [5587

**SIX** Edison 20-volt 4,000-5,000 milliamps. H.T. accumulators, perfect conditions; 45/-.—B. V., 10, Parshall Rd., Hampstead, N.W.6. [6161

**ACCUMULATORS**.—Buy direct, save 25 per cent.; lists.—Haynes, 847, Old Kent Rd., S.E.15. [6133

**CABINETS.**

**ARTCRAFT** Radio Cabinets and Panels for all "Wireless World" sets.

**ARTCRAFT** Cabinets made in Oak and Mahogany, properly french polished, and are priced at 6/- to £11/11.

**ARTCRAFT** Cabinets made to any Specification or Design; estimates by return.

**ARTCRAFT** Illustrated Catalogue Free.—The Artcraft Co., 156, Cherry Orchard Rd., Croydon. 'Phone: Croydon 1981. [0040

**FIRM** Able to take Contracts for Wireless Cabinet Work; quotations on receipt of particulars or quantities.—196, Lewisham Rd., Lee Green 1206. [5719

**DIGBY'S** Cabinets.—Table models in solid oak and mahogany, from 1/16 to 7/1-.

**DIGBY'S** Cabinets, fitted with Radion or Resistor ebomite if required.

**DIGBY'S** Cabinets.—Pedestal model, with separate battery compartment; from 56/- to £12.

**DIGBY'S** Cabinets Made to Customers' Own Designs.

**DIGBY'S** Cabinets.—Write for new 16-page art catalogue.—F. Digby, 9, Banbury Rd., South Hackney, London, E.9. 'Phone: Clissold 5458. [5979

**AMERICAN** Type Cabinets, with hinged top and baseboard, in hand polished oak, 12in. x 8in., 10/6, post free; any size supplied.—Phoenix Wood Engraving Co., 28, Market St., Manchester. [5870

**SOLODYNE** Cabinet, mahogany, as new; half-price.—Box 4061, c/o *The Wireless World*. [6107

**PEDESTAL** Cabinets in Massive Oak Jacobean Finish (as illustrated in *The Wireless World*, May 4 issue), for Everyman Four or any set with panel up to 26x8in., stands 3ft. high, 15in. deep, 10in. baseboard included; £5, carriage paid; may be inspected on van before acceptance; fully illustrated folder gives every detail; write to-day.—G. E. Ambatiello and Co., Ltd., Ambatiello House, Farringdon Rd., London, E.C.1. 'Phone: Clerkenwell 7440. 'Telegrams: Ambatiello, London. [0055

**BAKER'S SELHURST RADIO** for Coil Drive Speaker Parts and suitable pedestal cabinets.—89, Selhurst Rd., South Norwood, S.E.25. [6173

**COILS, TRANSFORMERS, ETC.**

**EVERYMAN** Four (both types), 11/- each coil with base, post free, All-wave Four, 33/- pair with base; specified materials only.—E. Rushton, 50, Humber Rd., Wolverhampton. [6137

**Coils, Transformers, Etc.—Contd.**

**AERIAL** Grid Coils and H.F. Transformers for stations (on L.S.), price 15/- each; H.F. transformers for the All-Wave Four, high and low wavelengths, set of two and base, 35/-; all coils of highest quality materials and finish.—H. Goodwin, Woodcock Hill, Elstree. [0051

**McMICHAEL** H.F. Transformers, barrel type; 4/- each.—Box 4063, c/o *The Wireless World*. [6109

**EVERYMAN** Four Coils, 28/- per pair; wound exactly to designer's specification, L.E.W. 27/42 Litzendraht wire, grooved spacers, polished ebomite bases, soldering tags on all positions; c.o.d. or cash with order; good discounts to trade.—New Era Wireless and Electrical Co., Hobmoor Rd., Small Heath, Birmingham. [6079

**15** McMichael, Bowyer-Lowe H.F. Transformers, all waves; 4/- each.—Redway, Point, Exmouth. [6089

**B & J**—You can pay more for your Everyman coils, but you cannot buy better ones.

**B & J** Guarantee that their coils are at the very least as good as the best obtainable.

**B & J**—Should this guarantee not be substantiated we guarantee that we will refund your money by return on receipt of the coils.

**B & J**—Everyman coils, 30/- per pair, all types.

**B & J WIRELESS** Co., 2-3, Athelstane Mews, London, N.4. 'Phone: Mountview 1635. [0043

**COILS** wound for any Special Circuit exact to Specification: Everyman's Four, 25/-; "Wireless World" Five, 38/-; Everyman's Three, 27/-; All-Wave Four, 35/6; screen and base 6-pin, 7/-; Coil Maker, 7/-; spacers, grooved, with screws, set of 8, 1/-; all-wave long 2/-, short 1/-; tubes, 3in. and 3 1/2in., 1/3; Litz wire, 27/42s., 1d. per ft.; discount to trade.—Norton Bannerman & Co., Bradfield Works, Hawksley Av., Sheffield. [6156

**GRAMOPHONE PICK-UPS.**

**WOOD** Horns.—Illustrated list of new models ready; there's one for every speaker base and gramophone attachments.—Maddison, Manufacturer of the Allwoodorn, 2a, Ronalds Rd., N.5. [5845

**PICK-UP**—No need to buy a gramophone! Get a motor and tone arm from H. Maddison, manufacturer of gramophones and the famous wood horn for loud speakers.—The Allwoodorn, 2a, Ronalds Rd., N.5. [5845

**PICK-UP**, latest used by 2LO for perfect gramophone reproduction; demonstrations daily by W. J. Turberville-Crewe, M.Inst.R.E.E.; 24/4.—J. Glascock and Co., 49, Eastcheap, E.C.3. [5945

**GRAMOPHONE** Pick-up G.E.C., new, 30/-; 2 R.I. Varley R.C.C. units, 12/- each.—Box 4070, c/o *The Wireless World*. [6111

**GRAMOPHONES**, pick-ups, motors, adaptors, turntables; lowest prices ever quoted.—Requirements to Browne, 65, Sinclair Rd., W.14. [6161

**GRAMOPHONE** Pick-up, G.E.C., new, 35/-; 3 high class sound boxes, new, 5/- each.—Mills, 73, Pelham Rd., London, S.W.19 [6167

**LOUD-SPEAKERS.**

**MIRROVON** Loud-speaker, oval pleated polished aluminium diaphragm, mahogany mounted, looks like a mirror, perfectly wonderful reproduction, equal to any speaker double the price; try one on 7 days' approval; satisfaction or money returned; 22/10, post free.—A. Brixey, Coldharbour Lane, Hayes, Middlesex. [5579

**REPAIRS**.—All loud-speakers repaired and maximum efficiency attained; 4/-, post free; every repair is accompanied with a 3 months' guarantee; don't discard if burnt out; trade invited.—Transform, 115, Links Rd., Tooting, London, S.W.17. [0084

**GOODMANS** Can Give Prompt Delivery of Moving Coil Units, the lowest prices consistent with highest possible grade workmanship; list MG3 on request.—Goodmans, 27, Farringdon St., E.C.4. [0069

**REED** Movements.—Double acting reed movements specially designed to operate cone and other large diaphragms, extremely sensitive on small input, yet capable of enormous volume with sufficient input; very capable of enormous volume with sufficient input; 27/6 each; full allowance on Brown & Lisenolas and other units in part exchange; send stamp for illustrated lists of these and seamless cones.—Goodmans, 27, Farringdon St., E.C.4. [0066

**If** You are in London Call and See Goodmans' Coil Drive and Reed Units before purchasing elsewhere.—Goodmans, 27, Farringdon St., E.C.4. [0090

**COIL** Drive Units from Stock; the usual high standard of workmanship associated with the name of Goodmans, 27, Farringdon St., E.C.4. [0091

**Loud-speakers.—Contd.**

**VAUGHTON**.—Guaranteed parts for coil drive loud-speakers described in "The Wireless World," September 28th.

**VAUGHTON**.—Accurately machined magnet pot casting, 17/6; frame, 17/6; moving coil, 7/6.

**VAUGHTON**.—Brass bobbins exact to specification, 5/6; plywood rings, 2/-; ebomite dust, 2/6.

**VAUGHTON**—Wire (D.C.C.) for above: 14 S.W.G. 2/-; 16 S.W.G. 2/2; 18 S.W.G. 2/5; 20 S.W.G. 2/10; 22 S.W.G. 3/4; 24 S.W.G. 4/-; 26 S.W.G. 4/10; 28 S.W.G. 5/6; 30 S.W.G. 7/3; 34 S.S.C. 10/2; 38 S.S.C. 17/6 per lb.

**VAUGHTON**.—88, Vyse St., Birmingham. Tel.: Mivsey, Birmingham. [5994

**UNITS** for Cone Speakers.—Highly efficient, patented, double acting reed movement, the result of years of experimenting; very sensitive to small impulses, but capable of handling enormous power without overloading, special resonance damping device, high class workmanship and keenest value yet offered, complete with fixings for attaching cone; fuller details, list of cones, complete speakers, etc., post free.—Everyman's Radio Service, Brent St., Hendon, N.W.4. 'Phone: Hendon 2378 [6026

**KONEDOPE** Makes Home Constructed Diaphragms Air-and Damp-proof; tins sufficient for 2 large cones, 1/8 post free.—Everyman's Radio Service, Brent St., N.W. 4. [5851

**LOUD-SPEAKER** Units, very substantial and well designed; post paid 10/- money back if not satisfied.—Storry's, Ltd., Eastbank St., Southampton. [6004

**THE** New Goodman Junior Reed Movement; 14/6; the finest unit, at anywhere near the price, for driving cone and other large disc type speakers; this unit should not be confused with converted earpieces or gramophone attachments; second only in efficiency and performance to our double acting reed movement; full description in our illustrated lists, free on request.—Goodmans, 27, Farringdon St., E.C.4. [0092

**FRAMES** for Cone Loud-speakers, 12in., polished wood; 3/- pair.—Cole, 24, Mons Way, Bickley, Kent. [6101

**MOVING** Coil Loud-speaker Parts.—I have been asked by everyone, including a representative of the "W.W." (who has heard my results) how it is obtained without umpteen valves, stages of push, pull, and output transformer, and additional amplifier, etc. The result is that of many years experience with magne flux and 4 years with this type of speaker. The pot is of a grade of steel, of which I have used for the past 35 years with, of course, the required gauge and quantity of wire to suit the voltage and on a suitable high resistance coil of 2,000 turns 47Ω wire (having designed and built a machine for winding same) mounted on a well-thought-out diaphragm (patents pending). When ordering coil give outside and inside dimensions and depth of gap.—Chas. Andrews, Hunton House, Hunton Hill, Erdington ('Phone: 203) Birmingham. [0093

**MOVING** Coil, as specified by Mr. Haynes, mounted on diaphragm flexible leads, with surround of rubber, ready to fix to plywood ring; 22/6; delivered from stock; other sizes and winding to specification, also other parts.—Andrews, Hunton House, Hunton Hill, Erdington, Birmingham. Erdington 203. [0096

**VIOLINA** Cabinet 2,000 ohm L.S. are magnificent in their grandeur of tone and elegant in piano polished mahogany, list £5/5, sale 25/-; call any time and hear one; reed units for cones and discs; double Viola, 15/-; Brown's original "A" few left 2,000 ohm at 12/6; Amplions, 25/-; Western Electric with ebomite horn, 2,000 ohms, 15/-; Buradpet "Peter Pan," 12/6; Dr. Nespers, 10/-; Skinderviken parts for crystal loud speakers at 50% off list.—Electradix Radios, 218, Upper Thames St., London, E.C.4. [6086

**PRECISION** Engineer and Toolmaker, having had a vast experience in the production of electrical and wireless instruments, is now manufacturing, on a scientific production basis, all component parts for the moving coil loud-speaker described "Wireless World," September 28th; all castings are of the best possible grade, and can be supplied in the rough, or machined ready for assembly; coils and minor details may be altered to clients' own instructions, and all enquiries will receive personal attention.—Alfred Pearson, Engineer and Toolmaker, Newland Av., Hfall. [6155

**BIRMINGHAM** and Midlands.—Marlow home constructors' all-in kit ready in few days, complete as per "Wireless World," September 28th.

**DANCE** Hall and Picture House Proprietors, gramophone salons retailers pursuing a better quality reception policy, and all connoisseurs use the Marlow M.O. Super; delightful on simple det. L.F. Majestic on real amplifier, demonstrations daily at 1, Church St., Lzells, Birmingham.

**BLACK** COUNTRY Readers, Marlow M.C. Super; sales and demonstrations daily by Percy Hill and Co., Wdnesbury. [6171

**ELLIPTICON** Cone Loud-speaker, brand new, list £4/15, bargain, £3/5.—854, Green Lane, Chadwell Heath. [6146

Mention of "The Wireless

World," when writing to advertisers, will ensure prompt attention.



**Loud-speakers.—Contd.**

**FULL-SIZE Horn Loud-speaker**, balanced reed, mica diaphragm, bargain, 35/-; approval willingly; Lissen base and horn, 8/6.—55, Fleeming Rd., E.17. [6166]

**Did you See the Moving Coil Loud-speaker**, built with Webson parts, manufactured by Star Engineering, at the Olympia Exhibition?

**If** so, you would appreciate the high class workmanship and finish, which is the standard for all Webson parts manufactured by Star Engineering.

**When** you Order Webson Parts, you obtain goods made by engineers and recommended by the principal wireless journals; see "Wireless World," August 10th and September 28th, 1927.

**For** Highest Efficiency, build your moving coil loud-speaker with Webson parts, manufactured only by Star Engineering, Didsbury, Manchester.

**Your** Name and Address, in block letters, will ensure you free lists per return post.—Star Engineering, Didsbury, Manchester. Phone: Didsbury 1765. [6157]

**BAKER'S SELHURST RADIO** for Coil Drive Loud-speaker Parts, as described in "Wireless World," April 13, August 10, and September 28; we manufacture everything at our works, from the pot castings to the finished article; we are thus able to sell a superior article at a reasonable price; all parts are available for inspection; call at our works and judge for yourself the superiority of our parts over all others available.—42, Cherry Orchard Rd., East Croydon Station (20 minutes main line from Victoria Station).

**BAKER'S SELHURST RADIO** for Coil Drive Loud-speaker Parts, described by F. H. Haynes in "Wireless World," September 28.

**BAKER'S SELHURST RADIO** for Coil Drive Loud-speaker Parts.—Quick delivery of magnet units with field windings for use with accumulators or D.C. mains, as required.

**BAKER'S SELHURST RADIO** for 2in. Moving Coils, lightest made.

**FRAMES** and Cradles specially constructed to enable unit to be assembled in a few minutes without tools, from Baker's Selhurst Radio; quick delivery.

**IMPORTANT.**—All coil drive speaker parts supplied by us are constructed by highly skilled engineers of the best possible materials, as we do not depart from specifications given in "The Wireless World" you are assured of good results; we manufacture everything, from the pot castings to the finished article.

**We** have received testimonials from all over the country and also from Belgium, Holland and Italy, expressing complete satisfaction with the parts and surprise at the wonderful results obtained.

**We** shall be glad to show you all our coil drive speaker parts at our works at Croydon at any time.—Baker's Selhurst Radio, 89, Selhurst Rd., South Norwood, S.E.25. Works: 42, Cherry Orchard Rd., East Croydon. Phone: Thornton Heath 1488. [6172]

**VALVES.**

**DO You Know That—**

(a) the greatest item in your running costs is your bill for H.T. supply?

(b) Your power valve probably takes about 5/6ths of this? Thus resistance-capacity will not help you here, for you will still need a power valve.

(c) An A.P. 4 electrode valve in place of your present power valve will work as well on less than half the H.T. voltage.

(d) You will thus save 5/6ths, say 1/4, of your present H.T. costs, on the power valve alone.

**WORK it Out and See What it Comes to in Your Case!**

(e) If your set is used at all you are probably spending from £3 to £6, at the least, and so you will save from 15/- to 30/- annually, i.e., the cost of one or two A.P. valves.

**A.P. 4 Electrode Valves** Can be Used in Conjunction with Existing 3 Electrodes.

**THE A.P. Range** Includes a Valve for Every Position and new Types for Super Amplification, super power, and screened grid work.

**WRITE To-day** for X-ray Photographs of the A.P. Range, together with other A.P. 4 electrode facts and data.

**ANELOY PRODUCTS**, 36, Hindmans Rd., East Dulwich, S.E.22. Phone: New Cross 4074. [5916]

**TRIORION Dull Emitter Valves**, 2 volt, 4/6, power 7/6; highly recommended; guaranteed and post paid.—Storrys, Ltd., Eastbank St., Southport. [6003]

**5/-**—British valves: 2-volt .06 H.F. and L.F., 2-volt .1 H.F. and L.F., 2-volt .25 P.V., 4-volt .06 H.F. and L.F., 4-volt .1 H.F. and L.F., 4-volt .12 P.V., 6-volt .1 H.F. and L.F., 6-volt .25 P.V.; all one price, 5/- each, and all guaranteed; trade supplied; write your name and address clearly.—H. Howarth, British Valve Depot, 288, Deansgate, Manchester. [5987]

**GENUINE Amplion Valves**, in sealed boxes, 2v. D.E. (.09) and 2v. power; all one price, 6/6 each, post free.—Paul, 68, Tennyson Rd., Southampton. [6088]

# Another "Peerless" winner!

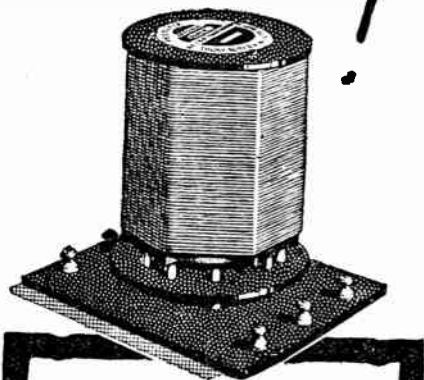

Another addition to the famous list of "Peerless" successes—the Peerless

## RESONIC SUPER H.F. TRANSFORMER OR AERIAL GRID TRANSFORMER

Suitable for all the circuits described in this publication. Covering 220-550 metres. Has interchangeable Litz Secondary wound with 27/42 Silk Covered Wire. PAXOLIN insulation throughout.

Either type - - - 21/- complete with base. Special long-wave transformers, 12/6 each.

Be sure to see **PEERLESS PRODUCTS** at **STAND No. 8 MANCHESTER WIRELESS EXHIBITION** Oct 24—Nov 5.

**PEERLESS PRODUCTS** from all good dealers or direct:—**BEDFORD ELECTRICAL & RADIO CO., LTD., 22, Campbell Road, BEDFORD.**

LONDON: 21, Bartlett's Buildings, Holborn Circus, E.C.4. GLASGOW: 113, St. Vincent Street, C.2.

**Valves.—Contd.**

**SCREENED Grid Valves.**

**THE A.P. 412 S.G.** for non-neutralised H.F. amplification, super R.C. amplification, and anode bend rectification; this is the only S.G. valve with a triple purpose; amplification factor 110, standard 4-pin base; write to-day for full data of all the A.P. 4 electrode valves.—Aneloy Products, 36, Hindmans Rd., E. Dulwich, London, S.E.22. [5539]

**CHARGERS AND ELIMINATORS.**

**ACCUMULATOR Chargers (A.C.)**, 45/- complete, post free; also components for same and for A.C. battery eliminators; fully guaranteed.—Stafford O'Brien and Partners, Ltd., 66, Victoria St., S.W.1. [0052]

**FOR Sale**, A.C. Rectaloy charger, as new; £2 or nearest offer.—D. Mann, Weymouth College, Do. set. [5982]

**PHILIPSON'S Safety High Tension Eliminator** for D.C. Mains, 200 to 250 volts, no hum or ripple, gives 7 voltages from 60 to 135 volts, maximum output 38 M.A.; fitted in well-finished oak cabinet, price £2/19/6, carriage paid.

**PHILIPSON'S Safety High Tension Battery Eliminator** for A.C. Mains, 200-250 volts, gives voltages from 20 to 120 volts at 20 M.A. discharge, and grid bias 5 voltages from 2 to 12 volts, maximum current output 50 M.A.; fitted in well-finished oak cabinet, £5/19/6, royalty 12/6; 12 months' guarantee given.

**PHILIPSON and Co. Ltd.**, Radio Engineers, Holland St. Works, Astley Bridge, Bolton. Phone: 2038 Bolton. Telegrams: "Safety," Bolton. [0081]

**MAKE Your Own High Tension Eliminators and Battery Chargers**, using Croix super-power transformers and filter chokes, guaranteed for one year; wiring diagrams free; set of parts from 16/6; write to-day, stating A.C. or D.C. mains.—The Wholesale Wireless Co., 103, Farringdon Rd., London, E.C.1. [0088]

**HOME A.C. Charger**, "The Wireless World," October 5th; angle if on uprights, 1/3 per set; angle iron feet, 6d. per pair; wire, 28 D.S.C., per lb. 8/-; wire, 22 D.S.C., per 1/2 lb. 3/6; wire, 16 D.S.C., per 1/4 lb. 1/3; baseboard mounting valve holders, 1/- each; wire, soldering tags, screws and nuts, Sankey laminations, etc., prices on application.—Vaughton, 88, Vyse St., Birmingham. Tel.: Mirvse, Birmingham. [5993]

**A.R.P.O. De Luxe D.C. High Tension Eliminators**, 6 tappings, for 1 to 6-valve receivers, mahogany cases; 60/-; guaranteed 6 months.

**A.P.R.O. Binocular Smoothing Chokes**, laminated core, most efficient; 15/-.

**A.R.P.O. Resistances**, tapped 10 points, 10,000 ohms, for 230 volts mains; 8/-.—Arnold Pochin and Bros., Trafford Park, Manchester. [6085]

**ATLAS Eliminator**, D.C. 200-250v., 3 H.T. Pos. (1 var.), 4 grid bias tappings; what offers?—S. Dent, 147, Great Portwood St., Stockport. [6094]

**PHILIPS H.T. Eliminator**, 240 volts, 50 periods, practically new, can be demonstrated after 6 p.m.; £5.—"Allerford," Queen's Walk, Kingsbury, N.W.9. [6095]

**ELECTRADIX D.C. Unit**, with 5 taps, is the safest unit with the most efficient filter circuit possible, humless, mahogany case, double ebonite panel; cheap, 30/-.

**A.C. Units**, single and double wave complete or kits, chokes from 2/6; 200 volt transformer, 10/-; with 30 years' experience and our huge stock come to us for the best advice; special line in Cossor 50 milli-amp rectifiers 6 volt, listed 25/-, sale 8/6.—Electradix Radios, 218, Upper Thames St., London, E.C.4. [6087]

**AEROPLANE Quality**, submarine prices.—Power transformers, output 150-0-150 v. 50 m.a. and 5 v. L.T., 17/6; chokes, 5/6; kit of components for H.T. eliminator, full wave rectification, output 150 v. 50 m.a., 52/6; send p.c. for full lists.—Simpson, Jerusalem Place, Leeds. [6012]

**THE New Grand H.T. Unit**, direct current, prices reduced! 20% quality unchanged, guaranteed 12 months, cash refunded if dissatisfied after 7 days' trial; 3 models, 60v., 19/6, 60v. and 100v., 23/6, 60v., 90v. and 120v., 27/6; c.o.d., post free.—Patentee, S. E. Grand, 88, Fenchurch St., E.C. [6170]

**WIRE.**

**GENUINE Beldon Enamelled Wire**, 44 gauge, for sale in 28lb. lots and over at 5/- per pound; limited quantity for disposal.—Apply Peto Scott & Co. Ltd., 118, Bunhill Row, E.C.1. [6083]

**LITZ Wire** (Lewcos 27/42), any length at 1d. per foot, 50 yds. 11/6, 9/38s. 4/- per 50 yds.—All above post free from Stoner's Radio Service, 42, Wellesley Rd., Wanstead, E.11. [6115]

**COMPONENTS, ETC., FOR SALE.**

**BELLING-LBE Panel Fittings** are designed to give an expert finish to any home-constructed set; catalogue post free.—Belling and Lee, Ltd., Queensway Works, Ponders End, Middlesex. [0018]

**DECKORFEM Components** are the finest you can include in any set you build. Write for free catalogue.—A. F. Bulgin & Co., 9, 11, Cursitor St., London, E.C.4. [5881]

**Components, Etc., for Sale.—Contd.**

**RELIABILITY WIRELESS GUIDE.**—New edition, No. 999, unequalled constructor's reference book; free upon request.

**RELIABILITY GUIDE RECOMMENDATION.**—J. H. C. Reading, writer. It has been an invaluable aid, and easily the best radio catalogue obtainable.

**RELIABILITY FREE DELIVERY TERMS.**—Applicable orders over 5/5, otherwise add 2d. per shilling.

**RELIABILITY MULTI-GANG CONDENSERS.**—0005 2-gang 4in. dial, adjustable rotors, low-loss square law, 18/-; 3-gang, 25/-.

**RELIABILITY BENCH MOUNTING COIL WINDING MACHINE.** metal turning handle, multi-pin honeycomb former, spindle for wire bobbin, etc.; 5/6.

**RELIABILITY GEARED MICRO-VERNIER DIAL.**—Fits 1/4in. or 2Ba spindle, 4in. dia.; 5/9.

**RELIABILITY MISCELLANEOUS COMPONENTS.**—Deco station log, 2/-; Cosmos H.F. choke, 6/6; Jewel detector, 2/-.

**RELIABILITY INCIDENTAL WIRELESS NECESSITIES.**—Pole finding paper book, 3d.; celluloid cement, 9d.; Fluxite, 8d.

**RELIABILITY AMPLION STOCK.**—A.R. 38, 38/-; A.R. 65, 65/-; Dragon A.R. 19, oak horn, 105/-; new Cabinet, oak, 42/-.

**RELIABILITY ANTI-CAPACITY SWITCH.**—D.P.D.T. 1-hole fixing, knob operated, screw connections; 3/-.

**RELIABILITY LOUD-SPEAKER FLEXIBLE.**—Twin, flat, any length cut, 2d. yard; twin extension wire, 1 1/2d. yard.

**RELIABILITY SUPERIOR FITTINGS.**—All ebonite panel switch, indicating on and off, 1/6; opal valve windows, 6d.

**RELIABILITY PANEL TRANSFERS.**—Per sheet, 2d.; Radio Press and Nugraving, 6d. sheet.

**RELIABILITY USEFUL GADGETS.**—Spring clip connectors, 1/2d.; porcelain 2-screw connectors, 2d.; brass, 1d.

**RELIABILITY INSULATING MATERIALS.**—Mica, 2in. x 1 1/2in., dozen 4d.; wax block, 6d.; celluloid sheet, 24 sq. in., 2d.

**RELIABILITY UNREPEATABLE LOTS.**—Com. position basket coil cases, 1/6; moving basket coilholders, 1/6; lever moving coilholders, 9d.

**RELIABILITY POPULAR COMPONENTS.**—Key switch, 1/-; non-reversible 2-pin telephone plug and sockets, 1/6.

**RELIABILITY CONE LOUD-SPEAKERS.**—Unequalled in tone and value; 30/-, with cord, adjustable.

**RELIABILITY ACCUMULATOR TRAYS.**—Moulded rubber, 9x6in., 2/-; 13 1/2x5 1/2in., 3/-; prevents damage.

**RELIABILITY PANEL BRUSHES.**—Ebonite 4Ba or 2Ba, 2d. pair; Clix type, 3d. dozen.

**RELIABILITY COMPOSITION HORNS.**—22in. long, 10in. flare, 7/6; stand to hold Lissencola also, 3/-.

**RELIABILITY HONEYCOMB COIL FORMER.**—R 46-pin, 1/-; with handle, 1/3; standard coil cores, 2d.

**RELIABILITY COMPETITIVE COMPONENTS.**—Baseboard valve holder, 6d.; rheostat, 30 ohms, 1/6; porcelain coilplug, 6d.

**RELIABILITY SUCCESSFUL MANUFACTURES.**—Admiralty pattern, 100ft. aerials, multi-stranded copper; exceptional value, 3/11.

**RELIABILITY SUPERIOR VARIOMETERS.**—All ebonite, broadcasting wavelength, terminal connections, D.S.C. winding; 3/-.

**RELIABILITY POTENTIOMETER PROPOSITIONS.**—Edison-Bell, 300 ohms, 4/-; Lissen, 2/6; Burndept, 6/-; ex-Government geared, 5/-.

**RELIABILITY NEUTRALISING CONDENSERS.**—Panel-mounting Peto-Scott, 6/3; baseboard, 5/-; Magnam, 5/-; McMichael, 4/9.

**RELIABILITY LEADING SUPER-VALUE.**—Sterling .0005 condenser, with Vernier and dial, all brass, square law; 9/6.

**RELIABILITY ECONOMICAL SUGGESTION.**—Ebonite panels in dozen lots, 6x1in., 2/-; 6x2in., 4/-; 2x2in., 1/3; 3x1 1/2in., 1/3.

**RELIABILITY LOW-LOSS SPECIALITIES.**—Colvren 6-pin former and base, 5/-; base only, 1/6; anode coilholder, 1/3.

**RELIABILITY TRANSFORMER VALUES.**—Five to one or three to one ratio, 4/-; Tangent, 7/6; Lissen, new, 8/6.

**RELIABILITY TRANSFORMER ACCESSORIES.**—Ebonite H.F. former, 1/-; L.F. bobbin, 5d.; K stampings, 6d. doz.

**RELIABILITY HEADPHONE ACCESSORIES.**—Stalloy diaphragms, 3d.; 3 3/4. 4d.; Comfort car-caps, pair 1/3.

(Continued third column.)

**THE ELTAX RED SEAL**

The Eltax Red Seal H.T. Battery is the most economical power unit because of its high efficiency, great recuperative power, and the low internal resistance which ensures a silent background.

These batteries can also be supplied in the new square shape.

**LANGHAM ELECTRICAL SUPPLIES CO.,**

Battery Specialists.  
52, DORSET STREET, LONDON, W.1.  
Telephone: Mayfair 0262.  
Telegrams: Outillage, Baker, London.

**PRICE 7/6**



Write for our new catalogue

**More Power to your Wireless!**

**"LEION" RADIO POWER UNIT**

(See "Wireless World," May 4, 1927)

It gives steady, silent power—volume without background.  
To B.E.S.A. Specifications.  
5 years Guarantee.

**MAKERS: P. B. G. Ltd.,**  
10, Vyse St., BIRMINGHAM.

For all types of D.C. Supply.



H.T. & Charger.

Agencies Vacant.

**Components, Etc., for Sale.—Contd.**

(Continued from first column.)

**RELIABILITY UNREPEATABLE CONDENSERS.**—T.C.C. 1 mfd non condensers, 2/8; 1-36th Siemens, 9d.; 5 mica Dielectric, 2/6.

**RELIABILITY VERNIER ADJUSTERS.—N.A.P.** knob, 6d.; Detex 3in. dial, 3/-; Elex, similar, 2/6.

**RELIABILITY NEWEST COMPONENTS.**—Eight-way coilrack, 2/9; Ediswan buzzer, 2/6; class enclosed grid leak, 8d.

**RELIABILITY ELECTRON VARIETIES.**—100ft. aerial, 1/8; Superial, 2/6; single strip, 12ft., 2/-.

**RELIABILITY IGRANIC RANGE.—I.F. trans-**formers 16/6; variometers, 7/6; rheostats, 2/9; potentiometers, 4/3; Balcon 2/-; micro condensers, 5/6.

**RELIABILITY COPPER AERIALS.**—7-22s. 100ft., bright, 2/3; enamelled, 3/3; 1/4in. tape, 1/6.

**RELIABILITY AERIAL ACCESSORIES.**—Bracketed insulator, 21in. projection, 1/9; galvanised spike fitted G.P.O. insulator, 1/6.

**RELIABILITY AERIAL INSULATORS.**—Large shell, 3d.; egg, 3d.; small shell, egg or reel, 1d.

**RELIABILITY AMERICAN COMPONENTS.**—"Royal" transformers, 20/-; "Amperites," 5/-; "Royal Frost" rheostats and potentiometers, 2/6.

**RELIABILITY H.T. BATTERIES.**—Plugs included, R 15v., 1/10; 36v., 4/6; 60v., 7/6; 90v., 11/-; 100v., 12/-.

**RELIABILITY GRID BATTERIES.**—6v., 1/-; 9v., 1/3; 1 1/2v. dry cell, 1/6; flashlights, 4d.

**RELIABILITY H.T. ACCUMULATORS.**—20-volt, glass unit, 10/-; Exide 20v. W.J., 12/6.

**RELIABILITY STRAIGHT-LINE CONDENSERS.**—With 4in. Trolite dial, .0005, 6/3; .0003, 5/9.

**RELIABILITY LOW-LOSS CONDENSER WITH KNOBBED DIAL.**—Square law .001, 6/6; .0005, 5/-; .0003, 4/6; Vernier, 1/- extra.

**RELIABILITY POLAR RECOMMENDATION.**—Cam Vernier 2- and 3-way coilholders, 3/- and 4/-; long handle, extra 6d.

**RELIABILITY WIRELESS CABINETS.**—Polished oak, linged lid, loose baseboard, panel dimensions 7x12in., 17/-; 14in., 17/6; 18in., 18/6; mahogany, 1/- extra.

**RELIABILITY CONDENSER DIALS.**—4in. knobbed Trolite, 1/6; 3in. ebonite lid, only 8d.

**RELIABILITY ORMOND SPECIALITIES.**—Rheostats, 2/-; dual and potentiometers, 2/6; Neutrodyne condenser, 2/-; shrouded transformers, 15/-.

**RELIABILITY L.T. ACCUMULATORS.**—2v. 40 Exide HZ, 17/6; 60 amp., 21/-; 80 amp., 24/6.

**RELIABILITY MANSBRIDGE CONDENSERS.**—2 mfd., 3/6; 1 mfd., 2/6; 5 mfd., 3/6; 25 mfd., 1/6; terminal connections.

**RELIABILITY EXPERIMENTERS PARCELS.**—Containing useful assorted components, worth 20/-; delivered 5/6.

**RELIABILITY SUPER VALUES.**—Three N.P. Crocodile clips, 6d.; panel brackets, pair 6d.; key switch, 1/-.

**RELIABILITY EARTH MATERIALS.**—Copper earth tube, 3/-; Army spik, 1/3; clip, brass, expandable, 6d.; galvanised, 2d.

**RELIABILITY MULTI CONDENSERS.**—.001, .0015, .0007, .0003, in one case, 1/9; all Dubilier, Edison-Bell, T.C.C. and Lissen stocked.

**RELIABILITY USEFUL ACCESSORIES.**—12 yards 1/4in. Empire tape, 6d.; coil black tape, 6d.; assorted box B.A. screws, nuts, 1/-; solder tags, 6d.

**RELIABILITY INSTRUMENT WIRES.**—Per lb., D.C.C. 26's 3/4, 28's 3/9, 30's 4/10; Litzten wire, 150ft., 12/-; square copper, 2ft., 1d.

**RELIABILITY S.O.S. HYDROMETER.**—3-bead type, 3/6; accumulators, Exide, D.T.G., 4/6; D.F.G., 3/6; Oldham O.D.V., 5/6; repair outfit, 1/6.

**RELIABILITY PANEL SWITCHES.**—Push pull, R 1/-; key type, 1/-; miniature, 6d.; all ebonite, 1/6.

**RELIABILITY COIL PLUGS.**—Basket type, 6d., with terminals, 9d.; honeycomb, 5d.; superior, pins cross-cut, 8d.

**RELIABILITY CLAYTON EBONITE.**—1/4in., square in., 3/4d.; any size new cuttings, 1/3 lb.

**RELIABILITY CLEARANCE LINES.**—Lissen T3 transformers, 9/6; tangent, 7/6; G.R.C. variometers, 7/-; .00075 condensers, 4/-; .00025 vernier, 4/-.

**RELIABILITY EX-GOVERNMENT GOODS.**—1-36th mfd. condensers, 9d.; lightning arresters, 1/-; valve cases, 1/3; microphone transformers, 5/-; 120 ohms Sullivan phones, 3/6.

**RELIABILITY FULL SIZE LOUD-SPEAKER.**—2,000 ohms, corded, 27/6; gramophone speaker unit, 7/6.

(Continued first column next page.)

Mention of "The Wireless World," when writing to advertisers, will ensure prompt attention.

Components, Etc., for Sale.—Contd.

(Continued from previous page.)

**RELIABILITY TWIN CONDENSERS.**—Elstree Six type, .0005, dialed, low-loss square law; 9/6.

**RELIABILITY TOOLS.**—Set spanners, 4d.; box keys, 7d.; hand drill, 3/6; 9 drills, 1/-; soldering iron, 6d.; electric, 10/-.

**RELIABILITY SUNDRY ACCESSORIES.**—Fluxite, 8d.; solder stick, 3d.; Britanol, 6d.; shellac, 3d.; Chatterton's compound, 9d.

**RELIABILITY CRYSTAL DETECTORS.**—Glass, enclosed on ebonite, 1/-; Universal movement type, 1/6; permanently set wave length, 6d.; liberty, 2 6.

**RELIABILITY TWO-WAY COIL-HOLDERS.**—Gearing, 3/-; cam vernier, 3/6; friction drive, 5 6; unequalled, 1/9.

**RELIABILITY JACKS AND PLUGS.**—Four contact, 1/9; single closed, 1/6; double filament, 2/3; ex-Government plugs, 1/-.

**RELIABILITY LEAD-IN TUBES.**—9in. or 12in., 8d.; 15in. or 18in., 1/-; 24in., 1/4; switch operating type, 3/6.

**RELIABILITY CHOKER COILS.**—600 ohms, ex-Government, 10d.; all advertised chokes stocked.

**RELIABILITY LISSON COMPONENTS.**—New transformer, 8/6; loud-speaker unit, 13/8; flare, 17/6; switches, 1/6, 2/6; rheostats, potentiometers, 2 6.

**RELIABILITY COMPLETE TERMINALS.**—Single W.O., plated, 1½d.; polished, phone 1d., pillar 1d.; W.O., 1½d.; all Belling Lee stocked.

**RELIABILITY DOUBLE HEADPHONES.**—All high resistance corded, Airweights, 7/6; adjustable, 8/6; unequalled, 5 6.

**RELIABILITY BARGAINS.**—R.A.F. modulation transformers, 8/6; 12 contact Dewar switches, 2/6.

**RELIABILITY USEFUL ACCESSORIES.**—Sub-panel connectors, 1d.; soldering spades, 2d. dozen; insulated hooks, 1d.

**RELIABILITY ANTIPHONIC HOLDERS.**—Unequalled, 1/6; superior, 2/-; Harlie, 1/4; Lotus, 2 3, 2/6; Benjamin, 2/-; W. and B., 1/9.

**RELIABILITY BASEBOARD RHEOSTATS.**—10 or 35 ohms, also panel, 7 or 30 ohms; 1/6.

**RELIABILITY FLEXIBLE WIRES.**—Per yard, red and black, 2d.; single, 1d.; tinsel, 1d.; 100ft. gal. straining wire, 1/6.

**RELIABILITY ALWAYS ASSURED.**—Use R.I. transformer, 25/-; Ferranti, 17/6, 25/-; Lotus coil-holder, 7/-; Penton, 6/-; Ediswan R.C. unit, 7/-.

**RELIABILITY HEADPHONE DISTRIBUTORS.**—6-way, on ebonite, 1/6; 4-way, terminal type, 6d.

**RELIABILITY DOUBLE SCALE METERS.**—100v-10v., 5/6; 6v. 12a., 5/6; voltmeter, 06v., 3/6.

**RELIABILITY EXTRAORDINARY VALUES.**—.0005 Sterling vernier condenser, 9/6; 3 mounted Darenty coils, 4/-; 46-pin coil former, 1/-.

**RELIABILITY MARK GUARANTEE.**—Covers materials advertised and many thousand items in Guide offered.

**RELIABILITY TRADE LIST** supplied to all legitimate traders making application for same.

**RELIABILITY TYPICAL TESTIMONIAL.**—J. C. B. Oldbury writes: "You fully justify the trade mark you possess."

**RELIABILITY GOODS AND SERVICE.**—Only obtainable from J. H. Taylor and Co., 15, Radio House, Macaulay St., Huddersfield. Send for Free Guide now. [0028]

**STORRY Bargains.**—Amplion Siftron loud-speaker filters protects loud-speaker windings, improves tone, usual price 33/-, offered at 12/6; Cleartron variable condensers, 4/11; post paid and guaranteed.—Storry's Ltd., The Wireless Mart, Eastbank St., Southport. [6002]

**DIAPHRAGM Dressing,** which has stood the test of over 2 years and given universal satisfaction. See you get Dilac. It is not the usual amyl acetate 7 celluloid medium; 1/3 and 1/9 per jar, post free; bronze, gold, or silver stocked.—Goodmans, 27, Farringdon St., E.C.4. [0067]

**CHAKOPHONE Tuning Unit** with Reaction, 300-2,000 metres, complete with instructions, 8/-; Everyman Four coils (Chakophone), boxed with "Wireless World" booklet, 31/-.

**TUNEWELL Coils,** 25, 35, 50, 75 1/6 each, 100 1/8, 150 2/3, 175 2/6, 200 2/9, 250 3/3, air spaced, robust, efficient; special lines: Wanderplugs, 1/3 doz.; terminals, with nut washer and indicating label, 2 B.A. pillar, 4 B.A. W.O., 2 and 4 B.A. phone, 2/- doz.; plated, 2/6 (state markings); coil holders, 2-way B.bd. 2/8, geared 2/9; switches, push pull, 11d.; S.P.D.T. on ebonite or porcelain, 9d.; D.P.D.T. on porcelain, 1/6; red and black flex, 1/6 doz. yards; R.C. cable, 2 mm. 1/-, 4 mm. 1/9, 5 mm. 2/3 doz. yards, insulated staples, 1/9 100.

**POSTAGE** up to 5/- 6d., over 5/- free; send us your enquiries.—Radio Supplies Co., 37, Bedford St., Leamington Spa, Official Traders and Repairers to Radio Society of G.B. and Wireless League. [5685]



24 MODELS ranging from the D.C. TYPE "M"



at 27/6 for one or two valve sets to the A.C. POWER UNIT FOR H.T. & L.T.

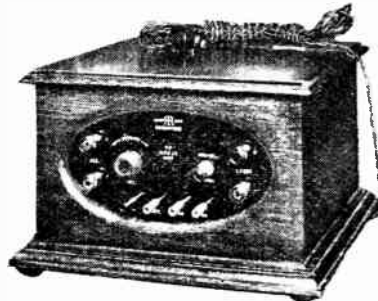

at £16 - 12 - 6 for multi-valve sets.

MANCHESTER EXHIBITION STAND 8

Our sixteen page catalogue, free on request, gives particulars of the model suitable for your set. You may try it out at home for seven days before definitely deciding to purchase. Components, kits of parts, and mains receivers are also described in our catalogue.

BEHIND EACH REGENTONE INSTRUMENT THERE LIES 4 YEARS' SPECIALISED EXPERIENCE.

ASK YOUR DEALER, OR COME AND SEE US. REGENT RADIO SUPPLY CO.

SHOW AND DEMONSTRATION ROOMS: 21 BARTLETT'S BLDGS., HOLBORN CIRCUS, E.C.1. Central 9661.

Components, Etc., for Sale.—Contd.

**REED Movements.**—Double acting reed movements specially designed to operate (one and other large diaphragms, extremely sensitive on small input, yet capable of enormous volume with sufficient input, will work up to a 3in. cone with ease, no rattle or distortion; 27/6 each; fair allowance on Brown A earpieces, or Lissencolas and other units in part exchange; send stamp for illustrated lists of these and seamless cones.—Goodmans, 27, Farringdon St., E.C.4. [0049]

**ALL-WAVE Coils** (May 11th), pair with 6-pin base; 42/6.—Jennens, below.

**EVERYMAN Coils,** 3, 4, 5, on ebonite bases; 15/- each.—Jennens, below.

**TUBES,** 3in. x 3½in. genuine Mikopac; 1 1/4, 2 2/8, 3 3/6.—Jennens, below.

**SPACERS,** grooved, with screws, 8 aerial or anode, 1/-; All-wave 6 short, 1/-; 12 long, 2/6.—Jennens, below.

**LITZEN Wire** (Lewcos 27/42), to wind 70 turns; 4/8.—Jennens, below.

**WYCHE Switch,** 2-way, 1/3; both battery, 1/6.—Jennens, below.

**LEOWE Multiple Valves,** 3 L.F. and 2 H.F.; write for price and particulars; trade enquiries invited for all above.—Jennens Radio, 30, Chapel St., Birmingham. [0075]

**TANTALUM.**—Tantalum metal sheet for A.C. rectifiers, tungsten, molybdenum, selenium, woods, metal, crystals.—Blackwell's Metallurgical Works, Liverpool. [5745]

**SHORT-WAVE Wavemeters,** 18-70 metres, every instrument individually calibrated by hand, enables any required station to be found immediately, in upright mahogany cabinet, complete with full instructions; 35/- cash, or c.o.d.—Deepees, 22, Ganton St., Regent St., W.1. [5894]

**A.J.S. Headphones,** light, strong, adjustable. Headbands, perfectly clear and comfortable. Full makers' guarantee, list price 15/-; on 7 days' approval; satisfaction or money refunded; 10/6, post free.—A. Brixey, Coldharbour Lane, Hayes, Middlesex. [5578]

**ARMONIC Valve Holders** are the finest value in British made components; model H antimicrophonic, 1/6 each.

**GRID Leak Holders** for Vertical or Horizontal Mounting, Bakelite mouldings with adjustable springs, fitted terminals, Aermonic No. 1; 1/-.

**ANGLE Bending Pliers,** Aermonic; one nip of the jaws bends wire to a right angle, indispensable for workmanlike wiring; price 2/- each.

**GRID Leak Clip** for Mounting Direct on the Wires, Aermonic No. 2; 4d.; if your dealer does not stock, write for free list to the manufacturers.—James Christie and Sons, Ltd., West St., Sheffield. [0078]

**REPAIRS.**—All transformers repaired and maximum efficiency attained; 4/-, post free; every repair is accompanied with a 3 months' guarantee; don't discard if burnt out; trade invited.—Transform, 115, Links Rd., Tooting, London, S.W.17. [0035]

**REPAIRS.**—All headphones repaired and maximum efficiency attained; 4/-, post free; every repair is accompanied with a 3 months' guarantee; don't discard if burnt out; trade invited.—Transform, 115, Links Rd., Tooting, London, S.W.17. [0086]

**SCREEN Coils.**—Split primary aerial, 250-550, 1,000-2,000, 5/6; split primary, H.F., 250-550, 7/6; 1,000-2,000, 7/6; split secondary H.F., 250-550, 7/6; 1,000-2,000, 11/-; 6-pin Bakelite base, 2/- each.—Below.

**EVERYMAN Four Coils,** complete with base; aerial, 15/-; transformers, 15/-; 28/- set.—Below.

**HYDRA Fixed Condensers,** tested 500 volts: 26 M.F., 2/-; 5 M.F., 2/3; 1 M.F., 2/6; 2 M.F., 3/6 each; other capacities in stock.—Below.

**VARIABLE Condensers.**—S.L.F., .0003, .0005, 7/6 each; L.M.L., .00035, .00025, 10/6.—Below.

**SUPER Filament Resistances,** 7, 15, 30 ohms, panel or baseboard types; 2/6 each.—Below.

**VALVE Holders,** antimicrophonic; 1/6 each.—Below.

**H.F. Chokes and Anode Resistances,** 60,000, 80,000, 100,000 ohms; 5/- each.—Below.

**LITZEN Wire,** 27-42, 20 yards, 5/-; 50 yards, 12/-; 9-40, 150 yards, 9/6; other lengths pro rata.—Below.

**PAXOLIN Tubes,** 3in. x 2½in., 1/6 each; ebonite spacers and screws complete, 2d. each.—Obtainable all dealers or Stone Mig. Co., 108-9, Great Saffron Hill, London, E.C.1. [0068]

**CONSTRUCTORS.**—Fit the Delophone aerial tuner and dispense with plug-in coils, special model made for baseboard mountings, 250-4,000 metres; price 2/6; send for descriptive leaflet.—E. and F. Deal, 283, Shilley Rd., Southampton. [5844]

**DECKOREM Components** are the finest you can include in any set you build. Write for free catalogue.—A. F. Bulgin & Co., 9-11, Curstort St., London, E.C.4. [5882]

**ANY Radio Component** supplied from Stock at List Price; no extra charge for postage; advice given.—Storrys, Ltd., The Wireless Mart, Eastbank St., Southport. [6005]



Components, Etc., for Sale.—Contd.

R.I. Retroactive Tuner, also R.I. reactive anode unit 35/- the pair; Ormond S.L.F. .0005 condenser friction control, 4in. dial, 12/6; Ormond Square Law .0003 condenser friction control, 4in. dial, 8/-; Varley 80,000 ohms resistance, with holder, 4/-; Lissen L.F. choke, 4/-; also other parts of Bestway De Luxe loud-speaker set, all nearly new, or would sell complete kit, mounted and wired up, including Ferranti A.F.3, £6/10.—Davis, 70, Wooler St., Waltham, S.E.17. [6113

FRAMES for Cone Loud-speakers, 12in., polished wood; 3/- pair.—Cole, 24, Mons Way, Bickley, Kent. [6102

SQUARE LAW Condensers.—Sterling .0005, geared, 6/-; Ormond .0005, with Vernier, without dial, 5/-; .00025 ditto, 4/-; Lotus geared double coil holder, 4/6; another Vernier coil holder, 3/6; W. and W. variometer coupler, 6/-; utility D.P.D.T. switch, 2/6; S.L.C. condensers, with knob and dial, .001 2/-; .0005 1/5; .0002 1/-; Igranite variometer, 5/-; potentiometer, 300 ohms, 1/-.—G. Illingworth, St. Bees, The Glen, Baldon, Yorkshire. [6118

BURNDIPT Super Vernier Dials, 2/9, 2 for 5/- post free; perfect; list free.—Selby and Co., 6, Hauberk Rd., Lavender Sweep, S.W.11. [6120

DECKOREM Components are the finest you can include in any set you build. Write for free catalogue.—A. F. Bulgin & Co., 9-11, Cursitor St., London, E.C.4. [5884

MARK IV Tuner with Het, wave meter, 500 to 1,600 meters, 40/-; Marconi valve-crystal receiver, with coils and valve, 27/-; C.A.C. 2-valve mains receiver, no batteries required, 40/-; cabinet loud-speaker, 35/-; Burndipt Gram speaker, 24/-; 4 Igranite H.F. transformers, 25 to 6,000 meters, 16/-; Lissencroft Mark I 2/-; Mark II 3/6; .001 variable Devicon condenser, 3/6; all the above are as new; 2 variometers, mounted in cabinet, 10/-; Marconi tuner, 10/-; Polar 3-valve H.F. unit, mounted on panel, with condenser, etc., 6/-; any evening after 7.30.—Webb, 10, Normanby Rd., N.W.10. [6123

KAYNITE Components for Mains Rectifiers.—D.C. units from 25/-; call or send for particulars.—The Lisle Radio Co., 37, Lisle St., W.C.2. [6074

MULTIFORMER.—This versatile component will function as an L.F. transformer, an I.F. transformer, R.C.C. unit or choke capacity unit without requiring the slightest alteration to the wiring of your set; it costs no more than a first class transformer.—For full details and prices write the Sole Manufacturer, Geo. E. Pohn, 16, Colville Rd., London, W.11. [6153

SCREENED Coils: Two Peto-Scott split primary and bases, 7/6 each; condensers: Ormond .0005 dual, 12/-; Sterling .0005, with vernier, 6/6; bargains.—Davies, 41, Nicholas St., Chester. [6152

MATEUR'S Surplus.—3 Ormond S.L.F. .0005 friction geared condensers, 1 each Igranite filament switch and 20 ohm rheostat, all mounted 26x8 ebonite panel, £3; 1 Ideal L.F. 4-1 transformer, 16/-; 1 Pye H.R. 1-1 telephone transformer, 11/-; 3 100,000, 4/- each, and 1 50,000, 12/-, anode resistances and bases; 1 set (combine five) coils, 10/-; all guaranteed.—Edwards, 85, Sillins Av., Redditch, Worcs. [6150

SIMMONDS BROS., Shireland Rd., Smethwick.

COIL Prices.—Everyman Four, 33/- pair; Everyman Three, 35/-; All-wave Four, 42/6; New Everyman Four, 33/-; "Wireless World" Five, 50/6 set of 3; Regional short-wave, 34 6 pair, long wave, 48/6 pair, bases, 6/- the two; Empire broadcast coil, mounted, 8/6; chokes, 7/6 pair; Quality Three coil, 16/6.

SCREEN Prices.—Everyman Four, 4/6; Everyman Three, 4/-; All-Wave Four, 5/-; New Everyman Four copper box, 17/6; Empire broadcast cabinet, £2.

BERCLIF Valve Holder is Essential for all high-frequency valves and short-wave work; approved by the experts, price 2/9, dealers please send for sample c.o.d. Readers and the trade supplied with all above; component lists and test report on coils free from the original Everyman specialists.

SIMMONDS BROS., Shireland Rd., Smethwick. [5954

DECKOREM Components are the finest you can include in any set you build. Write for free catalogue.—A. F. Bulgin & Co., 9-11, Cursitor St., London, E.C.4. [5885

MORE Arnel Bargains.—Phones, 4,000 ohms, double earpiece, price 12/6, our price 6/-; double reading pocket voltmeters, 0-5 and 0-120 volts high resistance, dead beat, usual price 7/6, our price 5/8; H.T. batteries, 60 volts, reliable and guaranteed, usual price 6/9, our price 6/-; anti-microphonic valve-holders, with terminals, 1/3 each.—Below.

SPECIAL Arnel Offer.—Atlas 3-way coil holders, usual price 9/-, our price 2/3 each; Atlas 2-way Vernier coil holders, usual price 9/9, our price 3/6 each; still a few T.M.C. loud-speakers left at 15/- and 40/- each; all goods new and perfect, and sent post paid for cash with order.—Arnel Manufacturing Co., Arnel Works, Gun St., Ancoats, Manchester. [6049

RESISTANCE Capacity Coupling Units.—First stage, Anode R. 5 meg., second stage, anode R. 2 meg., both stages, grid leak, 5 meg.; condenser, .001 mfd.; Pre-anti-microphonic valve-holder, mounted on erinoid base; 7/6 cash, 8/6 c.o.d.—C. H. P. Nutter, F.R.A., Radio Corner, 243, Selhurst Rd., South Norwood, S.E.25. [6134

One Year's Guarantee.



"C.S.I." L.F. TRANSFORMER.

Every C.S.I. Transformer is actually tested on aerial before despatch and is guaranteed for one year from date of purchase. We confidently claim it to be equal to the best on the market. Test it for yourself, and if not satisfied your money instantly refunded. Ratios 5-1, 3.5-1, 2.5-1. Entirely British.

12/6 THE CURZON SCIENTIFIC INSTRUMENT CO., 1, WINCHESTER HOUSE, BLACKHEATH, S.E.3



LOW INITIAL COST RUNNING COST NO TROUBLE

For charging H.T. Accumulators from A.C. Mains. This charger, the result of years of Scientific research, embodies a new form of electrode and electrolyte. Can be used on any voltage. No trouble, no fumes, no overheating, no waste or corrosion of electrode. Simple and safe. Model F.G.1, 30/- L.T. Trickie Charger, Model F.G.2, 45/-; packing and carriage 1/6 extra in both cases. 30/- Full particulars on request.



Faradex RECTIFIERS ROOKE BROS., LTD., 55, Cardington Street, N.W.1.

Components, Etc., for Sale.—Contd.

WILSON Bar Amplifier, perfect order, with instructions; 28/-.—Charlton, 8/3, New Buildings, Croydon. [6148

MANSBRIDGE Type Condensers, guaranteed to 450 volts; .01 mfd., 1/6; .1 mfd., 1/6; .25 mfd., 1/9; .5 mfd., 2/-; 1 mfd., 2/3; 2 mfd., 3/-; 3 mfd., 3/6; 4 mfd., 4/6 (post free).—Garrett and Spawforth, 92, Great Russell St., London, W.C.1. [6133

TWO 60-volt Elite Accumulators, almost new, 30/-; unused 3-valve Reinartz by Tutills, Manchester (first prize hospital battery), listed £12, offers; Brown A carpiece, 12/6.—Taylor, 8, Campden Rd., Croydon. [6132

A.J.S. Choke Coupling Unit, 10/-; A.J.S. L.F. choke, 7/-; J.B. .0005 condenser with vernier dial, 4/6; Burndipt switches, 4-pole D.T., 2/6; 2-pole D.T., 2/-; Marconiphone Velvet potentiometer, 2/6; Master rheostat, 2/6; valves, Mullard 3v. .06, P.M.5x, D.E.5h, 5/- each; P.M.4, 5/6; T.M.C. speaker unit, 5/-.—Rennie, 546, New Chester Rd., Rock Ferry, Birkenhead. [6131

COMPONENTS.—Variable condensers, fixed ditto, valves, high and low tension batteries, portable leather cases, and sets unfinished, assortment useful wireless goods.—H. Passmore, 8, Grosvenor Gardens Mews (North), London, S.W.1. [6130

TELETRON.—The one wire long distance remote control, the simplest remote control to install: one wire only required; private houses, Teletron will enable you to control the receiver from any room; estates, Teletron can link up all outlying cottages to one central receiver, a single wire covers any distance; Teletron is invaluable for institutions and hospitals; Teletron can be used with any type of receiver; price 35/6, post free.—Baily, Grundy and Barrett, Ltd., 2, St. Mary's Passage, Cambridge. [6028

EPOCH ELECTRICAL SOCIETY.—All standard lines and best foreign components in stock; mail orders despatched same day.

EPOCH ELECTRICAL SOCIETY.—Constructors' requirements specially catered for; let us quote for your kit.

EPOCH ELECTRICAL SOCIETY.—Buy from Epoch and be safe. Guaranteed goods only stocked.

EPOCH ELECTRICAL SOCIETY.—If you experiment for enjoyment's sake, buy your parts from us. If you want a guaranteed set, let our experienced engineers build it for you.

EPOCH ELECTRICAL SOCIETY.—Parts for all Wireless Press circuits at lowest prices.

EPOCH ELECTRICAL SOCIETY.—Bring your old components in part exchange for new ones.

EPOCH ELECTRICAL SOCIETY.—Repairs, re-wiring, modernising, etc., carried out by real experts. Consult our experts upon your problems; no charge or obligation.

EPOCH ELECTRICAL SOCIETY.—A few Epoch bargains: .0005 S.L.F. condensers, 3/3; ebonite grid-leak clips, 4/6d.; slow motion dials, 2/6, 3/-, 3/6; American grid leaks, 6d.; double-reading voltmeters, 4/3; hydrometers, 2/-; Jacobean oak pedestal cabinets, 35/-; push-pull switches, 7/6d., etc.

EPOCH ELECTRICAL SOCIETY, Ltd., 53, Gracchurth St., E.C.3. Call, write or 'phone Royal 8570 twenty yards from Monument Station. [6165

EXPERIMENTER Has for Sale Coils, Condensers, Transformers, etc. Apply for list; all very cheap.—Box 4082, c/o The Wireless World. [6158

EXPERIMENTER'S Surplus.—Carborundum crystal unit, 8/-; McMichael H.F. transformer, B.B.C. wavelength and reactance unit, 10/-; Gambrell C. and B., 3/6 each; Igranite tapped H.F. transformer, B.B.C., 3/6, Daventry, 4/6; Watmel L.F. choke unit, 10/-; 2 Dmic coils and base, B.B.C., 15/- pair; Dav., without bases, 12/- pair; Ormond twin condenser, .0005, 5/-; Celestion A3 loud-speaker, £5.—Dobson, Woodlea, Haywards Heath. [6160

DECKOREM Components are the finest you can include in any set you build. Write for free catalogue.—A. F. Bulgin & Co., 9-11, Cursitor St., London, E.C.4. [5886

LEWCOX Transformers, split secondary, 4 broadcast, 5/- each; 4 Daventry, 7/- each; split primary, 2 broadcast, Daventry, 5/- each; Bowyer-Lowe split primary, 3 broadcast, 5/- each; 1 aerial, ditto, 3/-; screens and bases, 3 Bowyer-Lowe, 6/- each; 6 Colvern, 5/- each; 4 Colvern selectors, dual .0005, 7/6 each.—Box 4083, c/o The Wireless World. [6159

MISCELLANEOUS.

EASY Payments.—We supply, by easy payments, components, accessories and sets, any make, 10% down, balance spread over 10 months.—Send list of requirements to London Radio Supply Co., 11, Oct Lane, London, E.C.2. [5591

THE Wireless Doctor Will Call (London and Home Counties) if your set is troublesome; no cure, no charge; Wireless Association registered repairer; sets installed, maintained and brought up to date; experiments and testing undertaken; Solodyne demonstrated.—Alexander Black, 2a, Woodville Grove, N.16. Clissold 3637 and Victoria 6215. [3841

WIRELESS Doctor Touring Midlands and South Coast.—Ernest J. Baty, B.Sc., Luton. [5464

Put it there!



Get the best out of your valves with the New AERMONIC no-loss, no-vibration holder. Anti-capacity because minimum di-electric between sockets. Anti-phonics because properly sprung. (Valves don't wobble all over the place with Model K.)

**AERMONIC ANTI-CAPACITY ANTI-PHONIC VALVE HOLDER 2/3**



AERMONIC Grid Leak Clip for horizontal or vertical mounting.

1/- each in cartons.



AERMONIC Grid Leak for mounting on wires of 4d. your set, only 4 each

If any difficulty write to either address below:  
List of AERMONIC Specialities Free on request.  
**JAMES CHRISTIE & SONS, LTD.,**  
246, West Street, SHEFFIELD.  
London Agents: A. F. BULGIN & CO., 10, Cursitor St., London, E.C.4

**RESISTON PANELS**



—in all successful Sets

American Hard Rubber Co., (Brit.) Ltd., 13a Fore St., London, E.C.2  
9798.

Miscellaneous.—Contd.

**MR. CLAUDE LYONS, M.I.R.E.**, will advise all constructors of super-sonic heterodyne receivers, without charge.—If you have trouble with your present superhet, or contemplate building this most efficient form of receiver, write him, c/o Messrs. Claude Lyons, Ltd. (G.R. Quality Parts), 76, Oldhall St., Liverpool. [0065]

**SCOTT SESSIONS**, the radio doctor (London and environs).—Any set or component supplied, installed, repaired, modernised; "Wireless World" set specialist; officially approved as radio repairer and trader by the Radio Society of Great Britain and the Wireless League; no work too big or too difficult!—Hill Top, Muswell Hill, N.10. Phone: Mounview 4928. [5671]

**BUILD Your Own Loud-speaker**, 12in. polished wood frames for cone; 3/- pair.—Cole, 24, Mons Way, Bickley, Kent. [6103]

**OTHER Systems are Superseded by Ecelex Plugs and Sockets**.—Ask your dealer, or Easticks, 118, Bunhill Row, E.C.1. [0024]

**EXPERIMENTERS Must Have Reliance in their Accumulators**; test with a Utility syringe hydrometer for certainty; post free, 4/6, with full instructions; satisfaction guaranteed.—The Utility Syringe Hydrometer Co., Dept. D, 16, Howard Rd., Ilford, Essex. [0059]

**EPOCH ELECTRICAL SOCIETY**.—Our doctors are at your service, bring your ailing sets or your problems; this department is carried on for our customers' entire benefit; advice given without charge or obligation, but should you entrust us with work you will be amazed at our reasonable charges.—35, Gracechurch St., E.C.3. [6164]

**WIRELESS Doctor Will Call and Solve Your Wireless Troubles**; guaranteed cures; moderate charge.—Morley, 18, Grangemill Rd., Catford. [6128]

**THE Little Imp**.—Combination gas blow pipe, indispensable to wireless workers. Jewellers, opticians, amateurs, etc., simplifies small soldering, fine intense flame, does away with soldering iron and blow pipe, marvellous invention; 2/6 post free; approval willingly.—Hammond, Market Hall, Burnley. [6127]

**SCOTLAND'S First Radio Doctor** (Glasgow and District) will call if your set is troublesome; no cure, no charge; sets installed, maintained and modernised; Everyman Four specialist; fees moderate; a postcard brings me.—"Radio," 74½, New City Rd., Glasgow. [6126]

**GLASGOW'S Original Wireless Doctor Repairs Receivers and Components**; City's most reliable battery charging service, under expert supervision; cut this out for a free trial charge; batteries collected on receipt of P.C.; advice free.—Dunbar, 902, Springfield Rd., Parkhead. [6125]

PATENT AGENTS.

**PATENTS and Trade Marks, British and foreign**—Gee and Co. (H. T. P. Gee, Member R.S.G.B. and A.M.I.R.E.), 51-52, Chancery Lane, London, W.C.2. Phone: Holborn 1525. [0001]

REPAIRS.

**ALL L.F. Transformers, 4/-**; headphones, 4/-; loud-speakers, 4/-, post free; maximum efficiency attained; every repair is accompanied with a 3 months' guarantee; don't discard if burnt out; trade invited.—Transform, 115, Links Rd., Tooting, London, S.W.17. [0011]

**HEADPHONES and Loud-speakers Rewound, remagnetised and overhauled, 4/-**; transformers rewound from 5/-; sent to our agents or direct to us.—Repairs fully guaranteed by M. I. Vaughan, 88, Vyse St., Birmingham. Tel.: Mivsey, Birmingham. [5831]

**EVERY Description of Repairs to Telephones, loud-speakers, eliminators, transformers, etc.**; all repairs guaranteed to be executed by expert staff approved by Radio Association; prompt delivery with moderate charges; we have been established for 18 years and can give our customers the benefit of our unique experience.—Callers: Davies, Coleman and Co., Ltd., First Floor, 63, Farringdon St., E.C.4. Post orders: Davies, Coleman and Co., Ltd., Dacol Works, Glenthams Rd., Barnes, S.W. Phone: Riverside 4019. [6077]

**LOUD-SPEAKERS, Headphones**.—Guaranteed repairs. Any make or type, rewound, remagnetised and adjusted by experts; best materials only used; post free 4/-.—Howell, 42, Fotheringham Rd., Enfield, Middlesex. [6117]

**LOUD-SPEAKERS, headphones rewound to any resistance and remagnetised, 3/-**; transformers rewound, 4/-; sets constructed and overhauled, work guaranteed.—Leeds Wireless Repair Service, 5, Boston Place, Green Rd., Leeds. [6114]

**VALVE Repairs, any make, half new price**; returned 3 days, guaranteed absolutely equal new; agents wanted.—Valve Repair Co., 10, Dyers Buildings, Holborn. [6133]

**HEADPHONES and Loud-speakers rewound, remagnetised and overhauled, 3/-** post free; guaranteed; Brown's A type, 4/-; trade invited; 24 hour service; established 1923.—Bradford & Co., 16, Prospect St., Plymouth. [6154]



**ANODE SUPPLY FILAMENT SUPPLY ROTARY-TRANSFORMERS**

Input ..... 12 to 250 v. D.C.  
Output ..... to 1,000 v. 100 w.

**MOTOR-GENERATORS**

Input ..... A.C. or D.C.  
Output ..... to 170 w. H.T., or 80 w. H.T. & 80 w. L.T.

Efficient. Silent. Ripple-free.

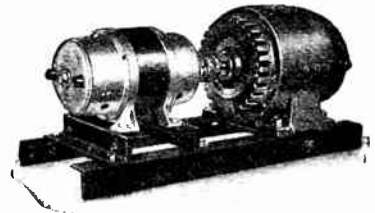

**M-L MAGNETO SYND. Ltd.,**  
Radio Dept., COVENTRY.  
(Phone: 5001.)



**GAMBRELL**

Centre-Tapped Coils not only give the best results, but are unlimited in use, as they can be employed in any circuit, centre-tapped, or otherwise. Standard fitting to all coil sockets, and occupy minimum baseboard space.

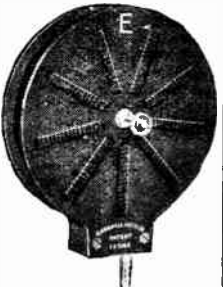

SIZE.	PRICE.	of Turns.
#2	4/10	18
A	4/10	25
A	5/-	30
B1	5/3	40
B	5/8	50
C	5/9	75
D	6/3	100
E1	6/9	150
E	7/9	200
F	8/6	300
G	10/-	500

There is a Gambrell Coil Holder specially designed for use with above coils, and which does away with all tieable leads. Price 2/6 each.

Prices Quoted are Standard Coils—Centre-Tapped Val. extra

**GAMBRELL BROS. Ltd.,**  
78, VICTORIA ST., LONDON, S.W.1.

**TANNOY COMPONENTS for MAINS UNITS**

Transformers, Chokes, High-Voltage Condensers, Potential Dividers, Rectifiers, etc.

Write or phone for particulars.

**TULSEMERE MANUFACTURING CO.,**  
Tulsemere Road, West Norwood, S.E.27.

Phone: Streatham 6731

Mention of "The Wireless World," when writing to advertisers, will ensure prompt attention.

**Repairs.—Contd.**

**A**LL Agree that We are the Leading Doctors of Valves. No matter whether your valves are dead or alive. Send them to us and we will let you know the cost to renew their original energy, or send for Price List to The North London Valve Co., Ltd., 223, Cazenove Road, N.16. B.E., 3/-; D.E., 25, 5/9; D.E., 06, 6/-.

**WANTED.**

**H.T.** Eliminator, 200 v., 50 cycles, A.C., perfect condition essential; specify make or components, also output.—Morgan, 24, Denton Drive, Wallasey.

**SUPERHET** Kit, block unit preferred, must be cheap and guaranteed.—Hore, 95, Burges Rd., Thorpe Bay, Essex.

**EXCHANGE** Ensign Reflex, 1/4 plate, Aldis 1/4.5, C and complete outfit, value £20, for Bel-Canto Concert loud-speaker, new model.—7, Mead Plat, Willenden, N.W.10.

**PERFECT** Aerial, reasonable price; also blue print of Kendall's all-enclosed superhet, "Modern Wireless," July, 1925; cost price paid for both.—Cavendish, 48, Upper Berkeley St., London, W.1.

**EXCHANGE.**

**EXCHANGE** Everyman Four Coils, sale 21/-, for 6 pin coils, S.P., H.F., bases and screen long and low.—W. Curtis Mount Pleasant, Plymouth.

**WIRELESS** and CAMERA EXCHANGE.—Send us your loud-speaker, wireless parts, or camera and exchange for something more useful to you. We stock all leading lines in radio and all best valves, so send your parcel and state what you want and we will do our best for you; don't send rubbish.—Wireless Exchange, 14, Peter St., St. Helena, Lancs.

**WANTED**, Ampion AR19 or good cone speaker; exchange coils, potentiometers, valves, condenser, switches, also small collection mint Irish stamps.—MacGregor, 42, Chichester St., Belfast.

**EXCHANGE**—Truth in advertising; deal with the original exchange; components or receivers taken in part payment; avail yourself of new Marconi offer, and let me supply your new receiver; state new requirements.—Browne, The Original Exchange, 65, St. Clair Rd., W.14.

**AGENCIES.**

**AGENTS** Wanted for Cheapest and Safest Non-pumping Petrol-gas Lamps; good living made converting all paraffin lamps into 150 c.p. Titus light.—Particulars, Titus, Kingston, Brighton.

**SITUATIONS VACANT.**

**YOUTHS** Required for Assembling and Wiring.—Apply Eastern Wireless Co., Ltd., Collingwood Rd., Sutton.

**FIRM** of Radio Manufacturers Making Sets, battery eliminators, loud-speakers and components, require the services of a chief draughtsman, able to turn out neat final designs of apparatus from technical laboratory data; applicant must have good knowledge of production and be a qualified designer and draughtsman.—Write, stating nationality, age, experience, and salary required, together with photograph, to Box 4004, c/o The Wireless World.

**TRAVELLERS** Having First-class Connection amongst leading wireless trade offered liberal commission to introduce good selling line.—Apply by letter, stating ground covered, etc., Box 4064, c/o The Wireless World.

**RADIO** Engineer, thoroughly conversant latest type high grade models, ability to handle technical correspondence essential.—Write, stating age, experience, salary required, etc., to Box 4058, c/o The Wireless World.

**WIRELESS** Technical Assistant, of good appearance, skilled in installing, fault-finding, and repair work on high class apparatus.—Write, stating age, experience, salary required, etc., to Box 4,059, c/o The Wireless World.

**500** Certificated Wireless Officers Required (aged between 16 and 25) by one company alone within a year; write at once for our booklet showing how after a short inexpensive training you can qualify for a well paid congenial post; join at any time; extended payments arranged.—Positions assured to all successful students of the London Telegraph Training College, Ltd., Earl's Court, S.W.5.

**ASSISTANTS** for High Class Wireless Shops Wanted, must be of gentlemanly appearance and address, and have comprehensive, up-to-date knowledge of all wireless goods; also junior assistants.—Epoch, 53, Gracechurch St., E.C.3.

**SITUATIONS WANTED.**

**RADIO** Engineer, 10 1/2 years' experience leading wireless companies, seeks appointment anywhere U.K., certificated, technical, practical, design, construction, or sales; highest references; interview requested.—A. E. Hay, c/o Mails, Bank of New Zealand, 1, Queen Victoria St., E.C.4.

**RADIO** Engineer and Draughtsman Seeks Situation, 5 years' experimental experience installation, construction, repairs.—Box 4008, c/o The Wireless World.

**Let your eyes guide your choice!**

**I**T is quite safe to allow your eyes to guide you to choose COLUMBIA Radio Batteries.

Because the materials employed are as good, and the internal construction is as thorough, as their external appearance is attractive.

It is when exceptionally heavy drains are made on Columbia Batteries that their exceptional efficiency is demonstrated!

For instance the Columbia 'Layerhil' is the only Battery which will maintain its voltage for any time in the face of a couple of L55s!

Use **Columbia** —They last longer.

**J. R. MORRIS**  
15, Kingsway, London, W.C.  
Scotland—J. T. CARTWRIGHT,  
3, Cadogan Street, Glasgow.

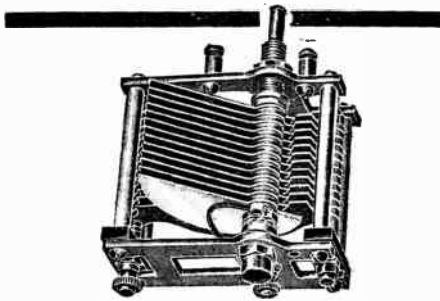

**BCM WAVEMASTER**  
**LOW LOSS LOGARITHMIC CONDENSER**  
Complete with 4in. dial, 0-180.

•0003 - - 9/-  
•0005 - - 9/6

- (a) One or three-hole fixing.
- (b) Heavy aluminium end-plates and vanes.
- (c) Pigtail connection, ensuring permanent contact and no loss.
- (d) Ball-race.

If your dealer cannot supply you, write to:  
**WEBB CONDENSER CO.,**  
42, Hatton Garden, E.C.1.

**Situations Wanted.—Contd.**

**WELL-KNOWN** Wireless Engineer, 7 years' commercial wireless aircraft experience, speaking perfect French and good German, knowing all European intimately; thorough knowledge all branches radio work and thoroughly up to date, possessing sound knowledge business and sales side, desires appointment; home or abroad.—Write Box 4069, c/o The Wireless World.

**WIRELESS** Mechanic, ex R.A.F., seeks situation, 6 years' experience.—Write Goard, Holloway Hill, Godalming Surrey.

**BOOKS, INSTRUCTION, ETC.**

**"THE ABC of the Superhet,"** by Mr. Claude Lyons, M.I.R.E., 88 pages, 17 explanatory diagrams or photographs, and including complete schematic and point-to-point wiring plan of the famous "Evening Chronicle" 8-valve superheterodyne receiver. The only book of its kind at present in existence; recently described by the Editor of "The Wireless World" as "A fascinating booklet. . . . A lucid description of the operation of the superhet receiver. . . . With constructional details all useful hints and for the home constructor."—Only 8d. complete, post free, from Claude Lyons, Ltd. (G.R. Quality Parts), 76, Oldhall St., Liverpool.

**3-VALVE** Receiver for 30/-.—Write now for booklet on how to build the L.R.C.3 valve set for 30/-, from guaranteed parts only; the ideal loud-speaker set—1/-, post free from H. Howarth, Lustroulox Depot, 288, Deansgate, Manchester.

**WET** (sao Leclanche) H.T. Batteries, latest booklet on how to make and maintain these economical and simple batteries; give perfectly silent and smooth reception with unlimited power, suitable for small or multi-valve sets of all sizes; information also of L.T. batteries free; enclose postage, 1/-.—Taylor, 57, Studley Rd., Stockwell, London.

**"GETTING** the Most out of Radio," a 76-page intensely educational catalogue, 200 illustrations, guide to receiver maintenance, all about superhets., all about H.T. eliminators, components for reception and transmission, including really new and worth while for everybody, something the advanced research worker; includes a guide to literature and the best circuits; no enthusiast should be without it, and it will save you money in the end; owing to heavy cost of printing and preparation (blocks alone cost over £150) we cannot give these away; price of this unique art catalogue—76 pages crammed full of interest—is, post free; we will refund the 1s. as a rebate on your first order value 5s. or more.—Claude Lyons, Ltd., 76, Oldhall St., Liverpool, Lancs.

**THE Best Way to Make Use of Mains for Radio Purposes.**—Write for comprehensive constructional booklet explaining battery eliminators from alternating current; post free 8d.—A. W. Knight and Co., 180, Tower Bridge Rd., S.E.1.

**PUBLIC NOTICES.**

**MESSRS. CLAUDE LYONS, Ltd.,** 76, Oldhall St., Liverpool, Lancashire, desire to apologise for delay in mailing their recently extensively advertised "60-page Educational Catalogue"; the publication of this has been purposely delayed for incorporation of several new and intensely interesting lines, chiefly H.T. eliminator transformers, double chokes, condenser blocks for D.C. and A.C. work, a new clarostat; also new combined H.T. eliminators and power amplifiers for working into moving coil and other heavy duty speakers, both completely assembled and also in knock-down kit form, complete to the last nut and bolt; also a new and unique method of L.F. amplification which is considered by independent laboratory test "superior to high-grade transformer, resistance capacity or choke coupling"; those who have already applied will receive by the end of October our new catalogue, which will now extend to 75 pages, and which will be well worth waiting for; this will be sent free to all clients at present on our books; transmitters' requirements have been given special attention, also short-wave enthusiasts; the catalogue will be entitled "Getting the Most out of Radio," as we hope it will for the very many thousands who will receive it; we cannot undertake to send this free to further applicants; in future price will be 1s. post free; the price will be refunded on any first purchase to list price of 5s. or more; please see also "Books, Instructions, etc." in other columns.—Note the address "CLAUDE LYONS," LTD., 76, OLDHALL ST., LIVERPOOL.

**MESSRS. CLAUDE LYONS, Ltd.,** cordially invite all amateurs and traders to visit their quite remarkable show of laboratory instruments, super-sonic and other receivers, including the world-famous "Universal Four," the new "G.R.-Lyons" 2-valve short-wave (10-2,000 metres), new "G.R.-Lyons" (British-built) "Laboratory Reproducer" for radio or gramophone amplification, components, "gadgets," speakers, H.T. eliminators, H.T. eliminator equipment, etc.; please remember these are on show at the Manchester Wireless Exhibition, City Hall, Deansgate, Manchester, October 24th to November 5th, 1927, inclusive, and at Stand No. 13; you will be unlucky if you miss Stand No. 13.—CLAUDE LYONS, LTD., 76, OLDHALL ST., LIVERPOOL.

As near perfection as possible

Coefficient of coupling for first stage is .982. For a perfect transformer this should be 1. This means a loss of only .018 or .18 per cent.

**POWQUIP**

**TRANSFORMERS**

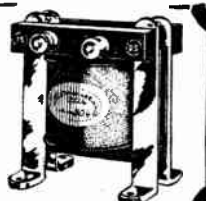

The Power Equipment Co. Ltd.  
Kingsbury Works, The Hyde,  
BENDON, N.W.9.

**RELIABILITY S.L.F. CONDENSER**  
with ebonite ends and 4" Trolite Dial.

•0005 5/8. •0003 5/8.  
Vernier Dial 1/8 extra.  
Post Free.

Further Attractive Items in  
Miscellaneous Column

**J. H. TAYLOR & CO**  
2 RADIO HOUSE -  
MACAULAY ST. HUDDERSFIELD.

Send for FREE  
Order now.  
Trade Enquiries  
Solicited.



**ORMISTON'S**  
No. 27/42 S.W.G.

**LITZEN WIRE**

is the best for Tuning Coils, Variometers, and H.F. Transformers.

Each individual strand is silk covered with an overall covering of silk.

THE "WIRELESS WORLD" USES IT.

PRICES:

20 yds. ....	5/6	50 yds. ....	12/-
25 yds. ....	6/6	60 yds. ....	14/6

150 yds. 9.40 Litzen Wire at 15/-.

**P. ORMISTON & SONS, LTD.,**  
Electric Wire Manufacturers,  
9, CLERKENWELL RD., LONDON, E.C.1  
Trade Terms on application.



**SIFAM**

**RADIO METERS**  
permit

**"SCIENTIFIC TUNING"**

Voltmeters - Moving Iron from 7/6  
- Moving Coil from 25/-  
Milliammeters - Moving Iron 10/-  
- Moving Coil from 25/-

**REPAIRS**

to HEADPHONES, LOUSPEAKERS, TRANSFORMERS, COILS.

First-class workmanship only. This is just the vital difference. We are specialists with almost 30 years' experience in every form of intricate and accurate coil winding, and we guarantee that work entrusted to us will be returned to you as good as new, if not better. This is no idle claim, but the unsolicited opinion of scores of satisfied clients.

**THE VARLEY MAGNET COMPANY**  
(Proprietors Oliver Pell Control, Ltd.),  
BLOOMFIELD ROAD, WOOLWICH, S.E.18.  
Telephone: Woolwich 4494.



**Your First Steps in Wireless**  
By **HUGH S. POCOCK**  
Editor of "The Wireless World"

A most helpful little book for those who are beginning to study wireless. It explains technical difficulties by simple analogies.

Price 9d By Post 11d

From **LIFFE & SONS LIMITED**  
Dorset House, Tudor Street, London, E.C.4  
and leading booksellers. W.W. 14

**EQUIP** your set with a Sifam Voltmeter and Milliammeter and make your Reception as accurate as Station transmission. These unconditionally guaranteed meters enable you to avoid sudden breakdowns and the consequent expense of over-discharged battery repairs; to trace distortion, and attain "perfectly balanced" reception. Sifam Meters are

**USED AND RECOMMENDED BY THE WIRELESS PRESS**

on their own sets. Come into line with modern developments. Fit Sifam Meters and make your set a precision receiving instrument.

**LORIOSTAT**  
as used in the  
"Wireless World Regional Receiver."

A multiple unit superseding the fixed Resistor. can be used in 4 way 7/3 any circuit to control any number 5 = 9/- of valves. For downright efficiency 6 = 10/6 use a LORIOSTAT in your set.

8. 15 or 30 ohms.

**A. W. STAPLETON,**  
19a, Lorrimer Buildings, Lorrimer St., Waltham S.E.17



TUNE IN WITH EASE.  
NO PANEL DRILLING  
NO BACKLASH

**MICROMETER CONDENSER ADAPTER**

Price 1/2 Post Free.  
**JOHNSON & Co.,**  
123, SECT. 1, ROYAL  
REDDITS, WORCS.

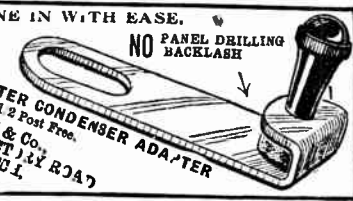

**9/6**

**NEW MOD. L**  
Pocket Voltmeter  
High resistance  
4,000 Ohms.  
Double reading  
Heavy nickel-plated case.

Ask your dealer to show you complete range.

**SIFAM ELECTRICAL INSTRUMENT CO. Ltd.**  
Dept. W.  
10a, Page Street, Westminster, London, S.W.1.

**EBONITE BUSHES**

FOR MOUNTING ON METAL OR WOOD.

PERFECT INSULATION  
Two required for each hole.

NUMBER	0	1	2	3	4	5	6
Hole in Bush	6BA	4BA	2BA	1"	5/16"	1"	7/16"
Price each	1d.	1d.	1d.	1d.	2d.	2d.	2d.

(Complete List of sizes free on application.)  
**DAREX RADIO CO.,**  
Waldram Rd., Forest Hill, London, S.E.23.  
TRADE SUPPLIED



**re Better Batteries**

Are you satisfied with your present H.T. Batteries? Would you like an interesting and instructive Booklet all about the better battery, the ETON H.T. Primary Battery? It's free—so send 1½d. stamp to cover postage, to the address below

**ETON GLASS BATTERY CO.,**  
46, St. Mary's Road, Leyton, E.10.

**Remember!**

**TEST YOUR SET TO-NIGHT**  
WITH A **SIFAM** RADIO METER  
and it won't let you down to-morrow.

M.B.29.

**CONDENSERS of QUALITY!**

No mass production methods are employed in the manufacture of Camden Condensers. Every Condenser is stamped with a Serial No., and accompanied with a guarantee of 6 months' real service

Send for list and prices to  
**Camden Electrical Co., Stanley Chambers, Runcorn.**

**The H.T.C. TWIN RECEIVER**

A complete up-to-date set, including loud speaker and all accessories, as shown at Olympia.

Seven days' trial and initial payment refunded if not entirely satisfactory.

**H.T.C. ELECTRICAL CO. LTD.,**  
2, Boundaries Rd. Balham, S.W.12.

Set and accessories sent carriage paid, on 7 days free trial, against signed agreement and a deposit of

**5/-**

Cash Price £6 4 0  
Royalty Paid.  
3 valve set, Cash Price £8 8 0  
Deferred Terms £5 15 0



**"SEVA" ELECTRIC SOLDERING IRONS.**

Special Radio and Telephone Model ..... 30/-  
"Hermetically sealed heating elements every part replaceable, thousands in daily use." Satisfaction guaranteed.

**G. H. HADLEY, Norwich Union Chambers, Birmingham**



Mention of "The Wireless World," when writing to advertisers, will ensure prompt attention.



**Insist on**  
**THE PERFECT EBONITE**  
 Made in Matt, Semi-Polished, Mahogany and Hand-Polished.  
**H. B. POTTER & CO., LTD.,** Station Buildings, ROCHDALE. Phone: 1435.



See our Exhibit on **STAND No. 73**  
 "Manchester Evening Chronicle" Wireless Exhibition

**FROM YOUR DEALER**

The **Home Constructor's Wireless Guide**

by **W. JAMES**  
 THIS book forms a most convenient little encyclopaedia of wireless technology: the kind of volume to refer to when in difficulties. It solves them for you.  
 A few of the main features:  
 Outdoor, Indoor and Frame Aerials; Earths, Variometers for Broadcast Wavelengths; Basket Coils, Plug-in Coils, etc.; Coupled Circuits; Common Faults in Tuners; Reaction and Self-Oscillation; Special Chapter on Sensitive Single-Valve Receivers; Double Magnification; Points on Dry Cells and Accumulators, etc., etc.

PRICE **3/6 NETT**  
 By post, 3/10.

Obtainable from Booksellers, or direct from the Publishers of "The Wireless World,"

**ILIFFE & SONS LTD.,**  
 Dorset House, Tudor Street, London, E.C.4. w.w.10

**10/- down**

secures immediate delivery of complete or partial Kit of Parts for the

**COSSOR MELODY MAKER**

Balance by easy monthly payments.

Here are a few items:

- Coils (ready wound) - 7/6
- Cabinet - - - - 30/-
- Baseboard - - - - 2/-
- Red Triangle Panel (drilled) 9/6
- Terminal Strip, do. 2/3

Delivery from stock in strict rotation.

We also supply Sets, Loud Speakers, H.T. Accumulators and Mains Eliminators.

Write to Desk W,

**New Times Sales Co.,**  
 56, Ludgate Hill, E.C.4.

P.8.0792.

**DIX-ONEMETERS**

are the best Bargain ever offered to Radio users. £10 worth of precision. Multi-range Mirror scale, Jewelled knife-edge Instrument for **55/-**

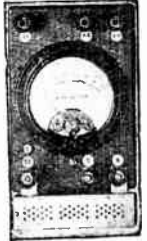

Have you a copy of the "CATALOGUE THAT SAVES YOU POUNDS."

Dynamos, 50/-; Alternators, 70/-; Cabinet Violina Loud Speakers, 25/-; Weston Relays, 25/-; Gyroscopes, 15/-; Micro-Ammeters to 1/2 micro-amp, 60/-; Fire-side Auto. Fila. Switches, 10/- & 15/-; X-Ray Tubes and Coils cheap. Frame Aerials 10/-; H.T. Eliminators, 30/-; 3 1/2" Paxolin Tubes, 6d.; G.P.O. Galvos, 7/6; Marconi Valve-Crystal Sets, 27/6; 2-Valve, 45/-; Sterling 3-Valve, £5 10s. 0d.; 5-Valve R.A.F., £5. 6-Valve Marconi, £14.

**ELECTRADIX RADIOS for Everything**

Send your enquiries and 4d. for Illustrated Catalogue, or call at **218, Upper Thames Street, E.C.4.**

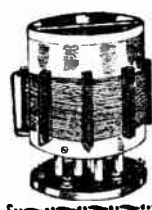

**"WIRELESSWORLD" COILS**

"L & H" Everyman Four. Exactly to specification. Bully Guaranteed. Price per pair including Bases **30/-**  
 "All-Wave Four" H.F. Transformers Short or Long Wave ..... 16/- each  
 6 Pin Base ..... 23 "  
 "Regional" Coils including Bases Short Wave ..... 35/- per pair  
 Long Wave ..... 42/-  
**LAWRENCE & HULL, 28, Parkhouse Street, S.E.5. Phone: Rodney 3810.**

**NO MORE CORRODED TERMINALS.**  
 The priceless boon to all electrical battery users.

**ANTYSULPH**  
 Guaranteed to kill existing and prevent future corrosion.  
 PRICE **1/3 POST FREE.**

Manufactured only by **BRITISH ELECTRIC G.I. Ltd.,** Strand House, Willesden Lane, Park Royal, N.W.10.  
 Trade enquiries welcomed

**LONDON LISTENERS!**

**Improved reception ensured** if you have your accumulators correctly charged by our skilled maintenance service. We collect weekly, fortnightly or monthly within 12 miles of Charing Cross, and exchange your accumulator (H.T. or L.T.) for one fully charged. If yours are not serviceable, you can hire ours. Both trouble-free, money-saving services. Terms—weekly, fortnightly, monthly or quarterly—no deposit required. And you can depend on our service for a solution in every wireless trouble.

Our service—the speciality of experts. Write for full details and terms **RADIO SERVICE (London) Ltd.,** 105, Torrington Avenue, Camden Rd., N.W.5. Phone: North 0823 (3 lines).



**ACCUMULATORS "ELITE"**

— The Elite of all —

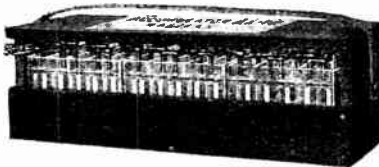

**H.T. ACCUMULATORS, 60 volts type, 02, Semi-oil Submerged. Complete, as illustrated. Price 22/6**

The World's Best High Tension Accumulator and of British Manufacture. The Unique Semi-Oil Submerged feature of the Elite absolutely prevents surface leakage losses. The battery lasts a life-time. Write for lists.

**ACCUMULATORS ELITE, Bedford Street, HALIFAX.**  
 Telephone: 4204. Telegrams: Elite Halifax.

London Distributor:—**CECIL POHLMAN, 77, Great Portland Street, LONDON, W.1**  
 Northern Distributor:—**G. A. WILSON, Millfield House, Keswick, Cumb. Tel. 99 Keswick.**

INDEX TO ADVERTISEMENTS.

Accumulators Elite .....	39	Falk. Stadelmann & Co., Ltd. ....	Cover ii.	Ormiston, P., & Sons, Ltd. ....	38
A.F.A. Accumulators, Ltd. ....	23	Ferranti, Ltd. ....	7	P.R.G., Ltd. ....	32
American Hard Rubber Co., Ltd. ....	36	Finston Manf. Co., Ltd. ....	40	Philips Lamps, Ltd. ....	18
Artic Fuse & Electrical Mfg. Co., Ltd. ....	28	Formo Co. ....	40	Potter, H. B., & Co., Ltd. ....	39
Batteries, Ltd. ....	31	Gambrell Bros., Ltd. ....	36	Power Equipment Co. ....	38
Bellford Elec. & Radio Co., Ltd. ....	26	Garnett, Whiteley & Co., Ltd. ....	8	Pye, W. G., & Co. ....	26
Belling & Lee, Ltd. ....	25	Graham Amphon, Ltd. ....	Cover ii.	Redfern's Rubber Works, Ltd. ....	22
Bowyer-Lowe Co., Ltd. ....	21	General Electric Co., Ltd. ....	14 & 27	Radio Service (London), Ltd. ....	39
Brandes, Ltd. ....	39	Graves, J. G., Ltd. ....	29	Regent Radio Supply Co. ....	33
British Electric G.I., Ltd. ....	17 & 20	Hadley, G. H. ....	38	R.I. & Varley, Ltd. ....	5
British Thomson-Houston Co., Ltd. ....	2	Hawkins & Soffe ....	34	Roobe Bros., Ltd. ....	35
Brown, S. G., Ltd. ....	13	Hildick & Hildick ....	40	Sankey, J., & Sons ....	Cover iii.
Bullphone ....	23	H.T.C. Electrical Co., Ltd. ....	38	Scott, G. I., & Co., Ltd. ....	34
Burndept Wireless, Ltd. ....	22	Hunt, A. H., Ltd. ....	27	Sifam Electrical Inst. Co. ....	28
Burne-Jones & Co. ....	19	Igranic Electric Co., Ltd. ....	12	Siumonds Bros. ....	38
Burton, C. F. & H. ....	38	Johnson & Co. ....	38	Stapleton, A. W. ....	38
Bush House ....	38	Lamplugh, S. A., Ltd. ....	26	Sutrown Co. ....	34
Camden Electrical Co. ....	20	Langham Electrical Supplies Co. ....	32	Taylor, J. H., & Co. ....	38
Carborundum Co., Ltd. ....	36	Lawrence & Hall ....	39	Telegraph Condenser Co., Ltd. ....	25
Christie, Jas., & Sons, Ltd. ....	28	Lectro Linx, Ltd. ....	Cover iii.	Trelleborgs ....	40
Cole, E. K., Ltd. ....	24	Lyons, Claude, Ltd. ....	37	Tulsemere Manf. Co. ....	36
Collinson Precision Screw Co., Ltd. ....	28	Maddison, H. ....	29	Tungstone Accumulator Co., Ltd. ....	6
Collie, J. H., & Co. ....	16	Marconiphone Co., Ltd., The ...	19 & Cover iv.	Vanderell, C. A., & Co., Ltd. ....	38
Cossor, A. G., Ltd. ....	35	W. Michael, L., Ltd. ....	10	Varley Magnet Co. ....	38
Curzon Scientific Instrument Co. ....	38	Metro-Vick Supplies, Ltd. ....	9 & 15	Walker Bros. (Guildford), Ltd. ....	24
D.A.R., Ltd. ....	38	Mic Wireless Co. ....	34	Watmel Wireless Co., Ltd. ....	40
Darex Radio Co. ....	38 & 39	M-L Magneto Synd., Ltd. ....	36	Webb Condenser Co. ....	37
Dubilier Condenser Co. (1925), Ltd. ....	11	Morris, J. R. ....	37	Wet H.T. Battery Co. ....	22
Eastick, J. J., & Sons ....	24	Mullard Wireless Service Co., Ltd. ....	1	Weston Electrical Inst. Co. ....	14
Edison Swan Electric Co., Ltd. ....	3	New Times Sales Co. ....	39	Whiteley, Boneham & Co., Ltd. ....	Cover iii.
Electradix Radios ....	39			Williams and Moffat, Ltd. ....	28
Eton Glass Battery Co. ....	38			Youngs (Glasgow), Ltd. ....	39

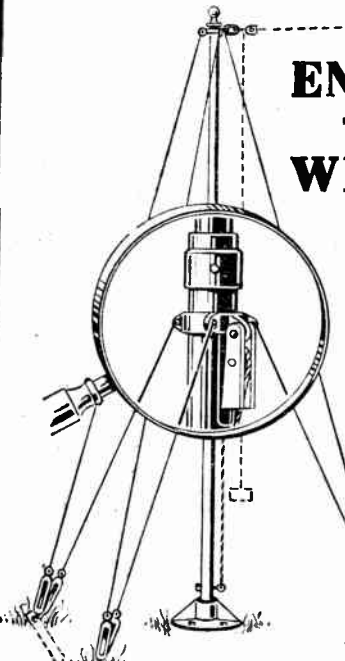

**A GOOD ENGINEER'S TELESCOPIC WIRELESS MAST**

(Patent Nos. 233035 & 244883.)  
 Note.— Enlarged view of catch to support top section when extended.

**Tubular, 17 ft. when telescoped, complete with guy wires, straining screws, base plate and ground pegs. The whole galvanised except ground pegs.**

**LASTS A LIFETIME**

34 Feet  
**£3 - 15 - 0**

50 Feet  
**£7 - 5 - 0**

**HILDICK & HILDICK,**  
**PLECK ROAD, WALSALL.**

**EVERYMAN FOUR COILS.**

There is no need to wait days for the correct coils for this popular and highly efficient receiver.

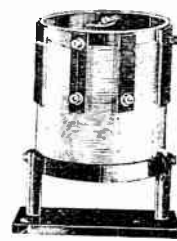

“FINSTON” Coils are wound exactly to designers specification, with 27/42 wire and are supplied complete with Ebonite Supports and Base.

**AERIAL COILS 14". TRANSFORMER 15".**  
**Complete Set 28".**

If your Dealer is sold out tell him we guarantee to supply by return of post.  
 We supply Coils and Transformers for all "Wireless World" sets.  
 Full details will be sent free on request.

Obtainable from all Dealers or  
**FINSTON MFG. CO., LTD.,** 65, HORSEFERRY ROAD, LONDON, S.W.1.





**LOG (or Mid-line) CONDENSER**

The most scientific Condenser ever produced,  
 Perfect in every detail of construction and performance.  
 For mounting either Panel or Baseboard.

**THE FORMO COMPANY,**  
 Crown Works, Cricklewood Lane, N.W.2.  
 Telephone: Hampstead 1787.

'0003, '00025, '0005.  
 Price 10/6 each.

Full Catalogue Free on Request.

# Trelleborgs

**GUARANTEED GENUINE EBONITE**

THE FINEST QUALITY PANEL OBTAINABLE.

**ONLY 1/2d. Retail Price**  
 per square inch.

**STANDARD GLOSSY FINISH 3/16" THICKNESS.**

Other prices:—<sup>1/8"</sup> Highly Polished, 3d. per sq. in.; <sup>1/4"</sup> Standard Glossy, 3d. per sq. in.; <sup>1/2"</sup> Highly Polished, 1d. per sq. in.

*The right place for the*

## Watmel

**H.F. CHOKE**



**PRICE 5/-**

The special method of cross winding the double silk covered wire in four accurately balanced sections reveals the superiority of the Watmel and the extreme scientific care taken in its manufacture. Low self-capacity—constant impedance and small external field are features which no other H.F. Choke can as truly claim as the Watmel. Windings protected by transparent cover. Mounted in bakelite base with nickel-plated terminals. The right place for the Watmel H.F. Choke is in every circuit where radio frequency chokes are specified. Write for particulars stating requirements for coil drive Loud Speakers.

**WATMEL WIRELESS CO. LTD.**  
 Imperial Works, High Street, Edgware, Middlesex.

**HIGH CLASS PATENT  
CONE LOUD SPEAKERS**  
at Popular Prices



The all-Bake lite Cabinet Model Cone Loud Speaker  
**£4 . 4 . 0**

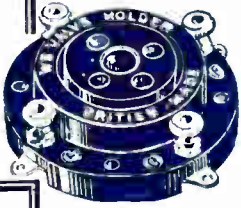

The W. B. anti-phonic Low Loss Valve Holder  
**1/9 each**

These Loud Speakers are fitted with a patent cone giving perfect reproduction and efficiency.

Oak Cabinet Model **£3 . 0 . 0**

The Junior Model (Suitable for portable sets)  
**£2 . 10 . 0**

Why pay more? when the W.B. Valve Holder, complete with terminals, is used in all modern sets, including the "Cossor Melody Three" and the "Wireless World Exhibition Five."

Stocked by all high-class Radio Dealers  
If unable to obtain quick supplies please write direct.

Manufactured and guaranteed by:  
**WHITELEY, BONEHAM & CO., LTD.,**  
NOTTINGHAM ROAD,  
MANSFIELD, NOTTS.

# CLIX

## RAINBOW TERMINALS

**A New Addition  
to the Family**

### Show you what's what

The brilliantly coloured tops enable you to recognise connections on sight. Terminals are nickel plated and take pin connectors, spade terminals, or both. A coloured ring is supplied with each terminal for affixing to the pin or other connector.

Fit your set with Rainbow Terminals—they will end identification worries and enhance its appearance. In nine distinctive brilliant colours.

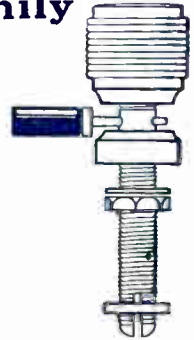

**5d. each complete**

with identity ring.

Patent applied for.

## CLIX COUNTER SHOW CASE



contains everything you need to ensure simple, efficient connection. Fit your set with CLIX fittings—they have banished contact troubles for thousands.



**CLIX Parallel Plugs**



**CLIX Pin Terminals**



**CLIX Spade Terminals**



**CLIX Wander Plugs**

nickel plated with red or black insulators.

**Price 2d. Each.**

CLIX Parallel Sockets, 1d. each.

## THE CLIX MULTIPLUG

a combination terminal designed to fit any ordinary valve holder as a two, three or four-way plug.

The mounting and wiring is extremely simple—the plugs being the patented CLIX Parallel type, longitudinally slotted and permanently resilient. The plugs are also free and interchangeable.

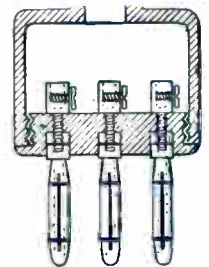

Patented.

**2/6 EACH.**

## LECTROLINX LIMITED

Electrical and Radio Engineers  
**254, VAUXHALL BRIDGE ROAD,  
WESTMINSTER :: LONDON.**

Telephone: Victoria 5120—Telegrams: Trolinx Churton, London

# "STALLOY"

(REGD. BRAND)

THE ONLY MATERIAL

for

**TRANSFORMERS**  
and  
**DIAPHRAGMS.**

**INSIST ON HAVING IT**

**JOSEPH SANKEY & SONS, LTD.**

**BILSTON.**

STAFFS.

LONDON:—168, REGENT STREET, W.1.

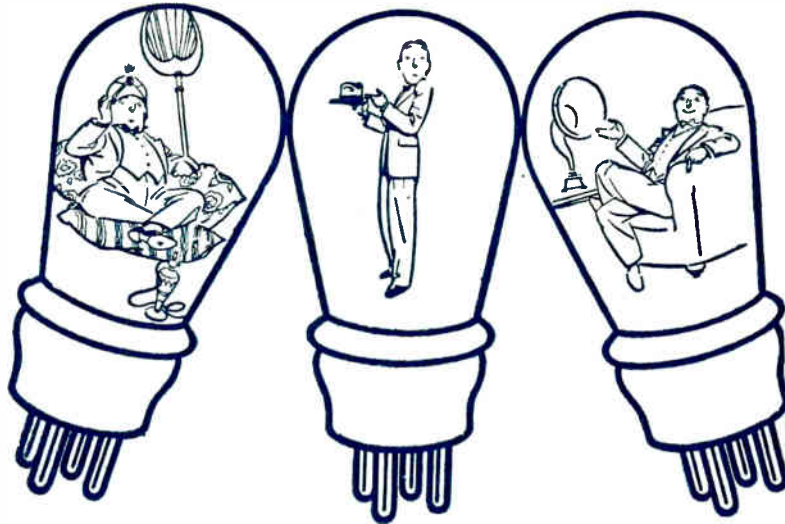

# CAPTURING THE ELUSIVE NOTHING

Were our philosophy oriental, we could sit peacefully and contemplate the glorious nothing which fills the space in the Marconi Valve. And, later, bore you stiff with talk of "high degree of vacuum."

Again, we could prose about a grid strong enough to hang your hat upon. Yet, talk of hatstands belongs rather in the furniture shops.

Let's be practical. Let's discuss the Marconi Valve upon the grounds of what it *does*. Let's say that it's better to buy a valve for the way it treats the accumulator. Let's say that it's only what comes out of the loud-speaker that matters. Let's suggest that the time a valve keeps at its job is of some value.

And, finally, let's agree that it's better to buy a valve to *do* things. Therefore, it's better to buy a Marconi Valve with a NAME.

Marconi Valves cover the widest possible range. If your accumulator is a 4-volt, for instance, here are the valves to use:—

FOR GENERAL PURPOSE—Marconi Type D.E.L.410 (price 10/6) or " D.E.H.410 ( " 10/6)

FOR THE LAST STAGE—D.E.P.410 (a power valve, price 12/6)

A full description of Marconi Valves, Marconi Sets, etc., is to be found in an amusing but informative free booklet called "Back Chat," just published. To secure your copy send off the coupon below at once.

**MARCONI VALVES**  
*-do everything that a valve should do*

The Marconiphone Co. Ltd. (and reduced)  
 210-212, Tottenham Court Road, London, W.1.  
 Please send me a copy of "Back Chat."  
 Thank you.

Name.....  
 Address.....  
 County.....  
 W.W.4.....  
 Add stamp if unsealed

Printed for the Publishers, Liffé & Sons Ltd., Dorset House, Tudor Street, London, E.C.4, by The Cornwall Press Ltd., Paris Garden, Stamford Street, London, S.E.2.

Colonial and Foreign Agents:  
 UNITED STATES—The International News Co., 131, Varick Street, New York. FRANCE—W. H. Smith & Son, 248, Rue Rivoli, Paris; Hachette et Cie, Rue Réaumur, Paris.  
 BELGIUM—W. H. Smith & Son, 78, Marche aux Herbes, Brussels. INDIA—A. H. Wheeler & Co., Bombay, Allahabad and Calcutta. SOUTH AFRICA—Central News Agency, Ltd.  
 AUSTRALIA—Gordon & Gotch, Ltd., Melbourne (Victoria), Sydney (N.S.W.), Brisbane (Queensland), Adelaide (S.A.), Perth (W.A.) and Launceston (Tasmania).  
 CANADA—The American News Co., Ltd., Toronto, Winnipeg, Vancouver, Montreal, Ottawa, St. John, Halifax, Hamilton; Gordon & Gotch, Ltd., Toronto; Imperial News Co., Toronto, Montreal, Winnipeg, Vancouver, Victoria. NEW ZEALAND—Gordon & Gotch, Ltd., Wellington, Auckland, Christchurch and Dunedin.