

# The Wireless World

4<sup>D</sup>

*The Paper for Every Wireless Amateur*

Wednesday, June 2nd, 1926.

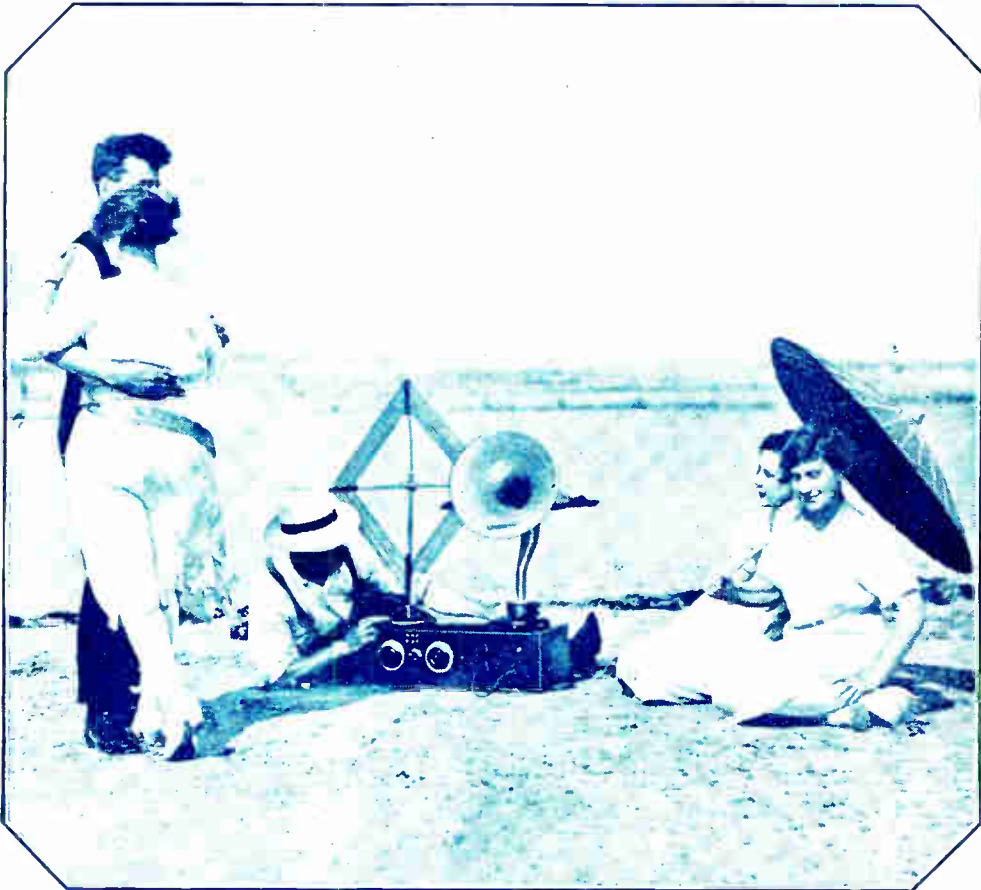

Did you notice  
the number of  
Amplions  
in use during the  
Strike?



**STANDARD DRAGON AMPLION**  
TYPE A.R.19

Price £5 : 5 : 0

Other Amplion Models from  
38/- to £13 : 13 : 0



There's a reason!

Announcement of Alfred Graham & Co. (E. A. Graham) Crofton Park, London, S.E.4

Mention of "The Wireless World," when writing to advertisers, will ensure prompt attention.

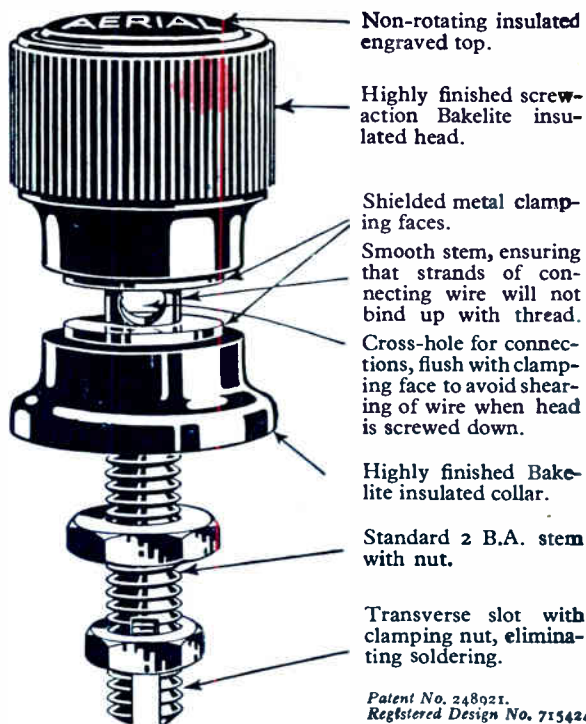

Patent No. 248921.  
Registered Design No. 715424.

*"Don't spoil the set for a haporth of Terminal"*

Belling-Lee Insulated Terminals may cost you a fraction more, but no one with a pride in his set will grudge it. Belling-Lee Terminals are finely finished work and an ornament to the set, as well as an aid to its efficiency. Every possible and desirable feature of an indicating terminal is found in the Belling-Lee, and twenty-eight different kinds of engraving are available.

Standard Model (Bakelite Insulated) (Type B), 9d. each  
Popular Model (Non-insulated) (Type M) .. 6d. each



These neatly finished dial indicators (metal, with polished raised letters) are much neater and more permanent than transfers.

Made with 8 names (one-hole fixing) .. .. 6d. each

Ask your dealer for Belling-Lee panel fittings, but if he cannot supply, send your order to us enclosing his name and address.

Illustrated Catalogue free on request.

**BELLING-LEE**  
**PANEL FITTINGS**

QUEENSWAY WORKS PONDERS END, MIDDLESEX.

Telephone: Enfield 0498

E.P.S.9

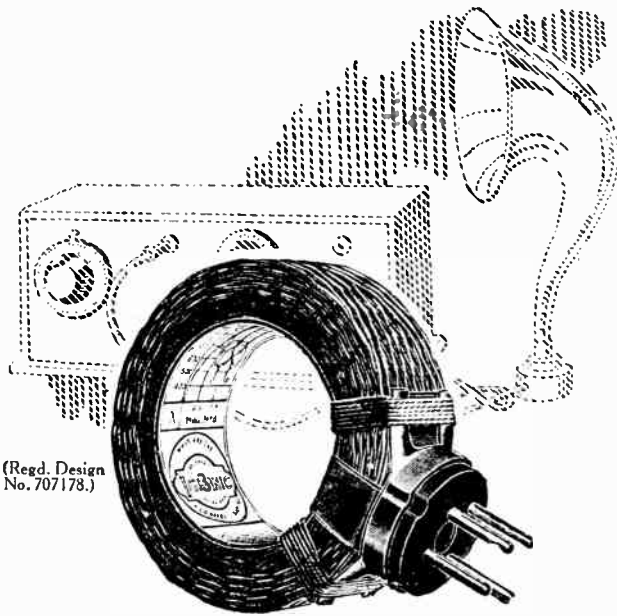

(Regd. Design No. 707178.)

The Igranic Honeycomb High-Frequency Transformer  
De Forest Patent, No. 141344 and Patent No. 240953.

## Don't blame your set

because those distant stations which came in easily during the winter months are now so difficult to find. It's a perfectly natural state of affairs—but you can help your receiver to accomplish its more difficult task by adding an H.F. amplifier. A stage of H.F. amplification will make all the difference—it will enable your set to "reach out" and get those distant stations which are now so elusive.

Use Igranic H.F. Transformers and feel sure that you are getting the best results under all conditions. They incorporate the well-known honeycomb duolateral form of winding. They possess qualities which make for high efficiency: low self-capacity, small H.F. resistance, a high inductive coupling and perfect insulation between windings. Further they are easy to tune, and are exceedingly stable in operation.

No.	Wavelengths obtainable when secondary is shunted by the capacity indicated.			Price
	0 mfd.	.00025 mfd.	.0005 mfd.	
1	288	422	538	8/-
2	530	846	1120	9/6
3	1050	1625	2090	11/-
4	1860	2500	3200	12/6

Ask your Dealer about them.  
Write for List U169.

Exclusive  
Manufacturing  
Licenses of



Patent  
Radio  
Essentials

149, Queen Victoria Street, London  
Works: BEDFORD

BRANCHES: BIRMINGHAM LEEDS BRISTOL MANCHESTER CARDIFF GLASGOW NEWCASTLE

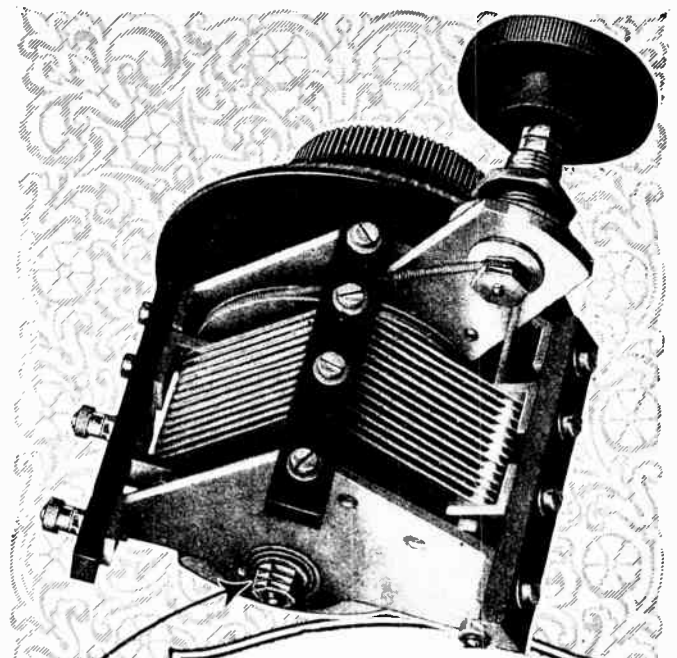

COMPENSATED  
SQUARE LAW  
EFFECT

LOW LOSS  
SQUARE LAW  
SLOW MOTION

LOW LOSS  
NO  
BACK LASH

THE "Cosmos" Condenser is a slow motion condenser with absolutely no backlash either when new or after use. This desirable feature is accomplished by the use of a spring belt held in tension, which permits coarse tuning with the large knob, and a 10:1 slow motion with the small knob.

Cone bearings allow for adjustment and the slow motion bracket can be mounted for remote control as shown in the lower illustration.

The condenser for fine tuning.  
METRO-VICK SUPPLIES LTD.,  
(Proprietors)  
Metropolitan Vickers Elec. Co. Ltd.)  
Metro-Vick House, 145 Charing Cross  
Road, London, W.C.2.

Prices:  
Slow Motion '00025 mfd. 14/9  
" '0005 " 15/6  
Ordinary " '00025 " 12/-  
" " '0005 " 13/-

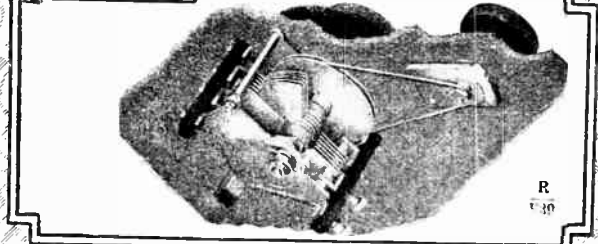
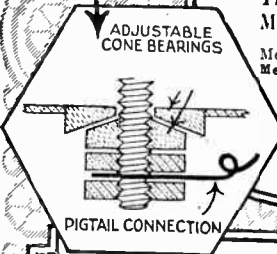

# COSMOS

## LIBERTY SUPERSONIC UNITS

(Pro. Patl.)

Comprising 3 intermediate matched transformers, filter, long and short wave oscillator, reactor and mechanical balancing devices, enabling all stations 250/3,000 to be received Any unwanted stations entirely cut out.

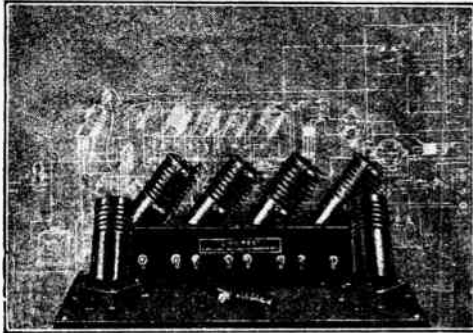

March 1st, 1926.  
I am pleased to say I managed to log 72 stations in 3 hours at terrific loud speaker strength, 4 of these being "Yanks."  
(Signed) G. E. C.

PRICE £5 complete set with theoretical and pictorial wiring diagrams and list of other components required.

Each transformer matched to half a turn.

Air cored, no iron being used, thus the sharpest uniform peak obtained.

Ensures ultra-selectivity.

Delivers maximum signal strength to detector valve. Send for illustrated descriptive leaflet.

Sole Manufacturers—

**RADIARC ELECTRICAL CO., LTD.**  
Phone: Chiswick 1834. Bennett Street, LONDON, W.4.

## EXTEND YOUR WIRELESS into the Garden and AMPLIFY IT on the Way

BY THE NEW NON-VALVE  
MAGNETIC MICROPHONE

### BAR AMPLIFIER

(Patent No. 248581 '25).

Complete  
Amplifier

PRICE  
**38/-**  
Post Free.

Dry Cells  
Extra.



Microphone  
and other  
parts of  
Amplifier  
also supplied  
separately.

Illustrated lists  
free.

REALLY GOOD LOUD-SPEAKER RESULTS from CRYSTAL RECEPTION of average strength. WEAK CRYSTAL or VALVE RECEPTION made STRONG AND CLEAR.

Not a Microphone Button. Entirely free from distortion and microphonic noises. No valves, accumulators or H.T. Batteries. No fragile parts. Nothing to get out of order. A child can adjust it. Operates on one or two Dry Cells lasting over 3 months. EQUALLY EFFICIENT ON VALVE SETS.

Order from your dealer or from Sole Manufacturers and Patentees:  
**NEW WILSON ELECTRICAL MANUFACTURING CO., LTD.,**  
18, Fitzroy Street, Euston Road, London, W.1  
Phone: Museum 2703.

## The Wireless World COUPON and Radio Review for "HIDDEN ADVT." COMPETITION

This coupon is available until Monday 10 a.m., June 7, 1926

Clue No.	Name of Advertiser.	Page
1		
2		
3		
4		
5		
6		

I enter the above solution subject to the published rules.

Name  
(Please write clearly)

Address



**STRAIGHT LINE FREQUENCY  
ULTRA LOW LOSS  
PRECISION CONDENSERS**  
0003 mfd. 0005 mfd. 12/6  
**MICRO VERNIER RECORDING  
DIAL. 7/6**

SEND FOR LIST OF COMPONENTS  
OF ADVANCED DESIGN.

**The FORMO COMPANY**  
Crown Works, Phone  
Grickwood, N.W.2. Hampstead, 1787.  
Northern Representative: J. B. LEVEE,  
23, Hartley St., Levenshulme,  
Manchester.  
Phone: Heaton Moor 475

## TIME & WEATHER by WIRELESS

By W. G. W. MITCHELL,  
B. Sc., F. R. A. S., F. R. Met. S.

The first half of this book explains how time-signals are sent and how they may be received with the utmost accuracy.

The latter part, devoted to the weather, will enable the amateur to distinguish the different weather telegrams. Crown 8vo. 125 pages. 66 diagrams and illustrations.

Price 3/6 net By post, 3/9

Obtainable from the publishers of "The Wireless World,"  
ILIFFE & SONS LTD., Dorset House, Tudor Street, London, E.C.4,  
and all leading booksellers. w.w.10

# EDISON BELL RADIO

NUMEROUS WIRELESS ENTHUSIASTS ARE USING THIS DEVICE—ARE YOU ?

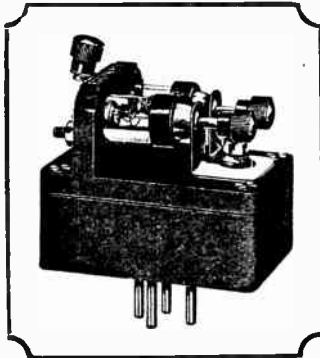

PAT. No. 205148.

## THE EDISON BELL CRYSTAL VALVE PLUG FOR WAVE LENGTHS UP TO 1,600 METRES.

Many users of powerful valve sets are handicapped when tuning in their local station. The results are too loud, distorted and far from musically perfect.

### WHAT THIS PLUG WILL DO.

The EDISON BELL Crystal Valve Plug is a patented device intended to replace the detector valve and reduce the distortion from such a set when receiving the local station. By removing the detector valve and substituting the E. B. Crystal Valve plug reaction effects are prevented and valve detector distortion eliminated. The slight loss of volume will be more than compensated for by the improved musical quality. The value of the device when a valve breaks is obvious.

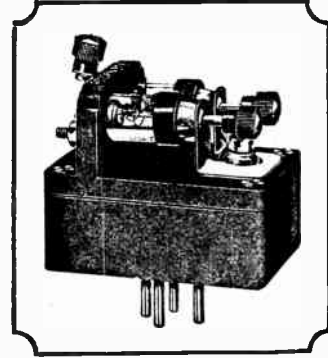

PAT. No. 205148.

PRICE 9/-

A CRYSTAL VALVE PLUG MEANS BETTER MUSICAL QUALITY.

TESTED 500 VOLTS  
FLAT TYPE



Your Dealer will be pleased to supply you with a full range of catalogues, free. If you experience any difficulty in obtaining them write direct to the Manufacturers:— EDISON BELL, LIMITED, Edison Bell Works, London, S.E.15, and at Huntingdon.

TESTED 500 VOLTS  
UPRIGHT TYPE



## INSIST ON EDISON BELL CONDENSERS

THEY ARE BRITISH MADE AND GUARANTEED BY A NAME WITH 30 YEARS REPUTATION BEHIND IT

## EDDYSTONE RADIO PRODUCTS

MOUNT YOUR SET on "ABSORBOS"

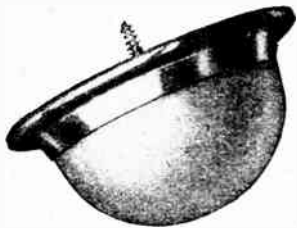

### The IDEAL Radio set mount

They take up all outside shock, thus giving longer life to the valves. Prevent microphonic noises and in addition they add an elegant touch to the cabinet. They prevent marking or scratching any polished surface the set may be placed upon.

MADE IN TWO SIZES:—  
Large size No.123 (2 1/4" diam.) with nickel mount. Price 3/6 per set of four.  
Small size No. 124 (1 1/4" diam.) with untarnishable gold finish mount. Price 3/- per set of four.

## 'EDDYSTONE' PANEL SUPPORTS

For baseboard built sets. Neat, strong and well finished; polished aluminium alloy; untarnishable. Complete with screws and nuts for fixing.

PRICE 1/3 PER PAIR

From all high-class dealers. If any difficulty write direct to the manufacturers:—

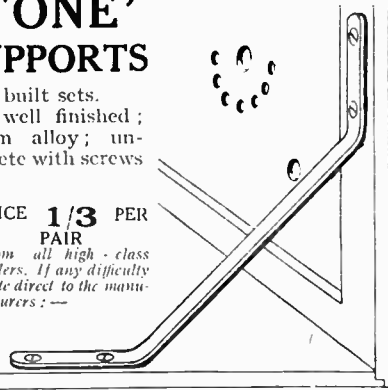

STRATTON & CO. LTD., Balmoral Wks, Birmingham.

## SUCCESS

COMPONENTS

## SUPER AUDIO CHOKE

PRICE

18/6



BEARD & FITCH LTD.  
34, AYLESBURY STREET  
LONDON, E.C.1

# Constructors!



No. 1 T.M.C.  
L.C. Key,  
Price 7/-

## TMC Low Capacity Keys

- combine
- Extreme Low self-capacity.
  - A positive locking action.
  - Rapid make and break.
  - Unvarying performance.
  - Adaptability to varied switching requirements.
  - Strong and accurate construction.
  - Pleasing appearance.

They are designed by Radio engineers. The "Gold-Silver" contacts will not oxidise. The live parts of the key are insulated from the frame. Individual parts are machine made, ensuring accurate construction. Ends of the springs are tinned to facilitate soldering. Escutcheon plates and levers are polished and lacquered brass or bright nickel plate.

- Made in Three Models.
- No. 1. 12 point, 3 position .. 7/-
  - No. 2. 6 point, 2 position .. 6/-
  - No. 3. 24 point, 3 position .. 15/6

Send for a copy of the T.M.C. Catalogue. It is free on request.

If your dealer does not stock T.M.C. Goods we will supply you direct at the above prices, post free.

TELEPHONE MANUFACTURING CO., LTD.,  
Hollingsworth Works,  
WEST DULWICH, LONDON, S.E.21.

\*Phones: Sydenham 2460/1.

### REDUCTION OF PRICE

Our No. 3 Lightweight Headphone, inclusive of plush-lined case, is reduced to 19/6 as from May 17th.

## FOR MUSIC THAT SOOTHES—USE



### L.F. TRANSFORMERS



They reproduce every ripple of the sound waves.

TYPE AF4 .. 17/6

TYPE AF3 .. 25/-

The "Nearly Perfect" Transformer.

Ask for Leaflets Wa401 and Wa402.

FERRANTI LTD., HOLLINWOOD,  
LANCASHIRE.



## The March of THE PELICAN UNIVERNIER

The Pelican Univernier is steadily moving on to more panels because it gives to the set owner that nicety of control which is needed to bring in those elusive stations.

The vernier control is secured through a mechanism which causes the rotation speed of the knob to be no less than twelve times that of the shaft.

The Pelican Univernier fits all sets, you simply replace the old dials with the Pelican.

PRICE 6/-

Guaranteed throughout.

Obtainable from most Dealers.

Write for details of the "Pelican" Self-contained Sets. Prices from £10 to £40 inclusive of Royalties.



CAHILL & COMPANY LTD.  
64, Newman Street,  
London, W.1.

Phone: Museum 9236.

Farr's Ad.

# Utility

= GUARANTEED =

## COMPONENTS

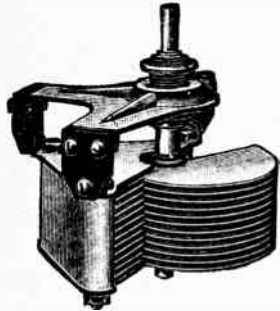

### New Prices.

'Utility' Low Loss Condensers without Vernier from 12/- for .001 capacity. With Vernier, fitted with slow motion dial, from 17/6.  
'Utility' 50-capacity change-over switches. Knob pattern from 3/-.. Lever pattern from 3/6.

## Reduced Prices

- the same quality
- the same 'Utility' Guarantee.

Every Wireless Amateur who takes his hobby seriously knows the value of accuracy and finish in the Components he uses—that is why so many choose 'Utility' Components.  
New Reduced Prices—made possible by greatly increased demand—now bring 'Utility' Components within reach of every wireless enthusiast. Better reception, longer life and a guarantee that any 'Utility' goods that develop faults with reasonable care will be repaired or replaced—all these are ensured if you demand 'Utility' Components. All good dealers stock them.

**WILKINS & WRIGHT LTD**  
= KENYON ST. *Utility* BIRMINGHAM =

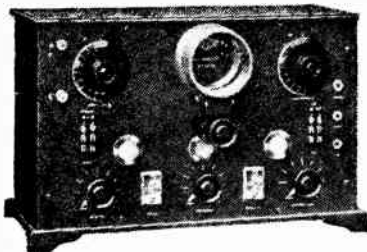

# 20/- down

### —and this superb Set is yours

**YOU** buy your House by deferred payments. You purchase your furniture out of income, and perhaps even your motor-car by the same up-to-date methods. Then why not choose a really good Wireless Set and pay for it as you use it. How much more satisfactory to buy out of income a really worth-while Set capable

of giving the very best possible results in preference to something considerably cheaper and less satisfactory. Each of the instruments listed here is fully tested and guaranteed, and the prices include tuning coils, Marconi Royalties and handsome polished mahogany cabinet. Now read particulars, and see how *easily* any one may be yours.

#### All Concert de Luxe Type B. *(as illustrated)*

Finished Instrument complete with 3 B.T.H. B5 Valves, 4 volt. 20 act. amp. hour Acc., Sterling Baby Loud Speaker, 99 v. Hellesen H.T. Battery. 20/- down and 13 monthly payments of 30/-

#### 2-Valve Reflex Receiver.

Finished Instrument complete with 2 B.T.H. B5 Valves, 4 volt. 10 act. amp. hour Acc. 100 volt. H.T. Battery, Ultra Loud Speaker.

15/- down and 10 monthly payments of 20/-

#### 4-Valve Family Receiver Type B.

Finished Instrument complete with 4 B.T.H. B5 Valves, 4 volt. 20 act. amp. hour Acc., Sterling Baby Loud Speaker, 99 v. Hellesen H.T. Battery. 25/- down and 15 monthly payments of 30/-

**FREE.** Send us your name and address on a postcard and we will send you a copy of our 50-page booklet which describes in detail a large number of well known Receiving sets. Not only can you purchase ready built Sets from us on our generous instalment terms, but we will supply you with the complete kit of parts so that you can construct the Set yourself, and gain experience in so doing.

**NEW TIMES SALES CO., Vulcan House, Ludgate Hill, E.C.4**

G.A. 5240

IMPROVES ANY SET



## TUNE IN WITH SUMMER

THE west is still luminous with the sunset's afterglow, and the "love-set" is abandoned for another.

Across the court comes the call of dance music, and white shoes weave a rhythmic pattern on the grass.

Youth will be served, and Ediswan Valves have given to the heart of youth the soul of music.

Ediswan Valves give the extra volume for outdoor reception, while preserving the purity of tone of the most carefully installed indoor set.

**BRITISH MADE**

*Ask your Dealer for  
Descriptive Literature*

# EDISWAN VALVES

The EDISON SWAN  
ELECTRIC CO. Ltd.  
123-5, Queen Victoria St.  
LONDON, E. C. 4

*Branches in all  
principal cities*

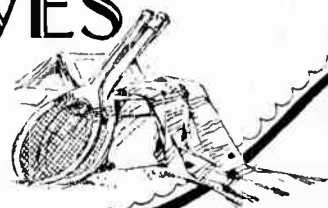

S.V. 1

# To 6-Volt Users -

**BETTER RESULTS AT  
A SIXTH OF UPKEEP COSTS**

## Osram D.E.8.

(H.F.) for 6-Volt Accumulators (L.F.)

**Only 0.12 Amp. Filament  
current consumption at 5.6 Volts**



**Characteristics :  
H.F. Type.**

Filament Volts - - - 5.6-6.  
Filament Current - 0.12 amps.  
Anode Volts - - - 40-120.  
Impedance - - - 25,000 ohms.  
Amplification Factor - - 16.

**Characteristics :  
L.F. Type.**

Filament Volts - - - 5.6-6.  
Filament Current - 0.12 amps.  
Anode Volts - - - 20-100.  
Impedance - - - 8,000 ohms.  
Amplification Factor - - 7.

**GET THE BEST  
OUT OF YOUR SET**

With a 6-volt accumulator, use  
D.E.8 OSRAM VALVES  
(D.E.8 H.F. as Detector).

Use an OSRAM D.E.5 Power  
Valve in the last stage.

**THE** introduction of the D.E.8, H.F. and L.F. OSRAM VALVES is a big advance in 6-volt valve construction. As D.E.2 OSRAM VALVES have established an unassailable reputation for better 2-volt reception, the D.E.8 types now come to the aid of 6-volt accumulator users.

D.E.8 OSRAM VALVES enable you to change over from extravagant bright emitter valves to dull emitter 6-volt valves consuming one-sixth of the current consumption *with no alteration* to your filament rheostat. They provide better characteristics which make for louder and clearer reception, and the maximum sensitivity for getting distant stations. Accumulator expenses are reduced to a fraction of what they ordinarily are with definitely a big increase in efficiency. It is NOT now necessary to maintain a bulky 6-volt accumulator to operate satisfactorily a 6-volt valve.

As a sensitive Detector the D.E.8 H.F. OSRAM VALVE is unsurpassed, and the addition of a "Neutrodyne" H.F.

Amplifier brings in the most elusive and distant stations with remarkable ease and volume.

For more volume, greater purity and lower running costs, use the D.E.8 L.F. as a low-frequency amplifier. It may also be used as an exceedingly economical small power valve.

From the time D.E.8 OSRAM VALVES are first put into service until their veteran days, they give the same satisfying volume and tone. By using OSRAM Dull Emitter Valves you are assured of a constant unvarying electron emission throughout a long and useful life. Behind them is the longest experience in the manufacture of dull emitter valves in the country.

PRICE 22/6 EACH

# Osram Valves

for Broadcasting

*The G.E.C. - your guarantee*

Advt. of The General Electric Co., Ltd., Magnet House, Kingsway, London, W.C.2.



# The Wireless World

AND  
RADIO REVIEW  
(14<sup>th</sup> Year of Publication)

No. 353.

WEDNESDAY, JUNE 2ND, 1926.

Vol. XVIII. No. 20.

Assistant Editor:  
F. H. HAYNES.

Editor:  
HUGH S. POCOCK.

Assistant Editor:  
W. JAMES.

Editorial Offices: 139-40, FLEET STREET, LONDON, E.C.4

Telephone: City 4011 (3 lines).

Advertising and Publishing Offices: DORSET HOUSE, TUDOR STREET, LONDON, E.C.4.

Telephone: City 2847 (13 lines).

Telegrams: "Ethaworld, Fleet, London."

COVENTRY: Hertford Street.

BIRMINGHAM: Guildhall Buildings, Navigation Street.

MANCHESTER: 199, Deansgate.

Telegrams: "Cyclist Coventry."  
Telephone: 10 Coventry.

Telegrams: "Autopress, Birmingham."  
Telephone: 2970 and 2971 Midland.

Telegrams: "Uiffe, Manchester."  
Telephone: 8970 and 8971 City.

Subscription Rates: Home, £1 1s. 8d.; Canada, £1 1s. 8d.; other countries abroad, £1 3s. 10d. per annum.

As many of the circuits and apparatus described in these pages are covered by patents, readers are advised, before making use of them, to satisfy themselves that they would not be infringing patents.

## A DEMONSTRATION OF OUTSTANDING INTEREST.

OUR readers will readily support us in the claim that *The Wireless World* is not guilty of exploiting the credulity of its readers, and nothing could be further removed from the policy of the journal than to publish sensational articles. Our aim has always been, and will continue to be, to keep to the truth and take all possible steps to avoid exaggeration and the publication of misleading statements.

Our policy must, by now, be so well known to our regular readers that it would be unnecessary to make the foregoing statement were it not for the fact that in this issue we publish an article entitled "Transmission and Reception without Aerial or Earth," which describes remarkable results obtained with apparatus which has been devised by Mr. Derek Shannon and recently demonstrated to us. Readers may remember that several weeks back a good many daily Press references were made to experiments carried out by Mr. Shannon, and although the claims set out in the Press reports appeared to us fantastic, we nevertheless felt that we were under an obligation to our readers to investigate the facts as far as possible. Accordingly, we invited Mr. Shannon to give us a demonstration at his home. Although the demonstration given appeared to substantiate all the claims previously made for the apparatus, yet we were so sceptical that we asked for a second demonstration, and took reasonable precautions to check the results obtained.

The article published in this issue is, therefore, a bare record of our investigation and an account of the results of which we were witnesses and which we were able to repeat when handling the apparatus ourselves. We hope that our readers will not expect us to be able to give them information as to the circuit arrangements, because these have not yet been disclosed to us, but they may rest assured that so soon as any such information is available our readers will be promptly informed.

o o o o

## MR. J. C. W. REITH.

WITH this issue of *The Wireless World* we present, as a supplement, a portrait of Mr. J. C. W. Reith, Managing Director of the B.B.C., which has been specially taken by *The Wireless World*. We feel sure that very many of our readers will appreciate having this happy study of the guiding spirit of British broadcasting taken in the surroundings of the busy organisation in Savoy Hill for which he is responsible.

It is an opportune moment to mark our appreciation of the broadcasting service which did so much to ease the difficulties of the intensely serious situation

from which this country has just emerged, and in no small measure was the successful effect of the broadcasting of intelligence and general news, during a time when other methods of news distribution had broken down, due to the arrangements organised by Mr. Reith and, more directly perhaps, to the personal effect at the microphone, since all the more momentous announcements were made by Mr. Reith himself in a voice which has in it that quality

## CONTENTS.

	PAGE
EDITORIAL VIEWS .. .. .	723
TRANSMISSION AND RECEPTION WITHOUT AERIAL OR EARTH .. .. .	725
READERS' NOVELTIES .. .. .	728
THE PROBLEM OF REMOTE CONTROL By A. P. Castellain.	729
LONG-RANGE THREE-VALVE SET .. .. .	731
By W. James.	
MR. J. C. W. REITH .. .. .	735
LOUD-SPEAKERS IN BATH ABBEY .. .. .	736
CURRENT TOPICS .. .. .	737
PRACTICAL HINTS AND TIPS .. .. .	739
SPEECH AMPLIFIER DESIGN .. .. .	741
By N. W. McLachlan.	
BROADCAST BREVITIES .. .. .	747
PIONEERS OF WIRELESS. 16.—BELL INVENTS THE WIRELESS TELEPHONE .. .. .	749
By Ellison Hawks.	
NEW APPARATUS .. .. .	751
READERS' PROBLEMS .. .. .	753

which helped perhaps no less than the statements themselves to inspire confidence and steadiness.

o o o o

### THE WIRELESS LEAGUE.

THE present issue of *The Wireless World*, being the first issue of the month, devotes four pages as usual to matters concerning the Wireless League, and we take this opportunity of asking all our readers not to dismiss lightly the invitation which the appearance of these pages month by month makes to every reader to add his name to the membership of this organisation. We are satisfied that, even though there may not appear to be at the moment any pressing need for the listening public to be represented by an organisation which can act on their behalf, yet there will undoubtedly be countless occasions in the future when the importance of such a means of expressing their wishes will be felt by every listener. A formidable standing army, even though inactive, will serve to ward off many contemplated aggressions, and we believe that the interests of the listener will not be encroached upon by forces conflicting with their interests with really powerful listeners' organisation in existence.

In the case of such an organisation as the Wireless League its power and influence is directly proportional to its membership. There may not appear to be anything of importance to many of our readers in the more direct advantages which are offered by membership of the League, although we submit that these are not so trivial that they can be lightly overlooked, but we would appeal to our readers to support the organisation on the question of broad principle, and we would like to hear that, as a result of this direct reference to our readers, every supporter of *The Wireless World* not already a member had taken steps to join the organisation. Again, we would like to point out that the Wireless League is not a technical body, but mainly a political one. No qualifications are required in order to join, and it is not the owner of a broadcast receiver alone who can apply for membership, but all those who participate in every household in the enjoyment of listening to the broadcast programmes or who are in any way interested in the development and perfection of our national broadcasting service.

o o o o

### AMATEUR TRANSMITTERS.

A GREAT deal has appeared under Correspondence in *The Wireless World* recently concerning the amateur transmitter and his position in relation to the broadcast listener, and since this correspondence

has been continued over several weeks, the moment seems opportune to summarise the views expressed and reiterate our own attitude towards the subject.

The complaints against transmitters are clearly not general, but arise from the fact that certain individual transmitters in different parts of the country carry out transmissions and indulge in "cross chat" with other transmitters of such a nature as to preclude the likelihood of the transmissions having any relation to serious experimental work. There can be no excuse for asking such questions over the ether as "What is my wavelength?" because every experimenter fit to be trusted with a transmitter should be able to answer such a question for himself. There does not appear to be any real bitterness felt by the general listener towards the *bona fide* experimenters.

We have every sympathy with the *bona fide* amateur transmitter, and would like to emphasise how important have been his contributions to the development of many branches of wireless.

Those who are interested only in the broadcast programmes are unfortunate if they happen to live within a very short distance of an energetic transmitter, but we are firmly convinced that there are very few transmitters who would not do what they could to meet the difficulties of local listeners and assist by either helping them to make their receivers more selective or, alternatively, by readjusting times of transmission as far as possible. It must, however, be remembered that many transmitters have to work for their living during the day, and find it hard enough to fit in the time for experimental work in the evenings. They cannot always be expected to wait until the B.B.C. transmissions are over. The transmitter in turn should remember that when he is granted a licence to transmit, he puts himself under an obligation not to cause interference with other stations, and, whilst the point has never been settled, it is quite conceivable that, although these regulations were drawn up prior to broadcasting, they would still be applicable if it could be proved that any listener was being deprived of reception of broadcasting through the activities of a local transmitter.

Our final word of advice is, wherever listeners suffer inconvenience from the activities of a local transmitter, first of all get in touch with the transmitter himself. If no satisfaction can be obtained—which would be most unlikely—then the next step would be to put the whole facts of the case before the Radio Society of Great Britain, and get evidence from other listeners in the neighbourhood who are similarly troubled.

#### TEN YEARS AGO.

From "*The Wireless World*," of May, 1916.



Drawn by W. A. Cross after the famous picture by Ingres.

#### LA SOURCE (A Prophecy).

[The above reproduction from "*The Wireless World*," of May, 1916, was described then, as a prophecy. The prophecy has undoubtedly come true to-day to a degree that would make the prophet of 1916 marvel.]



# TRANSMISSION and RECEPTION without AERIAL or EARTH

An account of a demonstration given by Mr. Derek Shannon to "The Wireless World" recently, when he justified the claims made for his interesting apparatus.

NO doubt many of our readers noticed the recent reports in the daily Press concerning duplex telephony experiments between the G.W.R. Company's steamer "Reindeer" and a coast station in Guernsey. It was stated that communication was maintained up to distances of 70 miles without aerial or earth, and without interference from the ship's spark transmitter, which was operating on 600 metres frequently throughout the trip.

These tests were made by Mr. Derek Shannon, who has kindly allowed us to inspect his experimental station, 5PX, at Sutton Coldfield, near Birmingham, and to test his apparatus in actual operation. His claims are:—

- (1) Transmission and reception without any form of aerial or earth.
- (2) A highly sensitive and selective receiver (other stations have been received within 20 yards of the Birmingham B.B.C. station aerial).
- (3) Due to the above, duplex telephony is possible when the wavelengths of the communicating stations differ by as little as 5 metres.
- (4) A practically non-radiating receiver.
- (5) Extreme portability and simplicity.

Time did not permit of an attempt being made to establish communication with a distant station before the commencement of the local broadcasting, but an interesting and successful demonstration of duplex working was given between two stations about 100 yards

apart. No interference was noticed from the near-by transmitter radiating .5 amps, which was separated from the receiver by only a few inches. We were given a demonstration of two sets working side by side, tuned to two different stations. It would seem that you may put many receivers side by side and each may be tuned to a different station without causing any interference or interaction with one another, as the receiver does not radiate like an ordinary aerial set.

**Performance of the Receiver.**

It is certainly a new experience, for the majority of us, to be able to "break-in" as easily as when speaking on a line telephone. A number of Q.S.I. cards were shown to us reporting reception from distances up to 140 miles or more.

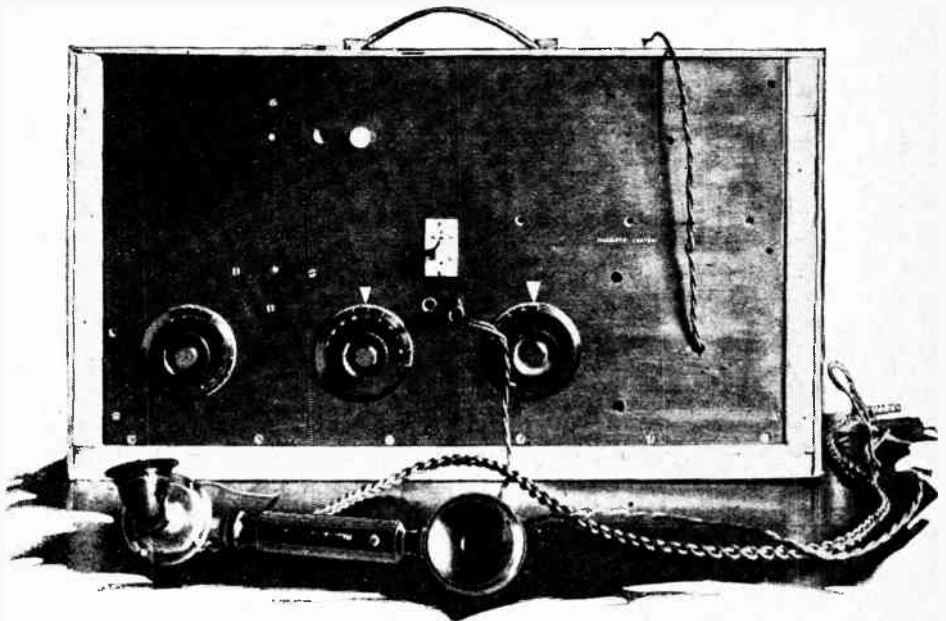

Front view of transmitter.

### Transmission and Reception without Aerial or Earth.—

As for the receiver, it was fortunately possible to make a more extended test, and its performance certainly exceeded all expectations. The first station tuned-in was Bournemouth, signals being so loud and clear that the writer was only convinced that it was not the local station when the identifying announcement was made. This was in broad daylight, and still without aerial or earth. Only two valves were used. A large number of other stations were received without difficulty, and free from interference, the "background" being exceptionally quiet. In fact, the set seemed to be comparable to a good superheterodyne, with the great advantage that it has only one tuning adjustment.

It is admitted that a super-regenerative receiver may sometimes give equivalent results with a few feet of aerial wire, but the writer has yet to handle one which is as easy to manipulate.

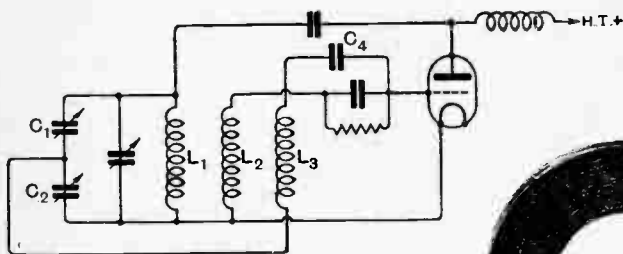
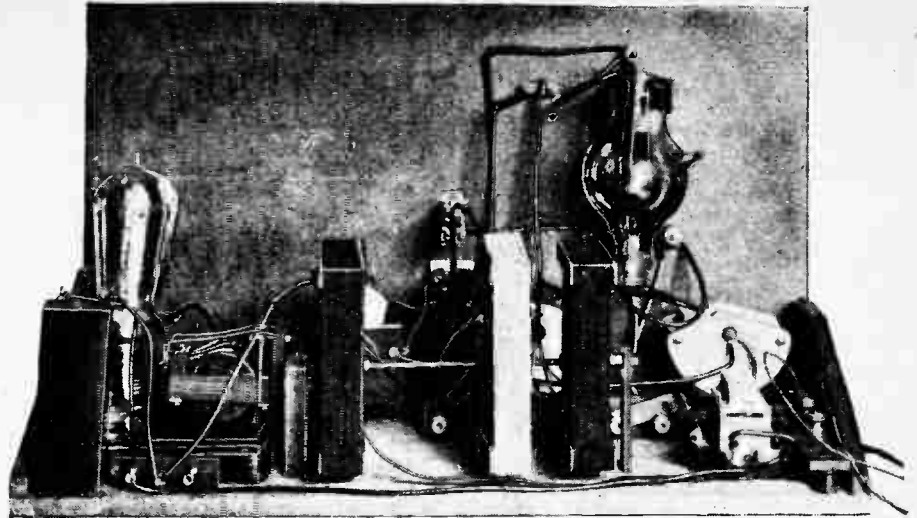

Fig. 1.—The basic circuit of the transmitter.



The arrangement of the transmitting apparatus.

The basic circuit diagram of the transmitter, which is operated on about 400 metres, is given in Fig. 1. The inductances  $L_1$ ,  $L_2$  and  $L_3$  are wound on rectangular section formers measuring only some 4 ins. by 5 in. The first two have apparently the usual value of some 200 microhenries, while that of  $L_3$ , which is tapped, is somewhat lower. The condensers  $C_1$ ,  $C_2$ , are described as balancing capacities, and it is stated that radiation only takes place when they are correctly set. The condenser  $C_4$  is of only a few micro-microfarads capacity. All the apparatus, with the exception of the batteries and microphone, is contained in a cabinet measuring some 24 in. long, and about 12 in. in height and depth.

### Power Supply.

The oscillator valve is an Osram T.50, while the modulator is an L.S.5, of the same make. The filaments are at present fed by an 80 A.H. accumulator battery, and H.T. supply is obtained from dry cells or from an "M.L." rotary converter which has recently been installed together with a bank of Hart H.T. accumulators. Various systems of modulation are used. The

maximum power input used so far with dry batteries is stated to be five to seven watts, but with the M.L. Rotary Converter an input of 15 watts has been obtained, giving greatly increased radiation. It will be interesting to follow the results obtained when the power is greatly increased, which we understand is shortly to be tested out for Transatlantic Duplex Telephony. Mr. Shannon claims

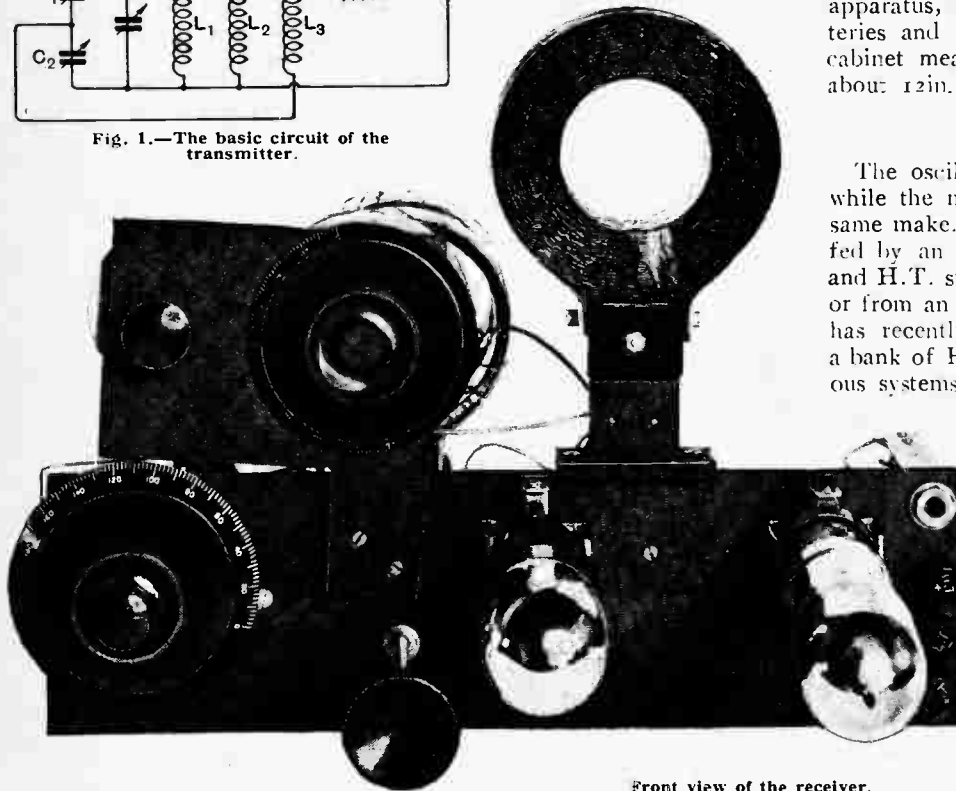

Front view of the receiver.

**Transmission and Reception without Aerial or Earth.**— to have communicated with stations in New Zealand and Mexico, but at the time of going to press there had not been sufficient time for Q.S.L. cards to reach him.

**Details of the Receiver.**

The circuit of the receiver is not disclosed. The grid condenser is of exceptionally high capacity (values up to 0.01 mfd. were mentioned), and the grid leak is of less than 100,000 ohms resistance. A large inductance (actually an Igronic No. 1,250 coil) and a variable condenser, of 0.00025 mfd. maximum capacity, are connected between the plate and grid circuits. The condenser operates as a form of critical reaction control, and even when the set is in a state of oscillation signals are still received quite clearly; this, as our readers well know, is contrary to usual practice. The large coil is not in inductive relation with the grid and plate inductances, which are 75 and 50 turn plug-in coils. Potentiometer control of the grid is used, but is not always necessary. It appears that almost any type of valves are suitable. The connections of the low-frequency amplifier are quite conventional, and a normal value of high-tension voltage is used on the anodes of both valves.

The claims made for this system are so unusual that it is impossible to offer a definite expression of opinion as to its utility without a very searching test, particularly in the absence of a satisfactory theory to account for the operation of the system. Whatever its merits may be, the demonstrations and proofs adduced are certainly most impressive.

Little imagination is necessary to foresee possible applications of such apparatus. For use in the Services, particularly the Army and Air Force, for civil aviation and communication from moving trains and cars, and in light-

houses, lifeboats, and other places where the erection of a normal aerial is impracticable, its advantages are obvious.

For the reception of broadcasting, the receiver would appear to have great possibilities, due to its selectivity, sensitivity, and ease of operation, while the fact that duplex working may be carried out without elaborate apparatus suggests various uses in linking up telephone subscribers in remote districts with the ordinary exchanges.

We understand from the inventor that these results are the culmination of many years of research along these

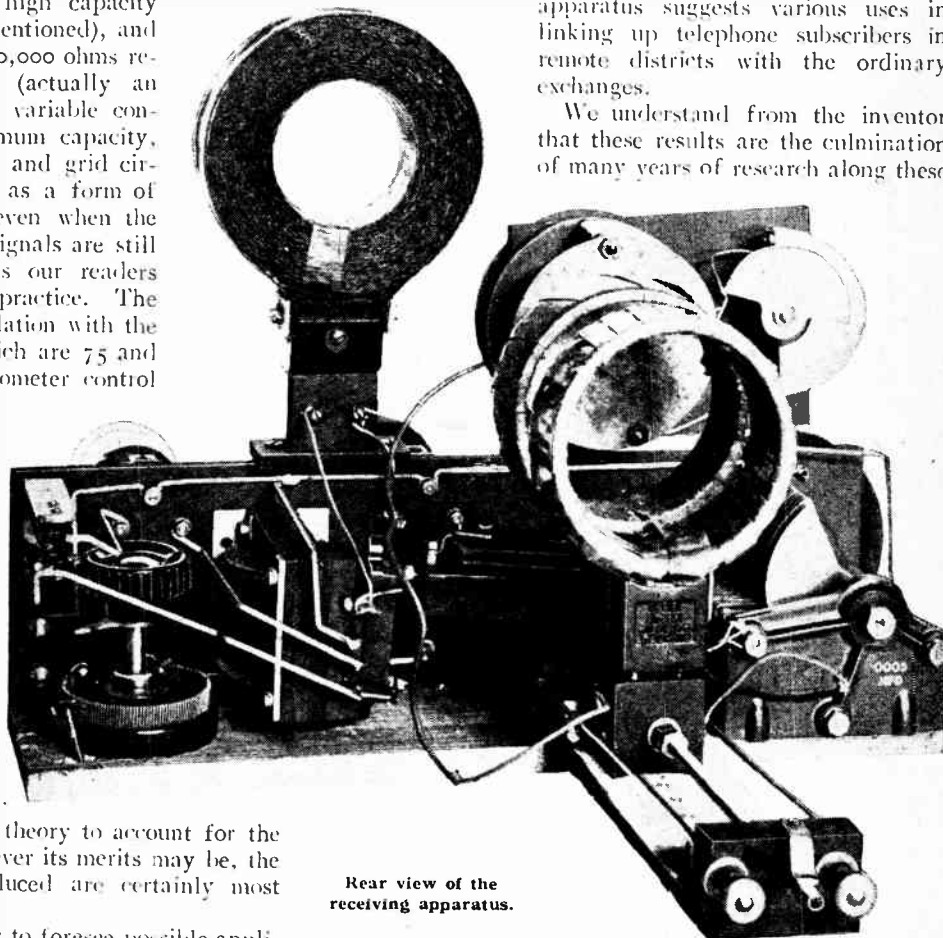

Rear view of the receiving apparatus.

lines, as it has always been his idea that the aerial is a hindrance and not a help in obtaining perfect reception and transmission.

**T.M.C. Headphones Reduced in Price.**

Messrs. The Telephone Manufacturing Co., Ltd., of West Dulwich, announce a reduction from 22s. 6d. to 19s. 6d. in the price of their No. 3 headphones, inclusive of plush-lined case.

o o o o

**The Osram Bulletin.**

"How to Use a High Frequency Amplifying Stage to its Best Advantage" is the title of a useful article appearing in the current number of the Osram Bulletin, published by the General Electric Co., Ltd., Magnet House, Kingsway, W.C.2. Other features of interest to the wireless amateur deal with new improvements in Osram valves and the choice of valves for portable receivers.

4

**TRADE NOTES.**

**British Goods for America.**

We are advised by the Radiall Company, of 50-52, Franklyn Street, New York, manufacturers of automatic current controls, that a director of the company, Mr. M. N. Leibowitz, expects to be in England on or about June 14th, and would be glad to receive from British wireless manufacturers catalogues of such of their products as would be suitable for export to America.

Literature should be forwarded to Mr. Leibowitz, c/o the American Express Co., London, marked "Will call."

o o o o

**B.S.A. Receivers.**

The B.S.A. Radio, Ltd., Small Heath, Birmingham, draws our attention to an error in the Supplementary Buyers' Guide to receiving sets on page 423 of our issue of March 17th. Their models Nos. 5100, 5110 and 5130 should have been included under the heading of Four-valve Sets, each having 1 H.F., 1 det. and 2 L.F. valves; while models 5000, 5010, 5030 are five-valve sets, having 1 H.F., 1 det. and 3 L.F. valves each. Their booklet from which we compiled the information was not clear on this point.

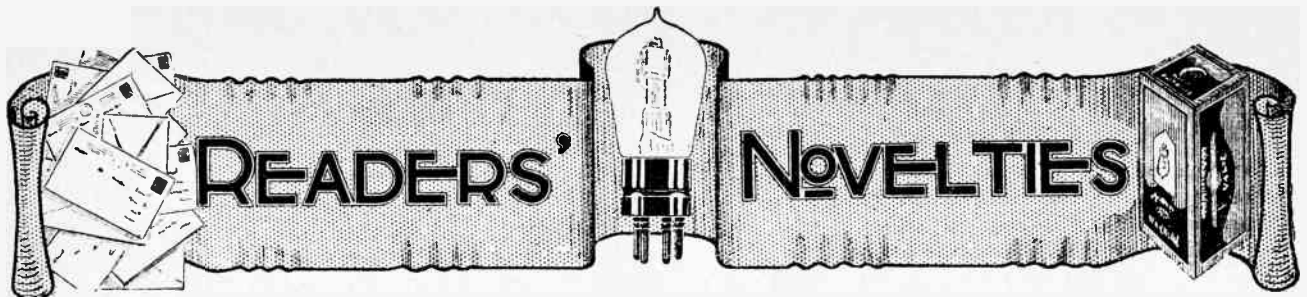

A Section Devoted to New Ideas and Practical Devices.

**VERNIER DIAL.**

First obtain a large clockwork gear wheel about 1 3/4 in. in diameter and the smallest pinion that can be found to mesh with it. The centre hole of the larger wheel is then enlarged to be an easy fit on the condenser shaft, and the pinion itself is mounted in a bearing hole in the condenser dial. The large gear wheel is assembled

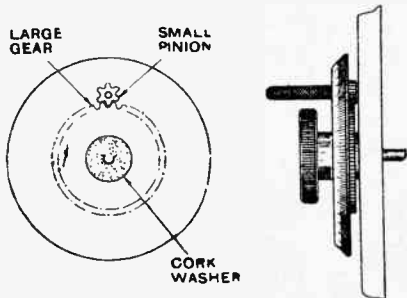

Geared vernier movement.

with a cork washer between the wheel and the panel, and a small metal washer between the dial and the wheel, and it will then be possible to turn the condenser dial in the ordinary way for coarse tuning and to employ the vernier movement by virtue of the friction supplied by the cork washer. J. H. B.

**TUNING HINT.**

When a loud-speaker is operated through long extension leads in a different room to the receiving set, it is difficult, if telephones are not available, to judge when the set is accurately tuned. If a standard loud-speaker is used and is operated at comfortable strength, it will be found that a small shock can be felt if the moistened fingers are placed across the output terminals of the receiver. By holding two fingers on these terminals, therefore, it is possible to tune the receiver to resonance without hearing the loud-speaker at all,

simply by estimating when the electric shock is at its strongest.—R. G. R.

**TESTING POLARITY.**

For those who have occasion to make repeated tests of battery polarity, the following indicator solution will be found very useful.

Make up a solution of table salt in water and add a few grains of phenolphthalein (obtainable for about 2d. at any chemist's). On dipping the wires into the solution a red coloration will occur at the negative pole. This coloration should disappear on shaking, but if it is found that it persists, a few drops of hydrochloric acid should be added. An excess of acid must be avoided, otherwise no coloration will be obtained.—H. H.

**TELEPHONE PLUGS.**

Telephone leads terminating in spade connectors with screw fittings can easily be changed to plug connections by inserting valve legs in



Converting spade connectors to telephone plugs.

place of the slotted blade of the spade terminal.

The screwed portion of each valve leg should be gripped in the jaws of a hand drill and filed at an angle to assist in clamping the ends of the telephone leads.—W. H. G.

**H.F. TRANSFORMER SWITCH.**

By means of the circuit arrangement shown in the diagram it is possible to use a single H.F. transformer for receiving both Daventry and the local station on the 300-500 metre waveband. A special transformer is used having a secondary

with approximately three times the number of turns in the primary, the latter winding being designed for the 300-500 waveband. With the switch in the left-hand position, the primary of the transformer is tuned by the variable condenser, and energy is

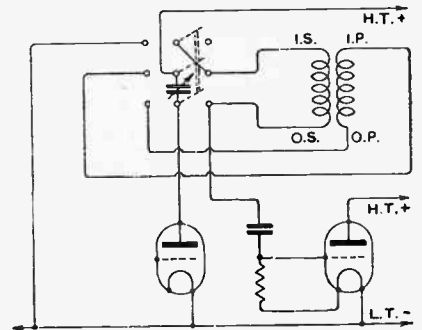

Switching from transformer to tuned anode H.F. coupling.

transferred through the coupling between the primary and secondary windings to the detector valve, a slight step-up voltage being obtained through the transformer.

To tune in the Daventry station the switch is moved to the right-hand position when the variable condenser is connected across the secondary winding. The same movement of the switch entirely disconnects the primary winding from the circuit, and modifies the connections, so that tuned anode instead of transformer coupling is employed. C. H. C.

**DRILLING MICA.**

When drilling mica sheet for building up fixed condensers or in constructing mica insulating washers, clamp the mica sheet between two pieces of soft wood held in the vice. A perfectly clean hole will then be obtained, and if more than one hole is to be drilled in each piece of mica one of the pieces of wood may be retained as a template.—J. J. P.

# THE PROBLEM OF REMOTE CONTROL.

## Relays and Circuits for Switching the L.T. Current.

By A. P. CASTELLAIN, B.Sc., D.I.C., A.C.G.I.

THE idea of control at a distance is one which intrigues nearly everybody, although there are not many who are interested in the practical carrying out of such control, probably because they do not understand the general principles which underlie all forms of electrical control.

In this article the writer intends to deal with one small part of the general remote control problem, namely, the control of a wireless receiving set from any part of the house where it is most convenient to do so.

Before going any further it would be as well to understand quite clearly what is meant by the *control* of a wireless receiving set. Where a set is used on the local station only, the only forms of control that are really necessary are the switching on and off of the valve filaments and perhaps a volume control of the loud-speaker output. Where the set is regularly used for the reception of two or more stations, the control problem becomes more complicated, as it is then necessary to alter various tuning adjustments in addition to the switching and volume control. In general, such control is too complicated to be worth doing—it would usually pay to have a portable set working from a small frame aerial and to carry it to wherever it was needed.

### The Relay.

The fundamental idea at the back of all these control systems is to use a small current to switch or control a much larger current, which in turn may control a current many thousands of times larger than the initial current. In other words, a small amount of energy at the control end may be used to influence a large amount at the controlled end.

There is an extremely useful instrument which enables the small current to influence the large current, which is called a *relay*.

The action of a relay may be studied in reference to Fig. 1. It consists essentially of an iron core A,

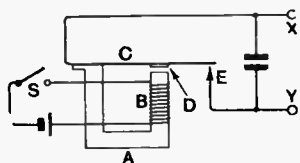

Fig. 1.—Diagram illustrating the principle of the relay.

generally shaped more or less as shown, carrying a coil of wire B on one limb. Fixed to the other limb is a flat springy strip which may be of steel, carrying a piece of iron D so placed as to be immediately over the part of the core carrying the coil, but separated from it by a small air gap. On closing the switch S a current flows round the coil B and magnetises the iron core.

The piece of iron D called the armature is thus attracted to the core immediately below it, and it therefore moves towards and may touch it, but in so doing it bends the spring C. A contact E is arranged as shown to touch an extension of the spring C when the latter is bent sufficiently.

When the switch S is opened the core ceases to be magnetised, so that the pull on D, which is bending the spring, also ceases, and the spring returns to its former position in which it does not touch the contact E.

Thus the switch S opens and closes the path between C and E, *i.e.*, between the terminals X and Y.

It will be seen that all the current flowing round the coil B has to do is to magnetise the core sufficiently to close the path between X and Y.

### Limitations in Relay Design.

The only limits to the current which can directly be switched at X and Y are the size of the contacts between C and E, the distance they separate and the voltage between X and Y when the contacts are open, and the pressure between them when they are closed. In general, the contacts have the smallest cross-section of the total path between X and Y, chiefly because it is difficult to obtain and keep the contact surfaces perfectly flat, so that the size of the contacts in this respect limits the current they will carry. Also, if the contacts are dirty there will be an appreciable resistance in the circuit at this point, so that excessive heat will be developed here due to this, which will again limit the current, though a good pressure between contacts will minimise this to some extent.

When the circuit is broken by the contacts separating, an arc will form between the latter if the voltage between X and Y is sufficient, and this will tend to burn and pit the contacts. This arcing effect may be reduced by shunting a condenser of fairly large capacity across the gap, as is shown in Fig. 1, either in series with a small resistance for high voltages between X and Y or without, as shown in the figure.

For a given current round the relay windings there will be a definite pull on the armature D, and thus the weight of this and the contact pressure cannot exceed a certain amount if the relay is to work.

For the relay to be efficient it is obvious that the input energy should give the biggest pull possible on the armature, and, as the pull is proportional to the cross-section of the air gap and to the square of the product of the current and the number of turns on the core per unit length of the magnetic circuit, it is obviously a relatively simple matter of design to obtain a relay to operate with a given input energy in a given form.

For example, two relays might be required to switch the same current value, so that their contacts would be the same; but one might be required to work with a

**The Problem of Remote Control.—**

current of 5 milliamps (say) at 10 volts, while the other might be required to work off a 2-volt accumulator, the current being about 30 milliamps or so, so the winding on the core of the first relay would require many more turns than that of the second.

The use and action of a relay should be understood by now, together with some of the general principles governing their design. The writer does not propose to go into the matter of relay design any further in this article—the subject is a large one, and will be dealt with more fully in a series on remote control which will be published at a later date.

**Application to Set Control.**

Let us now consider the various ways in which we can control from a distance a simple local station receiver. Here, all that is required at the set end is to switch on or off the valve filaments, so that a simple relay of the kind that has been taken as our example is all that is necessary.

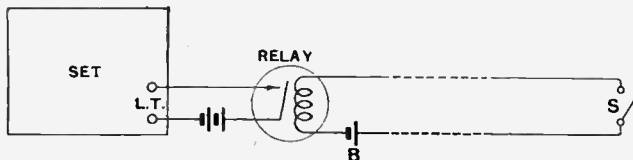

Fig. 2.—The simplest method of controlling L.T. current by means of a relay.

Fig. 2 shows the most obvious arrangement of this relay. The relay contacts are joined between the set and one side of the low tension battery, and two wires are taken to a switch S, placed where required, from the relay coil, and from a local battery B of sufficient size to operate the relay when S is closed.

A simplification of this circuit is obtained by using the low-tension battery of the set as the battery B and designing the relay winding to suit.

A unit on these lines was described by the writer in *The Wireless World* of March 3rd, 1926. It should be noted that four wires in all are required from the set—two for the relay and two for the loud-speaker.

By a fairly simple modification consisting in the use of

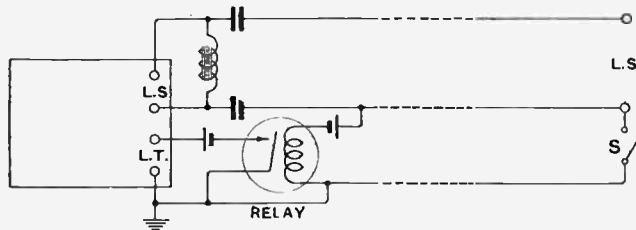

Fig. 3.—Utilising one of the loud-speaker leads in the relay circuit.

a choke feed arrangement to the loud-speaker it is possible to dispense with one wire and only to use three, or in some cases by using a local earth to use two wires only—such a circuit is given in Fig. 3.

There is another arrangement which is very much simpler than the above, in that it requires only the existing loud-speaker wires to operate it, and it can be made

in the form of a simple unit to add to almost any valve set.

The circuit is given in Fig. 4, where only the last valve in the set is shown for the sake of clearness.

It will be seen that if a and b are connected (by means of a loud-speaker or otherwise) the relay coil is connected

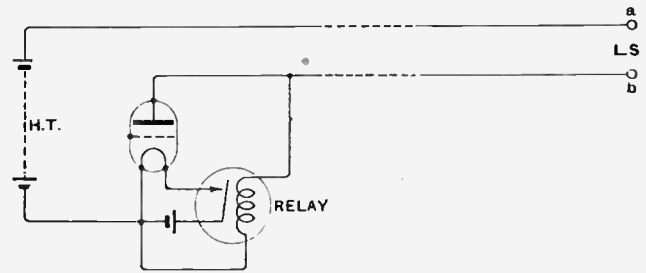

Fig. 4.—Simple circuit in which the loud-speaker leads are used to control the relays.

across the H.T. battery. If the relay is suitably designed to take a very small current—say only a milliamp. or two—when placed across the battery, and if it is designed to operate successfully with this current, then this circuit given in Fig. 4 is one of the simplest and most reliable possible.

A set incorporating this method has been constructed and will be described in the next issue.

Fig. 5 gives a single wire arrangement which is possible when local earths are available at the control points.

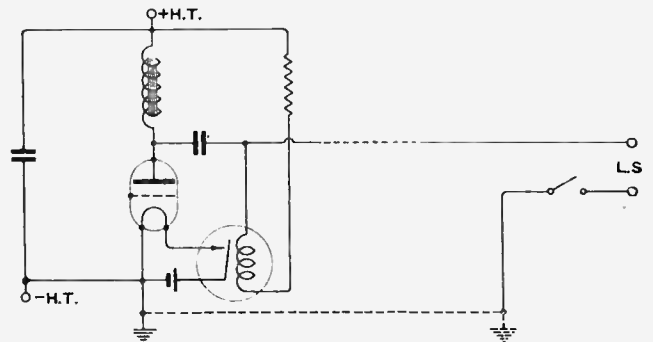

Fig. 5.—Remote control by means of a single extension wire.

One disadvantage inherent in nearly all remote control systems is the extra capacity across the loud-speaker which is introduced by the extension wires. This may be obviated to a considerable degree by spacing the wires to the loud-speaker as was advised in an article by N. P. Vincer-Minter on "Music Without Muffling" in *The Wireless World* of February 10th, 1926, and also in the writer's article of March 3rd.

Another disadvantage is leakage to earth from loud-speaker wires, causing deterioration of the H.T. battery. However, if good wire—such as bell wire, bell flex or electric light flex is used in the first instance, no trouble should be experienced on this score.

If this brief article has served to show some of the difficulties in the design of remote control for wireless sets and means of getting over them, then it has served its purpose.



# LONG RANGE THREE-VALVE SET.

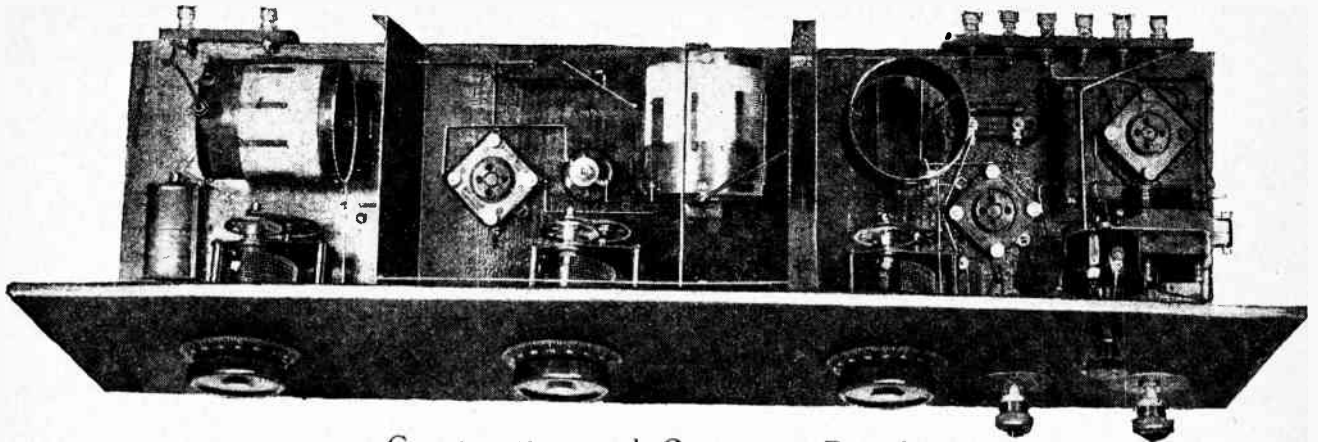

## Construction and Operating Details.

By W. JAMES.

(Continued from page 692 of previous issue.)

IN the first part of this article the theory of the receiver was explained, and it was pointed out that the coils are wound with Litz conductor with a view to reducing their losses to the lowest possible value consistent with economy. As a result the H.F. transformer gives the practically uniform amplification of 19-22 over the whole range of 200-600 metres, which compares with the more usual figure of 7-10 for transformers covering this wavelength range. To secure the full benefits of the low-loss coils certain precautions have to be taken, and advice was given on this point.

### Construction of the Coils.

Photographs and drawings show the arrangement of the parts. The set is an extremely simple one to build. There is an ebonite front panel measuring 30in. x 9in. x  $\frac{1}{16}$ in., and a baseboard of hard wood measuring 29in. x 9in. x  $\frac{1}{2}$ in. On the front panel the three tuning condensers, two filament rheostats, reaction condenser and output jack are mounted, the exact positions being given in Fig. 5. This panel is mounted at an angle with the baseboard, the latter being screwed 1in. above the lower

Fig. 6 gives the position of the parts on the top of the baseboard. On the back at the left-hand side is a terminal strip for the aerial and earth, while just in front of it is a dry cell used to give the grid of the first valve a negative bias.

There is also the input transformer. This is sketched in Fig. 2, and has a secondary of 55 turns of 27/42 Litz tight wound. The primary winding comprises nine turns of No. 30 D.S.C. wire, tapped at 4 and 7 turns, the wire being wound over 10 strips of ebonite  $\frac{1}{16}$ in. thick by  $\frac{3}{16}$ in. wide, cut from a 3in. tube. Three Clix sockets are mounted at the end of the Paxolin former and the taps on the primary coil are connected to them.

This coil is mounted on two pieces of ebonite rod carried on a small base of wood.

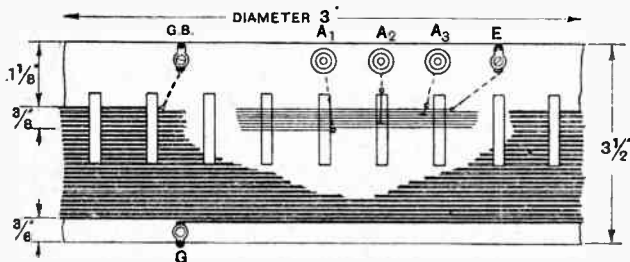

Fig. 2.—Constructional details of the input transformer. The tapped primary winding is connected to the aerial circuit and the larger coil is connected to the grid and filament of the first valve.

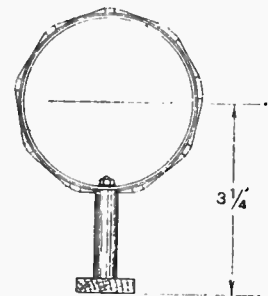
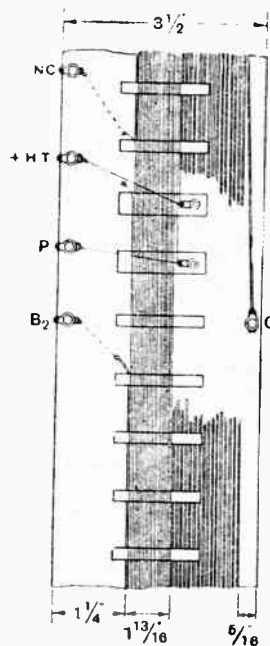

Fig. 3.—The transformer connected between the H.F. valve and the tuned detector circuit. There are three windings, the large winding being the secondary. The two small windings are the primary and balancing coils.

edge of the panel to allow room for the grid bias battery and two by-pass condensers which are screwed to the lower surface of the baseboard.

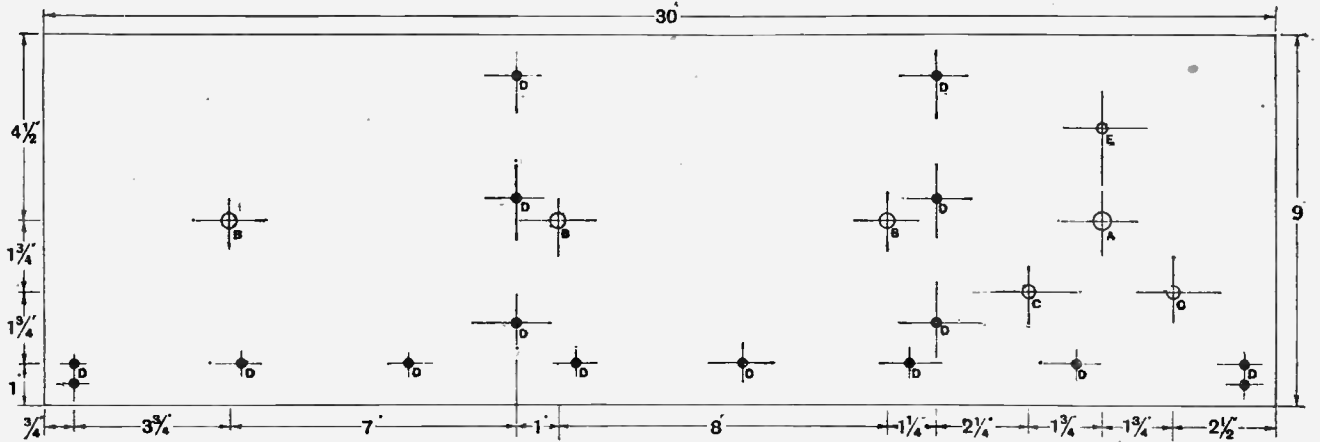

Fig. 5.—The ebonite front panel. A 1/4", B 1/4", C 1/4", D 1/4" and countersunk.

The next component is a screen of No. 24 gauge copper sheet, which has three edges turned at right-angles for fixing. Between the first and second screens is the valve-holder for the first valve, the balancing condenser, by-pass condenser, and H.F. transformer. The transformer must be carefully made; it is sketched in Fig. 3, and has a secondary of 51 turns of 27/42 Litz tight wound as shown. Seven narrow ebonite spacers 1/8 in. thick by 3/16 in. wide and two pieces 3/8 in. wide cut from a 3 in. tube are required. At the top of the two wide spacing strips a hole should be drilled to take a 6 B.A. countersunk screw, the heads of the screws being covered with a little paraffin wax or paper to prevent a contact between the screws and the secondary winding.

The primary winding of 11 turns of No. 40 D.S.C. can then be wound on, the turns being spaced 15 to the inch. Thread the beginning of this coil through the

two holes in the former and solder the wire to a connecting tag, and when the 11 turns are wound solder the end of the wire to one of the screws fixed to a spacer. The balancing winding is wound in the centre of the space between the primary turns, the method of winding being shown in the figures.

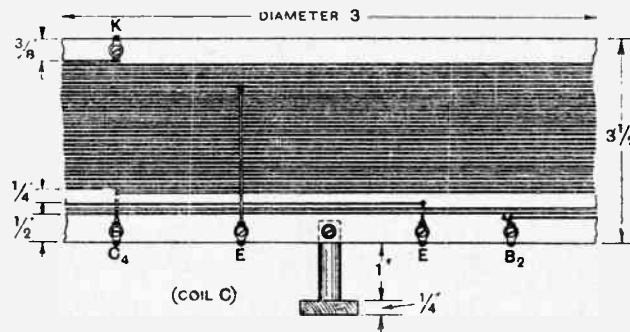

Fig. 4.—Constructional details of the third transformer, comprising coil C and the coupling coil

Thus the primary and the balancing winding run side by side, forming a double winding of 11 turns each. Finally, the beginning of the first winding should be marked +H.T. and the beginning of the second winding N.C. A wire is then run between the finish of the first winding to a tag marked P, while the finish of the second winding is connected by a wire to the tag marked +H.T. These connections are shown in Fig. 3.

The third transformer is an easy one to make. Starting at one end of the former, see Fig. 4, wind on 15 turns of the Litz. clean the end and solder it. Now

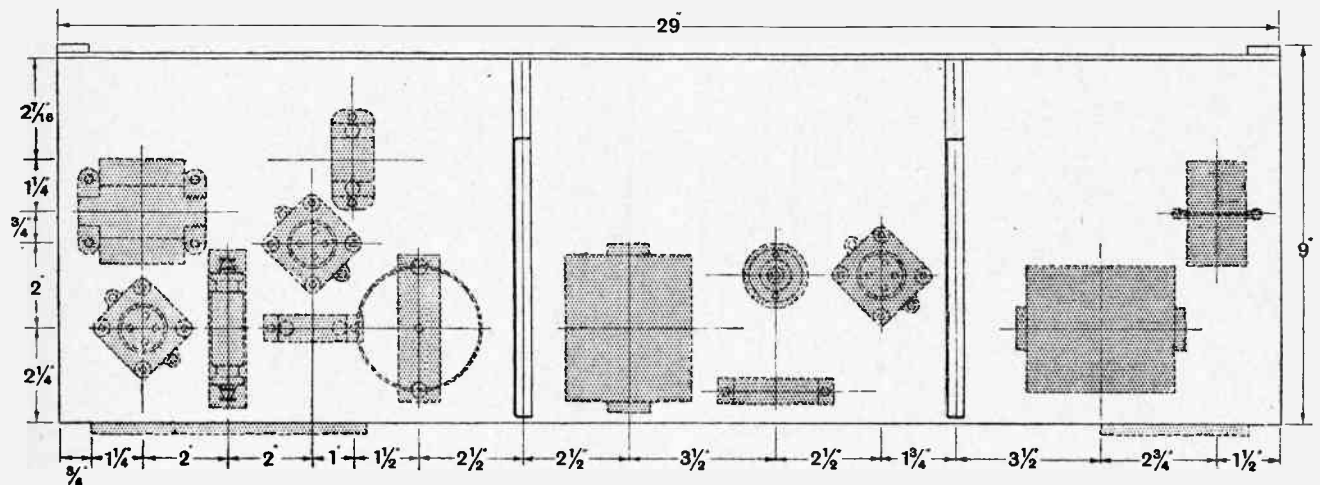

Fig. 6.—Arrangement of parts on the baseboard.

**Long Range Three-valve Set.—**

solder the beginning of the next part of the winding to this end and put the joint through a hole in the former, so that it projects through the surface towards the centre. Wind the remainder of the coil (40 turns) and solder the end to a tag. From the tap at the 15th turn run the wire to another tag. We now have a coil of 55 turns with a tapping at the 15th turn. For the coupling coil No. 22 or No. 24 gauge wire will suffice and 4 turns are required. These turns are put on at one end of the former, as shown in Fig. 4, and the two ends are connected to tags.

there is plenty of room the connecting wires can be run in short direct paths. The screens are earthed, and wires which have to pass through the screens are run in Systoflex. A few flexible wires are employed for connecting the grid bias battery, the aerial terminal, etc. These wires are marked in the diagram, and can also be identified in the illustrations.

**Testing the Set.**

The valves required are as follows: for the high-frequency stage, a low impedance power valve of the 5-volt  $\frac{1}{4}$  ampere type, such as the Burndept L.525 or the

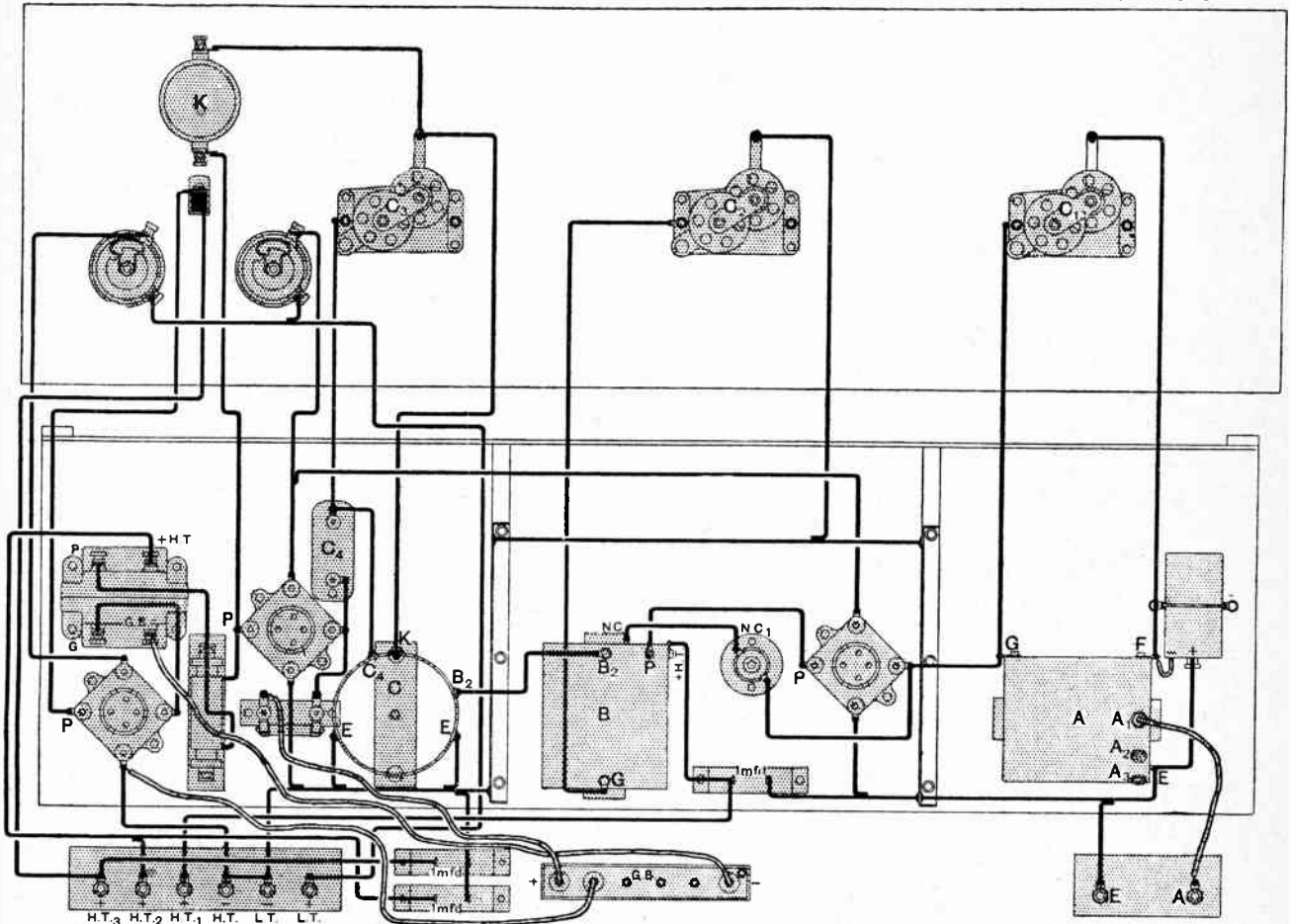

Fig. 7.—Wiring diagram. C<sub>1</sub>, C<sub>2</sub> and C<sub>3</sub>, 0.0005 mfd. tuning condensers; A, B and C, the three secondary windings; NC<sub>1</sub>, balancing condenser; C<sub>4</sub>, 0.0003 mfd. fixed condenser; K, reaction condenser; GB, grid bias battery.

The remainder of the components mounted on the baseboard are easily identified, and as there is plenty of room no trouble will be experienced. It is very important to place the coils exactly as indicated, the centre of the windings of the coils being in the same straight line. The screens should also be carefully placed in position and fixed by passing screws through the bottom edges into the baseboard and also by screwing through the front panel.

On the underside of the baseboard there is a grid bias battery for the L.F. stage and the detector and two by-pass condensers.

The wiring connections are given in Fig. 7, and as

Marconi or Osram D.E.5; for the detector, a Marconi or Osram D.E.5b; for the low-frequency stage, a Burndept L.525 or other power valve of this type. It must be remembered that it is just as important to use the right valves as it is to wire the set up correctly. The H.F. transformer is designed for a valve having an impedance of about 7,000 ohms; to use a valve having an impedance very different from this will result in quite a different amount of amplification and selectivity.

Connect about 60 volts to the plate of the H.F. valve, 60 to the detector, and 120 to the L.F. valve. Also connect the flexible wire from the I.S. terminal of the L.F. transformer to the negative end of the 9-volt grid bias

**Long Range Three-valve Set.—**

battery, the wire from the grid leak to the positive end, and the wire connected to the L.T. negative to the first tapping from the positive end of the grid battery. These connections provide a bias of negative 7.5 volts to the I.F. stage, while the grid leak return is positive 1.5 volts. This will give good rectification when a DE5b valve is used as the detector with a two megohm grid leak.

With the reaction condenser set at zero, tune in the local station at full strength. Take out the H.F. valve, wrap a piece of thin paper over one of the filament legs of the valve, and put it back in the holder. The signal will now probably be much weaker. To balance the H.F. stage adjust very carefully the balancing condenser to give a minimum sound in the telephones. Apply reaction to the circuit by moving the reaction condenser, and endeavour to set the balancing condenser so that nothing at all, or only a weak signal, is heard.

**General Notes.**

The Belgian amateurs, B W5 and B Y5, are working every Friday between 2200 and 2300 G.M.T. on 205 metres. Both stations are using an input of 40 watts. W5 employs grid modulation and Y5 the choke system. They will welcome co-operation with British amateurs. Communications for B W5 may be addressed to Le Manoir, Peruwelz, Belgium, and those for B Y5 to 34, Rue de la Chaussée, Mons.

o o o o

Scottish amateurs, although their proverbial modesty often prevents their achievements becoming widely known, are by no means asleep. Mr. J. Wyllie (G 5YG), 105, Mossiel Road, Newlands, Glasgow, has been in two-way communication with BZ 6QA, Señor. A. A. dos Santos, of S. Luiz do Maranhão, on 45 metres and with a power of only 8.64 watts. Contact was maintained for over an hour, and 5YG's signals reported to be a steady R4. Mr. R. Carlisle (6WG), 40, Walton Street, Shawlands, Glasgow, also exchanged messages with Madeira on the same wavelength and with a power of a little over 5 watts, his signals being reported R7. We understand that 6WG is shortly moving to Northern Ireland and will then be on the ether again with a GI prefix.

o o o o

**South African Transmitters.**

We are indebted to our contemporary, *The South African Wireless Weekly*, for the following call-signs and addresses which are additional to, or corrections of, the lists already published in the *Wireless Annual* and in *The Wireless World* for January 27th (p. 144), February 3rd (p. 189), and April 7th (p. 516):

**Additions.**

A 7M.—H. St. John Randall, M.B., 84 Caledon Street, Uitenhage.

A 7N.—A. V. Hollins, 21, Railway Cottage, Sydenham, Port Elizabeth.

A 7P.—W. Shakespear, 29, Railway Cottage, Sydenham, Port Elizabeth.

A 18

Now restore the valve and the circuit will be perfectly stable, provided the coils have been properly fixed.

When searching for signals the three tuning condensers should be turned in steps of a degree, as the tuning is sharp and stations are easily missed. It will be found that the reaction condenser can be set in a position where sufficient reaction is produced over a wide wavelength range.

If it is found that tuning is too sharp another turn can be added to the coupling coil; if, on the other hand, sharper tuning is required, a turn can be taken off this coil.

Tested at a place two miles from the London station it was found that about a dozen stations could be received in the evening at loud-speaker strength. Many more stations situated all over Europe were also received at very good phone strength. The receiver is considered to be an exceptionally good one. It will, therefore, be worth while to follow the instructions precisely.

## TRANSMITTERS' NOTES AND QUERIES.

A 7Q.—S. Larsen, P.O., Mayville, Durban.

A 7R.—A. G. Curtin, 45, Fifth Avenue, Parktown North, Johannesburg.

**Cancellations.**

A 3A.—R. W. Walker, Johannesburg.

A 3F.—A. W. Stanford, Kokstad. A 4J.

—A. W. C. Budge, Pietermaritzburg.

A 40.—J. D. Muirhead, Johannesburg.

A 5B.—J. D. Mail, Durban. A 5R.—J. Hodges, Port Elizabeth.

o o o o

**New Call-Signs Allotted and Stations Identified.**

G2BSQ (Art. A.)—E. Wilson, "Nidis", Bramhall Lane, Bramhall, Cheshire.

G 6PY (ex 2AXL, Art. A.)—L. W. Parry, 13, Huddersfield Road, Barnsley. Transmits on 150-200 and 400 metres.

A 3QH.—J. F. Feldman, Forest Street, South Geelong, Victoria, Australia.

CH 2AR.—Carlos Reiber, Casilla 3062, Valparaiso.

I 1BW.—F. Francarro, Castelfranco, Veneto, Italy.

I 1CE.—E. Caudiani, Badia, Rovigo.

I SRA.—Military Aeronautic Station, Viale Anilizie 5, Rome (Transmits on 41 metres).

J 1PP.—The Training School (Dept. of Communications), Shiba Park, Tokio, Japan.

TUK.—Tomsk University, Siberia.

U 2AEV.—J. L. Whittaker, Cottage Place, Allendale, N.J.

G 2BQI.—S. G. T. Knott, 57, Woodlands Crescent, Golders Green, N.W.11.

G 2BQL.—C. A. Richardson, 29, Craig-nish Avenue, Norbury, Surrey.

G 2KA.—B. Hodson, 31, Broomfield Avenue, Palmers Green, N.13. (This call-sign was formerly that of the Brighton and Hove Radio Society.)

G 6DQ.—H. Drury, New Housing Estate, West Ardsley, near Wakefield, transmits on 90 and 150 to 200 metres.

G 6HZ (ex G 2BKC).—L. Kane, 5, Burrard Street, Jersey.

G 6MI.—R. Maynard, Hazel Bank, Hutchinson Square, Douglas, Isle of Man. (Change of address from May 12th.)

I 1FL.—Flori, Ermio, Viale S. Michele del Corso 45, Milan. (Change of address.)

I 1GS.—Giovanni Serra, Via Legnano 45, Turin. (Change of address.)

o o o o

We regret that in lists previously published there have been errors in the names or addresses of the following, to whom we offer our apologies:—

BZ 1AW.—Vasco Abreu, Rua Riachuelo 89, C/4, Rio de Janeiro.

G 6FZ.—H. E. F. Taylor, Abbots Trace, Abbotswood, Guildford.

o o o o

**Danish Amateurs.**

Through the courtesy of Mr. H. Rafu (D 7EW), we are enabled to give our readers a list of Danish amateur transmitting stations which are now licensed:—

7AA F. M. Knuth, Knuthenborg, Bendholm, Lolland.

7AH C. Hoegsholm, 7, Manoegade, Copenhagen.

7AI A. Lykstoft, 37, Julius Blamsgade, Copenhagen.

7AJ Borge Jorgensen, Brandes Alle 8, Copenhagen.

7BK E. Sdyoedte, 77, Bredgade, Copenhagen.

7BZ C. F. Barditz, "Erikstaus," Ringkoebing.

7CF C. Fode, Vesterbrogade 41, Copenhagen.

7EW H. Rafu, 8, Blytsvej, Copenhagen.

7GL G. Langhorn, Willemoesgade 16, Copenhagen.

7JO J. Finsen, Thorshavn, Faeroerne.

7JM J. Fode, Dosserringen 32, Copenhagen.

7JS J. Steffensen, Ekkeisvej 8, Hellerup, Copenhagen.

7JW J. Krause-Thomsen, 18, J. Buggesensgade, Korsor.

7MT E. Poulsen, 6, Virginiavej, Copenhagen.

7NR J. Nissen Rahm, 15, Bispegade, Haderslev.

7ZM G. Branslev, 6, Roarsvej, Roskilde.

# MR. J. C. W. REITH.

Managing Director of the British Broadcasting Company.

**M**ANY careers have been made through the introduction of broadcasting, and probably a very large number of people would include the career of Mr. J. C. W. Reith, the managing director of the British Broadcasting Company, in the list of those who owe their success to the introduction of the new science; but this would be altogether a mistake in the case of Mr. Reith.

### How Mr. Reith Entered the Field of Broadcasting.

Before the time that he entered broadcasting he had already made a prominent name for himself in a wide variety of achievements, and he was really a much bigger man than the job which he undertook when he accepted the appointment of managing director of the B.B.C. Mr. Reith foresaw the possibilities and grasped the opportunity of pioneering in a new sphere where many lesser men would have hesitated to forsake an established career to enter upon what, in the early stages, appeared to be the hazardous task of steering the destinies of British broadcasting; a task which certainly lived up to its appearances.

Most successful men carve out for themselves a career by the gradual process of hard work and application, but making use of every achievement in their lives as a stepping-stone to the next progressive stride, but in the case of Mr. Reith one might almost say that he started afresh when he entered the sphere of broadcasting, because the public has never known, nor has Mr. Reith ever had occasion to fall back upon, what we may de-

scribe as his "reserve of prestige" gained through his earlier achievements.

The ascendancy of British broadcasting in its special attributes of idealism and enterprise has become almost too proverbial. It is apt to be taken for granted. It is appropriate, therefore, that during a period when transition is imminent there should be some recognition of the personality and directing force which are responsible for the creation and development of that organisation the initials of which already connote not only an expression of a new art-form, but also a tremendous factor for social well-being throughout Great Britain.

### Pre-Broadcasting Activities.

Although not yet thirty-seven years old, Mr. Reith already has a wide variety of achievements to his credit. He served in France during the first year of the war, but was lent to the Ministry of Munitions after a severe head-wound in 1915. Early in 1916 he was sent to the United States to supervise the production of the munitions on behalf of the Allies. He had there a staff of 600 inspectors under him, and one of the factories for which he was responsible employed 13,000 men. Returning from America in 1917, after nearly two years, he undertook various important engineering tasks for the Government, including special work for the Admiralty. His first work after the war was the liquidation of £15,000,000 worth of engineering and munition contracts which were in progress of execution. This was a heavy responsibility, but was carried out to the satisfaction of Lord Inverforth, who was then the head of the Ministry concerned. In 1920 Mr. Reith took over Bearmore's Coatbridge works, in order to transform a war factory to peace industrial conditions, and here remained two years.

Mr. Reith has been the executive head of broadcasting in this country since its inception three and a half years ago. He has devoted literally the whole of his time and energy to the service, and even his literary work has been concerned with broadcasting.

*A Supplement Portrait of Mr. Reith is included with this issue.*



A view of 2LO taken from Oxford Street.



### Improving Poor Acoustics in a Famous Church.

WHEN pious men built the ancient Abbey of Bath, either the question of acoustics did not come up for consideration, or clerical lungs were tougher than they are to-day. The length of the church from east to west is 210ft., and across the transepts 126ft., while the breadth of the nave and aisles is 72ft. Two portions of the building are acoustically bad, so that fully half of the congregation are unable to hear the sermon.

To overcome this trouble, Marconiphone Public Address Equipment has been installed with microphones in the pulpit and at the lectern, the loud-speakers being mounted in the organ loft in such a manner that they feed both "dead spots." The No. 1 Equipment has been found to be admirably suited to the task, the voices of the clergy being heard without the slightest trace of distortion. The amplifying apparatus is housed in a cellar-like compartment adjoining the transept, a charging board and batteries completing the equipment. A switch control board has been fitted into the transept in view of the pulpit and lectern, and by means of the switch gear it is possible to control the loud-speakers and change over

the microphones at the requisite times during the service. One of the loud-speakers requires less "throw" than the other, and a suitable damping control has therefore been placed in circuit in order that a full acoustic balance may be obtained. As will be seen from the photographs, all the equipment visible to the congregation is in accord with the general tone of the surroundings. The church authorities are to be congratulated on the progressive spirit which has prompted them to take advantage of modern scientific methods to make the service audible to every member of the congregation.

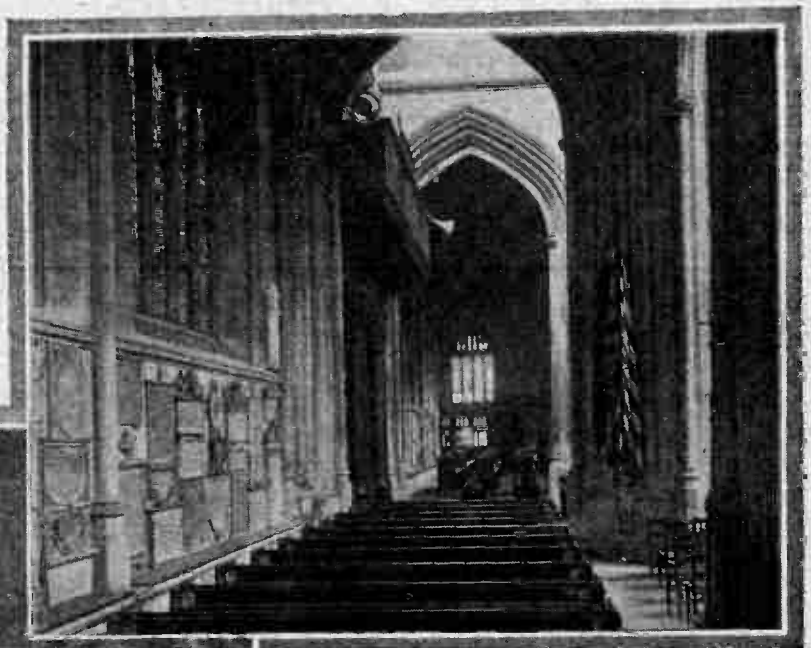

(Upper) This view, looking across the transepts, shows the loud-speakers in the organ loft.

(Lower) The amplifier and switchboard.

The title photographs show (left) the neat form of microphone in the pulpit, and (right) the microphone attached to the lectern.

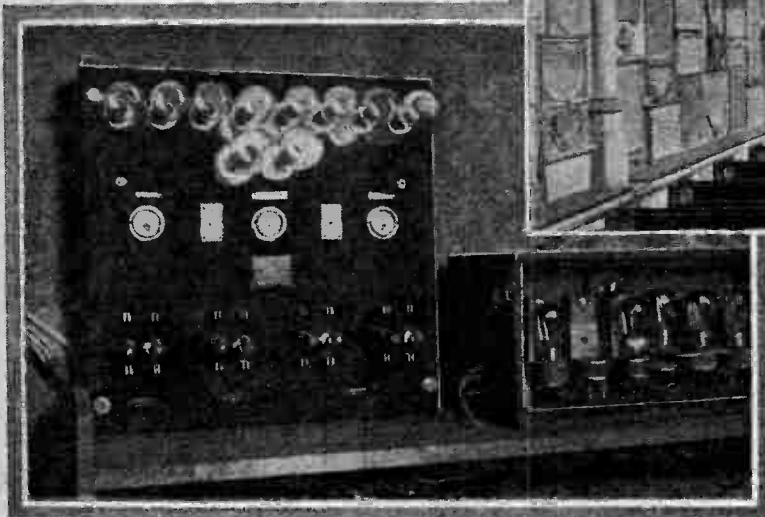

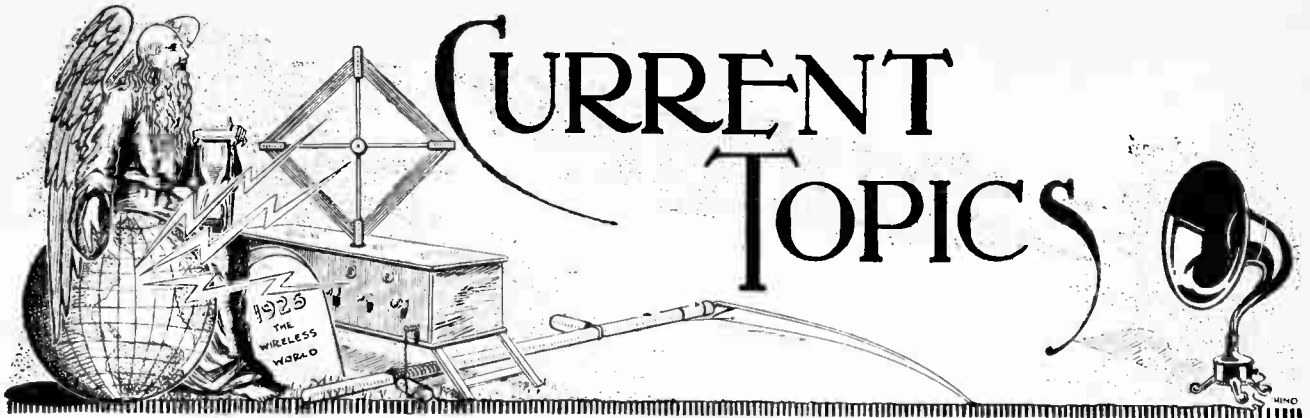

Events of the Week in Brief Review.

**BEGINNING THE THIRD MILLION.**

The number of wireless receiving licences issued by May 1st was 2,012,000, according to Post Office figures issued a few days ago.

○○○○

**A BABY LOUD-SPEAKER.**

A defendant at Swansea charged under the Wireless Telegraphy Act, explained that he had done away with the set as it was not loud enough, there being a baby in the house.

○○○○

**CRYSTAL WAVELENGTH CONTROL.**

For maintaining a constant transmitting wavelength quartz crystal control is rapidly gaining in favour in America. In the Chicago area alone six broadcasting transmitters now incorporate crystal control.

○○○○

**BROADCASTING AND BOOTLE.**

The Bootle Education Committee have decided that wireless installations in schools must not be used in school hours, except on special occasions, when permission can be obtained. The Liverpool Education Committee has expressed disagreement with Bootle's decision.

○○○○

**NAMES, PLEASE.**

A new excitement has been imparted to broadcast reception by the action of the B.B.C. in announcing the names of streets in which oscillation interference is very pronounced. Several streets in Walthamstow have been "named" in this manner, while residents in Leytonstone who dread publicity are said to be getting nervous.

○○○○

**TELEPHONY ON GERMAN TRAINS.**

Following upon the success of the wireless telephone service on two fast trains running between Berlin and Hamburg, it is reported that the German railway commission intends to introduce the service on several other routes. Those from Berlin to Bentheim, used by the trains for England *via* Holland, and from Berlin *via* Cologne to Aix-la-Chapelle on the Paris and Brussels routes, will be the earliest to have the installations.

**AMERICAN BROADCASTING CHANGE.**

The Broadcasting Company of America is the new name assumed by the American Telephone and Telegraph Company, which owns the station WEAF, New York.

○○○○

**ESPERANTO CONGRESS, 1926**

Broadcasting will be among the subjects coming up for discussion at the eighteenth International Esperanto Congress, to be held in Edinburgh from July 31st to August 7th.

○○○○

**A STABILISING DEVICE.**

The "Radiophonie du Midi" broadcasting station at Toulouse has placed its services at the disposal of the committee, under Marshal Joffre, which is working for the stabilisation of the franc.

**LICENCES IN FRANCE.**

The difficulties which British subjects resident in France have been experiencing in obtaining broadcast receiving licences have been eased considerably during the last few weeks.

○○○○

**UNDERGROUND ANTENNA TESTS.**

Successful tests with an "aerial" submerged in a three-foot pit partially filled with water have been carried out by an American amateur, G. W. Cook, of Hyattsville, Md. The device is an invention of Dr. J. Harris Rogers.

The antenna consists of a copper rod three feet long. To one end of this rod are soldered 25 copper discs, each 10 inches in diameter and spaced 1 inch apart.

Connected up with a superheterodyne set, the submerged antenna has given



**BROADCASTING FROM WESTMINSTER.** H.R.H. The Prince of Wales photographed on the occasion of the Parliamentary Banquet broadcast from Westminster Palace on Wednesday. Mr. Winston Churchill is on the right. Note the microphones on the table.

excellent signals on 40 metres, stations in the Hawaiian and Philippine Islands being heard at good strength

○○○○

#### COMMERCIAL SHORT-WAVES IN U.S.

The Radio Corporation of America has just opened a new short-wave commercial service on 18 metres from Rocky Point, N.Y.

○○○○

#### ANOTHER COAL QUESTION.

A wireless correspondent in a daily paper has been suggesting that his readers should rummage the coal cellar for likely "crystal" detectors. In the present troublous times this seems a doubtful economy.

○○○○

#### HOSPITAL WIRELESS.

The Oxford Wireless Telephony Co. report that they have equipped just on one hundred London hospitals with wireless equipment under the scheme organised by *The Daily News*.

○○○○

#### BRITISH CONTROL OF MARCONI'S.

Alterations in the articles of association of Marconi's Wireless Telegraph Co., Ltd., provide that in future no director may be appointed who is not a natural-born British subject. Not more than 25 per cent. of the issued share capital of the company may at any one time be in foreign hands.

○○○○

#### CORRESPONDENT WANTED.

A bed-ridden American wireless amateur, Mr. Maynard Bodley, sends out an appeal for a correspondent, about the age of 20, who would be willing to exchange interesting letters on radio subjects. Mr. Bodley's address is 1,418, Edgerton Street, St. Paul, Minn., U.S.A. His letter to us concludes: "Please note, ladies are invited to write also."

○○○○

#### THE RADIO RATCATCHER.

Oscillators at Portland, Ore., U.S.A., are apparently in for an unhealthy time, if the Portland Broadcast Listeners' Association has its own way. A search is being made to secure the services of a radio interference expert, or rat-catcher of the ether, who will track every form of interference to its lair. When the expert has finished, the good folk of Portland hope to sit back and enjoy the programmes.

○○○○

#### WIRELESS SET FOR RAILWAY VILLAGE.

A wireless set has been given to the railway village of Riccarton, in the Cheviot Hills, by Mrs. Falconer, the widow of the late Mr. C. A. Falconer, district engineer, L.N.E.R.

Riccarton village occupies a position of splendid isolation, 900ft. above sea level, and there are no roads leading to the village, which exists solely for railway purposes, being a junction on the Edinburgh and Carlisle main line, connecting with the L.N.E.R. line to Hexham and Newcastle.

A 22

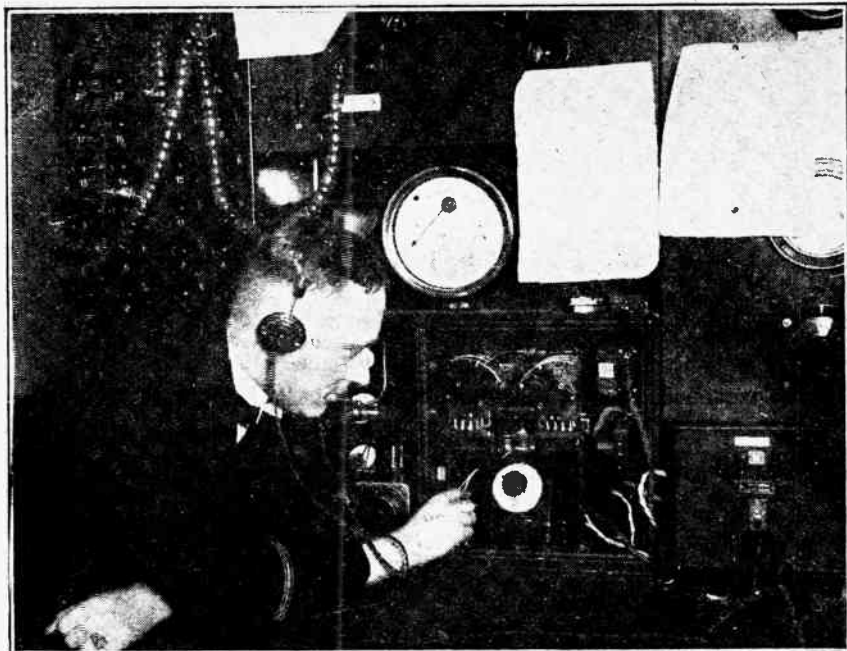

**WIRELESS ON THE MODERN LINER.** A glimpse in the radio room of the "Hamburg," the latest addition to the Hamburg-America Line. The second operator is seen operating the receiver, which covers a waveband from 200 to 3,000 metres. A novel feature of this instrument is the square bakelite jackets enclosing the coils.

#### DEVELOPMENTS IN CAIRO.

Language difficulties and apathy on the part of the Egyptian Government appear to be responsible for the slow progress of broadcasting in the land of Tutankhamen. According to a Cairo correspondent broadcasting shows a tendency to develop on American lines, i.e., the stations are run by the firms selling wireless receivers. The present Cairo station is operated by the Société Radic of Cairo, who have opened a radio shop in the vicinity of the station. The steel lattice masts, which were erected in January last, are about 75 feet high and the aerial is a 4-wire cage.

Most of the receivers on sale are "multi-valvers" and are intended for European reception.

○○○○

#### WEATHER MAPS FROM MUNICH.

An interesting innovation at the Munich broadcasting station is the transmission of weather maps on the Dieckmann system, which closely resembles the principle employed in the Thorne Baker method of photo transmission. According to the *Manchester Guardian* the map intended for telautographic transmission is drawn specially at the Bavarian Central Meteorological Establishment, all data being recorded in insulating ink on a metal foil. The drawing thus obtained, which comprises alternating conductive and insulating portions, is searched by a transmitting stylus connected with a source of current. As this stylus touches the conductive or non-conductive portions, the circuit is closed or opened, and the current impulses thus

produced are supplied through a cable to the Munich broadcast transmitter, in order thence to pass through amplifiers and to be sent out in the form of radio waves. The weather map is eventually recorded in the receiving apparatus of any broadcast subscriber on a chemically prepared sheet of paper. Transmissions of this kind are regularly made on working days about noon and on Sundays and holidays at 12.15, each transmission lasting about five minutes.

○○○○

#### TELEPHONY FROM THE AIR.

Amateur reception from an aeroplane was tried out in Paris a short time ago when an aeroplane flew over the city transmitting telephonic messages. The transmitter operated on an 800-metre wavelength.

○○○○

#### BROADCASTING BY TELEPHONE.

Broadcasting to outlying districts by means of the ordinary telephone installations is proving successful in Holland, particularly at Meyendel, a residential district between The Hague and Leyden. It is difficult to understand why this form of broadcasting should be persevered with, unless the Hollanders are imbued with the idea of economy.

#### A CORRECTION.

In the article "Reaction Control," by Harold H. Warwick, in the issue of May 5th, 1926, the circuits of Figs. 10 and 11 on page 655 should be transposed.



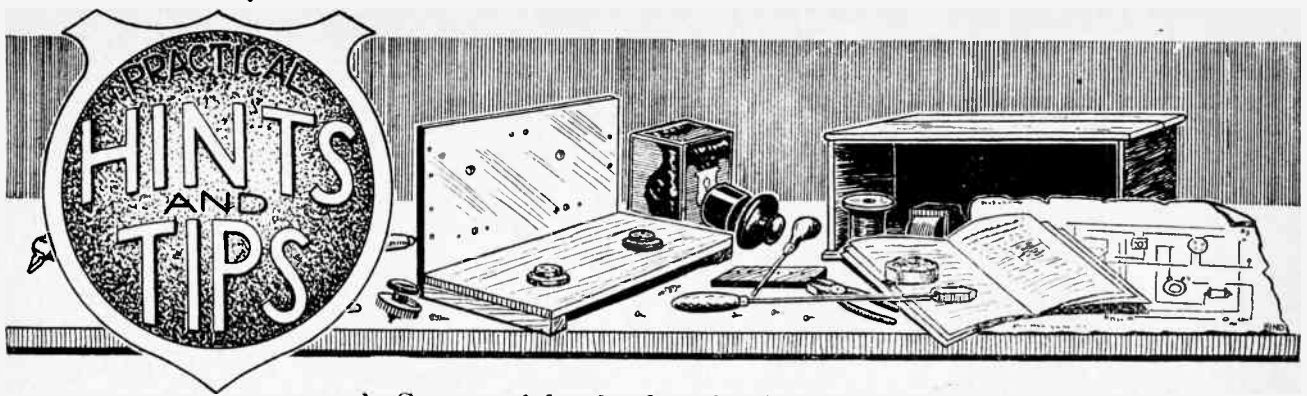

A Section Mainly for the New Reader.

**INTERMEDIATE FREQUENCY COUPLINGS.**

Although the great majority of superheterodyne receivers make use of transformers in the intermediate frequency amplifier, the constructor who wishes to make his own components should not neglect the possibilities of the "tuned anode" method of coupling, which has been successfully used both in amateur and commercial apparatus. Compared with transformers, the adoption of this device will probably not result in any appreciable economy, as intervalve condensers and grid-leaks are required for each stage, but the making of single-winding coils is certainly much simpler, and such coils need occupy only a small space.

of capacity to inductance in the various tuned circuits: it is customary to use an "input" coil of fairly low inductance, and having a large fixed tuning condenser with a capacity of about 0.001 mfd. The remaining couplings may have a considerably higher inductance and a small condenser, generally of not more than 0.0003 mfd., with the result that the tuning of these latter stages will be relatively fast, and risk of introducing distortion by the cutting-off of modulation sidebands will be reduced. The wavelength of these flatly tuned circuits may be adjusted to coincide with that of the input circuit by varying either capacity or inductance. The former alternative is probably the more con-

venient, and may fairly easily be removed turns from the winding. It will be found best to use valves of the high amplification type in the tuned anode stages: the majority of those primarily designed for resistance-coupled amplification will be found eminently suitable.

o o o o

**SOLDERING FLUX.**

It was recently stated in these columns that a good non-corrosive flux can be easily made up by dissolving resin in ether. Several readers have pointed out that they are using methylated spirit as a solvent, with good results. Although the substitution mentioned is certainly possible, it would seem that the use of ether is preferable, more particularly when the metal surfaces to be soldered are not perfectly clean.

It should be pointed out that ether is highly inflammable, and consequently great care should be taken when using it.

o o o o

**POTENTIOMETERS.**

A mistaken impression seems to exist to the effect that the resistance value of a potentiometer is governed by the type of circuit in which it is used. As far as wireless receivers are concerned, this is quite erroneous; actually, the resistance of the winding cannot well be too high. If this is low, an excessive amount of current may be drawn from the battery across which it is connected.

It should be remembered, however, that the greater the resistance of the potentiometer the greater becomes the need for a by-pass condenser, which should be of low reactance compared with that of the winding.

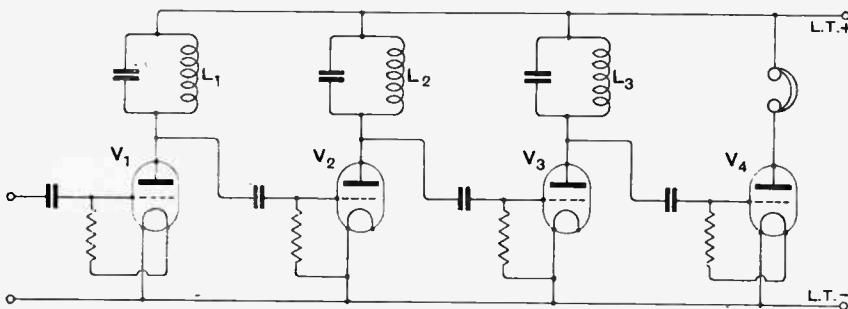

Fig. 1.—Intermediate frequency amplifier with "tuned anode" couplings.

In Fig. 1 is shown an arrangement on these lines, having a tuned anode input coil in series with the plate of the first detector, and two stages of intermediate frequency amplification coupled together on the same principle. There is, of course, no reason why three I.F. amplifiers should not be used, following standard practice.

The overall degree of selectivity will be influenced by the proportion

venient, and may fairly easily be carried out with the use of semi-variable condensers, such as those constructed with an outer electrode in the form of a winding of tinned copper wire, with adjacent turns touching and lightly soldered together. The capacity of these condensers may be varied with a sufficient degree of accuracy for the purpose of matching by adding or

**SOLDERING TAGS.**

It is rather unfortunate that many manufacturers, probably with a view to improving the appearance of their products, are in the habit of fitting nickel-plated brass soldering tags. It is generally found that the solder refuses to "run" freely on this surface, and, as a rule, it will

be best to file off the coating of nickel until the brass can be seen.

Many tags are made of brass or copper with a coating of tin; these are, at a glance, similar in appearance to the nickel-plated ones, and are almost certainly the best for general use. The amateur should assure himself on this point before going to the

trouble of removing the metal coating, as solder will always flow freely on a tinned surface.

The same precautions should be taken when dealing with plated terminal shanks or other metal parts which are to be soldered. The trouble is generally due to the deposition of a film during the finishing process.

**DISSECTED DIAGRAMS.**

**No. 31 (a).—Stage-by-Stage Tests of a Superheterodyne Receiver.**

*A consideration of the series of circuit diagrams given below will indicate an effective and logical course of procedure to be adopted when searching for faults in a set which is totally or partially inoperative. The method is obviously applicable, with modifications, to other receivers operating on a similar principle, but of slightly different design. Further tests of a superheterodyne will be shown in our next issue.*

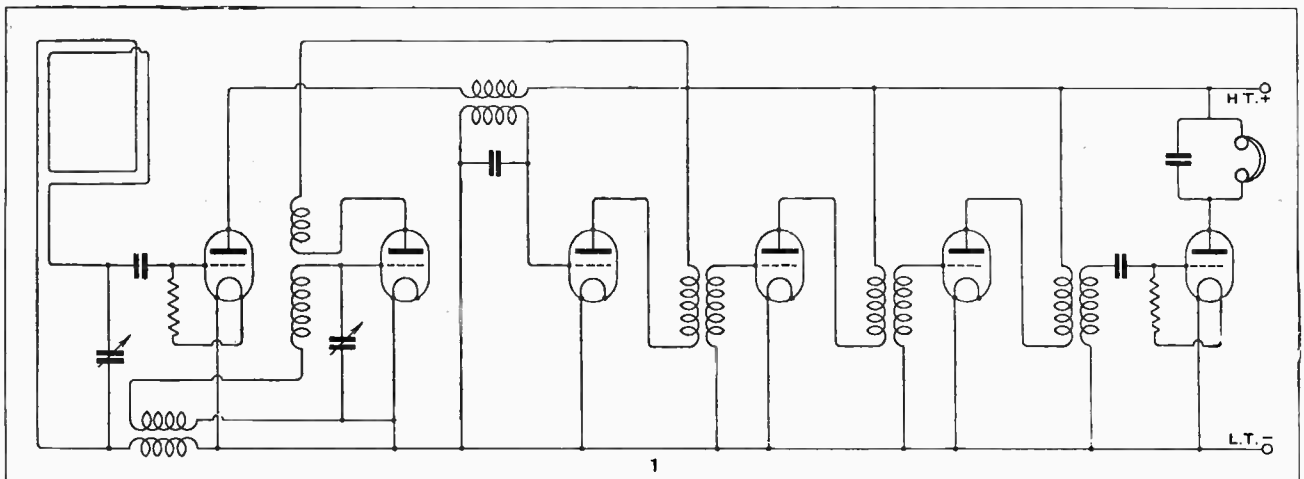

The complete circuit diagram of the receiver. It is assumed that the usual cursory examination and simple tests have failed to indicate any source of trouble. Filament circuits are omitted.

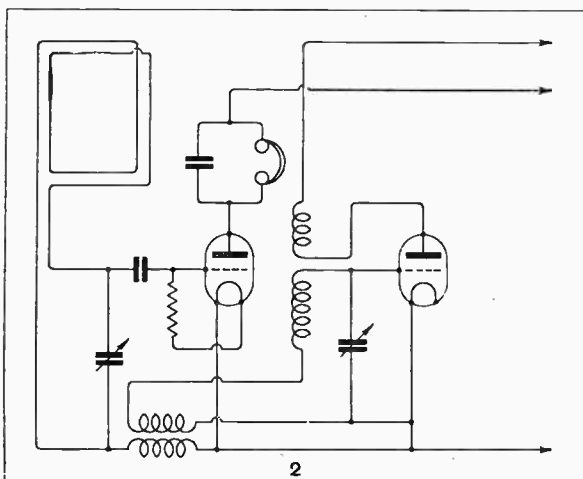

The first detector and its associated circuits may be tested by connecting the phones in series with its anode. Unless near to a broadcasting station, it may be necessary to couple an aerial system to the frame. The operation of the oscillator may be checked by noting if a beat note with the incoming carrier wave is produced when its tuning is varied.

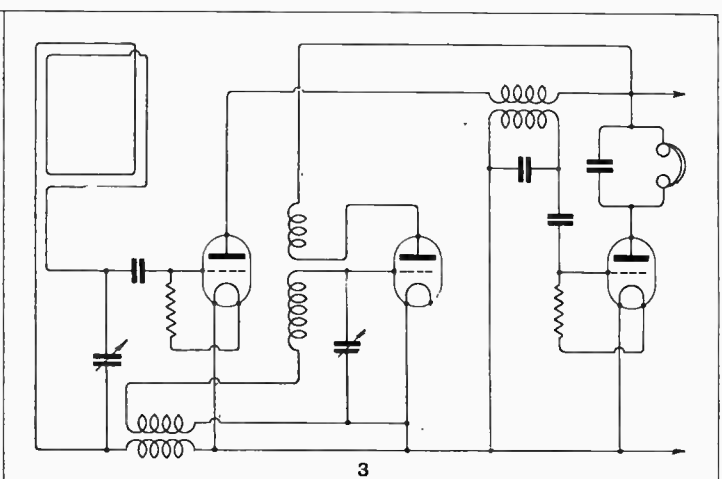

The phones are now transferred to the anode circuit of the first I.F. amplifier, which is converted to a second detector by the insertion of a leaky grid condenser. This test will provide a check on the operation of this valve, and also of the frequency-changing arrangement as a whole, although loud signals should not be expected.

# SPEECH AMPLIFIER DESIGN.

Further Considerations Arising out of Correspondence on the Original Article.

By N. W. McLACHLAN, D.Sc., M.I.E.E., F.Inst.P.

THIS article is a reply to a number of queries concerning the high-inductance transformer described by the author in this journal on January 13th, 1926. Some misconception appears to have arisen regarding the design and manufacture of the transformer, and it seems advisable to attempt to allay any doubts. It was desirable to use a core of standard design in order to keep the size and weight of the amplifier within limits and to avoid departing from the standard sizes suited to the winding machines. A simple calculation showed the number of turns required to give a certain inductance (the reader can see for himself that it is 1 henry per 1,000 turns), and as a consequence three 5,000-turn sections such as are used in certain standard transformers were chosen for the primary winding. Now some secondary sections of 9,000 turns each had been wound for a special experiment. Three of these, giving 27,000 turns, was 3,000 short of the 30,000 to give a 2:1 ratio. Accordingly, three 5,000-turn primary sections were sandwiched with three 9,000 secondary and one odd 3,000-turn secondary was added to make up the proper ratio. There was, therefore, no difficulty, since the sections were interleaved in the usual manner. It is perhaps only reasonable to add that one cannot wind sections accurately enough without special machines, and care must be taken to get wire with the best enamel. Faulty enamel is frequently encountered in small sizes of wire, and it is essential to subject each section to about 0.5 volt between turns. Tests are made afterwards, for either short-circuited turns, or turns where the insulation resistance is sufficiently low, to alter the performance of the transformer. An appreciable amount of short-circuiting will be equivalent to a large reduction in the primary inductance.

## Testing for Short-circuited Turns.

In our particular case this is exactly what is most to be avoided, since we aim at high primary inductance. Short-circuited turns can be readily tested by means of a feebly excited note oscillator and a pair of telephones loosely coupled thereto by an auxiliary coil. Under normal conditions the note is just audible. By bringing the faulty coil near the oscillator, the damping will be enhanced and the oscillator will be extinguished. On removal of the coil the note should be heard, otherwise the adjustment of the reaction is too critical.

I have at no time discussed whether this transformer is or is not a commercial article. It was made as indicated above, chiefly from standard parts, to fulfil a certain function, namely, to give uniform amplification from 50 cycles upwards, and to have a rising characteristic at the higher audio-frequencies in order to alleviate the influence of aerial and tuned anode circuits in attenuating such frequencies. Also it was found possible by proper combination of the primary sections (either

omitting or paralleling one with another), to get ratios of 2:1, 3:1, or 6:1, thereby giving great flexibility not only in the tone but in amplification. Furthermore, the amplification could be varied not only by the ratio tap, but by altering the valve. Using a 3:1 ratio and a D.E.5B., the magnification is 60 and is uniform down to 140 cycles.

One of these transformers has been in continual service for nearly two years. The winding is tested periodically and shows no signs of breakdown. The switching arrangement to the amplifier is such that the windings are never subjected to high-voltage kicks.

## Possible Cause of Primary Breakdown.

In general, very fine wire is extremely troublesome, and transformer primaries often become open-circuited. For this reason the diameter of the wire may be increased with beneficial results, especially if it is silk-covered. Several theories can be advanced to account for this defect. One theory is as follows: On switching off the H.T. battery (depends on connection) a high voltage is generated in both windings. An arc occurs between turns so that the insulation is burnt off. When this "kicking" process occurs sufficiently often, the arc has severed one or more turns. Alternatively the acids in the wax or insulating varnish attack the wire which is often impure and causes local electrolytic action similar to that in an accumulator. Ultimately the wire is eaten away until the circuit is open.

The cracking heard when a transformer is in a state of senile decay may be due to arcing across at the break, the application of the H.T. being sufficient to set the ball rolling. In one case which I examined the primary was broken in several places. A microscopic examination showed one-half of the break to be pointed, whilst the other had a crater-like appearance resembling an arc carbon. These shapes may have resulted from arcing.

In the case of "Nichrome" wire wound on ebonite where there is usually a film of sulphuric acid especially in damp, warm atmosphere, there is electrolytic action resulting in many breaks. The action is due to the presence of impurities and unalloyed metal, thereby forming small primary cells.

If these difficulties can be overcome, the design of high-inductance transformers on a commercial basis should be comparatively easy.

## Magnetic Condition of Iron in Amplifier.

There is one point which must be observed, namely, the magnetic condition of the iron. With a D.E.5 or L.S.5 valve the anode feed current causes an appreciable polarisation of the transformer core, and this must be kept away from the saturation point, or the effective primary inductance will be reduced. This means that the transformer will begin to cut off at a higher frequency in the lower register. It looks, therefore, as though the magnetic material for high-inductance trans-

<sup>1</sup> *The Wireless World*, Jan. 13th, 20th and 27th, 1926.

**Speech Amplifier Design.—**

formers should not get saturated at so low a magnetisation as iron.<sup>1</sup> This is by no means the only instance of its kind. Radio engineers are very limited in their designs by a lack of suitable conducting, magnetic, and insulating materials, and it is only when one desires to approach an ideal design that the defects in everyday commodities become very disconcerting.

**Alien Frequencies Due to Hysteresis.**

Another feature in transformer operation which merits attention is the hysteresis effect in the iron. There can be no doubt that for relatively large flux changes the voltage to the grid of the first valve is different in shape from that across the secondary of the transformer, due to the alien frequencies caused by hysteresis. This is especially the case at low frequencies, since the magnetising current *increases* as the frequency decreases. For example, for equal amplification the magnetising current at 40 cycles is approximately fifty times that required at 2,000 cycles. Thus there is much more scope for alien frequencies arising from hysteresis at 40 cycles than at 2,000. Furthermore, the alien frequencies introduced by the 40-cycle note occur within the *audible and aurally sensitive range*, whereas those due to the 2,000-cycle note occur chiefly outside the range. Calculation indicates that in the special 2:1 transformer described in the January 13th issue the maximum flux density  $B_{max}$  is from 20 to 25 lines per square centimetre when the peak voltage across the secondary winding at 40 cycles is 7 volts. The flux density is very low, although the output voltage is fairly high. The figures have more meaning when we consider a primary of only 20 henries, for the flux density would then be of the order 250 lines per sq. cm., which would almost certainly entail a greater proportion of alien tones. It is of interest that there is a case where hysteresis causes no alien tones. This arises if the hysteresis loop is elliptical. Obviously a circle and a

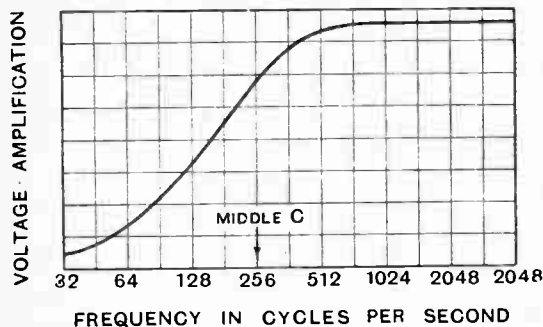

Fig. 1.—Form of voltage amplification curve of double note amplifier under following conditions: Detector valve "R" followed by 3:1 transformer (primary 40 henries); first amplifier, D.E.5, followed by 4:1 transformer (primary 15 henries).

straight line are particular cases of the ellipse. The straight line would mean zero hysteresis loss combined with zero distortion.

The preceding remarks are based upon the behaviour of the iron under the influence of a *single* input fre-

<sup>1</sup> The push-pull system would be of service in reducing saturation difficulties. To get the requisite primary inductance two ordinary size cores would be required, or one special core.

quency. In telephonic reception many frequencies act in a concerted fashion. Now it is known that the magnetic behaviour of iron at, say, 40 cycles is influenced by the action of the magnetisation due to a higher frequency, say, 2,000 cycles operating conjointly especially at low flux densities. The effect is to reduce the hysteresis at the lower frequency. What, then, is the behaviour of iron in an audio-frequency transformer with a multiplicity of frequencies present? The answer to this ques-

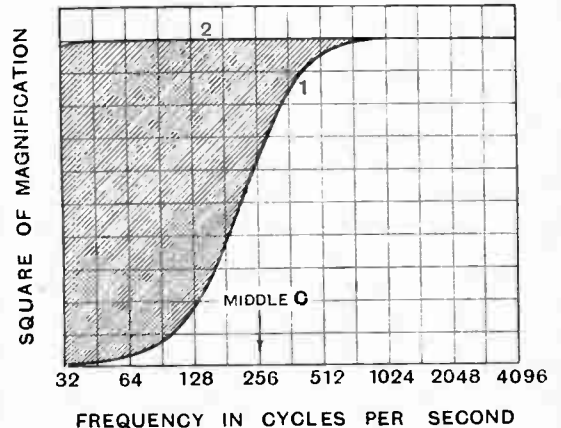

Fig. 2.—Output intensity curve (1) of arrangement indicated in Fig. 1 compared with curve (2) of variable characteristic amplifier under the following conditions: Detector D.E.5B resistance or choke coupled to D.E.5 with 2:1 transformer (primary 225 henries). The shaded area represents low tone loss of double transformer amplifier

tion is best obtained from an examination of voltage wave forms of input and output. It is to be hoped that some investigator will tackle the problem. Care must be taken to avoid alien frequencies due to non-linear valve characteristics. In some recent experiments with power valves using a high tension of 350 volts and a negative grid bias of 80 volts there were visible—not audible—indications of working beyond the linear portion of the characteristic with a grid swing of +20 to -20 volts using pure A.C.

Suppose an experimental examination reveals the creation of appreciable alien frequencies due to the iron, particularly in the lower part of the acoustic register. Are we to scrap transformers in order to attain greater purity of tonal reproduction? It would be illogical to eliminate transformers at the receiver on this score alone until iron is eliminated from the many other parts of the broadcasting system, e.g., microphone, transmitter, land line and other amplifiers, loud-speakers. In any case, before any radical change is effected, it is necessary to prove not merely the existence of alien tones, but that they can be appreciated aurally

**Overall Receiver Characteristics.**

Coming now to the problem of overall characteristic curves of a receiver, a statement appeared recently under "Readers' Problems" in this journal, which might have created the impression that high-inductance transformers of the type described by the author previously are only a luxury and that the usual two-valve transformer-coupled amplifier with high-impedance detector could give a performance little short of a resistance-coupled detector followed by the 2:1 special

**Speech Amplifier Design.—**

transformer. Now let us compare the curves for two such amplifiers. The lower tones must be supplied electrically to a loud-speaker to be reproduced acoustically. The acoustic output depends upon the square of the ordinates of these curves, and to make the comparison more readily grasped Figs. 1 and 2 are given. With a loud-speaker of reasonable characteristics, can it seriously be expected that curve 1 (Fig. 2) will give the same acoustic result as curve 2? The answer must be "No." There is, however, an exception—the inevitable one which proves the rule to be man-made—when the loud-speaker has a *very weak lower register*. In this case the lack of sensitivity in the bass register is so great that no appreciable difference in quality would be detected with (1) an amplifier of uniform characteristic, (2) an amplifier which cuts off at, say, 400 cycles. We are, therefore, in a position to make a definite statement as follows: If there is no detectable difference between the output of a loud-speaker under the two preceding conditions, it follows that the loud-speaker has a defective lower register. Should the reader meet with this misfortune, I think he ought to endeavour to construct at least a temporary loud-speaker with a good lower tone register. By following the principles set forth in recent publications,<sup>1</sup> there should be no difficulty in evolving some form of diaphragm instrument with a good bass. The results would give some satisfaction and would be an attempt to arrive at the truth—a very elusive attribute in this commercial era.

In my amplifier there is an arrangement for switching from one condition to the other. The effect of *rapid switching* is very marked, and this was demonstrated at a recent meeting of the R.S.G.B.<sup>2</sup> when the lower tones disappeared entirely.

It has been tacitly assumed throughout that deliberate H.F. reaction is absent from the receiver. Even with reaction the improvement in the bass would be obtained not only at the expense of the treble, but there would be a lack of definition due to the low damping of the H.F. circuit. Thus one cannot have it both ways.

cies.<sup>3</sup> Thus to compensate for this, the amplifier characteristic should slope upwards where the L.S. curve slopes downward. With some loud-speakers it is not always a practicable proposition to get a suitable amplifier characteristic, since the cut-off is too severe.

It is reasonable—but not exclusive—to take uniform input to the power valve at all frequencies as a standard to be attained for the amplifier. In the loud-speaker demonstrated to the R.S.G.B. this condition was approximately fulfilled, and the practical results justify the hypothesis.

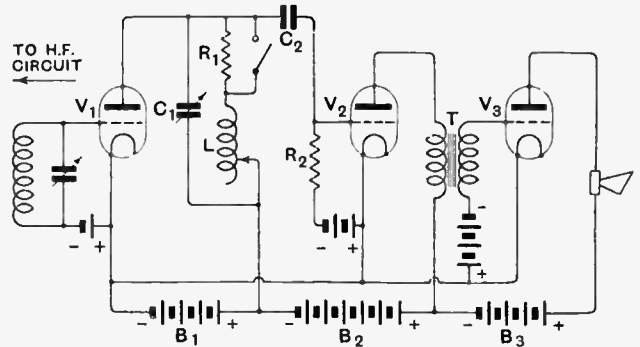

Fig. 4.—Experimental amplifier with variable characteristics. For details see Tables I and II.

The loud-speaker, be it noted, was a *coil driven* cone diaphragm, with a minimum of constraint, so that the upper and lower cut-off common to the reed-driven type were absent. But it is possible to design large diaphragm loud-speakers with reed drive having a less pronounced cut-off than one usually meets.

**High-Frequency Tuning.**

An examination of the lower curve of Fig. 3, which is reproduced from the original article, shows a fairly rapid falling away at the higher frequencies. This is clearly due to the comparatively sharp tuning of the aerial and closed circuit. This tuning is much sharper than would be obtained in the average set without reaction, and the curve can be taken to represent a fair degree of selectivity. It will be seen from Fig. 3 that the signal strength at  $f=5,000$  cycles is reduced to 0.3. This is about as much as can be allowed for reasonable reproduction, but it depends upon the characteristic of the loud-speaker.

The aerial and closed circuit curves of Fig. 3 were found separately, and the combined curve obtained by taking the product of corresponding ordinates. Although for present purposes this curve is quite convenient as a reference, it is different in shape from that obtained in practice. This arises from the omission of the influence of electrostatic and electromagnetic coupling.

Both of these flatten the tuning, and therefore the higher audio frequencies will not be reduced to the extent indicated by Fig. 3. Although a loose magnetic coupling is used, the energy ( $i^2R$ ) dissipated in the closed circuit is drawn from the aerial. The effective resistance of the aerial is increased therefore in virtue of the proximity of the closed circuit. Hence the aerial tuning measured with

<sup>3</sup> *Experimental Wireless*, loc. cit.

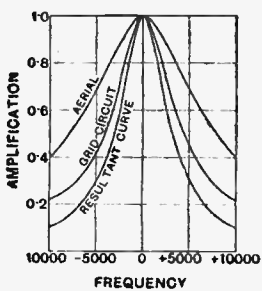

Fig. 3.—Selectivity curves for aerial and tuned grid circuit with resultant curve of the two circuits in combination. A loose coupling between the two circuits has been assumed.

**Standards of Reference.**

Unless there is some standard of reference at which to aim, the problem of quality will remain a purely arbitrary matter. Given a definite relation between air-pressure and voltage output from the transmitter, the performance of a receiving set *plus* loud-speaker can be visualised from the characteristics of transmitter, receiver, and loud-speaker.

The general characteristic of a diaphragm or a horn-type

loud-speaker shows a cut-off at high and at low frequen-

<sup>1</sup> *The Wireless World*, Nov. 4th, 1925. *Experimental Wireless*, p 152, March, 1926.

<sup>2</sup> *Experimental Wireless*, loc. cit.

**Speech Amplifier Design.—**

the closed circuit in operation will be flatter than that shown in Fig. 3.

Instead of the isolated transformer amplification curves one meets to-day, it would be well if the overall amplification-frequency curves of the complete receiver at some definite wavelength on a standard dummy aerial, using appropriate valves, H.T., etc., were given. The intelli-

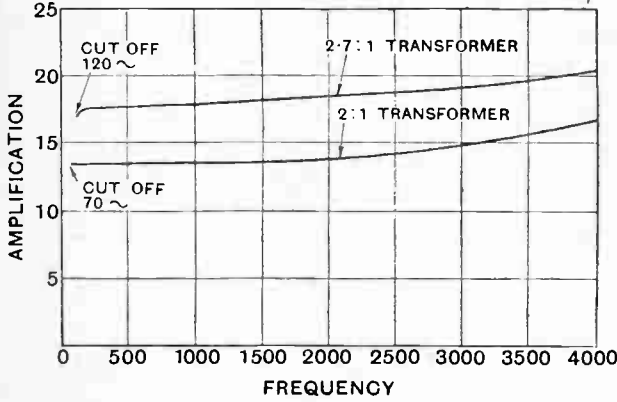

Fig. 5.—Approximate overall characteristic of amplifier in Fig. 4 with resistance R in anode circuit of detector. 2.7:1=50 henries, 2:1=100 henries.

gent user, instead of groping in the dark, could see what was going into the loud-speaker. Further, if loud-speaker curves were available, the user would be able to ascertain the output curve for the installation. Finally, if the output curve of the transmitter were published from time to time, broadcasting would surely make more rapid progress in its endeavour to attain better reproduction. The basis would be of a scientific nature, and the quantitative results could not be gainsaid.

**Experimental Amplifier.**

In order that the reader may experiment for himself, a modified arrangement of the speech amplifier illustrated on page 44 of the January 13th issue will be described. Fig. 4 shows such an amplifier, and it is to be assumed that any high-frequency amplification preceding the detector is devoid of reaction, within the practical meaning of the term. Table I shows some of the possible combinations, whilst Table II indicates the approximate amplification. The cut-off point is taken as the lower frequency at which the amplification has fallen to 95 per cent. of that on the horizontal portion of the curve. It will be realised that for the best quality there must be some sacrifice in magnification. By using appropriate valves and inverting the positions of the transformers in a double note magnifier, so that the high ratio is used as a choke with the detector, and the low ratio is used for the note magnifier, the quality can be enhanced appreciably with little change in overall intensity from the loud-speaker. From Table II it will be seen that case (1) is the best for all-round work. Not only is the amplification greater than that with the double note magnifier, but the cut-off—which is less acute—occurs 100 cycles lower down. Comparing (2) and (5) in Table II, the amplification of (5) is double that of (2). But the lower tones in (5) are not magnified appreciably, since cut off occurs at 400 cycles.

TABLE I.—Data for Fig. 5.

V <sub>1</sub>	V <sub>2</sub>	V <sub>3</sub>	Remarks.
D.E.5B, R or D.E.3B.	D.E.5 or L.S.5.	D.E.5A or L.S.5A.	(1) With R <sub>1</sub> in anode of detector alone the overall curve from V <sub>1</sub> to V <sub>3</sub> will be approx. of form shown in Fig. 5.
R <sub>1</sub> =0.05 to 0.2 megohm.	C <sub>2</sub> =0.1 mfd. mica.		(2) With L=20 in anode of V <sub>1</sub> (upper curve) the low tones will be cut off (see Fig. 6, p. 46, "The Wireless World," January 13)
L=20 and 200 to 400 henries.	R <sub>3</sub> =2 megohms.		(3) Introducing R <sub>1</sub> puts low tones in.
C <sub>1</sub> =0.003 mfd. variable. Valve set for anode rectification. B <sub>1</sub> =40v.	T=High inductance transformer, e.g., 2.7:1	B <sub>2</sub> =80 to 120v.	(4) Incorporating C <sub>1</sub> reduces high tones.
		B <sub>3</sub> =40v.	

TABLE II.—Data for Fig. 5 and comparative data for double note magnifier.

No.	V <sub>1</sub>	V <sub>2</sub>	Gross mag. from grid of V <sub>1</sub> to grid of V <sub>3</sub> *.	Cut off frequency (95% mag. on horizontal portion).
1	D.E.5B with 400 henry choke.	D.E.5B with 2.7:1 transformer.	1,000	300 cycles
2	Ditto	D.E.5 with 2.7:1 transformer.	360	120 "
3	D.E.5B with res. 0.1 megohm.	D.E.5B with 2.7:1 transformer.	500	300 "
4	D.E.5B with res. 0.1 megohm.	D.E.5 with 2.7:1 transformer.	200	120 "
5	R with 2.7:1 transformer	D.E.5 with 4:1 transformer.	700	400 "

\* Modulation factor at detector is neglected.

Thus the total intensity is not increased to the extent indicated by the amplification on the horizontal portion of the curve. It is to be understood that the loud-speaker is assumed to have a good bass.

One important experiment bearing upon the relative merits of the curves of Fig. 2 can be conducted as follows: using a high-impedance valve, V<sub>1</sub>, couple V<sub>1</sub> to V<sub>2</sub> (Fig. 4) by a grid leak of the order of 0.1 to 0.2 megohm, and by a switching arrangement substitute a choke of 10 to 20 henries in place of the resistance. The lower tones will immediately vanish, but will reappear when the resistance coupling is reinserted. This experiment is best conducted on an orchestral item (not jazz), with a full lower register. After the experimenter knows what to look for, he will obtain the same effect with various items. In fact, it is interesting to discover exactly what instru-

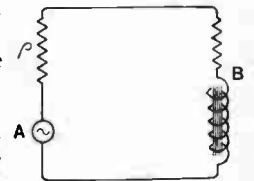

Fig. 6.—Equivalent electrical circuit of loud-speaker in the anode circuit of a power valve.

**Speech Amplifier Design.—**

ments, voices, etc., are appreciably affected by this procedure.

It cannot be too strongly urged that the human ear is a peculiarly elusive organ. In broadcasting, one has to deal with what is termed the "average" ear, which requires a little tuition and some reforming. Unless the "trained" ear knows what to look for in the reproduced version of music, etc., it can readily be deceived. I have on several occasions tested "average" ears, and found that at first the tendency was to give preference to a reproduction which had resonances—not pronounced—and which was appreciably less natural than a certain standard receiver with coil-driven cone loud-speaker.

When the defects were pointed out, the listener changed his mind about the quality of reproduction, and his former decision was permanently reversed.

**Aural Accommodation.**

Now there must be a reason for this behaviour. It seems that, for some psychological cause, the ear expects a reproduction to be unnatural; in fact, one unconsciously presupposes this to be the case. Also, the ear becomes so accustomed to the type of reproduction emanating from an ordinary loud-speaker, that a really good one does not, on first hearing, uphold the customary traditions. In fact, the ear becomes aurally drugged; rather an unpleasant statement, but unfortunately true, nevertheless.

So much for the "average" ear, but what shall we say of the "other ears." The musical ones can, with a little tuition, be left alone, but what of those which, according to Shakespeare, are "fit for treasons, stratagems, and spoils"? I have no polite answer to this question. Maybe the use of acoustic filters or some surgical treatment are the only remedies.

Whatever course is pursued in the interim, the ultimate aim must be to make the air pressure at every instant in the reproducing room equal to that in the studio or auditorium. This probably entails the absence of appreciable reflection from the walls in the reproducing room, but at the moment that aspect is of minor importance compared with the other issues, although it is undoubtedly of importance.

**Increasing the Output from a Loud-speaker.**

A point which has been raised by a reader is the increase in output likely to be obtained by putting several valves of the same class in parallel. This can be studied very conveniently by the aid of an equivalent circuit, as shown in Fig. 6.

The alternator A and resistance  $\rho$  are equivalent to the valve, whilst B is the loud-speaker or an equivalent choke-condenser or transformer circuit. Now we assume A to generate equal voltage at all frequencies for all values of  $\rho$ . If, for the sake of convenience, we treat the loud-speaker as an inductance in series with a resistance, and neglect the motional effect of the reed,<sup>1</sup> the problem is simplified and the general conclusion is unaltered, excepting at fairly low frequencies.

<sup>1</sup> This at low frequencies is chiefly equivalent to a condenser in series with the circuit, and it obviously reduces the low tones.

Taking a frequency of 256 cycles (middle C on piano) an inductance of 3 henries, an effective resistance of 3,000 ohms, and a D.E.5 valve ( $\rho=7,000$ ), the total impedance of the circuit is approximately 10,000 ohms.

If, now, two D.E.5 valves are used in parallel, the impedance would be 7,000 ohms. Hence the ratio of the

currents in the circuit would be  $\frac{10,000}{7,000}$ , i.e.  $\left[ \frac{2 \text{ valves}}{1 \text{ valve}} \right]$

$= 1.43$ . The effect of the second valve would be to double ( $1.43 \times 1.43 = 2$ ) the energy output from the loud-speaker at 256 cycles. In fact, since the reactance ( $2\pi f \times 3$ ) is relatively unimportant below 256 cycles, the acoustic output would be doubled at frequencies lower than 256, and augmented in proportionately lesser degree above 256 cycles. When tested experimentally, two conditions must be fulfilled: (a) there must be low tones in the transmission, i.e., do not test speech to get an appreciable effect, but try an orchestra; (b) the loud-speaker must be reasonably sensitive to low tones.

Suppose we go a step further and use three D.E.5's in parallel. The impedance at 256 cycles will then be

6,000 ohms. The current ratio is now  $\frac{10,000}{6,000} = 1.67$ ,

and the intensity ratio ( $1.67^2$ ) = 2.8. The latter is only 40 per cent. in excess of the intensity with two D.E.5's, and bearing in mind that there is not so much alteration in the frequencies above 256 cycles, it is doubtful whether the addition of the third valve would be noticeable. In any case, it would serve no useful purpose. We may, however, carry the process a step further and try seven D.E.5's in parallel. The impedance is now about 5,000 ohms, giving a current ratio of 2 and an intensity ratio of 4. The effect of this arrangement would probably be perceptible, but very unpractical. The proper course would be to use either a D.E.5A or an I.S.5A.

**Loud-speakers in Parallel.**

Obviously, from the foregoing analysis a plurality of the latter valves would not affect the intensity one iota. Consequently, we are compelled to look in other directions for an increase in output. Suppose we use an I.S.5A: this will enable the maximum output to be obtained from the loud-speaker. Now let us split the winding and use each of the two coils with an I.S.5A. The alternating current through each coil will now be greater than before, due to the reduced impedance of each circuit, and the intensity will be appreciably greater. To obtain still greater intensity—with the same H.T. voltage—the best policy is to reduce the impedance of the loud-speaker by using four coils, or by employing several loud-speakers in parallel. It will be clear from the equivalent circuit of Fig. 6 that the desideratum is alternating ampere-turns, and although reduced turns may mean augmented current, care must be exercised that the product of the two shall increase. Incidentally, it is of interest to remark that the dead loss resistive component—apart from the useful work component—should be kept as small as possible to obtain a good low-tone register.<sup>2</sup>

<sup>2</sup> The lower register is also reduced, due to the motional impedance resulting from the E.M.F. induced in the winding due to the motion of the reed. This is remedied by using a large diaphragm.

**Speech Amplifier Design.—**

It may be just as well to mention that unless the impedance of the loud-speaker is very low, e.g., the coil-driven cone,<sup>1</sup> the output cannot be increased by the use of a transformer. The desideratum is a design where the dead loss resistance and motional impedance (capacity component) are reduced, and the useful work component of resistance is relatively increased for any given inductance.

**Conclusion.**

In conclusion, it may be of interest to point out the advantages of the high-inductance transformer as follows:—

(1) It enables uniform amplification to be obtained over a wide range of frequency.

<sup>1</sup> 2 to 5 ohms in this case. A transformer can be used with larger resistances than this, e.g., 60 ohms.

(2) The increase in amplification at the higher frequencies enables a correction to be made for the effect of H.T. filter circuits<sup>2</sup> in attenuating the higher audio frequencies.

(3) The higher ratio of  $\frac{L}{\rho + R}$  involves a smaller phase shift of various frequencies, thereby assisting transients.

(4) The high inductance means a small flux change at low frequencies, thereby reducing the amplitude of alien frequencies due to hysteresis.

(5) It enables a variable ratio to be secured.

(6) It enables a large uniform magnification to be obtained over a wide range of frequency (60:1 with a D.E.5B valve).

<sup>2</sup> Where extreme selectivity is required the increase at the higher audio frequencies due to the transformer is not wanted since it reintroduces jamming.

**Ludlow, Salop.**

Brazil: 1AA, 1AB, 1AC, 1AE, 1AF, 1AH, 1AL, 1AN, 1AO, 1AP, 1AR, 1AV, 1AW, 1AX, 1AY, 1BC, 1BD, 1BF, 1IB, 1IA, 1IC, 2AB, 2AC, 2AF, 2AL, 2AJ, 2SP, 1LW, SQ1, PT1, PT2, PT3, PT5, 5AA, 5AB, 6QA. Philippine Islands: 1HR, 3AA, NEQQ, NAJD, NPO. Argentine: CB8, DB2, FA1, FA2, DD7, DG2. New Zealand: 3AF, 1AX, 2AE, 1AO, 2AC, 4AL, 4AC. Australia: 3XO, 5BG, 3AD, 3EF, 3BD, 4RB, 6AG, 3KB, 2BK, 2TM, 3HL, 3WM, 2CG, 3BQ, U.S.A.: 4AAE, 4AAH, 4RZ, 4SA, 4JE, 5ATX, 5YD, 5ZAI, 5JF, 5NQ, 4UR, 4WE, 6ZR, 6BHZ, KFUH, 7QR. Chile: 2LD, 3AT, 9TC. French Indo-China: 8QQ. India: HBK, CRP, 2BG. Uruguay: JCP, CDI. China: GFUP. Egypt: EG EH, 1DH. South Africa: A3B, A4V, A4Z, A6N. Canada: 1AR, 2CG, 3HE, 3KP. Borneo: H.M.S. "Hermes." Canada: U 99X. Portugal: 3FZ, 3GB. Others: LA 1A, LA 1B, NTT. Australia: 2CG, 2CM, 2CS, 2BK, 2TM, 2YI, 2LM, 2IJ, 3KB, 3XO, 3HL, 3WM, 3BQ, 3BD, 3EF, 3AD, 4RB, 5KN, 6AG. Tasmania: 7CW. New Zealand: 1AN, 1AO, 2AE, 2AC, 2XA, 3AF, 4AL, 4AC, 4AV, 4XA, 4AK, VLB. South Africa: A 3B, A 4L, A 4V, A 4Z, A 5T, A 6N. North Rhodesia: O 1SR. Uruguay: JCP, 1CD, 2AI. India: 2BG. Philippine Isles: 1HR, 3AA, NPO, NAJD, NEQQ, CD8. Chile: 2LD, 3AT, 9TC. Siam: HGK. Hawaii: KGI. British North Borneo: H.M.S. "Hermes." Russia: R 1ND. Canada: 1AR, 1ED, 2CG, 3HE. China: 8QQ, HYA, GFUP, 8LBT. Ceylon: GFSQ. Porto Rico: 4SA, 4JE, 4RX. Java: ANF. Others: 4FB, GEFT, KFUH, U 6XI, U 5JF, U 5NQ, WGHM, NOXQ.

(0-v-1 Reimartz) on 30-40 metres.

A. G. Livesey.

**Douglas, Isle of Man.**

Great Britain: 6YQ, 6YD, 6ZC, 6MU, 6UT, 6YW, 6HF, 6JH, 6JV, 6YC, 6QB, 6BJ, 6YK, 6IV, 6RM, 6RD, 6TD, 6BD, 5SO, 5JW, 5VG, 5VL, 5HJ, 5YM, 5TD, 5SI, 5MA, 5NJ, 5GW, 5SK, 5WV, 5FQ, 5WQ, 5AF, 5YG, 5UW, 5XM, 5SJ, 5NN,

## Calls Heard.

### Extracts from Readers' Logs.

5OC, 5YK, 5KU, 5PO, 2XX, 2FD, 2WW, 2XX, 2MX, 2BI, 2VQ, 2OQ, 2EP, 2ZA, AKB, EBX, AKA. France: 8KT, 8PEP, 8ZN, 8ISM, 8RST, 8SMR, 8DK, 8RVL, 8YOR, 8IL, 8GI, 8PGL, 8DP, 8JF, 8JRK, 8AH, 8PAM, ONM, OCNG. Holland: OPX, OWB, OWF, OWC, OXH, OPN, PC2, 2PZ. Belgium: W1, S4, J6, S5, E9, O8, B1, D4. Denmark: 7BX, 7MT. Scandinavia: SSMW, 5NB, SMU, 2CO, SMWF, 2ND. Germany: 4LV, Y1, K7, W3, Y5, KPL. Italy: 1AS, 1AX, 1AY, 1BW, 1GN, 1CN, 1CR, 1BK. Spain: EAR20, EAR21, EAR22. Miscellaneous: P 3FZ, WF, 3OK, GW 3XX, GW 3ZZ, BZ 1AW, BZ 1AC, BZ 1AP, BZ 1AL, U 1NO, U 3HG, TUK. (0-v-1) 30-50 metres.

B. C. Christian.

**Meersbrook, Sheffield.**

(March, 1926.)

France: 8MAC, FW, 8GO, 8TK, 8BUM, 8JYZ, 8FU, 8GI, 8PEP, 8KB, 8SOT, 8GRA, 8HM, ONM, 8HU, 8JM, 8WMS, 8VX, 8YOR, 8CN, 8UD1, 8RBP, 8VO, 8JMS, 8JNU, 8BU, 8AR, 8IX, 8IP, 8FMG, 8DGS, 8CP, 8WOZ, 8GSM, 8JEF, 8DK, 8BBW, 8PRD, 8NZ, 8NN, 8RF. Sweden: SMVJ, SMVH, SMUA, SMUK, SMXU, SMSR, SMWS, SDK, SMVG, SMUV, SMYC, SMTQ. Italy: 1AY, 1CE, 1AX, 1GH, 1AW, 1CT, 1BW, 1AD, 1CR, 1AS, 1CO, 1ER, 1NO, 1AT, 1RM, 1GN, 1AW, 1BB, 1GW, 1AM. Germany: K3, Y8, W7, POW, 18, K7, L7, W9, 4AJ. Belgium: S1, S3, P1, O8, B82, C22, B1, S2, U14, D4, E9, S4, J2, K3, M2, K8, V2, M8, R2, P7. Finland: 2ND, 2CO, 2NM, 2NS, 1NA, 5NF. Spain: EAR22, EAR9, EAR24, EAR21. Poland: TPAV, TPAV, TPBL. Yugo-Slavia: 7XX. Austria: AA. Portugal: 1AE. Russia: RCRL, TUK. Norway: LA1Q, LA1A, LA1W,

LA1G. Ireland: 6MU, 2IT. Denmark: 7BX, 7MT, 7ZM, 7GM. U.S.A.: 2XAF, 1CHY, 1BI, 1AJB, 1SI, WIZ, WIR, 1CMR, 1RD, 1AIU, 1CH, 1VA, 3AV, 1BV, 8XE, 2ACS, 3HG, 1XM, 2CVO, 2AEV, 2ACE, 1DI, 1BZP, 1AAO, 1ABP, 4BF, 3BD, 4MD, 1ADS, 4RM, 3XF, 1SK, 3CGS, 2AHM, 2ISM, 1AHH, 3CAB, 1AI, 3CBL, 3CHG, 2SZ, 5WR, 1CMK, 1GA, 8TU, 8DFT, 8ILY, 2NZ, 8BPL, 8ADG, NKF, 1CAL, KDKA, 8CRS. Holland: OWB, OPM, PCLL, PCUU, OZA, OWC, OFP, OWF, STB, OAX, PC2, ORW, PCK4, PCPP. Porto Rico: 4GE, 4UR, 4SA, 4RX, 4JE. Canada: 1DD, 1AR. Brazil: 1IA, 1A, 1AW, 1IB, 1AR, 1AL, 1AN, 1AP, 1BD, 1AF, 1AC, 1AO, 1BI, 1AQ, 1AJ, 1AD, 5AB. Australia: 2CM, 5KN. Chile: 3LJ. Argentina: BA1, DB2. Philippine Islands: 3AA. Morocco: MAROC. Madeira: 3GB, 3FG, 3FZ. Various: GBM, OCNG, OCMV, 4NI, KPL, NRL, PJC, OCDJ, FTUX, F3CA, BG2, CRL, X3OK, RNL, ANF, DJG, ISRA, X2M, Y1CD, TM, GW, PT3, WGHM, SP, GW3ZZ.

(0-v-1.) On 25 to 100 metres.

A. S. Williamson.

**Jersey.**

(February and March.)

New Zealand: 2AC, 4AC, 4AS. Australia: 2BK, 2YI, 3BD. South Africa: A4Z. Canada: 1AR, 1DD, 3HE, 8AR. Philippine Islands: PI 3AA. Porto Rico: 4JE, 4SA, 4UR. U.S.A.: 1AEP, 1AHH, 1ALD, 1BCM, 1BES, 1BQQ, 1BIL, 1BKR, 1BUX, 1CAA, 1CCX, 1CJC, 1CPQ, 1FO, 1GR, 1KK, 1SW, 1SZ, 1UW, 1XM, 1XZ, 1YB, 2ACS, 2ACP, 2AES, 2AFP, 2AGQ, 2AGT, 2AHK, 8APV, 2ARM, 2ATC, 2BUY, 2MK, 2PX, 2SQ, 2WR, 3ACM, 3ADB, 3BIT, 3BQJ, 3BWT, 3CAH, 3CHG, 3CKJ, 3CN, 3LD, 3MP, 3QT, 3ZO, 4RZ, 5IF, 5ZAI, 8ADM, 8BPL, 8BYN, 8CBI, 8DAJ, 8DEM, 8DRJ, 8EW, 8GZ, 8ILY, 8JQ, 8ZAE, 9BGX, 9CET, 9CK, 9EZ, 9NEG. Brazil: 1AF, 1AJ, 1BD, 1IA, 2AF, 6QA. Poland: TPAV, TPBL. Russia: RCRL, RCRN, RRP. Various: GB2, CL, B82, V6A, AKB, 4FB, SP, PIAE, ONM.

(0-v-1.) 30 to 75 metres.

J. Cutler Vincent.





# Broadcast Brevities

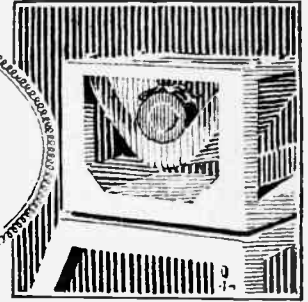

## Savoy Hill Topicalities : By Our Special Correspondent.

### Continental Relays.

The programme on Saturday last (May 29th) contained the introduction to a fresh series of attempts to relay Continental programmes to B.B.C. stations. These relays will be undertaken during June; but their continuance will depend both upon the atmospheric conditions and the quality of the programmes themselves. Until good reception is assured it is, of course, not advisable to make definite programme features of these international relays. We must obviously get beyond the present experimental stage before venturing upon any sort of guarantee that listeners will receive uninterrupted foreign programmes; and in this connection much depends upon the prospective development of apparatus that will exclude serious interference.

o o o o

### The Nightingales.

Behind the scenes at Savoy Hill, among the engineers in especial, keen

disappointment has been felt on several occasions at the unsuccessful efforts to induce the nightingales of Surrey woods to sing to broadcast listeners. Many hours have been spent in preparations which proved fruitless, and listeners afar who did not hear that first excellent broadcast in 1924, might have thought that the Surrey nightingales were a myth.

o o o o

### Three Microphones.

But the birds were magnanimous during Whitsuntide, and the best transmission yet given of their song can now be added to the record of broadcasting achievement. On this occasion three microphones were used. One was run out into the woods at the end of three quarters of a mile of cable; a second was placed within a few yards of Miss Beatrice Harrison's house to catch the strains of her 'cello as well as the song of the birds nearer home; a third was used for announcements. For the birds

the microphones were supported by two-valve amplifiers. The second microphone was dragged stealthily through the bushes until it was within a yard or two of the very branch on which one nightingale was perched, and it was this proximity that accounted for the thud of the bird's lower notes on the microphone, a phenomenon so marked that listeners might have supposed that the bird was actually perched on the microphone itself.

o o o o

### Street Scenes in London Town.

Mr. C. A. Lewis, until recently the Chairman of the Programme Board at Savoy Hill, has been making good use of his leisure since he freed himself from the shackles of the office chair. On June 11th listeners will hear the first of the special programmes which he has arranged. "Street Scenes in London Town" is the first of a series bearing the general title of "London Streets," and will consist of two episodes—"Westminster and Whitehall" and "Piccadilly and Hampstead Heath." The first episode includes an entire scene from Mr. John Drinkwater's play "Oliver Cromwell." The author has practically rewritten this scene for broadcasting. The dialogue in the second episode is the work of Miss Mabel Constanduros.

o o o o

### S.O.S. Calls.

A chart recently prepared by the B.B.C. shows that on an average about twenty S.O.S. calls are broadcast each month, of which twelve are successful, five are unsuccessful, and for the rest the result is unknown. These average figures point to a unique achievement and are eloquent of one of the noblest services that broadcasting renders to humanity; but listeners have commented on the speed with which the S.O.S. announcements are now broadcast, compared with former times. Moreover, it used to be the custom to repeat the S.O.S. in deliberate tones, so that the details were clearly emphasised. I should like to see a reversion to this method. Unless one is listening intently, a name, or the number of a house, is apt to be missed. The latter point may not matter in cases where the listener is familiar with the address of a sick relative; but I believe that in some instances it has been necessary to get into touch

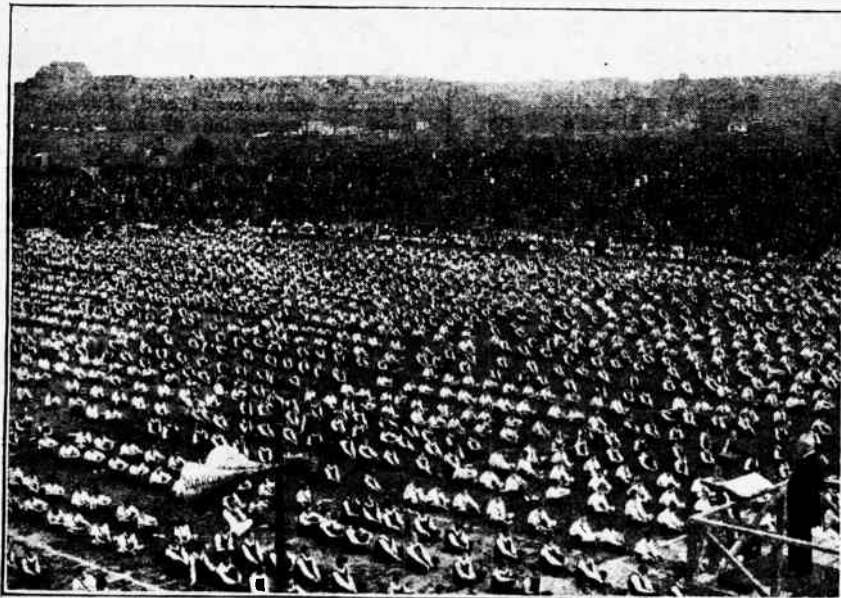

**THE INDISPENSABLE LOUD SPEAKER.** Without the aid of loud-speaking equipment it would have been impossible for Sir Ernest Cook, D.Sc., to conduct this gigantic demonstration of physical training methods at Bristol a few days ago. More than 8,500 school-children participated.

with Savoy Hill after the broadcast, to verify the particulars given.

### The Arctic Hears London.

The Church of England Mission at Shingle Point, on the Arctic coast, about sixty miles east of Herschel Island, which in turn is about fifty miles east of the Alaska-Yukon boundary line, has recently had its first experience of listening to London. Rev. W. A. Geddes writes to say that on January 11th last, at about 9.0 p.m., G.M.T., while tuning in on his receiving set, he was startled to hear the words "London Calling," and when the announcer proceeded to give the weather forecast for England, Wales and Scotland he realised that he was listening to the Motherland. The news items were much appreciated, especially as Shingle Point was still in the throes of the Arctic night and the sun had not been seen for a period of nearly two months.

### Mr. Geddes' Set.

The receiving set, in Mr. Geddes' own words, "comprises the so-called super-heterodyne circuit, having six peanut vacuum tubes, or valves, with an additional tube for operating the loud-speaker." The set was presented to the Mission by the Anglican Young People's Association of the City of Toronto. The Mission is in the diocese of Yukon, and its work is among the Eskimo people who are scattered along the Arctic coast.

### The Bells of Loughborough.

There is a double interest attaching to the wonderful carillon which listeners will henceforward be fortunate in hearing at intervals from Loughborough. The bells have been provided by the people of Loughborough to perpetuate the memory of their fellow-townsmen who gave their lives in the Great War. The purity of tone and accuracy of tune of the bells testify to the pre-eminence of this carillon which the B.B.C. is sparing no effort to transmit faithfully and without distortion.

### A Permanent Line.

The best position for the microphone has been found to be in the gallery almost at the top of the tower, and about 100 feet from the ground. In this gallery, which is above the bell chamber, the microphone is slung from a ladder. The engineers have as far as possible overcome the troubles of resonance connected with the transmission of bell music by fitting filter circuits in the amplifier. The Birmingham station is permanently connected by land-line to the tower.

### Miss Eva Moore.

A comedy by the well-known actor-manager, the late Mr. H. V. Esmond, entitled "The Woman in Chains," will be broadcast on June 10th. Mr. Esmond's widow, known to all players as Miss Eva Moore, will play in the title role. Miss Eva Moore recently produced and played in "Mary, Mary, Quite Contrary" at a West-End theatre.

## FUTURE FEATURES.

### Sunday, June 6th.

LONDON.—Shakespeare's Heroines: Edith Evans as Beatrice.  
BIRMINGHAM.—Favourite Classics.  
MANCHESTER.—The Story of "Peer Gynt."  
NEWCASTLE.—Orchestral and Vocal Concert.

### Monday, June 7th.

LONDON.—Symphony Concert conducted by Eugene Goossens.  
ABERDEEN.—Old Favourites in Music and Song.  
BELFAST.—Music—Grave and Gay. "The Last"—a play.  
GLASGOW.—Light Music and a Playlet.

### Tuesday, June 8th.

LONDON.—Variety; Plantation Chorus; Mystery Serial (3).  
BIRMINGHAM.—Orchestral and Instrumental Programme.  
BOURNEMOUTH.—Military Band Night.  
CARDIFF.—Sea Serpents: The Valve Set Concert Party.

### Wednesday, June 9th.

LONDON.—"Monsieur Beaucaire." Speeches at Dinner of African Society.  
ABERDEEN.—Julien Rosetti's Trio.  
GLASGOW.—The Production of a Daily Newspaper.

### Thursday, June 10th.

LONDON.—British Regimental Marches. Polishnoff.  
BOURNEMOUTH.—Irish Songs and Melodies.

### Friday, June 11th.

LONDON.—British Music Society Concert.  
BELFAST.—Glimpses of Childhood.  
LIVERPOOL.—The Station's Birthday.

### Saturday, June 12th.

LONDON.—Bertie Meyer's Party. Emilio Colombo's Orchestra.  
ABERDEEN.—Scots Programme.  
BIRMINGHAM.—The City of Birmingham Police Band. The B.B. Cabaret.  
CARDIFF.—A Radio Carnival—5WA Visits Bristol.  
GLASGOW.—Scots Programme. The B.B. Cabaret.

## To Find the Best Violinist.

An American broadcasting station recently held a competition for violinists, the prizes being awarded by Mr. Henry Ford, whose interest in motor cars is shared by his love of music and wireless. All the competitors played in the studio, and their efforts were subject to the votes of wireless listeners. Personality, therefore, played no part in the contest; but some of the disappointed competitors no doubt wondered what percentage of the judges were qualified to decide on the merits of the players.

## Editorial Reviews.

The history of the broadcast "editorial," upon which criticism has been turned, is quite simple. According to a B.B.C. official it is as follows:—For a year past the B.B.C. has broadcast "topical talks," containing a certain news interest. During the general strike, when the newspapers were restricted in size and circulation, and some of them disappeared altogether, the B.B.C. was officially authorised, under the Emergency Acts, to broadcast news bulletins, including Government communiques, at intervals throughout the day. These news bulletins ceased with the calling off of the general strike; and the correspondence received at Savoy Hill showed plainly that listeners generally had welcomed the broadcasting of news, and would appreciate with equal warmth a continuance of news bulletins.

## The Agreement with the Newspapers.

Under the terms of its agreement with the newspapers the B.B.C. was unable to conform with the wishes expressed by very many listeners; and quickly reverted to the former arrangement, which was to broadcast news bulletins at 7.0 and 9.30 p.m. only. The first-named hour, by the way, is the earliest at which the B.B.C. may, under the terms of its agreement, broadcast any news. But the Company decided on another development that it was thought would comply with the strong desire evinced by listeners for talks of a "newsy" character. The decision was reached to broadcast wireless reviews of matters of general interest under the title of "editorials."

## Not Controversial.

These "editorials," at the time when their nature and meaning were called into question, were attempts to amplify and explain salient points in the Report of the Royal Commission on Coal. They were not controversial, and, if there had been a presumption of controversy in them, official authority for their broadcasting would have been sought. Perhaps, however, much of the Press controversy would have been neutralised at the outset if the B.B.C. had adopted the title which was used subsequent to the criticism, i.e., "Editorial Review."

## Over-control.

A number of inquiries have been made respecting the paragraph which appeared in this page in connection with over-control during the general strike. The fact briefly is that all B.B.C. stations raised their modulation on speech only during the strike period. This was a temporary measure in order that those listeners who usually work with no factor of safety could be brought comfortably into range. Distortion naturally resulted; but a return to normal was made as soon as possible—to the disappointment, perhaps, of two per cent. of crystal listeners, but to the satisfaction of the bulk of listeners.

# PIONEERS of WIRELESS

BY ELLISON HAWKS F.R.A.S.

## 16.—Bell Invents the First Wireless Telephone.

**M**R. BELL! Mr. Bell! If you hear me, come to the window and wave your hat!"

Four years after the first transmission of the human voice over a telephone wire, Alexander Graham Bell heard (on February 15th, 1880) these words—the first ever spoken over a wireless telephone. The voice was that of Charles Sumner Taintor, speaking from the top of the Franklin School in 13th Street, Washington, to Bell in his laboratory near 14th Street, and the means by which the transmission was effected was a beam of light, the whole apparatus being subsequently known as the "Photophone."

Though credit for its invention is generally given to Bell, it must be mentioned that at least two other inventors had suggested, if not actually made use of, a similar means of communicating without wires. One of these was Steinheil, whose work in connection with wireless has already been dealt with. In his classic paper, "Telegraphic Communication especially by Means of Galvanism." Steinheil said:—

"Another possible method of bringing about transient movements at great distance, without any intervening artificial conductor, is furnished by radiant heat, when directed by means of condensing mirrors upon a thermo-electric pile. A galvanic current is called into play, which in its turn is employed to produce declinations of a magnetic needle. The difficulties attending the construction of such an instrument, though certainly considerable, are not in themselves insuperable. Such a telegraph, however, would only have this advantage over those [semaphores] based on optical principles—namely, that it does not require the constant attention of the observer, but, like the optical one, it would cease to act during cloudy weather, and never partake of the intrinsic defects of all semaphoric methods."

In 1878 A. C. Brown, of the Eastern Telegraph Company, submitted plans for a photophone to Dr. Bell, who afterwards said of them:—

"To Mr. Brown is undoubtedly due the honour of having distinctly and independently formulated the conception of

using an undulatory beam of light, in contradistinction to a merely intermittent one, in connection with selenium and a telephone, and of having devised apparatus—though of a crude nature—for carrying it into execution.

Bell's "Light Phone," as he first called it, was exhibited at both the Louisiana Exposition and the World's Fair, and there described as the "Radiophone." The instrument was based on the fact (discovered by Wilmoughby Smith in 1873) that selenium possesses the property of offering a greater resistance to the passage of an electric current in the dark than in the light. Bell's "Light Phone" relied on a ray of light falling on selenium connected to batteries with telephone transmitter and receiver in the circuits.

For transmission Bell developed a mirror of minimum thickness in the shape of a telephone diaphragm. Fastened to this was a mouthpiece, speech through which caused the mirror to vibrate. A beam of light was then thrown against the mirror, and, by reflection, was directed to the receiving apparatus.

In addition to employing selenium for receiving, Bell also experimented with vegetable fibre lamp-black placed in a glass bulb and demonstrated that many other substances could be used, such as black worsted cloth, silk, or even particles of rubber. The action of the rapidly

varying degree of heat in the light rays on these substances caused them to expel and absorb gases, which in turn produced vibrations in the air in the bulb in which they were enclosed. These vibrations, on being passed through rubber tubes to ear-pieces, enabled the listener to hear a reproduction of the words spoken at the transmitter.

Experiments were carried out between the top of the Franklin School and the Virginia Hills, a mile and a half away, until they were successful. Further work was done on the invention being taken over by the American Telephone and Telegraph Company, who, in some of the later models used an arc light in transmitting.

In April, 1897, Hammond B. Hayes, one of the company's engineers, noticed a humming sound audible in the

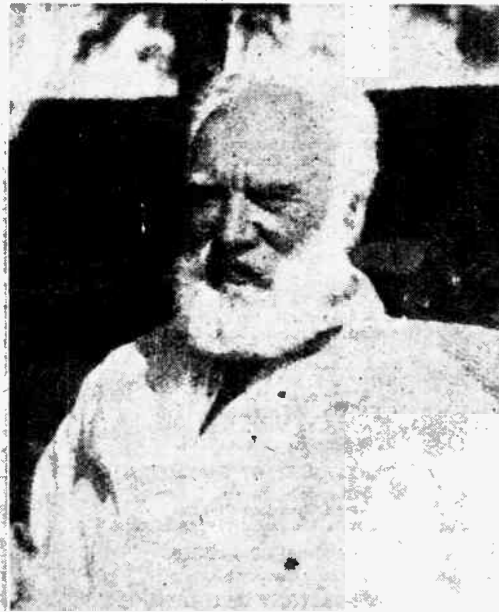

Alexander Graham Bell.

**Pioneers of Wireless.**—

receiver of the "Light Phone." This corresponded with the sounds produced by the generator supplying the current for the arc lamp used in the experiments. Hayes concluded that if words spoken into a telephone transmitter were made to act directly upon the lighting circuit it would not be necessary to use the mirror employed by Bell, and the distance over which speech could be transmitted would be greatly increased. In other words, the telephone current could be superimposed upon the lighting current by connecting the telephone wires to the wires in the arc circuit. The device was patented in June, 1897, and subsequent improvements enabled the voice to be heard with distinctness at points several miles from the transmitter.

**The "Photophone" System.**

The system is to-day known as the "Photophone," and in a further improved form it was demonstrated at the 1923 meeting of the British Association at Liverpool. In its most recent form the original principles are followed, the receiver consisting of a selenium cell enclosed in a small glass bulb. In making the cell, very fine brass wires, covered with a thin layer of selenium, are wound upon Indian pipe stone and connected to a telephone receiver. The rays of the lamp at the transmit-

ting station are then concentrated upon the selenium at the receiving station by a reflector.

The transmitting apparatus depends on a searchlight such as is used on warships. From the telephone transmitter wires lead to the lamp and are attached to the wires carrying the lighting current. When words are spoken into the transmitter the rays of the searchlight fluctuate (imperceptibly to the eye of an onlooker), and although the receiver may be miles out of sight the selenium responds to these fluctuations in the light rays and causes fluctuations in the current in the receiving circuit in thousands of infinitesimal changes. So wonderfully does the selenium respond that not only are the spoken words reproduced, but also the actual tones of the voice of the speaker.

Use of the "Photophone" is limited to clear skies, and although it may be used in the daytime as well as in the night time, it cannot be used in a fog.

The "Photophone" has been used successfully by the German Government for lighthouse work and by the U.S. Signal Corps. One of its principal advantages is its absolute secrecy, for the conversation cannot be tapped.

**NEXT INSTALMENT.**

Trowbridge Suggests First Transatlantic Wireless.

**EXPERIMENTAL TRANSMITTING STATIONS.****Revised List of Amateurs Working in Uruguay.**

For the benefit of our readers we give below a list of Amateur Call-signs and Addresses, for which we are indebted to our Argentine contemporary, "Revista Telegrafica." This supersedes the lists published in our issues of February 3rd and 24th.

Nationality Prefix: X (or, occasionally, Y).

<b>DEPARTMENT OF MONTEVIDEO.</b>	<b>1BS</b>	J. C. Massoué, Juan Paullier 2520.	<b>1IA</b>	C. M. Amaro, Estancia "El Mirador."
<b>1AA</b>	<b>1BT</b>	A. de Espada, Ellauri 685.	<b>1IB</b>	E. A. Da Silva, Estancia "El Torora."
<b>1AB</b>	<b>1BU</b>	A. J. Parietti, Av. Sarmiento 2533.		<b>DEPARTMENT OF SALTO.</b>
<b>1AC</b>	<b>1BV</b>	L. E. Rodriguez Subios, Iberia 20.	<b>1JA</b>	F. y D. Giordano, Uruguay 635.
<b>1AD</b>	<b>1BW</b>	J. J. Rabassa, Cnel. Brandsen 2016.	<b>1JB</b>	G. Thevenet, Agraciada 677.
<b>1AE</b>	<b>1BX</b>	W. Seré, Cerrito 585.	<b>1JC</b>	S. E. Pera, Uruguay 601.
<b>1AF</b>	<b>1BY</b>	P. Aragunde, Chaná 1834.	<b>1JD</b>	J. G. C. Amorin Asensio 336.
<b>1AG</b>	<b>1BZ</b>	A. Marroche Paronie, Previsión s/n (Manga).	<b>1JE</b>	F. H. Perroui, Uruguay 835.
<b>1AH</b>	<b>1CA</b>	C. Sirighelli, Bella Vista s/n.	<b>1JF</b>	L. G. Amorin, Uruguay 1173.
<b>1AI</b>	<b>1CB</b>	C. Butler, San José 838.		<b>DEPARTMENT OF ARTIGAS.</b>
<b>1AJ</b>	<b>1CC</b>	E. R. Morales, Uruguay 1816.	<b>1KA</b>	L. Greve, Ciudad de Artigas.
<b>1AK</b>	<b>1CD</b>	R. A. Walder, Minas 1721.		<b>DEPARTMENT OF FLORIDA.</b>
<b>1AL</b>	<b>1CE</b>	D. D. Suárez, Piedras 562.	<b>1LA</b>	R. A. Anaya, Cañña Progreso (La Cruz).
<b>1AM</b>	<b>1CF</b>	J. Lspicelli, Cerro Largo 2022.		<b>DEPARTMENT OF TACUAREMBO.</b>
<b>1AN</b>	<b>1CG</b>	W. Figuiera, Magallanes 1070.	<b>10A</b>	A. Galli, Santa Isabel.
<b>1AO</b>	<b>1CH</b>	R. Diaz Zupitria, Gral. Rondeau 1494.	<b>10B</b>	J. B. Larraburu, Dr. C. Berrutti s/n (S. Isabel).
<b>1AP</b>	<b>1CI</b>	J. Henderson (hijo), San Eugenio 1136.		The allotment of Call-signs to the various Departments is as follows:—
<b>1AQ</b>	<b>1CJ</b>	R. G. Nores, Justicia 2145.	<b>Montevideo.</b>	1AA to 9AZ; 1BA to 9BZ; 1CA to 9CZ.
<b>1AR</b>	<b>1CK</b>	C. J. Gavazzo, Ellauri 1009.	<b>Canelones</b>	1DA to 9DZ.
<b>1AS</b>	<b>1CL</b>	R. Elena, Garibaldi 2965.	<b>San Jose</b>	1EA to 9EZ.
<b>1AT</b>	<b>1CM</b>	J. Villamil, Av. Gral. Flores 705, F.	<b>Colonia</b>	1FA to 9FZ.
<b>1AU</b>	<b>1CN</b>	C. A. Colombo, 12, de Febrero s/n (Savago).	<b>Soriano.</b>	1GA to 9GZ.
<b>1AV</b>	<b>1CO</b>	Escuela Industrial No. 4, San Salvador 1674.	<b>Rio Negro.</b>	1HA to 9HZ.
<b>1AW</b>	<b>1CP</b>	A. Fournier, Gral. San Martín 3220.	<b>Paysandu.</b>	1IA to 9IZ.
<b>1AX</b>	<b>1CQ</b>	M. L. González, Dante 2354.	<b>Salto.</b>	1JA to 9JZ.
<b>1AY</b>	<b>1CS</b>	E. Maciel Flangini, Agraciada 3373.	<b>Artigas.</b>	1KA to 9KZ.
<b>1AZ</b>	<b>1CT</b>	E. G. López, Santa Lucia 72 (Paso Molino).	<b>Florida.</b>	1LA to 9LZ.
<b>1BA</b>	<b>1CU</b>	I. Colombo, Av. Canelones 1982.	<b>Durazno.</b>	1MA to 9MZ.
<b>1BB</b>	<b>1CV</b>	H. A. Urbina, Millán 2662.	<b>Tacuarembó.</b>	1NA to 9NZ.
<b>1BC</b>	<b>1CW</b>	R. D. Ferrero, Defensa 1061.	<b>Rivera.</b>	1PA to 9PZ.
<b>1BD</b>			<b>Maldonado.</b>	1RA to 9RZ.
<b>1BE</b>			<b>Minas.</b>	1SA to 9SZ.
<b>1BF</b>	<b>1DA</b>	M. Saldamando, Pando.	<b>Rocha.</b>	1TA to 9TZ.
<b>1BG</b>	<b>1DB</b>	P. Ferreri, Treinta y Tres s/n.	<b>Trinta y Tres.</b>	1UA to 9UZ.
<b>1BH</b>	<b>1DC</b>	A. Pernin, Cervantes 45 (Santa Lucia).	<b>Cerro Largo.</b>	1VA to 9VZ.
<b>1BI</b>				
<b>1BJ</b>				
<b>1BK</b>	<b>1EA</b>	A. Daverede, Arapey s/n.		
<b>1BL</b>				
<b>1BM</b>				
<b>1BN</b>	<b>1FA</b>	C. H. D. Walker, Conchillas.		
<b>1BO</b>				
<b>1BP</b>				
<b>1BR</b>	<b>1HA</b>	E. A. Da Silva, Estancia "El Carmen."		



A Review of the Latest Products of the Manufacturers.

**CELESTION LOUD-SPEAKER.**

Many readers are already acquainted with the Celestion loud-speaker, but it is the introduction of a new model incorporating some minor modifications that has brought about reference to it in this section.

It is exceedingly difficult to make a statement concerning the operation of a loud-speaker, for even response to all note frequencies cannot be judged by an aural test, whilst it is often due to distortion that a roundness of tone is created which is pleasing in its effect, and leads one to the favour of a particular instrument in preference to another.

In the case of the Celestion the most satisfactory test was to obtain the opinion of a number of wireless users connecting the instrument to their usual receivers, and examining it in comparison with other instruments. Even this test suffers from the defect that the ear of the listener may have become corrected by prolonged

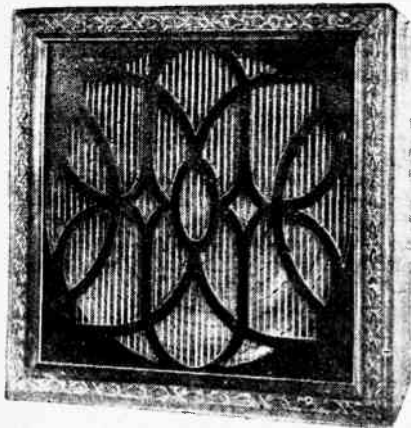

The Celestion cabinet type loud-speaker. The sound is emitted from a stiffened cone.

use to the failings of a particular loud-speaker, but in general the opinion of the listener is the most satisfactory gauge as to the merit of the loud-speaker. Those who examined this instrument were unanimous in their opinion as to its exceptionally good performance.

The mechanism is enclosed in a well-finished case of oak, mahogany, or walnut, a stiffened cone being set up as the sound emitter immediately behind the

grating. The cone is made of a parchment-like material, and is attached at its centre to an armature which is rigidly clamped at both ends and mounted between the two pole pieces of a polarised electro-magnet. Screw adjustment on the back of the case provides a critical adjustment of the setting of the armature between the pole pieces. The instrument is not critical with regard to input, and will be found exceedingly sensitive on weak signals, whilst it will not chatter when fed with signals extensively amplified. Of good appearance, this loud-speaker may probably be preferred by many to the horn type. It is of British manufacture, and is supplied with a twelve months' guarantee.

o o o o

**THE PURSUN GRID LEAK.**

A new type grid leak resistance has been submitted by J. Martin Blair, Amberley House, Norfolk Street, Strand, London, W.C.2.

The form of construction adopted is similar to that usually employed in grid leak manufacture, consisting of a tube of insulating material fitted with metal end caps. It is, however, very slightly longer than the standard grid leak, and also smaller in diameter so that it is not directly interchangeable when held between spring clips or clamped into the circular springs now often provided with grid condensers. Three specimens were examined of nominal resistance values of 0.5, 1 and 2 megohms. The measured resistances closely tallied with the stated values, and were found to be respectively 0.5, 0.83 and 2.69 megohms. The slight discrepancies are not unusual, and the resistance values must be considered as reasonably accurate. The construction is particularly robust, the resistance material being deposited on a glass rod.

In operation the grid leak was found to be entirely satisfactory, and was quite silent when used in an oscillating receiver.

o o o o

**SALIENT SOLDER FLUX.**

A new soldering flux has recently been placed on the market by S. A. Cutters, Ltd., 18, Berners Street, Oxford Street, London, W.1. It is stated to be non-corrosive, a claim which was verified as far as was possible by using the flux for

making the connections in a two-stage L.F. amplifier.

It was observed that the flux did not splutter, while it was found quite an easy matter to make a good joint without excess of the flux creeping along the wire or condensing around the joint. The flux is semi-transparent and red in colour, and will render easy the making of soldered connections.

o o o o

**NEW McMICHAEL VERNIER DIAL.**

The majority of vernier dials obtainable are of American manufacture, and although a few British dials are becoming available many of them are very similar in principle to the American models.

A new dial has recently been produced by L. McMichael, Ltd., Hastings House, Norfolk Street, Strand, London, W.C.2, which makes use of an entirely new principle for obtaining critical control. It must be admitted that to provide a critical control over all settings of the

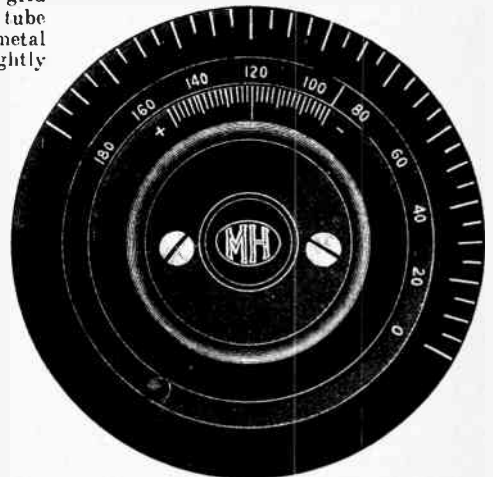

The McMichael vernier dial provides a direct rotation of the instrument spindle for coarse adjustment, whilst the vernier controlled by the centre knob gives a critical control.

tuning dial is not always an advantage, and renders quick searching rather a slow process. On the McMichael dial, therefore, a quick adjustment is obtained by operating the centre knob or the large diameter milled edge which is provided just above the engraved scale, while an independent movement is obtainable on

the centre knob giving a critical adjustment within a few degrees.

The construction is particularly simple, and possesses the merit that reducing gears and pinions are dispensed with. A good clean finish is obtained by avoiding the use of moulded materials and turning both knob and dial from solid ebonite. The ebonite is given a highly polished surface, a finish similar to many other McMichael products, while the scales are machine engraved. The dial is very easily attached, and by means of interchangeable expanding collets can be fitted to either  $\frac{3}{16}$  in or  $\frac{1}{4}$  in spindles. The dial is moderate in price.

o o o o

**EELEX LEAD-IN TUBE AND LIGHTNING ARRESTER.**

Much trouble is saved as regards wiring when the lead-in tube is combined with the lightning arrester and a knife switch for earthing the aerial.

The lead-in tube and arrester shown in the accompanying illustration, which is the

product of J. J. Eastick and Sons, 2, St. Dunstan's Hill, London, E.C.3. comprises the usual form of ebonite covered lead-in combined with a nickel-plated knife

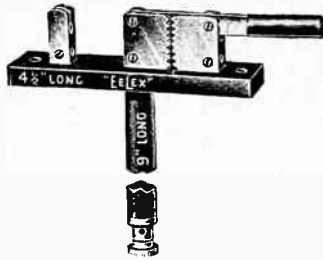

Eelex combined lead-in tube, lightning arrester and earthing switch.

switch and two serrated edged plates connected between aerial and earth to serve as an alternative path for lightning discharges.

This accessory is easily fitted by boring a  $\frac{1}{4}$  in. hole through the frame of a

window or door, and is held in position by two screws passing through the ebonite plate which carries the switch movement.

o o o o

**LABELS FOR FLEXIBLE LEADS.**

There is a growing tendency among amateurs to dispense with the use of battery terminals and substitute flexible leads fitted with connecting tags for joining directly to the battery terminals. This method is probably very much more convenient and less expensive than the fitting of terminals, but some provision must be made for suitably labelling the ends of the leads.

Messrs. F. E. Wilson and Co., 79, New Street, Erdington, Birmingham, have introduced a series of slip-on ivoryine labels, provided with two holes so that they can be attached to the lead before fitting the connecting tag. The labels are obtainable in red and black, carrying engraved white lettering indicating all the usual connections required in a receiving set.

**LETTERS TO THE EDITOR.**

The Editor does not hold himself responsible for the opinions of his correspondents.

Correspondence should be addressed to the Editor, "The Wireless World," Dorset House, Tudor Street, E.C.4, and must be accompanied by the writer's name and address.

**INSULATION EFFICIENCY.**

Sir,—Living as I do in a district where one of the staple industries is associated with the manufacture of insulators for wireless and other purposes, I am rather surprised that an insulator is not obtainable at a reasonable price that conforms to the obvious requirements of the serious-minded amateur. There are many types of insulators which are, in the main, fairly efficient in dry weather, but when exposed to the elements are practically useless, the whole surface, in a heavy storm, being covered with a film of water. An insulator of the following type, I feel sure, would meet with a ready demand and could be put on the market at a price within the reach of all, which could be made in either glass or porcelain. I append full size sketch below.

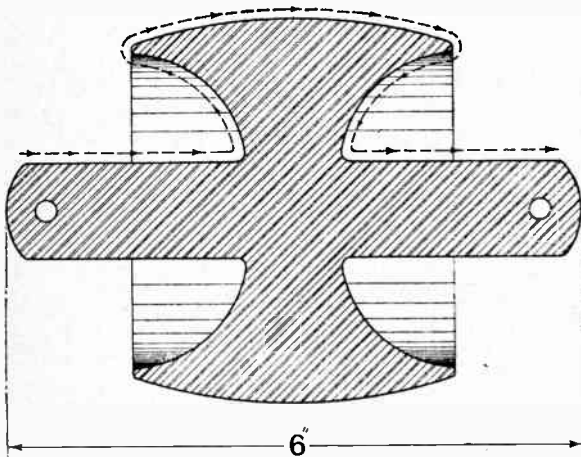

The advantages of this type is apparent, it being almost impossible under any circumstances for the surface to become coated with a film of moisture, while under all conditions the resistance path is very much greater than any other kind obtainable in this country.

A. W. WILSON.

Stoke-on-Trent.

A 40

**AMATEUR TRANSMITTERS.**

Sir,—It seems obvious to us that the majority of B.C.L.s have no grouse against the genuine transmitter, who is really doing useful work, whether using expensive apparatus or not, but rather against those who are abusing their rights and responsibilities as transmitters. We see no reason why any amateur transmitter should find it necessary to use a wavelength exceeding 200 metres, and understand that in any case the only authorised wavelength above that is a fixed one of 440 metres. In our case we never use a wavelength higher than 46 metres, but nevertheless have found ourselves occasionally up against a B.C.L. with an unselective receiving set (direct coupled crystal set?).

A B.C.L. using such a set, and living a few yards away, may imagine us to be employing a wavelength in the neighbourhood of that used by the local B.B.C. station.

The vast majority of transmitters are as incensed against those who abuse their privileges as are the B.C.L.s. If only the wrong type of amateur transmitter were to be got rid of and a better spirit of "give and take" between the B.C.L.s and the genuine transmitter manifested, we submit that the present feud would cease to exist.

F. C. McMURRAY.  
R. E. L. BEERE.

G 2FM.

Thornton Heath, Surrey.

**HIDDEN ADVERTISEMENTS COMPETITION.**

The following are the correct solutions of "The Wireless World" Hidden Advertisements Competition, May 5th, 1926.

Clue No.	Name of Advertiser.	Page.
1.	Dubilier Condenser Co. (1925), Ltd.	iv.
2.	H. Morser & Co. (Wireless), Ltd.	4
3.	H. Clarke & Co. (Mer.) Ltd.	10
4.	The Radio Devices Co.	3
5.	Ferranti, Ltd.	12
6.	Alfred Graham & Co.	ii.

**The following are the Prizewinners:—**

- Stephen H. Robert, Upper Tooting, S.W.17 .. 65
- L. F. White, Bristol .. .. 62
- Walter Fielding, Rochdale .. .. 61

**Ten Shillings each to the following:—**

- Mrs. A. F. Moffat, Hale Green, Birmingham.
- O. Meyhoff, Berlin.
- John W. Robinson, Sheffield.
- Mrs. C. Mills, Oxford.

# Readers' Problems

"The Wireless World" Information Department Conducts a Free Service of Replies to Readers' Queries. Questions should be concisely worded, and headed "Information Department." Each separate question must be accompanied by a stamped addressed envelope for postal reply.

### A "Soft" Valve.

I have a valve which has been in use for only a short period, but has commenced to emit a blue glow when it is used, and the efficiency of the valve has greatly declined. The valve has never been used with a greater filament or anode voltage than that specified by the makers, and the correct grid bias has always been used in accordance with the printed instructions. I find that the blue glow can only be eliminated by reducing the anode voltage to a very low value. Can you explain the cause of this trouble, and how it can be cured?  
K. A. Y.

It would appear from the symptoms you describe that your valve has become "soft," and if this is so its efficiency would be greatly reduced. Since the valve has only been in use for a short period, and care has been taken to follow out the makers' instructions carefully, it would appear that it was an imperfect specimen when purchased. You are advised to return the valve, carefully packed, to the manufacturers, giving full particulars and asking them to test it thoroughly and make a report to you. No difficulty should be anticipated in the case of reputable British manufacturers, although if the valve is of foreign manufacture there is little you can do, and it is best to profit by the experience and eschew foreign manufactured valves in future.

○○○○

### A Compact Portable.

I wish to construct a portable receiver containing two valves, the main feature of which is compactness, and for this reason I wish to reduce the number of coils to a minimum. I therefore do not wish to incorporate H.F. stages, but at the same time I wish to have a reasonable range of reception, and should be glad of your advice on this matter.  
F. M. C.

It is obvious that in order to compensate for the absence of any H.F. amplification in the receiver we must incorporate a very efficient and smooth reaction control system. Now, the ordinary method of supplying reaction by using a swinging coil is far too crude and cumbersome, both mechanically and electrically, for inclusion in a portable receiver, and indeed it is beginning to be realised that

its days are numbered, even in the case of "permanent" receivers. Fortunately, it is possible to incorporate an efficient system of reaction without using any plug-in coils whatever, the frame aerial being the only inductance used in the circuit. The theoretical aspect of this circuit was fully gone into in an article appearing on page 117 of our issue of January 27th, 1926, where full details of

section of this journal for February 24th, 1926, and may thus be of small size. Actually, it will be found that, provided no fixed condenser is shunted across the primary of the intervalve transformer, or telephones in the case of a single valve arrangement, the circuit will function equally well without the choke, although it is usually advisable to include it, because many people prefer to incorporate

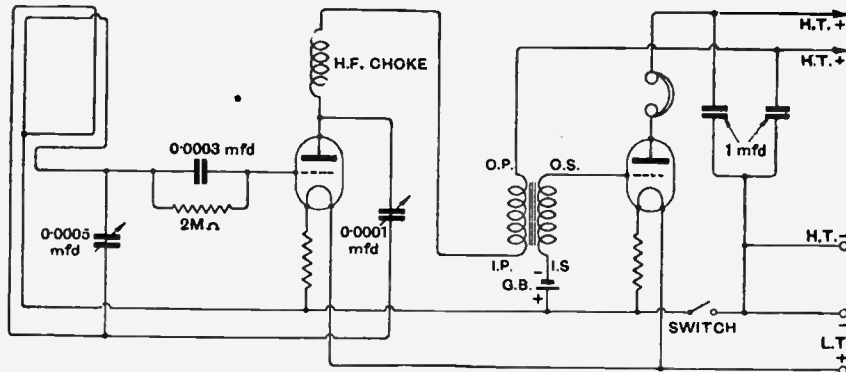

Fig. 1.—Capacity reaction in a frame aerial receiver.

the results obtained with it are given, and consequently little more need be said beyond the fact that the arrangement illustrated in Fig. 1 forms an extremely efficient and sensitive combination which, owing to its simplicity, is quite easy to handle.

Reaction, which is controlled by the small 0.0001 mfd. variable condenser, is exceptionally smooth, but at the same time, owing to the fact that both sides of the reaction condenser are at high potential, it is well to provide an extension handle for this component. It is not desirable to use a large condenser, but it should be of sufficient size to bring about actual oscillation. When set near to its maximum position many amateurs use an ordinary 0.0003 mfd. variable condenser. The L.T.+ terminal should be connected to the centre point of the frame. This latter component may be wound on a former designed for fitting into the lid of a suitcase, and may consist of about 15 turns. The H.F. choke may conveniently consist of any of the commercial chokes which are upon the market, or alternatively can be constructed in accordance with the instructions given in the "Hints and Tips"

a fixed condenser for the purpose of adjusting loud-speaker tone.

○○○○

### What is "Low-loss"?

I am building a receiver designed to give me a maximum of efficiency on the B.B.C. wavelengths. Would you advise me to use low-loss coils or not? I ask this because a friend has told me that it is necessary to use low-loss coils on wavelengths only below 100 metres, and that such components are apt to be actually productive of more losses on the B.B.C. wavelengths than if other components are used.  
J. W.

Since the term "low-loss" is merely a synonym for high efficiency, it is obvious that it would be impossible for high-efficiency components to be productive of greater losses on the B.B.C. wavelengths than would low-efficiency components, otherwise logic would tell us that the pseudo high-efficiency components were really the low-efficiency components, and vice versa. We think, however, that you are confused by the popular idea that the term low-loss coil indicates skeleton coils

wound with No. 10, or similar heavy gauge wire. Actually, of course, it is obvious that in any circuit high-efficiency or low-loss components will give better results than their low-efficiency or "high-loss" counterparts. The confusion arises from the fact that a design of coil which gives high efficiency and is therefore a "low-loss" coil in a frequency of 750 k.c. corresponding to 400 metres is not usually productive of high efficiency on a frequency of 7,500 K.C. corresponding to a wavelength of 40 metres, and *vice versa*.

Usually on wavelengths below 100 metres the greatest efficiency can be obtained by constructing space wound coils, using bare wire, and since the number of turns required is relatively small the length of the coil would not be large. If, however, in order to reduce self-capacity losses on a wavelength of 400 metres we attempt to use a generously spaced coil wound with bare wire it will result in a coil of very great length and the overall efficiency will be poor, far poorer, in fact, than if we used a far smaller gauge of cotton-covered wire. This point is strongly exemplified in the recent low-loss coil tests carried out by this journal.

#### Adding an H.F. Stage.

*I possess a conventional three-valve receiver using plug-in coils consisting of a detector with reaction and two transformer-coupled L.F. stages. I wish to construct an H.F. amplifier unit for coupling to this receiver when it is desired to receive distant stations. I wish to be enabled to tune this H.F. amplifier to my wavelength by means of plug-in coils, and so do not wish to use the neutrodyne system.* A. G. D. W.

It is fortunately quite a straightforward matter to construct an efficient H.F. amplifier for a conventional type of receiver, such as you mention, without resorting to the neutrodyne system by following the connections given in Fig. 2. The aerial coil can consist of a plug-in coil of value suitable to the desired wavelength. It is desirable to use an efficient H.F. choke of a type which is specially designed for use in an H.F. amplifier, such as the Marconiphone choke, to mention one specific instrument among others. It is not advised that a plug-in coil be used for an H.F. choke. The choke we mention is suitable for the B.B.C. wavelengths and, in fact, all wavelengths up to 4,000 metres.

Naturally it is assumed that you will use the same batteries for the H.F. amplifier as for the existing receiver, and so there is no necessity to provide a separate H.T.-terminal on the amplifier, this being automatically formed by the L.T.-connection. Similarly, the receiver is connected to earth *via* the low-tension battery connections, and no connection need therefore be made to the existing earth terminal of the receiver. The existing connections of the receiver will in no way be upset, the erstwhile aerial coil merely becoming the tuned grid coil of the detector valve with the reaction coil coupled to it. It should not be forgotten,

## BOOKS FOR THE HOME CONSTRUCTOR

Issued in conjunction with "The Wireless World."

"THE HOME CONSTRUCTOR'S EASY-TO-BUILD WIRELESS SETS," by F. H. HAYNES. Price 1/6 net. By Post, 1/9.

"TUNING COILS AND METHODS OF TUNING," by W. JAMES. Price 2/6 net. By Post, 2/0.

"HOW TO BUILD AMATEUR VALVE STATIONS," by P. R. COURSEY, B.Sc. Price 1/6 net. By Post, 1/8.

"THE CONSTRUCTION OF AMATEUR VALVE STATIONS," by Alan L. M. DOUGLAS. Price 1/6 net. By Post, 1/8.

"THE HOME CONSTRUCTOR'S WIRELESS GUIDE," by W. JAMES. Price 3/6 net. By Post, 3/9.

"MAST AND AERIAL CONSTRUCTION FOR AMATEURS," by F. J. AINSLEY, A.M.I.C.E. Price 1/6 net. By Post, 1/8.

Obtainable by post (remittance with order) from  
**ILIFFE & SONS LIMITED,**  
Dorset House, Tudor St., London E.C.4.  
or of Booksellers and Bookstalls

however, that the aerial coil in the original receiver should be changed in favour of a coil one size larger, the actual value required being the same as would be required in a tuned anode circuit for the same wavelength, or, in other words, a No. 50 on the normal B.B.C. wavelengths, and a No. 250 on the 5XX wavelength.

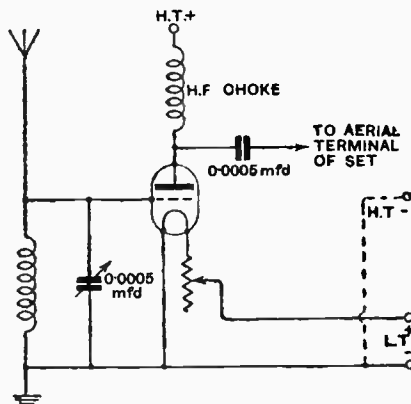

Fig. 2.—Choke-coupled H.F. valve for addition to an existing receiver.

This unit is equally suitable for use with a receiver embodying a tapped aerial coil or for most types of commercial detector and L.F. receiver, and can equally well be used for extending the range of a crystal set, in which case, of course, the H.T.-terminal shown in dotted lines will be needed, whilst at the same time a connection should be made from the L.T.-terminal of the unit to the earth terminal of the crystal receiver.

o o o o

#### Magnetic Saturation of Loud-speakers.

*I have been told that apart from the distortion which may be introduced mechanically by a loud-speaker, due to incorrect design of horn, distortion can be introduced electrically owing to magnetic saturation. I should be*

*glad if you will explain what this is, and how it causes distortion.*

W. G. P.

Briefly it may be said that the iron core of any electro-magnet is magnetically saturated when an increase in the value of the external magnetising force produces no further increase in the number of lines of force passing through the core, the core being, as the name implies, completely saturated. As is well known, if we take an electro-magnet and pass an electric current of definite value through its windings, there are, as a result of the magnetising force exerted by this current, a certain number of lines of force passing through the core. By increasing or decreasing this current we can produce a corresponding and proportionate increase or decrease in the number of lines of force passing through the core within certain limits laid down by the nature of the core construction, cross-sectional area being one of the most important limiting values. If we continue increasing the magnetising current it will be found that the density of the magnetic field will continue to increase proportionately up to a certain point known as the saturation point, when a further increase of current no longer produces a proportionate increase in the density of the magnetic field. The case is somewhat analogous to that of a valve in which, by varying the grid potential, we can obtain a proportionate change in the plate current within certain limits determined by the valve characteristics, the limits being more widely separated in the case of a power valve.

When connecting a loud-speaker in the plate circuit of the valve, we first have the steady magnetic field set up by the passage of the steady plate current. We can regard this in the nature of a "carrier" field upon which are superimposed the modulations and variations due to incoming signals. Thus the incoming signals will tend to cause this steady field to increase and decrease in step with the incoming signals. Provided that this steady magnetic field *does* increase and decrease *proportionately* with the incoming signals, all is well. It must be remembered, however, that if the final valve is a power valve the plate current will be considerable, so much so, in fact, that probably even the largest type of "household" loud-speaker will be saturated, and if this is so the incoming signals will fail to bring about a proportionate increase in density of the magnetic field, and not only distortion, but also loss of volume, will result. This explains the many puzzling cases which many readers come up against, where after taking great care and spending much money in constructing a "distortionless" amplifier and using power valves with correct values of H.T. and grid bias and a large loud-speaker, they find that the quality and volume attained falls very short of their expectations.

The remedy is fortunately simple, namely, to avoid saturation by keeping the steady plate current of the power valve out of the loud-speaker windings by using a choke-filter circuit.



# Plug in a LEWCOS Coil — and listen!

THAT'S the test. It makes all the difference when you tune in with a LEWCOS Coil. Listeners everywhere have been quick to realise the quality and advantages of this guaranteed coil.



Ask your dealer for a demonstration. Each LEWCOS Coil is tested in our laboratory. It is then boxed, sealed up, and reaches you in perfect condition. Be sure the LEW seal is unbroken.

No.	25	35	40	50	60	75	100	150	200	250	300
Price	4/6	4/6	4/6	5/-	5/6	5/6	6/9	7/6	8/6	9/-	10/-

# LEWCOS

Inductance Coil



### 3 LEWCOS advantages:

- 1 High electrical efficiency with great mechanical strength.
- 2 Great selectivity resulting in extremely fine tuning.
- 3 Exceptionally low high frequency resistance with increased signal strength.

THE  
LONDON ELECTRIC WIRE  
CO. and SMITHS LTD.,  
Manufacturers of Glazite  
Playhouse Yard, Golden  
Lane, London, E.C.1.



## MATCHED TONE HEADPHONES

IF you're fond of sitting up in the wee sma' hours to stretch a hand across the world, Matched Tone are extremely able confederates. With radio you span continents and with Matched Tone it becomes easier, "comfier" and much more efficacious. Distant signals stand out clearly; Matched Tone grope in the ether with unflinching accuracy. The specially matched receivers make them super-sensitive and tone perfect. You are logging a new call-sign every day with Matched Tone.

20/-

Table-Talker 30/-    Brandola 90/-    Audio Transformer 17/6

# Brandes

Brandes Limited, 296, Regent Street, W.1.

From any good Dealer

43/563-B.

SERVICE ADVERTISING

# £10 Weekly in Cash Prizes

Simple Competition  
for all Readers of "The Wireless World"

## HIDDEN ADVERTISEMENTS



Below will be found six reproductions of fragments cut from the Advertisement pages of this issue of "The Wireless World." Each fragment is a clue. Can you from these clues identify the Advertisements? Seven cash prizes will be awarded to the first seven readers who send us correct solutions. No technical skill is required, merely observation. There are no restrictions or entry fees and the conditions are simple.

**£5**

for the first  
correct solution  
opened.

**£2**

for the second  
correct solution  
opened.

ANY	
1	2
	NO
3	4
	20110.
5	6

**£1**

for the third  
correct solution  
opened.

and  
**4**  
consolation  
prizes of  
**10/-**

Each  
for the next four  
correct solutions  
opened.

### CONDITIONS

1. All solutions must be written on the special coupon appearing on an advertisement page in this issue and addressed to *The Wireless World*, Dorset House, Tudor Street, London, E.C.4, and marked "Hidden Advt." in bottom left corner.

2. Clues will not, of necessity, appear in the same way as in the advertisement page, but may be inverted or placed in some other position.

3. In order that town and country readers may compete on equal terms, solutions will not be dealt with until 10 a.m. on Monday next. All solutions received before that date will be retained until Monday morning. Competitors may submit any

number of entries. Erasures or alterations on a coupon will disqualify the entry.

4. The first prize of £5 will be awarded for the first correct solution opened; the second prize of £2 to the next correct solution; the third prize of £1 for the third, and four consolation prizes of 10/- each for the next four correct answers. In the event of no readers sending correct solutions the prizes will be awarded to the competitors whose solutions are most nearly correct.

5. The decision of the Advertisement Manager of *The Wireless World* is final, and no correspondence can be entered into. Competitors enter on this distinct understanding. No member of the staff of the paper is permitted to compete.

**THE H.M.H. PHONE 18'6**

**SPECIAL NOTICE.**

The closing date of this competition which also appeared in this Journal on May 5th, has owing to the recent strike been altered to June 19th, and Coupons from the earlier issue will also be accepted in connection with same, providing they reach us not later than June 19th, accompanied by P.O. covering the amount of entries submitted.

**Wear the finest British Headphones and WIN**

**A SIX VALVE DE-LUXE RECEIVING SET OR A LARGE CASH PRIZE.**

In order to introduce to the public their wonderful new wireless invention, the makers of H.M.H. HEADPHONES offer three valuable prizes, together with 25 sets of Headphones as consolation prizes, for the best solutions received of the cross-word puzzle given below.

Members of the Staff of the Company will not be allowed to compete.

- 1st Prize **A SIX VALVE DE LUXE RECEIVING SET** or **£50 Cash.**
- 2nd " **A FOUR VALVE** " " " **£25** "
- 3rd " **A TWO VALVE** " " " **£10** "

and 25 CONSOLATION PRIZES of a pair of H.M.H. HEADPHONES.

This Competition is also appearing in two other leading Wireless Journals, and a sealed solution is in the keeping of the respective Editors.

**YOU HAVE ONLY TO SOLVE THIS PUZZLE.**

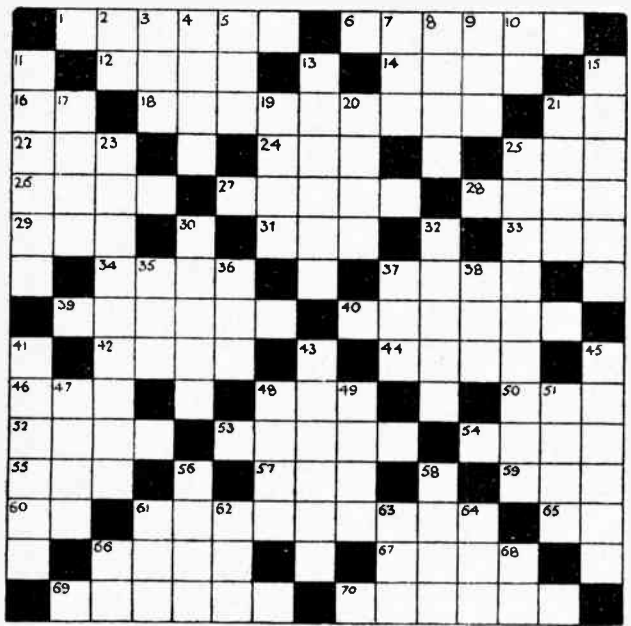

- CLUES ACROSS.**
1. Pertaining to the Lodestone.
  6. Confine in a cage.
  12. To draw asunder.
  14. Where the sun rises.
  16. Negative term.
  18. One guilty of treason.
  21. Denotes certain make of motor cycle.
  23. To lower headlights.
  24. A bay or creek (Shetland).
  25. Used for shooting arrows.
  26. Furze or gorse shrubs.
  27. Four-footed animals.
  28. A lump or ridge on metal.
  29. Kat-blished (abst.).
  31. The beak of a bird.
  33. A girl's name.
  34. Is unwell.
  37. Anything round.
  39. A soft bog or marsh.
  40. An allowance or pension.
  42. Longing desire.
  44. (Prefix) meaning against.
  46. A priest (ancient).
  48. A meadow.
  50. Negative term.
  52. Used for dressing wounds.
  53. Conceals.
  54. Instigates.
  55. Anger.
  57. A girl's name.
  59. Join together with a needle.
  60. Church of England (abst.).
  61. Offered as a gift.
  65. Errors excepted (abst.).
  66. Bottom of a ship.
  67. Shortly.
  69. A vessel for holding liquid.
  70. Penetrates.
- CLUES DOWN.**
35. Memorandum of debt.
  36. Sergeant, abbt. (army).
  37. Ladies' neck.
  38. A large quantity.
  41. A widow.
  43. Supreme happiness.
  45. To reply to.
  47. Italian coin.
  48. Sediment.
  49. A boy's name.
  51. A wave-like moulding.
  56. To irritate.
  58. Despatched.
  61. Foulle.
  62. Measure of cloth.
  63. Make brown.
  64. Female animal.
  66. Knock out (abst.).
  68. Near (abst.).

**RULES OF ENTRY.**

- 1.—Prizes are awarded strictly for the skil shown in the solving of this puzzle.
- 2.—The first prize will be awarded to the competitor sending in the correct solution. Should more than one correct solution be received, prizes to the total value will be divided among the successful competitors.
- 3.—Every purchaser of a pair of our H.M.H. Headphones (direct from us) will be entitled to 3 free entries in this competition. All other entries must be accompanied by P.O. for 1/- made payable to H. Morser & Co. (Wireless) Ltd., and must be crossed " & Co."
- 4.—Solutions must reach H. Morser & Co. (Wireless), Ltd., 67 and 68, Hatton Garden, London E.C.1, not later than June 19, 1926.
- 5.—Solution and names and addresses of prize winners will appear in THE WIRELESS WORLD, June 30, 1926.
- 6.—All prizes will be forwarded to successful competitors without delay.
- 7.—No correspondence can be entered into, and the decision of the Directors of H. Morser & Co. (Wireless), Ltd., must be accepted as final and binding.

**T. O. H. MORSER & Co. (WIRELESS) Ltd., 67 & 68 HATTON GARDEN, LONDON, E. C. 1**

Dear Sirs,—I enclose P.O. value . . . . . as Entrance Fee for the Enclosed Solutions. (Please use Block Capitals, in ink.)

W. W. NAME . . . . . ADDRESS . . . . .

**"Cabinets of Distinction"**

SOUNDLY CONSTRUCTED OF BEST QUALITY TIMBER ARE THE EMBODIMENT OF 50 YEARS' MANUFACTURING EXPERIENCE IN HIGH GRADE CABINET WORK.

**A GUARANTEE OF SATISFACTION TO EVERY PURCHASER.**

PANEL SIZE	INSIDE DEPTH	DARK OAK	MAHOG	OTHER SIZES LISTED
12 x 7"	8"	18/6	18/6	
18 x 7"	8"	23/-	26/-	
21 x 7"	8"	26/-	30/-	

Write direct if your dealer cannot supply. "Cabinets of Distinction" also supplied.

**W. & T. LOCK, ST. PETER'S WORKS, BATH.**

**Athol** TRADE MARK

For any circuit, any set, anywhere

Bracket for back-of-panel mounting, 2d. each extra.

**VALVE HOLDER**

Gives perfect insulation, brass sockets almost entirely air-spaced, minimum capacity effects. One-hole fixing to base board, or above panel, easily mounted below the panel. Complete with soldering tags and fixing bolt.

**ATHOL ENGINEERING CO.,**  
Seymour Road, Crumpsall, MANCHESTER.

# MISCELLANEOUS ADVERTISEMENTS.

## NOTICES.

**THE CHARGE FOR ADVERTISEMENTS** in these columns is:

12 words or less, 1/- and 1d. for every additional word, e.g., 18 words 1/6; 24 words, 2/- Name and address must be counted.

**SERIES DISCOUNTS** are allowed to Trade Advertisers as follows on orders for consecutive insertions, provided a contract is placed in advance, and in the absence of fresh instructions the entire "copy" is repeated from the previous issue: 13 consecutive insertions, 5%; 26 consecutive, 10%; 52 consecutive, 15%.

**ADVERTISEMENTS** for these columns are accepted up to **FIRST POST on THURSDAY MORNING** (previous to date of issue) at the Head Offices of "The Wireless World," Dorset House, Tudor Street, London, E.C.4, or on **WEDNESDAY MORNING** at the Branch Offices, 19, Hertford Street, Coventry; Guildhall Buildings, Navigation Street, Birmingham; 199, Deansgate, Manchester.

Advertisements that arrive too late for a particular issue will automatically be inserted in the following issue unless accompanied by instructions to the contrary. All advertisements in this section must be strictly prepaid.

Postal Orders and Cheques sent in payment for advertisements should be made payable to ILLIFFE & SONS Ltd., and crossed & Co. Treasury Notes, being untraceable if lost in transit, should not be sent as remittances.

All letters relating to advertisements should quote the number which is printed at the end of each advertisement, and the date of the issue in which it appeared.

The proprietors are not responsible for clerical or printers' errors, although every care is taken to avoid mistakes.

## NUMBERED ADDRESSES.

For the convenience of advertisers, letters may be addressed to numbers at "The Wireless World" Office. When this is desired, the sum of 6d. to defray the cost of registration and to cover postage on replies must be added to the advertisement charge, which must include the words Box 000, c/o "The Wireless World." Only the number will appear in the advertisement. All replies should be addressed No. 000, c/o "The Wireless World," Dorset House, Tudor Street, London, E.C.4. Readers who reply to Box No. advertisements are warned against sending remittance through the post except in registered envelopes; in all such cases the use of the Deposit System is recommended, and the envelope should be clearly marked "Deposit Department."

## DEPOSIT SYSTEM.

Readers who hesitate to send money to unknown persons may deal in perfect safety by availing themselves of our Deposit System. If the money be deposited with "The Wireless World," both parties are advised of its receipt.

The time allowed for decision is three days, during which time, if the buyer decides not to retain the goods, they must be returned to the sender. If a sale is effected we remit the amount to the seller, but, if not, we return the amount to the depositor. Carriage is paid by the buyer, but in the event of no sale, and subject to there being no different arrangement between buyer and seller, each pays carriage one way. The seller takes the risk of loss or damage in transit, for which we take no responsibility. For all transactions up to £10, a deposit fee of 1/- is charged; on transactions over £10 and under £50, the fee is 2/6; over £50, 5/-. All deposit matters are dealt with at Dorset House, Tudor Street, London, E.C.4, and cheques and money orders should be made payable to Illiffe & Sons Limited.

## THE SALE OF HOME-CONSTRUCTED UNLICENSED APPARATUS.

### A New Service to our Readers.

We have made an arrangement with the Patentees whereby readers who wish to dispose of a home-constructed receiver not licensed under the patents made use of, can do so by means of the Deposit System referred to above.

The person desiring to sell, in sending us particulars for his advertisement, will in every case make use of a Box No., and should add to the price which he requires the amount of royalty customarily paid by manufacturers, viz. in the case of Marconi Patents the amount should be calculated at 12/6 per valve holder.

If the purchaser is satisfied with his purchase, the sum realised will be forwarded to the seller, less the amount due in respect of royalties, which amount will be paid by "The Wireless World" to the owners of the patents concerned, and a certificate will be handed on to the purchaser of the set.

## FOR SALE.

**WOOD** Horns for all speakers and gramophone attachments. There's one for Amplion Junior, ditto goose-neck bases, Lissenola, etc. There's only one best; it's the "Allwoodorn."—Manufacturer: H. Maddison, 2A, Ronald's Road, Highbury, N.5. List free. (1914)

## For Sale.—Contd.

**OSCILLATING** Zincite and Contact, 2s. 6d.; simple, original circuit, 1s.; excellent results; other parts stocked.—Ledsham's, 297, King Street, Hammersmith. (1888)

**VALVES!**—Special offer of limited quantity only, 3v. .06 amp, 9s. each; 5v. .25 amp. power, 12s. each. Best make. Fully guaranteed.—F. Leng, 15A, Onslow Gardens, Wallington. (2062)

**JACOBAN** Oak Wireless Cabinets, direct from makers, 55s. Packed free. Carriage paid. Send for illustration, etc.—Wm. Nurse, Union Street Cabinet Works, King's Lynn. (2069)

**FOUR-VALVE** Family Receiver, 2 pairs phones, loud-speaker, accumulator, valves, coils; £15.—Box 8001, c/o WIRELESS WORLD Office. (2091)

**COMPONENTS** for the Enthusiast.—For short wave, superheterodyne, neutrodyne, and standard circuits: "Standardize on GR Parts Throughout," made by General Radio Company of America. Insist on "GR" trade mark; look for the red cartons. Low Loss Condensers (29 styles); Wavemeter and Filter (cuts out "locals," direct reading, accurate to 1 per cent.); Superheterodyne "Matched" Transformers; Noiseless Rheostats, Potentiometers; Variocouplers; Variometers; Chokes; Transformers; Ammeters and Milliampmeters; Laboratory and Experimental Apparatus, etc. Send for complete list (post free) and for interesting booklets "Truth About Variable Condensers," "Stop Interference," "True Mirrors of Tone Quality," "Low Loss Coils." In use world over. Cash iron guarantee. Reasonable prices, immediate despatch.—Sole English Concessionaires, Claude Lyons, Dept. "E," 76, Oldhall Street, Liverpool. London Stockists, Hamleys, 200, Regent Street. (2090)

**60-VOLT** Wet Cell High Tension Batteries, genuine Leclanché; 21s.; trade supplied, lists free.—Tennants, Hylton Road, Sunderland. (2092)

**SUPERIOR** Three-valve Set, in mahogany case, 14in. x 10in. x 10in., specially made for experimental work. Any circuit within three valves and crystal may be wired in few moments without disarranging set, best components throughout; particulars and photo, stamp; bargain, £6 10s.—21, Sandiway Road, Altrincham. (2093)

**BROWN** Microphone Amplifier, 50s.; Brown H<sub>2</sub> Loud-speaker, 30s.; both L.R.—Parker, Moudsley Road, North Walsham. (2094)

**2-VALVE** A.J.S. Receiver, complete with 1-valve amplifier, Amplion Junior De Luxe loud-speaker, 2 accumulators, batteries; £10; new this year.—Write J. C. Davis, 91, Abingdon Road, Kensington, W.8. (2102)

**ONE-VALVE** Single Control Super, 20 miles without aerial, earth, or frame, loud-speaker, 40 miles on frame, all B.B.C., Continental and occasionally American stations on poor aerial; just as easy to build as a crystal set, and total cost, including phones, D.E.06 valve, is 35s.; run off two 4½v. flashlamp cells; abolish accumulator and H.T. worries; full details and diagram, 2s.—E. Makin, 6, Bourne Road, Stoke, Coventry. (2096)

## For Sale.—Contd.

**MARCONIPHONE** Long-range Two-valve Receiver, absolutely perfect order; nearest cheque to £8.—Bonnett, Trinity Hall, Cambridge. Also

**WARD** and **GOLDSTONE** Four-valve Set, needing slight repair, all good stuff and licensed; £6.—Above. (2087)

**CROIX** Transformers, 3.1 and 5.1, guaranteed genuine; 4s. each, post 4d.; Continental Supplies.—497, Old Ford Road, London, E. (2095)

**TWO** Mullard o/50 Transmitting Valves, new and in perfect condition; £3 17s. 6d. each.—BM/ADHS, London, W.C.1. (2097)

**ROBERTS** Reflex Neutrodyne Valves, batteries, 2 pairs phones, Lissenola, all as new, also numerous components; reasonable offer, whole or part; stamp for reply; genuine.—Dunbabin, St. Paul's Terrace, Newport Pagnell. (2098)

**L.F.** Transformers for First and Second Stage; money-back guarantee; 3s. 9d. each, post 4d.—Davis, 15, Bournmouth Park Road, Southend-on-Sea, Essex. (2099)

**AMATEUR** has many high-class Components for sale. List furnished on application.—Hoare, Brownlow, Hindhead. (2101)

**2-VALVE** Loud-speaker Set, £2 5s.; 0003 Formo variable condenser, with vernier, 4s.; 2 0005 variable condensers, with verniers, 4s. 6d. each; Lissen L.F. choke, 5s. 6d.; Mansbridge 2mf. condenser, 2s. 6d.. Full list on application.—Howard, 3a, Shellfield Road, Southport. (2100)

## MISCELLANEOUS.

**A WIRELESS** Doctor.—If your set is giving trouble or you want advice a competent expert will call (anywhere in Greater London) and put you right. No result, no charge.—Alexander Black, 2A, Woodville Grove, N.16. Clissold 3687. (2002)

**LOOK!**—Why use H.T. Batteries if you have electric light in your homes? Make your own H.T. unit from either A.C. or D.C.—Write for full particulars and diagram, enclosing 1s.: Camberwell Electric Coil Winding Co., 35, Edmund Street, S.E.5. (2043)

## PATENT AGENTS.

**KING'S PATENT AGENCY, LTD.** (B. T. King, Registered Patent Agent, G.B., U.S., and Can.). Free "Advice Handbook" and Consultations. 40 years' references.—146A, Queen Victoria Street, London, E.C.4. (0002)

**PATENTS** and Trade Marks Obtained.—P. H. T. P. Gee, Patent Agent, Member R.S.G.B., A.M.I.R.E., 51-52, Chancery Lane, London, W.C.2. Phone: Holborn 1525. (0001)

**W. BRYSON**, B.Sc., Chartered Patent Agent, 29, Southampton Buildings, W.C.2. Phone: Holborn 672. (2052)

## REPAIRS.

**TRANSFORMERS** rewound to guaranteed efficiency for 12 months, 4s., or exchanged for another, any ratio, 5s.; iron core wire-wound chokes for L.F. amplifiers, 6s.—115, Links Road, Tooting. (0011)

**WANTED.**

**TO** Manufacturers.—Required, about 10 weekly "G.R." "Universal Four" Receivers; firms desirous of tendering for manufacture thereof please apply at once for exact constructional details; mention "W.W."—Claude Lyons, 70, Oldhall Street, Liverpool. (2089)

**W. WRENTMORE**, 52, Shaftesbury Avenue, will be happy to receive communications from manufacturers of Wireless Specialities. (2103)

**SITUATIONS WANTED.**

**RADIO** Engineer, A.M.I.R.E., 13 years' experience, spark arc valve, P.M.G. certificate, desires post responsibility home or abroad; knowledge 5 languages; disengaged September.—Box 7802, WIRELESS WORLD Office. (2047)

**BOOKS.**

**162** "Popular Wireless," 03 "Wireless Worlds," 55 "Amateur Wireless," 5 "Wireless Constructors"; what offers?—Morris, 02, Borwick Avenue, Walthamstow. (2088)

*The*  
**Home**  
**Constructor's**  
**Wireless Guide**  
by *W. James*

**THIS** book forms a most convenient little encyclopedia of wireless technology: the kind of volume to refer to when in difficulties. It solves them for you.

*A few of the main features:*

Outdoor, Indoor and Frame Aerials; Earths; Variometers for Broadcast Wavelengths, Basket Coils, Plug-in Coils, etc.; Coupled Circuits; Common Faults in Tuners; Reaction and Self-Oscillation; Special Chapter on Sensitive Single-Valve Receivers; Double Magnification; Points on Dry Cells and Accumulators, etc., etc.

PRICE **3/6** NET.

By post, 3/10.

Obtainable from Booksellers and Wireless Stores, or direct from the Publishers of "The Wireless World."

**ILIFFE & SONS Ltd.,**  
Dorset House, Tudor St.,  
London, E.C.4.

W.W.10

**PUBLIC NOTICE.**

CIVIL SERVICE (AIR MINISTRY).  
DESIGNERS' AND DRAUGHTSMEN'S COMPETITION.

**A** COMPETITION by interview will shortly be held for posts (pensionable under Civil Service conditions) for engineering designers and draughtsmen in the Air Ministry or at the Royal Aircraft Establishment, Farnborough, for work on aircraft design and calculations; aero engines, design and calculation; perspective sketches for reproduction; wireless and other accessories; ground equipment and general works machinery and plant. The scales of salary of the posts are:—

Designers, £250-15-£350 a year, plus Civil Service Bonus.

Draughtsmen, Grade I, £100-10-£200 a year, plus Civil Service Bonus.

Draughtsmen, Grade II, £125-7½-£150 a year, plus Civil Service Bonus.

The competition will be open to (a) designers and draughtsmen serving at the Air Ministry or at the Royal Aircraft Establishment, and (b) other engineering designers and draughtsmen who have either served in H.M. Forces or served at sea and been awarded the British War Medal or the Mercantile Marine War Medal.

Candidates must have attained the age of 24 and (unless they are serving under the Air Ministry) must not have attained the age of 45 on 1st January, 1926. Regulations and form of application may be obtained from the Secretary, Air Ministry, S.2 (Room 464), Admiralty House, Kingsway, W.C.2, by whom the completed form of application must be received on or before 10th June, 1926.

reproduction  
—volume  
—clarity

You get all these in Ericsson Super Tone Loud-speakers.

Made by a firm with a generation's experience in telephone research. No distortion. No rattling—just crystal-clear reproduction.

Put one to follow your set power valve and you'll be amazed.

18" high on wood base. Very melodic and pure. 2400 ohms, 83. Junior Super Tone for small rooms, 32/6.

Write for lists

The **BRITISH L.M. ERICSSON** Mfg. Co., Ltd., 67/73, Kingsway, London, W.C.2.



**Ericsson**  
SUPER TONE  
LOUD SPEAKERS

**Get the new**  
**'TENAX' CRYSTAL DETECTOR**

A low resistance reliable "Stay-put." Invaluable for all Valve-Crystal sets. Post free **4/6** C.O.D.

**THE TELEKTRON CO., 14, Lacy Rd., London, S.W.15.**

**Lo! Hear the gentle lark—**



**—accompanied by the valve!**

"Accompanied by the piano," the programme said, but "accompanied by the Valve and piano" would be truer of songs heard on many sets. Every time the door shuts, or a cart passes, or someone treads heavily, "Ping!" goes the valve and the best notes of your favourite melody are drowned.

But this unwanted accompaniment can very easily be stopped—by floating your valves in Benjamin Clearer Tone Valve Holders.

The extraordinary success of the Benjamin Clearer Tone Valve Holder is due to the fact that it is perfect in every detail. No loophole has been left where vibrations could possibly reach the filament—a fact you can judge for yourself from the accompanying brief descriptions of its construction.

There are terminal connexions for the experimenter and soldering tags for the permanent set. The Benjamin Clearer Tone Valve Holder is easily cleaned—little or no dust can collect in the sockets. The springs themselves, as shown in the lower of the two diagrams, form the valve pin sockets. No soldering joints—all one solid metal piece from tags to valve leg. No flexible wire connexions. The spring supports are not affected by stiff bus bar wiring.



**2/9**  
each.



**2/9** each

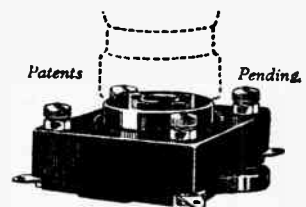

**BRITISH BENJAMIN MADE**  
**CLEARER TONE VALVE HOLDER**  
(ANTI-MICROPHONIC)

From your Dealer or Direct from  
**THE BENJAMIN ELECTRIC LTD.**  
Brantwood Works, Tariff Road,  
Tottenham, N.17.

The Benjamin Battery Switch gives perfect current control, 2/- each.

INDEX TO ADVERTISEMENTS.

Accumulators Elite ... ..	12	Edison Swan Elec. Co., Ltd. ... ..	5	Midland Radiotelephone Manf., Ltd. ... ..	9
Athol Engineering Co. ... ..	9	Ferranti, Ltd. ... ..	4	Morsor, H. & Co. (Wireless), Ltd. ... ..	9
Audion Radio Co. ... ..	12	Forno Company ... ..	2	New Times Sales Co. ... ..	5
Beard & Fitch, Ltd. ... ..	1	Fuller's United Electric Works, Ltd. ... ..	1	New Wilson Elec. Manf. Co. ... ..	2
Belling & Lee, Ltd. ... ..	Cover ii.	General Radio Co., Ltd. ... ..	6	Oliver Pell Control, Ltd. ... ..	1
Benjamin Elec. Co., Ltd. ... ..	11	General Electric Co. ... ..	6	Paragon Rubber Co., Ltd. ... ..	12
Brandes, Ltd. ... ..	7	Graham, Alfred, & Co. ... ..	Cover ii.	Pickett Bros. ... ..	2
British L.M. Ericsson Mfg. Co., Ltd. ... ..	11	Graves, J. G., Ltd. ... ..	1	Radiaro Electrical Co., Ltd. ... ..	2
Cahill & Co., Ltd. ... ..	4	Hamley Bros., Ltd. ... ..	1	Radio Devices, Ltd. ... ..	12
Caxton Wood Turnery Co. ... ..	12	Igranie Electric Co., Ltd. ... ..	1	Radions, Ltd. ... ..	12
Charlesworth, W. J. ... ..	12	Jones, Sydney & Co. (London), Ltd. ... ..	1	Sifam Electrical Inst. Co. ... ..	3
Christie, James & Sons, Ltd. ... ..	12	Lisenta Wireless Co. ... ..	9	Stratton & Co., Ltd. ... ..	11
Clarke, H. & Co. (Manchester), Ltd. ... ..	12	Lock, W. & T. ... ..	7	Telektron Co. ... ..	4
Cleartron Radio, Ltd. ... ..	12	London Elec. Wire Co. & Smiths, Ltd. ... ..	7	Telephone Manf. Co., Ltd. ... ..	11
Dixon, Leslie & Co. ... ..	12	Lustrolux, Ltd. ... ..	12	Veryard & Yates ... ..	11
Dubilier Condenser Co. (1925), Ltd. ... ..	Cover iv.	Mareoniphone Co., Ltd., The ... ..	1	Ward & Goldstone, Ltd. ... ..	11
Edison Bell, Ltd. ... ..	3	McMichael, L., Ltd. ... ..	1	Wamel Wireless Co., Ltd., The ... ..	5
		Metro-Vick Supplies, Ltd. ... ..	1	Wilkins & Wright, Ltd. ... ..	5

### H.T. Accumulators 37/6

60 Volts. 3 Actual Amp.-hour



The finest H.T. Accumulator in the world.



55-

60-volt, 3-amp.-hour, oil submerged. Will last a lifetime. Write for descriptive folder.

**SOLD ON APPROVAL SYSTEM.** Obtainable only from  
**ACCUMULATORS ELITE, 31, Waterhouse St., Halifax.**  
 Trade Supplied. Telephone: 1304.  
 Or from Messrs. **CEGIL POHLMAN, LTD.,**  
 77, Great Portland Street, London, W.1.



### The Home Constructors

EASY TO BUILD  
**Wireless Sets**  
 By F. H. Haynes.

## The Home Constructor's

EASY TO BUILD  
**Wireless Sets**  
 By F. H. Haynes.

### YOU CAN TAKE IT FROM ME!



That our Summer Catalogue contains the finest Radio Bargains ever offered. 600 Illustrations of a wonderful selection of unique apparatus.

Send 4d. stamps.  
**ELECTRADIX RADIOS,**  
 218, Upper Thames St., London, E.C.4.

Parrs Ad

### AERMONIC



#### ANTI-CAPACITY AIR-SPACE VALVE HOLDER

Capacity and Voltage Leakage Losses cut down to the absolute minimum. Will improve any circuit.

Model "D." Base-Board Mounting 2/6 each.  
 Model "E." Back of Panel, 2/6 each.

Manufacturers and Distributors for London and South England:  
**JAMES CHRISTIE & SONS Ltd., 248, West St., SHEFFIELD.**  
 London Agents: A. F. Bulgin & Co., 10 Cursitor Street, E.C.4.  
 Agents—Remainder British Isles:  
 Messrs. V. R. Pleasance, 56, Fargate, Sheffield.

### Working Sets

By F. H. Haynes.

IN THIS book the author introduces some entirely original sets which will make a strong appeal to the home constructor, on account of the simplicity of construction and the fact that they have not previously been described elsewhere.

EASY TO UNDERSTAND working drawings are given, with practical circuit diagrams, together with a sufficient explanation of the underlying principle to obtain a thorough understanding of the construction.

PRICE **1/6** NET.  
 By Post 1/9.

### LUSTROLOX

WIRELESS VALVES.  
 THE ECONOMICAL COMBINATION

2r. '06 H.F. & L.F. 9/- 2r. '34 P.V. 11/-  
 Obtainable from Lewis's Ltd., Liverpool and Manchester, and  
**LUSTROLOX LTD.,**  
 West Bollington, Near Macclesfield.

### PICKETTS CABINETS

Model-de-Luxe Polished.

Takes panel	Mahogany	Oak
12 x 9	25/-	20/-
12 x 12	35/-	30/-
12 x 15	40/-	35/-
12 x 18	45/-	40/-

Estimates—Per RETURN POST.  
 Send for cabinet designs and lists free.

**Picketts Cabinet (W.W.) Works, Bexleyheath, S.E.**

### LOEWE AUDION D.E. VALVES

FOR BEST RESULTS AT LOWER COST!

Will give better results than many at nearly double the price: specially suitable for Super-het. Sets.

L.A.75. 15 amp. 2 volt, 10/8 If your dealer L.A.74.06 amp. 3 volt, 11/8 (cannot sup- ply send p.o. L.A.101. Power valve. 21/- direct to  
**AUDION RADIO CO.,**  
 52, Dorset Street, LONDON, W.1.

### VALVES Repaired Quick

Let our valve making plant repair your broken or burnt out valves efficiently & promptly (most makes). Guaranteed equal to new. Bright emitters 5-; "D.E." 2 and 3v types, 7/6. Power valves slightly more; see list. Not repairable: S.P. W.F. 0 v. 24.

**RADION** Reliable Repairs  
**RADIONS Ltd., Bollington, Nr. MACCLESFIELD, Chesh.**  
 Largest valve-repairing firm in the world. List Free.

Obtainable from all booksellers or from the Publishers of "The Wireless World":  
**ILIFFE & SONS LTD.,**  
 Dorset House, Tudor Street,  
 LONDON, E.C.4

W.W. 11

WIRELESS becomes much more interesting when you are able to read Morse. Now is your opportunity to acquire a knowledge of the Morse Code.

**PERRY'S AUTO-TIME MORSE SYSTEM,**  
 Price 6d. net. By post 7d., provides a ready means of becoming proficient in Morse reception.

Published from the  
 Offices of "The Wireless World,"  
**Dorset House, Tudor Street, London, E.C.4**  
 W.W. 24

INVALUABLE TO THE EXPERIMENTER

# WIRELESS VALVE TRANSMITTERS

By W. James.

## The Design and Operation of Small Power Apparatus.

This book deals thoroughly with the design and operation of valve transmitters. Written by a recognised authority who has had a wide experience in the design and construction of valve transmitting sets, it is essentially a book for the practical amateur experimenter.

270 pages : 210 photographs and diagrams.

Price 9/- net.  
Post free 9/9.

Obtainable from leading booksellers or direct from the publishers :

ILIFFE & SONS LIMITED,  
Dorset House, Tudor Street, London, E.C.4.

W.W.

## The Home Constructor's Wireless Sets

By F. H. Haynes.



IN THIS book the author introduces some entirely original sets which will make a strong appeal to the home constructor, on account of the simplicity of construction and the fact that they have not previously been described elsewhere.

EASY TO UNDERSTAND working drawings are given, with practical circuit diagrams, together with a sufficient explanation of the underlying principles to obtain a thorough understanding of the construction.

Price 1/6 net. By Post 1/9.

Obtainable from all booksellers or from the Publishers of "The Wireless World":  
ILIFFE & SONS LTD., Dorset House, Tudor Street, LONDON, E.C.4.

W.W.

# A Service that gives Security!

MANY readers naturally hesitate to send money to unknown persons. We have therefore adopted a Deposit System which gives complete security both to buyer and seller. If the money be deposited with "The Wireless World" both parties are advised of its receipt. The time allowed for decision is three days, after which time, if the buyer decides not to retain the goods, they must be returned to the sender. If

a sale is effected we remit the amount to the seller; but, if not, we return it to the depositor.

Full particulars may be found on the Miscellaneous advertisement page at the end of the book.

Use this service for your wireless requirements and avoid all risk! Sell the apparatus you no longer require! Write out your advertisement to-day and send to—

PREPAID ADVT. DEPT., "THE WIRELESS WORLD," DORSET HOUSE, TUDOR ST., LONDON, E.C.4.

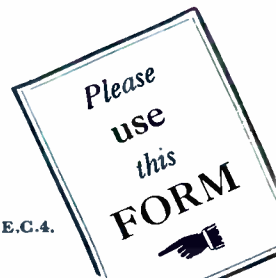

12 Words or Less 1/-

each additional word 1d.

Advertiser's name and address must be counted. If a box number is required 6d. extra must be sent for postage on replies.

W.W.39

Advertisements for "The Wireless World" are only accepted from firms we believe to be thoroughly reliable.

# ARE YOU A PATIENT MAN ?

# £200

## IF YOU ARE



"Let's see—five separate units give five capacities, taken singly. Then I can have the first two in series or parallel—total seven. Then the first three all in series or all in parallel—two more. The first and third and second and third in series, total 9. Ditto, in parallel, 11. First and second in series, and in parallel with the third—12 . . . . . And the total number of different capacities with the five units is ——— ?" What is it ?

*If you get it right,  
you win £200 !*

Whatever your skill in counting capacities, however, the purchase of a Dubilicon will bring you one sure reward. The Dubilicon gives any capacity up to 0.011 mfd. simply by varying the connections of the eight unit capacities of which it is composed; so that by using the Dubilicon you will be able to select with unfailing certainty the best value of fixed capacity for any desired part of your circuit.

The Dubilicon is a multiple condenser containing eight separate units, the terminals of each unit being brought out to sockets on the lid. By using Clix plugs (made by Messrs. Autoveyors, Ltd., 84, Victoria Street, S.W.1) of which two are given with every Dubilicon, the units can be connected in a variety of series, parallel and combined series parallel arrangements giving a very large number of different capacities.

The uses and advantages of the Dubilicon, which we have summarised above, make it more than worth its low price of 30/-.

In addition, the purchase of a Dubilicon entitles you to enter for the £200 prize competition. All you have to do is to estimate the number of different capacities you can get by connecting up the first five units in various ways.

Ask your dealer about one to-day—and mind you enter for the £200 competition ! He will tell you all about it !

*The  
Dubilicon*

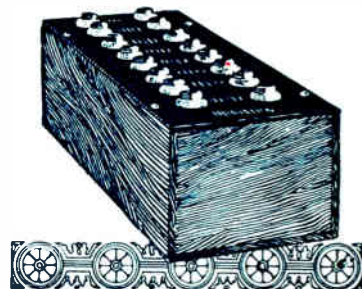

REGISTERED  TRADE MARK

# DUBILIER

CONDENSER CO (1925) LTD

ADVERT. OF THE DUBILIER CONDENSER CO. (1925) LTD., DUCON WORKS, VICTORIA ROAD, N. ACTON, W.5. TELEPHONE: CRISWICK 2241-2-3. B.P.S. 123

Printed for the Publishers, LILIFFE & SONS LTD., Dorset House, Tudor Street, London, E.C.4, by The Cornwall Press Ltd., Paris Garden, Stamford Street, London, S.E.1.

Colonial and Foreign Agents:  
 UNITED STATES—The International News Co., 83-85, Duane Street, New York. FRANCE—W. H. Smith & Son, 248, Rue Rivoli, Paris; Hachette et Cie, Rue Rânanneur, Paris.  
 BELGIUM—W. H. Smith & Son, 78, Marche aux Herbes, Brussels. INDIA—A. H. Wheeler & Co., Bombay, Allahabad and Calcutta. SOUTH AFRICA—Central News Agency, Ltd.  
 AUSTRALIA—Gordon & Gotch, Ltd., Melbourne (Victoria), Sydney (N.S.W.), Brisbane (Queensland), Adelaide (S.A.), Perth (W.A.) and Launceston (Tasmania).  
 CANADA—The American News Co., Ltd., Toronto, Winnipeg, Vancouver, Montreal, Ottawa, St. John, Halifax, Hamilton; Gordon & Gotch, Ltd., Toronto; Imperial News Co., Toronto, Montreal, Winnipeg, Vancouver, Victoria. NEW ZEALAND—Gordon & Gotch Ltd., Wellington, Auckland, Christchurch and Dunedin.



# The Wireless World

4<sup>D</sup>

*The Paper for Every Wireless Amateur*

Wednesday, June 9th, 1926.

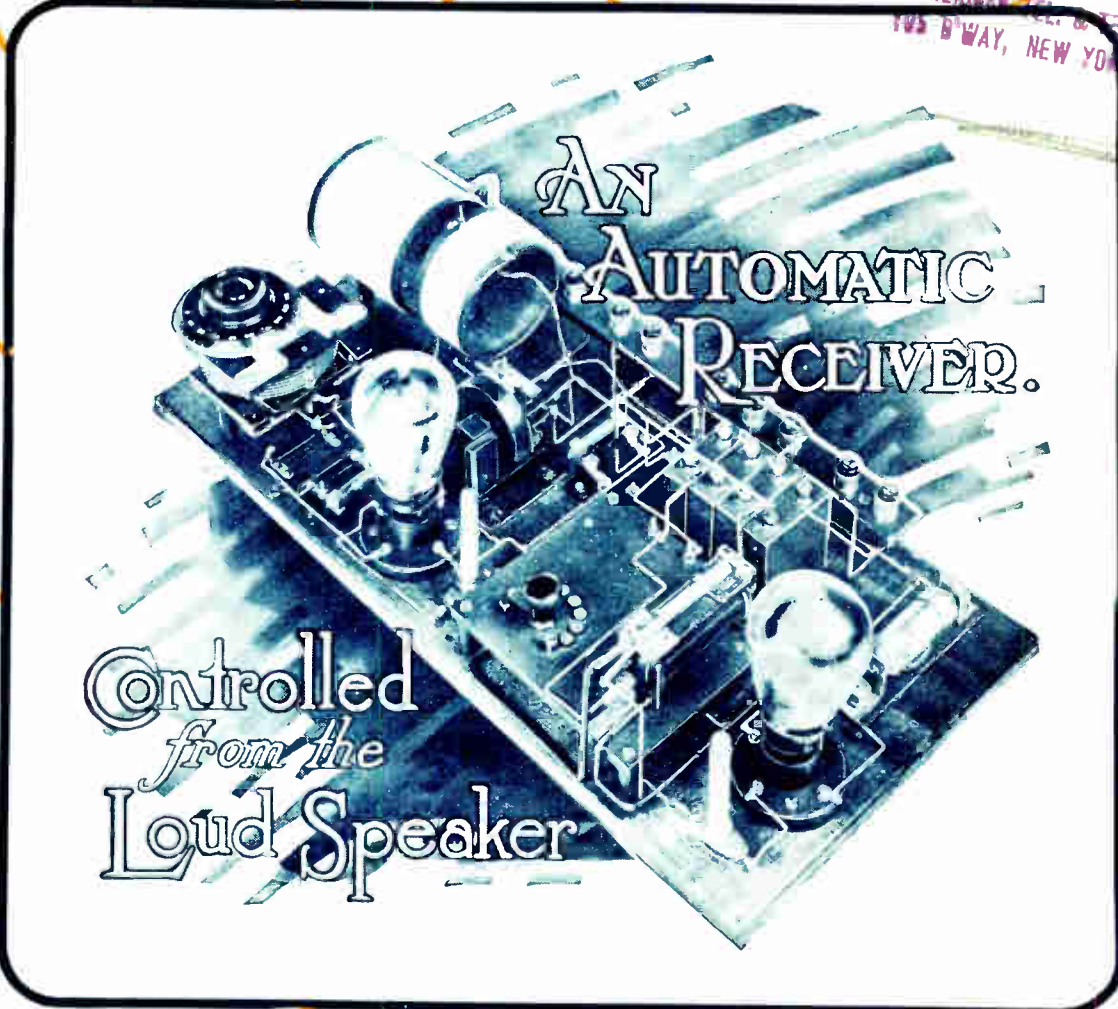

DEVELOPMENT AND RESEARCH LIBRARY  
AMERICAN TEL. & TEL. CO.  
193 B'WAY, NEW YORK, N. Y.

**"Just listen to the difference  
this LEWCOS Coil makes!"**



Each LEWCOS Coil is tested in our laboratory. It is then boxed and sealed up, and reaches you in perfect condition. Be sure the LEW seal is unbroken.

**C**LEAR as a bell the typical French Orchestra came through as the listener tuned in with his LEWCOS Coil. Coil after coil had been tried and discarded in an endeavour to realise that rare selectivity and fine tuning so essential to complete radio enjoyment.

Test this new coil yourself. It makes all the difference. Ask your radio dealer for a demonstration.

No.	25	35	40	50	60	75	100	150	200	250	300
Price	4/6	4/6	4/6	5/-	5/6	5/6	6/9	7/6	8/6	9/-	10/-

# LEWCOS Inductance Coil



**3 LEWCOS advantages:**

- 1 High electrical efficiency with great mechanical strength.
- 2 Great selectivity resulting in extremely fine tuning.
- 3 Exceptionally low high frequency resistance with increased signal strength.

**THE LONDON ELECTRIC WIRE CO. and SMITHS LTD.,**  
Manufacturers of Glazite  
Playhouse Yard, Golden Lane, London, E.C.1.

JUDD

Mention of "The Wireless World," when writing

**1/2d per day**

for keeping your accumulator charged!

(For A.C. use only).

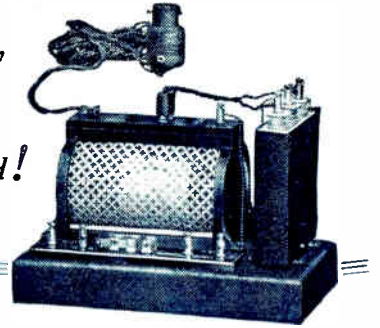

**ONE** halfpenny per day for keeping your accumulator charged—even if you own a five-valve set. That is how little it costs you with a Rectalloy Charger. And here is how it is done.

The Rectalloy Charger is coupled permanently (a) to your set, (b) to your Accumulator, (c) to the electric light socket. When you wish to use your set, the switch on the Charger automatically cuts out the Charger and brings the Accumulator in Circuit. After the Broadcasting is over reversing

the switch disconnects the Set and immediately sets the Rectalloy Charger charging up your Accumulator.

No mess, no worry, no expense. You can forget your Accumulator exists—for the Rectalloy Charger keeps it perpetually at concert pitch.

Model A for a.c. voltage between 100 and 120 65/-  
Model B for a.c. voltage between 200 and 250 85/-  
Model C for recharging H.T. accumulators from a.c. mains. All 40 to 60 cycle 80/-  
Folder "W.D." post free on request.

A new model is now available for charging H.T. Accumulators. It is just as simple to use and has nothing to go wrong. No moving parts, no rectifying valves, nothing to require replacement.

## RECTALLOY The ideal Battery charger

Rectalloy Ltd., Vulcan House, Ludgate Hill, London, E.C.4

P.S. 5227

## CAXTON 4-VALVE CABINET

Made for Sets, "As good as money can buy," "Harmony Four Receiver," "The Melody Three"

Special Cabinets made to Customer's measurements. Prices quoted.

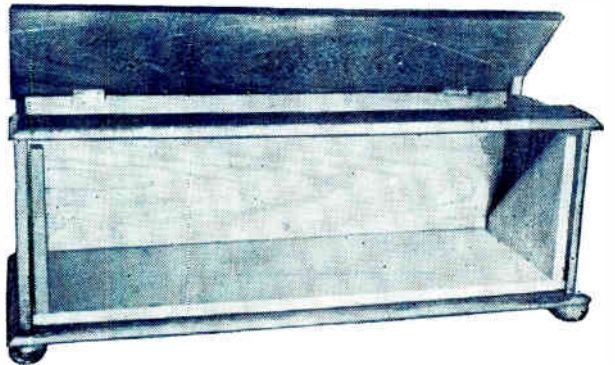

**Cash with Order.** Fumed Oak ... **£1 5 0**  
Dark or Jacobean Oak ... **£1 10 0**  
Real Mahogany ... **£1 14 0**

Detachable 7" deep Base Board to mount 21" by 7" panel to slide out of Cabinet front. Also supplied at 10/- extra with two beaded front doors placed 2 ins. in front of the enclosed panel.

**Ebonite or Radion Panels** Supplied and perfectly Fitted at low extra cost.

All Polished with the new enamel that gives a glass hard surface that cannot be soiled or scratched. **SENT FREE.**—Catalogue of standard Wireless Cabinets in various sizes and woods.

Packed and delivered free in U.K.

no. ca

**CAXTON WOOD TURNERY CO., Market Harborough**

to advertisers, will ensure prompt attention.

**T**O those who value purity of tone and fidelity of reproduction at their true worth, the Marconiphone Type 21 (Two Valve) Receiving Set, complete with Sterling "Dinkie" Loud Speaker and accessories (including Royalty) at an all-in price of

**£14 - 14 - 0**

is unquestionably the utmost value in Radio Equipment.

**E**VERYTHING in this outfit, which is constructed of the highest-grade components—"Ideal" Transformers, Marconi Valves, etc., is of the famous "Marconi" quality, and the cabinet has a plain dignity which harmonises with the furnishing of every home. In all ordinary circumstances this instrument will operate a loud speaker successfully at 50 miles range from a main broadcasting station. The wave-range is practically unlimited by means of interchangeable coils.

**T**HE Marconiphone gives life and charm to everything that is broadcast—it is the outcome of close concentration upon the scientific problem of radio reception—the most efficient two-valve receiver obtainable anywhere.

*Write for Publication No. 437.*

**The MARCONIPHONE Co., Ltd.,**  
210-212, Tottenham Court Road,  
London, W.1.



*The*  
**Marconiphone**  
(Type 21) 2 Valve  
Receiving Set  
WITH  
**Sterling Dinkie**  
Loud Speaker



# MELLOWTONE

The RECEIVER that is YEARS AHEAD

The MELLOWTONE "FOUR" £24.  
Tax £2 10s.  
The MELLOWTONE "TWO" £7 10s.  
Tax £1 5s.

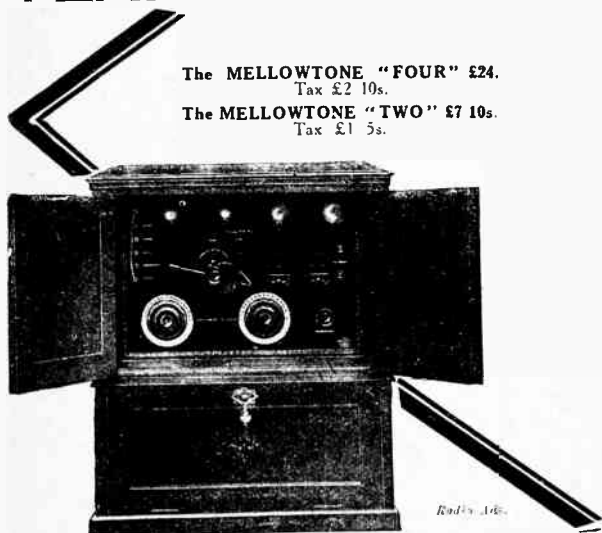

Has the Receiver you contemplate purchasing all these conveniences?

	ADOPTED BY MELLOWTONE
ALL Batteries inside the Cabinet	1923
NO ugly "Plug in" Coils	1923
Leads already fitted with Plugs, etc.	1923
TONE CONTROL (Mellowtone Patent)	1924
Panel Protected by Dust Proof Doors	1924
Cabinets hand made from Seasoned Oak or Mahogany, French Polished	1924
12 Months guarantee	1924
Vernier Dials	1925
Aerial at Earth Terminals at BACK	1925
Unbreakable Battery Leads and Self Adjusting Plugs	1926
TWO YEARS GUARANTEE	1926

The above are all "EXTERNAL" advantages—the "INTERNAL" developments have been even greater!

MELLOWTONE STANDARD 1923 FEATURES are advertised as innovations by competitors in 1926!!

Decide to buy MELLOWTONE—the Receiver that is YEARS AHEAD. Write for Illustrated Catalogue.



LONDON DEPOT: MELLOWTONE, 189 REGENT STREET, W.1.

## The Wireless World and Radio Review "HIDDEN ADVT." COUPON for COMPETITION

This coupon is available until Monday 10 a.m., June 14, 1926

Glue No.	Name of Advertiser.	Page
1		
2		
3		
4		
5		
6		

I enter the above solution subject to the published rules.

Name \_\_\_\_\_  
(Please write clearly)

Address \_\_\_\_\_

## Charge your batteries at home

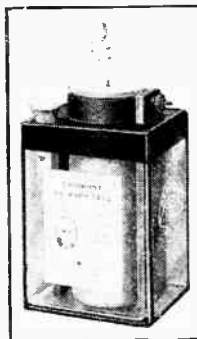

and dispense with the troubles associated with Accumulators and Dry Batteries.

Instal

**DARIMONT**  
**"HOME - SERVICE"**  
**BATTERIES**

with Dull Emitter Valves, and obtain Charges in Car-tons from your dealer.

When the Cells require charging you empty the contents and refill with new solutions.

Ask your dealer for particulars or write direct to:—Dept. A,

**DARIMONT ELECTRIC BATTERIES Ltd.**

Darimont Works, Abbey Road, Park Royal, London, N.W.10

Phone: Wembley 2807.

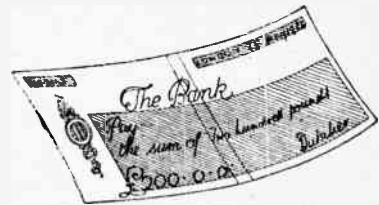
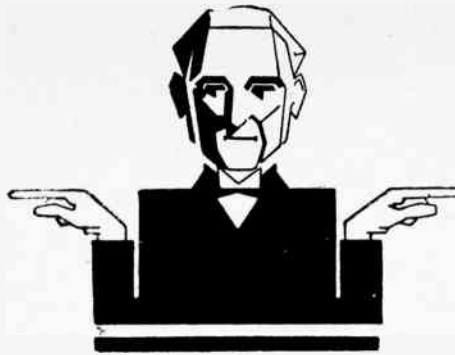
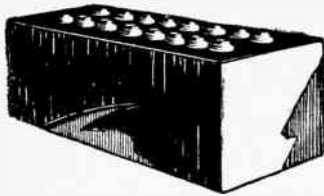

**WHAT IS THIS ?**

**WHAT IS THAT ?**

**Buy the one -  
and win the other!**

The Dubilicon is a multiple condenser containing eight separate units, the terminals of each unit being brought out to sockets on the lid. By using Clix plugs (made by Messrs. Autoveyors, Ltd., 84, Victoria Street, S.W.1) of which two are given with every Dubilicon, the units can be connected in a variety of series, parallel, and combined series-parallel arrangements giving a very large number of different capacities ranging from zero up to 0.011 $\mu$ F.

The Dubilicon, therefore, is of incalculable value to the experimenter who wants to find the best value of fixed capacity for any part of his circuit.

Every purchaser of a Dubilicon is entitled to enter for the £200 competition. All you have to do is to buy your Dubilicon from a Wireless dealer, and find out the total number of different capacities you can get by using the first five units. Full instructions are given with every Dubilicon sold.

Get one to-day!

THE PRICE OF A DUBILICON IS 30/-—  
AND THE PRIZE IS £200!



ADVERT. OF THE DUBILIER CONDENSER CO. (1925) LTD., DUCON WORKS, VICTORIA RD., NORTH ACTON, W.3 TELEPHONE: CHISWICK 2241-2-3.

H.P.S.195

# £10 Weekly in Cash Prizes

Simple Competition  
for all Readers of "The Wireless World"

## HIDDEN ADVERTISEMENTS

Below will be found six reproductions of fragments cut from the Advertisement pages of this issue of "The Wireless World." Each fragment is a clue. Can you from these clues identify the Advertisements? Seven cash prizes will be awarded to the first seven readers who send us correct solutions. No technical skill is required, merely observation. There are no restrictions or entry fees and the conditions are simple.

**£5**  
for the first  
correct solution  
opened.

**£2**  
for the second  
correct solution  
opened.

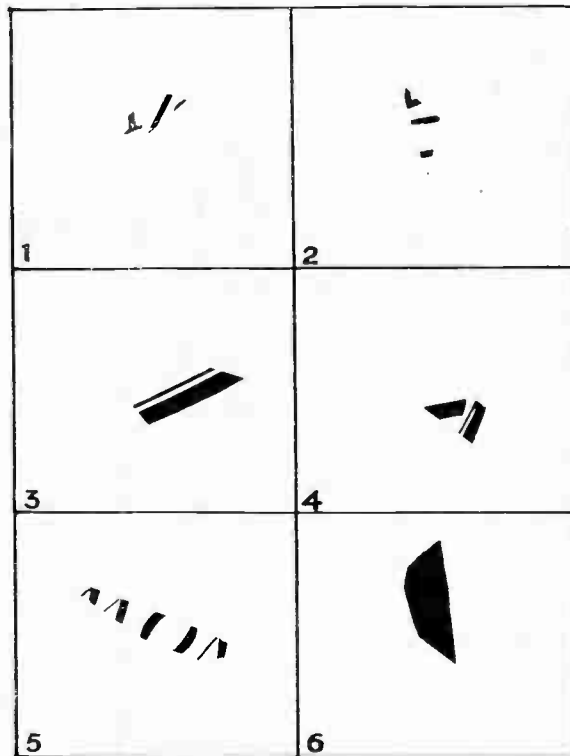

**£1**  
for the third  
correct solution  
opened.

and  
**4**  
consolation  
prizes of  
**10/-**  
Each

for the next four  
correct solutions  
opened.

### CONDITIONS

1. All solutions must be written on the special coupon appearing on an advertisement page in this issue and addressed to *The Wireless World*, Dorset House, Tudor Street, London, E.C.4, and marked "Hidden Advt.s." in bottom left corner.

2. Clues will not, of necessity, appear in the same way as in the advertisement page, but may be inverted or placed in some other position.

3. In order that town and country readers may compete on equal terms, solutions will not be dealt with until 10 a.m. on Monday next. All solutions received before that date will be retained until Monday morning. Competitors may submit any

number of entries. Erasures or alterations on a coupon will disqualify the entry.

4. The first prize of £5 will be awarded for the first correct solution opened; the second prize of £2 to the next correct solution; the third prize of £1 for the third, and four consolation prizes of 10/- each for the next four correct answers. In the event of no readers sending correct solutions the prizes will be awarded to the competitors whose solutions are most nearly correct.

5. The decision of the Advertisement Manager of *The Wireless World* is final, and no correspondence can be entered into. Competitors enter on this distinct understanding. No member of the staff of the paper is permitted to compete.

Knob and Dial  
Fixed with GRUB SCREWS

Knob & 4" Dial  
Beautifully  
Finished

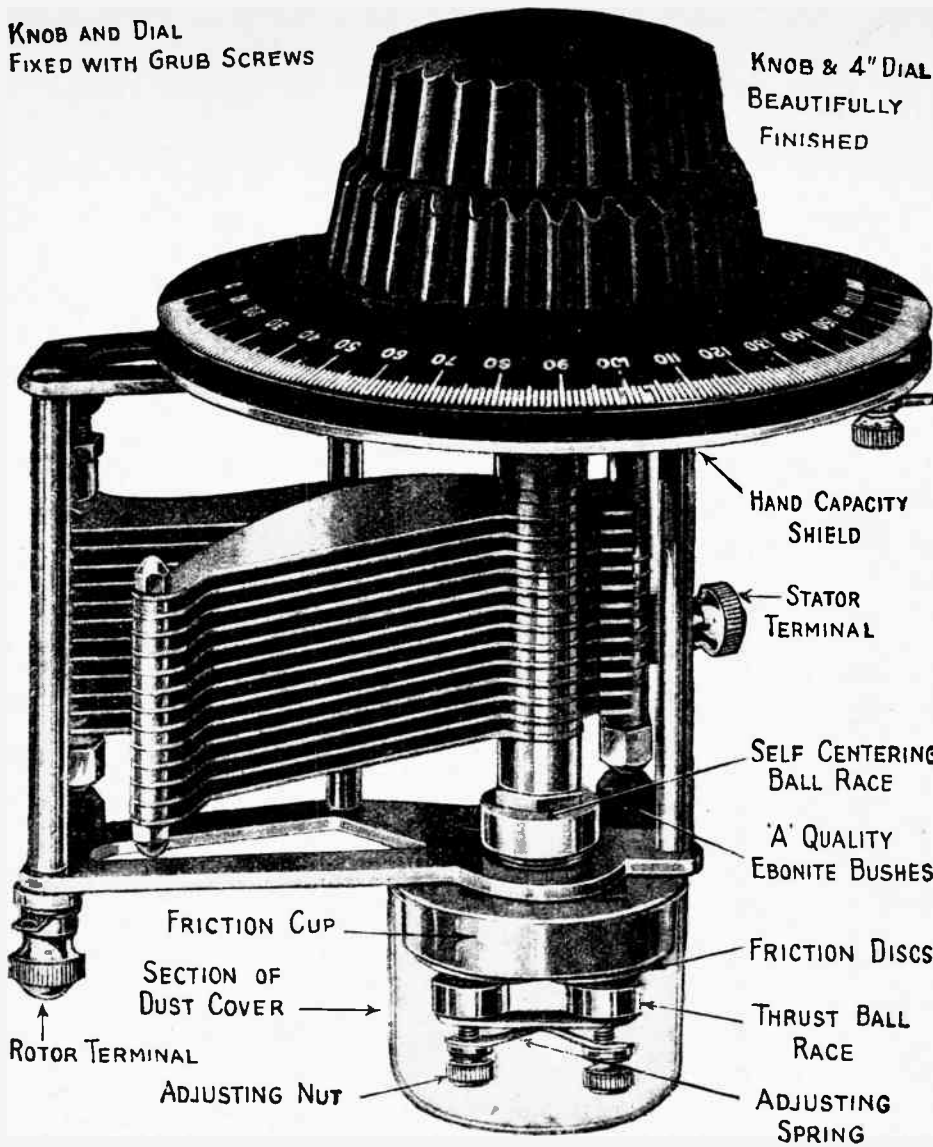

Hand Capacity  
Shield

Stator  
Terminal

Self Centering  
Ball Race

'A' Quality  
Ebonite Bushes

Friction Cup

Section of  
Dust Cover

Rotor Terminal

Adjusting Nut

Friction Discs

Thrust Ball  
Race

Adjusting  
Spring

PATENT APPLIED FOR

## ORMOND develop the first precision STRAIGHT LINE FREQUENCY CONDENSER

This newest Ormond S.L.F. Condenser, now for the first time upon the market, embodies the famous Ormond Slow Motion Friction Drive. Special Ball Bearings ensure a smooth action, giving a liquid-like movement, facilitating precise tuning adjustments with noiseless operations.

Construction is robust, it has bright brass vanes, perfectly rigid, and the heavily nickelled and polished end-plates ensure minimum eddy current losses.

The moving vanes are connected to the frame, thus eliminating stray capacity effects.

Specially shaped vanes give high maximum and low minimum capacity, with true S.L.F. readings throughout full 180 scale. Extremely low Radio Frequency losses. Special method of mounting the fixed vanes reduces di-electric losses to a minimum.

Highest quality scientific instrument finish, handsome bakelite combined knob and 4 inch dial, engraved with 180 separate degrees, and separate slow motion knob.

An anti-capacity earthing shield, which may be fitted, insulated from the condenser, and earthed by a separate connection, and particularly useful when condenser is used in circuits where both electrodes are at radio frequency potential.

Easy to mount "ONE" and "THREE" hole fixing.

Terminals and soldering tags for connections.

Note the astoundingly low prices:

·00025 micro farad	-	19/-
·00035 " "	-	19/6
·0005 " "	-	20/-

Complete with Knob and Dial.



199-205 Pentonville Rd., King's Cross,  
LONDON, N.1

'Phone Clerkenwell 9344-5-6  
'Grams " Ormondengi, Kincross."  
FACTORY: WHISKIN ST., CLERKENWELL, LONDON, E.C.7

# The Chinese have a proverb which says—

“One picture is worth more than ten thousand words”

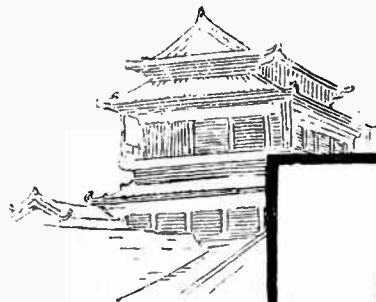

**TYPES AND PRICES:**  
 RED TOP. For H.F. use 15/6  
 18 volts 1 amp.  
 PLAIN TOP. For Detector 15/6  
 18 volts 1 amp.  
**The new Cossor Stentor Two**  
 GREEN TOP. Power Valve 18/6  
 18 volts 1.5 amp.



Made Under Cossor Patents

—therefore

EXAMINE closely this illustration of the new Cossor Point One. Observe particularly the seonite insulator at the top of the Anode—the key to the successful solution of the old problem of truly Co-axial Mounting. Week by week we shall unfold the story of this—one of the most remarkable contributions yet made to the Science of Radio.

## The new COSSOR Point One



# The Wireless World

AND  
RADIO REVIEW  
(14<sup>th</sup> Year of Publication)

No. 354.

WEDNESDAY, JUNE 9TH, 1926.

VOL. XVIII. No. 21.

Assistant Editor:  
F. H. HAYNES.

Editor:  
HUGH S. POCKOCK.

Assistant Editor:  
W. JAMES.

Editorial Offices: 139-40, FLEET STREET, LONDON, E.C.4

Telephone: City 4011 (3 lines).

Advertising and Publishing Offices: DORSET HOUSE, TUDOR STREET, LONDON, E.C.4.

Telephone: City 2847 (13 lines).

Telegrams: "Ethaworld, Fleet, London."

COVENTRY: Hertford Street.

BIRMINGHAM: Guildhall Buildings, Navigation Street.

MANCHESTER: 199, Deansgate.

Telegrams: "Cyclist Coventry."  
Telephone: 10 Coventry.

Telegrams: "Autopress, Birmingham."  
Telephone: 2970 and 2971 Midland.

Telegrams: "Hiffe, Manchester."  
Telephone: 8970 and 8971 City.

Subscription Rates: Home, £1 1s. 8d.; Canada, £1 1s. 8d.; other countries abroad, £1 3s. 10d. per annum.

As many of the circuits and apparatus described in these pages are covered by patents, readers are advised, before making use of them, to satisfy themselves that they would not be infringing patents.

## "UNDECIPHERABLE FOR THE 24 HOURS."

EARLY last month Dr. W. H. Eccles, who, it will be remembered, acted as Vice-Chairman of the Wireless Telegraphy Commission which was appointed to undertake the design of the Rugby station, in a letter to *The Times*, wrote:—"Rugby, in addition, affords one-way communication between the centre of the Empire and all points that care to equip themselves with simple receiving apparatus."

According to a statement which appeared in a recent issue of *The Daily Telegraph*, Mr. Fisk, of the Amalgamated Wireless Company in Australia, is credited with having stated that, in Australia, the Rugby station is "undecipherable for the twenty-four hours."

Such an announcement, coming as it does so soon after directly contrary announcements have been made by the officials here responsible for Rugby, seems to us to be a most remarkable comment which challenges further investigation.

*The Daily Telegraph*, in view of the statement by Mr. Fisk, comments that "Our greatest measure of hope for wireless communication with our Dominions overseas now rests upon the success of the short-wave wireless system; 'beam' directional wireless in particular."

It is most unsatisfactory that public opinion should be led to put aside Rugby as a failure for Empire communication simply on a statement made by one who, it must not be forgotten, is directly interested in the development and adoption of the "beam" system for communication between this country and Australia.

In spite of the fact, however, that Mr. Fisk belittles the importance of Rugby, he does not seem to be over-confident about the immediate success of "beam" stations, for he states that, as the result of tests, he holds the opinion that when the "beam" stations are completed, if suitable wavelengths are chosen, they will communicate with England for twenty-four hours daily. He states, further, that the present stations using short waves, with which he is experimenting, are not sufficiently reliable for public service, and that he thinks that his company should await the completion of the "beam" stations, with their greater power efficiency and concentrated energy, before accepting messages.

There have already been so many delays in the establishment of "beam" stations which have been promised for so long that the future of these stations is still uncertain, and whether the delay in the establishment of the stations is due to technical difficulties or to other reasons is immaterial. We should like more definite information before accepting the statement that Rugby is "undecipherable for the twenty-four hours" in Australia.

We cannot imagine that the Post Office can afford to allow such a statement to pass without some explanation. In our issue of April 21st we referred to the controversy which had arisen regarding the "beam" stations *versus* Rugby, and we appealed for a recognition of the distinctive merits of both. It seems to us very regrettable that the truth should be obscured by such contradictory statements as those to which we have referred above.

## CONTENTS.

	PAGE
EDITORIAL VIEWS	755
AN AUTOMATIC RECEIVER	756
By A. P. Castellain.	
THE ESSENCE OF THE REFLEX	761
By P. K. Turner.	
PRACTICAL HINTS AND TIPS	765
HIGH-FREQUENCY RESISTANCE	767
By S. Butterworth.	
CURRENT TOPICS	769
WIRELESS WITH THE BYRD ARCTIC EXPEDITION	771
BROADCASTING THE LOUGHBOROUGH CARILLON	773
A NEW HIGH-FREQUENCY AMPLIFIER	774
By Dr. H. Kröncke.	
BROADCAST BRIEVITIES	775
HIGH-SPEED PHOTOTELEGRAPHY	777
By Paul J. Gordon Fischel.	
NOVELTIES FROM OUR READERS	780
WIRELESS CIRCUITS IN THEORY AND PRACTICE	781
By S. O. Pearson.	
PIONEERS OF WIRELESS, 17	785
By Ellison Hawks.	
LETTERS TO THE EDITOR	787
READERS' PROBLEMS	789

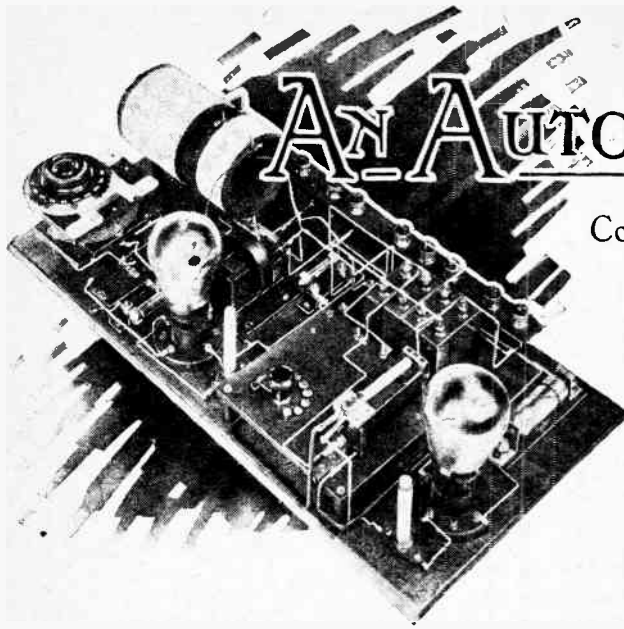

# AN AUTOMATIC RECEIVER.

Controlled by Connecting and Disconnecting the Loud-speaker.

By A. P. CASTELLAIN, B.Sc., D.I.C., A.C.G.I.

THE receiver which is described in this article is one which has been designed to meet the need of a large class of broadcast listener—perhaps the largest—namely, the listener who wants to hear the local station without being bothered with the adjustment of many knobs. As a rule, this class of listener regards a wireless set as an apparatus for giving him music and speech in his own home in the same way that a gramophone does, and the actual mechanism of reception does not interest him so long as he gets what he wants.

### A Permanent Installation.

This automatic receiver has been designed with the idea of its being placed in some convenient out-of-the-way place and forgotten, as a set, until the batteries require recharging or renewing, and as very low consumption dull emitter valves are specified, this will only occur at long intervals.

Nothing could be simpler than the installation and control of this set. When a suitable place has been found,

one well out of the way for preference, and the batteries, aerial, earth, and loud-speaker connected up, the local station is tuned in to its best advantage, and the tuning arrangements clamped in position.

In order to switch off the set, all that it is necessary to do is to disconnect one of the two wires going to the loud-speaker (at the loud-speaker end, of course), while in order to switch it on again, this wire is reconnected. It will be seen, therefore, that the loud-speaker may be placed wherever convenient; that it has only the usual pair of wires to it, and that the set may be controlled by a neat little switch on the loud-speaker. What could be simpler than this?

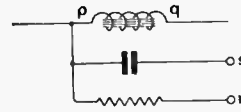

Fig. 2.—Alternative connections for choke coupling between the valves in Fig. 1.

However, the set has the further advantage of automatically indicating when the batteries require recharging or replacing, and also which battery is at fault.

These indications are as

follow:—

1. If the reception is normal and then fades away fairly quickly, the *low-tension* battery (usually accumulator) requires renewing or recharging.

2. If there are no signals at all when the broadcast is known to be on, even when first switching on, then the *high-tension* battery requires renewing.

Matters are so arranged that the high-tension battery must be replaced at the

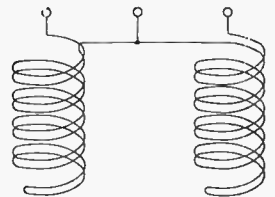

Fig. 3.—Method of winding grid bias resistance.

point where it will just begin to interfere with the quality of reception—thus ensuring that good quality reproduction is always maintained.

### Automatic Grid Bias.

An unusual feature of the circuit is the absence of a grid bias battery. Instead, there is provided an automatic grid bias obtained across a resistance through which the plate current of both valves is passing. This resistance is tapped so that the correct grid bias may be found when the receiver is first set up. (In Fig. 1 is shown the circuit of the set, and in Fig. 2 an alternative choke coupling.)

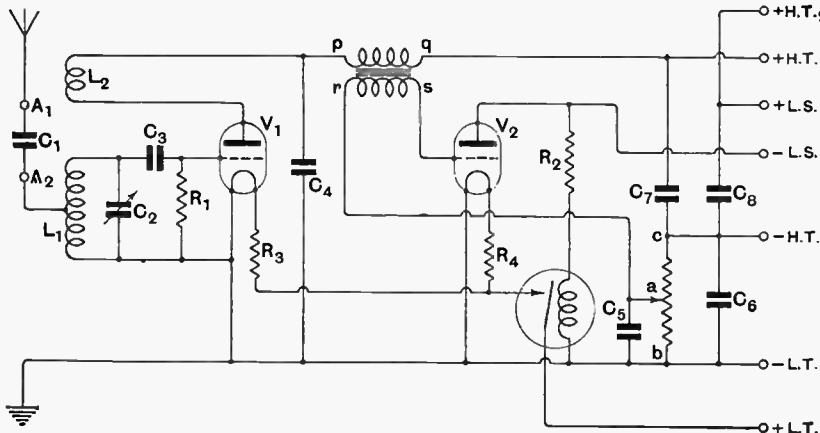

Fig. 1.—Complete circuit diagram of the receiver

**A.E. Automatic Receiver.—**

This resistance is specially wound in order that it may behave equally (*i.e.*, have the same impedance) over the range of speech frequencies, and thus give a grid bias voltage independent of frequency. This type of winding is a little more trouble than straightforward piling on of turns, but it is well worth doing. As will be seen in Fig. 3, the method consists of winding each section of the resistance as a loop. To do this, the required length of wire (from Table 1) is measured out, allowing about two inches extra for soldering to the connecting tabs, then doubled to form a loop.

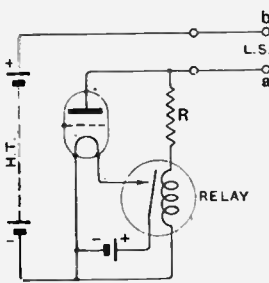

Fig. 4.—Connections of the relay circuit.

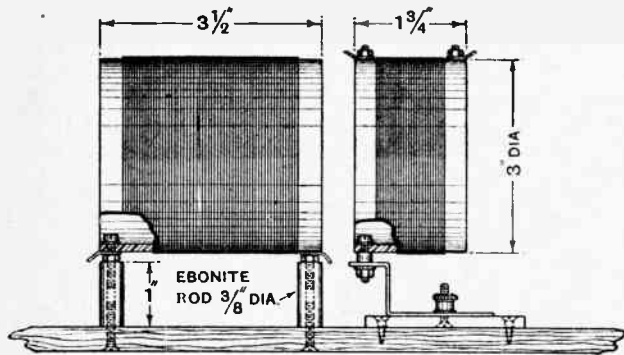

Fig. 5.—Dimensions of the A.T.I. and reaction coil formers.

and then this loop is wound on to the appropriate slot in the ebonite former, starting with the looped end. A fairly large number of tappings is provided for so that the bias voltage may be adjusted in small steps and

also so that there is plenty of adjustment to suit various valves if those specified are not used. Fig. 6 gives the details of construction of the former and switch.

TABLE I.—EUREKA WIRE.

S.W.G.	Length, yards per section.	S.W.G.	Length, yards per section.
38	9	44	3
40	6	46	1 1/2
42	4	47	1

It will be noticed that large condensers (1 mfd.) are shunted across the H.T. batteries and across the grid

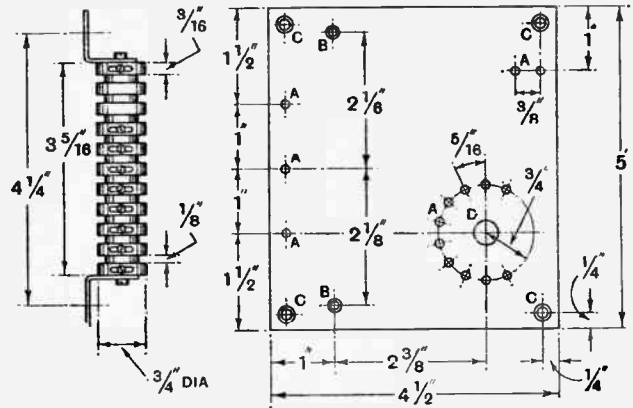
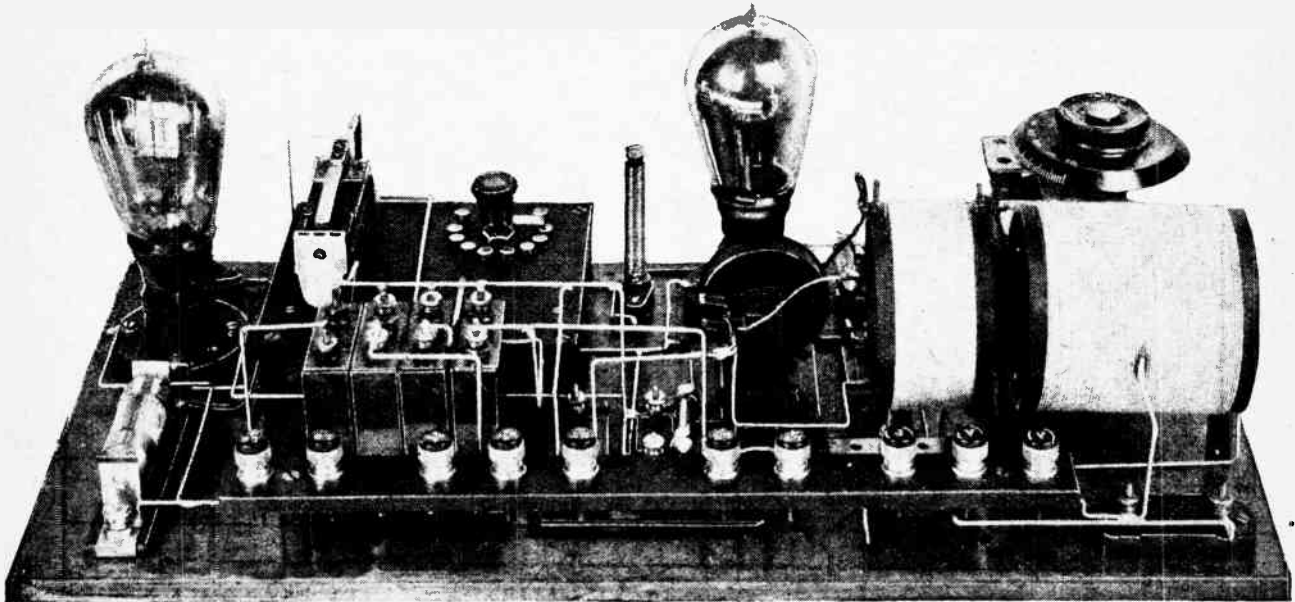

Fig. 6.—Constructional details of former and switch for grid bias resistance.

bias resistance; they are necessary to ensure that the amplifier valve will not oscillate, *i.e.*, "howl."

**The Relay Control.**

The rest of the circuit is normal, except for the relay and its resistance, which are shunted across the amplifier valve. For the benefit of those to whom a relay is an unknown instrument, it may briefly be described as a piece of apparatus which controls a relatively large



General view of the complete receiver.

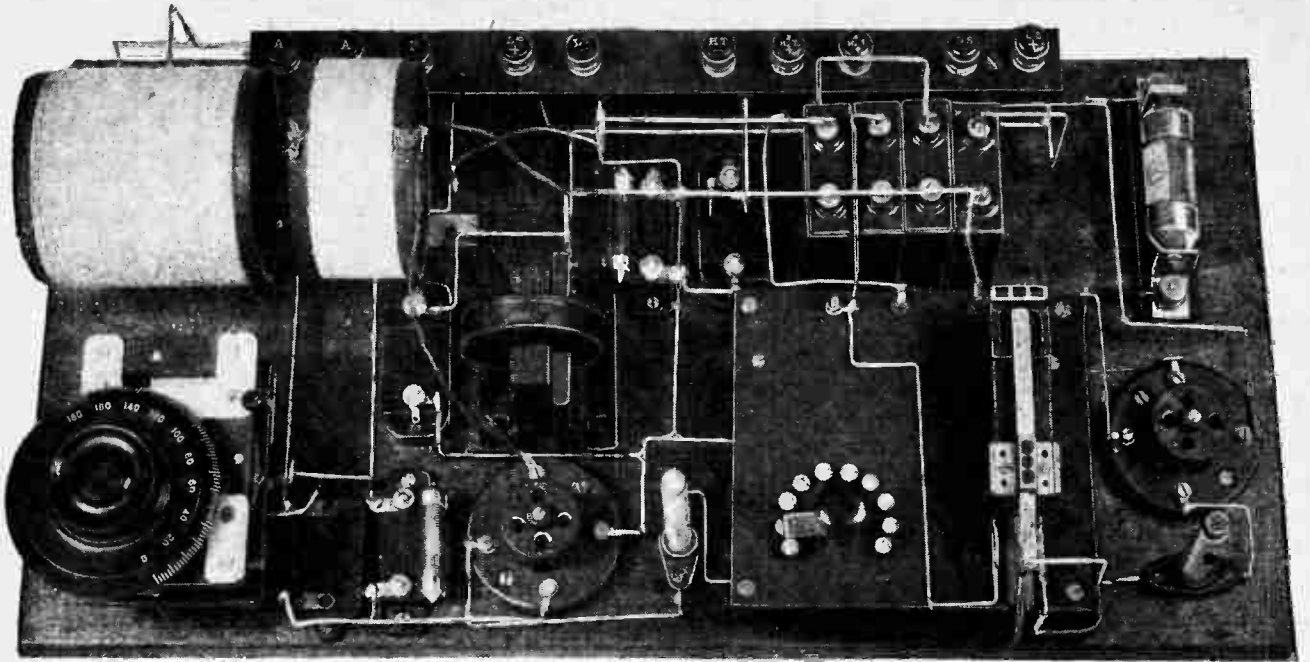

Plan view of receiver with valves removed.

current by means of a relatively small current. In the present set a commercial relay of the Post Office automatic telephone type is used, and may be obtained from Messrs. Elliott Brothers (London), Ltd., Century Works, Lewisham, London, S.E.13. This relay has a serial

number  $\frac{S/M\ 618A\ 1.7\ mA.}{10,000\ \Omega}$  and operates on a circuit of less than two milliamps, while its D.C. resistance is about 10,000 ohms.

The principle of operating of the relay control is

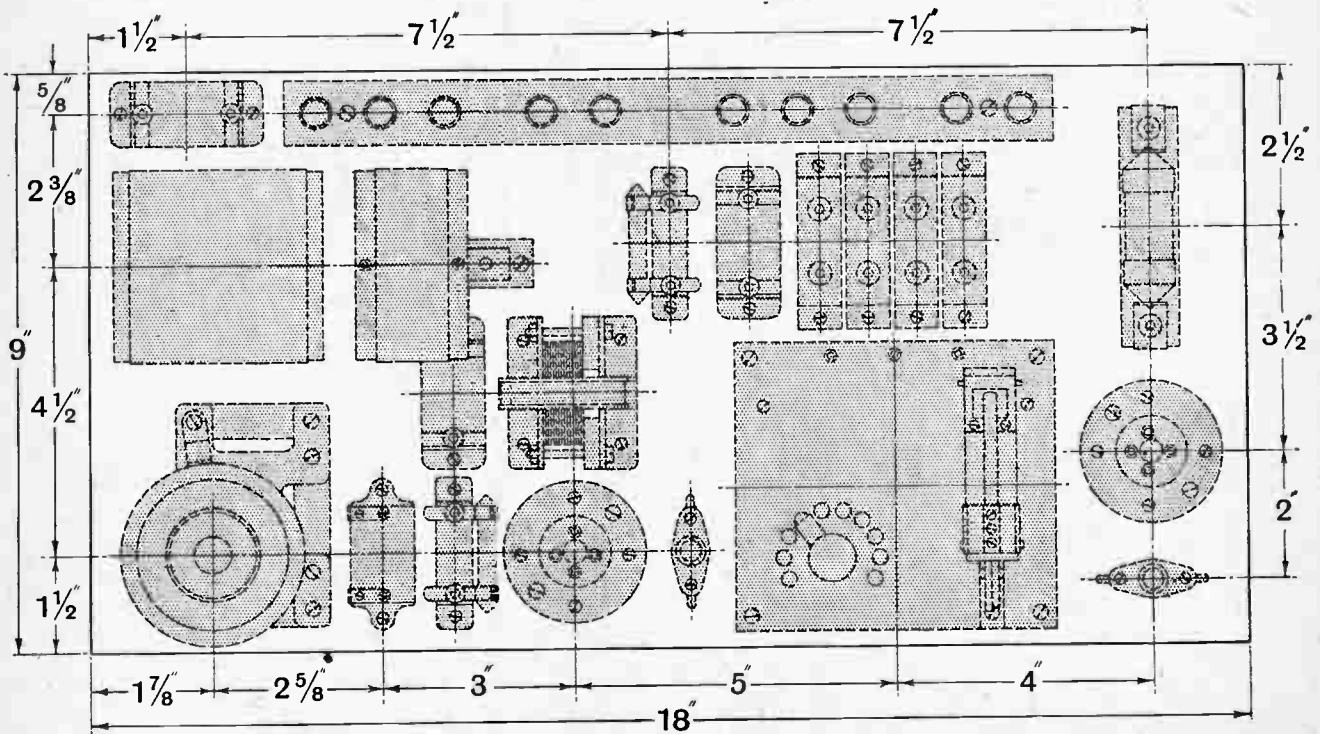

Fig. 7.—Layout of components on the baseboard.

LIST OF PARTS.

- 1 Variable condenser, 0.00025 mfd. (Ormond).
- 1 Fixed condenser, 0.0003 mfd. (Dubilier), No. 610 type.
- 1 Fixed condenser, 0.0001 mfd. (Dubilier), No. 610 type.
- 1 Fixed condenser, 0.005 mfd. (Dubilier), No. 610 type.
- 4 Fixed condensers, 1 mfd. (T.C.C.).
- 2 Grid leaks, 1 megohm ("Dumetohm" Dubilier), and holders.
- 1 Relay, 10,000 ohm (Siemens).
- 1 10,000 ohm wire-wound anode resistance (Varley).

- 2 Fixed resistors and holders (Burndept).
- 1 Choke (Pye).
- 1 8-stud switch (Bowyer Lowe).
- 2 Cosmos valve holders (Metro-Vick).
- 10 Terminals, "M" type (Belling & Lee).
- Ebonite strips, 12in. x 1in. (Britannia Rubber Co.).
- Ebonite panel, 4in. x 4in. (Britannia Rubber Co.).
- Ebonite tube, 8in. x 1/2in. (Britannia Rubber Co.).
- Ebonite tube, 6in. x 3in. diameter (Britannia Rubber Co.).

Approximate Cost

£5.

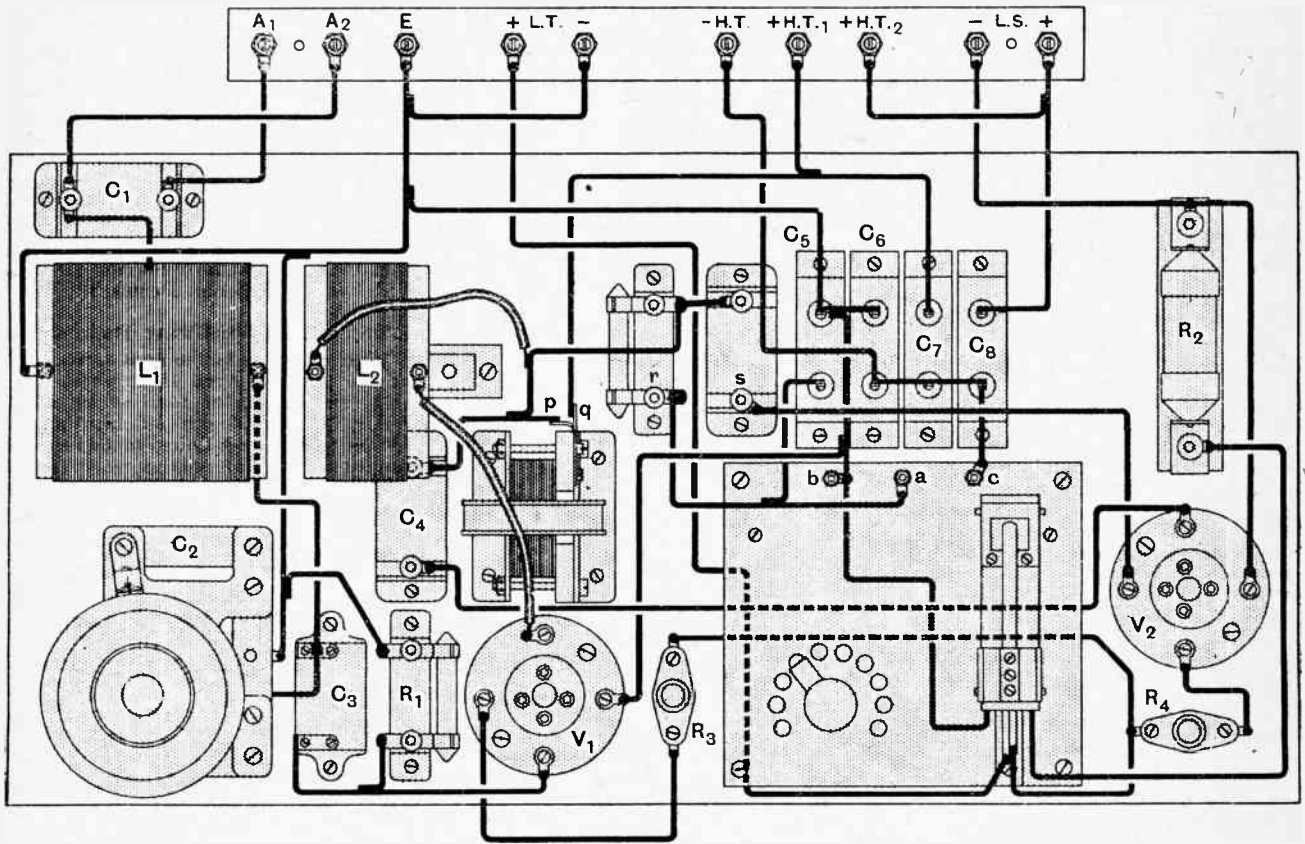

Fig. 8.—Complete wiring diagram.

shown in Fig. 4, where only one valve is shown for clearness.<sup>1</sup>

It will be seen that the relay coil in series with the resistance R will be across the H.T. battery if there is a connection between a and b—i.e. if the loud-speaker is connected. Thus, if the value of R is so chosen that 2 milliamps. flow through the relay coil when the H.T. voltage is the lowest permissible—i.e., consistent with good quality—then the relay will operate and close the filament circuit of the valves when the loud-speaker is connected.

It is also obvious that the relay will not work when the H.T. battery voltage has fallen below the "good

quality" value—thus automatically ensuring good quality output from the set.

Also it should be obvious that the state of the low tension battery will not affect the working of the relay in any way, thus allowing the volume of the loud-speaker output to give an indication of the state of this battery.

Constructional Details.

Constructional details of the rest of the set are given in Figs. 5 and 7, and wiring details in Fig. 8, and no difficulty should be experienced in the assembling or the wiring. The relay panel should be wired before it is fixed to the baseboard, and three small screws with soldering tags are provided in the design to facilitate this.

<sup>1</sup>A description of the action of a relay is given in an article by the writer in *The Wireless World*, June 2nd, 1926.

**An Automatic Receiver.—**

The various components used in the set are given in tabular form.

The valves and intervalve couplings advised are Mullard P.M.3 detector coupled by Pye choke to Mullard P.M.4 valve for a 4-volt L.T. accumulator, or two Mullard P.M.4 valves coupled with a Marconiphone 4 : 1 intervalve transformer.

For a 2-volt accumulator, valves such as the new

Mullard P.M.2 may be used in both cases coupled by a Marconiphone 4 : 1 intervalve transformer.

Transformer coupling is advised for all cases where a very good aerial cannot be erected or where the distance from the local station is over about five miles or in other circumstances where maximum amplification is required.

In conclusion, for the reader who wants a no-trouble set for family use the writer can strongly recommend this automatic receiver.

**General Notes.**

The use of "Radiese" as a means of international inter-communication, while doubtless convenient, often results in a quaint intermixture of languages. We give, as an example, the following extract from our contemporary, the "Journal des 8": "Pse OM de m'adresser renseignements sur votre reception du poste de.....Vci QRA.....Mni tux OM, best 73's."

Our French contemporaries are asking if any amateurs who have unused or obsolescent valve receivers can spare them for the isolated military stations in mountain regions, which during the winter are liable to be completely cut off from the outer world for several days. Particulars may be obtained from E.C.M.R., 51 bis, Boulevard de Latour-Maubourg, Paris.

On April 27th, Mr. J. H. Hollister (U 9DRD) of Forest Lake, Kansas, received A 7HL, Tasmania on telephony. The Tasmanian station was using 27 watts input and U 9DRD a regenerative detector with one stage of amplification. The wavelength used was 34 metres.

Mr. F. R. Neill, GI 5NJ, Chesterfield, Whitehead, Co. Antrim, tells us that on 19th May he was in communication with KEGK, s.s. "Chantier" of the Byrd Arctic Expedition and was able to give the operator news of Capt. Amundsen's Polar flight. Signals were reported strong at both ends and the wavelengths were 37 and 45 metres respectively.

Capt. E. H. Robinson (G 5YM), Langmead, Pirbright, Surrey, is at present investigating what is apparently a curious "jump" phenomenon connected either with the aerial system or the method of excitation employed at his station and will welcome reports from listeners within 200-mile range, provided they give particulars of the receiver used, audibility on the "R" scale and time. G 5YM will transmit morse for a period of 6 days from this date at 6.0, 6.10, 7.0, 7.10, 8.0 and 8.10 p.m. on 44 metres. The actual power will be indicated at the time of transmission.

**International Prefixes and Intermediates.**

The allocation of official Nationality Prefixes for amateur call-signs is still in abeyance, and some confusion is caused by the use of the same letter by different countries; as, for example, the letter

## TRANSMITTERS' NOTES AND QUERIES

"Y" was, until recently, used by India, Uruguay and Yugo-Slavia, and "R" is still used by both Russia and Argentina. We give below the indicating letters now in general use:—

A	Australia.
B	Belgium.
BE	Bermuda.
BO	Bolivia.
BZ	Brazil.
C	Canada.
CH	Chile.
CO	Colombia.
CR	Costa Rica.
CS	Czecho-Slovakia.
D	Denmark.
E	Spain.
EG	Egypt.
F	France.
G	Great Britain.
GI	Northern Ireland.
GW	Irish Free State.
H	Switzerland.
HU	Hawaiian Islands.
I	Italy.
IC	Iceland.
J	Japan.
K	Germany.
L	Luxembourg.
LA	Norway.
M	Mexico.
MF	Morocco.
N	Holland.
Q	South Africa.
O	Austria.
P	Portugal and Madeira (Stations in Madeira have Fig. 3 as distinguishing number: e.g., P 3CO).
PE	Palestine.
PI	Philippine Islands.
PR	Porto Rico.
Q	Cuba.
R	Argentine.
S	Russia.
SM	Finland.
SS	Sweden (incorporated in call-signs: e.g. SMUK).
T	Straits Settlements.
U	Poland.
V	United States.
W	Tunisia.
X	Hungary.
X	Uruguay (also uses letter "Y").
Y	Portable Stations.
YS	India.
Z	Yugo-Slavia.
	New Zealand.

**Danish Amateur Transmitters.**

We understand from our Danish correspondent that amateur transmitters are now able to obtain licences under the following conditions: Maximum input 100 watts, wavebands allotted, under 15, 43-

47, 70-75, and 95-115 metres. Transmission is permitted all day except between 7.30 and 10.30 p.m. (18.30-21.30 G.M.T.). Through the courtesy of the Telegraph Department, transmitters are allowed to retain the same call-signs as in their unlicensed days, unless they wish to change. These call-signs begin with the figure 7 and the nationality prefix is D. QSL cards for Danish amateurs may be sent via: Mr. James Steffenson (D) 7JS, Ehlersveg 8, Hillerup, Denmark.

**French Official Short-Wave Stations.**

With reference to the note on page 543 of our issue of April 15th, we are now able, thanks to the courtesy of Lient. Sudre, of the Nogent-le-Rotrou station (OCNG) in Eure-&-Loire, to correct and supplement the information we were then able to give. The call-signs and wavelengths of the "OC" stations are:—

OCDB	Djibouti, French Somaliland, 72 metres.
OCDJ	Issy-les-Moulineaux, Transmits weather reports "Meteo-Europe" on 33 metres at 1008 G.M.T.
OCMV	Mont-Valerien, near Paris, transmits at 1,000, 1,100, 1,230, 1,330, 1,600, 1,900, 2,000, 2,100 and 2,200 G.M.T. on 39 and 46 metres.
OCNG	Nogent-le-Rotrou, Eure-et-Loire, testing station, transmits on 29, 32, 45, 48 and 72 metres.
OCTU	Tunis, La Casbah, transmits weather reports "Meteo-Tunis" at 2130 G.M.T. and works on 48 metres.

**NEW CALL-SIGNS ALLOTTED AND STATIONS IDENTIFIED.**

G 2BOC	A. C. Porter, 1a, Manor Road, Brockley, S.E.4. (Art. A.) F. W. Miles, 266, Farnslon Avenue N, Coventry.
G 2BVL	(ex 2ANO). F. Graham Turner, 83, Chesterton Road Cambridge. Transmits on 23 and 45 metres.
G 2DB	J. Mellanby and J. Somerset Murray, Emmanuel College, Cambridge, transmit normally on 90 metres but expect to be testing on 8 metres shortly. Also licensed for 23, 45 and 150-200 metres. (This was formerly the call-sign of Mr. A. A. Campbell-Swinton, at 60, Victoria Street, S.W.1.)
G 2HK	A. E. Marlow, Penn Road, Penn, Wolverhampton, transmits on 45, 90, 150-200 and 440 metres.
G 6HT	Capt. Filippini, Tripoli.
AI 1TA	Experimental short-wave station of the Dutch East Indies Military Air Force, at Audir, near Bandoeng, Java (Capt. G. M. Claus).
Andir	Rainou de L. Galdames, 5, Estacion, Bilbao (change of address)—(ex 2ANO).
EAR 21	Roberto Nessi, 13, Via Giuseppe Verdi, Milan.
I 1AW	Elio Faguoni, 63, Via Ghibellina, Florence.
I 1CH	R. E. Earle, Electrical Engineer's Office, Keppel Harbour, Singapore, transmits on 37 metres, usually between 12.00 and 16.00 G.M.T. and occasionally from 21.00 to 23.00 G.M.T.
SS 2SE	G. Solet, Radio-Club de Bizerte, P.O. Box 72, Bizerta, Tunis.
TUN 2	

# THE ESSENCE OF THE REFLEX.

## General Principles Underlying the Design of Reflex Receivers.

By P. K. TURNER, A.M.I.E.E.  
(Research Department, Burndept Wireless, Ltd.)

**H**ARDLY a week now passes without the description of one or more reflex sets, and it is evident that at last it has been realised that this type of circuit is a legitimate economy and by no means a "freak." It seems opportune, therefore, to give a few notes on the general principles underlying the successful design of these sets, so that the would-be builder, instead of being limited to the particular details of the sets described, will be free to design many sets to suit himself, which he can always do once he has mastered the essential principles underlying *all* reflex sets.

Before we actually get down to the question of design, a word about names: I am constantly seeing descriptions of such things as a "three-valve reflex," and then finding that perhaps only one of the three valves is actually doing double work. I do not call that a "three-valve reflex" myself. My idea of a "three-valve reflex" is a set with six stages of amplification got with three valves—not the easiest set to design or use! I prefer myself to name my set from the actual number of *reflexed* valves, and then add (for example) "with one L.F. stage."

### Analysis of the Reflex Circuit.

Well, now, there are three "units," as it were, which are special in a reflex set and which can be combined with one another and with well-known circuits to form a great variety of complete circuits. These are:—

- (1) The combined H.F. and L.F. coupling between two amplifying valves.
- (2) The coupling from a dual amplifying valve to a detector.
- (3) The "throw-back" for L.F. currents, from the detector to a dual valve.

It will be simplest to give typical examples of each, and then proceed to show how they can be built up into complete sets.

Fig. 1 shows the simplest type of really satisfactory coupling between two valves which are both amplifying at H.F. and L.F. There is only one component in it which is in any way out of the ordinary; that is the H.F. transformer. It is possible to devise coupling circuits on the "tuned anode" principle, which do not make use of a transformer at all; but one gets into difficulties with the L.F. coupling, and it usually means providing an H.F. choke; so it seems simpler to use the transformer, especially as in this way it is quite possible to get a step-up which is very much worth while; but before going into details as to the transformer we may as well give the data for the other components.

The filament circuit shown in Fig. 1 is of the simplest type, no provision being made for rheostats. Of course, if the set is to be used for broadcast listening, the two valves will probably be of the same type, and one rheo-

stat can be used for both of them. On the other hand, the experimenter will probably prefer to put one into each filament circuit, so that he is in no way limited as to his choice of valves after the set has been built. It is, however, sound practice to use the same type of valve for both, remembering that both are being used for the same purpose.

### Practical Details.

In arranging such a stage as this, the golden rule is to choose a layout such that the high-potential leads are short; the important ones are those going from grid anode to the H.F. transformer. From the bottom end of both windings of this H.F. transformer, short leads should go to the filament circuit *via* the condensers A and B. These are important, their duty being to by-pass the H.F. currents round the windings of the L.F. transformer. In some cases the self-capacity of the transformer may be large enough to do this by itself, but the better the transformer the less self-capacity as a rule; it is much better to insert these condensers, as then the set will be much more stable if the transformers *do* happen to have low self-capacity.

The correct value of these two condensers depends mainly on the range of wavelengths to be received, but,

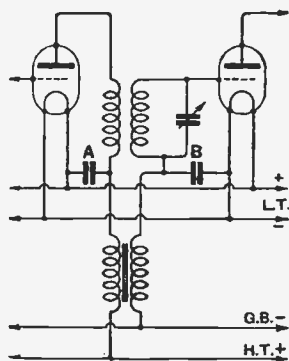

Fig. 1.—Method of coupling valves amplifying at both high and low frequencies.

luckily, exact accuracy is not necessary, so that one value can be chosen and used over quite a wide range of frequency. For the broadcast band, good values are 0.001 mfd. for A, and 0.0001 mfd. for B. The latter is kept small to avoid lowering the tone of the L.F. transformer. In fact, the design here is conditioned by having each condenser large enough to offer an impedance to H.F. which is negligible compared with the rest of its circuit, while at the same time not being so large as to produce an undue lowering of tone from the point of view of L.F. For Daventry and stations of wavelength in that neighbourhood, values of 0.002 mfd. for A and 0.0002 mfd. for B are likely to be successful; in any case, it is about right to make the one in the grid circuit one-tenth of that in the anode circuit.<sup>1</sup>

The L.F. transformer should be chosen for just the same reasons as would lead to its selection for any other set. If the finest tone is required, it will be large and

<sup>1</sup> The grid circuit is of higher impedance than the anode, for one thing; also, a condenser across the secondary of an L.F. transformer has a much greater effect on tone than one across the primary.

**The Essence of the Reflex.—**

probably expensive; but the user may be compelled to make some sacrifice either to the pocket or to considerations of space. In view of the fact that the valves used in this part of the set will very likely be of fairly high amplification factor, it will probably be best to choose a transformer of fairly low ratio; 3:1 is good, and it is not advisable to go beyond 4:1.

**Making the H.F. Transformer.**

Now as to the H.F. transformer. It is quite a mistake to think that there is anything mysterious about this. The requirements are: Two coils, with low self-capacity, tight magnetic coupling, and as little capacity coupling as possible. The low self-capacity is specified in order to get a fairly wide range of wavelength before having to change; the tight magnetic coupling in order that the single tuning condenser shall tune the whole transformer, and not only its own winding; and the low-capacity coupling between the two windings to ensure stability. It is quite possible to use two ordinary plug-in coils, but this is troublesome, as it means changing two things instead of one. There are also various brands of transformer on the market, but, if you buy, make sure that you *do* get the type intended for use with a tuning condenser; there are several types on the market wound with resistance wire or otherwise arranged to give a very flat tuning curve for use without a condenser, and these are quite unsuitable for this purpose. If, however, your tastes are like mine, you will probably want to make your own, especially as it is absurdly simple. I use formers of the type shown in Fig. 2, and usually make them of shellacked cardboard—comparison tests made with ebonite formers show that the difference is barely appreciable—held together for winding and drilling by one central screw and nut and in use by the valve-pins.

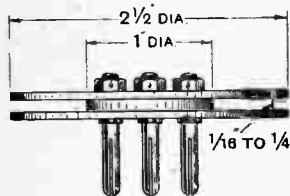

Fig. 2.—Dimensions of a convenient size of former for H.F. transformer windings.

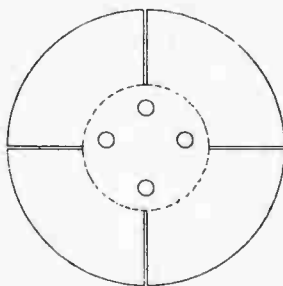

Fig. 3.—Arrangement of saw-cuts in H.F. transformer to facilitate withdrawal of the ends of each winding.

A handy size for all but the very longest waves is that of which the dimensions are marked on Fig. 2, but the dimensions are really not at all important provided the number of turns is adjusted by trial. In all cases the primary is wound on first, followed by a dozen turns of cotton or silk thread to keep primary and secondary well apart; the primary should occupy about  $\frac{1}{4}$  in. depth of the slot. For convenience in winding—or, rather, in finishing off—cut four slots in the lower flange, as shown in Fig. 3; the ends of the windings are brought out of these and then taken under the nuts of the valve-pins.

As regards the actual number of turns, this is likely

to vary a bit, even if the same dimensions are used; the number of turns *wanted* will vary with the stray capacity in the circuit as finally built, while the number of turns actually wound in a given space is not quite constant, as the insulation thickness varies as between various makes. But, as a guide, I give the turns I use myself. There are two tables, depending on whether the primary or the secondary is to be the tuned circuit. It is better to tune the secondary, as both theory and practice indicate a better efficiency.

TABLE I.

Primary tuned by a 0.0005 mfd. condenser.

Wavelength.	Slot Width.	Prim. Turns.	Sec. Turns.	Wire, S.W.G. (D.S.C.).
150—300.....	$\frac{1}{16}$ "	25	25	24
300—600.....	$\frac{1}{16}$ "	50	70	28
600—1200.....	$\frac{1}{8}$ "	100	150	28
1200—2500.....	$\frac{1}{4}$ "	200	400	36
2500—5000.....	$\frac{1}{2}$ "	400	800	36

TABLE II.

Secondary tuned by a 0.0003 mfd. condenser.

Wavelength.	Slot Width.	Prim. Turns.	Sec. Turns.	Wire, S.W.G. (D.S.C.).
150—300.....	$\frac{1}{16}$ "	30	30	24
300—600.....	$\frac{1}{16}$ "	45	60	28
600—1200.....	$\frac{1}{8}$ "	80	120	28
1200—2500.....	$\frac{1}{4}$ "	120	250	32
2500—5000.....	$\frac{1}{2}$ "	200	500	32

In actual practice there should be a good overlap between the transformers; each will give a wider range than shown here.

**Best Values for H.T. and Grid Bias.**

Lastly, as to values of anode and grid voltage. These depend, of course, mainly on the valves actually being used. The valves are doing pure amplification, and should, therefore, be used on the straight part of their curves and with sufficient grid bias. As I have shown elsewhere, there is only one valve in any ordinary set that needs more than one cell of bias, and that is the last one when operating a loud-speaker. We can therefore assume that both the valves in Fig. 1 are being worked at  $1\frac{1}{2}$  volts bias. Reference to the makers' curves for the valves to be used will give the right anode volts, which should be such that all that part of the curve between 0 and  $-3$  volts is straight. For valves of fairly high amplification factor it will probably be best to use somewhere about 90 volts.

This, then, is the typical coupling in a reflex set. Theoretically, we could repeat it as many times as we like, but, as my readers well know, there will soon be trouble with instability. In my own experience I have usually found that one stage is easy, and two not too difficult, but that with two it is desirable, and with three absolutely necessary, to adopt some stabilising device of which I will say more later. Before this I will take up



**The Essence of the Reflex.—**

the second unit of our three, which is the detector coupling.

Here there are a considerably greater number of efficient couplings, for in this case it is to be noted that we are not trying to couple the two valves for both H.F. and L.F. Obviously, there is no point in giving the detector an L.F. input; in fact, we shall be sending the L.F. output from the valve before the detector either to telephones or to a simple power valve if we are to use a loud-speaker. For it is very difficult to make the last valve of the set amplify H.F. currents with reasonable efficiency and stability, so that my considered advice in all cases where a loud-speaker is to be used is to make the last valve of the set a pure L.F. power valve.

**Valve or Crystal Detector?**

Variety in the input coupling to the detector also arises from the fact that the detector itself may be either a valve or a crystal. My own preference is for the crystal every time, both because it gives less distortion when receiving broadcasting, and also because a valve used as a detector is not doing nearly as much work as it might be. But as I realise that some readers may have a strong dislike of crystals I show couplings for both.

Fig. 4 shows the typical coupling where a valve is being used for rectifying. It will be seen that the anode circuit of the previous valve is exactly like that of Fig. 1, and the by-pass condenser should be of the same value as A in that drawing; but the grid circuit of the detector itself is different, naturally. As noted above, it does not contain the secondary winding of the L.F. transformer, which goes to the *next* valve. The detector grid circuit is put across the secondary of the H.F. transformer only, and there is also the usual leak and condenser. These should have the values found successful in other sets with the particular valve to be used as detector; in fact, this valve is just an ordinary grid current detector, to be treated as such. No by-pass condenser is needed in the grid circuit.

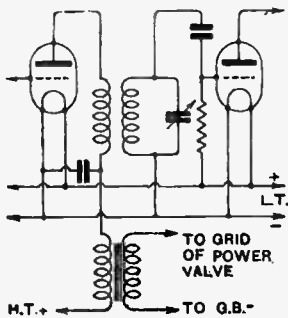

Fig. 4.—Coupling between a valve detector and the preceding reflex valve.

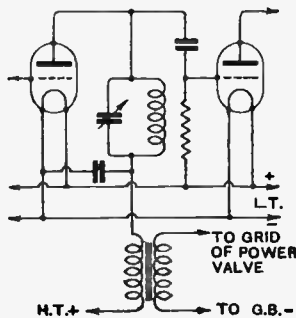

Fig. 5.—Tuned anode coupling between the last reflex valve and the detector.

The transformer coupling shown in Fig. 4 is the simplest if there is a previous stage of H.F., as the two transformers will be alike, and thus simpler to make than two different types of coupling. But if, as is often the case, the valve before the detector is the first in the set, and there is no objection to the loss of the "step-up" to be got with a transformer—this is not great on the

short waves, anyway—then the arrangement of Fig. 5 may be preferred. This is a simple "tuned anode" arrangement, with the exception that between the coil and the H.T. battery comes the primary of an L.F. transformer, and that there is a by-pass condenser (which corresponds, both in duty and in value, with A in Fig. 1). As in Fig. 4, the grid leak and grid condenser have normal values.

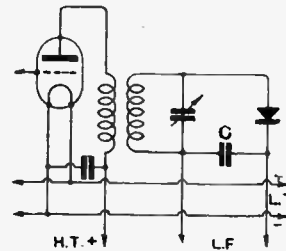

Fig. 6.—Connections of a crystal rectifier in a reflex receiver with H.F. transformer coupling to the preceding valve.

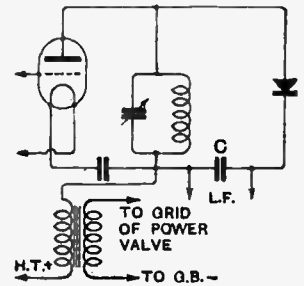

Fig. 7.—In a circuit of this type a steady potential will be applied to the crystal, due to the anode current and the D.C. resistance of the tuned anode coil.

With the crystal detector, naturally, connections are somewhat different, but those with an eye for the essentials of a circuit will see that in Figs. 6 and 7, which are for crystal detectors, there is very little real difference from the corresponding Figs. 4 and 5 for the valve. There is only one noteworthy point: in Fig. 6 the detector circuit itself is insulated from the anode circuit by the H.F. transformer, and, as will be seen later, it is probably also insulated from the grid circuit of the valve which takes its output. In consequence there is a certain amount of uncertainty as to the H.F. potentials in the detector circuit, and in my own sets I usually get rid of this by definitely connecting the bottom of the detector circuit at one or other of the two transformers.

**H.F. Transformer Ratios for Crystal Detectors.**

Although it is not shown in the figures, there is one important difference between the coupling to a valve and that to a crystal detector: this is in the ratio of the H.F. transformer. This ratio actually depends on the type of crystal to be used. For carborundum, use the tables already prepared, just as they stand. For Perikon, keep unchanged the number of turns for the tuned side (whichever it is), and use for the untuned winding *the same number of turns as for the tuned*. For galena do not alter the turns of the tuned side, but give the untuned side *two-thirds* the turns of the tuned if the primary is tuned, and one and a half times the turns if the secondary is tuned. Obviously, Perikon—or some detector of similar resistance—is the best suited to the connections of Fig. 7.

In the circuit shown in Fig. 7 there is another small point. Owing to the fact that the steady anode current to the valve before the detector passes through the coil, which has a definite D.C. resistance, there will be a steady D.C. voltage across the detector. The D.C. resistance of short-wave coils is so small that this voltage is negligible with them; but some long-wave coils have quite a large resistance, and this D.C. voltage may affect the detector, so that it works better one way round than

**The Essence of the Reflex.—**

the other. It is always worth while to try reversing the detector.

Lastly, as to the value of the condenser C in Figs. 6 and 7. This is a by-pass condenser and also has a good effect on the actual rectification; but the important point is that if C is too small it will not be a good enough by-pass to ensure that there is only a negligible H.F. voltage on the primary of the L.F. transformer which is connected across it. If there is any H.F. voltage across the primary, capacity effects will certainly set up an H.F. voltage across the secondary, and this secondary is in the grid circuit of one of the H.F. amplifying valves, so that some of the amplified H.F. will be transferred back to the input side, which is *reaction*. Hence, if C is not big enough, we may expect instability. A sound value for C is twice that of B in Fig. 1. The comparatively large capacity across the primary of this L.F. transformer is not likely to have an adverse effect on the L.F. tone, because—as will be shown later—this transformer is normally a high-ratio one, with a comparatively small primary.

The "throw-back" is, in a sense, the essence of the reflex type of circuit, and, therefore, must have careful attention. Assuming that an L.F. transformer is to be used here—and it is the only really efficient method—this part of the set may be arranged in one of two main types, which we shall refer to as the "series" and the "parallel" respectively. The series method, shown in Fig. 8, is practically identical with the grid circuit of Fig. 1, except that the primary of the L.F. transformer, instead of being in the anode circuit of a previous valve,

tains H.F. currents as well as L.F. However large (in reason) we make the condenser C in Fig. 6 or 7, some of these H.F. currents will get into the primary of the throwback transformer, and by capacity coupling will arrive at the secondary. In the circuit of Fig. 8 these H.F. voltages will be added to those set up in the tuning coil, and since they come from the output end of the amplifier they will lead to a certain instability. In the circuit of Fig. 9 the R.F. choke not only keeps the grid currents out of the L.F. transformer, but also prevents these undesirable H.F. voltages in the L.F. transformer from passing to the grid circuit.

With regard to the values of components in this part of the set, the stop condenser D should be of the

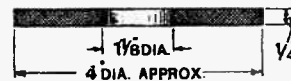

Fig. 10.—Slab-wound H.F. choke coil.

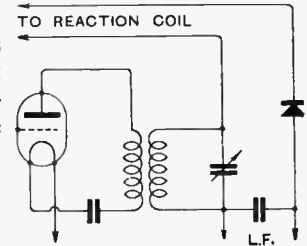

Fig. 11.—Showing how reaction may be used in a reflex receiver employing a crystal detector.

same value as that recommended for condenser B in Fig. 1. The choke E—at least, its *minimum* value—depends on the range of wavelengths for which the set is designed. It must have a large inductance compared with that of a tuning coil for the wave to be received, and it must have a small self-capacity.

In my present set I am using an Igranite "slab" coil of the general shape shown in Fig. 10, containing 1,800 turns, and this is quite efficient up to 6,000 metres, which is the longest wave it has been tried on. For the broadcast wave-band, any *good* coil of, say, 200 turns or over will serve. If it is desired to wind a special coil, use a former like that of Fig. 2, but without the four-pin fitting, and wind it full of No. 36 S.W.G. wire, D.S.C.

Now as to the provision of reaction. Where a valve detector is used, a reaction coil can be inserted in its anode circuit, just as in any ordinary set, and coupled back either to the aerial coil or to one of the intervalve H.F. transformers, or to the anode coil of Fig. 5 if this is being used. In the case of the crystal detector circuit of Fig. 7 the coil can be treated like a reaction coil, but the handling of it will seem a little queer at first, as it is tuned. It will, however, be found quite successful. A rather curious alternative, applicable to the circuits of either Fig. 6 or Fig. 7, is to open the crystal circuit itself, as shown in Fig. 11, and insert a reaction coil. The writer, when he first tried this, did not really expect it to work well, but in actual practice it has been a complete success.

We have now gone into the three special parts of the reflex set, and the complete design of such a set from this point onwards is a matter of individual taste and skill. With a fair outdoor aerial it will be found that a two-valve and crystal set, one valve reflexed—or, as I prefer to call it, a one-valve reflex with one power stage—will give good loud-speaker working up to about twenty-five miles, while a two-valve set with one power stage will get many European stations of good power.

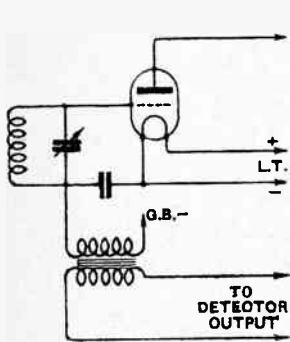

Fig. 8.—"Series" method of connecting detector output to first reflex valve.

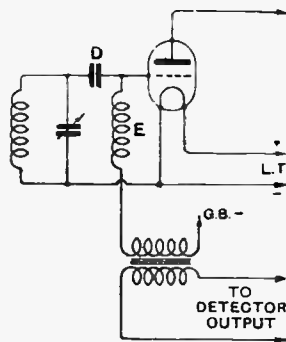

Fig. 9.—The "parallel" method of connection complementary to Fig. 8.

is in the output circuit of the detector. To facilitate comparison we will call attention at once to the alternative parallel circuit shown in Fig. 9. It will be seen that, while in the series type the L.F. current goes easily through the small inductance of the tuning coil, in the parallel type the H.F. and the L.F. currents are separated completely by the stopping condenser D and the radio-frequency choke E. The latter type needs an extra component—the R.F. choke—which is the reason why we have not recommended it for the intervalve coupling of Fig. 1, for there is otherwise no choice between the two circuits for intervalve work. But for the throw-back circuit itself, there is an advantage in the parallel circuit.

We must remember that the output of the detector con-

# PRACTICAL HINTS AND TIPS

A Section Mainly for the New Reader.

## REACTION IN A SUPERHETERODYNE.

Although it is quite common practice to omit the provision of reaction between the plate and anode circuits of the first detector of a superheterodyne receiver, there is little doubt that the extra sensitivity resulting from its inclusion can be of very real value, and its use is recommended in cases where maximum range is desired under somewhat unfavourable local conditions.

If an open aerial is used, there will be little difficulty in applying reaction in the normal manner, by con-

necting in the plate circuit a coil coupled to the grid inductance; otherwise the minimum wavelength to which the circuit can be tuned may be unduly high.

When it is not possible to find room for the coils necessary for the foregoing arrangement, the adoption of the circuit shown in Fig. 1 may be recommended, particularly when leaky grid condenser rectification is used. This is a modification of the Hartley circuit, the centre tapping of the frame being connected to the filament. The reaction condenser may be quite small; in actual practice a maximum capacity of 0.00005 mfd. is often sufficient. It should be noted that if the input transformer in the anode circuit has a condenser connected across its primary, the insertion of a radio-frequency choke in the position shown will be necessary. This choke should have the lowest possible inductance value, in order that, while deflecting a sufficient proportion of the high-frequency currents through the condenser, it may not offer an appreciable impedance to the currents of lower frequency to be passed on to the I.F. amplifier.

produced, due to a feed-back of current through the inter-electrode capacity of the valve itself, and provided the damping of these circuits is reasonably low. It is clear that we can take advantage of this effect for the purpose desired and set up any number of tuned circuits, all of which may be adjusted to the same wavelength. A small variable condenser is connected between grid and filament in order to stimulate reaction effects, as the self-capacity of the valve itself is generally insufficient for this purpose on the long waves which are to be dealt with. A very

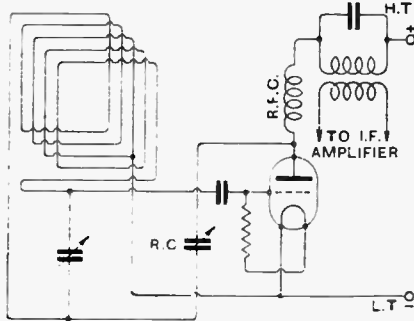

Fig. 1.—Modifying a superheterodyne.

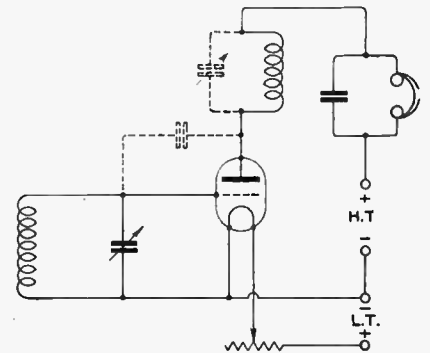

Fig. 2.—Matching intermediate frequency couplings.

necting in the plate circuit a coil coupled to the grid inductance. The problem is rather more complicated when dealing with a frame aerial set, particularly when it is desired to add reaction to existing apparatus. The most obvious way of making the addition is to insert a small inductance in series with the frame, coupling to it a coil connected between the plate and the primary of the input transformer. Both coils may be fairly small, and their inductance values, which will largely depend on the amount of damping present in the circuits, are best found by the method of trial and error. It should also be remembered that it may be necessary to remove a few turns from the frame

## MATCHING I.F. COUPLINGS.

A method of matching intermediate frequency transformers with a fair degree of accuracy was described in this section of *The Wireless World* for October 7th, 1925. An obvious modification of the same procedure may be adopted when dealing with tuned anode couplings of the type discussed in the preceding paragraph, but, fortunately, this operation may be carried out by a still simpler method, using the circuit shown in Fig. 2.

It is well known, when the grid and plate circuits associated with a valve are brought approximately into tune, that self-oscillation will be

small amount of magnetic coupling between the grid and plate coils is permissible, if oscillation is not easily obtained otherwise.

A large coil, the size of which will depend on the I.F. wavelength to be adopted, should be connected in the grid circuit. If this coil is of the plug-in variety, one may be guided by the maker's published data regarding wavelength obtained with a given shunting capacity; this will, as a rule, give a sufficient degree of accuracy, as it will be realised that it is not important that all the coils are tuned to any definite wavelength, but that they should all be tuned

to the same wavelength. The input coil, with its shunting condenser, is now connected in series with the anode, and the grid circuit tuning is varied until oscillation is produced, as indicated by the characteristic "plop" in the telephones. The capacity of this condenser should now be progressively reduced until oscillation is obtained at one critical adjustment of the grid condenser. The input coil is now removed, and is replaced by each of the intervalve couplings in turn, keeping the reading of the grid tuning condenser unchanged. The wavelength of these is adjusted in the manner already described, the production of oscillation being taken as an indication of resonance.

It is not suggested that this simple method will give results equal in accuracy to those obtainable when an elaborate equipment of measuring instruments is available, but it is capable of yielding good results when carefully carried out.

o o o o

**FOLLOWING A SPECIFICATION.**

Many readers who are considering the making of receivers described in constructional articles appearing in *The Wireless World* seem to be un-

certain as to whether it is permissible to depart widely from the author's specification in the selection of components. A few general notes on this subject may be of interest to those who wish to adopt a published design, and at the same time to use as far as possible the components already in their possession.

As far as variable condensers are concerned the matter is fairly straightforward; in the great majority of cases the substituting of another make will give results depending on its excellence of mechanical and electrical design as compared with the original, provided that the maximum and minimum capacities are the same. A high minimum will naturally result in a reduced tuning range, and may possibly be undesirable when the condenser is used for controlling reaction. Occasionally it is practicable to use a condenser of considerably smaller or larger maximum capacity than that specified, but this course is not to be recommended except in the case of the simplest circuits; it might be possible, for instance, to adequately cover the normal broadcast waveband by using 0.0003 mfd. and extra inductance instead of 0.0005 mfd., but such a circuit would probably have a lower degree of selec-

tivity than if the designer's original idea had been carried out.

The design of a low-frequency transformer (except in the case of an exceptionally inefficient type) will only affect quality and volume of reproduction, and will make little difference to the range and stability of a receiver. A possible exception to this rule may apply to certain reflex circuits.

When choosing valves one should always endeavour to closely duplicate the impedance values of those recommended by the author. With many modern circuits this is a matter of greatest importance; it will not be far wide of the mark to say that the selection of valves may make all the difference between success and almost complete failure. There is little need, however, to adhere slavishly to a specification; as a rule, little difference will be found if a 7,000 ohm valve is substituted for one of 10,000 ohms, or *vice versa*. This cannot be carried too far, however. To take a concrete example, it will often be found that a neutralised H.F. transformer designed for a valve of not more than 10,000 ohms internal impedance will become almost useless when replaced by one of some 18,000 or 20,000 ohms.

**DISSECTED DIAGRAMS.**

**No. 31 (b).—Stage-by-Stage Tests of a Superheterodyne Receiver.**  
(Continued from last issue.)

*A consideration of the circuit diagrams given below will indicate an effective and logical course of procedure to be adopted when searching for faults in a set which is totally or partially inoperative. The method is obviously applicable, with modifications, to other receivers operating on a similar principle, although of slightly different design. Tests of the initial stages were shown in last week's issue.*

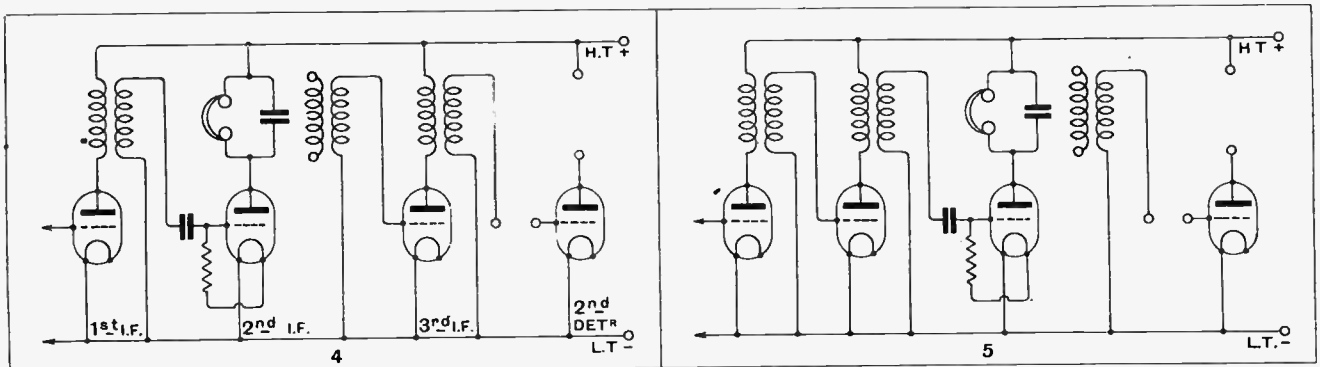

A condenser and leak are connected in the grid circuit of the 2nd I.F. valve, phones being substituted for the transformer primary in its anode circuit. This connection provides a test of the two first I.F. valves, and particularly of the first I.F. transformer.

Phones and leaky grid condenser are transferred to the next I.F. amplifying valve, giving a check on this valve itself and on the preceding transformer. A test of the last transformer and valve is obtained by replacing phones and condenser in their normal positions.

# HIGH-FREQUENCY RESISTANCE.

## The Case for Low-Loss Coils in Tuned Anode Circuits.

By S. BUTTERWORTH.

THE article on "High-frequency Resistance," which was published in the issue of *The Wireless World* for April 28th, shows that there is considerable diversity of opinion as to the practical utility of low-loss coils and condensers in receiving circuits.

It is shown that large resistances may be superposed upon the coil and condenser resistances in a tuned circuit owing to the associated valves and other apparatus connected to such a circuit. He therefore recommends that, instead of directing our attention to reducing the resistances of coils and condensers, we should simply make use of the principles of tapped inductances and of reaction in order to obtain the requisite amplification. He apparently attaches far greater importance to reaction than to the employment of tapped inductances, as in the circuits he develops later in his article he does not trouble at all about employing tapped inductances.

### Disadvantages of Reaction.

The purpose of this note is to show that the case for low-loss coils and condensers cannot be dismissed by merely bringing in the magic effects of reaction, and also to show that when the extraneous losses have been properly reduced by the use of tapped inductances, the use of more perfect coils and condensers will bring about further and appreciable improvement.

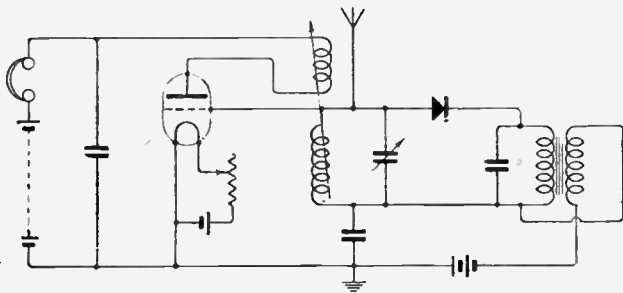

Fig. 1.—Reflex circuit with valve reaction.

The case against indiscriminate use of reaction is admirably illustrated by the valve-crystal reflex circuit reproduced here in Fig. 1. All that need be noted is the crystal load across the parallel tuning condenser. This load may readily introduce a resistance of 50 ohms in the tuned circuit, which resistance is balanced out by the effect of reaction. Your readers will readily see that when the crystal contact is momentarily removed for purposes of adjustment the set will burst into violent oscillation.

It should, by now, be common knowledge that reaction should only be employed for circuits in which the resistance to be balanced out is reasonably stable, and, since the balancing "negative" resistance itself contains elements of variability, the reaction should not be pushed so far that the variability of the "negative" resistance

will make itself felt either in producing a background of unwanted noises or in actually throwing the system into a state of oscillation. For these reasons it is seen that low resistance is desirable before applying reaction in order that the small residual resistance left after applying reaction shall be of as high a quality as possible. High-loss coils and condensers, when associated with reaction, will produce low resistances, having, so to speak, loose contacts, while low-loss coils and condensers will produce low resistances with good contact. If we desire to make use of reaction to produce low resistances of equal quality, then the magnitude of these resistances will be directly proportional to the original unbalanced resistance. Thus low-loss components are desirable even when we make full use of reaction.

We now turn to the use of low-loss components in the tuned anode circuit. Mr. Mallett points out that the large load introduced by the resistance of the valve may be dealt with by the use of a tapped inductance. The arrangement is then as shown in Fig. 2, and the detecting or amplifying circuit is brought to the condenser terminals.

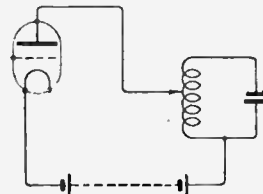

Fig. 2.—Tapped anode circuit.

But when this system is examined it is seen that it is virtually an intervalve transformer with grid coupling as the tapped portion of the inductance constitutes an auto transformer.

The theory of the intervalve transformer is therefore immediately applicable. From this theory it is easy to show that when the optimum coupling is used, the combined amplification produced at resonance by the valve and transformer is given by

$$M = \frac{\mu}{2\omega C \sqrt{Rr}}$$

in which  $\mu$  is the magnification factor of the valve,  $R$  is the resistance of the valve,  $r$  the resistance of the tuned circuit, and  $\omega C$  the capacity admittance.

Further, the ratio of the resonance amplification to the amplification given to a non-resonant signal is directly proportional to the resistance of the tuned circuit.

### A Numerical Example.

In order to form a numerical notion of the gains to be expected by diminishing coil and condenser losses the following table has been calculated. The efficiency of the tuned circuit is expressed by its power factor, which is the sum of the power factors of the coil and the condenser. The valve is assumed to have a resistance of 20,000 ohms and a magnification factor of 10, while the load across the condenser is taken to be 0.5 megohm. The amplifications are given in the columns headed "M" and refer to a resonant wavelength of 377 metres.

**High-Frequency Resistance.—**

The columns headed "S" are to indicate the selectivity, and give the ratio of the resonant amplification to the amplification obtained for a signal differing from resonance by 10 per cent.

Valve data    Internal resistance, 20,000 ohms.  
                  Amplification factor, 10.

Power Factor of Tuned Circuit.	Capacity, 200 $\mu\mu\text{F}$ . Inductance, 200 $\mu\text{H}$ .		Capacity, 100 $\mu\mu\text{F}$ . Inductance, 400 $\mu\text{H}$ .	
	M.	S.	M.	S.
0.050	4.2	1.9	6.8	1.9
0.020	7.5	4.5	10.2	4.2
0.010	10.2	8.3	13.4	7.1
0.005	13.4	14.3	16.7	11.1
0.002	17.7	25.0	20.4	16.6
0.000	25.0	50.0	25.0	25.0

The table clearly shows that both from the point of view of magnification and of selectivity it is worth attempting to obtain power factors as low as 0.002 if the components can then be produced at reasonable cost.

**Power Factors of Commercial Coils.**

As regards actual values of power factors, commercial coils of this order of inductance range in power factor from about 0.02 to 0.004, while a good commercial condenser has a power factor which is probably less than 0.001 at the above settings.

With a slightly increased cost, coils of 200  $\mu\text{H}$  may be designed of diameter approximately 4in. and length 2in., for which the power factor should not exceed 0.002.

Incidentally, the table clearly shows that reduction of condenser value increases magnification, but reduces selectivity, so that the author's statement that large condensers are best would seem to require further examination

**BOOKS AND CATALOGUES RECEIVED.**

"Loud-Speakers: Their Construction, Performance and Maintenance," by C. M. R. Balbi, A.M.I.E.E., A.C.G.I., with foreword by Prof. G. W. O. Howe, D.Sc., M.I.E.E., pp. 96, with 57 illustrations and diagrams. Published by Sir Isaac Pitman and Sons, Ltd., London. Price 3s. 6d. net.

"Die Hochfrequenz-Technik," edited by Dr. Carl Lübben. Part 7.—Störfreie in der drahtlosen Nachrichtenübermittlung, by Dipl.-Ing. Manfred Singelmann, pp. 151, with 236 diagrams and illustrations. Price 8.50 marks.

Part 8.—Der Detektor und seine Anwendung für Empfang, Verstärkung und

Erzeugung elektrischer Wellen, by Dr. R. Lehnhardt, pp. 95, with 62 diagrams and illustrations. Price 5.80 marks.

Published by Hermann Meusser, Berlin.

General Radio Co. (Cambridge, Mass., U.S.A.), Bulletin 923, relating to General Radio Precision Condensers, and giving British prices. (This catalogue is obtainable from the sole concessionaires for Great Britain: Claude Lyons, 76, Old Hall Street, Liverpool.)

Damard Lacquer Co., Ltd. (Warwick Road, Greet, Birmingham). Art booklet, descriptive of moulding in "Formite" Bakelite. Also brochure dealing with "Damarda" lacquers.

Radio Components, Ltd. (19, Rathbone Place, London, W.1). Folder giving particulars and prices of Radcom wireless components, including low loss tuners, valve holders, switches, coil holders, etc., etc.

Wates Bros. (13-14, Great Queen Street, Kingsway, W.C.2). Catalogue of a wide range of Wates wireless receivers, accessories, and components, with many illustrations.

Le Carbone (Coventry House, South Place, London, E.C.2). Third edition of the A.D. Primary Cell Catalogue. Deals with an extensive range of wet and dry cells, including cells for filament heating.

The Holrose Manufacturing Co. (43, Lonsdale Road, Kilburn, London, N.W.6). Leaflets descriptive of Holrose transformers, rheostats, coil-holders, and other components.

Priestly and Ford (3, Carrs Lane, Birmingham) (manufacturers and wholesalers). Radio catalogue for season 1926 for leading makes of sets, accessories, and components.

E. A. Wood (Midland Lighting Works, Aston Road, Birmingham). Price list of all classes of wireless apparatus and accessories. (Trade only.)

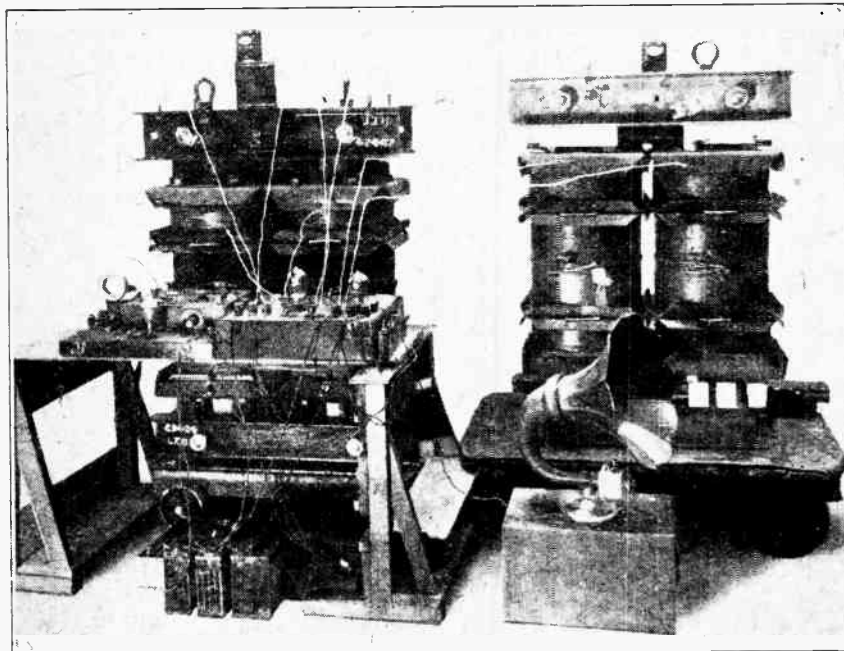
**FINALITY IN INTERVALVE TRANSFORMER DESIGN?**

A progressive increase in size characterises the new types of intervalve transformer which have recently made their appearance on the British market. Pursuing this line of development to its logical conclusion, Messrs Ferranti, Limited, have recently tested a receiver in which the L.F. valves are coupled with two of their 150 kVA power transformers. It is stated that nearly perfect results were obtained!



# CURRENT TOPICS

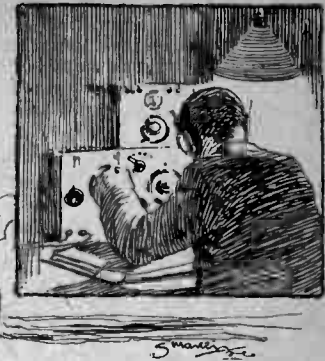

## Events of the Week in Brief Review.

### WISDOM FROM THE BENCH.

"A wireless licence for 10s. a year is the world's best value."—The Willesden Magistrate.

o o o o

### PROBLEM: FIND THE PLAN.

Portugal is said to be desirous of modelling her broadcast system on the United States plan.

o o o o

### SWEDISH RIVAL FOR 5XX?

The Swedish Government is reported to have decided on the erection of a 30-kilowatt broadcasting station at Motala, in Central Sweden.

o o o o

### AMBIGUOUS?

A certain make of telephone ear-pad is being marketed with the recommendation that it "rests softly on the side of the head on account of its vacuous nature."

o o o o

### DR. ECCLES AND THE I.E.E.

Prof. W. H. Eccles, D.Sc., F.R.S., has been nominated by the Council of the Institution of Electrical Engineers for the Presidential vacancy which will occur on September 30th next.

o o o o

### ALTERATIONS AT OTTAWA.

In forwarding the advance list of broadcast programmes from June 1st to 15th, the Canadian National Railways state that CNRO, the Ottawa station, will be out of commission on June 16th, 19th, 26th and 30th to permit of alterations to the transmitting equipment.

o o o o

### FIELD DAYS AGAIN.

The Ipswich and District Radio Society are holding their first field day during the summer season on June 13th at Flatford. The party meets at Flatford Bridge at 3 p.m., and members and friends are invited to bring sets (portable models if possible) for experiments in radio reception.

o o o o

### WIRELESS ON HOLIDAY.

Holiday-makers who contemplate taking their wireless sets to the seaside need have no legal scruples in the matter, in the light of a recent official announcement. The Post Office authorities offer no objection to an occasional change of address, but "if the apparatus is to be used more or less regularly at the second

address or a permanent aerial erected there, it will be necessary to obtain a separate licence for that address."

o o o o

### WIRELESS AIDS COPPER INDUSTRY.

The American radio industry is stated to have more than doubled its consumption of copper during the last two years, and is now using approximately 10,000,000 pounds a year.

o o o o

### 500 KW. FOR WGY?

The idea that 50-kilowatts is insufficient for any broadcasting station presuming to use the word "super-power" has led the General Electric Co. of America to consider the possibility of giving the famous WGY station at Schenectady a power of 500 kilowatts.

Reviewing the proposal, the chief engineer remarked: "The station would then be more nearly equal to its duty of supplying a signal level well above the noise level, over a reasonable range of approximately 250 miles."

### DR. FLEMING'S RESIGNATION.

Prof. J. A. Fleming, F.R.S., is resigning from the Chair of Electrical Engineering at University College, London, on July 31st next.

o o o o

### GADGETITIS.

"Beware of useless gadgets," writes the wireless correspondent of a Northern paper. This is sound advice, provided his readers know what to include under that category. Several of them are reported to have included the wireless licence.

o o o o

### WIRELESS TELEPHONY TO THE CONGO.

A Belgian experimenter, M. Robert Goldschmidt, of Malines, announces that he has established direct telephony communication with the Congo on short waves, his voice being heard distinctly at Stanleyville, about 4,155 miles away. He has offered to establish a wireless department for the use of the Colonial Minister.



A PHOTOELECTRIC CELL MICROPHONE. This is not a scene in a broadcasting studio. The photograph, which was taken in the recording room of a New York gramophone company, shows how nearly gramophone methods are approaching standard broadcasting practice. The microphone, embodying a photo-electric cell, is shown more clearly on the next page.

**NEW YORK RADIO SHOW.**

Mr. Herbert Hoover, the U.S. Secretary of Commerce, has consented to open America's Radio Show at the Grand Central Palace, New York, on September 10th. The exhibition will close on the 17th.

o o o o

**AN ALL-WELSH STATION?**

A plea for the establishment by the B.B.C. of an all-Welsh broadcasting station has been put forward by the National Union of Welsh Societies. Failing agreement to such a proposal, the Union asks for a bigger Welsh programme from existing stations.

o o o o

**CHOOSING THE RIGHT VALVE.**

Advice on the application of various types of valve to different receiving circuits will be given by a representative of the General Electric Co. at the next monthly meeting of the Kensington Radio Society, to be held on June 10th at 8.30 p.m., at 2, Penywern Road, Earl's Court. S.W.

o o o o

**MELBA'S FIRST BROADCAST.**

In "Broadcast Brevities," appearing in *The Wireless World* of May 26th, mention was made of Dame Melba's first broadcast, and it was stated that this took place at Writtle. The Marconi Company asks us to say that Dame Melba has never broadcast from Writtle, her first use of broadcasting being at the Marconi Works, Chelmsford, in 1920, under the technical direction of Captain Round and Mr. W. T. Ditcham.

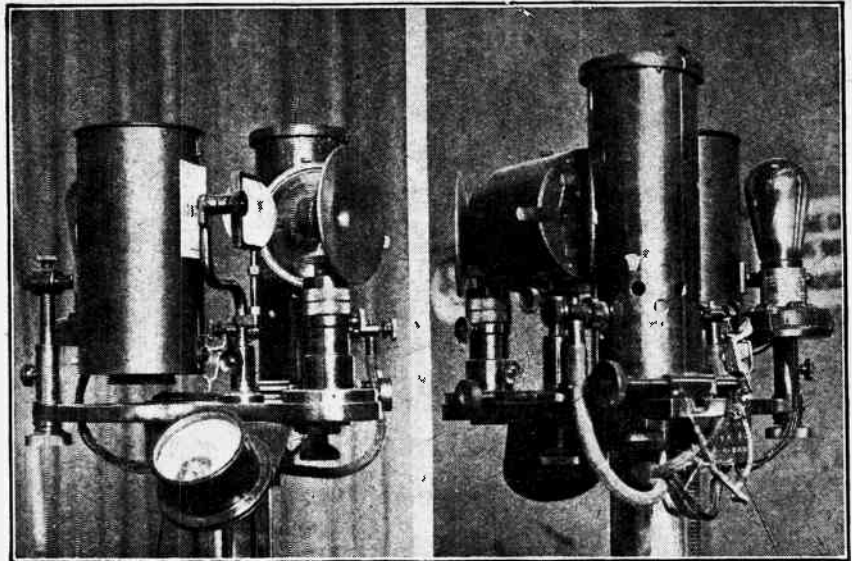

**RECORDING WITH A PHOTO-ELECTRIC CELL.** Two views of the new type of microphone which is proving successful for gramophone recording in America. A beam of light is reflected on to a photo-electric cell from a tiny mirror, mounted on a conical aluminum diaphragm.

**BOMBAY CLUB HEARD IN U.S.**

The Bombay Presidency Radio Club has received a report that signals from its station, 2FV, have been heard by Mr. M. F. Hoff, of Illinois, who was using a seventeen-valve super-heterodyne set embodying seven tuned H.F. stages. 2FV was using a power of only 100 watts.

o o o o

**THE BYRD ARCTIC EXPEDITION.**

The s.s. *Chantier*, KEGK, the depot ship of the Byrd Arctic Expedition, worked several British stations whilst at Spitzbergen, including the experimental station of Mr. A. J. Stevens, 5LS, also 5NJ, 6RM, 5SI, 6FA, 5BY, 2CC, 6IV, 2XY, and 6TD. It is interesting to note that Eastern U.S. signals were only audible from 0200 to 0400 G.M.T. Details of the wireless equipment of the *Chantier* are to be found elsewhere in this issue.

o o o o

**THE POLICEMAN AT THE DOOR.**

"Radio-Toulouse" is entering into the lives of its listeners in a novel manner. To augment the station funds the local police have prepared subscription lists, and a collection is made from door to door by members of the Force.

Votes of subsidy to the station have already been made by five south-western departments of France, viz., La Haute-Garonne, L'Aude Le Gers, Les Basses-Pyrenées and Le Tarn et Garonne. The Department of L'Aveyron has also expressed appreciation of the programmes, and is granting support.

o o o o

**NO ADDRESS.**

Mr. A. Drew, of Hammersmith, W.6, who wrote recently to Messrs. Darimont Electric Batteries, Ltd., is requested to send his address in order that the firm may comply with his requirements.

**SHORT-WAVE BROADCASTING TRIUMPHS.**

The claim put forward by the engineers at the 2XAF short-wave broadcasting station at Schenectady that their station has a "world-girdling" range must not be dismissed as merely a piece of American exaggeration. A report dealing with these 32.79 metre transmissions during the past three months indicates that 2XAF has been making itself heard very widely.

On April 3rd a programme broadcast by 2XAF was relayed by JB, the Johannesburg broadcasting station. The same programme was picked up in its entirety by E. C. Cox, an Australian amateur at Elsternwick, Victoria. A week later JB rebroadcast a further transmission from 2XAF.

The B.B.C. assisted in the good work on April 12th, when 2XAF's transmission was successfully broadcast from 2LO, and subsequent reports showed that the same programme was heard by listeners at Perth, Australia, 11,495 miles from Schenectady. The Arctic regions took up the refrain on May 3rd, when 2XAF was heard by the crew of the *Chantier*, the base ship attached to the Byrd Polar expedition. Then came a report of reception by the American explorer, Frank Gow Smith, sailing in Brazilian waters.

The aerial at 2XAF consists of fifty feet of wire suspended from the cross arm of a wooden pole seventy feet high. The station at present transmits WGY's programmes on Tuesday and Saturday evenings (Eastern Standard Time).

o o o o

**ADDRESS, PLEASE.**

We should be glad if Mr. L. W. Ruskham, whose letter was published in *The Wireless World* of April 28th, would kindly forward his address, his earlier communication having been mislaid.



**EGYPT'S NEW BROADCASTING STATION.** Regular concerts are now being broadcast in Cairo by the local radio society. The new station, with its imposing masts, is seen in the photograph.





By R. W. H. BLOXAM.

*The utility of the short wave for long-distance aircraft communication is exemplified by the successful working during the recent North Polar flight. Full details of the wireless equipment are given in this article.*

THROUGH the courtesy of the U.S. Shipping Board, the writer was able to pay a visit to the s.s. *Chantier* whilst she was lying in dock in London on her return from the Arctic exploration trip. The *Chantier* is a small lake steamer of the cargo-carrying type with a displacement of some 4,000 tons. She is a steel-hulled ship and steam driven, with a single screw.

The ship left New York on April 5th and sailed direct for Spitzbergen, but called at Trondjem, Norway, *en route*, in order to pick up supplies and an ice pilot. On arrival in Spitzbergen an anchorage was made in King's Bay, which was made the base from which the attempt to fly to the North Pole and back was to be made.

Two aeroplanes were carried, one being an American

Curtiss biplane, and the other a Fokker monoplane fitted with three engines. The machines were fitted with ice skids in place of the usual wheel landing equipment.

The *Chantier's* operating room is of small dimensions and is situated on the main deck on the starboard side. The commercial radio apparatus consists of a 1 kW. Marconi quenched-gap spark transmitter, operating on 600, 706, and 800 metres. The 600-metre wave is used for distress calls, 706 metres being the regular working wavelength, whilst the 800-metre wave is used for direction finding. It will be noted that this arrangement of wavelengths is somewhat different to British practice.

**Short-Wave Equipment.**

It was realised that for long-distance communication in the Arctic regions, with the moderate power input available, it would be necessary to take advantage of the properties of short waves in order to maintain reliable communication.

This was especially necessary in the case of the aeroplanes, which had to make a journey of some 660 miles each way from the base to the Pole and back. The strictest economy of weight and space was necessary here, the aim being to carry some two months' rations for the pilot and observer, and as much fuel as possible.

The short-wave transmitter on the ship, and also that on the aeroplane, was designed by Mr. M. P. Hanson, of the U.S. Naval Laboratories at Bellevue, and was built and installed with the assistance of the

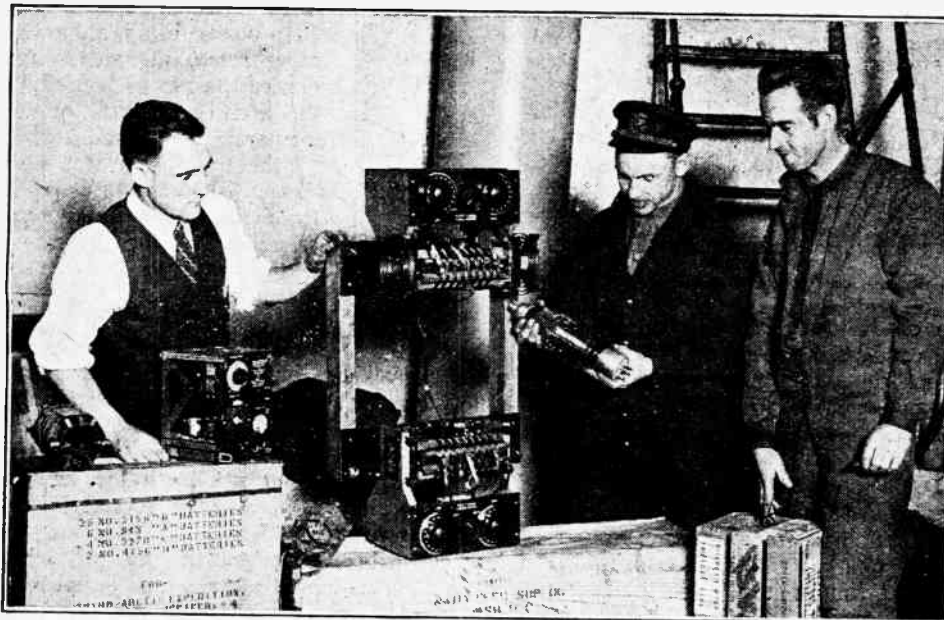

The transmitting set carried on the aeroplane in the flight over the Pole and the short-wave transmitter installed on the s.s. "Chantier." Mr. M. P. Hanson, the designer, is on the left.

**Wireless with the Byrd Arctic Expedition.—**

two operators, Messrs. Grenlie and James. The ship transmitter consists of two type U.V.204a tubes (250 watts American rating) operating in a self-rectifier circuit, which is a modified form of the KFUH transmitter used for the South Seas Expedition ship operating under that call and which has been heard in England. The circuit employs tuned anode and tuned grid coils.

The entire apparatus is mounted on a wooden framework, the tubes fitting side by side into the space between the copper strip inductances. The complete unit was mounted on a wooden partition in the operating room and suspended on rubber to absorb the ship's vibration.

Two outstanding features of this transmitter are the grid and plate circuit chokes and the fixed condensers. The H.F. chokes are wound on  $\frac{1}{2}$  in. ebonite rods, and consist of four small basket-wound coils about 1 in. diameter and  $\frac{1}{2}$  in. thick. Each coil has approximately 100 turns, and the four sections are connected in series, the coils being spaced  $\frac{3}{4}$  in. apart on the rods. The grid

**Aerial System.**

The set was designed to work on any wavelength between 8 and 100 metres. The actual wavelengths used were 8, 12, 13, 20, and 36 metres. Since perpetual daylight is experienced in the Polar regions at this time of year, it was thought that 20 metres would prove the most satisfactory wavelength. When tried, however, this wavelength was found to be useless, either for sending or receiving, the only stations heard being FW, WIL, and KEL.

The wavelength used for most of the short-wave work was 36 metres, and many readers will have heard the distinctive I.C.W. note of KEGK, which was very loudly received in England when the ship was at Spitzbergen, a distance of well over 2,000 miles from London.

The aerial consisted of a 30ft. vertical 4-wire cage lead-in with a 45ft. 4-wire fan-shaped top. This aerial was used for both the long- and short-wave transmitters, working at an harmonic in the case of the latter, with an aerial current of  $2\frac{1}{2}$  amps. on 36 metres. Earth connection was made to the hull of the ship, and used for both transmission and reception.

The whole of the antenna system was insulated by means of 12 in. Pyrex glass aerial insulators and "stand-off" insulators. Contrary to expectations, no trouble was experienced through ice on the insulators.

The receiver comprised a Grebe type CR 18 detector and tuner with a range of 10 to 200 metres, and was used in conjunction with the audio-frequency amplifier.

Owing to bad interference from power lines in the operating room, the short-wave receiver had to be housed on the after poop deck, under temporary cover, and keying of the transmitter was also accomplished from this point by means of a relay constructed by the operators whilst at sea from an alarm bell.

**Aeroplane Transmitter.**

This transmitter was exceedingly compact and weighed only some 7 lb., complete with valve and inductances. It may be seen at the left in the illustration on the previous page, and consisted of a single Western Electric tube type 211D in a special crystal-controlled circuit, operating on 41, 44, or 61 metres, the crystals being ground to the fundamental wavelength. The power was supplied by an air-driven generator at 400 volts, the power output obtained being 16 watts. The aerial consisted of a single wire 60ft. long, while ground was made to the metalwork of the machine, all of which was bonded together. This set operated under the call sign KNN.

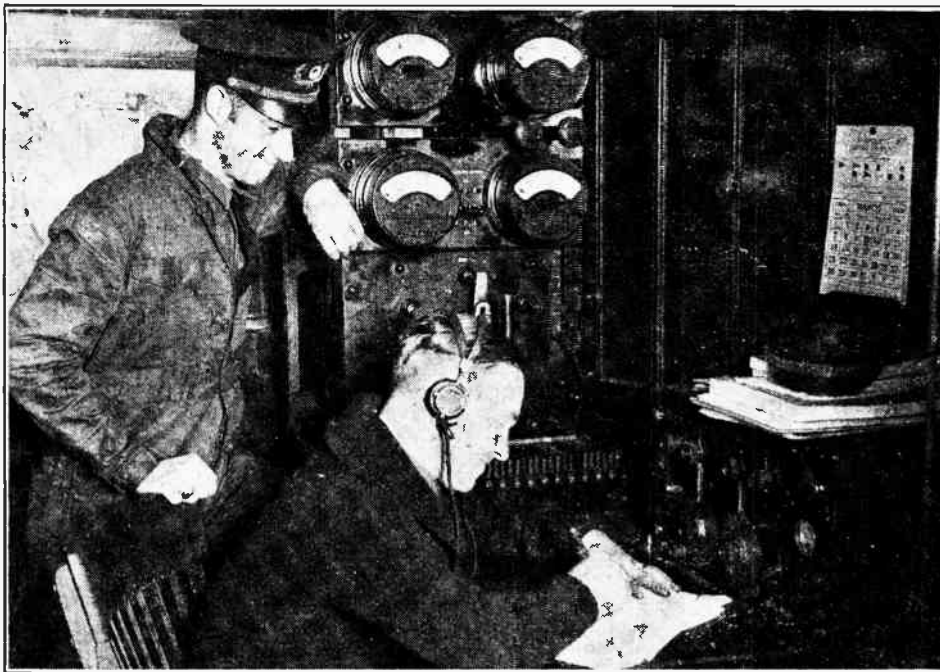

The commercial 1 kW. Marconi quenched-spark set of the "Chantier."

leaks are wire wound and each of 10 ohms resistance only. The plate circuit blocking condensers consist of a bank of twelve Dubilier Micadons connected in series-parallel, each condenser being 0.00025 mfd. capacity. Each of the grid condensers consists of a similar bank of three condensers in series.

The ship's generator supplies D.C. at 120 volts, which drives a motor generator delivering A.C. at 220 volts 500 cycles. The latter supply is fed to a transformer which delivers 1,500 watts at 3,000 volts 500 cycles, this being fed direct to the anodes. A 12-volt 10-amp. Escoc motor generator supplies the filament current. Keying is accomplished in the centre tap of the transformer. The same motor generator supplies the commercial spark transmitter.

# BROADCASTING THE LOUGHBOROUGH CARILLON.

By L. B. POWELL.

**B**ROADCASTING the music of bells is a difficult business even when the number of bells is small.

It becomes much more difficult when it is a carillon that is to be broadcast, because there are many more bells, covering a much wider and more varied range of musical tones. When, therefore, the engineers of the Birmingham station installed the microphone and amplifier in the Memorial Carillon Tower at Loughborough, in Leicestershire, which contains the largest and most beautifully toned collection of bells in the country—forty-seven in all—they were faced with problems which made their task extremely difficult.

It should perhaps be explained that the arrangement of the bells in a carillon differs considerably from the method commonly known in England, where change-ringing and chiming have prevailed for hundreds of years. In a carillon, the art of which is but little known in England, the bells remain stationary in their frames and are struck by hammers which are operated by big wooden keys in a clavier, like an enlarged organ keyboard. The smallest bell is no bigger than an average-sized flower-pot; the largest weighs four or five tons. The carillonneur plays by striking the keys with the underpart of his half-closed hand, which is protected by a thick glove. Although the playing demands considerable dexterity, he can execute brilliant crescendoes, and arpeggio or harp-like chords, delicate diminuendoes, and subtle variations of light and shade.

To receive this music without loss of balance and without the "blasting" which would be caused by the microphone picking up the vibrations of the tower was the problem which faced the 5IT engineers, and it resolved itself largely into a question as to where the microphone should be placed. After a good deal of trial-and-error work, occupying several hours, the best position was found by suspending the microphone from one of the rungs in a ladder in the open gallery near the top of the tower. Here it was directly above the bell chamber, and the deep-toned resonance of the large bells and the silvery notes of the small ones all came through

well. But it was necessary to exercise careful, almost minute, control over both tone and volume. A rough-and-ready method of volume control was offered by the lead-covered trap-doors in various parts of the tower, some of which can be fully opened, others partly opened or shut, according as the nature of the recital varies.

In the amplifier, which is installed in the chamber below that containing the clavier, the microphone being connected by cables running down the outside of the tower, fine degrees of tone and volume control are obtainable. This instrument is a five-valve resistance-coupled one, similar to that described by Capt. H. J. Round in *The Wireless World* of November 19th, 1924. Filter

circuits, shielded in copper cases and controlled by jacks, enable the operator to compensate for any tone-lowering effect which the line may have, or to reduce the ratio of high tones to low tones or *vice versa* when necessary. These controls are of vital importance in the transmission of carillon music, because each bell is rich in harmonics and overtones and there is nearly always a tendency for the deep booming notes of the large bells to submerge the delicate tones of the small bells. The final control in the Loughborough transmissions is in the studio at 5IT, where, generally, the musical director listens across the line and gives instructions to the operator at the tower. The Loughborough Tower is now permanently connected by land line to the Birmingham broadcasting station.

Many listeners who heard the last recital from Loughborough, given on Sunday evening, May 30th, were reminded of the B.B.C.'s successful re-transmission of the Bruges carillon more than a year ago. On that occasion the carillon music was conveyed from Bruges to Brussels by land line; it was then broadcast from the Brussels station, picked up by the B.B.C.'s special receiver in Kent, relayed to London, and broadcast through all stations.

Built on the Flemish model, the Loughborough carillon has much in common with its famous prototype, and it seems probable that the mellowing effects of time will serve to increase the richness and delicacy of its tones.

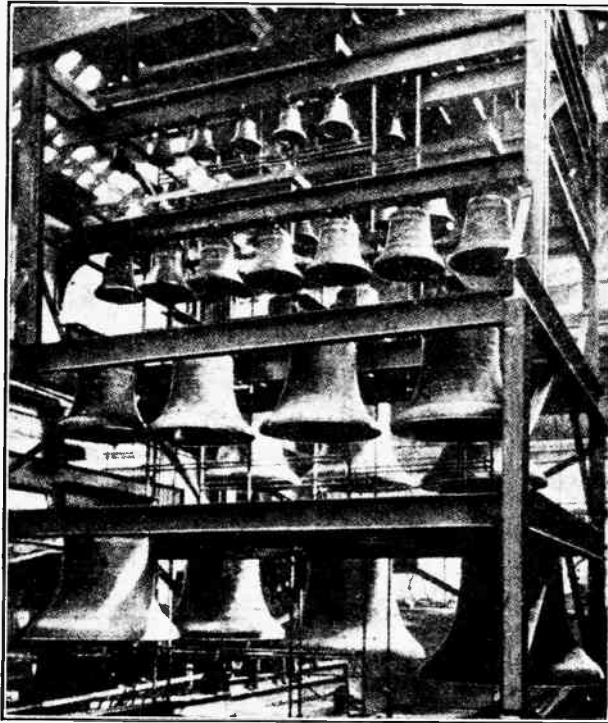

The Memorial Carillon at Loughborough, which has been connected to the Birmingham broadcasting station by permanent land line. The forty-seven bells constitute the largest and most beautifully toned collection in this country. Listeners heard a carillon recital from Loughborough on Sunday, May 30th.

# A NEW HIGH-FREQUENCY AMPLIFIER.

## Balancing Out Inter-electrode Capacities in Four-electrode Valves.

By DR. H. KRÖNCKE.

THE following is a short description of a new application of the four-electrode valve, which was recently employed for the first time by Professor Dr. Wigge at Köthen. The circuit is to a certain extent a modification of the Ultra-audion circuit (Fig. 1). The high-frequency oscillations to be amplified are taken to the interior grid and to the anode, whilst the exterior grid receives the amplified oscillations, as is shown in Fig. 2.

The purpose of this circuit is to compensate the internal and external harmful capacities of the valve, so that efficient high-frequency amplification is possible, even on very short waves, without giving rise to self-oscillation.

The said internal and external harmful capacities of the valve are shown in Fig. 3 by  $C_1$ ,  $C_2$ ,  $C_3$ , and  $C_4$ .

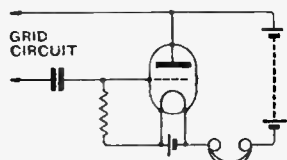

Fig. 1.—The Ultra-audion circuit, from which the new amplifier has been developed.

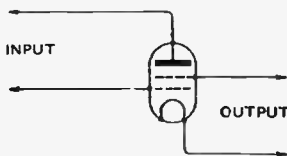

Fig. 2.—Showing how the input is applied to the plate and inner grid of the four-electrode valve.

There are not, of course, condensers placed at the points here indicated, and the illustration will only represent schematically these harmful capacities. Dr. Wigge sets himself the task of arranging the circuit in such a way that points A and B are always at the same potential (apart from the positive anode potential of the high-tension battery), so that no oscillatory excitation can take place.

### A Capacity Bridge.

The conditions will be better understood if the capacities  $C_3$  to  $C_4$  are represented in a somewhat more comprehensive manner, as has been done in Fig. 4. Here the grid circuit is also shown, whilst the valves and all other parts are omitted. From Fig. 4, which represents

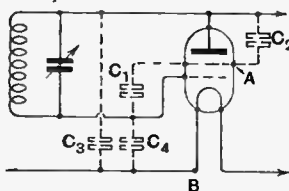

Fig. 3.—Inter-electrode capacities in the four-electrode valve.

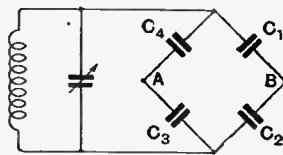

Fig. 4.—Equivalent electrical circuit for the capacities shown in Fig. 3.

an ordinary bridge connection, one will at once recognise that the points A and B, even in the case of any desired oscillatory excitation of the circuit L C, are constantly at the same relative potential, if the capacities are

related by the following equation:  $\frac{C_1}{C_2} = \frac{C_3}{C_4}$ .

Now, it is not possible, of course, to vary the internal capacities of a valve or to adjust the external capacities of  $C_3$  and  $C_4$  at will. The condition  $C_1 : C_2 = C_3 : C_4$ , however, contains no statement as to the magnitude of the different condensers, and it is at once possible, for example, to connect two condensers  $C_5$  and  $C_6$  in parallel with the internal capacities  $C_1$  and  $C_2$ , and to arrange the condensers in such a way that the condition  $\frac{C_1+C_5}{C_2+C_6} = \frac{C_3}{C_4}$  now applies. It is sufficient, therefore, that the ratio of the two condensers  $C_5$  and  $C_6$  be suitably chosen in order that the points A and B may be maintained continuously at the same potential and oscillation rendered thereby impossible.

### Balancing the Circuit.

Practical tests have demonstrated the correctness of this consideration. Dr. Wigge, in his circuit, uses, as condenser  $C_6$ , any fixed condenser of about 100 cm. capacity, and the condenser  $C_5$  is a rotatable condenser of

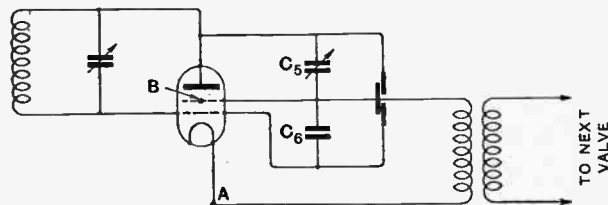
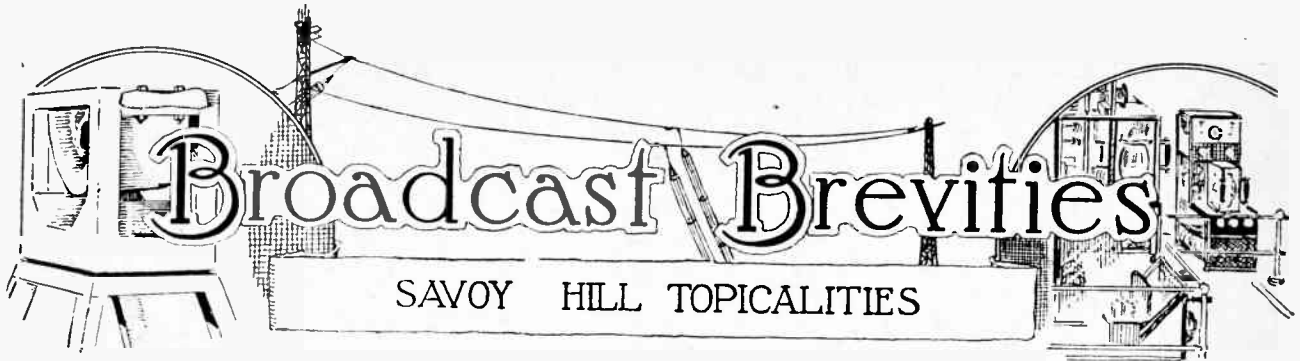

Fig. 5.—Complete circuit of the four-electrode H.F. amplifying valve and its associated coupling circuits.

the same magnitude. The interior capacities of the valves  $C_1$  and  $C_2$  play practically no part in relation to these two condensers. One has therefore only to adjust the condenser  $C_5$  in such a way that the ratio of  $C_3$  to  $C_4$  is as  $C_5 : C_6$ , from which it will be recognised that no self-excitation takes place, whatever be the wavelength of the oscillations received. The precise tuning of the condenser  $C_5$  is, however, somewhat difficult. For this reason, Dr. Wigge only tunes the condenser  $C_5$  coarsely at first, and then carries out the fine adjustment with a compensating condenser.

For the coupling between two stages of amplification, high-frequency transformers with a high ratio of transformation are used. According to verbal information, Dr. Wigge has succeeded in carrying out effective high-frequency amplification with transformer coupling, even on wavelengths as short as 26 metres. It should, however, be pointed out that the amplification efficiency of the valve is not so large in the new circuit as in the former circuits using valves with one or two grids. On the contrary, however, there exists no difficulty in principle in the construction of a correspondingly larger number of stages of amplification, since all oscillation excitation is, in fact, rendered impossible, and when the compensation of the capacities in the amplifier itself has once been effected it is unnecessary to alter anything further.



By Our Special Correspondent.

**What Moscow Thinks of Daventry.**

A Moscow listener who listens to Daventry every night tells Savoy Hill in an interesting letter that the British high-power station has the best modulation and the clearest tone among all the stations that he has heard. Even when the Moscow Central station is working on 1,450 metres, he receives 5XX from 9.30 to 10 p.m., and again from 10.30 p.m. until the hour of closing down.

o o o o

**Five Stations.**

This correspondent adds that five broadcasting stations in Moscow give regular transmissions. Moscow Central, with a power of 12 kW., has its Children's Corner, Esperanto reports, frequent lessons in English and concerts, as well as operatic relays from the Moscow Grand Theatre. The Sokolniki station, known under the name of Popov, the oldest Russian broadcasting station, works on 6 kW., and includes experimental transmissions in its programmes. The radio station of the Moscow Council of Trade Unions is a 500-watt station which gives concerts, operas, lectures, reports, etc. The other two are the station of the Radio Broadcasting Joint Stock Company (2.5 kW.) and the station of the Commercial Officers' Trade Union (500 watts), both of which broadcast propaganda.

o o o o

**Fewer Licences.**

The announcer at Savoy Hill is still occasionally directing the attention of listeners, at the request of the Postmaster General, to the penalties attaching to failure to take out receiving licences. The underlying reason is probably that the monthly increase in the number of new licences is steadily diminishing; for whereas the January figures showed an increase of 195,000 over those for December, 1925, those for February showed an increase of only 65,500 over January's, while for March the increase had dropped to 59,000, and for April to 47,000 over the preceding month.

o o o o

**Three Million Soon?**

The total number of licences at the end of April was 2,012,252; but it is estimated that the figures for May will add some 150,000 to that total, on account

of the great accession to the ranks of listeners during the general strike. The B.B.C. hopes to reach the three million mark by the end of the year; and if the official assumption that there are still a number of persons who have omitted to take out licences is correct, it is probable that, with the addition of even a moderate number of new listeners, the hopes of Savoy Hill will be realised.

7.10 p.m.—S.B. talks every day—except Wednesday, with the object of allowing all stations which dispense with 7.40 talks to have one local talk weekly. The critics will probably continue, with a short intermission, and the French talks also, though they will be adapted to holiday conditions.

7.40 p.m.—Optional talks throughout the week. Spanish talks will be discontinued.

9.40 p.m.—Talks will be generally topical and of short duration. The short story series on Monday will be continued as a regular programme feature.

*Special Bulletins.*

As regards the extra bulletins which have been given at 6.40 p.m., the various societies and other bodies concerned will probably discontinue the feature during the greater part of the holiday period. The 6.30 p.m. Tuesday broadcasts to Europe will be discontinued.

o o o o

**Topical Talks.**

The editorial reviews will be continued; but in view of their wide scope they will be moved about in the programme, being sometimes given before the second general news bulletin and at other times after it, or in some other part of the programme, according to the relative importance of the subject. They will not necessarily be called "editorials" or "reviews," as the tendency now is to give them a topical title. It is also proposed during the holiday period to try some new experiments, such as the reading of serial stories by popular authors, running over several evenings.

o o o o

**Miss Ruby Helder.**

An interesting sidelight on the extent to which the older stars of broadcasting retain their hold on the public esteem is provided in the case of Miss Ruby Helder, the lady tenor. This talented singer has been the subject of a large proportion of appreciative comment received recently at Savoy Hill, and the suggestion is put forward that she might sometimes make her own announcements. As listeners may have assumed, Miss Helder's speaking voice does not betray her sex. She said some time ago that in speaking to a stranger on the telephone she is invariably addressed as "sir," and sometimes has difficulty in convincing the distant subscriber that she is really Miss Helder.



**LOUGHBOROUGH CARILLON BROADCAST.** A picturesque view of the Loughborough Memorial Tower containing the carillon which listeners heard on Sunday, May 30th. Further recitals are to be given at intervals.

**Summer Programmes.**

The usual seasonal curtailment of the B.B.C. talks feature is to come into operation during the summer months. This has given rise to a mistaken impression on the part of many listeners that the important educative and informative aspects of the feature are to be sacrificed. The arrangements now being formulated will merely follow the same lines as in previous years and will affect the programmes in the following ways:—

**Gun Broadcasts.**

By the way, if gunfire is a technical possibility, it would probably interest listeners if a microphone were installed at places where gun salutes are fired on various occasions. In London, for instance, such salutes are fired by a battery of artillery posted in Hyde Park, and occasionally also at the Tower of London. Suitable military music could be superimposed on the gun transmissions.

o o o o

**"Remnant Acre."**

A one-act play entitled "Remnant Acre," by Dion Titheradge, is to be broadcast on June 24. It is the story of a bargain driven by a clever woman who taught a grasping employer that the price and the value of a thing may differ considerably. The characters will be played by Henry Oscar, Michael Hogan, and Phyllis Panting.

o o o o

**Shakespeare's Heroines.**

The "Shakespeare's Heroines" series are, on the whole, proving an entertaining addition to the Sunday afternoon programmes, owing, no doubt, to the fact that the chief rôle has been played in succeeding weeks by such well-known actresses as Miss Edith Evans, Mrs. Patrick Campbell, Miss Gwen Ffrangcon-Davies, and Miss Cathleen Nesbitt. To this list will be added Miss Laura Cowie, who will take the part of Viola in the excerpts from "Twelfth Night," which are to be broadcast on June 13th.

o o o o

**Period or Modern Music?**

But a good deal depends on the provision of suitable music for this series. It is suggested that it would be far better to play the music of the Shakespearean period rather than the music specially written for the plays by modern composers. The latter is designed for large orchestras, and therefore sounds inartistic when played by the small combination which, it is understood, is usually employed for these studio features. The officials at 2LO will, it is hoped, adopt this idea shortly.

o o o o

**The Popularity of Recitals.**

The pianoforte recitals at 7.25 each evening have been so widely appreciated that the feature may soon be developed so as to include also song, violin and cello recitals. These recitals will incorporate mainly classical music, as heretofore.

o o o o

**Somewhat Mixed.**

An amusing medley will be broadcast on June 22nd, when a novel attempt is to be made to mix humour and pathos. Two plays will be performed in succession in the studio, one of them being drama and the other comedy. Then the two plays will be acted together as one. The dialogue will be found as ingenious as the idea.

A 28

**FUTURE FEATURES.****Sunday, June 13th.**

LONDON.—Shakespeare's Heroines, No. 7. "Twelfth Night."  
Viola—Laura Cowie.

MANCHESTER.—Chester Cathedral, Bells and Evensong.

NEWCASTLE.—Orchestral Concert.

**Monday, June 14th.**

LONDON.—Chamber Concert relayed from New Chenil Galleries.

BIRMINGHAM.—Scenes from Famous Comedies.

BOURNEMOUTH.—Irish Songs and Melodies.

BELFAST.—Musical Comedy.

**Tuesday, June 15th.**

LONDON.—"The Way of an Eagle."  
GLASGOW.—Grieg Programme.

**Thursday, June 17th.**

LONDON.—Variety Programme. Un-announced Orchestral Programme.

BIRMINGHAM.—Excerpts from Lighter Operas.

BOURNEMOUTH.—Song Cycles and Orchestral Features.

BELFAST.—Gounod Anniversary.

CARDIFF.—The Merry-makers' Concert Party.

MANCHESTER.—Special Programme by the Piccadilly Picture Theatre Orchestra.

**Friday, June 18th.**

LONDON.—Albert Sandler and the Grand Hotel, Eastbourne, Orchestra.

GLASGOW.—"Remnant Acre."

LEEDS-BRADFORD.—Waterloo (18th June, 1815)—Drums and Bugles of the 7th Bn. West Yorkshire Regiment.

MANCHESTER.—Polish and French Composers.

**Saturday, June 19th.**

LONDON.—Popular Orchestral Programme.

ABERDEEN.—Scottish Programme.

CARDIFF.—"A Cornish Pasty."

GLASGOW.—Popular Variety.

MANCHESTER.—The Shaw Prize Brass Band.

NEWCASTLE.—The "Merries" Concert Party.

**Broadcast Humour.**

Although the few, the precious few, regular broadcast humorists still get a modest number of bouquets thrown to them, the enquiries as to when entirely new funny artists are to appear before the microphone outnumber the appreciations of the older "stars." The B.B.C. would like to get more artists of the John Henry and Vivian Foster type; but such artists are not as plentiful as blackberries in autumn. The broadcast humorist who appears unsupported is at a great disadvantage when compared with the musical troupe or concert party, whose turn succeeds partly on the strength of the music.

**Obstacles.**

The individual broadcasting artist's disability lies not altogether in the fact that the audience cannot see his baggy trousers, his red nose, or the jaunty little hat cocked on one side of his head. The belief is growing that the absence of rapport forms a serious barrier to success in broadcast humour. There is the additional fact that laughter is contagious. It spreads through an audience like quicksilver and a large proportion of people catch it, as they would catch infection, from their neighbours.

o o o o

**That Unseen Audience.**

The broadcast humorist, therefore, cannot localise his puns; nor can he tell what jokes "catch on" with his unseen audience. Thus the fact that a funny man is a success on the music-hall stage cannot influence Savoy Hill in paying him a high fee for broadcasting.

o o o o

**£20 a Minute.**

This leads to some comment on a recent case where, because he was not inclined to accept the fee offered and regarded by the B.B.C. as adequate for his services, an artist's grievances were given publicity in the Press. If a music-hall paid this particular artist at the rate offered by the B.B.C., he would be receiving between £270 and £300 a week—a far higher figure, in fact, than he has actually been paid.

o o o o

**Difficulties of Comparison.**

If it is suggested that by broadcasting he would be reaching a probable audience of two million listeners in one transmission, as against an audience of not more than 20,000 at any music-hall in a dozen turns spread over a week, it may be pointed out that it would cost the B.B.C., in operating expenses alone, at least £20 a minute for a simultaneous broadcast from all stations, and that the artist could not be used more frequently than once in about two months. Thus the difficulty of comparison is immense. Savoy Hill must not be influenced by any outside standard of values; for obviously an artist may be worth more, or even less, to broadcasting than to any other medium.

o o o o

**The Aldershot Tattoo.**

The Aldershot Command Searchlight Tattoo, as already announced in these columns, will be relayed from Aldershot on Tuesday next, June 15th. The programme will include the entry of massed bands; the First Post and bugle marches with band accompaniment; the massed drum and fife bands; and a Musical Drive by the First Brigade of the Royal Horse Artillery and massed trumpeters. An interlude of dance music will be given at 10.35 p.m., and at 11.22 p.m. the Aldershot Tattoo will be continued, closing the programme with the Last Post and The King.

# HIGH-SPEED PHOTOTELEGRAPHY

The System Developed by the Telefunken Company and Dr. Karolus, of Leipzig.

By PAUL J. GORDON FISCHEL.

THE development of phototelegraphy has made a great step forward during the past year. Tests carried out recently between Königswusterhausen and the receiving station of the Radio Austria A.G. (Marconi Concern) at Vienna gave a fresh insight into the future of phototelegraphy. Several German inventions used in the new phototelegraphic apparatus of the Telefunken Wireless Co. have removed the last difficulties in transmission of pictures by radio, and are about to revolutionise commercial high-speed telegraphy.

The wireless telegraph systems in use at present in the great commercial transmitting stations allow a maximum speed of about 150 words per minute under best atmospheric conditions, and of about 100 to 130 words per minute under normal conditions. The Telefunken-Karolus system for photo-transmission allows a speed of at least 200 words per minute—correctly an area of 100 sq. cm. per minute, which contains about 200 words—and successful tests have already been carried out in which such telegrams have been sent in thirty and twenty seconds! The speed is merely a question of the wavelength used for radio transmission, and with the use of short waves a few seconds will suffice for the same number of words. Moreover, this system is largely independent of atmospheric conditions. With the usual systems of high-speed telegraphy with Morse code, bad atmospheric result often in partially or completely unreadable tele-



Photograph and specimen of the handwriting of the famous wireless engineer Count Arco transmitted by wireless from Königswusterhausen to Vienna with the Telefunken - Karolus apparatus.

grams. With the system described hereafter, atmospheric only cause small lines and dots on the photoradiogram, not injuring in the least the legibility of the handwriting or typewriting, and not even disturbing the quality of received photos. Only high-quality reproductions need good radio weather.

As the principles of the new inventions used here give practically no limit in speed, the development of television and of the radio-cinema has gone hand in hand with the perfection of phototelegraphy. Promising results have already been obtained in the laboratories of Dr. Karolus at Leipzig, and in a few years the problem of television will be solved. Meanwhile, the new apparatus will be used for international wireless communication.

The different systems of phototelegraphy have reached a high grade of perfection, but there are two main features of the Telefunken-Karolus system, which make it superior to others: (1) The possibility to transmit directly the original telegrams (such as manuscript, photographs, etc.) without any form of preparation, and (2) the high speed of transmission and reception with perfect quality. The former is made possible by the new ring-shaped photoelectric cell, constructed by Dr. Schröter, of the Telefunken Co., the latter by the famous "Karolus-cell,"

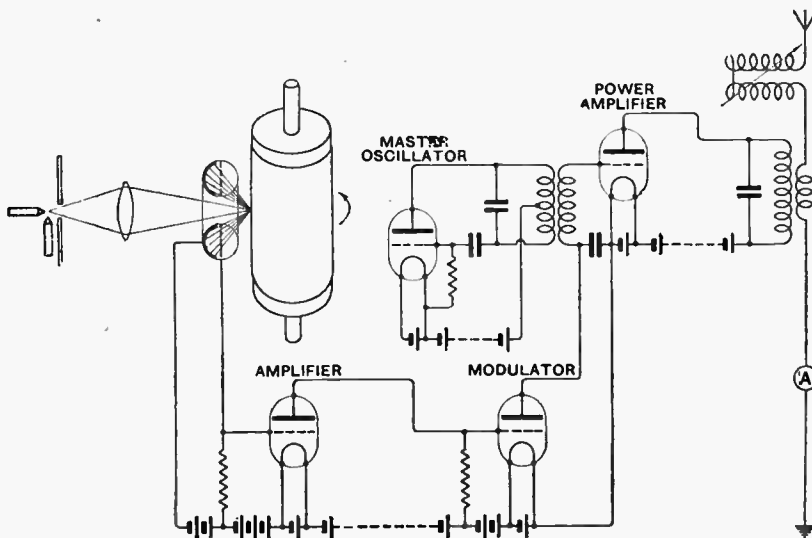

Fig. 1.—Schematic diagram of the transmitter showing the connections of the photoelectric cell.

**High-Speed Phototelegraphy.**—

which makes use of the so-called "Kerr effect," well known to physicists, which works entirely free from

and anode of this cell is connected to various resistance-coupled amplifiers, and finally to the wireless transmitter.

The ray of light from the electric arc goes through the free centre of the tube-ring of the photoelectric cell, and is reflected more or less on to the potassium cathode of the latter by the white or black spots exposed on the telegram. The reflected ray forms a cone of light which is fully used by the ring-shaped cathode of the cell. Corresponding to the reflection of the ray of light, current is allowed to pass through the photoelectric cell, and the transmitter is correspondingly

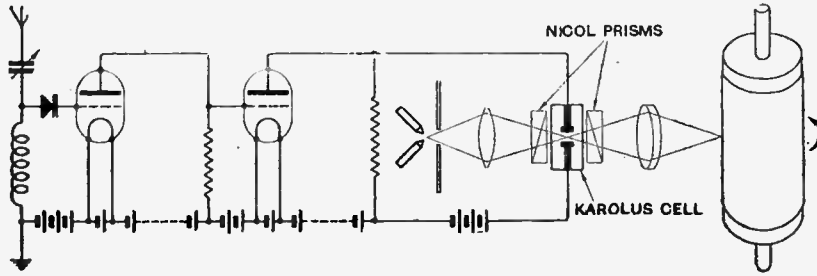

Fig. 2.—Simplified circuit diagram of the receiver.

mechanical inertia, thus forming a perfect light-relay.

The original telegram is mounted on a cylinder which is rotated and at the same time pushed forward in an axial direction by an electric motor. The rays of light of an electric arc are concentrated by a system of lenses towards the cylinder, thus forming a spot of light on

modulated through the medium of a suitable amplifier.

On the receiving side a cylinder of the same size and rotating at the same speed as the one in the transmitter is covered by an unexposed negative film and is enclosed in a lightproof box. Again, the ray of an electric arc is projected against the cylinder by suitable lenses. This ray has to pass a sensitive light relay, the Karolus-cell, before it exposes the negative film.

The relay is connected to the wireless receiving set through several stages of resistance-coupled amplification. Corresponding to the changes of light and dark on the transmitted telegram and to the resulting modulation of the transmitter's carrier wave, changes of potential are generated in the receiver circuits and finally in the circuit of the relay, a photograph of which is shown in Fig. 4. The latter consists of a small cell filled with

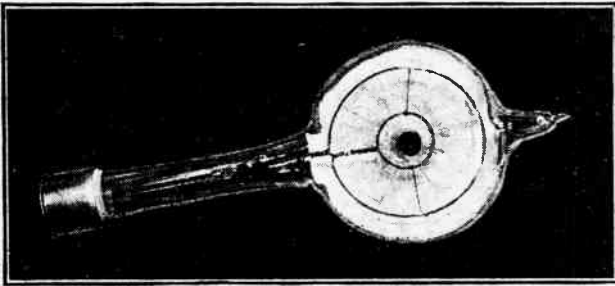

Fig. 3.—The ring-shaped photoelectric cell, designed by Dr. Schröter, of the Telefunken Company.

the telegram. As the cylinder moves, the light-spot traverses the surface of the telegram in a thread-like line of light. At the above-mentioned tests this spot of light covered the area of  $\frac{1}{2.5}$  square millimetre, giving a thread width of  $\frac{1}{6}$  mm. Between the source of light and the rotating cylinder, close to the latter, the "optical microphone"—Dr. Schröter's photo-

electric cell—is arranged. It consists of a ring-shaped glass tube, covered on half of its inner surface with potassium—an element which emits electrons when exposed to light—and of a grid of fine wires (also forming a ring) suspended in its centre, the anode. A photograph of the cell is seen in Fig. 3. The D.C. circuit containing the cathode

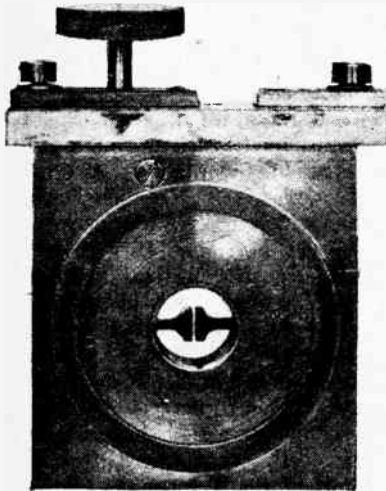

Fig. 4.—Karolus cell with adjustable electrodes. The central cavity is filled with nitrobenzene.

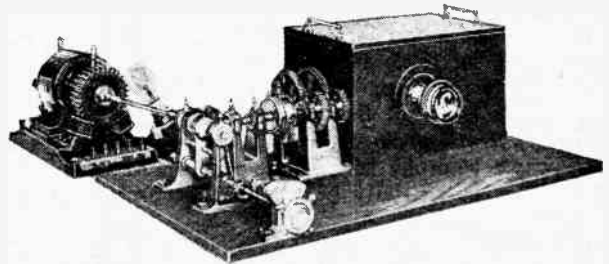

Fig. 5.—General view of the transmitter. The picture to be transmitted is mounted on a revolving drum inside the rectangular light-tight box together with the photoelectric cell

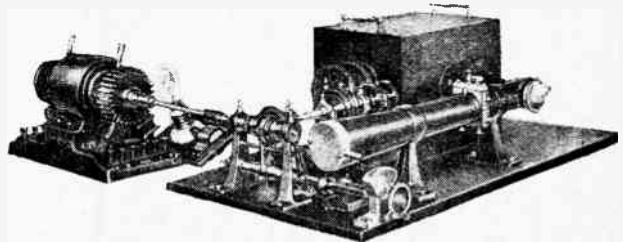

Fig. 6.—The receiving apparatus. The Karolus cell will be identified as the flat rectangular box intercepting the horizontal tube in the foreground.

nitrobenzene and containing two small electrodes which form a condenser. These electrodes or condenser plates are connected to the L.F. amplifier circuits of the receiver. A Nicol prism is arranged in front of the cell to polarise the ray of light before it passes the space between the condenser plates. Due to the "Kerr



**High-Speed Phototelegraphy.—**

effect," the plane of polarisation in the liquid is rotated according to the changes of potential applied to the electrodes, and the intensity of light leaving the second Nicol prism after the Kerr-cell is consequently varied. The Nicols are crossed, so that normally no light passes through to the film. The controlled ray of light exposes point after point of the picture in thread-like lines of exactly the same nature as those in the transmitter.

The Kerr-cell can handle not only applied potentials

of extremely high frequency, but also controls an enormous intensity of light without heating or otherwise going out of action. These properties make it specially suitable for experiments with television.

The synchronous rotation of the two cylinders in the transmitter and receiver is obtained with neon lamps and toothed wheels in a simple and ingenious manner.

A general view of the transmitting apparatus is shown in Fig. 5, while Fig. 6 shows the receiver.

**Jersey.**

(April 29th-May 21st.)  
Great Britain:—2GO, 2LZ, 2NM, 2QC, 2UD, 2YK, 5BY, 5BW, 5HS, 5JW, 5KU, 5NJ, 5RZ, 5VL, 5WQ, 5WV, 5YM, 6GF, 6HZ, 6OG, 6OH, 6ON, 6PG, 6QB, 6TD, 6YV, 6ZN, GI 2LJ, 6MU. Belgium:—G33, E4, S2, S5, D2, D8, L9. France:—8ABF, 8AOK, 8BN, 8BW, 8DDH, 8DP, 8FR, 8GSM, 8IL, 8IX, 8JC, 8JF, 8KI, 8MGR, 8MR, 8MM, 8NOX, 8PEP, 8RTT, 8SN, 8VO, 8WE, F 8LY, F OCNG. Spain:—EAR21. Holland:—PB2, PB3, OBX, OWC, OPX, O4N, OM8, OMS. Denmark:—7MT, 7BX. Italy:—1FP, 1CH, 1RM, ISRA. Various:—K 4GA, 4EITU, WIZ, 1JR, 7WA, ETOIET, 11Z, DCN. A. M. Houston-Fergus.  
(All on 35-47 metres.)

**London, W.1.**

(April 21st to May 20th.)  
Belgium:—B1, D2, O2, O8, Y8. Holland:—OBX, OFP, OMS, OPX, OWC, ONL2. Germany:—K7, W1, W9. Spain:—EAR15, EAR21. Sweden:—SMUK, SMUV, SMVG, SMVL, SMWQ, SMWS, SMWT, SMXV. Finland:—2CO, 2ND, 2NL, 5NF. Portugal:—1AE, 3GB. Italy:—1BK, ISRA. Denmark:—7BZ. Jugoslavica:—7XX. Czechoslovakia:—1OK. Poland:—T PAV. Tripoli:—1TA. U.S.A.:—1AAO, 1ABZ, 1ACI, 1AFL, 1AE, 1AIU, 1APU, 1BJ, 1BQ, 1BVL, 1CH, 1CTB, 1CO, 1CKP, 1SW, 1WP, 1XV, 2ADM, 2AEV, 2AHM, 2AFN, 2AIM, 2AMJ, 2APV, 2ATC, 2ATK, 2ANQ, 2BSL, 2CVJ, 2CNL, 2FR, 2GK, 2NZ, 2PM, 2RS, 2WH, 3BLC, 3PF, 4IF, 8AJ, 8JQ, 9BBW, NTT. Porto Rico:—4JA, 4RL. Canada:—1AR, 2AX. Cuba:—2LC. Brazil:—1AK, 1AL, 1AN, 1AP, 1BR, 1BD, 1IB, 2AG, 5AA, 5AB, 6QA, 8NI. Miscellaneous:—AGB, AQE, KEGK, SGL, SQ 1Q, SS BF2.  
M. Williams-Pilpel.

(0-v-1) On 26 to 100 metres.

**Rawalpindi, India.**

(March 20th to May 10th, 1926.)  
Great Britain:—2SZ, 2OD, 2CC, 2NM, 2FM, 2VQ, 2LZ, 2NH, 2XY, 2KF, 2VL, 2IH, 2WY, 2GM, 5NJ, 5MA, 5MW, 5NN, 5LS, 5WQ, 5HS, 5AR, 5VL, 5OC, 5SZ, 5PZ, 6NF, 6UZ, 6RY, 6YD, 6EP, 6MP, 6BR, 6MU, 6TD, 6TZ, 2SZ, 2FM, 2IT, 5TZ, 6UZ. France:—8CA, 8YOR, 3CA, DCN, 8BF, 8HM, 8NX, 8SZ, 8UD, 8GK, 8MC, 8FR, 8JN, 8JC,

**Calls Heard.**  
Extracts from Readers' Logs.

8KE, 8IX OCNG, FW. Sweden:—SMUK, SMSV, SMPN, SMSR, SMXU, SMVL, SMVG, SGK, SMUV. Finland:—S2CO, S2NX, S2ND, S2NL, S2NM, S2NC, S2BS, S2NX, S2NL. Italy:—1BK, 1BW, 1AX, 1AS, 1RC, 1SR, 1CR, 1BO, 1GN, 1CT, 1AT, 1VV. Belgium:—D4, 4YZ, B82, Y2, O2, O8, W1, Z1, U5, J2. Philippines:—3AA, 1HR, 2ND, 1AU, CD8, 1AR. Australasia:—A 2BK, 2YI, 5DA, 5KN, 3BD, Z 4AK, 1AX. Holland:—ONM, STB, PB7, PB3, PC2, OWC. Germany:—Y4, Y5, W3, KPL, IB, POP. Miscellaneous:—T PAV, T PAL, T PAX, D 7BX, LA 4X, O A3X, 4LA, A5T, PR 4SA, EAR23, EAR24, U 1AMD, S8 2SE, SS 8LBT, GBI, M 1DH, OTOT, GEFT, NPP, 6YX, 6YC, GHA, GHB, GBM, GFP, GFC, KIO, R 2QW, R 5NRL, LAS, KEGK.  
(Reinartz 0-v-1.)

R. J. Drudge-Coates  
Y DCR.

**Hale, Ches.**

(May 29th.)  
U.S.A.:—1CWQ, 1UW, 1SI, 1RJ, 1AAO, 1CMF, 1BAD, 1AMD, 1QC, 2BUR, 2AWQ, 2AFN, 2MD, 2AJA, 2AIT, 2CRK, 2AHA, 2RJ, 2CYX, 2QS, 2CD, 2DIA, 3ACW, 3RF, 3CJN, 3JW, 3AHL, 3BK, 4KJ, 4AG, 4LK, 4HK, 4CJN, 4SC, 4HP, 4EZ, 5ND, 5GK, 5KC, 5MX, 5ML, 6BJR, 6CKC, 6ADT, 7DX, 7GR, 7DF, 8GZ, 8CIL, 8ATX, 8CNY, 8CW, 8QB, 8DQZ, 8BDS, 8DDL, 8BYG, 8MC, 8DZC, 8CDJ, 8CWT, 8CUK, 8BZT, 9ARU, 9DPW, 9EE, 9DAJ, 9ADN, 9CUA, 9EJS, 9EJI, 9AKP, 9EK, NIDK, NAR. New Zealand:—4AA, 4AC, 4AR. Mexico:—M 1K, M 9A, M 5J, NDA. Australia:—2BK, 2TM, 3KB, 4AN. Panama:—RXY.  
(0-v-1, Reinartz.)

F. N. Baskerville.

**Goteborg, Sweden.**

(March 25th to April 30th.)  
Great Britain:—2CC, 2DQ, 2FU, 2KF, 2MA, 2OD, 2UA, 2ZC, 2ZZ, 5DH, 5PZ, 5SZ, 5UW, 5WT, 6FZ,

6KK, 6KO, 6UP, 6YD. France:—8AR, 8BQ, 8BE, 8DE, 8DP, 8EF, 8EZ, 8FJ, 8FR, 8GSM, 8HFD, 8HM, 8IL, 8LN, 8JRK, 8JU, 8KF, 8NK, 8NA, 8PA, 8RS, 8SO, 8ST, 8SSY, 8ST, 8VU, 8XL. Germany:—K 12, K JI, KLO, KPL, K Y5, K Y8, K P6, K W9, KWS, K W1, K 4PC. Belgium:—B 1BH, E1, F4, O2, O8, U5, PF, XY, 4YZ, Z1, 4QQ, 4PK, 4RD, BF, D4. Holland:—OCM, OMW, OPX, OWB, OWC, STB, PCLL. Italy:—1AD, 1AN, 1AX, 1BB, 1BD, 1BK, 1BP, 1BW, 1CA, 1CE, 1CH, 1CN, 1CT, 1FL, 1IB, 1OR, 1ZA, ISRA. Poland:—T PAL, T PAV, T PAW, T PAX. Russia:—RCRL. Luxembourg:—L 11W. Yugoslavia:—YS FXX, Spain:—EAR9, EAR21, EAR22, EAR23. Morocco:—MAROC. Tunis:—8GST. Sweden:—SMZG, SMTY, SMYC, SMXV, SMXU, SMWS, SMVL, SMVJ, SMVH, SMVG, SMUT, SMUK, SMUH, SMUA, SMSV, SMSR, SMSP, SMSB. Denmark:—7BX, 7BZ, 7DX, 7EW, 7ZM. Norway:—LA 1A, LA XX. Finland:—2BS, 2CO, 2ND, 2NL, 2NM, 5NF, U.S.A.:—1AAO, 1ADS, 2APV, 2FS, 5AME Ships NOT. KEGK. Brazil:—1AR, 1IB. New Zealand:—4AM. Palestine:—6ZK. Miscellaneous:—X 2M, S4, R 1FLD, SPRBK, R 5NRL, GBM, ELII.

(0-v-1) On 30-50 metres.

G. Holmland  
(SMZN).

**Johore, Singapore, S.S.**

(March 18th to 31st.)  
Great Britain:—5LS, 6CM. Australia:—3AD, 6KX, 3WM, 6KX, 6BO, 5DA, 2BK, 2YI, 2AJ. U.S.A.:—2BK, 6AJM, 6BJX, WHE, 6IM, 6BDI, 6HB, 6HM, 6CHL, 6AWT, 6APK, 6KB, 6ADT, 6CTB, 6OI, 6ALT, WIZ, 6AHP, 6BZ, 6RN, 6JS, 6BHZ, 6DA, 6EA, 6BQ, 6BOX, 6CCL, 6NX, 6CHO, 6HW, 6BJD, 6RJ, 6DAT, 6CCV, 6BQT, 6SM, KIO. New Zealand:—2BX, Chili:—2AG. Japan:—1AA, South Africa:—A4V. Germany:—AGW, POZ. Dutch East Indies:—PKE, Argentina:—LRT. Burma:—BZB. Philippines:—CD8, 1AR, 1AV, 1DL, GWG, 1AT. Holland:—PCLL. Brazil:—SN1. French Indo-China:—822, 8LBT, HVN. Hong Kong:—BXY. South Africa:—1SN. Russia:—RCRL. Italy:—1KK. Miscellaneous:—C9M, KG, BZK, CDZ, KG, CL, 8FLC, OGDJ, WGHN, GHC, FW.  
(0-v-1) On 13 to 60 metres.

Charles W. Randall.

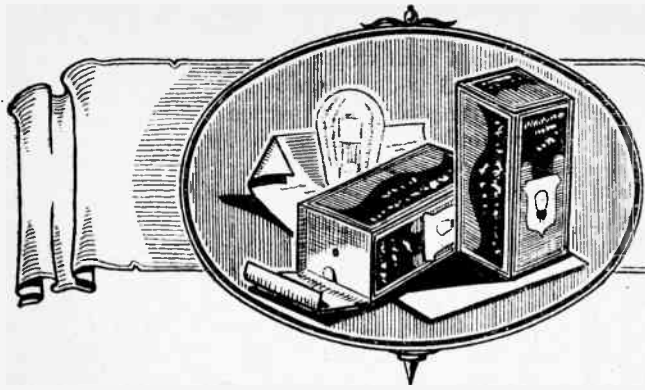

# NOVELTIES

## FROM OUR READERS

A Section Devoted to New Ideas and Practical Devices.

**SOLDERING HINT.**

A useful adjunct to the soldering equipment can be made by cutting and bending to shape a section of the edge of an old tin lid, as shown in the diagram.

The gap so formed allows the faces of the iron to lie parallel with

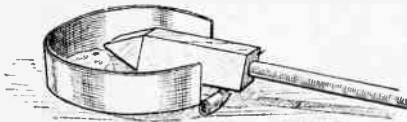

Soldering tray.

the bottom of the tin, and it is possible to tin a much greater surface. The rolled portion of the edge serves to tilt the lid and prevent solder from running out through the opening in the side, and also acts as a rest for the iron to prevent it burning the bench.—G. A. H.

o o o o

**VALVE CONNECTIONS.**

In Ediswan valves a different length of pin was at one time used for each of the grid, plate, and filament connections to reduce the possibility of damaging the valve by inadequately forcing one of the filament pins into the plate socket. This idea

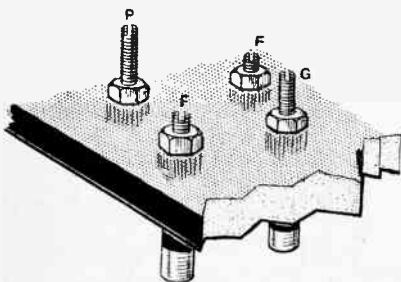

The soldering of connections to valve sockets is facilitated by cutting the screws to different lengths

may be extended to the valve socket connections at the back of the panel. If these are made of varying length the process of soldering wires to the end of each screw will be greatly facilitated.—F. W. T.

o o o o

**BALANCING INDUCTANCES.**

It is often required that two or more inductances should be carefully matched in order that they may be tuned simultaneously by double or triple tuning condensers. Although this may be very nearly achieved by carefully winding with an equal num-

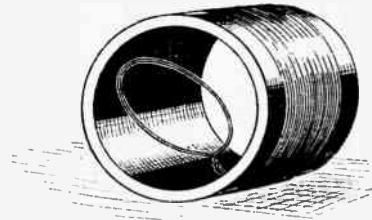

Fine adjustment of inductance.

ber of turns, it does not make allowance for slight differences in the inductance of connecting wires, etc.

If the coil is of the solenoid type the last turn may be wound in the form of a loop inside the former, the final adjustment of inductance being made by rotating the loop in order to

**VALVES FOR IDEAS.**

Readers are invited to submit brief details, with rough sketches, where necessary, of devices of experimental interest for inclusion in this section. A receiving valve will be despatched to every reader whose idea is accepted for publication.

Letters should be addressed to the Editor, "Wireless World and Radio Review," Dorset House, Tudor St., London, E.C.4, and marked "Ideas."

vary the coupling with the remainder of the coil.—A. R. T.

o o o o

**L.T. CONNECTIONS.**

When the L.T. battery is installed in a dark place, say, under the wireless table, the attachment of the L.T. leads where these are provided with spade terminals is often troublesome.

Plug-in connections will solve the problem, and a convenient method of converting the accumulator terminals is shown in the diagram. A standard lead connecting strip is screwed to each of the positive and negative terminals of the battery, and a socket is fitted to the free end of each strip.

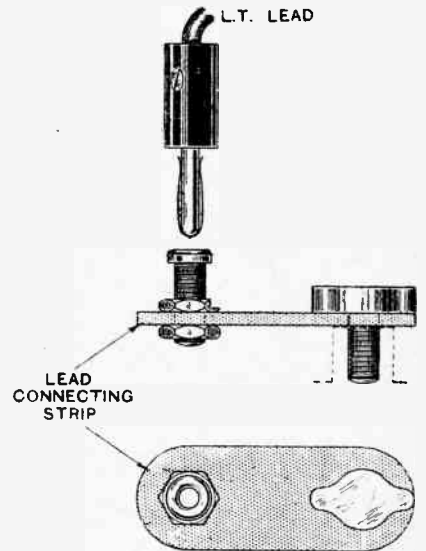

Plug-in L.T. connections.

As it is essential that a low-resistance contact should be obtained at this point, particularly if 2-volt valves are employed in the receiver, a plug and socket giving a large area of contact should be chosen.—R. W. G.

# WIRELESS CIRCUITS

## in Theory and Practice.

### 13.—Receiving Valves (continued).

By S. O. PEARSON, B.Sc., A.M.I.E.E.

AT the conclusion of the previous instalment a circuit was given showing how the grid voltage-anode current characteristic curves could be obtained for a three-electrode valve, and the diagram is repeated here for reference (Fig. 1). Keeping the anode voltage  $V_a$  and the filament voltage  $V_f$  constant, a series of readings of the plate voltage is obtained in milliamperes for various values of the grid voltage  $V_g$ , which is adjusted by means of the potentiometer P. Plotting as a graph the plate voltage vertically against the grid voltage horizontally, we get a static anode characteristic curve for the particular value of the plate voltage employed. For

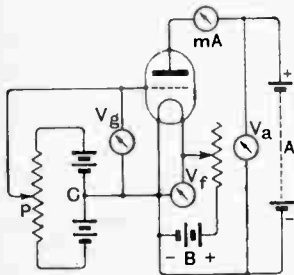

Fig. 1.—Circuit for plotting the anode characteristics of a three-electrode valve.

each value of anode voltage (kept constant during any one series of readings) we obtain a separate static characteristic curve. Thus we see that for any particular valve there is not only one characteristic curve, but an infinitely great number corresponding to all the possible values of plate potential that may be used.

In Fig. 2 a number of such characteristic curves is given for a well-known make of receiving valve, and this group or "family" of curves enables us to predict the most important properties of the valve as far as performance is concerned. There is, however, one other very important curve from which the internal resistance of the valve is found, namely, the plate voltage-plate current curve. The value of plate voltage to which each of the curves of Fig. 2 corresponds is indicated on the curve itself.

#### Anode Characteristics.

There are three important points to be noted regarding this group of curves.

(1) Each curve reaches approximately the same upper limit. This maximum value of the plate current, called the saturation current, is determined by the maximum number of electrons which the filament is capable of emitting at the fixed temperature of operation. If the filament temperature is raised by increasing the current, the upper limit of plate current will be raised, the saturation current or maximum emission rising very rapidly as the filament current is increased.

(2) There are two distinct bends in each curve, and the portion of each curve between the two bends is approximately a straight line; we shall see later that this is a very important fact. Incidentally, the straight portion of each curve is the steepest part.

(3) The straight portions of all the curves are very

nearly parallel. This means that for any value of plate voltage within wide limits the change of plate current is the same for a given small change of grid voltage, provided operation takes place on the straight part of the corresponding curve in each particular case. Note that operation on the straight part of any of the curves gives the greatest change in plate current for a given change in grid voltage. We see at once from Fig. 2 that increasing the plate voltage does not materially alter the shape of the curve, but merely moves it bodily to the left.

#### The Valve as an Amplifier.

The most important property of the three-electrode valve is its power of amplifying small voltage changes. This property arises from the fact that the change of plate current produced by a given small change of grid voltage is sufficient to produce a change of voltage across a high resistance (or impedance in the case of A.C.)

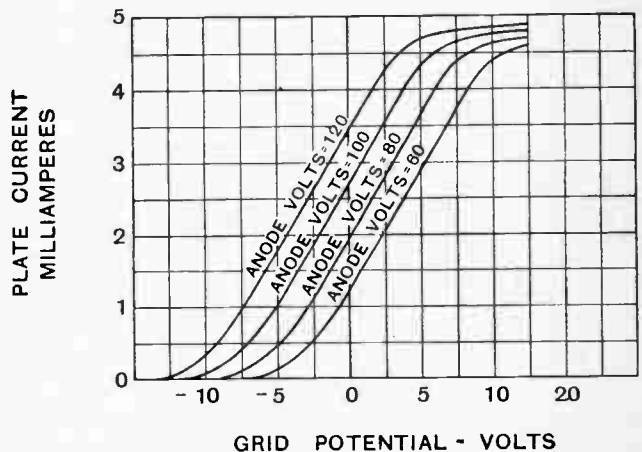

Fig. 2.—Group or "family" of anode characteristic curves for a three-electrode valve.

connected in the plate circuit, several times greater than the change of voltage applied to the grid. The writer has often seen it stated that a three-electrode valve is capable of amplifying because the change of plate current is large compared with the change of grid voltage producing it; but this statement in itself really has no meaning, because we cannot compare two things which are measured in different units any more than we can compare the flavour of an apple with the size of a house! It is only because the internal resistance between the plate and filament of the valve is sufficiently large that the change of current is capable of producing a comparatively large change of voltage across a high impedance in the plate circuit.

We see, then, that it will be necessary to know the magnitude and the nature of the resistance offered to the

**Wireless Circuits in Theory and Practice.**—

passage of the electron current between the filament and the plate of the valve before we can determine its amplifying powers. Now in a plain resistance such as a wire resistance its magnitude is given by dividing the voltage by the current, and the ratio is usually very nearly constant over a wide range of values. With the valve, however, we cannot obtain the plate-to-filament resistance merely by dividing the plate voltage by the plate current, because there is the equivalent of an E.M.F. in series acting between the filament and the plate, this being due

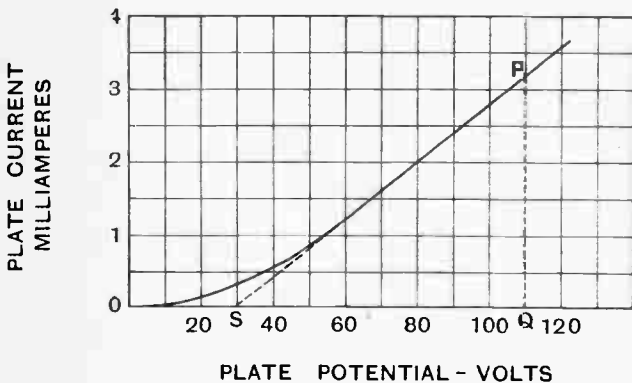

Fig. 3.—Plate potential—plate current curve of three-electrode valve with grid at zero potential.

to the presence of the space charge and the charge (if any) on the grid. Thus if  $R_a$  denotes the internal resistance of the valve in ohms,  $V_a$  the plate voltage, and  $e$  the equivalent internal E.M.F. due to the space charge and the charge on the grid, we see from Ohm's law that the plate current is given by

$$I_a = \frac{V_a - e}{R_a} \text{ amperes} \dots\dots\dots (1)$$

Now, for a constant grid potential of zero with respect to the negative leg of the filament,  $e$  is a constant quantity except for very low values of plate voltage, and therefore a curve showing the relation between the plate potential and plate current with the grid voltage kept at zero will be a straight line except for low values of plate voltage, and from this straight-line portion we are enabled to find the internal resistance of the valve. In Fig. 3 this particular curve is given for the same valve whose anode characteristic curves we considered above; the filament current was kept constant and the grid voltage kept at zero during the measurements. Now from equation (1) above it is clear that the resistance  $R_a$  depends alone on the slope of the straight portion of the curve. To find the internal resistance of the valve, then, produce the straight portion of the curve down to meet the horizontal axis at S; draw any vertical line PQ from a point P on the curve to meet the horizontal axis at Q. Then the ratio of SQ in volts to PQ in amperes gives the internal resistance of the valve in ohms. From the figure,  $SQ = 80.7$  volts and  $PQ = 3.2$  mA or  $\frac{3.2}{1,000}$  amps.

Thus the internal resistance of the valve is

$$R_a = \frac{80.7 \times 1,000}{3.2} = 25,200 \text{ ohms.}$$

This is the resistance obtained when the valve is oper-

ated on the steepest part of any one of the anode characteristic curves of Fig. 2. It is a fairly large number, and one naturally asks: Where does the energy go when the plate current flows through this resistance? It is dissipated at the plate as heat which is produced by bombardment of the plate by the electrons. In fact, if an excessive positive potential is given to the plate it will become red hot. Transmitting valves often run under normal operating conditions with the plates a dull red heat.

**The Amplification Factor.**

Suppose that we have 80 volts on the plate of the valve, and that the grid voltage is changed from zero to -1 volt. From the 80-volt curve in Fig. 2 we see that this causes the plate current to decrease from 1.95 mA to 1.62 mA. Now, referring to the curve of Fig. 3, we find that the change of plate voltage required to decrease the current from 1.95 to 1.62 milliamps. is 8.7 volts. Thus changing the grid potential by one volt has the same effect as changing the plate potential by 8.7 volts. A small change in grid potential produces the equivalent of a comparatively large change of plate voltage, and this is the property which accounts for the amplifying qualities of a three-electrode valve. The number 8.7 which we have just found is called the "amplification factor" or "amplification constant" of the valve, and is usually denoted by  $\mu$ . In general terms we may define the amplification factor of a valve as the ratio of the change of plate voltage necessary to bring about a given change of plate current, to the change of grid potential required to produce the same change of plate current, or the number of volts by which the plate potential must be raised to maintain the current constant when the grid potential is lowered by one volt. The amplification factor  $\mu$  is the greatest possible amplifica-

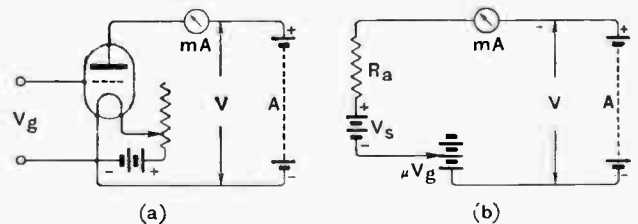

Fig. 4.—Diagram showing analogy between the anode circuit of a valve and a simple electrical circuit with resistances and batteries

tion of voltage which the valve is capable of giving theoretically. The voltage amplification obtained from a valve is generally less than  $\mu$ , the only exception being the case where a step-up transformer is used in conjunction with the valve.

From the foregoing it follows that if the grid voltage is changed from zero to  $V_g$ , the effect on the plate current is exactly the same as if the plate voltage had been changed from  $V_a$  to  $(V_a + \mu V_g)$  volts, without altering the grid voltage at all. For simple explanation the complete plate circuit of the valve as shown in Fig. 4 (a)—namely, the circuit through the H.T. battery A, the milliammeter mA, from plate to filament inside the valve, and from the negative leg of the filament back to the H.T. battery again—may be replaced by the simple circuit shown in Fig. 4 (b), where  $R_a$  represents the internal resistance of

**Wireless Circuits in Theory and Practice.**—

the valve,  $V_s$  the internal E.M.F. due to the space charge (opposing the flow of current), and  $\mu V_g$  the equivalent internal E.M.F. due to the grid voltage  $V_g$  with respect to the negative leg of the filament.  $\mu V_g$  will be either positive or negative according to whether the potential of the grid is positive or negative. It should be remembered that the plate and grid potentials are always measured with respect to the *negative* leg of the filament.

Applying Ohm's law to the circuit of Fig. 4 (b) we see that the plate current is given by

$$I_a = \frac{(V_a - V_s + \mu V_g)}{R_a} \text{ amps} \dots\dots\dots (2)$$

For the particular valve we have under consideration we find from Fig. 2 that when the plate potential is 80 volts the plate current is 1.95 milliamps for zero grid potential, and we have seen that  $R_a = 25,200$  ohms. Substituting these values in the above equation we get

$$\frac{1.95}{1,000} = \frac{(80 - V_s + 0)}{25,200} \text{ from which the space charge}$$

voltage  $V_s = 31$ . This is a constant number provided the valve is operated on the straight portion of any of the anode characteristic curves of Fig. 2. Thus, for our valve, equation (2) becomes

$$I_a = \frac{V_a - 31 + \mu V_g}{25,200} \text{ amps.}$$

To check this equation for truth make  $V_a = 100$  volts and  $V_g = -1$  volt, so that  $\mu V_g = -8.7$ . This gives a plate current of  $I_a = (100 - 31 - 8.7)/25,200 = 2.39$  milliamps. Now, looking up the 100-volt curve of Fig. 2 we

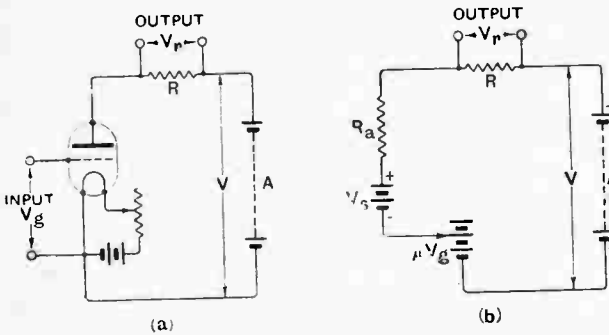

Fig. 5.—(a) Valve circuit with resistance R connected in the anode circuit. (b) Equivalent circuit made up of batteries and resistances.

find that for a grid voltage of  $-1$  the plate current is actually 2.39 milliamps, which verifies the formula.

We have seen that giving the grid a voltage  $V_g$  is equivalent in effect to generating a voltage  $\mu V_g$  in the plate circuit, *but inside the valve*. In order to obtain at least a part of this "generated" voltage across some portion of the external circuit, we must connect something such as a high resistance R in series with the plate of the valve as shown in Fig. 5 (a). A pure resistance is considered here as being the simplest arrangement. Any variation of the current due to change of grid voltage will result in a corresponding change in the potential difference across the ends of the external resistance R. This will be made clear by reference to the equivalent circuit

shown in Fig. 5 (b), where the various symbols have the same meanings as in Fig. 4.

The voltage  $V_r$  across the external resistance R is given by the product of the current and the resistance, namely,  $V_r = I_a R$  volts. Let us now consider two conditions in turn—first, the condition when the grid voltage is zero, so that  $\mu V_g = 0$ ; and, secondly, when the grid is given a small potential  $V_g$  with respect to the negative end of the filament, and then proceed to find the *change* in voltage produced across R. Let the voltage given by the H.T. battery be V in each case. When  $V_g = 0$  the plate current is given by  $I_a = \frac{V - V_s}{R + R_a}$  amps., and therefore

the voltage across the external resistance, given by multiplying this current by R, is equal to  $(V - V_s) \frac{R}{R + R_a}$

volts. Similarly, in the second case when the grid voltage is  $V_g$  we find that the voltage across R becomes

$(V - V_s + \mu V_g) \frac{R}{R + R_a}$  volts, where  $\mu$  is the amplification factor of the valve. Subtracting the former result from the latter we see that the *change* of voltage which has occurred across the resistance R due to changing the grid voltage by an amount  $V_g$  is equal to

$$\mu V_g \frac{R}{R + R_a} \text{ volts.}$$

From this we see that the voltage change produced across the external resistance is  $\mu \frac{R}{R + R_a}$  times the voltage

variation applied to the grid of the valve. This expression then gives us the number of times that the valve, in conjunction with the resistance R, multiplies the voltage changes applied to the grid, the number being referred to as the "voltage amplification" of the combination.

If we applied the amplified change of voltage produced across R to the grid of another similar valve with a similar resistance in the plate circuit, it would again be multiplied by  $\mu \frac{R}{R + R_a}$ . We see,

therefore, that by using a sufficient number of valves in succession (cascade) we can theoretically multiply an infinitely small voltage change up to any magnitude we please. But in practice there are limitations in both directions preventing the use of more than a very small number of valves.

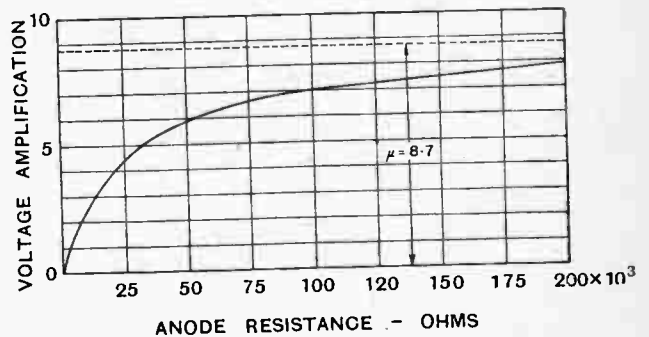

Fig. 6.—Voltage amplification curve of three-electrode valve (internal resistance 25,000 ohms, amplification factor 8.7) for various values of external resistance in the plate circuit.

**Wireless Circuits in Theory and Practice.—**

The principle described above is made use of in the well-known resistance-capacity method of coupling valves in cascade in an amplifier, a subject which will be dealt with more in detail at a future date. Our immediate object is to see what are the conditions for obtaining the greatest possible voltage amplification from a given valve. By inspection we see at once that the voltage amplification,

$\mu \frac{R}{R + R_a}$ , will be greater the higher the value of the external resistance R. But it will be realised that the voltage on the plate of the valve will be less than that given by the high-tension battery by the amount "dropped" in the resistance R, and therefore the greater the value of the resistance connected in the plate circuit the higher will the voltage of the high-tension supply have to be in order to maintain the plate at an adequate potential above that of the filament. It is this which sets a limit to the magnitude of resistance to be employed.

The voltage amplification for the same valve as considered above, which had an amplification factor of 8.7 and an internal resistance of 25,200 ohms, has been worked out from the formula  $\mu \frac{R}{R + R_a}$  for various values of resistance connected in the plate circuit, and the results are indicated by the curve of Fig. 6. It will be noted that when the external resistance is made equal to the internal resistance of the valve, namely, 25,200

ohms, the voltage amplification is equal to 4.35, being just half the amplification factor of the valve. When the external resistance is four times as great as the internal resistance, the voltage amplification is four-fifths of the amplification factor, and so on. We see then that to obtain a moderately large voltage amplification it is necessary that the series resistance should be at least four or five times as great as the internal resistance of the valve.

A good average value of anode resistance for use with valves having internal resistances of the order of 25,000 or 30,000 ohms is 100,000 ohms.

From the foregoing it will be realised that whatever voltage variations are applied to the grid of the valve they will be exactly reproduced across the series resistance but magnified several times. Thus, if the complex voltage variations representing speech vibrations are applied between the grid and the filament, they will be faithfully reproduced across the anode resistance with much greater amplitude.

Thus far we have considered the use of a pure resistance in series with the plate circuit of the valve, this giving us a constant voltage amplification quite independent of the rate at which the grid voltage is varied, and, therefore, in the case of alternating voltages, quite independent of the frequency. In the next section the case will be considered where an impedance, such as that of a pair of telephones, is connected in the plate circuit in place of the non-inductive resistance.

**STEADY INCREASE IN LICENCES.**

An Interesting Indication of Progress.

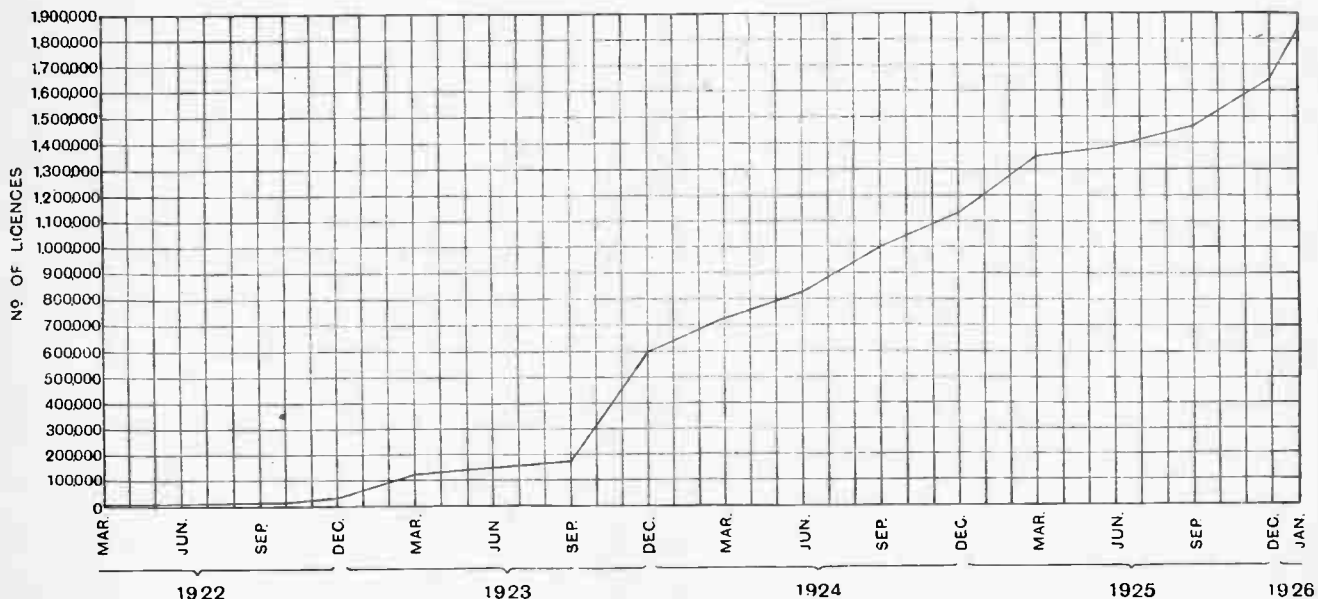

The above chart, which is prepared from figures given in an appendix to the Report of the Broadcasting Committee, shows at a glance the steady increase in the number of Broadcast Licences issued by the Post Office from March, 1922, up till January of this year. It is a good reply to those who say that the interest in wireless is on the wane.

# PIONEERS of WIRELESS

BY ELLISON HAWKS F.R.A.S.

## 17.—Trowbridge Suggests Transatlantic Wireless.

IT is difficult to-day to understand the importance of Bell's invention of the telephone to wireless research. Previously, all signals had to be transmitted and received with ordinary telegraphic apparatus, which at its best was not nearly so sensitive as the telephone receiver. The telephone was, indeed, found to be of greater sensitiveness than even the mirror galvanometer. Its invention enabled the problem of wireless to be attacked with some prospect of success, and scientists were not slow to take advantage of the situation.

### Early Induction Effects.

Prior to 1868 the effects of induction on telegraph wires had been noticed, and before the telephone had long been in general use it was observed that it was particularly sensitive to induced currents. Neighbouring wires supported by the same poles were affected, transmission being picked up by parallel circuits and reproduced in the receiver.

Even as late as 1888 this curious property was without a name, and was referred to as "bug-a-boo" by Sir William Prece. It was subsequently named "induction" by Clerk Maxwell, and was the subject of considerable study and speculation. Sacher in Austria, Dufour in France, and Edison in America all experimented with wireless transmission by induction, with varying success.

At Harvard University Professor John Trowbridge systematically studied the problem and revived the often-talked-of project of transatlantic wireless telegraphy. In this connection he stated it to be his opinion that: "The theoretical possibility of telegraphing across the Atlantic without a cable is evident from the experiments I have undertaken. The practical possibility is another question. Powerful dynamos could be placed at some point in Nova Scotia, having one end of their circuit grounded near them and the other end grounded in Florida, the connecting wire being of great conductivity and carefully insulated throughout. By exploring the coast of France, two points on surface lines not at the same potential could be found; and by means of a telephone of low resistance, Morse signals sent from Nova Scotia to Florida could be heard in France."

Trowbridge concluded his

remarks by stating: "Theoretically this is possible; but practically, with the light of our present knowledge, the expenditure of energy by the dynamo-electric machines would be enormous."

### The Pioneer of the Wireless Lighthouse.

Abandoning this imaginative project of signalling across the Atlantic, Trowbridge (in 1880) suggested that his method might be used by ships at sea for communicating with each other. Each ship was to be equipped with a powerful dynamo, one terminal of which was to be "earthed" in the sea at the bow of the vessel. The other terminal was to be connected to a long insulated wire, which was to be trailed over the stern and fastened to a buoy, not insulated. The current would thus be spread over a large area of water and could be picked up by other ships, equipped with similar trailing wires, the signals being received by means of a telephone connected in the circuit. By these means Trowbridge suggested collisions at night or during fog would be prevented.

For four years Trowbridge was engaged on these experiments, and he also worked on a modification of the system, which he called aerial telegraphy. This would also enable ships to communicate with each other by using wires stretched from the yardarms, the ends of the wires dipping into the sea on each side of the ship. In this case a delicate galvanometer was, for some unknown reason, substituted for the telephone.

It may perhaps be claimed for Trowbridge that he was a pioneer of the modern wireless lighthouse, for he suggested that his aerial telegraph could be installed on dangerous rocks and signals sent out to give warning to ships of their position.

Continuing with his researches, Trowbridge suggested (in 1891) that it was possible to signal without wires by means of electromagnetic induction. He proposed that ships should be equipped with ten or twelve wires, that these should be stretched from the yardarms and their ends connected either to a powerful battery or to a dynamo. Wires stretched similarly on the ship to receive the signals were to be connected to a telephone in order to detect the signals.



Prof. John Trowbridge.

**Pioneers of Wireless—Trowbridge.**

Experiments were carried out on board ship, and it was noticed that signals were strongest when the two coils were parallel to each other. Trowbridge suggested that by this fact the direction of a signalling vessel could readily and accurately be found—an early suggestion of modern directional wireless!

Although in theory Trowbridge had in a manner practically solved the problem of wireless communication, in practice the difficulties of all his systems were too great to be overcome. In his induction method, for instance, for communication between ships at only half a mile distance, coils were required composed of ten turns of wire with a radius of 800ft.

Altogether, his results were unpromising and only seemed to emphasize the difficulties of the subject. He himself seems to have been greatly disappointed, for in

1891 we find him expressing it as his opinion that "it is hardly probable that any electrical method could be devised in which air, or the ether of space, could advantageously replace a metallic conductor on land for signalling over considerable distances."

This was indeed a remarkable opinion, and little did Trowbridge suppose that in less than five years' time a young Italian would be transmitting and receiving wireless signals through "the ether of space" for distances of two miles and upwards, before representatives of the British Navy and Army! But, as we shall see shortly, events were to move rapidly in the next few years, for the work of the pioneers was beginning to bear fruit.

**NEXT INSTALMENT.**

Dolbear Nearly Forestalls Marconi.

**NEW APPARATUS.****A Review of the Latest Products of the Manufacturers.****A NEW REDUCTION GEAR.**

The new "Simplicon" variable condenser produced by Williams and Moffat, Ltd., Grange Road, Small Heath, Birmingham, which has recently appeared on the market, is provided with a novel system of reduction gearing.

The engraved dial is locked upon the condenser shaft and revolves in unison with the moving plates, but the spindle

portions on the stems do not extend right through the bushes, which act as bearings, as is often the case, and thus a good bearing surface is obtained.

Both electrically and mechanically the condenser is a good job, and the plates are particularly well stamped, the edges being clean and true, though the knob and dial are not quite as attractive in appearance as many of the modern large diameter geared dials.

method of valve mounting, for at present in most receiver designs the valve is either hidden away inside the set or attached to the front of a panel where it is very liable to be damaged.

A receiver made up with this new holder has a very attractive appearance,

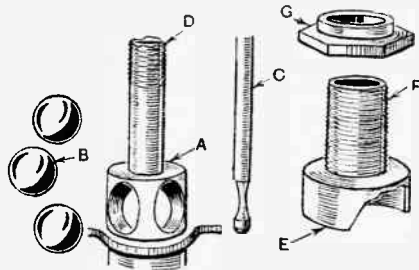

Details of the reduction gear fitted into the head of the new Simplicon variable condenser.

is hollow, and a thin stem passing down the centre is used for adjusting the condenser setting. Details of the reduction gearing are shown in an accompanying illustration. The main spindle is drilled out as shown at A, and three steel balls B are fitted so that they engage upon the reduced end of the spindle C, which passes through the main spindle D. Rotating C causes the balls to revolve, and as they rest in contact on the inside wall of the cup E, a rotation is applied to the main spindle. F is the main bearing piece, which is held in position on the ebonite end plate by means of the nut G, whilst an additional nut is supplied to provide one-hole fixing. A very smooth movement is obtained entirely free from backlash.

The plates are set up without the use of spring washers, and the spindle is entirely free from end play. The threaded

**NEW HARLIE VALVE HOLDERS.**

Messrs. Harlie Bros., 36, Wilton Road, Dalston, London, E.8, have recently produced two new types of valve holder, one of which, called the Harlie Pot Holder, is of a particularly original design.

Shown in the accompanying illustration it will be seen to consist of a recessed cylinder carrying the valve connections

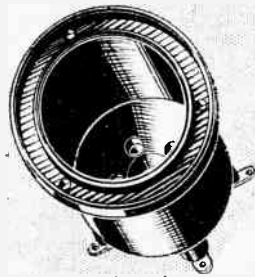

The Harlie Pot Holder, a new type of valve holder for recessing the valve below the surface of the panel.

at its base. It is intended for panel mounting, and by cutting a 1½in. diameter hole through the panel the valve is mounted so as to be recessed below the panel face.

This holder provides a new alternative

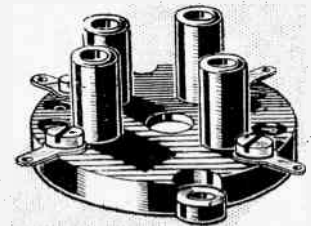

A baseboard mounting valve holder in which the valve sockets are ebonite covered to prevent the filament pins of the valve accidentally making contact with the H.T. supply.

the valve can be observed whilst the risk of damage is eliminated. The small type valve sinks nicely down into the holder, and although a larger type can be accommodated it does, of course, project from the set. The valve sockets are so arranged that the valve pins cannot make contact with H.T. supply should a valve be incorrectly inserted.

Another valve holder recently introduced is for baseboard mounting. It is a clean moulding possessing low inter-pin capacity and in which insulating sleeves completely cover the connectors to avoid accidental contact between the plate and filament pins.



JUNE 9th, 1926.



# LETTERS TO THE EDITOR

The Editor does not hold himself responsible for the opinions of his correspondents.

Correspondence should be addressed to the Editor, "The Wireless World," Doiset House, Tudor Street, E.C.4, and must be accompanied by the writer's name and address.

## H.F. RESISTANCE OF COILS.

Sir,—In the issue of *The Wireless World* for April 28th your contributor Mr. Mallett states that the high-frequency resistances of coils are greater than can be accounted for by the mere copper losses. Now, although this statement is true, the residue in reasonably designed coils is so small that it is hardly worth mentioning. I tried to indicate the probable proportion of copper to total loss in my article in your issue of March 31st.

My reason for drawing your attention to the matter is that qualitative statements such as those made by Mr. Mallett and others have in the past led manufacturers totally astray in regard to the design of inductance coils intended for use at radio frequencies.

Further, I cannot agree with Mr. Mallett in regarding coil losses as of very minor importance, even in tuned anode circuits. I have dealt more fully with this matter in an article appearing in another part of this issue.<sup>1</sup>

S. BUTTERWORTH.

## INTERVALVE TRANSFORMERS.

Sir.—Judging from Mr. Smith Rose's remarks about transformer faults he seems to have been singularly unfortunate.

I have a shrewd suspicion that the transformers which he uses are of a well-known type, of which I have had four in constant use for the past 22 months. Two of these have been in the hands of relatives whose knowledge of W/T is confined to the simple act of switching on, or off, to give them something they do, or do not, want. As the H.T. passes through the primaries it speaks volumes for their construction that there has been not the faintest sign of any fault as yet.

The other two are fitted in experimental reflex circuits of my own—in each case with H.T. deliberately *via* primaries. They are used perfectly brutally—again deliberately; and again I have found, as yet, no fault, although two other types, one English and one French, broke down in three weeks and in five days respectively under the treatment.

That Mr. Smith Rose's experience must be exceptional, I think, borne out by the knowledge that the people who buy these transformers would certainly return them under the guarantee in case of fault; and that the firm in question has not gone into liquidation.

It is hardly necessary to point out to a scientist of Mr. Smith Rose's experience that there is a possibility of some control, condition, or external state having in his case been overlooked.

Or possibly—we have all heard of those people on whom a watch invariably gives up the ghost! Does this also apply to transformers?  
C. E. V. WILKINS.

Houghton-on-the-Hill, nr. Leicester.

Sir,—As I do not intend to disclose the name or type of any transformers to which I have referred in former issues, it is impossible to say whether Mr. Wilkins is correct in his assumption that he is using transformers of the same type that I have employed. This, however, is not important, as I endeavoured

to indicate in the article recently published that the fault was common to many makes of transformers. I very much regret now that I have kept no record of all these breakdowns, but I can think of five or six types and at least fifty individual transformers which have suffered a breakdown of the primary winding during the last six years or so.

When returning one of the defective transformers to its manufacturer I was informed that this was the first breakdown that had come to his notice, although he had sold over 10,000 transformers of the same type. Within a week or two of this announcement I experienced another breakdown of the same type of transformer, and I have since had several more! It is curious, if not uncanny, that it should be somebody's business to select for me the one defective transformer in every ten thousand manufactured.

I have mentioned in former articles that this breaking-down habit is shared to some extent with the telephone receiver and loud-speaker, and it is interesting to note in this respect that less than a fortnight ago a colleague informed me that the winding of his loud-speaker—of a well-known make—had broken down. This and other examples have demonstrated to me that my "singularly unfortunate" experience is at least shared by some of my friends and colleagues.

London, S.W.14.

R. L. SMITH ROSE.

## BRETWOOD AUTO AUDIO FREQUENCY AMPLIFIER.

Sir,—We notice two letters in *The Wireless World* of May 26th trying to go into a higher technology of the meaning of the word "Transformer." We on our part did not intend to give a lecture as to the proper meaning of the word as applied in different branches of electrical science, but to call our Auto Audio Frequency Amplifier a "Transformer" or a "Choke" is a misnomer.

No doubt in any instrument having a primary and secondary there is a step-up in voltage, and it is therefore a transformer (we leave the proper term to our critics), but we say it is detrimental to pure amplification.

It has been proved by individual amateurs that you cannot use more than two stages with any success as regards purity and clarity of tone, thereby demonstrating that the step-up in voltage as applied to the grid of the valve in the audio stage is of no benefit. That is why there is now a general leaning to choke and resistance coupling for pure amplification, which shows that a step-up effect is detrimental for purity and clarity of tone.

No doubt some people would say that you get more amplification with two stages of transformer coupling against two stages of choke or resistance coupling, but in our opinion this is not so. Taking pure amplification, the strength is equal, and in most cases it is more than in transformer coupling, that is, again taking our amplifier as an example; there might be a semblance of more power (and noises) coming through from the transformer coupling due to a slight unnoticed distortion causing mush, noisy backgrounds, etc., which would give one the idea of a stronger amplification, but when it comes to a third stage, the slight distortion which is causing the mush, etc., is brought out still further, and is sometimes simply unbearable, which, of course, can be cured again by

<sup>1</sup> "H.F. Resistance," page 767.

different means, such as introducing resistance or capacities across the transformers, which lowers the amplification, and the result is less power than in the other methods of coupling.

As regards the letter signed G. M. Meyer, this gentleman does not seem to know what the discussion is about, and we think his remarks are not at all helpful and quite out of place, and unsuitable for a paper such as *The Wireless World*.

London, W.1. For and on behalf of Bretwood, Ltd.,  
R. WOODS.

#### HARMONICS ON ULTRA-SHORT WAVES.

Sir,—On a recent occasion, whilst experimenting with a single-valve Reinartz receiver on wavelengths between 10 and 20 metres, utilising a single-turn aerial coil, 3-turn grid coil, and 2-turn reaction coil, in conjunction with an indoor aerial approximately 20 feet long, and direct earth, I received harmonics from the following long-wave commercial stations:—GBR (Rugby), MUU (Carnarvon), and LY (Bordeaux). Since the actual radiated wave in each case is considerably over 10,000 metres, one would no doubt be inclined to imagine that such a high-numbered harmonic, even from so powerful a station as GBR, would be so weak as to be practically unreadable.

I have, on numerous occasions, listened to GSW's (Stonehaven) high-powered transmissions on his  $\frac{1}{2}$  harmonic, but the strength was only about equal to R2,3 in comparison.  
Blackburn, Lancs. ARTHUR TOMLINSON.

#### WHAT IS THE BEST IMPEDANCE VALUE FOR THE TELEPHONES?

Sir,—The article on crystal detectors in your issue of May 5th contains a statement which needs a certain amount of qualification if it is not to be misleading with regard to the desirable characteristics of a crystal detector. Referring to a Perikon detector the writer of the article says: "This combination has the advantages that it possesses a fairly high resistance and that a good firm pressure can be used. . . ." Actually it is not inherently an advantage that a crystal detector should have a high resistance (except, of course, in the reverse direction). In fact, the lower the resistance of the detector in the pass direction the more efficient and more sensitive the detector will be, provided it is properly associated with the receiving circuit. If in any case a high resistance detector appears to be more sensitive than a low resistance detector the reason will almost certainly be that the circuit conditions are less inefficient for the former than for the latter. The means of obtaining circuit conditions appropriate to a low resistance detector are described in the article referred to and were first pointed out by the present writer in this journal in April, 1924.

Further, with regard to the most suitable telephone impedance in crystal reception:—The actual variation as between high and low resistance telephones is less than a detailed analysis of the case would lead one to expect. In the experience of the present writer, however, telephones of lower resistance than those suggested in the article referred to will give an appreciably greater intensity with the optimum detector tapping. About 1,000 ohms with a Perikon detector and 500 ohms with a galena detector appear to be suitable values for signals of medium to loud intensity.

In connection with this same matter of suitable telephone impedance, the article by Mr. W. H. F. Griffiths in the same number (May 5th) is a welcome contribution to this hitherto

rather neglected subject. The conclusions arrived at, however, are not entirely convincing. Mr. Griffiths assumes that constancy of telephone current for a constant grid voltage amplitude of varying frequency is the right thing to aim at, and on this assumption his recommendations are certainly quite sound. Suppose, however, that, apart from any pronounced diaphragm resonance, the acoustic energy delivered by the telephones is an approximately constant proportion of the total electrical energy consumed in the telephones. In this case constancy of total electrical power in the telephone would become the right criterion, and it can be shown that this condition will be more nearly realised by the exact opposite of Mr. Griffiths' recommendations, that is, by making the telephone impedance very high compared with the internal resistance of the valve. This is actually the condition which obtains in direct crystal reception, especially when a galena detector is used with high resistance telephones. The apparently good quality of such reception is generally recognised. It is not suggested that this view is necessarily any more correct than that put forward by Mr. Griffiths, but it is suggested that the subject is a rather more complicated one than Mr. Griffiths' account would indicate, and that more detailed information with regard to the behaviour of telephones over the audible frequency range is required.  
N.P.L., Teddington. F. M. COLEBROOK.

Sir,—I entirely agree with Mr. F. M. Colebrook that the whole subject of distortionless telephone impedance is much more complicated than is indicated by conclusions arrived at by assuming the criterion of constant telephone current for constant grid voltage amplitude of varying frequency. In the article to which Mr. Colebrook refers, this assumption was made in order to obtain the simplest possible basis for the comparison of various telephone load impedances, more particularly for the comparison of tone quality obtained with series and parallel groupings. It will be noted that my statements are confined to *comparisons* of tone quality, although in the concluding paragraph I indicate my inclination to Mr. Colebrook's own "constancy of total electrical power in the telephones" criterion in the following words:—

"In conclusion the writer does not wish to create the impression that impedance adjustments must be made on the load circuit in order to obtain a flat or nearly flat curve (of telephone current for constant grid voltage plotted against frequency), since it appears that . . . after adjusting a rejector circuit to eliminate the diaphragm natural frequency hump, a boosting of the lower tones is necessary to preserve tone balance," after which it is stated that a much higher impedance telephone circuit "might conceivably give more pleasing or even more faithful overall results."

My reference to the "peculiarly high-toned quality" obtained with a constant current condition under the sub-heading "High tones better with phones in parallel" also, I think, serves to show that I am not an advocate of this criterion. Further, it should be noted that I refer to "apparently ideal flat curves."

May I be permitted, however, to thank Mr. Colebrook for emphasising this point.

In conclusion may I point out that the pressure between the telephone receiver earcaps and the ears determines to some extent the tone quality obtained, a very considerable pressure on to the cheekbones being apparently required to give due prominence to the very lowest notes.

London, S.E.18.

W. H. F. GRIFFITHS.

#### HIDDEN ADVERTISEMENTS COMPETITION.

The following are the correct solutions of THE WIRELESS WORLD Hidden Advertisements Competition, May 26th, 1926.

Clue No.	Name of Advertiser.	Page.
1.	The Marconiphone Co., Ltd.	1
2.	Brandes, Ltd.	11
3.	The Blackadda Radio Co., Ltd.	14
4.	Jones & Stewart	15
5.	Midland Radiotelephone, Ltd.	7
6.	Hamley Bros., Ltd.	13

The following are the prizewinners:—

A. Colc, Clapham Common, S.W.	£5
A. Maskill, Crossgates, Yorkshire	£2
Capt. K. J. Lee, Bedford	£1

Ten Shillings each to the following:—

Eric W. Heather, London, N.8.	Mrs. C. E. Leaper,
Hither Green, S.E.13.	C. H. Stocks, Seven Kings,
Essex.	Mrs. C. Mills, Oxford.

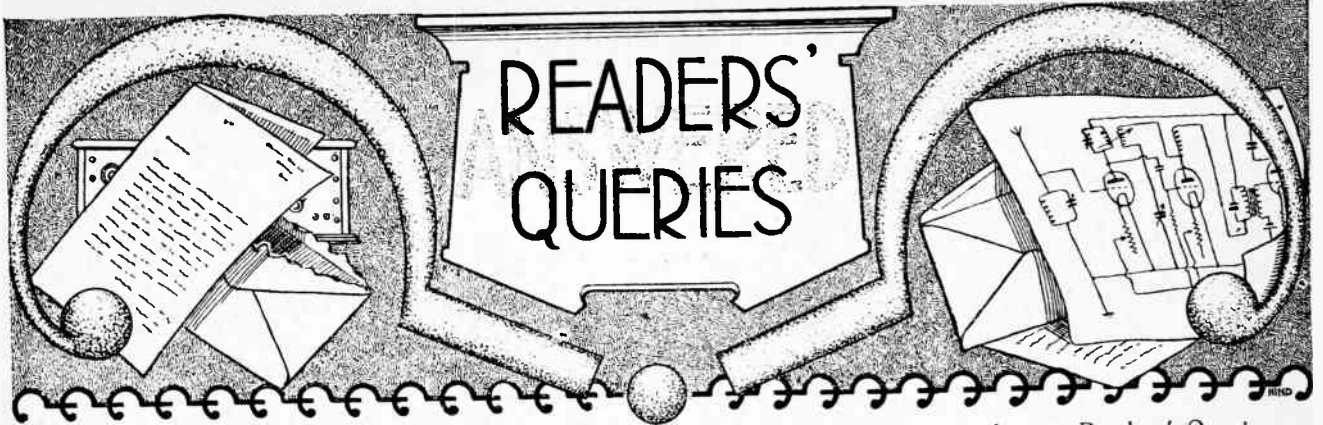

"The Wireless World" Information Department Conducts a Free Service of Replies to Readers' Queries.

Questions should be concisely worded and headed "Information Department." Each separate question must be accompanied by a stamped addressed envelope for postal reply.

**The Roberts Reflex Neurodyne.**

I have been endeavouring to obtain a copy of the issue of "The Wireless World," dated July 1st, 1925, wherein was described the "Roberts Reflex Neurodyne," but am told that this issue is now out of print. Can you therefore give me the circuit of this receiver together with details of coil values, etc.?  
Y. P. F.

The issue of July 1st, 1925, in which full constructional details of this receiver were given, is, as you have been informed, now out of print. This receiver was first described by Dr. B. Van Roberts, in the American magazine *Radio Broadcast* in December, 1924, and was modified in order to be adaptable to the requirements of British listeners by Mr. H. A. Hartley, full constructional details being given by him in the issue to which you refer.

We reproduce in Fig. 1 the theoretical diagram of this receiver. Coil A consists of 40 turns of No. 26 D.S.C. wire wound in the form of a basket coil, windings being taken to a stud switch on the panel, from the 1st, 2nd, 5th, 10th, 20th, 30th and 40th turns. Coils S<sub>1</sub> and S<sub>2</sub> are identical and are wound with 44 turns of No. 26 D.S.C. wire, also in basket coil formation, whilst the reaction coil R has 18 turns of No. 26 D.S.C. With regard to coil P, this should be made by winding 20 turns of No. 26 D.S.C. winding two wires simultaneously, the inside of one winding being connected to the outside of the other winding as shown in the circuit diagram. The winding of this coil considered as a whole, therefore, proceeds from outside to inside and then returns direct to the outside and is wound once more towards the centre. Needless to say, coils A and R are mounted suitably

mfd.: C<sub>1</sub>, 0.001 mfd. It should be noted that in the diagram all moving plates of variable condensers are shown unslid.

It is essential from all points of view that the dual valve be of the low impedance power type, the impedance not exceeding about 10,000 ohms. Considered from the point of view of H.F. only, a medium or high-impedance valve would be difficult to neutralise, and, furthermore, amplification would be poor owing to the limited number of turns on the primary of the H.F. transformer. From the point of view of L.F., of course, any but a power valve will be overloaded and distortion will set in. It is necessary to use a power valve such as the D.E.5, with 120 volts on the anode and 6 volts negative grid bias. The detector may consist of a general purpose valve of the 0.06 amp. class if desired, or a high-impedance valve such as the D.E.3B or the D.E.5B, in which case, of course, the L.F. transformer should be of low ratio.

If you desire to obtain the original article giving full constructional details, your best course is to insert a small advertisement in the miscellaneous advertisements section of this journal, price one penny per word, since there are doubtless many readers who would be willing to dispose of their copy. A large number of amateurs who are desirous of obtaining this copy have been enabled to do so by inserting a small advertisement in this manner.

o o o o

**Calculating Amplification.**

I understand that when using resistance or choke coupling in an L.F. amplifier the whole of the amplification obtained is provided by the valves, and that it is not possible to obtain a greater amplification than the amplification factor of the valve used. Is this correct?  
M.L.L.

Actually, it is impossible with choke or resistance coupling even to equal the amplification factor of the valve unless the value of the resistance or the choke impedance be infinite. By making the

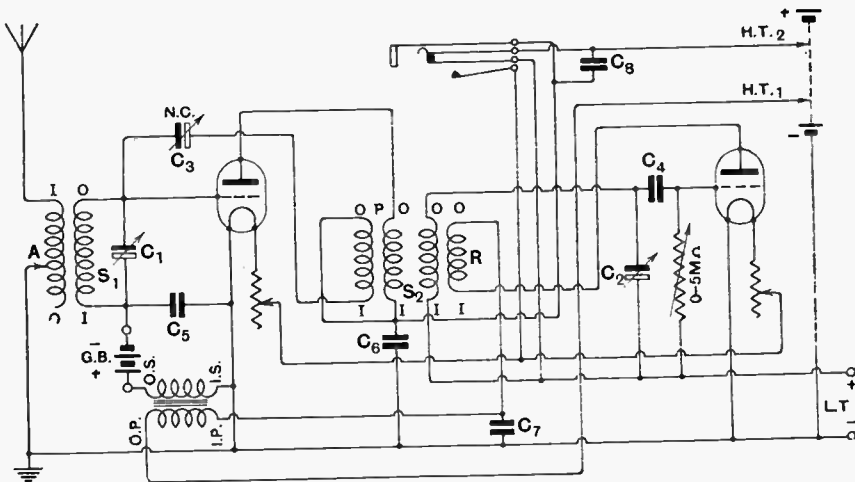

Fig. 1—The Roberts reflex neurodyne circuit.

Subsequent technical information concerning the correct operation of this receiver appeared in subsequent issues of this journal as follows: August 5th, 1925, page 170; August 26th, 1925, page 270; and February 24th, 1926, page 324.

so that their position to their respective adjacent coils can be varied.

With regard to condensers, values are as follow:—C<sub>1</sub> and C<sub>2</sub>, 0.0005 mfd.; C<sub>3</sub>, 0.00005 mfd.; C<sub>4</sub>, 0.00025 mfd.; C<sub>5</sub>, 0.0002 mfd.; C<sub>6</sub>, 0.005 mfd.; C<sub>7</sub>, 0.00025

value of the anode resistance ten times the value of the internal impedance of the valve, or the choke impedance twice the valve impedance, however, it is possible to obtain 90 per cent. of the amplification factor of the valve. Probably in the average amplifier used the amplification obtainable will be between 80 and 90 per cent. in the case of a choke and 60 and 70 per cent. in the case of a resistance. The necessity of using a high value of anode resistance or a choke of high inductance value is clearly indicated. Furthermore, the necessity of using a valve of high amplification factor in either a choke or resistance coupled amplifier is shown. With regard to transformers, it is often incorrectly stated that the amplification obtained is equal to the amplification factor of the valve multiplied by the transformer ratio. This is not strictly true, since the transformer primary must be considered as a choke, and, as we have just seen, with a choke having twice the valve impedance at any given frequency it is only possible to obtain 90 per cent. of the amplification factor of the valve. Now, a transformer primary necessarily contains far fewer turns than does a choke, and therefore it would probably be more correct to say that in the case of the average transformer the amplification obtained is equal to the transformer ratio multiplied by about 60 to 70 per cent. of the valve amplification factor.

o o o o

#### Charging H.T. Accumulators from A.C. Mains.

*I have a 120-volt H.T. accumulator, and am desirous of charging it from my A.C. mains. Would you kindly give me details of a circuit for accomplishing this, it being borne in mind that neither the initial cost nor the running cost must be high. C.L.D.*

One of the best methods of accomplishing this is by means of a step-down transformer and a full-wave valve rectifier, and full constructional details of an instrument of this type were given in our issue dated June 17th, 1925. This instrument, however, is undoubtedly very expensive to build. It becomes, therefore, necessary, in the interests of economy, to use an electrolytic rectifier of some type, this piece of apparatus being more usually known under the name of the Nodon valve. The objection usually made to the Nodon valve is that when used to handle a heavy current of two or three amperes, such as is the case when charging L.T. accumulators, it is apt to be both troublesome and malodorous, and undoubtedly there is some justification for these objections. When used, however, for the charging of H.T. accumulators, or for supplying H.T. direct to a receiver from A.C. mains, where we are dealing in milliamperes instead of in amperes, these objections disappear, and the electrolytic rectifier is constant and reliable in its action and is to be recommended. We recommend, therefore, that you make use of a step-down transformer and an electrolytic rectifier obtaining full-wave rectification

by means of the centre tap on the transformer secondary in accordance with Fig. 2. The details of the step-down transformer will depend on the voltage and periodicity of your mains, and should preferably be purchased from some reliable firm, such as the Zenith Manufacturing Co., to mention one well-known firm who undertake such work for amateurs. If constructed at home however, very great care must be exercised, and you are advised to read thoroughly the articles in our issues dated August 22nd and September 24th, 1924, which were specially devoted to the construction of small power transformers, and in which details will be found for the construction of transformers suitable for any mains voltage or periodicity and for any output load.

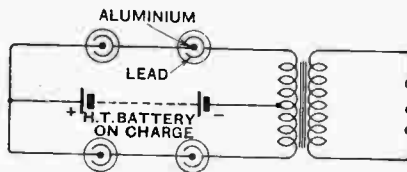

Fig. 2.—Electrolytic rectifier connections for battery charging.

The electrolytic cells also call for great care in construction if they are to be trouble-free, and in our opinion the best course for you to pursue is to obtain a copy of the November, 1925, issue of our companion journal, *Experimental Wireless*, where on page 377 you will find a complete article devoted to the obtaining of both H.T. and L.T. direct from A.C. mains, in which very full details are given for the construction of these components in a reliable manner. Unlike the making of a power transformer, their construction is very simple. The actual apparatus described in this article is for the purpose of supplying the receiver with both H.T. and L.T. direct

from A.C. mains, although, of course, the H.T. portion of it is equally suitable for the charging of H.T. accumulators, except that the smoothing chokes and condensers would not be required.

o o o o

#### An Efficient Four-Valve Receiver.

*I am desirous of constructing a really efficient four-valve receiver, using the best possible components. Two L.F. stages are required, with switching arrangements for eliminating them when desired, and a switching arrangement is also required to eliminate the H.F. valve when not desiring to bring in very distant stations. Sensitivity, selectivity and quality are features which are essential, and, of course, the receiver must be suitable for all wavelengths. I should be glad, therefore, if you will give me constructional details of such a receiver. H.H.F.*

We think that by far the best advice which we could offer is that you should obtain a copy of No. 4 of our *Ezi Wiring* series of books entitled "A Four-valve Combination Receiver," by W. James, which should fully meet your requirements. This book, which may be obtained from us at a cost of 2s. 2d. post free, gives the fullest possible constructional details of a highly efficient four-valve receiver. Sensitivity is assured owing to the use of an H.F. stage and double reaction; selectivity is achieved both by means of a coupled aerial circuit and by optional use of a series condenser in the aerial, whilst quality is achieved by the expedient of choosing transformers the primary impedance of which is compatible with the internal impedance of the valves preceding them. The receiver is adaptable to all wavelengths, and a separate H.T. tapping is provided for each valve, provision being also made for grid bias. It is possible to switch off the L.F. valves as desired.

With regard to the H.F. valve, it is well known that any switching in H.F. circuits is conducive to great inefficiency, and yet it is rather wasteful to use a stage of H.F. when receiving the local station. This difficulty is completely overcome in this receiver by the use of a unique circuit, whereby it is only necessary to turn out the filament of the H.F. valve by means of the rheostat in order completely to eliminate the H.F. stage without the slightest loss of efficiency. Turning on the rheostat of the H.F. valve again immediately brings the H.F. stage into use once more without the slightest trouble.

In this book there will be found complete wiring diagrams, both practical and theoretical, printed in four colours, whilst drilling templates, diagrams of panel and baseboard, and photographs of the receiver in various stages of construction will also be found. Advice is given concerning the choice of components, a full list of the manufacturers of the actual components used by the author being included. Needless to say, details of operating the receiver are given, together with the dial settings for various stations on an average P.M.G. aerial.

### BOOKS FOR THE WIRELESS EXPERIMENTER

Issued in conjunction with "The Wireless World."

"THE AMATEUR'S BOOK OF WIRELESS CIRCUITS," by F. H. HAYNES. Price 3/6 net. By Post, 4/.

"TUNING COILS AND METHODS OF TUNING," by W. JAMES. Price 2/6 net. By Post, 2/10.

"WIRELESS VALVE RECEIVERS AND CIRCUITS IN PRINCIPLE AND PRACTICE," by R. D. BANGAY and N. ASHBRIDGE, B.Sc. Price 2/6 net. By Post, 2/10.

"WIRELESS VALVE TRANSMITTERS—THE DESIGN AND OPERATION OF SMALL POWER APPARATUS," by W. JAMES. Price 9/- net. By Post, 9/6.

"DIRECTION AND POSITION FINDING IN WIRELESS," by R. KEEN, B.Eng. Price 6/- net. By Post, 9/6.

"THE RADIO EXPERIMENTER'S HANDBOOK," Parts 1 & 2, by P. R. COURSEY, B.Sc. Price 3/6 net. By Post, 3/10.

Obtainable by post (remittance with order) from  
**ILIFFE & SONS LIMITED,**  
Dorset House, Tudor St., London, E.C.4,  
or of Booksellers and Bookstalls.

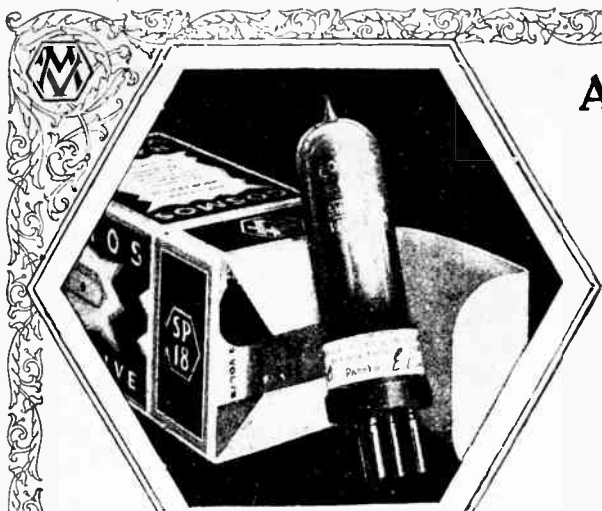

## Another SHORTPATH Valve S.P. 18/B (BLUE SPOT)

This new S.P. 18 Valve supplements the well-known S.P. 18 Red Spot and Green Spot Valves. It is designed especially for use in resistance-capacity coupled sets and for use as a Detector and in H.F. neutrodyne tuned anode stages using 80-120 Volts H.T., so that where this H.T. is employed in the last stage, the difficulty of two H.T. supplies is avoided.

In addition, it gives still more amplification and consumes very little H.T. current.

The S.P./B (Blue Spot) is an excellent valve for anode bend detection.

Designed to work in parallel with the S.P. 18 Red Spot and Green Spot Valves, it operates for a 2-volt accumulator and consumes only 0.09 amp. filament current.

PRICES OF "COSMOS" SHORTPATH S.P. 18 VALVES.

RED SPOT : GREEN SPOT : BLUE SPOT

12/6 : 12/6 : 12/6

**METRO-VICK SUPPLIES, LTD.**

(Proprietors: Metropolitan-Vickers Electrical Co., Ltd.)

METRO-VICK HOUSE, 145, Charing Cross Road, LONDON, W.C.2

"Cosmos" SHORTPATH S.P. 18 Valves are recommended for use as shown below with alternative H.T. values:—

Stage	Coupling	Recommended Valve H.T., 20-80 V., 80-120 V.	
H.F. Amplifier	Tuned Anode (neutrodyne)	Green	Blue
	Tuned Anode (not neutrodyne)	Green	—
	Transformer (tense coupled)	Red	—
Detector (Grid Leak)	Transformer (tight coupled)	Green	—
	L.P. Transformer or Choke	—	Blue
Detector (Anode Bend)	All Couplings	—	Blue
	Resistance Coupling	Green	—
L.F. Stages	L.P. Transformer or Choke	Green	Blue
	Resistance Coupling	Green	Green
Last Stage	All Couplings	Red	Red

# Cosmos

## RADIO VALVES

R  
V39

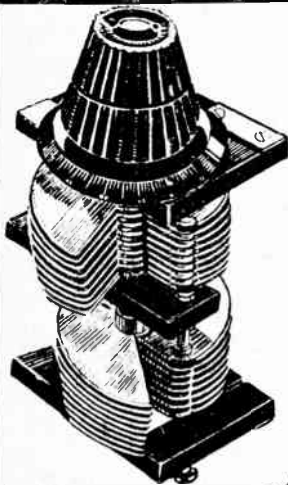

"DEVICON" BRIDGE CONDENSER.  
Autogyres Patent No. 201720/23.

### "DEVICON" TRUE SCALE FRICTION CONDENSER.

Patent Application No. 13990/25.

Has a 2 to 1 movement with additional slow motion device attached. One drilling hole in Panel is all that is required. The very latest improvements in condenser construction.

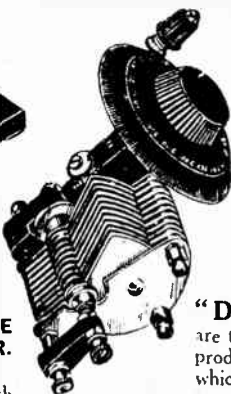

## CHOOSE A "DEVICON" CONDENSER

for YOUR Set

PRICES

including Knob & Dia

7/3 to 25/-

SIZES

from .0002

to .001

"Devicon" Condensers

are the finest tuning Condensers produced. Ask your Dealer which type to use for your set.

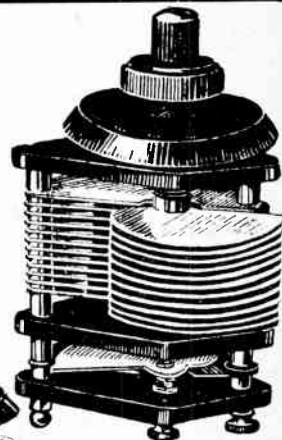
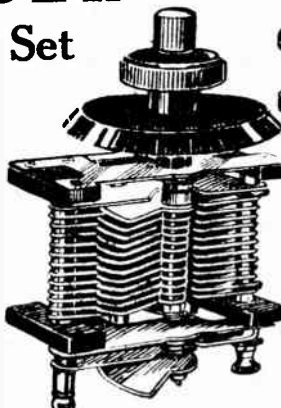

"DEVICON."

Model 2 Type. Square Law. 20 S.W.G. Aluminium Vanes. Bakelite or Ebonite End Plates. Thumb Screw Terminals and Rigid Dome Nuts. The finest material only.

"DEVICON" Low Loss. Sound Rigid Construction. Solid Brass Nickelled End Plates. Negligible losses. Best workmanship. Perfectly free and smooth action. 20 S.W.G. Aluminium Vanes.

Manufactured and fully guaranteed by—  
**THE RADIO DEVICES CO.**  
Newdigate Street, *Telegrams: "DEVICON."* Nottingham.  
*Telephone: 6798.*

**"Japa"** REGD

PLUG & SOCKET TERMINALS ARE THE **FINEST TERMINALS IN THE WORLD FOR ALL WIRELESS CONNECTIONS.**

**BRITISH MADE.**

If your Dealer cannot supply send direct to the Manufacturer through the post.

**W. J. CHARLESWORTH**  
58 & 59, Aston Street, BIRMINGHAM.  
— Established 1897 —

No bits of bent tin of brass, or screwed composition sleeves to make your connection, but a reliable mechanical article which has been copied by many but equalled by none.

Insist upon the genuine article.

**6d. EACH Post free.**

Made in Red, Black, Pale Blue, Green, Royal Blue, Amber, Yellow, Brown.

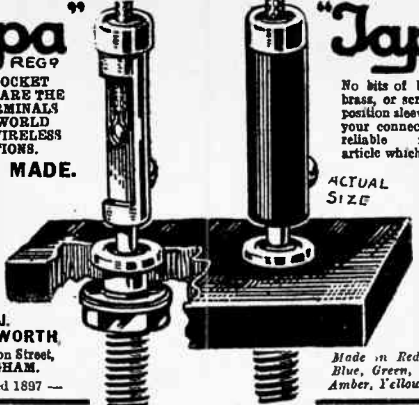

To get pure **EBONITE**, ask for

**BECOL**

Registered Trade Mark.

It is made from finest rubber and sulphur and is guaranteed free from surface leakage.

It proves its quality in every test. Its polish will also please you—ask to see it.

**QUALITY EBONITE**

RODS. TUBES SHEETS, PANELS, MOULDINGS

Ask your dealer for "BECOL"

**THE BRITISH EBONITE CO., Ltd., HANWELL, LONDON, W.**



**"YOU'LL CONVERT YOUR RIGID HOLDERS NOW"**

Fig. 975. Code Word **"WOBBLERS"**  
Per 1/6 Set of 4 (3 black, 1 red)

JUST PLUG THEM IN!

Full Size Illustration.

Fig. 976. Code **"DUAL"** Word **PURPOSE**

DOUBLE ENDED. Price 1/9 each.

**THE FOOL-PROOF HOLDER FOR BASE OR PANEL FITTING OR IN ANY OTHER POSITION.**

The smallest and neatest combined holder on the market. No joints because the soldering tag is the same piece of wire as the spring. Show cards and display cards free.

Full Size Illustration.

Fig. 974. Code **"WOBBLY"** Word.

PRICE .. 2/3 each.

**THE IDEAL EXPERIMENTER'S HOLDER TOO SIMPLE TO IMPROVE**

For the genuine experimenter who must have a holder without capacity, and perfectly sprung, Hunt's "WOBBLY" is ideal. It is impossible to have fewer parts, or to better insulate, separate or spring them. Separately sprung legs are far more effective than a closed-in solid spring top.

Full Size Illustration.

Made under Patent 242057/24, Prov. Pats. 30670/23 and 40/26, by—

**A. H. HUNT, Ltd. (Dept. 12), Croydon, Surrey.**





THE **EMERALD**

**Valve Wave-meter**  
200-600 metres

Designed by Lieut.-Col. K. E. EDGEWORTH, D.S.O., M.C., A.M.I.E.E.  
(Patents applied for.)

The Instrument is being placed on the market with a view to meeting the demand for an accurate and permanent standard of wave-length at a reasonable price. Its special features are:—

- 1.—The wave-length is read directly on the geared dials without the use of calibration charts.
- 2.—The calibration is not affected by moderate changes in high or low tension voltage.
- 3.—The valve can be replaced without affecting the calibration.
- 4.—The accuracy is high: in the present pattern, covering 200-600 metres, the readings are correct within 1 metre.
- 5.—The construction is robust, the condenser bearings are of ample size to provide against wear, and the whole instrument is designed with a view to permanence and accuracy.
- 6.—The instrument is effectively screened, and is free from effects due to stray capacity.

**Price - - £5 17s. 6d.**  
Marconi Licence, 12/6. Osram Dull Emitter Valve, 14/-.

Descriptive Pamphlet on application.

**HEATH & CO.**  
(Agents for the Inventor)

**New Eltham, London, S.E.9.**  
Showroom: No. 2, Tower Royal, Cannon St., E.C. (nr. Cannon St. Stn.)

NOTE.—The following alternative patterns will be available in a few weeks: 20-60 metres, 40-120 metres, 100-300 metres, 400-1,200 metres, 1,000-3,000 metres.



**Netaglass** (TRADE MARK)

**SECURE AGAINST LOSS**

The **"NETAGLASS"**

VALVE HOLDER with resistor template for Panel or Baseboard.

The New Valve Holder with the Glass Base and a dielectric constant of 5 to 7 and fitted with 3-way channel tags.

**PRICE 3/- Post Free.**  
(Entirely British)

**E. A. WOOD** 100 Aston Road - - BIRMINGHAM.  
80 Belgrave Gate - - LEICESTER.  
77 Gallowgate - - GLASGOW.



**PERFEX AERIALS**

**INCREASE SELECTIVITY, VOLUME & RANGE OF RECEPTION & REDUCE INTERFERENCE.**

Claims proved by thousands of Users in many different countries.

**ASK THOSE WHO USE THEM.**

36 inch 75/-, 20 inch 58/6, complete with downlead.  
Masts—16 ft. 20/-, 22 ft. 30/-, Brackets 25/- pair.

Obtainable from all branches of the General Electric Co., Ltd. and the Marconiophone Co., Ltd., and all good Wireless Manufacturers and Dealers.

**WIRELESS APPARATUS LTD.,** 35, Pantons Street, Haymarket, London, S.W.1



# Constructors!

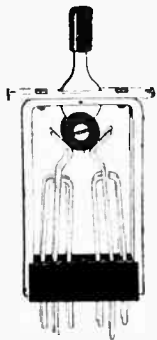

No. 1 T.M.C.  
L.C. Key,  
Price 7/-

## T.M.C. Low Capacity Keys

- combine  
Extreme Low self-capacity.  
A positive locking action.  
Rapid make and break.  
Unvarying performance.  
Adaptability to varied switching requirements.  
Strong and accurate construction.  
Pleasing appearance.

They are designed by Radio engineers. The "Gold-Silver" contacts will not oxidise. The live parts of the key are insulated from the frame. Individual parts are machine made, ensuring accurate construction. Ends of the springs are tinned to facilitate soldering. Escutcheon plates and levers are polished and lacquered brass or bright nickel plate.

Made in Three Models.

- No. 1. 12 point, 3 position .. 7/-
- No. 2. 6 point, 2 position .. 6/-
- No. 3. 24 point, 3 position .. 15/6

Send for a copy of the T.M.C. Catalogue. It is free on request.

If your dealer does not stock T.M.C. Goods we will supply you direct at the above prices, post free.

TELEPHONE MANUFACTURING CO., LTD.,  
Hollingsworth Works,  
WEST DULWICH, LONDON, S.E.21.

Phones: Sydenham 2460/1.

### REDUCTION OF PRICE

Our No. 3 Lightweight Headphone, inclusive of plush-lined case, is reduced to 19/6 as from May 17th.

## Only the perfect Condenser passes the strenuous T.C.C. tests

YOUR fixed condenser is one of the most vital components in your set; yet you buy it on faith. For without an elaborate test you cannot tell whether it is functioning correctly. Experts say that the majority of faults in home-built receivers are traceable to the use of inferior and badly insulated condensers. It is false economy to buy an unknown condenser, for although you save perhaps a few pence in the first place, it eventually becomes much more costly when breakdown occurs. Only by producing Condensers which give absolute satisfaction can T.C.C. hold their good name. When you buy a T.C.C. Condenser you know that you

have chosen a component that because of the strenuous and elaborate tests through which it has passed, can be indefinitely relied upon to be not only breakdown-proof but to have an almost negligible percentage of error. Look through the files of any of the technical Wireless papers and you'll find repeated testimony to the quality of the T.C.C.—its specification in circuit after circuit by experts who know. Can you afford to overlook this Condenser—renowned for its accuracy and dependability—for one of doubtful origin and still more doubtful qualities. Do as the experts do—specify T.C.C.

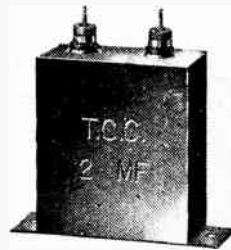
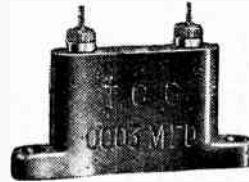

### PRICES AND CAPACITIES.

Mansbridge, 2 mfd. - 4/8	Mansbridge, .1 mfd. - 2/6
Mansbridge, 1 mfd. - 3/10	Mansbridge, .09 to .01 - 2/4
Mansbridge, .5 mfd. - 3/4	Mansbridge, .009 to .005 2/-
Mansbridge, .4 mfd. - 3/2	Mica, .004 to .001 - 2/4
Mansbridge, .25 mfd. - 3/-	Mica, .0009 to .0001 - 2/4



# T.C.C. Condensers (Mica and Mansbridge)

Manufactured only by:  
Telegraph Condenser Co., Ltd.,  
Wales Farm Road, N. Acton, W.3.

G.A.5284

# MISCELLANEOUS ADVERTISEMENTS.

## NOTICES.

**THE CHARGE FOR ADVERTISEMENTS** in these columns is:

12 words or less, 1/- and 1d. for every additional word, e.g., 18 words 1/6; 24 words, 2/- Name and address must be counted.

**SERIES DISCOUNTS** are allowed to Trade Advertisers as follows on orders for consecutive insertions, provided a contract is placed in advance, and in the absence of fresh instructions the entire "copy" is repeated from the previous issue: 13 consecutive insertions, 5%; 26 consecutive, 10%; 52 consecutive, 15%.

**ADVERTISEMENTS** for these columns are accepted up to **FIRST POST ON THURSDAY MORNING** (previous to date of issue) at the Head Offices of "The Wireless World," Dorset House, Tudor Street, London, E.C.4, or on **WEDNESDAY MORNING** at the Branch Offices, 19, Hertford Street, Coventry; Guildhall Buildings, Navigation Street, Birmingham; 199, Deansgate, Manchester.

Advertisements that arrive too late for a particular issue will automatically be inserted in the following issue unless accompanied by instructions to the contrary. All advertisements in this section must be strictly prepaid.

Postal Orders and Cheques sent in payment for advertisements should be made payable to **ILIFFE & SONS Ltd., and crossed & Co. Treasury Notes, being untraceable if lost in transit, should not be sent as remittances.**

All letters relating to advertisements should quote the number which is printed at the end of each advertisement, and the date of the issue in which it appeared.

The proprietors are not responsible for clerical or printers' errors, although every care is taken to avoid mistakes.

## NUMBERED ADDRESSES.

For the convenience of advertisers, letters may be addressed to numbers at "The Wireless World" Office. When this is desired, the sum of 6d. to defray the cost of registration and to cover postage on replies must be added to the advertisement charge, which must include the words Box 000, c/o "The Wireless World." Only the number will appear in the advertisement. All replies should be addressed No. 000, c/o "The Wireless World," Dorset House, Tudor Street, London, E.C.4. Readers who reply to Box No. advertisements are warned against sending remittance through the post except in registered envelopes; in all such cases the use of the Deposit System is recommended, and the envelope should be clearly marked "Deposit Department."

## DEPOSIT SYSTEM.

Readers who hesitate to send money to unknown persons may deal in perfect safety by availing themselves of our Deposit System. If the money be deposited with "The Wireless World," both parties are advised of its receipt.

The time allowed for decision is three days, during which time, if the buyer decides not to retain the goods, they must be returned to the sender. If a sale is effected we remit the amount to the seller, but, if not, we return the amount to the depositor. Carriage is paid by the buyer, but in the event of no sale, and subject to there being no different arrangement between buyer and seller, each pays carriage one way. The seller takes the risk of loss or damage in transit, for which we take no responsibility. For all transactions up to £10, a deposit fee of 1/- is charged; on transactions over £10 and under £50, the fee is 2/6; over £50, 5/-. All deposit matters are dealt with at Dorset House, Tudor Street, London, E.C.4, and cheques and money orders should be made payable to Iliffe & Sons Limited.

## THE SALE OF HOME-CONSTRUCTED UNLICENSED APPARATUS.

### A New Service to our Readers.

We have made an arrangement with the Patentees whereby readers who wish to dispose of a home-constructed receiver not licensed under the patents made use of, can do so by means of the Deposit System referred to above.

The person desiring to sell, in sending us particulars for his advertisement, will in every case make use of a Box No., and should add to the price which he requires the amount of royalty customarily paid by manufacturers, viz. in the case of Marconi Patents the amount should be calculated at 12/6 per valve holder.

If the purchaser is satisfied with his purchase, the sum realised will be forwarded to the seller, less the amount due in respect of royalties, which amount will be paid by "The Wireless World" to the owners of the patents concerned, and a certificate will be handed on to the purchaser of the set.

## FOR SALE.

**WOOD** Horns for all speakers and gramophone attachments. There's one for Amplion Junior, ditto goose-neck bases, Lisenola, etc. There's only one best; it's the "Allwoodorn."—Manufacturer: H. Maddison, 2A, Ronald's Road, Highbury, N.5. List free. (1914)

Mention of "The Wireless World," when writing to advertisers, will ensure prompt attention.

## For Sale.—Contd.

**O**SCILLATING Zincite and Contact, 2s. 6d.; simple, original circuit, 1s.; excellent results; other parts stocked.—Ledsham's, 297, King Street, Hammersmith. (1888)

**J**ACOBEAN Oak Wireless Cabinets, direct from makers, 55s. Packed free. Carriage paid. Send for illustration, etc.—Wm. Nurse, Union Street Cabinet-Works, King's Lynn. (2069)

**C**OMPONENTS for the Enthusiast.—For short wave, superheterodyne, neutrodyne, and standard circuits: "Standardize on GR Parts Throughout," made by General Radio Company of America. Insist on "GR" trade mark; look for the red cartons. Low Loss Condensers (29 styles); Wavemeter and Filter (cuts out "locals," direct reading, accurate to 1 per cent.); Superheterodyne "Matched" Transformers; Noiseless Rheostats, Potentiometers; Variocouplers; Variometers; Chokes; Transformers; Ammeters and Milliammeters; Laboratory and Experimental Apparatus, etc. Send for complete list (post free) and for interesting booklets "Truth About Variable Condensers," "Stop Interference," "True Mirrors of Tone Quality," "Low Loss Coils." In use world over. Cash iron guarantee. Reasonable prices, immediate despatch.—Sole English Concessionaires, Claude Lyons, Dept. "E," 76, Oldhall Street, Liverpool. London Stockists, Hamleys, 200, Regent Street. (2090)

**60-VOLT** Wet Cell High Tension Batteries, genuine Leclanché; 21s.; trade supplied, lists free.—Tennants, Hylton Road, Sunderland. (2092)

**K**ONE amplifier with valves and loud-speaker. Nearly new, £13. Old type Celestion 30s., Primax £3.—Col. Bayldon, Beaulieu, Hants. (2086)

**H**.T. from A.C. Mains.—Our rectifiers are suitable for all valve sets (2-8 valves). 120 volt D.C. output free from hum.—Price complete £3 10s., or with 45 volt tap for H.F. and Det. valve £3 15s. plus Marconi royalty, 12s. 6d.—Davy, 80, Essendine Mans., Maida Vale, London, W.9. (2104)

**PLATE-GLASS** Panels, 3/4 in. thick, 16 in. x 8 in., drilled five 3/16 in. holes in suitable positions for condensers and resistances. 7s. each. Any size or drilling supplied; also wireless components.—Stratton, 63, Barn Lane, King's Heath, Birmingham. (2105)

**NEW C.A.V.** Junior Loud-speaker. Cost £45s., take half.—Spencer, Botolph's Corner, Sevenoaks. (2106)

**F**ELLOWES Two-valve Set, two Dutch .06 valves. 65s.—Goodacre, Gosberton, Rise-gate, Spalding. (2107)

**P**RACTICALLY new and unused. Two D.E.T. 1 valves, £3 10s. each. Two U 3 Rectifiers, 19s. each. QX and V 24, 14s. each. One 4 MF Condenser, 1,500 volts, 17s. 6d. One 1 M.F. ditto, 12s. 6d. 2-0-50 Milliammeters, £1 each. All post free C.O.D.—Box 8109, WIRELESS WORLD OFFICE. (2110)

**1** HIGH-GRADE Micro Ammeter by Tinsley Instrument Co. 1 200-watt Newton Alternator.—Box 8108, WIRELESS WORLD OFFICE. (2111)

**R**ADIO Record D.E. Valves, 3 volt .06 amp, 6s. 6d. Power valve, 3-4 volt, .1 amp., 10s. Four electrode, 3 volt, .06 amp., 10s. All valves guaranteed. Post free.—E. Makin, 6, Bourne Road, Stoke, Coventry. (2112)

## For Sale.—Contd.

**7-VALVE** "Polar Radio-phone," 3 H.F. Det. and 3 L.F. in polished sloping cabinet, £9 10s. 4-Valve as above, 1 Det. and 3 L.F., £5 10s. 2-Valve Elwell Aristophone Set, 300-3,000 metres, £6. All new goods.—218, Upper Thames Street, E.C.4. (2114)

**M**CMICHAEL Supersonic Heterodyne out-fit, perfect condition, £2 10s.; H.F. transformer, R.I. tapped reactance; also DEV, DEQ, DE3B valves, quite new, at half list price.—Dunn, 36, Flower Street, Northwich, Cheshire. (2115)

**T**WO-VALVE Loud-speaker Receiver with automatic switching, built with best components, £6 5s., including royalties. Three-valve £7 17s. 6d. L.F. transformers from 11s. 6d. Anti-Microphonic Valve Holders, 2s. 3d. each. All components stocked; lists on application. Trade supplied.—G. Small, 161, Greenway Road, Taunton, Somerset. (2116)

**F**OR SALE.—4-Valve Set, in mahogany cabinet, with D.F. valves (H.F. Det., 2-power), tuning 175 to 4,000 metres, complete with accumulator, H.T., and Ethovox loud-speaker. £17 or offer, in perfect condition.—J. Dipper, 81, Frederick Street, South Shields. (2117)

**"EXCELOPHONE"** (Sloping cabinet) 2-valve receiver, with valves and phones. Original cost £20; accept £9.—Box No. 8113, WIRELESS WORLD Office. (2118)

**E**XPERIMENTER'S CLEARANCE.—For Sale, one 2-valve H.F. Det., six Marconi V.24 type valves, one Marconi Q type, two Marconi R.5v. type, very little used, equal to new; offers whole or singly.—10, Sowe Lane, Binky, Coventry. (2121)

**M**OTOR GENERATOR SETS.—Two complete with gear. Motor 400v. A.C., generator 60v. 70 amp., 1,680 r.p.m., and motor 200/400 v. A.C., generator 60/70v., 60 amp., 1,450 r.p.m. Inspected S.W., London.—Box 8117, WIRELESS WORLD OFFICE. (2120)

**F**OUR-VALVE Set (H.F., D., 2 L.F.) All stations received; hear any evening. Genuine bargain. £5.—2, Dollis Hill Avenue, Cricklewood. (2108)

**A**MATEUR has high-class components for disposal, including Marconiphone two-valve speech amplifier. List on application.—Farley, Midhurst. (2122)

## MISCELLANEOUS.

**A** WIRELESS Doctor.—If your set is giving trouble or you want advice a competent expert will call (anywhere in Greater London) and put you right. No result, no charge.—Alexander Black, 2A, Woodville Grove, N.16. Clissold 3687. (2002)

**L**OOK!—Why use H.T. Batteries if you have electric light in your homes? Make your own H.T. unit from A.C. or D.C.—Full particulars and diagram of either sent for 1s.: Camberwell Electric Coil Winding Co., 35, Edmund Street, S.E.5. (2125)

**A**DVERTISER, establishing Motor and General Engineering Business, large West of England centre, invites catalogues and terms from manufacturers of wireless accessories.—Replies to Box 8083, WIRELESS WORLD Office. (2109)



Miscellaneous.—Contd.

**CHARGE Your Own Accumulator.**—Send 3d. stamp to-day for lists of our small gas and petrol engines and dynamos, and complete charging sets, from 20 to 160 watts.—Tom Senior, Cleckheaton, Yorks. (0013)

**SELECTED Natural Galena,** finest for distant reception, 1s. 6d. oz. Send 6d. p.o. for sample crystal and graphite catwhisker. Accessories list post free.—Radio Supplies, 51, Eden Street, Kingston-on-Thames. (2123)

PATENT AGENTS.

**PATENTS and Trade Marks Obtained.**—H. T. P. Gee, Patent Agent, Member R.S.G.B., A.M.I.R.E., 51-52, Chancery Lane, London, W.C.2. Phone: Holborn 1525. (0001)

**W. BRYSON, B.Sc.,** Chartered Patent Agent, 29, Southampton Buildings, W.C.2. Phone: Holborn 672. (2052)

REPAIRS.

**TRANSFORMERS** rewound to guaranteed efficiency for 12 months, 4s., or exchanged for another, any ratio, 5s.; iron core wire-wound chokes for L.F. amplifiers, 6s.—115, Links Road, Tooting. (0011)

WANTED.

**1,000-2000 v. D.C. generator,** about 150 watts: Transmitting Gear; Supersonic components.—Pryce Williams, Antelope Mine, Bulawayo, Rhodesia. (2113)

SITUATION VACANT.

**WANTED.**—Partner with capital. Wireless and electrical established business, Woodford. Capable repairing, making sets. Good opportunity.—Particulars, A. L., 138, Thorold Road, Ilford, Essex. (2124)

SITUATION WANTED.

**ADVERTISER,** aged 30, eight years technical, four years commercial wireless experience; first-class P.M.G. certificate; desires post reputable firm.—Box 818, WIRELESS WORLD Office. (2119)

The Home Constructor's Wireless Guide

by W. JAMES

THIS book forms a most convenient little encyclopedia of wireless technology: the kind of volume to refer to when in difficulties. It solves them for you.

A few of the main features: Outdoor, Indoor and Frame Aerials; Earths, Variometers for Broadcast Wavelengths; Basket Coils, Plug-in Coils, etc.; Coupled Circuits; Common Faults in Tuners; Reaction and Self-Oscillation; Special Chapter on Sensitive Single-Valve Receivers; Double Magnification; Points on Dry Cells and Accumulators, etc., etc.

PRICE 3/6 NETT.

By post, 3/10.

Obtainable from Booksellers, or direct from the Publishers of "The Wireless World,"

ILIFFE & SONS LTD., Dorset House, Tudor Street, London, E.C.4.

w.w.10

PUBLIC NOTICE.

CIVIL SERVICE (AIR MINISTRY). DESIGNERS' AND DRAUGHTSMEN'S COMPETITION.

A COMPETITION by interview will shortly be held for posts (pensionable under Civil Service conditions) for engineering designers and draughtsmen in the Air Ministry or at the Royal Aircraft Establishment, Farnborough, for work on aircraft design and calculations; aero engines, design and calculation; perspective sketches for reproduction; wireless and other accessories; ground equipment and general works machinery and plant. The scales of salary of the posts are:—

Designers, £250-15-£350 a year, plus Civil Service Bonus.

Draughtsmen, Grade I, £160-10-£200 a year, plus Civil Service Bonus.

Draughtsmen, Grade II, £125-7½-£150 a year, plus Civil Service Bonus.

The competition will be open to (a) designers and draughtsmen serving at the Air Ministry or at the Royal Aircraft Establishment, and (b) other engineering designers and draughtsmen who have either served in H.M. Forces or served at sea and been awarded the British War Medal or the Mercantile Marine War Medal.

Candidates must have attained the age of 24 and (unless they are serving under the Air Ministry) must not have attained the age of 45 on 1st January, 1926. Regulations and form of application may be obtained from the Secretary, Air Ministry, S.2 (Room 464), Adastral House, Kingsway, W.C.2, by whom the completed form of application must be received on or before 19th June, 1926.

Finston SUPER COILS



Totally enclosed in moulded Bakelite cases giving mechanical strength without impairing their efficiency.

The centres of coils are always in alignment when two or more are used, thereby getting maximum results from their magnetic field. All connections are soldered.

A loose plug is provided enabling winding of coils to be reversed.

PRICES: 25, 35, 40: 2/6 each. 50, 60: 3/- each. 75, 100, 150, 3/6 each. 175, 200: 4/- each. 250, 300: 4/6 each.

FINSTON MFG. CO., LTD., 45, Horseferry Road, Westminster, London, S.W.1.

Parr's Ad.

2-Volt Power Valve 12/6

This is a REAL power valve—British Made—Radion Guaranteed—and far less money than other leading makes. From untied dealers or direct.



RADION'S save you money but beware of imitations. Write for free book. RADIONS Ltd. — Bolling-on-Nr. Macclesfield, CHESHIRE

HANDBOOKS

There is a handbook for every phase of Wireless. Send a post card for the complete list of books published in conjunction with

"THE WIRELESS WORLD" Dorset House, Tudor St., London, E.C.4.

w.w.23

H.T. Accumulators 37/6

60 Volts. 3 Actual Amp.-hour



The finest H.T. Accumulator in the world.

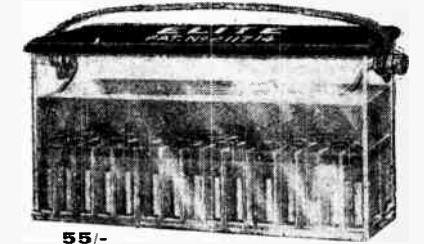

55/-

60-volt, 3-amp.-hour, oil submerged. Will last a lifetime. Write for descriptive Folder.

SOLD ON APPROVAL SYSTEM. Obtainable only from

ACCUMULATORS ELITE, 31, Waterhouse St., Halifax. Trade Supplied. Telephone: 1304.

Or from Messrs. CECIL POHLMAN, LTD., 77, Great Portland Street, London, W.1.

YOU CAN TAKE IT FROM ME!



That our Summer Catalogue contains the finest Radio Bargains ever offered. 600 Illustrations of a wonderful selection of unique apparatus.

Send 4d. stamps. ELECTRADIX RADIOS,

118, Upper Thames St. London, E.C.3.

Parr's Ad.

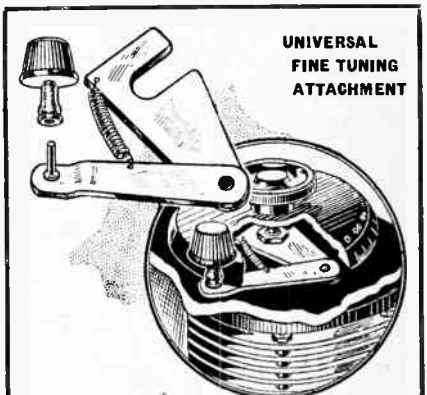

UNIVERSAL FINE TUNING ATTACHMENT

ALL Stations obtained by fine tuning for the cost of 2/-, will attach to any Set, and with a three inch dial gives a reduction of 20 to 1.

Post Free 2/- from the manufacturers.

"Imperial Condensers"

(Agencies Vacant in Certain Districts)

WOODING & CO.,

105, The Wells Road, NOTTINGHAM.

# The Wireless World

AND RADIO REVIEW

## INDEX TO ADVERTISEMENTS.

Accumulators Elite	11
Autoveyors, Ltd.	11
Belling & Lee, Ltd.	11
Blackadda Radio Co., Ltd.	11
Brandes, Ltd.	11
Browood, Ltd.	11
Britannia Rubber & Kamptulicon Co., Ltd.	11
British Ebonite Co., Ltd.	8
British L.M. Ericsson Mfg. Co., Ltd.	12
Bulgin, A. E., & Co.	12
Burndept Wireless, Ltd.	Cover ii.
Caxton Wood Turnery Co.	Cover ii.
Charlesworth, W. J.	5
Cleartron Radio, Ltd.	6
Cosser, A. C., Ltd.	6
Darimont Electric Batteries, Ltd.	2
Dixon, Leslie, & Co.	11
Dubilier Condenser Co. (1925), Ltd.	5

Edison Swan Electric Co., Ltd.	11
Ferranti, Ltd.	11
Finston Manf. Co., Ltd.	11
Graham, Alfred, & Co.	11
Hamley Bros., Ltd.	8
Heath & Co.	8
Hildick & Hildick	12
Hunt, A. H., Ltd.	12
Igranie Electric Co., Ltd.	Cover iv.
Jones & Stewart	12
L.G. Russell Laboratories	12
Lisenin Wireless Co.	Cover ii.
London Elec. Wire Co. & Smiths, Ltd.	Cover ii.
Lustrolux, Ltd.	12
Marconiphone Co., Ltd., The	1
Metro-Vick Supplies, Ltd.	7
Midland Radiotelephone Manfs., Ltd.	2
Moorhouse & Co.	11

"Ormond" Engineering Co., Ltd.	5
Pugh's Wireless	11
Radio Accessories, Ltd.	7
Radio Devices Co.	11
Radio Instruments, Ltd.	11
Radiations, Ltd.	Cover ii.
Rectallory, Ltd.	Cover ii.
Rothermel Radio Corpn. of Gt. Britain, Ltd.	Cover ii.
Sankay, Joseph, & Son, Ltd.	12
Sifam Electrical Inst. Co.	12
Taylor, J. H., & Co.	9
Telegraph Condenser Co., Ltd.	9
Telephone Manf. Co., Ltd.	9
Varley Magnet Co.	1
Watmel Wireless Co., Ltd., The	8
Wireless Apparatus, Ltd.	8
Wood, E. A.	8
Wooding & Co.	11

reproduction  
—volume  
—clarity

You get all these in Ericsson Super Tone Loud-speakers

Made by a firm with a generation's experience in telephone research. No distortion. No rattle—just crystal-clear reproduction.

Put one to follow your set power valve and you'll be amazed.

18" high on wood base. Very melow and pure. 2400 ohms. 63/- Junior Super Tons for small rooms, 32/6.

Write for lists

The BRITISH L.M. ERICSSON Mfg. Co., Ltd. 67/78, Kingsway, London, W.C.2.



**Ericsson**  
SUPER TONE LOUD SPEAKERS

All Post Free & At Callers Prices

<b>IZION HAND DRILL</b> 		<b>Wireless Cabinets</b> 	
TAKES DRILLS UP TO 5/16 in. <b>3/6</b> SIX DRILLS - 1/-		For Panels 7" high. Width 8". Hinged Lid. Oak 12", 18.6", 14", 19", 18", 20", Mahogany 1" extra.	
<b>Square Law Var. Condenser</b> With Knob and Dial 18 1/11 3/5 9" x 6" 2/2 1/10 .001 Panel type 6/6 20 2/2 4/2 12" x 9" 4/6 3/9 .0003 5/- 22 2/6 4/7 12" x 12" 5/9 6/- .0003 4/6 24 2/11 5/- 12" x 9" 5/6 4/9 Vernier Blade extra 25 3/4 5/9 15" x 13" 7/8 5/8 Dubilier, McMichael, 28 3/4 6/6 4" x 4" 8d. 6d. Edison-Bell, Lisenin, 30 4/10 7/6 7" x 6" 1/6 1/2 Millard (usual prices) 32 5/6 8/9 6" x 6" x 4" 10d. New Mansbridge, 34 8/- 12/- Any size cut. 2 mfd. 3/8, 1 mfd. 2/6 4/9 17/- 20/- Sq. in. 4", id., 4", id.		<b>Ebonite Panels</b> Matt. 4" 3/18" 9" x 6" 2/2 1/10 12" x 9" 4/6 3/9 12" x 12" 5/9 6/- 12" x 9" 5/6 4/9 15" x 13" 7/8 5/8 4" x 4" 8d. 6d. 7" x 6" 1/6 1/2 6" x 6" x 4" 10d. Any size cut. Sq. in. 4", id., 4", id.	
<b>Ton Holders.</b> Reliability Vernier 3/6 "Lotus" 2-way 7/- "Newey" 2-way 6/6 "L. & P." 2-way 8/6 "Polar" 2-way Can vernier 6/- Goldtone Vernier 7/- Back of Panel 6/-		<b>Transformers L.F.</b> Radiolust. 25/-, 27/6 Igranie 21/- and 20/- Eureka, No. 2 21/- "Uncert'nd 25/- Baby Grand 15/- Ferranti A.F.4 17/8 A.F.3. 25/- H.T.C. (Empire) 7/6 "Formic" Spr'd 10/- McMichael H.F.10. "Dimic" Coil 10/-	
<b>Aerial Wire 7/22s</b> Enam. Bright 4 strd. 100ft., 3/3, 2/3. 1/1 Ro. Electron 1/8 Shell Insulators, 8d. Lead-in Tube 9in. 1/-		<b>Valve Holders.</b> Type A 7d. Polar 1/3 Screwed 8 nuts 6d Ebonite 1/6 Antiphonic 1/6 Security Type 1/- Sullivan's 120-ohm Phones, ex-Govt. 3/6	
<b>RELIABILITY WIRELESS GUIDE, No. 2.</b> Free on request		<b>SPECIAL VALUES.</b> Wates Microcatal 2/9 R.L. Detector 6/- Liberty Detector 8/6 Lissenoin Unit 13/6 Antiphonic Valve-holder 1/6 H.T. Batteries. With Wander Plugs 90v., 11v., 60v., 7/8 36v., 4/8, 15v., 1/10 44v., F.L.B. 4/7 4d. 60v., Ev'r-dy 12/6 36v., 7v., 16v., 3/6 Siemens same price. Lisenin 47v. 11/6 Orders 5/6 value, carriage paid. Under 5/6, 2d. per 1/- for packing.	

# LISENIN

POSITIVE GRIP PLUGS & SOCKETS

Pat. No. 245586.



THERE can be few amateurs who have not been troubled with broken leads, or said hard things about faulty connections. Of the whole set there is probably no part which is so often abused as the connections. "Lisenin" Positive Grip Plugs & Sockets solve this evil. They are designed to take the smallest flex up to 5 m/m cable. Sleeves and indication discs red and black. N. Plated.

**PRICE 6D.**

Plug and socket complete, or Spade End Terminal. Obtainable of all dealers. Liberal Trade Discount.

Sole Manufacturers and Patentees:—  
THE LISENIN WIRELESS CO.,  
1d, Edgware Road, London, W.2.

Phone: Iaddington 2734.  
Tel. Address: "Posgrip, Padd., London."

Plug and Socket or Spade End, 6d. each.

## WIRELESS MASTS.

GALVANIZED TUBULAR TELESCOPIC.

Complete with base plate, ground pegs, stay wires, straining screws, pulley and cleat.  
34ft. High £3 15 0 50ft. High £7 5 0  
HILDICK & HILDICK, Pleck Road, Walsall.

**LUSTROLOX**  
WIRELESS VALVES.  
THE ECONOMICAL COMBINATION  
2v. '06 H.F. & L.F. 9/- 2v. 34P.V. 11/-  
Obtainable from Lewis's Ltd., Liverpool and Manchester, and  
**LUSTROLOX LTD.**  
West Bollington, Near Macclesfield.

**J.H. TAYLOR & CO.**  
2 RADIO HOUSE,  
MACAULAY ST., HUDDERSFIELD.  
Tel. 3-91 Grams: THOROUGH HUDDERSFIELD.

## The BEST BOOKS on WIRELESS

The range of books published from the offices of "The Wireless World" covers every conceivable phase of wireless. Below are given a few selected titles. A complete list will be sent on request.

- "The Thermionic Valve and Its Development in Radio Telegraphy and Telephony": by J. A. FLEMING, M.A., D.Sc., F.R.S. Price 15/- net. By Post 15/9.
- "Continuous Wave Wireless Telegraphy—Part 1": by W. H. ECCLES, D.Sc., A.R.C.S., M.I.E.E. Price 25/- net. By Post 25/9.
- "Direction and Position Finding in Wireless": by R. KEEN, B.Eng., A.M.I.E.E. Price 9/- net. By Post 9/6.

- "Thermionic Tubes in Radio-Telegraphy and Telephony": by JOHN SCOTT-TAGGART, F.Inst.P., A.M.I.E.E. Price 15/- net. By Post 15/9.
- "Wireless Valve Transmitters": by W. JAMES. Price 9/- net. By Post 9/6.
- "Calculation and Measurement of Inductance and Capacity": by W. H. NOTTAGE, B.Sc. Price 7/6 net. By Post 8/-.
- "Wireless Telegraphy and Telephony": by H. M. DOWSETT, M.I.E.E. Price 9/- net. By Post 9/6.
- "Telephony without Wires": by R. A. COURSEY, B.Sc., F.Inst.P. Price 15/- net. By Post 15/6.

Obtainable from all booksellers or direct from the publishers:  
**LIFFE & SONS LTD., Dorset House, Tudor Street, London, E.C.4.**

w.w.1

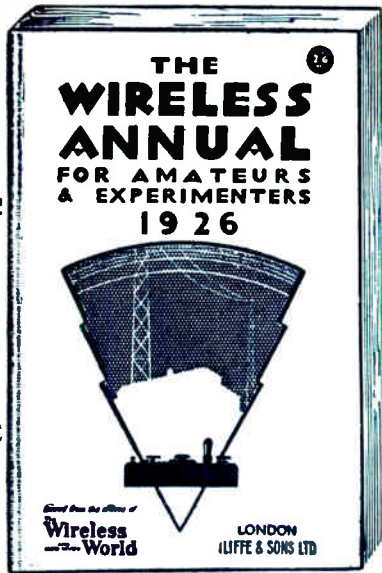

w.w.8b

PRICE NET  
2/6

BY POST  
2/8½

**Y**OU will find that "The WIRELESS ANNUAL" is a real help to you in your wireless work. It contains a mass of valuable information. Get your copy to-day!

Obtainable from all booksellers or direct from:

"The Wireless World," Dorset House, Tudor Street, London, E.C.4.

## "More than pleasing!"

*A recent advertiser writes as follows :*

"HAVING recently sold my Burndept Ethophone Grand Receiver through the medium of your advertisement columns, I was surprised at the number of replies thereto.

I may mention that my set was sold to a provincial gentleman within four hours of the publication of "The Wireless World," following exchange of telegrams. I think this is more than pleasing."

A. J. NEILL,  
"Dalmeny,"  
Woodberry Grove,  
North Finchley,  
London, N.12.

The Miscellaneous Advertisement columns of "The Wireless World" are the best market place for the purchase and disposal of all wireless sets, components and accessories

# A Service that gives Security!

**M**ANY readers naturally hesitate to send money to unknown persons. We have therefore adopted a Deposit System which gives complete security both to buyer and seller. If the money be deposited with "The Wireless World" both parties are advised of its receipt. The time allowed for decision is three days, after which time, if the buyer decides not to retain the goods, they must be returned to the sender. If

a sale is effected we remit the amount to the seller; but, if not, we return it to the depositor. Full particulars may be found on the Miscellaneous advertisement page at the end of the book. Use this service for your wireless requirements and avoid all risk! Sell the apparatus you no longer require! Write out your advertisement to-day and send to—

PREPAID ADVT. DEPT., "THE WIRELESS WORLD," DORSET HOUSE, TUDOR ST., LONDON, E.C.4.

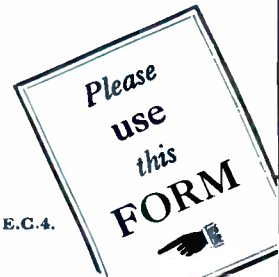

**12**  
Words  
or  
Less  
**1/-**

each  
addi-  
tional  
word  
**1d.**

Advertiser's name and address must be counted. If a box number is required 6d. extra must be sent for postage on replies.

w.w.39

Advertisements for "The Wireless World" are only accepted from firms we believe to be thoroughly reliable.

# You need these IGRANIC RADIO DEVICES—NOW!

Perhaps you have already felt the need for making certain changes in your receiver. Those distant stations which came in easily during the winter months cannot now be found. It is necessary for you to ensure that the components in your receiver are of the highest efficiency, and possibly the addition of a stage of H.F. amplification will help you to maintain the good all-round reception which is now so difficult to achieve. With the coming of summer, it is more than ever necessary to guard against lightning by fitting an efficient

earthing switch. Then, there is the need for a portable set so that you may gain the fullest pleasure from days in the open-air combined with the joys of radio music.

Igranic Radio Devices will enable you to fill the foregoing needs—and many others—with perfect satisfaction.

Here are a few of the most interesting Igranic and Igranic-Pacnet components—your dealer will show you the complete range.

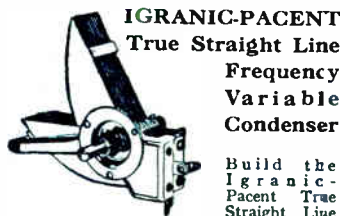

**IGRANIC-PACNET True Straight Line Frequency Variable Condenser**

Build the Igranic-Pacnet True Straight Line Frequency Variable Condenser into your receiver, and you may feel confident that the energy in your aerial is being utilised to the best possible advantage, thus ensuring maximum signal strength.

Further, the perfect ease of tuning afforded by the even distribution of stations over your condenser dial will make reception a real pleasure. Price: .00035 mfd., 14/6; .0005 mfd., 18/6.



**IGRANIC High-Frequency Transformers**

Fit these Transformers and be sure that your H.F. amplifier is operating at maximum efficiency. They incorporate the well-known honeycomb duolateral form of winding, and possess electrical features which are conducive to highly satisfactory results. They will enable your set to "reach out" for those distant stations which are now becoming so difficult to receive. Fitted with standard 4-pin mounting and made in four sizes covering wavelengths from 288 to 3,200 metres when tuned by .0005 mfd. condenser. Prices, 8/- to 12/6.



**"XLLOS" (Extra Low Loss) COILS**

The new Igranic Coils with real low-loss features. Equally suitable for indoor or outdoor use, because the windings are protected by attractive Bakelite covers, which protect them from the harmful effects of dust and damp. Low-capacity mounting, with variable spacing of pin and socket, six sizes—220 to 1,000 metres aerial tuning. Prices 5/- to 7/-.



**IGRANIC Combined Earthing Switch, Lightning Arrester and Lead-in Tube**

A highly efficient "lead-in" device, affording perfect protection against lightning and static discharges, and simplifying connections. The ebonite lead-in tube is 10in. long, and all metal parts are heavily nickel plated. Price 6/6.



**IGRANIC-PACNET Jacks and Plugs**

A few yards of flex and the appropriate Igranic-Pacnet Jacks and Plugs will enable you to place the loud-speaker, or any number of 'phones wherever required in the house or garden. There are 10 types of Jacks and various Plugs and Adapters with which you can arrange any combination of connections according to the needs of the moment. They are all robust in construction and reliable in action, and are fully guaranteed. Prices 1/6 to 6/6.



**IGRANIC-PACNET Porcelain Rheostats**

The Igranic-Pacnet Rheostat affords extremely satisfactory control for any type of valve. Its robust construction and dependability enable it to stand up to hard wear, while its small size renders it very suitable for use in portable sets. Resistances of 6, 10, 20, 30 and 50 ohms are available at the reasonable price of 2/6 each.

All reputable dealers stock them

Write for List U.170.

Exclusive Manufacturing Licensees of



Pacnet Radio Essentials

149, QUEEN VICTORIA ST.,

LONDON. WORKS: BEDFORD

4<sup>D</sup>

# The Wireless World

AND  
RADIO REVIEW

*The Paper for Every Wireless Amateur*

Wednesday, June 16th, 1926.

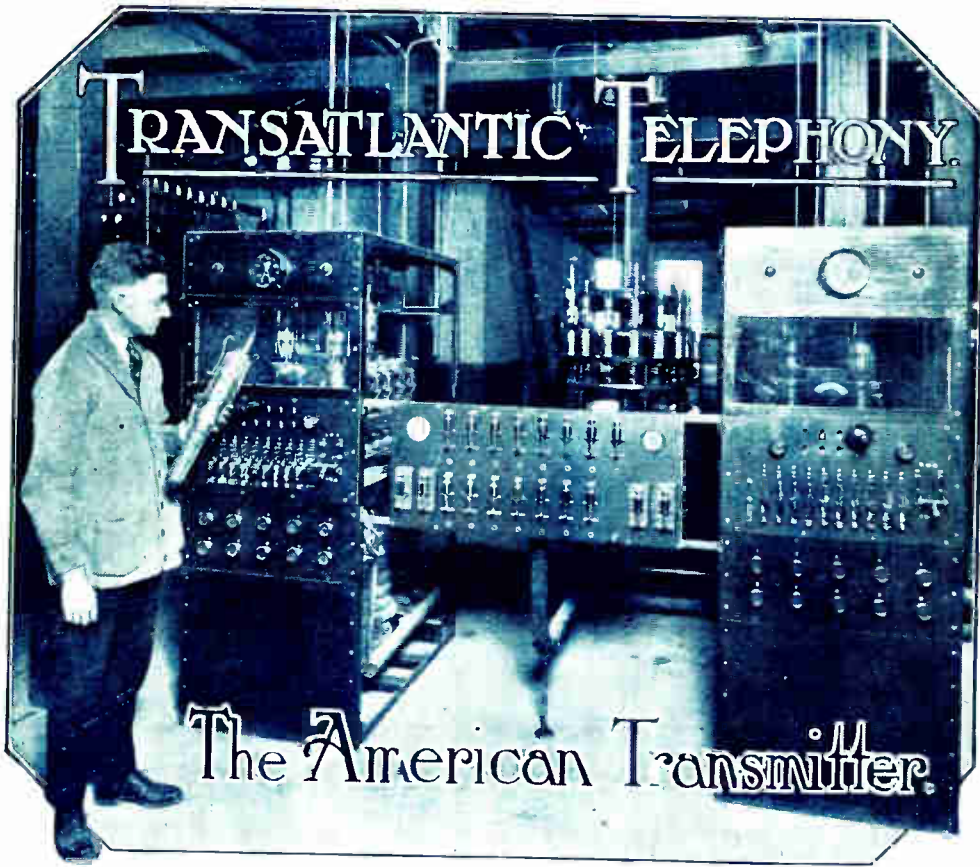

# NATURAL TONE



The Radiolux Amplion has many good points but perhaps none is more striking than the quality of natural reproduction which it possesses to a remarkable degree.

Prices from £4.15.0

Other AMPLION Models from 38/- to 13 Gns.  
Write for latest illustrated lists



The World's Standard  
**AMPLION**  
Wireless Loud Speaker

Advertisement of Alfred Graham & Co. (E. A. Graham), London, S.E.4.

Mention of 'The Wireless World,' when writing to advertisers, will ensure prompt attention.

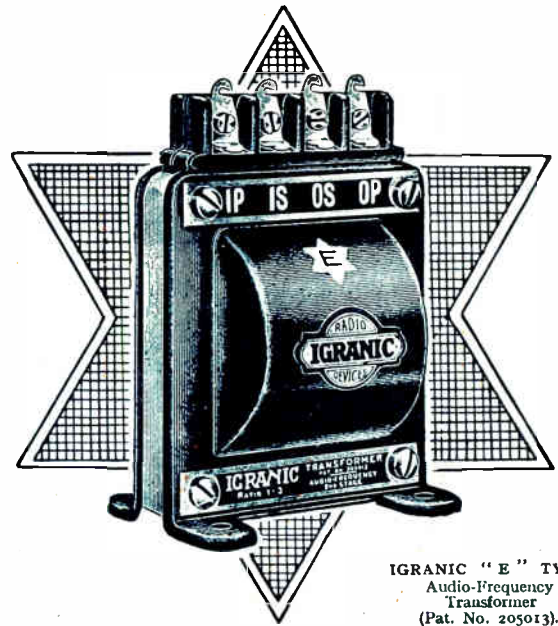

IGRANIC "E" TYPE  
Audio-Frequency  
Transformer  
(Pat. No. 205013).

## Extra Volume for Out-of-Doors Listening

For out-of-doors listening you need volume and, of course, purity of reproduction. Often one is sacrificed for the other; you can have both by using Igranitic E Type Transformers.

If you want additional volume from your receiver why not build an amplifier with Igranitic Transformers? They are made in two ratios: E1 (ratio 1:5) for first and single stages at 21/- and E2 (ratio 1:3) for second and subsequent stages at 19/6. Both possess a high amplification factor which is constant over a very wide range of frequencies. They are shrouded and will not interact.

The use of Igranitic E Type Transformers is the easiest and surest way of obtaining ample volume and purity of reproduction.

All reputable dealers stock them.

Write for List U173.

Exclusive  
Manufacturing  
Licensees of



Potent  
Radio  
Essentials.

149, QUEEN VICTORIA STREET, LONDON.

Works: BEDFORD.

Branches:

BIRMINGHAM,  
LEEDS,

BRISTOL,  
MANCHESTER,

CARDIFF,

GLASGOW,  
NEWCASTLE.





**A NEW 2 VOLT VALVE  
WITH THE WONDERFUL P.M FILAMENT**

Superior to many 6-volt valves and has up to three times greater emission surface.

Gives better results than any other 2-volt valve in all stages of a receiving set.

*Makes each accumulator charge last three times as long.*

Embodies the special patented P.M. Filament that cannot be broken except by the very roughest handling.

Is so economical that no sign of glow can be discerned.

**THE P.M.1 . . . . 15/6**

(For H.F., Detector and L.F. Operation - 2 volts One-Tenth Ampere)

GET ONE FROM YOUR RADIO DEALER.

Ask for particulars of the P.M. Series for 2, 4 and 6 Volts.

**Mullard**  
**THE • MASTER • VALVE**

ADVT. THE MULLARD WIRELESS SERVICE CO., LTD.,  
NIGHTINGALE LANE, BALHAM, LONDON, S.W.12.



**G.P.4**

**P.V.4**

## Two New Valves

*WHICH ESTABLISH A NEW STANDARD OF EFFICIENCY*

EDISWAN—originators of the radio valve—now take reception a definite step forward. Here are two new DULL EMITTER valves—G.P.4 and P.V.4, with characteristics so decidedly superior that a new standard of valve efficiency is established.

You will identify G.P.4 and P.V.4 by these special features: (1) The Clear Glass Inspection Window; (2) The Wafer Disc; and (3) The Seal.

*For detailed description and full specification obtain from your Dealer the Ediswan Folder—"Two New Valves."*

**G.P.4.**—General Purpose dull emitter. Low current consumption. Long Life. Powerful amplification. Elimination of objectionable microphonic effects.

**P.V.4.**—Ideal power valve, companion to G.P.4. When used for Loud Speaker work: powerful, distortionless amplification. No microphonic effects.

*\*Both valves work off 4-volt accumulator*

# EDISWAN VALVES

*Will improve any set*

THE EDISON SWAN ELECTRIC CO. LTD  
123-5, Queen Victoria Street, LONDON, E.C.4

N.V.

## To Purchasers of Radio Sets: You require FAITHFUL REPRODUCTION

Therefore, when you order your Set  
**SPECIFY**



## L.F. TRANSFORMERS

Type AF4 - - 17/6  
Type AF3 - - 25/-

*The "Nearly Perfect" Transformer.  
Ask for Leaflets Wa401 and Wa402*

**FERRANTI LTD., HOLLINWOOD, LANCASHIRE**



## Two in One!

Here's a splendid little component, the Watmel combined Grid Condenser and Fixed Grid Leak. Saves space, time and money. Built to allow the Grid Leak to be connected either across the condenser or direct to the filament of the detector valve.

Price 2/6 each.

*Send a postcard for full details of the various Watmel products.*

**The Watmel Wireless Co. Ltd.,**  
332a, Goswell Rd., London, E.C.1.  
*Representative for Lancashire & Cheshire:*  
Mr. J. B. Leveson, 23, Hartley Street, Levenshulme, Manchester.

For trouble-free condenser efficiency always specify the famous round Watmel fixed condenser.

Sizes up to '002 - 2/-  
Sizes '0025 to '006 - 2/6



## The Latest Valve Holder for the Experimenter

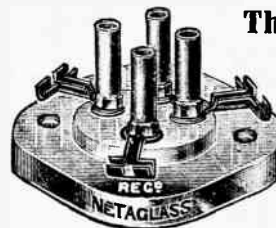

### The "NETAGLASS"

VALVE HOLDER with resistor template for Panel or Baseboard.

The New Valve Holder with the Glass Base and a dielectric constant of 5 to 7 and fitted with 3-way channel tags.

**PRICE 3/-** Post Free.  
*Buy British the Best.*

**E. A. WOOD** 100 Aston Road - - BIRMINGHAM.  
80 Belgrave Gate - - LEICESTER.  
77 Gallowgate - - GLASGOW.





# Pedestal of 35 Years Experience

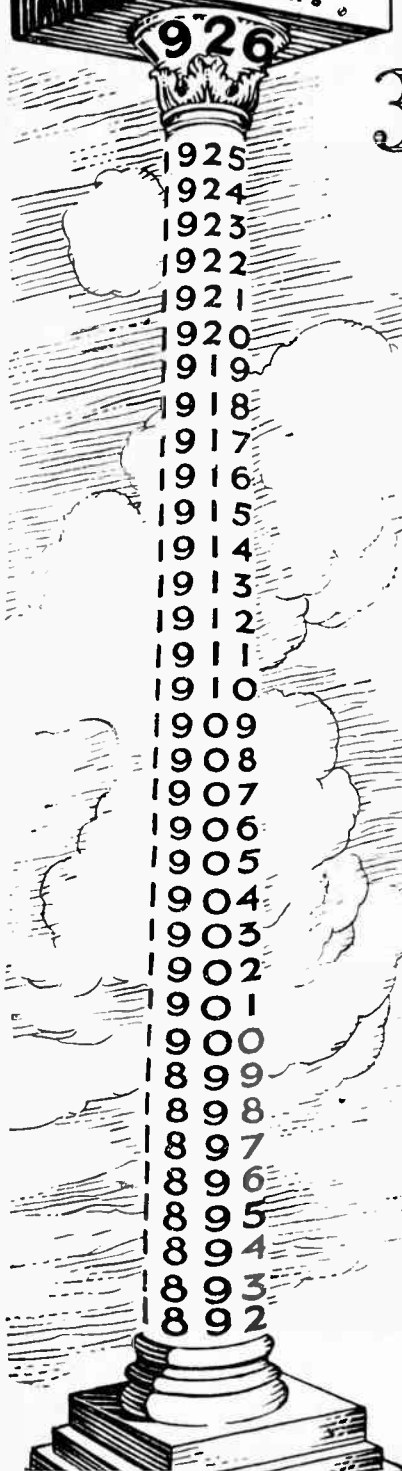

C.A.V. H.T. ACCUMULATORS are not built of the ordinary test tubes but tubes of special design and material assembled to eliminate intercell current leakage, which is so common amongst block form accumulators of much greater capacity; which large capacity is, in many cases, superfluous. An H.T. Accumulator need not necessarily have a large ampere hour capacity, because the current taken by the average broadcast receiver is comparatively small, and therefore the greatest feature must be the absence of intercell current leakage and consequent maximum retention of charge. The C.A.V. H.T. ACCUMULATOR possesses this most important feature, the path of intercell leakage being more than 9 in.—an exclusive design.

That is why the leading experimenters, such as—

- Mr. W. K. Alfrod, radio 2 DX.
- Mr. V. E. M. Oliver, B.A., A.M.I.E.E., radio 6 BV.
- Mr. J. A. Partridge, radio 2 KF.
- Mr. E. J. Simmonds, M.I.R.E., F.R.S.A., radio 2 OD.

use them when carrying out noteworthy experiments.

**C.A.V. H.T.3.—60 Volts 60/-**      **C.A.V. H.T.4.—30 Volts 30/-**  
 All C.A.V. H.T. Accumulators are supplied fully charged (First charge free).

## For your L. T. supply— "ACTON" ACCUMULATORS in glass.

The specially designed stout moulded glass jar has many important features in addition to its transparency. It prevents the risk of fire, eliminates frothing, is clean and of good appearance. No separators are fitted between the plates which are correctly spaced by grooves moulded in the sides of the glass jar. The plate sections are suspended from the ebonite lid which is sealed in position. Screwed vent plugs are made of porcelain and therefore easily cleaned.



### 2-VOLT SINGLE CELLS.

TESTED CAPACITY.	WEIGHT, LBS.		PRICE
PERCENTION. ACTUAL.	DRY.	WET.	£. s. d.
60	30	7 8	13 6
80	40	9 10 1/2	16 0

4 and 6-volt assemblies at proportionate prices.

Inspect them at your local radio dealer or any of the following Service Depots:

- |  |  |   |   |  |  |  |  |
|--|--|---|---|--|--|--|--|
| <b>BIRMINGHAM</b> ... (LUCAS) ... GREAT HAMPTON STREET.<br>Grams: "Lucas-Birmingham."<br>Phone: No. 1111 | <b>BRISTOL</b> ... (ROTAX) ... 7 TEMPLE STREET<br>Grams: "Rotax-Bristol."<br>Phone: Bristol 3756 | <b>COVENTRY</b> ... (LUCAS) ... PRIORY STREET<br>Grams: "Lucas-Coventry."<br>Phone: Coventry 1-68 | <b>GLASGOW</b> ... (LUCAS) ... 227, 229, ST. GEORGE'S ROAD<br>Grams: "Lucas-Glasgow."<br>Phone: Douglas 307-0 | <b>MANCHESTER</b> ... (LUCAS) ... 277, DEANSGATE<br>Grams: "Luminous-Manchester."<br>Phone: Central 6849 | <b>MANCHESTER</b> ... (LUCAS) ... CHESTER ROAD, STRET FORD<br>Grams: "Lucas-Stretford."<br>Phone: Trafford Park 1117 | <b>NEWCASTLE-ON-TYNE</b> ... (LUCAS) ... 68, ST. MARY'S PLACE<br>Grams: "Motolite-Newcastle-on-Tyne."<br>Phone: City 306 | <b>LEEDS</b> ... (ROTAX) ... 117, PARK LANE<br>Grams: "Rotax, Leeds."<br>Phone: 2678 |
|--|--|---|---|--|--|--|--|

**C.A. Vandervell & Co. Ltd.**  
 WARPLE WAY ACTON LONDON W3  
 Telephone: Chiswick 2000.  
 Telegrams: "Vanteria, Act, London."

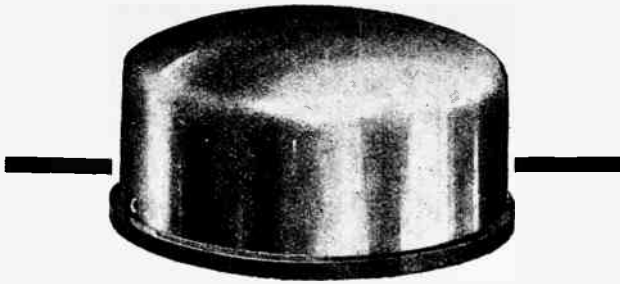

# Get this BURNDEPT HIGH NOTE BUZZER

**H**ERE is the Buzzer for which you have been waiting. Ideal for wavemeters and many other purposes. One that is self-starting and trouble-free. The note is clear and steady and of constant frequency. By means of a convenient thumbscrew it can be adjusted to vibrate at any frequency from about 500 to 800 per second. A single 1½-volt dry cell is usually sufficient for operation, the current then being about 40 milliamps., but two cells may be used if desired. **The Buzzer is provided with a self-contained non-inductive shunt across the magnet bobbins,** and therefore may be placed straight across any coil and condenser to generate radio frequency oscillations. The Buzzer is circular, 2½ inches in diameter, 1½ inches high. The whole is protected by a bright nickelled brass cover.

**High Note Buzzer No. 403. Price 15/-**

Referring to the diagram:—

1. Screws 1 and 2 are the terminals for connecting Buzzer to any external circuit.
2. Screws 3 and 4 are connected to the two ends of the 30-ohm shunt, which is wound in the grooved flange of the moulded base; this shunt may be reduced in value if desired by removing some of the wire (each turn equals about 3 ohms).
3. Thumbscrew 5 adjusts the tension of the armature and therefore the frequency of the note.
4. Thumbscrew 6 adjusts the make and break contacts (which are made of special non-burning alloy).

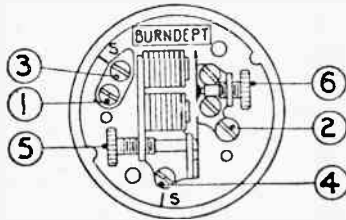

## BURNDEPT

### WIRELESS LIMITED

**USE BURNDEPT SUPER - VALVES.** They will give best possible results under all conditions. There is a super - valve — either bright or dull-emitter — to suit every type of wireless receiver, and every valve is guaranteed.

**Aldine House, Bedford Street,  
Strand, W.C.2.**  
 Telephone GERRARD 9072.  
 Telegrams: 'Burndept, Westrand, London.'  
 Branches and Agents  
 Everywhere.

## DARIMONT Batteries and the "WIRELESS WORLD"



"The Darimont wet cell, capable of giving comparatively heavy discharge, and recharged by renewing the solutions, promises to prove a boon to country users without charging facilities. No appreciable voltage rise results when left standing, a property which renders it superior to the dry cell. The measured capacity reveals its capability to maintain full capacity on excessive load."

Write now  
for our list.

"... Can be considered a true 'home service' battery."

## DARIMONT Electric Batteries Ltd.

DARIMONT WORKS, ABBEY ROAD,  
PARK ROYAL, LONDON, N.W.10.  
 Phone: Wembley 2807.

## VERNIER CONTROLS National Velvet Vernier, TYPE "B"

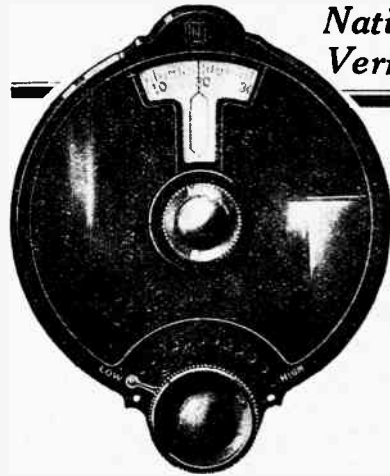

**R**ECOGNISING a demand for a vernier control which can be mounted on any condenser with ½" shafts, the National Type "B" has been devised. It is made of bronze or brass, nickel-plated, and outlasts any set in which it is used. Smooth and regular throughout its range. No backlash exists or can develop. Variable ratio having a minimum reduction of 6 to 1 and a maximum of 22 to 1 obtained instantly by shifting lever. In pure black bakelite case designed to harmonise with any panel. One hole mounting. Clock or anti-clockwise patterns. Price **15/-**

Profusely-illustrated 48 page list of American Apparatus free and post free on request.

*Hamleys*  
ESTD 1760  
HAMLEY BROS LTD

200-202, REGENT STREET, LONDON, W.1.

# Only the new Cossor Point One can give you these three advantages

WHEN a man buys a Valve three questions flash through his mind. The first is "Will it be cheap to run? I cannot afford to use a valve that consumes a lot of current." Then follows "Is its filament strong? A valve that becomes useless after the first slight blow is expensive at any price." And finally "Can I be sure that it will give as good result after twelve months as on the first day I use it?"

These are the three essential needs of every wireless enthusiast. In this new low consumption Valve, Cossor is enabled to offer a Dull Emitter which utilises principles of construction so strikingly new that the whole future trend of valve design is likely to be influenced. Read below how this wonderful new valve, consuming only 1 of an ampere (hence its name) will satisfy your most exacting requirements.

## 1 Current consumption cut to one-third

Ever since the days of the bright emitter the whole resources of Science have been enlisted in ceaseless efforts to reduce current consumption. In the new Cossor Point One a further tremendous cut has been made. This new valve now requires only one-tenth of an ampere at a voltage of 1.8. That means that a Super-Heterodyne using seven of these new valves would still consume less current than a one-valve Set using one Bright Emitter. Or to make the

comparison still more striking the same accumulator which served the one-valve Set for, say, one week, would—with its cells connected in parallel to give two volts only—last longer than two months on a charge. Even then it would only need re-charging to prevent sulphation of its plates. This phenomenally low current consumption renders the Cossor Point One quite suitable for use with dry cells when required.

## 2 A shockproof filament suspension system

The system now evolved by Cossor offers outstanding advantages and automatically ensures for the valve a greatly increased life. Whereas in many valves the filament, being straight, is held under tension, that in the new Valve is arched and retained in position by a fine wire which is secured to a selenite insulator situated immediately above it.

It is not held under tension. The fine wire provides exactly the degree of elasticity required to enable the filament to withstand harmlessly the sharp concussion caused by an accidental blow. A knock which would shatter the filament in an ordinary valve is easily absorbed by this amazingly efficient shockproof suspension system.

## 3 Long life uniformity due to Co-axial Mounting

If a number of valves were made with identical filaments, grids and anodes without due regard to the exact spacing between these elements, all the valves would show very considerable variations in performance. Absolute uniformity in results can only be obtained among valves of the same class when the relative position of their elements is identical.

In the new Cossor Point One the system of mounting infallibly aligns the filament, the grid and the anode at the top as well as at the bottom. Even the

hardest shock will fail to displace their exact relative positions.

Frequently the working characteristics of a valve will change as time goes on—perhaps due to filament sag or to the grid or anode being moved out of position through an accidental blow. This cannot possibly happen in a Cossor Point One. Users of Neutrodyne Receivers employing two or more stages of matched H.F. amplification will appreciate the immense importance of this exclusive Cossor feature.



**COSSOR POINT ONE**  
**RED TOP:**  
 For H.F. use consuming 1 amp. at 1.8 volts. **15/6**  
**PLAIN TOP:**  
 For Detector consuming 1 amp. at 1.8 volts. **15/6**  
**COSSOR STENTOR TWO**  
**GREEN TOP:**  
 For Power Valve consuming 1.5 amp. at 1.8 volts. **18/6**

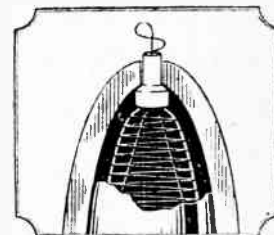

Observe how the selenite insulator securely aligns and holds in their correct relative positions, the filament, the grid and the anode. Through the centre of the insulator will be seen the fine wire which supports the filament and safeguards it against shocks.

# Cossor Valves

# ANOTHER CLEARTRON PRODUCT

*Rotor and Stator, die-cast in one piece, give results hitherto unattainable.*

**CONDENSERS ONLY:**

- 0002 - - - **13/9**
- 0003 - - - **14/3**
- 0005 - - - **14/9**

*"Station Selector" Dial (precision movement)*

**10/6 extra**

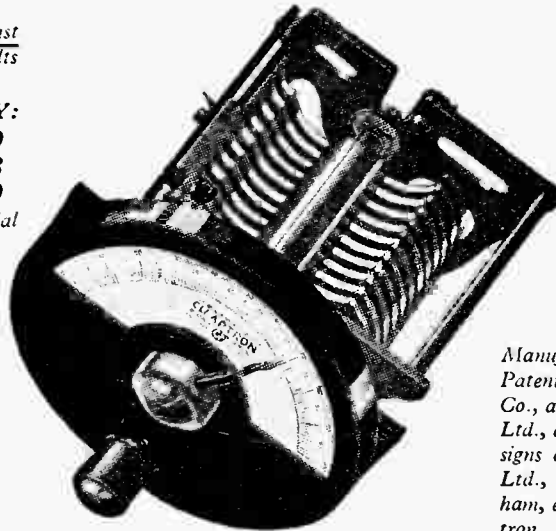

*Manufactured under the Patents of Western Electric Co., and Cleartron Radio, Ltd., and the registered designs of E. A. Lamplugh, Ltd., Tyldesley, Birmingham, exclusively for Cleartron Radio, Ltd. (Sole Proprietors).*

## THE DI-KAST CONDENSER

is a distinct innovation in Condenser design. Avoids the contact resistance losses experienced with separately assembled condensers. Rotor and Stator are die-cast in one, which means positive connexion and perfectly matched characteristics. The specially designed vanes provide straight-line reading, greater range, easy short wave tuning and very low minimum capacity. Another feature of unusual interest is the MICRO STATION SELECTOR, a newly designed dial precision movement, allowing completely selective tuning and ten or more different adjustments between each degree. Play and back-lash entirely eliminated.



and of course

### CLEARTRON VALVES

America's foremost Valve made in Britain's newest factory.

**ALL DULL EMITTERS**

**12/6** Standard Prices **15/-**

Full technical data from your Dealer or from us.



Ask your dealer or send for complete explanatory leaflet to:

## CLEARTRON RADIO LIMITED

ONE CHARING CROSS, LONDON (Works: BIRMINGHAM)

Regent 2231/2.

Cleartron, Westtand, London.



CT/50.

# The Wireless World

AND  
RADIO REVIEW  
(14<sup>th</sup> Year of Publication)

No. 355.

WEDNESDAY, JUNE 16TH, 1926.

VOL. XVIII. No. 22.

Assistant Editor:  
F. H. HAYNES.

Editor:  
HUGH S. POCOCK.

Assistant Editor:  
W. JAMES.

Editorial Offices: 139-40, FLEET STREET, LONDON, E.C.4

Telephone: City 4011 (3 lines).

Advertising and Publishing Offices: DORSET HOUSE, TUDOR STREET, LONDON, E.C.4.

Telephone: City 2847 (13 lines).

Telegrams: "Ethaworld, Fleet, London."

COVENTRY: Hertford Street.

BIRMINGHAM: Guildhall Buildings, Navigation Street.

MANCHESTER: 199, Deansgate.

Telegrams: "Cyclist Coventry."  
Telephone: 10 Coventry.

Telegrams: "Autopress, Birmingham."  
Telephone: 2970 and 2971 Midland.

Telegrams: "Hiffe, Manchester."  
Telephone: 8970 and 8971 City.

Subscription Rates: Home, £1 1s. 8d.; Canada, £1 1s. 8d.; other countries abroad, £1 3s. 10d. per annum.

As many of the circuits and apparatus described in these pages are covered by patents, readers are advised, before making use of them, to satisfy themselves that they would not be infringing patents.

## CHOICE OF PROGRAMMES.

IN a recent communication to the Press, Captain Eckersley has stated that new developments in the organisation of the B.B.C. are under consideration whereby, instead of the present mixed programmes, which cannot ever hope to satisfy all tastes, different types of programme will be available on different wavelengths, and the endeavour is to be made to put all listeners, even those with the simplest sets, in the position of being able to choose their programme from classical music, jazz, or educational talks, according to their various tastes. This desirable goal as outlined by Captain Eckersley is, it will be remembered, one of the recommendations of the Broadcasting Committee, and very naturally the B.B.C. have, since the publication of the Committee's Report, been engaged in efforts to devise ways and means of meeting the recommendations so that when the time comes for them to be put into operation the B.B.C. staff may be found prepared and ready, with the necessary preliminary work already accomplished. Although no statement has as yet been made as to how the alternative programme scheme is to be attained, yet it is interesting to consider how some scheme might be put into operation without serious dislocation of the present broadcast system. The method which occurs to us as the most feasible and practical arrangement is one where the stations at present in operation and linked together by telephone wires should be divided into three or more groups according to the number of different programmes

required. Each group would be made up of stations so situated that the combination of stations would cover the whole country as nearly as possible. Each of these groups of stations would put out the same programme, and each station in the group would work on precisely the same wavelength, the frequency being controlled by the crystal or tuning-fork method, the control being over land line if necessary. By such an arrangement we should get what in practice would work out to be three "distributed" high-power stations, the power being reckoned as the sum of the powers of the stations comprising the group.

Having thus limited our wavelengths to three or perhaps four, instead of the present much larger number, it would be possible to allow for wide differences between the wavelengths of different programmes, thus facilitating reception of one or another as required. In addition, such an arrangement would permit of considerable increase in the power of stations without producing mutual interference, because the wavelength spacing would be great.

The organisation which we have outlined above would be open to an objection, in that local stations would lose local colour in their programmes. We believe, however, that this is a matter which is trivial in comparison with the advantages which would be gained by having a real choice of programmes and the improvement in the programmes which could be brought about through central organisation of all the programme work, if necessary, through London studios, and limitation of the number of programmes to be compiled and organised to three or at the most four.

## CONTENTS.

	PAGE
EDITORIAL VIEWS ... ..	791
TRANSATLANTIC TELEPHONY TESTS ... ..	792
By A. Dinsdale.	
READERS' NOVELTIES ... ..	798
IS MY SET INTERFERING? ... ..	799
By N. P. Vincer-Minter.	
HINTS AND TIPS FOR NEW READERS	805
CURRENT TOPICS ... ..	807
BROADCAST BREVITIES ... ..	809
D.C. MAINS RECEIVER ... ..	811
By Harold Bright.	
WIRELESS CIRCUITS IN THEORY AND PRACTICE ... ..	815
By S. O. Pearson.	
REVIEW OF APPARATUS ... ..	819
PIONEERS OF WIRELESS, 18—DOLBEAR NEARLY FORESTALLS MARCONI ... ..	821
By Ellison Hawks.	
NOTES ON THE SUPERHETERODYNE ... ..	823
By Capt. H. T. B. Hampson.	
LETTERS TO THE EDITOR ... ..	826
READERS' PROBLEMS ... ..	827



## A Description of the Apparatus and Methods Employed at the American End of the Circuit.

By A. DINSDALE.

THE human voice was first transmitted across the Atlantic by radio in 1915, when the American Telephone and Telegraph Company transmitted from the U.S. Navy station at Arlington, Virginia, to the Eiffel Tower, Paris. During these early tests hundreds of small receiving valves were used to provide power for the transmitter, and it was only for a few minutes at a time, during extremely favourable periods, that intelligible speech was received in France.

Since that date the American Telephone and Telegraph Company have continued their researches until, at the present day, an intelligible conversation can be carried on between New York and London for several hours on end. Much experimental work remains to be carried out, however, before the service can be opened up on a successful commercial basis.

### The Two-way Circuit.

An excellent idea of the wire and radio circuit between the two terminals of the system can be obtained from a study of the map shown in Fig. 1. From London speech is transmitted over the ordinary telephone lines to Rugby, where it is transferred to the radio transmitter and directed across the Atlantic to the American receiving station at Houlton, Maine. From Houlton the received speech is once more transferred to a wire circuit and conducted to New York City.

The return path from New York to London is first by wire from New York to the Radio Corporation of America's high-power wireless station at Rocky Point, Long Island, thence by radio across the Atlantic to the British receiving station at Wroughton, Wilts, and from there on to London by wire. The wavelength used by Rugby is 5,770 metres (52 k.c.), whilst Rocky Point transmits on 5,260 metres (57 k.c.).

The method by which

the speech frequencies are transmitted across the ocean is known as the *single side-band carrier-eliminated* method of transmission. The technicalities of this system were fully described by Mr. E. K. Sandeman in two recent issues of this journal,<sup>1</sup> so the present writer need only outline the reasons for its adoption before passing on to a description of the actual apparatus employed at the American end of the circuit.

### Advantages of Single Side-band Transmission.

The original patents for single side-band transmission were issued to John R. Carson, to whom belongs the credit of having first suggested the method. It is interesting to note, in passing, that the system was originally developed for use on the American long-distance telephone lines, and its experimental use to-day for transatlantic telephony is but a further development of the land wire system, using, instead of wire conductors, the ether.

In commencing to develop a system of radiotelephony for successful transatlantic operation, the first considerations are those of wavelength and power. Readers of this journal are well aware of the fact that it is not possible at present to obtain reliable reception in this country of American broadcast stations owing to the vagaries of the comparatively short (broadcast) wavelengths, between 300 and 500 metres, when used to cover such enormous distances.

Neglecting for the present the possibilities of ultra-short waves (for they have not yet been fully explored), past experience has shown that the constancy of received signal strength improves with increase in wavelength. Now, according to the decisions of the London Convention, the range of wavelengths available for transatlantic communication extends from 8,000 metres up, and as this range is already almost

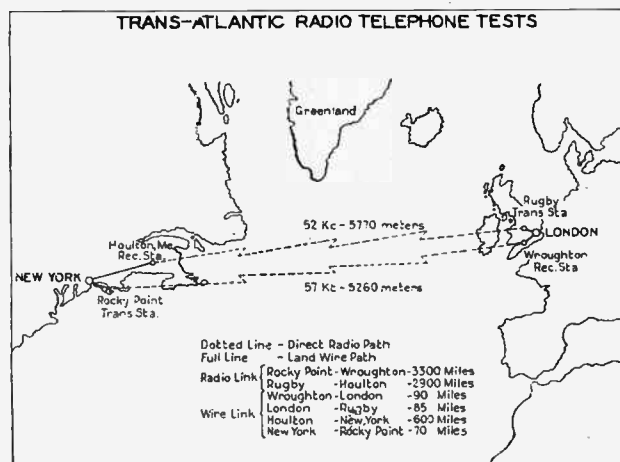

Fig. 1.—Wireless and land line links in the two-way transatlantic telephony circuit.

<sup>1</sup> *The Wireless World*, March 31st and April 7th, 1926.

**Transatlantic Telephony Tests.—**

entirely filled up by radiotelegraphic services, transoceanic radiotelephony must be conducted on wavelengths somewhere below 8,000 metres (37,500 cycles).

**Width of Side-bands.**

Ordinary speech frequencies range between about 300 and 3,000 cycles, so that if the ordinary modulated carrier wave system is used, a frequency band is occupied in the ether which extends 3,000 cycles above the carrier frequency and 3,000 cycles below. That is to say, a frequency band 6,000 cycles wide is used up, which means that, when transmitting on 8,000 metres, the side-bands

side-band carrier-eliminated system were clearly indicated in the article previously referred to. It only remains to be said, therefore, that the transmitters now being tried out experimentally at Rugby and Rocky Point radiate only the minimum essential component parts of the original speech frequencies picked up by the microphone. All the power radiated is usefully employed in doing this work and nothing else; there is no power wasted in radiating a carrier wave which can, of itself, convey no message.

For the purposes of the present experiments, the American Telephone and Telegraph Company installed their transmitter at Rocky Point, this being the site of one of the Radio Corporation of America's high-power trans-

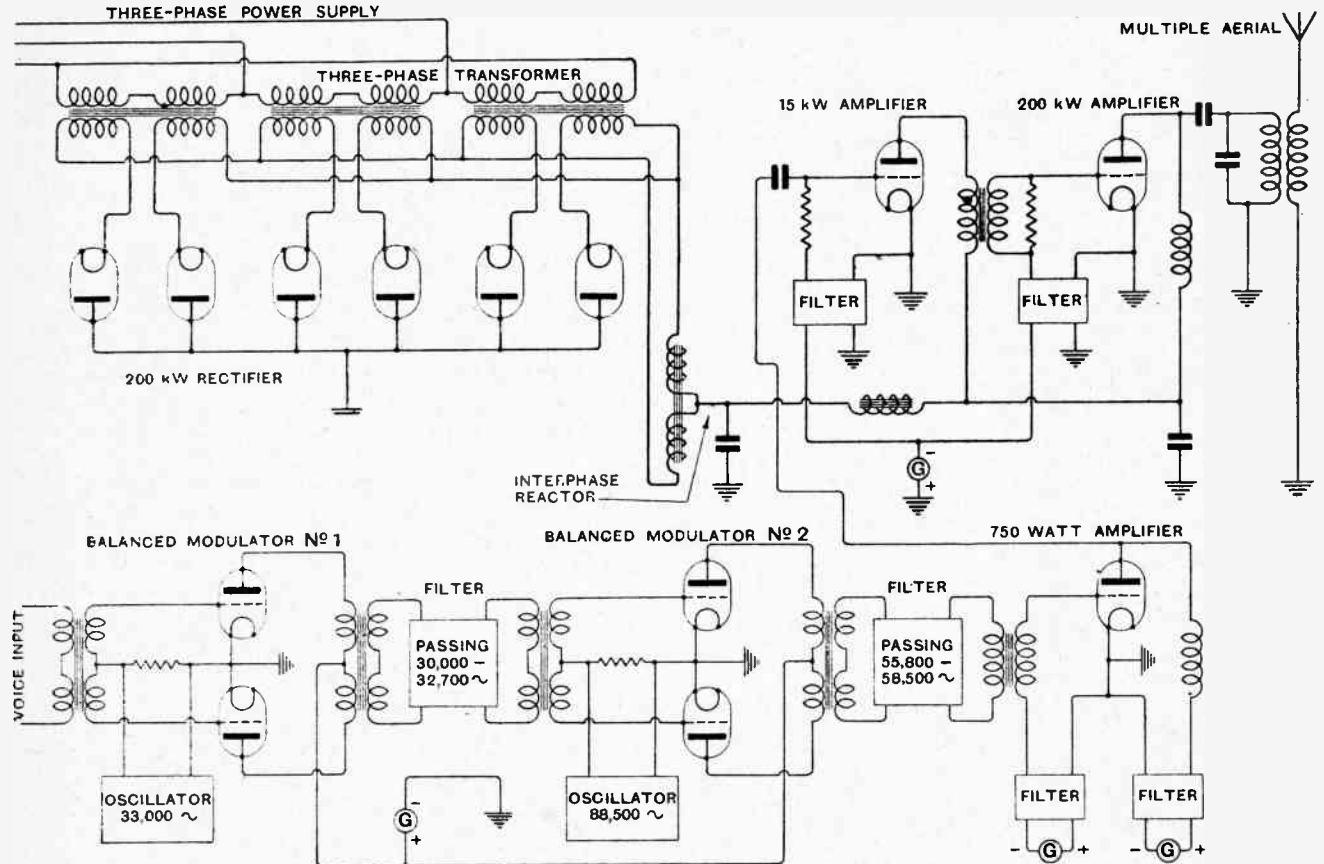

Fig. 2.—Simplified circuit of the transmitter at Rocky Point, Long Island.

will spread between about 7,400 and 8,700 metres. Apart from the difficulties of tuning both transmitter and receiver, and the inefficiency of such flat tuning, such extravagance in the utilisation of the available waveband would result, in actual practice, in the restriction of the number of different channels to about four.

In attempting to cover great distances with absolute certainty and reliability under all conditions, the question of power becomes one of the utmost importance. Sufficient must be employed to obtain the desired results, but the question of cost makes it imperative that no more be used than is absolutely necessary.

The economies in both power and width of frequency band which can be effected by the adoption of the single

atlantic radiotelegraph stations, where there are available two highly efficient multiple-tuned aerials. The use of an aerial of this type is desirable for directional purposes, and also on account of the low damping inherent in such a system. As many readers have observed, experiments are at present confined to Sundays, on which days the Radio Corporation's volume of traffic is low, thus leaving one aerial available for the tests.

**The Transmitter at Rocky Point.**

The simplified circuit diagram of the Rocky Point transmitter is shown in Fig. 2, and, as drawn, it falls naturally into three sections; the low-power modulating and amplifying stages in the lower half; the high-



Fig. 3.—Low-power section of the transmitter, including speech input, modulating filter, and 750-watt amplifier panels.

power amplifiers, shown in the upper half and to the right; and the rectifier which supplies the power amplifier with direct current at high voltage, shown in the upper left-hand portion of the diagram.

Taking these sections in order, it will be seen that the input voice frequencies, coming either from a local microphone, or from a telephone line, are fed into balanced modulator No. 1. Here the speech currents are modulated with a carrier current of a frequency of about 33,000 cycles, which is provided by the local oscillator shown. In the output circuit of this modulator there appears a modulated current representing the two side-

bands, *e.g.*, the upper one extending from 33,300 to 36,000 cycles, and the lower one from 32,700 down to 30,000 cycles. The carrier current supplied by the oscillator, with which the input speech currents were modulated, is suppressed, and does not appear in the output circuit.

#### Function of the Filter Circuits.

These components in the output circuit are then fed into a band filter, which selects the lower side-band to the total exclusion of the upper one and any small portion of the carrier which may still be present owing to slight unbalance of the No. 1 modulator. There remains, therefore, only one side-band, and this is then impressed upon the input side of balanced modulator No. 2, which is also provided with a local oscillation generator which supplies a carrier current at 88,500 cycles.

The result of modulation between the single side-band and this carrier current is to produce a pair of side-bands which are very widely separated in frequency, the upper one, representing the sum of the two frequencies, extending from 118,500 to 121,200 cycles, and the lower one, representing the difference between the two frequencies, extending from 58,500 down to 55,800 cycles.

In this second stage of modulation there is a relatively wide separation between the two side-bands which facilitates the selection at these higher frequencies of one side-band to the exclusion of the other. Another very important advantage is that it allows a range of adjustment of the transmitted frequency without the necessity for changing filters. This is accomplished by varying the frequency of the oscillator in the second step.

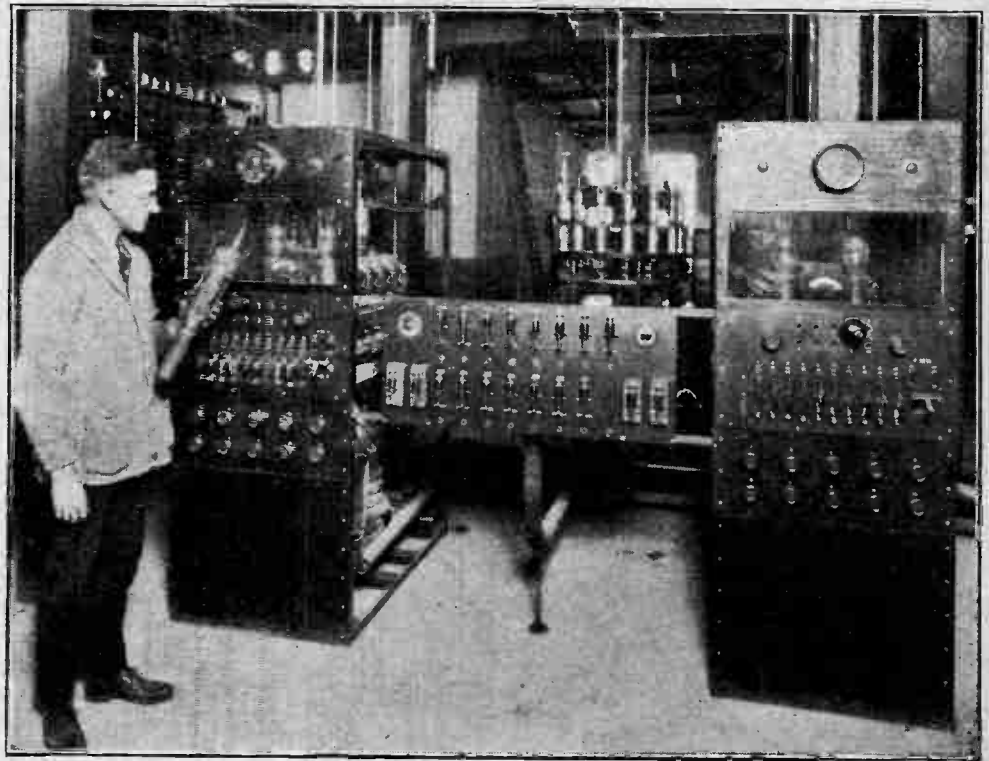

Fig. 4.—High-power section of the transmitter, giving an output of 200 kW.



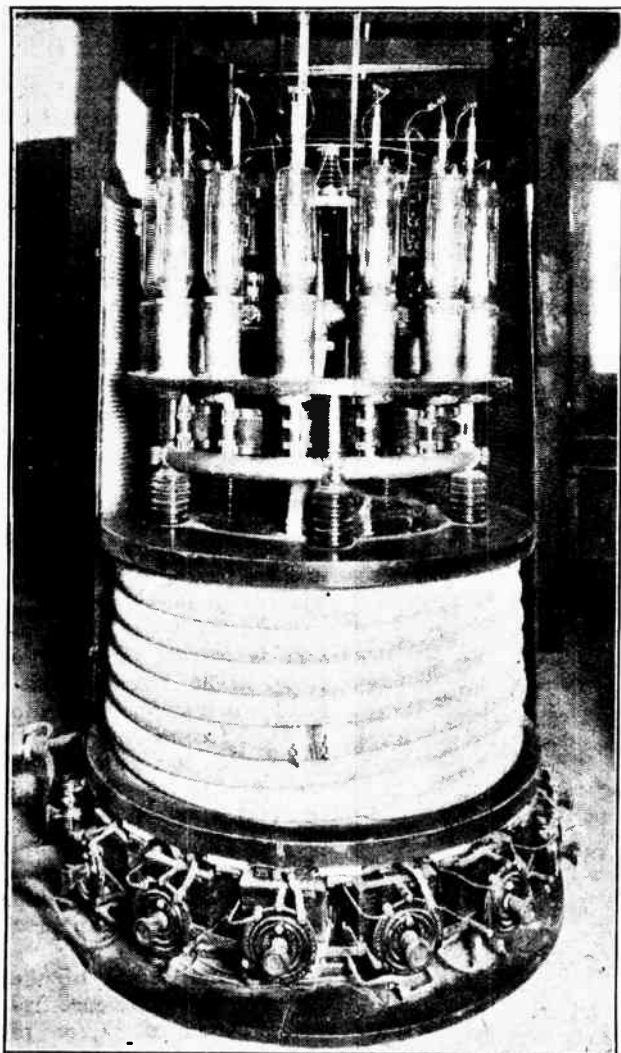

Fig. 5.—Circular bank of fifteen water-cooled valves each handling a power of 10 kW.

The frequency band which it is desired to transmit in this case is that corresponding to the lower side-band of the second modulator, *i.e.*, 58,500 to 55,800 cycles, and this band is therefore selected by means of the output filter from the second modulator, shown in Fig. 2. This filter excludes not only the upper side-band, but also, as in the case of the first filter, any small residual of the carrier current supplied to the second modulator which may get through the modulator circuit if it is imperfectly balanced.

The side-band currents of the desired frequency having been prepared at low power, it is now necessary to amplify them to the required extent for application

to the transmitting aerial. The first stage of this amplification increases the power to 750 watts, which output is then applied to the high power amplifier section shown in the upper right-hand part of Fig. 2.

The low-power section of the transmitter, so far described, is illustrated in Fig. 3. From left to right the panels are devoted to speech input, modulators, filters, and, on the extreme right, the 750-watt amplifier. This latter has two sets of three 250-watt air-cooled valves, one set acting as spare. These valves operate on 1,500 volts H.T.

As a first step in the high-power amplification of the single side-band, the output of the 750-watt amplifier is applied to the 15 kW. amplifier shown in Fig. 2. This consists of two water-cooled valves in parallel, operating on a plate voltage of about 10,000 volts.

**The Power Amplifier.**

By means of a transformer, the output of this amplifier is then applied to the 200 kW. amplifier, illustrated in Fig. 4. The two frameworks shown at right and left of the picture were originally built to contain ten 10 kW. water-cooled valves each, in two banks of five. The engineer at the left is holding up one of these valves. The switches in the centre section of each of the panels are for the purpose of connecting a meter in the filament circuit of any valve. Immediately below are the ten filament rheostats.

As now arranged, however, these two panels contain only four valves each, a further bank being mounted in a circular mounting in the rear of Fig. 4. This bank, shown more clearly in Fig. 5, contains fifteen 10 kW. valves, the water-cooling arrangements of which are well shown in the illustration. The handles at the base of the mounting belong to the filament rheostats. This method of mounting such a large number of high-power valves considerably shortens the filament, grid, and plate leads, and facilitates the arrangement of the water-cooling system. The total output of the high-power amplifier system is 200 kW., and this is then fed into the multiple-tuned aerial system.

The high-power valves shown in the illustrations were specially developed for the purpose. The plate is actually part of the wall of the valve, the upper part, through which pass the grid and filament leads, being of glass, which is joined to the copper plate by means of a

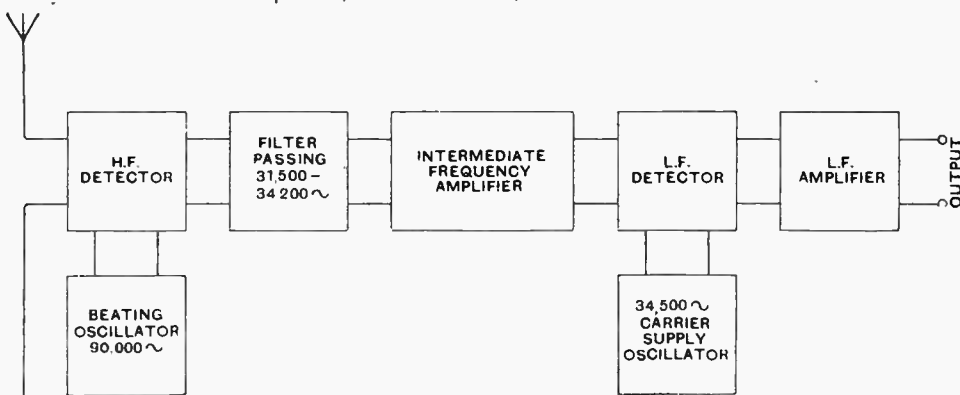

Fig. 6.—Simplified diagram of the apparatus for receiving single side-band carrier-eliminated transmissions.

**Transatlantic Telephony Tests.—**

specially developed seal. This seal has to hold the vacuum at varying temperatures, and is actually capable of doing so at temperatures varying between that of liquid air,  $-190$  degrees Centigrade, and  $+350$  degrees Centigrade, the boiling point of mercury. The filament requires a current of 25 amperes, and with 10,000 volts on the plate is capable of giving a maximum electron emission of 6 amperes. The valve is mounted so that the copper plate fits into a water jacket, round which flows the cooling water. This water is in actual contact with the plate, and is therefore at high potential with respect

power is built up to a high value by a succession of powerful amplifiers.

**The Receiving System.**

The receiving apparatus used at the American end of the London-New York circuit is a development of the well-known superheterodyne method of reception, the principal modification being the addition of a second oscillator which is coupled to the second detector for the purpose of supplying the missing carrier wave. The circuit is illustrated in simple form in Fig. 6. A view of the complete receiving station at Houlton, Maine, is given in Fig. 7. The radio apparatus is to the right, whilst to the left is the telephone testboard and amplifiers for the wire circuit to New York.

The theoretical details of single side-band reception have already been described in these pages, so there is no need to go into them now.

Referring to Fig. 6, reception is carried out in two steps. The received side-band is first stepped down to a lower frequency before it is detected, this action being accomplished by combining in the first, or H.F., detector the incoming side-band of 55,800 to 58,500 cycles with a locally generated current of about 90,000 cycles.

From the output of the detector the difference-frequency band of 34,200 to 31,500 cycles is selected by a band filter and passed through the intermediate frequency amplifier, and thence to the second, or L.F., detector. This detector is supplied with a carrier of

34,500 cycles, which, on "beating" with the selected band, gives in the output of the detector the original voice-frequency band.

The object of so complicating the system is to secure the combination of a high degree of selectivity with flexibility of tuning. This high selectivity is obtained by the use of the band filter, and it is further improved by applying the filter after the frequency is stepped down rather than before.

To illustrate this improvement, assume that there is present an interfering signal at 60,000 cycles, 1,500 cycles off from the edge of the received telephone band. This is a frequency difference of about  $2\frac{1}{2}$  per cent., but after each of these frequencies is substrated from 90,000 cycles, the difference of 1,500 cycles becomes almost 5 per cent. This enables the filter to make a sharper discrimination against the interfering signal.

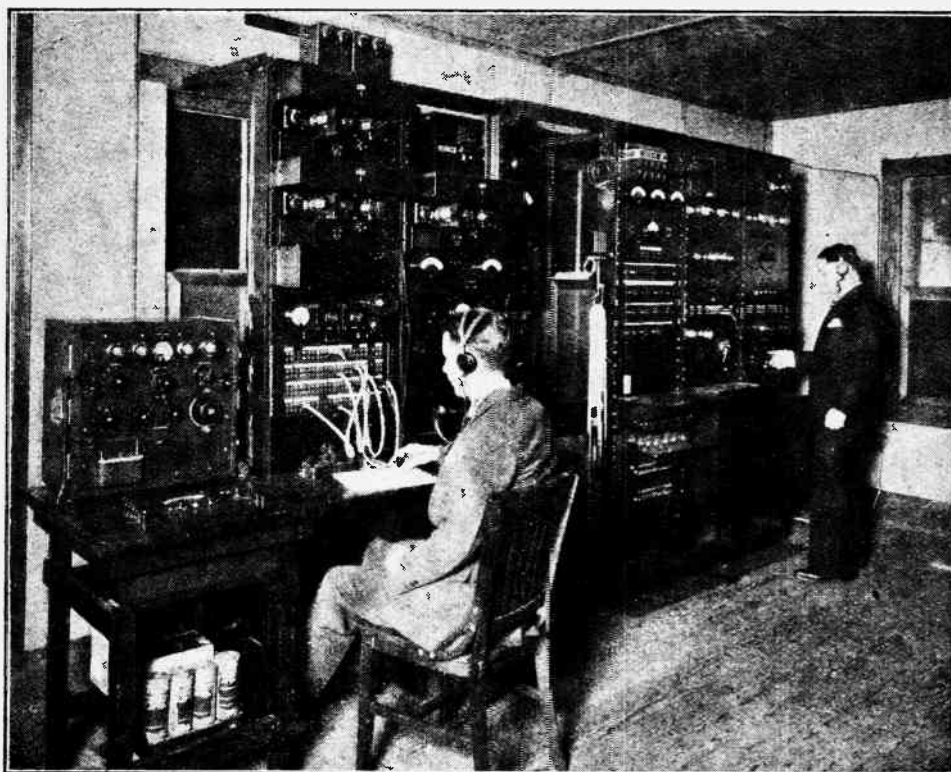

Fig. 7.—Interior of receiving station at Houlton, Maine, U.S.A. The wireless receiver is on the extreme right, the other panels being the terminal boards and amplifiers for the telephone lines from New York.

to earth; hence the coiled rubber tubing, the purpose of which is to improve the insulation of the water column.

**Power Rectifiers.**

The 200 kW. rectifier unit, which supplies all the high-power valves with the requisite 10,000 volts high tension, contains 12 rectifying valves, two of these being used for each half wave, so that full-wave rectification is obtained on all three phases. The output of this rectifier is fed to the amplifiers through an interphase reactor and smoothing circuits. The purpose of the interphase reactor is to balance the output of each phase, and also to protect the transformer windings in the event of the failure of one of the rectifier valves.

Thus, the transmitting system is one in which the useful side-band is first developed by modulation and filtration at lower power (one watt, or less), and then its

**Transatlantic Telephony Tests.—**

Furthermore, the filter is not required to be of variable frequency, as would be the case were it employed directly at the received frequency, since by adjusting the frequency of the beating oscillator the filter can be readily applied anywhere in a wide range of received frequencies. The entire method, therefore, enables the filter circuit and also the intermediate frequency amplifiers to be designed for maximum efficiency at fixed frequency values without sacrificing the flexibility of the receiving set should a change of operating wavelength be decided upon.

A question may arise in the minds of readers as to the synchronism of the frequency of the local carrier supply oscillator with the frequency of the original carrier wave at the transmitter.

If both side-bands were transmitted, without a carrier, the difficulty of synchronising the receiver would indeed be very great, and unless the synchronism were perfect, the system would not work. With single side-band transmission, however, such great exactitude is not necessary, and it has been found in practice that a difference in frequency as large as 50 cycles may exist between the carriers of the transmitter and receiver without causing any serious distortion of the received speech.

**Results of the Tests.**

Before the English terminal station at Rugby was built, the American Telephone and Telegraph Company were experimenting with this new system of transmission as applied to a radio circuit. Transmissions have been made every Sunday from the Rocky Point station for the last three years, the object of which has been to collect data on the conditions prevailing in the ether medium between America and this country. Diurnal and seasonal variations in the strength of Rocky Point's signals as received in England have been exhaustively studied and plotted, and also the ratio between signal strength and the strength of interfering noises due to static and other causes. In America, simultaneous observations were made on various British high-power radiotelegraph stations operating on different wavelengths in order to investigate receiving conditions in the States on the different wavelengths.

A typical curve of the signal field strengths received in England from American stations operating on different wavelengths is given in Fig. 8. This curve is the average of the diurnal variations for the month of September, 1923, and illustrates very clearly the effect of the sun's rays over the Atlantic and how this effect varies on different wavelengths. From this curve it will be seen that the worst conditions are met with at sunset in this country, and this also holds good for the reception of British stations in America.

The procedure in making tests is as follows: 5 minutes of tone telegraph identification signals for receiver adjustment purposes; 10 minutes of disconnected spoken words, followed by 10 minutes of five-second tone dashes separated by five-second intervals.

These tone signals are obtained by switching into the microphone circuit a valve oscillator, consuming about one-hundredth of a watt, which oscillates at a frequency of 1,500 cycles. During the third test period, the inter-

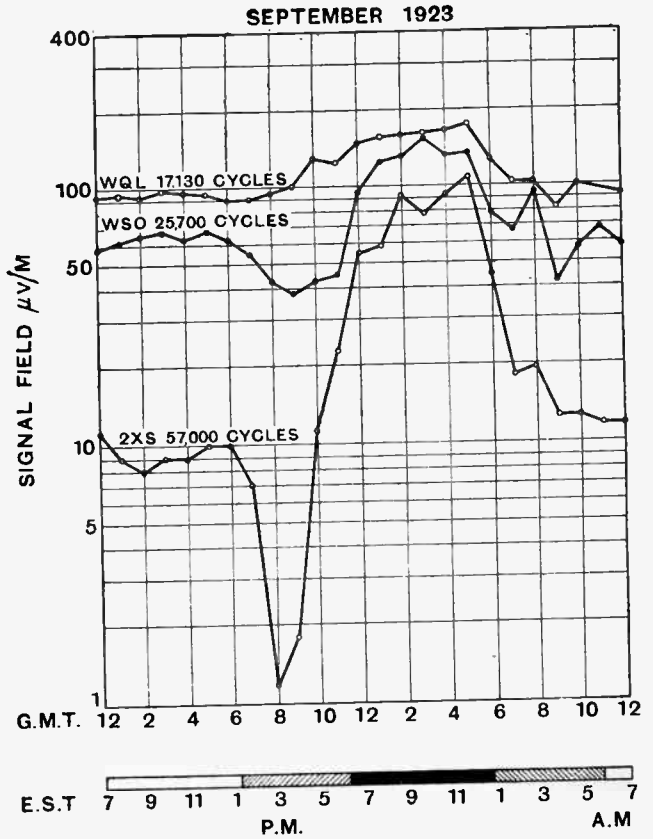
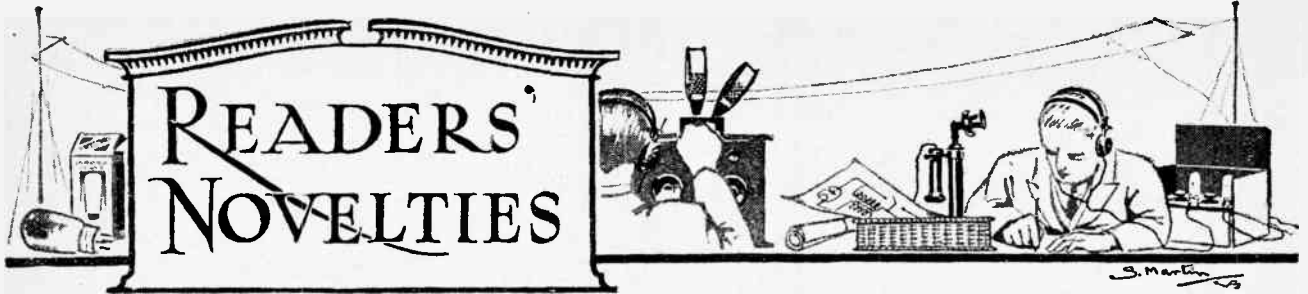

Fig. 8.—Average diurnal variation in field strength of three American stations received at New Southgate, London, during the month of September, 1923. Antenna currents were as follow: WQL, 600 amps.; WSO, 600 amps.; 2XS, 300 amps.

vals between the dashes are utilised for throwing into circuit at the receiver a local signal generator, the strength of which can be varied, so that an accurate comparison can be made between local and distant signal strengths, and a more or less exact measurement made of the received signal field strength.

Measurements of noise due to static are made in a similar manner. In this connection, it has been found that both the American and British receiving stations are troubled by atmospheric which arrive mainly from the same source, presumed to be south-eastern Europe, Asia, and Africa. The receiving system illustrated in Fig. 6 was first used in conjunction with a frame aerial, but it has been found that immensely improved results, as regards freedom from atmospheric, are obtained by using a Beverage wave-antenna for reception, and such aeriels are now in use at both terminal receiving stations.

Although enormous progress has been made towards the establishment of reliable telephone communication between London and New York, much still remains to be done, and it is not yet possible to say when the service will be opened to the public on a commercial basis, but the day will come when a private individual will be able to speak from his home anywhere in the British Isles to another individual situated in any part of the United States or Canada. Thus will another great connecting link be forged between the great English-speaking countries of the world.



A Section Devoted to New Ideas and Practical Devices.

**EARTHING SWITCH.**

The diagram shows a convenient form of weatherproof earthing switch incorporated in the lead-in tube.

The tube should be preferably of ebonite, and of as large a diameter as possible to facilitate the insertion of the terminals shown. Each end

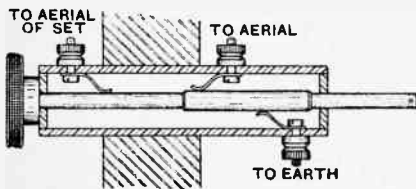

Weatherproof earthing switch.

of the tube is plugged with a disc drilled centrally to act as a bearing for the ebonite rod actuating the switch. This rod is drawn backwards and forwards by a knob fitted inside the house. Contact between the aerial and the aerial terminal of the set is established through a piece of metal tubing fitted to the ebonite rod. This also serves to connect the aerial through to earth when the rod is pushed in.—H. G. N.

o o o o

**SWITCHING REINARTZ RECEIVER.**

Instead of employing a single-pole change-over switch to cut out the

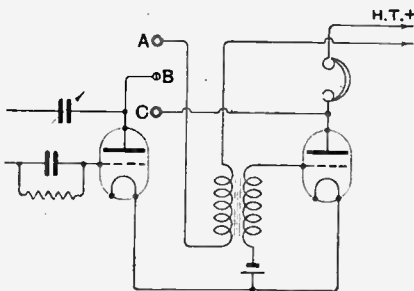

Switching the L.F. valve in a Reinartz receiver.

A 14

I.F. amplifying valve in a two-valve Reinartz receiver, an arrangement of coil plugs and sockets may be employed, assuming that a plug-in coil is used for the H.F. choke.

In the diagram, B represents a coil pin and A and C sockets fitted to the panel, with standard spacing. With the coil plug between B and C the detector valve alone will be in circuit. On plugging in the coil between A and B, however, the output from the primary winding of the transformer coupling, the detector, and I.F. valves, thus bringing the amplifying valve into operation.

the telephone bobbin has been stopped. With the wire in position, however, the slack is automatically taken up and the speed of winding

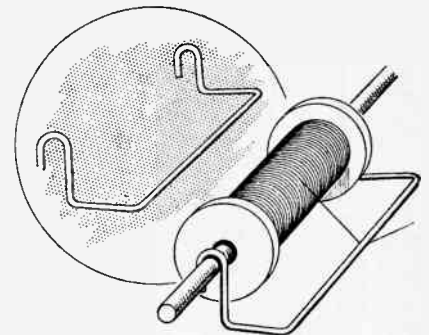

Preventing formation of kinks in fine wire.

may be increased without risk of breakage.—J. A. S.

o o o o

**LIGHTNING ARRESTER.**

A very convenient mounting for a spark gap lightning arrester can be made from a porcelain lighting fuse box. The spark gap electrodes are cut from sheet metal and screwed to the existing terminal plates. Not only does the screw cap effectually

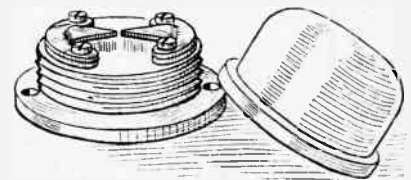

Lightning arrester.

protect the gap from the weather, but the glazed porcelain base provides insulation of a very high order which does not depreciate through atmospheric corrosion.—F. T.

19

**VALVES FOR IDEAS.**

*Readers are invited to submit brief details, with rough sketches, where necessary, of devices of experimental interest for inclusion in this section. A receiving valve will be despatched to every reader whose idea is accepted for publication.*

*Letters should be addressed to the Editor, "Wireless World and Radio Review," Dorset House, Tudor Street, London, E.C.4, and marked "Ideas."*

**WINDING FINE WIRE.**

A piece of copper wire bent to the shape shown in the diagram and fitted to the spindle carrying the supply bobbin of wire will prove of great assistance when rewinding telephones with No. 47 S.W.G. wire.

In the ordinary way kinks would be formed in the wire if the winding were stopped for any reason, due to the fact that the heavy supply bobbin of wire continues to rotate after

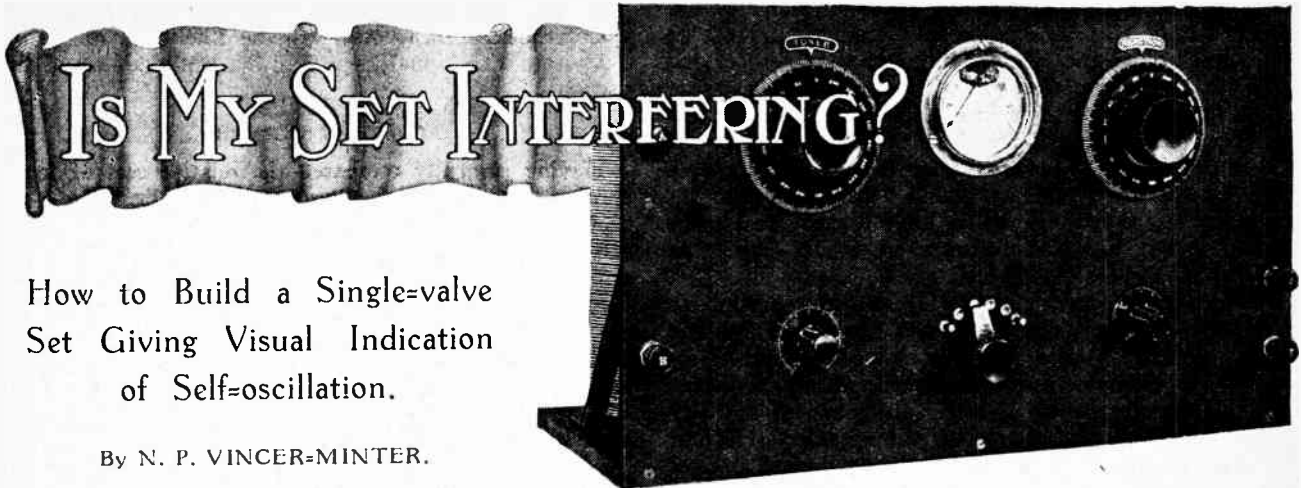

## How to Build a Single-valve Set Giving Visual Indication of Self-oscillation.

By N. P. VINCER-MINTER.

THE man of moderate means whose sole incursion into the realm of broadcasting consists of the use of an inexpensive crystal receiver must often grow very envious when he reads of the many feats of distant reception accomplished by people able to indulge in the luxury of a multi-valve receiver. The more he reads about the apparatus customarily used by such persons, however, the greater does the prospect of ever being able to emulate them recede from the realms of possibility. He reads of "Trinidynes," of "counterphase, reflex neutrodyne," and such-like expressions beloved of those who never seem to get any farther than receiving 2LQ and 5XX, and decides, after all, that in order to accomplish the reception of other stations than the local one a combination of the financial and technical genius of Rockefeller and Einstein is necessary, and accordingly he regretfully puts the project out of his mind. He is usually strengthened in this attitude of mind after listening to the futile efforts of a friend to cut out the local station with a home-constructed multi-valve receiver which has probably cost him £20 for parts and a considerable amount of labour.

### Cost of Loud-speaker Reception.

Unfortunately, however, the crystal user of moderate means gets the equally erroneous impression that in contrast to the expense and trouble involved in receiving distant transmission, loud-speaker reception of the local station is simple, inexpensive, and foolproof. He accordingly rushes blindly into the building of an L.F. amplifier and the purchase of a loud-speaker, and, to his subsequent amazement and sorrow, discovers that really good loud-speaker reception of the local station is not quite such a simple and inexpensive matter as he at first thought. From actual personal experience the writer is in a position to state definitely that whilst headphone reception of dis-

tant stations is a comparatively easy and inexpensive matter well within the scope of the man of moderate means and moderate skill and knowledge, loud-speaker reception of the local or any other stations is a task which only those possessed of a considerable amount of knowledge and experience and willing to expend a relatively large amount of money both in actual outlay and upkeep should attempt to tackle.

### False Economy of Cheap Components.

Let us examine these two spheres of wireless activity in detail, and we shall very quickly see that this is by no means a false impression. In the first place, if the quality obtained is to be really worth while, it is of little use economising by the purchase of cheap transformers, and one must be prepared to pay from twenty to thirty shillings for a good transformer. The ordinary small dull emitter is definitely ruled out of the question, and power valves, which are by no means cheap, must be purchased. The H.T. battery must total not less than 120 volts, and since the plate current consumed by power valves is quite considerable, it is of little use purchasing the smallest type of H.T. battery, and either the expensive large-cell type or an H.T. accumulator must be purchased, whilst in addition it might be observed that loud-speaker manufacturers are not noted for their philanthropy. So much for initial outlay; and now what about running costs. First, the filament accumulator must be of reasonably large type, and even then will require fairly frequent recharging, since the majority of power valves consume a quarter of an ampere apiece, and we cannot contemplate the use of the popular 0.06 type of dull emitter. Even though we have purchased the large-cell type of H.T. battery, it will not be many months before it succumbs under the insistent demands made by the power valves, even though the correct value of grid bias is used. In hot

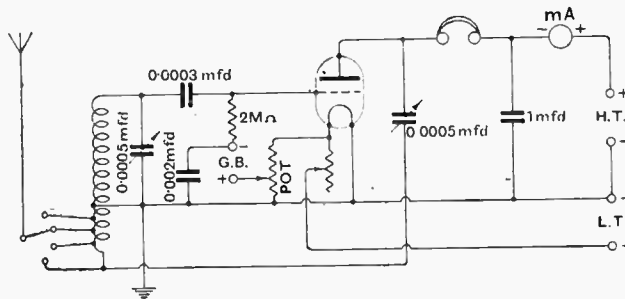

Fig. 1.—The theoretical diagram.

**Is My Set Interfering?—**

weather it will be found that the useful career of our H.T. battery will be considerably diminished, and we may have to face the prospect of purchasing another 120 volts of H.T. sooner than we anticipated. Lastly, power valves and even expensive L.F. transformers do not last for ever. Then, again, the technical pitfalls are many, and it so often happens that after the expenditure of a great deal of time and money and "following your instructions to the letter" results leave a great deal to be desired, owing to some obscure cause which may often baffle even the highly technical.

On the other hand, what do we need for headphone reception of stations other than the local? In the first place, we want a good sensitive and selective receiver, well able to eliminate the local station and receive distant stations, a project which is within the grasp of anybody possessing a very modest amount of mechanical skill and patience. Our receiver need contain no expensive components, the most expensive item being variable con-

comes for renewal the outlay on a new battery will not be heavy. There are no expensive components such as transformers, which, owing to the likelihood of breakdown, are a continual menace to the bank balance of the user.

**Choice of a Circuit.**

Having carefully compared the relative cost of loud-speaker operation on the local station, or headphone reception of distant stations, the question will naturally arise concerning the reliability and the simplicity of both construction and of operation of the instrument, and the potential "DX chaser" will naturally bethink him of the unreliability and general lack of results obtained by his friends with their large multi-H.F. sets, and he will remember that, apart from lack of satisfactory results, both the initial and the running costs of such a large number of valves could be by no means small, quite apart from the difficulty of construction and operation. Whilst wishing in no way to discourage the multi-valve enthusiasts and all their works, the writer would, however, respectfully suggest that in a large number of cases their many valves are more of a hindrance than a help, and that their mighty home-made engines of reception may well be compared to high-powered and highly inefficient cars of years ago, wherein most of the available power was wasted, and they would do better if they used up less power in heating up valve filaments, etc., and turned their attention to the more efficient use of a smaller amount of energy. This must not be taken to mean that the modern well-designed and well-made receiver is not capable of greater things than a single-valve set, because it *is*, just as much, indeed, as a

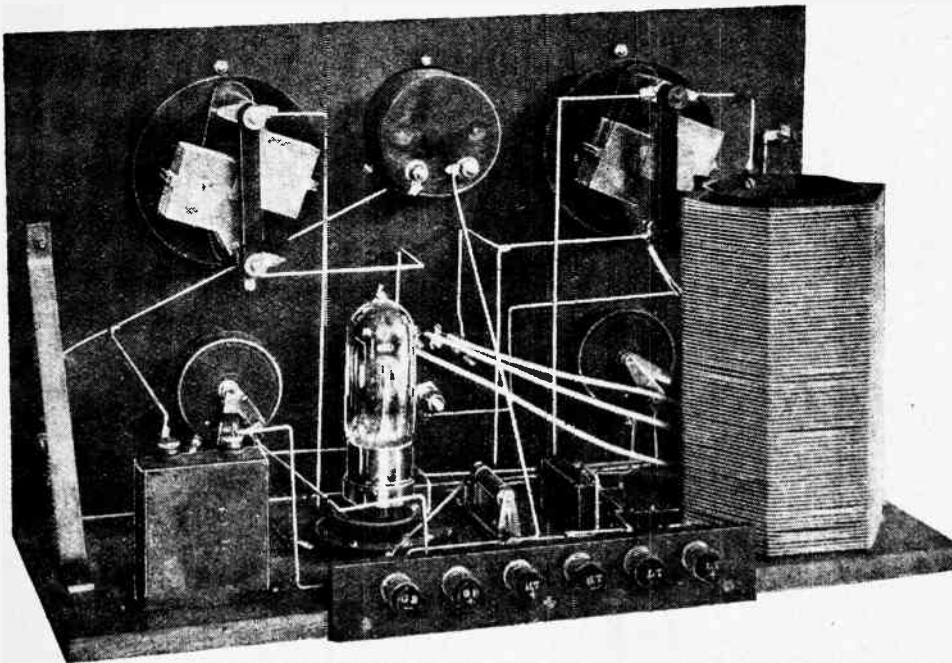

View from rear of receiver. The wiring is short and direct.

densers, which, however, are not subjected to the same strain as an expensive L.F. transformer, and will last considerably longer. Our valve can be a moderately priced dull emitter whose filament is heated by a small and comparatively inexpensive accumulator. We do not require 120 volts H.T., 40 to 60 volts being ample, and, furthermore, since the plate current will be small, we have no need to purchase the expensive large types of battery. We require no loud-speaker, but can purchase instead two or three pairs of really good headphones. As for the running costs, they are negligible. Our accumulator need cost us no more than 10s., and, if the correct slow-discharge dull emitter type is purchased, will give several weeks' service between charges. The plate current being small, even the small-cell type of 60-volt H.T. battery will last a considerable time, and when the time

modern and properly designed racing car is capable of greater feats of celerity than the more humble family affair, and yet from the point of reliability and service the ordinary man would undoubtedly choose the latter, the whole point being that the former is solely for the expert, and does undoubtedly need an expert to get the best out of it. It is exactly the same with the multi-valve wireless receiver. When designed, built, and handled by an expert, its potentialities are truly amazing, but the skill in construction and operation necessary to obtain real efficiency from it are far beyond the scope of the ordinary non-technical man working from a blue print. It is surely far better for the average man with little or no knowledge and the disinclination to spend £50 or so on a professional instrument of good design to confine himself to simple receivers whose construction

**Is My Set Interfering?**—

and operation are well within his powers. It is not going too far to say that the success obtainable with a home-constructed wireless receiver is in inverse ratio to its simplicity in design and construction. Given a well-designed and well-constructed single-valve receiver (and the constructional work need only be of the simplest type), it is surprising the number of distant stations that can be received at good strength on the telephones.

What, then, constitutes a good single valve set? Certainly not the conventional type of single valve receiver with its cumbersome moving coils and technically unsound direct-coupled aerial circuit. It has been shown by the writer in a recent article that success or otherwise in achieving long range results with a single-valve receiver depends on the smoothness or otherwise of the control over reaction. He furthermore showed in that article that one of the best methods of achieving that result was the Reinartz circuit.<sup>1</sup> The writer would go farther in this article and say that the more simple the particular form of Reinartz circuit used (and there are several variations) the better the results obtained. Furthermore, if we are to obtain the selectivity necessary to eliminate the local station, we must use a coupled aerial circuit. In the particular receiver under discussion, the writer uses one single coil and one coil only, this coil being as fixed and immovable as the rock of Gibraltar, and yet he would back it for sensitivity, selectivity, and reliability against any single-valve receiver using three moving coils, a fully tuned aerial circuit, variable grid leak, and all the other paraphernalia beloved of the "experimenter." He would not, however, attempt to

<sup>1</sup> *The Wireless World*, April 28th, 1926, page 608.

say that the receiver was capable of giving the same results as a good neutrodyne receiver capably handled, but he would say unequivocally that it will do a lot better in the hands of the ordinary man than a very large percentage of the home-made "2 H.F." receivers it has been his misfortune to encounter.

**The Oscillation Nuisance.**

There is, however, just one failing in a single-valve regenerative receiver which has led to its not being encouraged greatly by the powers that be ("Ah!" says the reader, "here comes the inevitable 'but'!"), and that is its power of annoying other listeners with its cacophonous caterwaulings when it goes into oscillation, as it usually does when placed in the hands of either the unskilled listener or the wilful ether-hog. There is, of course, no implement short of a heavy mallet which will prevent the wilful oscillator from pursuing his nefarious path, but the writer is still foolish and inexperienced enough to put his faith in human nature and to believe that the average honest citizen does feel genuinely distressed when he thinks that he is interfering with the pleasure of his fellow men, and he has, therefore, taken the trouble to include in this receiver an instrument which will give visual indication when the danger point is being approached, and will, as it were, throw out the "thus far and no farther shalt thou go" sign, and enable the conscientious citizen to keep from actually oscillating. Most people know that when they hear

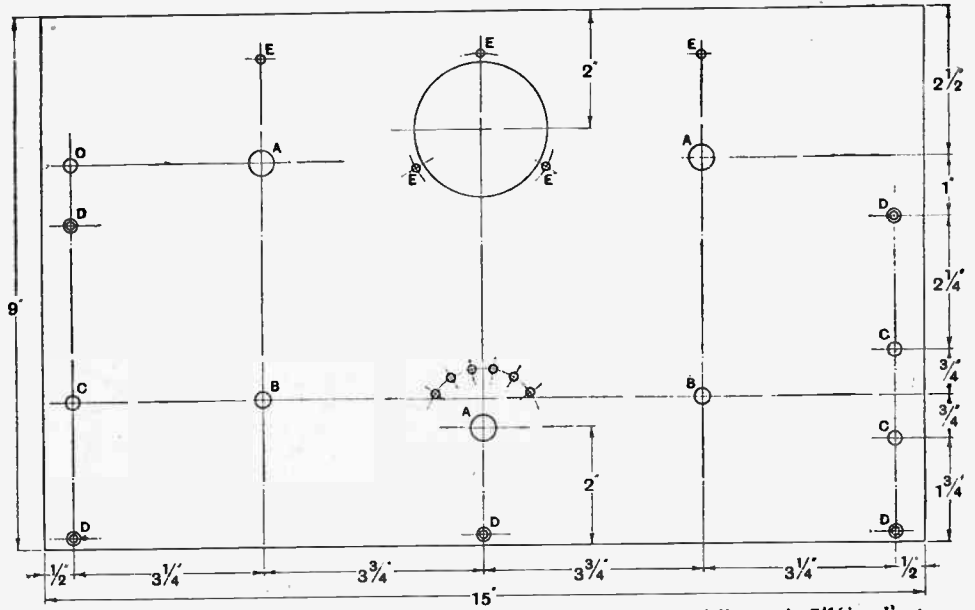

Fig. 2.—Dimensional details of the front panel. Drilling sizes are as follow: A, 7/16in. dia.; B, 1/2in. dia.; C, 7/32in. dia.; D, 1/4in. dia. and countersunk for No. 4 wood screws; E, 1/2in. dia.

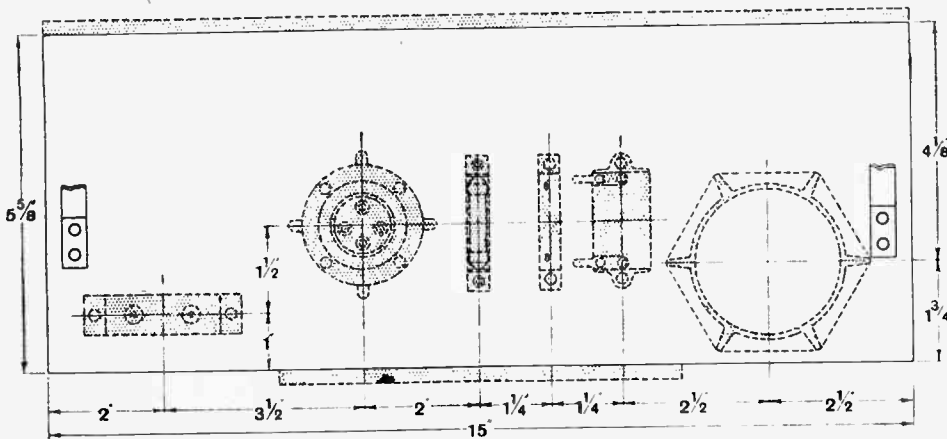

Fig. 3.—Layout of baseboard. All components should be well spaced as shown.

## LIST OF COMPONENTS.

- 1 Ebonite panel, 15in. × 9in. ×  $\frac{1}{8}$ in.
- 1 Baseboard, 15in. × 5 $\frac{1}{2}$ in.
- 1 Ebonite terminal strip, 7in. × 1 $\frac{1}{4}$ in. ×  $\frac{1}{8}$ in.
- 1 pair panel mounting brackets.
- 2 .0005 variable condensers with slow-motion dials (Newey).
- 1 Low-loss coil former, 6in. × 3in. (Becol).
- 1 Stud switch for panel mounting (Bower-Lowe).
- 1 .0003 mfd. fixed condenser (Dubilier).
- 1 .002 mfd. fixed condenser (Dubilier).
- 1 1 mfd. fixed condenser (T.C.C.).

- 1 5-ohm rheostat (Lissen).
- 1 400-ohm potentiometer (Lissen).
- 1 2-megohm grid leak (Dubilier).
- 1 Valve holder (Lotus).
- 1 Milliammeter with scale reading 0 to 5 (Sifam).
- 8 Indicating terminals, A., E., H.T.+, H.T.-, L.T.+, L.T.-, G.B.+, G.B.- (Belling Lee).
- No. 24 D.C.C. wire.
- 2 Dial indicators, "Tuner," "Reaction."

Approximate cost . . . £5

the familiar whistle in their headphones, when turning their dials, they are oscillating, but this is of little use in assisting to avoid the oscillation bugbear since once the whistle is heard, the mischief has been done. One often reads the rather futile advice of touching the aerial terminal with a moistened forefinger and that a particularly loud plop will result when oscillation sets in. This, again, is a case of locking the stable door after the horse has been stolen, and in any case one cannot sit in front of the receiver persistently tapping the terminal like an animated marionette, quite apart from the fact that usually both hands are necessary in tuning anything but a crystal set.

## Plate Current Milliammeter.

What is wanted, then, is some device which will give an indication of the approach of the oscillation point before the valve has actually commenced to oscillate.

This is so simply arranged for that it is a cause of great wonderment that it is not more often done. All that is necessary is that a milliammeter, with a suitable scale reading, be connected in series with the H.T. supply. It will then be found that when the receiver is switched on and the filament temperature and H.T. volt-

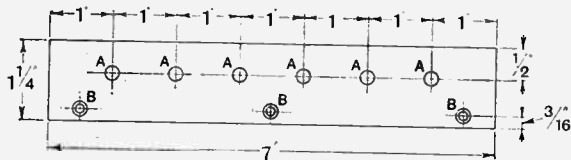

Fig. 4.—Details of terminal strip. A,  $\frac{7}{32}$ in. dia.; B,  $\frac{1}{8}$ in. dia and countersunk for No. 4 wood screws.

age suitably adjusted, the milliammeter will give a certain definite reading according to the characteristics of the valve employed. The actual value of the milliammeter reading does not concern us, but what does concern us is that as we increase the amount of reaction control the needle will steadily move from the original position it takes up, and when the critical point is reached and oscillation sets in the needle will give a sudden and very definite downward swoop. With a very little practice we shall be able to so manipulate our controls that we never quite reach the point where the needle will swoop and so indicate actual oscillation, and yet by careful practice we shall be able to take full advantage of reaction, since we shall be able to bring the needle right up to the point where previously acquired experience has taught us it is about to dip, and we know very well that we are now getting the full benefit of reaction and so getting the last

ounce possible out of the receiver, and any further application of reaction will be of no benefit, but will merely cause useless oscillation. Now we shall not be using a power valve, but merely a general-purpose dull emitter, or, better still, a high-impedance power valve like the D.E.5B. and an instrument with a scale reading of up to 5 milliamperes will be ample. A D.E.R., for instance, with the correct voltage of 40, when used as a detector and with the grid biased two volts positively, will have a plate current of  $1\frac{3}{4}$  milliamps., a D.E.3 having less, whilst a D.E.3B. will have a current of less than one milliamp. The use of a larger scale instrument is not advised since the movement of the needle will be too small to be of any real practical value.

## Points in the Design.

With regard to the actual receiver, it will be noticed that the single coil used is wound in the form of a solenoid, since experience shows that this form of coil winding is productive of the least losses. The carping critic will at once say that it is of little use making the coil low-loss if we are going to use grid current rectification and, in any case, we can make up any losses there may be in the coil by the application of reaction. Quite so. It is equally true, moreover, that if it be found possible to run a locomotive at a certain speed by a certain expenditure of energy, then it will be found also that when the brakes are partially applied a certain loss of speed is experienced and it will be a simple matter to counteract the losses so experienced and bring the speed up to its former value by the application of more power. Surely, however, it would be more economical to see that the brakes were *not* partially applied, and so maintain our desired speed at a less expenditure of power.

Another point worthy of note is the use of a potentiometer for adjusting the value of positive bias given to the grid of the valve for producing the usual cumulative grid rectification effected. Now it is fairly safe to say that in 90 per cent. of the receivers employing this almost universal method of rectification, the grid is made far too positive. In nearly all cases the best value is between  $1\frac{1}{2}$  and 2 volts positive, this value being easily ascertained from the curves supplied by the valve manufacturers, and yet how often does one see the grid return lead taken direct to the positive terminal of a six-volt accumulator, thus giving the grid a six-volt positive bias. The net result of this excessive positive bias is merely to cause very poor control over oscillation by the introduction of electrical "backlash," and this, of course, very seriously diminishes the useful range which can be obtained from



**Is My Set Interfering?—**

the receiver, and probably accounts for the poor results so often obtained by single-valve users. Indeed, it is not going too far to say that in all probability this technical fault is responsible for a great deal of the oscillation which is doing so much to bring the broadcasting receiver into disrepute, for one can well imagine a single-valve user rendered desperate by his erratic reaction control and resorting to the old, bad method of receiving stations by heterodyning its carrier wave and then descending to the silent point and steadily oscillating. When thus settling on the silent point, a heterodyne whistle will not be heard, of course, but the quality of reception obtained not only by the offender, but by all the unfortunates situated in the neighbourhood, will suffer considerably. The potentiometer is provided, therefore, so that the grid of the valve is correctly biased. The potentiometer will only consume a few milliamperes of current, provided, of course, by the accumulator, and no anxiety need be felt on this score, although the potentiometer should be connected as shown in Fig. 1, and not in its usual position directly across the low-tension terminals. Connected as shown, the turning off of the rheostat will effectively cut off all current from the potentiometer windings.

The grid bias terminals should be normally short-circuited by a piece of wire, and are provided for the insertion of a grid battery when it is desired to obtain maximum purity from the local station by the employment of bottom bend rectification, the potentiometer being again useful in adjusting the working point accurately on the bottom bend of the characteristic curve. Do not forget the by-pass condenser, which should shunt both the grid battery and the potentiometer windings. With regard to the variable condensers, they should be of a good type fitted preferably with some form of slow-motion dial. From the point of view of ease of control, it is highly desirable that the reaction condenser be of a type in which neither set of plates is connected to the operating shaft in order to avoid hand capacity effects, since both sides of the variable condenser are at high oscillating potential.

**Winding the Tuning Coil.**

The coil consists of a total of eighty-five turns of No. 24 D.C.C. wound on a low-loss former, six inches long by three inches in diameter, and is very simply constructed. The whole eighty-five turns are wound on in the same direction, and a tapping is made at the sixtieth turn for the grid end of the coil, this being for the L.T. — and earth connection. Five turns from the earth

tap comes the first aerial tap, the other three aerial taps being at the tenth, fifteenth, and twenty-fifth turns from the earth tapping, this twenty-fifth turn being the other end of the coil to which also is attached one side of the reaction condenser. The remainder of the constructional work is absolutely straightforward. It will be noticed that the receiver baseboard goes back less than six inches from the panel. If desired, this can be made to extend much farther back in order to make room for a small accumulator and a small H.T. battery, thus rendering the receiver completely self-contained. The only other part worthy of mention is the milliammeter. This instrument has two terminals marked positive and negative, and care

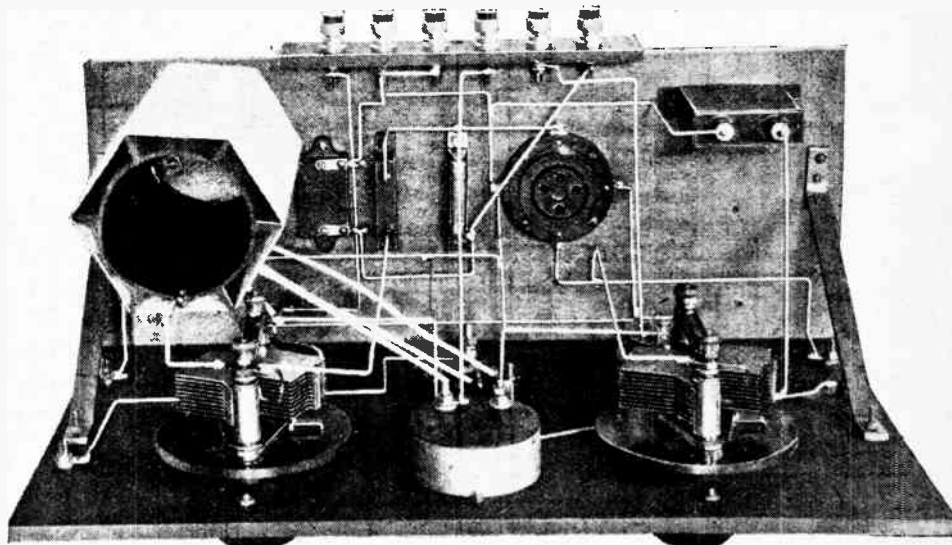

Plan view with valve removed.

should be taken to connect up as shown in Fig. 1, the 1 mfd. condenser shunting both meter and H.T. battery.

**Operation.**

When first putting this receiver into use, the first thing to do is to make the necessary adjustments for obtaining a smooth control over reaction. This is done by a careful adjustment of the H.T. voltage, which will probably be round about 40 volts, and a careful adjustment of the potentiometer. The user should not be satisfied with these adjustments until the receiver glides almost imperceptibly in and out of oscillation, until, in fact, the only indication of oscillation is that provided by the meter. If the receiver is so badly adjusted that oscillation stops and starts with an audible pop, the only station ever heard will be the local one. This receiver definitely will *not* receive Daventry, or any other long-wave station, and the writer declines to offer any suggestions for making it do so. Any switches or other arrangements included to effect this would not only destroy the simplicity of the receiver but would affect its sensitivity and ease of control on the normal broadcasting wavelengths, and would materially reduce its selectivity. In the writer's opinion it is on this very point where so many amateurs have come to grief. The high selectivity and sensitivity

**Is My Set Interfering?—**

of the good-class American receiver as compared with its British equivalent has long been a sore point among British listeners. One of the principal causes of this is that until quite recently the American manufacturers were not confronted with the problem of having to make pro-

headphones, but here again the primary winding must not be shunted by any condenser.

This receiver was first tested on a normal aerial and earth about eight miles from 2L.O, and by using fifteen turns in the aerial not the slightest difficulty was experienced in entirely eliminating 2L.O and in receiving, and receiving well, a large number of other stations both British and Continental. Tested on an indoor aerial in the same locality it was still found possible to receive several stations. Tested later on an outdoor aerial about three miles from 2L.O, it was found that that station interfered badly, using fifteen turns in the aerial. Reducing this to ten turns a number of other stations were tuned-in, although 2L.O could still be heard in the background. Using five turns only in the aerial 2L.O was completely eliminated, and other stations received, although, of course, their signal strength was considerably diminished.

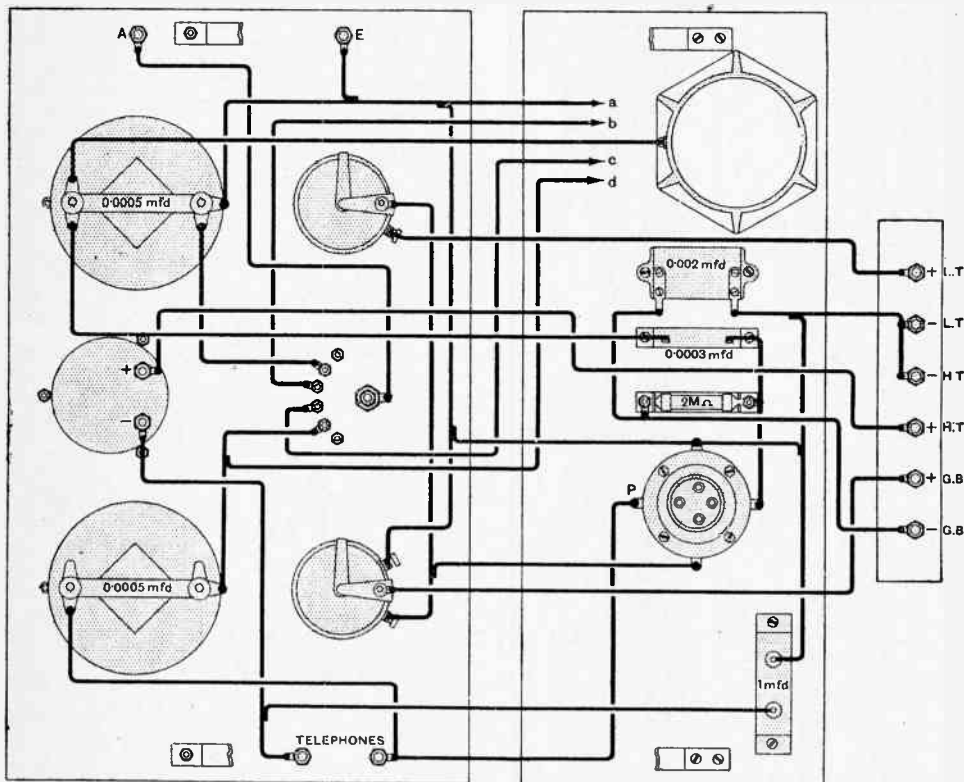

Fig 5.—Practical wiring diagram

**Conclusion.**

It should be pointed out with regard to the aerial switch that this should be made full use of, and careful experiment should be made with the various tapings, since the tapping

vision for the reception of a station far removed from the wavelengths of the other stations. Surely it is not worth while to sacrifice the chance of receiving innumerable British and Continental stations with the receiver for the sake of including Daventry and one or two long-wave Continental stations in its repertoire.

It will be noticed in this receiver that no H.F. choke is used, the reason being that it is unnecessary and superfluous, and would only be an extra component to the receiver without any compensating gain in efficiency. Do not, however, connect a fixed condenser across the telephones. An I.F. amplifier may be added in the normal manner, the transformer primary taking the place of the

which gives the best results on one aerial and on one wavelength will not necessarily give the best results on a different aerial, nor, indeed, on the same aerial on a different wavelength.

It is not claimed by the writer that those who construct this receiver will be able to achieve good results immediately. Patience and perseverance are necessary in learning to tune this receiver in the correct manner, but the necessary skill is easily obtained by the average individual after a few hours' practice, and once the knack is acquired the time and trouble spent will be amply repaid by the many hours of inexpensive enjoyment which this instrument will give.

**HIDDEN ADVERTISEMENTS COMPETITION.**

The following are the correct solutions of THE WIRELESS WORLD Hidden Advertisements Competition, June 2nd, 1926.

Clue No.	Name of Advertiser.	Page.
1.	London Electric Wire Co.	7
2.	Accumulators Elite.	12
3.	Stratton & Co.	3
4.	H. Morser & Co.	9
5.	Wilkins & Wright, Ltd.	5
6.	Alfred Graham & Co.	ii.

**The following are the Prizewinners:—**

Edwin Ellis, London, S.W.17	£5
J. W. Mann, Mytholmroyd, Yorks	£2
E. P. Beel, Glastonbury, Somerset	£1

**Ten Shillings each to the following:—**

M. Warner, Clapham Junction, S.W.11.	C. A. Wuy,
Milan.	H. J. Price, Cardiff.
	F. Lines, Acocks Green, Birmingham.

# HINTS and TIPS for NEW READERS

A Section Devoted to the Practical Assistance of the Beginner.

**PORTABLE CRYSTAL RECEIVERS.**

A moderately efficient aerial-earth system is generally regarded as essential for the operation of a crystal receiver, and stories of sets of this type which operate without an aerial at any distance from the transmitter are very properly regarded

ambitious sets, this will depend on local conditions.

It is recommended that the various earth connections which may be available, such as water or gas pipes, or even electric bell wiring, should be tried in turn. Incidentally, it may be remarked that a bell system, in conjunction with a water-pipe earth, and generally with a small condenser of 0.0001 mfd. in series, sometimes acts as a surprisingly effective aerial.

Such an impression probably gained currency in the early days of broadcasting, when the power of the transmitting stations was very much less than it is to-day. At the present time it may be said fairly definitely that conditions are exceptionally bad when a regenerative detector valve followed by two effective stages of low-frequency amplification fails to give adequate loud-speaker volume up to a distance of at least five miles with a short indoor aerial.

It cannot be denied, however, that the operation of a set with this kind of aerial is much less easy than when working under more favourable conditions: very possibly many have been discouraged by the difficulties encountered when making preliminary

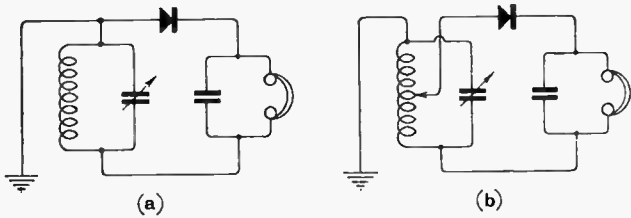

Fig. 1.—Crystal receivers without an aerial.

with suspicion. It is quite possible, however, to obtain comfortably loud telephone signals within a radius of a mile or two from a powerful main station by using an earth connection only, although results will be improved by the addition of even a rudimentary form of aerial.

Loudest signals will generally result from the scheme of connections shown in Fig. 1 (a), in which the earth lead is joined to the crystal end of the tuning coil, being actually in the position usually occupied by the aerial. If a short indoor aerial is used as well as an earth, it should be connected to the opposite end of the coil. Unfortunately, capacity effects are often troublesome when the wearer of the headphones moves about the room, but in spite of this drawback there are occasions when the knowledge that a simple receiver of this kind will afford reasonably loud signals may be of advantage. It is not possible to make any very definite statements as to the range obtainable; as in the case of more

required under unfavourable conditions, all reasonable precautions should be taken to prevent loss of efficiency, and when using a low-resistance crystal it will be found of advantage to join the crystal and phones across only a portion of the coil, as shown in Fig. 1 (b). The best tapping point will easily be found by trial, and is not critical.

**THE USE OF INDOOR AERIALS.**

It seems probable that there are still a large number of people living in flats or for other reasons unable to erect an outdoor aerial of normal dimensions who have abandoned the idea of making or purchasing a receiving set through a

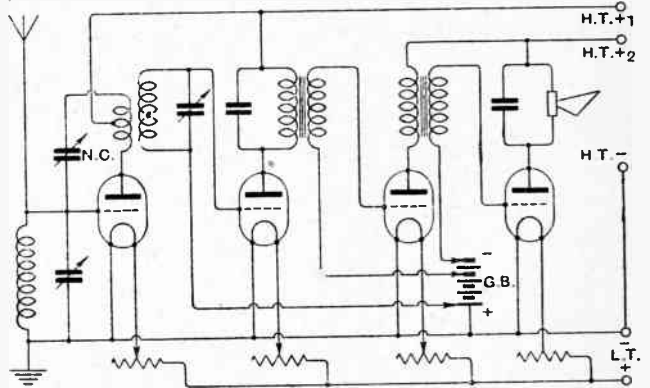

Fig. 2.—A sensitive receiver for use with an indoor aerial.

primary adjustments and clearing the small faults which so often have to be put right when setting up a new set. These difficulties are generally increased by the lack of a strong incoming signal.

The thoughts of those considering the installation of a set under the conditions we have imagined generally seem to turn towards the use of a frame aerial; this seems to be a mistake, as a very indifferent open aerial has superior receptive powers as compared with a frame of normal dimensions, which would seem to have no advantages other than its directional properties. Even from the point of view of appearance, the advantage is probably with the open aerial, which may be quite inconspicuous. At distances beyond the range of the simple detector-L.F. combination which has been already suggested, or where screening is exceptionally bad, a receiver wired to the circuit shown in Fig. 2 can be recommended with confidence for the reception of the local station. It consists of a neutralised H.F. amplifying valve followed by a "bottom bend" or anode rectifier and two transformer-coupled L.F. stages. On the assumption that a short indoor aerial is to be used, the addition of a coupled circuit is considered as neither necessary nor desirable, and, due to the small damping imposed by such an aerial, it will be found almost essential to adopt some artificial stabilising device; the "neu-

trodyne" method is suggested in this case as being most likely to give the best results.

o o o o

#### LOUD-SPEAKER FAULTS.

In searching for the causes of poor-quality reproduction one should not neglect the possibility of mechanical faults in the loud-speaker itself, particularly if the instrument has been dropped or otherwise mishandled. Experience proves that a distressing form of distortion may be caused by the vibration of some part lacking in rigidity. Sometimes this looseness is due to normal wear of the threads on the screw controlling the spacing between the magnets and diaphragm, although in the majority of the better designs a strong spring is fitted to take up any slackness.

Many loud-speakers of the "hornless" type make use of a thin steel rod to transmit movement from the armature to the diaphragm proper; this is occasionally a source of trouble, and it is as well to look carefully to the points of attachment at either end.

When the fault is definitely attributable to the loud-speaker the amateur would be well advised, before endeavouring to repair it, to

assure himself that he has suitable appliances for the work, otherwise it would be better to have it carried out by the manufacturers.

o o o o

#### L.F. HOWLING.

Low-frequency howling in a two-stage transformer-coupled amplifier is often traceable to the presence of a high resistance in the H.T. battery, across which by-pass condensers of one or two microfarads are usually shunted in an attempt to provide a low-impedance alternative path.

In certain cases, particularly where high-ratio transformers are used, it will be found that comparatively small battery resistances are sufficient to set up howling, and, as condensers of the capacities mentioned themselves offer a by no means negligible resistance to currents at the lower audible frequencies, their presence may do little to overcome the cause of the trouble.

The most obvious remedy is to increase the by-pass capacity to a value offering a really low resistance to currents of the frequencies to be dealt with. In practice, additional condensers may be connected in parallel with the existing ones, and a total of some five microfarads may be necessary.

### DISSECTED DIAGRAMS.

#### No. 32.—Improving a Simple Valve Receiver.

*In the present series of diagrams it is proposed to show how various popular types of receivers may be improved and brought into line with modern practice. By treating the various points separately, necessary alterations in wiring are clearly shown. The suggestions made below apply equally to a valve detector followed by L.F. amplification.*

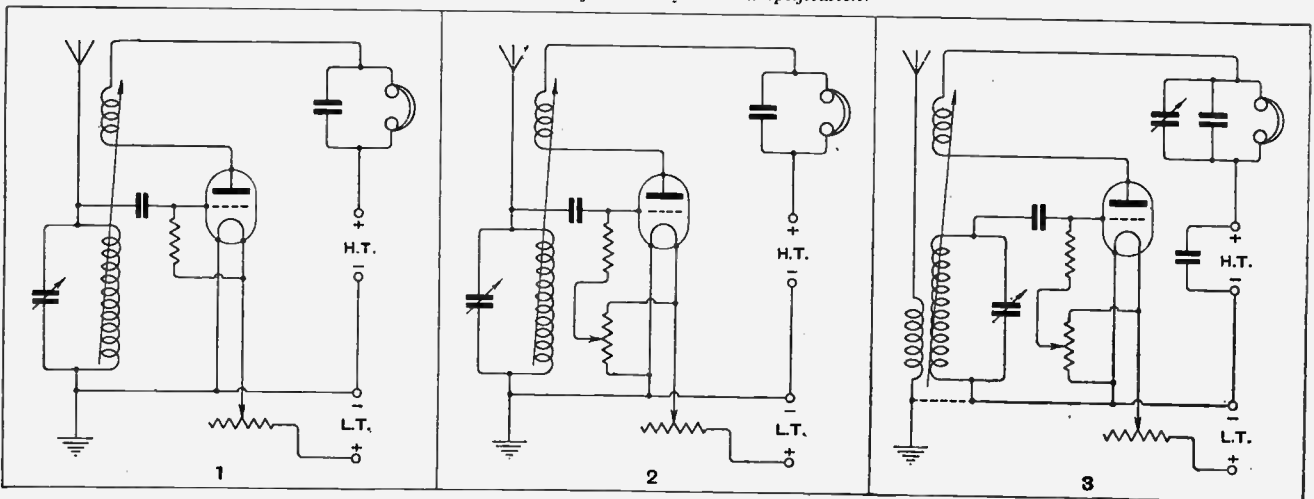

1. The circuit diagram of the simplest form of regenerative single-valve receiver. Such a set may suffer from lack of selectivity, poor detection, and difficult reaction control with bad "overlap."

2. The grid voltage may be accurately adjusted by connecting the lower end of the leak to the slider of a potentiometer, permitting a compromise between most efficient detection and smoothest reaction control.

3. The addition of a loose-coupled aerial circuit will improve selectivity, while a variable condenser shunted across the phones acts as a "vernier" control of reaction. A large H.T. by-pass condenser is suggested.



# CURRENT TOPICS

## Events of the Week in Brief Review.

### LIGHTNING STOPS A PROGRAMME.

"Radio Paris" was struck by lightning last Wednesday evening and had to abandon its programme.

### DAIL'S DELAY.

Dublin broadcast pirates are being given a breathing space by the delay in the Dail over the Bill which will give 2RN a full legal status.

### THE EMPTY BANDSTAND.

Following the recent experiments in broadcast reception with loud-speakers in the Temple Gardens bandstand, London, the L.C.C. is to make further tests in Battersea Park.

### DOWN IN THE DEEP.

The B.B.C. promises us a thrill on July 5th, when a diver will talk into the microphone while he is at work under the Thames. It would give us a greater thrill to hear a talk from a miner at work in a coal mine.

### INDIA'S BROADCASTING DIFFICULTY.

The two projected broadcasting stations in India, at Calcutta and Bombay respectively, will, it is hoped, be ready for transmission by the next cold weather season. One problem which is perturbing the promoters is the difficulty of obtaining programme talent.

### RADIO BELGIQUE INCREASES WAVELENGTH.

The famous Brussels station appears to have settled down on its new wavelength of 486 metres. Transmission is considered to have been improved though clashing occurs with Munich and Varsovie.

### RESERVE OF AIR FORCE OFFICERS.

The Air Ministry announces that vacancies exist in the Reserve of Air Force Officers for candidates requiring to be trained as pilots *ab initio*. Applicants, who should be of good education and physique, but need not have had any previous flying experience, must with certain exceptions be between the ages of 18 and 25. Full particulars may be obtained from the Secretary (S.7 Reserves), Air Ministry, Adastral House, Kingsway, London, W.C.2.

### WIRELESS TELEPHONY IN THE AIR.

This year's Royal Air Force display at Hendon on July 3rd will show the immense progress which has been made in the wireless telephonic control of manoeuvres during the last twelve months.

A special demonstration of air drill conducted by wireless will be given by the No. 25 squadron equipped with Grebe fighting scouts.

### AMPLIFIERS BANNED.

The use of a microphone and loud-speaker for religious services on the beach has been forbidden by the Eastbourne Watch Committee.

### WIRELESS AND THE MOTOR.

The Golders Green and Hendon Radio Society will hold a motor picnic on Berkhamsted Common on Sunday, June 27th.

### RUGBY TELEPHONY SUSPENDED.

No telephony experiments are at present being conducted from the Rugby high-power station owing to the need for economy in coal.

### WIRELESS IN OCCUPIED TERRITORY.

Steamers on the Rhine passing through occupied territory are now permitted to use wireless transmitters and receivers. The transmitters are limited to a power of 250 watts and must use the 600-metre wavelength.

### INTERNATIONAL PROGRAMMES BEGIN.

The International Radio Bureau at Geneva, in accordance with its aim of bringing about a better understanding between the nations, has inaugurated a novel series of programmes, the first of which was given last Wednesday, June 9th. On this occasion a programme arranged by Norway, comprising Norwegian music and literature, was broadcast in eleven countries, including Iceland, Spain, Sweden, and Austria. Aberdeen was the B.B.C. station taking the special programme.

### 4,000 VIOLINS IN ACTION.

The microphones will be strained to their uttermost at the Crystal Palace on Saturday next, when 4,000 child violinists belonging to the National Union of School Orchestras will play at the 17th annual concert of the Union. H.M. Grenadier Guards Band will assist the performers, who have been selected from schools in London and the Home Counties.

The broadcasting of the similar concert last year was highly successful; this year it is hoped to effect even clearer transmission. London and Daventry will transmit the concert between 6 and 6.30 p.m.



**A MODERN SHIP TRANSMITTER** The 1 kilowatt transmitter, suitable for both Morse and telephony, installed on the new German liner "Hamburg." The present day trend towards compactness is clearly shown in this neat layout.

### INDEPENDENT CZECHO-SLOVAKIA.

The Czecho-Slovakian Government has received a memorandum from the Federation of Radio Manufacturers requesting that no more wireless concessions be granted, that the regulations for import licences be altered, and demanding an increase of 140 crowns per kilogram in the import duty on radio material, which is now 60 crowns per kilogram.

**PREPARED FOR BREAKDOWNS.**

The recently launched "Ile de France," the largest transatlantic liner in the French marine, is to have six separate wireless installations.

○○○○

**DISCONTENT IN LIVERPOOL.**

Liverpool listeners are complaining that the programmes from the local relay station practically amount to ordinary telephony and not wireless, as the bulk of the material comes by land line from London and suffers from land line distortion. One critic remarks that "the human voice sounds like nothing on earth."

○○○○

**DENMARK'S NEW HIGH-POWER STATION.**

The contract for a new high-power broadcasting station has finally been drawn up by the Danish Government, and considerable speculation is being made in all quarters as to which firm will eventually secure the order for the construction of the station, writes a correspondent.

The work has now been offered on contract to several well-known wireless firms. Among these there are three Danish engineering firms, but it is not thought that they will secure the order. Of the remaining firms, none of which are Danish, four have been asked to tender for the work. These include two British firms, namely, the Western Electric Company and the Marconi Company. Both these firms have created a very good name for themselves in Denmark, and it is hoped among a great number of Danish wireless amateurs that one of these companies will secure the order. The other two foreign companies who have also been asked to tender are the Telefunken Company and "La Société Française Radio-Électrique."

The new high-power station will, no doubt, be very well heard in Great Britain, and it will be a further station to add to the Continental stations which have now become a source of pleasure for British listeners.

○○○○

**THE NEW RIO STATION.**

The new high-power wireless station at Rio de Janeiro, which was opened recently by the Brazilian Minister of Communications, has been equipped with a high power valve transmitter by Marconi's Wireless Telegraph Company.

The station is being used for communication between Brazil and Europe, Africa, Australia, North America, and the various countries of South America.

○○○○

**ROBERTS REFLEX RECEIVER.**

Some months ago we published an article describing the construction of a receiver embodying a circuit of American

origin known as the Roberts Reflex. Very great interest was shown in this receiver, and we are therefore arranging to include in our next issue a description of a similar receiver, but built to a new design and with certain modifications bringing it more into line with modern practice.

○○○○

**INTERNATIONAL PROGRAMMES FROM SPAIN.**

"Radio Catalana," one of the best known of the Spanish broadcasting stations, has increased its power to one kilowatt. The station is organising an

**LOUD-SPEAKERS IN A CATHEDRAL.**

Loud-speakers and microphones have been brought into use to improve the acoustic properties of Cologne Cathedral.

○○○○

**WIRELESS OPERATORS ENQUIRY OPENED.**

The hearing by the Industrial Court of the claims in connection with the service conditions of sea-going wireless operators opened last week, the Court consisting of the President, Mr. J. McKie Bryce, and Mr. D. C. Cummins. It may be recalled that when a settlement of the recent strike of wireless operators was reached it was decided that any outstanding points should be referred to this Court.

Among the questions to be dealt with will be those affecting wages, hours of duty, and pensions.

○○○○

**WIRELESS AT WESTMINSTER.**

BY OUR SPECIAL PARLIAMENTARY CORRESPONDENT.

**P.M.G. AND THE B.B.C. "EDITORIALS."**

Last week in the House of Commons, Sir W. Mitchell-Thomson, Postmaster-General, informed Mr. Day that he had been in communication with the British Broadcasting Company, and he understood that care was now being taken to avoid the broadcasting of statements which might be regarded as being of a controversial character.

○○○○

**AUSTRALIA AND THE RUGBY EXPERIMENTS.**

Sir Archibald Sinclair asked the Postmaster-General whether, in view of the statements of the managing director of Amalgamated Wireless (Australasia), Ltd., that Australia had wireless stations capable of conducting experiments in wireless telephony with those in this country, that the stations were ready, and that they were willing to co-operate on receipt of an invitation from Great Britain, he would say whether that invitation would be extended; and, if not, for what reason?

Sir Wm. Mitchell-Thomson replied: "I have communicated with the Australian authorities and I understand that the Australian Wireless Company have no stations which could undertake suitable radio-telephonic transmission to this country. Two-way experiments are therefore impracticable; but they have offered to receive the experimental transmissions from Rugby and report their strength. I have informed them that I welcomed this offer, and I have furnished the necessary particulars of the Rugby transmissions.

"Unfortunately, however, it has been necessary to suspend the Rugby experiments during the present emergency in order to economise coal."



**WIRELESS PICTURE RECEPTION AT SEA.** Prof. Max Dieckmann with the radio picture receiver with which he had been conducting experiments in the s.s. "Westphalia." Weather charts transmitted from Hamburg Observatory were received successfully and displayed on board ship.

interesting series of international programmes, each devoted to the music and literature of a particular country. On Monday last, June 14th, Radio Catalana transmitted a programme dedicated to Swiss amateurs, and on Monday next a special transmission will be made for the benefit of Germany. Radio Catalana employs a wavelength of 462 metres.

○○○○

**WINGS AND WIRELESS.**

Pigeon fanciers throughout the country are issuing an appeal to wireless users to deck their aerials with corks or similar objects likely to prevent the birds from injuring their wings on semi-invisible wires.



# Broadcast Brevities

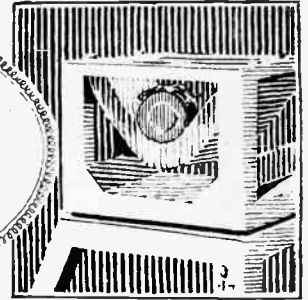

## Savoy Hill Topicalities: By Our Special Correspondent.

### High-power Experimental Station.

For experimental purposes only, a station operating on 300-500 metres and with a power of 10-15 kW. will be working shortly at Daventry. It will not transmit during B.B.C. programme hours and its work will be entirely devoted to testing the possibility of conducting a service on high-power within the present broadcast waveband and without causing interference to other wireless services.

○○○○

### 100 Per Cent. Alternative Service.

Upon the success of the experiments will depend the inauguration of the scheme of higher-power stations for the provision of alternative programmes. The present computation is that 85 per cent. of the population is within range of a broadcasting service. The ambition is not only to increase the percentage to 100, but to give the majority of that 100 per cent. an alternative service. This applies to crystal users; but the valve user will still be better off; for as the facilities for crystal reception extend, so the number of alternative programmes available for valve users will increase. If development proceeds uninterruptedly, London listeners will eventually have a choice of four programmes.

○○○○

### Just Bad Luck.

Recent breakdowns at 2LO have again drawn attention to the possibilities of failure in parts of the transmitting apparatus which cannot be foreseen and are to be ascribed in great measure to a run of ill-luck.

○○○○

### The Cause of Breakdowns.

Cessations are generally due to an obscure cause which may take a considerable time to trace. The matter of an oscillator valve burning out and its replacement is quite simple; but some of the defects that occur are not remediable quickly. For instance, there may be a broken connection in the drive panel H.F. choke, shorted turns and brushing may occur in the tuning inductances, or, as on a recent occasion, a disconnection may occur in the grid resistance of the modulator panel. Last week's interruption was caused by internal disconnection in the grid negative biasing battery.

### More Interruptions this Year.

It is almost invariably the case that these mishaps crop up at an unfortunate moment in the programme; hence the conspicuous ill-luck that the London station has suffered. Listeners should, however, take heart of grace. The material used is always improving and the mechanical details are under constant supervision. The percentage breakdown during this year is so far comparatively



**MELBA'S FIRST BROADCAST.** The famous prima donna, whose farewell performance at Covent Garden was heard by listeners on June 8th, was the first artiste to use the broadcast microphone in this country. The photograph shows Dame Nellie before the carbon microphone at the Marconi Works, Chelmsford, on June 15th, 1920.

high, i.e., 0.42 per week, as against 0.08 per week for the whole of 1925.

○○○○

### Summer Programmes.

I gave details last week of the proposed changes in the talks programme during the summer months. These alterations will take effect as from July 1st.

### "Tune In" on July 3rd.

On July 3rd, the day on which Sir Harry Lauder gives the third and last of his present series of broadcasts, a new radio revue, successor to "Radio Radiance" and "Listening Time," will "take the other." This will be called "Tune In," and the producer is James Lester. Sketches by George Murray and Sewell Collins, with music by various composers and a burlesque of "Hamlet" by Adrian Johnson, with music by Stanley Holt, will form part of the revue. Mr. Holt will conduct.

○○○○

### Broadcasting under Water.

The diving novelty which was announced some time ago and postponed has now been fixed to take place on July 5th. As already announced in *The Wireless World*, Mr. F. Shield, of Whitstable, will make a descent in the Thames.

○○○○

### A Diver's Life.

Mr. Shield tells me that he thinks most people have an entirely false impression as to the difficulties and dangers of diving work in general. Given a normal, healthy man, he says, there is no great danger to life, or health, in the ordinary work of a diver. But he intends to give listeners, as part of his broadcast, some idea of risks that a diver must take, as, for instance, that of entering a flooded mine, or crawling among submerged debris and dragging his air-pipe and other paraphernalia behind him. These are times when the diver's life is hanging by a thread.

○○○○

### The Theatrical Garden Party.

Sir Gerald du Maurier will to-morrow (June 17th), in a five-minutes' chat from 2LO, tell listeners something of interest about the Theatrical Garden Party, which takes place at Chelsea on June 22nd.

○○○○

### An English Cabaret.

An English cabaret will be broadcast for the first time on June 19th from the Cavour Restaurant. The artists are Miss Helen Chappy, who has already broadcast on several occasions; Mr. Sidney Nesbitt, with his ukulele, and who is a favourite radio "star"; Miss Elsa Lan

chester, who made her reputation in burlesque and grotesque dancing; and Miss Florence Oldham, who gives syncopated songs at the piano. Mr. Henry Carne, the well-known actor who was the interlocutor in Mr. Bernard Shaw's burlesque play, "Passion, Poison and Putrefaction," when it was broadcast from London some months ago, will compère the programme.

o o o o

#### Magna Charta Commemoration.

At Rummymede, opposite the little island where Magna Charta was signed, a ceremony to commemorate the historic event will be held on Sunday next, June 20th, at 3.15 p.m., and will be broadcast. An address will be given by Lord Hewart, Lord Chief Justice of England, and bands from Egham and Staines will take part in the broadcast. Among the notable people who are expected to be present are the Marquess of Lincolnshire, the Speaker of the House of Commons, and Sir Joseph Cook, High Commissioner of Australia, with Lady Cook.

o o o o

#### New Wavemeter for T.T. Transmissions.

The engineers' difficulties in finding a wavemeter that might commend itself to other broadcasting authorities have been mentioned in these columns on several occasions: but a new wavemeter has now been installed at Keston and great things are expected of it. The immediate purpose for which it will be used is the introduction of a series of tonic train test transmissions from the relay stations with the object of securing constancy. These transmissions will take place either within ten minutes of the start of the ordinary programmes or a few minutes after they finish. Time will show whether we have found in this wavemeter an instrument suitable for universal use.

o o o o

#### The Prince of Wales.

The Prince of Wales will broadcast from Enham Village Centre for Disabled Ex-Service Men on June 29. The speech by Major-General Seely, Lord Lieutenant of Hampshire, will also be transmitted on this occasion.

o o o o

#### Two Further Broadcasts.

By the way, the Prince is to be heard again by listeners in July. He is attending the meeting of the National Savings Association at the Albert Hall on the 9th. Then on August 4 his speech at the British Association at Oxford is to be broadcast.

o o o o

#### Programmes a Month Ahead.

There must be very few broadcasting organisations, controlling as many as ten stations, which are able to issue printed programmes in respect of each station for a whole month ahead. This feat is achieved monthly by the Canadian National Railways, whose CNR stations form a chain stretching from Moncton in the east of Canada to Vancouver on the Pacific coast.

### FUTURE FEATURES.

#### Sunday, June 20th.

LONDON.—Shakespeare's Heroines: Fay Compton as Ophelia.  
BOURNEMOUTH.—Popular Symphony Concert relayed from the New Central Hall, Southampton.  
GLASGOW.—Symphony Concert.  
MANCHESTER.—Radio Star Concert.

#### Monday, June 21st.

LONDON.—Chamber Concert from the Chenil Galleries.  
ABERDEEN.—A Gather-round in the Studio.  
BIRMINGHAM.—Fantasia on the T.T. Races arranged by Major Vernon Brook.  
BELFAST.—"Columbine"—The Belfast Radio Players.  
NEWCASTLE.—Frank Gomez and the Municipal Orchestra relayed from Whitby.

#### Tuesday, June 22nd.

LONDON.—Variety and Folk Songs.  
DAVENTRY.—Concert from Verrey's.  
CARDIFF.—Light and Shade.  
GLASGOW.—The Wingate Temperance Band.  
MANCHESTER.—The Haworth Public Prize Band.

#### Wednesday, June 23rd.

LONDON.—The Roosters. Light Symphony Concert.  
ABERDEEN.—The City of Aberdeen Police Pipe Band.  
BIRMINGHAM.—String Orchestral Concert relayed from the Midland Institute.  
BELFAST.—"Remnant Acre," a play in one act.  
MANCHESTER.—Music and Farce.  
NEWCASTLE.—Reminiscences of Opera.

#### Thursday, June 24th.

LONDON.—St. Hilda's Colliery Band. "Remnant Acre," a play in one act.  
BIRMINGHAM.—Studio Community Singing. Midsummer Day programme.  
BOURNEMOUTH.—A Sussex Evening relayed from the Mansfield Hall, Worthing.  
GLASGOW.—Symphony Concert.

#### Friday, June 25th.

LONDON.—"Manon" (Act. III) relayed from the Royal Opera House.  
ABERDEEN.—Ladies' Night.  
GLASGOW.—Chamber Music.

#### Saturday, June 26th.

LONDON.—Revue Memories.  
BIRMINGHAM. and NEWCASTLE.—Lester's New Revue.  
SWANSEA.—Aberystwyth Musical Festival relayed from the University Hall, Aberystwyth.

### A Travelling Diversion.

Monotony is the demon against which the radio organisation of the Canadian National Railways has to fight unceasingly. The programme directors have always to remember that many of their audience are listening in order to escape the boredom of a long railway journey. The programmes are of the lightest character, talks are decidedly few, and when a departure is made from music, it is generally solely for the purpose of giving time signals, weather reports, and lessons on parlour games, such as bridge, chess, draughts, etc.

o o o o

### Riot in the Ether.

There is a clockwork regularity about the progress of events in the ether, following a breakdown at 21.0. The sudden break in transmission is invariably followed by an awful and ominous hush, which persists for about thirty seconds. Then comes a cry like that of a distant meadow pippit. Other pippits join in and before a minute is up the ether is alive. The medley of screams, howls and whistles continues for another five minutes and then dies down. The ultimate silence tells only too plainly of dismantled sets and ruffled tempers. A high authority is said to have estimated that the amount of energy radiated in London alone during a broadcast breakdown would be sufficient to transmit Captain Eckersley's voice from 5XX, saying, "Please don't do it!" one hundred and ninety-seven times!

o o o o

### Qualifications of the Modern Announcer.

Mr. A. C. Hunold, the chief representative in Switzerland of the Northern News Service, which frequently supplies information to *The Wireless World*, has just been appointed as director and first announcer of the Broadcasting station at Zurich. Mr. Hunold speaks and writes English fluently and correctly, having studied at British Universities and passed in English and in the History of Art and Literature at University College, London. *The Radio-Programm* of Zurich, in announcing this interesting news, gives a portrait of Mr. Hunold, and in congratulating him on the appointment, wishes him every success in a post requiring a knowledge of German, French, Italian and English, as well as of Art, Music and Literature, plus the journalistic touch, which will enable him to cater for listeners-in, both in Switzerland and the other European countries which receive the wireless programmes from Zurich.

o o o o

### Card King at the Microphone.

Datas, the man with the memory, will be unable to broadcast on June 17th, as originally arranged. His place in the programme will be taken by Carlton, who is known alternatively as the Card King and the Human Hairpin. Carlton will explain to listeners how he does some of his wonderful card tricks, and will also explain some of the mysterious things that can be done with figures.



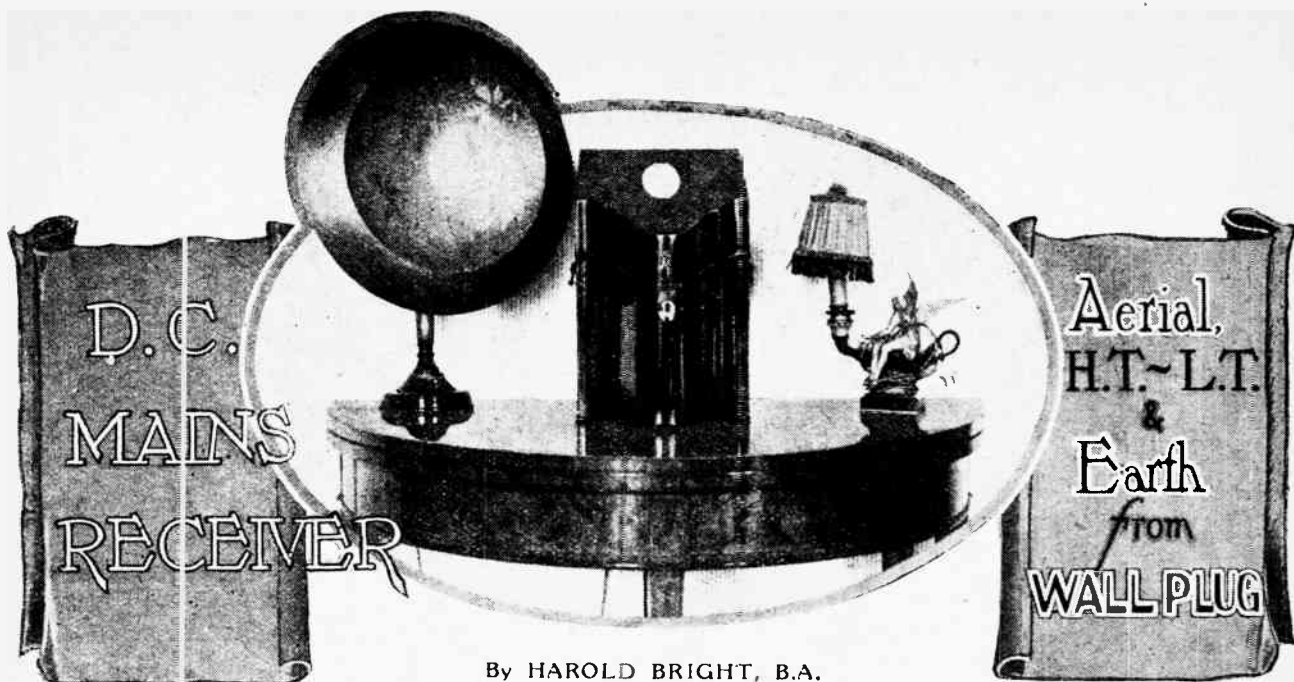

By HAROLD BRIGHT, B.A.

As will be seen from a glance at the illustrations of this receiver, it is not of a design that many would wish to copy, and for this reason the writer does not propose to give full constructional details, but to deal rather with some of the considerations which influenced the design.

The set draws all its requirements from 240-volt D.C. mains, filament and anode current, grid potentials, and aerial energy. It was designed to comply with these conditions, viz., that it must

- (1) Work a loud-speaker without distortion from the local station (only two miles distant).
- (2) Require no attention at any time for battery renewals, etc.
- (3) Have only one switch to operate it.
- (4) Be portable within the house.
- (5) Have a minimum of loose connections.

Regarding (3), tuning controls were provided in case of possible wavelength changes, but they are never used except to adjust the volume. Condition (5) is reasonably fulfilled, as the only external wire is a twin flexible ending in a twin-pin plug which fits a wall socket on the house wiring. The loud-speaker cord ends in a smaller plug connecting with a socket at the back of the cabinet.

The first matter to be calculated was the running cost, and in order to keep this a minimum all the valves (which are of the 0.06 class) were connected in series, with the rheostats shunted across them potentiometer-wise. In order to allow these rheostats to be of fairly low value, they were designed to

carry the same current as the valves when in their normal working position. This fixed the total current at about 0.12 amp., which represents at 240 volts a consumption of under 30 watts. This is the figure actually obtained, and, at a rate of 5d. per B.O.T. unit, works out at over six hours' running for a penny.

The external appearance of the set is shown in the photograph in the title of this article, where it is seen connected to a Sterling "Mellovox" loud-speaker. It is built in a Sheraton knife box, which completely conceals it, the hinged lid closing over the panel.

The circuit used is given in Fig. 1, and, as far as the grids and anodes are concerned, is a normal tuned anode, reacting detector and transformer-coupled low-frequency arrangement. The tuned grid circuit of the first valve derives its aerial energy from the positive main through a coupling condenser,  $C_3$ , of 0.00025

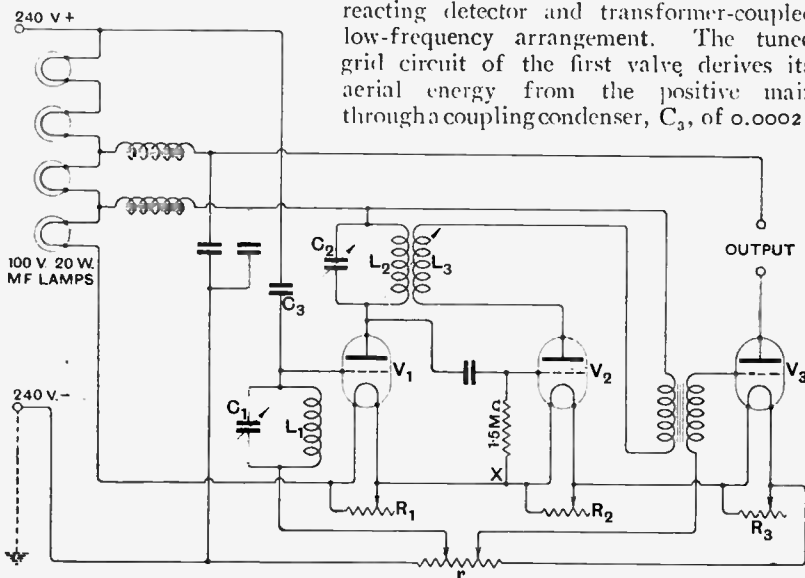

Fig. 1.—Complete circuit diagram of the receiver.

**D.C. Mains Receiver.—**

mfd. The reaction coil  $L_3$  is coupled with  $L_2$  so that the set can nearly be made to oscillate. Connected also in the series mains circuit and at the negative end of it is the resistance coil  $r$ , of such a value that there is a drop of about 6 volts along it. This serves for grid biasing the first and last valves, the grid wires of which are connected to sliders moving along it. The grid leak of the detector valve is connected to the point X, so that it is at a potential slightly more positive than its own filament. After trial it was found that  $r$  could have been dispensed with by connecting the filaments in the order  $V_3V_1V_2$ , as in Fig. 2, so that sufficient grid bias could have been obtained from sliders on the filament rheostats.

**The Resistance Lamps.**

The device by which the current from the mains is kept down to the 0.12 amp. is a bank of four 100-volt 20-watt tubular lamps in small bayonet holders, which are all in series with each other and with the valves. Thus they have only about 50 volts across each, and do not burn at full brilliance, so that their life should be a very long one. The amount of heat generated is small and is effectively dispersed through the ventilating door at the back of the cabinet, which can be seen in Fig. 3. In this photograph the three filament resistances with their phosphor-bronze sliders are also visible, and somewhat above them the grid bias resistance  $r$ . All four were wound on pieces of gauge-glass tubing, as ebonite or fibre would have warped with the heat. Immediately behind are the four resistance lamps, and at the top the bases of the valves can be seen above the valve holder platform. All adjustments necessitated by the changing of a valve can be made without removing the instrument from its case.

In Fig. 4 the top of the panel is shown. The nearer condenser is the A.T.C., the A.T.I. being mounted vertically near the lamp holders. The aerial coupling condenser  $C_3$  is next to the A.T.I. and just in front of

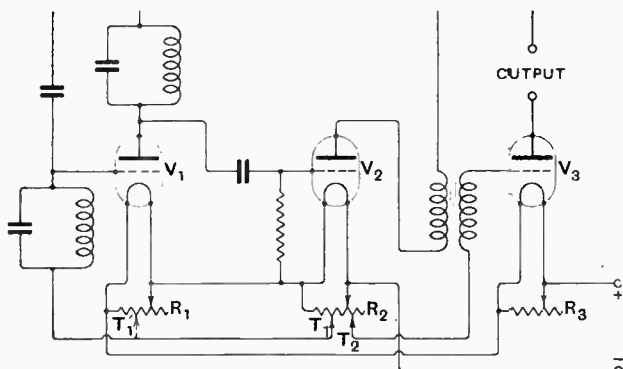

Fig. 2.—Schematic diagram of filament and grid connections  $T_1$  and  $T_2$ ; grid bias tappings;  $T_1$ , alternative position for  $T_1$ .

the transformer. It will be noticed that, in order to avoid microphonic disturbances, the valve platform is cushioned in its brackets with sponge rubber, and the holders themselves are of the sprung variety.

The stud switch between the condenser dials is a tone control device which shunts various condensers across the

output terminals. The lowest knob is the on-and-off switch, described later.

The last view, Fig. 5, shows the anode condenser, on the back of which is mounted the anode coil and the basket reaction coil closely coupled to it. Below are

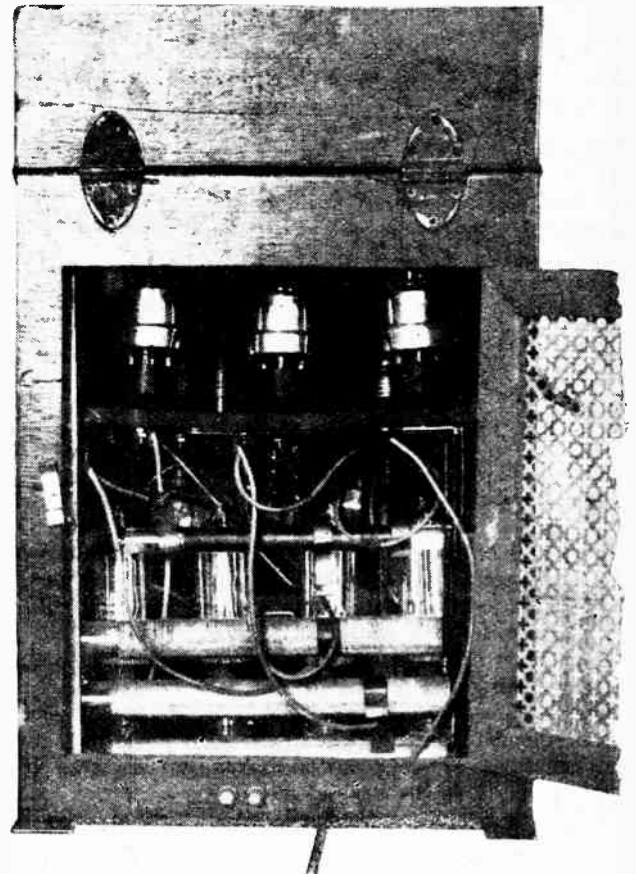

Fig. 3.—Back view of cabinet showing ventilating door and tubular filament resistances.

the Mansbridge smoothing condensers, with the hedgehog chokes immediately behind. These chokes were specially wound with 6,000 turns of No. 42 S.W.G. enamelled wire, paper insulated every few layers. The iron wire core was turned over so as to surround the bobbin completely, and the whole bound with insulating tape.

It will be noticed that the smoothing arrangement is very simple. There is a hum from the mains which is slightly audible when there is no broadcast on, but the addition of more condensers did not seem to reduce it. It is unnoticeable during the programmes, and so no further effort has been made to deal with it.

**Varying the H.T. Voltage.**

An anode potential of the order of 100 volts is applied to the last valve, but if more volume had been required a 6-volt valve of the c.06 class could have been used as a power amplifier, and a plate potential of 150 volts used by tapping off the next lamp. Owing to the convenience with which high anode voltages may be obtained,

**D.C. Mains Receiver.—**

this arrangement is particularly suitable for use with resistance-capacity amplification. The writer has had a three-stage amplifier of this type working off 240-volt D.C. mains for the past two years with very satisfactory results.

Before this set was built in its present cabinet it was laid out on a board and a number of experiments carried out prior to success being obtained.

**L.T. Current Surges.**

Owing to the resistance of metal filament lamps being lower when cold than hot, it was found that, when the current was suddenly switched on, a momentary surge passed through the valves, causing them to flash brightly and tending to burn them out. No form of simple series

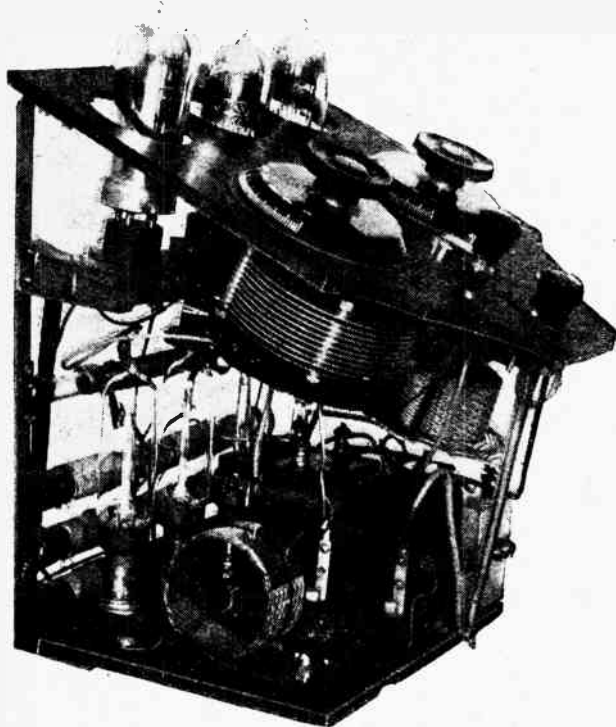

Fig. 4.—Receiver unit removed from the cabinet. This view clearly shows the arrangement of the controls on the top panel and also the positions of the valves and resistance lamps.

resistance seemed very successful in overcoming this difficulty, so a switch was designed which in its first position lighted the lamps but short-circuited the valves. This reduced the trouble considerably, as the lamps were already hot when the valves were switched on, but another intermediate step was provided which opened the valve circuit through a resistance. The arrangement is shown diagrammatically in Fig. 6. In the same switch there is a contact which breaks the circuit also at X to remove the potentials from the smoothing and coupling condensers when the set is not in use.

The principal claims made for a set of this type are its economy and convenience. The running costs are less than H.T. battery renewals alone in an ordinary receiver. Moreover, it is very satisfactory to feel that there is no risk of a battery running down at an inconvenient time

and that all the changing of cells, and in many cases the taking of them to be charged, is obviated.

It is thought that readers may welcome some additional suggestions which, in conjunction with the particulars

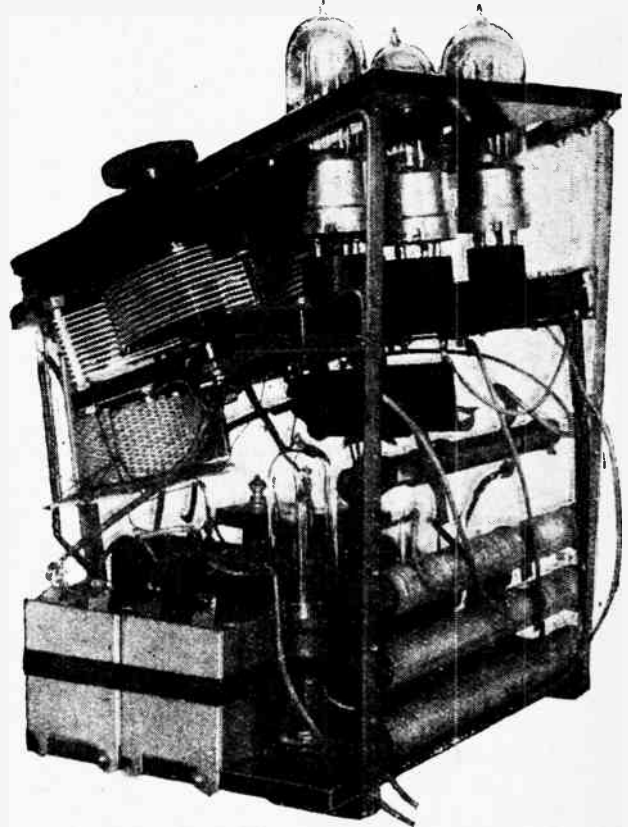

Fig. 5.—Another view from the rear of the receiver. The hedgehog smoothing chokes are mounted on the baseboard immediately behind the Mansbridge type smoothing condensers.

already given, should be sufficient to enable them to design a set to their own requirements. If, as is probable, an outside aerial is to be used, the aerial circuit must be loose-coupled to  $L_1C_1$ , whether one of the mains is earthed or not. Aperiodic tuning of this first circuit will

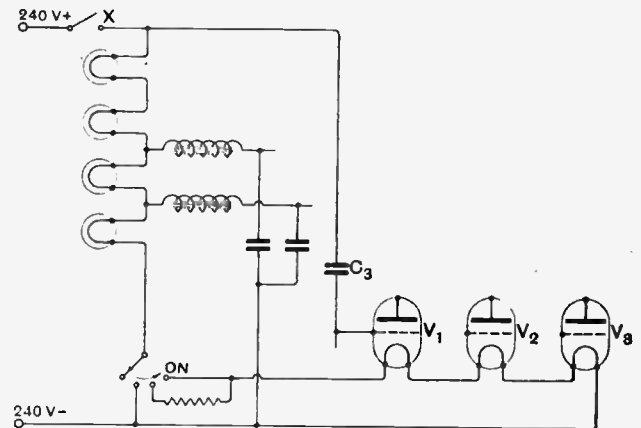

Fig. 6.—Connections of special switch to prevent current surges when switching on.

**D.C. Mains Receiver.**—

give good results in most cases, unless great selectivity is needed. Now that well-made filament rheostats of high resistance are available, they may be used for  $R_1$ ,  $R_2$ , and  $R_3$ , provided they are not overloaded. Additional clips or contacts will have to be provided for the grid wires if  $r$  is to be dispensed with.

On some electric supply mains the disturbances may be sufficient to necessitate more elaborate smoothing arrange-

ments to eliminate them. Care must be taken with the insulation of all portions of the circuit which are at a high potential relative to earth. The use of insulating sleeving of different colours is recommended to enable the high voltage wires to be seen at a glance.

In conclusion it may be of interest to mention that this set has been in frequent use for the past year without any mishap and without a valve having been changed. It has given completely satisfactory service throughout.



## TRANSMITTERS' NOTES AND QUERIES

**General Notes and Queries.**

As the result of his letter published in our correspondence columns on March 24th, Mr. Erwin Meissner (DE 0122), P.O. Box 30, Ettlingen, Baden, tells us that he has received replies from 13 British amateurs, including GI 6YW, G 2ZC, and G 6YQ, whose cards he gratefully acknowledges.

o o o o

Mr. Edmundo Guevara (CH 1EG), Casilla 69, Valcun, Chile, informs us that he is now operating an experimental station, using the call-sign CNAE and transmitting Morse on 42.6 metres and telephony on 40 metres. He is now working with an input of 150 watts, but will also be testing on 5, 10 and 32 watts, and will be glad to get into communication with British amateurs.

o o o o

**Tests from Belfast.**

Telephony and C. W. signals on 45 metres are being transmitted by Mr. T. P. Allen (6YW) from the Municipal College of Technology, Belfast, and reports from over 500 miles distant would be very welcome.

**Cards for Irish Experimenters.**

Mr. W. R. Burne, managing editor of *The Irish Radio Journal*, would be pleased to forward cards to Irish experimenters from amateurs in this country. Cards should be addressed to the station, c/o *The Irish Radio Journal*, 34, Dame Street, Dublin.

o o o o

**Changes of Address and Call-sign.**

The new address of 5 AI (Mr. A. H. Sheffield) is "Gleneagles," Whitehall Road, Chingford, Essex.

Mr. Stanley Newell (late 2 BJJ) has moved to 9, Western Road, Stacksteads, Bacup, and has been allotted the call-sign 5 RX.

The call-sign 2 BVR has been allotted to Mr. A. C. Grimes, 67, St. John's Road, West Cliff-on-Sea.

Mr. J. E. Howard Smith, of 110, Whiaker Road, Derby, has been allotted

the call-sign 6 ZG, in place of 2 ATA. He would be glad to arrange tests on Sundays outside broadcasting hours.

o o o o

**NEW CALL-SIGNS ALLOTTED AND STATIONS IDENTIFIED.**

- G 2BRH (Art. A.) E. Harvey, 28, Cowley St., Derby.  
 G 2BUJ (Ex-6IQ) H. Forshaw, 45, High Street, Standish, near Wigan. Transmits on 370 metres.  
 G 2BVO (Art. A.) H. F. Malcher, Station House, North Ealing, W.5.  
 G 2BWB (Art. A.) A. Blake, Ivy Cottage, Costessey, Norwich.  
 G 2KA B. Hodson, 31, Broomfield Avenue, Palmers Green, N.13.  
 G 5MG J. W. Green, Staveleigh, Knott End, near Fleetwood, Lancs. Transmits on 45 metres.  
 G 6ZA H. C. and L. A. Lafone, Hill Rise, Colham, Surrey.  
 G 6ZD S. Smith, 14, Hatters Lane, Berwick-on-Tweed.  
 GW 14B J. P. Campbell, Martello Terrace, Sutton, Co. Dublin.  
 GW 16B H. J. Duncan, 29, South Anne Street, Dublin.  
 GW 17B W. F. Warren, 130, Tritanville, Sandymount, Dublin.  
 GW 18B D. F. and D. M. O'Dwyer, 9, Upper Leeson Street, Dublin.  
 C 3XI J. E. Hayne, 303, N. Brock Street, Sarua, Canada.  
 ISRA Scuolo Radio Aeronautica, Viale Milizie 15, Rome.  
 G 5WT A. S. Wood, 37 St. James Road, Forfar.  
 G 5XD B. C. Christian, 7, Hutchinson Square, Douglas, I. of M. Transmits on 23, 45 and 90 metres.  
 G 6CL J. Clarecoats, 107, Friern Barnet Road, N.11. Transmits on 45 metres.  
 G 6LL J. W. Matthews, 178, Evering Road, Clapton, E.5.  
 G 6OU E. Willis, 9, Winchester Street, Basingstoke. (Change of address.)  
 GI 6YM Belfast Y.M.C.A. Radio Club, Wellington Place, Belfast. Transmits on 23, 45, and 150-200 metres.  
 GW 15B W. R. Burne, "Irish Radio Journal," 34, Dame Street, Dublin. Transmits on 45 metres and intends also to use 8, 23, and 90 metres.  
 GW 19B H. Goldsbrough, Kethard, Tipperary. I.F.S., transmits on 8, 15, 23, 45, 90 and 150-200 metres.  
 B 72 A. Embrechts, 15, Violetstreet, Antwerp.  
 B 2SM (Ex-J2 and W2) R. Couppez, 23, Rue Elise, Brussels.  
 D 7BX C. Schioedte, Bredgade 77, Copenhagen.  
 L 1JW J. Wolff, 67, Avenue du Bois, Luxembourg.  
 O AB J. L. Mossig, Am Hoc 13, Vienna I (Herr Mossig will be pleased to forward QSL cards to other Austrian amateurs).  
 R 1FL T. Lboif, Novaja Str. 40, Nichni Novgorod, Russia.  
 U 2ARM W. C. Andre, 62, Maple Av., Hackensack, N.J.  
 U 4EX L. C. Baird, Winter Gardens, Florida.  
 U 4XE J. Lee, Box 345, Winter Park, Florida.  
 Y 2JY C. S. J. Crooks, The Sugar House, Cossipore, Calcutta. Transmits on 33 metres.

**QRA'S WANTED.**

- |       |       |         |       |
|-------|-------|---------|-------|
| G 2LJ | G 2NC | G 2SC   | G 2RL |
| G 5DX | G 5SS | G 58Y   | G 5UR |
| G 5WL | G 6HU | G 6OT   | G 6ZA |
| G AKD | DCN   | SS 8LBT |       |

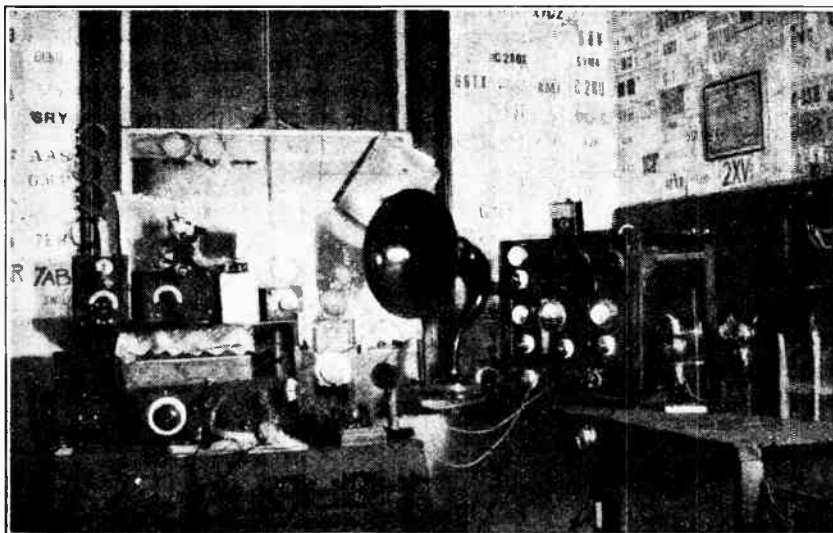

**A SHORT-WAVE STATION** Mr. Gerald A. Jeapes, owner and operator of 2XV, seen in the photograph, has communicated with more than 170 other amateur stations during the past nine months, using a wavelength of 45 metres and an input power of about 10 Watts. 2XV is situated at Great Shelford, Cambs

# WIRELESS CIRCUITS

## in Theory and Practice.

### 14.—The Valve as an Amplifier.

By S. O. PEARSON, B.Sc., A.M.I.E.E.

WE come now to the consideration of a three-electrode valve as an amplifier of small alternating voltages applied to the grid, and to discuss in brief the various plate circuit arrangements which will enable an amplified alternating voltage to be obtained for the purpose of operating on the grid of a succeeding valve in a cascade amplifier, and, on the other hand, for obtaining the greatest energy output from the plate circuit for actuating telephones, etc.

The ordinary anode characteristic curve of a valve shows the relationship between grid voltage and plate current when there is no external resistance or impedance connected in the plate circuit. It does not seem to be sufficiently well recognised that these conditions do not hold when a resistance or impedance is connected in the plate circuit. This is due to the fact that in the former case the plate potential is maintained constant for all values of plate current, whereas in the latter case any change in the anode current causes a change of anode potential, thus altering the conditions altogether. This change of anode potential occurs because it is at every instant equal to the difference between the voltage of the high-tension battery and the voltage across the resistance or impedance connected in the plate circuit.

Suppose that a small alternating voltage obeying the sine law is applied to the grid of the valve, the mean potential of the grid being so adjusted that the valve operates over the central portion of its anode characteristic curve corresponding to the particular value of plate voltage in use. Assume for the present that there is no external impedance in the plate circuit; then from the anode characteristic curve shown in Fig. 1 we see at once that the sine wave of voltage applied to the grid does not cause any change in the mean value of the plate current (provided operation takes place over the straight portion only of the curve), and no change would be indicated by a moving coil milliammeter in the plate circuit; but it

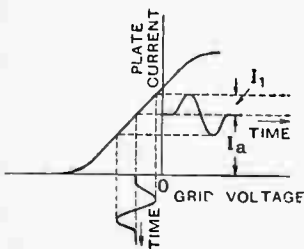

Fig. 1.—Diagram showing effect on the anode current of an oscillation applied to the grid of a three-electrode valve.

causes an alternating component of current to be superimposed on the mean value of plate current, this component also obeying a sine law. The plate current is now really made up of two separate currents added together—one a steady, direct current of magnitude  $I_a$ , and the other an alternating current whose amplitude is  $I_1$  (see Fig. 1).

If now a pure resistance  $R$  is connected in the plate circuit as shown in Fig. 2 (a), this resistance will offer equal opposition to both the steady and the alternating

components of the plate current. The first result is that the mean value of the plate potential will be lowered by an amount equal to the mean value of the voltage across the resistance itself. To increase the plate potential to its normal value again the voltage of the high-tension supply would have to be increased. The second result is that the alternating component of the plate current is

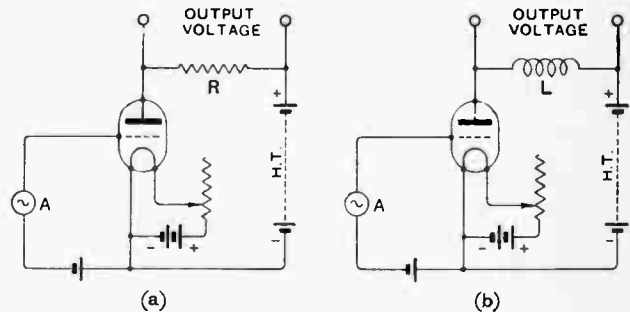

Fig. 2.—Three-electrode valve with load connected in the anode circuit; (a) pure resistance, (b) pure reactance.

reduced in amplitude because the total resistance of the plate circuit has been increased, and that an alternating component of voltage is set up across the series resistance. The whole object of the arrangement is to obtain this alternating voltage. It was shown in the last instalment that, if  $R$  is the external resistance in series with the plate,  $R_a$  is the internal plate to filament resistance of the valve, and  $\mu$  is its amplification factor, then the amplitude of the alternating voltage set up across  $R$  will be  $\mu \frac{R}{R + R_a}$  times the amplitude of the alternating voltage or oscillation applied to the grid, the amplification being independent of the frequency.

Now, in driving the plate current through the resistance  $R$ , a considerable amount of energy is wasted and converted into heat, this energy being drawn from the high-tension battery. Thus the arrangement is not economical; the higher the value of series resistance used the more wasteful it becomes for a given mean value of voltage on the plate itself.

#### The Use of a Choke.

Clearly then what is required in order to effect economy in power in the plate circuit is some device which will offer little or no opposition to the steady component of the plate current, and at the same time offer a high degree of opposition to the passage of the alternating component. Such an arrangement is easily obtained by connecting a choking coil of considerable inductance and of more or less low ohmic resistance in the plate circuit of the valve, as shown in Fig. 2 (b), in place of the pure resistance considered above.

**Wireless Circuits in Theory and Practice.—**

Assuming for the present that the ohmic resistance of the choke is negligibly small compared with the internal resistance of the valve, the mean plate potential will be equal to the voltage given by the high-tension battery, because a pure inductance offers no opposition to a steady current. The alternating component of the plate current, however, will set up an alternating magnetic field through the coil, and this field will induce an alternating voltage or back E.M.F. in the coil in such a manner as to choke back the (alternating) current. Since a pure inductance does not consume any energy we see that no energy is wasted, as heat in the external part of the plate circuit. If  $L$  is the inductance of the coil

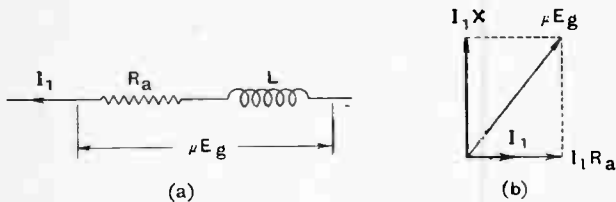

Fig. 3.—Simple circuit (a) equivalent to choke in series with internal resistance of valve; and (b) the corresponding voltage vector diagram.

in henries, and  $f$  the frequency of the alternating component of the current, the reactance  $X$  of the coil is given by  $X = 2\pi fL$  ohms. This is the opposition offered to the alternating component of the current by the choke.

**Voltage Amplification with a Choke.**

If  $E_g$  is the amplitude of the alternating voltage applied to the grid, then there will be the equivalent of an alternating voltage whose magnitude is  $\mu E_g$  "induced" into the plate circuit, where  $\mu$  is the amplification factor of the valve. This voltage is expended in driving the oscillating component of the plate current through the internal resistance  $R_a$  of the valve and through the reactance  $X$  of the choke. Thus the total alternating voltage (amplitude) across  $R_a$  and  $X$  in series will be  $\mu E_g$ . Now, it will be remembered that for a pure inductance the current lags in phase by exactly 90 degrees behind the voltage.<sup>1</sup> Further, the internal resistance of a valve is almost in the nature of a pure resistance, except for very high radio frequencies, where the effects of inter-electrode capacity become appreciable. Thus for all moderate frequencies the choke in series with the internal resistance of the valve can be represented by the simple circuit of Fig. 3 (a). Let  $I_1$  be the amplitude of the alternating component of the plate current: then the alternating voltage across  $R_a$  is  $I_1 R_a$  in phase with  $I_1$ , and across  $X$  the alternating voltage will be  $I_1 X$  leading  $I_1$  by 90°. These voltages and their phase relations are clearly indicated by the vector diagram of Fig. 3 (b). Now, obviously the voltage across the whole circuit will be equal to the vector sum of these two separate voltages, i.e.,  $\mu E_g = I_1 \sqrt{R_a^2 + X^2}$  volts, and, therefore, the ratio of the voltage across  $X$  to the total voltage available is:

$$\frac{I_1 X}{I_1 \sqrt{R_a^2 + X^2}} = \frac{X}{\sqrt{R_a^2 + X^2}}$$

But the total voltage is  $\mu E_g$ , and, therefore, the oscillating voltage across  $X$  is  $\mu \frac{X}{\sqrt{R_a^2 + X^2}}$  times the amplitude

of the oscillation applied to the grid of the valve, the number being the voltage amplification obtained, and sometimes termed the "voltage ratio" of the combination.

From the above we see that a choke has a very similar effect to that of a pure resistance, as far as the oscillating components are concerned, but that, unlike the resistance, the choke does not alter the mean value of the plate voltage, and is, therefore, more economical as regards high-tension supply. Further, we see that the voltage amplification  $\mu \frac{X}{\sqrt{R_a^2 + X^2}}$  is dependent upon

the frequency of the oscillations, because the reactance  $X$  is not only proportional to the inductance  $L$  of the choke but also to the frequency, being  $2\pi fL$  ohms. This is a distinct disadvantage as compared with the pure resistance. The choke method of coupling two valves in cascade is particularly useful for frequencies within the audible range, i.e., for frequencies up to about 5,000 or 6,000 cycles per second, and an iron cored choke is usually employed. For radio frequencies the inductance coil in the plate circuit is usually tuned by means of a variable condenser to the frequency of the oscillations, offering a high impedance to that particular frequency and constituting the well-known rejector circuit which was discussed in a previous instalment.<sup>2</sup>

**High Inductance Essential.**

At the present stage we shall confine our attention to an untuned iron-cored choke for audio frequencies and see how the voltage amplification varies with the frequency. Considering as an example a valve whose amplification factor is 9, and whose internal resistance is 25,000 ohms, in conjunction with a choke of 20 henries inductance, we can calculate the voltage amplification from the expression  $\mu \frac{X}{\sqrt{R_a^2 + X^2}}$ . For instance, at a frequency of 800 cycles per second, the reactance of the choke is

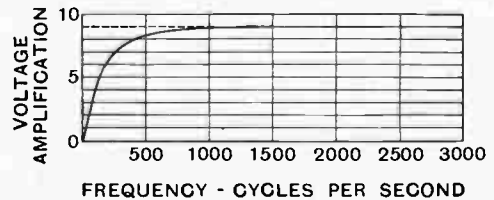

Fig. 4.—Curve showing variation of voltage amplification with frequency. Inductance of choke, 20 henries; valve resistance, 25,000 ohms; amplification factor, 9.

$2\pi fL = 2\pi \times 800 \times 20 = 100,000$  ohms. Thus at this frequency the voltage amplification is

$$9 \frac{100,000}{\sqrt{25,000^2 + 100,000^2}} = 8.73.$$

Note that using a pure resistance of 100,000 ohms instead of the choke the voltage amplification works out to only 7.2. A number of values of the voltage amplification

<sup>1</sup> See Part 4, *The Wireless World*, Feb. 17th, 1926.

<sup>2</sup> Part 7, *The Wireless World*, March 17th, 1926.

**Wireless Circuits in Theory and Practice.—**

have been worked out in this manner for the 20-henry choke over a wide range of frequencies, and the results are shown by the curve of Fig. 4. It will be noted that for frequencies above 1,000 the voltage amplification approaches very approximately to the amplification factor of the valve, namely, 9. On the other hand, for frequencies below 500 the voltage amplification falls off very rapidly; for instance, at 100 cycles per second the amplification obtained is only about 4. Such an arrangement used in a low-frequency amplifier would result in the higher pitched notes being amplified to a much greater extent than the bass notes; and when a number of such valves and chokes are used in cascade, those frequencies below about 300 would be so weak compared with those above 500 that they would not be discerned at all, and the tone of the received music or speech would be what is commonly termed "tinny." With three valves, for instance, a frequency of 1,500 would be amplified  $9 \times 9 \times 9 = 729$  times, whereas a frequency of 100 would be amplified only  $4 \times 4 \times 4 = 64$  times, *i.e.*, to only one-twelfth the extent.

**Methods of Improving Low Tones.**

The only thing to do to increase the amplification at the lower frequencies is to employ a choke or chokes of much higher inductance. As an example, let us calculate the value of inductance required to give a voltage amplification of 8.73 at 200 cycles per second. We saw above that the amplification was 8.73 when the reactance was 100,000 ohms, so that what we require now is a coil of such inductance that its reactance will be 100,000 ohms at a frequency of 200 cycles per second. We have  $2\pi fL = 100,000$ , where  $f = 200$ , so that  $L = \frac{100,000}{2\pi \times 200} = 80$

henries. This is quite a large inductance, and the usual type of low-frequency choke on the market does not, as a rule, approach this figure. A very common practice is to use chokes of lower value and to shunt them with fixed condensers to by-pass the higher frequencies to a certain degree, but this lowers the amplification and does not give such good results as regards quality of reproduction compared with the use of the higher value of inductance unshunted.

**Effect of Choke on Anode Current.**

It is interesting to note what happens on connecting in the plate circuit a choke of extremely great reactance, but whose resistance is sufficiently low to allow the D.C. component of the plate current to flow freely, and thus maintain the average potential of the plate. Under these conditions the plate current could contain practically no oscillating component at all, even though an oscillation is being impressed on the grid. But across the choke there will be an oscillating potential difference of such a value that the plate potential is varied in a manner which maintains the plate current almost constant. If we could imagine a choke of infinite reactance, the plate current would be maintained absolutely constant and the valve would give its greatest possible amplification, being actually equal to the amplification constant of the valve. These are really the ideal conditions of operation, but in

practice it is, of course, impossible to employ inductance values above a certain figure.

The foregoing remarks have been added because it does not seem to be generally appreciated that the current oscillations in the plate circuit of a valve, used in the manner described above, are suppressed as far as possible, being virtually converted into voltage oscillations. The choke is actually placed in the circuit to prevent the current from varying, and in so doing to produce an oscillating voltage across its ends. We do not get variations of plate current of the order suggested by the ordinary anode characteristic of the valve at all, but much feebler oscillations.

Thus far we have neglected the ohmic resistance of the choke itself, and by taking it into account we find that two slight modifications are introduced into the theory of operation. Firstly, the resistance of the coil will cause a slight drop in the mean value of the anode potential, and, secondly, the voltage amplification is now given by  $\mu \frac{Z}{Z_t}$ , where  $Z$  is the impedance of the choke itself and  $Z_t$  is the total impedance represented by the choke and the internal resistance of the valve in series. If  $R$  is the resistance of the choke and  $X$  its reactance at a given frequency then  $Z = \sqrt{R^2 + X^2}$  ohms, at that frequency. Similarly,  $Z_t = \sqrt{(R + R_a)^2 + X^2}$  ohms, where  $R_a$  is the internal resistance of the valve. As a rule, the resistance  $R$  is negligibly small compared with the other quantities.

The various methods of coupling valves in cascade will be discussed in a subsequent instalment, and it will be shown that even with transformer coupling the broad principles discussed above in connection with the choke in the anode circuit still hold good.

**Energy Amplification.**

When a pair of telephones or a loud-speaker is connected in the plate circuit of a three-electrode valve, we require, not the maximum voltage amplification, but the conditions for obtaining the greatest *energy output* from the telephones or loud-speaker. It should be pointed out that the energy dissipated as heat in the resistance of the telephones plays no part in the production of the sound vibrations and that this energy is simply wasted. In rating telephones according to their resistance we are merely making use of the fact that the resistance gives a rough indication of the number of turns on the coils and, therefore, of the useful impedance of the telephones at a given frequency. If we could imagine a pair of telephones without any resistance at all it would probably appear at first sight that they could not consume any energy, because it is well known that an inductance without resistance does not take any power, the current and voltage being  $90^\circ$  out of phase. But a telephone cannot be represented by an inductive resistance in the ordinary way: it is really equivalent to a small electric motor which converts electrical power into mechanical power represented by the reciprocating motion of the diaphragm acting on the atmosphere and setting up sound waves. The movement of the diaphragm induces in the coil windings a component of E.M.F. which is in phase with the current, and it is this component of E.M.F.

**Wireless Circuits in Theory and Practice.—**

which, when multiplied by the current, gives the useful power taken by the telephones from the plate circuit.

It is a very difficult matter to estimate what fraction of the total effective or apparent resistance of a telephone under working conditions is due to the movement of the diaphragm, because there are other losses, such as eddy current losses and hysteresis losses, in the iron produced by the alternating magnetic flux. It is therefore rather by experience than by hard-and-fast rules that one decides upon the best resistance of telephones to use in a circuit. For use in the plate circuit of a receiving valve a good average value is 4,000 ohms, as this is capable of giving a robust winding and at the same time producing a fairly sensitive pair of telephones if carefully designed. In the case of a loud-speaker a much lower value of ohmic resistance will give a sufficiently high impedance over the whole range of audible frequencies; 2,000 ohms is a usual value of resistance for a loud-speaker directly connected in the plate circuit. As the coils and various parts of a loud-speaker are much larger than those of a head telephone, the ratio of the energy usefully converted into sound to that wasted in heating the coils is much higher for the loud-speaker.

The diagram of Fig. 5 shows a simple circuit for a crystal detector and single-valve note magnifier. The high-frequency oscillations are rectified by the crystal detector, and the resulting audio-frequency current oscillations are made to pass through the high resistance R

connected in series with the crystal. The value of R should be of the order of 100,000. The voltage across R is at every instant proportional to the current, and, therefore, varies in exact accordance with it. This potential difference is applied between the grid and filament of the valve as shown. Such an arrangement will generally give better reproduction than by using the valve alone as a detector without the crystal.

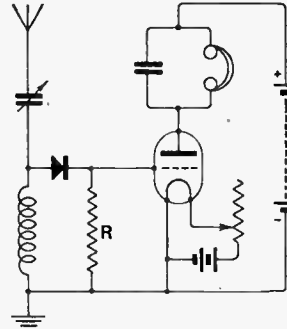

Fig. 5.—Simple crystal receiver with valve amplifier.

connected in series with the crystal. The value of R should be of the order of 100,000. The voltage across R is at every instant proportional to the current, and, therefore, varies in exact accordance with it. This potential difference is applied between the grid and filament of the valve as shown. Such an arrangement will generally give better reproduction than by using the valve alone as a detector without the crystal. In the circuit diagram no grid battery is shown to provide the requisite negative grid bias. This is supplied by the crystal circuit itself as follows: The rectified current through R from the received carrier wave is a steady direct current, and this sets up a steady potential difference across the ends of R, and thus applies a steady potential to the grid. Obviously the crystal must be connected the right way round in the circuit to make the grid negative with respect to the negative leg of the filament. This circuit is rather interesting, because it automatically adjusts the grid potential to suit the strength of telephony signals being received.

**The Slack Season.**

It seems a pity that so many clubs, which are hives of activity during the winter season, should close down for a six months' siesta directly the swallows arrive. To enterprising club secretaries summer should present itself as a period which offers facilities for experimentation entirely lacking in the winter.

A well-conducted field day, with its opportunities for D.F. tests of mobility and reception in the open, offers an excellent means of maintaining interest among members, and, what is perhaps equally important, local publicity. A loud speaker in the open is a fine advertisement agent.

o o o o

**Wireless Measurements.**

At a meeting of the Golders Green and Hendon Radio Society, held on May 20th, Mr. A. Castellaine, B.Sc., lectured on "Measurements in Wireless." Mr. Castellaine said the general impression was that this branch of radio required the use of expensive apparatus. On the contrary, a very high degree of accuracy could be obtained with entirely home-made instruments, and, in proof of this, he exhibited a very fine collection he had made himself.

The lecturer showed how capacity and resistance were measured, and devoted some time to the subject of wave meters and valve voltmeters.

Prospective members are invited to communicate with the Hon. Sec., Lt.-Col.

A 34

NEWS FROM THE CLUBS.

H. A. Scarlett, 357a, Finchley Road. N.W.3.

o o o o

**Society for Free State Transmitters.**

A society has been formed in Dublin to foster the interests of the transmitting amateur in the Irish Free State. The membership is now twenty-five, and includes experimenters residing in Cos. Kerry, Kilkenny, Wexford, Waterford, Meath, Westmeath, Galway, Cork, Tipperary, and Dublin.

It is not necessary for prospective members to hold transmitting permits, providing that they are keenly interested in short-wave experimental work. Mr. W. R. Burne, 34, Dame Street, Dublin, has been elected hon. secretary pro tem., with Messrs. D. B. Bradshaw, L. H. Carder, and D. F. O'Dwyer as a temporary committee.

o o o o

**Taunton Society Busy.**

A demonstration of wiring and soldering held the attention of a keen gathering of members of the Taunton and District

Radio Society on May 31st, the lecturer being Mr. Scott Settrington.

The demonstration was followed by a Sale and Exchange, in which much surplus apparatus changed hands.

On June 14th Mr. G. W. Douglas lectured on the appropriate subject of "Portable Sets."

The Hon. Secretary of the Society is Mr. E. Scott Settrington, 61, Addison Grove, Taunton.

**TEMPORARY EXTENSION WIRES.**

A very convenient method of supporting temporary loud-speaker extension leads which have to be carried round the walls of a room is to make use of ordinary safety pins. The pins should be opened and the point pushed downwards between the wallpaper and the plaster; the extension wires are then carried by the metal cap of the pin, which forms a hook when inverted.

The weight which pins inserted in this way are capable of supporting without pulling out is remarkable, and should it be desired to remove the extension wires the pins can be withdrawn without causing any unsightly damage to the wallpaper.— F. M.





# REVIEW of APPARATUS

A Review of the Latest Products of the Manufacturers.

## THE TAPA CONNECTOR.

An insulated base carrying a pair of sockets is useful in a number of ways both on the experimental station and as an accessory to the broadcast receiving set.

For telephone or loud-speaker extension leads plug and socket connectors are probably more convenient than the usual form of terminal mounted upon an

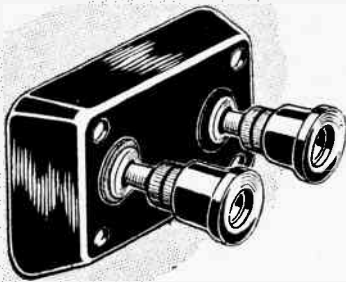

The Tapa connector is useful for terminating loud-speaker extension leads. It is a very handy fitment for use on the experimental set.

ebonite strip, and it is for this purpose that the Tapa connector manufactured by W. J. Charlesworth, 89, Aston Street, Birmingham, is particularly applicable. Consisting of a moulded base piece supporting a pair of sockets it can be attached by screws passing through the four corner holes. A pair of plugs are provided, and the turned coloured top pieces indicate the correct method of connection so that a reversal of connections may be avoided.

## MULTI-WAY CONNECTORS.

There are several methods of making "T" junctions in instrument wiring. There is the arrangement in which an "L" bend is made at the end of the wire so that when soldered ample surface is in contact to provide a strong joint while there is also an alternative of bending a small loop. Many amateurs, on the other hand, prefer to merely touch the end of one lead into contact with the other,

making the joint by a liberal application of solder. This latter method makes a really neat joint, but is mechanically weak.

For making junctions between two,

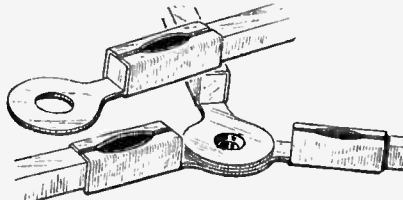

Sinew terminals facilitate the making of multi-way connections and are obtainable for linking together at a common point. 2, 3 or 4 leads.

three, or four leads, Messrs. Clarkes, of Sinew Works, Redditch, have introduced a series of connectors which are marketed under the name of Sinew terminals, and consist of a suitable number of tags held together by an eyelet. The tags are constructed from metal of substantial thickness, and can be attached to either round or square No. 16 wire. In addition to the junction pieces, single tags of the same pattern are supplied together with small tubular connectors for making junctions between wires arranged end on end.

## IGRANIC PACENT RHEOSTAT.

Among the range of Pacent products marketed by the Igranic Electric Co., Ltd., 147, Queen Victoria Street, Lon-

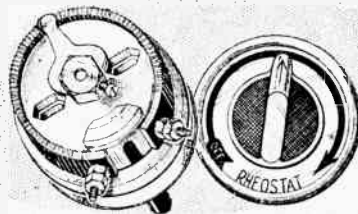

Igranic Pacent filament rheostat.

don, E.C.4, is a filament rheostat which in appearance closely follows American design.

The base piece is of porcelain, with the resistance winding supported in the usual way on a fibre strip, the rubbing con-

tact being a stiff spring blade. The knob is a clean moulding of attractive design, and a particularly fine appearance is obtained by the fitting of a silvered metal dial.

o o o o

## IGRANIC PACENT JACK.

Break jacks in a wide range of types are now obtainable from the Igranic Electric Co., Ltd.

The form of construction is, of course, entirely standard, and includes the provision of several spacing washers for adjusting to the thickness of the panel and

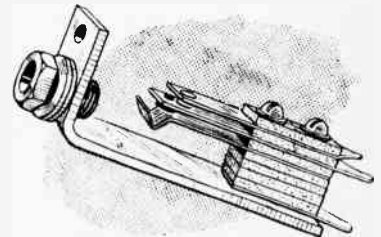

The tag connectors of the Igranic Pacent jack are turned alternatively in each direction to facilitate soldering.

a hole for an additional screw to prevent rotation. A point of interest is the spreading out of connecting tags alternatively in each direction, so that they are easily accessible for soldering, while the danger of short circuits occurring by excess of solder is avoided.

It is understood that arrangements are being made for the manufacture of Pacent apparatus at the Bedford works of the Igranic Company.

o o o o

## CONSTRUCTIONAL BLUE PRINT.

L. McMichael Ltd., Hastings House, Norfolk Street, Strand, London, W.C.2. has prepared for free distribution a large size blue print showing the construction of a wavetrap. The instrument is designed for connecting in series with the aerial lead to the receiver and comprises a tuned closed circuit making use of a Dimic coil and to which the aerial connection is made at the centre point. This is quite a useful instrument of simple construction.

**ATLAS FIXED CONDENSERS.**

A new type of fixed condenser has recently been introduced by H. Clarke and Co. (Manchester), Ltd., Atlas Works, Eastnor Street, Old Trafford, Manchester.

The plates, which are of copper, are carried in a recess, and are clamped in position together with the mica dielectric by screws which on the top of the condenser form the terminals.

Three condensers were examined of nominal values 0.001, 0.0003, 0.0001 mfd., and measurement showed the actual values to be 0.001619, 0.00035, and 0.000086 mfd. respectively. These discrepancies in the stated and actual capacity values probably arise from the presence of air between the plates, as no sealing compound is used.

The tags, to which soldered connections are to be made, are nickel plated, and it might be suggested that were tinned tags provided the making of soldered connections would be rendered easier. The mouldings are particularly clean, and the condenser is of good appearance.

o o o o

**SMOOTH-ACTION RHEOSTAT.**

The desirable feature of a filament resistance is that it possesses a smooth action. A smooth movement implies a reliable contact, and a novel way of producing a good action is adopted in the filament rheostat just introduced by A. W. Stapleton, 19a, Lorrimore Buildings, Lorrimore Street, London, S.E.17.

The resistance wire is wound upon an

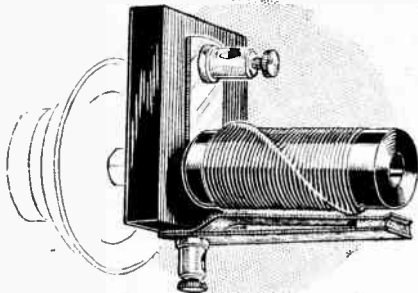

The "Smoothac" filament rheostat gives a smooth action by the contact obtained between a reinforced spring and a raised spiral on the resistance winding.

ebonite rod carrying a thread to keep the turns, which are spaced, in position. Under the winding is a spiral of insulating material producing a raised spiral along the turns. The spiral makes contact with a spring blade, as the ebonite former is rotated by the spindle which passes through a one-hole fixing bush to the knob and dial. To ensure good contact the spring is backed up by an additional spring and a small indiarubber packing piece.

The rheostat possesses a good finish, the ebonite being polished and all metal parts nickelled.

o o o o

**SHORT-WAVE OUTFIT.**

The tuning range of a short-wave receiver is invariably far too limited unless the inductance coils are arranged to be

interchangeable. Here a difficulty is encountered, for the standard type of plug-in coil is not entirely satisfactory, whilst it is no easy matter to construct a series of coils carrying the necessary four connectors joining to both the aerial and closed circuit windings.

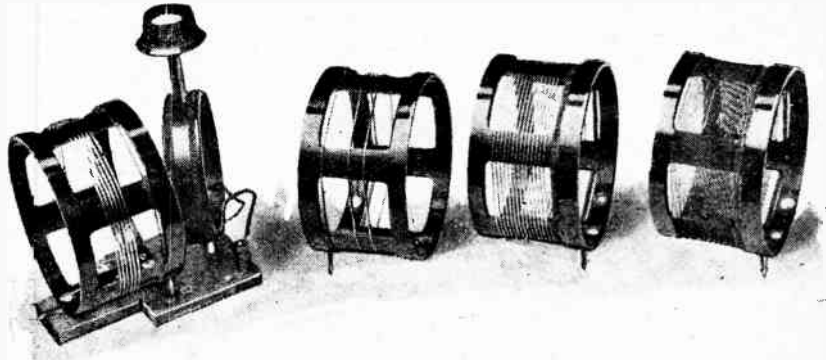

The Bremer Tully short-wave tuning outfit comprises a set of well-designed short-wave inductances covering a range of 12.5 to 200 metres.

A set of coils tuning over a wave range of 12.5 to 200 metres has been produced in America by the Bremer Tully Manufacturing Co., of Chicago (agents: Rothermel Radio Corporation of Great Britain, Ltd., 24-26, Maddox Street, Regent Street, London, W.1). The aim in design has been to keep losses to a minimum and produce inductances possessing the lowest possible resistance at the ultra-short wavelengths to which they are tunable. A glance at the coils reveals that the manufacturers undoubtedly understand the essentials of short-wave coil design. Each of the four interchangeable plug-in units carries aerial and closed circuit windings, the aerial coils in which moderate damping normally occurs being wound with fine wire (about No. 30 D.S.C.) with turns touching. The closed circuit windings are spaced

correct. The coils are 3in. in diameter.

One reaction coil is used over the entire wave band. On test this was found to be quite satisfactory, and a good feature is that it couples with the aerial winding end of the plug-in unit.

The base piece is of transparent Bakelite. Rotation of the reaction coil is obtained by means of a bearing consisting of a split pin and socket, which is perhaps a little unsteady, though, by opening out the pin, a more rigid support is obtained. This form of bearing is probably adopted to allow for easily replacing the reaction coil if desired with others of different inductance value. The problem of combining in a single instrument a tuner that can be operated over the entire range of amateur short wavelengths is effectively solved with the Bremer Tully outfit.

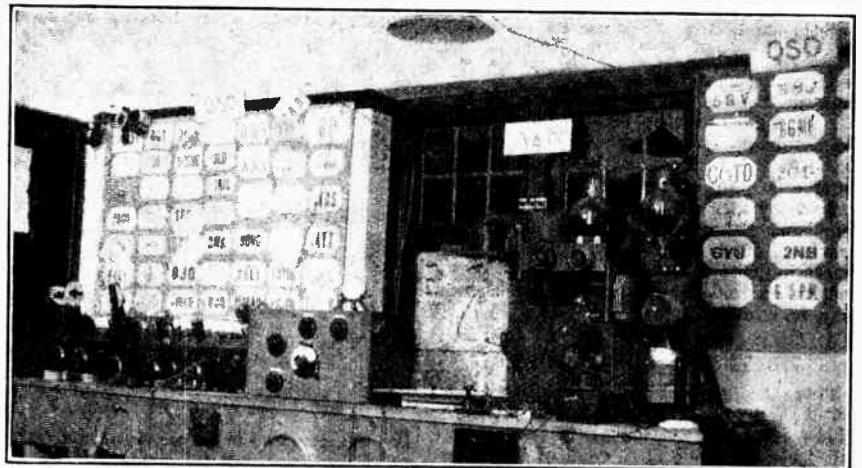

A WELL-KNOWN SOUTH AFRICAN STATION.—O A6N, owned and operated by Mr. J. G. Swart at "Cambral," Milnerton, Cape Town, has been in communication with amateurs in most countries of the world. Mr. Swart kindly undertakes to forward QSL cards to South African transmitters if accompanied by International Postal Coupons, but begs listeners to send only those which are likely to be of service to their recipients.

# PIONEERS of WIRELESS

BY ELLISON HAWKS F.R.A.S

## 18.—Dolbear Nearly Forestalls Marconi.

LOOKING back and reviewing the work of the pioneers of wireless, we are forcibly reminded of the fact that more than one worker had the secret of a successful system in his grasp, but failed to realise the fact. One of those who came very close to success was A. E. Dolbear, Professor at Tuft's College, Boston, U.S.A., who actually succeeded (in 1883) in transmitting signals through space without wires, and came near to forestalling Marconi. His apparatus, which was very simple and quite practicable for short distances, was patented in the United States. It included a microphone, induction coil, 100-volt battery, and condensers. Signals were transmitted by a Morse key, and a kite carried a fine wire from the secondary coil corresponding to the aerial of Marconi's subsequent system.

### Dolbear's System Transmits Over 13 Miles.

In 1883 Dolbear described his apparatus before the American Association for the Advancement of Science. "The idea," he said, "is to cause a series of electrical discharges into the earth at a given place, without discharging into the earth the other terminal of the battery or induction coil—a feat that I have been told so many, many times, is impossible, but which certainly can be done. An induction coil isn't amenable to Ohm's law always!

"Suppose that at one place there be apparatus for discharging the *positive* pole of the induction coil into the ground, say, 100 times per second, then the ground will be raised to a certain potential 100 times per second. At another point, let a similar apparatus discharge the *negative* pole 100 times per second; then between these two places there will be a greater difference of potential than in other directions, and a series of earth-currents, 100 per second, will flow from the one to the other. Any sensitive electrical device, a galvanometer or telephone, will be disturbed at the latter station by these currents, and any intermittence of them, as can be brought about by a Morse key in the first place, will be seen or heard in the second place.

"The stronger the discharges that can be thus produced, the stronger will the earth-currents be, of course, and an insulated tin roof is an excellent terminal for such a purpose. I have

generally used my static telephone receiver in my experiments, though the magneto will answer.

"I am still at work upon this method of communication, to perfect it. I shall soon know better its limits on both land and water than I do now. It is adapted to telegraphing between vessels at sea."

Some very interesting results were obtained when the static receiver with one terminal was employed. We are told that a person standing upon the ground at a distance from the discharging point could hear nothing; only very little standing upon ordinary stones, as granite blocks, or steps; but standing upon asphalt concrete the sounds were loud enough to hear with the telephone at some distance from the ear.

At first Dolbear could send signals only over distances of about half a mile, but later he claimed to have sent and received signals over 13 miles. Had Hertz at that time made his discovery of the waves that to-day bear his name, there seems little reason to doubt that Dolbear would have anticipated Marconi. His projection into free air of the ungrounded terminals of the transmitting and receiving apparatus is, in effect, very similar to the use of the vertical aerial of Marconi's early system. His condensers and kites "carrying fine wires" were yet another anticipation. Had he employed thick wire he would have been even more successful.

### Dolbear Unknowingly Uses Hertzian Waves.

Dolbear patented his system in 1883, and the following year demonstrated his apparatus at the Electrical Exhibition at Philadelphia. One terminal of his induction coil was connected to earth, the other being fitted with points for "discharging into the air." Interesting results were obtained, the signals being clearly heard in the telephone when transmitter and receiver were separated by roof.

"By grounding the one terminal of the induction coil to the gas or water pipes, leaving the other end free," he wrote, "telegraph signals can be heard in any part of a big building and its neighbourhood, without any connection whatever."

Although Dolbear was not unnaturally under the impression that it was the air that, in some mysterious manner,



A. E. Dolbear.

**Pioneers of Wireless.—**

assisted to bridge the gap between transmitter and receiver, we know now that he was undoubtedly using the Hertzian waves, the existence of which did not become known until six years later.

As was the case with Faraday, Graham Bell, and many other scientists, Dolbear had a charming personality. He was modest to a degree, and his unwillingness to claim anything for himself, which characterised his life, was well illustrated when he was invited to write an article on New England inventors of the nineteenth century. Every name ever known to scientists from the six New England States was found in the article with the exception of that of Amos E. Dolbear!

**The Aerial System Patented.**

As an inventor Dolbear resembled many others, before and after him, gifted with imagination and inventiveness—he did not develop his conceptions to the point of rendering them capable of commercial application. The law wisely says that the inventor must describe his invention in such terms that one skilled in the art may reproduce it and make it of practical use, and this Professor Dolbear failed to do.

He appreciated the fact early in the 'eighties that wireless telegraphy meant ether-wave telegraphy, and that both to send and to receive messages aerial antennæ would be required. Accordingly, we find him at that early date taking out a patent on aerial antennæ. But here he stopped. He did not know how to set up electrical oscillations, nor did he know how to detect the infinitely feeble oscillations set up in his receiving antennæ by the incident ether-waves. Before the advent of commercial wireless telegraphy many discoveries needed to be made and an enormous amount of experimental work accomplished. Dolbear saw wireless telegraphy just as he might have seen a ship through the fog—and he knew he saw it—but the individual ropes and spars, the planks and timbers, he did not see at that time, nor could he be expected to see how they were put together. He had one of the main requisites of a great inventor, breadth of vision and audacity of conception, but he failed to realise the importance of detail.

**Dolbear at Work.**

His peculiar attitude to scientific complexities is illustrated by an incident related by one of his pupils, W. H. Hooper, who later became Assistant Professor of Physics at Tuft's College. He tells us that in the winter of 1877-78 he was assisting him with some experiments in telephony. Some fault developed in the transmitter, and, opening the box that contained it, Dolbear poked about for some minutes and then remarked with an exclamation of disgust: "I can't make head or tail of all this mess of stuff; see what you can do with it." It took his pupil but a short time to find and remedy the trouble, who tells us that to him "the complexities of the system seemed natural, a thing to be grappled with and mastered. The wonderful thing was that the energy of the air vibrations in articulate speech could be transformed into a highly complex system of electric waves, and that the energy of these waves, after travelling a hundred or a thousand miles, could then again be transformed into articulate speech in the receiver. That the

telephone should talk seemed natural to Professor Dolbear, the unnatural being the complexity of the mechanical details."<sup>1</sup>

Dolbear was a most active investigator in physics, and apart from his telephone inventions he invented (in 1889) a spring-balance ammeter, and in his later investigations endeavoured to make practical the cubical organ pipe, in which there lies enormous power, but which requires enormous wind supply. Some of his other contributions to science included the electric gyroscope used to demonstrate the rotation of the earth, tuning forks for the illustration of Lissajous' curves, the opeidoscope for the illustration of vocal vibrations, and a new system of incandescent lighting. Almost every problem came under his notice, and those who ventured into almost any physical or electrical fields found that he had already written or spoken on the identical subjects.

As early as 1864 he had invented a writing telegraph. He discovered the convertibility of sound into electricity in 1873, and when the Bell telephone came into public notice he had already a speaking telephone of his own on which he held a patent that was afterwards purchased by the Western Union. It was his telephone, indeed, that was the subject of the litigation between that company and the Bell Telephone Co. His system, for which he received a bronze medal at the Philadelphia Exposition, was entirely different to Bell's, and it was claimed for it that it was capable of transmitting the human voice to a greater distance than any device in use at the time.

**A Successful Telephone System.**

In 1879 he invented his electrostatic telephone, for which he received a gold medal and with which (in 1881-82) satisfactory communication was carried on between Boston and New York and Boston and Wilkes-Barre, Pa. In 1882 the Dolbear telephone was in effective operation between London and Manchester and London and Glasgow, and no other telephone in existence was successful over such distances as these. In 1884-86 in experiments in Russia carried out for the Russian Government officials, telephonic communication was successfully maintained with it between St. Petersburg and Reval (150 miles), St. Petersburg and Bologna (200 miles), and St. Petersburg and Moscow, a distance of 400 miles.

This remarkable man, described by one who knew him as being a "theoretical scientist, interested primarily rather in discovering new possibilities that lie in the great unexplored force around us than in marketing them," was born in 1837 and died in 1910. He thus lived long enough to realise how nearly he had, in his early experiments, forestalled Marconi.

**BOOKS RECEIVED.**

"The Theory and Practice of Radio-frequency Measurements," by E. B. Moullin, M.A., A.M.I.E.E., pp. 278, with 134 diagrams and illustrations. Published by Charles Griffin and Co., Ltd., London, price 25s.

"Die Antenne und ihre Verwendung in der Radiotechnik," by Dr. P. C. Lübben (being Part 9 of "Die Hochfrequenz-technik"), pp. 76, with 69 diagrams and illustrations. Published by Hermann Meusser, Berlin, price M. 4.80.

<sup>1</sup> Address to Tuft's College Club, Boston, April 7th, 1910.

# NOTES ON THE SUPERHETERODYNE

## Some Practical Hints for the Experimenter.

By CAPT. H. T. B. HAMPSON (G 6JV).

THE interesting correspondence which has taken place recently regarding the superheterodyne prompts me to offer a few observations as the result of over two years experimenting with superheterodynes, and some little experience also with neutrodyne. At the same time, it should perhaps be stated, in fairness to readers, that I do not claim to be a wireless engineer with a profound knowledge of mathematics, and my conclusions are drawn almost exclusively from "the fool experiment."

In view of the undoubted interest now centring in the superheterodyne, perhaps some statement as to what may and may not be expected from such an instrument will assist those who are in doubt and who may very possibly have acquired an exaggerated idea of its capabilities. Only the other day I heard of disgust being expressed because a well-known commercial superheterodyne, when used in conjunction with a frame, and tested against a good straight four-valve set employing an outside aerial, "gave no better results!" What did the critic expect? What better testimony could the super receive? The answer to the query: "What results should I obtain from a good super?" would be, in my experience, that an eight-valve instrument (Det.—Osc.—3 I.F.—Det.—2 I.F.) used with an indoor aerial would be approximately equivalent to a five-valve neutrodyne (2 H.F.—Det.—2 I.F.) upon an outside aerial. This is in point of volume and DX ability. The super would certainly score in selectivity, while the neutrodyne might be slightly superior as regards purity of reproduction. Much depends upon design.

### Reaction in Multivalve Receivers.

The superheterodyne may be divided for consideration thus:—

- (1) The short-wave tuner and detector (and amplifier if used).
- (2) The local heterodyne oscillator and coupling, etc.
- (3) The intermediate-frequency amplifier.
- (4) The low-frequency amplifier.

The statement is frequently made that there is no advantage in providing for regeneration in the tuner and allied circuits. With this statement I am emphatically in disagreement. The provision of regeneration is of great assistance in bringing in distant stations, though its use makes little difference upon the reception of relatively near-by transmission. It will, of course, be appreciated that the use of excessive regeneration in any set, be it straight, super, -dyne, or -flex, will inevitably ruin the quality, but used with moderation and discretion the provision of regeneration is of real assistance in DX work. In any case, the writer has yet to hear reception upon any type of set, and from any but the local station, which is really worth listening to from a purely musical point of view; simply because the static to signal ratio

precludes the possibility of designing *any* set of infinite range.

Under this heading falls also any design in which the first detector is preceded by one or more stages of H.F. (cf. W. James in *The Wireless World* for March 4th, 1925, and the letter of Capt. Round, also in *The Wireless World* of September 23rd, 1925). In both these cases the object of the H.F. stage lies rather in the direction of increased selectivity than of amplification of the incoming frequencies, no provision for regeneration being provided in either case.

### Tuning Adjustments.

Doubtless this is done in order to avoid additional tuning controls, but I maintain that such simplicity is only secured at the expense both of selectivity and sensitivity. Actually, I usually employ one stage of sharply tuned H.F. ("tuned anode") with a reaction coil from the first detector, coupled to the anode of the previous H.F. This coupling is only tightened up to assist the first detector where a DX station is being received. Such assistance is, moreover, remarkable, and in my experience increases the range appreciably, while the additional complication of adjustment is more apparent than real: for with the reaction coil loosely coupled, the tuning of the H.F. valve becomes relatively flat. In this way it is an easy matter to pick up the desired carrier by allowing the I.F. amplifier to oscillate while swinging the oscillator tuner. Once the carrier has been located it is the matter of a moment only to adjust the aerial and anode tuners; finally damping the I.F. amplifier. Actually the process takes longer to describe than to accomplish. Further, the adjustments of the oscillator and anode tuners can be noted, and even calibrated, since these will remain independent of whatever frame or aerial may be employed. Perhaps it should be added that this method of searching does not lead to interference, since the heterodyning of the "carrier" takes place in the I.F. amplifier. In my own instrument a second stage of "incoming H.F." is available, though seldom used or required. I have found that stability is easily secured by employing a loose-coupled transformer in the first stage, with (if necessary) slight reverse reaction on the anode coil of the second stage—a reverse reaction switch being provided on the panel. No neutralising of the valve capacities is thus required, though readily fitted if desired. It is not, however, advised that a second stage of H.F. be attempted until considerable experience has been gained with one stage only.

### The Frame Aerial.

When using a frame in conjunction with a detector only I have found a very satisfactory method of securing regeneration to be the winding of a few additional turns upon the frame itself. Usually three or four turns in the reaction winding, and twelve to fifteen turns on the

**Notes on the Superheterodyne.—**

zft. frame winding, with a 0.0005 mfd. condenser, will be found to cover the band 250-550 metres. Regeneration control may be by the Reinartz or "shunted choke" methods.

Experiments with the relative efficiency of frame and indoor aerials lead me greatly to prefer the latter, the directional peculiarities being less marked and searching thus simplified, while the efficiency I have also found to be higher. This may be criticised on the grounds that the added selectivity of the frame is thereby sacrificed. My reply is that actually the behaviour of a frame is frequently perplexing. In some cases directionality is marked, and in others it seems almost non-existent. The theory of this phenomenon is too lengthy to discuss here, and has already been dealt with by abler exponents of the subject than myself.

**Local Oscillator Coupling.**

Almost any oscillating circuit is suitable; my own preference being for the standard two-coil Hartley type, with tuned grid and aperiodic anode. The coupling is most easily arranged by placing the oscillator anode coil close to the anode coil of the H.F. valve immediately preceding the detector. This system not only obviates the necessity for a separate pick-up coil, but serves also to reduce possible interference by interposing a valve between the aerial and the source of local oscillations. Although not advocating it, I am reasonably sure that an outside aerial could be used with this system without risk of interference, provided that the tuner were of the loosely coupled two-circuit variety, and I invariably employ such a tuner even with an indoor aerial, the said tuner being fitted with a "Stand-by" and "Tune" switch. I think that the advantages of this system of coupling have been sufficiently indicated. The coupling between the oscillator and anode coils should be adjustable. In general, the coupling should be fairly tight, and the local oscillator should be capable of producing strong oscillations when required. This is best effected by the use of an oscillator with separate H.T., since varying the tapings to the battery varies the strength of oscillations without appreciably affecting tuning, which is not the case when the coupling is adjusted. In practice the strength of the local oscillations is more critical than is generally realised, and in my experience should be stronger for strong signals and weaker for weak signals.

**Amplitude of Local Oscillations.**

Beware of excessively strong local oscillations and tight coupling on a weak station. "Wipe out" will quite possibly result. There appears to be an optimum ratio between the strength of the incoming and the local oscillations. I have dwelt upon this at some length because I appreciate the fact too well that if I had received just such hints during early experiments many hours of perplexities would have been saved.

Much ink has been spilled regarding the respective merits of air *v.* iron core transformers, and of sharp *v.* flat resonance peaks, etc. This is too lengthy a subject to discuss here, but the broad principle remains that, the sharper the tuning, the greater the amplification, although the peak must not be so sharp as to cut off side bands of

the modulated carrier. In this connection the explanation so ably given by Capt. Round applies equally, of course, to the I.F. amplifier as to the incoming frequencies. My own instrument employs home-wound air core transformers, which are loosely coupled, and sharply tuned by variable condensers, such sharpness of tuning being controlled by the amount of regeneration permitted, and this I find to be perfectly satisfactory. Reproduction is thus relatively pure or distorted according to the regeneration allowed, and this is controlled by a moderate use of potentiometer damped grids, in conjunction with slight detuning of the first I.F. stage. Neutralising of the I.F. amplifier has also been tried with success and is probably the soundest method viewed from a theoretical standpoint.

**Screening the I.F. Stages.**

Very comprehensive shielding of the I.F. amplifier (and of the entire instrument for preference) is strongly to be recommended, my own amplifier being built upon a heavy-gauge tinned iron panel, while the cabinet is lined within and on all sides with the same material. Each stage, with its own transformer, tuning condenser, and valve, is shielded from its neighbour by means of a similar iron shield, which is in electrical contact throughout and connected to -L.F. Only in this way can interference from powerful long-wave stations be eliminated, and the user of a superheterodyne is frequently in ignorance of the fact that such disturbance is actually forcing its way in. It is only when such shielding is carried out that the great improvement effected by absence of background indicates the source of previous noises. I repeat, then, that in my experience it is not sufficient to "shield" the intervalve couplings only. To the rich I would advocate the use of heavy-gauge copper sheet in preference to iron. The question of the frequency to which the I.F. amplifier should be tuned is a somewhat vexed question. It should clearly not be such as to approach the audio range, while too high a frequency sometimes causes difficulties with stability of the amplifier, particularly if low-impedance valves are employed. A frequency corresponding to 3,500 to 7,000 metres appears to be satisfactory in most cases, providing that shielding of stages is carried out as described, in order to obviate interaction.

**The Low-Frequency Amplifier.**

My present (I say this advisedly!) preference lies in the direction of one stage of transformer coupling, using a first-class instrument of low ratio, followed by one or two stages, as required, of resistance capacity. Whatever system is adopted, however, the importance of a real power valve with high anode voltage and suitable grid bias in the last stage cannot be over-stated. Further, the common-sense and superiority of the system of switching specified in the article cited should be adapted to whatever system of intervalve coupling is chosen.

In conclusion, the writer hopes that his remarks may not be considered over-assertive. They are prompted entirely by practical experience, and he is always open to correction; indeed, he invites criticism and correction by any who are qualified to do this, since nothing is farther from the writer's wish than to mislead; rather he desires to assist. In view, however, of the attention now

**Notes on the Superheterodyne.—**

directed upon the superheterodyne, and in view of the relatively small amount of information which has yet found its way into print concerning this most interesting and efficient method of reception, it was thought that the above notes might assist some who are as yet only contemplating the construction of their first superheterodyne.

Finally, my advice to such is on no account to add 100 per cent. to their difficulties by attempting to make

any valve perform more than one function. Oscillator-detectors and reflexed valves may be interesting enough toys for the wireless engineer (though it will probably take even such six months to make the thing work—and note that *the engineer does not use such apparatus for practical work*), but, for the amateur who is attempting to build his first super, learning as he goes, such complications will almost certainly lead to disappointment and probably to profanity, since the “straight” superheterodyne is task enough for the beginner.

**BASKET COIL FORMERS.**

**A Simple Method of Drilling the Radial Holes.**

UNLESS the experimenter has a lathe with dividing head, or other suitable tool, the production of a basket coil former with pin holes at all true proves to be a difficult and tiresome business. The centre of the former is usually held in the vice and the holes are drilled with a hand drill held as steadily and vertically as possible. The tool described below enables the holes to be drilled perpendicular to the axis of the coil and to a uniform depth. It is easily and quickly made, and proves very efficient and simple in operation, and uses only wood screws and a small breast drill, the standard stock-in-trade of the amateur.

For the baseboard is required a piece of wood 12 in. x 5 in. x 1/2 in. thick. Parallel to the edge, scribe a centre line for the whole length of the board. Parallel to this and at a distance equal to the radius of the former to be used, attach to the board, with wood screws or glue, two strips of wood 1/2 in. square by 5 in. long in the positions shown on the figure. At 2 1/2 in. from the other end of the board, and with the scribed line as a centre line

drill a 3/8 in. diameter hole (or other size of hole to suit the type of hand drill employed). The hand drill is then assembled on the board by means of the side handle in the manner shown in the drawing. Line up the drilling machine with a square, so that with a drill in the chuck the point of the drill is immediately above the scribed line.

For the centre of the former procure a suitable cylindrical piece of wood, the ends of which are square with the sides. With the correct drill in the machine, drill a hole in the former by placing it on the board between the guides, as shown dotted in the figure, then as the former is fed up to the drill, keep it pressed against the baseboard, and hold it firmly to prevent any tendency to rotation. The length of travel of the former along the board should be marked so that the other holes may be drilled to the same depth.

The remainder of the holes for the radial winding pegs may be marked off in the following manner:—

Along the edge of a strip of paper mark off the length of the circumference of the former. Divide up this length to suit the number of holes required, then fold the paper round the former, and, with the marked edge as a guiding line, mark off on to the former. The spacing is all that matters in this marking off, since the distance of the holes from the end of the former is decided by the height of the drill above the baseboard. Drill in the manner outlined above.

For pins, the writer used wooden knitting needles cut down to suitable lengths. These needles can be obtained approximately 3/16 in. diameter, made in hard wood (beech), and prove very suitable for the job.

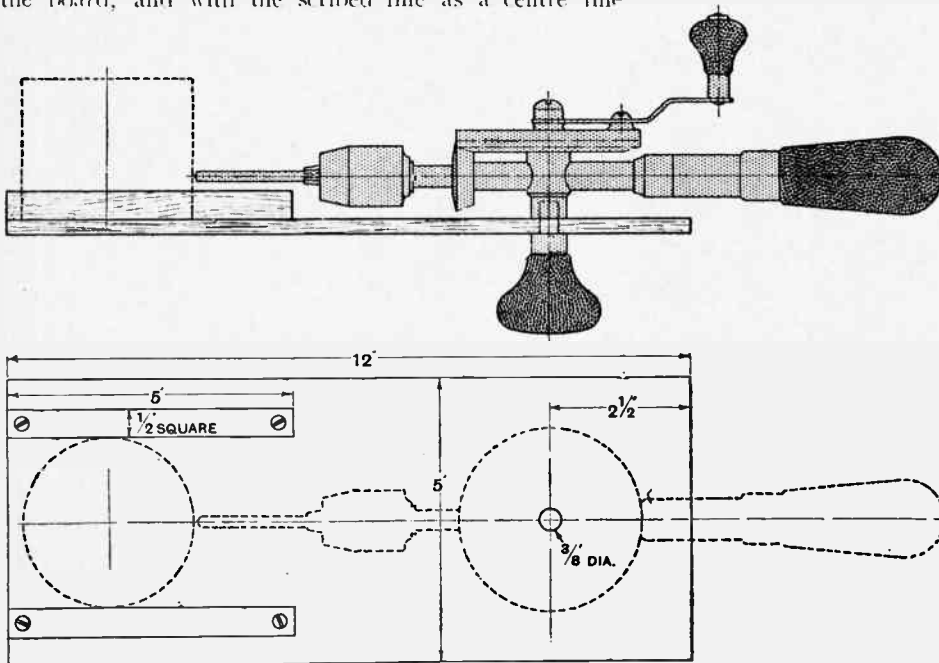

Plan and elevation of the attachment, showing position of guides and method of fixing the hand drill.

F. F. A.

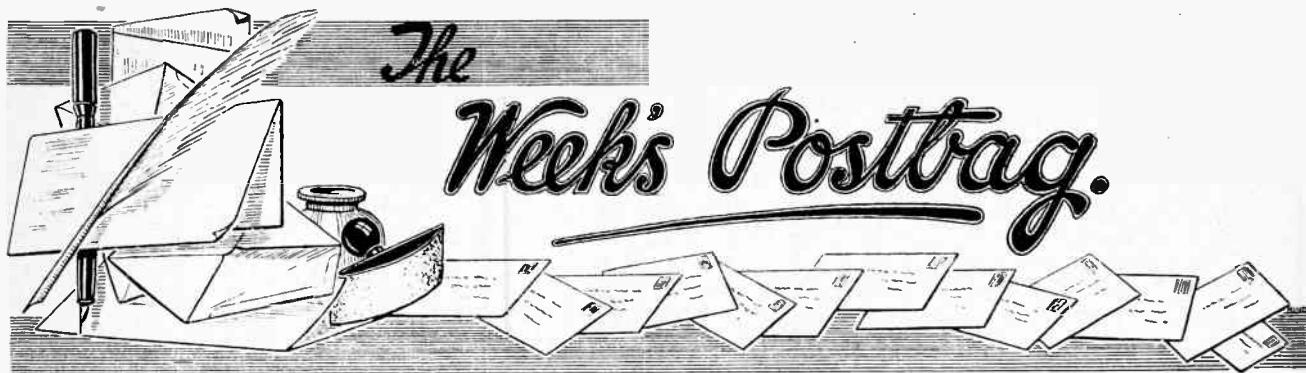

The Editor does not hold himself responsible for the opinions of his correspondents.

Correspondence should be addressed to the Editor, "The Wireless World," Dorset House, Tudor Street, E.C.4, and must be accompanied by the writer's name and address.

#### DEFECTS IN INTERVALVE TRANSFORMERS.

Sir,—We have read with interest the articles by Dr. Smith Rose and Dr. McLachlan in your issues of May 26th and June 2nd respectively, and, while we are generally in agreement with the views they express, we consider that they cast an unmerited reflection on the products of certain manufacturers. For example, Dr. McLachlan lays particular stress on the fact that L.F. intervalve transformers are exceedingly liable to breakdown in the primary windings. We have kept very close observation on the few transformers returned to us as defective, and we find that the majority of the total returned are O.K. The remainder are open-circuited either in the primary or the secondary, about half of each. In 95 per cent. of these open-circuited transformers the break has occurred not in the winding itself but in the wires connecting the winding to the terminal block, and in most cases there are signs of the transformers having received rough treatment—possibly in transit—which would account for the fracture. In all cases it is possible merely by replacing the connecting wire external to the winding itself to make the transformer O.K. Improved methods of making this connection have now been devised, so that even this defect is eliminated.

We would like you to publish this letter, because it is, in our opinion, desirable to remove the impression that manufacturers are not able to supply reliable transformers.

FERRANTI, LTD.

R. H. Schofield, Sales Manager.

Hollinwood, Lancashire.

#### LARGE LOOP AERIALS.

Sir.—In *The Wireless World* of October 14th, 1925, I pointed out that the best aerial for reception by a crystal set from one particular broadcasting station was a large loop, provided it could be made fairly directional. This has not been disputed; but some further tests may be of interest.

The conditions under which the experiments that follow were carried out were such that an ordinary inverted "L" aerial, about 26ft. high and 66ft. long, in one garden could be tested on the same table as a single-wire, vertical-loop aerial, about two-thirds as high and two-thirds as long, with the lower horizontal wire 2ft. above the ground, fixed in the next garden. The enclosed area of the loop was therefore less than one-half of the other. The two aerials were related one to the other so that they formed the two sides of the letter V, very open at the top, and were connected in turn to a tuner at the bottom. The same low-resistance galena crystal was used for both, and the catwhisker on it was not shifted at all from the spot on which it was placed at the beginning of the tests, nor did it seem to vary in efficiency. The tests were on 2FD, about six miles away.

The "L" aerial was tuned with a single-layer, subdivided inductance, and the aerial, or crystal, could be connected to any point on it to obtain the highest reading on a moving-coil galvanometer of 10 ohms resistance in the circuit. The earth was a large metal surface in wet soil; the loop was tuned by a .001 condenser, and consisted of 7.24ths stranded copper.

The two pairs of headphones were of different type, of 2,000 and 4,000 ohms respectively.

With the open aerial and the best adjustment of the tuner, the rectified current was 95° through the 2,000-ohm telephones, 85° through the 4,000-ohm, and 130° through the crystal and meter only.

With the loop, the figures were 90°, 95°, and 115°. Other tests gave similar readings. But whereas the current was always at its highest with the "L" aerial through the crystal alone, without any telephones or added inductance, this did not occur with the loop. A certain inductance, chosen by chance (the primary of an open-core transformer), added to the crystal, and the condenser slightly retuned, brought the current up to 150°, while the addition of some inductance to the 2,000-ohm telephones increased the current 20 per cent.

The lower, and smaller, loop thus proved to be the better of the two aerials, though it is possible this would not have been the case if the earth had been of exceptionally low resistance, or an excellent counterpoise, not likely to be erected by ordinary people, had been employed. It must be remembered that the impedance of a loop can always be reduced, at the cost of quite a small sum of money, by better wire or wires in parallel; but it is often difficult to improve an earth or keep it constant. Even if equal in loudness, reception with the loop is much freer from annoying oscillation and more selective.

In my opinion, therefore, this method of reception, for the purpose mentioned, deserves more attention than it has received. Streatham. S.W.16.

LESLIE MILLER.

#### INTERNATIONAL OFFICE OF THE TELEGRAPH UNION.

WE have received from Berne the annual report of the year's work of the international office of the Telegraph Union, from which it appears that all the countries belonging to the Telegraphic Union have also subscribed to the International Radiotelegraphic Convention, with the exception of Finland, Lebanon, Syria, Luxembourg, Palestine, and the territory of the Sarre. In addition to these the following countries outside the Telegraphic Union have subscribed to the Radiotelegraphic Convention: Cuba, U.S.A. and their possessions, Canada, Guatemala, Honduras, Mexico, the Republic of Panama, and Peru. The international office at Berne is, therefore, in touch with the administrations and telegraph companies of practically every country in the world.

The growth of commercial, ship and official radiotelegraphy is demonstrated by a comparison between the first and last editions of the international list of radiotelegraphic stations—commonly known as the "Berne List." In August, 1909, the number of ship and land stations was 690 and the edition comprised 99 pages. The 10th edition, published last April, contains particulars of 16,920 stations and, even though the section for ship stations has been compressed into a far more compact form than in earlier editions, the book has grown to 437 pages.



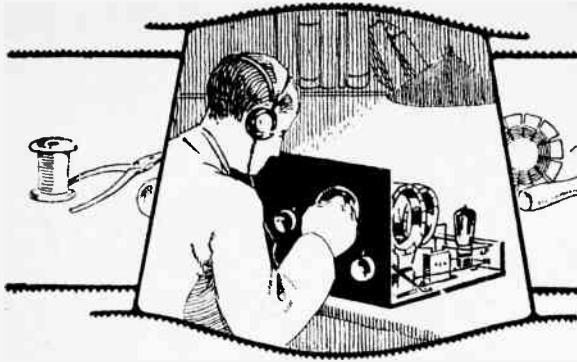

# READERS' PROBLEMS

J. Martin

"The Wireless World" Information Department Conducts a Free Service of Replies to Readers' Queries.

Questions should be concisely worded, and headed "Information Department." Each separate question must be accompanied by a stamped addressed envelope for postal reply.

### An Unusual Query.

I wish as a family man to ask a rather unusual question. I am building a conventional 0-v-2 receiver, using transformer coupling. I wish to incorporate a switch in the receiver which will disconnect the amplifier portion of my installation from the detector portion, and to switch it over to the connections coming from a microphone suspended over a child's bed upstairs. The idea is to switch over the amplifier and loud-speaker to the microphone in order to verify from time to time that no attention is needed upstairs.

W. J.

Your idea is quite a practical one. You cannot, however, arrange a switch to connect the primary of your transformer to microphone or output of detector valve at will, because the resistance of the primary of the intervalve transformer is very high in comparison with the microphone, and a very high voltage battery would be needed in series with the microphone. It is necessary to use a proper microphone transformer. The microphone transformer can be placed on the base-board of the receiver, and a double-pole double-throw switch incorporated to connect the grid and filament of the first L.F. valve to either the secondary of the first intervalve transformer, or to the secondary of the microphone transformer as desired. Another method would be to connect the secondary of the microphone transformer permanently in series with the secondary of the first inter-valve transformer. The microphone would then be permanently in circuit, whilst any sounds picked up by it would be superimposed on the broadcast programme. By far the best method, however, would be to adopt the circuit given in Fig. 1. Here the microphone transformer is embodied in the receiver as before, whilst a single-pole double-throw switch, which may be of the panel mounting type, is connected in accordance with the diagram. Now, normally, the switch should be kept open, and then any sounds from upstairs will be heard superimposed on the programme, when by throwing the switch to A the broadcast programme is immediately silenced in order that the nature of the

sounds may be verified. On the other hand, should the noises picked up by the microphone prove of such a nature that no investigation is needed, but yet of such intensity that they spoil the programme, the switch may instantly be thrown to B, thus silencing them.

It is best to purchase microphone and transformer from the same firm. A six-volt battery must be connected as shown, but since the current drawn will probably not exceed 15 or 20 milliamperes, four dry cells or four wet Leclanche cells would be suitable. It is advisable, however, to connect a switch as shown, in order to avoid unnecessarily running down the battery when the receiver is not in operation. The best scheme would be to mount a single-circuit jack on the panel of the receiver.

ceiver, it can be mounted in a neat box and placed outside the set, a telephone plug being connected to its secondary terminals. A single-circuit jack should then be arranged on the panel and internally connected so that on insertion of the plug the microphone transformer secondary becomes connected between the I.S. terminal of the intervalve transformer, and the G.B. - tapping as in Fig. 1, withdrawal of the plug short-circuiting I.S. direct to G.B. - . The S.P.D.T. switch marked A B in the diagram could still be used, of course, with any of these arrangements.

It is necessary to place the microphone as close as possible to the anticipated source of noise, and in your particular case it would be best to suspend it,

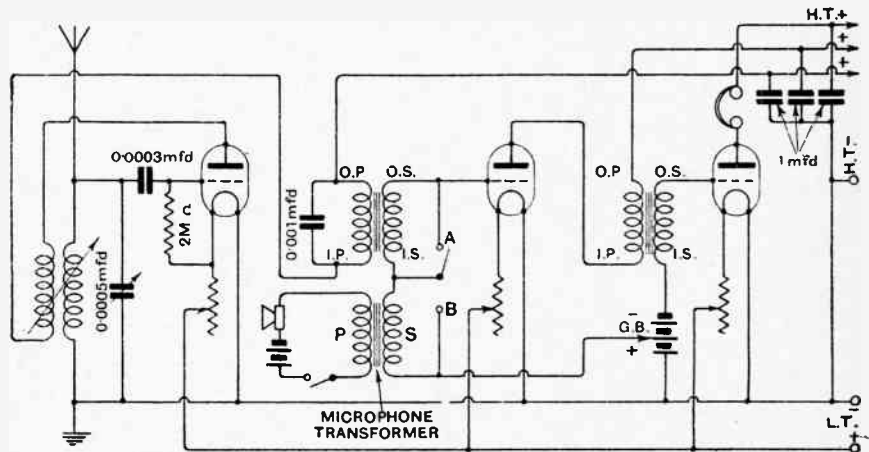

Fig. 1.—Incorporating a microphone amplifier in a standard receiving circuit.

connections being made inside the set from the jack to the primary of the microphone transformer. A telephone plug could then be attached to the twin "flex" coming from the distant microphone and battery. Withdrawal of the plug would then automatically switch off the distant microphone battery, and at the same time would completely disconnect the receiver from this external apparatus at any time when it was desired to discontinue its use. If it is not desired to place the microphone transformer inside the re-

mouthpiece downwards, from the ceiling, a large home-made cardboard horn being placed over the mouthpiece in order to collect the sound more efficiently. Microphones and transformers may be obtained from various firms, such as Messrs. The Sterling Telephone Co., Messrs. S. G. Brown, Ltd., Messrs. The British L.M. Ericsson Co., Ltd., and Messrs. Burndept. Ltd., to mention four well-known firms.

This scheme has many possible applications.

**Methods of Volume Control.**

*Can you tell me the best method to adopt for controlling the volume from a two-stage transformer coupled power amplifier?*  
T. W. S.

Provided that proper power valves are used so that there is no likelihood of the valves being overlooked, one of the best methods to adopt is that given in conjunction with the receiver described on page 608 of our April 28th issue. Here we used a device for regulating the amount of energy delivered from the output terminals of the amplifier to the loud-speaker. This is an excellent device when only one L.F. stage is used, as was the case in that particular receiver, because it is unlikely that signals from even the local station will be sufficient to overload the output valve if a small power valve is used as it should be. Thus in this receiver volume could be reduced as desired without altering the tone, and, furthermore, if a small loud-speaker was being used, and it was found that the loud-speaker was overloaded, thus causing distortion, this could be at once cured by adjustment of the control.

In the case of a two-stage transformer coupled amplifier being used to amplify the signals from the local station, however, it is more than probable that not only would the loud-speaker be seriously overloaded, but the output valve would also be overloaded unless a large type of power valve, such as the D.E.5A, were used in this position. The volume control would still suffice to cure the overloading of the loud-speaker, and volume could, by its use, be reduced from very loud down to quiet headphone strength, but this would in no way diminish the input to the final valve, and this valve would still be seriously overloaded, and therefore causing distortion. It is obvious, therefore, that the proper place for the volume control is in front of the amplifier, for in this position it would give satisfactory results under all conditions, preventing both loud-speaker and valve from being overloaded, and at the same time enabling the volume from the loud-speaker to be adjusted to the requirements of the moment without in any degree marring the quality.

In an amplifier in which a stage of resistance coupling is used in the initial stage, it becomes a very simple matter to do this, full details being given in the amplifier described on page 480 of our March 31st issue. Using a transformer in the first stage it would be possible to adopt the same principles by means of a stud switch connected to various tappings on the secondary of the transformer. Such transformers are not, however, generally available, although the principle is used in some commercial broadcast receivers. The most convenient method to adopt in general practice is to shunt the secondary of the transformer with a variable high resistance. No trouble will be experienced with the resistance, as there will be no steady D.C. current passing through it to cause noises in the amplifier. It is advisable, however, to make

**BOOKS FOR WIRELESS BEGINNERS**

*Issued in conjunction with "The Wireless World."*

- "YOUR FIRST STEPS IN WIRELESS," by HUGH S. POCOCK. Price 9d. net. By Post, 11d.
- "WIRELESS TELEPHONY," by R. D. BANGAY. Price 2/6 net. By Post, 2/9.
- "THE WIRELESS TELEPHONE," by P. R. COURSEY, B.Sc. Price 2/6 net. By Post, 2/9.
- "CAPT. ECKERSLEY EXPLAINS," by CAPT. P. P. ECKERSLEY. Price 2/- net. By Post, 2/2.
- "UNCLE JACK FROST'S WIRELESS YARNS ON GOOD RECEPTION AND HOW TO GET IT," by CAPT. C. C. J. FROST. Price 2/- net. By Post, 2/2.

Obtainable by post (remittance with order) from  
**ILIFFE & SONS LIMITED,**  
Dorset House, Tudor St., London, E.C.4,  
or of Booksellers and Bookstalls.

use of a well constructed component, and the actual instrument used to control the volume of the receiver described in our April 28th issue would serve equally well when employed in this position, with the added advantage of it being possible to avoid distortion by keeping the loud-speaker and amplifying valves well within their working limits.

o o o o

**A Full-wave Crystal Rectifier.**

*I understand that some time ago you published a circuit of a crystal receiver in which two crystals were used for the purpose of rectifying both halves of the wave, and I shall be glad if you will reproduce this circuit.*

S. J. A.

The circuit concerning which you enquire is reproduced in Fig. 2. It is necessary to make use of two telephone transformers, which may either be of the step-down type for the use of 120-ohm telephones, or, if it is desired to use the ordinary 2,000-ohm or 4,000-ohm telephones, it will be necessary to use telephone transformers of 1 to 1 ratio such as those sold by Messrs. W. G. Pye, Ltd., of Granta Works, Cambridge, and various other manufacturers. Alternatively, if it was not desired to use transformers, two pairs of telephones could be used, or it would be equally possible to use one pair of telephones by connecting one earpiece

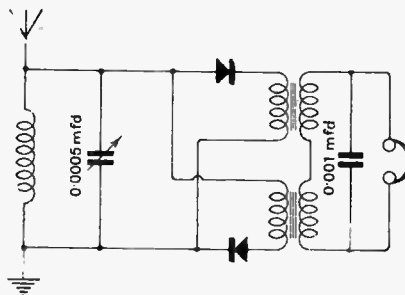

Fig. 2.—Full-wave crystal rectifier.

in place of the primary of one of the telephone transformers, the second ear-piece taking the place of the primary of the remaining transformer. The tuner may, of course, be of any conventional type used with other types of crystal set. This circuit is often referred to under the name of the "push-pull" crystal circuit, and although this name does to some extent aptly describe the circuit it must not be confused with the L.F. amplifier of that name, which is designed for a different purpose altogether.

o o o o

**Controlling Volume by Means of a Tapped Choke.**

*I am very interested in the use of a tapped anode resistance for volume control described on page 480 of your March 31st issue, and would be glad to know whether it is possible to use a tapped L.F. choke in the same manner for volume control; if so, I should like the constructional details. Is it possible to obtain either a tapped anode resistance or a tapped L.F. choke from firms advertising in your journal?*  
X.M.P.

With regard to the tapped anode resistance used in this receiver, various advertisers, such as Messrs. N. V. Webber, Ltd., of Vale Road, Oatlands Park, Weybridge, have expressed their willingness to supply this article to those readers who do not desire to make it themselves. It is an extremely difficult matter to construct this component without the assistance of a lathe. With regard to the tapings, it will be noticed that these are taken at every third slot, thus giving six tapings in all. This gives a very fine control over volume, although for those who desire it a still finer control could be had by tapping at every slot. In the list of components included in the article it is erroneously stated that 2 oz. of No. 47 D.S.C. Eureka wire is required. This is an unfortunate error, the actual amount used being only 1/2 oz. Needless to say, this would greatly affect the price of this component. It is quite possible to use a tapped choke in place of the tapped anode resistance with equally good results. The choke may consist of 42,000 turns of No. 42 D.S.C. copper wire wound on a bobbin 3 1/2 in. long and 2 1/2 in. in outside diameter. An iron wire core built up with No. 22 gauge soft iron wire to a diameter of 1/2 in. should pass through the centre of the bobbin and the ends bent back over the outside of the winding and fixed in this position in order to provide a closed magnetic circuit. A tapping should be taken every 7,000 turns for the purpose of volume control, thus making 6 taps in all. A finer or coarser control of volume can be obtained by either increasing or decreasing the number of taps. The combination of this choke may prove a very difficult problem, and it will probably be best in the long run for you to obtain this tapped L.F. choke from Messrs. W. G. Pye, Ltd., of Granta Works, Montague Road, Cambridge, or any other reputable firm who would be willing to supply it.

## Anti-vibration Valve Holders

No sponge rubber, which absorbs moisture, is used in the construction of "Cosmos" Anti-vibration Valve Holders. They are made in two types as shown in the illustration. The panel mounting type can be readily fitted in place of an ordinary holder, as the fixing screws have standard spacing, while the baseboard type can be fitted to a wooden base with wood screws. "Cosmos" Anti-vibration Valve Holders abolish the objectionable noises due to vibration and "sound coupling" and obviate trouble from the microphonic tendency of some valves.

### METRO-VICK SUPPLIES LTD.

(Proprietors: Metropolitan-Vickers Electrical Co., Ltd.)  
 Metro-Vick House, 145 Charing Cross Road, London, W.C.2

Price { Panel Mounting } 2/9  
 { Base Mounting }

# Cosmos

RADIO COMPONENTS

## ACCUMULATORS ELITE

HALIFAX, Eng.

SPECIAL

14

DAYS

OFFER

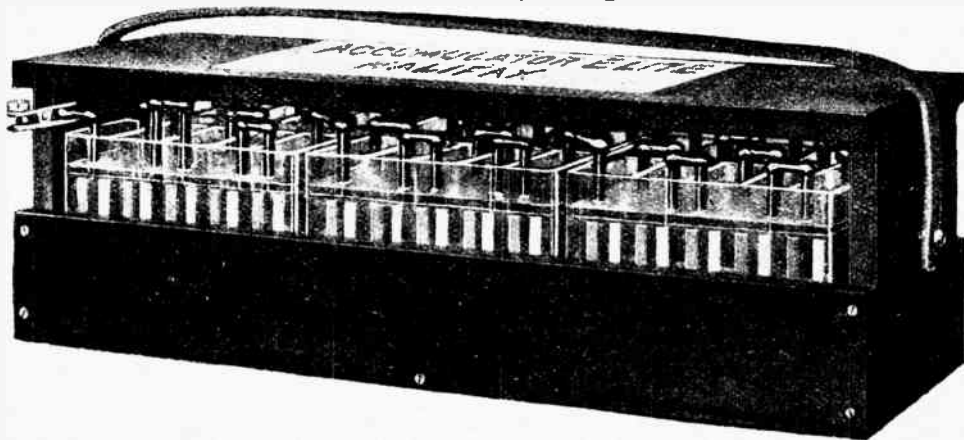

FOR

14

DAYS

ONLY

30/-

Semi Oil Type 02.

60 volts, 3 ampere-hour.

Special Price 30/-. Standard Price 37/6.

In order to bring before the public the finest and absolutely latest improved High Tension Accumulator obtainable, we are offering our Standard 60 volts, 3 ampere-hour, never done, High Tension Accumulator at a reduced price of 30/- for fourteen days only, after which the price will be 37/6. The above offer definitely closes on June 30th.

Chief points of advantage over all other accumulators: Electrical surface loss entirely eliminated. No acid creeping whatever. After long use when a plate becomes done a new one can be refitted instantly without skill, consequently the battery will last a lifetime and is never done. Tappings may be taken at any intermediate two volts, and is as clean in operation as the ordinary dry battery, and is a means of obtaining a full year's H.T. at a cost of a few pence. Dead silent in operation. Sold entirely on approval system.

## ACCUMULATORS ELITE

31, Waterhouse Street, HALIFAX, and 32, King Cross Street, HALIFAX.

'Phone 1304

TRADE SUPPLIED.

Telegrams, Elite, Halifax

# MISCELLANEOUS ADVERTISEMENTS.

## NOTICES.

**THE CHARGE FOR ADVERTISEMENTS** in these columns is:

12 words or less, 1- and 1d. for every additional word, e.g., 18 words 1/8; 24 words, 2/- Name and address must be counted.

**SERIES DISCOUNTS** are allowed to Trade Advertisers as follows on orders for consecutive insertions, provided a contract is placed in advance, and in the absence of fresh instructions the entire "copy" is repeated from the previous issue: 13 consecutive insertions, 5%; 28 consecutive, 10%; 52 consecutive, 15%.

**ADVERTISEMENTS** for these columns are accepted up to **FIRST POST ON THURSDAY MORNING** (previous to date of issue) at the Head Offices of "The Wireless World," Dorset House, Tudor Street, London, E.C.4, or on **WEDNESDAY MORNING** at the Branch Offices, 19, Hertford Street, Coventry; Guildhall Buildings, Navigation Street, Birmingham; 199, Deansgate, Manchester.

Advertisements that arrive too late for a particular issue will automatically be inserted in the following issue unless accompanied by instructions to the contrary. All advertisements in this section must be strictly prepaid.

Postal Orders and Cheques sent in payment for advertisements should be made                      & Co. payable to **ILIFFE & SONS Ltd.**, and crossed                      Treasury Notes, being untraceable if lost in transit, should not be sent as remittances.

All letters relating to advertisements should quote the number which is printed at the end of each advertisement, and the date of the issue in which it appeared.

The proprietors are not responsible for clerical or printers' errors, although every care is taken to avoid mistakes.

## NUMBERED ADDRESSES.

For the convenience of advertisers, letters may be addressed to numbers at "The Wireless World" Office. When this is desired, the sum of 6d. to defray the cost of registration and to cover postage on replies must be added to the advertisement charge, which must include the words Box 000, c/o "The Wireless World." Only the number will appear in the advertisement. All replies should be addressed No. 000, c/o "The Wireless World," Dorset House, Tudor Street, London, E.C.4. Readers who reply to Box No. advertisements are warned against sending remittance through the post except in registered envelopes; in all such cases the use of the Deposit System is recommended, and the envelope should be clearly marked "Deposit Department."

## DEPOSIT SYSTEM.

Readers who hesitate to send money to unknown persons may deal in perfect safety by availing themselves of our Deposit System. If the money be deposited with "The Wireless World," both parties are advised of its receipt.

The time allowed for decision is three days, during which time, if the buyer decides not to retain the goods, they must be returned to the sender. If a sale is effected we remit the amount to the seller, but, if not, we return the amount to the depositor. Carriage is paid by the buyer, but in the event of no sale, and subject to there being no different arrangement between buyer and seller, each pays carriage one way. The seller takes the risk of loss or damage in transit, for which we take no responsibility. For all transactions up to £10, a deposit fee of 1/- is charged; on transactions over £10 and under £50, the fee is 2/6; over £50, 5/-. All deposit matters are dealt with at Dorset House, Tudor Street, London, E.C.4, and cheques and money orders should be made payable to Iliffe & Sons Limited.

## THE SALE OF HOME-CONSTRUCTED UNLICENSED APPARATUS.

### A New Service to our Readers.

We have made an arrangement with the Patentees whereby readers who wish to dispose of a home-constructed receiver not licensed under the patents made use of, can do so by means of the Deposit System referred to above.

The person desiring to sell, in sending us particulars for his advertisement, will in every case make use of a Box No., and should add to the price which he requires the amount of royalty customarily paid by manufacturers, viz. in the case of Marconi Patents the amount should be calculated at 12/6 per valve holder.

If the purchaser is satisfied with his purchase, the sum realised will be forwarded to the seller, less the amount due in respect of royalties, which amount will be paid by "The Wireless World" to the owners of the patents concerned, and a certificate will be handed on to the purchaser of the set.

## FOR SALE.

**OSCILLATING** Zincite and Contact, 2s. 6d.; simple, original circuit, 1s.; excellent results; other parts stocked.—Ledsham's, 267, King Street, Hammersmith. (1888)

**60-VOLT** Wet Cell High Tension Batteries, genuine Leclanché; 21s.; trade supplied, lists free.—Tennants, Hylton Road, Sunderland. (2002)

## For Sale.—Contd.

**WOOD** Horns for all speakers and gramophone attachments. There's one for Amplion Junior, ditto goose-neck bases, Lisenola, etc. There's only one best; it's the "Allwoodorn."—Manufacturer: H. Maddison, 2A, Ronald's Road, Highbury, N.5. List free. (1914)

**JACOB** Oak Wireless Cabinets, direct from makers, 55s. Packed free. Carriage paid. Send for illustration, etc.—Wm. Nurse, Union Street Cabinet Works, King's Lynn. (2069)

**KONE** amplifier with valves and loudspeaker. Nearly new, £13. Old type Celestion 30s., Primax £3.—Col. Baylton, Beaulieu, Hants. (2086)

**LARGE** quantity Transmitting and Receiving Gear for Sale. Stamp list or call by appointment.—2TK., 69, Kingsmead Road,ulse Hill, S.W.2. (2128)

**PORTABLE** and other 3- and 4-valve sets, best components, clear reception. Bargain prices.—Russell, Harting, Petersfield. (2135)

**COMPONENTS** for the Enthusiast.—For short wave, experimental, superheterodyne, neutrodyne, and all standard circuits: "Standardise on 'G.R.' Quality Parts Throughout," made by the General Radio Company of America. Insist on seeing the "G.R." trade mark and look for the red cartons. Variable Condensers (29 styles) comprising counterweighted and continuous balanced vernier geared models; hard rubber or metal end plates; Shielded Condensers; S.L. Capacity Condensers; S.L. Wavelength Condensers; S.L. Frequency Condensers; Tandem Condensers; Calibrated Variable Condensers; Neutrodyne Condensers; Direct Reading Wavemeter and Filter, 200/200/600 metres, accurately calibrated to 1 per cent., only 57s. 6d.; matched kit of 4 I.F. Transformers for Superhets (1 input, 3 I.F., 30 K.C.), with blue prints, only 90s.; Noiseless Rheostats, all usual resistances to carry generous current loads, only 6s. each; Potentiometers, special quality, 6s.; Variocouplers, special, only 13s. 6d.; Variometers; Special A.F. Chokes; exceptionally good I.F. Transformers; Telephone Transformers; Compensating Transformers; Modulation Transformers for Transmission; Ammeters, Milliampmeters; Precision Wavemeters; American Sockets; American Valves; Raytheon Tubes. Send at once for complete lists, free and post free. Mention of usual stockist is desirable. Ask for interesting leaflets and booklets, "The Truth about Variable Condensers"; "True Mirrors of Tone Quality," describing type 285 "G.R." transformers ("A Perfect Transformer at Last"); "Stop Interference," describing type 247W. combined wavemeter and acceptor or rejector; "Low Loss Coils," describing special very low loss coils, interchangeable, for all wave-lengths, and coupling coils and their special uses. Very reasonable prices. Many other interesting items.—Sole Concessionaires for Great Britain and Ireland, Claude Lyons, Dept. "E.", 76, Oldhall Street, Liverpool. In London all lines on show by Hamleys, 200, Regent Street, W.1. In Scotland our distributors are W. J. Hannah and Co., 95, Waterloo Street, Glasgow, C.2. Large stocks; immediate despatches. Trade should write for best terms and territory still open. (2090)

## For Sale.—Contd.

**TWO-VALVE** Loud-speaker Receiver with automatic switching, built with best components, £6 5s., including royalties. Three-valve £7 17s. 6d. L.F. transformers from 11s. 6d. Anti-Microphone Valve Holders, 2s. 3d. each. All components stocked; lists on application. Trade supplied.—G. Small, 101, Greenway Road, Taunton, Somerset. (2116)

**MARCONI** Transformer, 2.7 to 1, 23s.; 2 Polar R.C.C. units, 7s. each; R.1, P.M. Detector, 3s.; 3 B.5 Valves, 8s. each; 3 Utility Switches, 1 4-pole, 2 2-pole, 3s. 6d. and 2s.—Shawcross, 192, Whiteacre Road, Ashton-under-Lyne. (2141)

**SALE**—Mullard of 30B. Transmitting Valve, new. Best offer.—Monckton, 15, Berkeley Road, Bishopston, Bristol. (2127)

**THREE** R1 Super-Het. Transformers, almost new, £1 10s.—Crabtree, 77, Reed Street, Burnley, Lancs. (2129)

**2KQ** has for sale the following:—3-Valve Armstrong Super-regenerative Receiver, frame and valves, £5 10s.; P.O. Morse inker, with siphon attachment. Record 100 words per minute. £6 10s.; 4,000 ohm, P.O. Relay, 17s. 6d.; 800 ohm, P.O. Relay, 17s. 6d.; 4,000 ohm, large Brown Loudspeaker, £2, Complete ex W.D. 80 metre Portable Transmitter and Receiver (5-valve), choke control, only requires valves, batteries. As new, £10 10s.; Heterodyne Wavemeter, ex-W.D., with chart and valve, 450-3,100 metres, £4 10s.; Transmitting 220 volt 50 cycle Transformer H.T., 2,000 volt centre tap, I.T. 80 volt, 8 amps., £7 10s.; Marconi 55 HF. Amplifier, 6 HF. Detector, with valves altered to cover broadcast wavelength, £13 10s.; Mark III Turner to suit above, £3 10s. (the two make ideal broadcast receiver); Towns-end Wavemeter, 300-4,000 metres direct reading, £3.—H. Taylor, Woodhill, Tettenhall Wood, Wolverhampton. (2130)

**WIRELESS** Generators for Sale.—600 volt, 30 milliampres, in oak case, new, by Marconi Co., £4 15s.—Howell, 28, Ponsard Road, College Plk., N.W.10. (2132)

**BRAND** New 5-Valve Neutrodyne Set, complete with Valves, Batteries, Loud-speaker, etc., in handsome oak cabinet. Any station received. Genuine bargain.—Ayles, Bickerley, Ringwood. (2134)

**SUPERSONIC** Three Success Superformas. £2. McMichael Set and Daventry unit, £3 10s. McMichael H.F. two 1,000-3,000, one 300-600. 5s. each. Bargain.—Box 8213, WIRELESS WORLD Office. (2136)

**ST. 100**, Set only and Coils, by Radio Insts. £5; seen after 8, evening.—Fossett, 371, Camden Road, Holloway. (2138)

**MOTOR**, protected, 220 v., .27 h.p. continuous rating; suitable lathe, blower, etc. Also Radio Press publications. Owner ordered abroad.—Box 8218, WIRELESS WORLD Office. (2140)

**DEALER'S SURPLUS**—Double range Variometers. 200-1,800 metres, automatic switch, low loss. Brand new, best make, 3-hole fixing, handsome 360 dial. Sale price 7s. 6d. post free.—Simmonds, 405, Harborne Road, Birmingham. (2142)

**BURNDEPT** Ultra IV., Mk. III, Tuner, 1924 model, shop soiled, electrically perfect. Cost £44, accept £20. Genuine bargain. Cash wanted.—Box 8225, WIRELESS WORLD Office. (2145)

**For Sale.—Contd.**

**SUPER HETERODYNES**, 7 valves. The last word in radio reception. Comprising the finest procurable transformers and units. Nothing better made. In solid polished oak cabinet 3in. high, 2ft. 4in. long. All enclosed batteries and accumulator; all stations received as powerful and clearly as local station. Guaranteed for 12 months. £27 includes £5 17s. 6d. royalties, or with Burndept Ethervox speaker, 7 Marconi matched valves, dull emitter, accumulator, and H. T. Batteries, £39 10s. Easy payments if desired. As under.

**TWO-VALVE SET** in beautiful solid mahogany cabinet with fall fronts, enclosing coils, batteries, and accumulator. Ready for use. Only best manufacturer. Guaranteed for 12 months. Sterling Baby Speaker, 4-volt accumulator and H. T. Batteries. £14 14s. includes royalties. Easy payments. As under.

**THREE-VALVE Portable Set**, in best polished oak cabinets, attache case shape. Including royalties, Sterling Baby Speaker, Valves, Batteries, etc., £16 10s. Easy payments.

**MONEY** refunded if not perfectly satisfied. The above sets are of Grade "A." Grade "B" can be had at various prices.—A. J. Neill, Radio Engineer, Woodberry Grove, N. Finchley, N. 12. (2144)

**TANTALUM.**—Tantalum metal sheet for A.C. rectifiers.—Blackwell's Metallurgical Works, Liverpool. (2148)

**BROWN** Microphone Amplifier, 2,000 ohms. B input and output. £2.—H. Grimmer, Brook House, Kenton Road, Kenton. (2149)

**BURNDIPT** Mark IV. Tuner, as new. 75s. 7 Marconi 1-Valve Amplifier, new. 30s. Valve and Crystal Receivers, 20s.—Webb, 10, Normanby Road, Dollis Hill. (2146)

**MISCELLANEOUS.**

**A WIRELESS Doctor.**—If your set is giving trouble or you want advice a competent expert will call (anywhere in Greater London) and put you right. No result, no charge.—Alexander Black, 2A, Woodville Grove, N. 16. Clissold 3687. (2002)

**SELECTED** Natural Galena, finest for distant reception, 1s. 6d. oz. Send 6d. p.o. for sample crystal and graphite catwhisker. Accessories list post free.—Radio Supplies, 51, Eden Street, Kingston-on-Thames. (2123)

**RADIO** and Electrical Apparatus constructed or repaired for the trade. Let us quote you.—Bishop & Co., 174, High Street, Croydon. (2131)

**PATENT AGENTS.**

**PATENTS** and Trade Marks Obtained.—H. T. P. Gee, Patent Agent, Member R.S.G.B., A.M.I.R.E., 51-52, Chancery Lane, London, W.C.2. Phone: Holborn 1525. (0001)

**W. BRYSON**, B.Sc., Chartered Patent Agent, 29, Southampton Buildings, W.C.2. Phone: Holborn 672. (2052)

**KING'S PATENT AGENCY, LTD.** (B. T. King, Registered Patent Agent, G.B., U.S., and Can.). Free "Advice Handbook" and Consultations. 40 years' references.—146A, Queen Victoria Street, London, E.C.4. (0002)

**WANTED.**

**WANTED**, July 1st, 1925, issue of the WIRELESS WORLD. State price.—Address Geo. White, 45, Witney Street, Sheffield. (2147)

**EXCHANGE.**

**WE** Exchange Sets. Cash or Terms.—Express Radio Service, Factory Square, Streatham (2143)

**REPAIRS.**

**TRANSFORMERS** rewound to guaranteed efficiency for 12 months, 4s., or exchanged for another, any ratio, 5s.; iron core wire-wound chokes for L.F. amplifiers, 6s. Transform.—115 Links Road, Tooting. (0011)

**BUSINESSES & PROPERTY FOR SALE, TO BE LET, OR WANTED.**

**LIVERPOOL** District.—Wireless, genuine, firmly established; annual turnover £3,000. Could be easily increased to £5,000 with introduction of other lines. Stock about £600; splendid opportunity. Price £1,000. Principal only.—Apply Box No. W.W., Wallasey News Office, Wallasey, Cheshire. (2133)

**WIRELESS Dry Battery Business** for sale, would entertain introduction of new capital. Excellent factory, complete with all necessary plant organisation, staff; now running as going concern, manufacturing first-class battery according to patented formulae, possessing Registered Trade Mark well known to trade.—Write Box 601, Sells, Fleet Street, E.C.4. (2150)

**TUITION.**

**AMATEUR Societies.**—Experienced radio engineer and research worker would give lectures on radio subjects; also answer queries and give advice for research work.—Box 8217, WIRELESS WORLD Office. (2139)

**SITUATIONS WANTED.**

**ADVERTISER** (20) desires situation, 2 years' practical experience installing and repairing broadcast apparatus, expert licence since 1921.—Box 8141, WIRELESS WORLD Office. (2126)

**EX-MARCONI** Operator requires situation ashore, home or abroad, 9 years' sea experience; references, Marconi Marine Co.—Box 8214, WIRELESS WORLD Office. (2137)

63/-



**reproduction**  
—volume  
—clarity

You get all these in Ericsson Super Tone Loud Speakers.

Made by a firm with a generation's experience in telephone research. No distortion. No rattle—just crystal-clear reproduction.

Put one to follow your pet power valve and you'll be amazed.

18" high on wood base. Very mellow and pure. 2400 ohms, 63s. Junior Super Tone for small rooms, 32/6.

Write for lists

The BRITISH L.M. ERICSSON Mfg. Co., Ltd. 67/73, Kingsway, London, W.C.2.

**Ericsson**  
SUPPORTIVE LOUD SPEAKERS

**VALVES Repaired Quick**

Let our valve making plant repair your broken or burnt-out valves efficiently & promptly (most makes). Guaranteed equal to new. Bright emitters 5-: "D.E." 2 and 3v types) 7/6. Power valves slightly more, see list. Not repairable: S.P.'s WECO v.34.

**RADION** Ltd., Bollington, Nr. Macclesfield, Ches. Largest valve-repairing firm in the world. List Free.

**Stop that corrosion!**

**DECKOREM VASELINE CUPS**



PRICE 1/- per pair.

A welcome device for all accumulator users. Effectually prevents corrosion and is easily fitted in one minute to any size accumulator. Supplied with Red and Black ivoryine discs. Provides a cheap insurance.

THANKS. We have much pleasure in thanking all the numerous readers of this journal for their interest in our last advt., regarding this product. All coupons were dealt with as received, and many of the fortunate 100 have already written expressing entire satisfaction.

NOW OBTAINABLE FROM ALL THE BEST DEALERS.

**A.F. BULGIN & Co**  
9-11 CASITOR STREET  
TEL HOLBORN 2072 CHANCERY LANE E.C.4. WORKS CHISHKIN  
TRADE DECKO MADE

**REPAIRS**

By specialists skilled in every form of accurate and intricate coil winding.

Headphones, Loud Speakers & Transformers rewound, remagnetised, and reconditioned.

**EQUAL TO NEW**

and returned the same day on C.O.D. system. The unsolicited opinion of one of our many satisfied clients:—"—all I can say is, they are better than when new."

**VARLEY** Magnet Co.  
1/3 Home Dept., Woolwich, S.E.18.

Proprietors: Oliver Pall Control Ltd.

**THE STARS OF VALVE ECONOMY**

Great Selectivity      Distortionless Amplification      Loud Speaker Volume

**9\***      **9\***      **11\***

2Y-06 HF      2Y-05 LF      2Y-34 PV

Obtainable from Level's Ltd., Liverpool and Manchester, and LUSTROLUX, LTD., West Bollington, Nr. Macclesfield.

**PICKETTS CABINETS** Model-de-Luxe Polished.

Takes panel	Mahogany	Oak
12 x 9	25/-	20/-
12 x 12	35/-	30/-
12 x 15	40/-	35/-
12 x 18	45/-	40/-

Estimates—Per RETURN POST. Send for cabinet designs and lists free.

Picketts Cabinet (W.W.) Works, Bexleyheath, S.E.

**Valves Repaired**  
AS GOOD AS NEW!!

**HALF LIST PRICE**

(Except Weco, S.P.'s and low capacity types). Minimum D.E. current 0.15 amps when repaired. All Bright & Dull Emitters listed at less than 10/- minimum charge 5/-.

**VALCO LTD.**, Dept. W.W., Tabor Grove, Wimbledon, S.W.19

The  
**Wireless**  
AND  
RADIO REVIEW **World**

INDEX TO ADVERTISEMENTS.

	PAGE		PAGE		PAGE
Accumulators Elite ... ..	7	Dixon, Leslie & Co. ... ..		Metro-Vick Supplies, Ltd. ... ..	7
Athol Engineering Co. ... ..		Dubilier Condenser Co. (1925), Ltd. ...	Cover iv.	Midland Radiotelephone Manfs., Ltd. ...	1
Beard & Fitch, Ltd. ... ..		Edison Bell, Ltd. ... ..	Cover iii.	Mullard Wireless Service Co., Ltd., The ...	1
British L.M. Ericsson Mfg. Co., Ltd. ...	9	Edison Swan Elec. Co., Ltd. ... ..		Oliver Poll Control, Ltd. ... ..	9
Bulgin, A. F., & Co. ... ..	9	Ferranti, Ltd. ... ..	2	Pickett Bros. ... ..	9
Burndept Wireless, Ltd. ... ..	4	Forno Company ... ..		Radiare Electrical Co., Ltd. ... ..	
Cahill & Co., Ltd. ... ..	2	General Electric Co. ... ..		Radio Devices, Ltd. ... ..	
Caxton Wood Turnery Co. ... ..		Graham, Alfred, & Co. ... ..	Cover ii.	Radions, Ltd. ... ..	9
Charlesworth, W. J. ... ..		Hamley Bros., Ltd. ... ..	4	Sifam Electrical Inst. Co. ... ..	10
Christie, James & Sons, Ltd. ... ..		Igranie Electric Co., Ltd. ... ..	Cover ii.	Valco, Ltd. ... ..	9
Cleartron Radio, Ltd. ... ..	6	London Elec. Wire Co. & Smiths, Ltd. ...	Cover iii.	Vandervell, C. A., & Co., Ltd. ... ..	3
Cossor A.C., Ltd. ... ..	5	Lustrolux, Ltd. ... ..	9	Watmel Wireless Co., Ltd., The ... ..	2
Darimont Elec. Batteries, Ltd. ... ..	4	Marconiphone Co., Ltd., The ... ..		Wood, E. A. ... ..	2

*Have you had your*  
**SIFAM** *Book?*  
*If not, send for FREE copy to-day.*  
**SIFAM ELECTRICAL CO.**  
Dept. W1, 95, Queen Victoria Street, London, E.C.4

**MODERN** <sup>1/-</sup> MONTHLY  
*Incorporating*  
**CONQUEST SCIENCE**  
A MAGAZINE OF PROGRESS, INVENTION AND DISCOVERY  
"MODERN SCIENCE" is a monthly magazine which records recent advances and discoveries in all departments of science and industry: surveys technical and mechanical developments; and provides a forum for the interchange of information and views on all subjects coming within the scope of the journal.  
SUBSCRIPTION: 14s. per annum, post free.  
From all newsagents and bookstalls or direct from the Publishers: ILIFFE & SONS LTD., Dorset House, Tudor St., London, E.C.4.

**"More than Pleasing!"**

*A Satisfactory Result from an Advertisement in*  
**The Wireless AND RADIO REVIEW World**  
Full particulars of rates for advertising will be found in any issue of "The Wireless World."  
**EVERY WEDNESDAY FOURPENCE**

*An Advertiser writes as follows:—*  
"HAVING recently sold my Burndept Ethophone Grand Receiver through the medium of your advertisement columns, I was surprised at the number of replies thereto. I may mention that my set was sold to a provincial gentleman within four hours of the publication of 'The Wireless World,' following exchange of telegrams. I think this is more than pleasing."  
A. J. NEILL,  
"Dalmeny," Woodberry Grove,  
North Finchley, London, N.12.

# EDISON BELL RADIO

USE THESE CONDENSERS AND BE SATISFIED

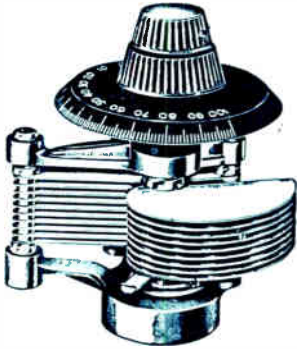

EDISON BELL SQUARE LAW CONDENSER WITH VERNIER

The Edison Bell Square Law Vernier Type is fitted with a patent bottom metal end-plate designed to act as vernier. The maximum capacity of the vernier is approximately '00005, which allows for critical adjustment in reception of long-distance Stations, and is controlled by a micrometer movement which every user will appreciate

Capacity.	Retail Price
'001 .. .. .	14/6 each
'0003 .. .. .	10/6
'0005 .. .. .	11/6

\* The Edison Bell Square Law Condenser has been designed to give proportional changes of wavelengths in relation to uniform readings on the dial, also of low dielectric losses. The metal end-plates are constructed of specially designed die castings which provide for small insulating bushes.

\* The dielectric losses between the fixed and moving vanes are, for all practical purposes, negligible. The spindle runs between a flexed friction bearing and a conical bearing, which can be adjusted to any required movement. Provided with a sound one-hole fixing to the panel system.

Capacity.	Retail Price.
'001 .. .. .	12/6 each
'0003 .. .. .	8/6
'0005 .. .. .	10/-

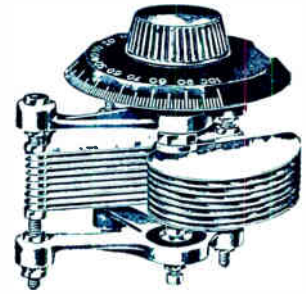

EDISON BELL SQUARE LAW CONDENSER

TESTED 500 VOLTS  
FLAT TYPE



Your Dealer will be pleased to supply you with full range of catalogues, free. If you experience any difficulty in obtaining them write direct to the Manufacturers:  
**EDISON BELL, LIMITED, LONDON, S.E.15, and at Huntingdon.**

**INSIST ON EDISON BELL CONDENSERS**

**THEY ARE BRITISH MADE AND GUARANTEED BY A NAME WITH 30 YEARS REPUTATION BEHIND IT**

TESTED 500 VOLTS  
UPRIGHT TYPE

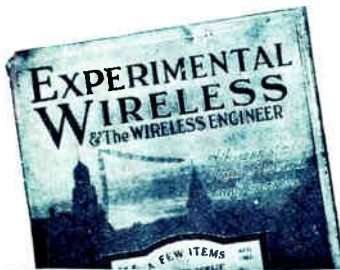

*The Journal of Radio Research and Progress*

"EXPERIMENTAL WIRELESS" is a monthly publication devoted to the interests of all keen radio enthusiasts, advanced amateur workers and experimenters, and professional wireless engineers. It contains authoritative technical and scientific information relating to every aspect of wireless experiment and research.

The following articles in the JUNE ISSUE will appeal to readers of "The Wireless World"

"The Correlation of some Recent Advances in Wireless,"

by Halth. van der Pol, D.Sc.

"Some Notes on Intervalve Couplings,"

A Lecture to the R.S.G.B.,

by H. L. Kirke.

"Inductance Coils Quantitatively Compared,"

by A. L. M. Sowerby, B.A., M.Sc.

"Mathematics for Wireless Amateurs,"

by F. M. Colebrook, B.Sc., A.C.G.I., D.I.C.

"Long-Distance Work,"

by Hugh N. Kyan, (5 BV).

Monthly 1s. : Post Free 1s. 3d. : Subscription, 15s. per ann

Publishers: ILIFFE & BONS LTD., Dorset House, Tudor Street, London, E.C.4  
W.W 2

... lower H.F. resistance than any other commercial plug in coil !

Made by the manufacturers of Glazite.



THIS is the independent verdict of the National Physical Laboratory after thoroughly testing the LEWCOS Coil.

Its low H.F. resistance combined with great selectivity and mechanical strength make the LEWCOS Coil the finest you can buy.

Try a LEWCOS Coil in your set—it makes all the difference! Descriptive leaflet sent free on request to

The LONDONELECTRIC WIRE CO. and SMITHS, LTD.,  
Playhouse Yard,  
Golden Lane, London, E.C.1.

No.	25	35	40	50	60	75	100	150	200	250	300
Price	4/6	4/6	4/6	5/-	5/6	5/6	6/9	7/6	8/6	9/-	10/-

**LEWCOS** Inductance COIL

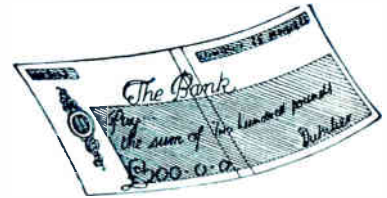
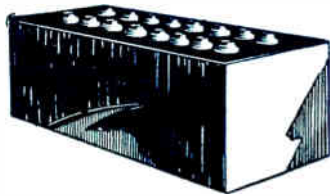

**WHAT IS THIS ?**

**WHAT IS THAT ?**

**Buy the one -  
and win the other !**

The Dubilicon is a multiple condenser containing eight separate units, the terminals of each unit being brought out to sockets on the lid. By using Clix plugs (made by Messrs. Autoveyors, Ltd., 84, Victoria Street, S.W.1) of which two are given with every Dubilicon, the units can be connected in a variety of series, parallel, and combined series-parallel arrangements giving a very large number of different capacities ranging from zero up to 0.011 $\mu$ F.

The Dubilicon, therefore, is of incalculable value to the experimenter who wants to find the best value of fixed capacity for any part of his circuit.

Every purchaser of a Dubilicon is entitled to enter for the £200 competition. All you have to do is to buy your Dubilicon from a Wireless dealer, and find out the total number of different capacities you can get by using the first five units. Full instructions are given with every Dubilicon sold.

Get one to-day !

**THE PRICE OF A DUBILICON IS 30/- —  
AND THE PRIZE IS £200 !**

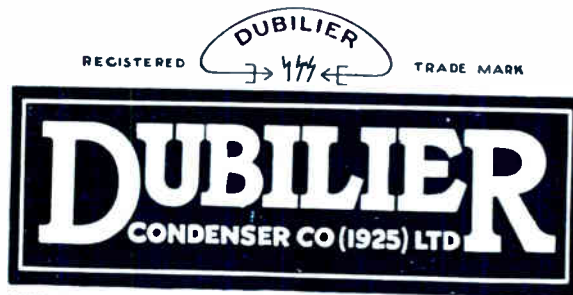

ADVERT. OF THE DUBILIER CONDENSER CO. (1925) LTD., DUCON WORKS, VICTORIA RD., NORTH ACTON, W.3 TELEPHONE: CHISWICK 2241-2-3.

E.P.S.195

Printed for the Publishers, ILLIFFE & SONS LTD., Dorset House, Tudor Street, London, E.C.4, by The Cornwall Press Ltd., Paris Garden, Stamford Street, London, S.E.1.

UNITED STATES—The International News Co., 83-85, Duane Street, New York. FRANCE—W. H. Smith & Son, 248, Rue Rivoli, Paris; Hachette et Cie, Rue Réaumur, Paris. BELGIUM—W. H. Smith & Son, 78, Marche aux Herbes, Brussels. INDIA—A. H. Wheeler & Co., Bombay, Allahabad and Calcutta. SOUTH AFRICA—Central News Agency, Ltd. AUSTRALIA—Gordon & Gotch, Ltd., Melbourne (Victoria), Sydney (N.S.W.), Brisbane (Queensland), Adelaide (S.A.), Perth (W.A.) and Launceston (Tasmania). CANADA—The American News Co., Ltd., Toronto, Winnipeg, Vancouver, Montreal, Ottawa, St. John, Halifax, Hamilton; Gordon & Gotch, Ltd., Toronto; Imperial News Co., Toronto, Montreal, Winnipeg, Vancouver, Victoria. NEW ZEALAND—Gordon & Gotch Ltd. Wellington, Auckland, Christchurch and Dunedin.



4<sup>D</sup>

# The Wireless World

*The Paper for Every Wireless Amateur*

Wednesday, June 23rd, 1926.

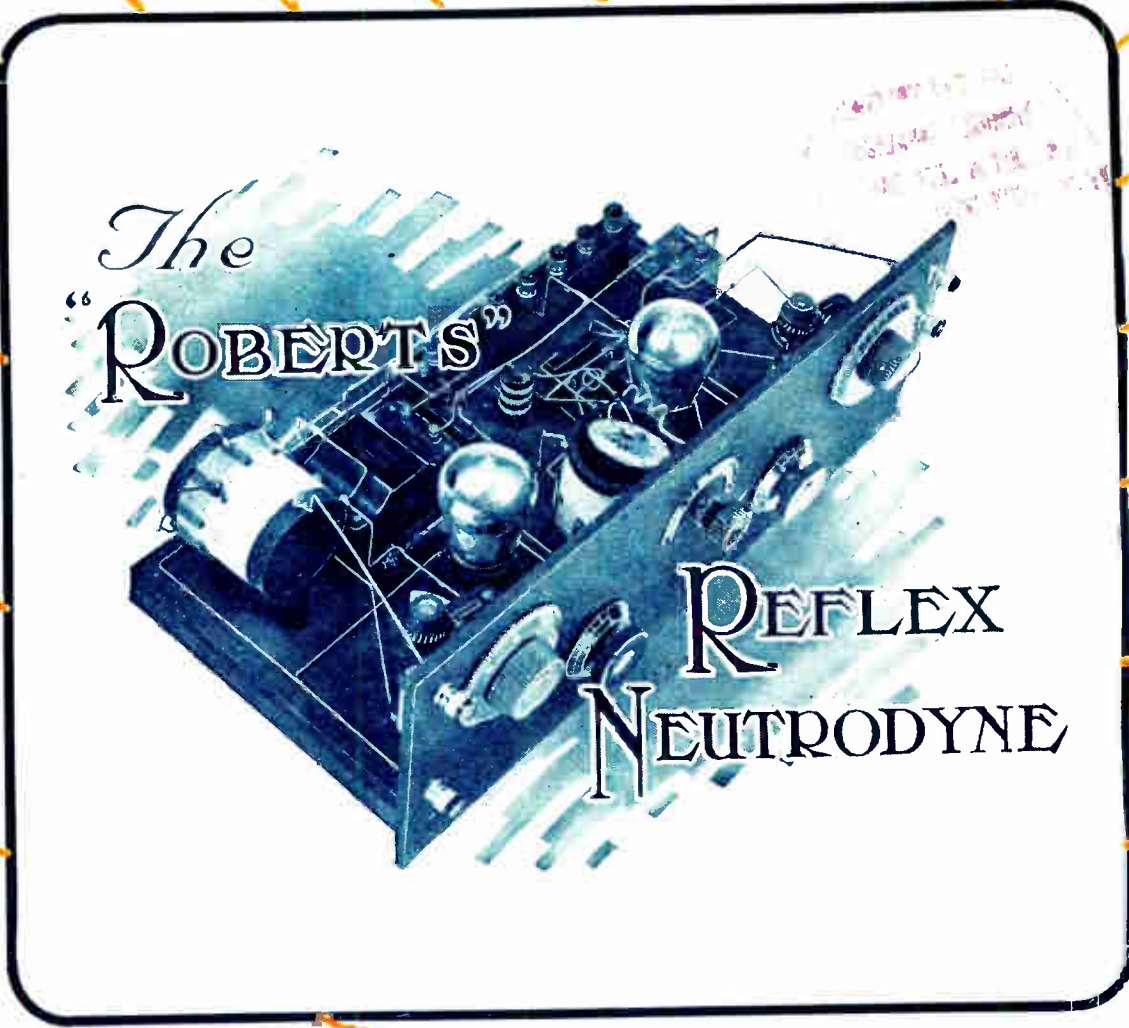

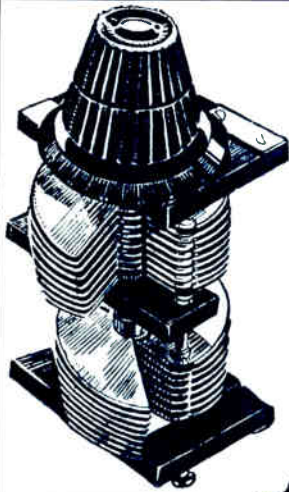

**"DEVICON" BRIDGE CONDENSER.**  
Autoveyors Patent No. 201720/23.

**"DEVICON" TRUE SCALE FRICTION CONDENSER.**

Patent Application No. 1990/25.

Has a 2 to 1 movement with additional slow motion device attached. One drilling hole in Panel is all that is required. The very latest improvements in condenser construction.



# CHOOSE A "DEVICON" CONDENSER

for YOUR Set  
PRICES

including Knob & Dial

7/3 to 25/-

SIZES

from '0002  
to '001

"Devicon" Condensers are the finest tuning Condensers produced. Ask your Dealer which type to use for your set.

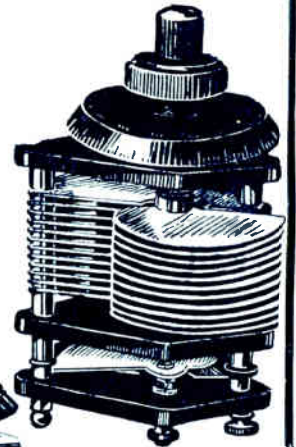
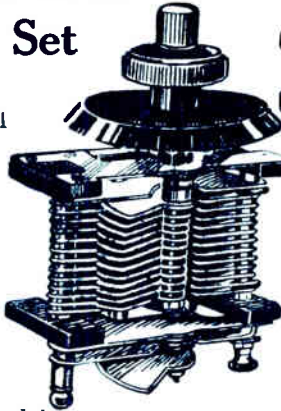

**"DEVICON."**

Model 2 Type. Square Law. 20 S.W.G. Aluminium Vanes. Bakelite or Ebonite End Plates. Thumb Screw Terminals and Rigid Dome Nuts. The finest material only.

"DEVICON" Low Loss. Sound Rigid Construction. Solid Brass Nickelled End Plates. Negligible losses. Best workmanship. Perfectly free and smooth action. 20 S.W.G. Aluminium Vanes.

Manufactured and fully guaranteed by—

**THE RADIO DEVICES CO.**  
Newdigate Street, *Nottingham.*

Telegrams: "DEVICON."  
Telephone: 6798.

# ACCUMULATORS ELITE

HALIFAX, Eng.

SPECIAL

**14**  
DAYS  
OFFER

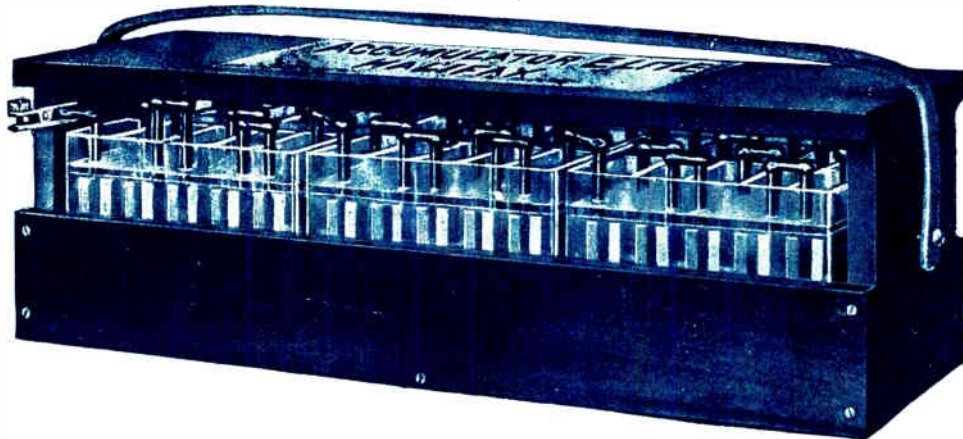

FOR

**14**  
DAYS  
ONLY  
**30/-**

60 volts, 3 ampere-hour.

Semi Oil Type 02.

Special Price 30/-. Standard Price 37/6.

In order to bring before the public the finest and absolutely latest improved High Tension Accumulator obtainable, we are offering our Standard 60 volts, 3 ampere-hour, never done, High Tension Accumulator at a reduced price of 30/- for fourteen days only, after which the price will be 37/6. The above offer definitely closes on June 30th.

Chief points of advantage over all other accumulators: Electrical surface loss entirely eliminated. No acid creeping whatever. After long use when a plate becomes done a new one can be refitted instantly without skill, consequently the battery will last a lifetime and is never done. Tappings may be taken at any intermediate two volts, and is as clean in operation as the ordinary dry battery, and is a means of obtaining a full year's H.T. at a cost of a few pence. Dead silent in operation. Sold entirely on approval system.

## ACCUMULATORS ELITE

31, Waterhouse Street, HALIFAX, and 32, King Cross Street, HALIFAX.

'Phone 1304

TRADE SUPPLIED.

Telegrams, Elite, Halifax

Mention of "The Wireless World." when writing to advertisers, will ensure prompt attention

# "Ideal" Combinations for faithful magnification



Marconi  
D E R  
(2 volt) 14/-

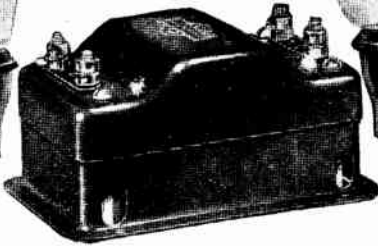

Ideal "Junior"  
Transformer  
Ratio 3 to 1, 21/-



Marconi  
D E 8  
(6 volt) 22/6



Ideal Transformer  
Ratios 2-7-1, 4-1,  
6-1 and 8-1, 30/-

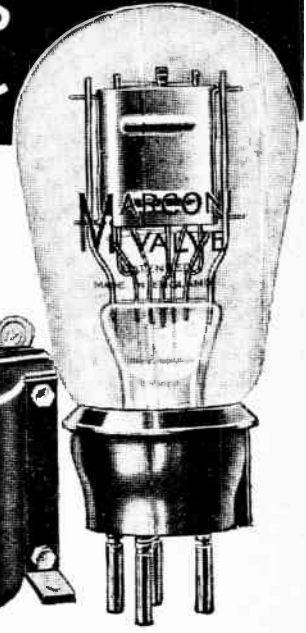

Marconi  
D E 5  
(6 volt) 22/6

Fidelity of reproduction, the *natural* re-creation of the entire range of sound, in abundant volume *without distortion*, is possible only when the right type of valve is coupled to the correct ratio of low frequency transformer.

The following are a few recommended combinations for the first and second L.F. amplification stages of Receivers or Amplifiers, with the correct anode voltage and grid bias for superb tone quality, in song, symphony and speech.

Detector Valve	Anode Volts	1st Stage Transformer	1st LF Valve	Anode Volts	Grid Bias Volts	2nd Stage Transformer	2nd LF Valve	Anode Volts	Grid Bias
DER	60	"Ideal Junior"	DER	120	-6	"Ideal" 2.7 to 1	DE6	120	-9
DE2HF	40 to 60	do	DE2LF	100	-6	do	DE6	100	-7.5
DE8HF	40 to 60	"Ideal" 2.7 to 1	DE8LF	100	-4.5	"Ideal" 4 to 1	DE5	100	-6
R5V	40 to 60	do	DE5	120	-9	"Ideal" 6 to 1	DE5	120	-9

There is a Marconi Valve for every radio purpose, each type guaranteed by the name MARCONI—first and foremost in radio for thirty years.



The Marconiphone "Ideal" is the most dependable and efficient Transformer that human skill and ingenuity has yet devised.

# MARCONI VALVES AND Marconiphone 'Ideal' Transformers

Write for literature dealing with Marconi Valves and Marconiphone "Ideal" Transformers.  
THE MARCONIPHONE COMPANY Ltd. Regd. Office: Marconi House, Strand, London, W.C.2.

Advertisements for "The Wireless World" are only accepted from firms we believe to be thoroughly reliable.

# ORMOND precision Straight Line Frequency Condenser Triumph!

All the engineering knowledge and refinements of over 25 years British Manufacturing Experience guarantees the efficiency of this new ORMOND development — the *precision* S.L.F. Condenser.

Many of the famous ORMOND condenser features are embodied including the ORMOND SLOW MOTION FRICTION DRIVE. Others are new, but all represent absolute perfection and advancement in radio engineering science.

ORMOND, as ever, lead in condenser construction by developing this new Precision S.L.F. Condenser and offering same at prices well within the reach of all classes of wireless constructors. Note the remarkably low

## PRICES:—

·00025 micro farad - 19/-  
·00035 .. .. - 19/6  
·0005 .. .. - 20/-

Complete with Knob and 4" Dial.

Without Friction Control but with 3" Dial and including Hand Capacity Shield:

·00025 micro farad - 11/-  
·00035 .. .. - 11/6  
·0005 .. .. - 12/-

From all dealers or direct.



199-205 Pentonville Rd.,  
King's Cross, London. N.1.

'Phone - - - Clerkenwell 9344-5-6  
'Grams - "Ormondengl, Kincross."

FACTORY:  
WHISKIN ST., CLERKENWELL, E.C.1.

KNOB AND DIAL  
FIXED WITH GRUB SCREWS

KNOB & 4" DIAL  
BEAUTIFULLY  
FINISHED

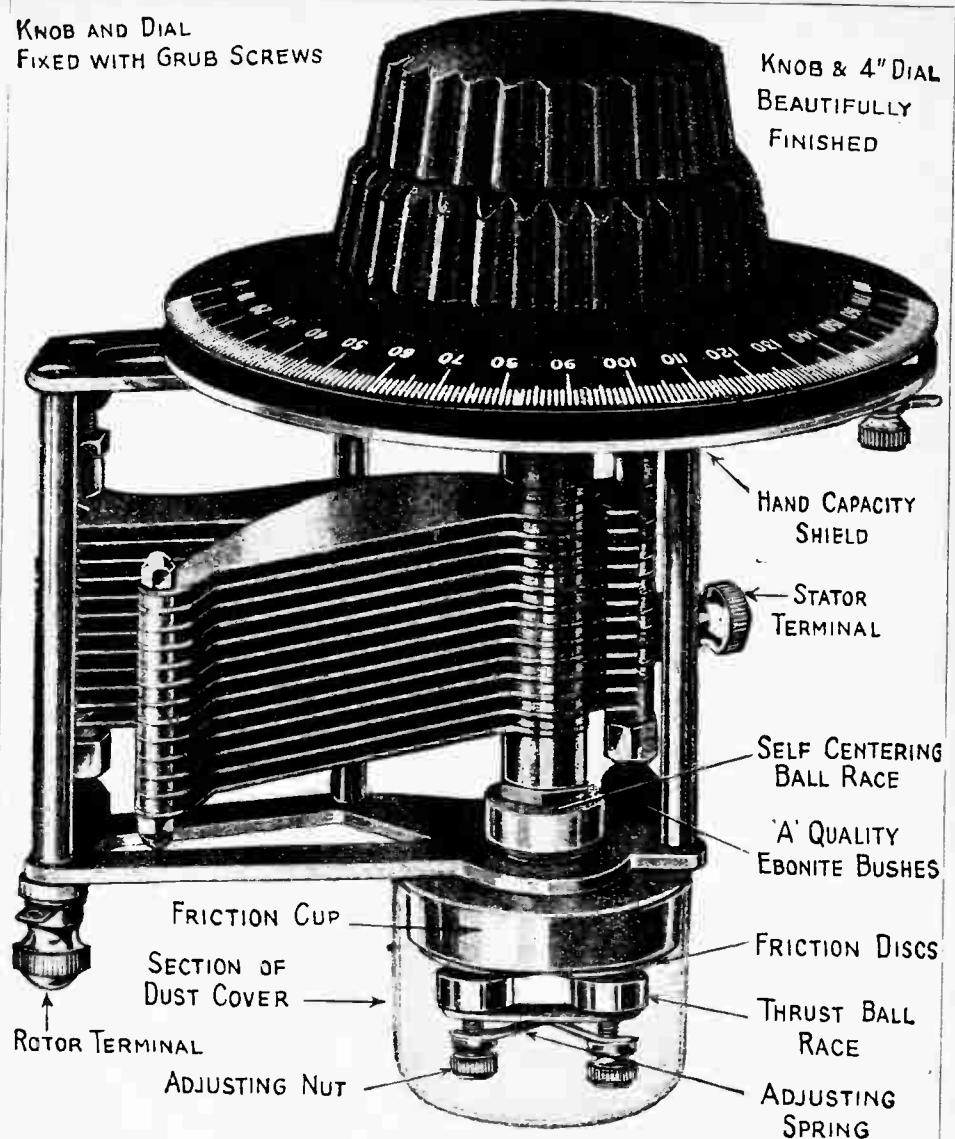

PATENT APPLIED FOR

THIS newest Ormond S.L.F. Condenser, now for the first time upon the market, embodies the famous Ormond Slow Motion Friction Drive. Special ball bearings ensure a smooth action, giving a liquid-like movement, facilitating precise tuning adjustments with noiseless operations.

The whole construction is robust. It has bright brass vanes, perfectly rigid, and the heavily nickelled and polished end-plates ensure minimum eddy current losses. The moving vanes are connected to the frame, thus eliminating stray capacity effects. Specially shaped vanes give high maximum and low minimum capacity with true S.L.F. readings throughout full 180 scale. Extremely low Radio frequency losses. Special method of mounting the fixed vanes reduces di-electric losses to a minimum.

Highest quality scientific instrument finish, handsome bakelite combined knob and 4-inch dial, engraved with 180 separate degrees, and separate slow motion knob. It has an anti-capacity earthing shield which may be fitted, insulated from the condenser, and earthed by a separate connection. This is particularly useful when condenser is used in circuits where both electrodes are at radio frequency potential. Easy to mount, "ONE" and "THREE" hole fixing.

Terminals and soldering tags for connections.

## ORMOND develop the first precision Straight Line Frequency Condenser.

**Red Top :**

For H.F. use.

**Plain Top :**For Detector  
or L.F. use.**15/6**For 2-volt  
Accumulators.

# The new Cossor Point One

—the '1 amp. Valve which  
utilises Co-axial Mounting

**Cossor****Stentor Two**

Power Valve

Consumption '15 amp

**18/6**For 2-volt  
Accumulators.

**I**T was a flash of genius that enabled Simpson Eighty years ago to discover chloroform. Genius, too, helped James Watt to read the lesson of the steam engine in the escaping steam from his mother's kettle. Assuredly it was genius that caused Montgolfier to visualise in the floating remnants of a burning paper bag the world's first balloon—the prelude to man's conquest of the air.

And once again a touch of genius has been responsible for an entirely new method of valve construction that bids fair to produce results which, but a year ago, would have been considered impossible.

The new series of Cossor valves employ—for the first time in the history of Radio—a method which, accurately and for all time, ensures perfect alignment for the filament, grid and anode. At the same time it provides a shockproof support for the filament.

Thus throughout the whole life of the valve its working characteristics cannot alter. Age cannot cause filament sag nor can hard wear disturb the exact relative positions of the filament, grid or the anode.

But this is not all. The improved Cossor filament consumes but a moiety of the current required by other Dull Emitters—its consumption at 18 volts being barely one-tenth of an ampere. A seven-valve Super Heterodyne, for example, using these new Cossor Point One Valves would not con-

sume as much current as a little one-valve set using a single bright emitter.

As can be imagined, the filament used in this new Cossor is no ordinary filament. Owing to its exceptional length and its scientific method of preparation a great latitude in working voltages is permitted. Satisfactory results are obtainable at a voltage as low as 1'2, so that the valve can, if required, be used with dry cells. Further, its operating temperature is lower than that of any other valve on the market. And everyone knows that low temperature means long life.

The Cossor system of Co-axial Mounting has now finally abolished the last bug-bear of dull emitter valves—microphonic noises. Individual movement of either the grid or the anode in the Cossor Point One is utterly impossible. The seonite insulator holds them both in a vice-like grip which defies the hardest shock.

With its handsome pipless glass bulb, its re-designed low loss moulded base, and its new positive contact pins the introduction of these new valves represents one of the most important events in the progress of the Valve. See your Dealer about them to-day—we can promise you new delights in radio reception. A greater economy, improved sensitivity, a wonderful richness of tone, with a length of life and uniformity of performance which will positively astonish you.

## Cossor Valves

—The new Dull Emitters with the long-life '1 amp. filament.



# "STALLOY"

(REGD. BRAND)

THE ONLY MATERIAL

for

TRANSFORMERS  
and  
DIAPHRAGMS.

INSIST ON HAVING IT

JOSEPH SANKEY & SONS, LTD.

BILSTON.

STAFFS.

LONDON:—168, REGENT STREET, W.1.

Now  
you can  
Charge your  
H.T. Accumulator  
at home!

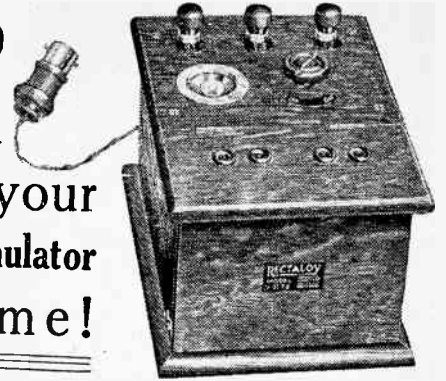

WITH the Rectalloy Charger shown above you can keep your high tension accumulator fully charged at practically no cost from your a.c. mains. It will charge any high tension accumulator up to 90 volts in the normal series arrangement. It takes very little current, wasteful resistance being entirely obviated. At last the big difficulty of charging high tension accumulators is solved by an entirely new and patented method.

No need to carry heavy accumulators to the charging station and wait while they are charged (and perhaps ruined). Install a Rectalloy and leave it to do its work satisfactorily and well.

The charging rate is automatically governed so that a 20 or 90 volt H.T. Accumulator receives practically the same charge. An extremely neat charge-indicator and excess-current fuse is incorporated, making the apparatus fool-proof and trustworthy.

**47/6**

For a.c. only, 200-250 volts, 40-60 cycles.

A separate charger is also available for filament lighting, accumulators with a.c. current

**RECTALLOY**  
The ideal Battery charger

Send at once for full particulars and explanatory Folder 'M.S.' post free.

Rectalloy Ltd., Vulcan House, Ludgate Hill, London, E.C.4

G.A. 5306.

THE ONLY WAY—  
Scrap your old junk and fit—

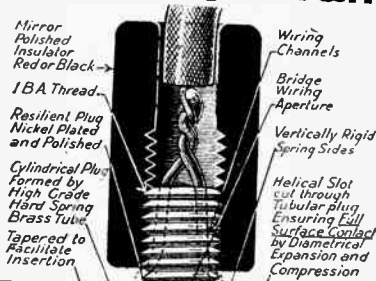

A perfect fitment for every type of H.T. Battery.

PRICE:  
**2D.**  
EACH

From all traders or direct.

**CLIX**  
REGD TRADE MARK  
**WANDER-PLUGS**  
(NON-MICROPHONIC) PATENTED

90% of the efficiency of a soldered joint.  
For all other connections use CLIX plug sockets and adapters.

From all traders or direct from  
**AUTOVEYORS LTD., 84 VICTORIA ST., LONDON, S.W.1**



PRICE NET  
**2/6**

BY POST  
**2/8½**

YOU will find that "The WIRELESS ANNUAL" is a real help to you in your wireless work. It contains a mass of valuable information. Get your copy to-day!

Obtainable from all booksellers or direct from:  
"The Wireless World," Dorset House, Tudor Street, London, E.C.4.

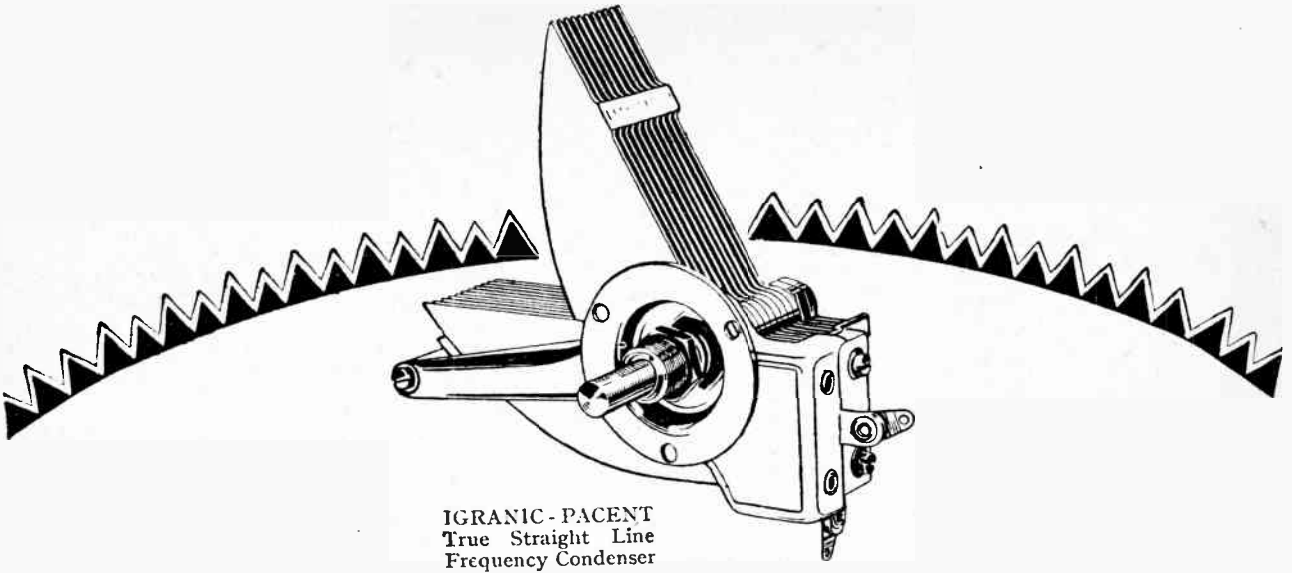

IGRANIC - PACENT  
True Straight Line  
Frequency Condenser

# On this Variable Condenser the plates cannot touch

This is only one reason for the superiority of the Igranic-Pacent True Straight Line Frequency Variable Condenser.

It is a high-grade variable condenser with low-loss characteristics, a true straight line frequency curve and negligible minimum capacity.

The framework is particularly rigid and, being in electrical connection with the moving plates, prevents hand capacity effects.

Dust-proof bearing gives smooth, silky movement which remains reliable indefinitely and facilitates accurate adjustment.

Single or three hole fixing is also provided for.

All reputable dealers carry stocks.

•00035 mfd. . . . . Price 14/6  
•0005 mfd. . . . . Price 18/6

Write for list U175.



Exclusive  
Manufacturing  
Licensees of

Pacent  
Radio  
Essentials.

149, QUEEN VICTORIA ST., LONDON.

WORKS: Elstow Rd., BEDFORD.

Branches:—BIRMINGHAM BRISTOL CARDIFF GLASGOW LEEDS MANCHESTER NEWCASTLE.

Here's the  
reason  
why

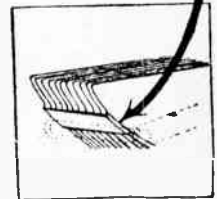
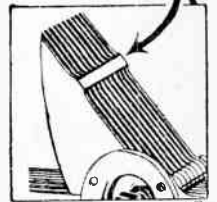

Fixed and moving plates are of brass, riveted together and soldered, ensuring permanent alignment and sound electrical connection.



**ANOTHER CLEARTRON PRODUCT**

CONDENSERS

ONLY:

- 0002 - - - 13/9
- 0003 - - - 14/3
- 0005 - - - 14/9

"Station Selector"  
Dial  
(precision movement)  
**10/6 extra**  
or sold separately.

Manufactured, under the Patents of Western Electric Co. and Cleartron Radio, Ltd., and the registered designs of S. A. Lamplugh, Ltd., Tyseley, Birmingham, exclusively for Cleartron Radio, Ltd. (Sole Proprietors).

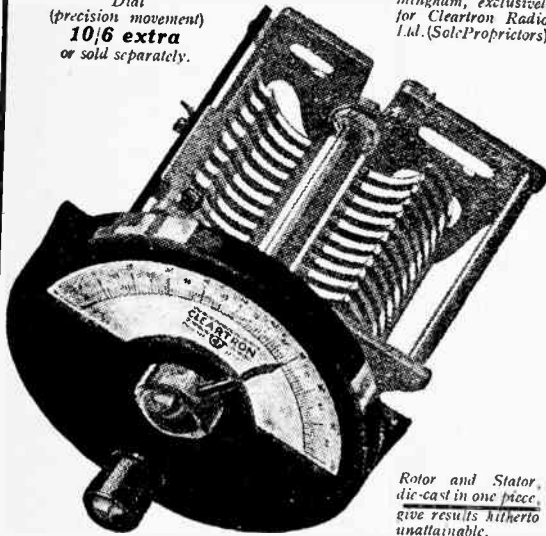

Rotor and Stator, die-cast in one piece give results hitherto unattainable.

**THE DI-CAST CONDENSER**

is a distinct innovation in Condenser design. Avoids the contact resistance losses experienced with separately assembled condensers. Rotor and Stator are die-cast in one, which means positive connexion and perfectly matched characteristics. The specially designed vanes provide straight-line reading, greater range, easy short wave tuning and very low minimum capacity. Another feature of unusual interest is the MICRO STATION SELECTOR, a newly designed dial precision movement, allowing completely selective tuning and ten or more different adjustments between each degree. Play and backlash entirely eliminated.

Ask your dealer or send for complete explanatory leaflet.

and of course

**CLEARTRON VALVES**

America's foremost Valve made in Britain's newest factory.

ALL DULL EMITTERS.



12/6 STANDARD PRICES 15/-

Full technical data from your Dealer or from us.

**CLEARTRON RADIO LIMITED**  
ONE CHARING CROSS, LONDON, S.W.1.  
Regent 2231/2. Cleartron, Westrand, London.  
Works: BIRMINGHAM.

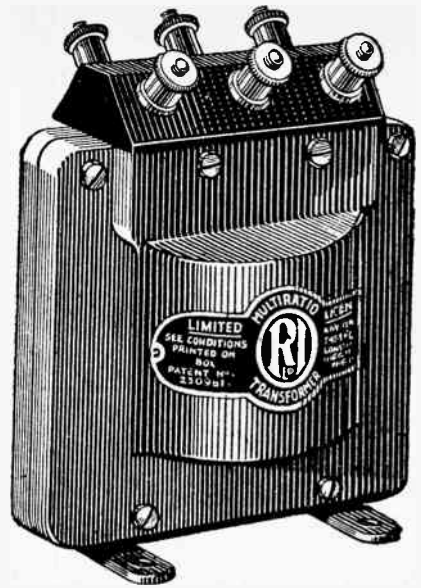

**For Every Valve**

The R.I. Multi-Ratio Transformer will operate at maximum efficiency in conjunction with any valve. The wide range of impedance values available ensures perfect results because a suitable impedance can always be found for the valve in use.

Only by using this transformer can you be assured of the finest reception. We have received hundreds of letters testifying to the wonderful results obtained and the entire elimination of distortion. Have we had one from you? This transformer solves all the difficulties experienced by most amateur constructors, such as choosing the correct combinations of ratio to give the purest reproduction. Incorporated in your set it will at once prove its superiority.

**RATIO TABLE**

Ratio
1 - 1
1½ - 1
2 - 1
3 - 1
4½ - 1
6 - 1
9 - 1

**Price**  
**27/6**

Write for the R.I. Blue and Gold Catalogue.



**THE MARK OF BETTER RADIO.**

Advt. R.I. Ltd., 12, Hyde Street, New Oxford Street, London, W.C.1

Mention of "The Wireless World," when writing to advertisers, will ensure prompt attention.



# The Wireless World

AND  
RADIO REVIEW  
(14<sup>th</sup> Year of Publication)

No. 356.

WEDNESDAY, JUNE 23RD, 1926.

VOL. XVIII. No. 23.

Assistant Editor:

F. H. HAYNES.

Editorial Offices: 139-40, FLEET STREET, LONDON, E.C.4

Advertising and Publishing Offices: DORSET HOUSE, TUDOR STREET, LONDON, E.C.4.

Telegrams: "Ethaworld, Fleet, London."

COVENTRY: Hertford Street.

Telegrams: "Cyclist, Coventry."  
Telephone: 10 Coventry.

BIRMINGHAM: Guildhall Buildings, Navigation Street.

Telegrams: "Autopras, Birmingham."  
Telephone: 2970 and 2971 Midland.

Assistant Editor:

W. JAMES.

Telephone: City 4011 (3 lines).

Telephone: City 2847 (13 lines).

MANCHESTER: 199, Deansgate.

Telegrams: "Ilfite, Manchester."  
Telephone: 8970 and 8971 City.

Subscription Rates: Home, £1 1s. 8d.; Canada, £1 1s. 8d.; other countries abroad, £1 3s. 10d. per annum.

As many of the circuits and apparatus described in these pages are covered by patents, readers are advised, before making use of them, to satisfy themselves that they would not be infringing patents.

## AMATEUR RESEARCH.

ALTHOUGH in pre-broadcasting days there existed quite a formidable body of amateurs and experimenters, their numbers, as estimated then, are insignificant in comparison with the enormous number of those who have taken up the study of wireless as a result of the popularity which the subject has gained through broadcasting. Wireless is one of the new sciences, and we need not go back so very many years before we find that any worker who made observations, however crude, was likely to become regarded as a research worker of importance. But today, before research work can be of much value, the student has a great deal of preparatory work to perform, and it may be assumed that most of the easy paths to inventive success have already been explored. It is of little use for those who wish to devise something new or observe some little-known phenomena to attempt to cover a wide subject. We would urge all those who take a serious interest in wireless to try to put their time and inventive talents to some definite object, and even if no practical utility is found as a result of the investigations, yet it may be safely assumed that an addition will have been made to the scientific knowledge of that particular subject, which in itself should be a sufficient reward.

Now, as to the method of setting about the endeavour to contribute really useful knowledge. It is essential to specialise, and because of the very large number of contributions continually being made to our knowledge of

wireless, it is essential that the student should acquaint himself with the work which has already been done on the particular branch which he selects for study. It is a waste of time, and demoralising in the extreme, to devote perhaps months of study to some particular phenomena, only to discover in the end that the subject has already been exhaustively dealt with by some other worker, and probably described in some technical paper a year or so before. First choose your subject; and then proceed to collect, or at least to read and make notes on, everything of importance which has been written on the subject. Libraries where scientific books are available will greatly facilitate the search, especially if some form of subject index is available, whilst to keep in touch with current literature where research work is likely to be recorded, one cannot do better than to follow the technical abstracts which, by arrangement with the Department of Scientific and Industrial Research, are now appearing month by month in our sister journal, *Experimental Wireless*.

The amateur has a splendid opportunity for carrying out research in matters of detail, because at the present time most of the professionals are engaged in work of a productive character, and only comparatively few are in a position to carry out research work which has no immediate prospect of commercial application. The amateur need not put commercial considerations first; but he is none the less likely to develop some subject hitherto little explored, which will eventually bring him a practical reward and the honour of achievement.

## CONTENTS.

	PAGE
EDITORIAL VIEWS	829
THE VARIABLE CONDENSER	830
By F. H. Haynes.	
THE "ROBERTS" REFLEX NEUTRO- DYNE	833
By H. F. Smith.	
PRACTICAL HINTS AND TIPS	839
READERS' NOVELTIES	841
COMPARISON OF SIGNAL STRENGTH	842
By Paul D. Tyers.	
CURRENT TOPICS	843
BROADCAST BREVITIES	845
CONDENSER PLATE DESIGN	847
By W. H. F. Griffiths.	
LONG RANGE THREE VALVE RE- CEIVER	853
THE PENTATRON	854
By Dr. H. Kröncke.	
BUYERS' GUIDE TO COMPONENT PARTS. FIXED AND VARIABLE CON- DENSERS	855
READERS' PROBLEMS	863

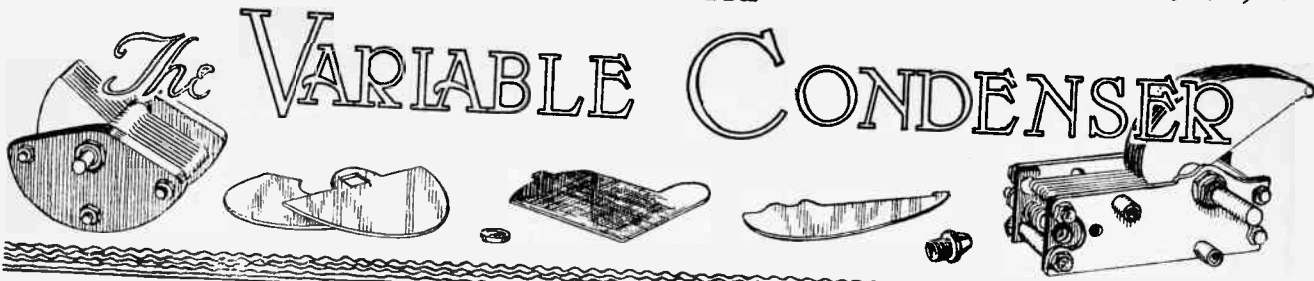

Present Practice and Future Designs.

By F. H. HAYNES.

IT is an extraordinary fact, and one often remarked upon, that the variable condenser, one of the oldest of wireless components, is still in such a marked state of evolution. Admitting that finality in condenser design is not likely to be reached for some time to come, it is surprising how drastic are the changes encountered almost from day to day. The trend would appear to be towards the production of radically new forms of construction.

During the past two or three years we have looked upon new models as embodying all the necessary features of perfection, and within a few short months these have become obsolete when eclipsed by still more attractive successors. In spite of this apparent progress, however, the condenser of to-day is very little better electrically and mechanically than a good-quality instrument of five years ago.

End Plates.

Reviewing the progress made since condensers have been produced in large numbers various stages of development are well defined. The first models were built with ebonite end plates, and the fixed and moving vanes supported on spindles with spacing washers. Next, the use

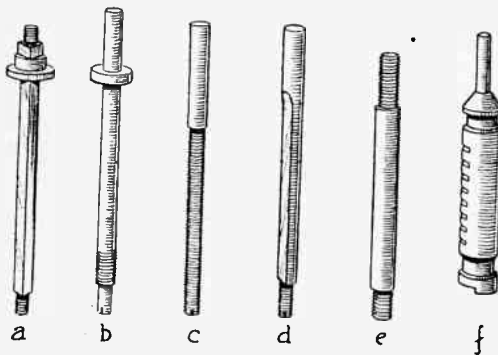

SPINDLES. (a) The square shaft with elaborate top collar and bearing. (b) A good form turned from large diameter rod to produce the collar. (c) The threaded stem. (d) Cut away shaft to which the plates are secured by collars having "D" shaped holes. (e) A threaded spindle passing through the top bearing is unsatisfactory. (f) Here the plates are soldered into slots on a sleeve, slipping over a plain spindle. A conical top thrust bearing is provided together with a cut away piece at the bottom to serve as the stop.

of metal end plates with insulating bushes was considered an advancement, to be superseded rapidly by a type in which the end plates were no longer insulated from the moving spindle, thus overcoming the electrical and

mechanical defects brought about by the use of the small ebonite insulating bushes. The supporting of the fixed plates on ebonite tie-bars, so that the operating spindle could be earth-connected, the die casting of plates and the use of the well-known square law shaped plate were features all to be found in high-grade condensers of several years ago, and yet, to-day, these modifications seem of recent introduction.

Much misapprehension exists as to what constitutes a good variable condenser for use in a receiving set. The points to be regarded are briefly:—

1. Low equivalent resistance depending essentially upon the arrangement of the dielectric material supporting the fixed plates, the method of bonding the plates together, good electrical connection with the moving spindle, and the rotating plates evenly set up between the fixed plates.
2. Low minimum capacity compared with the total maximum capacity of the condenser.
3. A top plain bearing of adequate length.
4. The provision of some form of friction preferably adjustable to prevent the moving plates from changing their positions when the condenser is mounted edgewise.
5. A lower adjustable bearing which, without exerting undue friction or a bending strain upon the end plates, will positively prevent play of the moving spindle.
6. The method of panel mounting must not distort the condenser.
7. The tie-bars bridging the end plates must hold the instrument rigid, even when a fair twisting motion is exerted while gripping the top and bottom plates.
8. If spacing washers are used, they must be of adequate surface area to prevent them bedding down into soft aluminium and to ensure good electrical contact.
9. Some form of "pig tail" or spiral braid connector is usually necessary for making a positive connection with the spindle.
10. A stop is desirable, precisely limiting the movement of the vanes between maximum and minimum to prevent continuous rotation.

How these various requirements have been incorporated in modern condensers is depicted in the accompanying drawings.

An examination of condenser spindles would seem to reveal that manufacturers have endeavoured to avoid the use of a turned shaft. Some form of collar is needed to fix the position of the shaft between the end plates and to produce this by turning down from large diameter

**The Variable Condenser.—**

rod is, perhaps, undesirable. Such a spindle with a raised collar is shown (b) with a plain stem for passing through the top bearing, and also a plain shaft for mounting the plates, which are clamped up tightly by means of a nut. End play is adjusted by carefully setting the bottom mounting plate, whilst the lower end of the spindle is reduced in diameter, passing through a small bush with external "pig tail" or spiral connector.

A simplified form of shaft (c) is threaded along most of its length, and a nut or threaded bush is run on to serve a collar. An ingenious method of rigidly securing the plates to the shaft is shown in (d). It is cut away to present a face whilst the plates are clamped between top

why this large diameter piece should not be made up separately and slipped over a plain straight spindle, being securely attached by a small taper pin or grub screw. The square spindle (a) is to be found in ex-Government

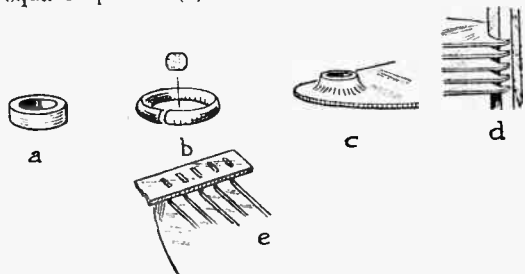

**SPACING WASHERS.** (a) The turned brass washer (b) Flattened wire ring. (c) Pressed up spacer used in conjunction with a thin stamped washer.

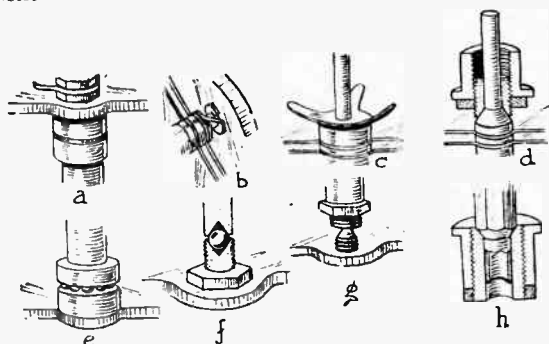

**THRUST BEARINGS.** (a) The fibre ring, a reliable method of controlling end play. (b) and (c) The spring washer should not be found in a precision instrument. (d) Adjustable conical thrust bearing. (e) The ballrace is perhaps unnecessarily elaborate. (f) A single ball now much used in British condensers. (h) Adjustable lower bearing with hollow spindle for linking up with the spindle of another condenser.

condensers. It is somewhat complicated in form, and involves a great deal of detail work. The square shaft is entirely unnecessary and errs a little towards crudity.

For the purpose of holding the spindle precisely in position with the moving plates centrally placed between the fixed plates, some form of adjustable thrust bearing is required. In several designs the thrust bearing also provides the necessary degree of friction. Thus in (a) a small fibre washer lubricated with a little thin oil is inserted between the face of the top bearing and the collar

and bottom bushes, having "D" shaped holes, and held together by a pin, though special equipment in assembling is undoubtedly required for obtaining uniformity.

One of the commonest forms of spindle is (c). Here the plates are clamped between top and bottom nuts run

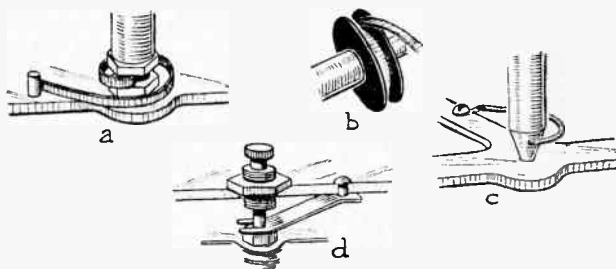

**MOVING PLATE CONNECTORS.** (a) Copper spiral. (b) Protected spiral. (c) Braided copper lead. (d) Spring connector which is very little better than the bearing faces.

on the spindle. At first sight this may not appear to be satisfactory, but a fibre washer used in this way is particularly durable and will impart a very smooth movement as the condenser is operated.

The well-known spring washer method (b) is to be deprecated, for pressure on the spindle tends to drive

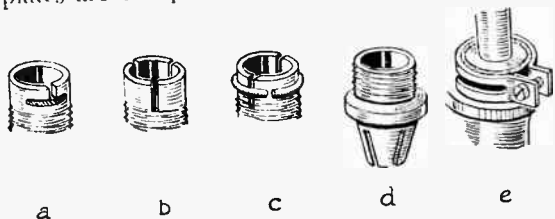

**FRICION BEARINGS.** (a) and (b) Split bushes. (c) Half of the bush is detached and held in position with a spring ring. (d) Bush split on the underside. (e) Adjustable friction collar consisting of a clamp and felt ring.

down on the threaded portions at each end, and although the bottom end of the spindle is probably held quite firmly by a pointed centre screw, the top bearing obtained between the threaded stem and a plain bush is entirely unsatisfactory, and side play can invariably be detected. Now that the use of dials with threaded centre holes are little used, this form of construction is fortunately becoming obsolete.

A good form of spindle is (f), in which a conical top piece controls adjustment and provides a suitable degree of friction. The plates are held in slots and soldered in position, while a cut-away portion at the lower end limits the movement to exactly 180°. There is no reason

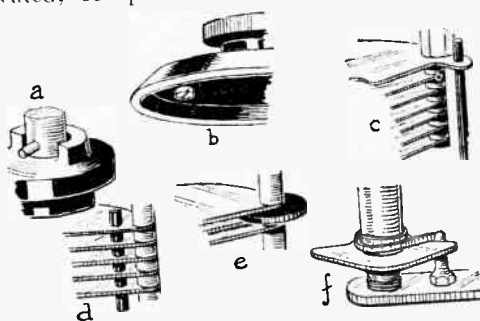

**STOPS.** (a) Moulded end piece with stop pin. (b) A stop under the dial is difficult to fit and requires a pair of screw heads on the instrument panel. (c) Extensions on two of the fixed plates to support an ebonite rod. (d) Ebonite rod carried in holes in the fixed plates. (e) Insulating washer as stop and pin stop.

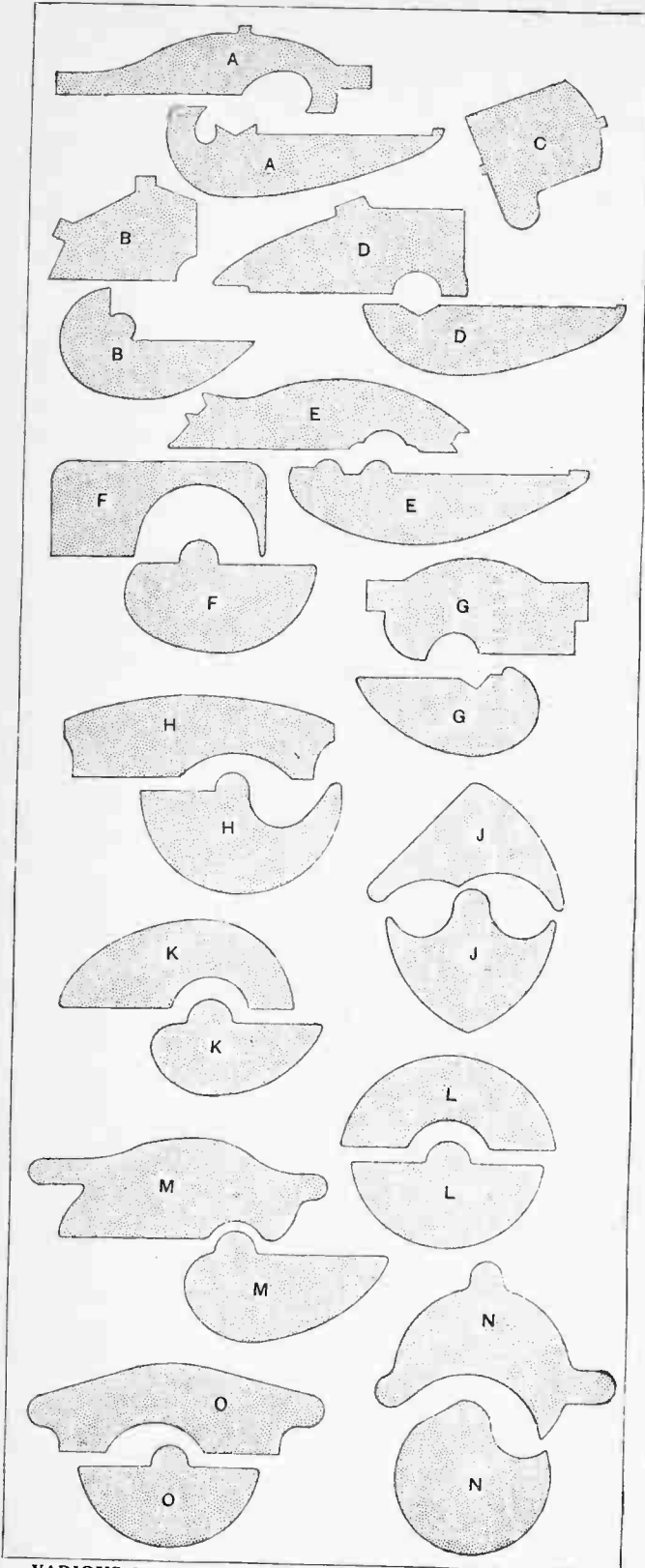

VARIOUS TYPES OF PLATES. A, B, D, E, F, straight line frequency. C, G, H, J, K, M, N, O, straight line wavelength or square law. L, straight line capacity.

A 10

the plates out of position, whilst they are apt to rise and fall as the spring washer rotates. Another form of spring washer made either of steel or bronze is (c), which is undoubtedly an improvement on (b), but must not be considered good practice.

A satisfactory form of adjustable thrust bearing is (d), consisting of a large diameter bush which is inserted from the under side of the top plate with a finely threaded interior hole into which is fitted a smaller adjustable bush held in position by a locknut. The well-known ballrace thrust bearing (e) would seem to be a little too elaborate for so small a shaft. Great care is necessary in setting up such a bearing, and its satisfactory use does, perhaps, indicate a precision job. Slight distortion of an end plate, however, due to absence of "give," is apt to slightly distort the race. A now common form of thrust control is shown in (f), which is a simple and reliable arrangement provided that the faces which engage upon the ball are correctly shaped. Centring by means of a pointed screw (g) is reliable though apt to wear to an extent that would destroy the calibration of a precision instrument.

Another adjustable inset is (h), which, although very similar to (d), is designed for use as a lower bearing, and the hollow piece is intended for inserting the spindle of another condenser for simultaneous operation.

#### Friction Devices.

The introduction of a critical degree of friction is most necessary. The various forms of friction devices shown are almost self-explanatory, excepting possibly (e), which consists of a non-rotating spring clip binding on to a felt ring. This possesses the merit of being adjustable, whilst, as the friction device wears, the setting of the plates is not likely to change.

Several forms of spacing washers, stops, and "pig tail" connectors taken from various British condensers are included among the illustrations and require no comment.

The provision of a vernier plate so common in condensers of a year ago is now perhaps obsolete owing to the introduction of the slow motion dial.

With regard to the multiplicity of slow-motion dials now available, it need only be said that practically all forms employing a train of toothed pinions are almost certain to possess some degree of backlash, and among other methods of gearing that most extensively adopted consists of reducing pinions coupled together by friction.

Future developments will probably incorporate a more substantial form of linking together of the top and bottom bearings possibly taking the shape of a cast "U" piece. The one-hole method of fixing will probably be replaced by the earlier method using screws and spacers. Friction devices and bearing systems will perhaps be more universally adopted, while the solid bars of insulating material will be more robust though arranged to form only a strictly limited part of the electrostatic field. The insulating materials generally approved for this purpose include high-grade Bakelite, Pyrex, and Isolantite. Where Bakelite is used as the insulating material the purchaser looks for a particularly clean moulding, and there is always room for improvement as regards finish so as to present a precision job of attractive appearance.

# The "Roberts" REFLEX NEUTRODYNE

By H. F. SMITH.

IT is doubtful if any American receiver has enjoyed the popularity of the "Reflex Neutrodyne" first described in 1924 by W. van B. Roberts in *Radio Broadcast*. A constructional article, dealing with this circuit, was published in this journal nearly a year ago,<sup>1</sup> and aroused so much interest as to make it seem probable that a further description of the receiver in a modified form would be acceptable.

The writer, who personally considers that the range of a receiver should be stated in terms of its daylight performances, would hesitate to subscribe to some of the more enthusiastic claims made for this set, and considers that no receiver at present known, irrespective of the number of valves used, could be said to have a broadcast reception range of thousands of miles. "Freak" signals might, however, well be received at such distances, and, in fact, are often so received on a very much less effective receiver than the one in question, which is certainly hard to beat, both as regards range and volume, when the fact that only two valves are used is taken into consideration. The set as described covers the normal broadcast band of wavelengths.

<sup>1</sup> *The Wireless World*, July 1st, 1925.

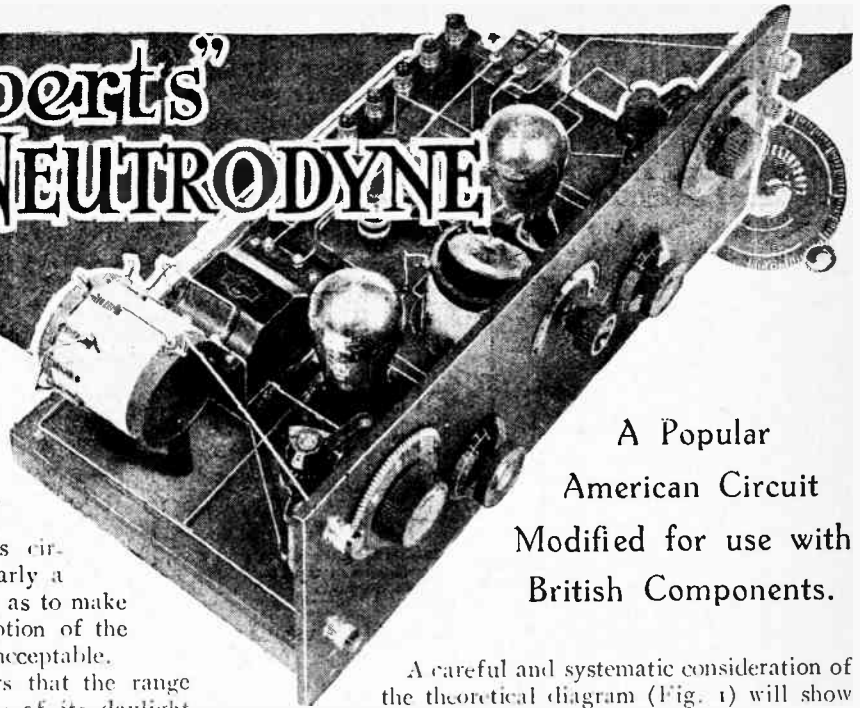

A Popular American Circuit Modified for use with British Components.

A careful and systematic consideration of the theoretical diagram (Fig. 1) will show that the circuit is not unduly complicated. High-frequency voltages built up across the aerial-grid tuning condenser  $C_1$  are applied between grid and filament of the dual or reflex valve  $V_1$ , and, in an amplified form, are passed on by the neutralised H.F. transformer to the grid-filament of the detector valve,  $V_2$ . In order to increase the overall sensitivity of the receiver, and to improve selectivity, reaction is applied between the plate and grid circuits of this valve by variably coupling a coil to the high-potential end of the secondary of the H.F. transformer.

### Winding the Transformers.

Rectified pulses in the plate circuit are passed back through the primary of the L.F. transformer, an air-cored choke and by-pass condenser ( $C_4$ ) being interposed in order to dispose of the H.F. component. Low-frequency voltages set up across the transformer secondary are applied between grid and filament of the dual valve, the small condenser  $C_3$  acting as an H.F. by-pass, following conventional "reflex" practice. Amplified L.F. currents in the anode circuit of  $V_1$  operate the telephones or loud-speaker.

Three "home-made" components are used, and it will be as well to undertake their construction before commencing the assembly of the receiver itself. The details of the H.F. transformer are shown in Fig. 2, from which it will be seen that a method of winding described in several recent issues of this journal has been adopted. The secondary consists of 65 turns of No. 24 D.C.C. copper wire, closely wound on an ebonite tube of  $2\frac{1}{2}$  in.

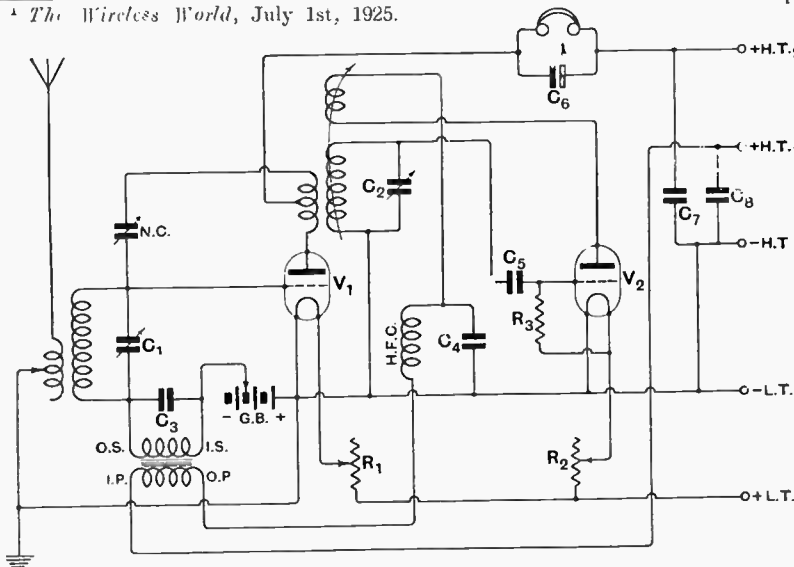

Fig. 1.—The theoretical circuit diagram,  $C_1, C_2 = 0.0005$  mfd.;  $C_3 = 0.0002$  mfd.;  $C_4 = 0.0005$  mfd.;  $C_5 = 0.0003$  mfd.;  $C_6 = 0.001$  mfd.;  $C_7, C_8 = 1$  mfd.;  $R_3 = 2$  megohms

**The "Roberts" Reflex Neurodyne.—**

diameter, and 3in. long. Over the lower (earthed) end of this are the primary and neutralising sections, having each 15 turns of No. 30 D.S.C. wire. In other words, this winding has a total of 30 turns, tapped in the centre for connection to H.T.+ (through the telephones). Adjacent turns are slightly spaced from each other, and occupy a total winding space of  $\frac{3}{8}$ in. The primary is separated from the secondary by 10 ebonite strips, approximately 1 $\frac{1}{8}$ in. long by  $\frac{1}{8}$ in. square in cross section. Before winding on the primary, it will be as well to put a tightly fitting rubber band over these strips, in order to hold them securely in position while commencing operations. The various ends of the coils are brought out to conveniently arranged soldering tags secured to the upper and lower edges of the tube by 6 B.A. brass screws and nuts; the transformer being screwed to the baseboard by means of two small brass brackets.

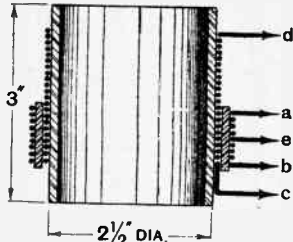

Fig. 2.—Sectional sketch showing details of the H.F. transformer.

**The Reaction Coil Mounting.**

The reaction coil is wound on a thin presspahn "basket" former (actually a commercial pattern, reduced in diameter), having 9 radial slots, with an internal diameter of 1in. Its external measurement will depend on the thickness of the wall of the ebonite tube inside of which it is to rotate, and will be slightly less than 2 $\frac{1}{4}$ in. A small ebonite block is secured to the centre of this former by means of small brass screws and nuts, and through its centre is drilled and, if possible, tapped, a hole to accommodate the brass control spindle, of 2 B.A. threaded rod, which passes through the upper edge of the ebonite tube and also through the panel; a brass bush

is inserted in the latter to provide a smooth working bearing. Suitable bushes are obtainable from some dealers, but, if not readily available, the constructor will no doubt be able to remove one from a discarded "one hole fixing" component. A suitable knob and graduated scale should also be obtained. There are 15 turns of No. 24 D.C.C. wire on the former.

The aerial-grid transformer is of very similar construction, the only difference being in the primary winding, which has 15 turns of No. 30 D.S.C. wire, spaced to occupy  $\frac{3}{4}$ in. The end nearest to the centre of the coil connects to the aerial terminal, while tappings are taken at the 5th, 8th, 10th, 12th, and 15th turns for alternative connection to earth. These taps are made by removing the insulation from about  $\frac{1}{4}$ in. of the wire, and soldering on a small strip of copper foil. After making a tap, and before resuming winding, a fragment of insulating material, such as oiled silk or empire tape, should be placed underneath the tap connection. This transformer is raised 1 $\frac{1}{2}$ in. above the baseboard by means of ebonite tube distance pieces. In both transformers all windings are in the same direction.

Fig. 3.—Sectional sketch showing construction of the H.F. choke.

The H.F. choke may be constructed in the manner illustrated in Fig. 3. A piece of ebonite or hardwood rod of the dimensions shown carries three winding sections, each having about 175 turns of No. 42 D.S.C. wire, put on in an irregular criss-cross formation. To facilitate the starting of a

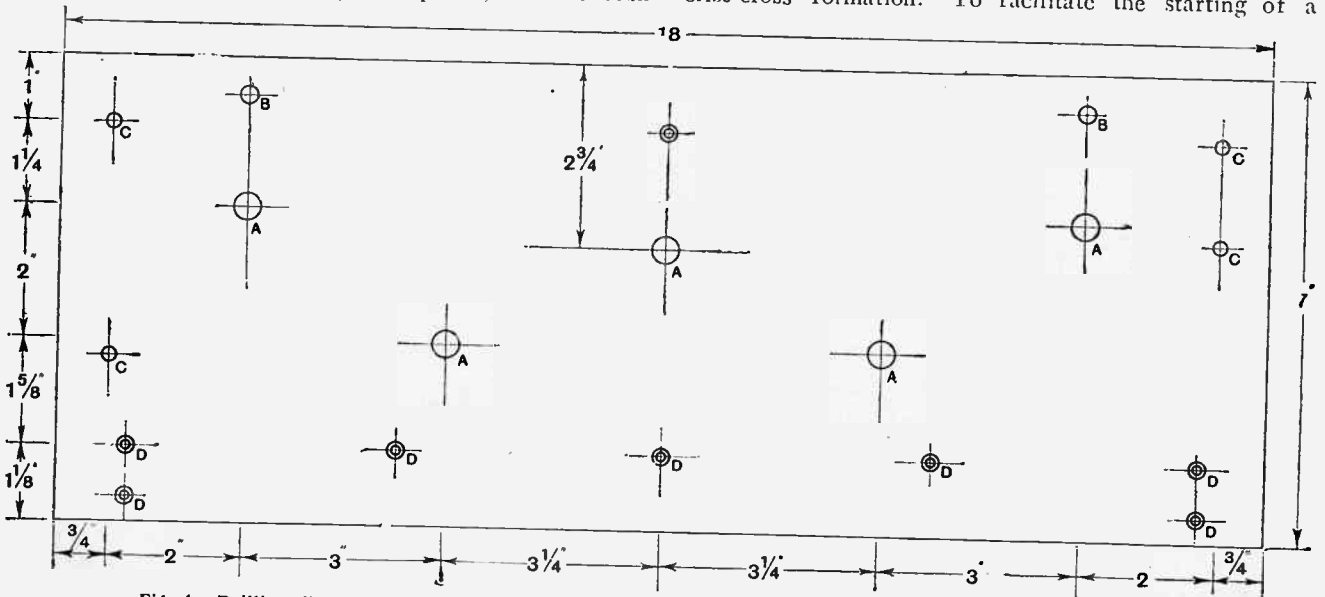

Fig. 4.—Drilling diagram of the iron panel. A,  $\frac{3}{8}$ in. dia.; B,  $\frac{1}{2}$ in. dia.; C,  $\frac{5}{8}$ in. dia.; D,  $\frac{1}{2}$ in. dia. countersunk

**The "Roberts" Reflex Neutrodyne.—**

section, the former may be slightly grooved, as shown, and it can conveniently be rotated for winding by inserting the terminal shank (which will eventually be passed through a hole in the baseboard) into the chuck of a hand drill or lathe. It may be pointed out that any compact form of commercial H.F. choke can be substituted if desired.

The panel should now be prepared and drilled in

conventional manner; the method used here has, however, the advantage that the somewhat difficult task of accurately cutting a slot in the back of the containing cabinet is avoided, as the connecting wires can be led in through holes, which, for the sake of appearance, may be fitted with ebonite bushes.

The wiring is clearly shown in Fig. 7, and little further comment is called for, although it may be pointed out that one of the flexible leads (necessary to allow

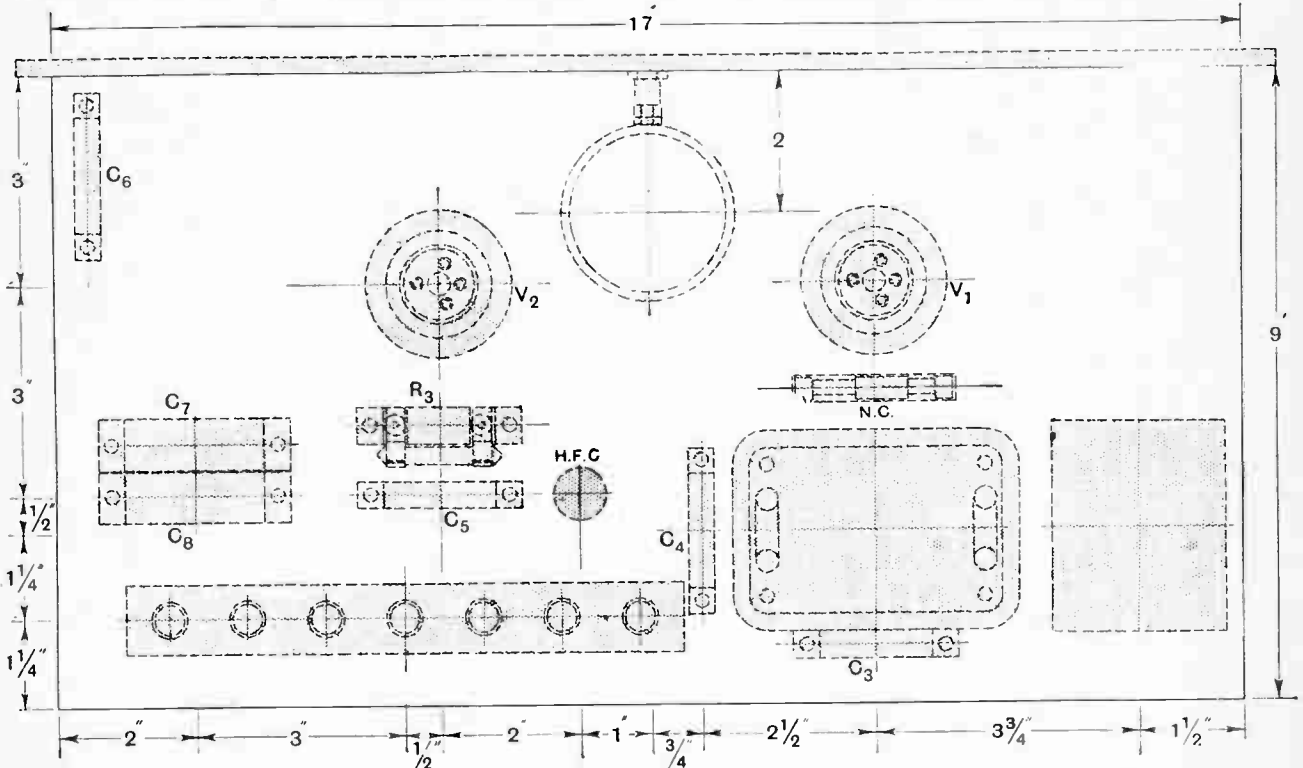

Fig. 5.—Positions of components on the baseboard.

accordance with the dimensions given in Fig. 4. The centre hole for the bush of the reaction spindle may be left until the panel and baseboard are fitted together, in order that its correct position may be found, irrespective of the height of the transformer-supporting brackets.

The baseboard itself should be of well-seasoned wood and is finished to the dimensions shown in Fig. 5, which also indicates the relative positions of the various components. Two wooden strips,  $\frac{7}{8}$  in. square in cross section, are screwed on to the lower edges of this board, thus raising its upper surface about  $1\frac{1}{2}$  in. above the lower edge of the panel. This allows the low-potential leads to be carried under the board if desired, although this method of wiring has not been adopted in the set actually illustrated.

A terminal strip, dimensioned and drilled as indicated in Fig. 6, is secured to the baseboard by screws passing through ebonite distance pieces,  $1\frac{1}{2}$  in. in length. An upright terminal panel may be fitted if desired in the

movement of the reaction coil) is anchored to a soldering tag screwed on to the panel. Another flexible connection carrying a light brass clip at one end, joins to the earth wire whichever aerial coil tapping may be in use.

A valve having an impedance of not appreciably more than 10,000 ohms may be regarded as essential in the first position, while the high-tension and grid bias voltages applied to it should be of the maximum values recommended by the manufacturers. Any good general-purpose valve will serve as a detector, and should be supplied with some forty to fifty volts of H.T., it being noted that this valve is fed through the terminal marked H.T. + 1 in Fig. 7.

When making preliminary adjustments, the reaction coil should be set at minimum coupling with its axis at right angles to that of the transformer coils. The variable earth tap should be set in such a way as to include some 10 turns of primary in the aerial circuit, and the "Neutrodyne" condenser set at its lowest capacity

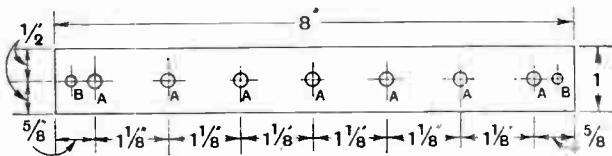
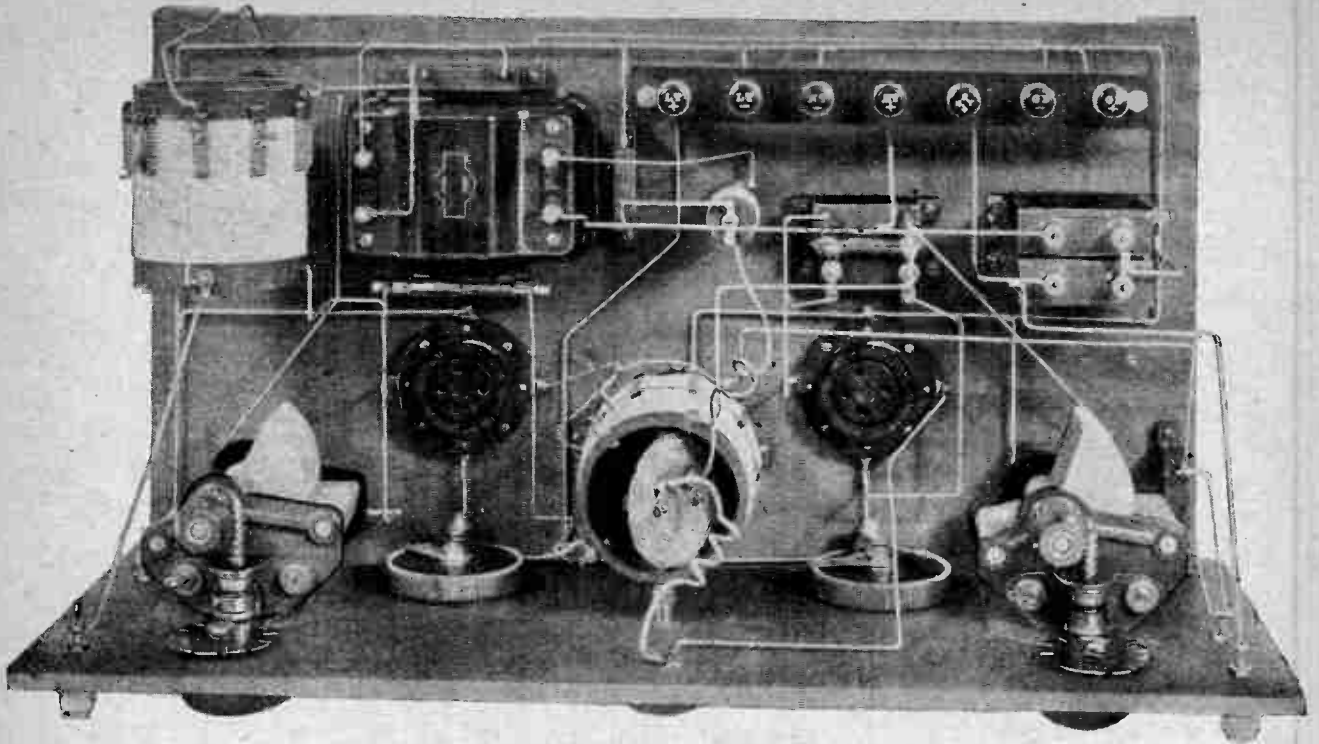

Fig. 6.—The terminal panel. A,  $\frac{3}{8}$  in. dia.; B,  $\frac{1}{2}$  in. dia.



View from above, showing position of components:

by sliding the sleeve to either end: Normally, the set will break into oscillation as the two tuned circuits are brought into resonance by rotation of the tuning condensers. To correct this, the sleeve of the balancing condenser should be gradually moved towards the centre, preferably by the use of a long rod of wood or other insulating material, until oscillation ceases. The two circuits should now be retuned, when a further slight movement

of the neutralising condenser may be necessary. To make sure that the balance obtained in this way is perfect over the whole tuning scale, an attempt should be made to receive distant stations, always remembering the absolute necessity of keeping the two circuits in tune with each other while searching.

The strength of signals is improved by increasing the reaction coupling, but care must be taken to avoid work-

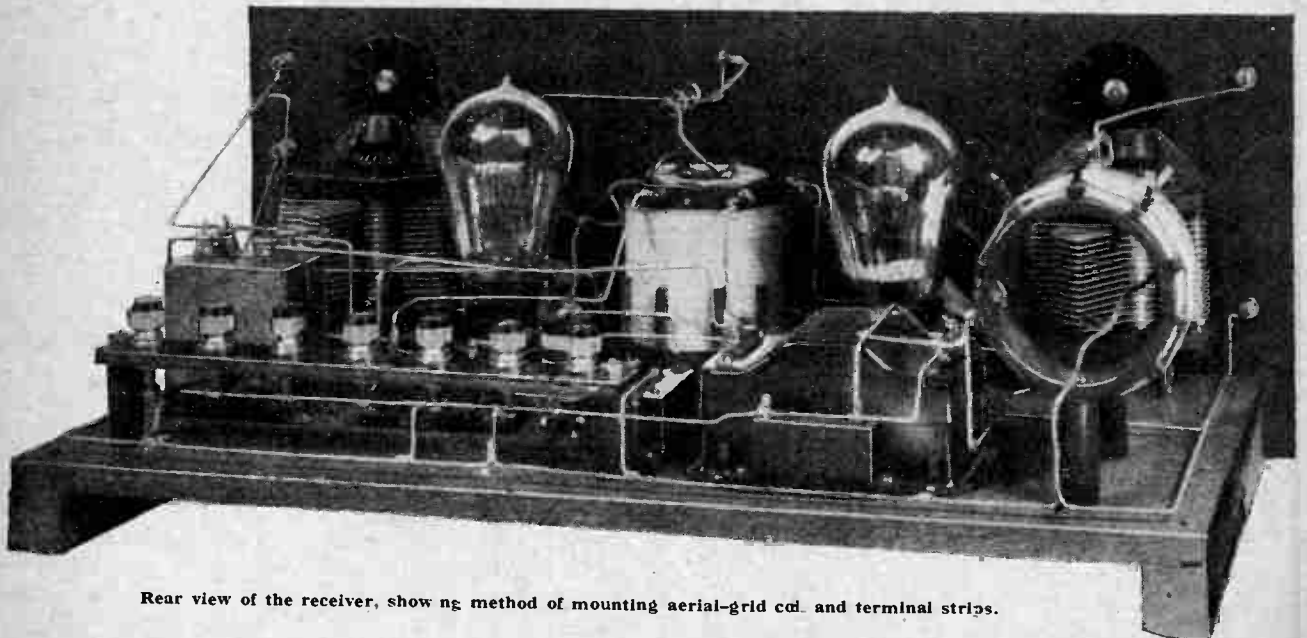

Rear view of the receiver, showing method of mounting aerial-grid coil and terminal strips.



**The "Roberts" Reflex Neurodyne.—**

ing the set just on the point of oscillation, as low-frequency howling is likely to be produced when the valves are in this condition.

In making the above suggestions as to the carrying out of preliminary adjustments, it is assumed that every-

terminals are short-circuited, and the primary of the L.F. transformer is disconnected, a pair of telephones being connected in its stead. It will probably be as well, also, to disconnect temporarily the reaction coil, joining together the ends of its leads.

If the receiver, connected up in this manner, fails to

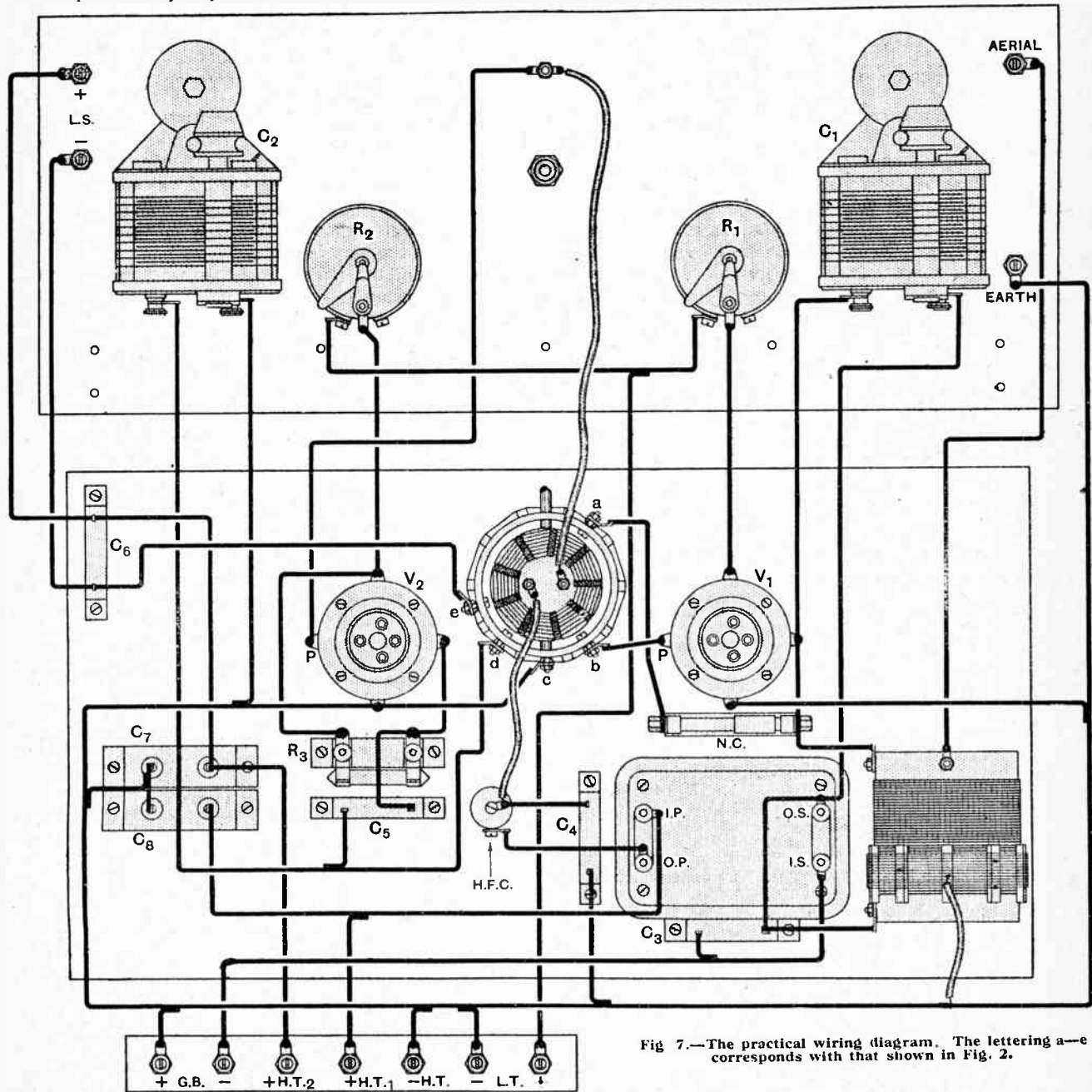

Fig 7.—The practical wiring diagram. The lettering a—e corresponds with that shown in Fig. 2.

thing is in order. This, unfortunately, is not always the case with any newly assembled receiver, and, when dealing with a reflex, it is not always easy to locate the real source of the trouble unless steps are taken to simplify matters. This may be done very easily by converting the set to a single H.F. and detector circuit. To make this alteration, which only takes a few moments, the 'phone

oscillate freely with the neutralising condenser set at minimum, and both circuits in tune, the effect of short-circuiting the transformer secondary should be tried. The production of oscillation will now indicate that the shunting condenser C<sub>3</sub> is too small, and an additional capacity of 0.0001 or 0.0002 mfd. should be connected in parallel with it. One should, however, always en-

## LIST OF PARTS.

1 Ebonite panel, 7in. x 18in.,  $\frac{1}{4}$ in. thick.  
1 Ebonite panel, 8in. x  $\frac{1}{2}$ in.,  $\frac{1}{4}$ in. thick.  
1 Wooden baseboard.  
2 Variable condensers, 0-0005 mfd. (Colvern).  
1 L.F. Transformer (Marconiphone Junior).  
2 Valve holders (Lotus).  
2 Fixed condensers, 1 mfd.

1 Fixed condenser, 0-0002 mfd. (Dubilier).  
1 Fixed condenser, 0-0005 mfd. (Dubilier).  
1 Fixed condenser, 0-001 mfd. (Dubilier).  
1 Fixed condenser, 0-0003 mfd. (Dubilier).  
1 Grid leak, 2 megohms, with holder (Dubilier).  
1 Neutralising condenser (Igrantic).  
Ebonite tube, rod, wire, terminals, screws, etc.

Approximate cost, without cabinet - - - - £5 15s. od.

deavour to use the smallest possible condenser in this position.

The instructions already given for balancing the receiver should now be carried out, and, when it is perfectly stable, the reaction coil may be reconnected. If oscillation is present with the setting of this coil, corresponding to minimum coupling, its inductance must be reduced by removing a few turns. Should the stability of the set still seem to be capable of improvement, a larger by-pass condenser (C<sub>1</sub>) should be tried, and it is even permissible to try the effect of short-circuiting the H.F. choke.

As there is only one stage of low-frequency amplification, it is clear that long-distance reception on the loud-speaker can hardly be expected consistently, although it is found that under favourable conditions, and at night time, such results are often obtained. The range on phones is distinctly good, particularly when the fullest possible use of reaction is made.

In conclusion, the writer would impress on the prospective constructor the need of using a valve of low impedance in the reflex position, as no other can give the results of which the set is capable.

## Calls Heard.

## Extracts from Readers' Logs.

## South Tottenham, London, N.15.

Brazil:—2AB, 1AZ. China:—GFUP.  
Sweden:—SMES, SMSR, SMTN, SMUA, SMYU, SMUT, SMVJ, SMVL, SMZZ. Denmark:—7ZM, 7MT, 7XU, 7KW, 7BX. Russia:—NRL. Germany:—KC4, KI6, KWS, 4LV, 4KAL. Unknown:—PCK4, 4QQ, LIA6, PR8QQ.  
(0-v-0) W. P. Dolphin,  
G 2BQK

## London, S.W.12.

(April-May.)  
Belgium:—4RS, P7, S2, G3, M2, M3, K3, U2, C22, 4YZ, K6, K4, S4, E1, 4QQ, O8, O2, E4, E9.  
Spain:—EAR6, EAR9, EAR20, EAR21, EAR10, EAR28. France:—8DP?, 8FR, 8JF, 8HM, 8CL, 8IX, 8AH, 8JW, 8CA, 8FU, 8BS, 8BU, 8JN, 8RAT, 8NA, 8BE, 8EF, 8DT, 8LG, 8PY, 8VS, 8BA, 8GSM, 8LZ, 8PAM, 8UD, 8GS, 8GZ, 8PEP, 8CY, 8PW, 8BE, 8EF, 8VO, 8DL, 8MM, 8YOR, 8EZ, 8SSS, 8BF, 8MR, 8DGS, 8RG, 8CM, 8SSY, 8KF, 8JR, 6YK.  
British:—2BDY, 5PO, 5DC, 6RM, 5HS, 2SM, 2MF, 6AL, 5GQ, 5KU, 5MF, 5BL, 6NH, 5HJ, 5WV, 5TD, 2DQ, 5LS, 5NJ, 6VA, 5DH, 5FQ, 2BQ, 5FQ, 2IT, 2WY, 6FT, 5WQ, 5PZ, 6VP, 2NT, 5BY, 6QD, 5IN, 6MU, 6IA, 6YD. Italy:—1BW, 1BB, 1BD, 1AU, 1CT, 1GW, 1SRA, 1CO, 1RM, 1CH. Germany:—KW9, KW3, KIO, KIB, KWL. Holland:—OWC, OBA, PB7, PCTT, PCLL, 2PZ,

PCK4, OAG, PC7, OPM, OVN, PCPP, OBL. Portugal:—IAE, 1CK. Finland:—2ND, 2CO, 2NS, 2NB. Tunis:—TUN2. Sweden:—SMUK, SMVL, SMXG, SMXU, SMWS, SMRU, SMTH, SMWQ, SMUV. U.S.A.:—WIZ, NOT. Switzerland:—9XA. Java:—PKX. Russia:—RCRL. Denmark:—7EW. Various:—FW, 1MEF, T PA1, 9YU, GBM.  
(Reinartz, 0-v-0.) B. G. Russell.  
Small indoor aerial.

## Jersey.

(April and May.)  
Great Britain:—2CC, 2DQ, 2MX, 2NM, 2SN, 2SZ, 2ZC, 5FQ, 5JW, 5KU, 5TD, 5WQ, 6BR, 6IZ, 6KT, 6LC, 6NH, 6PU, 6RD, 6TD, 6UT, 6UZ, AKC, AKD, GBM, GFL, GFR, GKD. U.S.A.:—1AAO, 1ADS, 1AFO, 1AHX, 1ATU, 1AMD, 1ASF, 1ATV, 1AVF, 1AYL, 1AZD, 1BCN, 1BOA, 1BXG, 1BZ, 1CLN, 1CMF, 1CNP, 1CW, 1GA, 1XV, 2APM, 2BBB, 2CAW, 2CJE, 2CVJ, 2CXL, 2CYX, 2EV, 2JB, 2KG, 2KR, 2KU, 2ME, 2MM, 2NF, 2NZ, 2RZ, 2SZ, 2ZV, 3AFQ, 3BHA, 3BLC, 3BVA, 3FC, 3FY, 3LW, 4AG, 4AI, 4BI, 4CL, 4HU, 4IR, 4NI, 4OC, 4QJ, 4WQ, 5NI, 8AC, 8ADA, 8AHK, 8ALY, 8AVL, 8BSM, 8CSV, 8DBB, 8KF, 8XE, 9ADK, 9ADN, 9BBW, 9BPB, 9BRG, 9CXC, 9DPJ, 9EEV, 9EGH, 9EKF, 9IM, 9ZA, NEM, NIDK, NTT. Argentine:—DE3. Brazil:—1AL, 2AG, SNM. Mexico:—1J. Norway:—LAJE, LA4X, LGN. Arctic Ocean:—KEGK (U.S. Exploration Ship "Chantier") calling U1AAO. Various:—PCMM, PCPP, P3GB, YS7XX, GW7QX, LIJW, D7BX, C3FC, PRRX, CGK, AQE, NT12, XC51, SKA, FBVY, AGB, KPL.  
(0-v-1) 30 to 75 metres.

J. Cutler Vincent.

TRANSMITTERS' NOTES  
AND QUERIES.

## New Zealand on 10 Watts.

Mr. Donald Woods (G5WV), of Braintree, reports that he established two-way communication with New Zealand Z2AC, of Gisborne, on June 6th, using an input of only 10 watts 300 volts R.A.C., with an LS5 valve. Signals were exchanged for half an hour from 4.15 a.m. (B.S.T.), the New Zealander reporting 5WV as R4. On June 30th Mr. Woods worked with U2GP, of New York, using the same power, and was reported as R3.

o o o o

## Well-known Irish Transmitters.

GI 6MU Eric Megaw, "Arden," 3, Fortwilliam Drive, Belfast.  
GI 5NJ Frank R. Neill, "Chesterfield," Whitehead, Co. Antrim.  
GI 6YM City of Belfast Y.M.C.A. Radio Club, Wellington Place, Belfast.  
GI 2IT Bertie Walsh, "Clovell," Armagh.  
GI 6TB John Sang, 22, Stranmillis Gardens, Belfast.  
GW 15B W. R. Burne, 34, Dame Street, Dublin.

o o o o

## Test Signals from Belgium.

The Belgian transmitter BV33 advises us that he is at present carrying out test transmissions until June 27th on a wavelength of 17 metres. The transmissions are effected daily between 11 and 11.30 a.m., and between 10 and 10.30 p.m. (G.M.T.). BV33 operates on C.W. with an input of 50 watts. He listens on wavelengths between 15 and 25 metres.

Reports should be addressed BV33, c/o Réseau Belge, 11, rue du Congrès, Brussels.



# PRACTICAL HINTS AND TIPS

## A Section Mainly for the New Reader.

### PHONES AND LOUD-SPEAKER.

It is not infrequently desired to listen on headphones while a loud-speaker (possibly in another room) is in operation from the same set. The usual result of connecting the 'phones directly in series or parallel with the loud-speaker is unbearably loud signals from the former, while volume from the latter is often appreciably reduced. Thus we sometimes find that a deaf member of the household, who customarily listens on headphones, is forced to endure the rattling produced by actual contacts between the diaphragms and pole-pieces, while the remainder of the family are possibly not obtaining adequate volume from the loud-speaker. A similar state of affairs may arise when the 'phones are used for tuning-in a comparatively weak signal, or when adjustments are being made to the apparatus.

Luckily, the trouble may be easily overcome by the adoption of the simple arrangement shown in Fig. 1, in which the telephones, in series with a high non-inductive resistance, are connected in parallel with a loud-speaker. An "on-off" switch is shown, but will be unnecessary if the variable resistance has a definite "off" position.

The best value for the resistance can hardly be ascertained except by the method of trial and error, although, as a rough guide, it may be stated that it will generally exceed 100,000 ohms. A variable resistor may be used, if one can be found to stand up to the current passed without producing noises; otherwise it will be best to use one or more wire-

wound resistances of the type sold for use in intervalve couplings.

If desired, all the parts may be mounted in a small box, with two pairs of terminals, one for connection to the receiver and the other to the headphones.

Provided that the resistance used is of a really high value compared with the other impedances in the circuit, including that of the valve itself, it will be found that the addi-

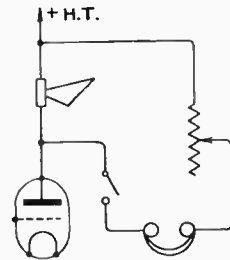

Fig. 1.—Connecting loud-speaker and telephones in parallel.

tion of this device makes no appreciable difference to the tone of the loud-speaker.

### BROKEN EARTH CONNECTIONS.

It is almost certain that the earth connection receives less attention than any other part of a receiving installation, probably because it is out of sight. The possibility of trouble at this end of the aerial circuit must not, however, be neglected; and, if contact is made to a water pipe, it should be examined periodically, and cleaned if necessary.

A buried earth must, naturally, be taken more or less "on trust"; this, incidentally, reminds one of the need for care when the original connections are made. It is possible, of course, to examine and even to test the earth lead up to the point where it enters the ground.

It is fortunate that audible indications of a fault in this circuit are generally given. If there is a high-resistance connection, the tuning of the aerial circuit will be unusually flat, while a complete lack of continuity will be suggested when the reading of the aerial tuning condenser is considerably higher than usual, while hand-capacity effects will be more pronounced than usual.

o o o o

### "UNTUNED AERIAL" RECEIVERS.

Aerial coupling coils, with a primary winding of a dozen turns or so, not tuned separately, and wound in close proximity to the secondary, are almost invariably designed for use with an aerial of the full normal dimensions.

When occasion arises to use a receiver embodying one of these devices on a very short indoor aerial, results are generally disappointing, and it may well be found that signals are equally strong when the aerial is completely disconnected. It will be useful to many readers to know that signal strength will, almost invariably, be vastly improved by connecting the aerial, assuming that it is of the kind under consideration, directly to the high-potential end of the tuned secondary coil (that which connects to the grid of the first valve). This connection will, of course, necessitate reduction of tuning capacity.

o o o o

### MASTER RHEOSTATS.

In order that a multivalve set may be put into operation by anyone quite unskilled in the operation of wireless sets, it is often recommended that either a master switch or a master rheostat should be connected in the filament circuit, each valve being fitted with an individual variable or fixed resistance. It is often pointed out that when using a variable rheostat instead of a simple "on-and-off" switch the filaments are heated

**Practical Hints and Tips.—**

comparatively gradually, with the result that they will give longer service. As to whether the increase in life is appreciable, we are not at the moment concerned, but it may be pointed out that if a rheostat is chosen it should be used in such a way that, when the receiver is in operation, it

is turned to the zero position, unless all the valves have similar filament characteristics. In other words, the variable resistance is acting purely as an "on-off" switch, but is applying the voltage more gradually than is possible if an ordinary switch is used.

The exact reason for the foregoing

would involve a rather wearisome dissertation on Ohm's Law, but, without going fully into the matter, it will be fairly obvious that great complication will be introduced if we endeavour to feed, say, a 3-volt 0.06-amp. valve and another taking 0.3 amp. at 3.8 volts from a 4-volt accumulator through a common rheostat.

**DISSECTED DIAGRAMS.**

**No. 33.—Improving a Standard H.F.-and-Detector Set.**

*In the present series of diagrams it is proposed to indicate methods whereby various popular types of receivers may be improved and brought into line with modern practice. By treating the various points separately it is hoped that the necessary alterations in wiring will be made clear.*

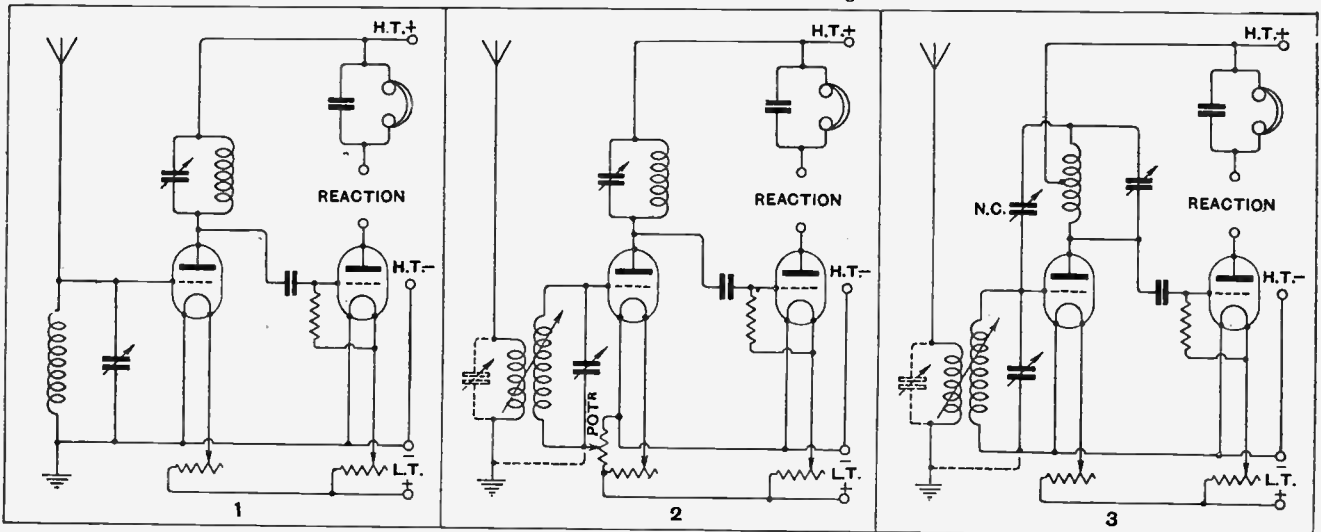

(1) A popular form of receiver, with "tuned anode" H.F. amplifier and regenerative detector. The reaction coil may be coupled to either the aerial or anode coils. This circuit lacks selectivity, and the set may be improved—

(2)—by adding a coupled aerial circuit, which may be separately tuned if desired. The consequent reduction in aerial damping will, unfortunately, necessitate some form of stabilising. The potentiometer shown is the simplest device, but—

(3)—a balancing or neutralising arrangement is infinitely better. The "tuned anode" circuit shown above can be substituted with a minimum of alteration, and is suitable when a valve of high impedance and amplification is used.

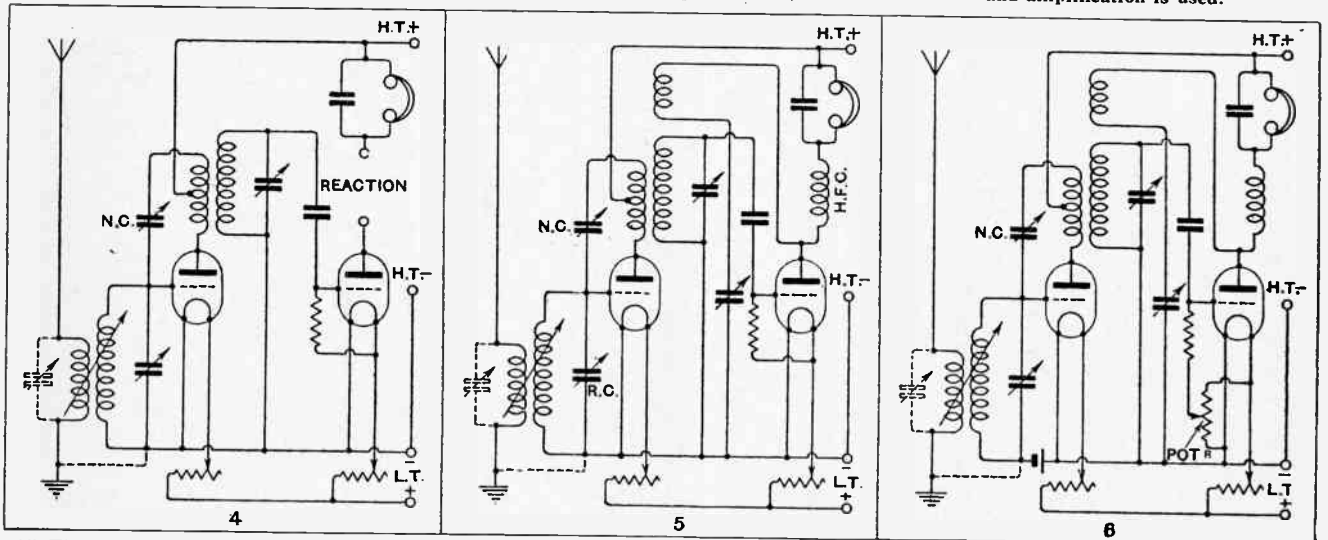

(4) The substitution of a neutralised H.F. transformer has certain advantages when a low-impedance valve is used, and may perhaps be preferred.

(5) The use of capacity-controlled reaction is shown above; this will generally permit of closer adjustment, and consequently increased range, while—

(6)—the addition of a potentiometer to control the voltage of the detector valve grid is well worth while in any circuit.

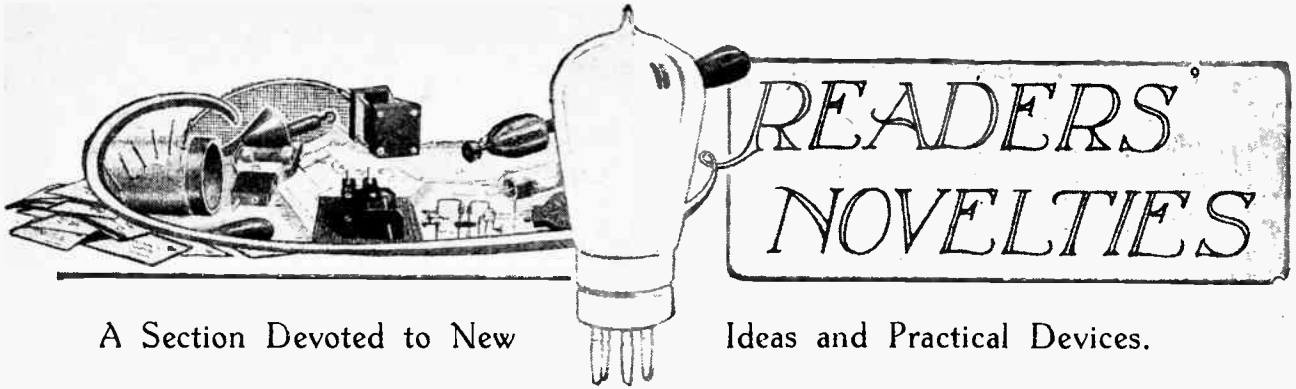

A Section Devoted to New

Ideas and Practical Devices.

**A USEFUL ENAMEL.**

Sealing wax is sold in various colours and may be dissolved in methylated spirits to form a series of different coloured enamels. These are very useful in wireless work for marking the tops of battery terminals, etc., and can also be used to mark bottles containing accumulator acid, as the enamel is not attacked by acid which may run down the outside of the bottle.—S. H.

o o o o

**CONDENSER DIAL ADJUSTMENT.**

There are still condensers in use in which the knob and dial are tapped and lock together on a threaded spindle. With such condensers it is not uncommon to find that the dial tilts to one side when locked in position, and investigation reveals that the brass nut inserted in the moulded knob is out of truth. Instead of locking against the under surface of the brass insert, the dial is pulled

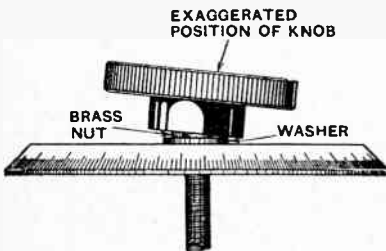

Condenser dial adjustment.

out of truth against the lower surface of the knob itself.

To remedy this defect, if only one knob is available, insert a brass washer between the knob and dial. This will raise the moulded portion of the knob out of contact with the dial, which will then take its level from the brass insert.—F. M.

**NEUTRODYNE CONDENSER.**

There must be no back-lash in the movement of a neutralising condenser, the adjustment of which is always critical in a neutrodyne circuit which is properly designed and constructed.

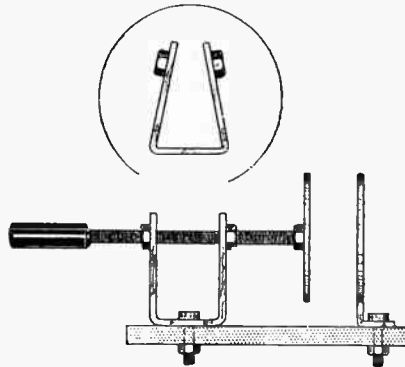

Neutralising condenser.

Several methods of taking up wear in the adjusting screw have been devised, such as split collets, nuts with saw-cuts, etc. A far simpler method is illustrated in the diagram. The adjusting screw is supported by a U-shaped bracket of spring brass to each side of which is soldered a brass nut. Before assembly, the sides of the bracket are bent in towards each other, so that when the screwed rod is inserted they are forced apart and

**VALVES FOR IDEAS.**

Readers are invited to submit brief details, with rough sketches, where necessary, of devices of experimental interest for inclusion in this section. A receiving valve will be despatched to every reader whose idea is accepted for publication.

Letters should be addressed to the Editor, "Wireless World and Radio Review," Dorset House, Tudor Street, London, E.C.4, and marked "Ideas."

exert a pressure which precludes the development of any form of back-lash.—H. W. M.

o o o o

**PERMANENT DETECTOR.**

The zincite-bornite or Perikon detector does not depend upon a delicate adjustment of contact pressure to obtain maximum sensitivity, and, therefore, lends itself to the construction of so-called permanent detectors. Indeed, most commercial detectors of this type make use of the Perikon or a similar combination.

The amateur can construct a very neat detector unit for himself, making use of an insulated wander plug as the container.

A No. 6 B.A. countersunk brass screw is inserted in the hole in the insulating cap and locked in position with a nut on the outside. Small fragments of crystal are then dropped into the cavity and the wander plug inserted, the latter being secured by the locking ring, if this is provided.

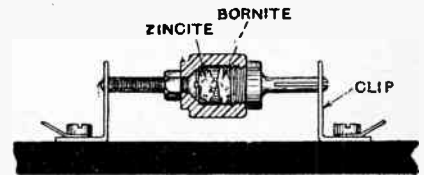

Permanent detector made from wander plug.

The unit is held in suitable clips screwed to the base of the receiver.

One or two comparative tests should be made by unscrewing the wander plug slightly and shaking the crystals to find new points of contact in order that one may be satisfied that the best possible results are being obtained.—F. M.

# COMPARISON OF SIGNAL STRENGTH.

## A Development of the Shunted Telephone Method.

By PAUL D. TYERS.

IT is believed that many experimenters frequently compare the relative strength of received signals by the shunted telephone method. The method consists essentially of shunting the telephone receivers with a variable resistance, and adjusting the value of this resistance until the signal is either inaudible or is identical with some local source of acoustic energy. Actually, of course, the current in the output circuit of a receiver takes a divided path, part flowing through the windings of the telephone receivers, and part through the resistance which is in parallel with them; this resistance being of such a value that the voltage across the telephone terminals is insufficient to render them operative, or, alternatively, is sufficient to cause them to emit a predetermined intensity of sound. Signal strengths are then calculated by simple inverse proportion from the amount of resistance in parallel.

Now, it is well known that the output of a valve or the amplification obtainable per stage, is dependent upon the impedance in the anode circuit. Thus, if a simple variable resistance is connected in parallel with the telephone receivers included in the anode circuit of a valve, a loud signal will necessitate a small value of the resistance across the telephones. In other words, the impedance of the anode circuit will be very materially lowered, so far, in fact, as to cause a considerable loss of amplification, and, accordingly, inaccurate results are obtained. In order to compensate for this error it is usual to employ two similar variable resistances, and to arrange them so that when the value of one is decreased, the value of the other is increased. This means that the impedance of the anode circuit remains substantially constant.

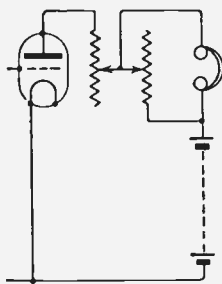

Fig. 1.

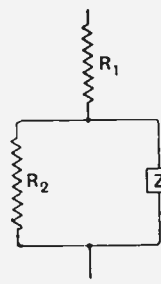

Fig. 2.

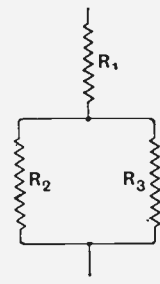

Fig. 3.

This however, is not really the case. Redrawing Fig. 1, as shown in Fig. 2, we have two resistances  $R_1$ ,  $R_2$ , and an impedance  $Z$ . In the case of a loud signal the value of resistance in shunt with the telephones, *i.e.*,  $R_2$ , will be fairly small. If we regard the telephone receivers as a plain resistance, we obtain Fig. 3, in which the total impedance of the anode circuit is constituted by the resistance  $R_1$  in series with the resistances  $R_2$  and  $R_3$  in parallel. In operation the resistances  $R_1$  and  $R_2$  are adjusted so that their sum is always constant. Now, the resistance of the network  $R_2$ ,  $R_3$  is equal to  $\frac{R_2 R_3}{R_2 + R_3}$ .

Hence it is clearly seen that the total value of the resistance in the anode circuit will be equal to

$$R_1 + \frac{R_2 R_3}{R_2 + R_3}$$

Obviously, this expression is not constant for any value of  $R_2$ , with the result that the amplification given by the valve will vary, and hence a true indication of relative signal strength cannot be obtained. The lower the impedance of the telephone receivers the greater will be the error.

Fig. 4 shows a method which has been employed by the writer, and is preferable from many points of view.

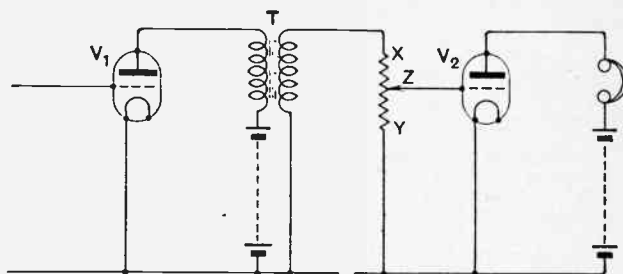
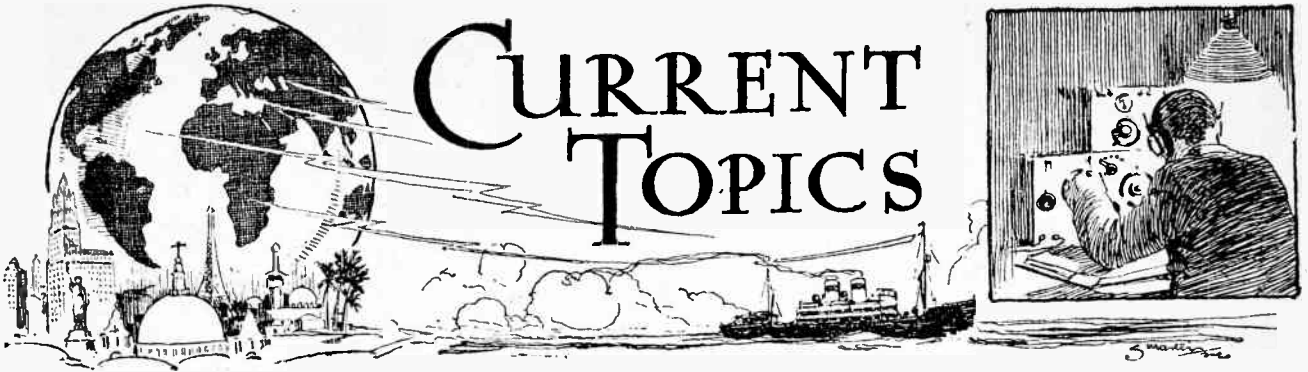

Fig. 4.

It will be seen that the anode circuit of the last amplifier valve contains an output transformer T, or, if desired, this may be replaced by a choke and condenser, or a resistance and condenser. Across the secondary of the transformer is connected a potentiometer XYZ. The lower side of the potentiometer and the slider are connected between the grid and filament of the second valve  $V_2$ , which contains the telephone receivers. It will be seen that the impedance of the anode circuit of the valve  $V_1$  will be determined by the impedance of the transformer, which in turn is partially influenced by the load on the secondary. The load on the secondary simply constitutes the resistance XY. Since this load is constant, the amplification of the valve  $V_1$  is also substantially constant. Now, there will be a voltage drop along the resistance XY due to received signal.

By moving the slider Z, part of this voltage can be tapped off and applied to the grid-filament circuit of the valve  $V_2$ . The greater the signal strength the greater will be the voltage drop across XY, and accordingly the greater the voltage drop across ZY. Hence the amount of voltage transferred to the grid of the valve  $V_2$  is directly proportional to the received signal strength. This voltage then renders the telephone receivers in the anode circuit of the valve  $V_2$  operative. Again, the slider Z can be adjusted so that no sound is heard in the telephones, or so that a predetermined volume of sound is obtained. Although this method involves the use of an additional valve, it has the advantage of using only one variable resistance. The chief point in favour of this method is the fact that it is more accurate than the double resistance method, since the amplification is maintained substantially constant.



### Events of the Week in Brief Review.

#### NOT A FREE STATE.

From the number of recent prosecutions, it appears that the P.M.G. has instituted a round-up of unlicensed listeners in the Belfast area.

#### FRANCE'S LARGEST STUDIO?

"Radio Toulouse" has opened a new studio, fifty feet in length and twenty-four feet wide, which is probably the largest in use in France.

#### DRINK TO ME ONLY . . .

The Belfast Licensing Magistrates have cancelled the licence held by the Telfair Street Radio Club. The licence was of the non-wireless variety.

#### COAL STRIKE DELAYS BEAM SERVICE.

In consequence of delays due to the coal strike, which is holding up supplies from this country, the Amalgamated Wireless Company of Australia does not expect beam wireless between England and Australia until October next. A similar service between Australia and Canada is unlikely until about December.

#### RUGBY TRESPASSER'S ESCAPE.

A Rugby schoolboy had a narrow escape from death the other day when he attempted to climb one of the wires suspended from the Rugby mast. He received an electric shock and fell 12 feet. The engineer-in-charge stated that trespassers on the station property ran grave risks, and that it was impossible to label all danger points.

#### NEW ZEALAND AS U.S. WIRELESS DUMP

American wireless manufacturers are capturing the New Zealand market despite the 10 per cent. preferential rate for British goods. Sets are being "dumped" into New Zealand from U.S.A. at absurdly low prices, due to the slump in America. "The American wireless industry," says *The Wireless Trader*, "is in a state almost indescribable. One firm alone, and one of the best known in the American wireless industry, produced last year three hundred thousand multi-valve sets which remain unsold!"

#### FINDING JOBS BY WIRELESS.

The Frankfort-on-Maine Labour Bureau is making use of the broadcasting service to inform the unemployed where there are opportunities of obtaining work.

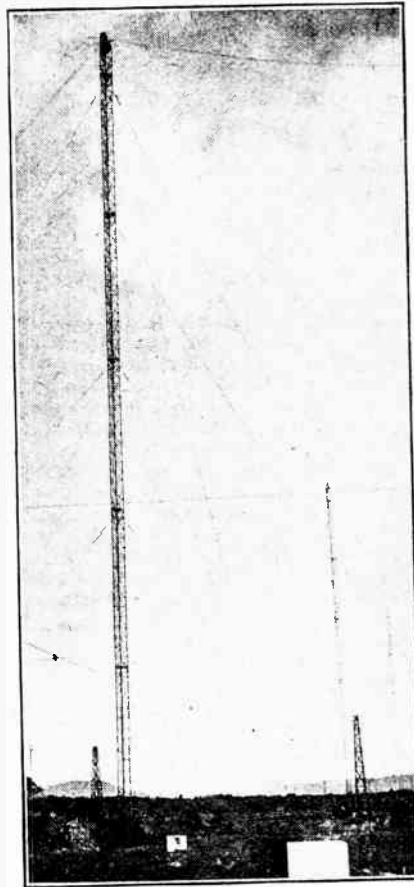

A MODERN HIGH POWER STATION. The aerial and earth screen at Rio de Janeiro. The aerial, which is 800 feet high, was erected by the Marconi Company, together with the earth screen and its supporting wires.

#### PIRATES "DOWN UNDER."

The postal authorities in Western Australia have opened a campaign against unlicensed listeners. Official complaints are

being made that listeners build their sets before procuring licences.

#### A HOWLING SUCCESS.

A popular design of receiver in Melbourne is appropriately known as the Howell Reinartz.

#### INTERNATIONAL PROGRAMMES FROM SPAIN.

Continuing its series of international transmissions, "Radio Catalana" (EAJ13, Barcelona) will broadcast a programme dedicated to Italian amateurs on July 7th.

#### RADIO SOCIETY OF GREAT BRITAIN.

An ordinary meeting of the Radio Society of Great Britain will be held this evening (Wednesday) at 6 p.m. (tea at 5.30) at the Institution of Electrical Engineers, Savoy Place, W.C.2. A lecture will be delivered by Mr. E. H. Slaughnessy, O.B.E.

#### ANNIVERSARY HONOURS FOR MARCONI.

Senator Marconi was the recipient of civic honours in his native town of Bologna last week, when the thirtieth anniversary of the first wireless patent was celebrated.

After a speech in the old University, Senator Marconi was presented with a gold medal by the Commune, and it was announced that a yearly prize for the best science student had been instituted under the name of Guglielmo Marconi. In the evening the famous inventor visited the little village of Sasso, where as a youth he conducted his first experiments.

#### PUBLIC ADDRESS EQUIPMENT AT AIR DISPLAY.

During the Royal Air Force display at Hendon, on Saturday, July 3rd, more than 20 Marconiphone loud-speakers will be in operation in different parts of the ground. The system will be used for four purposes, viz.: (1) To relay band music; (2) to relay orders given to aeroplanes while in the air; (3) to receive replies from the aeroplanes; and (4) to make announcements.

Special precautions will be taken this year to guard against the interference

experienced while receiving from aeroplanes last year. Four receiving stations will be used, each one receiving independently of the others. It is expected that the main reception will be carried out at a point within five miles of the Hendon Aerodrome, it having been found that best reception is obtained when the aeroplanes are some distance from the receiving point.

BROADCASTING TASTES IN AUSTRALIA.

A broadcast plebiscite in Victoria (Australia) shows that the popular preference lies in the direction of band music, with religious services a good second. Dance music received comparatively few votes, while fashion talks came last.

The Chinese have a proverb which says— "One picture is worth more than ten thousand words" The new Cossor Point One

CAUGHT OUT! This arresting advertisement of Messrs. Cossor, which appeared recently in The Wireless World, did not escape the Oriental critic! His letter is reproduced on this page.

STATION RATING BY "METRE-AMPERE" METHOD.

The "metre-ampere" method of rating wireless stations, first used about twelve months ago, is gaining in favour, and is now generally applied to all-round wireless stations as an accurate method of signifying power. The formula for determining this rating can be briefly stated as "the effective height in metres of the aerial multiplied by the aerial current," and may be regarded as the rating of a station expressed in the amount of power put into the aerial. The "metre-ampere" rating is regarded by many as the most scientific and accurate description of a station's powers.

FIELD DAY WITH MOBILE TRANSMITTER.

What promises to be a field day of exceptional interest will be held by societies on the northern outskirts of London on Saturday, June 26th. The Tottenham Radio Society will install a

transmitting station near Welwyn and also a mobile station on a car. With these it is hoped to establish communication with a station near Cuffley operated by the North Middlesex Society. Communication will be opened at 3.30 p.m. from the Welwyn station, and messages will be sent at five minute intervals.

The active co-operation of members of North London radio societies will be welcomed, and reports on reception by other amateurs will be warmly appreciated.

AMPLIFIERS ON BOARD SHIP.

At a "the dansant" recently held on board the Royal Mail ship "Asturias" in Buenos Aires harbour, many thousands of visitors were entertained by music distributed by the Marconi Band Repeater. Thanks to the distribution of loud-speakers throughout the ship the music of a special band was broadcast all over the vessel, and there was no congestion of dancing couples in the neighbourhood of the orchestra itself.

THE LONG, LONG TRAIL.

The vicissitudes of a wireless message originating in the Hawaiian Islands and intended for delivery in China are related in an interesting story issued by the American Radio Relay League. The message travelled a distance of nearly twice the circumference of the earth before it reached the addressee. The original sender was 6DBL, at Honolulu, and from there the message went to 2NZ, an amateur in New York, who passed it on to 9ZT, of Minneapolis; but the latter evidently deciding that it would be better to go back a little and get a running start, passed it to the U.S. Naval station NKF, at Bellevue, Washington, D.C.

From Bellevue the message reached New Zealand, where 2AC, unable to effect communication with China, handed it to a French station. The Frenchman passed it along to a South African amateur, who, happening to hear a Philippine amateur, delivered the message to him. The latter thereupon communicated with an amateur in China who saw that the message reached its destination.

AUTOMATIC TELEPHONE RELAY.

Readers intending to purchase the commercial relay of the Post Office automatic telephone type, referred to in Mr. Castellain's article in The Wireless World of June 9th are asked to note that the relay is obtainable from Messrs. Siemens Bros. and Co., Ltd., Woolwich, and not from Messrs. Elliott Bros. (London), Ltd., as stated in the article.

A CORRECTION.

In the "Readers' Problems" section of our issue of June 9th, page 799, col. 2, lines 13 and 14, for August 22nd please read August 27th, 1924.

PERU'S BROADCASTING SUCCESS.

Peru is being congratulated by many authorities on the excellence of the transmitting from the broadcasting station at Lima (OAX). Perfect daily working has been carried on for nearly a year, with the exception of one day when the alternator had to be dismantled. Throughout this period only two valves have been replaced in the transmitter, which is a Marconi "Q" type transmitter similar to those at the main British broadcasting stations.

The results obtained are the more creditable because the conditions are by no means ideal. The transmitting aerial is supported on towers only 70 feet high, the surrounding country is mountainous, and atmospheric conditions are generally unfavourable.

During the international radio week at the beginning of this year OAX was heard perfectly in Canada, the United States, Argentine, Cuba, and Mexico. Programmes transmitted from Lima have also been received on a Canadian National Railroad train running in West Ontario.

City, 9th June, 1926 Messrs. A.C.Cossor Ltd., Highbury Grove, E.C. Dear Sirs, Referring to your advertisement in to-day's issue of the "WIRELESS WORLD", I beg respectfully to point out that the Chinese characters are upside down and reversed. These should be as follows: 造 畫 萬 意 言 能 Yours most obediently, Chou-Chen-Chou.

SO NOW WE KNOW. The letter of criticism received by Messrs. Cossor, pointing out a flaw in their "Chinese" advertisement.

WIRELESS AT WESTMINSTER.

By our Special Parliamentary Correspondent.

"Wireless" Bands in Parks

In the House of Commons last week, Mr. Day asked the Under-Secretary of State for the Home Department, as representing the First Commissioner of Works, if he would state whether it was proposed to introduce wireless concerts in London parks as a substitute for bands.

Capt. Hacking, who said he could only answer for the Royal Parks, replied that it was not proposed to introduce wireless concerts as a substitute for bands in any of these parks.



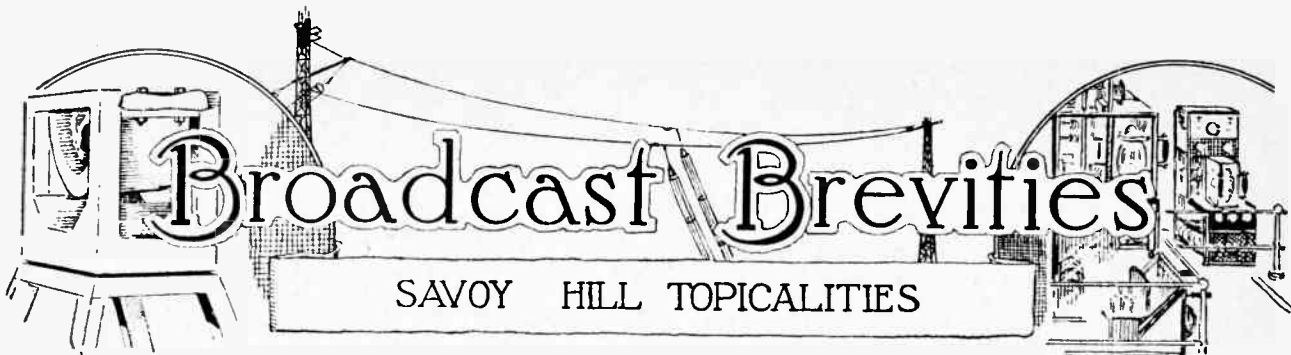

By Our Special Correspondent.

**B.B.C. Officials' Exit?**

Many of the prospective adjustments of staff at Savoy Hill, when the new broadcasting authority gets to work, are not of great importance; but the perturbing rumours now current of some flittings to America, in which the highest officials of the B.B.C. are involved, are of paramount significance. On the surface they bear evidence of authenticity.

o o o o

**The New Régime.**

There is a movement on the part of the American broadcasting authorities towards centralisation along the lines familiar to us in Great Britain; and who could be better fitted for the carrying out of that revolution than the men who have played so large a part in the British system of development? Listeners generally, I believe, realise that those who have done the "donkey-work" for British broadcasting and whose judgment never has hitherto been found wholly at fault, will need at any rate the inducement of unimpaired executive liberty if they are to be expected to carry on under the new régime in this country; and the sooner some assurance is given to them as to the future the better for British broadcasting.

o o o o

**B.B.C. Tests.**

Complaints have reached me that the B.B.C. tests after transmitting hours, to which I referred recently in these columns, are upsetting foreign reception. An official to whose notice the complaints were brought points out that it would be extremely difficult to take any responsibility as regards people who wish to listen to foreign stations, and, in any case, the tests must be carried out at the time most convenient for the staff, so as to cause no interference to British programmes.

o o o o

**Private Detective Work.**

Besides, it appears to be desirable at present to keep a specially close check on transmissions, as a certain gentleman with plenty of leisure and no keen wish to listen to broadcast programmes for themselves, is spending his evenings in going round the B.B.C. stations and taking readings of signal strength in order to see whether they transmit symmetrically. He has evidently been reading

Captain Eckersley on Quality v. Quantity.

o o o o

**Canterbury Cathedral.**

In view of the acoustic difficulties at Canterbury Cathedral, the help of wireless engineers has been sought by the Dean in trying to find a solution, particularly in respect of broadcast transmissions. One of the engineers from Savoy Hill is devoting a considerable part of his time to this work, and I hope when his investigations are completed to give readers of *The Wireless World* some details of his experiments.

o o o o

**Music Sales Increase.**

Notwithstanding the increased number of broadcasting stations in America, the sales of sheet music for March, 1926, increased 7.1 per cent. over March, 1925. In the first three months of 1926 an 8.7 per cent. increase over the sales for the similar period of 1925 is recorded. In the evidence given before the British Broad-

casting Committee last February, it was stated that there was nothing to prove that broadcasting had prejudiced the sales of sheet music in this country. The American figures are the more interesting to us, as showing the need of a Census Bureau similar to that which records the American statistics.

o o o o

**Readings by Authors.**

New stories, in many cases by well-known authors, will make their appearance in the programmes about the middle of July. They are to be broadcast in serial form, that is, instalments will be given on consecutive evenings, and the broadcasting of each work will be completed before publication in book form.

o o o o

**Publicity Value.**

I gather that some authors who have been approached have been inclined to place a somewhat arbitrary figure on the broadcast rights of new works. In this they seem to be making a mistake. There

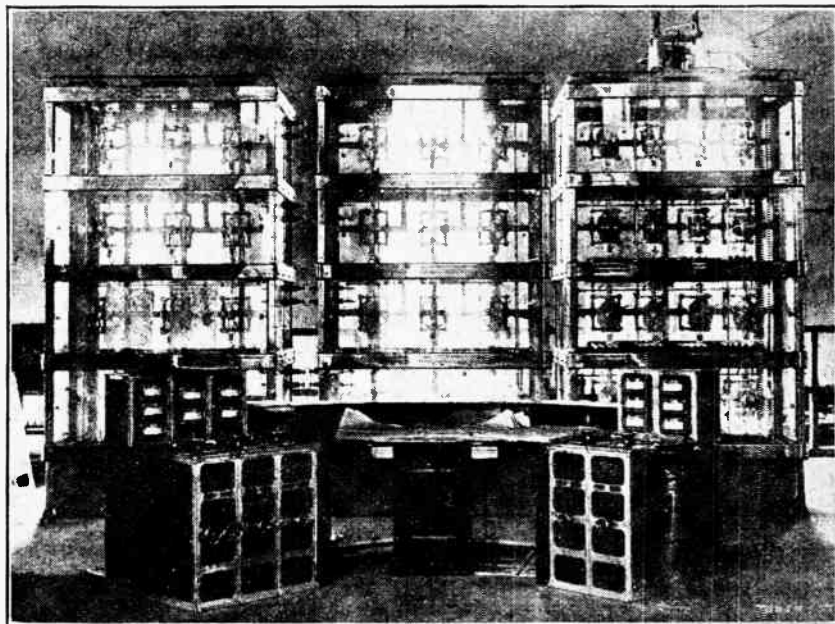

SOMETHING LIKE A VALVE PANEL! The Marconi 20,000 metre-ampere valve transmitter at the Rio de Janeiro high-power station, recently opened. The engineer's controlling table is seen in front.

is, undoubtedly, great publicity value to an author in getting any new book of his brought to the notice of millions of people on the eve of its publication, and it can scarcely be argued that the rather rapid reading of works running into twenty thousand words would detract from the subsequent sales.

o o o o

#### A New Departure.

The idea adopted in the case of Dora Stroeve of describing an artist's appearance might be used more frequently. A number of listeners who on that occasion appreciated the innovation have remarked that it was an aid to their enjoyment of that clever artist's performance. But, on the other hand, the move might sometimes have its drawbacks—if the descriptions were genuine and not merely eulogistic.

o o o o

#### Transmitting Licences.

Applications for transmitting licences in the United States of America continue to increase, and as quickly as one station drops out several other organisations apply for leave to take its place.

o o o o

#### Newspaper Radio Stations.

Although some six hundred stations are daily adding to the ethereal cacophony over the Western hemisphere, many other important concerns are clamouring for licences. One big group of newspapers wants to start up stations in New York, Baltimore, Washington, San Francisco, Seattle, Detroit, Boston, Albany, Rochester, Syracuse and Chicago. Other applications include a savings bank, a Lutheran radio committee, an estate agent, a Chamber of Commerce, the First Presbyterian Church at Pine Bluff, a flour mills and a Baptist seminary.

o o o o

#### Workhouse Wireless.

The example of the workhouse officials at Ware in installing wireless for the benefit of the inmates of that institution is one that will be followed by other similar establishments. Having a very limited financial grant, the authorities in that case sought the advice of the B.B.C. engineers who specified a line of procedure.

o o o o

#### Sets in Clubs.

While hospitals and workhouses are adding hundreds of thousands to the ranks of listeners, I note a report that although during the general strike wireless was installed in most of the West-End clubs for the convenience of members who wanted the news bulletins, there was a revulsion immediately after and the sets were stored away amongst the limbo of forgotten things. In spite of this, the number of licences is affected only in the direction of increase.

o o o o

#### Dominion Day.

In spite of the keen interest which he has taken in wireless matters, through his newspapers, Lord Beaverbrook has not yet appeared before the microphone. I

### FUTURE FEATURES.

#### Sunday, June 27th.

LONDON.—The Royal Parks Band.  
GLASGOW.—The Massed Bands at Glasgow's Annual Flower Procession.

MANCHESTER.—Master Choruses and Master Instrumentalists.

NEWCASTLE.—Light Orchestral Programme.

SWANSEA.—Aberystwyth Musical Festival.

#### Monday, June 28th.

DAVENTRY.—Special Continental Programme.

ABERDEEN.—Operatic Excerpts.

BOURNEMOUTH.—The New Forest Concert Party.

GLASGOW.—Light Orchestral Concert.

NEWCASTLE.—Frank Gomez and the Municipal Orchestra, relayed from Whitby.

#### Tuesday, June 29th.

LONDON.—Popular Orchestral Concert and a short play, "The Test."

ABERDEEN.—Irish Programme.

BOURNEMOUTH.—Light Symphony Concert, relayed from the Winter Gardens.

BELFAST.—An Hour in London. "Old Memories."

CARDIFF.—"Devon, Glorious Devon."

MANCHESTER.—Musical Comedy: Yesterday and To-day.

#### Wednesday, June 30th.

LONDON.—Robert Carr's Georgian Concert Party, relayed from Ramsgate.

DUNDEE.—William Hartley's Senior Students' Orchestra.

HULL.—An Old-fashioned Night.

LIVERPOOL.—The Band of the Liverpool City Police.

#### Thursday, July 1st.

LONDON.—Dominion Day — Canadian Programme.

GLASGOW.—Dominion Day Programme.

MANCHESTER.—Programme in commemoration of the first Battle of the Somme.

#### Friday, July 2nd.

LONDON.—A Broadcast from Brighton.

BIRMINGHAM.—Shakespearean Programme.

BOURNEMOUTH.—The Municipal Military Band.

CARDIFF.—A Welsh Programme.

NEWCASTLE.—"The Proposal," a Play by Anton Tchekoff.

#### Saturday, July 3rd.

LONDON.—"Tune In," a Revue. Sir Harry Lauder.

ABERDEEN.—Scottish Programme.

BOURNEMOUTH.—Popular Light Music.

BELFAST.—Solos and Duets.

understand that he will rectify this omission on July 1, when a Canadian programme is broadcast. The compere on that evening will be Major Gladstone Murray, a member of the B.B.C. staff and a Canadian of considerable attainments. One of the items of the programme will be an excerpt from "Hearts and Diamonds," the musical play at the Strand Theatre, featuring Miss Louise Edvina.

Miss Margaret Bannerman also will recite from her dressing room at the Globe Theatre two poems by Robert W. Service, entitled "The Law of the Yukon" and "The Call of the Wild," followed by a few minutes of "Bannerisms."

o o o o

#### A Canary Solo.

The "Aucklands," a well-known music-hall turn, are taking their famous roller canary to 2LO on July 8, to share with them the task of entertaining listeners. This bird begins to sing as soon as the artists, who are concertina duettists, start playing and continues its song for some time after the instrumental music has ceased.

o o o o

#### Open Air Broadcasting.

Music lovers, I hear, are apprehensive respecting the experiment made recently in the Temple Gardens of amplifying (not broadcasting) gramophone records in lieu of providing a band performance. But there is no need for alarm. Only in cases where it is deemed expedient, on the score of the inconvenience of providing bands, will loud-speaker amplification of gramophone records, or possibly of broadcasting, be attempted. It is well known that nothing would appeal to the frequenters of the parks and open spaces to the same extent as a proper band or orchestra; also the authorities are anxious to avoid prejudicing the interests of the performers in those bands. What listeners themselves prefer are broadcast performances by military and municipal bands in public places, similar to those which have already been transmitted.

o o o o

#### The Last of "That Child."

The sixth and last of the series of studies of child life by Mrs. Kilpatrick, which have been broadcast under the title of "That Child," will be given on July 5. The references to this feature in listeners' letters show that there is a demand for what might be called "true-to-life cameos," and if they are kept fairly short I think that they would prove more acceptable to listeners than the proposed arrangement to broadcast new stories in serial form.

o o o o

#### British-Italian Friendship.

Sir Austen Chamberlain's speech, proposing the toast of British-Italian Friendship, will be broadcast from New Princes Restaurant on June 28th. The occasion is the dinner and presentation to Senatore Antonio Cippico of the medal which has been struck in his honour in commemoration of the services which he has rendered to British-Italian friendship.

# CONDENSER PLATE DESIGN.

## Simple Methods of Calculating the Curvature for Uniform Variations of Wavelength and Frequency.

By W. H. F. GRIFFITHS.

IT is well known that ordinary variable air condensers having semi-circular moving plates and consequently a uniform capacity change for a uniform angular movement, although useful for capacity measurements, etc., are far from ideal for use in general radio work, where they are required chiefly to adjust the natural frequencies of circuits to resonance with frequencies of impressed electromotive forces.

Condensers may be designed having their moving plates shaped so as to give, for uniform angular movement, uniform changes of *wavelength*, or *frequency*, or *percentage change* of wavelength or frequency, each having its own special advantages. It is not the object of this article to discuss these advantages, but it may, perhaps, help to give just one or two of them for each type of plate.

### Types of Condenser Scales.

The condenser designed to have a *uniform scale of wavelength* has the advantage of easy recognition (in tuning) of transmissions being received, as one is familiar, at the moment, with the wavelengths of the transmitting stations, and from condenser settings corresponding to the reception of two standard transmissions one is enabled to roughly calibrate, for wavelength, the whole of one's variable condenser scale.

*Frequency* tuning with a condenser having a uniform scale of frequency facilitates supersonic heterodyning where constant frequency differences between short-wave receiver and local oscillator are required. This design of variable condenser is also extremely convenient where harmonic frequencies are to be selected by an oscillatory circuit from such apparatus as a multi-vibrator.<sup>1</sup>

The third design of variable condenser, that having a *constant percentage change* of wavelength and frequency over its whole scale length, is useful in obtaining relative ideas of the "sharpness of tuning" of various transmissions or in the plotting of resonance curves, etc., and it is important to note that the percentage change of wavelength or frequency for a given angular movement of the condenser remains constant for any inductance with which it is associated, provided that the values of the distributed capacities of the inductances are not appreciably different.

At the present time the only widely used variable condenser having a special "law" connecting its capacity with its angular movement is that of the "square law" type, and this is not always correctly designed. It is the object of this article, therefore, to give simple methods of designing the moving plates of condensers to conform with the laws of capacity increase correspond-

ing to the special types outlined above. For a more complete and mathematical treatment of this subject the reader is referred to a previous paper by the present author.<sup>2</sup>

### Square Law Plate.

Since the wavelength of a circuit is proportional to the square root of the capacity of the condenser by which it is being tuned, it follows that, in order that the latter shall have a uniform scale of wavelength, its capacity must, at any setting, be proportional to the *square* of its degree scale reading.

Fig. 1 shows a true "square law" condenser plate which is very simply constructed by making the radius  $R$ , at any point, proportional to the square root of the angle  $\theta$ , *i.e.*, if the radius at 20 degrees is  $\sqrt{1}$ , then that at 40 degrees must be  $\sqrt{2}$  and so on, the radius at 0 degree being, of course, zero.

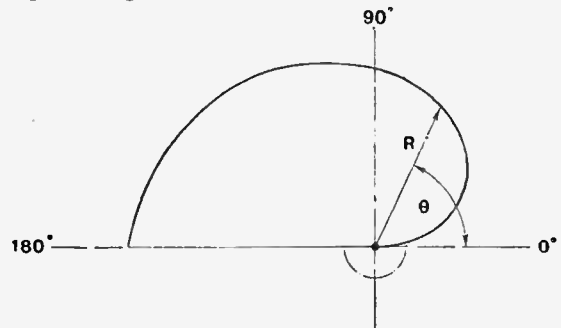

Fig. 1.—Square law area condenser plate. Radius  $R$  is proportional to the square root of the angle  $\theta$ .

It is well known, however, that a plate of this shape, although giving a true "square law" of *area* increase, will not give a uniform wavelength scale. This is so because it does not give a true "square law" of *capacity* increase, due to the fact that its method of design assumes a minimum capacity value (at 0 degrees) of zero, and, further, it assumes that the inductance being tuned has a negligible distributed capacity, and that there is no capacity augmentation by leads and other conducting masses associated with the apparatus.

In order to design a "uniform wavelength scale" condenser plate, therefore, the estimated value of the minimum capacity of the completed condenser as augmented by the distributed capacity of the inductance and by leads, etc., must be taken into account. The same applies, of course, to the design of condenser plates to suit any other law, and in the following examples of plate design this value of augmented minimum capacity

<sup>1</sup> *The Wireless World and Radio Review*, April 15th, 1925.

<sup>2</sup> *Experimental Wireless*, January, 1926, page 3.

**Condenser Plate Design.—**

is assumed to be 36 micromicrofarads and the maximum capacity to be 500 micromicrofarads. In each case the condenser is assumed to have a scale uniformly divided into 180 degrees.

**Condenser Plates for a Uniform Wavelength Scale.**

In order that a variable condenser shall have a uniform scale of wavelength it is necessary that the square root of its capacity value shall vary uniformly throughout the rotation of its moving plate system. In other words, the curve plotted between the square root of its capacity and angular displacement (or degree scale reading) must be a straight line.<sup>3</sup>

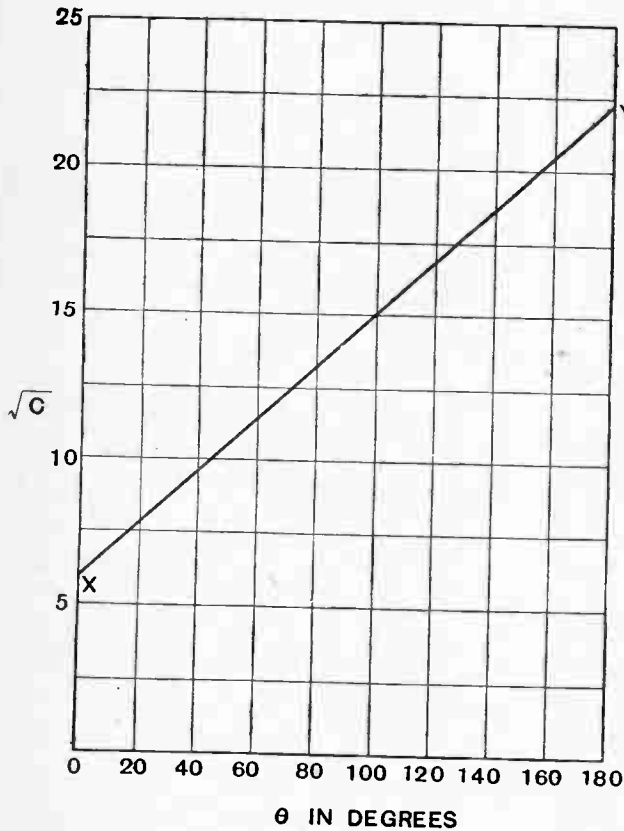

Fig. 2.—Curve showing relation between scale reading and square root of capacity for a square law condenser.

This curve is given in Fig. 2, and is formed by merely drawing a straight line through the points X and Y corresponding to the square roots of the minimum and maximum values of the condenser, for when the degree scale reading is 0 degree,  $\sqrt{C} = \sqrt{36} = 6$ , and when the scale reading is 180 degrees,  $\sqrt{C} = \sqrt{500} = 22.4$ .

Augmented minimum capacity is assumed to be 36 micromicrofarads and the maximum capacity to be

<sup>3</sup>  $C = (a\theta + b)^2$  where C=capacity for any degree scale reading  $\theta$  and a and b are constants.

If the square root of each side of the equation be extracted this becomes  $\sqrt{C} = a\theta + b$ , which is recognised at once as the equation to a straight line connecting  $\sqrt{C}$  with  $\theta$ , two points on which are known from data.

500. In each case the condenser is assumed to have a scale uniformly divided into 180 degrees.

From this curve other values for  $\sqrt{C}$ , corresponding with various values of the angle  $\theta$ , 20, 40, 60 degrees, etc., can be directly read and entered in the second column of Table I. below.

TABLE I.

$\theta$ (Degrees)	$\sqrt{C}$ .	C. Micro- mi ro- farads.	$\delta C$ .	$\sqrt{\delta C}$	Additional Values of $\sqrt{\delta C}$ by Interpolation and Extrapolation from Curve Fig. 4.	$R(\text{cms.})$ $= \sqrt{\delta C} \times \frac{4.5}{0.12}$
0	6.0	36.0	—	—	4.64	2.29
10	—	—	24.8	4.98	—	—
20	7.8	60.8	—	—	5.30	2.62
30	—	—	31.4	5.60	—	—
40	9.6	92.2	—	—	5.88	2.90
50	—	—	37.8	6.15	—	—
60	11.4	130.0	—	—	6.40	3.16
70	—	—	44.0	6.64	—	—
80	13.2	174.0	—	—	6.90	3.40
90	—	—	51.0	7.14	—	—
100	15.0	225.0	—	—	7.40	3.65
110	—	—	59.0	7.62	—	—
120	16.8	284.0	—	—	7.85	3.87
130	—	—	65.0	8.06	—	—
140	18.7	349.0	—	—	8.30	4.10
150	—	—	71.0	8.50	—	—
160	20.5	420.0	—	—	8.72	4.30
170	—	—	80.0	8.95	—	—
180	22.4	500.0	—	—	9.12	4.50
(1)	(2)	(3)	(4)	(5)	(6)	(7)

By squaring these values, the values of total capacity for these same values of  $\theta$  are found and entered in column 3. Column 4 of this tabulation gives the increments of capacity ( $\delta C$ ) for every 20 degrees increase of  $\theta$ , and is, of course, found by subtracting each value of C from that corresponding to an angle 20 degrees greater. These values of capacity increase must be entered against an angle  $\theta$  midway between the angles whose capacity values were used to determine the increase.

As the values of  $\delta C$  represent the capacity that must be added for every 20 degrees of movement of the moving plate system, the area of moving plate to be brought into operation by these angular movements must be directly proportional to these values.

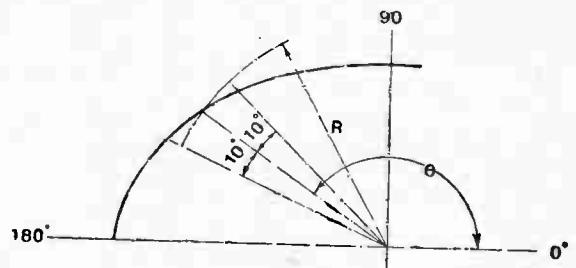

Fig. 3.—Diagram illustrating the assumption, upon which the calculations in Table I. are based, that the increments in area may be regarded as sectors of a circle of radius R.

These increments of area may, as an approximation, be regarded as sectors of a circle of radius equal to the radius of the moving plate which bisects the angle of the incremental sector as shown in Fig. 3.

Now, the area of a sector of a circle is proportional to the square of the radius of the circle, therefore the radius of the circle is proportional to the square root of the area. And, as each value in column 4 is propor-

**Condenser Plate Design.—**

tional to the area of a 20-degree sector, the bisecting radius of each sector must be proportional to the square root of  $\delta C$  at that radius. Column 5 is, therefore, completed by merely entering square roots of the values of  $\delta C$  of column 4.

A curve can now be plotted showing the relation between  $\sqrt{\delta C}$  and  $\theta$  (Fig. 4) in order to obtain a more complete series of values for  $\sqrt{\delta C}$  by interpolation, and values for this quantity corresponding to angles of  $\theta$  degrees and 180 degrees by extrapolation.

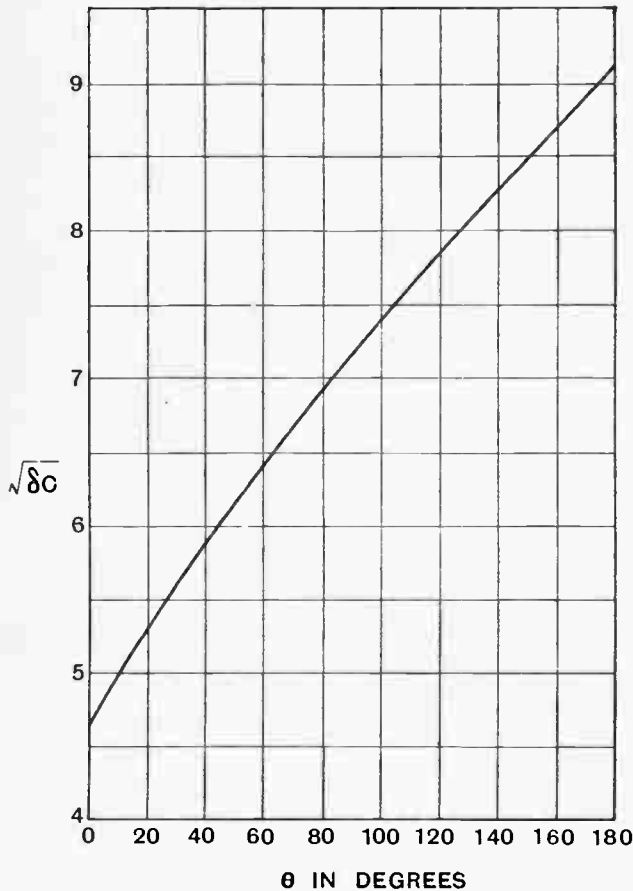

Fig. 4.—Curve showing the relation between  $\sqrt{\delta C}$  and  $\theta$  from which intermediate values in Table I. have been interpolated.

If the greatest radius of moving plate (at 180°) permissible is now assumed to be, say, 4.5 centimetres, the radius  $R$  at any angle  $\theta$  may be directly found from the values of  $\sqrt{\delta C}$  in column 6 by simple proportion.

$$R = \frac{4.5}{9.12} \sqrt{\delta C}$$

(9.12 being the value of  $\sqrt{\delta C}$  at 180 degrees). since, as has already been shown,  $R$  must be proportional to  $\sqrt{\delta C}$ .

The values of the radii so computed are given in the last column of Table I., and the plate shaped to these dimensions is shown in Fig. 5.

A very slight inaccuracy is introduced by the fact that the area of the semicircular cut-away portion at the centre of the fixed plates, which renders inoperative a corresponding area of the moving plates, has been

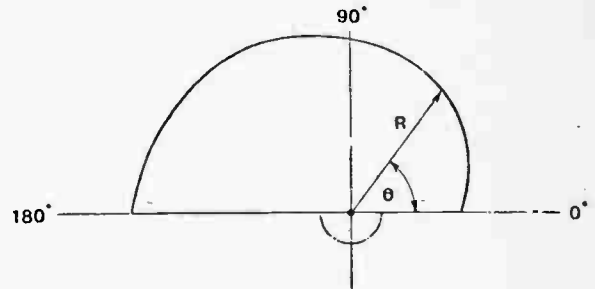

Fig. 5.—Shape of plate of "straight line wavelength" condenser plotted from data in Table I.

ignored. If the accuracy required demands it, a common sense correction may be applied by the reader by adding to each 20° sector an area about equal to that of the small 20° sector of the cut-away semicircle. This added area will only appreciably increase the smaller radii of the plate.

**Condenser Plate for a Uniform Scale of Frequency.**

Since the natural frequency of an oscillatory circuit is inversely proportional to the square root of its capacity, it follows that, in order that uniform angular movement of the condenser plate shall effect a uniform change of frequency, the capacity of the condenser corresponding to any scale reading must be inversely proportional to the square of that degree scale reading.

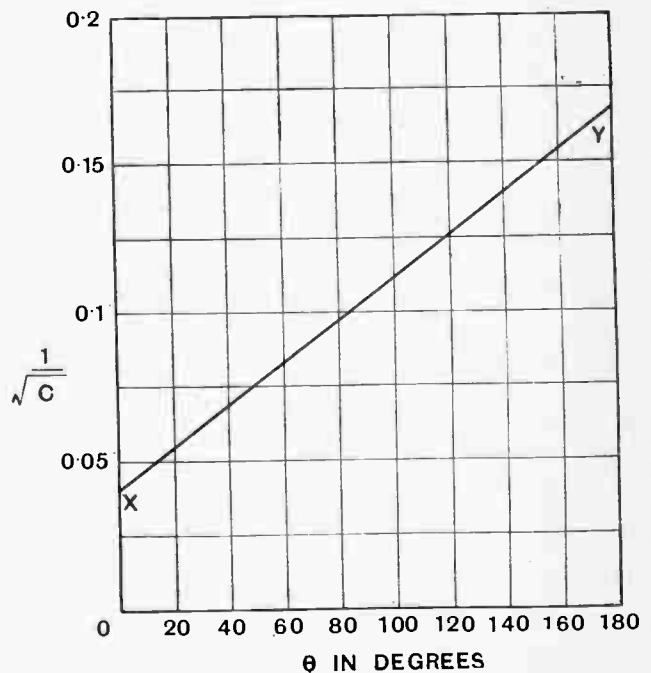

Fig. 6.—Straight line relationship between scale reading and reciprocal of the square root of capacity in a condenser giving uniform variation of frequency.

**Condenser Plate Design.—**

From this it is easy to show<sup>4</sup> that a curve plotted between the reciprocal of the square root of the capacity and the degree scale reading must be a straight line.

This curve is given in Fig. 6, and is obtained by merely drawing a straight line through the points X and Y corresponding to the reciprocals of the square roots of the minimum and maximum values of the condenser,

for when the scale reading is 0 degree,  $\frac{1}{\sqrt{C}} =$

$\frac{1}{\sqrt{500}} = 0.0446$ , and when the scale reading is 180

degrees,  $\frac{1}{\sqrt{C}} = \frac{1}{\sqrt{36}} = 0.167$ .

From this curve other values for  $\frac{1}{\sqrt{C}}$ , corresponding

to various values of the angle  $\theta$ , 20, 40, 60 degrees, etc., can be directly read and entered in the second column of Table II. below. The reciprocals of these values are entered in column 3, and by squaring the quantities in this latter column, values of the capacity C, corresponding with these degree scale readings  $\theta$  can be entered in column 4.

TABLE II.

$\theta$ (Degrees)	$\frac{1}{\sqrt{C}}$	$\sqrt{C}$	C. (Micro- farads.)	$\delta C$	$\sqrt{\delta C}$	Additional Values of $\sqrt{\delta C}$ by Interpolation and Extrapolation from Curve of Fig. 7.	R(cms.) $= \sqrt{\delta C} \times \frac{8.25}{17.5}$
0	0.04465	22.4	500.0	—	—	17.5	8.25
10	—	—	—	—	—	—	—
20	0.0580	17.25	297.0	203.0	14.24	11.7	5.51
30	—	—	—	—	—	—	—
40	0.0715	14.0	196.0	101.0	10.05	8.70	4.10
50	—	—	—	—	—	—	—
60	0.085	11.77	138.0	58.0	7.62	6.70	3.16
70	—	—	—	—	—	—	—
80	0.099	10.10	102.0	35.0	6.00	5.30	2.50
90	—	—	—	—	—	—	—
100	0.112	8.91	79.3	22.7	4.76	4.40	2.07
110	—	—	—	—	—	—	—
120	0.126	7.93	63.0	16.3	4.04	3.75	1.77
130	—	—	—	—	—	—	—
140	0.140	7.14	51.0	12.0	3.47	3.20	1.51
150	—	—	—	—	—	—	—
160	0.154	6.51	42.4	8.6	2.94	2.75	1.30
170	—	—	—	—	—	—	—
180	0.167	6.0	36.0	6.4	2.53	2.40	1.13
(1)	(2)	(3)	(4)	(5)	(6)	(7)	(8)

The fifth and sixth columns of this tabulation, giving the values of  $\delta C$  and  $\sqrt{\delta C}$ , are next filled in, as was done in Table I. for the "square law" example, and a curve (Fig. 7) plotted between values of  $\sqrt{\delta C}$  and degree scale readings  $\theta$ , in order to obtain the complete series of readings at 20-degree intervals shown in column 7.

If the greatest radius of the moving plate permissible in this design is, say, 8.25 cms., the radius R at any

angle  $\theta$  may be directly found from the values of  $\sqrt{\delta C}$  in column 7 from the simple relation—

$$R = \frac{8.25}{17.5} \sqrt{\delta C}$$

17.5 being the value of  $\sqrt{\delta C}$  at 0° corresponding to the maximum radius of the plate.

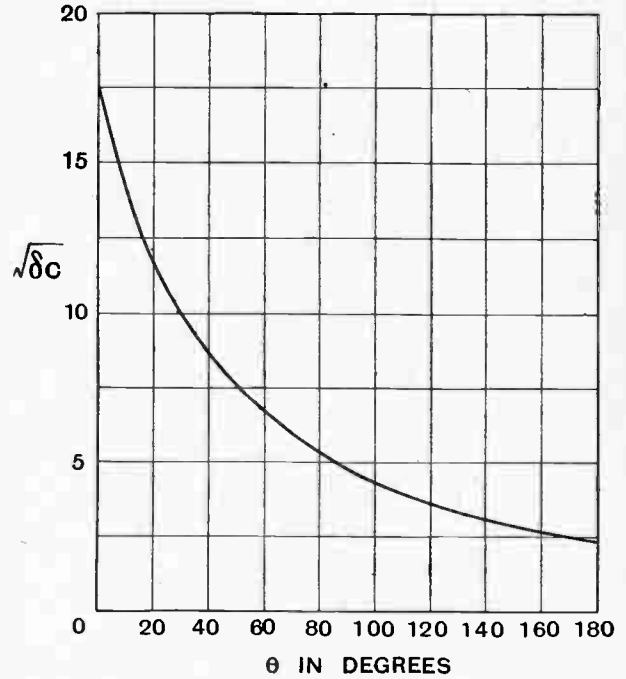

Fig. 7.—Curve for interpolating values of  $\sqrt{\delta C}$  in Table II.

The computed values of radii are given in the last column of the tabulation, and the plate formed by them is shown in Fig. 8.

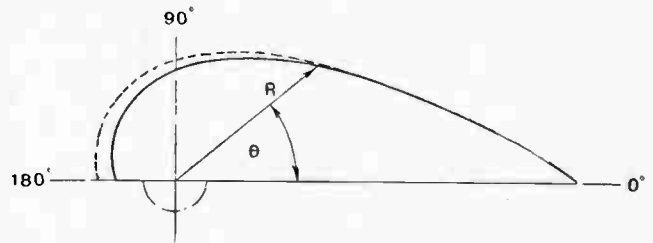

Fig. 8.—Shape of Plate of "straight line frequency" condenser plotted from data in Table II.

The error in plate shape introduced by neglecting to take account of the centre cut-away clearance portion of the fixed plates is slightly more important in this design at the smaller radii positions. This is, of course, due to the greater variation in plate radius, and in the present example the error is such that the radius at 180 degrees should be about 0.4 centimetre greater than that shown, and at 90 degrees about 0.2 centimetre greater, if a fixed plate clearance radius of about 1 centimetre is employed. A correction of this nature can be quite easily applied by the reader, as explained in the "square law" section, and the dotted outline of Fig. 8 gives some idea of the plate shape modification due to this correction.

<sup>4</sup>  $C = \frac{1}{(a\theta + b)^2}$  adopting the same notation as in the previous example. And if the square root of each side of this equation be extracted it becomes  $\sqrt{C} = \frac{1}{a\theta + b}$ , which can immediately be written as an equation to a straight line  $\frac{1}{\sqrt{C}} = a\theta + b$ , two points on which are readily computed as shown in the text.

**Condenser Plate Design.—**

In order that the percentage change of wavelength or frequency shall be constant throughout the entire scale of the condenser, it is necessary that the law connecting its capacity and degree scale reading shall be an exponential or *compound interest law*.<sup>5</sup> From this it can be shown<sup>6</sup> that if the logarithms of the capacity be plotted against degree scale readings a simple straight-line curve will be obtained.

**Uniform Percentage Change of Wavelength and Frequency.**

This curve is given in Fig. 9, the logarithms of the maximum and minimum capacity values of the condenser providing the two necessary points at 180 degrees and 0 degree through which the straight line can be drawn.

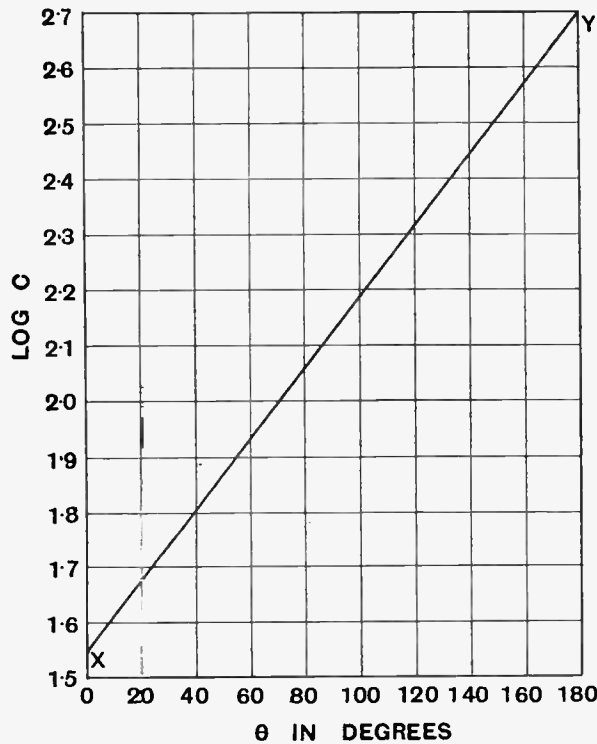

Fig. 9.—The relationship between scale degrees and the logarithms of capacity values.

As before, from this curve other values for log. C can be read and entered in column 2 of Table III., and the antilogarithms of these values give the actual capacity values which are entered in column 3.

As previously described, the fourth and fifth columns of this tabulation can be filled in and a curve (Fig. 10) plotted between values  $\sqrt{\delta C}$  and degree scale readings  $\theta$  in order to obtain the complete series of values in column 6.

If the greatest radius of this moving plate is limited

to, say, 5.8 cms., the radius R at any angle  $\theta$  is given, simply, by

$$R = \frac{5.8}{12.2} \sqrt{\delta C}$$

12.2 being the value of  $\sqrt{\delta C}$  at 180 degrees.

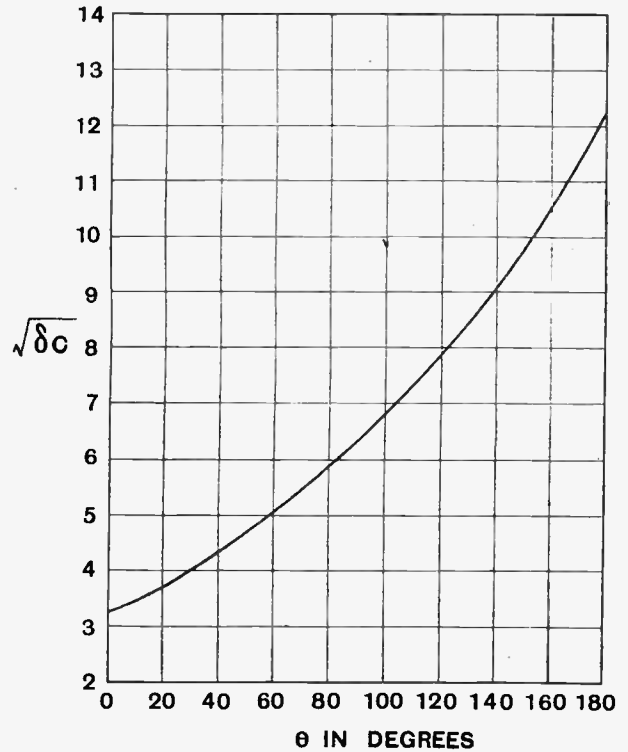

Fig. 10.—Curve for interpolating values of  $\sqrt{\delta C}$  in Table III.

The values of the radii so computed are given in the last column of Table III., and the plate formed by them is shown in Fig. 11.

TABLE III.

$\theta$ (Degrees)	Log. C.	C (Micro- micro- farads.)	$\delta C$ .	$\sqrt{\delta C}$ .	Additional Values of $\sqrt{\delta C}$ from Curve of Fig. 10.	Radius. = $\sqrt{\delta C} \times \frac{5.8}{12.2}$
0	1.556	36.0	—	—	3.20	1.52
10	—	—	11.9	3.45	—	—
20	1.680	47.9	—	—	3.72	1.77
30	—	—	16.2	4.02	—	—
40	1.807	64.1	—	—	4.23	2.01
50	—	—	21.8	4.67	—	—
60	1.934	85.9	—	—	5.02	2.39
70	—	—	28.9	5.38	—	—
80	2.060	114.8	—	—	5.52	2.77
90	—	—	39.4	6.28	—	—
100	2.188	154.2	—	—	6.75	3.21
110	—	—	52.3	7.24	—	—
120	2.315	206.5	—	—	7.80	3.60
130	—	—	71.5	8.45	—	—
140	2.444	278.0	—	—	9.05	4.30
150	—	—	95.3	9.77	—	—
160	2.572	373.3	—	—	10.5	5.00
170	—	—	126.7	11.28	—	—
180	2.699	500.0	—	—	12.2	5.80
(1)	(2)	(3)	(4)	(5)	(6)	(7)

As in the previous designs, and for the same reason, a plate shape inaccuracy is present, and the application of the previously described rough correction gives the modification indicated by the dotted outline of Fig. 11.

<sup>5</sup> For a full explanation of this statement the reader is referred to the author's article in *Experimental Wireless*, January, 1926, page 11.

<sup>6</sup>  $\lambda = a\epsilon^{b\theta}$ , from which  $C = a_1\epsilon^{b_1\theta}$ , and, by taking logarithms of each side of this equation,  $\log C = \log a_1 + b_1\theta \log \epsilon$ , which can be instantly recognised as the equation to a straight line,  $\log C = b_1 \log \epsilon \theta + \log a_1$ .

**Condenser Plate Design.—**

If the cut-away portion of the fixed plates is of the order of 1 centimetre radius, the plate radius should be 0.4 centimetre greater (than that obtained in Table III) at 0 degree and 0.1 centimetre greater at 100 degrees.

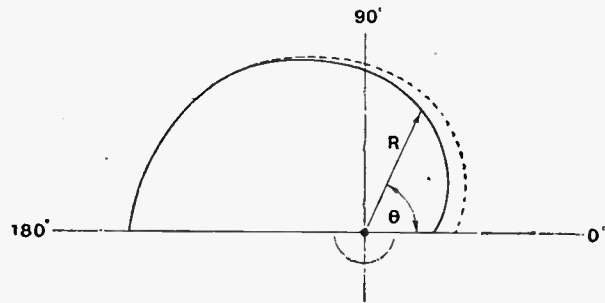

Fig. 11.—Shape of condenser plate giving uniform percentage change of wavelength or frequency plotted from data in Table III

**Concluding Remarks.**

In each of the designs given, the maximum plate radius R has been chosen so as to give a total plate area of 20 square centimetres.

The closeness with which the condensers built with plates shaped to the designs given will follow the required laws of wavelength, or frequency variation will depend, of course, upon the agreement between the estimated and actual values of their minimum capacities. It will depend, also, to a limited extent, upon the value of the distributed capacity of the inductance with which the condenser is associated. The law may vary with a change of coil, and the consequent change in the disposition of its connections, etc. But, if the value of augmented minimum capacity be estimated on the high side, say, 50 or 60 micromicrofarads, the actual value can always be made up to the estimated value by the addition of a very small fixed value air condenser permanently joined in parallel with the main variable unit, and whose value can be adjusted by trial in order to satisfy the desired law.

# LONG-RANGE THREE-VALVE RECEIVER.

An Interesting Modification when Extreme Selectivity is not Required.

IN *The Wireless World* of May 26th and June 2nd we described in an article entitled "Long-range Three-valve Receiver" a receiver having a coupled circuit in addition to the usual input and intervalve high-frequency couplings. Great interest has been taken in this set, and several readers have asked whether they can dispense with the third tuned circuit comprising a coil C and tuning condenser C<sub>3</sub>, Fig. 1 (reproduced from page 690 of the original article), on the grounds that they would be using the receiver at a distance of five miles or more from a main broadcast station. These readers point out that in their particular case exceptional selectivity is not required, and enquire whether the additional circuit, which was expressly used for the purpose of making the set extremely selective, is necessary in the circumstances.

The answer to the question is, of course, that those who intend to use a receiver at a place about five miles or more from a main broadcast station do not

necessarily require a set giving such extreme selectivity as the one described, and that one tuned circuit can be dispensed with. A saving in cost, represented by the price of one tuning condenser and one coil, is thereby effected, and, further, the panel can be reduced in length.

There is also a slight increase in the signal strength as a result of eliminating the losses of a coil and condenser, but it must be borne in mind that the selectivity of the modified receiver will not approach that of the receiver with the coupled circuit. Nevertheless, the selectivity will be ample for many readers, because of the good coils and special connections employed, and we would certainly advise those who find that selectivity is not such a great problem, because they are not "on top" of a broadcast station, to eliminate the third circuit, as shown in Fig. 2. On the other hand, those who find it rather difficult to eliminate the local station because it is received at such great strength are advised to

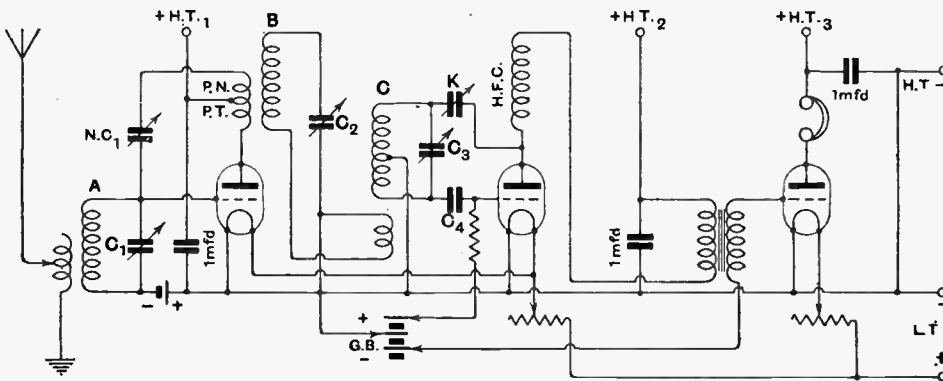

Fig. 1.—The original circuit of the receiver.

adhere to the original design in all respects. At the writer's place, for instance, distant 2½ miles from the London transmitter, it is not unusual to receive 12 to 15 volts across the terminals of a carefully made tuner. When the receiver contains a stage of high-frequency magnification amplifying 20 or more times, we sometimes wonder where the volts go—the set invariably squeaks and ceases to function. In such a case as this, then,



**Long-range Three-valve Receiver.—**

which is quite normal, it is necessary to give a lot of attention to selectivity, and three lightly damped tuned circuits are necessary if Bournemouth is to be received clear of London.

Turning now to Fig. 2, which shows the modified cir-

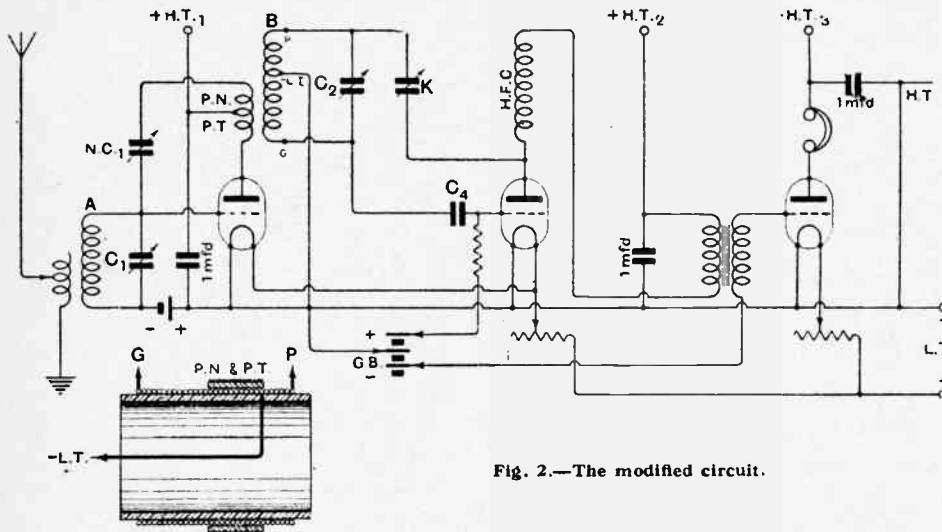

Fig. 2.—The modified circuit.

fifteenth turn from the top. This tap is connected to - L.T., one end of the coil to the grid condenser, and the other end of the coil to the reaction condenser.

It will be noticed that if the primary and balancing windings are put at one end of the secondary coil there may be a transfer of energy by capacity coupling. This will not be of importance, as the primary and balancing windings are wound of fine wire (No. 40 D.S.C.) and have only a few turns. Those who would care to modify the construction, however, with a view to making the capacity coupling no more than it is in a normal transformer, might put the primary and balancing windings over the filament end of the secondary, as sketched in Fig. 2. With the particular number of turns employed, however, it is not strictly necessary to go to this trouble.

The input transformer, which connects the grid of the first valve to the aerial, remains unchanged, and may be mounted in a horizontal position, while the intervalve transformer should be fixed in an upright position. In other words, the new intervalve transformer replaces the coil marked C, Fig. 1, coil B and its condenser C<sub>2</sub> being eliminated. W. J.

cuit which will suit those we have been referring to, we now have circuit AC<sub>1</sub> as in the original receiver (Fig. 1), and also a high-frequency transformer. The primary and balancing windings of this transformer remain as in the Fig. 1 circuit, but the secondary winding has an additional three turns, making 55 in all, and a tap at the

**Burndept Valve Chart.**

A useful reference chart, giving filament voltage and current, magnification factor and impedance of receiving valves of the principal makes, has just been issued by Burndept Wireless Ltd., Aldine House, Bedford Street, Strand, London, W.C.

o o o o

**Accumulators in the Arctic.**

Fresh evidence of the reliability of the modern accumulator battery under strenuous conditions is provided by the fact that the airship "Norge" derived current for wireless and other purposes from "Exide" batteries during her eventful trip over the North Pole. The Byrd and Wilkins expedition also used "Exide" batteries.

**TRADE NOTES.**

**New Address.**

The new address of Messrs. Wright and Weaire, Ltd., manufacturers of "Wearite" wireless components, is 740, High Road, Tottenham.

o o o o

**C.A.V. in Manchester.**

Messrs. C. A. Vandervell and Co., Ltd., Warple Way, Acton, announce that their Manchester branch at 35, Bridge Street, has now been transferred to that of Joseph Lucas Ltd., 277, Deansgate, Manchester, where ample stocks are available of all radio apparatus, including accumulators.

**"Atlas" Price Reductions.**

Interesting reductions in the price of the well-known "Atlas" concert coils, fixed condensers, etc., are apparent in the literature we have received from the manufacturers, Messrs. H. Clarke and Co. (M/c), Ltd., Atlas Works, Old Trafford. Folders No. 17 and 18, which we have also received, describe the "Atlas" high tension battery eliminators, both for A.C. and D.C.

o o o o

**Darimont Battery Offer.**

Many readers will be interested in the special offer made in our advertisement pages this week by Messrs. Darimont Electric Batteries, Limited. During the next five weeks readers can obtain three No. 10 cells, value 28s., for £1 carriage paid.

**HIDDEN ADVERTISEMENTS COMPETITION.**

The following are the correct solutions of THE WIRELESS WORLD Hidden Advertisements Competition, June 9th, 1926.

Clue No.	Name of Advertiser.	Page.
1.	Rectalloy, Ltd.	ii.
2.	Heath & Co.	8
3.	A. C. Cossor, Ltd.	6
4.	A. H. Hunt, Ltd.	8
5.	Igranic Electric Co., Ltd.	iv.
6.	The London Electric Wire Co. and Smiths, Ltd.	ii.

**The following are the Prizewinners:—**

Edw. E. Trotman, London, W.C.2	..	£5
G. F. Hilton, Newton Heath, Manchester	..	£2
W. Dierickx, Malines, Belgium	..	£1

**Ten Shillings each to the following:—**

J. H. Cropper, Widnes, Lancs.	— White, Bournemouth.
G. H. Mackerell, Lower Edmonton, N.9.	
Mrs. F. Morley, Keyham, Devonport.	

# THE PENTATRON.

## A New Five-electrode Receiving Valve.

By DR. H. KRÖNCKE.

ON the occasion of a lecture before the Heinrich Hertz Gesellschaft, Berlin, Dr. Leithäuser recently demonstrated a receiver fitted with a new type of valve called the "Pentatron." Outwardly, the valve is indistinguishable from an ordinary receiving valve, with the sole exception that its cap is provided with six contact pins. An important feature of the new valve lies in its smallness, and it requires, therefore, but little space.

The "Pentatron" really consists of two three-electrode valves with a common filament, and the construction of the electrodes is shown diagrammatically in Fig. 1. Two long filaments are connected in parallel, so that they can both be made to glow with a heating potential of 1.6 to 1.8 volts and a total current of 0.3 ampere. Around each filament a very closely wound grid is fitted, and around this, in turn, is the anode. The two grids and the two anodes are connected separately to pins in the base, the two remaining pins serving to supply the filament.

characteristics supplement each other, *i.e.*, double emission is obtained, and, what is of special importance, the steepness of the characteristic is twice as great. The average steepness of a single system is already relatively

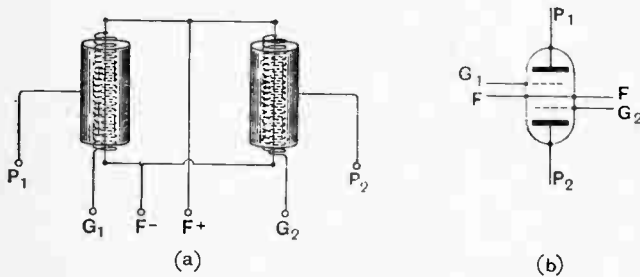

Fig. 1.—(a) Arrangement of electrodes in the Pentatron, (b) symbol used in circuit diagrams.

By the joint construction of two such valve systems in a single bulb, several important advantages are secured. First of all, *each valve system can be used as a separate unit*, as shown in Fig. 2, for example, to combine in one valve a receiver with a reacting valve detector and one stage of low-frequency amplification. The receiver, which was demonstrated by Professor Leithäuser, was, in fact, constructed on this plan. In this case, therefore, the valve acts as a substitute for two valves of the type used hitherto, with a simplification of operation and a consequent saving of space. It is, of course, understood that a suitable potential can be applied to each grid separately, and that each anode can be given the appropriate anode tension.

It is likewise possible to use the Pentatron for "push-pull" circuits. Such a circuit is represented diagrammatically in Fig. 3. Here also we obtain the advantage that the construction of the circuit and its operation are considerably simplified, and, the two valve systems being accommodated in one and the same bulb, the characteristics of the two valves can be made as near alike as possible.

A third possible way of using this valve is to connect the two grids and the two anodes direct. In this case, the

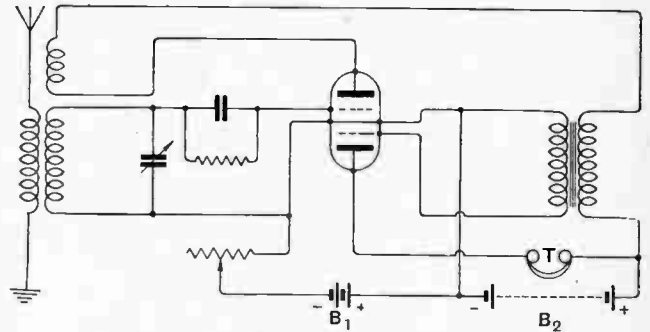

Fig. 2.—The Pentatron connected as a reacting valve detector with one stage of L.F. amplification.

high, namely, 0.6 to 0.8 milliamperes per one volt. By joining the two systems in parallel, and by using somewhat more suitable dimensions, valves can be secured with a steepness of 1.6 to 2 milliamperes per volt, with a voltage-amplification factor of about 6.5 to 8.5, corresponding to an internal resistance of only about 4,000 ohms. The emission of each individual system amounts to 6 to 8 milliamperes, with zero grid potential, and with an anode potential of 90 volts. With a valve with electrodes connected in parallel, this current is increased somewhat, and amounts, in the same circumstances, to between 14 and 18 milliamperes. The valve is, therefore, very suitable for working even large loud-speakers,

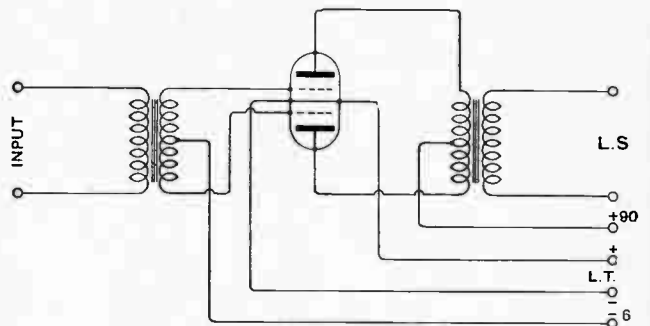
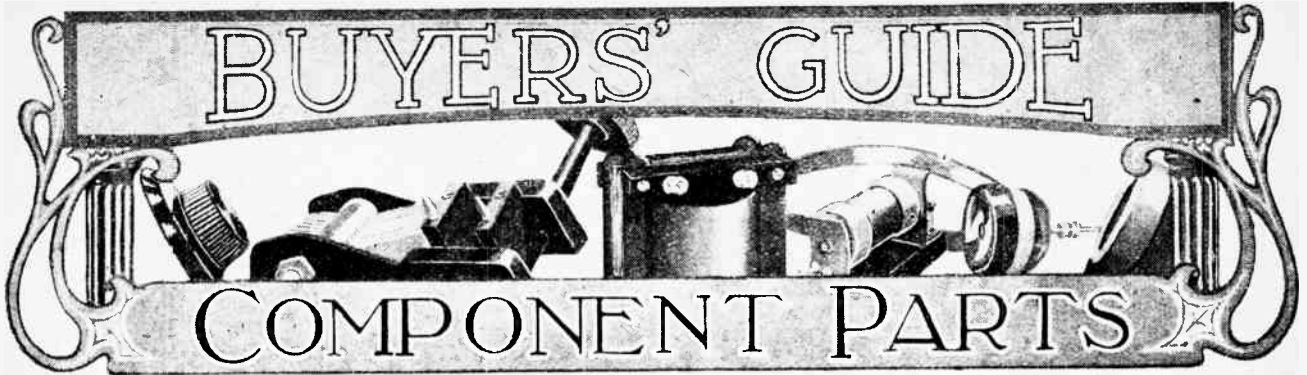

Fig. 3.—A symmetrical "push-pull" amplifying circuit is possible with the Pentatron valve.

using for the purpose a single accumulator cell as heating battery and an anode battery of 90 volts.

It will be understood that these new valves are of the greatest interest to experimenters, being at the same time suitable for general broadcast reception.



Condensers—Fixed and Variable.

UNDER the heading "Buyers' Guide" we have previously published a list of complete sets on the market, and more recently have extended the principle to dealing with component parts. In our issue of May 26th last we included a "Buyers' Guide" list of components used in the construction of low-frequency amplifying units, and articles were included in that issue relative to the same subject. In the present issue we deal in our "Buyers' Guide" section with condensers both fixed and variable, which are listed under manufacturer, type, capacity, and price, whilst articles relating especially to the design and the mechanical

construction of variable condensers form a feature of the issue.

The many expressions of appreciation of this special section which we have had from our readers convince us of the utility of these lists as a ready reference to apparatus for use in the construction of sets and for the comparison of prices, types, and so forth.

Whilst we cannot claim that these lists are entirely comprehensive, yet every endeavour has been made to render them as complete as possible. We should be glad to have brought to our notice any possible omissions from this list.

FIXED CONDENSERS.

Manufacturer.	Name or Type.	Capacity.	Price.	Remarks.
		Microfarads.	£ s. d.	
Anodon, Ltd., 72/86, Oxford Street, London, W.1.	Anodon .....	0.0001	0 2 3	Mica.
.. .. .	.. .. .	0.00025	0 1 5	..
.. .. .	.. .. .	0.001	0 2 6	..
.. .. .	.. .. .	0.002	0 2 6	..
.. .. .	.. .. .	0.003	0 2 11	..
.. .. .	.. .. .	0.006	0 3 6	..
Blackadda Radio Co., Ltd., 48, Sudler Gate, Derby.	Adda 13 .....	0.0003	0 2 0	Mica.
.. .. .	.. 14 .....	0.001	0 2 0	..
Rowyer, Herbert, & Co., 1a, Railey Mews, Leverton Street, London, N.W.5.	Dorwood Precision ..	—	0 2 6	Mica. With or without grid leak clips.
.. .. .	.. .. .	Up to 0.006	0 3 0	.. .. .
.. .. .	.. .. .	From 0.006-0.02	0 4 6	.. .. .
British L.M. Ericsson Manufacturing Co., Ltd., 67/73, Kingsway, London, W.C.2.	Eriesson .....	0.002	0 2 6	Mounted in ebonite with mica dielectric; provision for mounting screws.
Clarke, H., & Co. (Manchester), Ltd., Atlas Works, Eastnor Street, Old Trafford, Manchester.	Atlas .....	0.0001-0.0005	0 1 6	Mica.
.. .. .	.. .. .	0.001-0.002	0 1 9	..
.. .. .	.. .. .	0.0025-0.004	0 2 0	..
.. .. .	.. .. .	0.005-0.007	0 2 6	..
.. .. .	.. .. .	0.01	0 3 6	..
Dubilier Condenser Co. (1925), Ltd., Ducon Works, Victoria Road, North Acton, London, W.3.	No. 600 .....	0.0001-0.0009	0 2 6	Mica. With or without grid leak clips.
.. .. .	.. .. .	0.001-0.006	0 3 0	..
.. .. .	No. 600A .....	0.0001-0.0009	0 2 6	For vertical mounting.
.. .. .	.. .. .	0.001-0.006	0 3 0	..
.. .. .	No. 610 .....	0.0001-0.0009	0 3 0	With detachable grid leak clips.
.. .. .	.. .. .	0.001-0.009	0 3 6	..
.. .. .	.. .. .	0.01	0 4 0	..
.. .. .	.. .. .	0.011-0.015	0 4 6	..
.. .. .	No. 620 .....	0.0001-0.0009	0 3 0	For vertical mounting.
.. .. .	.. .. .	0.001-0.009	0 3 6	..
.. .. .	.. .. .	0.01	0 4 0	..
.. .. .	.. .. .	0.011-0.015	0 4 6	..
.. .. .	No. 577 .....	0.0001-0.01	0 7 6	For vertical mounting in metal cases.
.. .. .	Dubilier-Mansbridge	0.01-0.1	0 2 6	..
.. .. .	.. .. .	0.2	0 2 8	..
.. .. .	.. .. .	0.25 and 0.3	0 3 0	..
.. .. .	.. .. .	0.4	0 3 3	..
.. .. .	.. .. .	0.5	0 3 6	..
.. .. .	.. .. .	1.0	0 4 0	..
.. .. .	.. .. .	2.0	0 5 0	..
Falk, Stadelmann & Co., Ltd., 83/93, Farringdon Road, London, E.C.1.	Etesca, W.90082 ..	0.001	0 1 6	Mica.
.. .. .	.. W.90080 ..	0.002	0 1 9	..
.. .. .	.. W.90415 ..	0.005	0 2 0	..
.. .. .	.. W.90252 ..	0.006	0 2 0	..
.. .. .	.. W.90081 ..	0.0001-0.0005	0 1 4	..
.. .. .	.. W.90147 ..	0.05-2	2/4 to 4/8	..

FIXED CONDENSERS.—Continued.

Manufacturer.	Name or Type.	Capacity.	Price.	Remarks.
Finston Manufacturing Co., Ltd., 45, Horseferry Road, Westminster, London, S.W.1.	Finston	Microfarads. 0.0001-0.001	£ s. d. 0 1 0	
"	"	0.002-0.006	0 1 9	
General Electric Co., Ltd., Magnet House, Kingsway, London, W.C.2.	Geophone	0.0001-0.006	0 2 6	
Hough, J. E., Ltd., Edison Bell Works, Glengall Road, London, S.E.15.	Edison Bell	0.0002	0 1 3	Tubular.
"	"	0.0015-0.006	0 1 6	
"	"	0.0001-0.001	0 1 3	
"	"	0.0015-0.006	0 1 3	With grid leak clip.
"	Hermetic	0.0001-0.001	0 1 9	
"	"	0.0015-0.006	0 1 0	Moulded case.
"	"	0.002-0.006	0 1 6	"
"	"	0.01	0 2 0	"
"	Edison Bell	0.0001-0.001	0 1 0	Upright.
"	"	0.0015-0.006	0 1 6	"
"	"	0.0001-0.001	0 1 3	"
"	"	0.0015-0.006	0 1 3	With grid leak clip.
Hydeman, L. J., & Co., 12, Chapel Street, London, E.C.2.	Baltic	0.000028	0 1 9	
"	"	0.000055	0 3 0	Air dielectric. Interchangeable. Holders, 1/-.
"	"	0.00011	0 3 0	"
"	"	0.00022	0 3 9	"
"	"	0.00055	0 3 9	"
"	"	0.0011	0 2 0	Mica dielectric. Interchangeable. Holders, 1/-.
"	"	0.00022	0 2 0	"
"	"	0.00033	0 2 0	"
"	"	0.00055	0 2 0	"
"	"	0.0011	0 2 9	"
"	"	0.0022	0 2 9	"
"	"	0.0033	0 2 9	"
"	"	0.00055	0 2 6	Transmitting condensers. Mica dielectric.
"	"	0.001	0 3 3	For voltages up to 1,500.
Igranic Electric Co., Ltd., 117, Queen Victoria Street, London, E.C.1.	Igranic Freshman	0.001, 0.002 and 0.001-0.0005	0 2 0	
"	"	0.003-0.006	0 2 6	
India Rubber, Gutta Percha & Telegraph Works Co., Ltd., (The Silvertown Company), Silvertown, London, E.16.	Silvertown	0.0001-0.001	0 2 0	Mica.
"	"	0.002-0.005	0 2 6	"
"	"	0.01	0 3 6	"
Lissen, Ltd., Lissenium Works, Friars Lane, Richmond, Surrey.	Lissen	0.0001-0.006	1/3 to 2/-	Mica.
McMichael, L., Ltd., Wexham Road, Slough, Bucks.	M.H.	Up to 2	Up to 4/8	Paper type.
"	"	0.0001-0.0009	0 2 6	Mica, with clips mounted on ebonite base, with terminals, 1/- extra.
"	"	0.001-0.01	0 3 0	"
"	"	0.015-0.02	0 4 0	"
Marconiphone Co., Ltd., 210/212, Tottenham Court Road, London, W.1.	Marconiphone	0.0001, 0.0002, 0.0003 and 0.0005	0 1 3	Mica. " Tubular. " " "
"	"	0.001	0 1 9	"
"	"	0.001	0 2 8	"
"	"	0.002	0 2 10	"
"	"	0.003	0 3 0	"
"	"	0.0006	0 2 10	"
"	"	0.00005 and 0.0001-0.0005	0 2 4	"
Metro-Vick Supplies, Ltd., Trafford Park, Manchester.	Cosmos Permacon	0.0001, 0.0002 and 0.0005	0 1 6	Mica, copper foil plates.
"	"	0.0003	0 1 8	" with grid leak clips.
"	"	0.001	0 1 8	Mica dielectric, copper foil plates.
"	"	0.002	0 1 10	"
"	"	0.005	0 2 8	"
"	"	0.01	0 3 9	"
Millet, J., 22, Farringdon Avenue, London, E.C.4.	Alembie	0.001-0.006	0 1 6	On porcelain base.
"	"	0.0001-0.0006	0 1 3	"
"	"	2	0 3 11	Mansbridge type.
"	"	1	0 2 4	"
"	"	0.5	0 2 1	"
"	"	0.25	0 1 11	"
"	"	0.1	0 1 2	"
"	"	0.01-0.05	0 1 1	"
Needham, C. E. & Bro., Ltd., No. 3 Warehouse, Milk Street, Sheffield.	Solent	0.0001-0.0005	0 1 0	Mica. " "
Ormond Engineering Co., Ltd., 199/205, Pentonville Road, London, N.1.	Ormond	0.001-0.003	0 1 3	
"	"	0.000025	0 1 6	Air dielectric.
"	"	0.000035	0 1 6	"
"	"	0.00005	0 1 6	"
Paragon Rubber Manufacturing Co., Ltd., 86, Gray's Inn Road, London, W.C.1.	Paragon	0.0001-0.0003	0 2 0	Mica. " "
"	"	0.0001-0.001	0 2 6	"
"	"	0.002-0.01	0 3 0	"
Penton Engineering Co., 15, Cromer Street, Gray's Inn Road, London, W.C.1.	Penton	0.0002-0.0009	0 1 0	Mica.
"	"	0.001-0.009	0 1 3	"
"	"	0.01	0 2 0	"
Peto Scott Co., Ltd., 77, City Road, London, E.C.1.	Peto Scott	0.0001-0.0005	0 1 3	Mica dielectric. Moulded ebonite cases.
"	"	0.001-0.006	0 1 6	"
"	"	0.0001-0.0009	0 2 6	Plug-in type as above, fitted in special moulded cases with plugs and sockets.
"	"	0.001-0.004	0 3 0	Sockets, 2d. per pair extra.
Radio Experimental Co., Ltd., Carver Street Works, Sheffield.	—	0.0001-0.002	0 1 9	Mica.
Radio Instruments, Ltd., 12, Hyde Street, London, W.C.1.	R.I. No. 16	0.0002	0 2 0	Moulded cases.
"	" No. 16a	0.0005	0 2 0	"
"	" No. 17	0.0011	0 2 6	Metal cases.
"	" No. 18	0.002	0 2 6	"
"	" No. 19	0.05	0 2 9	"
"	" No. 20	0.25	0 3 0	"
"	" No. 21	0.5	0 3 4	"
"	" No. 22	1.0	0 3 10	"
"	" No. 23	2.0	0 4 8	"
Ripaults, Ltd., King's Road, St. Pancras, London, N.W.1.	Ripaults	0.0001-0.002	0 1 6	Mica. " "
"	"	0.003-0.006	0 2 0	"
Saxon Shore Co., Henry Street Works, South Shore, Blackpool, Lancs.	Saxon	0.0002-0.01	1/6 to 3/-	Mica.

FIXED CONDENSERS.—Continued.

Manufacturer.	Name or Type.	Capacity.	Price.	Remarks.
Stevens, A. J. & Co. (1914), Ltd., Walsall Street, Wolverhampton.	A.J.S. ....	Microfarads. 0.0001-0.0005	£ s. d. 0 1 9	Mica dielectric, moulded container, one-hole fixing.
	" .. .. .	0.001-0.006 and 0.00015	0 2 0	
Telegraph Condenser Co., Ltd., Wales Farm Road, North Acton, London, W.3.	T.C.C. No. 22 .....	1	6 19 1	Standard Mansbridge types. D.C. test voltages: Nos. 22 and 23, 1,500 volts; Nos. 24-31, 300 volts.
	" No. 23 .....	2	0 10 0	
	" No. 24 .....	2	0 1 8	
	" No. 25 .....	1	0 3 10	
	" No. 26 .....	0.5	0 3 4	
	" No. 26 .....	0.1	0 3 2	
	" No. 26 .....	0.3	0 3 0	
	" No. 27 .....	0.25	0 3 0	
	" No. 28 .....	0.2	0 2 8	
	" No. 28 .....	0.1	0 2 6	
	" No. 30 .....	0.09 -0.01	0 2 4	
	" No. 31 .....	0.009-0.005	0 2 0	
	" No. 33 .....	0.001-0.001	0 2 4	
	" No. 31 .....	0.0009-0.0001	0 2 1	
Type S.P. ....	0.0009-0.0001	0 2 10	Standard mica.	
Wainwright Manufacturing Co., Ltd., 531, Forest Road, Walthamstow, London, E.17.	W. & M. ....	0.0001-0.002	0 1 3	Mica. Ebonite base.
	" .. .. .	0.003-0.006	0 1 6	
	" .. .. .	0.01-0.015	0 2 0	
	" .. .. .	0.0001-0.0009	0 1 6	
Ward & Goldstone, Ltd., Frederick Road (Pendleton), Manchester.	Goltone .....	0.0001-0.0009	0 1 6	Mica, dielectric. For vertical and horizontal mounting. With grid leak clips. Do, but without grid leak clips.
	" .. .. .	0.001-0.006	0 1 9	
	" .. .. .	0.007-0.009	0 2 0	
	" .. .. .	0.01	0 2 6	
Walmel Wireless Co., Ltd., 332a, Goswell Road, London, E.C.1.	Walmel .....	0.00005-0.0005	0 2 0	Mica. Standard grid condensers. Mica. Standard fixed condensers. With fixed grid leak, 6d. extra. Mica.
	" .. .. .	0.001-0.002	0 2 0	
	" .. .. .	0.0025-0.006	0 2 6	
	" .. .. .	All capacities	1 9 to 3 -	
Vokes, C. G., & Co., 38, Conduit Street, London, W.1.	Micamold .....	All capacities	1 9 to 3 -	

VARIABLE CONDENSERS.

Manufacturer.	Name or Type.	Capacity.	Price.	Remarks.
Anodon, Ltd., 72/86, Oxford Street, London, W.1.	Anodon .....	Microfarads. 0.0003	£ s. d. 0 16 6	Straight line frequency. Bakelite insulation.
	" .. .. .	0.0005	0 17 9	
	" .. .. .	0.0003	0 15 6	
Autoveyers, Ltd., 82/84, Victoria Street, London, S.W.1.	Devicon Bridge Con- denser .....	0.0005	1 5 0	Square law, panel mounting, one-hole fixing.
	Spiral Vernier .....	0.0003	1 5 0	
Baty, Ernest J., 157, Dunstable Road, Luton, Beds.	Baty .....	0.00035 0.00088	0 4 0 0 7 6	Two-plate, 3in. diameter.
Beard & Fitch, Ltd., 34, Aylesbury Street, London, E.C.1.	Success .....	—	0 3 6	Neutrodyne. Geared reduction 4-1, copper vanes, without knob and dial.
	" .. .. .	0.0005	1 7 6	
Benoit, M., 17, Ashchurch Park Villas, London, W.12.	Hamm .....	0.001	0 8 9	Standard type, with "staggering vanes" giving a low minimum capacity. Without vernier.
	" .. .. .	0.0005	0 8 0	
Blackadda Radio Co., Ltd., 18, Sadler Gate, Derby.	Adda 10 .....	0.0001	0 11 9	Friction reducing gear with a ratio of 44-1. If mounted on an ebonite panel, 2/- extra.
	" 11 .....	0.0003	0 10 6	
	" 12 .....	0.0005	0 12 6	
	" .. .. .	0.0005	0 11 6	
	" .. .. .	0.0005	0 10 6	
British L.M. Ericsson Manufacturing Co., Ltd., 67/73, Kingsway, London, W.C.2.	Ericsson No. 1010 .....	0.0005	0 12 6	Ball-bearing movement, with vernier attachment. Ebonite end plates.
	" No. 1011 .....	0.001	0 10 6	
	" No. 1060 .....	0.0003	0 11 0	
	" No. 1061 .....	0.0005	0 13 6	
	" No. 1062 .....	0.001	0 15 6	
British Radio Corporation, Ltd., Weybridge, Surrey.	B.R.C. ....	—	0 5 0	Movable plates connected to terminal by means of a spiral phosphor bronze strip. Vernier type.
Bulgin, A. F. & Co., 9/11, Corsitor Street, London, E.C.4.	Decko .....	—	0 3 0	Neutralising special design to operate with the B.R.C. high-frequency combination transformer, semi-adjustable.
	Cydon .....	0.0002	0 15 6	
	" .. .. .	0.00025	0 16 0	
	" .. .. .	0.0003	0 16 6	
	" .. .. .	0.0005	0 17 6	
Burndept Wreless, Ltd., Aldine House, Bedford Street, London, W.C.2.	I. Standard, Model S.V.:	—	1 1 0	Neutralising condenser, with fibre adjusting rod. Straight line wavelength, ball-bearing phosphor bronze pigtail connection with 4in. dial.
	" No. 917 .....	0.00027	1 7 6	
	" No. 918 .....	0.0005	1 12 6	
	" No. 919 .....	0.0005	1 7 6	
	" No. 920 .....	0.001	1 15 0	
	" Model N.:	—	—	
	" No. 921 .....	0.00027	1 2 6	
	" No. 922 .....	0.0005	1 7 6	
	" No. 923 .....	0.0005	1 2 6	
	" No. 924 .....	0.001	1 10 0	
	II. Anode, Model S.V.:	—	—	
	" No. 925 .....	0.0002	1 2 6	
	" No. 928 .....	0.0002 (each half)	1 7 6	



VARIABLE CONDENSERS—Continued.

Manufacturer.	Name or Type.	Capacity.	Price.	Remarks.
Gent & Co., Ltd.—(contd.)	Tangent .....	Microfarads. 0.001	£ s. d. 0 9 10	Low-loss. With vernier, 2/- extra.
" " " "	" .....	0.00075	0 9 6	" " " "
" " " "	" .....	0.0005	0 8 10	" " " "
" " " "	" .....	0.0003	0 8 4	" " " "
" " " "	" .....	0.0002	0 7 10	" " " "
Gladwell & Kell, Ltd., 258, Gray's Inn Road, London, W.C.1.	Heath 11A .....	0.00025	1 1 6	Plain. Without dial, 3/- less.
" " " "	" 23A .....	0.0005	1 4 6	" " " "
" " " "	" 42A .....	0.001	1 8 6	" " " "
" " " "	" 12A .....	0.00025	1 6 6	Geared vernier. Without dial, 3/- less.
" " " "	" 24A .....	0.0005	1 8 9	" " " "
" " " "	" 44A .....	0.001	1 14 0	" " " "
Hough, J. E., Ltd., Edison Bell Works, Glengall Road, London, S.E.15.	Edison Bell .....	0.001	0 12 6	The vernier type can be fitted with Heath Radiant Micrometer Indicator at 6/6 extra.
" " " "	" .....	0.0003	0 8 6	Square law.
" " " "	" .....	0.0005	0 10 0	" " " "
" " " "	" .....	0.001	0 11 6	" " " With vernier.
" " " "	" .....	0.0003	0 10 6	" " " "
" " " "	" .....	0.0005	0 11 6	" " " "
" " " "	" .....	0.001	0 14 2	Variable. with vernier.
" " " "	" .....	0.0003	0 10 0	" " " "
" " " "	" .....	0.0005	0 11 6	" " " "
Hydeman, L. J., & Co., 12, Chapel Street, London, E.C.2	Baltic .....	0.00955	0 13 6	" " " "
" " " "	" .....	0.00055	1 2 6	Fitted with a " Baltic " D.1 straight line frequency knob and dial.
" " " "	" .....	0.00033	1 2 0	For transmitting.
" " " "	" .....	0.0005	1 5 0	Designed for inputs up to 150 watts, suitable up to 2,500 volts. Dial extra.
" " " "	" .....	0.000028	0 5 0	Micro type. Knob and dial extra.
" " " "	" .....	0.00083	0 8 0	" " " "
" " " "	" .....	0.00022	0 10 0	" " " "
Igranic Electric Co., Ltd., 117, Queen Victoria Street, London, E.C.1.	Igranic .....	0.00015	0 19 6	Square law. Aluminium end plates. 4in. knob and dial.
" " " "	" .....	0.0003	1 1 0	" " " "
" " " "	" .....	0.0005	1 4 0	" " " "
" " " "	" .....	0.0021	1 7 6	" " " "
" " " "	" .....	0.0003 (each half)	1 5 0	Square law. Dual.
" " " "	" .....	0.0005 ( " " )	1 9 6	" " " "
" " " "	" .....	0.0002	1 15 0	Square law. Transmitting.
" " " "	" .....	0.0001	0 5 6	Micro condenser.
" " " "	" .....	—	0 5 6	Vernier balancing condenser.
" " " "	Igranic-Pacnet .....	0.00035	0 14 6	Straight line frequency, one or three-hole fixing.
" " " "	" .....	0.0005	0 18 6	Vernier.
India Rubber, Gutta Percha & Telegraph Works Co., Ltd. (The Silvertown Company), Silvertown, London, E.16.	Silvertown .....	0.00003	0 5 6	"
" " " "	" .....	0.00006	0 6 0	"
" " " "	" .....	0.0001	0 6 6	"
" " " "	" .....	0.0002	0 7 0	"
" " " "	" .....	0.00025	0 7 6	"
" " " "	" .....	0.0003	0 8 0	"
" " " "	" .....	0.0005	0 9 6	"
" " " "	" .....	0.001	0 12 6	"
" " " "	" .....	0.00025 (each half)	0 17 6	Dual.
" " " "	" .....	0.0001	0 8 6	Slow motion type.
" " " "	" .....	0.0002	0 9 0	" " " "
" " " "	" .....	0.00025	0 9 6	" " " "
" " " "	" .....	0.0003	0 10 0	" " " "
" " " "	" .....	0.0005	0 11 6	" " " "
" " " "	" .....	0.001	0 14 6	" " " "
" " " "	" .....	0.00025 (each half)	0 19 6	" " " Dual.
" " " "	" .....	0.00003	0 13 0	Enclosed, with vernierometer. Vernier.
" " " "	" .....	0.00006	0 13 6	" " " "
" " " "	" .....	0.0001	0 14 0	" " " "
" " " "	" .....	0.0002	0 14 6	" " " "
" " " "	" .....	0.00025	0 15 0	" " " "
" " " "	" .....	0.0003	0 15 6	" " " "
" " " "	" .....	0.0005	0 17 0	" " " "
" " " "	" .....	0.001	1 0 0	" " " "
" " " "	" .....	0.00025 (each half)	1 5 0	" " " Dual.
Jackson Bros., 8, Poland Street, London, W.1.	J.B. Standard Model .....	0.001	0 8 6	Air dielectric. One-hole fixing. With vernier, 4/- extra.
" " " "	" .....	0.00075	0 8 0	" " " "
" " " "	" .....	0.0005	0 7 0	" " " "
" " " "	" .....	0.0003	0 5 9	" " " "
" " " "	" .....	0.00025	0 5 9	" " " "
" " " "	" .....	0.0002	0 5 0	" " " "
" " " "	" .....	0.0001	0 4 9	" " " "
" " " "	J.B. Super All-metal .....	0.001	0 9 6	Brass end plates, large ebonite brushes, triangular vanes. With vernier, 4/6 extra.
" " " "	" .....	0.00075	0 9 0	" " " "
" " " "	" .....	0.0005	0 8 0	" " " "
" " " "	" .....	0.0003	0 6 9	" " " "
" " " "	" .....	0.00025	0 6 9	" " " "
" " " "	" .....	0.0002	0 5 6	" " " "
" " " "	" .....	0.0001	0 5 3	" " " "
" " " "	J.B. Square Law .....	0.001	0 9 6	One-hole fixing. With vernier, 4/6 extra.
" " " "	" .....	0.00075	0 9 0	" " " "
" " " "	" .....	0.0005	0 8 0	" " " "
" " " "	" .....	0.0003	0 6 9	" " " "
" " " "	" .....	0.00025	0 6 9	" " " "
" " " "	" .....	0.0002	0 5 6	" " " "
" " " "	" .....	0.0001	0 5 3	" " " "
" " " "	J.B. Twin Model .....	0.0002 (each half)	0 19 6	One-hole fixing. Standard or square law
" " " "	" .....	0.0003	0 19 6	Triangular fixed vanes. Pure ebonite end plates.
" " " "	" .....	0.00025	0 19 6	" " " "
" " " "	" .....	0.0005	1 1 0	" " " "
" " " "	J.B. Plain Type .....	0.001	0 13 0	Geared, 4/6 extra. " " "
" " " "	" .....	0.00075	0 11 9	" " " "
" " " "	" .....	0.0005	0 10 6	" " " "
" " " "	" .....	0.0003	0 9 0	" " " "

VARIABLE CONDENSERS—Continued.

Manufacturer.	Name or Type.	Capacity.	Price.	Remarks.
Jackson Bros.—(contd.)	J.B. Plain Type. . .	Microfarads. 0.0025	£ s. d. 0 8 9	Geared, 4/6 extra.
" " " "	" " " "	0.0002	0 8 6	" " " "
" " " "	" " " "	0.0001	0 8 3	" " " "
Lamplugh, S. A., Ltd., King's Road, Tyseley, Birmingham.	Lamplugh . . . . .	0.0002	0 4 0	Micrometer vernier condenser.
" " " "	" " " "	0.0003	0 10 0	Low-loss straight line type, with dial.
" " " "	" " " "	0.0005	0 10 6	" " " "
" " " "	" " " "	0.0002	0 11 0	" " " "
" " " "	" " " "	0.0003	0 11 6	Straight line. "Ebonite" model, with dial.
" " " "	" " " "	0.0005	0 12 0	" " " "
" " " "	" " " "	0.0002	0 14 0	Low-loss. "Straight" line, with dial. "One-hole fixing.
" " " "	" " " "	0.0003	0 15 0	" " " "
" " " "	" " " "	0.0005	0 17 6	" " " "
Lever, Eric J., 33, Clerkenwell Green, London, E.C.1.	Trix . . . . .	0.0005	0 8 0	With "or without vernier", low-loss or "standard." Other capacities proportionate prices.
Lissen, Ltd., Lissenium Works, Rich- mond, Surrey.	Lissen . . . . .	0.0000009-0.0000977	0 4 6	Neutrodyne micrometer.
" " " "	" " " "	0.001	0 17 6	Mica.
" " " "	" " " "	—	0 12 6	Standard vernier for H.F. circuits.
Lyons, "Claude," 76, Old Hall Street, Liverpool.	G.R. . . . .	0.00025	1 4 6	Geared vernier.
" " " "	" " " "	0.00035	1 5 6	" " " "
" " " "	" " " "	0.0005	1 7 6	" " " "
" " " "	" " " "	0.00025	0 18 6	Provided with counterweight.
" " " "	" " " "	0.00035	0 19 6	" " " "
" " " "	" " " "	0.0005	1 1 0	" " " "
" " " "	" " " "	0.00025	1 7 6	Mounted precision. "With gear, 7/6 extra.
" " " "	" " " "	0.0005	1 10 0	" " " "
" " " "	" " " "	0.00025	0 19 6	Grounded rotor vernier.
" " " "	" " " "	0.00035	1 1 0	With gear, 6- extra.
" " " "	" " " "	0.0005	1 2 6	" " " " 6/6 "
" " " "	" " " "	0.000125	0 19 6	" " " " 6/- "
" " " "	" " " "	0.00025	1 2 6	Straight line frequency.
" " " "	" " " "	0.00035	1 12 6	" " " "
" " " "	" " " "	0.0005	1 15 0	" " " "
" " " "	" " " "	0.00025 (each half)	1 7 6	Dual. " " "
" " " "	" " " "	0.00035 ( " )	1 10 0	" " " "
" " " "	" " " "	0.0005 ( " )	1 12 6	" " " "
" " " "	" " " "	0.001	2 15 0	Laboratory. With gear, 10/- extra.
" " " "	" " " "	0.002	3 7 6	" " " " 18/6 "
" " " "	" " " "	—	0 7 6	Micro condenser.
Marconiophone Co., Ltd., 210/212, Tottenham Court Road, London, W.1.	Sterling Minifloss . . . . .	0.00025	1 1 0	Square law.
" " " "	" " " "	0.0005	1 4 0	" " " "
" " " "	" " " "	0.001	1 10 0	" " " "
" " " "	Sterling . . . . .	0.00025	0 17 6	Panel mounting type, with vernier.
" " " "	" " " "	0.0005	1 1 0	" " " " " "
" " " "	" " " "	0.001	1 1 0	" " " " " "
" " " "	" " " "	0.00025	0 15 0	Panel mounting type, without vernier.
" " " "	" " " "	0.0005	0 17 6	" " " " " "
" " " "	" " " "	0.001	1 1 0	" " " " " "
" " " "	" " " "	0.00025	0 19 0	Geared square law (ratio 6-1).
" " " "	" " " "	0.0005	1 2 0	" " " " " "
" " " "	" " " "	0.001	1 5 0	" " " " " "
" " " "	" " " "	0.00025 (each unit)	1 2 0	Double square law.
" " " "	" " " "	0.00025 (each unit)	1 5 0	Triple " " "
" " " "	" " " "	0.00025 (each unit)	1 3 0	Double balanced. " " "
McMichael, L., Ltd., Wexham Road, Slough, Bucks.	M.H. . . . .	—	0 2 6	Neutrodyne. One-hole fixing.
Metro-Vick Supplies, Ltd., Trafford Park, Manchester.	Cosmos . . . . .	0.0005	0 13 0	Vernier.
" " " "	" " " "	0.00025	0 12 0	Square law, adjustable cone bearings, pigtail connection, one-hole fixing, with knob and 3in. dial.
" " " "	" " " "	0.0005	0 15 6	" " " " " Slow motion.
" " " "	" " " "	0.00025	0 14 9	" " " " " " " "
Naylor, J. H., Ltd., Central Brass Works, Wigan.	Fulstop . . . . .	0.0002	0 8 3	Geared (2-1), 1/3 extra.
" " " "	" " " "	0.0003	0 8 9	" " " " 1/6 "
" " " "	" " " "	0.0005	0 9 6	" " " " 1/9 "
" " " "	" " " "	0.001	0 11 6	" " " " 2/- "
" " " "	Super Fulstop . . . . .	0.0002	1 4 0	Fitted with vernier adjustment with rotors, geared 125-1.
" " " "	" " " "	0.0003	1 7 0	" " " " " "
" " " "	" " " "	0.0005	1 8 6	" " " " " "
" " " "	" " " "	0.001	1 10 6	" " " " " "
" " " "	" " " "	0.00025	1 5 6	" " " " " "
Needham, C. E., & Bro., Ltd., No. 3 Warehouse, Milk Street, Sheffield.	Seamark Comnode . . . . .	0.0005	0 19 6	Combined condenser and geared coil-holder. One or three hole fixing.
Neophone Radio Co., 10, Little St. Andrew Street, London, W.C.2.	Ordinary Type. . . . .	0.001	0 7 0	Complete with knob and dial. With vernier, 1/6 extra.
" " " "	" " " "	0.00075	0 6 6	" " " " " "
" " " "	" " " "	0.0005	0 6 0	" " " " " "
" " " "	" " " "	0.0003	0 5 0	" " " " " "
" " " "	" " " "	0.0002	0 4 0	" " " " " "
" " " "	" " " "	—	0 3 6	Vernier.
" " " "	Square law . . . . .	0.001	0 8 0	Complete with knob and dial. With vernier, 1/6 extra.
" " " "	" " " "	0.00075	0 7 6	" " " " " "
" " " "	" " " "	0.0005	0 7 0	" " " " " "
" " " "	" " " "	0.0003	0 6 0	" " " " " "
" " " "	" " " "	0.0002	0 5 0	" " " " " "
" " " "	" " " "	—	0 4 6	Vernier.
" " " "	Square Law, Low- loss. . . . .	0.001	0 9 0	Complete with knob and dial. With vernier, 1/6 extra.
" " " "	" " " "	0.00075	0 8 6	" " " " " "
" " " "	" " " "	0.0005	0 7 6	" " " " " "
" " " "	" " " "	0.0003	0 7 0	" " " " " "
" " " "	" " " "	0.0002	0 6 0	" " " " " "
" " " "	" " " "	—	0 5 6	Vernier.
Ormond Engineering Co., Ltd., 199/205, Pentonville Road, London, N.1.	Ormond . . . . .	0.000005	0 2 0	Neutrodyne.
" " " "	" " " "	0.00005	0 4 0	Midget type.
" " " "	" " " "	0.00025	0 19 0	One or three hole fixing. Special low-loss design, with friction control for fast and slow motion (ratio 53-1), with earthing shield and 4in. knob and dial.
" " " "	" " " "	0.00035	0 19 6	" " " " " "
" " " "	" " " "	0.0005	1 0 0	" " " " " "



VARIABLE CONDENSERS—Continued.

Manufacturer.	Name or Type.	Capacity.	Price.	Remarks.
Crimen—contd.	Ormond S.L.W. ...	Microfarads. 0.00025	£ s. d. 0 6 6	Square law. With or without friction control gearing. With knob and dial. One-hole fixing.
"	"	0.0003	0 7 6	"
"	"	0.0005	0 8 0	"
"	"	0.001	0 9 0	"
"	"	0.00025	0 13 6	Do. do. With friction control (slow motion ratio 55-1).
"	"	0.0003	0 11 6	"
"	"	0.0005	0 15 0	"
"	Ormond	0.00025	0 8 0	With vernier attachment. Square law, with knob and dial. One-hole fixing.
"	"	0.0003	0 9 0	"
"	"	0.0005	0 9 6	"
"	"	0.001	0 10 6	"
Penton Engineering Co., 15, Cromer St., Gray's Inn 1 d., London, W.C.1.	Penton	0.0005	0 13 6	Geared. Gear ratio 6-1.
"	"	0.0003	0 14 0	"
Peto Scott Co., Ltd., 77, City Road, London, E.C.1.	Peto Scott	—	0 5 0	Neutrodyne. Baseboard mounting.
"	"	0.0002	0 6 3	Panel mounting.
"	"	0.00025	0 6 6	Standard Model. Square law, low-loss, ebonite end plates and solid brass bushings, 3in. knob and dial. Vernier, 2/- extra.
"	"	0.0003	0 7 0	"
"	"	0.0005	0 7 6	"
"	"	0.001	0 8 0	"
"	"	0.0002	0 9 0	"
"	"	0.0003	0 10 0	De Luxe Model.
"	"	0.0005	0 11 6	With 10-1 reduction gear, 4/6 extra.
"	"	0.001	0 14 6	"
"	"	0.0003	0 19 6	"
"	"	0.0005	1 1 0	Dual.
"	"	0.001	1 5 0	"
"	"	0.0003	0 14 0	Straight line frequency, low-loss, ebonite end plates and 4in. dial. Direct drive 0°-180° dial.
"	"	0.0005	0 15 0	With helical 2-4 gearing and 0°-360° dial.
Portable Utilities Co., Ltd., Eureka House, Fisher Street, London, W.C.1.	Eureka	0.0003	0 18 6	Straight line frequency.
"	"	0.0005	0 19 6	"
"	"	0.001 and 0.0003	0 11 6	Condenser in dial.
"	Dial-O-Denser	0.0005 and 0.001	0 15 6	"
Radio Communication Co., Ltd., 31/35, Norfolk Street, London, W.C.2.	Polar Cam Vernier	0.001	0 10 0	Compensated square law. Ball bearings.
"	"	0.0005	0 14 0	"
"	"	0.0003	0 13 0	"
"	"	0.001	0 12 0	"
"	Polar Junior	0.001-0.0005-0.0003	0 6 6	Latest model. With large knob and dial.
"	"	0.001-0.0005-0.0003	0 5 6	Old model. With flat metal dial.
"	Polar Micrometer.	—	—	—
"	N. Type	0.000012	0 5 6	—
"	P.7991 Type	0.000025	0 5 6	—
Radio Devices Co., Newdigate Street, Nottingham.	Devicon Bridge Condenser.	0.0005	1 5 0	Square law, panel mounting, one-hole fixing.
"	"	0.0003	1 5 0	"
"	New Devicon True Scale Friction Condenser.	0.001	0 15 6	Single-hole fixing, slow movement attachment.
"	"	0.0005	0 14 6	"
"	"	0.0003	0 14 0	"
"	"	0.0002	0 13 6	"
"	Devicon Model 2...	0.001	0 9 6	Square law, ebonite end plates, all nickel finish.
"	"	0.0005	0 8 3	With vernier, 2/- extra.
"	"	0.0003	0 8 3	"
"	"	0.0002	0 7 9	"
"	"	0.0005	0 7 3	"
"	"	0.0003	0 7 3	"
"	"	0.0005	0 8 9	Low-loss, nickelled brass end plates and ebonite strips. With vernier, 1/9 extra.
"	"	0.0003	0 8 3	"
"	"	0.0002	0 7 9	"
Radio Instruments, Ltd., 12, Hyde Street, London, W.C.1.	Standard Precision.	—	—	—
"	No. 11	0.0012	1 5 0	10/- extra for fitting in polished mahogany case, with ebonite top and terminals.
"	No. 15	0.0005	1 1 0	"
"	No. 162	0.00025	0 18 6	"
"	No. 66	0.0001	0 16 0	"
"	Geared Precision.	—	—	—
"	(Ratio 11-1.)	—	—	—
"	No. 212	0.001	1 12 6	"
"	No. 213	0.0005	1 8 6	"
"	No. 211	0.00025	1 6 0	"
"	Square Law Precision, with vernier).	—	—	—
"	No. 206	0.0005	1 4 0	"
"	No. 207	0.00025	1 2 6	"
Ripaults, Ltd., King's Road, St. Pancras, London, N.W.1.	Ripaults	0.0001	0 8 0	Square law. With vernier, 2/- extra. Single-hole fixing.
"	"	0.0002	0 8 6	"
"	"	0.0003	0 9 6	"
"	"	0.0005	0 10 0	"
"	"	0.00075	0 11 6	"
"	"	0.001	0 12 6	"
Robbins Bros., 19, Claylands Place, Church Street, Clapham, London, S.W.8.	"	0.001	0 8 0	Square law or standard patterns. Ebonite ends, with knob and dial.
"	"	0.00075	0 7 0	"
"	"	0.0005	0 6 0	"
"	"	0.0003	0 5 6	"
"	"	0.0002	0 4 6	"
"	"	0.0001	0 3 0	"
"	"	0.001	0 9 9	"
"	"	0.0005	0 7 9	With vernier.
"	"	0.0003	0 7 3	"
Rothermel Radio Corporation of Gt. Britain, Ltd., 24/26, Maddox Street, London, W.1.	Amsco	0.0003-0.0005	£1 3s. to £1 6s. 6d.	S.L.F. Pigtail connections.
"	Bremer-Tully	0.000125-0.00075	£1 2s. 6d. to £1 14s.	Square law. Pigtail connections.
"	Hammarbund	0.00025-0.0005	£1 1s. 6d. to £1 3s.	Clock spring pigtail.
"	Karas	0.000125-0.00005	£1 13s. to £1 15s.	Orthometric S.L.F. Pigtail connections.
"	Itender	0.00035-0.0005	1 11 9	Twin rotor condenser. No stator plates. Square law.
"	Silver-Marshall	0.00035	1 9 6	S.L.F. cone front and rear adjustable bearings.

VARIABLE CONDENSERS—Continued.

Manufacturer.	Name or Type.	Capacity.	Price.	Remarks.
Service Radio Co.	Service	Microfarads.	£ s. d.	
"	"	0.00015	0 2 6	Neutrodyne vernier. One-hole fixing.
"	"	0.0005	1 2 0	Straight line frequency, brass vanes, knob and dial. With 4in. knob and dial, 1/6 extra.
"	"	0.0003	1 0 6	
"	"	0.0002	0 19 6	
Stevens, A. J., & Co. (1914), Ltd., Walsall Street, Wolverhampton.	A.J.S.	0.0002	0 8 6	Low-loss, square law, fitted with direct reading vernier attachment.
"	"	0.0003	0 9 6	
"	"	0.0005	0 10 6	
"	"	0.001	0 13 6	
Thomas, Arnold, 9, Bennett's Hill, Birmingham.	Straight Line Frequency.	0.0005	0 17 6	4in. one-piece knob and dial.
"	"	0.0003	0 16 6	
"	Square Law	0.0005	0 8 0	With vernier, 1/6 extra.
"	"	0.0003	0 7 6	
Vokes, C. G., & Co., 38, Conduit Street, London, W.1.	Wade	0.000125	1 15 0	With vernier.
"	"	0.00025	1 17 6	
"	"	0.00035	1 18 6	
"	"	0.0005	1 19 6	
"	Barrett & Paden	0.00025	1 9 6	
"	"	0.00035	1 9 6	
"	"	0.0005	1 9 6	
"	Pilot	0.00035	0 9 6	
"	"	0.0005	0 12 6	
"	Commodore	0.00025	0 12 6	
"	"	0.00035	0 12 6	
"	"	0.0005	0 12 6	
"	Precise	0.00035	0 16 6	
"	"	0.0005	0 19 6	
Wainwright Manufacturing Co., Ltd., 531, Forest Road, Walthamstow, London, E.17.	W. & M.	0.001	0 13 6	Square law. For panel mounting, with knob and fixing screws. If fitted with bevelled dial and knob, 1/6 extra.
"	"	0.0005	0 10 6	
"	"	0.0003	0 9 0	
"	"	0.00025	0 8 0	
"	"	0.0002	0 7 0	
"	"	7-plate	0 5 6	
"	"	5-plate	0 5 0	
"	"	3-plate	0 4 6	
"	"	0.0003 (each half)	0 14 6	Square law, double-coupled, with knob and fixing screw. If fitted with bevelled dial and knob, 1/6 extra.
"	"	0.0002 ( " )	0 13 0	
"	"	7-plate ( " )	0 8 6	
"	"	5-plate ( " )	0 7 6	
"	"	0.001	1 2 6	Square law, panel mounting, with vernier attachment, fitted with bevelled dial and knob, vernier lever handle and fixing screws.
"	"	0.00075	1 0 0	
"	"	0.0005	0 16 6	
"	"	0.0003	0 15 0	
"	"	0.00025	0 14 6	
"	"	0.0002	0 11 0	
"	"	0.0005 (each half)	1 7 6	Dual.
"	"	0.0003 ( " )	1 0 0	
"	"	0.0002 ( " )	1 1 0	
"	"	0.001	1 0 0	All the above W. & M. types are also made with old pattern semi-circular plates instead of square law at prices 10 per cent. less than the above.
"	"	0.00075	0 18 6	Geared vernier, square law combination dial and knob and separate slow motion knob, for panel mounting, with fixing screws.
"	"	0.0005	0 15 0	
"	"	0.00025	0 12 6	
"	"	0.0002	0 11 6	
"	"	0.0003 (each half)	1 0 0	Double-coupled
"	"	0.0002 ( " )	0 18 6	
"	"	0.001	1 0 0	Low-loss, with geared vernier, square law, combination knob and dial and separate slow motion knob, micrometer vernier adjustment.
"	"	0.0005	0 15 0	
"	"	0.0003	0 13 6	
Wallis, H. O., & Co., Newdigate Street, Nottingham.	Eldorado	All capacities	From 6/0-£1/5 0	Square law types, low-loss, aluminium or brass vanes, geared vernier and ordinary.
Ward & Goldstone, Ltd., Frederick Road (Pendleton), Manchester.	Goltone	0.001	0 9 0	Square law. Moulded insulated top and bottom plates, complete with knob and dial. With vernier, 1/6 extra.
"	"	0.00075	0 8 6	
"	"	0.0005	0 8 0	
"	"	0.0003	0 7 6	
"	"	0.0002	0 6 6	
"	"	—	0 2 6	For Neutrodyne circuit, air dielectric.
Watson Jones, Ltd., St. Stephen's House, Victoria Embankment, London, S.W.1.	Westminster	0.0005	0 12 6	Straight line frequency.
"	"	0.0003	0 11 0	
Western Laboratories, Ltd., 11, Hanbury Road, Acton, London, W.3.	The W.L.	0.0005	0 12 6	Square law, slow motion.
"	"	0.0003	0 12 0	
"	"	0.0002	0 11 6	
"	"	0.0001	0 11 0	
"	"	0.001	0 16 6	
"	"	0.0000147	0 2 9	Neutrodyne.
Wilkins & Wright, Ltd., Utility Works, Kenyon Street, Birmingham.	Utility	0.001	0 12 6	With vernier, 2/6 extra.
"	"	0.00075	0 11 9	
"	"	0.0005	0 10 6	
"	"	0.0003	0 8 9	
"	"	0.0002	0 7 9	
"	"	0.0001	0 7 6	
"	Utility Low-Loss	0.001	0 11 9	Vernier fitted with slow motion dial, 5/- extra.
"	"	0.0005	0 12 6	
"	"	0.0003	0 10 0	
"	"	0.00025	0 9 6	
"	"	0.0002	0 9 0	
Wootton, F. E., Ltd., 56, Ilich Street, Oxford.	Wootophone	0.0003	0 7 0	Square law. Polished ebonite end plates, heavy aluminium vanes. Vernier, 3/- extra. With standard knob and dial.
"	"	0.0005	0 7 6	
"	"	0.0003	0 16 6	Square law, low-loss. Brass vanes. With 4in. Radion dial.
"	"	0.0005	0 17 6	
"	"	0.0003	1 2 0	With geared dial.
"	"	0.0005	1 3 0	

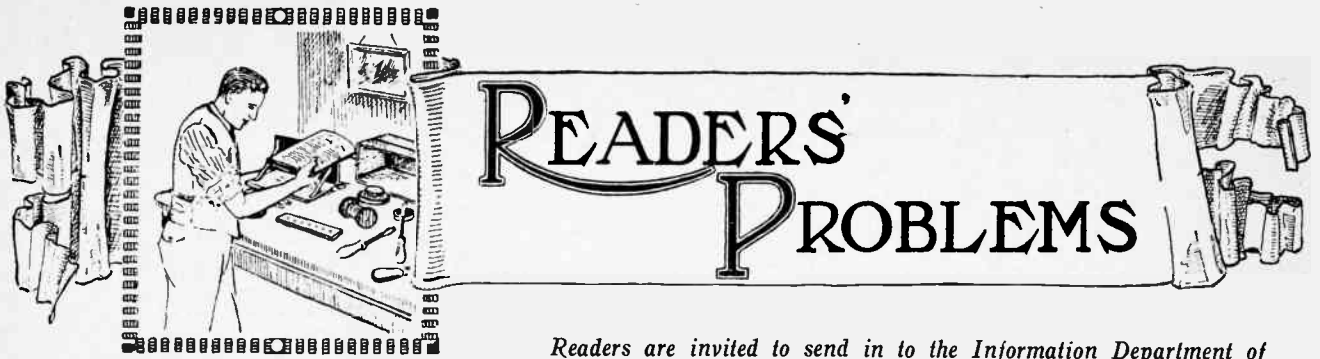

Readers are invited to send in to the Information Department of "The Wireless World" questions relating to their technical difficulties. Every question should be accompanied by a stamped addressed envelope for reply. No charge is made.

**Correct Connections of Choke-filter Circuit.**

I have noticed that in those receivers employing choke-filter, output circuits sometimes the condenser is connected to the valve end of the choke, and sometimes at the H.T. + end. I shall be glad if you can indicate to me which is the correct method of connecting up. M. W. M.

There are, broadly speaking, three methods in which a choke-filter circuit may be connected up, and these are illustrated in Fig. 1. All three methods give exactly the same volume and tone, but method (c) is the one to be recommended, since it possesses all the advantages of methods (a) and (b) without certain disadvantages possessed by those two methods.

Method (a) is probably the most commonly adopted one. It can be used as shown, or in conjunction with the single-wire loud-speaker connection scheme described on page 217 of the issue of February 10th, 1926. Its disadvantage

high-voltage H.T. battery or electric light mains if the metal headbands should come into contact with the telephone windings. Many amateurs using circuit (a) are surprised at receiving a shock when touching one of the telephone terminals, and usually imagine that the condenser dielectric has broken down. This is not so, of course, as we have just seen.

By moving the condenser to the other end of the choke as in method (b), we can at once get rid of all these disadvantages, such as risk of short-circuiting the H.T. battery, damaging the telephones or receiving shocks, but, unfortunately, we can no longer make use of single-wire loud-speaker connection in case we desire to use the loud-speaker or telephone at some considerable distance from the receiving apparatus.

By adopting method (c), however, we can at once obtain all the advantages of both methods (a) and (b), and at the same time eliminate the disadvantages associated with both. Method (c), then, is the one which we would recommend you

by connecting the telephones directly in the plate circuit of the valve. It should be pointed out that in method (c) it is immaterial whether the telephones are connected to L.T. +, L.T. -, or to the earth terminal of the receiver.

Another method of accomplishing the same results as in method (c) is to make use of method (a) but to use two condensers, one on each side of the telephones. Whilst this is, of course, effective, it represents an unnecessary expenditure upon an extra condenser, since exactly the same results can be obtained at less expenditure by adopting method (c).

o o o

**Constructing Filament Resistances.**

I am constructing a three-valve receiver employing a detector valve followed by two stages of low-frequency amplification. I propose to use two D.E.5 valves for the L.F. stages, and must therefore use a 6-volt accumulator. I intend that in the interests of economy the detector valve shall be of the 0.06 ampere type, its filament being safeguarded by a fixed filament resistance. Can you tell me how to estimate the value of resistance I shall require, and if I can construct this at home? W. O. T.

The value of resistance shunted across a difference of potential of 6 volts in order to maintain a current flow of 60 milliamperes can readily be ascertained from

Ohm's Law:  $R = \frac{E}{C}$ . By substituting,

$R = \frac{6}{0.06} = 100$  ohms. Now, part of this

resistance is supplied by the valve filament. It is necessary, therefore, to ascertain the resistance of the valve filament, and then to subtract it from the total of 100 ohms. Now the valve is rated at approximately 3 volts 0.06 amp., which means that if a difference of potential of three volts is applied across the filament a current of 60 milliamperes (0.06 amp.) will flow. By once more using the same formula it is a simple matter for us to ascertain that the resistance of the valve filament is 50 ohms, which, being subtracted from the total of the 100 ohms required, gives us 50 ohms as the necessary value of the external fixed resistance.

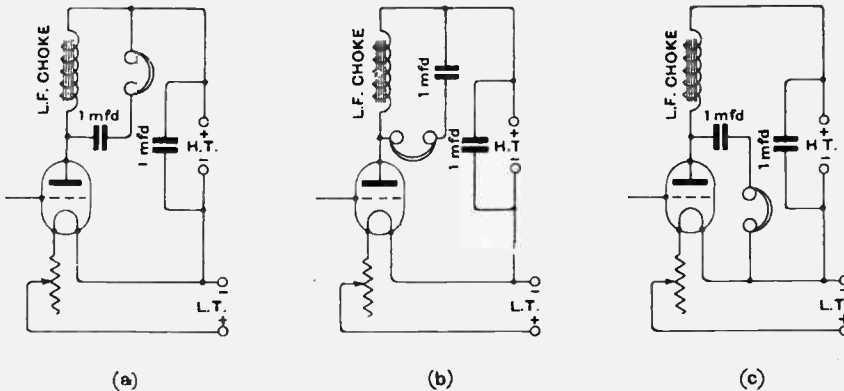

Fig. 1.—Alternative choke filter circuit connections.

when used as shown is that if by any chance one of the telephone leads should come into contact with earth the H.T. battery will be short-circuited, whilst if the other telephone lead comes into contact with earth the full voltage of the H.T. battery is applied across the telephone with probable risk of damage to them. Moreover, this circuit does not protect the user from shocks from the

to adopt in all cases. Both the telephone terminals are definitely "dead" with regard to D.C. and so all risk of shocks, damage to telephones or H.T. battery is eliminated.

Many people wrongly think that a certain amount of volume is sacrificed by the adoption of method (c). This is not so, and the volume is neither greater nor less than that given by method (a) or (b), or

**Readers' Problems.—**

The first requirement of the fixed resistance is that it must safely carry the current of 0.06 amp. without heating up. It is as well when estimating the current carrying capacity to allow a very generous margin. A suitable gauge would be No. 30. Nine yards of this gauge of Eureka resistance wire will give an approximate resistance of 50 ohms, and would be suitable. It may be wound in any suitable manner on an insulated former.

o o o o

**A Practical Four-valve Superheterodyne.**

*I am desirous of building the four-valve superheterodyne described in your issue dated August 26th, 1925, but have mislaid my copy of that issue, and have been unable to obtain another copy. Can you give the circuit with the necessary particulars?*  
S. F. H.

We reproduce the circuit diagram of this receiver in Fig. 2. The values of the various condensers are as follow:— $C_1$  and  $C_2$  are variable condensers of 0.0005 mfd. capacity and should be fitted with vernier control,  $C_3=0.001$  mfd.,  $C_4=0.0002$  mfd. variable with vernier control,  $C_5=0.001$  mfd.,  $C_6=0.0003$  mfd.,  $C_7=0.001$  mfd.,  $C_8=0.0003$  mfd.,  $C_9, C_{10}, C_{11}, C_{12}=1$  mfd.,  $C_{13}=0.001$  mfd. With regard to the grid leaks,  $R_5=1$  megohm, and  $R_1=0.25$  megohm.

The grid and aerial coils are wound on

The oscillator and reaction coils  $L_3$  and  $L_4$  consist of 200 and 150 turns respectively of No. 26 D.S.C. wire, and are wound on ebonite bobbins resembling the disc formers used for commercial plug-in transformers. The two discs are  $2\frac{1}{2}$  inches in diameter, and may be cut out from  $\frac{1}{8}$  inch ebonite. A third disc,  $1\frac{1}{2}$  inch in diameter, should be cut from the same piece of ebonite sheet, and the two large discs should be clamped together with the smaller disc in between them. The two complete bobbins should then be mounted on a threaded brass rod in order that their position with regard to each other may be varied.

The former for the input anode coil  $L_5$  should be constructed in a similar manner to the oscillator coil, except that the large discs should have a diameter of  $3\frac{1}{4}$  inches, the former for the reaction coil being the same as for the oscillator coil. These two formers should be permanently bolted together with a separation of  $\frac{1}{4}$  inch, which can be provided by an ebonite washer of this thickness. The windings of  $L_5$  consist of 575 turns of No. 30 D.S.C.,  $L_6$  having 300 turns of the same wire.

The H.F. transformer represented by  $L_7$  and  $L_8$  is of conventional type, and may consist of a No. 5a Sullivan transformer. If it is desired to construct the former at home, however, it should be made in the same manner as the oscillator coil former, except that the large discs should have a diameter of 5 inches, and the usual four valve pins should be fitted. Both primary

to that used for  $L_7, L_8$ , except that the winding slot is  $\frac{1}{8}$  in. wide. The inner and outer sections are connected in series, and together form the primary, while the secondary is sandwiched between them. The commencing ends of the primary and secondary windings connect, respectively, to the plate of  $V_3$  and to the crystal detector. It will be noticed that the fixed coupling condenser  $C_8$  is connected between the "in" ends of the windings.

It will be noticed that the first valve rectifies on the bottom bend of the grid volts-anode current characteristic curve, and the necessary grid bias should therefore be adjusted in accordance with the instructions given in a reply to R. S. R. on page 478 of our March 24th issue. This first valve combines the functions of first detector and second harmonic oscillator. Since the number of valves is small, it is obvious that energy must not be wasted, and accordingly the intervalve coupling transformer  $L_7$  and  $L_8$  is fully tuned. The second valve operates purely as a long-wave amplifier, whilst the third valve acts in a dual capacity, the functions of second detector being carried out by a crystal. The final valve acts purely as an L.F. amplifier.

Unless you have the fullest possible information concerning the construction and operation of this receiver, we can hardly recommend you to make it unless you have had considerable experience with the more complex circuits, and your best course is to obtain, if possible, a copy of the issue in

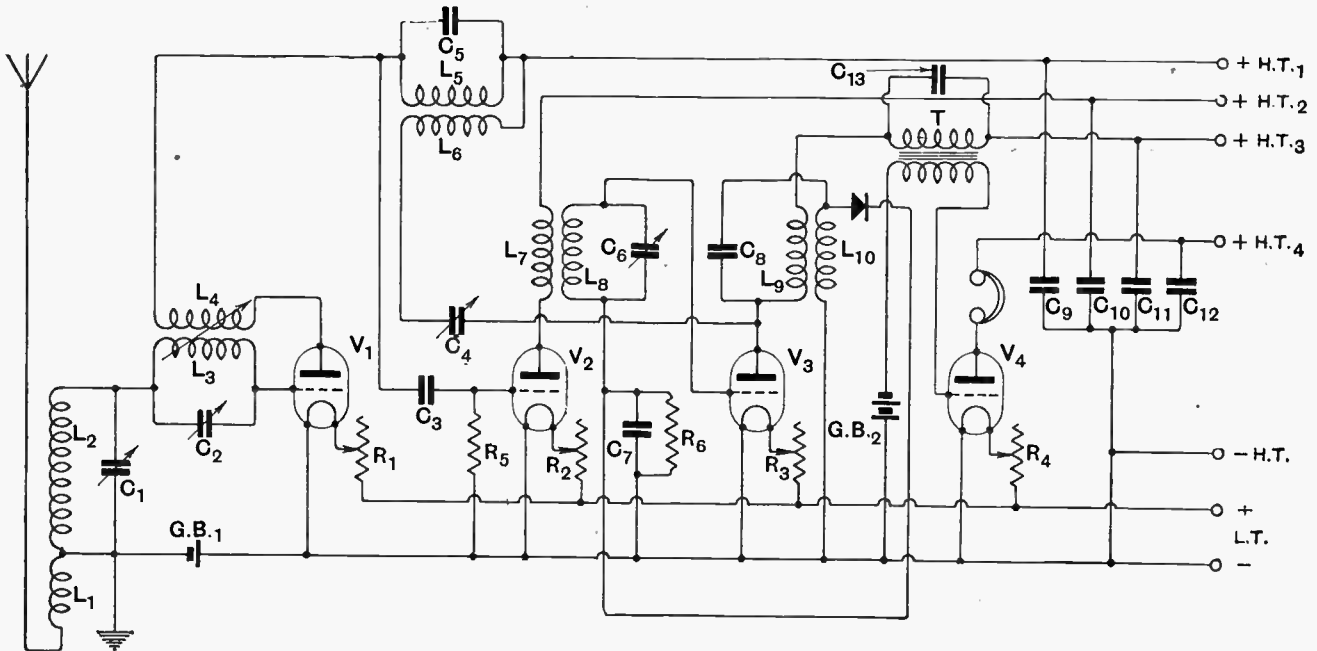

Fig. 2.—A four-valve reflex superheterodyne receiver.

a former 5 inches long by 3 inches in diameter. They are constructed by winding on 75 turns of No. 20 D.C.C. for the grid coil, leaving a half-inch space, and then winding on five more turns for the grid coil.

and secondary windings have 1,300 turns of No. 42 D.S.C. wire.

The valve-to-crystal coupling transformer,  $L_9, L_{10}$ , has three windings with 1,300 turns of No. 42 S.S.C. wire in each section on a former of similar dimensions

which this receiver was described. It is unfortunately now out of print owing to the large demand for it, but you would probably be able to obtain a copy by following the advice given to Y. P. F. in our June 9th issue.

# SPECIAL OFFER OF DARIMONT "HOME-SERVICE" BATTERIES

**£1** TO USERS OF DULL-EMITTER VALVES !  
 To make the merits of the DARIMONT HOME SERVICE BATTERY more widely known we make this **SPECIAL OFFER of THREE No. 10 Cells of 1.5 volts each**, 42-44 amp.-hour capacity, complete with charging materials, **DELIVERED Free**, at the reduced price of £1 against the regular price of 28/-.

If our claims are not completely fulfilled, when the cells are used according to instructions, return them and we will refund your money.  
 This Special Offer will remain open until 31st July, after which full list prices will be charged.  
 If the discharge rates given below meet your requirements send your order at once, as this offer cannot be repeated.



*Outstanding characteristics of the DARIMONT BATTERY.*

1. Steady voltage on discharge, thereby minimising risk of damage to valves.
2. It is noiseless in operation.
3. It obviates the necessity for accumulators.
4. It is more efficient than dry batteries.
5. When run down it is quickly recharged at home, without electrical connections.
6. It is economical and convenient.

Send your name and address with that of your usual Wireless Dealer and enclose £1.

Table showing the approximate life per charge of No. 10 Cells at the stated rates of discharge.

Filament Current (Amperes).	Life per charge (Hours).
.08	750
.12	375
.15	300
.18	250
.20	220
.25	170
.30	140
.40	105

The number of cells required for valves of a stated voltage may be calculated as under:

Voltage of Valve.	No. of cells required.
8 to 1.1	one.
1.7 to 2.0	two.
3.0 to 3.5	three.
4.0	four.

Prices of other sizes on application.

## DARIMONT ELECTRIC BATTERIES LTD.

DEPT. A., DARIMONT WORKS, ABBEY ROAD, PARK ROYAL, LONDON, N.W.10. 'Phone: Wembley 2807.



## The World's Wireless Programmes in your own Home

"WORLD-RADIO" is the only journal which tells listeners a week in advance about Dominion and Foreign programmes. It brings the outside world's broadcasting to Britain and keeps listeners abreast of the times with interesting and up-to-date information about international broadcasting. Another outstanding feature of this companion paper to "Radio Times" is an accurate table of stations abroad, in the order of wave lengths, which makes it the essential paper for the enthusiastic listener.

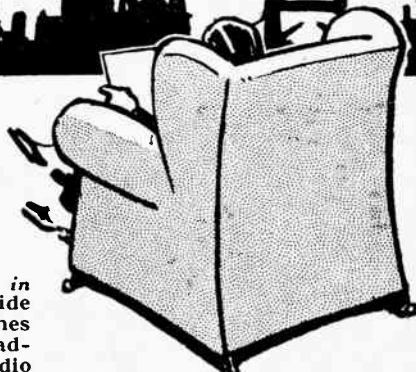

On sale at all Newsagents and Bookstalls every Friday, 2d., or by post (one year's subscription 13/6) from the Publishers, George Newnes, Ltd., 8-11, Southampton Street, Strand, London, W.C.

# WORLD-RADIO

WITH WHICH IS INCORPORATED  "RADIO SUPPLEMENT"

## The RADIO EXPERIMENTER'S HANDBOOK

In Two Volumes

By P. R. Coursey, B.Sc.

**T**HE Second Edition of this popular handbook in two volumes, which deals with the theory and practice of modern wireless telegraphy, has been thoroughly revised and brought up-to-date.

Written by a wireless authority of wide experience, "The Radio Experimenter's Handbook" is the best and safest guide to all amateurs who wish to build sets which will meet their own requirements. These two volumes furnish all the information necessary to secure a successful result.

**PART ONE** deals with the general principles underlying the design of radio receiving equipment.

**PART TWO** is devoted to data and actual quantitative design.

PRICE 3/6 NETT

per volume.

By Post 3/10 each.

From leading booksellers or direct from the publishers of "The Wireless World":

ILIFFE & SONS LIMITED,  
Dorset House, Tudor Street,  
LONDON, E.C.4.

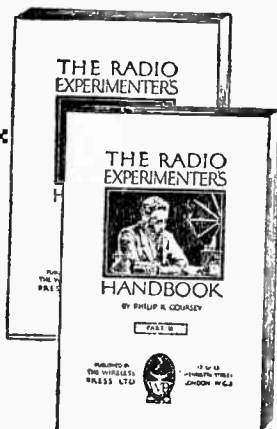

w.w.5

## TUNING COILS and METHODS of TUNING

By W. JAMES.



**A** VERY useful manual giving the maximum of information on the subject. Following a simple explanation of the principles of wireless, the author discusses the many methods of tuning circuits, with explanations of spade, condenser and variometer tuning. Other chapters treat in detail of the choice, construction and design of coils, and give particulars as to size of coil required, the best shape, size of wire, type of insulation, and special uses of the various coils.

PRICE 2/6 NET

By Post 2/10

Obtainable from all booksellers or direct from the Publishers:

ILIFFE & SONS LTD.,  
Dorset House, Tudor Street,

LONDON, E.C.4

W.W.32

## The EZI- WIRING SERIES

THIS Series will be appreciated by all amateurs who are anxious to make trouble-free sets. Each volume gives complete working instructions, detailed measurements and explanations of the components necessary for building highly efficient sets at moderate cost. A four-colour wiring diagram enables you to build the set without any possibility of incorrect wiring.

**No. 1. A Three-valve Portable Receiver.** By Hugh S. Pocock, Editor of "The Wireless World."

**No. 2. A Three-valve Receiver.** By F. H. Haynes.

**No. 3. A Two-valve and Crystal Reflex Receiver.** By W. James.

**No. 4. A Four-valve Combination Set.** By W. James.

PRICE 2/- NETT  
per volume.

By Post 2/2 each.

From leading booksellers or direct from the publishers of "The Wireless World."

ILIFFE & SONS LIMITED,  
Dorset House, Tudor St.,  
LONDON, E.C.4.

W.P. EZI-WIRING Series. No. 1

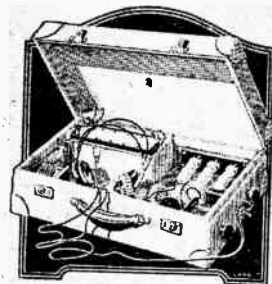

By HUGH S. POCOCK

A THREE VALVE  
PORTABLE  
RECEIVER

Containing  
COMPLETE INSTRUCTIONS  
& WORKING DRAWINGS.



PRICE  
2/- NETT

ILIFFE & SONS LTD.  
DORSET HOUSE, TUDOR STREET, W.C.4

GRASSH CUTS PREVENT ACID FROM CORRODING

FITTED WITH TERMINALS FOR CABLES

MONITE SEPARATORS PREVENT SHORTS

MAXEL BATTERY CHARGER

SEPARATE CASES PREVENT LEAKS & ACCIDENTS

ADJUSTABLE SLOW PLATE FOR SEDIMENT

## The New MAXEL Accumulator

GUARANTEED 12 MONTHS.

AMPERES (Intermittent)

	44	66	88	110
2-volt	8 -	10 -	12 -	15 -
4-volt	16 -	20 -	24 -	30 -
6-volt	24 -	30 -	36 -	45 -

Now Packed Free. Cash Paid. Increased Trade Discounts.

H.T. 60 volts, 7/6 post free.

MAX L BATTERY CHARGER  
From Your Electric Mains.  
THE LAST WORD IN SIMPLICITY AND EFFICIENCY. Post Free 27/6  
Fully guaranteed. With instructions.

\*Phone: MUSEUM 4 0708.

**MAXEL ELECTRICAL CO.,**

4, Maxel House, 28, Clifton Street, Ct. Portland Street, W.1

## "Japa" REGD

PLUG & SOCKET TERMINALS ARE THE FINEST TERMINALS IN THE WORLD FOR ALL WIRELESS CONNECTIONS.

**BRITISH MADE.**

If your Dealer cannot supply send direct to the Manufacturer through the post.

W. J. CHARLESWORTH,  
18 & 20, Aston Street, BIRMINGHAM.

— Established 1897 —

## "Japa" REGD

No bits of bent tin or brass, or screwed composition sleeves to make your connection, but a reliable mechanical article which has been copied by many but equalled by none.

ACTUAL SIZE

Insist upon the genuine article.

**6D EACH**  
Post free.

Made in Eng. Black, Pale Blue, Green, Royal Blue, Amber, Yellow, Brown.

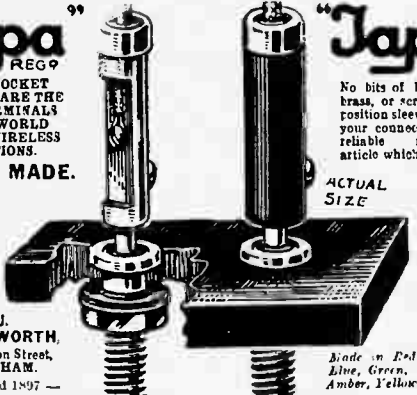

To get pure EBONITE, ask for

# BECOL

Registered Trade Mark.

It is made from finest rubber and sulphur and is guaranteed free from surface leakage.

**RODS. TUBES. SHEETS. PANELS. MOULDINGS**

Ask your dealer for "BECOL"

**QUALITY EBONITE**

It proves its quality in every test. Its polish will also please you—ask to see it.

**THE BRITISH EBONITE CO., Ltd., HANWELL, LONDON, W**

## A Guide to WIRELESS LITERATURE

HAVE YOU YET RECEIVED YOUR COPY of our booklet, "A Guide to Wireless Literature," which describes all the volumes published in conjunction with "The Wireless World"? There is a book for every phase of wireless and for all wireless workers, from the beginner to the advanced experimenter and research worker.

Write for your copy to-day.  
**FREE on REQUEST.**

ILIFFE & SONS LTD., Dorset House, Tudor St., London, E.C.4



**COMPENSATED SQUARE LAW EFFECT**

**LOW LOSS**

**NO BACK LASH**

### LOW LOSS SQUARE LAW SLOW MOTION

THE "Cosmos" Condenser is a slow motion condenser with absolutely no backlash either when new or after use. This desirable feature is accomplished by the use of a spring belt held in tension, which permits coarse tuning with the large knob, and a 10:1 slow motion with the small knob.

Cone bearings allow for adjustment and the slow motion bracket can be mounted for remote control as shown in the lower illustration.

**The condenser for fine tuning. METRO-VICK SUPPLIES LTD..**

(Proprietors)  
Metropolitan-Vickers Elec. Co. Ltd.)  
Metro-Vick House, 145 Charing Cross Road, London, W.C.2.

**Prices:**

Slow Motion	00025 mfd.	14/9
"	0005	15/6
Ordinary	00025	12/-
"	0005	13/-



ADJUSTABLE CONE BEARINGS

PIGTAIL CONNECTION



# COSMOS

# MISCELLANEOUS ADVERTISEMENTS.

**NOTICES.**

**THE CHARGE FOR ADVERTISEMENTS** in these columns is:

12 words or less, 1/- and 1d. for every additional word, e.g., 18 words 1/8; 24 words, 2/- Name and address must be counted.

**SERIES DISCOUNTS** are allowed to Trade Advertisers as follows on orders for consecutive insertions, provided a contract is placed in advance, and in the absence of fresh instructions the entire "copy" is repeated from the previous issue: 13 consecutive insertions, 5%; 26 consecutive, 10%; 52 consecutive, 15%.

**ADVERTISEMENTS** for these columns are accepted up to **FIRST POST** on **THURSDAY MORNING** (previous to date of issue) at the Head Offices of "The Wireless World," Dorset House, Tudor Street, London, E.C.4, or on **WEDNESDAY MORNING** at the Branch Offices, 19, Hertford Street, Coventry; Guildhall Buildings, Navigation Street, Birmingham; 199, Deansgate, Manchester.

Advertisements that arrive too late for a particular issue will automatically be inserted in the following issue unless accompanied by instructions to the contrary. All advertisements in this section must be strictly prepaid.

Postal Orders and Cheques sent in payment for advertisements should be made payable to ILLIFFE & SONS Ltd., and crossed & Co. Treasury Notes, being untraceable if lost in transit, should not be sent as remittances.

All letters relating to advertisements should quote the number which is printed at the end of each advertisement, and the date of the issue in which it appeared.

The proprietors are not responsible for clerical or printers' errors, although every care is taken to avoid mistakes.

**NUMBERED ADDRESSES.**

For the convenience of advertisers, letters may be addressed to numbers at "The Wireless World" Office. When this is desired, the sum of 6d. to defray the cost of registration and to cover postage on replies must be added to the advertisement charge, which must include the words Box 000, c/o "The Wireless World." Only the number will appear in the advertisement. All replies should be addressed No. 000, c/o "The Wireless World," Dorset House, Tudor Street, London, E.C.4. Readers who reply to Box No. advertisements are warned against sending remittance through the post except in registered envelopes; in all such cases the use of the Deposit System is recommended, and the envelope should be clearly marked "Deposit Department."

**DEPOSIT SYSTEM.**

Readers who hesitate to send money to unknown persons may deal in perfect safety by availing themselves of our Deposit System. If the money be deposited with "The Wireless World," both parties are advised of its receipt.

The time allowed for decision is three days, during which time, if the buyer decides not to retain the goods, they must be returned to the sender. If a sale is effected we remit the amount to the seller, but, if not, we return the amount to the depositor. Carriage is paid by the buyer, but in the event of no sale, and subject to there being no different arrangement between buyer and seller, each pays carriage one way. The seller takes the risk of loss or damage in transit, for which we take no responsibility. For all transactions up to £10, a deposit fee of 1/- is charged; on transactions over £10 and under £50, the fee is 2/6; over £50, 5/-. All deposit matters are dealt with at Dorset House, Tudor Street, London, E.C.4, and cheques and money orders should be made payable to Illiffe & Sons Limited.

**THE SALE OF HOME-CONSTRUCTED UNLICENSED APPARATUS.**

**A New Service to our Readers.**

We have made an arrangement with the Patentees whereby readers who wish to dispose of a home-constructed receiver not licensed under the patents made use of, can do so by means of the Deposit System referred to above.

The person desiring to sell, by sending us particulars for his advertisement, will in every case make use of a Box No., and should add to the price which he requires the amount of royalty customarily paid by manufacturers, viz. in the case of Marconi Patents the amount should be calculated at 12/6 per valve holder.

If the purchaser is satisfied with his purchase, the sum realised will be forwarded to the seller, less the amount due in respect of royalties, which amount will be paid by "The Wireless World" to the owners of the patents concerned, and a certificate will be handed on to the purchaser of the set.

**FOR SALE.**

**OSCILLATING** Zincite and Contact, 2s. 6d.; simple, original circuit, 1s.; excellent results; other parts stocked.—Ledsham's, 207, King Street, Hammersmith. (1888)

**60-VOLT** Wet Cell High Tension Batteries, genuine Leclanché; 21s.; trade supplied. Lists free.—Tennants, Hyllton Road, Sunderland. (2092)

**For Sale.—Contd.**

**WOOD** Horns for all speakers and gramophone attachments. There's one for Amplion Junior, ditto goose-neck bases, Lisensola, etc. There's only one best; it's the "Allwoodorn."—Manufacturer: H. Maddison, 2A, Ronald's Road, Highbury, N.5. List free. (1914)

**JACOBAN** Oak Wireless Cabinets, direct from makers, 55s. Packed free. Carriage paid. Send for illustration, etc.—Wm. Nurse, Union Street Cabinet Works, King's Lynn. (2069)

**PORTABLE** and other 3- and 4-valve sets, best components, clear reception. Bargain prices.—Russell, Harting, Petersfield. (2135)

**SUPERSONIC** Three Success Superformas, £2. McMichael Set and Daventry unit, £3 10s. McMichael H.F. two 1,000-3,000, one 300-600. 5s. each. Bargain.—Box 8213, WIRELESS WORLD Office. (2136)

**TANTALUM.**—Tantalum metal sheet for A.C. rectifiers.—Blackwell's Metallurgical Works, Liverpool. (2148)

**COMPONENTS** for the Enthusiast.—For C short wave, experimental, superheterodyne, neutrodyne, and all standard circuits: "Standardise on 'G.R.' Quality Parts Throughout." made by the General Radio Company of America. Insist on seeing the "G.R." trade mark and look for the red cartons. Variable Condensers (29 styles) comprising counterweighted and continuous balanced vernier geared models; hard rubber or metal end plates; Shielded Condensers; S.L. Capacity Condensers; S.L. Wavelength Condensers; S.L. Frequency Condensers; Tandem Condensers; Calibrated Variable Condensers; Neutrodyne Condensers; Direct Reading Wavemeter and Filter, 200/200/600 metres, accurately calibrated to 1 per cent., only 57s. 6d.; matched kit of 4 I.F. Transformers for Superhets (1 input, 3 I.F., 30 K.C.) with blue prints, only 90s.; Noiseless Rheostats, all usual resistances to carry generous current loads, only 6s. each; Potentiometers, special quality, 6s.; Variocouplers, special, only 13s. 6d.; Variometers; Special A.F. Chokes; exceptionally good L.F. Transformers; Telephone Transformers; Compensating Transformers; Modulation Transformers for Transmission; Ammeters, Milliammeters; Precision Wavemeters; American Sockets; American Valves; Raytheon Tubes. Send at once for complete lists, free and post free. Mention of usual stockist is desirable. Ask for interesting leaflets and booklets, "The Truth about Variable Condensers"; "True Mirrors of Tone Quality," describing type 285 "G.R." transformers ("A Perfect Transformer at Last"); "Stop Interference," describing type 247W. combined wavemeter and acceptor or rejector; "Low Loss Coils," describing special very low loss coils, interchangeable, for all wavelengths, and coupling coils and their special uses. Very reasonable prices. Many other interesting items.—Sole Concessionaires for Great Britain and Ireland, Claude Lyons, Dept. "E.", 76, Oldhall Street, Liverpool. In London all lines on show by Hamleys, 200, Regent Street, W.1. In Scotland our distributors are W. J. Hannah and Co., 95, Waterloo Street, Glasgow, C.2. Large stocks; immediate despatches. Trade should write for best terms and territory still open. (2090)

**For Sale.—Contd.**

**SUPER HETERODYNES**, 7 valves. The last word in radio reception. Comprising the finest procurable transformers and units. Nothing better made. In solid polished oak cabinet 3in. high, 2ft. 4in. long. All enclosed batteries and accumulator; all station received as powerful and clearly as local station. Guaranteed for 12 months. £27 includes £5 17s. 6d. royalties, or with Burndepi Ethervox speaker, 7 Marconi matched valves, dull emitter, accumulator, and H. T. Batteries, £39 10s. Easy payments if desired. As under.

**TWO-VALVE SET** in beautiful solid mahogany cabinet with fall fronts, enclosing coils, batteries, and accumulator. Ready for use. Only best manufacture. Guaranteed for 12 months. Sterling Baby Speaker, 4-volt accumulator and H. T. Batteries. £14 14s. includes royalties. Easy payments. As under.

**THREE-VALVE** Portable Set, in best polished oak cabinets, attache case shape. Including royalties, Sterling Baby Speaker, Valves, Batteries, etc., £16 16s. Easy payments.

**MONEY** refunded if not perfectly satisfied. The above sets are of Grade "A." Grade "B" can be had at various prices.—A. J. Neill, Radio Engineer, Woodberry Grove, N. Finchley, N.12. (2144)

**BRAND** New 5-Valve Neutrodyne Set, complete with Valves, Batteries, Loudspeaker, etc., in handsome oak cabinet. Any station received. Genuine bargain.—Ayles, Bickerley, Ringwood. (2134)

**MARCONI** Ideal Transformer. 4-1, 21s. Polar R.C.C. Unit, 7s. 6d. Guaranteed new and perfect.—Box 8321, WIRELESS WORLD Office. (2166)

**CROIX** Transformers, 3-1 and 5-1, guaranteed genuine; 4s. each, post 4d.—Continental Supplies, 497, Old Ford Road, London, E. (2161)

**ANGLO-AMERICAN** SIX without valves, in cabinet, with batteries. £15 or offers. Liberty Supersonic Unit Eight, £3 10s.—Box 8256, WIRELESS WORLD Office. (2151)

**PETO-SCOTT** M.W., 8 valves, supersonic, complete with oscillator couplers for 250 to 2,000 metres, frame aerial (without valves or batteries). Perfect condition. £10 or offer.—Box 8264, WIRELESS WORLD Office. (2152)

**4-VALVE SET**, 250-3,000 metres, complete with switches, ammeter, milliammeter, arrester, 7 valves (3 power), 6 v.; 100 A.H. Accumulator H.T. Boxes and close-up teak case, £7. Owner going East. Appointment.—Campbell, 116, Westbourne Terrace, W.2. (2154)

**LARGE**, solid mahogany inlaid boxwood cabinet, built for super heterodyne, with voltmeter and jacks, made for all enclosed batteries, and frame aerial for same, £7. Super heterodyne kit, as new, £3 15s. 70-watt Marconi transmitting valve, hardly used, £2 10s. "Wireless Worlds" in excellent condition, from April 9th, 1924, to May 26th, 1926. Offers invited. American power valves with sockets. Few only left. 10s. 6d. each.—Hearn's, 58, High Street, Harlesden. (2157)

**COPPER** Sheet, 12 in. x 12 in., 16 gauge, Excellent earth plates, 4s. Exide Accumulators, 6 volts, 30 amps, new, uncharged. To clear, 35s., carriage paid.—Box 8316 WIRELESS WORLD Office. (2158)



**For Sale.—Contd.**

"SPECIAL FIVE" for Sale. Built exactly as designed by "Modern Wireless." Geophone Condensers.—Marconi Transformer. In polished mahogany case. All as new. Without valves or batteries, £11, carriage paid.

A.T.S.O. 4-valve Transatlantic—without valves or batteries, in polished mahogany case. £6, carriage paid.—Davies, Lyth Hill, Shrewsbury. (2153)

SALE.—2 60 volt H.T. Hart Accumulators, good condition, £1 each; 2 Simon's RB3 H.T. Batteries, 72 volts, each partly used, 7s. 6d. each; 2 DE5B, 2 DE5, 2 DE5A Valves, hardly used, 14s. each. Offers for "Wireless Worlds" No. 1 to July, 1915; also November, 1919, to December, 1925, inclusive. Good condition. Carriage extra.—6UC, 102, Hagley Road, Birmingham. (2150)

STERLING Squire Law Condensers, one .0005, two .00025, all with verniers. Two polar micrometer condensers. Lot cost £3 15s. 6d. Brand new. Accept £2.—Watson, 34, Grosvenor Road, Chiswick, W.4. (2160)

TWO Mullard c/50 Transmitting Valves, new and in perfect condition; £3 17s. 6d. each.—BM/ADHS, London, W.C.1. (2097)

ELECTRO-MAGNETIC Reproducer. Suitable for transmission of gramophone records or coupling gramophone to loud-speaker. 52s. 6d.—J. B. Woodroffe, 93, Harwood Road, S.W.6. (2162)

MICHAEL Super-Het. Kit, new, unused; £3 5s., or nearest offer. List £5 5s.—Box 8320, WIRELESS WORLD Office. (2163)

MARCONI PHONE V.3 (Three Valve), in closed mahogany cabinet; Range Blocks 300-2,000 metres, with valves only. Cost £30. Sell 15s.

FOUR-VALVE Receiver in mahogany cabinet, double doors, 200-4,000 metres; Set of Burndept Power Valves, Six Volt Accumulator, H. T. Battery, and Mellox Loud-speaker. £20. Both sets in new condition and perfect.—Fitch, London Road, Marks Tey. (2164)

AMATEUR, desirous disposing accumulation receiving sets by Marconi, Burndept and Sterling, also wavemeters, loud-speakers, Morse inker, relay and large variety condensers, coils, valves, and other component parts, wishes to hear of someone who, after inspection in South-East district London, is prepared to make offer for the lot.—Box 8322, WIRELESS WORLD Office. (2165)

2-VALVE Set, DES and DE5 valves, Marconi Transformer, Kom Loud-speaker, 6 volt, 6 amp. Accumulator, H.T. Battery Eliminator, read to use. £10. Also DE5A Valve, £1; moving Coil Voltmeter, 0-120, 15s.; Set Haynes Griffin Super Hetrodyne Transformers, £2. Sundry coils, switches, etc. Lot as above £12 10s.—H. Spriggs, c/o Roselyon, Mount Park, Harrow. (2167)

CRYPTO 600 volt, 100 milli.-amp; H.T. Generator. £10 or offer.—Box 8330, WIRELESS WORLD Office. (2168)

2-VALVE Receiver (Detector and 2 Res-cap. L.F. Amplifiers), complete with all accessories, including "Amplion" Loud-Speaker and Marconi DE5 Valves. Practically new. £12.—Fellows, 78, South Street, London, S.E.10. (2171)

BROWN'S CRYSTAVOX and Battery, new December, hardly used, perfect. Four guineas.—Upton, 40, Shaftesbury Road, Richmond, Surrey. (2174)

**For Sale.—Contd.**

MICROPHONE Amplifier (Brown), 2,000 ohms. input, 2,000 ohms. output. Nearly new, perfect condition. £2 10s. or offer.—Marston, 240, Cherrywood Road, Bordesley Green, Birmingham. (2173)

MELLOVOX Loud-Speaker, new, 35s. Ultra Loud-Speaker, 15s. Also various accessories. Details stamp.—6, Hauberik Road, Clapham Common, S.W.11. (2175)

8-VALVE SUPER, complete valves, batteries, frame aerial, loud-speaker, etc., as new; accept £25 or near offer.—110, High Road, Tottenham. (2177)

8 GRANIC Coils, Nos. 25 to 250. New condition. 25s.—S. 1, Bourne Road, Crouch End, N.8. (2178)

WIRELESS VALVES in first-class quality, will be supplied for prices interesting to all modern wireless businessmen by Oosterhuis Brothers, Arnhem (Holland). (2180)

**MISCELLANEOUS.**

A WIRELESS Doctor.—If your set is giving trouble or you want advice a competent expert will call (London and Home Counties) and put you right. No result, no charge.—Alexander Black, 2A, Woodville Grove, N.10. Clissold 3087. (2002)

CHARGE Your Own Accumulator.—Send 3d. stamp to-day for lists of our small gas and petrol engines and dynamos, and complete charging sets, from 20 to 100 watts.—Tom Senior, Checkheaton, Yorks. (0013)

**PATENT AGENTS.**

W. BRYSON, B.Sc., Chartered Patent Agent, 29, Southampton Buildings, W.C.2. Phone: Holborn 672. (2052)

PATENTS and Trade Marks Obtained.—T. H. T. P. Gee, Patent Agent, Member R.S.G.B., A.M.I.R.E., 51-52, Chancery Lane, London, W.C.2. Phone: Holborn 1525. (0001)

**REPAIRS.**

TRANSFORMERS rewound to guaranteed efficiency for 12 months, 4s., or exchanged for another, any ratio, 5s.; iron core wire-wound chokes for L.F. amplifiers, 6s. Transform.—115 Links Road, Tooting. (0011)

HEADPHONE REPAIRS.—2s. 6d. per ear-piece. Send your burnt-out headphones to the address below. They will be carefully repaired by an expert and returned within two days. Detach damaged earpiece from bands and send with p.o. to: Radioe, 24, Nottingham Road, Isleworth, Middlesex. (2176)

**EXCHANGE.**

WE Exchange Sets, Cash or Terms.—Express Radio Service, Factory Square, Streatham (2143)

**WANTED.**

WANTED.—160 Volts of H.T., 3 amp. Hr. Accumulators, 60 volt units, good condition, reasonably cheap. 6 Volt 80 amp. Hr. Actual Accumulator.—J. Walsh, 55, Mona Street, Halliwell, Bolton. (2156)

WANTED.—A Copy of "Wireless World," July 1st, 1925.—R. J. Osborn, Tower Street, Brightlingsea. (2155)

WANTED.—Magnavox Senior. State condition and price.—Box 8320, WIRELESS WORLD Office, (2169)

**SITUATION WANTED.**

EXPERIENCED designer-Constructor (34). E seeks situation with sound firm, commercial receivers a speciality.—Box 8328, WIRELESS WORLD Office. (2170)

**BUSINESSES & PROPERTY FOR SALE, TO BE LET, OR WANTED.**

WIRELESS, Etc.—Ex.-Pos. D.F. Shop, good accommodation. Turnover £4,000 p.a. Profits £1,000 p.a. Price £1,600 a.a.—John Davey & Co., Old Charlton, S.E.7. (2172)

**AUCTION SALES.**

IMPORTANT TWO DAYS' SALE BY AUCTION. WITHOUT RESERVE.

Removed for convenience of Sale to 550-550, OXFORD STREET, MARBLE ARCH. TUESDAY, June 29th, and following day, commencing at 11.30 prompt.

HENRY J. SHAW,

in conjunction with Messrs. Seymour, Seymour & Co., is instructed to Sell as above the whole of the Stock of a Wireless Goods Factor.

Electrical Goods, Instruments of all kinds, the whole of the plant of a cabinetmaker, machinery and stock; also Cricket Bats, Tennis Rackets, etc., all in convenient lots. On View day previous and mornings of sale. Catalogues from Henry J. Shaw, 85, Newington Causeway, S.E.1.

Chosen for the "Elstree Six"

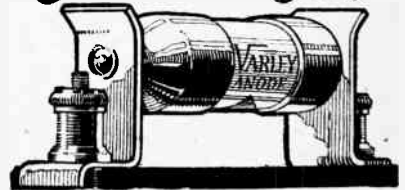

**The Varley Constant Wire Wound Anode Resistance.**  
Every wireless enthusiast to-day is talking about the Varley Anode Resistance—the Resistance chosen for the "ELSTREE SIX". Non-inductively wire wound on the famous Varley Bi-Duplex system, with turns silk separated, this perfectly designed and constructed component ensures a wonderful purity of tone, and is absolutely unaffected by atmospheric conditions. This is only the beginning—Varley Anode Resistances will be used in all sets in the near future—their success is already assured.

Complete with Clips and base . . . . . 7/6  
Without Clips and base . . . . . 6/-  
60,000, 80,000 and 100,000 ohms.

Write for Leaflet.



Constant always

THE VARLEY MAGNET Co., WOOLWICH, S.E.18  
(Proprietors: Oliver Pell Control, Ltd.; Phone: Woolwich 9888.)

**—WIRING—**

Save time and trouble by using "The Grip" Connectors. No nuts, washers, tags, loops or solder required. Perfect contact guaranteed. Sample, post free, 41d.

TELEKTRON CO.,  
14, LACY ROAD, LONDON, S.W.15.

# The Wireless World

AND RADIO REVIEW

## INDEX TO ADVERTISEMENTS.

	PAGE
Accumulators Elite ... ..	Cover ii
Autoveyors, Ltd. ... ..	4
Bretwood, Ltd. ... ..	4
Britannia Rubber & Kamptulicon Co., Ltd. ... ..	Cover iii
British Ebonite Co., Ltd. ... ..	9
Bulgin, A. E. & Co. ... ..	9
Burndept Wireless, Ltd. ... ..	9
Caxton Wood Turnery Co. ... ..	Cover iii
Charlesworth, W. J. ... ..	9
Cleartron Radio, Ltd. ... ..	6
Cossor, A.C. Ltd. ... ..	3
Darimont Electric Batteries, Ltd. ... ..	7
Dubilier Condenser Co., 1925, Ltd. ... ..	7
Edison Swan Electric Co., Ltd. ... ..	12
Electradix Radios ... ..	12

	PAGE
Ericsson Telephones, Ltd. ... ..	12
Ferranti, Ltd. ... ..	12
Finston Manf. Co., Ltd. ... ..	12
Graham, Alfred, & Co. ... ..	12
Hamley Bros., Ltd. ... ..	12
Hildick & Hildick ... ..	12
Igranite Electric Co., Ltd. ... ..	5
Jones & Stewart ... ..	Cover iii
Lisenin Wireless Co. ... ..	12
London Elec. Wire Co. & Smiths, Ltd. ... ..	Cover iii
Lustrulox, Ltd. ... ..	12
Marconiophone Co., Ltd., The ... ..	1
Maxed Electrical Co. ... ..	9
McMichael, L. Ltd. ... ..	Cover iv
Metro-Tick Supplies, Ltd. ... ..	9
"Ormond" Engineering Co., Ltd. ... ..	2

	PAGE
Radio Devices Co. ... ..	Cover ii
Radio Instruments, Ltd. ... ..	6
Radios, Ltd. ... ..	12
Reetrlory, Ltd. ... ..	5
Rothermel Radio Corps. of Gt. Britain, Ltd. ... ..	4
Sankey, Joseph, & Son, Ltd. ... ..	4
Sifam Electrical Inst. Co. ... ..	12
Taylor, J. H., & Co. ... ..	12
Telegraph Condenser Co., Ltd. ... ..	11
Telephon Co. ... ..	Cover iii
Telephone Manf. Co., Ltd. ... ..	12
Valce, Ltd. ... ..	13
Varley Magnet Co. ... ..	11
Watmel Wireless Co., Ltd., The ... ..	11
Wireless Apparatus, Ltd. ... ..	Cover iii
World Radio ... ..	7

reproduction  
—volume  
—clarity

You get all these in Ericsson Super Tone Loudspeakers.

Made by a firm with a generation's experience in telephone research. No distortion. No rattle—just crystal-clear reproduction.

Put one to follow your jet power valve and you'll be amazed.

18" high on wood base. Very mellow and pure. 2400 ohms, 63/- Junior Super Tone for small rooms, 92/6.

Write for lists.

**ERICSSON TELEPHONES LIMITED.**  
87/79, Kingsway, London W.C.2.

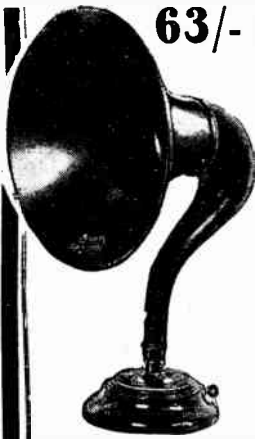

**Ericsson**  
SUPERTONE LOUDSPEAKERS

### All Post Free At Callers Prices

<b>S.O.S. BATTERY TESTER</b> 3-Read Type	<b>Wireless Cabinets.</b> For Panels 7" high, Width 8", Hinged Lid Only 3/6 15" - 18", 16", 18" Mahogany 1/- extra	<b>RELIABILITY CONDENSERS.</b> Mansbridge type. 20 mfd. 1/8 5 mfd. 1/9 1 mfd. 2/6 2 mfd. 3/6
<b>Square Law Var. Condenser.</b> With Knob and Dial 001 Panel type 6/6 0005 " 5/- 0003 " 4/6 Vernier Blade extra 1/4 Dubilier, McMichels, Edison-Bell, Lisenin, Mullard, Watmel, Igranite-Freshman. (usual prices).	<b>British Wires.</b> avg. dec. 18 22 26 24 28 30 32 36 40	<b>Ebonite Panels.</b> Matt. 1" 3/10 9" x 6" 2 1/2 1/10 12" x 9" 4/6 3/9 12" x 12" 5/9 5/- 15" x 9" 5/6 4/9 15" x 12" 7/6 5/8 4" x 4" 8d. 6d. 5" x 5" 1/6 1/2 6" x 6" 1" 10d. Any size cut. See in " " " " 1d.
<b>Coil Holders 2-wav.</b> Lotus 7/-; L & P 8/6 Yesley 7/-; Vernier 3/6 Geared 3/6; Polar 8/- Newey 6/6; Quality 3/6 Magnon 9/6; A1 1/6 Goldtone 6/-; A2 1/6 Cam-Vernier 3/6; A3 2/- Woodall 10/6; A4 2/- Burndept 15/-; A5 2/6	<b>Transformers L.F.</b> Radio Inst. 25/-; 27/6 Igranite 21/-; anti 20/- Eureka, No. 2 21/- " Concertina 25/- Baby Grand 15/6 Ferranti A.F.4 17/6 " A.F.3 25/- H.T.C. (Empire) 7/6 Formo Shred 10/- McMichael H.F. 10/- " Dimie' Coil 10/-	<b>Special value.</b> Wates Microstats 2/6 R.I. Detector 8/- Liberty Detector 3/6 Lisenola Unit 13/6 Coil Former 46 Pin Type 1/3 H.T. Batteries With Wander Plus 90v. 11/-, 60v. 7/8 30v. 4/6, 15v. 1/10 41 v. F.L. Battery 4d. 60v. Ferr'dy 12/6 36v. 7/-, 16v. 3/6 Siemens same price Lisen 6v. 11/6
<b>RELIABILITY WIRELESS GUIDE, No. 2.</b> Free on request.	<b>Valve Holders.</b> Type A 6d. Polar 1/3 Screwed 8 nuts 6d Ebonite " 10d. Antiphonic " 1/6 Resonant Type 6d. Mullivan 1/30-ohm Phones, ex-Govt. 4/6	<b>Orders 5/- value carriage paid.</b> Under 5/- per 1/- for packing.

# LISENIN

## POSITIVE GRIP PLUGS & SOCKETS

Pat. No. 245586.



THERE can be few amateurs who have not been troubled with broken leads, or said hard things about faulty connections. Of the whole set there is probably no part which is so often abused as the connections. "Lisenin" Positive Grip Plugs & Sockets solve this evil. They are designed to take the smallest flex up to 5 m/m cable. Sleeves and indication discs red and black. N. Plated.

**PRICE 6D.**

Plug and socket complete, or Spade End Terminal. Obtainable of all dealers. Liberal Trade Discount.

Sole Manufacturers and Patented:  
**THE LISENIN WIRELESS CO.,**  
14, Edgware Road, London, W.2.  
Phone: Iaddington 2734.  
Tel. Address: "Posgrip, Padd., London."

Plug and Socket or Spade End, 6d. each.

# FINSTON SUPER COILS

Totally enclosed in moulded Bakelite cases giving mechanical strength without impairing their efficiency. The centres of coils are always in alignment when two or more are used, thereby getting maximum results from their magnetic field. All connections are soldered. A loose plug is provided enabling winding of coils to be reversed.

PRICES: 25, 35, 40; 2/6 each. 60, 60; 3/- each. 75, 100, 150, 3/6 each. 175, 200; 4/- each. 250, 300; 4/6 each.

**FINSTON MFG. CO., LTD.,**  
45, Horseferry Road, Westminster, London, S.W.1.

## J.H. TAYLOR & CO.

2, RADIO HOUSE, MACAULAY ST., HUDDERSFIELD

Mark of Reliability

## Valves Repaired

AS GOOD AS NEW!!

**HALF PRICE**

(Except Weco, S.P.'s and low capacity types). Minimum D.E. current 0.15 amps when repaired. All Bright & Dull Emitters listed at less than 10/-, minimum charge 5/-.

**VALCO LTD.,** Dept. W.W., Tabor Grove, Wimbledon, S.W.18

# 600 WE BELIEVE THAT OUR SUMMER CATALOGUE

gives you a greater selection of Radio Bargains and Precision Instruments than any other catalogue obtainable. It contains nearly 600 illustrations and a wonderful selection of reasonably priced apparatus.

For 4d. stamps we will send you a copy by return of post.

## ELECTRADIX RADIOS,

218, Upper Thames St., London, E.C.4

Parre Ad.

# LUSTROLOX

## WIRELESS VALVES.

### THE ECONOMICAL COMBINATION

2v. '06 H.F. & L.F. 9/- 2v. '34 P.V. 11/-  
Obtainable from Leet's Ltd., Liverpool and Manchester, and LUSTROLOX LTD., West Bollington, Near Macclesfield.

## WIRELESS MASTS.

### GALVANIZED TUBULAR TELESCOPIC.

Complete with base plate, ground pegs, stay wires, straining screws, pulley and cleat.

34ft. High £3 15 0 50ft. High £7 5 0

**HILDICK & HILDICK,** Pleck Road, Walsall.

# '06 DE'S 10/6

Our Valves are admitted to be the best British made valves on the market. 3 Volt '06 L.F. or H.F. only 10/6. 2 Volt '34 only 10/6. Power Valves from 12/6. Write at once for our FREE BOOK and get full particulars. If your dealer is "stied" we supply direct. **RADION LTD.** Radion Works, BOLLINGTON, Macclesfield, England

**RADION** Reliable Valves

**BRITKAM-EBONITE**  
 THE FINEST EBONITE.  
**PANELS** — MATT or POLISHED SURFACE.  
**SHEETS, RODS and TUBES.**  
 Large Stocks available.  
*Awarded Silver Medal for Ebonite  
 Crystal Palace Electrical Exhibition. 1892.*  
**BRITANNIA RUBBER & KAMPTULICON Co., Ltd.**  
 7, Newgate Street, London, E.C.1.  
 Telephone: Central 2168 (2 lines). Telegrams: Britannia, London.

*Don't forget to use*  
**GLAZITE**  
**BRITISH MADE** REGD  
**COLOURED CONNECTING WIRE**  
 [RED · YELLOW · BLUE · BLACK · WHITE and GREEN]  
*Write for descriptive leaflet to*  
**The LONDON ELECTRIC WIRE CO & SMITHS LTD**  
 Playhouse Yard, Golden Lane, London, E.C.1.  
*Makers of Electric Wire*  *for over 40 years*

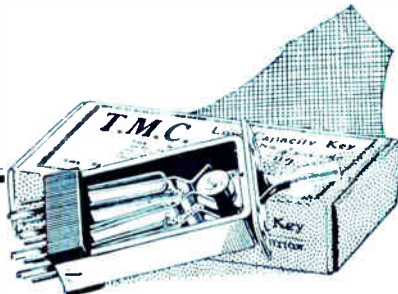

**TMC** SOLVE THE SWITCHING PROBLEM  
 Low Capacity Keys.

DESIGNED by radio engineers, the adaptability of the T.M.C. Low Capacity Key to varied switching requirements is simple. They combine a positive locking action with rapid make and break of unvarying performance. They are of strong and accurate construction, the live parts of the key being insulated from the frame, while the gold-silver contacts will not oxidise. Escutcheon plates and levers are polished and lacquered brass or bright nickel and give a neat and pleasing appearance.

Made in 3 Models.  
 No. 1. 12 point, 3 position, 7/-  
 No. 2. 6 point, 2 position, 6/-  
 No. 3. 24 point, 3 position, 15/6

Send for copy of the T.M.C. Catalogue—free. If your dealer does not stock T.M.C. goods, we will supply you direct at above prices, post free.

**Telephone Manufacturing Co. Ltd.**  
 HOLLINGSWORTH WORKS, WEST DULWICH, S.E. 21  
 Phone: Sydenham 2460/1. Telegrams: "Bubastis, Dulcros, London."

**Special Wireless Cabinets**  
*to Customer's orders*

*Cabinets that at any time are illustrated or described by the Editor of this Journal we can make to order. Ask for prices. Delivered free anywhere in the United Kingdom.*

*Hundreds of readers of this Journal have expressed their satisfaction with workmanship and price of our cabinets*

*Specialist makers of Wireless Cabinets  
 Caxton Wood Turnery Co.  
 Market Harborough*



**PERFEX AERIALS**  
 Patented in Great Britain and abroad.  
**INCREASE SELECTIVITY, VOLUME, AND RANGE OF RECEPTION AND REDUCE INTERFERENCE AND ENABLE MAXIMUM AERIAL EFFICIENCY TO BE OBTAINED AT ANY LOCATION.**  
**ASK THOSE WHO USE THEM.**

30 inch 75/-; 20 inch 58/6, complete with download.  
 Masts—16 ft. 20/-; 22 ft. 30/-, Brackets 25/- pair.

Obtainable from all branches of the General Electric Co., Ltd., the Marconiphone Co., Ltd., and all good Wireless Manufacturers and Dealers.  
**WIRELESS APPARATUS LTD.,** 35, Panton Street, Haymarket, London, S.W.1

TRADE ENQUIRIES INVITED.



THE 'DYNIC' D.C. REGULATOR  
 for using current from D.C. mains

**DOES AWAY WITH THE NECESSITY FOR HT BATTERIES**

Single tapping models, price .. ..	£2. 7. 6
5 " " " from .. ..	£3. 0. 0
10 " " " " .. ..	£3. 10. 0
Super Heterodyne " " .. ..	£5. 15. 0
Special Model for Marconi- phone Straight Eight, price .. ..	£6. 10. 0

(Postage 1/-)  
 Inestimable running costs.  
**JONES & STEWART,**  
 247a, St. Vincent Street, GLASGOW, CO.  
 Phone: Cent. 4892. Telegrams: "Galgeta."



*Modernise & Beautify your Receiver*

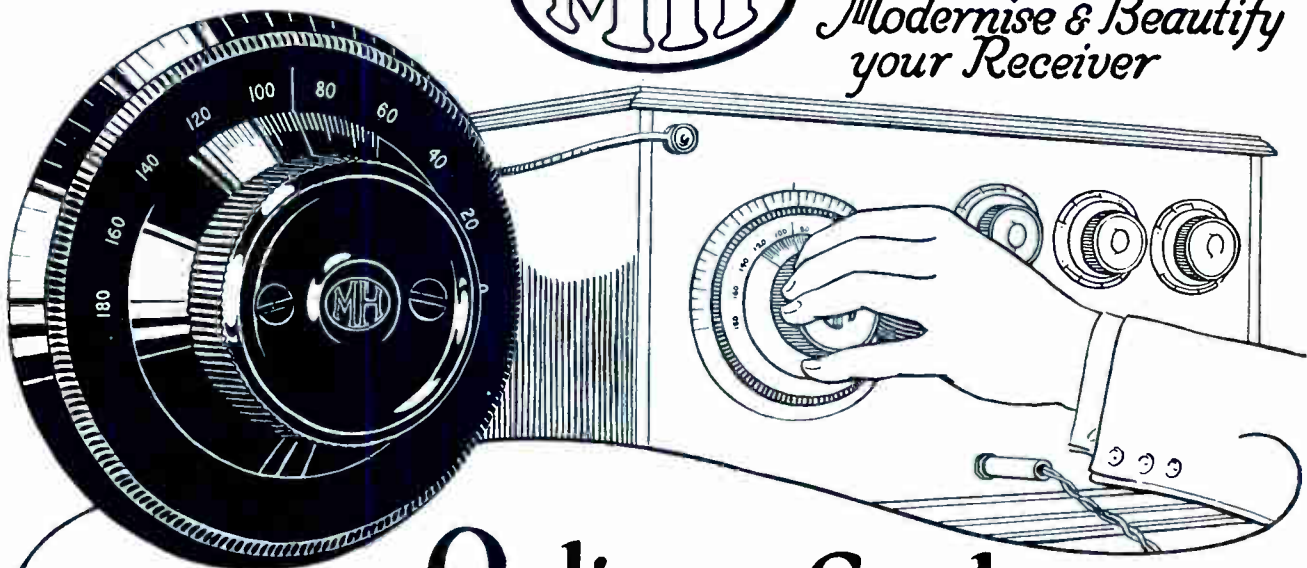

# Ordinary Condensers become *Vernier* Condensers!

Have you ever asked yourself why you find it difficult to receive distant Broadcasting? If the receiver is in working order, then only your tuning can be at fault. The

## MH VERNIER DIAL

gives just that fine control so necessary for the tuning in of weak signals. The patent movement gives a total absence of that annoying grating usually associated with geared dials, and, at the same time, allows the condenser to be coarsely adjusted as with a plain dial,—an advantage that will be readily appreciated. The short wave enthusiast will find, either for Morse or American broadcasting, the MH Dial will give him that fine control which makes the difference between success and failure.

PRICE 5/6 Each.

**L.M<sup>c</sup>MICHAEL LTD**  
Manufacturers of Wireless and Scientific Apparatus  
WEXHAM ROAD, SLOUGH, BUCKS.

Telephone:  
Slough 441-442.

Telegrams:  
Radiether, Slough.

**CONSIDER THESE Advantages**

1. Total absence of backlash.
2. Smooth adjustment of capacity over the whole range of Condenser.
3. The two collets supplied to fit standard spindle can be exchanged on request, to fit oversize spindles.

*Ask your dealer for MH Components*

**THEY GIVE CONSTANT GOOD SERVICE**



Printed for the Publishers, BLIFFE & SONS LTD., Dorset House, Tudor Street, London, E.C.4, by The Cornwall Press Ltd., Paris Garden, Stamford Street, London, S.E.1.

Colonial and Foreign Agents:

UNITED STATES—The International News Co., 83-85, Duane Street, New York. FRANCE—W. H. Smith & Son, 248, Rue Rivoli, Paris; Hachette et Cie, Rue Réaumur, Paris.  
 BELGIUM—W. H. Smith & Son, 78, Marche aux Herbes, Brussels. INDIA—A. H. Wheeler & Co., Bombay, Allahabad and Calcutta. SOUTH AFRICA—Central News Agency, Ltd., Johannesburg.  
 AUSTRALIA—Gordon & Gotch, Ltd., Melbourne (Victoria), Sydney (N.S.W.), Brisbane (Queensland), Adelaide (S.A.), Perth (W.A.) and Launceston (Tasmania).  
 CANADA—The American News Co., Ltd., Toronto, Winnipeg, Vancouver, Montreal, Ottawa, St. John, Halifax, Hamilton; Gordon & Gotch, Ltd., Toronto; Imperial News Co., Toronto, Montreal, Winnipeg, Vancouver, Victoria. NEW ZEALAND—Gordon & Gotch Ltd., Wellington, Auckland, Christchurch and Dunedin.

4<sup>D</sup>

# The Wireless World

RADIO REVIEW

*The Paper for Every Wireless Amateur*

Wednesday, June 30th, 1926.

## "No Battery"

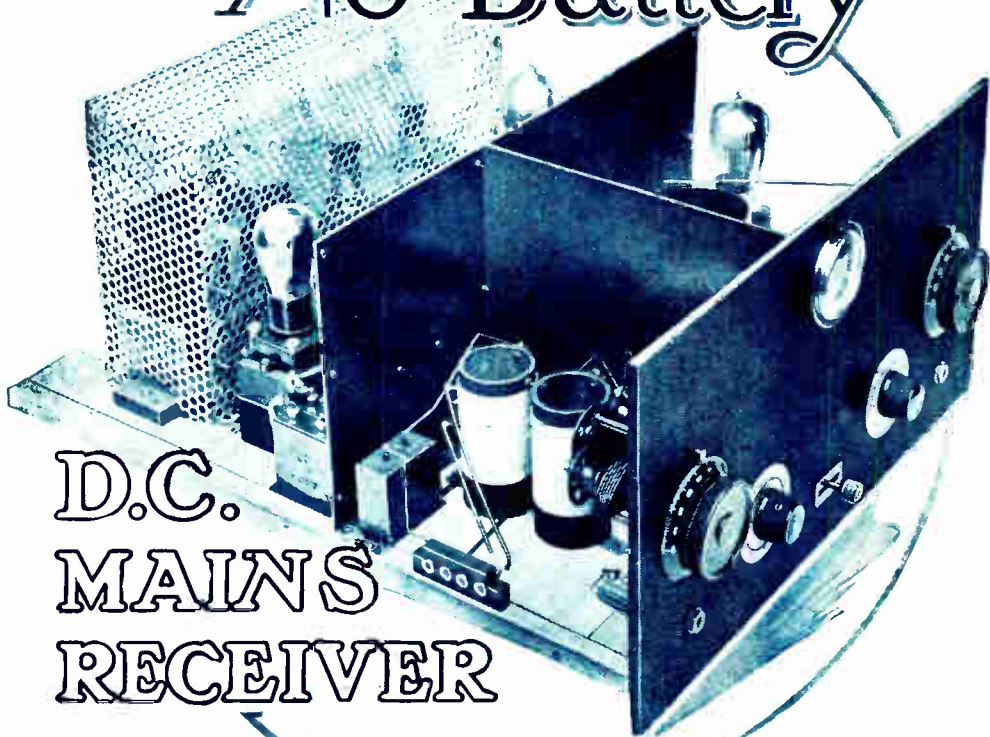

### D.C. MAINS RECEIVER

# 100% Value

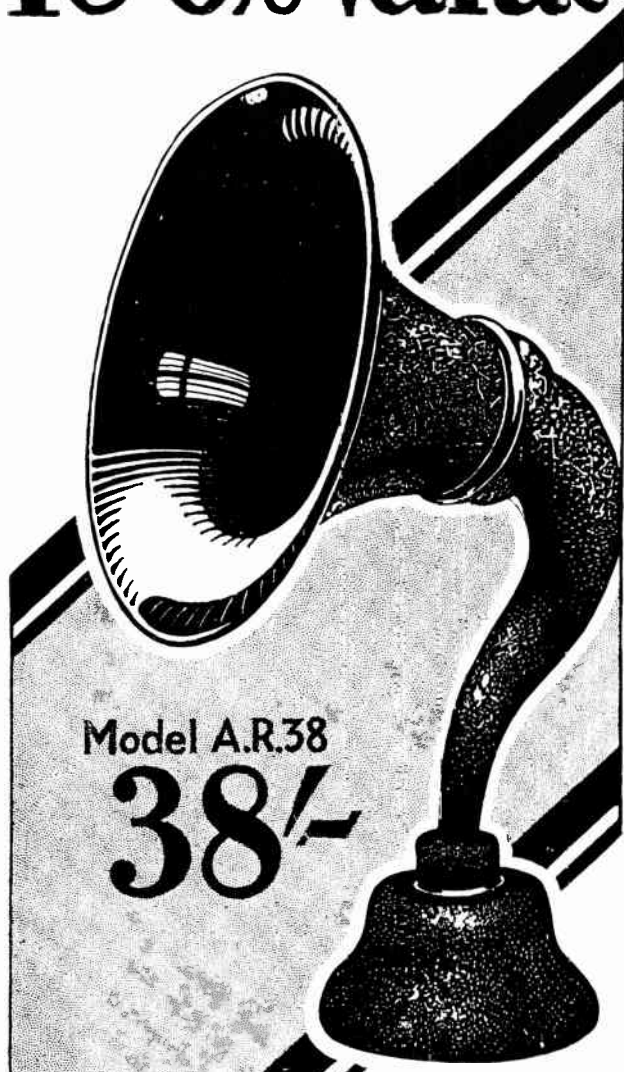

Model A.R.38  
**38/-**

A junior loud speaker with a senior performance



Obtainable from all AMPLION STOCKISTS, Radio Dealers or Stores.  
Write for latest illustrated list.

# AMPLION

Advertisement of Alfred Graham & Co., Crofton Park, S.E.s.

## HOME ACCUMULATOR CHARGING

NO TECHNICAL KNOWLEDGE OR ATTENTION REQUIRED.  
CLEAN, ECONOMICAL AND CONVENIENT!

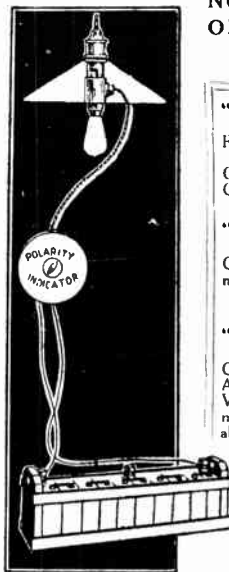

### "INDISPENSO" CHARGING SET.

(Direct Current, as illustrated.)  
For High Tension Accumulators. Plug-in to any convenient lampholder. Costs nothing for charging if light is in use. Complete with cords and Polarity indicator and full instructions. PRICE 6/-

### "ALTERNO" CHARGING SET.

(Alternating Current.)  
Charges your High Tension Accumulator at negligible cost. Plug-in to any convenient lampholder. Complete with instructions. PRICE 21/-

### "PENDELTON" CHARGER (Pat. App.)

(Alternating Current.)  
Charges your Low Tension 2, 4, or 6 volts Accumulator economically and effectively. No Valves or replacements. Simply connect to the most convenient lampholder; charging rate about 2 amp. PRICE £2 12s. 6d.

Send for Catalogue and full details.



...lower H.F. resistance than any other commercial plug in coil!

Made by the manufacturers of Glazite



TESTS carried out by the National Physical Laboratory show that the LEWCOS COIL has a lower H.F. Resistance than any other coil on the market. Its low H.F. resistance combined with great selectivity and mechanical strength make the LEWCOS Coil the finest you can buy.

your set—it makes all the difference! *Descriptive leaflet sent free on request to:*

THE LONDON ELECTRIC WIRE COMPANY & SMITHS LTD.  
Playhouse Yard, Golden Lane, London, E.C.1.

Try a LEWCOS Coil in

No.	25	35	40	50	60	75	100	150	200	250	300
Price	4/6	4/6	4/6	5/-	5/6	5/6	6/9	7/6	8/6	9/-	10/-

## LEWCOS Inductance COIL

# Do you know

that the factors controlling the volume of pure reproduction from your receiver are based on the design of the filaments of your valves —

## Everybody

who knows about valves will tell you that a filament that is up to 3 times greater in length and has an increased emission surface up to 5½ times that of the ordinary filament will mean a 33% increase in your results.

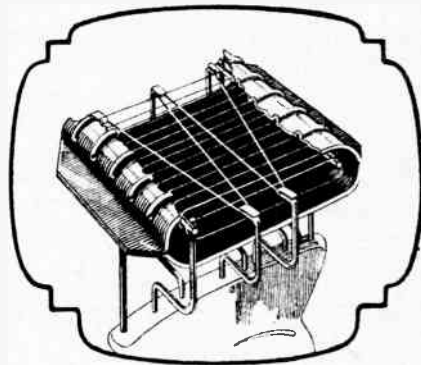

There is no mystery in the construction of a valve. Any anode and grid will operate with any filament but it is the filament that counts, and this is what you pay for.



## Now look at The Mullard P.M. Filament

Its increased length completely within the field of the anode and grid is obviously greater than that of any other valve on the market. It is supported by five strong but resilient hooks. It has a large core of a special ductile metal that prevents it from breaking except by the very roughest handling.

It consumes **ONLY ONE TENTH AMPERE** and is so economical that no sign of glow can be discerned. Will give you consistent powerful results during a long life.

For 4-volt accumulator or 3 dry cells	
THE P.M.3 (General Purpose)	0.1 amp. 16/6
THE P.M.4 (Power)	0.1 amp. 22/6
For 6-volt accumulator or 4 dry cells	
THE P.M.5 (General Purpose)	0.1 amp. 22/6
THE P.M.6 (Power)	0.1 amp. 22/6
For 2-volt accumulator	
THE P.M.1 (General Purpose)	0.1 amp. 15/6
THE P.M.2 (Power)	0.15 amp. 18/6

Ask Your Radio Dealer  
for the Valves with the P.M. Filament —

# Mullard

**THE MASTER VALVE**

ADVT. THE MULLARD WIRELESS SERVICE CO., LTD., NIGHTINGALE LANE, BALHAM, LONDON, S.W.12.

Advertisements for "The Wireless World" are only accepted from firms we believe to be thoroughly reliable.

Charge your  
Accumulator at  
Home for 1/2<sup>D</sup> per day  
with a  
**BURNDEPT  
BALKITE  
Trickle Charger**

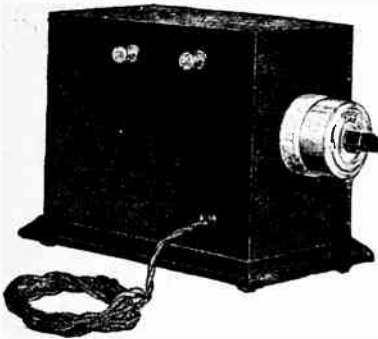

No Valves  
No Noise  
No  
Moving  
Parts  
No Trouble

**B**URNDEPT BALKITE TRICKLE CHARGER contains no valves and no mechanism, cannot make any noise and cannot go wrong. But it can keep your accumulator charged, and it does so at a cost of less than 1/2d. per day. It is small and compact and works while you sleep. Reckon up what it is at

present costing you to keep your batteries charged. Think of the trouble of handling them, then look at the price of this charger.

Price £2-18-0

**THE VALVE FOR  
BETTER MUSIC**

Type L, 253, 1/2 to 5 volts  
253 amps. Price 22/6

**ONE OF THE  
BURNDEPT  
SUPER VALVES**

**BURNDEPT**

**WIRELESS LIMITED**

**Blackheath, S.E.3.**

'Phone: Lee Green 2100. Telegrams: "Burncoil, Phone. London."

**AMPERITES  
for the ELSTREE SIX**

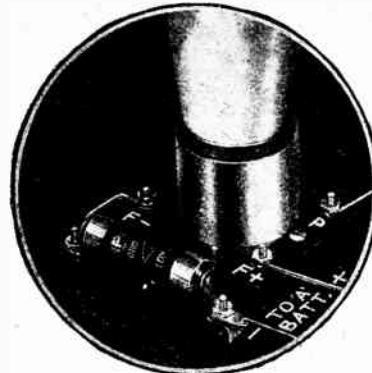

There are six Type 1A Amperites specified in the ELSTREE SIX RECEIVER because they eliminate hand rheostats, simplify wiring, and ensure perfect automatic filament control.

Type 1A. For 5 volt 25 valves on a 6 volt accumulator.  
Type IV-199. For 3 volt 296 valves on a 4 volt accumulator or 41 volt batteries.  
Type 6V-199. For 3 volt 296 valves on a 6 volt accumulator.

List Price 5/- each.

Write for Free "Hook-ups."

The Second Edition of our 1926 Radio Catalogue is now ready and will be sent on receipt of 2d. in stamps to cover cost of postage.

**ROTHERMEL** RADIO CORPORATION OF GREAT BRITAIN, Ltd.,  
24 and 26, Maddox St., Regent St., London, W.1.  
Telephone Nos.: Mayfair 578 and 579. Telegrams: Rothermel, Wesdo, London.

**A NEW  
BOWYER-LOWE  
PRODUCT, EMBODYING ALL  
BOWYER-LOWE REFINEMENTS  
AND CRAFTSMANSHIP  
JACKS**

The Design of Bowyer-Lowe Jacks was evolved to obviate faults usually apparent in Jacks adapted from telephone uses. The following details indicate the superiority of these Components:—

1. Girder frame, ensuring rigidity.
2. Hard phospt. or brnze springs (tinned).
3. Silver contacts accurately positioned.
4. Ebonite insulation.
5. No loose panel washers.
6. Wide fan-tail contacts.

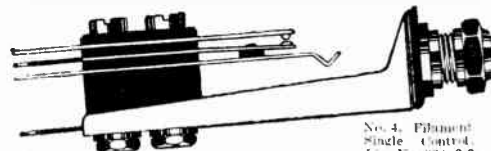

No. 4, Filament Single Control List No. 234, 2 9

**PRICES**

- |                                |              |     |
|--------------------------------|--------------|-----|
| No. 1. Single circuit open     | List No. 231 | 2/2 |
| No. 2. Single circuit closed   | List No. 232 | 2/7 |
| No. 3. Double circuit          | List No. 233 | 3/- |
| No. 4. Filament single control | List No. 234 | 2 9 |
| No. 5. Filament double control | List No. 235 | 3/3 |

**use  
BOWYER-LOWE**

**Tested Components  
They are Guaranteed**

Announcement by the Bowyer-Lowe Co., Ltd., Letchworth.



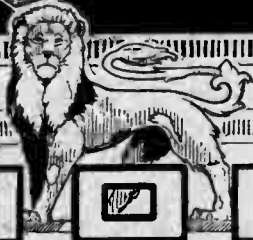
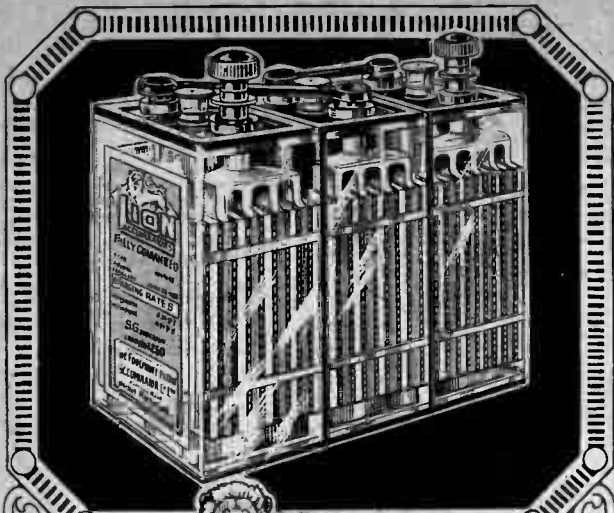

# LION ACCUMULATORS

The construction of **LION ACCUMULATORS** is such that they will give years of hard and continuous service. The many improvements embodied in their design renders them practically fool-proof. Every cell is a separate unit, the positive plates are of abnormal thickness, allowing a special construction of the grid which prevents shedding. These are a few of the outstanding features, our latest leaflet will give you all particulars of our complete range. Drop us a postcard and let us send you one along.

Such confidence have we in **LION ACCUMULATORS** that with every Battery we are giving a unique guarantee, never before has such a guarantee been given—Never before such a service as we are offering. Particulars of this guarantee are enclosed with each Battery and will appear in the next issue of this paper.

**Our prices range from 8/10d.**

With the **LION HIGH TENSION BATTERY** 2 to 60-volt can be obtained at will.

This Battery is mounted in a varnished and stained ashcrate. Fitted with drop handles.

**PRICE £3.2.6**

**THE FOOLPROVE PATENT  
ACCUMULATOR CO. LTD.**  
*Market Harborough, (ENGLAND)*

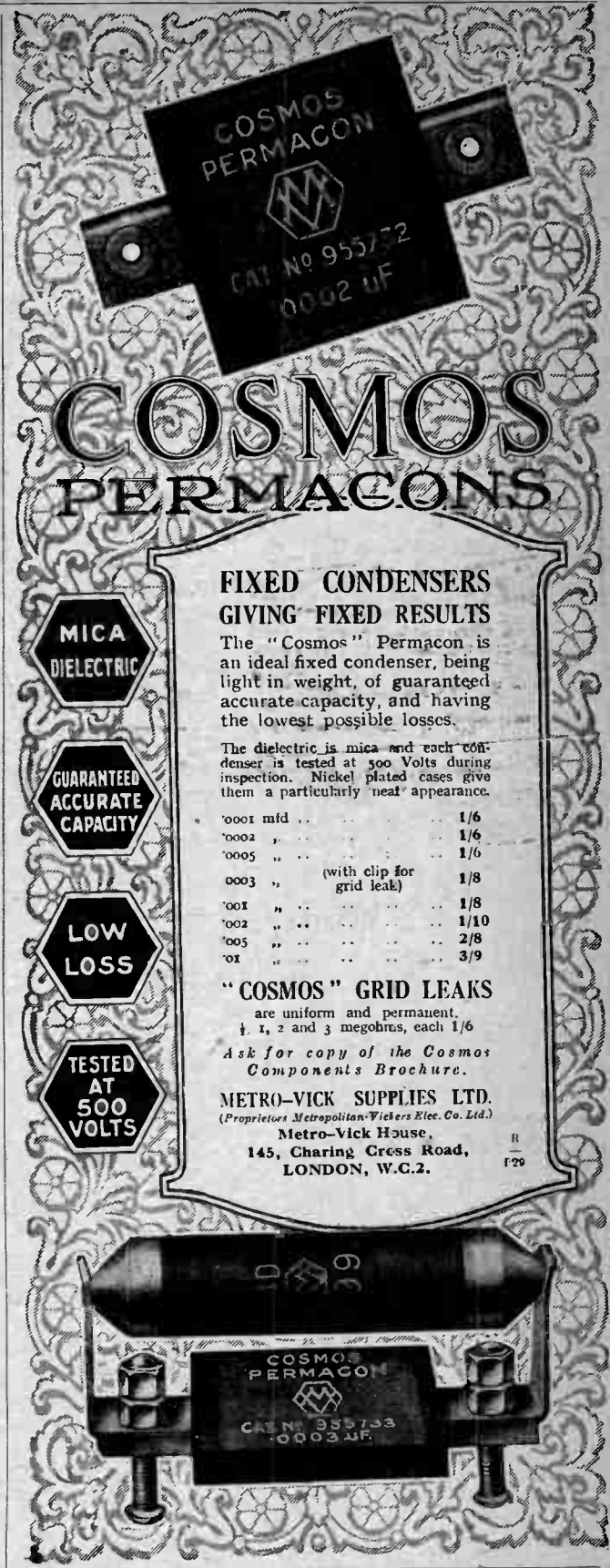

# COSMOS PERMACONS

## FIXED CONDENSERS GIVING FIXED RESULTS

The "Cosmos" Permacon is an ideal fixed condenser, being light in weight, of guaranteed accurate capacity, and having the lowest possible losses.

The dielectric is mica and each condenser is tested at 500 Volts during inspection. Nickel plated cases give them a particularly neat appearance.

'0001 mfd .. .. .	1/6
'0002 .. .. .	1/6
'0005 .. .. .	1/6
0003 .. .. .	1/8
	(with clip for grid leak)
'001 .. .. .	1/8
'002 .. .. .	1/10
'005 .. .. .	2/8
'01 .. .. .	3/9

**"COSMOS" GRID LEAKS**  
are uniform and permanent.  
1, 2 and 3 megohms, each 1/6

Ask for copy of the *Cosmos Components Brochure*.

**METRO-VICK SUPPLIES LTD.**  
*(Proprietors Metropolitan-Vickers Elec. Co. Ltd.)*  
Metro-Vick House,  
145, Charing Cross Road,  
LONDON, W.C.2.

- MICA DIELECTRIC
- GUARANTEED ACCURATE CAPACITY
- LOW LOSS
- TESTED AT 500 VOLTS



VISIT THE ROYAL AIR FORCE DISPLAY AT HENDON, 3rd JULY, 1926



**Two in One!**

Here's a splendid little component, the Watmel combined Grid Condenser and Fixed Grid Leak. Saves space, time and money. Built to allow the Grid Leak to be connected either across the condenser or direct to the filament of the detector valve.

Price **2/6** each.

*Send a postcard for full details of the various Watmel products.*

**The Watmel Wireless Co. Ltd.,**  
332a, Goswell Rd., London, E.C.1.  
*Representative for Lancashire & Cheshire:*  
Mr. J. B. LEVÉE, 23, Huttley Street,  
Levenshulme, Manchester.

For trouble-free condenser efficiency always specify the famous round Watmel fixed condenser.

Sizes up to '002  
Sizes '0025 to '004



**FORMO**  
ARTHUR PREL & CO LTD

**HIGH EFFICIENCY LOW LOSS VARIO COUPERS.**  
3 CIRCUIT 12/6  
200-600 METRES.

Send for New Catalogue OF COMPONENTS OF ADVANCED DESIGN.

**The FORMO COMPANY,**  
Crown Works, Cricklewood, N.W.2.

Phone: Hampstead 1787.  
Northern Representative:  
J. B. LEVÉE, 23, Huttley Street,  
Levenshulme, Manchester.  
Phone: Heaton Moor 478.



**SUCCESS**  
COMPONENTS

**SUPER AUDIO CHOKE**



PRICE **18/6**

**BEARD & FITCH LTD.**  
34, AYLESBURY STREET  
LONDON, E.C.1

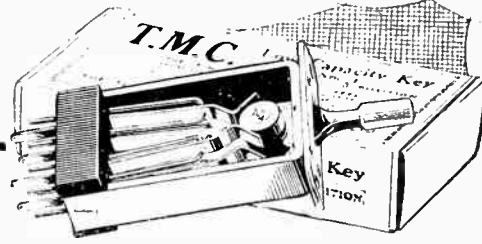

**T.M.C. SOLVE THE SWITCHING PROBLEM**

Low Capacity Keys.

DESIGNED by radio engineers, the adaptability of the T.M.C. Low Capacity Key to varied switching requirements is simple.

They combine a positive locking action with rapid make and break of unvarying performance. They are of strong and accurate construction, the live parts of the key being insulated from the frame, while the gold-silver contacts will not oxidise. Escutcheon plates and levers are polished and lacquered brass or bright nickel and give a neat and pleasing appearance.

Made in 3 Models and packed in black, red and yellow labelled cartons.

No. 1. 12 point, 3 position, 7/-  
No. 2. 6 point, 2 position, 6/-  
No. 3. 24 point, 3 position, 15/6

*Send for copy of the T.M.C. Catalogue—free. If your dealer does not stock T.M.C. goods we will supply you direct at above prices, post free.*

**Telephone Manufacturing Co. Ltd.**  
HOLLINGSWORTH WORKS, WEST DULWICH, S.E. 21  
Phone: Sydenham 2460/1. Telegrams: "Bubastis, Dulcrox, London."



**Athol**  
TRADE MARK

For any circuit, any set, anywhere

Bracket for back-of-panel mounting, 2d. each extra.

**VALVE HOLDER**

Gives perfect insulation, brass sockets almost entirely air-spaced, minimum capacity effects. One-hole fixing to base board, or above panel; easily mounted *below* the panel. Complete with soldering tags and fixing bolt.

**ATHOL ENGINEERING CO.,**  
Seymour Road, Crumpsall, MANCHESTER.

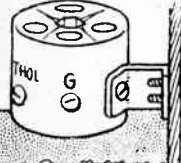

**MODERN** <sup>1/-</sup> MONTHLY  
**CONQUEST SCIENCE**

Incorporating  
A MAGAZINE OF PROGRESS, INVENTION AND DISCOVERY

"MODERN SCIENCE" is a monthly magazine which records recent advances and discoveries in all departments of science and industry; surveys technical and mechanical developments; and provides a forum for the interchange of information and views on all subjects coming within the scope of the journal.

SUBSCRIPTION: 14s. per annum, post free.  
From all newsagents and bookstalls or direct from the Publishers:  
LIFE & SONS LTD., Dorset House, Tudor St., London, E.C.4.

w.w.13

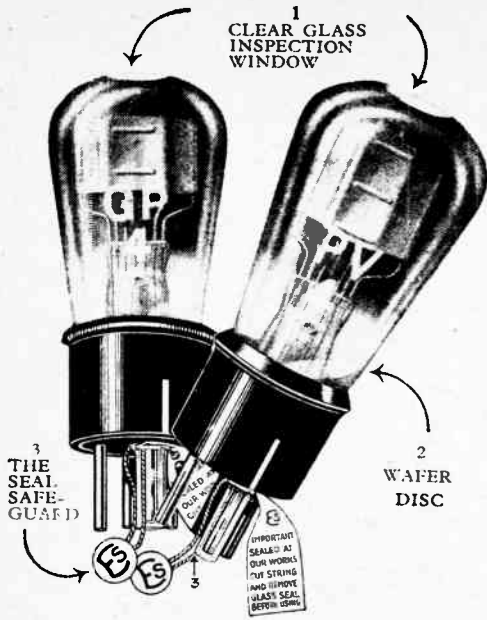

## TWO NEW VALVES

G.P. 4 GENERAL PURPOSE AND P.V. 4 POWER VALVES—  
for use with 4-volt accumulator  
(or three dry cells).

The salient features of these ideal companion DULL EMITTERS are, economy of consumption—a longer lasting accumulator charge and high efficiency—clearer, better reception—with louder volume.

You can identify G.P. 4 and P.V. 4 by:

- (1) The clear glass inspection "Window."
- (2) The Wafer Disc—a hallmark.
- (3) The Seal—ensuring the valve being unused after final test in the Ediswan laboratories.

### SPECIFICATIONS

EDISWAN G.P. 4	EDISWAN P.V. 4
Volts, 3.5-4	Volts, 3.5-4
Amps., .15	Amps., .35
Plate Voltage, 60-120	Plate Voltage, 60-120
Amplification Factor, 12	Amplification Factor, 6
Slope, .55 Ma/v	Slope, .65 Ma/v
Impedance, 22,000 Ohms	Impedance, 9,500 Ohms

G.P. 4.—General Purpose dull emitter. Low current consumption. Long Life. Powerful amplification. Elimination of objectionable microphonic effects.

P.V. 4.—Ideal power valve, companion to G.P. 4. When used for Loud Speaker work: powerful, distortionless amplification. No microphonic effects.

Price 16/6      Price 22/6

Obtain from your Dealer the Ediswan Folder—"2 New Valves"

# EDISWAN VALVES

Will improve any set

THE EDISON SWAN ELECTRIC CO. LTD

## The cheapest component in your set; yet the most vital of all—the Condenser

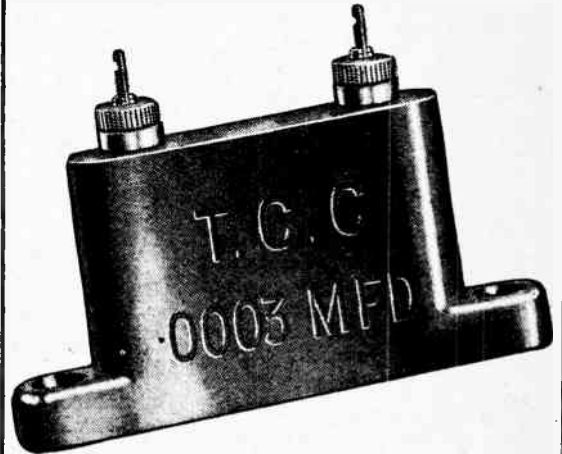

If your set is not giving the results you expect from it, scan mentally the components you have used. Have you, for instance, exercised the same discrimination in selecting your condenser as you have in the case of your transformer? For your fixed condenser—on which so much depends—is one of the least expensive of all the components you buy. The difference in cost between a genuine T.C.C. and an un-named condenser is very slight; with the latter you are taking a risk—with T.C.C. you obtain a permanent assurance against breakdown.

Choose the T.C.C. Mica Condenser shown above. It embodies all the well-known T.C.C. features, and owing to its convenient shape takes up very little room on the panel; because it is sealed from below instead of from above it is proof against the heat of the soldering iron. For those who do not wish to solder their con-

nections a convenient milled head is provided to ensure a perfect electrical contact. Finally, because every T.C.C. Condenser—whether Mica or Mansbridge—has to pass so many tests before it is released for issue, you know that its accuracy within a very small percentage of error is a foregone conclusion.

### Capacities :

There is a full range of T.C.C. Mica Condensers from .009 mfd to 2 mfd.

From all Wireless Shops

# T. C. C. CONDENSERS (Mica & Mansbridge)

Advertisement of Telegraph Condenser Co., Ltd., Water Farm Road, N. Acton, W.3

Gilbert A.I. 5391

N.V. 2

# Co-axial Mounting

The new Constructional System which ensures (a) longer life (b) lower running costs and (c) greater uniformity in results. Used for the first time in this wonderful new Cossor Dull Emitter.

FOUR years ago Cossor astonished the Radio world by evolving a method of valve construction which, for the first time, utilised almost the whole of the electron stream. Two years later this success was followed up by the introduction of a unique triple-coated filament which operated at a phenomenally low temperature.

And now Cossor—in introducing the new Cossor Point One—demonstrates that the same spirit of progress which has always dominated its activities is as vigorous as ever.

## Why valves vary in performance

It is well known that if a batch of valves were made up using identical filaments, grids and anodes without due regard being paid to the accurate spacing of the elements that every valve would vary considerably in results. There would be hardly two alike. Any variation of distance between filament and grid or between grid and anode exercises considerable influence upon performance. All elements must be mounted co-axially to obtain the best results and any method which *guarantees* this must result in an incomparably higher standard of efficiency.

In the new Cossor Point One there is at last available a patented system of mounting which infallibly aligns the filament, grid and anode from top to bottom.

## How Co-axial Mounting is achieved

Owing to the peculiar advantages possessed by the shape of the Cossor grid and anode it has been found possible to secure these

two elements together at the top by means of a seonite insulator. The grid itself ends in two prongs which are inserted into the base of the seonite insulator. The anode rests on a wide flange provided, and is welded at its base to two stout nickel supports. Even extreme force cannot disturb the exact relative positions of these two elements—once fixed in their places, to a hundredth part of an inch, they are there for all time.

## The new Shockproof Filament Suspension System

Through the centre of the seonite tube runs a fine wire which holds the filament in its

correct position. Unlike other valves the filament in the Cossor Point One is not held under tension. Its shockproof support provides exactly the degree of elasticity to enable it to absorb the sharp concussion caused by an accidental blow. A knock which would shatter the filament in an ordinary valve is rendered harmless by this amazingly efficient suspension.

## Greater uniformity and economy

Thus with the filament, grid and anode in permanent alignment it is reasonable to expect a greater uniformity in results. The supreme importance of this will be instantly appreciated by users of Neurodyne Receivers employing several stages of *matched* H.F. amplification.

But in addition this new valve is exceptionally economical. Its triple coated filament consumes only one-tenth of an ampere at 1.8 volts. A super-heterodyne using 7 of them would actually consume less current than a little one-valve set with a single bright emitter.

Bearing in mind, too, the fact that this filament operates at a glow which is practically invisible, it will be obvious that at last wireless enthusiasts have available a valve which must give an incredibly long and uniform service.

### Types and Prices

<b>Cossor Point One</b>		
RED TOP: For H.F. use 1.8 volts		
Consumption 1 amp.		15/6
<b>PLAIN TOP: For Detector 1.8 volts</b>		
Consumption 1 amp.		15/6
<b>Cossor Stentor Two</b>		
GREEN TOP: For power use 1.8		
volts Consumption 15 amp.		18/6

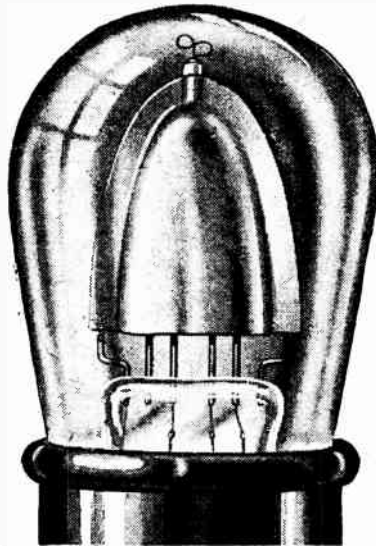

# The new COSSOR Point One

— the long-life Dull Emitter with the new 1 amp. filament

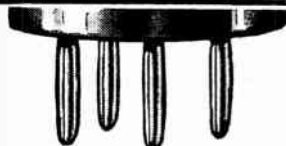

Gilbert Ad. 5,381.

# The Wireless World

AND  
RADIO REVIEW  
(14th Year of Publication)

No. 357.

WEDNESDAY, JUNE 30TH, 1926.

VOL. XVIII. No. 24.

Assistant Editor:  
F. H. HAYNES.

Editorial Offices: 139-40, FLEET STREET, LONDON, E.C.4  
Advertising and Publishing Offices: DORSET HOUSE, TUDOR STREET, LONDON, E.C.4.

COVENTRY: Hertford Street.  
Telegrams: "Cyclist Coventry."  
Telephone: 10 Coventry.

Subscription Rates: Home, £1 1s. 8d.; Canada, £1 1s. 8d.; other countries abroad, £1 3s. 10d. per annum.  
As many of the circuits and apparatus described in these pages are covered by patents, readers are advised, before making use of them, to satisfy themselves that they would not be infringing patents.

Editor:

HUGH S. POCOCK.

Telegrams: "Ethaworld, Fleet, London."

BIRMINGHAM: Guildhall Buildings, Navigation Street.

Telegrams: "Autopress, Birmingham."  
Telephone: 2970 and 2971 Midland.

Assistant Editor:  
W. JAMES.

Telephone: City 4011 (3 lines).  
Telephone: City 2847 (13 lines).

MANCHESTER: 199, Deansgate.  
Telegrams: "Hiffe, Manchester."  
Telephone: 6970 and 6971 City.

## ENGLAND v. AMERICA.

WHEN the manufacturer finds that times are dull he invariably criticises firstly the broadcasting service for lack of enterprise by way of introducing new features into the programmes, and secondly the technical experts for failing to create new developments. Placing the blame in this way is apt to have evil effects, not so much with the maligned parties, but on the trade itself, for the manufacturer stands by and waits. Meanwhile, the vast wireless-interested public looks on and waits, too, for the time when the wireless hobby spirit will be rekindled by the production of components of irresistible attractiveness.

Wireless component design is probably more ruled by passing fashion than any other pursuit. Wireless as a hobby lives on progress, whether real or only apparent, and the public is always clamouring for something new. It is this point which is appreciated in the United States and is the key to business success. Just as one is heartily tired of the ebonite end plate condenser, however technically perfect it may be, so are we to-day becoming weary of the majority of components of orthodox design.

Less than three years ago we looked upon amateur wireless development in the United States with something bordering on contempt. At that time their journals rarely showed any system of H.F. amplification, resistance L.F. coupling was little known, and the *sine qua non* of good reception was valve detection, with critical reaction control, followed by a multi-stage L.F. amplifier.

Things are very different now. The number of broadcasting stations in the United States in congested areas, coupled with the American temperament for big distance, has firmly established the superheterodyne receiver, which has probably been the starting-off point for the development to apparent ultra-efficiency of practically every wireless component.

American apparatus can be imported into this country almost free of duty, and the British manufacturer cannot afford to ignore the competitive situation which is likely to arise. A process of intensive research is required leading to attractive designs which, with the aid of determined financial backing, mass production methods of manufacture, and compelling advertising, will undoubtedly create a clamouring public.

An examination of many of the components on the market reveals that quite a lot of hand work and individual attention has been devoted in their making, whilst the class of apparatus one hopes to find should be built up from clean stampings, small turned parts, and smooth mouldings. Such minor details as colouring, proportioning of dimensions, lacquering, and even packing, coupled with essential electrical efficiency, are of vital importance.

points bearing on

The world's wireless market to-day is in the hands of British and American manufacturers, and we feel sure that the British manufacturer will not let the grass grow under his feet, and that the designs now being contemplated for production next autumn will bear in full the evidence of British supremacy.

## CONTENTS.

	PAGE
EDITORIAL VIEWS	865
WIRELESS BEARINGS FROM THE AIR	866
WORKING A SET FROM D.C. MAINS	869
By W. James.	
READERS' NOVELTIES	872
WIRELESS CIRCUITS IN THEORY AND PRACTICE	873
By S. O. Pearson.	
WIRELESS WITH THE NORTHERN AUSTRALIAN EXPEDITION	876
CURRENT TOPICS	877
"NO BATTERY" RECEIVER	879
By W. James.	
INVENTIONS OF WIRELESS INTEREST	888
PRACTICAL HINTS AND TIPS	889
PIONEERS OF WIRELESS	891
By Ellison Hawks.	
SOME NOTES ON HIGH OHMIC RESISTANCES	892
REVIEW OF APPARATUS	894
BROADCAST BREVITIES	895
LETTERS TO THE EDITOR	897
READERS' PROBLEMS	899



### Independent Direction-finding by the Pilot or Navigating Officer.

THE importance of the part which has been played by wireless in connection with the development of commercial flying is probably by no means fully appreciated by the majority of those who to-day take the efficiency of aircraft communication for granted. In the early days of wireless the telegraph and cable provided efficient means of communication between fixed points, and the special application of wireless for communicating between a fixed point and a moving station was immediately realised, so that it is not surprising to find that the first developments of wireless were along the lines of erecting fixed coast stations for the purpose of communi-

cating with ships at sea. In the case of communication with aeroplanes and airships, wireless is even more essential than it is in its application to ships.

#### Rapid Bearings Essential.

A ship at sea, by means of its compass and the accurate information as to all matters which concern the navigator, is in a very much more secure position than the aeroplane, which has not the time to calculate or consider its position from such guides as the stars, but is in need of immediate information, should there be any deviation from its course. Again, in bad weather a vessel at sea

can hold off from the coast and delay putting into port until weather conditions improve, but the aeroplane has not yet developed this advantage fully, and must therefore keep in touch with its aerodrome of destination, and be acquainted with the conditions under which it is to land, no matter how disadvantageous the weather may be. It can be said, without fear of contradiction, that without wireless our commercial air services could not have been developed to their present state of efficiency and security.

Many difficulties were encountered in the problem of equipping aeroplanes with wireless in the early days. The war, of course, stimulated invention and improvement to a large extent, but at the time when little had been done to reduce the noise

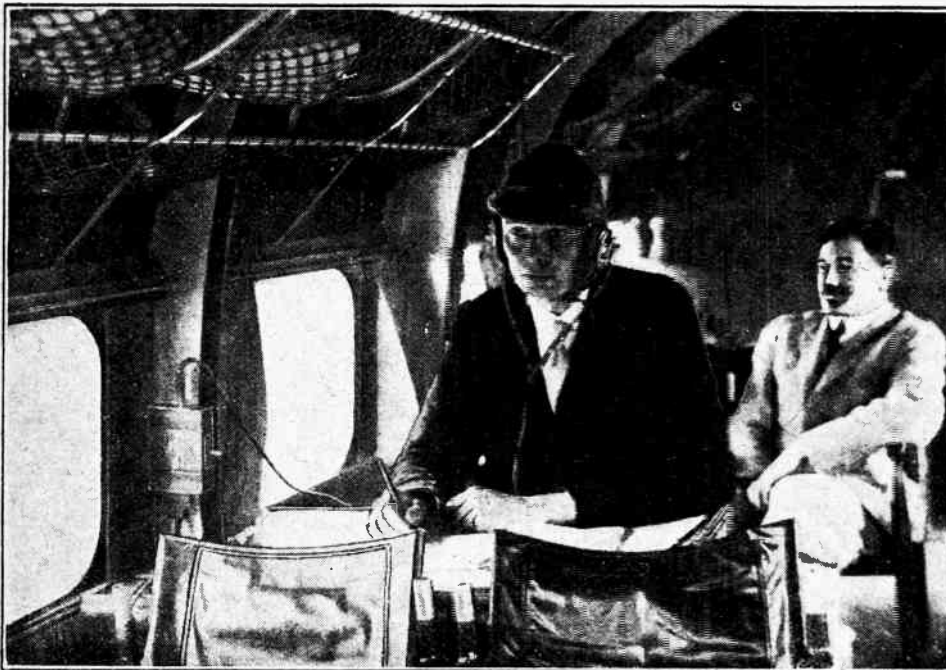

The navigator using the intercommunication unit to the pilot.

**Wireless Bearings from the Air.—**

and vibration of the aeroplane engines, reception on a plane was found to be well-nigh impossible, and on this account we find that it was not until comparatively late in the war that reception on aircraft was extensively employed, and wireless was used as other than a one-way means of communication from the air to the ground, or other than for such purposes as recording observations of enemy positions to assist artillery. As, later on, the vibration and some of the noise of the engines was reduced, and amplification of signal strength became possible as a result of development of the valve, reception in the air advanced rapidly.

**Aids to Navigation.**

The service which wireless renders to aircraft may be roughly stated under two headings. First, as a means of ensuring the safety of the aircraft by aiding the pilot in obtaining his position by means of

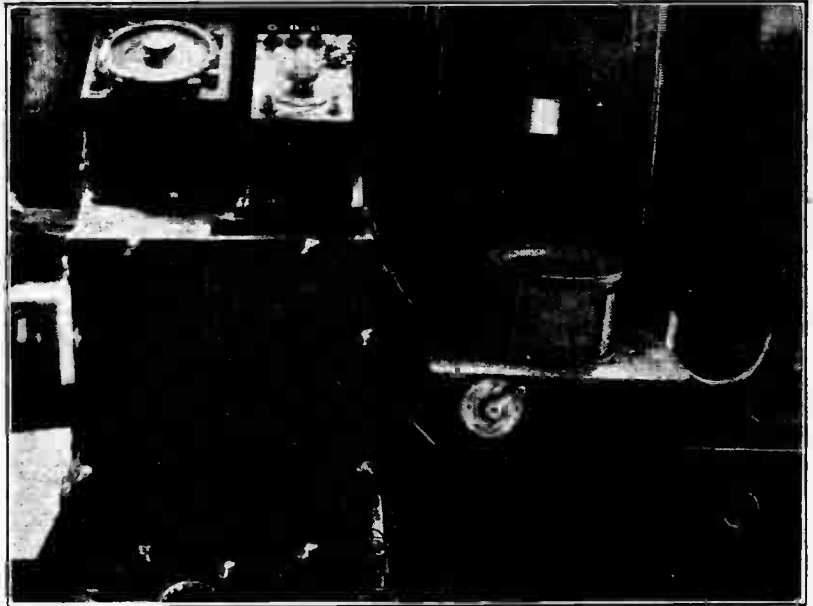

Experimental Bellini-Tosi direction-finding equipment and aperiodic compass.

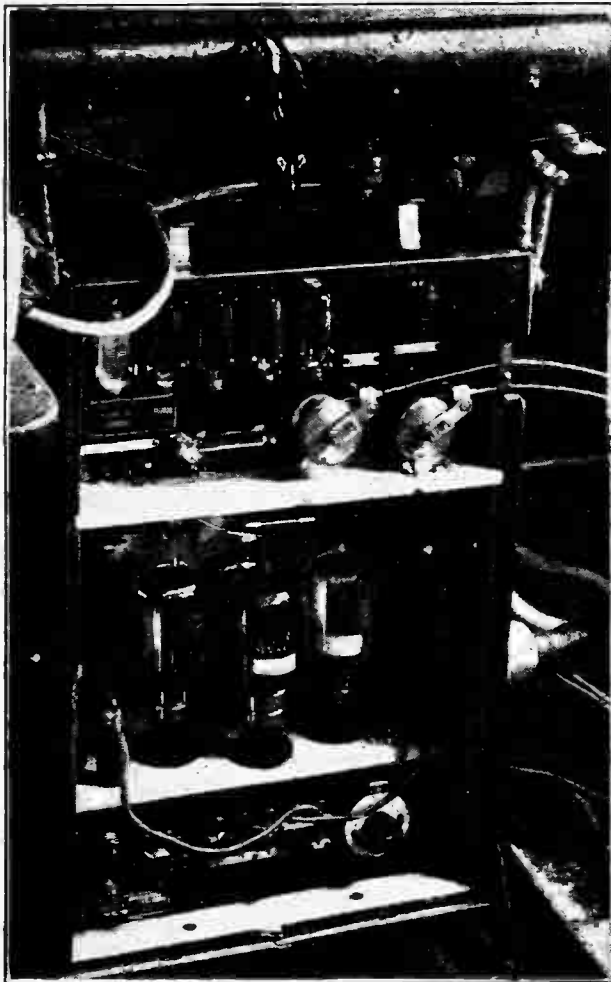

Standard Marconi A.D.6 aircraft transmitter and receiver used in the tests.

directional wireless; and, secondly, the convenience of being able to communicate with the ground to obtain general information, and possibly in future developments for putting facilities in the way of passengers to hold telephonic communications with individuals in their homes or offices on land. The importance of the first of these considerations needs no emphasis, for the very safety of the pilot and passengers depends upon it. The second is not of great importance, perhaps mainly owing to the fact that the journeys for the present undertaken are for the most part short ones, and it is scarcely likely that any communication would be so urgent that it could not await the arrival of the aircraft at its destination.

**Delay with Ground D.F. Stations.**

The above remarks lead us to the conclusion that directional wireless is of first-rate importance in commercial aviation. Hitherto the procedure has been for direction-finding stations to be established at convenient points on land along the airways, and these stations, when required, communicate to the pilot by wireless his correct position. Every aircraft which crosses the Channel makes use of this service, and it has been found in practice that very little delay arises in obtaining the bearings, even admitting the necessity for communicating with two or more stations on land, and then waiting whilst the correct positions are calculated from the bearings so obtained. The average time taken is, in fact, under one minute. The idea of making the aeroplane itself the direction-finding station, so that it can take bearings on known fixed stations on land, has been considered as a desirable goal for a long while past; but attempts which have been made to carry this theory into practice have failed, largely on account of the fact that the earlier types of aeroplanes were not sufficiently steady, nor certain in their course, for such directional bearings to be taken with any accuracy.

**Wireless Bearings from the Air.—**

A very interesting series of tests have been carried out during the past fortnight on the Vickers-Vanguard machine G—EBCP, in order to ascertain the value of the adoption of this system with modern apparatus for commercial aviation. Two distinct systems of direction-finding apparatus were employed on the Vanguard, these being the Bellini-Tosi apparatus, specially built for these experiments by the Marconi Company's Aircraft Department, and the wing-coil system modified for commercial aviation purposes. The wireless experiments were conducted under the direction of Capt. D. Sinclair, of the Air Ministry, and the check navigation of the machine was in the hands of Capt. F. Tymms, also of the Air Ministry; whilst Messrs. Smith and Huggins of the Marconi Company, and Messrs. Smith and Sutton of the Royal Aircraft Establishment, ably assisted on the technical side. The pilot was the well-known Capt. F. L. Barnard. Flights were made to Amsterdam, Paris, and Zurich, totalling fifty hours, and a considerable amount of valuable data has been obtained.

**The Apparatus.**

With the Bellini-Tosi apparatus aerials were mounted at right angles on the machine in the customary manner with this particular system. The same loop aerials were used for the wing-coil apparatus. The wing-coil system in its commercial form is a type of apparatus which is essentially simple, and can be operated single-handed by the pilot. This system has not yet been described in detail, and no information is at the moment available. With the Bellini-Tosi system it is necessary to carry a navigator and a wireless operator in addition to the pilot, and it would therefore seem that the developments would tend towards the adoption of the wing-coil system on the smaller aircraft, whilst the latter system may be more suitable for larger machines carrying, say, ten or more passengers. With the Bellini-Tosi system, bearings are taken of various stations of known position along the route, the signals being intercepted during the flight, and it is then a matter of straightforward navigation to work out the position of the aircraft from time to time in the air.

The tests carried out during the fifty hours of flying have not been exhaustive, and it is anticipated that further tests will have to be undertaken before either system is introduced as a standard fitting on commercial aircraft. There is very little doubt that both systems have very considerable potential advantages for commercial flight, and it is interesting to record that on several

of the flights the position was determined with no mean degree of accuracy by the Bellini-Tosi method, whilst by means of the wing-coils the machine was brought out right over the Eiffel Tower during the time that station was transmitting. In view of the fact that these are the first systematic tests to be carried out where the direction-finding apparatus is installed on the machine instead of at the direction-finding stations on land, the success already achieved augurs well for the future development.

The aerials do not show in the photographs reproduced for this article, but consisted of two loops, which were

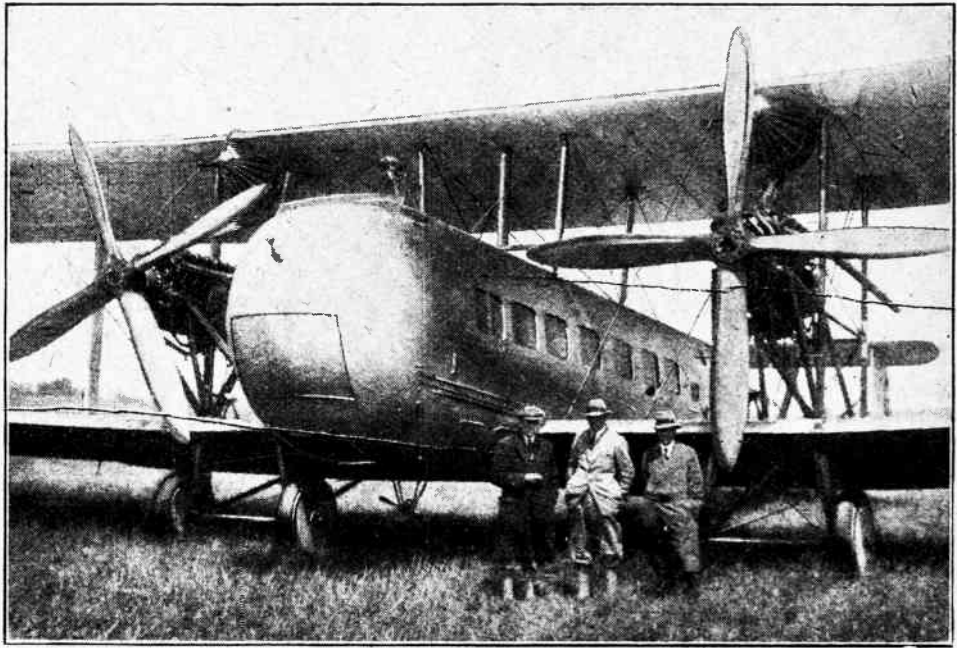

Vickers-Vanguard machine which flew to Amsterdam, Paris and Zurich during the preliminary trials of the direction-finding equipment.

“doped” on to the wings and fuselage, the two loops being at right angles to each other in the usual Bellini-Tosi manner, and being led in by a switching system either to a search coil component, which is included in the apparatus illustrated, or to the wing-coil set.

**Advantages of Independent Direction-finding.**

There is no doubt that these tests, and the development which is likely to follow as a result of them, are of the utmost importance. Under the present methods of navigating an aircraft, the machine is practically dependent during bad weather on the existence and operation of D.F. stations on land along the route, so that there is sometimes a pronounced degree of risk in air navigation when the machine is out of range of the D.F. stations; but with the perfecting of this new system an aircraft would be at home along any route where signals from ordinary wireless stations of known position could be intercepted. The necessity for direction-finding stations on the ground would no longer exist so far as aircraft navigation is concerned, except as an auxiliary method for use in the event of a breakdown in the D.F. equipment on the aircraft, or as a check where an extremely accurate determination of the course is required.



# WORKING A SET FROM D.C. MAINS.

## Methods of Obtaining Plate and Filament Currents.

By W. JAMES.

ONE of the most unsatisfactory accessories of a broadcast receiving apparatus is the power supply, for, quite apart from questions of convenience, the accumulator and dry cell battery are responsible for a good deal of the poor quality loud-speaker reception so often met with. It is well known that the output valve of a receiver, that is, the one connected to the loud-speaker, must be of a type designed to deal with a fair amount of power with a reasonable factor of safety. If the output valve is of the quarter ampere type, having an amplification factor of 7 and an impedance of 8,000 ohms, we ought to work it with an anode voltage of 150-200 and a grid bias of negative 10-15 volts to make sure of obtaining good results. An output valve having a lower impedance and amplification factor than this may often be used to advantage, but with an anode voltage of 150 and a grid bias of negative 20 the steady anode current is of the order of 15 milliamperes.

### Potentiometer and Smoothing Circuit.

Now the ordinary dry cell battery will not last very long when it is discharged at the rate of 15-20 milliamperes, and it is usual to cut down the anode current by using low voltages and small valves, with the result that the quality of the reception is not so good as it might be. The valve manufacturers have, of course, designed most of their products to meet the requirements of users employing small batteries, with the result that there are at the present time a very large number of valves which take quite a small heating current and work off low anode

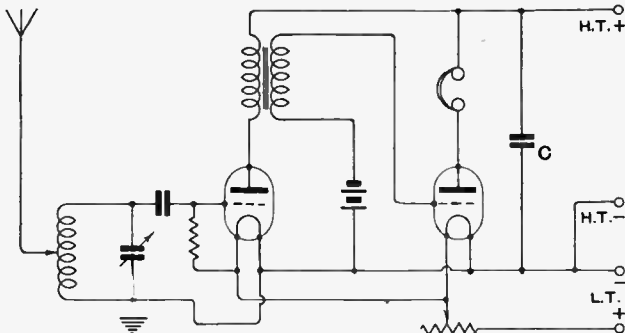

Fig. 1.—A normal 2-valve receiver with detector and low-frequency amplifier.

voltages. But these have been produced in many instances simply to meet the demands of those who will use small batteries, and not because such valves are best from the point of view of life and operating characteristics, given ample power to work them. A good example is the class of valve designed to work from dry cells. These valves usually have a short life, are expensive to run, and are not able to deal with strong signals.

Those who have a direct current electric light supply in the house can use it without much trouble and at little

expense to replace the accumulator and dry cell battery. Not only do the supply mains provide an effective substitute, but the supply is cheaper and more reliable, and, because of the higher anode voltages which may be used, better adapted to sets intended for loud-speaker work. Thus we may supply 150-200 volts to the output valve of the set, given a suitable valve, and not worry about the magnitude of the anode current.

Now the D.C. mains do not give a perfectly steady direct current, but one which has alternating currents superimposed on it, the magnitude of the ripple and its

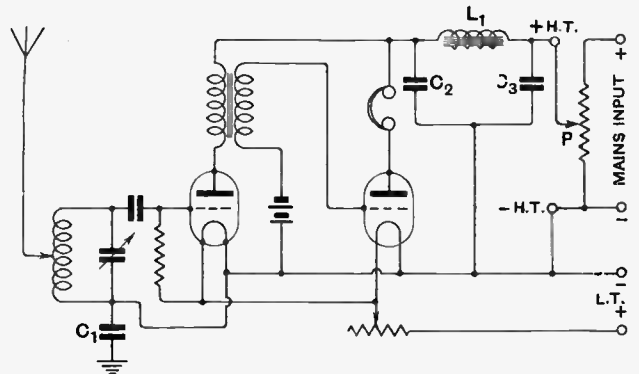

Fig. 2.—The receiver of Fig. 1 with direct current mains for the plate current supply.

nature depending on the source of the supply, and to some extent on the load connected to the mains. In some districts the ripple is negligibly small, whilst in others it is very pronounced; in addition, the ripple will be found to vary in magnitude during the day.

The current is therefore not suitable as it stands for applying direct to a receiver, for the variations would produce noises and hum sufficient in some cases to render weak passages in music quite unintelligible. It is therefore necessary to pass the current through a filter or smoothing system so that only pure direct current is supplied to the valves and also to provide means for reducing the main voltage to a suitable value.

### Connecting a Two-valve Set.

Suppose we take as our starting point the two-valve receiver connected as in Fig. 1. This has a detector and transformer-coupled low-frequency amplifier, and in many instances will provide fair loud-speaker operation from the local broadcast station. The anode circuits are supplied from a battery shunted by a condenser C, and our problem is to remove this battery and connect the D.C. mains.

If the mains are of 200-240 volts it is first of all necessary to connect a potentiometer of some sort across the positive and negative terminals; a number of electric lamps connected in series may be used, or a wire resistance of one or two thousand ohms will do quite nicely.

**Working a Set from D.C. Mains.—**

The voltage between the negative terminal and the + H.T. terminal of the set, Fig. 2, will then depend on the position of the contact P and may be adjusted to provide the most suitable voltage. It should be noted that when the valves are alight, the current flowing from the mains is equal to the current in the resistance between

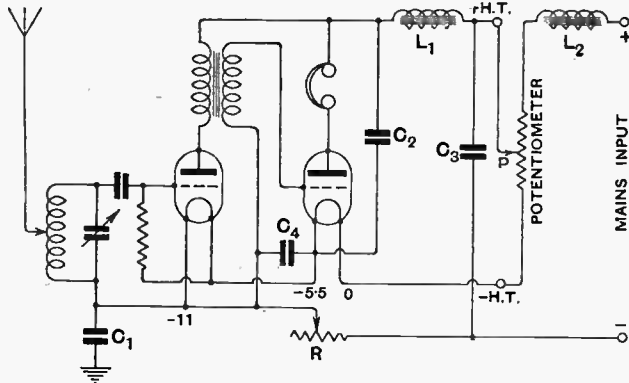

**Fig. 3.—The receiver of Fig. 1 with direct current mains for the plate and filament circuits.**

point P and the - main terminal added to that which passes to the set. Hence the ratio of the voltage of point P to the total voltage is less than the ratio of the resistance of the potentiometer between point P and negative to the whole resistance. The difference is not very marked, however, except when the current flowing to the valves is an appreciable fraction of the current from the mains. A further point of interest is that the voltage of point P cannot be measured with accuracy on an ordinary voltmeter; however, if the voltmeter has a high resistance so that it takes but little current compared with the total current flowing in the circuit, the voltage indicated will not be much lower than the actual voltage when the instrument is removed. Perhaps the easiest way of determining the voltage applied to the valves is by connecting a milliammeter in the anode circuit of the second valve. If its characteristics and the grid bias are known, the anode voltage may be estimated with an accuracy sufficient for practical purposes.

We have now connected a potentiometer across the mains, but before joining it to the + H.T. and - H.T. terminals of the set, we must make sure that the mains will not be earthed. For this purpose a condenser  $C_1$  of about 0.5 mfd. is connected in the earth wire, and as the voltage between one of the mains and earth will usually be of the order of a few volts, this condenser need not be specially insulated. In some districts the voltage to earth of the negative main is only a few volts;

in others, the positive main is the one which is more nearly at earth potential. This condenser is in the aerial circuit, however, and its high-frequency loss resistance should not be unduly high; for this reason it may be preferable to employ a condenser having a mica dielectric.

The next thing to be considered is the filter, or smoothing system. This should usually be connected in the high voltage side of the supply, and when the negative main is the side nearest earth potential should be joined as indicated in Fig. 2. The smoothing system shown in this figure comprises a choke coil  $L_1$  and condensers  $C_2$  and  $C_3$ ; it is usually found that the supply of anode current is satisfactorily smoothed when the choke has an inductance of about 30 henries and the condensers a capacity of about 5 mfd. Sometimes condenser  $C_3$  is not required, and it may be found that the primary winding of an L.F. intervalve transformer is satisfactory as  $L_1$ , but in general it is advisable to employ a specially made choke and large condensers. The choke used need not be a large one physically; the type sold for an intervalve coupling is suitable, although it must not be forgotten when ordering that it has to carry the anode current for two valves, which may amount to 15 milliamperes.

Used as indicated in Fig. 2, the mains will provide an economical source of anode current, and when the smoothing system  $L_1, C_2, C_3$ , is properly fitted, the receiver will in the great majority of cases be quite silent.

The amount of current taken from the mains, and, therefore, the cost of the energy consumed, is determined mainly by the resistance of the potentiometer resistance or lamps, and will usually be about 0.2 ampere. Thus, with a 200-volt supply, the receiver is responsible for 40 watts.

**The Filament Circuit.**

If the two valves employed in the receiver of Fig. 2 take the same filament current we can connect them in series. In the case of D.E.5 valves the voltage drop across the two filaments in series will be 11, and the current 0.25 ampere. Now the current flowing through the potentiometer in the above example was assumed to be 0.2 ampere; we can therefore connect the valve filaments in series with the potentiometer, and by reducing

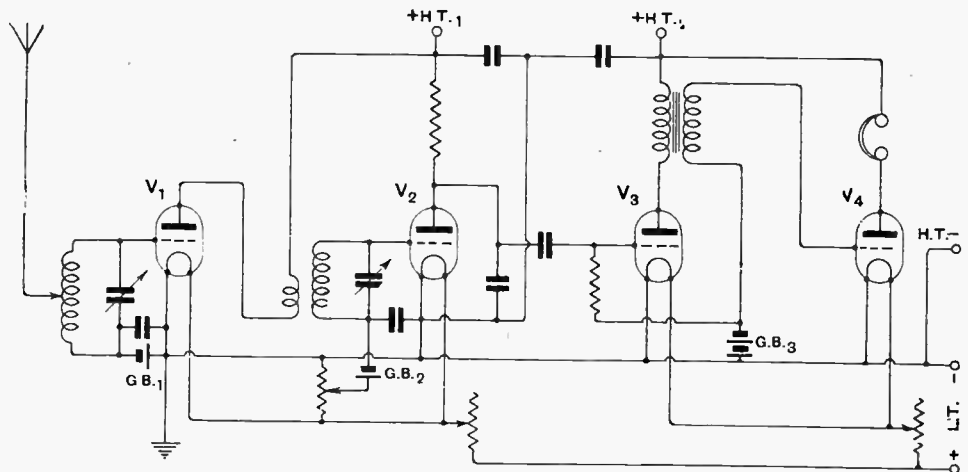

**Fig. 4.—A typical 4-valve receiver with one stage of high-frequency amplification, anode rectification and two low-frequency magnifiers.**

**Working a Set from D.C. Mains.—**

its resistance by a suitable amount, arrange for a current of 0.25 ampere to flow through the filaments.

The connections will then be as in Fig. 3, where R is a regulating resistance, and it should be noted that the grid of the L.F. valve has a negative bias of 5.5 volts. Regulating resistance R may have a value of about 30 ohms, and is provided to permit a close adjustment of the filament current to be made, and for starting up.

The resistance can have a higher value provided it will carry the current.

It will usually be found that if the filaments are connected in series with a resistance across the mains without any smoothing arrangement that a hum is heard. To remove this it is necessary to connect a choke in series with the filaments, and it has been found satisfactory to connect the choke in the positive side, as at L<sub>2</sub>, Fig. 3. This choke has to carry a relatively large current, 0.25 ampere in the example being considered. It has therefore to be wound with a fairly heavy gauge of wire, and the iron core must be so arranged that it is not saturated. For this reason an open core choke will suffice, and if a choke of the closed core type is used, an air gap of the right size must be provided.

**A Four-valve Set.**

The inductance required to smooth the filament current depends to some extent on the type of valve used as well as on the impurities in the supply, so that the best choke for a given bad case will have to be found by trial. A choke which has been found effective in removing the last trace of hum consists of a winding of No. 27 enamelled copper wire on an intervalve transformer core, one end of the core being pulled out to provide an air gap. The air gap is adjusted for least noise while listening to the set.

Referring to Fig. 3 again, it will be seen that the anode voltages of the valves have been changed by connecting the filaments to the potentiometer, and to compensate for the reduction in voltage applied to V<sub>2</sub>, contact P should be raised. A fixed condenser C<sub>4</sub> has been added and may have a capacity of 1 mfd.

With the filaments connected in this way the power taken by the set is 50 watts for a 200-volt supply, and 20 hours' running will cost about sixpence when the current is taken from the electric light mains, and much less than this if the power mains are used.

While it is satisfactory to give the valves of a two-valve set the same anode voltage, it is usually preferable to arrange for different voltages in larger sets. The four-valve set of Fig. 4, for instance, will normally have a low H.T. voltage for the H.F. and detector valves, and a

supply at a higher voltage for the L.F. valves. Further, valves V<sub>3</sub> and V<sub>4</sub> will usually be of the power type, capable of taking an anode voltage of 150-200. The problem in this case then is to provide the two anode current supplies from the mains, and this is effected as indicated in Fig. 5. It will be seen that the potentiometer, which may comprise a wire resistance or lamps, is tapped at two points, P<sub>1</sub> for the lower voltage and

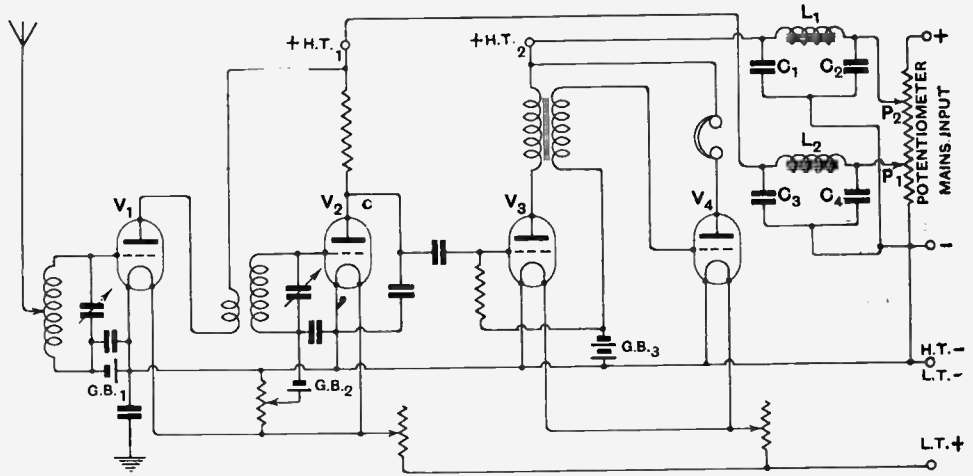

Fig. 5.—The receiver of Fig. 4 with direct current mains for the plate current supply.

P<sub>2</sub> for the higher voltage. Two separate smoothing systems are usually necessary, and each has its choke and condensers. Sometimes condensers C<sub>2</sub> and C<sub>4</sub> are not required. This can only be found by trial, but it is important to notice that condensers C<sub>1</sub> and C<sub>2</sub> should be well insulated ones when the voltage across them is 150 volts or more. Condensers C<sub>3</sub> and C<sub>4</sub> may be the ordinary paper condensers, as the voltage across them will normally be less than 100 volts.

**Fuses and H.F. Chokes.**

The wires of the electric lighting system and power circuits carry high-frequency currents, and these may be of sufficient strength to interfere with the satisfactory working of a set. In many instances it will be found desirable to connect high-frequency choke coils in the main leads to the receiver. These coils can be connected quite close to the set, as indicated in Fig. 6, and should not be wound with wire of too fine a gauge, as they have to carry about one-quarter of an ampere in the case of the receivers discussed above. Coils having an inductance of 200 microhenries will suffice for the 200-600 metres wavelength band, and 5,000 microhenries for the longer wavelengths.

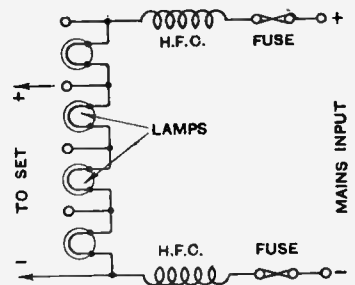
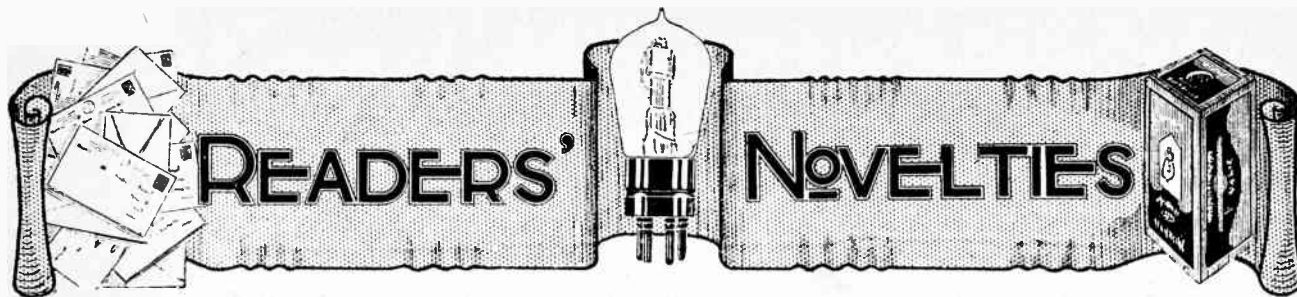

Fig. 6.—Method of connecting lamps to replace the potentiometer of Figs. 2, 3 and 5, also fuses and high-frequency chokes.



A Section Devoted to New Ideas and Practical Devices.

**VARIABLE COIL HOLDER.**

Experience with short wave receivers shows that it is advisable to mount tuning coils and condensers some distance from the front panel if hand-capacity effects are to be avoided. A simple and practical way for putting this principle into effect in the case of plug-in coils is shown in the diagram. It is peculiarly well adapted to sets built on the so-called American principle, in which vertical ebonite panels are screwed to the front and back edges of the base-board.

The bearing hole should be drilled as close as possible to the lower edge of each panel, after making due allowance for the flexible wires to be attached to the nuts securing the plug and socket. The latter should be fitted as near as possible to the end of the rod to minimise vibration due to the flexibility of the rod and in order that most of the weight of the coil may be supported by the back bearing.

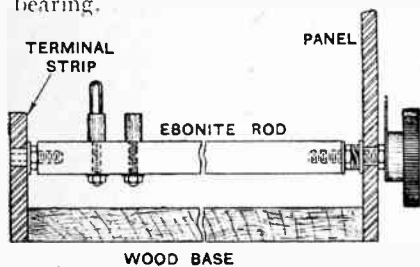

Variable mounting for plug-in coil

It is recommended that the bearing holes should be bushed and a spring washer fitted near the front bearing to take up any end play in the shaft.—W. L. S.

**OILING PULLEYS.**

To oil the pulley at the top of an aerial mast, tie to the aerial halyard a piece of sponge of such a size that

it can just pass through the pulley block when compressed. Soak the sponge in oil and pull through the pulley block, when the oil will be discharged in sufficient quantity to find its way to the bearing.—N. M. M.

**TEMPORARY CONNECTIONS.**

The diagram shows a method of modifying an ordinary pillar type terminal in order that connections

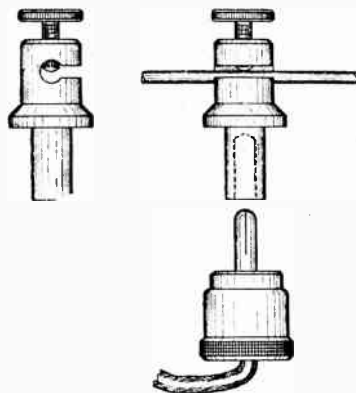

Making connection to the wiring of a receiver.

may be made for experimental purposes to various points of the wiring of a receiving set.

**VALVES FOR IDEAS.**

*Readers are invited to submit brief details, with rough sketches, where necessary, of devices of experimental interest for inclusion in this section. A receiving valve will be despatched to every reader whose idea is accepted for publication.*

*Letters should be addressed to the Editor, "Wireless World and Radio Review," Dorset House, Tudor Street, London, E.C.4, and marked "Ideas."*

A slot is cut in the side of the terminal in order that it may be clamped to the wiring at the required point, and a valve socket is substituted for the fixing screw. Connection is then picked up by means of a flexible lead and wander plug fitting into the valve socket.—C. G. B.

**POLARITY INDICATOR.**

To save searching for a small receptacle in which to place acid every time it is necessary to make a test of polarity, it is a good plan to make up the permanent tester illustrated in the diagram.

A glass test-tube is fitted with a three-hole rubber bung which can be obtained from dealers in chemical apparatus. Terminals, to which short lengths of copper wire have been attached, are then forced into the outside pair of holes in the bung, leaving the centre hole as a vent for the gas. The tube is then filled with slightly acidulated water; only a few drops of acid are necessary, and if excess is added the fuses may be blown when the indicator is connected across the mains direct.

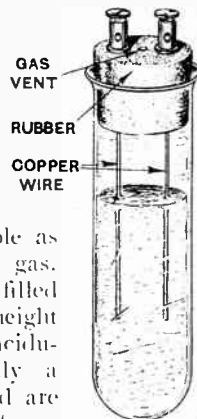

Polarity indicator.

The use of a glass tube enables the electrodes to be closely observed (the negative pole gives the greater evolution of gas). For strength, the special test-tubes known to chemists as "boiling tubes" are recommended.—J. W.

# WIRELESS CIRCUITS in Theory and Practice.

## 15.—The Valve as a Detector.

By S. O. PEARSON, B.Sc., A.M.I.E.E.

THE three-electrode valve possesses characteristics which make it eminently suitable for use as a detector as well as an amplifier of high-frequency oscillations. As in the case of the simple crystal, detection is effected by rectification of the modulated high-frequency oscillations. The valve must be operated in such a manner that it separates out the audio-frequency variations from the high-frequency carrier wave, thus enabling audible sounds to be heard in the telephones or loud-speaker.

There are two distinct methods of making a three-electrode valve act as a detector, both of these methods employing the principle of rectification; that is to say, all the negative half-waves of the high-frequency oscillations are completely or partially suppressed, whilst the positive half-waves are allowed to pass freely.

The rectification is effected in both cases by making use of the property of the one-way or unilateral conductivity possessed by the valve between the various electrodes. The two methods are known as *anode rectification* and *grid rectification* respectively, the former making use of the curvature of the anode characteristic curve of the valve, and the latter employing the unilateral conductivity of the grid to filament circuit inside the valve. Each method has its advantages and disadvantages, and the conditions under which one or the other is the more suitable will be discussed.

### Anode Rectification.

In Fig. 1 the ordinary anode characteristic curve showing the relation between the plate current and grid voltage is given for a typical receiving valve. If the normal grid potential of the valve is adjusted by means of a potentiometer or grid battery, so that the valve operates on the lower bend of the anode characteristic curve, as shown in Fig. 3, then any increase of the grid voltage in a positive direction will cause a corresponding increase in plate current, which is large compared with the decrease of plate current obtained by decreasing the grid voltage by an equal amount below the normal value. Thus, if an alternating voltage is applied to the grid, the increase of plate current during each positive half-wave will be greater than the decrease during each negative half-wave. These conditions are clearly shown by the sine curves in Fig. 1. The diagram shows that the *mean value* of the plate current is actually increased when an alternating voltage is applied to the grid, provided the valve is operated on the bend of the characteristic curve. It will be remembered that for amplification the valve is operated on the straight portion of the characteristic, and that a small alternating voltage applied to the grid does not cause any change in the mean value of the plate current.

For the valve to act as an ideal rectifier for the reception of telephony, the change of plate current from the normal value should be directly proportional to the amplitude of the high-frequency oscillations applied to the grid. But these ideal conditions are not met with in practice, being only approximately approached when the circumstances are favourable.

It was shown in a previous instalment that the energy received by the aerial in the case of radiotelephony is in the form of modulated high-frequency oscillations, the amplitude of the carrier wave being varied in accordance with the wave shapes representing the speech or music. As a rule the amplitude of the carrier wave does not vary more than about 20 per cent. on the loudest notes. The function of the valve detector is to cause the mean value of the plate current to vary in exact accordance with the wave shape of the audio-frequency component of the incoming oscillations.

### Dynamic Characteristics.

The rectifying properties of a valve can be seen more clearly from the dynamic characteristic curve, *i.e.*, from the curve showing the relation between the amplitude of the alternating voltage applied to the grid, and the mean value of the plate current, than from the ordinary static anode characteristic curve. It is quite an easy matter to find experimentally the dynamic characteristic curves

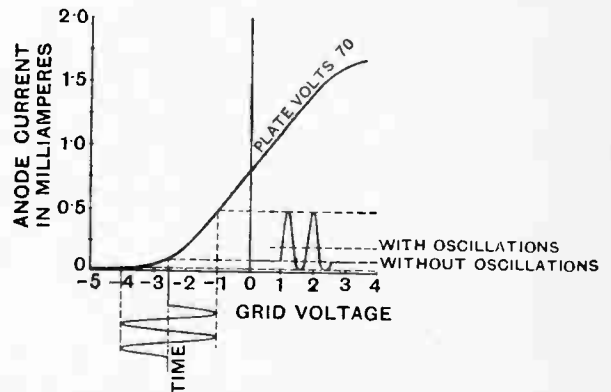

Fig. 1.—Diagram showing how the mean value of the plate current is increased by applying an oscillating E.M.F. to the grid when the valve is operated at the lower bend of the anode characteristic.

of a valve if a source of A.C. supply is available. In the ordinary way it is not easy to measure low values of alternating voltage, but the difficulty can be overcome by using a potential divider which can easily be constructed by any amateur as follows:—Measure out ten pieces of No. 22 or 24 S.W.G. bare "Eureka" resistance wire, making each as nearly as possible 2 metres long. Wind each piece into two tight spirals on a rod about  $\frac{1}{16}$  in.

**Wireless Circuits in Theory and Practice.**—

diameter or less, beginning from each end in turn, and leaving a straight portion about  $\frac{3}{16}$  in. long in the centre, and straight ends each about  $\frac{1}{16}$  in. long, as shown in Fig. 2(a). These ten resistances are then mounted on the underside of a board about 2 ft. long and 10 in. wide, the ends being soldered to the shanks of 11 terminals mounted in a row near one of the longer edges of the board, as shown in Fig. 2(b). The centre portion of each resistance wire is bent round a small bobbin type insulator mounted near the opposite edge of the board, the 10 insulators so required being mounted in a row parallel to the terminals. The shanks of the terminals should each have a saw-cut in the end to facilitate soldering, the method of fixing being shown in Fig. 2(c). The board should have four legs at the corners to prevent the wires and terminal shanks from touching the bench when in use.

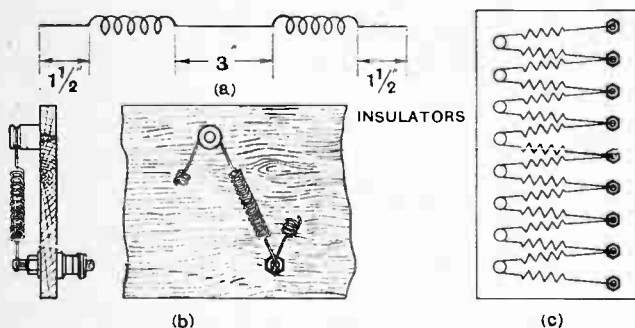

Fig. 2.—Details of simple potential divider

We have now a resistance of the order of 30 ohms which is divided into ten equal parts, and thus, when a given voltage is applied across the two outer terminals, one-tenth of this voltage exists between any two adjacent terminals on the board. Such a piece of apparatus is extremely useful to the listener who constructs his own sets for making various simple measurements on valves or crystals.

To obtain the dynamic characteristic of a valve a known alternating voltage of constant value is applied to the ends of the resistance, and any fraction, in tenths, of this voltage can be applied between the grid and filament of the valve. The circuit arrangement is shown in Fig. 3. The filament of the valve is connected to one end B of the potential divider through the grid battery C, which is included to give the necessary negative grid bias in order that the valve shall operate at a suitable point on the anode characteristic curve. The grid itself is connected in turn to the various terminals, starting at the end B. When connected to the extreme end terminal, marked O, the alternating voltage applied to the grid is zero, and when connected to the terminal marked 3, the alternating voltage on the grid will be three-tenths of the voltage across A B, and so on.

The alternating voltage across A B should be adjusted to about 10 or 15 volts R.M.S. value, and since the source of supply voltage is usually much higher than this, one or more lamps must be connected in series as shown, unless a step-down transformer is available. Those who have a step-down transformer, used in connection with

their battery charging apparatus, may use this instead of the lamps, the potential divider being connected directly across the secondary winding. The R.M.S. voltage across A B is measured by means of an ordinary A.C. voltmeter or otherwise, and the maximum value or amplitude of this voltage is obtained by multiplying it by 1.414.

The mean plate current is read off from the milliammeter (mA) for the various A.C. voltages applied to the grid. There will be a separate set of readings and a separate curve for each value of the *mean* grid potential applied through the medium of the grid battery C. In this way the three curves shown in Fig. 4 were obtained for the same valve, whose anode characteristic curve is given in Fig. 1. Each curve corresponds to a definite value of normal or mean grid potential as indicated on the curve. Although the plate current contains an oscillating component, the moving-coil milliammeter in the plate circuit indicates the average value, *i.e.*, the D.C. component.

The curves show that the mean value of the plate current increases rapidly as the amplitude of the voltage applied to the grid is increased, but as none of these curves obeys a straight-line law over any part of its length, the change of mean plate current is not proportional to the strength of the applied oscillation. In fact, it is more nearly proportional to the *square* of the applied voltage, especially near the lower ends, and therefore for very weak signals or low amplitudes of oscillating voltage on the grid there is practically no rectification at

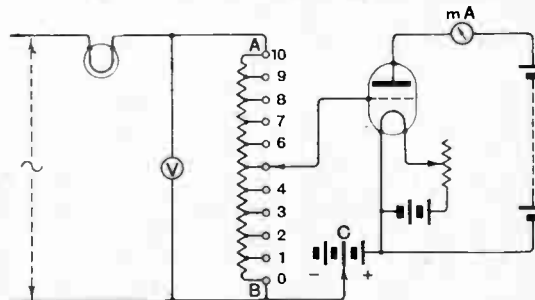

Fig. 3.—Circuit for obtaining dynamic characteristic for anode rectification.

all. This explains clearly why the use of a high-frequency amplifier before the detector valve increases the receiving range of a set to such a marked extent.

**Conditions for Minimum Distortion.**

It has been explained that the amplitude of the high-frequency oscillations received from a broadcasting station is only varied to a small extent by the low-frequency modulation. When the valve is used as a rectifier it will function most efficiently if the *variations* of amplitude take place over the steeper parts of the dynamic characteristic curve. Suppose that the valve is being operated with  $-3$  volts on the grid, the conditions being given by the upper curve of Fig. 4, which is repeated in Fig. 5. Suppose, further, that the average amplitude of the high-frequency oscillation applied to the grid is 10 volts, and that the modulation on the loudest notes is 20 per cent. Then during operation the amplitude of the oscillations will vary at an audio-frequency between 8 and 12 volts, and therefore between the points A and B on the curve.

**Wireless Circuits in Theory and Practice.—**

If the H.F. oscillation is being modulated by a pure sine wave of low frequency, we can see from the curve of Fig. 5 whether the resulting variations of the mean plate current will also be according to a sine law or not. The diagram shows us that the wave shape is very nearly a faithful reproduction of the audio-frequency component of the voltage applied to the grid, but not absolutely true. If the portion AB of the curve had been a straight line, then the reproduction would have been perfect. The shorter the length AB, and therefore the lower

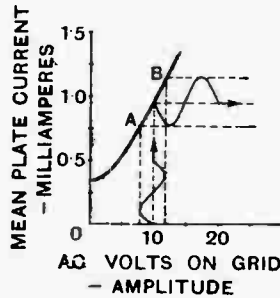
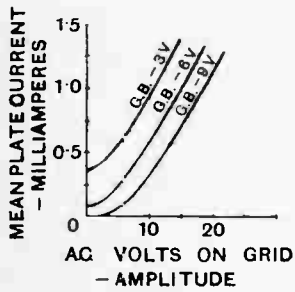

Fig. 4.—Dynamic characteristic curves showing the relation between mean plate current and amplitude of oscillation applied to the grid.

Fig. 5.—Diagram showing that low-frequency variations are faithfully reproduced by an anode rectifier if the percentage modulation is not too great.

the percentage modulation, the more nearly perfect will the rectification be, and on the other hand, for a high degree of modulation, the length corresponding to AB may extend right round the bend in the curve, and so produce a certain amount of distortion which might be particularly pronounced where complex wave forms are to be reproduced.

A further important point in connection with anode rectification is indicated by the dynamic characteristic curve, namely, that in order to obtain efficient and more or less distortionless rectification, the amplitude of the oscillation applied to the grid should be at least 4 volts, the rectification being very inefficient for weak signals.

The valve considered above is an ordinary "general purpose" valve, but there are on the market special types of valves with particularly steep anode characteristics and

sharp lower bends designed for use as detectors employing anode rectification. Valves of this type usually have high values of amplification factor and internal impedance. As examples can be mentioned the Marconi QX type, which has an amplification factor of 25 and an internal resistance of 80,000 ohms; the SP. 1S/B. (Blue Spot), with an amplification factor of 35 and an internal resistance of 70,000 ohms; and the D.E.5B. type, which has an amplification factor of 20 and an internal impedance of 30,000 ohms.

**Best Values of Anode and Grid Voltage.**

The best value of negative grid bias to use for a particular valve naturally depends on the high tension voltage applied to the plate, the higher the value of the H.T. voltage the more negative will the grid have to be made in order that the valve shall operate at the lower bend in the anode characteristic curve. Now, it is quite common practice to employ quite a low plate voltage so that little or no negative grid bias is required; but this has a certain disadvantage in another respect. When the grid potential is increased above zero in a positive direction, an electron current will flow between the grid and filament, and for a given grid potential this grid current decreases as the plate voltage is raised. Now, as grid current is liable to cause distortion, it is better to use a fairly high plate voltage in conjunction with the requisite negative grid bias.

Whilst on the subject of anode rectification, it should be mentioned that a "soft" valve, *i.e.*, one with a small trace of gas left in the bulb, is particularly sensitive as a detector employing this method. Owing to the rapid ionisation of the gas as the grid voltage is raised, a very steep anode characteristic curve is obtained with a sharp bend at the lower end. The adjustment of plate voltage, filament current, and grid voltage are quite critical, and owing to disintegration of the filament, due to bombardment by the positively charged particles or ions of the gas, the characteristics of the valve are continually changing, and the life of the valve is comparatively short. Soft valves have almost gone out of use for these reasons.

The next instalment will deal with grid rectification, and a general comparison will be made between the two methods.

**General Notes.**

We are asked to state that G BVJ is the call-sign of the R.N. College, Dartmouth. This is sometimes mistaken for a Belgian Station. Reports will be cordially welcomed and acknowledged.

We understand that U.S.S. "Memphis" (NISS) left U.S.A. for Europe on the 14th instant, and is carrying out a series of tests on 100 watts until July 14th. The wavelength is about 56 metres, but varies for day and night working. When the vessel reaches Europe, the transmitter will be transferred to U.S.S. "Pittsburg" (NOT) by Dr. Taylor.

The Belgian Amateur B H5 works regularly every Friday night, sometimes with B Y5 and sometimes with B G11, from 23.00 G.M.T. onwards, on a wavelength of about 200 metres, and will welcome reports. He also transmits on 44.46 metres with an input of 15 watts, using a Hartley circuit.

**TRANSMITTERS' NOTES AND QUERIES.**

B 05, on 190-200 metres using 30 watts and a Hartley circuit, also desires reports. Mr. A. G. Binnie, 1, Cromford Road, West Hill, S.W.18, is willing to forward reports to G11.H5, 05, and Y5.

**Chilean Amateurs.**

Through the courtesy of Mr. Luis M. Desmaras (CH 21.D), Castilla 50 D, Santiago de Chile, we are able to give our readers the call-signs and addresses of

Chilean Amateurs who are working on Short Waves.

**A Correction.**

We regret an error in the list of International prefixes on page 760 of our issue of June 9th, the indicating letter for South Africa should have been O and that for Austria Ö.

**Q.R.A.'s WANTED.**

- |        |         |         |         |        |
|--------|---------|---------|---------|--------|
| G. 2AK | G. 2ARM | G. 2BL  | G. 2BRZ | G. 2LS |
| G. 2GC | G. 2KJ  | G. 2ST  | G. 5HR  | G. 5IH |
| G. 5SY | G. 5TB  | G. 5TC  | G. 6AM  | G. 6AR |
| G. 6AX | G. 6MLB | A. 4VS  | AT. 8EF | A. 5KN |
| U. 7BW | U. SSE  | X. 1VJ. |         |        |

**NEW CALL-SIGNS ALLOTTED AND STATIONS IDENTIFIED.**

- |         |  |
|---------|--|
| G. 2BLG | E. R. Martin, Castlemount, Worksop, Notts.   |
| G. 2BQQ | D. D. Longmore, Northcot, Balsall Common, Coventry. Transmits on 100 and 410 metres. |
| G. 2BVK | A. S. Watford, 6, Bexley Villas, Clarence Road, Windsor.                             |
| G. 6OT  | H. A. Clark, 71, Station Road, Bedford. Transmits on 45 and 90 metres.               |
| G12BNR  | L. Marshall, 58, Peman Street, Belfast.  |



## Wireless with the NORTHERN AUSTRALIAN EXPEDITION.

**M**R. MICHAEL TERRY, F.R.G.S., who took the first motor across Northern Australia in 1923 (incidentally an old Ford), found, on his return, that so very little was known concerning Northern Australia that he spent much time in lecturing and attending discussions, and found that the story of his experiences created a great deal of interest. It was with the idea of familiarising people with the conditions and people of Northern Australia that a second journey was organised from which Mr. Terry recently returned.

His party started from Darwin, Northern Territory, and, having followed a south-south-west direction, eventually arrived at Gregory's Inland Sea, 1,000 miles away. From there the expedition penetrated into Warburton, the great sandy desert, as far as Mount Cornish, where, it seems, the party were the first white men to arrive. It had been intended to carry out further investigations of the sand plains, but owing to an exceptionally dry season (one of the worst ever known in the North) it was safest to be content with visiting Mount Cornish! From that time onwards a new route was planned, which involved skirting round the edge of the dry country, where water was more plentiful, till eventu-

ally the expedition arrived at Broome, having covered 2,000 miles in about four months.

There were seven men in the party, two Guy-Roadless 1-ton lorries, each pulling a trailer, and an A.J.S. motor cycle and sidecar.

Amongst the equipment of the expedition there was a Gambrell three-valve wireless receiving set, which was the first set to be taken into the interior. It was a source of never-ending amusement and intense interest to the few white men met during the course of the journey, and should result in a number of receiving sets being erected in this little-known part.

When the expedition left Darwin it went by rail the first 200 miles to Katherine; for the next 300 miles to Wave Hill Station the course of the Dry River Stock route was followed. At Wave Hill Cattle Station the route of 1923 was joined and followed to Gordon Downs. This stage proved to be far easier than had been anticipated, because where there had been only the most indefinite signs to guide the traveller in 1923, in 1925 it was found a good track had been made in the meantime. From Gordon Downs a course was pursued down Sturt Creek to the last settlement at Billiluna Station. One white man was living there, with many natives looking after a few cattle. Onwards from this last place roving bands of blacks were the only inhabitants.

It would be difficult to over-estimate the companionship rendered to the party by the presence of the wireless set, which kept them constantly in touch with what was going on in the more civilised parts of Australia. Although they could not communicate, the receiver, nevertheless, proved the means of contact with the outside world, which could not have been maintained in any other way. In any further expeditions undertaken, a wireless set will always be regarded as one of the most essential units of the equipment.

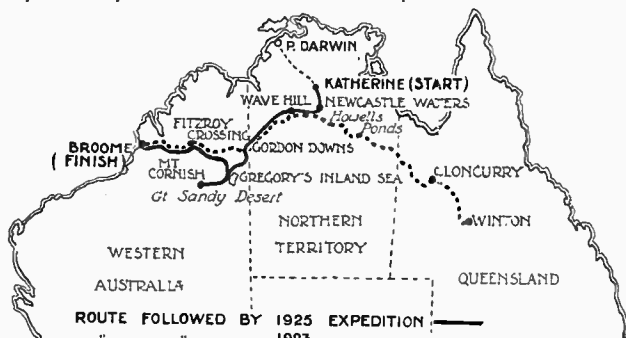

The route followed by the two expeditions



# CURRENT TOPICS

## News of the Week — in Brief Review

### UNIVERSITY WIRELESS.

A wireless set is to be installed in Sheffield University for educational purposes.

o o o o

### A CHILLY RECEPTION.

Mr. Achille Alziari, of Kentish Town, has been fined 40s. and 21s. costs for using a wireless set without a licence.

o o o o

### NEW ZEALAND BROADCASTING.

By to-day (June 30th) the Radio Broadcasting Company of New Zealand, Ltd., has undertaken to have stations erected and in working order at Auckland and Christchurch.

o o o o

### EXIT THE HALLE BROADCASTS.

Next season's concerts by the Halle Orchestra, Manchester, will not be broadcast owing to differences arising between the Musicians' Union and the B.B.C. on the question of additional payment.

o o o o

### WIRELESS AT THE R.A.F. DISPLAY.

The Royal Air Force Display at Hendon on Saturday next, July 3rd, should attract many wireless enthusiasts.

An event which will have a popular appeal will be squadron drill carried out by wireless telephony, orders being given by the squadron leader from his machine in the air or from the wireless ground station. The call sign of No. 25 Fighter Squadron, which will carry out this event, is "Mosquito," while the ground wireless station with which it keeps in touch is "Fantail."

About 130 aircraft, drawn from Home Defence, Army Co-operation and training units will take part in the display. Sixteen new machines, most of which have since their inception been regarded as highly secret, will be present.

As Hendon is now the property of the Air Council it has been possible for important improvements to be undertaken by the Display Committee for the comfort and convenience of spectators.

Boxes for six (price £4, £5 and £7) and tickets 5s. and 10s. can be obtained from any agency or library or from the Secretary, R.A.F. Display, Inland Area, Bentley Priory, Middlesex. Two shilling tickets are available at Hendon aerodrome on the day of the display.

### NO COLLECTION?

A "radio parish" has been instituted at Portland, Maine, U.S., the "pulpit" being a broadcast studio.

o o o o

### UNSIGHTLY MASTS.

The district surveyor for Markyate (Hertfordshire) has been complaining that certain local wireless masts resemble Harry Lauder's walking stick. Tenants on the housing estate are now forbidden to erect masts without official permission.

o o o o

### P.O. WIRELESS.

The Postmaster-General states that during the financial year ended March 31st 1926, the number of cablegrams and wireless messages dealt with by the Post Office amounted to 11,314,458.

### DANZIG CALLING!

The Free City of Danzig will shortly be added to the list of European cities possessing broadcasting stations. Building operations have just been started, and it is hoped to have the new station in working order at the beginning of August.

o o o o

### THREE MORE STATIONS FOR I.F.S.

The Irish Minister of Posts and Telegraphs announces that it is hoped to equip three extra broadcasting stations in the Free State, each with a power equivalent to that of the Dublin station.

o o o o

### QUIET READING.

The Reading Town Council has passed a by-law that "No person shall in any street or public place operate any loud-

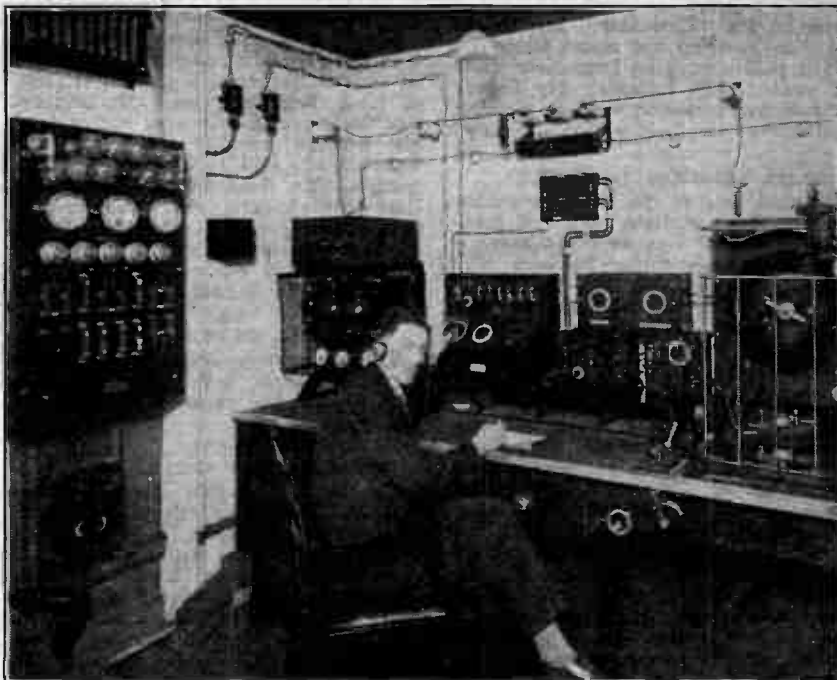

SHIP SET ON TERRA FIRMA. Many interesting pieces of wireless apparatus used by Senator Marconi and other pioneers are now on view at Marconi House, where certain modern equipment is also exhibited. The photograph shows a liner's transmitting and receiving plant installed as if on board ship.

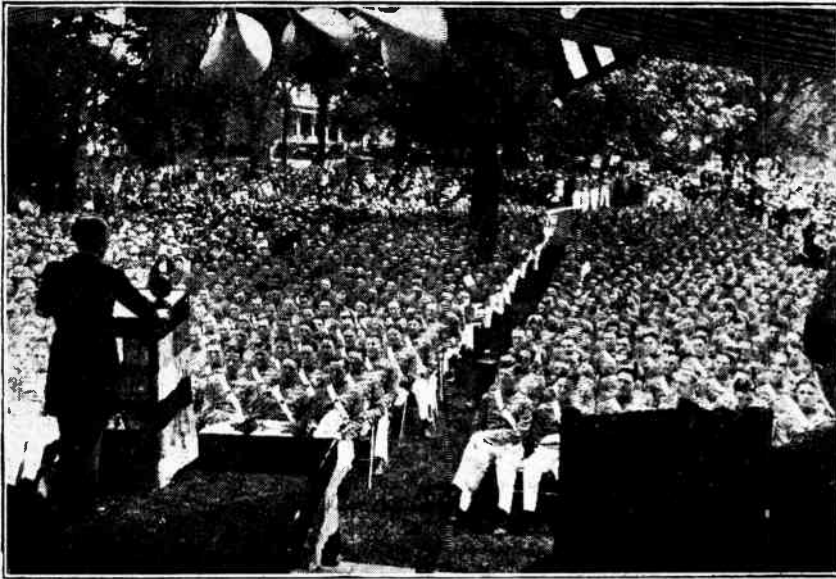

**THE UBIQUITOUS LOUD-SPEAKER.** The use of loud-speakers and amplifiers for public speaking has practically ceased to arouse comment in America where these benefits are taken as a matter of course. The photograph shows Mr. Hanford MacNider, Assistant Secretary of War, addressing cadets at the West Point Military School.

speaker in such a manner as to cause annoyance to or disturbance of residents or passengers." Offenders are liable to a penalty of £5.

○○○○

#### WIRELESS AND A THIEF.

A wireless message to the police that jewellery valued at £1,535 was missing from the luggage of an American passenger on the "Leviathan," resulted in detectives boarding the vessel when she arrived at Southampton from New York last week. The following day Robert Harrison was sentenced to three months' imprisonment for theft of the jewellery.

○○○○

#### BEAM WIRELESS TO CANADA.

The first link of the chain of world-encircling beam stations will be completed in a few days with the opening of beam communication between the British Isles and Canada. The transmitting and receiving stations in this country for the Canadian service are at Bodmin and Bridgwater respectively.

○○○○

#### WIRELESS AT THE N.P.L.

Curiosity as to the work of the National Physical Laboratory during the past year was satisfied to some extent on Tuesday of last week, when the laboratories at Teddington were open for the annual inspection.

Probably the most interesting exhibit in the wireless section was the N.P.L. standard wavemeter, which gives a frequency measurement from ten to 50,000 kilocycles. A quartz crystal oscillator, with its amplifying valves, was also on view. With regard to the measurement of coil resistances it was surprising to note that no screening was employed. As if to atone for this, however, was the screened oscillator, placed in a

special room screened with wire netting. From the oscillator the leads were taken through screened cases to the measuring instruments in the next room, where even the operator was screened in a special cabinet.

Frame aerials were conspicuous everywhere.

○○○○

#### CUCUMBERS AND WIRELESS.

Considerable excitement has been aroused in the Midlands by the claims of an amateur gardener, Mr. William Bout, of West Bridgford, near Nottingham, that his plants are drawing energy from his wireless aerial. Cucumbers and tomatoes are said to be peculiarly susceptible. Mr. Bout omits to state what class of programme is most encouraging to vegetable growth, and until we know whether a cucumber is "highbrow" or "lowbrow," we can only await further experiments in breathless silence.

○○○○

#### WIRELESS IN THE OPEN-AIR.

Summer wireless concerts, with open-air loud-speakers, have been inaugurated as a regular feature at the Dell, Port Sunlight.

○○○○

#### WIRELESS FOR ARCTIC POLICE.

The Royal Canadian Mounted Police post at Tree River, Coronation Gulf, in the Western Arctic, is to be moved to Kent Peninsular, Bathurst Inlet, 135 miles east of Tree River. Bernard Harbour, at the mouth of Coronation Gulf, is to have a post opened there, whence the police will exercise supervision over 74,000 square miles of the west side of the Victoria Land Preserve. Wireless receiving sets will be installed at both posts to enable the men to hear programmes from stations in Canada and the United States.

#### WIRELESS THE WONDERFUL.

Never has the long arm of coincidence been more manifest than in recent prosecutions under the Wireless Telegraphy Act. In nearly every case the summons has been received on the very day on which the defendant had intended to take out his licence!

○○○○

#### WHERE IGNORANCE IS . . .

The other day Mr. L. J. Wallace, of Tobermore, Ireland, summoned under the Wireless Act, pleaded ignorance of the necessity of taking out a wireless licence. He got off with a nominal fine of one shilling and costs!

○○○○

#### WIRELESS TELEPHONY ON HARBOUR VESSELS.

Very satisfactory results are reported from the working of the Marconi wireless telephone sets installed on harbour vessels some twelve months ago by the Basrah Port Trust. The vessels so equipped in the Persian Gulf are the control vessels "Alert" and "Yenan," the pilot vessels "Nearchus," "Liger," and station ship "Harmaq," working with shore stations at Tanoomah and Fao.

A wireless bell is included in each installation, which is of the Marconi YB type, so that there is no necessity for maintaining a continuous watch. Any vessel or station can call any of the others with the facility of an ordinary telephone. The transmitters have a power of 100 watts, and the range for telephony, depending on local conditions, varies from 35-80 miles. The radius for telegraphy is from 100 to 200 miles.

○○○○

#### WIRELESS AT WESTMINSTER.

*By our Special Parliamentary Correspondent.*

#### Broadcasting Controversial Matter.

Last week in the House of Commons Mr. T. Shaw raised the question of why the Postmaster-General had forbidden the broadcasting of an explanation by the employers and workers in the National Boot and Shoe Trade of their conciliation scheme which had prevented any general upheaval for upwards of 31 years.

Sir Wm. Mitchell Thomson said that since the end of the general strike the Government had exercised no control over the operations of the B.B.C. The action which he took in this particular matter was taken in his ordinary capacity as Postmaster-General, and he was enforcing the understanding under which there was a rule that topics which related to matters of political controversy should not be broadcast.

#### THE CYLDON CONDENSER.

The Cyldon condenser, referred to on page 857 of our issue of June 23rd, is a product of Messrs. Sydney S. Bird, "Cyldon Works," Sarnesfield Road, Enfield Town, Middlesex.

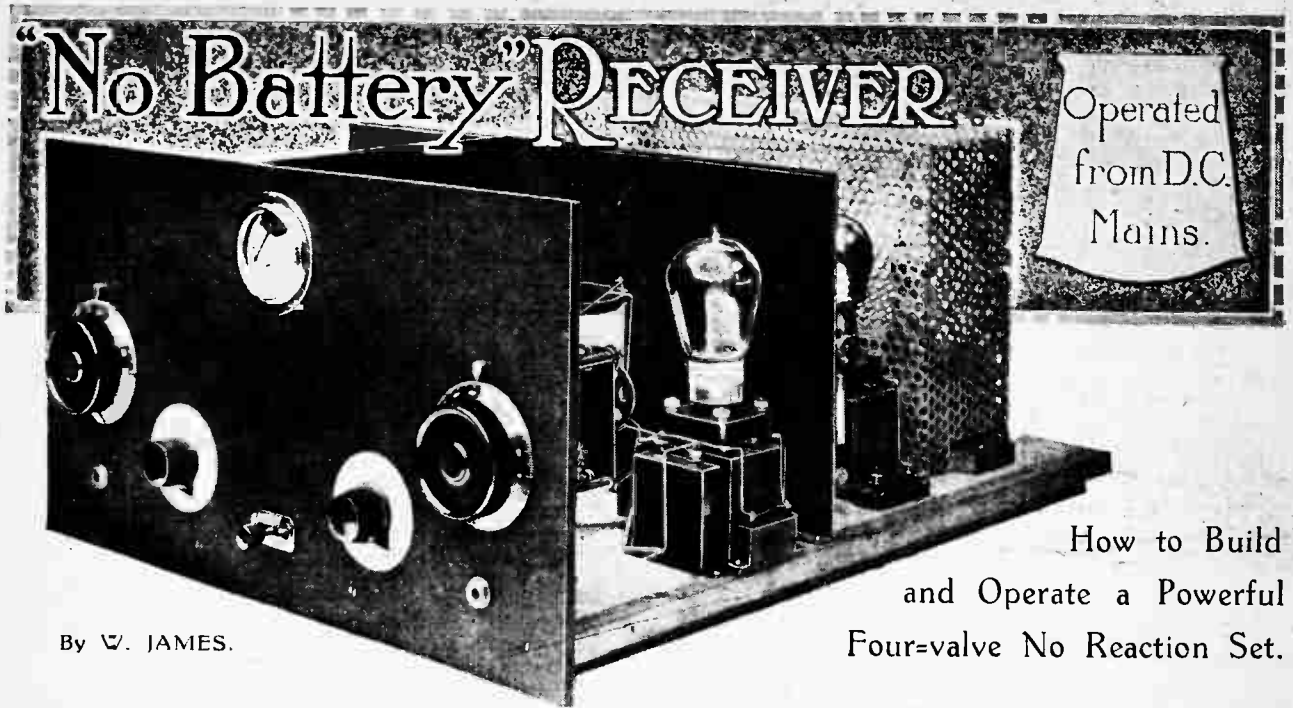

By W. JAMES.

## How to Build and Operate a Powerful Four-valve No Reaction Set.

QUITE a large number of people would invest in a high-class valve receiver if they could be sure it would not be troublesome. There can be no doubt that the necessity for using dry cells and accumulators as power units, requiring constant attention and frequent replacement as they do, has played a large part in limiting the demand for receivers capable of giving a satisfactory volume of sound with pleasing quality.

In this connection it is important to note that one of the most serious defects of dry cells and accumulators is their variability. A receiver might be adjusted to give good quality with fresh batteries, but what happens when the batteries have been working for a short time? Their voltage falls, the internal resistance of the dry cell battery goes up, and this, with the majority of receivers, produces couplings between circuits, and as a consequence a serious falling off in the quality of the reception.

This falling off in quality is experienced as a rule long before the dry cell battery has reached the end of its useful life, reckoned in terms of its current-giving capacity, and cannot be prevented merely by adding a few fresh cells to maintain the voltage. Moreover, the harmful effects due to the resistance of the plate circuit battery increasing after a short period of use are more serious the better the design of the set from a quality standpoint.

Quite apart from considerations of economy, convenience, and appearance, then, it is a good thing to provide a source of power which has definite electrical characteristics, *i.e.*, characteristics which do not change with time. Small accumulators can, of course, be used with success by those who know how to take care of them, but even here we are faced with the fact that the voltage of a 150-volt battery, for example, may be allowed to fall to 135 volts before recharging is necessary.

It would appear, therefore, that the most satisfactory source of power is likely to be the supply mains, and when suitable precautions are taken this is in practice found to be the case. Precautions certainly do have to be taken, but these do not call for any very expensive apparatus; it is usually necessary to employ iron cored chokes and large condensers to level out the supply, as explained in another article in this issue, but once this apparatus has been set up the supply can be switched on and off by means of an ordinary tumbler switch, and no further attention is likely to be required at any time because of the reliability of the apparatus employed.

### Features of the Set.

The receiver illustrated here was primarily designed to give good quality from the local station, but it is sufficiently selective and sensitive to enable several other B.B.C. stations to be received at good strength; the second outstanding feature is that no batteries whatsoever are required for its operation, the direct current supply mains being used for filament heating and for the plate circuits, while the grid bias for all the valves is obtained by connecting the grid return wires to suitable points in the circuit. Four valves are used, and these are of the type requiring a filament heating current of one-quarter ampere. The total power consumed by the set when connected to 200-volt D.C. mains is, therefore, about 50 watts, and 20 hours' running is had for a cost of about sixpence, or much less if the power mains are used.

A glance at the schematic diagram, Fig. 1, will reveal the remaining features of the set. It will be seen that one stage of tuned high-frequency amplification is used, and that this is followed by an anode bend rectifier and two stages of low-frequency amplification. The detector

**"No Battery" Receiver.**—

is connected to the first low-frequency amplifying valve by a resistance-capacity coupling, and this is followed by a transformer-coupled amplifier. A switch and two jacks are used to enable the loud-speaker to be connected to the

coils of the receiver can be placed in a position which gives minimum direct pick up, but the second coil has to be placed at right angles to the other coil or else screened if magnetic coupling between the coils is to be prevented. Hence this second coil will act as a collector if it is of

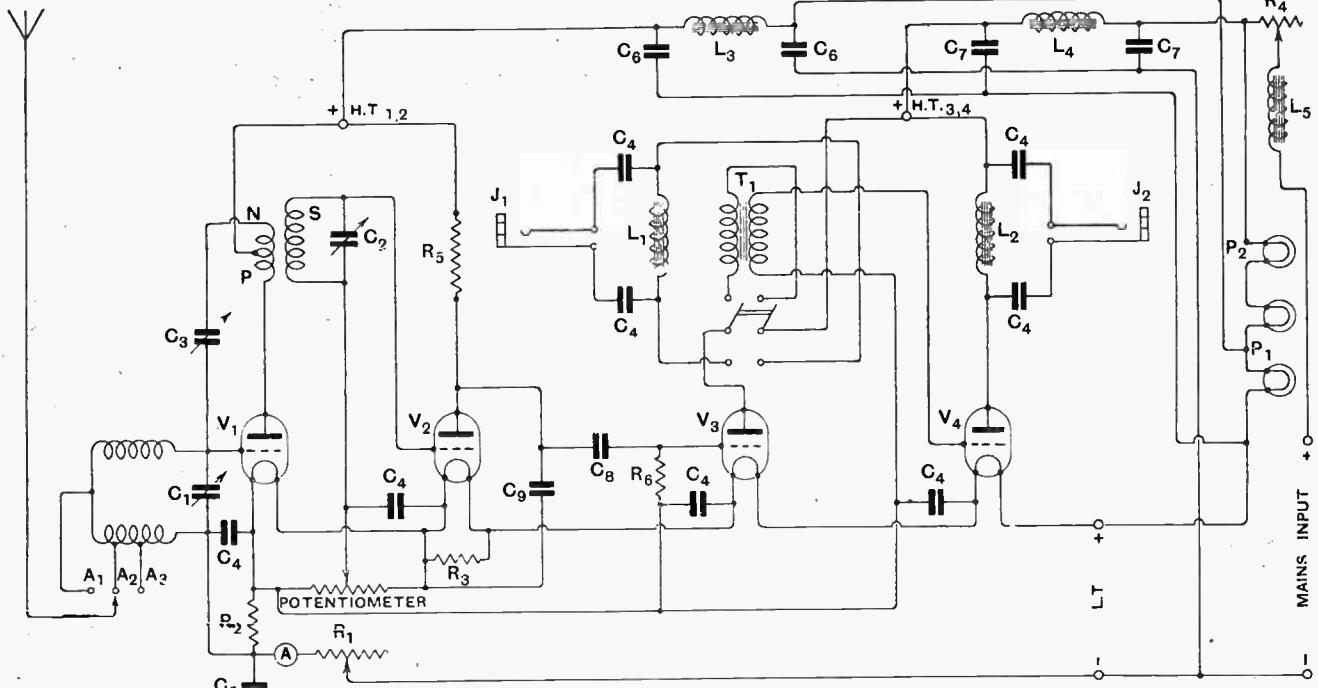

Fig. 1.—Schematic connections of the set. A<sub>1</sub> A<sub>2</sub> A<sub>3</sub>; aerial connections; V<sub>1</sub> H.F. valve; V<sub>2</sub> detector valve; V<sub>3</sub> first L.F. valve and V<sub>4</sub> the last valve; C<sub>1</sub> C<sub>2</sub> 0.0003 mfd. tuning condensers; C<sub>3</sub>, balancing condenser; C<sub>4</sub>, 1 mfd. fixed condenser; C<sub>5</sub>, 0.5 mfd. fixed condenser of 600 volt type; C<sub>6</sub>, 2 mfd. fixed condenser; C<sub>7</sub>, 5 mfd. fixed condenser of 600 volt type; C<sub>8</sub>, 0.01 mfd. mica condenser; C<sub>9</sub>, 0.0002 mfd. mica condenser; R<sub>1</sub>, 30 ohms filament rheostat; R<sub>2</sub>, 10 ohms fixed resistor; R<sub>3</sub>, 30 ohms fixed resistor; R<sub>4</sub>, home made resistance of 30 d.s.c. eureka wire; R<sub>5</sub>, 1 megohm grid leak; L<sub>1</sub>—L<sub>2</sub> L<sub>1</sub>—L<sub>2</sub> 32 henry chokes; L<sub>3</sub>, 100 henry choke; T<sub>1</sub>, 4:1 transformer; A, filament current ammeter.

third or the fourth valve, and each jack is connected to a choke-condenser filter circuit for the purpose of insulating the loud-speaker. This is quite necessary, since the low-frequency valves are worked with a high plate voltage, and, further, head telephones might be used in the third stage to tune in distant stations.

One of the problems met with when a set is used near a broadcast station is that of direct reception due to the coils and wiring acting as collectors. Now, one of the

ordinary type. In this receiver the high-frequency transformer was made to stand upright in the set, as in this position it does not collect any appreciable amount of energy directly, and it was considered advisable to use a special type of coil for the aerial circuit.

The coil used is of the double-wound type, and comprises two similar coils mounted side by side and connected in series. This type of coil behaves as though it has a negligibly small external magnetic field, and,

providing it is properly placed with respect to the coils of the high-frequency transformer, there is no magnetic coupling between them. So far as direct pick-up is concerned, the field due to an incoming broadcast signal affects each coil alike, but in opposite senses, and the net result is that no voltages are set up across the ends of the coil.

The particular double-wound coil used is designed to tune over 200-600 metres with a 0.0003 mfd. tuning

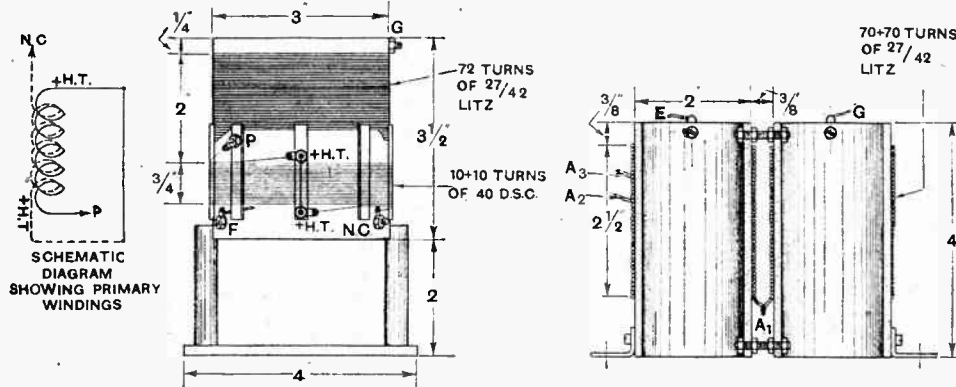

Fig. 2.—Constructional details of the H.F. transformer (left) and the aerial tuning coil (right).

**"No Battery" Receiver.—**

condenser and is constructed as indicated in fig. 2. Two ebonite tubes, 2in. in diameter and 4in. long, are used, and these are bolted together at the top and bottom by 4 B.A. screws and nuts; two small brass feet are provided as indicated in the sketch. Each coil is wound in the same direction with 70 turns of 27/42 litzendraht, tappings being taken for  $A_2$  and  $A_3$  at 40 and 20 turns from the top end of one of the coils. When the two coils are wound they are bolted together and the two lower ends connected, this connection also being used as an aerial tap,  $A_1$ . This coil can be clearly seen in the illustrations; looking at the front of the set, it is situated to the left of the copper screen.

**Tuned High-frequency Transformer.**

The tuned high-frequency transformer is also illustrated in Fig. 2, and comprises a cylindrical coil of low resistance with the primary and neutralising windings carried on ebonite spacers on its outer surface and at the cathed end. A paxolin tube, 3in. in diameter by 3 1/2 in. long, is used as the coil former; this is held on two pieces of ebonite rod 2 3/4 in. long, which are screwed to a flat piece of wood, 4in. long by about

1in. wide. The base and pillars form a convenient support for the transformer, as it is only necessary to screw through the base piece to hold the transformer firmly in position.

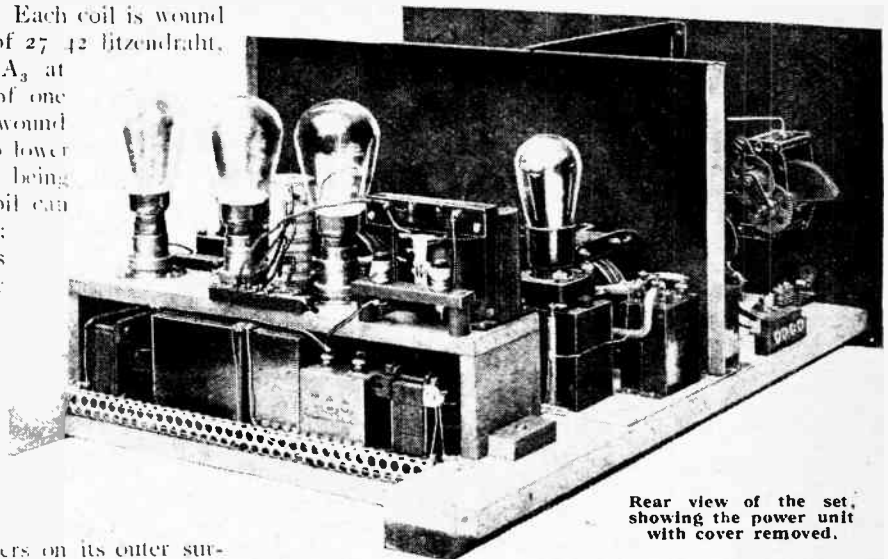

It is necessary to fit three sets of screws and nuts, two being for the ends of the secondary winding (marked F and G) and the third for the neutralising condenser connection (N.C.). The secondary coil is a straightforward winding of 72 turns of 27/42 litzendraht conductor, the wires having a single silk covering with an outer covering of double silk; the turns are wound touching.

Eight pieces of ebonite, about 1 1/2 in. long and 3/8 in. wide, cut from a 3in. ebonite tube with 3/8 in. wall, are required for spacers, and, as is shown in Fig. 2, one spacer has a small screw and nut fixed at each end, while two other spacers have a similar screw and nut at one end. The screws should have countersunk heads, and the holes in the spacers be well countersunk on the underside. Two windings of No. 40 D.S.C. wire are put on over the spacers, which can for convenience be held with elastic bands while the turns are being wound. Solder one end of the wire to the lower screw marked +H.T., and wind 20 turns, leaving a space between the turns. Finish this winding by soldering the end to the terminal marked P. Now

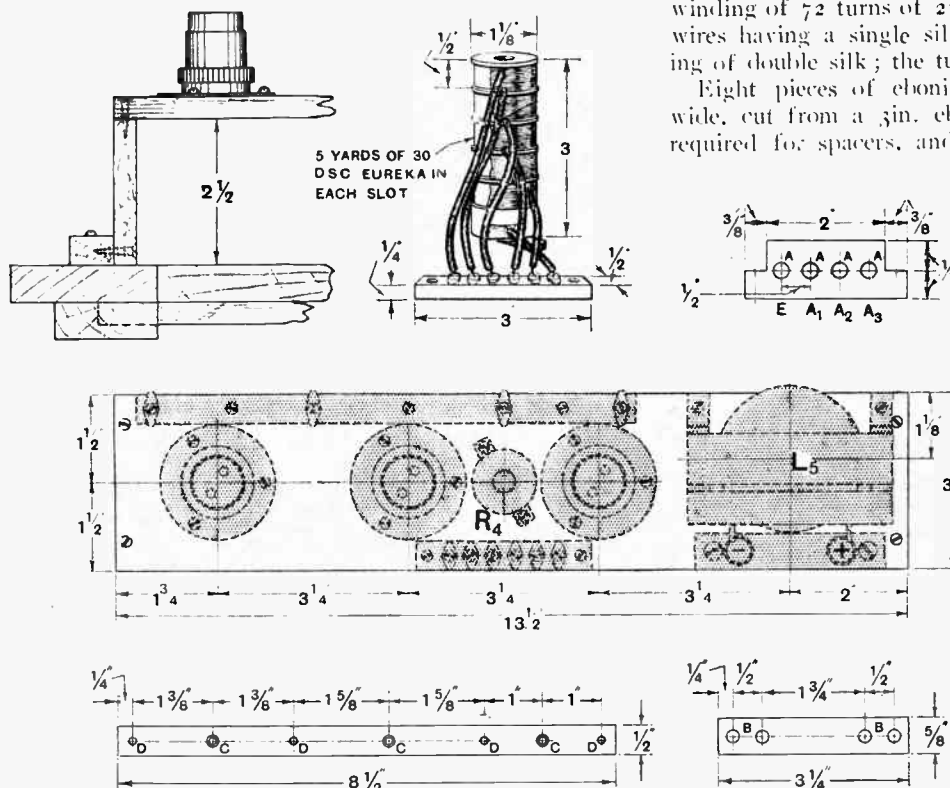

<sup>1</sup> "Litzen" can be obtained from P. Ormiston and Sons, 79, Clerkenwell Road, London, E.C.1, at the price of 12s. for 50 yards.

**"No Battery" Receiver.—**

solder the end of the wire to the terminal marked N.C. and wind on 10 turns; these turns lie in the space between the primary turns and the end of this coil finishes at the upper terminal marked + H.T.

Thus the primary and balancing windings have ten turns each, and form a double winding of small capacity. The two + H.T. terminals should be connected.

This transformer is designed for a valve having an impedance of 10,000 ohms or less, and when used with a valve having an impedance of 8,000 ohms and an amplification factor of 7.5, gave the following amplification:

Wavelength Metres.	Amplification.	Wavelength Metres.	Amplification.
540	26	375	23.2
480	26.5	320	29
450	26.5	260	29.4
400	27.3	230	28.5

This is pure radio-frequency amplification: reaction does not enter into the question at all, but when the transformer is used in the set the balancing condenser is so adjusted that there is no self oscillation over the whole scale: then the effective amplification due to the

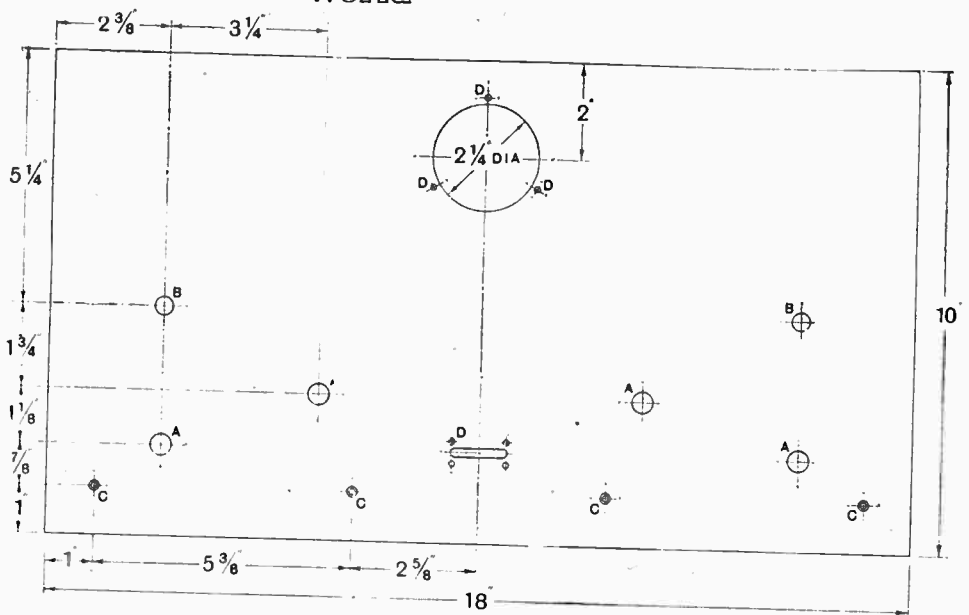

Fig. 4.—Details of the ebonite front panel. A, 7/16in.; B, 3/8in.; C, 1/8in. countersunk; D, 1/8in.

combined pure amplification given above multiplied by the regenerative contribution is many times the amount given in the table. In fact, without the least self-oscillation the single high-frequency stage will magnify weak signals to such an extent that several B.B.C. stations can be received in daylight on a loud-speaker with the set.

It should be noted that adjustable reaction is not used, and that no reaction is used on the high-frequency transformer: consequently it was found necessary to reduce the detector damping to the lowest amount, and anode

bend rectification with ample negative grid bias is employed. The transformer is therefore quite selective, this being due in part to the absence of serious valve damping, but mainly because of the low resistance of the secondary coil. The low resistance of the secondary coil also accounts for the high and uniform amplification obtained. The amplification is higher than when a 200-microhenry coil tuned by a 0.0005 mfd. condenser is used for the secondary coil (as in the Long Range Three-valve Receiver described in *The Wireless World* for May 26th and June 2nd), because the coil is of higher inductance and therefore less capacity is required to tune it to a given wavelength. The selectivity of this transformer, however, is not quite so good as in the earlier receiver referred to.

This transformer can be

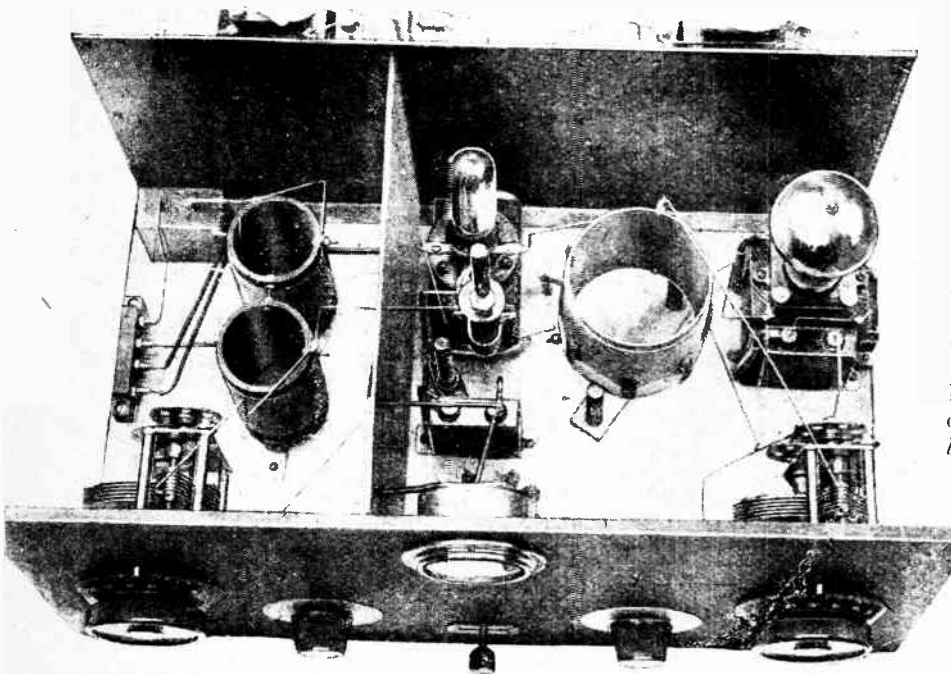

A view which shows the high-frequency and detector valves and the tuning apparatus.

**"No Battery" Receiver.**—

seen in the illustration between two valves on the right-hand side of the set.

**Special Detector Connection.**

We will now pass to the detector which is set to detect as an anode bend rectifier and has a high resistance of 1 megohm in its plate circuit. This resistance is marked  $R_5$  in the diagram, and is an ordinary grid leak; a grid leak resistance is suitable because the plate current is of the order of 10 to 15 microamperes only, when the potentiometer which is used to bias the grid negatively is set for best rectification. A by-pass condenser  $C_4$  of 0.0002 mfd. is connected between the plate and filament and the coupling condenser and grid leak  $C_8$  and  $R_6$  have values of 0.01 mfd. and 5 megohms respectively. These values are rather unusual, but we may say that the rectifier works very efficiently and that the lower frequencies are amplified particularly well. If a plate circuit resistance of, say, 100,000 ohms had been used, it would have been necessary to have used a coupling condenser  $C_4$  of about 0.1 mfd. with a grid leak  $R_6$  of 0.5 megohm, but when a 1 megohm plate circuit resistance is used, the grid leak can be considerably increased

in value and the coupling condenser correspondingly reduced for the same amplification-frequency characteristics. Now one of the advantages gained is the increased amplification, because it must be remembered that the plate impedance of a valve set to rectify is very high—of the order of one or two hundred thousand ohms, and a second advantage is this, that the filament current of the detector can be considerably reduced with a gain in rectification efficiency and the probability of greatly increased life.

The valve used may be a D.E.5b, or similar valve having a high amplification factor, and the resistance  $R_4$  shunting the filament may have a value of 30 ohms, wire being taken off this resistor until best operation of the detector is obtained. We prefer, however, to use a valve of the 2-volt type for detection, and the one recommended is a Cosmos S.P.18 Green Spot. This valve works very well when its filament is shunted by a 30 ohms resistance, the remaining valves of the set taking one-quarter ampere.

Reference to the drawings will show that the 1 megohm plate circuit resistance has been mounted in an upright position, being held between terminals screwed in a piece of ebonite which in turn is fixed to the baseboard.

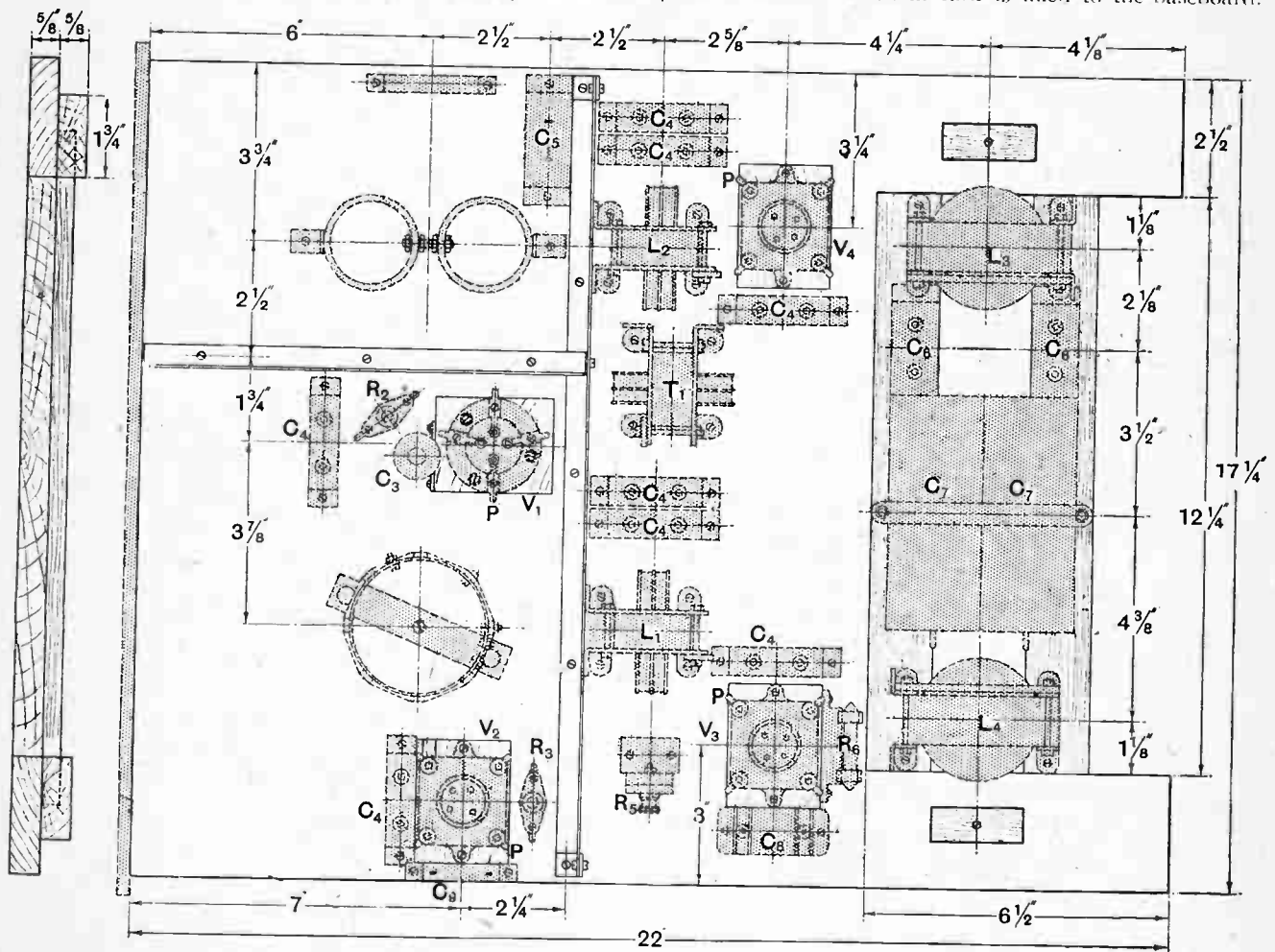

Fig. 5.—Arrangement of parts on the baseboard.

**"No Battery" Receiver.—**

This mounting was used because the set as originally made up used a large wire-wound resistance; this was found unnecessary, however, and the grid leak may be held in an ordinary holder screwed to the baseboard. The grid leak is mounted just behind the detector valve  $V_2$  on the L.F. side of the screen.

**Low-frequency Stages.**

The two low-frequency amplifying valves have a transformer coupling, the transformer having a ratio of 4:1, but a switch and two jacks are provided in order that the loud-speaker may be connected to  $V_3$  and  $V_4$ . Two filter circuits, comprising an iron-cored choke coil of 32 henries and two 1 mfd. condensers each, are also provided.

If the filament circuit is traced out it will be seen that the positive wire from the supply is connected to one side of  $V_1$ , passes through this valve to  $V_3$ , through the shunted filament of  $V_2$ , and thence to  $V_4$ , through a fixed resistor  $R_2$ , to the ammeter and filament rheostat  $R_1$  of 30 ohms. The resistor  $R_2$  is employed to give the grid of  $V_1$  a negative bias and its value is 10 ohms.

A negative bias for the two L.F. valves is obtained by connecting the grid return wires of these valves to one side of the filament of valve  $V_1$ , shunting condensers  $C_4$  of 1 mfd. being employed to reduce noise.

For the detector valve we have a potentiometer which

is connected across the filament of  $V_1$  and a by-pass condenser of 1 mfd. is joined between the moving contact of the potentiometer and the negative end of the filament of the detector. These by-pass condensers are quite essential, as they help to remove hum and noise.

The screen which can be seen in the illustration is made from No. 24 gauge copper sheet, and serves to isolate the H.F. part from the remainder of the receiver.

**The Power Unit.**

The power unit comprises a tapped resistance  $R_1$  and three lamps for reducing the mains voltage to a suitable value for applying to the valves, and the necessary smoothing apparatus. A choke coil  $L_3$ , a home-made affair, is connected in the main positive lead and carries the full current of 0.25 ampere; its function is to smooth the filament current for the valves. Two other chokes are used, a 32-henry choke at  $L_1$  and a 100-henry choke at  $L_2$ . The chokes have different values because they carry the plate current of different circuits, valves  $V_1$  and  $V_2$  being fed through a 100-henry choke and the two L.F. valves through the 32-henry choke. Two 5 mfd. condensers,  $C_7$ , are associated with the 32-henry choke, and as the voltage in the circuit is higher these condensers are of the 600-volt type. Two condensers,  $C_6$ , are also connected to the 100-henry choke, but these are of only 2 mfd. each, and are of the ordinary type, as the H.F. valve and detector are worked with a low plate voltage.

The series resistance  $R_4$  has five sections, each containing five yards of No. 30 D.S.C. Eureka wire wound on a wooden former as shown in the upper part of Fig. 3. This former is 3in. long and 1½in. in diameter, and the taps are connected to tags mounted on a piece of ebonite, 3in. long by ½in. wide by ¼in. thick. This resistance is therefore adjustable in steps, and is used to adjust the filament current to 0.25 ampere when first setting up the set. The lamp resistances absorb most of the waste power, of course, but we cannot rely on the lamps passing the exact current required. Choke  $L_3$ , as we have mentioned, is home-made, and consists of an intervalve transformer core and a winding of No. 27 enamelled copper wire. When assembling the core an air gap must be left and arrangements made for holding the core plates securely. In the choke used it was only necessary to file slots in the four brass side pieces, which

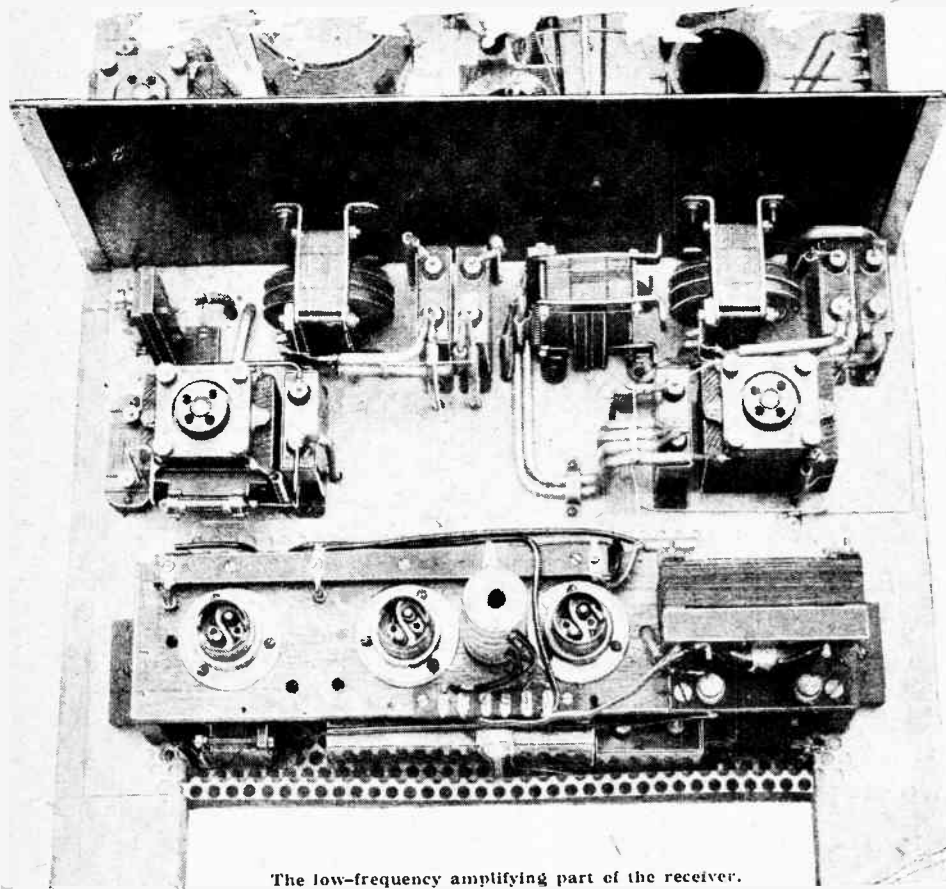

The low-frequency amplifying part of the receiver.



**"No Battery" Receiver.**

also act as supports for the completed component. The air gaps should preferably total at least 0.25 in. to begin with; when the set is put into operation the holding screws can be released and the core gently tapped down to reduce the gaps until the best setting is found.

**Assembly of the Receiver.**

Fig. 4 gives details of the ebonite panel which carries the two tuning condensers, rheostat, potentiometer, two

aerial-earth connection strip carries four sockets and is sketched in the top right-hand corner of Fig. 3.

The parts can now be mounted in their proper positions, and the position of the holes which are required for the connecting wires can be marked; also those which are to be drilled in the screen opposite the feet of the transformer  $T_1$  and choke  $I_2$ .

The low-frequency and filament circuits are wired with lead-covered cable, a good idea of the layout being given in the illustrations. Lead-covered wire is used to prevent

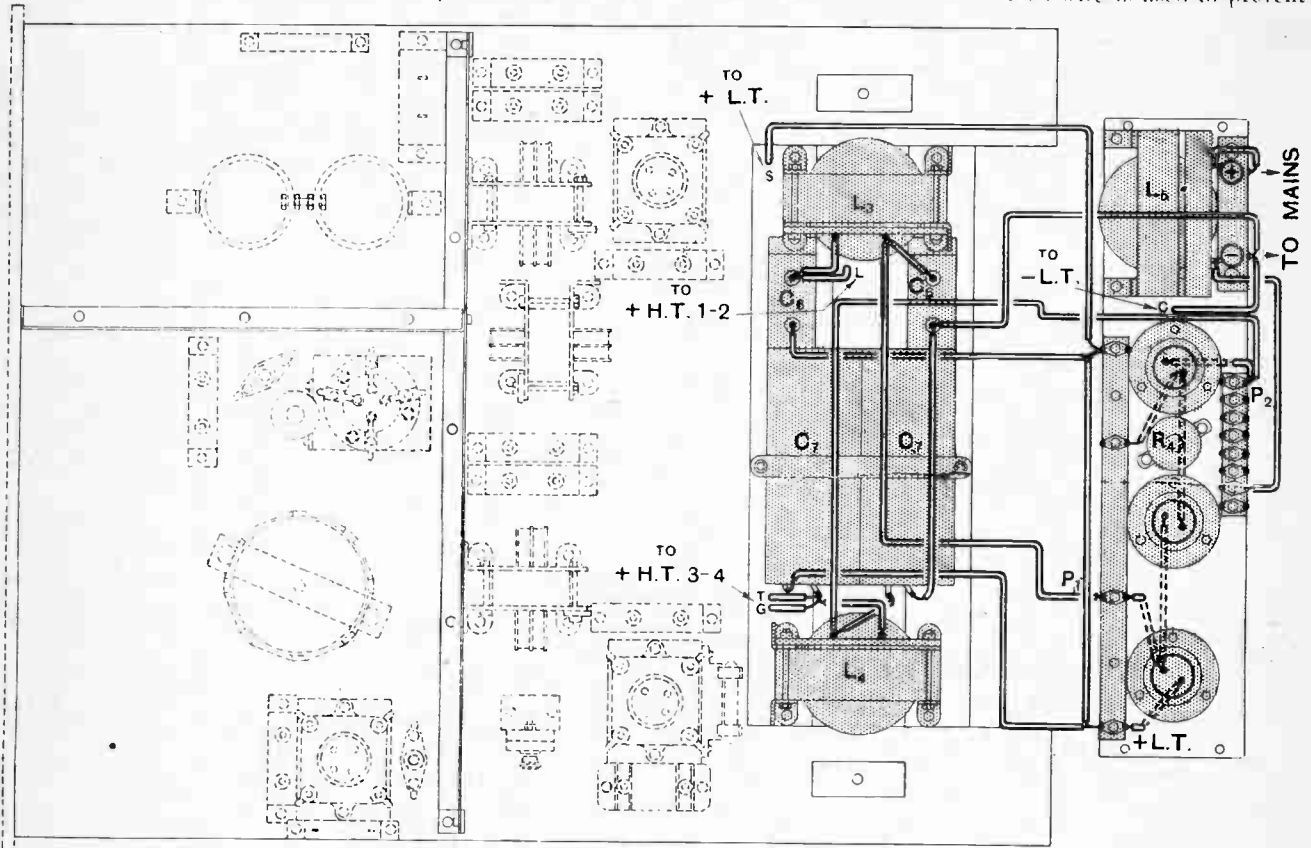

Fig. 6.—Wiring diagram of power unit.

jacks, switch, and filament ammeter. This panel is screwed to a baseboard provided with battens  $1\frac{1}{4}$  in. wide by  $\frac{3}{8}$  in. thick, as shown in Fig. 5. Details of the arrangement of the parts on the baseboard are given in this figure, but before assembling the parts the copper screen should be made and the end of the board cut away and fitted for the power smoothing unit. As the power unit is enclosed in a box of perforated zinc, the base will have to be made and fitted, and then the chokes  $L_3$  and  $L_4$  and the condensers  $C_6$  and  $C_7$  can be put in position and screwed down. Above these parts a wooden platform is mounted, and this carries the three lamp holders, the resistance  $R_1$ , choke  $I_2$ , mains terminal strip, and a second connection strip. These parts are shown in Fig. 5.

The only parts which remain to be made are the wooden blocks for the valve holders, which are  $2\frac{1}{2}$  in. high by 2 in.  $\times$   $2\frac{1}{2}$  in., and the aerial-earth connection strip. There is also a support for the balancing condenser. The

couplings and to reduce any possibility of the set howling and picking up noises from the mains.

All leads carrying high frequency currents are of ordinary connecting wire, and some of them are run in systoflex. The connections are given in Figs. 6 and 7, Fig. 6 showing the wiring of the power circuit and Fig. 7 that of the receiver proper. It will be noticed that in the diagram certain wires are not shown in full. This is done in order to prevent confusion. These wires are marked by letters. From the filament of valve  $V_4$ , for instance, a wire is shown passing to condenser  $C_4$  to a point marked U; the wire passes below the baseboard at this point, and comes up again at point U by the side of valve  $V_3$ . The same method of identification is used with the remaining wires which pass below the baseboard.

When the wiring has been done it should be strapped together and earthed by connecting the lead covering to the screen. This in turn is connected to one side of

**"No Battery" Receiver.—**

condenser  $C_5$  joined in the earth lead of the set.

**Valves Used.**

For the H.F. position a D.E.5 type valve or a Cosmos S.P.18 Red Spot valve is recommended; for the detector a Cosmos S.P.18 Green Spot, and for the two L.F. valves a D.E.5 and a D.E.5a. These valves work very well in series when the filament current is adjusted to 0.25 ampere.

Three lamps are required, and here a difficulty is met with. If metal filament lamps are used a heavy current passes at the instant of switching on; on the other hand, the current gradually increases to its working value when carbon filament lamps are used. Now the voltage for the detector and H.F. valves should be about 60, which is obtained by connecting the H.T. wire for these valves to point  $P_1$ , the three lamps to being approximately equal in resistance. These lamps also have to be of such a size that they will pass rather more than the normal filament current with the regulating resistances cut out.

The writer actually uses two 30-watt 100-volt metal filament lamps, and one 50-watt 200-volt carbon filament lamp, the mains voltage being 220. No surge of current through the filaments then takes place at the instant of switching on.

When setting up the set, however, it is advisable to connect a temporary resistance in one of the main leads to prevent the possibility of overrunning the valves, gradually cutting out this resistance while noting the current indicated by the filament ammeter.

**Final Adjustments.**

Fuses and high-frequency choke coils should also be connected as explained on page 871, and these can be mounted on the inside of the back of the cabinet. There is plenty of room for these components, as a space was left for them.

Finally, it is necessary to adjust the balancing condenser

Fig. 7.—Wiring diagram of the receiver.

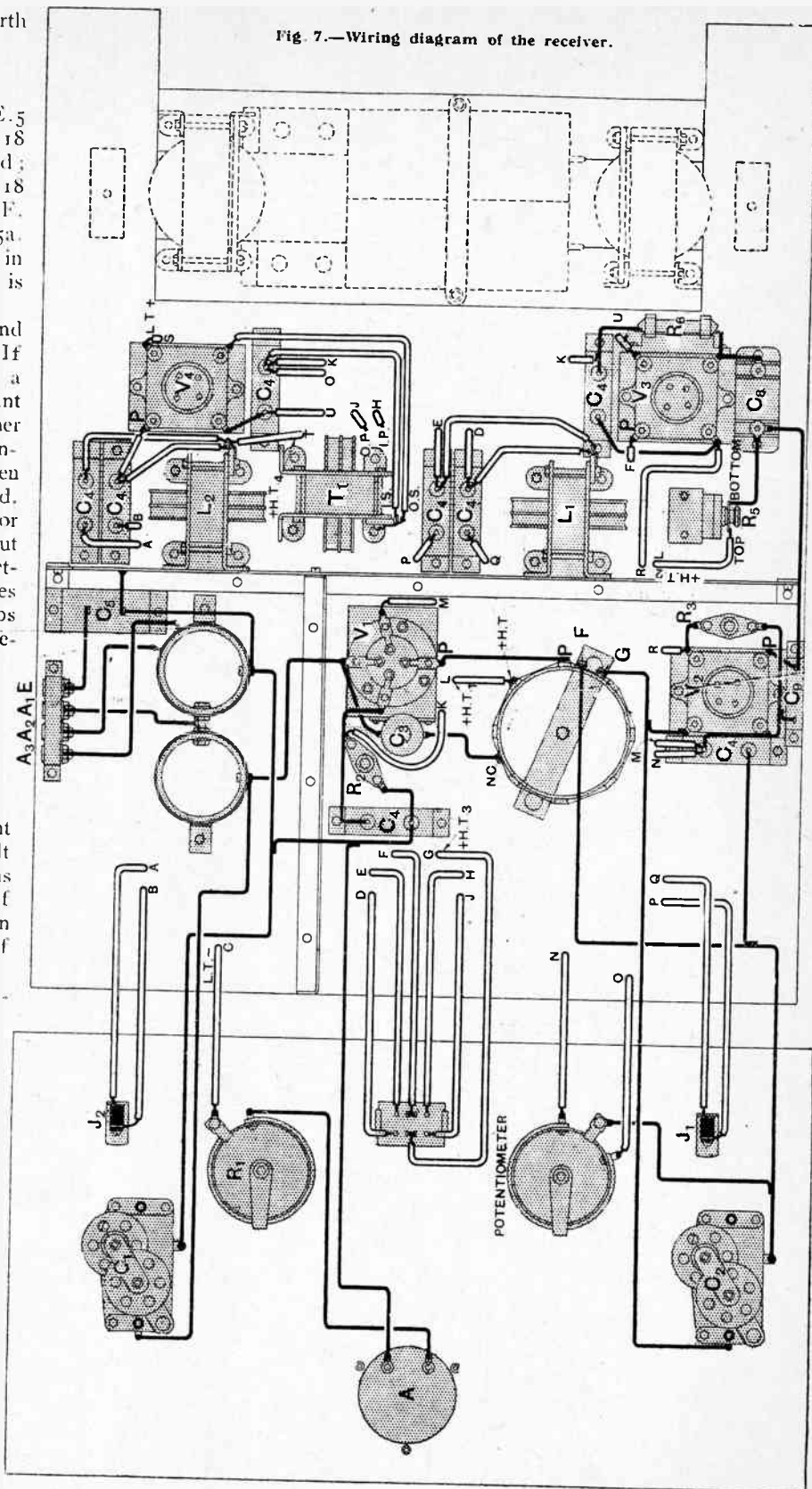

LIST OF PARTS.

- 3 1/2 in. of 3 in. paxolin tube, 1/16 in. thick (Micanite & Insulator Co.).
- 2 Variable condensers, 0.0003 (G.E.C.).
- 2 Condensers, 5 mfd., for working off 250 volts D.C. main (Telegraph Condenser Co.).
- 1 Condenser, 0.5 mfd., for working off 250 volts D.C. main. (Telegraph Condenser Co.).
- 8 Condensers, 1 mfd. (Telegraph Condenser Co.).
- 2 Condensers, 2 mfd. (Telegraph Condenser Co.).
- 3 Lamp holders (G.E.C.).
- 1 Transformer, 4 to 1 (Pye).
- 1 100 Henry choke (Pye).
- 3 32 Henry choke (Pye).
- 1 Fixed resistor, 10 ohms (Burndept).
- 1 Fixed resistor, 30 ohms (Burndept).
- 2 Holders (Burndept).
- 1 Filament rheostat, 30 ohms (Burndept).
- 1 Fixed condenser, .0002 (Dubilier).
- 1 Grid leak, 5 meg. (Dumetohm), and holder (Dubilier).

- 1 Grid leak, 1 meg. (Ediswan).
- 3 Valve holders (Benjamin).
- 1 Valve holder (Bowyer-Lowe).
- 1 Potentiometer (Burndept).
- 1 Neutro vernier (Gambrell).
- 1 Filament ammeter (Sifam Elec. Co.).
- 1 D.P. two-way switch (Burndept).
- 2 Single jacks (Edison Bell).
- Lighting lead covered cable, 24 yds., single strand No. 20 (G.E.C.).
- No. 27 enamelled copper wire, 1lb. (London Elec. Wire Co.).
- 1/4 lb. No. 30 D.S.C. Eureka (London Elec. Wire Co.).
- 2 "Decko" dial indicators.
- 4 Sockets and 2 plugs (Lamplugh).
- Perforated zinc, 1/4-in. hole, No. 22 to 24 gauge.
- Copper sheeting, No. 24 gauge.
- Litzen wire (P. Ormiston and Sons).
- Ebonite panel, 18 in. x 10 in. x 1/4 in.
- Basboard.

Approximate cost - £17 0 0

to prevent the high-frequency stage producing oscillations in the aerial circuit.

This is easily done by adjusting the balancing condenser while listening to the local broadcast station. A station working on a longer wavelength should then be tuned in, and if necessary the balancing condenser slightly reset. It is possible so to adjust this condenser that the receiver will not oscillate over its whole tuning range.

It will be noted that the selectivity of the set can be varied by means of the aerial tappings provided. Tuning will be sharp when the aerial is connected to point A<sub>4</sub>, and fairly broad when connected to point A<sub>1</sub>, provided a full-size outdoor aerial is used. If an indoor aerial is used tuning will, of course, be much sharper, but signals will not be so strong.

A further point which will be noticed is that it is not necessary to alter the potentiometer once the best setting has been found.

To switch on the set it is only necessary to turn on the filament resistance; however, as this leaves the high voltage of the mains connected to the set when the fila-

ments are switched off, it is preferable to switch off the mains when finally closing down. If a valve filament burns out, the ammeter will show that no current is passing. The faulty valve can be found by removing one valve at a time and inserting one known to be good.

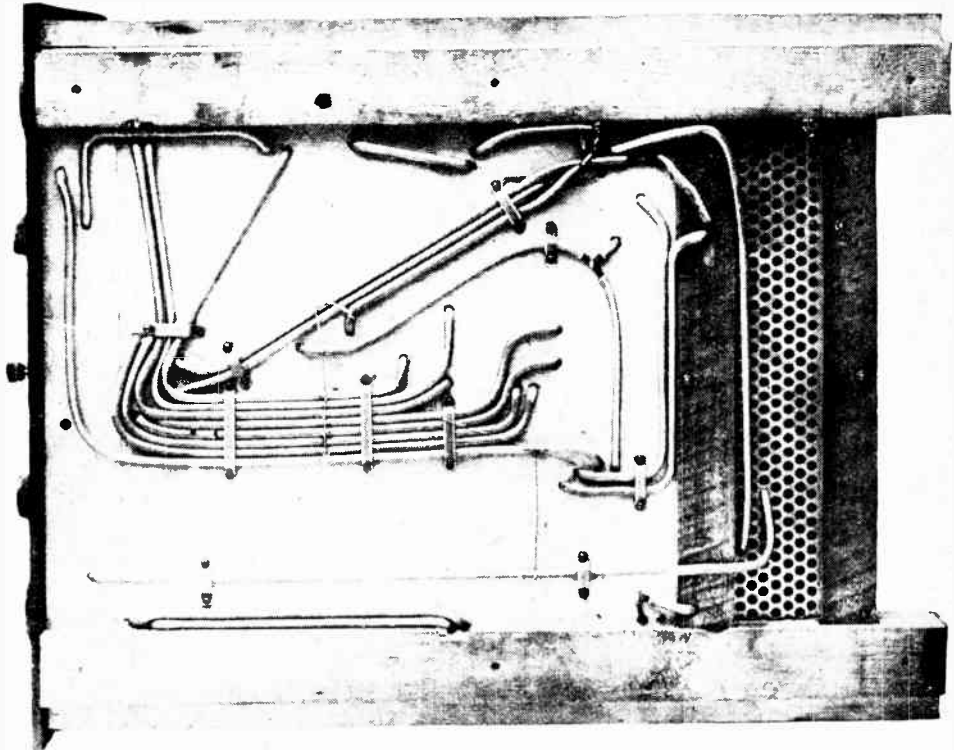

View of the under side of the set, showing the lead covered wiring.

## A.C. MAINS.

For the benefit of Readers in districts where Alternating Current Supply is available, we shall publish in our next week's issue, a description of how to build a Unit to provide H.T. and L.T. from A.C. Mains.

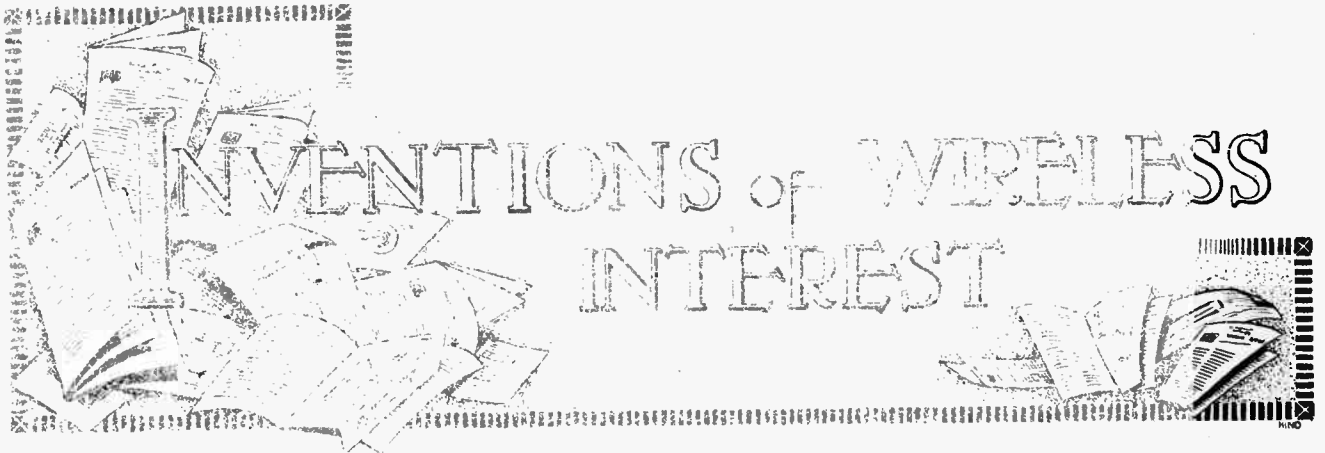

The following patents are proposed, with the permission of the Controller of H. M. Stationery Office. Specifications obtainable at the Patent Office, 25, Southampton Buildings, London, W.C.2, price 1/- each.

**The Reisz Microphone.**  
(No. 250,430.)

Application Date, June 25th, 1925.

Details of the Reisz microphone are described in the above British patent by E. Reisz. The microphone consists essentially of a block of marble M provided with two tunnels T joined by a channel C. The two tunnels contain electrodes E, which are connected to terminals by means of rods passing through the marble block. The channel and the two tunnels are filled with coal dust, and the dust is kept in position by a diaphragm of thin stretched rubber. An additional feature of the invention is the use of a ring R

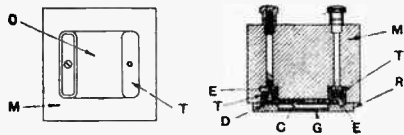

Details of the Reisz microphone.  
(No. 250,430.)

of appreciable thickness, which covers the rubber diaphragm in front of the region over the ends of the electrodes, and this protects the ends of the electrodes from the direct action of any sound waves. The diaphragm is protected by a piece of gauze which is carried by the ring. The specification mentions that the distance between the rubber diaphragm and the adjacent surface of the channel is from three to four millimetres, the size of the grain is that which would not pass through a sieve of two hundred meshes per square inch, and the pressure of the rubber diaphragm is that of a rubber skin 0.15 mm. thick slightly stretched.

**Carborundum Detector.**  
(No. 251,078.)

Application Date, March 26th, 1925.

A modification of the carborundum crystal detector is described by the Carborundum Company in the above British patent. It is pointed out that if potentials of fairly high magnitude are applied to a crystal rectifier it may not be capable of rectifying them fully, and the object of this invention is to modify the crystal

in such a way that it is capable of dealing with larger potentials. One arrangement of the device is shown in the accom-

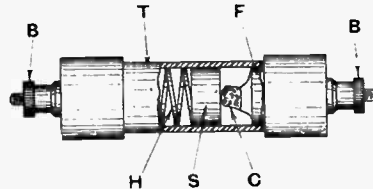

Permanent carborundum detector (No. 251,078.)

panying illustration, in which a piece of silicon carbide or carborundum C is very carefully cleaned to remove all impurities from its surface. One portion of the surface is then coated or sprayed with a thin deposit of metal, which is subsequently built up and fixed to a piece of solder F. The other end of the crystal is in contact with a steel plate S controlled by a fairly heavy spring H, the whole being contained in a tube T provided with terminals B.

**A Variometer Detail.**  
(No. 250,278.)

Application Date, July 13th, 1925.

A combination of two variometers providing for a number of circuitual arrangements is described by R. B. Matthews

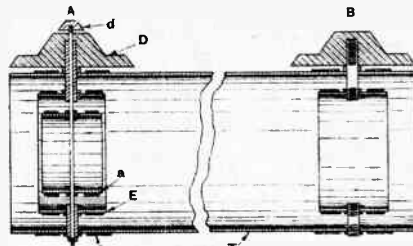

Twin variometers, with provision for reaction coupling. (No. 250,278.)

and W. H. R. Pike in the above British patent. The invention consists in providing an insulating tube T with two windings forming respectively the stators of

two variometers. One variometer B is provided with a rotor. The other variometer A is provided with one rotor E controlled by a knob D, this variometer also containing another rotor a, controlled by a knob d, and, in addition, the second rotor a forms part of the stator winding of the variometer B. By this means it is found possible to couple one variometer to the other conveniently and also to introduce reaction and other effects by means of one or other of the rotors.

**Cone Loud-speaker Diaphragm.**  
(No. 241,869.)

Conv. Date (U.S.A.), October 21st, 1924.

The British Thomson-Houston Company, Limited and W. B. Potter, in the above British patent, describe the construction of a loud-speaker in which the novelty lies essentially in the use of a type of diaphragm illustrated by the accompanying diagram. The diaphragm D is composed of stiff paper or similar material made into the form of a cone,

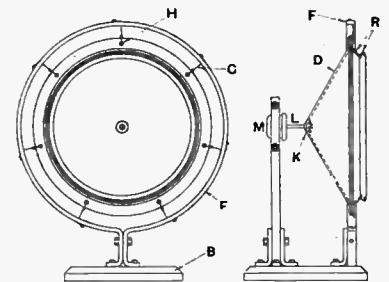

Cone diaphragm of special construction.  
(No. 241,869.)

the end of which is flanged and attached to a ring R, the edge of the base of the cone being bent as shown. The ring R is provided with a number of holes H through which are attached pieces of cord C, fixed to a circular framework F. The apex of the cone is attached to a link L, which is operated by an ordinary telephone movement M, fixed to an upright support. The chief novelty of the invention lies, of course, in the method of suspending the cone, and also in the method of bending the edge.



A Section Mainly for the New Reader.

**THE "SINGLE-COIL" REINARTZ RECEIVER.**

It seems fairly certain that the simplest form of Reinartz receiver, having a single continuously wound tuning coil, with tapplings for connection to grid, filament, aerial, and reaction condenser, which was described in *The Wireless World* for June 16th, is at least as effective as the more elaborate forms of the same circuit. Not the least of its advantages lies in the fact that it is readily adaptable to the very short wavelengths, although it must be admitted that there are certain difficulties in modifying it for reception of long-wave stations, such as Daventry. Fortunately, however, this station, which uses very high power, may be received at considerable distances without the need for maximum efficiency in the receiver.

The circuit, with the addition of a single stage of transformer-coupled L.F. amplification, has been redrawn in Fig. 1, which shows, at the same time, how the coil may be interchanged. This coil may well be considered in sections, as shown in the diagram, those marked A, B, and C being respectively grid, aerial, and reaction sections. Assuming a coil of the conventional diameter of 3in., some 60, 15, and 20 turns will be required in the various sections, in the order given, to adequately cover the normal broadcast band of wavelengths, with a tuning condenser of 0.0005 mfd.

The capacity of the reaction condenser (R.C.) and the number of turns in the reaction section (C) are interdependent. The greater the capacity of this condenser, the fewer are the number of turns required. Current practice varies widely in this respect, and, indeed, it is not a matter of very great importance, but it is

perhaps as well to use a condenser of 0.0002 mfd., with the reaction winding specified above. An existing condenser of 0.0003 mfd. may be reduced to 0.00015 (a satisfactory value) by connecting in series with it a fixed capacity of 0.0003; this arrangement has the advantage that if the fixed and moving vanes should accidentally become bent and make contact, a short-circuit of the H.T. battery will be prevented.

given above for the windings of a "broadcast" coil, it should be noted that the use of a tuning condenser of 0.00025 mfd. will necessitate a slight increase to the number of turns in the grid section.

The use of a variable tapping for the aerial connection is always an advantage, particularly on the shorter wavelengths, as it is hardly possible to lay down a hard-and-fast rule as to the number of turns which should

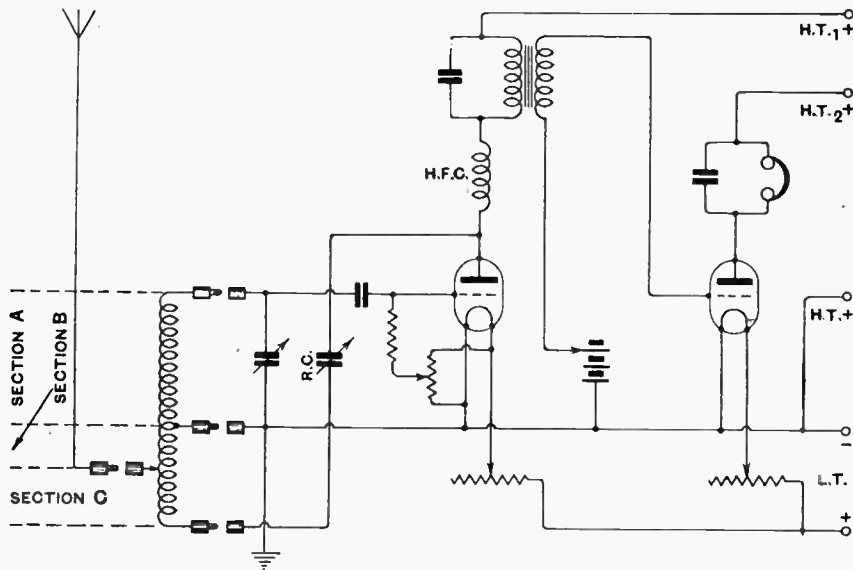

Fig. 1.—A modified Reinartz receiver with interchangeable coils.

A coil with a total of some 20 turns having, respectively, 10, 5, and 5 turns in the sections A, B, and C already mentioned will be found suitable for receiving several of the more interesting short-wave transmissions, provided that a tuning condenser of 0.00025 mfd. is used. This, it may be added, is quite as large a capacity as is permissible for this class of work, and is a good value for a set intended to cover a large band of wavelengths. Referring to the data

be included in this circuit; this will vary with different aerials and, to a lesser degree, with the actual wavelength to be received.

A suitable coil for the 1,000-2,000 metre waveband would have a total of some 400 turns, depending on the diameter and method of winding, with 250, 75, and 75 turns respectively in sections A, B, and C. Such a coil, if wound as a single-layer solenoid, would be unduly bulky, and it is better to adopt some form of lattice

520

or file winding, with the three sections side by side and connected in the same magnetic sense.

It is useful to know that windings of comparatively heavy wire are by no means necessary in the aerial and reaction sections (particularly the latter), and that considerable economy in space may be effected by using fairly fine wire. As for the inductance coil in the aerial sections A and B, they may be wound with No. 22 D.S.C. wire, and for the remainder, No. 20 D.S.C. or even finer wire, is apt to be better. Use of the aerial section, as with the reaction coil, is a matter of convenience rather than necessity, so far as the reaction coil is concerned.

o o o o

**BIASSING THE DETECTOR VALVE.**

In conventional circuit diagrams it is usual to show the return lead of the detector grid circuit as connected

to either the positive terminal of the L.T. battery or to the positive side of the valve filament. Alternatively a similar effect is obtained by connecting the leak between the grid and the same low-potential point as

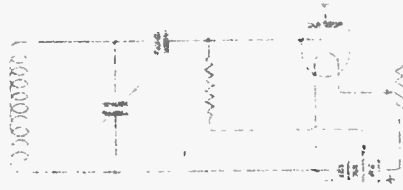

Fig. 2.—Positive bias from the L.T. battery.

With certain valves and under certain operating conditions it may well be found that this method causes the application of an excessive amount of positive voltage to the grid, particularly when a 4- or 6-volt L.T. battery is used. The result will be an impaired detection efficiency and an

unnecessarily heavy drain on the L.T. battery, and it is for this reason that the use of a potentiometer has often been advocated in this journal. The addition of this component to an existing set may, however, be inconvenient in many cases, when the system of connections shown in Fig. 2 may be tried, often with advantage. This allows of adjustment of the leaking grid potential by steps equal to the voltage of each individual cell of the L.T. battery.

The diagram is almost self-explanatory, and it will be seen that the lower end of the grid leak, instead of being joined to the filament lead, which is brought out from the set for connection to the point on the L.T. battery which is found to give best results. Needless to say, the method, for obvious reasons, is only applicable when this battery has two or more cells.

**DISSECTED DIAGRAMS.**

**No. 34.—Improving a Valve-crystal Reflex Receiver.**

*In the present series of diagrams it is proposed to indicate methods whereby various popular types of receivers may be improved and brought into line with modern practice. By treating the various points separately, it is hoped that the necessary alterations in wiring will be made clear.*

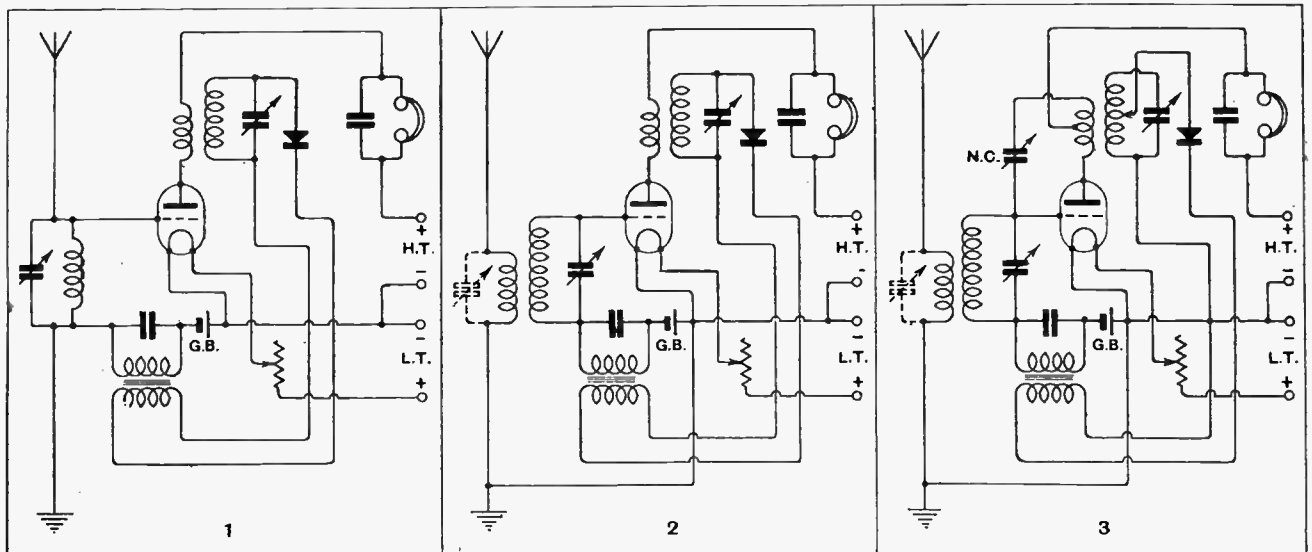

A conventional type of single-valve reflex receiver with crystal detector. Both tuned circuits are more or less highly damped, so the set cannot be regarded as selective, and the crystal detector is probably not operating under the best conditions.

The addition of a coupled aerial circuit (which may be separately tuned) results in a distinct gain in selectivity, and, moreover, enables us to "earth" the batteries. Self-oscillation is generally prevented by the damping effect of the crystal detector, but—

—it is distinctly better to use a neutralized transformer, at the same time reducing damping by connecting the crystal across only a part of the secondary inductance. Note that the H.F. transformer secondary may often be earthed with advantage.



# PIONEERS of WIRELESS



BY ELLISON HAWKS F.R.A.S

## 19.—Johnson, Melhuish and Stevenson.

THE success of the experiments of Trowbridge and Dolbear in America inspired further research in England and elsewhere. The most notable results of these experiments were achieved by W. P. Johnson and W. F. Melhuish, in India—who sent wireless messages by conduction across canals and rivers—and by C. A. Stevenson, in Scotland, whose results were to a certain extent based on Trowbridge's suggestion of the previous year for communication by induction.

### Successful Experiments in Conduction.

On September 9th, 1876, Johnson, Chief Electrician to the Indian Telegraph Department, successfully transmitted across a canal 200 yards in width, using a modification of Morse's system. He had previously at intervals experimented with fair success across the River Hooghly, at Barrackpore, near Calcutta, and as a result of his work he was led to the following conclusions: (1) It is perfectly easy to signal through a bare wire under water up to distances of one and a half miles. (2) That, judging from experiments, practical signalling is not possible for greater distances.

In April, 1889, Johnson died, and W. F. Melhuish was appointed in his place as Electrician to the Indian Telegraph Department. Melhuish continued to experiment as Johnson had done, and produced some very interesting results, which he embodied in a paper read before the Institution of Electrical Engineers on April 10th, 1890.

"Having studied the recorded labours of my predecessor," he said, "and learnt that by pursuing the same lines it was hopeless to expect to be able to signal through a bare wire across a river that had a greater breadth than one and a half miles, I resolved to change the class of signalling apparatus and to continue the experiments. . . . I tried to signal across a waterway without a metallic conductor by laying down two earth-plates on each of its opposite banks.

After signals had passed, the distance separating each pair of plates was varied, with a view to ascertaining how close the plates might be brought together. Readable signals were exchanged when the distance separating the plates was equal to the breadth of the river. Reading became more difficult as the plates approached each other, and clearer and more distinct as the distance between the plates exceeded the breadth of the river."

Melhuish concluded from these experiments that in order to obtain practicable signals it would be necessary to erect on each bank a line that was much longer than the breadth of the river. As the rivers along the coasts in India are extremely wide, he came to the conclusion that the system was unworkable.

He thereupon tried a new experiment and laid two

bare uninsulated iron wires across the water-way, looping the ends together by means of an insulated conductor. Thus, although much of the circuit was under water, it was, nevertheless, a continuous metallic circuit. He commenced with a complete square of wire, laying the wires as many yards apart as the river was wide. Loud signals were instantly exchanged, but when the length of wires under water was gradually increased to 740 yards, and the distance separating them gradually diminished to 35 yards, the strength of the signals diminishing proportionately and ceased to be readable when the wires were further approached.

The conclusion arrived at from these experiments was that, for the practical and useful purpose of signalling messages across a broad river, in the absence of an insulated cable, a complete metallic circuit was at least desirable. Acting on this conclusion, he endeavoured to apply it practically, and the following experiment was carried out. Fifteen miles west of Calcutta a cable was laid across the River Hooghly, which at this point was 900 yards in width. The iron guards of this cable were employed to form one of the metallic conductors, and at a distance of 450 yards down-stream a single wire was laid across the river to form the second metallic conductor, insulated land-lines having been run up to loop the two parallel conductors together. The experiment was quite a success, the signals being readable without difficulty.

### Experiments with Faulty Cables.

A second experiment was then made of a defective cable across Channel Creek, at the mouth of the Hooghly. This creek was crossed by two cables laid in the same trench, the length of each being 3,000 yards. One of these cables had been completely parted by a steamer's anchor, and several attempts were made to signal across by using the guards of one of the cables as a lead, and the guards of the other as a return wire. The efforts proved unsuccessful, however, owing to the too close proximity of the cables. "For every crossing there is a certain minimum distance apart at which the cables must be laid," wrote Melhuish, "and if this minimum, which depends on the breadth of the river be exceeded, an absolute short circuit becomes established. But although it was not possible here to signal through the iron guards, the most perfect signals were passed through the two conductors when they were formed into a loop, notwithstanding the fact that the two ends of the broken conductor were exposed in the sea and were lying at a considerable distance apart."

A third experiment was then made to ascertain the possibility of signalling across the two conductors should an accident occur to the good cable. Accordingly, the conductor of the good cable was disconnected in the cable

**Pioneers of Wireless.--**

house from the signalling apparatus and placed upon the ground, and it was found that the signals, though greatly diminished in volume, still continued to be distinctly readable. "It may therefore be reasonably inferred," said McWhisker, "that should the good cable suffer a similar fate to that of the defective cable communication can, by means of Cardew's senders, be kept up by looping the ruptured conductors until arrangements can be made for laying a new cable or repairing the defective ones."

**Stevenson and His Experiments with Induction.**

In 1892 C. A. Stevenson suggested in *The Engineer* (March 24th) that wireless telegraphy could be established between ships by coils of wire. Two years later, in a paper read before the Royal Society of Edinburgh, he mentioned that experiments on a large scale had been made with the object of employing the method for communication between the lighthouse on Muckle Flugga, in the Shetlands, and the mainland—a distance some 800 yards.

Stevenson calculated that it would be necessary to use coils 200 yards in diameter, and that in each coil there must be nine turns of Post Office wire and a current of 1 ampere to ensure success. "It is difficult," he said, "to understand how this system of coils, in opposition to the parallel-wire system, has not been recognised as the best; for assume that, with the arrangement we had, we heard equally with 100 cells by both systems, both having the same base (200 yards). By simply doubling the number of turns of wire on the primary and using thick wire, the effect would have been practically doubled, whereas by the parallel-wire system there is nothing for it but to increase the battery power. . . . What is wanted is to get induction at a great distance from a certain given base with a small battery power. Laboratory experiments and trials in the field show that the way to

overcome the difficulty of the current is by using a number of turns of wire. The secret of success is to apportion the resistance of primary and secondary, and the number of turns on each, to a practical battery power."

In concluding his paper, Stevenson said:—

"It has been attempted to show that the coil system is not only theoretically, but practically, the best, and I trust that we will soon hear of the Admiralty experimenting with it and ultimately putting it in practice. Meanwhile my brother has recommended the Commissioners of Northern Lighthouses to erect the coil system at Muckle Flugga, and the Commissioners have approved. I have seen a plan of the erection of this novel system of communication at the most northern point of the British Isles. It will be on our warships to resist a tact manoeuvring by the establishment of a station on a vessel, and to be affected by wind or weather.

"The application of the coil system to communication with light vessels is obvious, viz., to moor the vessel in the ordinary way, and lay out from the shore a cable, and circle the area over which the lightship moorings will permit her to travel by a coil of the cable of the required diameter, which will be twice the length of her cabin cable. On board the vessel there will be another coil of a number of turns of thick wire. Ten cells on the lightship and ten on the shore will be sufficient for the installation."

In conclusion, it must be mentioned that the installation of Stevenson's system at Muckle Flugga did not materialise, because of financial difficulties. The Commissioners were impressed by experiments of the system conducted on a small scale, during which, it is interesting to note, signals were transmitted through stone walls.

**NEXT INSTALMENT.**

Edison Signals Without Wires to Moving Trains.

**SOME NOTES ON HIGH OHMIC RESISTANCES.**

By Dr. H. KRÖNCKE.

**H**IGH ohmic resistances are used in wireless reception, both as grid leaks and as anode resistances in the couplings between the several stages of high-frequency or low-frequency amplifiers. According to the purpose for which they are used, resistances are required of approximately one hundred thousand to ten million ohms, and these cannot be manufactured effectively from wire for radio-frequency circuits. A prerequisite of such resistances is that they shall be free from capacity and self-induction, and, further, that they shall be as far as possible unaffected by variations of temperature or by humidity in the air, and finally that they shall make good contact at their points of connection. As it is impossible to wind high ohmic resistances of wire which are free from capacity and self-induction, resistances for radio purposes are constructed either from

graphite, Indian ink, or rods of special resistance material.

Resistances of graphite or Indian ink are no longer practicable for important work. It has been found that such resistances can, in fact, be used temporarily, but that they possess so many disadvantages that they must be replaced by something more reliable. Until recently the view was entertained that the high ohmic resistance rods afforded a satisfactory solution of the problem, although it had to be admitted upon investigation that the value of these rods was extremely doubtful. More precise scientific investigations, such as, for example, those of Alberti and Günther-Schulze, showed that the resistance of the "Silit" rods, widely used in Germany, was in a great measure dependent upon the applied potential, or, in other words, that the current-potential



**Some Notes on High Ohmic Resistances.—**

characteristic of "Silit" rods is curved, and, in fact, with certain rods, of an extremely diverse form. A typical characteristic of a "Silit" rod is shown in Fig. 1. Alberti and Günther-Schulze concluded from his that a "Silit" rod, provided a suitable potential be used (the characteristic being essentially symmetrical) would probably act as a detector, and they succeeded, in fact, in receiving broadcasting with a high ohmic resistance as detector, although naturally the intensity of the signals was considerably less than with a good crystal detector.

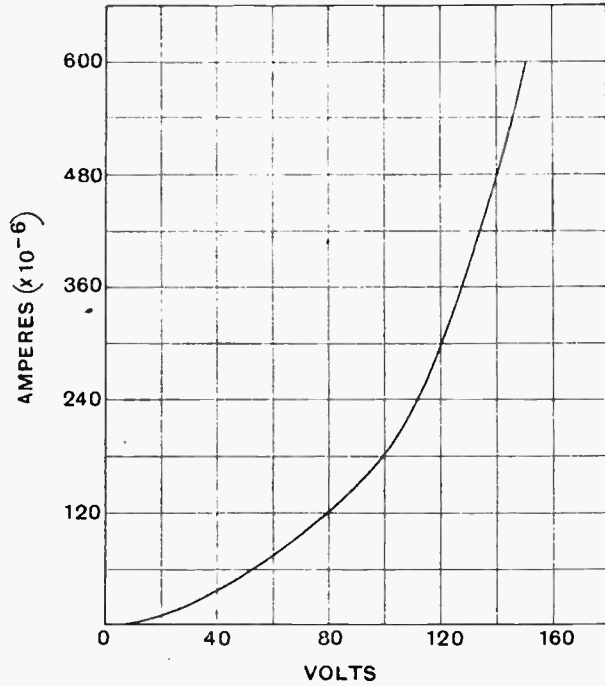

Fig. 1.—Characteristic curve of a "Silit" resistance rod indicating a variation of resistance with applied voltage.

For the purposes of radio reception this dependency of the resistance upon the load is in no way favourable. A greater disadvantage, however, is the phenomenon which manifested itself when the current-potential characteristic of "Silit" rods is taken with high-frequency alternating current. Alberti and Günther-Schulze discovered, in fact, that such a characteristic

material possess a distributed capacity which, with the usual short rods, amounted to about ten to twenty cm., a value which, with short waves, becomes noticeable. This property also renders the rods unsuitable for use as consequent disturbances of the detector effect in the valve, the cause of which was formerly not clear.

As the reason for these disturbing phenomena is obviously attributable to the small conductivity of the material used (since it is known to every physicist that bodies whose electronic conductivity is not pure, show very complicated phenomena) the general view is that a means of overcoming these difficulties is to be found in constructing the necessary high ohmic resistances of metal, not, however, of wire of great length, but in the form of an extremely thin layer. The manufacture of very thin metal layers, for example of a thickness of a millionth of a millimetre or even less, on a good insulating body, no longer offers any considerable difficulties. For this purpose use is made of the phenomenon of "sputtering," which is known to everybody who has worked with high vacuum, and which, for example, is the reason why Röntgen tubes and also amplifying valves become covered with a dark layer, in course of time, or the inside of the glass bulbs.

By means of a sputtering process Messrs. Loewe-Audion, of Berlin, manufacture high ohmic resistances (Fig. 2) consisting of a very thin metal layer on a short insulating tube about one inch long. The little tube with its connection is inserted in a glass tube about two inches in length, which is provided with metal caps and exhausted.

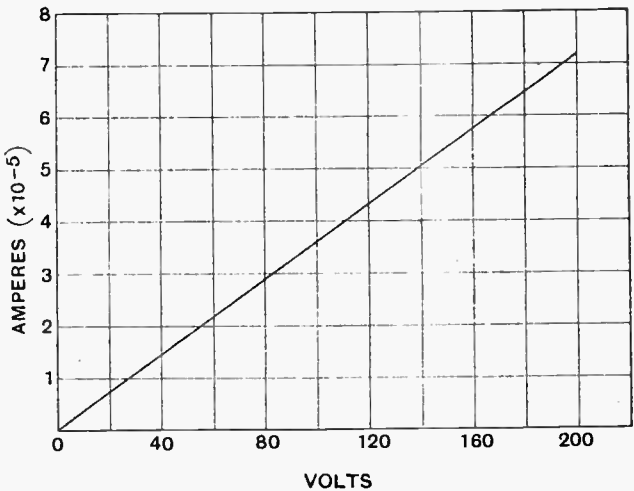

Fig. 3.—Characteristic of the Loewe resistance for potentials up to 180 volts.

The resistances thus manufactured, which are produced in values from about one hundred thousand to ten million ohms, are not only completely independent of atmospheric influences, but they have also no noticeable self-capacity, and are completely independent of the load, as is shown in Fig. 3, which represents the current potential characteristic of a Loewe resistance with potentials of 0-180 volts. The Loewe resistances are therefore suitable for use not only as grid leaks, but also for coupling valves in high-frequency and low-frequency amplifiers.



Fig. 2.—Resistance unit consisting of a thin metallic film deposited on a short tube of insulating material

takes the form of a loop, a phenomenon which can only be explained by the fact that one is not here concerned with a pure resistance, but with a resistance having a noticeable capacity in parallel with it. It is, of course, difficult to say whence such capacity proceeds. The fact is, however, that resistance rods of bad conducting

# REVIEW OF APPARATUS

Latest Products of the Manufacturers

## CRYSTAL DETECTOR.

The first detector is a clip-on type, which can readily be brought into operation, is, moreover, always useful for providing a comparative test of crystal adjustment.

The second detector, which can readily be brought into operation, is, moreover, always useful for providing a comparative test of crystal adjustment.

The clip-on detector is well made, and although quite small, the illustration being about two-thirds full size, is quite reliable. The pieces of crystal are enclosed in a small insulating tube, one of them being actually secured by means of Wood's metal into a brass cup, which

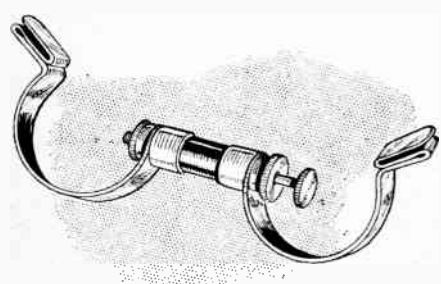

An auxiliary detector provided with spring connectors arranged for bridging the contacts or terminals of a detector permanently fitted to a receiving set.

is a considerable improvement upon the arrangement so often adopted of clamping together two pieces of crystal under a spring. The metal parts would appear to be actually silver plated, which is a departure from the more usual practice of nickel plating.

## PHILIPS FILAMENT FUSE.

When changing valves or in the course of altering connections, it sometimes occurs that the filaments are accidentally placed in circuit with the high tension battery, resulting in the destruction of all valves on the circuit.

The easiest way of overcoming this difficulty is to connect a spool of resistance wire in one of the H.T. battery leads, though it will readily be appreciated that

The voltage drop produced by such a resistance is appreciable, and would amount to as much as 25 volts in the case of a receiver passing a plate current of 15 mA., being the product of 1,700 times 0.015. It is obvious, also, that a resistance which ensures sufficient protection at 100 volts could not be relied upon at 125 volts or more.

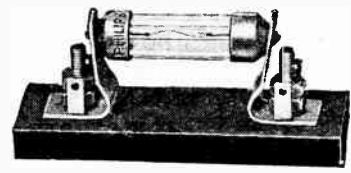

The Philips filament protecting fuse.

Philips Lamps, Ltd., 145, Charing Cross Road, London, W.C.2, now manufactures a protecting device in the form of a filament fuse. The safeguard is in the form of a small glass tube fitted with metal end caps and containing a thin sealed-in wire, which under normal working conditions offers such a small resistance that the potential drop is limited to a very small voltage. The maximum current passing through the fuse under normal working conditions is about 30 mA., while the resistance amounts to only about 18 ohms. When the resistance is placed between the negative terminal of the anode battery and the lead to the accumulator, the valves are satisfactorily protected against breakage through excess of current.

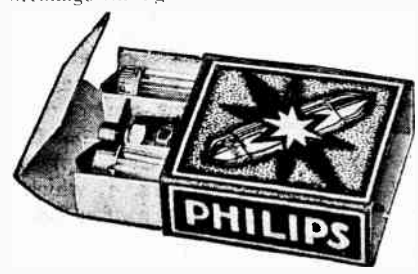

Philips filament fuses are supplied in pairs, complete with mounting base.

The direction of winding adopted in the construction of plug-in coils is by no means uniform, and when interchanging coils of various makes it is not uncommon to find that the direction of reaction coupling has been reversed. A reaction reversing switch is undoubtedly a useful device, though valuable space is often taken up when fitting a double-pole two-position switch for this purpose, whilst the receiving set is further complicated by the additional wiring. The proper

## REACTION REVERSING SWITCH.

The direction of winding adopted in the construction of plug-in coils is by no means uniform, and when interchanging coils of various makes it is not uncommon to find that the direction of reaction coupling has been reversed. A reaction reversing switch is undoubtedly a useful device, though valuable space is often taken up when fitting a double-pole two-position switch for this purpose, whilst the receiving set is further complicated by the additional wiring. The proper

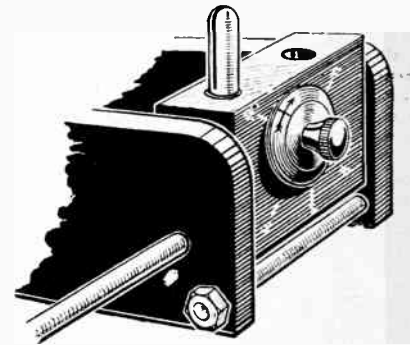

Compact reaction reversing switch incorporated in the plug and socket mount of the Quality coil holder.

place to fit the reaction reversing switch is on the coil holder itself and this has been carried out in a very neat manner by the Goswell Engineering Co., Ltd., 95-98, White Lion Street, London, N.1, manufacturers of "Quality" radio components.

The switch is of quite simple construction, the contacts being recessed into one side of the holder. The design is certainly ingenious, though the action would be rendered more reliable if stiffer springs were employed for the contacts, which are composed of flat brass strips pressed down into contact with screw heads. The idea is certainly a good one, and the design adopted should lend itself to the setting up of a really reliable switch.



# Broadcast Brevities

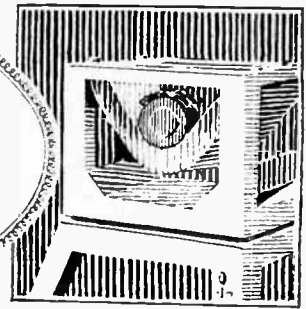

## Savoy Hill Topicalities : By Our Special Correspondent.

### Broadcast Range Extended.

Listeners noticed that reception from 2LO was a good deal more powerful during the general strike; and many appear to have jumped to the conclusion that the input power of the transmitter had been increased. This was not the case. A certain amount of over-control was effected to ensure good reception, particularly of the news bulletins. By overcontrolling, the B.B.C. brought some two per cent. of additional listeners within crystal range; but considerable detuning had to be resorted to by valve users.

o o o o

### But not Permanently.

The inquiry now made is: Why cannot the engineers, having once done it, extend the crystal range of 2LO permanently? In the first place, there is no reason why control should be adapted for people with poor sets and to the detriment of those with decent apparatus. Complaints were heard a year ago, when the transmitter was transferred from Marconi House to Oxford Street, about the inability of valve users to tune out London, owing to the increased power of the new station. We should surely have a revival of those complaints if the signals were made permanently stronger. During the strike, there was comparatively little "reaching-out." Listeners were content to receive the British stations in order to get the latest information about the crisis.

o o o o

### Quality Preferable to Quantity.

In the second place, the wear and tear on apparatus at the transmitting end hardly justifies over-modulation in normal circumstances. The policy of quality rather than quantity still prevails at Savoy Hill, and that it is the wise policy seems to be proved by the fact that Continental stations which formerly made a regular practice of over-modulation are now following the lead of the B.B.C., as they found that their valve bills would not stand the racket.

o o o o

### Gramophone Transmissions.

The question whether gramophone record transmissions are wanted or not received a decided answer last week at 2LO. The purely accidental omission by the announcer of the title and number of a record brought sufficient correspondence

to indicate that listeners are taking a large amount of interest in these transmissions and that the feature is even more popular than was supposed.

o o o o

### Perlmutter to Broadcast.

Mr. Nick Adams, the original Perlmutter in "Potash and Perlmutter," is to do a stump Jewish speech as one of the items in the variety programme of July 8.

o o o o

### Deep Sea Diving.

Mr. Frank Shield, the diver who is undertaking the novel broadcast for the B.B.C. on July 5, will dive from the parapet of the County Hall, Westminster Bridge, by kind permission of the London County Council. He will talk on "Deep Sea Diving" before his immersion and will also describe his movements from the bed of the river.

### An Interesting Subject.

Our diver's talk should be interesting to people who have but a hazy conception of the methods adopted, especially for bringing a diver to the surface after he has done his work. If he has been working for one hour at a depth of 150 feet it takes an hour and a half to bring him to the surface.

o o o o

### Matinée Concerts.

The B.B.C. has been contemplating the transmission of matinée concerts and hopes soon to be in a position to make an interesting announcement on the subject. The scheme in view is to obtain the services of stage "stars" who would be willing to take part in performances, say once a week, at a time which would not interfere with their other engagements. These would be in the nature of "all-star" broadcasts.

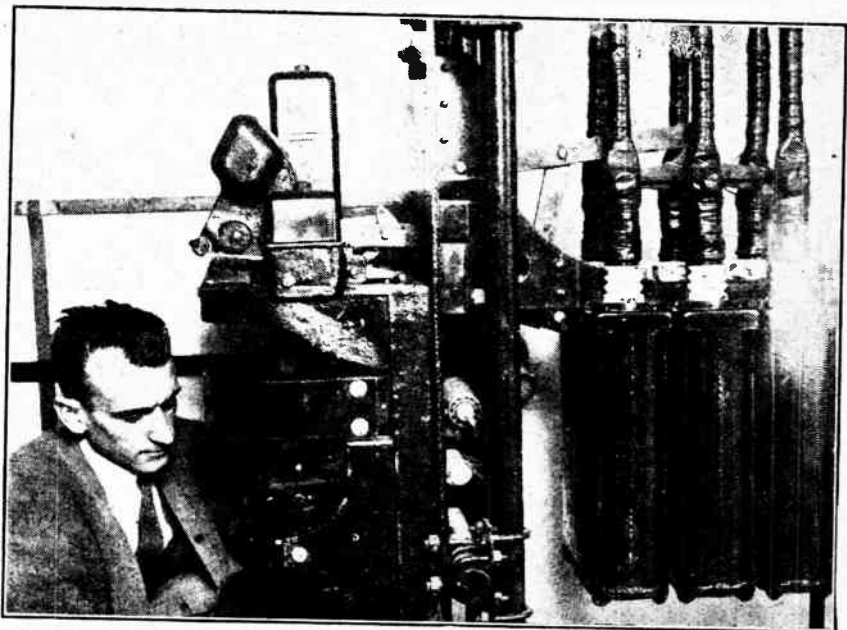

**A LARGE SIZE IN SWITCHES.** This photograph gives a good idea of the generous scale on which WJZ, the super-power broadcasting station at Bound Brook, N.J., is built. This is one of the motor-operated switches worked from the control room.

**What do Listeners Prefer?**

London broadcasts from Daventry (which involved opposition to alternative programmes) were demanded by listeners to the high-powered station almost from the day of its birth. Now the problem under discussion is: To what extent do listeners to the provincial stations generally favour local talent in preference to artists imported from 2LO and who would broadcast from the London studios.

**To Test Local Opinion.**

Up to the present day preference that may exist has not found the necessity for experimental tests in the case of the Leeds-based station, where local opinion is in favour of local talent, but I should not be surprised if the Programme Board in London were soon to put opinion elsewhere to the test by trying the experiment of giving some of the main stations programmes of their own from the London studio. If this were done at all, the move would not be carried out on the grounds of economy, but in order to give other stations the benefit of the talent concentrated in the metropolis. Such programmes would be relayed by land line to individual stations and would be distinct from S.B. programmes.

o o o o

**Daventry's Birthday.**

Daventry station, by the way, celebrates its first anniversary on July 27 and the event will be suitably celebrated in the programme of the high-power station for that day.

o o o o

**Weird Noises at 2LO.**

As I ascended in the lift at 2LO one morning last week, I was startled by weird and sustained rumblings. I entered one of the upper rooms, where the rumblings took on a sweeter and more musical sound. This was traceable to a ventilating shaft filling one angle of the room—a curious structural phenomenon to be found in several of the rooms in the newer part of the B.B.C. offices opened less than a year ago.

o o o o

**The Sousaphone.**

The ventilating shaft, it was stated, connected with the studios and the sounds of bands at rehearsal often penetrated to the offices above; so down I went to the studios to investigate the cause of the rumblings. I found that a Sousaphone was responsible for the unfamiliar noise, and inquiry showed that this instrument has been proved to transmit very effectively indeed when used in conjunction with a certain type of microphone. It corresponds to the double-bass in the ordinary string orchestra and the dance band is greatly improved by its inclusion. Its use may therefore be extended as occasion offers.

o o o o

**A Brighton Broadcast.**

The new series of broadcast from prominent towns, referred to some time ago in these columns, will begin on July 2, when listeners should hear the programme

**FUTURE FEATURES.****Sunday, July 4th**

LONDON.—American Programme.  
BOURNEMOUTH.—King's Hall Concert relayed from the Royal Bath Hotel.  
DAVENTRY.—Children of the "May Bower," an Independence Day Programme.

NEWCASTLE.—Light Vocal and Instrumental Concert.

**Monday, July 5th.**

LONDON.—Variety Programme by Leslie Henson.  
ABERDEEN.—A Musical Revue.  
NEWCASTLE.—Night Orchestra.

BIRMINGHAM.—Night Orchestra.  
BOURNEMOUTH.—"The Last"—A Drama of the North-West of Canada.

BELFAST.—"The Sweep," a Play presented by the Belfast Radio Players.

GLASGOW.—Night Orchestral Concert.

**Tuesday, July 6th.**

LONDON.—"What Would You Do?"—A Competition.

DAVENTRY.—A Village Concert—The Vicar of Mirth in the Chair, supported by the Roosters.

CARDIFF.—The Genius of Hungary.  
MANCHESTER.—A Breath of Sea Air and a Round of Golf.

**Wednesday, July 7th.**

LONDON.—Willie Rouse and Party.  
"Rigoletto."

ABERDEEN.—Scottish Programme.  
CARDIFF.—A Request Programme.  
GLASGOW.—Elizabethan Programme.

NEWCASTLE.—The Black Dyke Mills Band.

**Thursday, July 8th.**

LONDON.—The Royal Parks Band relayed from Hyde Park Bandstand.

ABERDEEN.—The Black Dyke Mills Band.

BOURNEMOUTH.—Concert from the Winter Gardens.

NEWCASTLE.—Variety in Song and Humour.

**Friday, July 9th.**

LONDON.—Murray Ashford's Entertainers relayed from the Summer Theatre, Ranelagh Gardens, Felixstowe.

BIRMINGHAM.—The Radio Follies.  
BOURNEMOUTH.—"John Citizen" has a Picnic.

BELFAST.—Variety Programme.  
GLASGOW.—The Black Dyke Mills Band.

MANCHESTER.—Spanish Landscape.

**Saturday, July 10th.**

LONDON.—Programme arranged by Andre Charlot.

BIRMINGHAM.—Parks Concert. The City of Birmingham Police Band.

GLASGOW.—Music and Mirth.  
NEWCASTLE.—A Ballad Concert.

relayed from Brighton. This will with a few remarks by the Mayo Brighton from the Hotel Metropole by Sir Cooper Rawson, Brighton's M from the London station. The Bar the Royal Dragons will be relayed the West Pier Pavilion and a performance by V. H. Gane and Company from program. The Sussex Women's 1 Club will contribute to the programme from the Octagon Room a Metropole and the programme will be a dance music by the "Metropolitan" from the Winter Garden of the

o o o o

**Who Killed Cynthia?**

What happened to Cynthia? The studio was sufficient of a to the people at Savoy Hill; but the of her death remains a mystery which apparently insoluble.

o o o o

**Microphone Fright.**

Cynthia was (1) electrocuted, (2) she had taken something in her diet mineral nature and was thus attracted the magnetic field into which she suddenly thrust for broadcasting poses, or (3) she died of stage fright (4) the jazz band rehearsing in an ad studio was the cause of her demise. microphone had been uncovered and thia was placed upon it in order to her capacity for conveying to lis the tapping of her tiny feet in a *pas* To the dismay of her owner, Mr. Hogarth, who is to broadcast a ta the propensities of her tribe during she expired within one minute; and Mr. Moore Hogarth Broadcasts he have to enlist the co-operation of th Cynthia's heirs, executors and assi

o o o o

Cynthia was a mosquito.

o o o o

**The Popularity of Martial Music.**

As *The Wireless World* has times pointed out, broadcasts in military and marine activities for *piece de resistance* find great favour listeners, owing to the fact that the is full of harmonious bustle. S martial music will always have a following among the rank and listeners than the rather subdued and sedate chamber music to which they been more or less responsive for time past. Hence, I hope that the cials at Savoy Hill will not overlo Annual Torchlight Tattoo of the Marines at Deal next August. the counterpart of the recent Sear Tattoo at Aldershot and some of the then broadcast, notably that magnificent finale, might be incorporated.

o o o o

**Autumn Programmes.**

Programme timings will be early in the autumn. The chief of the rearranged programmes will transfer of the second general news tin to 10.0 o'clock and the introduction a music recital at 9.45 in continuation the 7.25 recital of the classics which been widely appreciated. This r bears out the forecast made in columns several weeks ago.



The Editor does not hold himself responsible for the opinions of his correspondents.

Correspondence should be addressed to the Editor, "The Wireless World," Dorset House, Tudor Street, E.C.4, and must be accompanied by the writer's name and address.

**BELOW 25 METRES.**

Sir.—May I be permitted to point out through the medium of your columns that it is a great pity that the band of wavelengths below 25 metres is not more generally used.

This section of the wireless spectrum has several very great advantages to its credit, amongst which are: No QSS, little static, remarkable DX, and the fact that the further down the wavelength scale we go the more room there is for all.

As an example of the utility of this wave band, may I remind readers of the fact that during the great "fade out" of U and C stations on 40 metres, many of these, and such stations as KFGK at Spitzbergen, were regularly audible on 20 metres in this country.

While I am on the subject of the U stations, I find that they have decidedly "come back" on 40 metres, and are very loud around 5 a.m.

In conclusion, I feel sure that if the attention of the short wave experimenter's among your readers were drawn to this matter, many would be found willing to co-operate in a more or less general exodus to really short waves.

Hale, Cheshire.

F. N. BASKERVILLE.

**AN AUTOMATIC TELEPHONE RELAY.**

Sir.—Your readers may be interested to learn that the telephone relay mentioned in the article "An Automatic Receiver," in your issue of June 9th, may be purchased from dealers in ex-Government stock, but having a lower resistance—50-1,000 ohms. If these are rewound full of 44 S.W.G. enamelled wire the resulting sensitivity will be about equal to that of the portable relay mentioned.

A. R. TURPIN.

Wembley Park, Middlesex.

**CHOICE OF BROADCAST PROGRAMMES.**

Sir.—The ideal scheme of programme distribution outlined in your Editorial of June 16th is excellent in theory, but would suffer one grave disadvantage in practice. The station originating the programme would of course put it out direct, but the two others concerned would of necessity be linked up by land line. In other words, two-thirds of the programmes put out would be S.B.

We hear much of the perfection attained by American S.B., but my experience of such programmes here is that nine out of ten of them are so seriously mutilated by line distortion and inductive interference that they are not worth serious consideration from a musical standpoint. Speech is usually so distorted that it is only by the closest attention that one can follow it coherently.

During an all-station S.B. I occasionally go round the various stations and note the degrees of distortion compared with the station originating. These vary greatly, as between stations on different occasions, and although one occasionally finds exceptions there is in the majority of cases a very great difference in quality between the station originating and the S.B. Even Daventry is not exempt, though there are times, particularly during the morning transmissions, when its quality is exceedingly good. In the evening direct comparison with London will generally demonstrate the loss in purity entailed by land transmission.

The exceptions show that good S.B. is a physical possibility, but one is forced to the conclusion that the happy conditions which occasionally produce it are mainly accidental, and not in

control. One hears that keen minds are at work on this subject, but the fact remains that the quality of S.B. has made no practical advance during the last two years, and to-day the announcement of an S.B. programme causes most discriminating B.C.L.s to switch off their receivers with a sigh!

The Post Office takes a large slice of our fees, and, I believe, also takes further large sums from the B.B.C. for hire of land lines. In exchange they give us what is unquestionably the weakest link in the whole broadcast system.

Perhaps it is rather futile to look for measurable progress from a State-controlled department. One also views with apprehension the time when our excellent broadcast system may fall under the same deadening influence. DONALD STRAKER.

Bembridge, I.O.W.

**AMATEUR RECORDING OF MORSE SIGNALS.**

Sir.—Our attention has been called to a very interesting article on the amateur reception of Morse signals in *The Wireless World* of May 5th, and perhaps you will permit us to offer some comment that may be of use to any of your readers who may lack the time and patience necessary for constructing such apparatus at home.

We wish to point out that for some years past we have been manufacturing and supplying to wireless administrations special apparatus for Morse reception. This apparatus is, in fact, the standard equipment for handling international traffic in the stations of the leading European wireless telegraph companies. The Creed Relay and Undulator (or siphon recorder) are used,

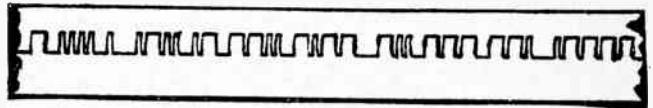

and the slip produced is like the sample we enclose. Descriptive leaflets are also enclosed for your information, and we shall be glad to supply them to any of your readers who would be interested enough to write us for them. C. A. DUKE-BAKER,

Telegraph Works, Croydon. Secretary, Creed and Co., Ltd.

**MEASURING CURRENT IN A RECEIVING AERIAL.**

Sir.—I have been carrying out some experiments on the reception of broadcasting at Kingsclere, using a galvanometer to measure the rectified current. The aerial, a single wire of 7/22 enamelled copper wire, 150ft. long, is 80ft. high at the far end and 50ft. at the lead-in. The earth consists of a zinc plate immediately under the set; which leads to a 100ft. of 3ft. wire netting laid beneath the aerial; an earth screen is also available for short waves.

The inductance used for Daventry consists of 120 turns of Litz wire (ex-Govt.) on an 8in. skeleton former, and the crystal tap comes about 30 turns above the earth connection. No condenser is used.

The rectified currents received with galvanometer in series with a 120 ohm loud-speaker, 8:1 ratio Marconi "Ideal" transformer, and 4,000 ohm phones, were respectively 120, 105, and 82 microamps.

When receiving London and Bournemouth, both about 55 miles distant, the earth screen was used, and 2.4 and 3.6 microamps, respectively were received with 4,000 ohm phones in series.

...the writer... Canadian Caveat and a British Provisional Patent... August 22nd, 1924, was also granted Canadian Caveat No. 15415 and British Patent No. 23262/23. The description contained in our application is almost a duplication of the account stated in your issue of March 10th. In our application we... the lateral loop circuit to reduce... On November 18th, 1924, we... Canadian Patent No. 294846.

...with any idea of detracting from... Messrs. Watson Watt and Herd, the priority of publication both in England and in this country, and we would be... excellent record in any way. It would be appreciated if you would... issue of your paper, so that the... may be known to your readers.

M. ARTHUR STEEL, Major.  
Department of National Defence (Militia Service),  
Ottawa, Canada.

INSULATION EFFICIENCY

...the effect of leakage over a moist surface is best dealt with by a series of flanges. These should not be of large diameter, because it is useless increasing the length of leakage path and at the same time increasing the cross-section of the path. In Mr. Wilson's design there is a fair length of leakage path, but it is at so large a diameter that the cross-section of the path is greatly increased.

although it is no dirt and insects will collect in any deep recess, and permanently. It is much better to leave the whole of the surface of the insulator exposed to the rain, as it has a very marked cleaning effect. The effect of leakage over a moist surface is best dealt with by a series of flanges. These should not be of large diameter, because it is useless increasing the length of leakage path and at the same time increasing the cross-section of the path. In Mr. Wilson's design there is a fair length of leakage path, but it is at so large a diameter that the cross-section of the path is greatly increased. We think if you will compare it with the design that we are now marketing you will appreciate the points we are emphasising.  
R. MILWARD ELLIS  
London, S.W.15. (Climax Radio Electric, Limited).

Sir,—Mr. A. W. Wilson's letter, published in your interesting issue of June 2nd, discloses the fact that he has not yet come across the Silvertown Co.'s "Everdry" insulator. This insulator was, you will remember, described and illustrated in *The Wireless World* of October 24th, 1923.

My experience proves that the "Everdry" is a perfectly efficient insulator, and in the very wettest weather has no leakage path whatever.  
WILLIAM A. MILLER.  
Belvedere, Kent.

DIRECT-READING DIRECTION-FINDER.

Sir.—In your issue of March 10th, 1926, you published an account of a direct-reading goniometer described for the Wireless Section of the I.E.E. on March 3rd, 1926, by Messrs. R. A. Watson Watt and J. F. Herd. We would like to take this opportunity of calling attention to certain prior claims of the writers of this letter with regard to direction indicating equipment employing a cathode ray oscillograph in conjunction with loops and radio-frequency amplifiers to produce a visual indicating device. In August, 1923, Brig.-General A. G. L. McNaughton and

Sir.—Major Steel's letter raises two distinct questions: (a) that of the similarity of the device described in his patent application with that described in our paper; and (b) that of priority.

The documentary evidence available to us does not suffice to decide the question (a), and it appears necessary to await the receipt of a copy of the Canadian specification before coming to a conclusion on it.

But whatever the answer to (a), question (b) is readily answerable. Major Steel's letter was based on an abstract of our paper; he has now, doubtless, received the full text, which contained a sentence showing that the device was in full operation at Aldershot before May, 1923. The sentence runs: "The first decisive test of observations on atmospherics with the device described was made on May 5th, 1923."

The factors governing the progress of the development work and its publication are too complex for discussion here, but official records are in existence, dated May, 1919, and contain detailed proposals for the device. Even before this date one of us had conceived the scheme of a cathode ray direction finder substantially in the form in which it is now worked, and discussions of this scheme took place as early as 1916.

We thank Major Steel for his graceful reference to the work carried out under the Radio Research Board, and would assure him that whether his device proves identical with that described in our paper or not, we can offer him our sincere congratulations on his independent work in this interesting field.  
R. A. WATSON WATT.  
J. F. HERD.

Department of Scientific and Industrial Research,  
Radio Research Station, Langley, Bucks.

Hospital Sets in Merthyr Tydfil.

"Ericsson" wireless equipments have been fitted in four hospitals in the Merthyr area. The installation work was carried out by Mr. Lewis J. Dixon, M.I.E.E., Managing Engineer of the Merthyr Electric Traction and Lighting Co., Ltd., and his staff.

o o o o

Wireless on Easy Terms.

A special department for the supply of wireless accessories on Deferred Terms has been opened by the Express Radio Service, Factory Square, Streatham, S.W.16.

The same firm is running a Valve Exchange Service whereby burnt out valves are changed for new ones at moderate

TRADE NOTES.

cost. Dull emitters and power valves are included in the scheme.

o o o o

"The Osram Bulletin."

Perhaps the most useful article in the current number of *The Osram Bulletin* is that dealing with the use of Osram D.E.8 valves as detectors. Instructions are given with the aid of circuit diagrams and curves for obtaining best results both in the reception of distant signals and the local station. The notes on anode rectification are especially valuable.

Quarter of a Million.

Messrs. The Athol Engineering Co., Crumpsall, Manchester, state that they are well over 250,000 Athol Reversible Valve Holders now in use.

o o o o

"The Radio Mail."

The current number of *The Radio Mail*, published by Messrs. A. C. Cossor, Ltd, devotes several pages to an interesting and detailed description of the two new valves, viz., the Point One and the Stent Two, the latter a power valve.

Some intimate facts are given concerning the state of the wireless trade in France, and it is interesting to note that the dull emitter has almost completely banished the bright valve in that country.

# READERS' PROBLEMS

The Wireless World Information Department Conducts a Free Service of Replies to Reader Queries.



Questions should be concisely worded, and headed "Information Department." Each separate question must be accompanied by a stamped addressed envelope for postal reply.

### Combined Choke and Transformer Coupling.

I understand that a  $2\mu\text{f}$ . coupling circuit has been put forward with which it is claimed that "the coupling quality with a transformer and choke" can be obtained, the latter coupling arrangement being a transformer and a choke. I should be glad if you will give me the circuit together with the full operating data.

E. L. T.

It is difficult to understand exactly what circuit you have in your mind, but we believe that you are referring to a circuit which we reproduce in Fig. 1, which is a very old arrangement for protecting the primary windings of the inter-valve transformer that, when lastly been noticed in various matters, principally America, with its own and startling claims.

It is well known that the reason why a transformer is the best satisfactory method of inter-valve coupling from the point of view of coupling quality is that the number of turns of the primary winding is insufficient to amplify the lower musical frequencies to the same degree as the middle range of frequencies. If an attempt is made to increase the number of primary turns to any large extent, due to the increasing of the self-inductance of the primary winding, the higher musical frequencies will be attenuated by the primary inductance and the impedances which are amplified are in proportion to the circuit impedance. It is known, also, that the ability of an amplifier to lower musical frequencies can be characterized by an impedance ratio, hence coupling in the form of choke coupling, but transformer coupling is an amplification stage is not affected by the presence of the self-inductance voltage provided by the primary winding.

It is claimed that, using the circuit of Fig. 1, all the above-mentioned objections are avoided and the circuit is shown to adapt itself to the wide frequency range of the lower musical frequencies, and to be a step-up in voltage. The circuit is not, of course, but the transformer, when coupled as shown, will give a step-up in voltage of 100 times, which is the ratio of its turns.

It is also pointed out in the more conventional manner that careful consideration will be given to the design of the transformer, and that the number of turns of the primary winding is as compared to the secondary winding, and the number of turns of the secondary winding is as compared to the primary winding, and the number of turns of the secondary winding is as compared to the primary winding, and the number of turns of the secondary winding is as compared to the primary winding.

The circuit is simple and not too costly. It is known that the higher the inductance of the transformer, the lower the frequencies are reproduced. Now a good low-impedance transformer has a primary inductance of about 50 henrys, which is a good choke suitable for use at the medium or high impedance detector stage, as an inductance of about 100 henrys

must be realized that the primary of the inter-valve transformer and the choke are actually in parallel. It is known that the resultant inductance obtained by connecting inductances in parallel is equal to the reciprocal of the sum of the reciprocals of each individual inductance. Now, assuming that in this case we have a 100 henry choke, and a transformer with a 50 henry primary, then the resultant inductance is 33 henrys approximately. In other words, we have a far less inductance, and shall therefore get far less quality than if we used the inductance of the conventional primary. Another way of looking at Fig. 1 is to note that, if we are concerned only of the quality given by this 50 henry primary, we might well dispense with the choke by using a transformer with a 50 henry primary.

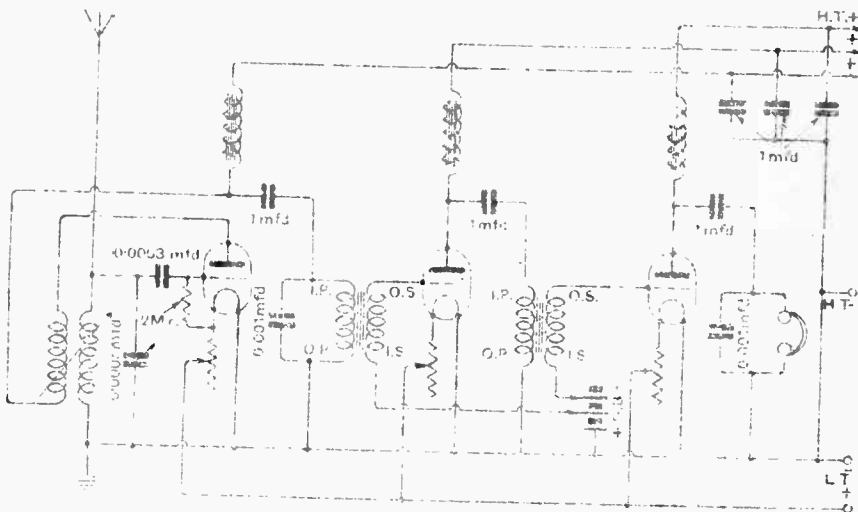

Fig. 1.—Three-valve receiver employing combined choke and transformer coupling.

The circuit will therefore give much better results than the transformer, although the transformer having a 50 henry primary is used by the method of being in parallel with a secondary of 100 henry, or a 50 henry primary.

It is well known that the higher the ratio of the turns of the secondary to the primary, the higher the resultant inductance would never quite equal the primary inductance of the transformer. When used in a 50

quality would never be so good as when using the transformer alone.

The scheme shown in Fig. 1 does protect the primary winding of the transformer from breakdown due to the passage of the steady plate current, although, of course, the choke is liable to breakdown. A good choke, however, is always cheaper to replace than a good transformer. There is another and more important advantage actually given by the circuit, and that is that by keeping the steady plate current out of the transformer primary all risk of magnetic saturation of the transformer core is eliminated. If a transformer of not very good design is connected in the plate circuit of a large power valve saturation is likely to occur, and if this is so, of course, volume and quality will be lost. This is fully discussed in an article appearing on page 701 of our May 26th issue.

It is extremely doubtful, however, whether even this latter advantage outweighs the disadvantage of the loss of amplification of the lower frequencies and the expense of purchasing a choke as well as a transformer. It would be better to avoid this circuit and to devote the money saved on the choke to the purchase of a really good transformer of first-class design which is suitable for use with power valves and which by virtue of a large primary would give us reasonably good amplification of the lower musical frequencies.

Of course, anode resistances could, if desired, be substituted in place of the chokes in Fig. 1, but this would not in the slightest degree affect the arguments which we have put forward.

o o o o

#### Howling in L.F. Amplifier.

*I have constructed a three-valve receiver consisting of a detector valve with no reaction, followed by two stages of L.F. amplification, the couplings being a low and a high ratio transformer respectively, both being of first-class make. Power valves are used in the L.F. stages with proper values of H.T. and C.B. The object of the receiver is to give large volume and good quality from the local station, which is situated quite close to me. At times quality is all that can be desired, whilst at other times speech becomes harsh and music takes on a jangling tone for no apparent reason. Can you assist me in tracing the trouble? M. I. T.*

The trouble appears to be that normally your L.F. amplifier is not far from the oscillation point, and that an extra strong passage of speech or music causes the amplifier to actually oscillate, these oscillations being sustained for a time and not necessarily ceasing at the moment when the loud passage of music has concluded. There is, of course, some coupling effect existing in the amplifier. This coupling may be caused by the resistance of that portion of the H.T. battery which is common to all valves, this usually being curable by shunting large capacity condensers across from each H.T.+ tapping to H.T.—. The value

of such condensers is usually given as 1 mfd., which is usually sufficient. In certain cases, however, a 2 mfd. condenser is needed, and often an obscure cause of L.F. howling is cured by increasing the value of these condensers. The trouble frequently occurs when dry batteries are used for H.T. supply. Another cause of the trouble is coupling between the two transformers, and careful spacing of these components cures the trouble. Yet another cause of the trouble is capacity coupling between the various wires of the amplifier, this specially applying if complicated switching arrangements are used. It is best to adopt the method of switching L.F. valves given on page 434 of our March 17th issue, which is nearly always successful in curing troubles of this type.

Often, however, in spite of the utmost care in design, construction, and operation, the quality of reproduction is marred by the fact of the L.F. amplifier being too near the oscillation point. The best method of procedure in these cases

amplifier is being sacrificed owing to the amplifier being too near the oscillation point, and the fitting of clips to the secondary terminals of each intervalve transformer is advised for the insertion of grid leaks when necessary.

o o o o

#### Resistance and Impedance.

*Can you explain simply the difference between impedance and resistance?*  
J. L. D.

Resistance is the term usually employed to indicate the opposition offered by a conductor to the passage of a current under the influence of a steady pressure or voltage always acting in the same direction, namely, a D.C. voltage. It varies directly as the length of the conductor, inversely as the cross-sectional area, and varies also in accordance with the specific conductivity of the wire. Should the conductor be wound in the form of a coil over an iron core, no difference occurs in its D.C. resistance unless the total length of wire is thereby lengthened.

When dealing with A.C., however, we have to take other factors into consideration. Thus, if a length of copper wire were wound in the form of a coil, it might have a very high "resistance" to the passage of a current of a given frequency, although actually having a low D.C. resistance. Moreover, this resistance to A.C. is not constant at all frequencies, but rises as the frequency is increased. Now it is known that if a condenser is inserted in a D.C. circuit, however, all current will cease, since the resistance of the condensers dielectric, which is made of some insulating material, is infinitely high. In the case of A.C., however, no infinite barrier is raised by the condenser, although still it offers a certain amount of "resistance" to the passage of A.C. As in the case of an inductive choke coil, however, this resistance is not constant for all frequencies, but, unlike the case of the choke, the resistance to A.C. lessens as we increase the frequency.

Thus, when considering the resistance which a circuit offers to an A.C. current, we have first to find out the amount of inductive reactance (as it is usually termed) in the circuit, and also the amount of capacity reactance. We must also take into account the ordinary ohmic resistance of the circuit. Having taken all these things into consideration, we now have the actual resistance of the circuit to the passage of a current under the influence of an E.M.F. of given voltage and frequency. This is known as the impedance of the circuit. Thus the term impedance embodies the actual resistance of the circuit to an alternating current of given frequency and indicates the combined effective value of resistance when ohmic resistance and inductive and capacitative reactance have been taken into consideration. In D.C. work the "impedance" of the circuit is purely the ohmic resistance, a choke having no disturbing effect, and a condenser acting as a direct break in the circuit.

### BOOKS ON THE WIRELESS VALVE

*Issued in conjunction with "The Wireless World."*

"WIRELESS TELEPHONY," by R. D. BANGAY. Price 2/6 net. By Post, 2/9.

"THE OSCILLATION VALVE—THE ELEMENTARY PRINCIPLES OF ITS APPLICATION TO WIRELESS TELEGRAPHY," by R. D. BANGAY. Price 6/- net. By Post, 6/3.

"WIRELESS VALVE RECEIVERS AND CIRCUITS IN PRINCIPLE AND PRACTICE," by R. D. BANGAY and N. ASHBIDGE, B.Sc. Price 2/6 net. By Post, 2/10.

"THE THERMIONIC VALVE AND ITS DEVELOPMENT IN RADIO TELEGRAPHY AND TELEPHONY," by Dr. J. A. FLEMING. Price 15/- net. By Post, 15/9.

"CONTINUOUS WAVE WIRELESS TELEGRAPHY," Part 1, by W. H. ECCLES, D.Sc. Price 25/- net. By Post, 25/9.

Obtainable by post (remittance with order) from  
**ILIFFE & SONS LIMITED**  
Dorset House, Tudor St., London, E.C.4  
or of Booksellers and Bookstalls

is to shunt the secondary of each transformer with a grid leak of  $\frac{1}{2}$  megohm value. This also serves to flatten out any resonance effects in the transformer and still improve quality. There are very few transformers which are not greatly improved by this expedient. The value should not be lower, otherwise an unnecessary amount of volume will be sacrificed. Practical experience indicates the value which we have given to be approximately correct, since it is high enough to prevent any appreciable sacrifice of volume, whilst it is low enough to exercise real benefit in flattening out the amplification curve of the transformer and of reducing any tendency to L.F. oscillation. The use of grid leaks in the manner suggested is usually sufficient to cure even the worst amplifiers of this trouble. In far more cases than are suspected a certain amount of quality in an expensive transformer-coupled