

4^D

195 Broad Street, New York

UNIVERSITY OF CALIFORNIA

FESTIVAL
AND
RADIO REVIEW

wireless World

Wednesday, May 5th, 1926.

DEVELOPMENT
NEW YORK
AMERICAN TELEPHONE
195 B'WAY, NEW YORK

JENKINS TELEVISION APPARATUS

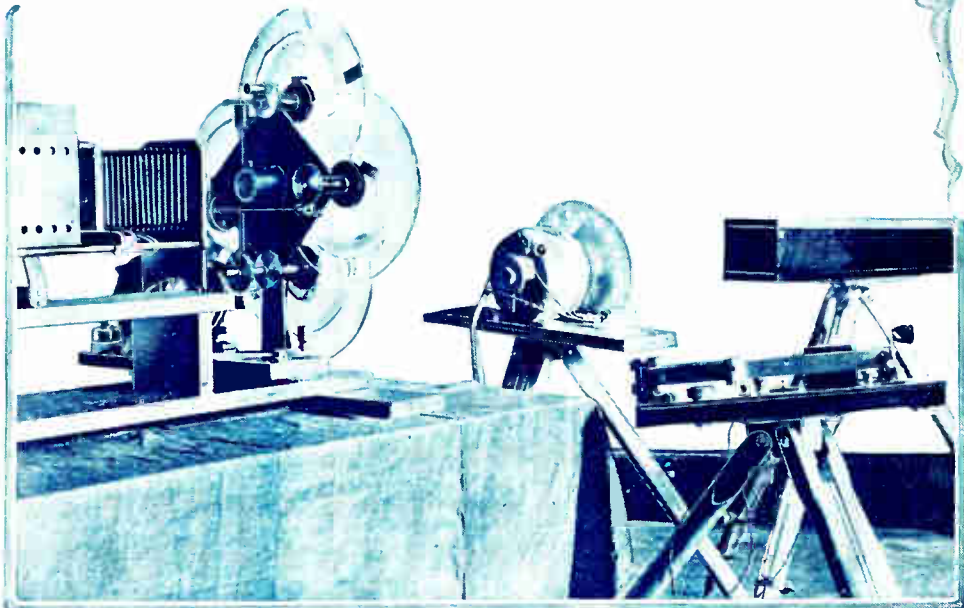

DESCRIBED IN THIS ISSUE

THE WORLD'S STANDARD **AMPLION** WIRELESS LOUD SPEAKER

Natural Tone

RADIOLUX AMPLION
Type R.S.1.0
Price £7:7:0
Other Amplion Models from 38/-

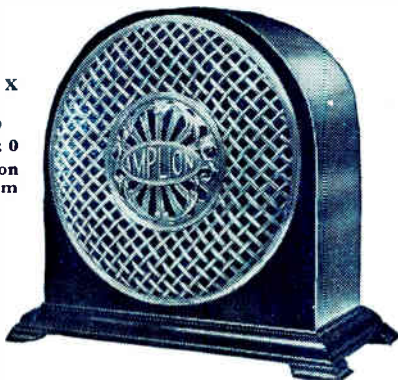

The Radiolux AMPLION has many good points, but perhaps none is more striking than the quality of natural reproduction which it possesses to a remarkable degree.



Obtainable from AMPLION STOCKISTS, Radio Dealers or Stores.

Demonstrations gladly given during business hours at the AMPLION Showrooms:

25-26, Savile Row, London, W.1. 10, Whitworth St. West, Manchester
78-82 High St., Clapham, S.W.4. 101, St. Vincent Street, Glasgow

There is no substitute for a genuine AMPLION

Advertisement of Alfred Graham & Co. (E. A. Graham), London, S.E.4

Mention of "The Wireless World," when writing to advertisers, will ensure prompt attention

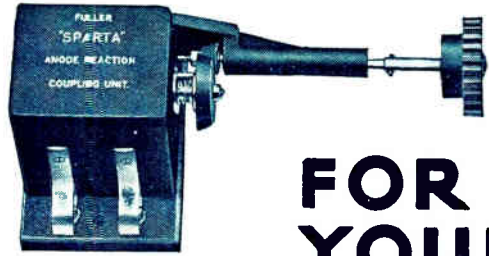

(a)



(b)

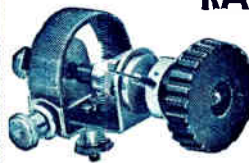

(c)

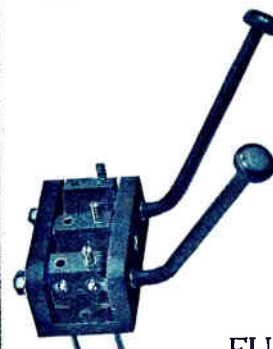

(d)

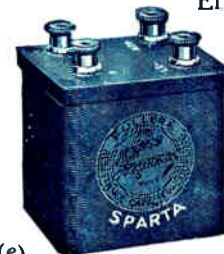

(e)

FOR YOUR NEW SET

use components that will repay your confidence. Reliability goes with all

SPARTA
Fuller
ALL BRITISH

RADIO COMPONENTS

(a) Sparta Anode Reaction Coupling complete with base and handle.
AR 1 .. 280-600m .. 12/6
AR 2 .. 600-1500m .. 12/6
AR 3 .. 1500-3000m .. 13/6
Ebonite base .. 4/- extra
Handle .. 1/6 extra

(b) Sparta Filament Resistance Standard Type.
1-Valve .. 4/3
2-Valves .. 4/6
1-Valve (dull emitter) .. 4/6
3-Valves .. 4/9

(c) Sparta Potentiometer. Standard Type .. 6/-
Type E.P. (as illustrated) .. 6/9

(d) Sparta Coil Holder.
CH 3 (triple as illustrated) .. 14/-
CH 2 (double) .. 9/-
CH 1 (single) .. 3/-

(e) Sparta Resistance Capacity Couplings LF and HF patterns, 19/6

FULLERS UNITED ELECTRIC WORKS, LTD

Chadwell Heath, ESSEX

Telephone: - - - Ilford 1200

Telegrams: Fuller, Chadwell Heath.

MARCONI VALVES

for Volume

CHANGE the last valve on your receiver—whether a 2, 3, or 4 valve set—to a Marconi Power Valve and you will obtain *vastly increased volume and more natural tone.* The Marconi Power Valves illustrated will give 50% to 100% louder and clearer amplification to any receiving set provided the correct H.T. and L.T. current and grid bias is used. Write for Publication No. 443, giving full particulars of all types of Marconi Valves and recommended combinations.



THE MARCONIPHONE COMPANY Ltd.
Marconi House, Strand, London, W.C.2.

Marconi
D.E. 6
Power Valve
for 2-volt
Accumulator
18/6

Marconi
D.E. 5
Power Valve
for 6-volt
Accumulator
22/6

Marconi **L.S.5**
for 6-volt Accumulator.
Recognised as the best valve
yet designed for Power
Amplification Work **40/-**

The most efficient intervalve transformers ~ human skill and ingenuity have yet devised

The heaviest transformer on the market. The great amount of the highest grade material necessary to ensure perfect results makes the "Ideal" higher in price than other less efficient Intervalve Transformers. The method of winding is covered by a patent, without which it is impossible to get the same results. Supplied in four ratios, viz. 2.7 to 1, 4 to 1, 6 to 1 and 8 to 1. Price 30/- each.

Mr. H. H. Wheat, 11 Bridge Street, Runcorn, writes:—

"I am using two Marconiphone 'Ideal' Transformers in a four-valve set, and would like to express my appreciation of the quality of these wonderful instruments. My first stage employs the 2.7 to 1 transformer, and the second stage the 6 to 1, and I am delighted with the wonderful volume and tone of the set."

10th February, 1926.

Ideal (Junior Model) Ratio 3 to 1.
21/-

Marconiphone "IDEAL" Transformers

Write for Publication No. 425a.

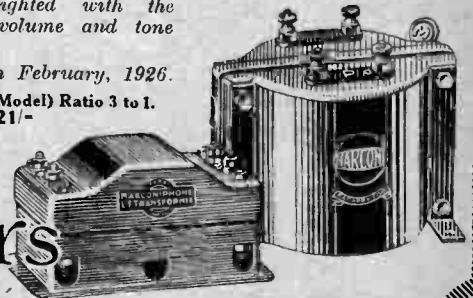





£10 Weekly in Cash Prizes

Simple Competition
for all Readers of "The Wireless World"

HIDDEN ADVERTISEMENTS

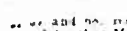
Below will be found six reproductions of fragments cut from the Advertisement pages of this issue of "The Wireless World." Each fragment is a clue. Can you from these clues identify the Advertisements? Seven cash prizes will be awarded to the first seven readers who send us correct solutions. No technical skill is required, merely observation. There are no restrictions or entry fees and the conditions are simple.

£5
for the first
correct solution
opened.

 1	 2
 3	 4
 5	 6

£2
for the second
correct solution
opened.

£1
for the third
correct solution
opened.

and
4
consolation
prizes of
10/-
Each

for the next four
correct solutions
opened.

CONDITIONS

- All solutions must be written on the special coupon appearing on an advertisement page in this issue and addressed to *The Wireless World*, Dorset House, Tudor Street, London, E.C.4, and marked "Hidden Advt." in bottom left corner.
- Clues will not, of necessity, appear in the same way as in the advertisement page, but may be inverted or placed in some other position.
- In order that town and country readers may compete on equal terms, solutions will not be dealt with until 10 a.m. on Monday next. All solutions received before that date will be retained until Monday morning. Competitors may submit any

- number of entries. Erasures or alterations on a coupon will disqualify the entry.
- The first prize of £5 will be awarded for the first correct solution opened; the second prize of £2 to the next correct solution; the third prize of £1 for the third, and four consolation prizes of 10/- each for the next four correct answers. In the event of no readers sending correct solutions the prizes will be awarded to the competitors whose solutions are most nearly correct.
- The decision of the Advertisement Manager of *The Wireless World* is final, and no correspondence can be entered into. Competitors enter on this distinct understanding. No member of the staff of the paper is permitted to compete.

Constructors!



TMC Low Capacity Keys

combine
Extreme Low self-capacity.
A positive locking action.
Rapid make and break.
Unvarying performance.
Adaptability to varied switching requirements.
Strong and accurate construction.
Pleasing appearance.

No. 1 T.M.C.
L.C. Key.
Price 7/-

They are designed by Radio engineers. The "Gold-Silver" contacts will not oxidise. The live parts of the key are insulated from the frame. Individual parts are machine made, ensuring accurate construction. Ends of the springs are tinned to facilitate soldering. Escutcheon plates and levers are polished and lacquered brass or bright nickel plate.

Made in Three Models.

No. 1.	12 point, 3 position	..	7/-
No. 2.	6 point, 2 position	..	6/-
No. 3.	24 point, 3 position	..	15/6

Send for a copy of the T.M.C. Catalogue. It is free on request.

TELEPHONE MANUFACTURING CO., LTD.,
Hollingsworth Works,
WEST DULWICH, LONDON, S.E.21.

Phones: Sydenham 2460/1.

If your dealer does not stock T.M.C. Goods we will supply you direct at the above prices, post free.

TERMINALS

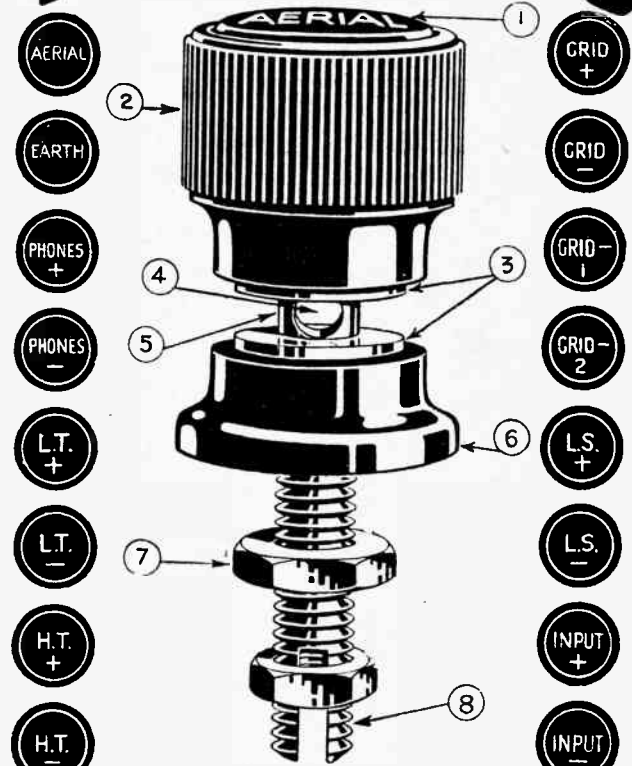

Patent No. 248921.
Registered Design No. 715424.

1. Non-rotating insulated engraved top.
2. Highly finished screw-action Bakelite insulated head.
3. Shielded metal clamping faces.
4. Cross hole for connections, flush with clamping face to avoid shearing of wire when the head is screwed down.
5. Smooth stem, ensuring that strands of connecting wire will not bind up with thread.
6. Highly finished Bakelite insulated collar.
7. Standard 2 B.A. stem with nut.
8. Transverse slot with clamping nut, eliminating soldering.

STANDARD MODEL (Bakelite insulated) (Type B)	POPULAR MODEL (Non-insulated) (Type M)
9d. each.	6d. each.

Ask your dealer for them, but if he cannot supply, send your order to us enclosing his name and address.

Illustrated catalogue free on request.

BELLING-LEE, Queensway Works,
Ponders End, Middlesex.

BELLING-LEE

E.P.S.7.

From all
NEWSAGENTS
and
BOOK-
STALLS

MODERN SCIENCE

Incorporating
CONQUEST

A MAGAZINE OF PROGRESS, INVENTION AND DISCOVERY

1/-

MONTHLY

SUBSCRIPTION:
14s. per annum,
post free.

Get your copy of the

MAY
ISSUE

Now on SALE

ITS PURPOSE & SCOPE

THE purpose of "MODERN SCIENCE" is accurately to reflect, month by month, the most recent advances in all departments of science and industry; to record important discoveries in the various branches of human activity; to survey technical and mechanical developments; and to provide a forum for the interchange of information and news on all subjects coming within the scope of the journal.

Special interest is taken in the progress and development of the science of wireless communication, and articles by expert writers, illustrated by photographs and diagrams, frequently appear in the pages of "Modern Science."

PRINCIPAL CONTENTS:

THE LODGE "N" CIRCUIT,
by M. A. Laqui.

APPLICATIONS OF SPEC-
TROGRAPHY, by C. F. Smith.

THE PROBLEM OF POPU-
LATION, by Prof. D. Fraser
Harris, M.D., D.Sc., F.R.S.
(Edin.)

NEW GOLD MINES OF
CANADA, by E. L. Chicanot.

THE KING'S WHITE TIGER,
by R. I. Pocock, F.R.S.



Publishers & Proprietors:
LIFFE & SONS LIMITED

Dorset House, Tudor Street,
LONDON, E.C.4.

ADVERTISEMENT COMPETITION RESULTS

The following are the prizewinners in the Advertisement Competition announced in the issue of "The Wireless World" dated April 21st, 1926.

First Prize £5

Miss M. O'LEARY, 110, Chaucer House, Tabard St., London, S.E.1.

Second Prize £2

H. DENNIS, Nethercroft, Braunton, Devon.

Third Prize £1

HAROLD R. MOSS, 11, Laurel Gardens, Hanwell, W.7.

Four Consolation Prizes of 10/- each:

CECIL G. BILLET, 41, Haviland Road, Bournemouth. R. THORBURN, Wellington Cottage, Berwick-on-Tweed. S. A. PACEY, 17, Fernside Road, Balham, London, S.W.12. A. E. DUCKETT, 92, Carver Street, Birmingham.

CHEQUES HAVE BEEN DISPATCHED TO THE PRIZEWINNERS.

The WINNING ORDER for the nine advertisers was as follows:

Whole Page Advertisements.			Half-Page Advertisements.			Quarter-Page or Smaller Adverts.		
	Page No.	Name of Advertiser.		Page No.	Name of Advertiser.		Page No.	Name of Advertiser.
1st	9	L. McMichael, Ltd.	1st	5	Belling-Lee.	1st	4	Ferranti, Ltd.
2nd	iv	The Marconiphone Co., Ltd.	2nd	3	Metro-Vick Supplies, Ltd.	2nd	13	Nelson Electric Co., Ltd.
3rd	1	Dubilier Condenser Co. (1925), Ltd.	3rd	11	Cleartron Radio, Ltd.	3rd	13	Sydney Jones & Co. (London), Ltd.



Try the coil that makes all the difference!

Every listener who has tried the new LEWCOS Coil is talking about the difference it makes. Some say that this coil in the blue box is as different from ordinary coils as "Glazite" is from the old connecting wire.

The Lewcos Coil embodies high electrical efficiency, with great mechanical strength. It gives extremely fine tuning and, having an exceptionally low high frequency resistance, increases signal strength.

Try the LEWCOS Coil for yourself—it makes all the difference.

No.	25	35	40	50	60	75	100	150	200	250	300
Price	4 6	4 6	4 6	5 -	5 6	5 6	6 9	7 6	8 6	9 -	10 -

LEWCOS

Inductance Coil

The LONDON ELECTRIC WIRE COMPANY & SMITHS LIMITED

Manufacturers of Glazite Connecting Wire
Playhouse Yard, Golden Lane, London, E.C.1

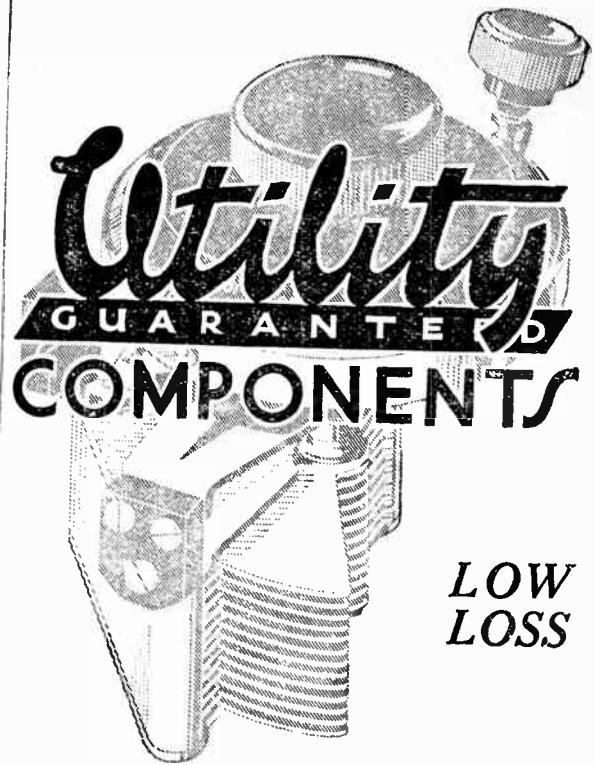
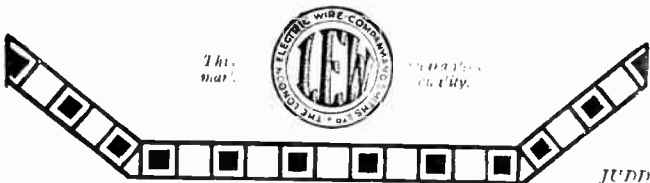

LOW LOSS

Reduced Prices.
—the same Quality
—the same Utility Guarantee

Every Wireless Amateur who takes his hobby seriously knows the value of accuracy and finish in the components he uses—that is why so many choose "Utility" Components. New reduced prices—made possible by greatly increased demand—now bring "Utility" Components within reach of every wireless enthusiast. Better reception, longer life, and a guarantee that any "Utility" goods that develop faults with reasonable care will be repaired or replaced—all these are ensured if you demand "Utility" Components. All good Dealers stock them.

NEW PRICES.

"Utility" Low Loss Cor without Vernier from '001. With Vernier f Other sizes reduced

"Utility" no-capac change-over pattern, 3/6. L Other sizes re

The "Utility" no-capacity change-over switch.

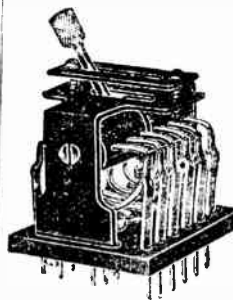

WILKINS & WRIGHT
KENYON ST. *Utility*

A PERFE^{CT} VALVE

C.T.25.

Filament Volts 5-6
 Filament Amps 25
 Anode Volts 30-300
 Voltage Amplification Factor 9
 Impedance 10,000
 Mutual Conductance 800
 Plate Current Saturation at 50
 Volts over 30 milliamps

15/-

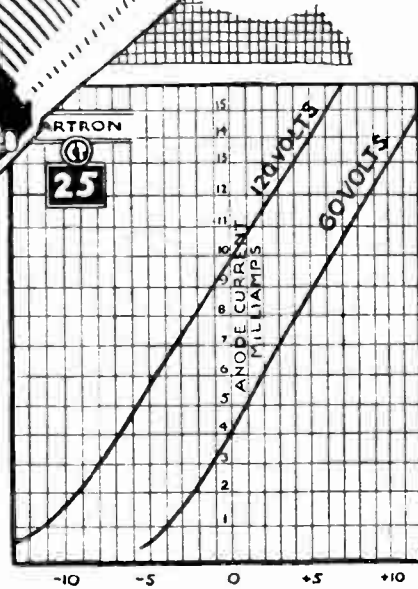
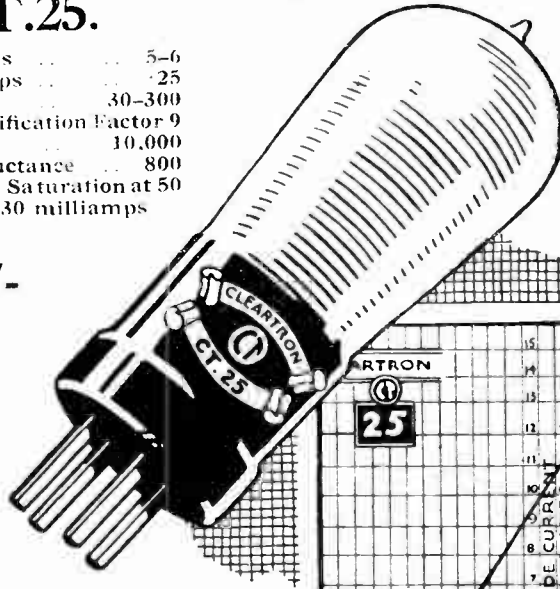

*America's foremost valve
 now made in Britain's
 newest factory.*

YOU CANNOT

be using the valve with qualifications for the supreme realities of wireless—generous volume, pure and sonorous tones or longer distances—unless you use CLEARTRON Valves, which are really guaranteed under CLEARTRON'S IRONCLAD GUARANTEE.

12/6 STANDARD PRICES 15/-

They are ALL Dull Emitters, with lowest current consumption, and sold at Standard Prices. For 2, 3, and 5-6 v. Accumulators and Dry Cells. H.F. Detector and L.F.

Full technical data from your Dealer or:

CLEARTRON RADIO LIMITED

1 CHARING CROSS, LONDON; (Works: BIRMINGHAM),

Telephone: Regent 223172.

Grants: Cleartron, Westrand, London

British



Made

5/593

Mention of "The Wireless World," when writing to advertisers, will ensure prompt attention.

The Wireless World

AND
RADIO REVIEW
(14th Year of Publication)

No. 351.

WEDNESDAY, MAY 5TH, 1926.

VOL. XVIII. No. 18.

Assistant Editor:
F. H. HAYNES.

Editor:
HUGH S. COCKOCK.

Assistant Editor:
W. JAMES.

Editorial Offices: 139-40, FLEET STREET, LONDON, E.C.4

Telephone: City 4011 (3 lines).

Advertising and Publishing Offices: DORSET HOUSE, TUDOR STREET, LONDON, E.C.4.

Telephone: City 2847 (13 lines).

Telegrams: "Ethaworld, Fleet, London."

COVENTRY: Hertford Street.

BIRMINGHAM: Guildhall Buildings, Navigation Street.

MANCHESTER: 199, Deansgate.

Telegrams: "Cyclist Coventry."
Telephone: 10 Coventry.

Telegrams: "Autopress, Birmingham."
Telephone: 2970 and 2971 Midland.

Telegrams: "Hiffe, Manchester."
Telephone: 8970 and 8971 City.

Subscription Rates: Home, £1 1s. 8d.; Canada, £1 1s. 8d.; other countries abroad, £1 3s. 10d. per annum.

As many of the circuits and apparatus described in these pages are covered by patents, readers are advised, before making use of them, to satisfy themselves that they would not be infringing patents.

STRAINING AT THE LEASH.

HOW long will broadcasting suffer the restraint of the leash which artificially prescribes the limit of activity of the service? It is interesting to conjecture how long it will take before the public realises that broadcasting could exercise a much greater influence than at present if only the artificial regulations limiting its sphere of operations were abolished.

It should be recalled that there was a time when it looked as if the development of railways in this country might be retarded because of the influence which was exercised at Court by those interested in well-established but more cumbersome and tardy methods of transport.

Just the same kind of situation exists to-day in regard to broadcasting. Development of the Service in certain important directions is definitely suppressed by regulations which have been drawn up in deference to the dictates of the very powerful organisations which represent the Press of this country. We have, of course, every sympathy with the Press or any other group of interests which may be adversely affected by the extension of a new art such as broadcasting, but is it of any use to endeavour to ward off merely temporarily the effect of progress which, in the very nature of things, must eventually assert itself? The art of printing was not allowed to stagnate because its introduction adversely affected the professional scribe, nor can the distribution of news by the instantaneous means

which broadcasting provides be allowed to give place for long to the less speedy methods of print.

It would be quite absurd to suggest that broadcasting will ever be able to take the place of the newspaper for many and obvious reasons, but we believe that the time must come when the public will demand that broadcasting shall be more topical than it is possible for it to be under the present regulations. We look forward to the time when at every event of popular interest the broadcast reporter will be present to give, by means of a portable wireless transmitter, the story of the event, which will be retransmitted by the broadcasting station. In only a few instances would this detract seriously from the value of the daily paper, but it would mean for broadcasting an added interest for the public which might well exceed anything that it has been possible to do hitherto.

Already there are signs that the broadcast authorities are straining at the leash, and it is only a matter of time before the leash will no longer bear the strain set upon it. If the Press accepted now the inevitable, instead of vainly endeavouring to stave it off, not only would the air be cleared of a constant feeling of unpleasant friction, but the Press would have the opportunity of competing with a new service by gradual preparation, whereas the only other alternative is to be confronted suddenly with an opposition service when public opinion is so strong as to override the artificial regulations which are at present in force.

CONTENTS.

	PAGE
EDITORIAL VIEWS	641
TELEVISION APPARATUS	642
By A. Dinsdale.	
READERS' NOVELTIES	646
AMATEUR RECORDING APPARATUS	647
By J. Anderson.	
DISTORTION IN TELEPHONES	650
By W. H. F. Griffiths.	
REACTION CONTROL	653
By Harold H. Warwick.	
SIMPLE L.F. AMPLIFIER DESIGNS	657
CURRENT TOPICS	661
BROADCAST BREVITIES	663
RECEIVING AERIALS	665
By F. M. Colebrook.	
WIRELESS ON THE POLAR AIRSHIP	669
NEW APPARATUS	672
PRACTICAL HINTS AND TIPS	673
WIRELESS CIRCUITS IN THEORY AND PRACTICE	675
By S. O. Pearson.	
LETTERS TO THE EDITOR	679
RECENT INVENTIONS	682
READERS' PROBLEMS	683

TELEVISION APPARATUS

A Description of the Jenkins System

By A. DINSDALE.

EFFORTS to transmit pictures electrically were first made some fifty years ago, practically at the same time that attempts were being made to transmit sound electrically. Since that time many workers have devoted their time and energies to this end, with varying degrees of success, till at the present time it is possible to send photographs of excellent quality from one place to another, either over a wire circuit or by radio. Going even further, it is possible to transmit by the same means cinematograph pictures, and also actually to see by radio distant scenes and moving objects.

One of the most distinguished workers in this field at the present time is the American inventor, Mr. C. Francis Jenkins, of Washington, D.C.

Pioneer Work.

Born in the country, north of Dayton, Ohio, in 1868, Mr. Jenkins spent his boyhood on a farm. After leaving school he "explored" the wheatfields and timber lands of the north-west, and later the cattle ranges and mining camps of the south-western portion of the United States. In 1890 he came to Washington, where he engaged in secretarial work for five years, at the end of which period he resigned his position and definitely commenced his career as an inventor. His earliest work was associated with the development of the cinematograph, and it was he who built the prototype of the motion picture projector which is used to-day in every picture house the world over.

Having commenced his career in such a fashion, what more natural than that the problem of transmitting pictures to distant points by electricity should have made an early appeal? As early as 1894, in fact, he published in the *Electrical Engineer* an article on the subject, with an illustration of proposed apparatus.

Mr. Jenkins now admits that this first suggestion of his

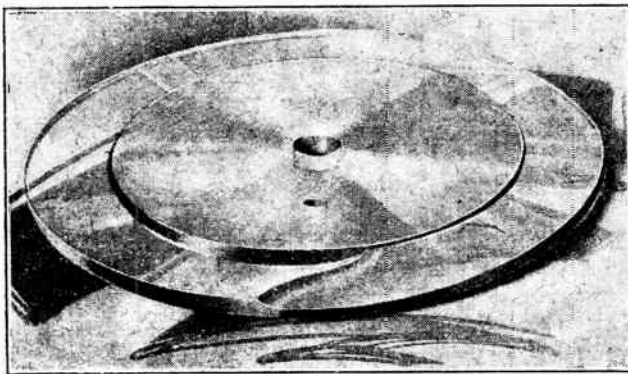

Fig. 1.—Disc type prismatic ring.

A photograph (50 lines per inch) sent and received by wireless with the Jenkins apparatus.



was hopelessly impractical, and it was not until 1913 that he published a second proposed scheme for "Motion Pictures by Wireless" in the magazine *Motion Picture News*. From that time Mr. Jenkins has been steadily working on the problem of television, and has overcome many difficulties which at first sight appeared almost insuperable.

Use of a Flat Screen.

In the transmission of pictures, either by wire or by radio, only two methods have so far been employed, namely, one using a cylinder mechanism, and the other a flat surface. The majority of workers have chosen the former method, and many have achieved excellent results thereby, but it does not lend itself to fast work such as is essential for actually seeing by radio, or for the transmission of motion pictures.

Such work demands that the received image be projected upon a screen, and the impression of motion must be derived in the same manner as it is in a picture theatre — by throwing a rapid succession of individual pictures on the screen and relying upon the persistence of the vision of the spectator to blend the whole into a smoothly changing scene.

With this aim in view Mr. Jenkins rejected the cylindrical method in favour of the flat surface, for this represents the only possible method of attaining the desired objective. All methods developed to date make use of a tiny spot of light which is made to traverse the picture to be transmitted in a series of lines. Light and dark parts of the picture alter the intensity of the light beam, which is then focussed on to some form of light cell. This transforms the light variations into electrical current variations which can be transmitted to some distant point.

Having decided upon the method which must be used, Mr. Jenkins cast about for suitable apparatus with which

Television Apparatus.—

to put his theories into practice. As mentioned above, in both possible systems it is necessary to cause a beam of light to cover the picture in a series of lines. With the cylinder method this is easily arranged by placing the light source within a cylinder of glass, on the outside of which the picture is wrapped, and rotating it, at the same time giving to it a gradual longitudinal motion.

With the flat surface method some other means of moving the beam of light had to be found, and one way of moving or bending a beam of light is by means of a prism. No suitable prism or combination of prisms existed, however, so the inventor set to work and developed what is now known as the Jenkins Prismatic Ring, an entirely new contribution to optical science. In use it is comparable to a solid glass prism which changes the angle between its sides, so that a beam of light passing through it is hinged or bent on one side of the prism whilst preserving the fixed axis of the beam on the other side.

For the particular purpose in hand this prismatic ring is ground into the face of a disc of suitably sized selected mirror glass, which gives the ring its own support on the rotating shaft upon which it is mounted. From one end to a point half-way round the periphery of the disc the prism has its base inward, and from there round to the starting point it has its base outward, the warp from one end to the other being gradual. These rings, as made in the original grinding machine, may have one, two, or four prismatic sections to the ring, may be right- or left-handed, and are made in 6in. or 7in. sizes, also in disc ring form, or in band ring form.

Function of the Prismatic Rings.

Both forms of ring are illustrated in Figs. 1 and 2. By rotating such a ring between a source of light and a screen, the beam of light is bent, or oscillated to and fro, and thus made to cover the screen from end to end, whilst another similarly revolving ring causes the light beam to change its course so that each time it traverses the screen it does so along a different track. This action is illustrated in Fig. 3, in section in (a), and in elevation in (b).

If, now, a photographic plate is substituted for the screen, and the intensity of the light source is varied, or modulated, in accordance with the variations of an electric current arriving from a distant transmitter which is sending a picture of a large capital "A." for example, an image like that shown in Fig. 3 (c) will appear upon the plate when it is developed.

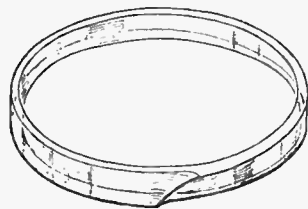

Fig. 2.—Band type prismatic ring.

Thus the result of the action of the prismatic rings is similar to that which would be obtained if the light beam, containing within its variations the light equivalent of the picture image, remained stationary, whilst the plate was being moved backwards and forwards across it, and moved up slightly after each line had been traced on it by the beam.

The foregoing is an outline of the principles made use of in the Jenkins system as applied to reception.

To understand the action of the transmitter, let us suppose, for example, that the light source shown in Fig. 3 (a) is the projection lens of a magic lantern containing an ordinary lantern slide. The beam of light issuing from the lens contains within it the complete image of the picture on the slide, and if projected on a screen would be made up essentially of light and dark

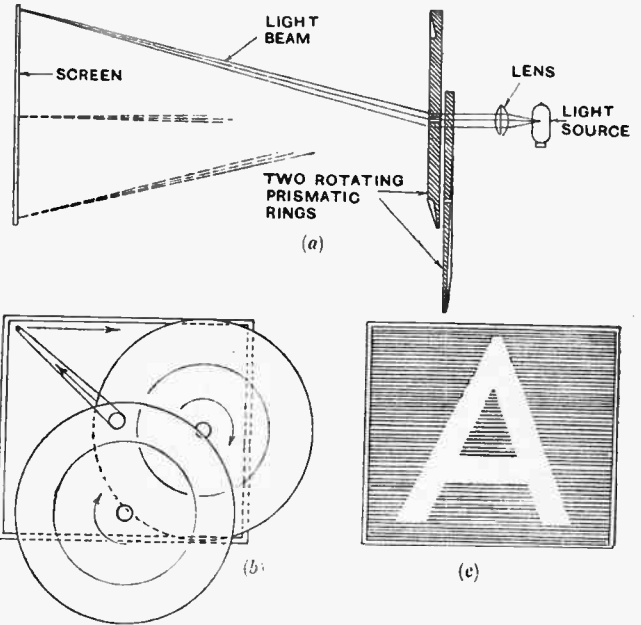

Fig. 3.—Section (a) and elevation (b) of prismatic ring mechanism showing principle of operation. The screen is completely covered by the oscillating point of light and an image can therefore be reproduced as at (c).

areas. Instead of being projected on a screen, however, the lantern beam is focussed on a light sensitive cell, which is a device for transforming light variations into electric current variations.

When the overlapping prismatic rings are now rotated, the picture is swept vertically across the cell by one ring, and at the same time moved laterally by the other ring. It is as if the picture were cut up into thin slices containing light and dark sections, just as a bacon slicer reduces a side of bacon to thin slices, or sections, containing fat and lean.

Layout of the Transmitter.

Fig. 4 illustrates a form of Jenkins transmitter which conforms in substance to the above description. At the extreme left is a magic lantern which projects the image through four overlapping prismatic discs, four being used in this case instead of two for the purpose of obtaining optical correction. In the long oblong box to the right and in the background is the light-sensitive cell. It is carefully shielded from daylight by the housing, so that only light from the projector, entering by a small opening in the end of the box, can affect it and cause it to operate.

The purpose of the motor-driven perforated disc, situated between the projector and the cell, is to act as an interrupter, so that the electrical output of the light

Television Apparatus.—

sensitive cell shall take the form of an interrupted direct current which can be amplified by means of an ordinary L.F. valve amplifier. After amplification the current impulses can be put on to a wire circuit, or caused to modulate a radio carrier wave, just as speech currents modulate the carrier wave of a broadcasting station. If this modulated carrier were listened to, however, it would sound like an irregularly interrupted I.C.W. note.

The most satisfactory type of light sensitive cell available until recently was the selenium cell, but, as is well known, such a cell is sluggish in action, and this fact prevented the reduction of the period of time necessary for the transmission of a photograph. More recently, however, it was discovered that some of the alkali metals, such as potassium, sodium, caesium, rubidium, etc., have, under certain conditions, the property of directly converting light into electric current.

The Photoelectric Cell.

Suitable cells made from these metals vary their electrical output in very accurate proportion to the amount of light to which they are exposed and their response is so extremely rapid as to be almost instantaneous. An example of such a cell was described in detail by the present writer in *The Wireless World*, January 6th, 1926. By making use of these cells the transmission process can be speeded up to such an extent that an entire picture can be flashed through almost instantaneously, instead of taking twenty or thirty minutes as used to be the case when selenium cells were employed.

An illustration of one type of Jenkins receiver is given

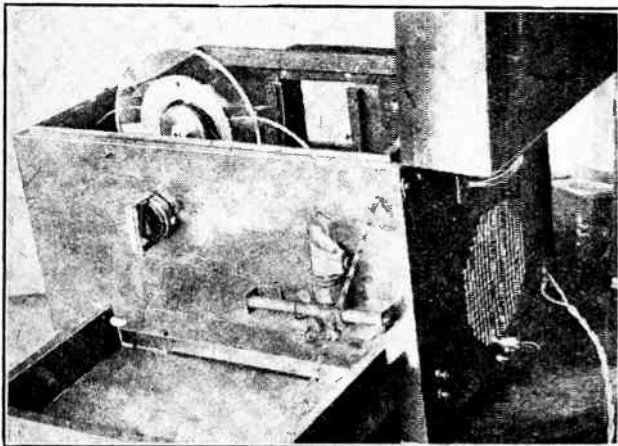

Fig. 5.—The receiver showing the prismatic rings and the plate upon which photographs are received.

A 12

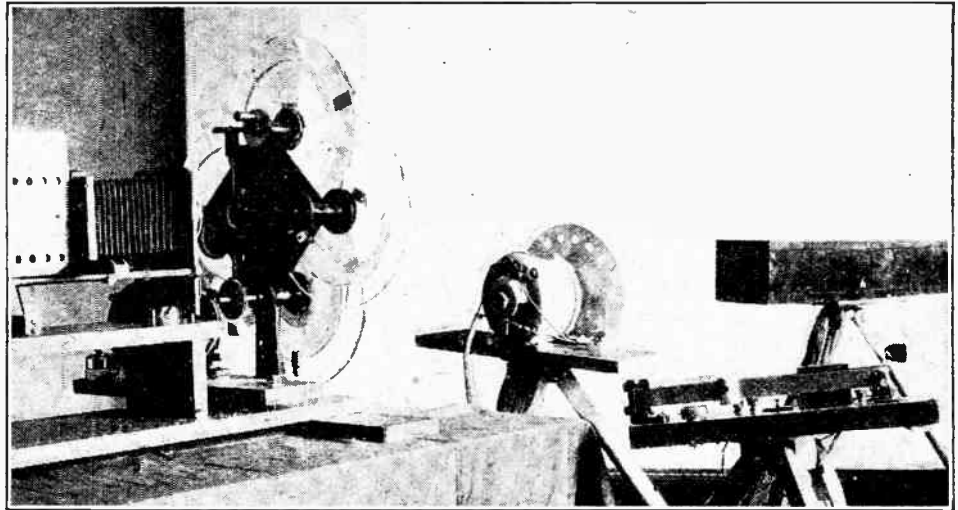

Fig. 4.—Transmitting apparatus used in the Jenkins system

in Fig. 5. Its action is identical with that described with the aid of Fig. 3. In the photograph the light source and the lens with diagonal reflecting mirror are mounted on the outside of the box at the front. The four overlapping prismatic rings, similar to those used in the transmitter, and the photographic plate upon which the picture is received, will be readily identified inside the box. The whole of this apparatus, except the lamp, is contained in a light-tight box.

The prismatic discs are rotated by an electric motor at exactly the same speed as the transmitting discs. The method of synchronisation will be discussed later. The lamp used is of a special type, developed for Mr. Jenkins by the General Electric Company. The filament is a single-turn coil, enclosed in an atmosphere of hydrogen, and offset to bring it as close as possible to the glass wall of the bulb. By offsetting it in this fashion a sharper image is obtained.

In operation the filament is brought up to a predetermined temperature by means of a battery current, and the L.F. output of the radio receiver is then passed through it, thus varying the degree of filament brilliancy in accordance with the incoming impulses which represent the picture values. A beam from this varying light source is focussed on to the photographic plate, first passing through the rotating prismatic discs, as shown in Fig. 3.

Tone Gradation.

Mr. Jenkins claims that, by adjusting the speed of the disc driving motor to the temperature change of the filament, soft gradations of light and shade are obtained which probably can never be equalled by any other device, thus giving an image of true photographic value, entirely free from lines.

Mention has been made of the necessity for synchronism between the transmitter and the receiver. In the Jenkins system this is attained by means of rather heavy vibrating control forks, one of which is used at each end of the circuit. The forks are so adjusted that they work together in exact synchronism, with provision

Television Apparatus.—

for such slight and occasional automatic correction by radio as may be required to keep all receiving forks in step with the station which at the moment is sending. By means of these forks the speed of the driving motors, both at the transmitting and receiving ends, is kept absolutely constant. One of these forks is shown in the right foreground of Fig. 4.

Another method of synchronising is by means of a small synchronous radio motor, which is driven partly by power received by radio from the photo-broadcasting station, and partly by a local current in the same way that a loud-speaker is operated. These small motors, rotating in synchronism with the motor at the transmitting station, control the driving motors at the receiving stations, thus keeping them all in step.

Checking Synchronism.

It would never do, of course, to have to wait till the picture was developed to find out if the receiving motor was getting out of control, so a special neon lamp is arranged to shine on a revolving marker on the motor-shaft of the receiving instrument. This lamp is flashed by the incoming radio signals, which latter bear a definite relation to the rotation of the transmitter motor.

The same wavelength carries both the picture frequency, from which the received photograph is built up,

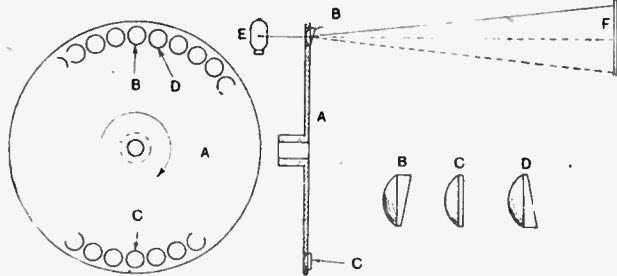

Fig 6.—Modified form of prismatic ring designed for the high speeds required in television.

and the synchronism frequency which controls the motors, and also it lights the neon lamp. A still further advance has been made by adding voice frequencies to the same carrier wave. This is done by modulating the carrier, as in an ordinary broadcasting station, and superimposing the picture at a frequency far above audible range. Thus a single carrier wave can be used to broadcast not only the voice of a singer, but also his appearance and gestures. At the receiving end the same radio receiver may be used to feed both a loud-speaker and a television apparatus, there being no mutual interference between them. This feat has actually been accomplished in the Jenkins laboratories in Washington.

Modifications Necessary for Television.

The transmitter illustrated in Fig. 4 is arranged for the transmission of transparent pictures, such as lantern slides, but it can also be used to send opaque pictures, such as photographic prints. To accomplish this the light (either daylight or artificial light) reflected from the picture surface is focussed on to the light sensitive cell. With light cells available which will give an almost in-

stantaneous response, it is but a step from the transmission of a single still picture to the sending of several pictures in rapid succession, so as to reproduce living scenes at the receiving station.

Thus motion pictures may be broadcast, or an actual scene containing moving people. For this purpose the transmitting apparatus shown in Fig. 4 is modified somewhat. To broadcast motion pictures, the magic lantern is replaced by a motion picture projector, and to transmit natural scenes the light reflected from the scene is collected in a lens, just as a camera lens collects light reflected from the scene before it. The light issuing from this lens, or, in the case of motion pictures, the light issuing from the lens of the projector, is focussed through the rotating prismatic rings on to the light sensitive cell in the manner already described.

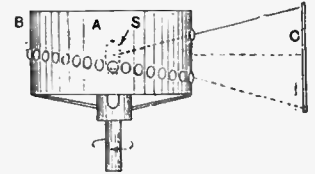

Fig. 7.—An alternative arrangement to that shown in Fig. 6.

The receiving apparatus for such work is necessarily somewhat different in design to that shown in Fig. 5, owing to the great increase of speed necessary; but the underlying principle remains the same. Instead of focussing the received image upon a photographic plate, it must be directed on to a screen, similar to that used in picture theatres. Also the individual pictures making up the film, or a rapid series of instantaneous photographs of the natural scene, must be shown at regular intervals on the screen to give a motion picture effect, that is, a picture which animates smoothly and naturally.

Mr. Jenkins has achieved this result by means of several different types of apparatus, two of which are illustrated diagrammatically in Figs. 6 and 7.

In the Fig. 6 arrangement the prismatic rings are replaced by a disc, A, around the periphery of which are mounted several lenses, B, C, D, etc. Behind each lens is mounted a small prism. The angle of these prisms is altered slightly and progressively all the way round, so that an effect similar to a prismatic disc is obtained. The rotation of the disc A sweeps the image of the light source E across the screen F in a horizontal direction, whilst line displacement in a vertical direction is effected by reason of the changing angle of successive prism elements. If the disc is rotated at a speed of sixteen revolutions per second a motion picture effect is obtained on the screen.

Persistence of Vision.

In referring to "motion-picture effect" it should be understood that, in a picture house, the film is run through the projector at the rate of sixteen separate and complete pictures per second, so that although, to the eyes of the observer, a smoothly flowing scene appears on the screen, this effect is due to an optical illusion known as "persistence of vision." In viewing motion pictures as received by wireless, persistence of vision plays an even bigger part, for the eyes are not only called upon to smooth out sixteen pictures per second to give a natural movement effect. They must also smooth out the extremely rapid movements of the light beam as it traces each one of the sixteen pictures.

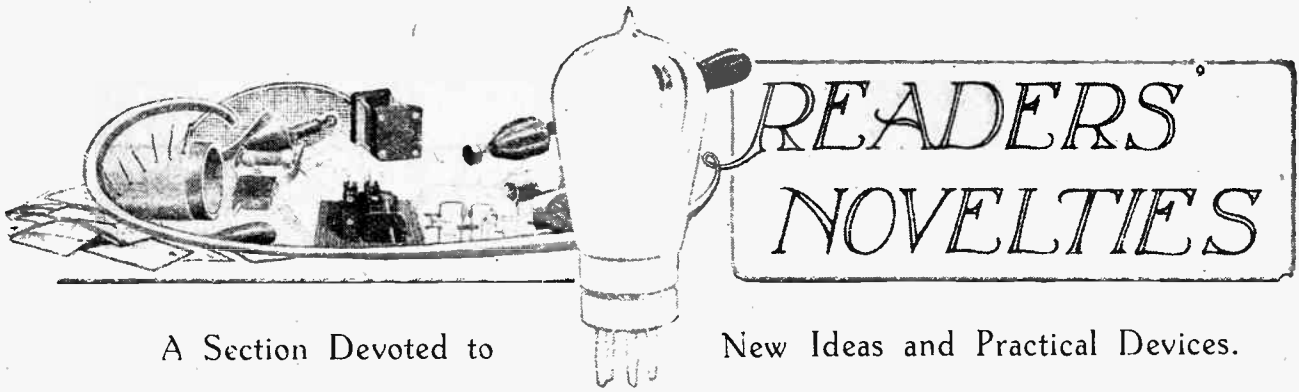

CUTTING CARDBOARD TUBE.

In cutting cylindrical formers for tuning coils or H.F. transformer windings from cardboard or Paxolin tube, the device illustrated in the diagram will be found of great assistance.

A block of wood about 1 in. in thickness is screwed vertically to a baseboard of suitable dimensions, and an old safety razor blade is clamped by means of two screws and a brass

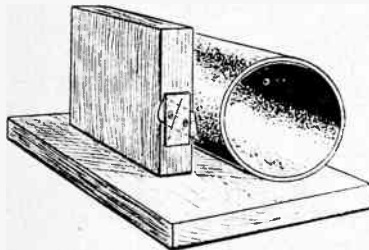

Cutting board for cardboard tube.

plate to the edge of the vertical block. The tube to be cut is then pressed against the vertical support and slowly rotated, care being taken to avoid lateral movement which would result in the formation of a spiral cut.

Where more than one piece of tube of the given length is required it may be found convenient to screw a short strip of wood parallel to the front edge of the baseboard to act as a stop.—A. J. B.

o o o o

EXPERIMENTAL THREE-COIL HOLDER.

To improve the selectivity of a valve receiver employing direct coupling to the aerial, the three-coil tuner unit shown in the diagram may be used with advantage.

The three-coil holder is mounted on a small ebonite panel with pairs of terminals at each side for the aerial

and earth and reaction connections respectively. The plug and socket connections of the fixed centre coil holder are joined to the plug and socket of an additional fixed holder screwed to the underside of the panel.

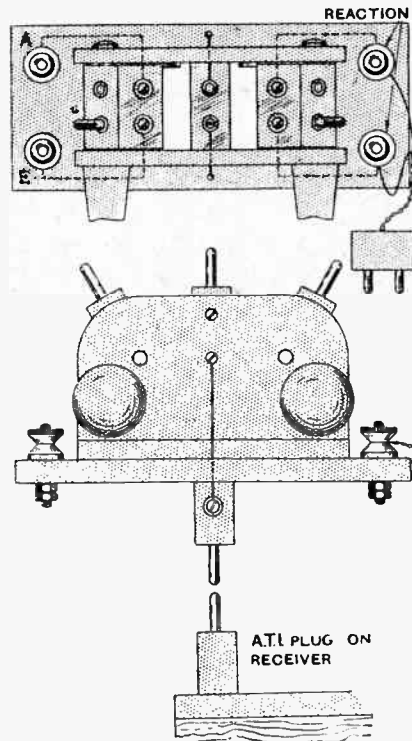

Coil holder unit for converting to loose coupling.

It is intended that this should be fitted into the existing A.T.I. plug on the receiving set, so that the centre coil is utilised in the secondary circuit of the coupled tuner. If the reaction leads are connected to a reversible plug, much time will be saved in finding the direction of current in the coil winding which gives positive reaction.—A. K.

GRID LEAK MOUNTING.

Several types of anti-vibration valve holder are constructed with a square moulded ebonite base, with terminals at each corner for the grid, plate, and filament connections. The mounting of the grid leak in a receiver employing valve holders of this type is quite an easy matter. It is only necessary to fit spring clips underneath the grid and positive filament terminals, which will be found to have approximately the correct

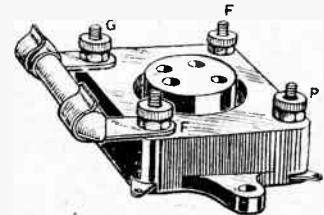

Mounting grid leak directly between grid and filament.

spacing for grid leaks of standard length.—J. B.

o o o o

MOUNTING GRID BATTERY.

In fitting the grid battery to the baseboard of a receiver it is usual to make use of a clamp consisting of a strip of brass or other material. This method takes time, and, as the grid battery is usually fitted just before the completion of a receiver when one is anxious to obtain results, the delay is annoying.

A simple method of overcoming this difficulty is to utilise the cardboard lid of the battery (if of the 9-volt type) as a holder. The lid is fixed in position by pushing two or three ordinary drawing-pins through the bottom into the wooden baseboard. The battery can then be inserted in the upturned lid, when it will be securely held in place.—J. B.

AMATEUR RECORDING APPARATUS



A Successful Installation, Home Constructed with Old Telegraph Components.

By J. ANDERSON.

NO doubt there are still a great many amateurs who have not altogether deserted the field of Morse reception for telephony and to whom the following particulars of an amateur's recorder may be of interest. A great deal of the fascination of the construction and operation of this apparatus, at least to the writer, lies in the combination of the electrical with the mechanical. The apparatus about to be described has been in use with successful results in more or less the same form for about four years. The circuits used are of a straightforward and simple type, and the instrument is self-contained, requiring only to be connected to the output terminals of an ordinary valve receiver. It is in two units, as shown in the photographs, namely, the relays

need not be accurate, as it is merely an indicator.

The relay inserted in the anode circuit is of the Post Office type rewound to 5,000 ohms, and as this type is in its most sensitive condition when the current changes in its windings vary from zero, it is an advantage to have the steady anode current balanced out. This is arranged for by incorporating an adaptation of the Wheatstone bridge. Referring to Fig. 1, it will be seen that the anode of the valve is connected through I_2 to the high-resistance potentiometer by a non-inductive resistance. This resistance should be approximately of the same value as the internal resistance of the valve being used, say, 10,000 or 12,000 ohms: 250-volt 8-watt bulbs are used as non-inductive resistances, and two joined in series will give a suitable value. The relay is connected through the milliammeter to the high-resistance potentiometer P_2 , placed across the high-tension battery, which should be 50 or 60 volts. This potentiometer must be of a very high resistance, or it will be a serious drain on the high-tension battery. This special potentiometer

Valve Relay.

We will deal firstly with the relay portion, and, to simplify matters, will take it in two stages, the first being the "valve relay." It is of the trigger type, wherein the valve is arranged so that it only requires the incoming signal to be impressed on the grid to cause it to oscillate, and, of course, cause a large change in the current flowing in the anode circuit in which is placed a high-resistance relay and a centre zero milliammeter. Immediately the signal ceases, the valve stops oscillating, owing to the fact that the grid has a positive potential of 9 volts applied to it. The milliammeter was made out of an old pocket-type moving coil voltmeter, and was calibrated against a standard instrument. It

could, no doubt, be done away with. An ordinary potentiometer put across a few cells and used in conjunction with a tapped high-tension battery would serve. The writer has not tried this, as he has lighting mains at 50 volts available, thus making the current consumption of the potentiometer of no importance. The condenser C_1 is important and should have a fairly large value, say, 2 microfarads. The instrument is coupled to the

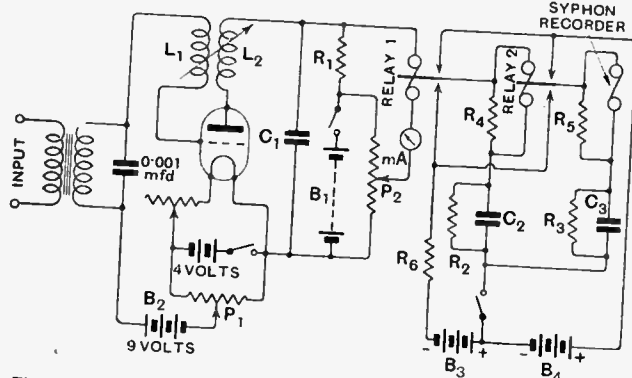

Fig. 1.—Circuit diagram of the valve relay and syphon recorder.

Amateur Recording Apparatus.

receiver by an ordinary intervalve transformer. The inductances L_1 and L_2 are mounted so that their coupling can be varied. They are honeycomb coils made on a home winder, both being two inches in diameter, L_1 having 210 turns of No. 30 S.C.C., and L_2 100 turns of No. 28 S.C.C. Pancake or similar coils can be used, provided they can be closely coupled if necessary. The grid bias battery consists of two $4\frac{1}{2}$ -volt pocket lamp batteries connected in series and joined to the slider of the potentiometer P_1 across the filament battery. An ordinary "R" valve is used and gives good results.

To operate, place the potentiometer P_1 in the mid-position. Next, adjust the coupling of L_1 and L_2 and the filament brightness until the valve goes in and out of oscillation without overlap. Leave the valve just off the oscillation point and at the same time adjust the potentiometer P_2 until the milliammeter shows zero, thus indicating that there is no current flowing in the relay windings. The point where oscillation commences can be detected by the sudden change in the reading of the milliammeter. Adjust the bias of the relay until the tongue just rests against the spacing stop and no more, then switch on the receiver. If the signals are coming in on a noisy background, it will be necessary to put the valve still further off the oscillation point, which can be done with potentiometer P_1 , which will now give complete control of oscillation.

It will be found that there is a certain fairly low note to which the relay responds most readily, and the incoming signals should be tuned to this when possible. Great use can be made of this characteristic when jamming is bad, and it will be found that the relay will

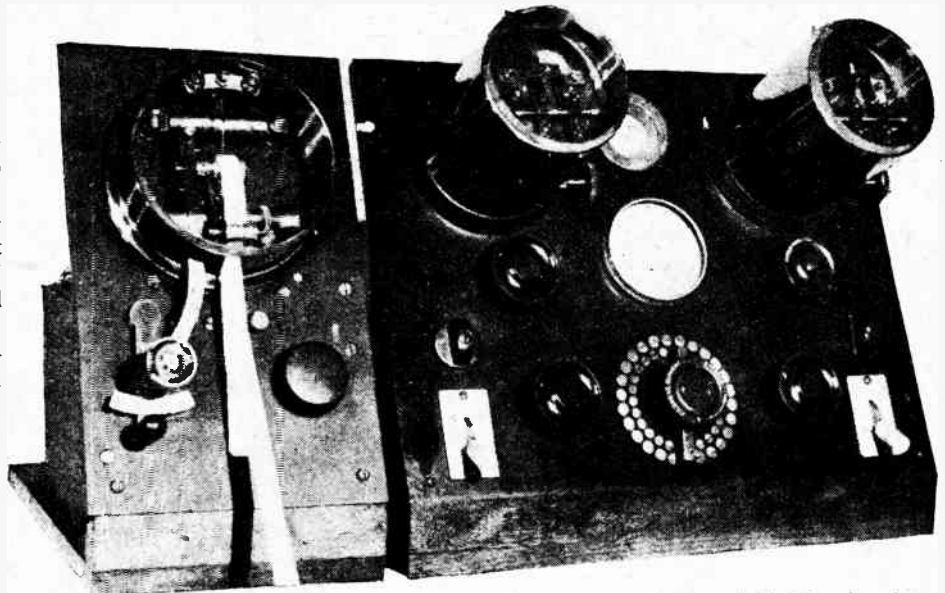

Front view of the relay panel (right) and syphon recorder (left).

continue to operate correctly when signals, heard in the phones, seem to be hopelessly jammed. To receive high-speed transmission, best results are got by tuning the signals to a fairly high note. The success or otherwise of the instrument depends almost entirely on the first relay, and great care must be taken with its adjustment. It will be found necessary to keep the contacts as close as is safe.

Turning now to the second portion consisting of the local circuits, it will be seen from Fig. 1 that a second Post Office relay is used. It is not rewound and was used because difficulty was experienced in getting the first relay to "make" contact with certainty as well as to "break" contact, especially when receiving weak signals. As the syphon recorder is of the polarised type working without springs and thus requiring complete reversals of current for its operation, definite contact on both stops of the relay is essential, making the second relay necessary.

Relay Adjustment.

The bias of the second relay is adjusted so that it still works should the tongue of the first relay not reach the marking stop. The second relay also enables the load on the first to be kept light, thus obviating sparking troubles

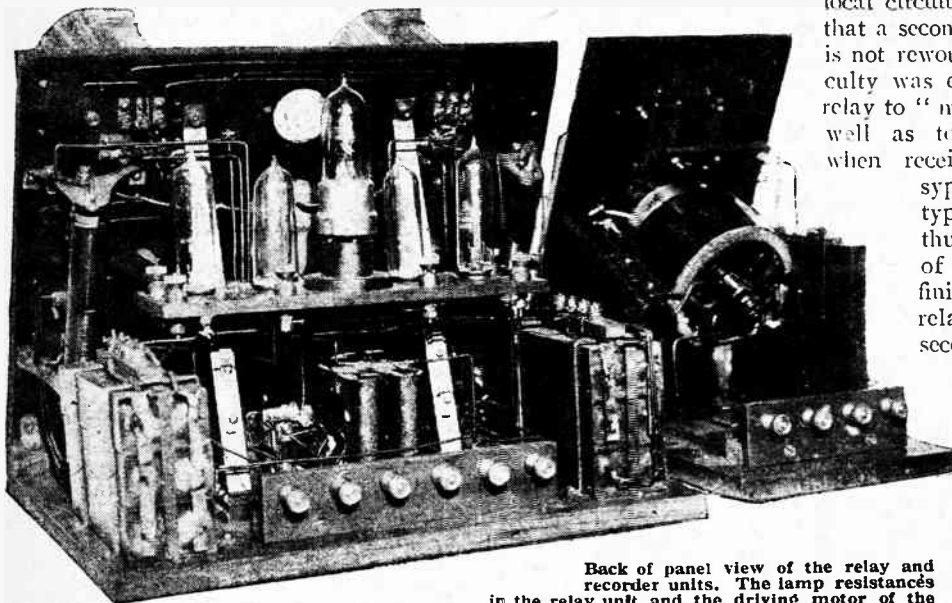

Back of panel view of the relay and recorder units. The lamp resistances in the relay unit and the driving motor of the syphon recorder will be readily identified.

Amateur Recording Apparatus.

and sticking of the contacts. A cheaper type of relay could, of course, be used, provided its moving parts were light. The Post Office type was used in this case, because, at the time the instrument was built, they were to be had very cheaply. This second relay could be done away with completely, if desired, and an ordinary Morse inker connected to the first relay. The shunted inductances R_2 and R_3 are essential if it is desired to record automatic transmission without overloading the relay contacts. Their value depends on various factors. In this instance they are 5,000 ohms, and the condensers C_2 and C_3 2 microfarads. The non-inductive resistances R_4 and

used magneto telephone bell of 1,000-ohms resistance fitted with a suitable armature and arranged behind the panel. The armature spindle is carried through to the front, where the silver syphon tube is fixed. Both the syphon and the reservoir are made easily detachable for cleaning.

The knob seen in the right-hand corner of the front view of the panel controls the motor speed and is an ordinary filament rheostat. The knurled screw projecting through the end of the lever on the other side adjusts the pressure of the syphon on the tube. This lever is held down normally by a spring, and it is so arranged that when the screw is lifted bodily it withdraws the

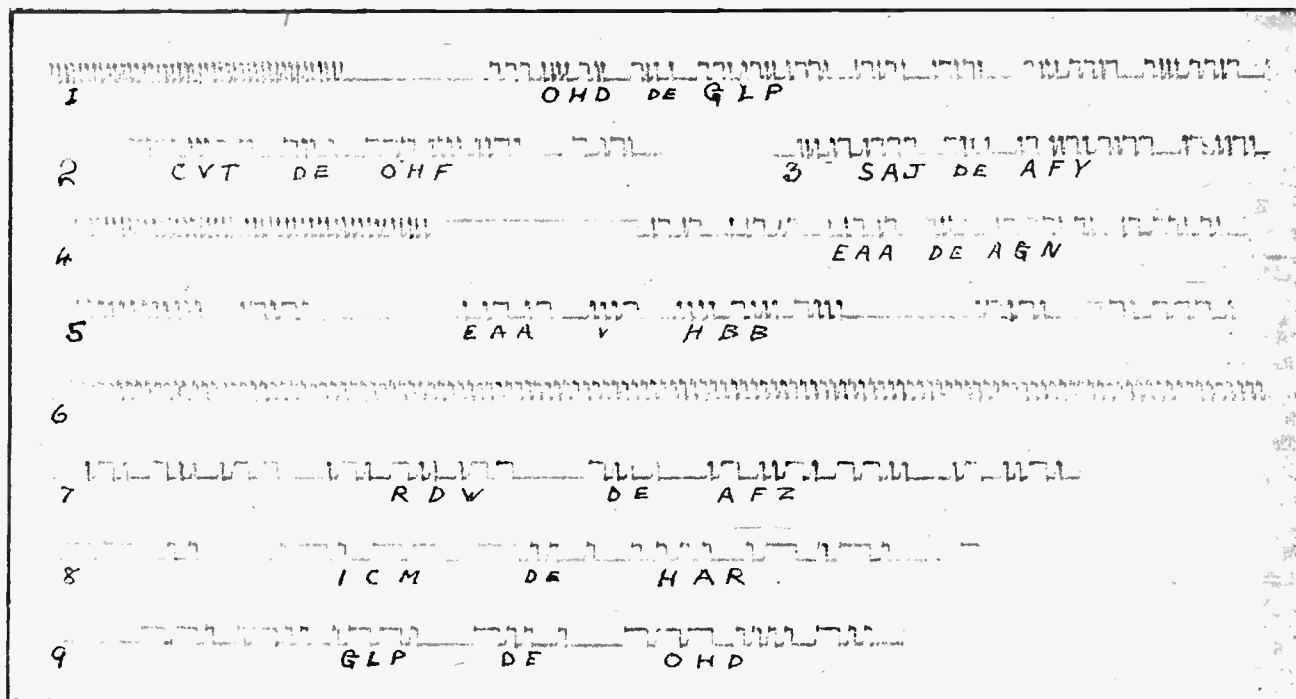

Fig. 2.—Tape records from well-known European stations. Nos. 1-5, high-speed automatic transmission: No. 6, Wheatstone dots at 1,500 per minute: Nos 7-9, normal hand transmission.

R_5 are to prevent sparking at the contacts and are approximately 6,000 ohms. For batteries B_3 and B_4 a voltage of 12-25 is necessary. R_6 is a resistance placed in the circuit to prevent the batteries being shorted in the event of the relay contacts being screwed up accidentally together.

The syphon recorder is constructed mainly of the parts of an ex-Government duplex telephone key complete with glass top cover. The paper drive consists of a small drum, worm-driven direct from an electric motor which came originally from an electric horn. The worm wheel was cut by using a $\frac{1}{16}$ in. Whitworth tap as a hob, and the worm is simply a spindle with a $\frac{1}{16}$ in. thread at the end. The gear ratio was purposely kept fairly high in order to cut down the motor speed and thus avoid vibration. A heavy flywheel is included to steady up the drive, and the motor is mounted in felt to still further reduce vibration. A 2-microfarad condenser is connected across the motor to prevent interference with the receiver. The syphon movement consists of an old polar-

paper from the syphon and at the same time lifts the pressure roller from the paper drum, thus stopping the tape, although the motor is still running, yet without affecting the adjustment of the syphon. The small lever seen below the adjusting screw is loaded so that it springs along and holds the large lever in the upward position. This feature enables the motor to be kept running during an interval in transmission, without using up tape, and also makes it possible to commence recording instantly when the signals resume, without missing more than a letter or so, owing to the fact that it is not necessary to wait until the motor speeds up as would have to be done if the motor was stopped every time.

The writer resides near Glasgow, where he can record almost all the British and Continental high-power stations with a two-valve receiver, three valves being the most used at any time.

The valve relay will be found to be very easily operated, and when once adjusted to a station it can be left working for hours without attention.

DISTORTION IN TELEPHONES.

Effect of Series and Parallel Connections on Quality.

By W. H. F. GRIFFITHS.

SO many experimenters are, at the moment, devoting their attention to the problem of distortion in radio receiving apparatus that the writer feels that it is important to stress the well-known fact that very considerable distortion is introduced by telephone receivers and loud-speaking receivers themselves, in order that efforts to eliminate very slight "set distortion" may not be wasted. In other words, it should be realised at once that it is the elimination of "overall" distortion of set and telephones or loud-speaker at which one must aim, and not necessarily just that existing in the set itself.

Output Circuit Impedance.

It is not the object of this article, however, to enumerate all the possible causes of distortion in these essential sound producers, nor to classify them in the order of their importance. The object is to draw attention to the variation of "tone" quality caused by varying the mean impedance of the output circuit of a radio receiver or amplifier. This variation of tone quality is due to frequency distortion, and becomes more important as the ratio of mean load impedance to the internal anode impedance of the load valve is made higher. The particular case the writer has in mind is that which occurs in the series-parallel grouping of high-resistance telephone receivers. If one has several pairs of telephones, one usually groups them in series, parallel, or series-parallel combinations, to give a maximum apparent signal strength. Since the impedance of the telephones is rather a complex quantity, the best grouping is usually determined by trial. The probability is, however, that this "signal strength grouping" is not the most ideal one when regarded from a faithful reproduction viewpoint.

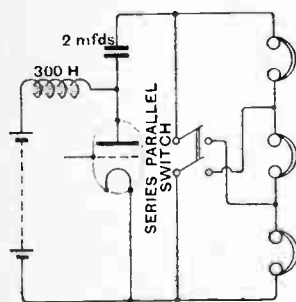

Fig. 1.—Series-parallel connections of telephone receiver load obtained with a D.P.S.T. switch.

The reason for this is to be found in the fact that the impedance of a telephone receiver is not constant for all frequencies. With an increase of frequency from 100 to 10,000 cycles per second its impedance may increase to twenty times its former value, and unless this impedance variation with frequency is made inappreciable by ensuring that, by sacrificing loudness, the mean impedance of the telephone or group of telephones is considerably less than that of the valve with which they are associated, frequency distortion will certainly occur. The impedance increase with frequency is, of course, due to an increase in both effective resistance and effective inductive reactance, both contributing considerably.

Since the impedance variations of the telephones must be "swamped" by a constant impedance if the resultant

total impedance variations are to be small, it follows that frequency distortion due to impedance variation is more troublesome with the lower impedance valves, such as, for instance, those of the Marconi and Osram D.E.5 type. For an experiment in this connection a D.E.5 valve was employed in the output stage of a radio amplifier, and three pairs of telephones each of 8,000 ohms resistance (D.C.) were arranged so that they could be quickly switched from all in series to all in parallel by a simple double-pole single-throw switch as shown in the diagram of Fig. 1.

The first test was made upon speech, it being found that overtones were certainly partially eliminated when

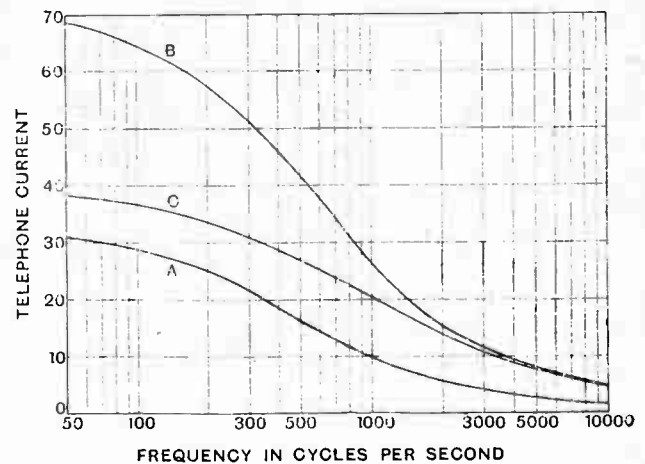

Fig. 2.—Telephone current-frequency curves for a low impedance output valve.

the telephone receivers were changed from parallel to series grouping. An apparent strength reduction of high-pitched soprano voices occurred upon changing from parallel to series, although no such reduction was detected on the lowest bass notes. Aural tests were then carried out, using pure musical notes of 100, 1,500, and 5,000 cycles per second frequency. The apparent strength of the 100-cycle note was not materially changed by a change in telephone grouping, whereas the 1,500-cycle note was definitely much louder with the parallel grouping.

High Tones Better with Phones in Parallel.

The 5,000-cycle note was to a much greater extent intensified upon changing over from series to parallel grouping, so much so that a signal of this frequency that could be heard well with the three telephones in parallel was entirely eliminated upon changing over to the "all-in-series" grouping. That this great strength reduction in the series grouping case was due to a very high telephone impedance at this frequency was then proved by inserting a non-reactive resistance of 300,000 ohms in series with the telephone group. When the telephones

Distortion in Telephones.—

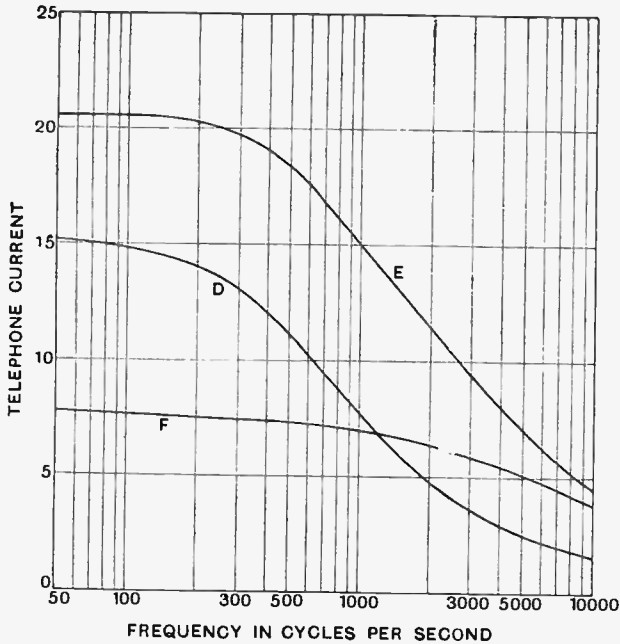

Fig. 3.—Telephone current-frequency curves for a high impedance output valve.

were grouped in parallel the insertion of this high resistance reduced a fairly loud 5,000-cycle signal to inaudibility, whereas when the telephones were in series its insertion caused practically no strength reduction, although the strengths of notes of much lower pitch were, of course, considerably reduced by the insertion of the high resistance in whatever manner the telephones were grouped. This latter phenomenon has probably been noticed by many experimenters upon the opening of the telephone circuit whilst wearing the telephones, the resulting telephony, besides being, naturally, very weak, is of a peculiarly "high toned" quality.

Calculated Curves.

In order to give some idea of the extent of the frequency distortion which may occur due to telephone impedance changes with frequency changes, the telephone current for a constant output valve voltage at all fre-

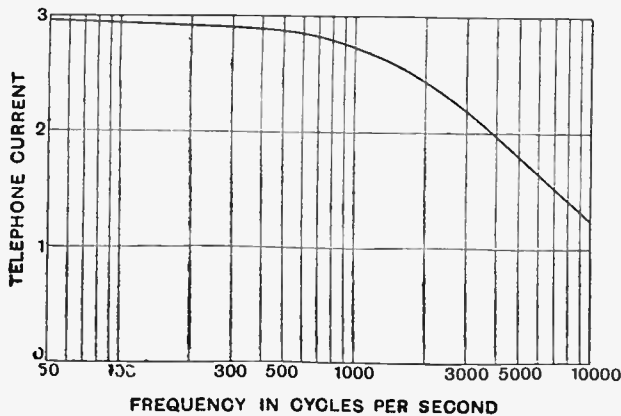

Fig. 4.—Current-frequency curve flattened by the insertion of a valve "swamping" resistance.

quencies has been calculated for varying combinations of telephones, and these results plotted in Fig. 2. The curves given in this figure show the current (in arbitrary units) obtained when using a low-impedance D.E.5 valve with three pairs of 8,000-ohm telephones in series (curve A), one pair of 8,000-ohm telephones singly (curve B), and through each of three pairs of 8,000-ohm telephones connected in parallel (curve C).

It will be noticed that a logarithmic frequency scale has been employed in order that the important frequency band of instrumental and speech fundamentals (from 200 to 1,500 per second) shall occupy a reasonably large portion of the curves.

Some Interesting Comparisons.

It will be observed that curve C more nearly approaches the *apparently* ideal flat curve due to the lower ratio of load impedance to valve impedance for this parallel grouping. Curve A, obtained with the series grouping, naturally shows the greatest current variation with frequency. The ratios of current values at 100 cycles and 10,000 cycles per second for curves A, B, and C are 19, 14, and 7 respectively.

As previously explained, when an output valve having a much higher impedance is employed, the telephone-

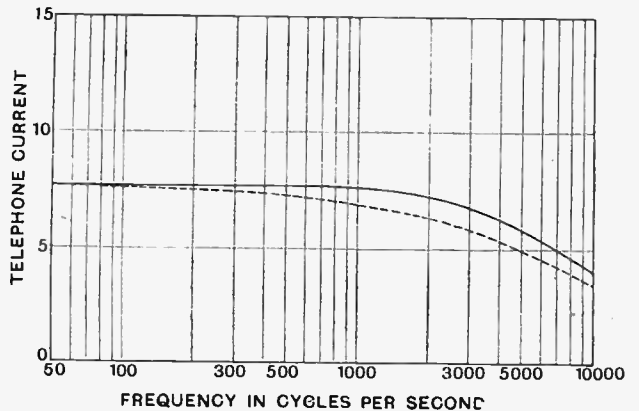

Fig. 5.—Current-frequency curve assuming a constant effective resistance of telephone receivers.

current-frequency curves are flattened considerably. In Fig. 3 are plotted curves D, E, and F, corresponding to A, B, and C of Fig. 2, but for an ordinary high-impedance "R" type output valve, it will be seen that these curves are considerably flatter than those obtained with a low-impedance valve, the ratios of current values at 100 and 10,000 cycles per second being in this case 10, 4.7, and 2.1 for D, E, and F respectively. Curve F is very closely approaching perfection, due to the *constant* valve impedance being sufficiently high in value to "swamp" the varying telephone impedance in this case, since the three pairs of telephones were in parallel.

In order to obtain a fairly flat telephone current-frequency curve, whatever valve is employed, the telephone-impedance variations must be swamped by the insertion of a high non-reactive resistance in series with the telephone group. The value of this resistance must be comparable with the impedance of the telephone group at the highest frequencies, and in the worst case of three 8,000-

Distortion in Telephones.—

ohm telephones in series will have to be of the order of 300,000 ohms. Fig. 4 shows a telephone current variation curve for this case when a D.E.5 valve is used. The current ratio at 100 and 10,000 cycles per second is in this case about 2-4, and the curve should be compared with curve A of Fig. 2. Had the telephones been in parallel instead of in series a much lower value of inserted resistance would, of course, have produced a much more perfect curve.

High-impedance Output Valves.

Although not a practical case it may be of interest to note that the current-frequency curve that would be obtained with an ordinary "R" valve and with three pairs of 8,000 ohm telephones in parallel for the load would be absolutely flat from 50 to 2,000 cycles per second if the effective resistance of the telephones with varying frequencies remained constant at their D.C. value of 8,000 ohms, *i.e.*, if the impedance increase was entirely due to an increase of inductive reactance. A curve representing this case is shown in Fig. 5, and should be compared with Fig. 3 (F), (dotted for convenience in Fig. 5 also); the difference between the two curves shows well the impedance augmenting effect of the resistance of the telephone receivers.

All the telephone current-frequency curves given here are plotted from reciprocals of the *total* impedance values of the output circuit, the latter being computed from a knowledge of approximate and mean measured values of effective inductance and effective resistance, and do not,

of course, take account of any local resonance variations of impedance.

In conclusion the writer does not wish to create the impression that impedance adjustments must be made on the load circuit in order to obtain a flat or nearly flat curve since it appears that, even though the efficiency curve of a flat diaphragm receiver is somewhat as repre-

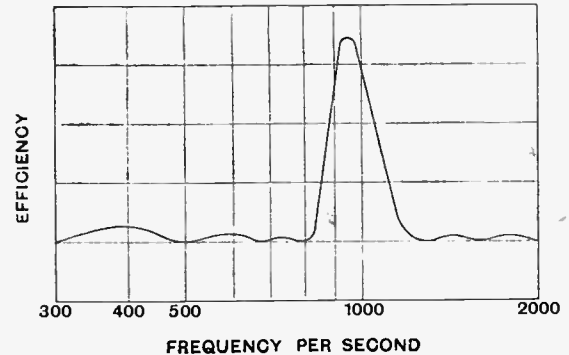

Fig. 6.—Efficiency curve of an ordinary flat diaphragm telephone receiver.

sented in Fig. 6, after adjusting a rejector circuit to eliminate the diaphragm natural frequency hump, a boosting of the lower tones is necessary to preserve tone balance. If this is so an output impedance adjustment giving a curve somewhat as B, Fig. 2, might conceivably give more pleasing or even more faithful overall results than one giving curve C.

The QSL Question.

In the course of our daily toil we receive, for forwarding and other purposes, many and varied QSL cards of different nationalities. G 6CJ (ex BCL "Dud") is, however, the first to send one in which the Muse of Poetry has been invoked. We print below an extract therefrom as a solemn warning to other possible transgressors:—

"O 3XYZ! Amateur, whose CQ's I have heard, I beg of U to QSL: Oh! pse send me a crd, For if U do not answer, it will be for Ur worse: I'll call the wrath of Jupiter upon U in my curse. As Nelson said at Waterloo in 1962, "Up then Guards and Atom"—so shall I say of U—"Up Sturbs and Electrons"—and by the seven spheres May the heavens belch forth QRN, fit for Thor's own ears; May the sky be rent with lightnings, and the earth be rent with 'quakes, And Ur Aerial Mast be stricken, so that every Gay Wire breaks: May Ur Radiation wither, and Ur Amps refuse to amp; May Ur Bottles all Disintegrate, and Ur Lo-Loss Coils git cramp; May Ur Generator sizzle, and Ur Meters all go fut; Ur Condensers stop condensing, and Ur Tuning ne'er sta-put. And so because you didn't write things all turn out so bad, When this Maldiction comes to pass, perhaps U'll wish U had.

"However, if U QSL, or send a word or two, I wish U YY 73's and I raise my hat to U!"

TRANSMITTERS' NOTES AND QUERIES.

Apropos the "QSL" controversy which has been raging in our correspondence columns, we think that a certain number of listeners are only concerned in collecting replies for decorating their walls and are merely actuated by that "stamp collecting" craze which was once so prevalent in U.S.A. Of course, a large proportion of QSL cards contains information of real value to serious experimenters, and is in consequence cordially welcomed. Many cards, however, are worthless even for mural decoration and only a nuisance to their recipients.

Mr. Hugo Francke (SMUK), of Saltsjobaden, Sweden, wishes to express his gratitude to the many English amateurs who have sent him cards, but he is at present unable to reply to them all without engaging a secretary entirely for that purpose.

This is not the only instance which has recently come to our notice of an unfortunate transmitter being "snowed under" with QSL cards, and we would urge listeners

to consider whether their observations or remarks are likely to be of real value to a transmitter before lightheartedly sending him a post-card to which they expect a reply. To those who are only concerned in collecting mural decorations we would repeat the immortal words, "Please don't do it!"

Perhaps the best solution of this difficulty would be if an established code could be devised for transmitters which would signify the nature of the reports desired. Thus an experimenter working on comparatively high power would be interested only in reports from distant stations, while one who was conducting tests on low power would probably welcome cards from listeners in his neighbourhood as well as from a greater distance, to enable him to judge the practical range of his transmission and the strength of his signals at various distances. Another might be only interested in fading effects or meteorological conditions, and cards merely stating that he had been heard at such-and-such a time and place would be of no material value to his investigations.

New Call-Signs Allotted and Stations Identified.

G 2BOW (Art. A).—G. L. Brownson, Bryning, Hale, Cheshire.

G 2BQW.—G. H. Kitley, 57, Vicarage Road, Plumstead, S.E.18.

G 2BRC (Art. A).—G. E. Moreman, 146, St. Andrew's Road, Montpelier, Bristol.

REACTION CONTROL.

How to Increase Efficiency and Eliminate "Overlap."

By HAROLD H. WARWICK.

THE object of this article is to outline the oldest and the newest forms of reaction and to stress the importance of proper consideration of reaction arrangements in a receiving set, a consideration affecting both the operator and his listening neighbours.

First let us consider what reaction or regeneration is and what it does.

If oscillations are introduced into an oscillatory circuit connected to the grid and filament of a valve, corresponding but amplified oscillations will be set up in the plate circuit, which may be magnified still further by putting them back into the input grid circuit. That is the simplest way of looking at it. Beginners have been heard to remark that it sounds too much like perpetual motion to be true, but, of course, it has no real resemblance to that elusive process, for, although oscillation may be sustained indefinitely, energy is being consumed constantly from the batteries. A better way of regarding it is to realise that what limits the period during which an oscillation will continue in a circuit is the resistance of the circuit itself. Energy is derived from the output circuit to overcome these losses, and as these losses are very high, reaction is invaluable. Reaction is invaluable for another reason, that of selectivity, because resistance in an oscillatory circuit not only damps out oscillations therein, but renders it responsive to a considerable range of frequencies depending directly on the damping.

Classification of Reaction Control.

These are the uses of reaction in receiving gear, and they will be referred to later when the relative merits of different methods are discussed, and also when reaction distortion is considered.

Attention will be paid to the following circuitual arrangements:—

- A. Detector valve alone.
- B. Detector valve preceded by H.F. valves.
- C. Detector valve followed by L.F. valves.

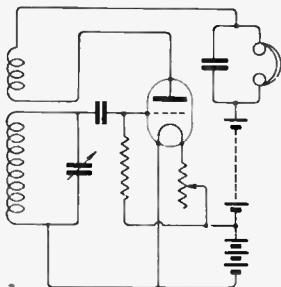

Fig. 1.—Pure magnetic reaction.

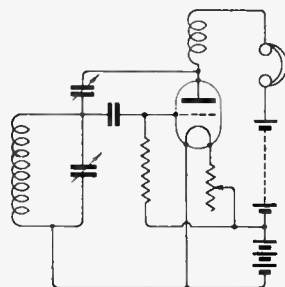

Fig. 2.—Pure capacity reaction.

No remark will be made of valves used solely for the generation of oscillations or crystal valve circuits.

Reaction may be divided under two main headings:—

- (a) Magnetic or inductive.
- (b) Capacitative.

Magnetic reaction is the term used when two coils, one in the grid circuit and one in the plate circuit, are coupled together, and capacity reaction when the coils are electrically remote but a flow of energy is allowed between them through the medium of a condenser. There is also

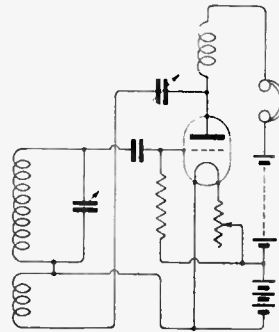

Fig. 3.—Combined magnetic and capacity reaction—the Reinartz circuit.

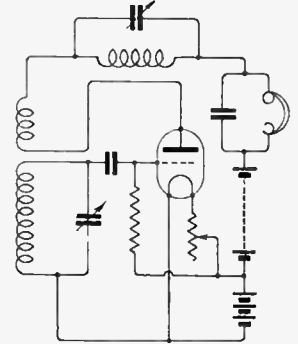

Fig. 4.—Capacity control of reaction through a variable by-pass condenser.

another method rarely employed, in which energy is fed back through a high resistance, but this is only effectively practicable when a multi-stage high-frequency amplifier is used. Many, however, are the combinations which have been evolved from the two main forms, and the arrangements about which particular mention is to be made are tabulated below.

They relate more particularly to Section A.

Type.	Methods of Control.	Example.
1. Pure magnetic.	Variable coils.	Fig. 1.
2. Pure capacity.	Variable condenser.	Fig. 2.
3. Magnetic with capacitive feed (Reinartz).	Variable condenser.	Fig. 3.
4. Magnetic with cap. control.	Variable condenser.	Fig. 4.
5. Magnetic with resistance damping.	Variable resistance.	Fig. 5.

Undoubtedly the most widely used single-valve receiver circuit is that shown in Fig. 1, and excepting that shown in Fig. 2, it is certainly the least desirable of any of those indicated above; and the reasons for this are very real, as they not only apply to this single-valve circuit but to any circuit incorporating a coil holder for reaction purposes.

Disadvantages of Magnetic Reaction.

The first objection is that adjustment of reaction is crude, inasmuch as for even a small variation in the mutual position of the coils a very appreciable, though not constant, movement of the aerial tuning condenser is essential. The second objection is that this arrangement more than any other seems to be prone to reaction overlap even with a low anode voltage, whereas a Reinartz or similar circuit will give perfectly smooth reaction control

Reaction Control.

with the maximum H.T. voltage permissible for efficient rectification. The third objection is the vast space taken up by coils and coil-holder and the additional hand capacity accruing from the nearness of the hand to the coils when making tuning adjustments.

It has one doubtful virtue—that, however great the losses due to faulty components or construction, the reaction coupling is so intense by this method that it is difficult not to obtain some sort of result. The spasmodic howls given vent to by a bad set testify to the doubtfulness of this one virtue. The reason for the popularity aforementioned is due to the fact that the circuit is really fundamental—a circuit which was tried first by investigators and which gave such good results that it was passed on at once without any attempted refinements, refinements which would at that time have been of little importance.

Capacity Reaction.

Fig. 2 is introduced, not for its practical utility, but for the way it shows the underlying principle of some of the following circuits. Again, there is the tuned grid circuit, but the plate circuit contains a choke which will not allow the passage of H.F. oscillations; these, therefore, pass through the small variable condenser and enter

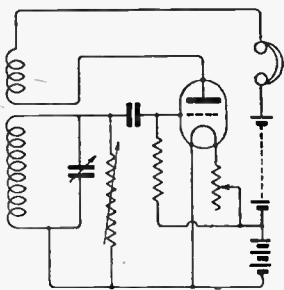

Fig. 5.—Resistance control of reaction.

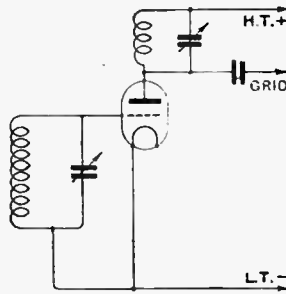

Fig. 6.—The tuned-anode system of high-frequency coupling.

the grid circuit again. The degree of reaction varies directly as the capacity of the condenser, and thus control is obtained. A variation of this may be arranged by bringing the plate circuit into resonance with the grid circuit. The reaction effect is then very much greater, so much so that oscillation will occur even when the variable condenser is removed, energy transference taking place by means of inter-electrode valve capacity. The handling of such a circuit is difficult, as are all tuned reaction circuits.

The Reinartz Circuit.

Fig. 3, a circuit using Reinartz reaction, is one of the improved types of circuit; indeed, the original Reinartz was the first to break away from the old design. There is the same grid circuit as before and the high-frequency choke of Fig. 2, whilst the reaction coil will be seen connected to the filament end of the grid coil and to a variable condenser that has the same effect as the one shown in Fig. 2. Coupling is fixed and reaction is aperiodic, for the feed-back condenser is in no way a tuning condenser. A very tight coupling is obtained in this way because it is almost impossible to create reaction

overlap, and a minute adjustment only has to be made of the grid circuit tuning condenser, even when reaction feed is altered from the one extreme to the other.

In common with a number of other circuits, this circuit undoubtedly has one fault. Both sides of the coupling

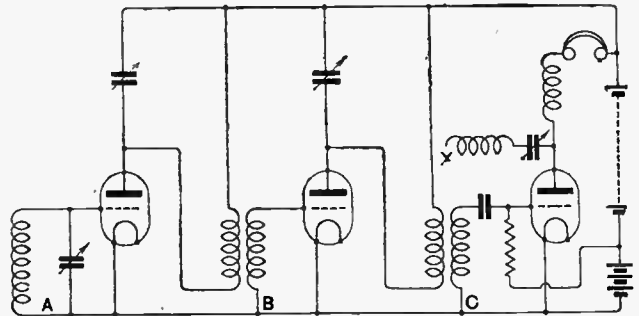

Fig. 7.—The "Reinartz" system of reaction applied to a three-valve circuit with two stages of H.F. amplification.

condenser are at high-frequency potential to earth, so that body capacity must be troublesome unless shielding is resorted to.

Eliminating Hand Capacity.

The circuit of Fig. 4 overcomes this difficulty and operates on a slightly different principle. Still there is the same grid circuit, and closely coupled to it is a coil in the plate circuit, in series with which is a high-frequency choke shunted by a variable condenser. Now, when the condenser is at minimum, if perfectly designed, it should be non-existent as far as the rest of the circuit is concerned. The coupled coil then acts as though it were part of the choke, which is in no way aperiodic over the range of the grid circuit, so that no reaction can take place. As the capacity of the condenser is increased the coupled coil becomes segregated from the choke until at maximum the choking effect is nullified, when tight reaction coupling results. The small variable condenser in this case is not a feed-back condenser, but a condenser used to create losses through the choke, at the same time one side of the condenser is at earth potential, so that no body capacity should be apparent. Of course, it is

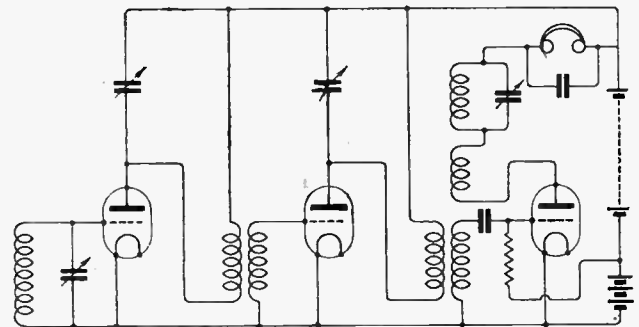

Fig. 8.—The circuit of Fig. 4 adapted for use in a high-frequency amplifier.

immaterial whether the earth potential side of the condenser is connected to H.T. plus or the filament so long as the H.T. battery is shunted by a large condenser.

At this juncture the writer wishes to relate a particular personal experience which has so far defied explanation

Reaction Control.—

and which may assist some of those who appreciate the point of this article and follow up the suggestions made.

A Useful Hint.

Having constructed a considerable number of receivers incorporating the Reinartz circuit of Fig. 3, and a greater number using Fig. 4, one of either type has occasionally refused to work. Signals have been received perfectly, but not the slightest response has been obtained from the reaction control, no matter what artifice has been employed. Each component has been tested, different coils have been tried; in fact, everything has appeared to be perfect. It was found at last that if the defaulting circuit, Fig. 3 say, was changed to that of Fig. 4, and *vice versa*, perfect results were obtained at once and thereafter. It should be observed that apparatus used in both circuits is the same, and only few wiring changes need be made to effect the transformation. No alteration, such as changing the deposition of apparatus, need be made, excepting the wiring.

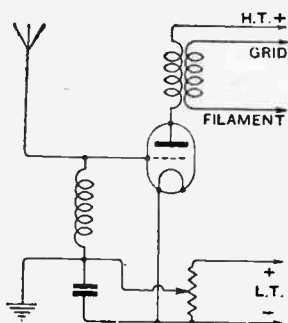

Fig. 9.—Potentiometer control of reaction.

a smooth variable damping a good non-inductive variable resistance must be used, and one very good reason why the circuit has been little used is that such a resistance until lately has been unprocurable. One may be obtained now from one of the foremost wireless firms having a continuously variable resistance of from 0 to 40,000 ohms. Incidentally, the same firm use this circuit in a number of their own receivers.

Relatively there is very little to choose between the circuits in Figs. 4 and 5, whilst both are a little better than Fig. 3, but each of these is a better and more desirable circuit than Fig. 1.

These, then, without dealing with stunt and super circuits, are sufficient to show what is to be aimed at when using a single valve.

Reaction in H.F. Amplifiers.

We now come to Section B of our classification of circuits.

Let it be understood at once that all the foregoing applies to any receiver incorporating high-frequency valves, and that all the arrangements mentioned may be used with variations whose forms will be indicated.

Fig. 6 represents diagrammatically the well known tuned anode system of connections. The trouble encountered with the system is the feed back through the

valve due to the rejecting action of the anode coil, unwanted oscillation is set up, and artifice has to be employed to neutralise the feed-back. This does not come within the scope of the article, but it will be obvious that, whatever damping is used, a control of reaction may be obtained by varying the damping factor, but as this is

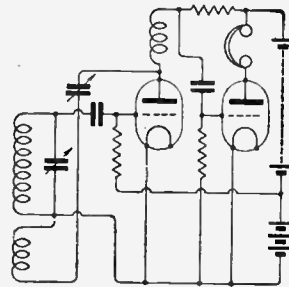

Fig. 10.—Incorrect method of connecting grid coupling condenser between reacting detector and resistance coupled L.F. amplifier.

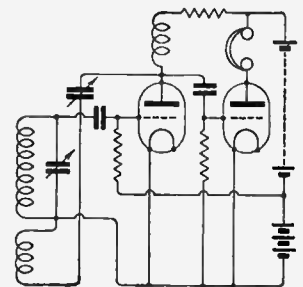

Fig. 11.—Corrected circuit of Fig. 10. High-frequency oscillations are prevented from reaching the L.F. amplifier and reaction effects are increased.

not wholly satisfactory it will be assumed that complete stability in the amplifier has been obtained and that separate reaction from the rectifying valve is to be used.

Confine Reaction to the Detector Valve.

As a typical example, Fig. 7 shows how Reinartz reaction may be applied to any valve of a three-valve set consisting of two high-frequency valves and detector. Two transformer-coupled high-frequency valves are shown, and the end of the reaction coil has only to be connected to any of the points A, B, or C in order to obtain reaction. Reaction may thus be applied at any of three points. It is usual to couple to the aerial coil, that is, the grid circuit of the first high-frequency valve, because the damping there is greatest, but it is often the case that if the damping is insufficient, as when reaction is applied, auxiliary oscillation is set up due to feed back through the high-frequency valve. Consequently, it

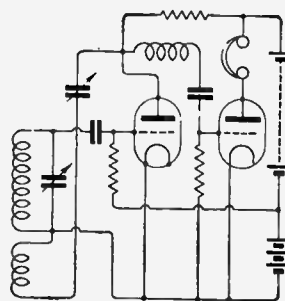

Fig. 12.—An alternative to the circuit of Fig. 11. With this circuit a choke of low self-capacity is essential.

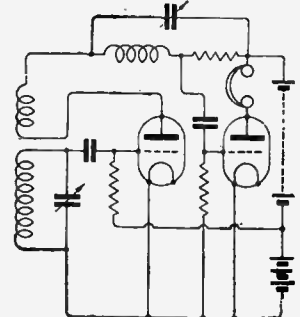

Fig. 13.—Reaction control by means of a by-pass condenser in a resistance-coupled circuit

is often better to restrict reaction to the plate and grid circuits of the rectifier.

The application of Fig. 4 to such a circuit is simple enough, and is shown in Fig. 8.

One method of reaction control in high-frequency amplifiers is worthy of note, namely, the potentiometer method.

Reaction Control.—

The first H. F. valve of an amplifier is shown in Fig. 9, the lower side of the grid coil being connected to the slider of a potentiometer in parallel with the filament battery. Normally, the slider is placed at L.T.— and oscillation occurs due to feed back through the valve. If the slider is moved over to L.T.+ oscillation is made to cease owing to the damping of the circuit due to the flow of grid current caused by a positive potential on the grid. On the whole not a method to be recommended, because separate controls are required for each valve. A better method is to stabilise the whole circuit and to apply reaction independently, as previously indicated.

Let us now turn to section C, and note the necessary precautions when a low-frequency amplifier is used.

That there are precautions may not at first be apparent to all, but reference to Figs. 10 and 11 will show how a right and wrong connection may be made when using resistance coupling. A choke may be used in place of the resistance to give choke coupling. The coupling condenser must be connected to the side of the high-frequency

choke remote from the plate, otherwise high-frequency oscillations will be shunted on to the low-frequency valve, which will cause bad distortion, due to the partial amplification of the parasitic high-frequency oscillations, and weak reaction, due to the very considerable leakage. A wrong connection, therefore, of this nature will ruin the working of a receiver.

An alternative system of connections is given in Fig. 12, which is quite effective with resistance coupling, although not always with a choke if it has a high self-capacity. The former method is the surer.

The remarks regarding the coupling condenser apply equally well to the schematic arrangement of Fig. 4, but the best coupling when used with an amplifier is given in Fig. 13, the reaction condenser being shunted across both the high-frequency choke and the resistance, or high-frequency choke and low-frequency choke, depending on the coupling employed.

In all these circuits suitable values for the grid circuit and reaction condensers are 0.0005 mfd. and 0.0003 mfd. respectively.

Finding Faults in a Reinartz.

A "fault-finding" competition which proved both entertaining and instructive was held by the Sheffield and District Wireless Society recently, when prizes of £1 and 10s. respectively were awarded to Messrs. Barlow and Peck. A Reinartz single-valve receiving set was connected up in such a way that at least six faults had to be discovered and remedied before reception could be carried out. The competitors, in batches of three, were given 15 minutes in which to discover and tabulate the faults.

Entries were also judged for the competition for the most efficient two-valve resistance capacity-coupled L.F. amplifiers constructed by members, the prize of £4 being divided equally between Messrs. Mills and Rayner. ○○○○

When is a Wavemeter not a Wavemeter?

A wavemeter with certain refinements which enable it to be used for a variety of purposes, was described by Mr. W. Gartland before the Middlesex Wireless Club at a recent meeting.

Detailed instructions for making the instrument were first given, and the method of calibrating it from a standard wavemeter was described. Fortunately, the club possesses a Townsend Wavemeter calibrated by the National Physical Laboratory, so that members desiring to follow the lecturer's example will have no difficulty with the accurate calibration of their instruments.

Mr. Gartland showed how, by a few additions, the wavemeter could be adapted to various other uses. Some of those described were:—Tuned anode unit for H.F. amplification, rejector circuit, loading unit, side tone receiver for telephony, and an ordinary crystal receiver. Hon. Secretary, H. A. Green, 100, Pellatt Grove, Wood Green, N.22. ○○○○

A Visit from Captain Round.

Captain H. J. Round, M.C., M.I.F.E.E., attended the general meeting of the Mus-

**NEWS FROM
THE CLUBS.**

well Hill and District Radio Society on March 31st in the capacity of president, giving an extremely interesting talk on "Short Wave Work." After describing many short wave experiments recently conducted, Captain Round replied to the many questions put to him by his audience. Much curiosity was shown on the question of microphones, and the lecturer

FORTHCOMING EVENTS.**WEDNESDAY, MAY 5th.**

Institution of Electrical Engineers, Wireless Section. At 6 p.m. (light refreshments at 5.30). At the Institution, Savoy Place, W.C.2. Lecture: "On the Cause and Elimination of Night Errors in Radio Direction Finding," by Dr. R. L. Smith-Rose, M.Sc., and R. H. Barfield, M.Sc.
Royal Society of Arts. At 8 p.m. At John Street, Adelphi, W.C.2. Lecture: "Radio, Its Past, Present, and Future," by Mr. C. F. Elwell, B.A. In the chair: Prof. W. H. Eccles, D.Sc., F.R.S.
Barnsley and District Wireless Association. At 8 p.m. At 22, Market Street. Discussion: "Measuring Instruments and Their Functions."
Tottenham Wireless Society. At 8 p.m. At 10, Brose Groer, N.17. Business Meeting, followed by a talk on "The Photography of Radio Scis," by Mr. F. J. Taylor.

THURSDAY, MAY 6th.

Golders Green and Hendon Radio Society. At 8 p.m. At the Club House, Willfield Way. Demonstration with Lantern Slides. "The Super-heterodyne," by Capt. L. F. Plugge, B.Sc.

MONDAY, MAY 10th.

Hackney and District Radio Society. At 8 p.m. At 18-24, Lower Clapton Road, E.5. Question Night.
Croydon Wireless and Physical Society. Lecture by Mr. J. H. A. Whitehouse, of the B.B.C.

TUESDAY, MAY 11th.

Essex Radio Group. At 8 p.m. General Rally at the Wesleyan Institute, Ilford.

was able to supply some interesting information regarding the placing of studio microphones for securing varying effects.

The Society's syllabus for the ensuing months contains many attractive fixtures. Full particulars of membership may be obtained from the Hon. Secretary, Mr. Gerald S. Sessions, 20, Gasmere Road, N.10. ○○○○

L.T. Coupling.

At a meeting of the Golders Green and Hendon Radio Society held on April 1st, Mr. W. J. T. Crewe (5CT) gave a talk on "Methods of L.T. Coupling."

He exhibited transformer, choke, and resistance capacity coupled amplifiers, and after a brief description of these gave a demonstration which provided an interesting comparison between each of the three types.

The Hon. Sec., Lt.-Col. H. A. Scarlett, 357a, Finchley Road, N.W.3, will be pleased to hear from anyone wishing to join this society. ○○○○

Wireless—Past and Present.

To conclude a very successful winter session the Ipswich and District Radio Society were fortunate in securing as lecturer, Mr. Whitehouse, of the B.B.C., who delighted an attentive audience on April 12th.

Mr. Whitehouse showed how the discoveries of the early scientists such as Sir Isaac Newton—who discovered the light spectrum—were in reality the fundamental backbone of modern wireless transmission. Radio, he contended, was a form of light transmitted by vibrations, and being on the ultra-red side of the spectrum.

Gradually Mr. Whitehouse went through the development of broadcasting, until he arrived at the now famous 2LO. Actual photographs of the station and others of the more powerful Daventry, including a fair sprinkling of slides showing the broadcasting of divers forms of outside broadcast, concluded his programme.

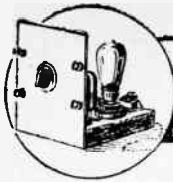

Simple L.F. Amplifier Designs

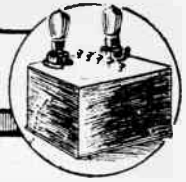

Constructional Details of One and Two Valve Unit Amplifiers.

SINGLE VALVE L.F. AMPLIFIER.

THIS is an easily constructed instrument, suitable for adding to any set where not more than one L.F. stage is already provided. The input operates through an intervalve transformer so that separate or common batteries may be connected to the receiving set. The amplifier unit can be added without danger of short circuit so long as the H.T. and L.T. negative leads in the receiver are connected together.

Construction.

Panel is first adjusted by filing to be perfectly square. The base-board is next made up with its cross battens, a file being used to square up the ends. After rubbing down with glass-paper the wood should be treated with shellac varnish or polished to render the surface durable and to prevent

warping. Screwing the components in position and the wiring up can be followed from the working drawings.

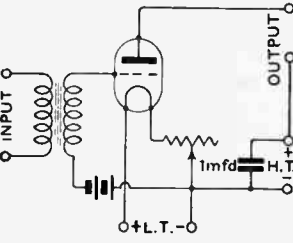

Circuit of single stage amplifying unit.

Parts Required.

Ebonite panel cut accurately to size, $6\frac{1}{2}$ in. \times $7\frac{3}{8}$ in. \times $\frac{1}{4}$ in., also ebonite for terminal strip.

Planed $\frac{1}{2}$ in. mahogany for making base-board $6\frac{1}{2}$ in. \times $6\frac{1}{2}$ in., also two wooden strips about $1\frac{1}{8}$ in. \times $\frac{3}{8}$ in. and $6\frac{1}{2}$ in. in length. (Hobbies, Ltd.). Intervalve transformer, ratio about 3 to 1. Valve holder for base-board mounting. Filament resistance.

H.T. bridging condenser, $\frac{1}{2}$ to 2 mfd. Four terminals. Terminals or screws for battery leads, and 2 yards of twin flex. 9-volt grid battery and two wander plugs. Various brass screws. Approximate cost. £1 13s. 6d.

TWO-STAGE AMPLIFIER.

Although the construction is easy the circuit is somewhat complicated, yet, owing to the arrangement of the components, the wiring is not unduly difficult. The switches provide for interchanging choke and resistance coupling in either of the amplifying stages, whilst the first valve can be cut out of circuit, leaving the grid leak and condenser in shunt across the input. To prevent short-circuiting of the H.T. battery a 1 mfd. blocking condenser is connected in one of the input leads. The set might first be constructed as a choke-coupled amplifier, and the alternative resistance coupling subsequently added.

Construction.

The panel should first be fitted to the box. All holes, excepting those required for securing the anode resistances, can be drilled, while two additional holes not shown must be made for holding down the wooden strips carrying the condensers and leaks. These strips are held in position by means of 4BA screws and nuts passing through the bases of the mica condensers. The grid cells

are held in the bottom of box by wooden cross strips. Spirals of No. 28 Eureka wire supported on the wiring are used in place of filament rheostats. Battery and input leads are of flex with indicating plugs or coloured leads.

Parts Required.

Ebonite panel finished 9 in. \times 7 in. \times $\frac{1}{4}$ in. Containing cabinet (Compton Electrical and Radio Trades Supplies, 63, Old Compton Street, London, W.1). Two valve holders—Aermonic (V. R. Pleasance, 56, Fargate, Sheffield). Two intervalve transformers or L.F. chokes of suitable dimensions. One condenser, 1 mfd. Two mica dielectric condensers, 0.05 to 0.2 mfd. Two grid leaks, 0.5 megohm, with bases. Three two-way press switches (Lissen). Two output terminals. Grid bias battery. Strips of wood for mounting condensers and leaks, various screws. Glazite insulated connecting wire. Approximate cost, £5.

Additional apparatus for alternative resistance coupling.—Two 100,000 wire-wound resistances; 2 two-way switches. Approximate additional cost, £1.

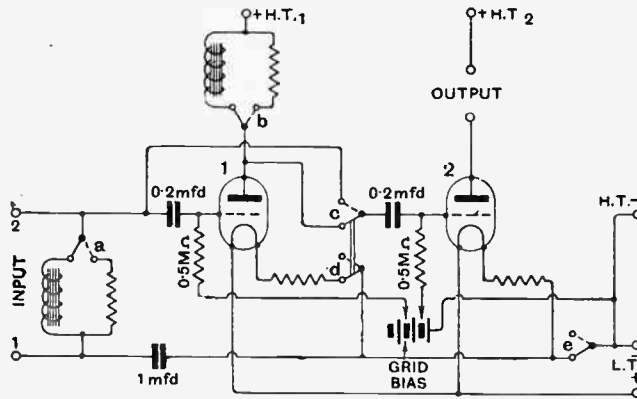

Alternative choke or resistance coupling is obtainable in either stage of the amplifier by plunger switches which also provide for taking one valve out of circuit.

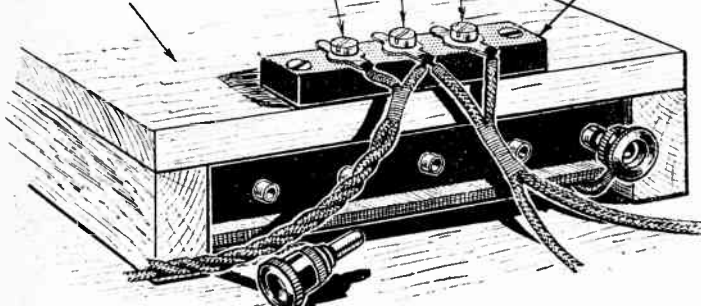
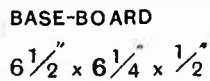
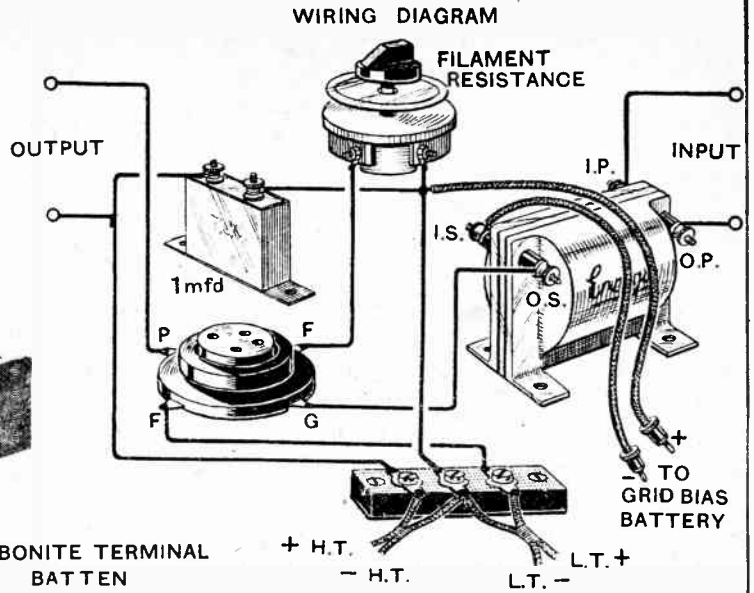
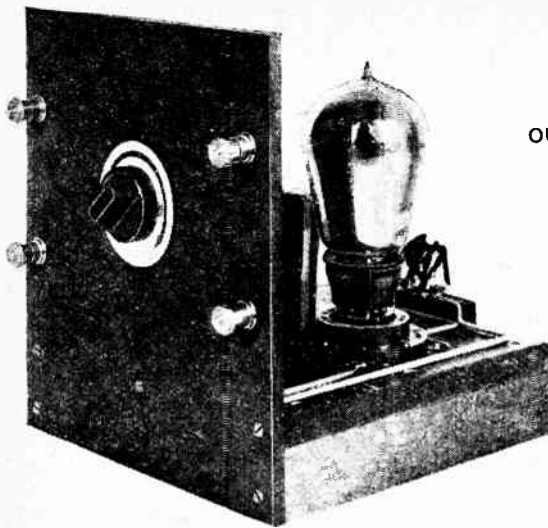

PANEL DRILLING SIZES

- HOLES A DRILL $\frac{1}{4}$ " DIAMETER
- B DRILL $\frac{5}{32}$ " DIAMETER
- C DRILL $\frac{1}{8}$ " DIAMETER AND COUNTER SUNK ON TOPSIDE FOR NO 4 WOOD SCREWS

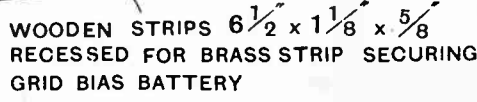
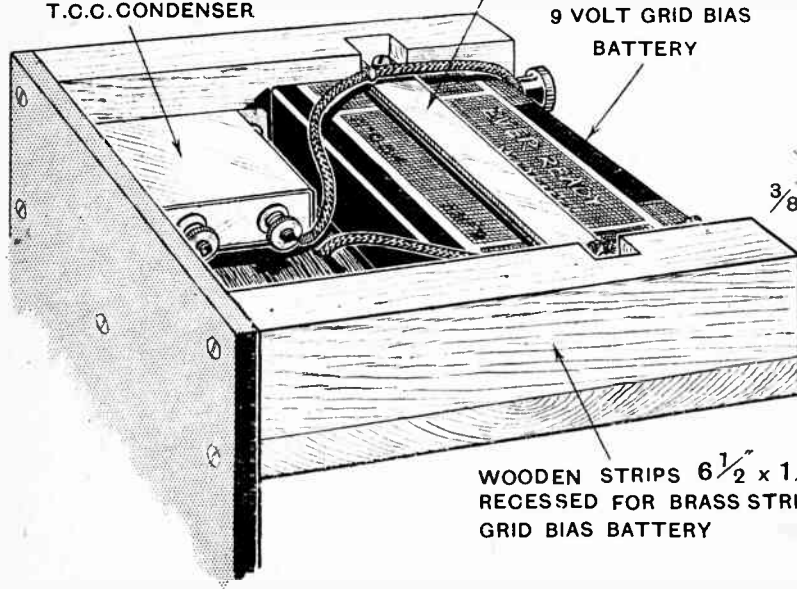
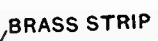
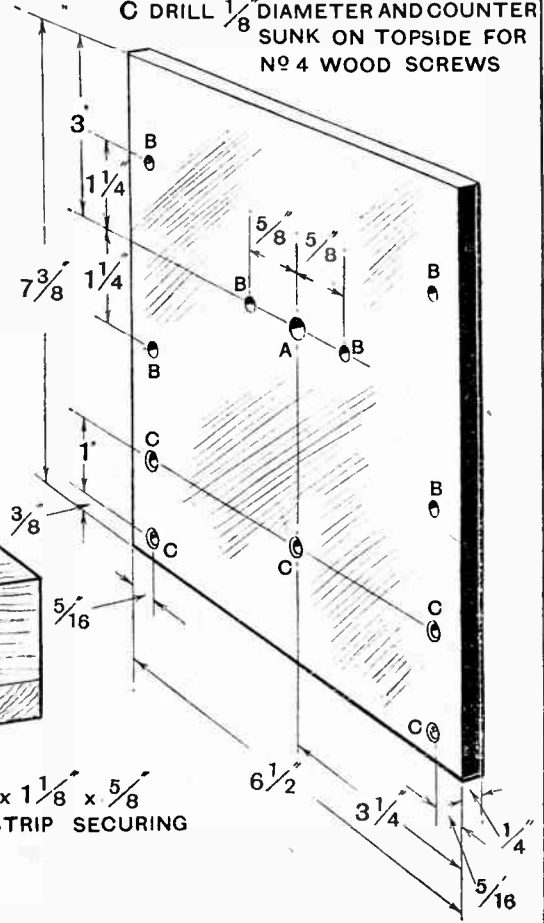

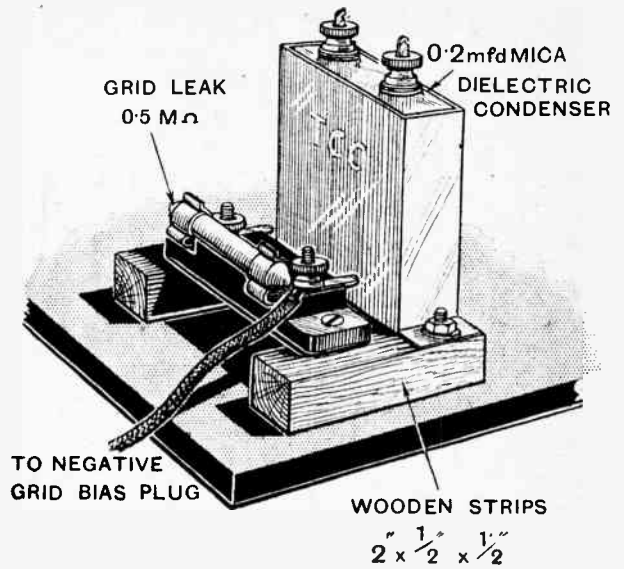
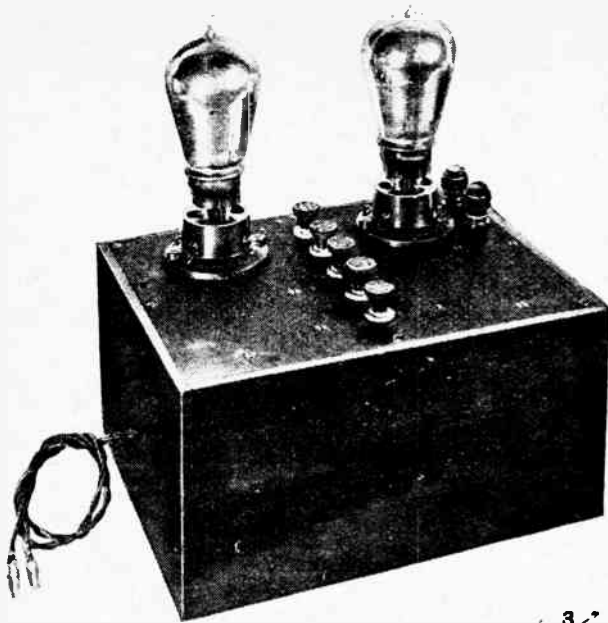

PANEL DRILLING SIZES

- HOLES A DRILL $\frac{3}{8}$ " DIAMETER.
- " B DRILL $\frac{5}{32}$ " DIAMETER.
- " C DRILL $\frac{5}{32}$ " DIAMETER AND COUNTER SUNK $\frac{3}{32}$ " ON TOPSIDE FOR NO 4 B.A. SCREWS
- " D DRILL $\frac{1}{8}$ " DIAMETER AND COUNTER SUNK ON TOPSIDE FOR NO 4 WOOD SCREWS.
- " E DRILL TO CLEAR WIRING FROM VALVE HOLDERS

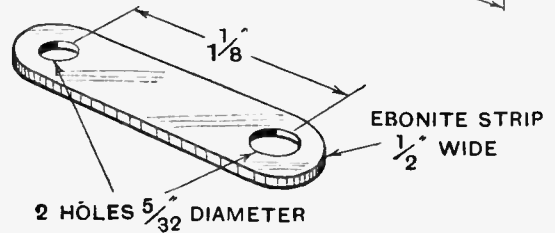
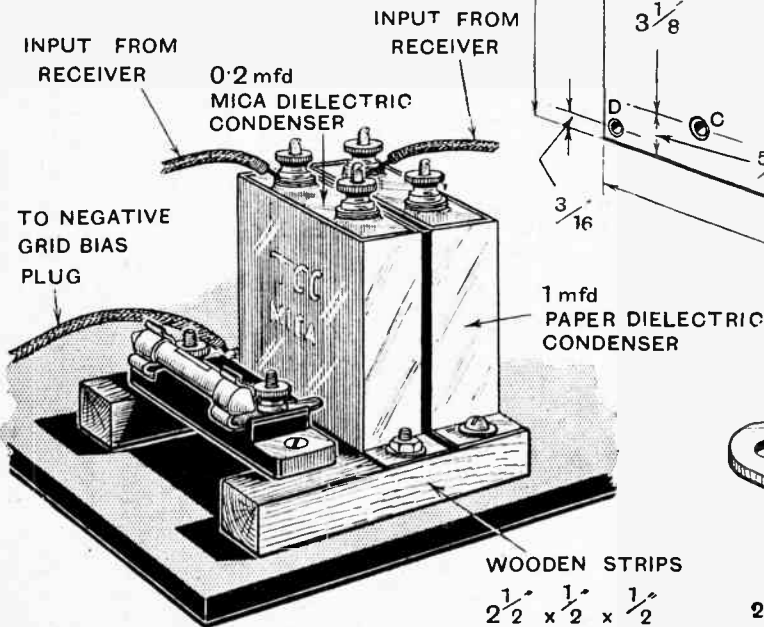
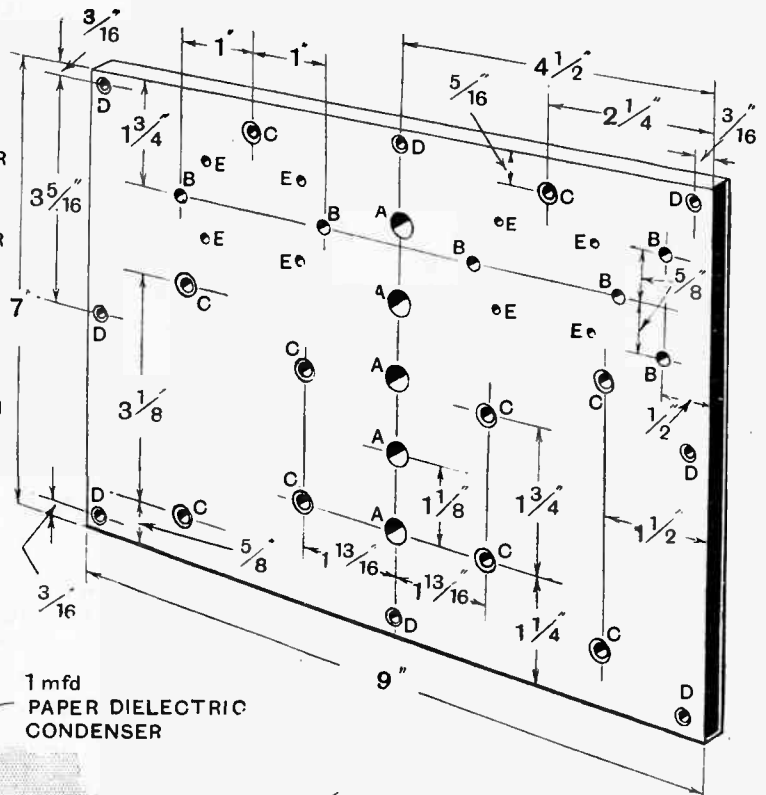

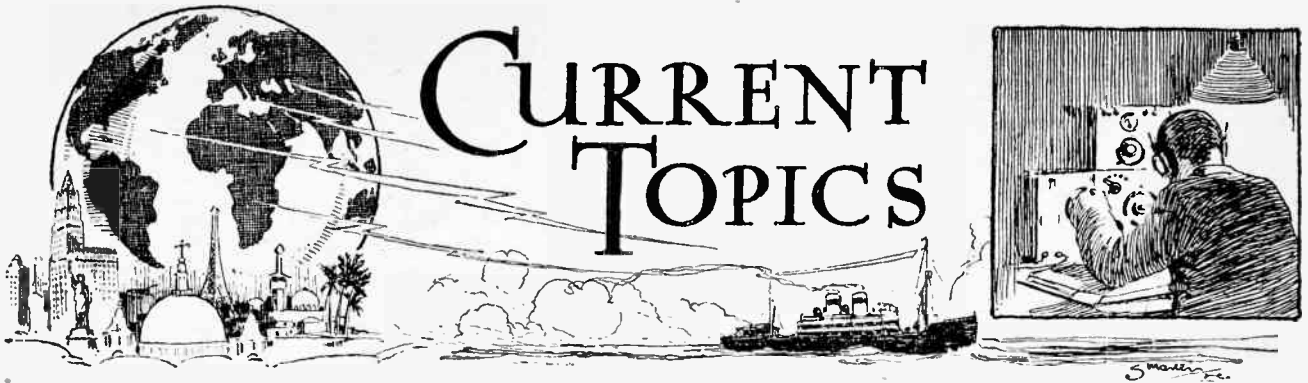

Events of the Week in Brief Review.

BELGIAN WIRELESS EXHIBITION.

The Palais des Fêtes, in Ghent, is to be the scene of a wireless exhibition in September, organised by the Ghent Radio Club. Amateurs and professionals will both be represented.

○○○○

WIRELESS PLATITUDES.

"Radio is only in its infancy," is a monumental saying which has weathered a quarter of a century and is still going strong. Its only possible rival at the moment is: "In the first place, a portable set must be really portable."

○○○○

A SOLEMN SECRET.

After stating that there are at present 800,000 licensed listeners in France, our Belgian contemporary, *La Radiophonie pour Tous*, says: "In Belgium . . . we do not know. That is the great secret of the Administration."

○○○○

INDIA'S NEW WIRELESS STATION.

To be able to transmit messages to England at 1,000 words per minute is the aim of the engineers now engaged on the construction of the large wireless station at Kirkee, 65 miles inland from Bombay. The station is expected to be in full working order by July 1st.

○○○○

WIRELESS ON ITALIAN TRAINS.

Appropos of our note on the success obtained in the reception of broadcasting on the Rome to Naples express recently, we learn from the Italian Marconi Company that similar experiments were carried out successfully with a Marconi V2 receiver on the same express in September, 1924.

○○○○

JAPANESE INDEPENDENCE.

Japan is stated to be showing a healthy spirit of independence in matters affecting broadcasting. Much of the receiving apparatus in use is of home manufacture, and this applies even to the complicated valve. The receiving licence fee is 4 yen, about 8s., and as evidence that Japan is following Western ideals it may be mentioned that Tokio possesses a goodly number of pirates!

SAFER?

The officials at the 2FC broadcasting station at Sydney are arranging for a trained choir to sing from the Jenolan Caves, in the Blue Mountains.

○○○○

AERIAL TERRORS.

Australian listeners have been given food for thought by an article in the *Melbourne Argus* which calls for a standard design in the construction of wireless aerials. The paper fears that otherwise the fair city of Melbourne will be disfigured by all kinds of ingenious but ugly erections.

○○○○

SAVING MONEY BY WIRELESS.

American farmers are loud in their praise of wireless market reports. A survey carried out by the National Farm Radio Council in Chicago shows that 46 per cent. of the farmers making use of the reports could show specific instances in which early information by wireless had resulted in the saving of cash.

BROADCASTING PLAN FOR KOREA.

By the end of July, it is hoped, Korea will enjoy broadcasting from its own station, which will be situated at Seoul. The programmes will be in both Korean and Japanese.

○○○○

DOES THE ETHER EXIST?

Among the protagonists engaged in the scientific struggle concerning the existence or non-existence of the ether must now be numbered Professor Miller, an American research worker who has just stepped into the limelight with the assertion that the ether does exist. Professor Miller, who carried out his experiments in the Mount Wilson University, California, states that he transmitted light waves from one point to various others and measured their speed. The result was, he affirms, that when the rays travelled against the hypothetical "ether draught" their speed diminished. When they travelled with the draught their speed was increased.



THREE VALVES IN ONE. A German inventor, Herr D. L. Loewe, is here seen with the remarkable valve which he has recently perfected. The valve incorporates a detector and both high and low frequency stages. Only a tuning unit is necessary to form a complete receiver.

CANADIAN BEAM SERVICE.

A public "beam" wireless service is the early prospect held out by the signing of an agreement between the Canadian Marconi Company and the British Post Office, whereby marconigrams for transmission by the new system will be accepted by any post office.

It is expected that tests with the new beam stations will be carried out towards the end of this month.

o o o o

TRANSMITTING RECORDS.

"Transmitting amateurs may be divided into three classes, namely, competent Morse key manipulators, learners who will improve with practice, and learners who will never succeed in getting beyond fifteen or twenty words per minute."—*South African Wireless Weekly.*

Our esteemed contemporary seems to have overlooked the fourth class, namely, those who in one short hour can run through twenty gramophone records.

o o o o

WIRELESS IN NAVAL ESTIMATES.

The costs for erecting several remote control stations figure in the Naval Estimates for 1926-27. Provision is made for the installation of remote control in connection with the Matara wireless station, in Ceylon, and for similar plants at Hong Kong and Aden. Money is also being spent on new wireless masts at Aden and the Rinella station, Malta.

About £4,400 each is allotted to the Lizard and Rame Head stations. The new transmitting building at Horsea Island, Portsmouth, cost about £7,700.



WIRELESS IN THE ARCTIC. The powerful radio equipment which is being taken into the Arctic by the U.S. expedition led by Lieut.-Commander Byrd. It is hoped to receive broadcast programmes during the period when the expedition is otherwise out of touch with civilisation.

WIRELESS IN THE COASTGUARD SERVICE.

Interesting facts relating to the use of wireless telephony in the British Coastguard Service are set forth in the annual report on the lifesaving apparatus of the Board of Trade.

In the case of light vessels, telephone cables are being gradually superseded by wireless telephony. Under this system a group of light vessels is in communication by wireless telephone with a centrally situated coastguard station. The coastguard station acts in liaison with the G.P.O. coast wireless stations. Thus any S.O.S. signal picked up by a light vessel is immediately passed on to the

WIRELESS AT WESTMINSTER.

BY OUR SPECIAL PARLIAMENTARY CORRESPONDENT.

Telephony Experiments with U.S.A.

IN the House of Commons on Tuesday of last week Sir A. Sinclair asked the Postmaster-General whether the Government refused to conduct experiments in wireless telephony with either

The Vicarage, Stoke St. Milboro, Ludlow, Salop, Eng.

To Radio Ur { at a. m. (G.M.T.) Clg. Wg.	<h1 style="font-size: 2em; margin: 0;">BRITISH</h1>	for sig red hr on Clg. Wg. { Audibility R Readability R
--	---	--

Swinging.....Key Chirp.....	<div style="border: 2px solid black; width: 60px; height: 60px; margin: 0 auto; display: flex; align-items: center; justify-content: center;"> <div style="text-align: center;"> <p>RADIO</p> <p>"DX"</p> </div> </div>	QRN.....QRM.....
-----------------------------	---	------------------

(This station receives only)

DX. U.S.A. 1. 2. 3. 4. 5. 6. 7. 8. 9.	Date sent.....
---------------------------------------	----------------

Canada. 1. 2. 3. Chile.	Maroc, Russia, China, Uruguay,
Argentina, Brazil, Porto Rico, Java,	Japan, Philippine Islands, Panama,
Iceland, All Europe, S. Africa, Mosul,	Cuba, Palestine, Arctic Ocean, India, "A.R.R.L." New Zealand, Australia, Indo China.

Receiver:—O-V-I Reinartz Tuner. 12-150 Mts.	PSE QSL by Card O.M.
Æ Hl.....ft. Log.....ft. No Earth.	"73" and Dx." Op. A. E. LIVESKY.

A NEW QSL CARD. This card, designed by a receiving amateur, is a model which might well be followed by other amateurs. It provides for a maximum amount of information likely to be useful to the transmitter whose signals have been heard.

central coastguard station, whence it is communicated either to a coast wireless station or to the coastguard station nearest to the vessel in distress.

o o o o

SKITTLES BY WIRELESS.

A novel skittle tournament was played a short time ago in the Indian Ocean. On March 5 the "Herefordshire," homeward bound from Rangoon, received a wireless message from the "Oxfordshire," outward bound, challenging six men passengers to a game of skittles on the following morning, six rounds each, and after each round the scores to be wireless from one steamer to the other.

The "Herefordshire" team made a score of 27 points (says a correspondent of *The Times*). This was immediately sent by wireless to the "Oxfordshire," then about 200 miles away, and within two minutes the reply came back that her team had scored 32. Up to the fifth round it was a neck-and-neck race, and amidst great excitement the final message showed that the "Oxfordshire" had won by nine points, 146 to 137. The precision with which the scores were communicated was remarkable, the results being known every time in less than three minutes.

o o o o

ADDRESS WANTED.

Messrs. Ripaults, Limited, would be glad if Mr. H. S. Poock, who recently wrote for particulars of the company's products but gave no address, would communicate with them again.

Australia or Canada on account of their commitments with the United States of America.

Sir W. Mitchell-Thomson (P.M.C.) said that the only reason why the experiments had so far been confined to the U.S.A. was that the U.S.A. was the only country equipped with suitable transmitting and receiving apparatus for the purpose of reciprocal experiments. The Government were under no obligation to the United States which would preclude their undertaking experiments with Canada or Australia in the event of stations for the purpose being provided.

Wireless Talks on Fisheries.

Mr. Guinness, the Minister of Agriculture, in response to an appeal by Mr. Harrison, said he would be glad to try to arrange suitable wireless talks on fish and fisheries with the object of stimulating the fishing trade, both in the interests of the nation and the industry itself.

REVIEW.

"Daily Express Broadcasting Map of Europe." Published by Geographia (1923), Ltd. Paper, 1s.; cloth, 3s.—A map of Europe indicating the broadcasting stations and provided with a scale so that distances between stations can be measured to a very close approximation, the projection of the map being on the Zenithal Equidistant basis. Call signs and other particulars of the stations are given and also the magnetic bearings. The map should prove of interest to those who go in for distant broadcast reception.

The LISTENER



WIRELESS LEAGUE

NOTES AND NEWS

A NOTE OF WARNING TO LISTENERS.

STANDING out boldly amongst a mass of opinion and evidence that was submitted to the Broadcasting Committee, whose Report, it will be remembered, was laid recently before the House of Commons, finance in relation to the maintenance of the broadcast service proved to be a question that could not be lightly ignored. The Broadcasting Co. makes no secret of it, and the managing director, Mr. Reith, has described it as "an issue that was giving them occasion for grave concern."

The average listener is, naturally, not interested in the detailed requirements of the broadcast organisation. In paying his licence fee to the Post Office he feels that his obligations are at an end. With over a million and three-quarter subscribers the programme service should be, and must be, all that can be desired. It certainly appears feasible to argue that, with seemingly so large an income, the standard of programme should be left without much room for criticism.

Is it the Thin End of the Wedge?

What, then, is the real position? The Post Office, with eyes ever searching for sources of unearned income and "windfalls" that come conveniently to cover up the ghosts of departments that show losses instead of profits, find in the revenue from broadcast licences a wonderful opportunity, deriving therefrom two and sixpence to cover the cost of collecting each licence and for taking adequate steps to protect the listeners from "interference" in the reception of broadcast programmes.

Does the listener really receive any protection at all? Has any real attempt been made to render the service as free from interruption as is reasonably possible?

*A Message from Mr. J. C. W. REITH,
Managing Director of the B.B.C.*

Sir Arthur Stanley has asked me to send a message to "The Listener," and for various reasons I am glad to comply with the request. The B.B.C. is keenly appreciative of the interest and support of the Wireless League. The Broadcasting Service is passing through an unusually difficult time. The stewardship of the Company is apparently about to end. Our main task has been the creation and consolidation of a new tradition for a new form of Service. We hope and believe that this tradition will be perpetuated and developed under the Broadcasting Commission. We feel sure that the Wireless League will continue to work to this end.

We have occasionally been accused of reluctance to consider the views of our listeners. Competent observers agree that there is no foundation in this criticism. The reverse may be nearer the truth. We envisage Broadcasting as one of the greatest of public services. It has always been our aim to build up the programmes from the best available material. We have studied carefully the wishes as well as the needs of listeners all over the country, and have tried to meet legitimate demands. But if it be arbitrary to decline to broadcast anything which in our opinion might be injurious morally or intellectually, then we are certainly open to this charge. Once the policy has been laid down, a Broadcasting Service can only be conducted successfully if it is given freedom of action within the broad limits of policy. High standards and flexibility are essentials of the British Service; and it is gratifying to know that the Wireless League, representing a growing and active movement among listeners, is solidly behind these conceptions.

Many listeners are even now under the impression that the broadcast organisation is in receipt of the full seven and sixpence out of every licence fee paid. This is not the case. The income of the B.B.C. is considerably restricted. Is it fair to

the listening public? Are listeners receiving the best service to which they are rightly entitled? Behind the scenes there lies a dangerous menace. It is suggested that the Treasury, harassed by the demand on all sides for economy in the administration of the public services and expenditure, may also take advantage of the opportunity for helping itself to the broadcast funds. Surely there is no one who will suggest that the service and science of broadcasting has yet arrived at the stage when its finances are due for restriction.

Need for United Front.

If the great British listening public is to have, and continue to have, a broadcast service which stands unrivalled in the world, a service which is imitated by other nations, and of which every British listener is so proud, then the Treasury and Post Office would be well advised to drop a policy the results of which will be disastrous.

Every listener must be prepared to resist this attack on the funds which are subscribed and provided for a specific purpose. It is the thin end of the wedge to dupe the listeners. To popularise the art we must seek to improve the service, not to restrict it, and the future holds unbounded hopes for discovery and improvements. Immense possibilities lie before us, but without adequate financial support progress will be retarded.

The Wireless League is the only organisation which can and does effectively represent the great body of listeners, and it is only by force of numbers with an organised front that the listener can hope to receive fair treatment. The slogan of every listener must be: "Support the Wireless League and so protect the ideals of broadcasting."

Broadcasting Commission and the League.

In response to numerous requests and enquiries, we set out below the main points of the evidence submitted by the League before the Broadcasting Committee. That the Committee recognised the importance of the suggestions and their value as representing the collated opinions of over 80,000 listeners is shewn by the extracts from the recommendations of the Committee to the Postmaster-General. It is hoped this information will provide additional propaganda for use at local meetings and lectures on behalf of the League's membership campaign.

Suggestions in League Evidence.

(1) We suggest that this central (broadcasting) authority should be a specially constituted British Broadcasting Commission instead of a company. The P.M.G. would be associated with the Commission by appointing a representative on it, but would not be in control as heretofore, except for the purpose of allocating wavelengths.

We suggest a Commission on the lines of the Trustees of the National Gallery or the Charity Commission, and appointed by the Government.

- (a) A chairman.
- (b) A vice-chairman.
- (c) A chief commissioner.
- (d) Seven commissioners.

The Broadcasting Commission suggested would combine the functions now performed by the P.M.G. and the B.B.C. Licences would be issued as at present by the Post Office, and the revenues, less the cost of such issue, handed to the Commission to be devoted to the Service and its improvement.

The assets and staff of the B.B.C. would be transferred to the Commission, the shareholders being paid out on an equitable basis. ○○○○

(2) The Commission would be required to appoint advisory committees. A Programme Advisory Committee would be one of the most important, and would enable the Commission to keep in touch with the listeners. The listener is very anxious to have a method whereby he can express his opinion on broadcast programmes. The principal demands of the listener are for:—

- (a) Best possible programme.
- (b) The widest choice of programme.
- (c) A voice in association with his fellow listeners in deciding the type of programme to be provided.
- (d) That the licence revenue shall be devoted wholly to the maintenance and improvement of the broadcasting service.

(e) Punishment of persons who interfere with wireless reception either carelessly or wilfully by oscillation on wireless sets or by other electrical disturbances. ○○○○

(3) We think the problem of giving a satisfactory educational service would be solved by allotting a special wavelength for this purpose. Greater freedom in the broadcasting of news is urgently needed. Our members are anxious to have an improved news service.

Broadcasting Committee's Recommendations.

(1) That the broadcasting service should be conducted by a public corporation acting as Trustee for the national interest, and that its status and duties should correspond with those of a public service.

That the corporation should be known as the "British Broadcasting Commission"; that it should consist of not more than seven or less than five Commissioners, all nominated by the Crown, the first Commissioners to hold office for five years; that the Commissioners should be persons of judgment and independence, free of commitments, with business acumen and experienced in affairs; that one of the Commissioners might, if thought desirable, be one of the existing members of the British Broadcasting Company; that the Commissioners should have the power to appoint an Executive Commissioner with a seat on the Board; that all Commissioners should be adequately remunerated.

That the Postmaster-General should remain the licensing authority and be responsible for collecting the licence fees; that the detection and prosecution of those who conceal their equipment should be vigorously pursued.

That the entire property and undertaking of the British Broadcasting Company as a going concern should be vested in the Commission on January 1st, 1927; that all existing contracts and staff of the British Broadcasting Company should be taken over by the new Commission.

(2) That the Commissioners should appoint, in consultation with appropriate societies and organisations, as many advisory committees as are necessary to ensure due consideration of all phases of broadcasting. . . . these advisory committees may frankly comprise advocates, as their duty will be to ensure due consideration for particular phases of broadcasting in relation both to programmes and to scientific progress and research. These important bodies should meet regularly and have ready access to the Commissioners. . . .

It will be the duty of the Postmaster-General to pay to the Commissioners from the licence fees an income thoroughly adequate to enable them to ensure the full and efficient maintenance and development of the service.

(No recommendation—left for such action as new Commission may consider is required.)

(3) That the claims of those listeners who desire a large proportion of educational matter, though relatively few in number, should, if possible, be met. . . . A solution may possibly be found in the allocation of a special wavelength for a special subject. . . .

That the Commissioners should be entitled to all the ordinary rights as regards the use of copyright material—whether in news or otherwise—and that it is unnecessary to invest them with any special privilege or preference. . . . We can . . . see no adequate reason for withholding from the Commissioners all ordinary rights as regards the use of copyright material, whether in news or otherwise.

SANDY JOINS THE LEAGUE.

SOME people don't know when they're in luck. I have a friend, Sandy McListen by name, whom I regard as extremely fortunate. He, on the other hand, considers himself unlucky.

Sandy, as you will probably have guessed, is a Scot. He is thrifty but not, of course, mean. He doesn't trust banks, and for that reason keeps his financial assets in a buried biscuit tin which also serves him as a very good wireless earth.

"Sandy," I said the other day, "why don't you join the Wireless League? Think of the benefits!"

His eyes lighted up. He drank in eagerly my description of the advantages which must accrue if all listeners are bonded together in unity, and he paid special attention to the details of the Insurance Scheme.

"Hoo muckle dae ye hae to pay?" he asked.

"Only two shillings."
"Twa shillin's? Did ye say *twa*? No, I couldna pay it."

Sandy's decision seemed to be final. I left him trying to obtain H.T. by toasting run down dry cells.

You may guess I was surprised when, a couple of days later, Sandy called on me looking as if he had drunk a pint of accumulator acid.

"Tell me," he cried hoarsely, "tell me more aboot yon Wireless League. Did ye say it was only twa shillin's?"

"That's all, Sandy."
"Weel, Ah'm thinkin' Ah'll join. D'ye ken, mon, Ah've had a fearful dream! Ah dreamed there was an awfu' storm!"

With a shudder he continued:—
"There was lightnin' and wind, and what's more, a host o' thieves struttin' aboot! Ay, and Ah dreamt that in the mornin' my mast had blown doon and killed Angus McDougall's hen, that ma set had been struck by lightnin', and that the thieves had taken my earth and a' the money in it! And there were my three neighbours, Tammas and Wully and Jamie, all grinnin' over the fence!"

"But it wasn't true," I remarked.

"It was only a dream."

"Never mind. Ah'll join the League. 'Twa shillin's did ye say?"
Although, as I could plainly see, it hurt him like a "painless extraction," Sandy paid his two shillings like a man. But if I thought that was the end of it, I soon discovered my mistake.

He rushed in upon me a morning or two later, looking as if he had swallowed a gross of cat-whiskers.

"What now?" I exclaimed.
"The vera wurrrt!" he growled.

"Did ye hear the thunder last nicht?"

I admitted that it had kept me awake.
"Mon, the storm was awful! No sooner had Ah gone to ma bed when 'Crrash! Bang!! Wallop!!!' Ah lookit oot! There was ma mast swishin' like a tuppenny swagger cane, and by the

The Listener.—

flashes o' lightin' Ah could see thieves prowlin' about in the garden! And when Ah can doon in the mornin' . . . when Ah can doon in the mornin' . . ."

"Well? What then?"

"Tammas's mast had slaughtered a bullock, Wully's set had been struck by lightnin', and the thieves had got off wi' Jamie's loud-speaker!"

"And I suppose your little outfit had been blown up?"

"Mon," said Sandy, speaking sadly, "that's the curse o' it! Nothin' was touched! And Ah'd paid twa shillin' to you League!"

"And yet," he added, reflectively, "Ah'm not really sorry Ah joined the League. Ah've had a gude laugh over the fence at Tammas and Wully and Jamie."

E. C. THOMSON.

o o o o

REASONS WHY.

At the risk of being informed by our readers that we are guilty of vain repetition, we wish to ask those members of the Wireless League who have not yet sent in their subscriptions to do so immediately to the Secretary at the League Headquarters, Chandos House, Palmer Street, S.W.1. Founder members who paid one shilling on joining renew at two shillings. Two shillings is such a small sum to spend that it is easily forgotten, and still more easily can it be spent by the Wireless League in postage if reminders of overdue renewals of subscription have to be sent to members.

In a few months the Broadcasting Commission will be in operation. Is it not as well for all listeners to be prepared to state their requirements for the listening service collectively? It is only because so far no crisis in broadcasting affecting the interests of listeners has arisen that it is possible to remain apathetic.

The Wireless League, as a listeners' organisation, should be supported for reasons of broad principle, but for those who want immediate advantage from their membership there are many other advantages to gain.

At any moment your wireless set may be burnt or stolen. This very night your aerial may come down more quickly than it went up, and bring you a bill for £50 for repairs and third-party damages, whilst storm damage is not so infrequent as might be supposed. Is it not common sense to guard against this by the payment of two shillings?

Full details of the Insurance Benefits were published with League Notes and News of March 24th. Particulars will be sent on application to the League.

The ultimate object of any student of research is to reproduce some programme item better than it has been done before.

Is it not worth while to help in this desirable object? Perfect transmission would be worthless without a perfect programme. Nothing in the world can be perfected without mass effort.

AROUND THE BRANCHES.

Abertillery Branch.

This branch was only formed in October last and is going strong. Membership 65 and increasing weekly. The lecture room is Central Schools, and meetings are every Tuesday, 7 to 9 p.m., when lectures, demonstrations and discussions on wireless are given. Any members in difficulties with their sets are assisted by wireless experts. The branch is helping to equip the local hospital with wireless. Hon. secretary, G. J. Jones, 10, Ty Bryn Road.

o o o o

Sheffield.

A public meeting organised by this branch was held at the Cutlers' Hall on April 22nd, and was regarded as an event of great importance. Professor Low gave an interesting speech. The B.B.C. kindly arranged to broadcast from the hall part of the proceedings.

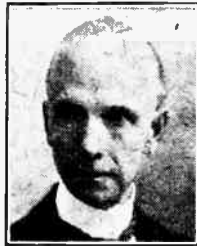

Mr. Sydney J. Adams, Hon. Sec., Sheffield Branch.

Sir William Clegg, C.B.E., J.P., was in the chair, and pointed out the real necessity of listeners combining by joining the League. Hon. secretary, Mr. S. J. Adams, 38, Church Street.

o o o o

Belfast Branch.

The League in Belfast has been steadily adding to its membership, and the local Executive Committee urge that all connected with the League should take a close and active part in its affairs. Meetings are held at regular periods. Hon. secretary, Mr. D. B. McCausland, Mount Vernon Lodge, Shore Road, Belfast.

o o o o

Bournemouth Branch.

An interesting Wireless Conference was held on Monday, April 26th, when important subjects came up for discussion. Hon. secretary, Mr. H. J. Bliss, 140, Old Christchurch Road.

o o o o

Bristol Branch.

The B.B.C. is co-operating in the effort by the Bristol branch of the Wireless League to provide a receiving set for Southmead Hospital. A ball and cabaret was held at the Grand Hotel, on Friday, April 23rd, at which, in addition to dancing to music of Ernest George's Society Orchestra, visitors had an hour of Jean Lensen's Band, specially relayed from Ciro's Club, London, and received in the hotel ballroom on an eight-valve receiver. Hon. secretary, Mr. H. Munro Nelson, 1, Glenwood, Hillfields Park.

Cardiff Branch.

Several enthusiastic meetings have been held as a result of co-operation between Cardiff Branch and several other localities extending 30-40 miles therefrom. Wireless League branches have been commenced, and are proving to be live wires in their particular areas.

Hon. secretary, Mr. F. A. Davies, 106, Newfoundland Road.

o o o o

South Midlands Area.

The chief centres of activity in this area at present are Oxford and Bedford, both of which branches are very much alive and progressing rapidly. There is, however, much room for work to be done in some of the other towns in the area, several of which suffer from the fact that they have no local official to give them a lead.

Will any enthusiastic members in those places in the S.M. area where there is no branch formed write to the area secretary, 22, Cornwall Road, Bedford, and undertake to form a local branch?

o o o o

Redruth and District Branch.

Since the formation of this branch in June last rapid strides have been made and the membership is continually increasing. The branch is fortunate in having Messrs. C. J. Cooke and A. D. Trounson as chairman and vice-chairman respectively, two very keen supporters of wireless, the latter being an experimenter who has devoted a great portion of his time and skill to the benefit of the branch. Meetings are held monthly, and there have been a number of exceedingly interesting lectures. Owing to the abnormal conditions of reception in Cornwall it is absolutely essential that all users of wireless receiving sets should join the League, so that their particular interests may be safeguarded and proper representations made to the broadcasting authorities. Hon. Secretary, Mr. W. S. Trevena, Stanley Villas.



Mr. W. S. Trevena, Hon. Sec., Redruth Branch.

o o o o

o o o o

Goole Branch.

Membership increasing each week. Goole's motto is "Advance." The local committee is strong and active, and anxious to serve the listeners in Goole and district. Hon. secretary, Mr. G. H. Hillary, 75, Carlisle Street.

o o o o

Kingston and District Local Branch.

At the invitation of the B.B.C., parties of members have spent evenings at the studios (2LO) and also made tours of the premises, etc.—this was extremely

The Listener.— interesting owing to the excellent descriptions and explanations of Mr. H. Menzies, who conducted the parties round. Hon. secretary, Mr. S. J. L. Woodward, 68, Park Road, Hampton Wick.

Leicester Branch. Fortnightly lectures are a feature of this branch, with the gratifying result of steadily increasing membership. Finance is an obstacle, but it is hoped to surmount this by a small local subscription. This branch also applies for 50 badges—a healthy sign. Hon. secretary, Mr. L. Stuart Rudkin, A.F.I., Rechabite Hall, Dover Street, Leicester.

Manchester Branch. The Manchester Branch is progressing rapidly, and is paying a good deal of attention to the social side, having held two successful dances this season. The last was attended by Sir Arthur Stanley. Manchester is the centre for the area, and many new branches in Lancashire and Cheshire are now in process of formation. Hon. secretary, Mr. H. McMullen, 3, Foxbank Street, Chorlton-on-Medlock, Manchester.

Gillingham (Kent) Branch. Held one of their periodical meetings on Thursday at Richmond Road School, and were encouraged by one of the largest attendances they have yet had. Members brought their own sets down for trial on the aerial. Faults were thus detected and remedied. Mr. Nutton gave a lecture on "High-frequency Circuits," which was much appreciated. Mr. F. Griffiths (chairman of the branch) presided, supported by the vice-chairman, Mr. Parrett, B.Sc. (London), Mr. R. Harrison (secretary), Lieut. Atterton, R.E. Signals Office, and others. Hon. secretary, Mr. Robert Harrison, 48, Chester Street.

Redhill Branch. Inaugural meeting held on March 26th last, when Professor A. M. Low greatly

interested an audience with his lecture on wireless. The result of the meeting has been most profitable, as since the lecture membership has been increased by 20 per cent. Hon. secretary, Mr. G. N. Howe, 44, Somerset Road, Meadvale, Redhill.

Kensington and District Branch. This branch, which includes West Kensington, South Kensington, Kensington High Street, and Earl's Court, will hold a general meeting later this month. All members in the above-named areas are urged to attend and to bring interested friends. Hon. secretary, the Hon. C. M. de Adlersparre, 37, Talgarth Road, West Kensington, W.14.

Sutton Branch. Inaugural meeting held March 4th.



Mr. W. C. Smith, Hon. Sec., Sutton Branch.

Professor A. M. Low gave a most interesting talk. Mr. Richards (chairman, Home Counties Area Committee) also spoke, and amongst those present were Mr. Venner (secretary, Home Counties Area Committee), Mr. Smith (Mitcham), and Mr. Scott (Croydon). Many new members were enrolled after the meeting. Hon. secretary, Mr. W. C. Smith, 234, High Street.

Port Talbot Branch. This branch has nearly completed a good season's programme, including several lectures with good attendances, the last being held on April 12th at the Riding School, under the presidency of Mr. Gribble. The subject at this meeting was "The Short Wave." This branch has recently obtained a transmit-

ting licence with call sign 5 T.P. Hon. secretary, Mr. Horace Potts, 17, Curwen Terrace, Port Talbot.

Leeds Branch. A series of monthly talks have been arranged with the B.B.C. from Leeds and Bradford Stations, conducted by the Leeds branch chairman, Mr. E. N. Kent-Lemon. All information regarding the League will be gladly given by the hon. secretary, Mr. J. Watson, 4, Arnley Grange Drive, Arnley.

Coventry Branch. The committee hopes at a later date to obtain a room in which meetings could be held and addresses or lectures given to members on wireless topics. A library of blue prints which members could borrow would be extremely useful, and no doubt a good collection of these could soon be got together, if all those who had copies would bring them in. The secretary will be pleased to hear from anyone who is willing to help. Hon. secretary, Mr. F. C. Davenport, "Highfield," Exhall, near Coventry.

Stratford-on-Avon. The secretaryship of the League in this district has changed hands, Mr. J. W. Timms, of 9, Park Road, Stratford-on-Avon, having succeeded Mr. E. W. Knight.

Woodford Branch. At the inaugural meeting held on April 15th last, Mr. J. E. Nickless was in the chair, and the speakers were Mr. D. S. Richards (chairman, Home Counties Area) and the General Secretary of the League. The branch committee was elected and many new members enrolled. The branch covers the district from Wanstead to Loughton. The branch has started well, and has a promising future. Hon. secretary, Mr. E. J. Turbyfield, F.L.A.A., 42, Alexandra Road, E.18.

All branch news for publication should be sent to the Secretary, at the League Headquarters.

MEMBERSHIP AND RENEWAL FORM.

To be filled in by readers who wish to become members of the League, or to renew their membership for a further twelve months as from 1st April last.

To the Secretary, The Wireless League, Chandos House, Palmer Street, Victoria Street, S.W.1.

Please enrol me as a member / renew my membership of The Wireless League. I enclose P.O. for Two Shillings,† which entitles me to membership with all the privileges and rights as enumerated in the constitution of the League, including FREE Insurance, Free Legal Advice and Free Technical Advice.

* Cross out Line not required.

† Keep the Counterfoil of your Postal Order.

WRITE IN CAPITAL LETTERS. Name (in full)..... (State whether Mr., Mrs. or Miss) Address

My Membership No. is..... (This is only applicable in the case of renewals).

Please enclose stamped addressed envelope.

"The Wireless World" will devote four pages in the first issue of each month to League Notes and News.



Broadcast Brevities

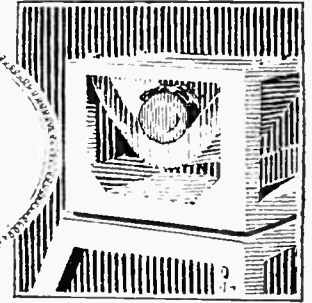

Savoy Hill Topicalities : By Our Special Correspondent.

Short-wave Transmissions.

American listeners are looking for a reciprocal move on the part of Great Britain, following on the successful relaying of WGY through Keston. What they desire in the United States are short-wave transmissions from Daventry, which would stand a better chance of being picked up by Bound Brook, or some other super-receiving station, than the present transmissions on 1,600 metres. At present, the B.B.C. engineers have a lot of overhauling to do, and there is no immediate prospect of development in the direction of short-wave transmissions; but in about a year's time we shall, no doubt, see a second station erected at Daventry for short-wave experiments of a novel nature. If it were a choice between a second station for London and a short-wave station for Daventry, listeners in Great Britain would, without doubt, plump for the former.

○○○○

British Broadcasts are Best.

A British listener in Nigeria, however, suggests that on behalf of himself and other Britons in the Colonies, the B.B.C. should give a low wavelength transmission, since British broadcasts are notoriously better than those of other countries, including KDKA. A listener in Lagos says that good reception is obtained on the west coast of Africa from 5NO, 2LO and 6BM, as well as from several Continental stations, Madrid on 575 metres and 592 metres being the best. Since the third week in March, 2LO has been better than 6BM, although previously the reverse was the case. On March 20th a noticeable change took place at Lagos in the middle of the Savoy Bands, which came in at unusual strength—too strong, indeed, for headphones—putting the atmospherics which had previously been strong, into the background. This definite mention of a time at the equinoxes when reception conditions so completely altered has a scientific value.

○○○○

Prince of Wales to Broadcast.

The speeches at the National Savings Movement 10th Anniversary Meeting at the Albert Hall on May 14th, to be broadcast from 7.0 to 7.50 p.m., will consist of those delivered by the Prince of Wales

(who is presiding), Mr. Winston Churchill, Mr. William Graham and Sir Austen Chamberlain.

○○○○

The Sir Harry Lauder.

The third and last of Sir Harry Lauder's present series of broadcasts has been fixed for July 5th. The great little man is arranging a very special programme for this occasion, as he has been mightily pleased by the couple of thousand letters or more of appreciation and suggestion which reached him from listeners in all parts of the world after his previous broadcasts.

○○○○

That Child.

The variety programme on May 11th will include the fourth episode of "That Child," Mrs. Florence Kilpatrick's series of sketches of the average youngster's everyday life: syncopated duets by Johnson and Grenop, two artists who are new to broadcasting, and an unusual entertainment by Datas, the man with the wonderful memory. Every regular visitor to the variety theatre probably knows something of this artist's extraordinary feats of memory. It will be more difficult for him to display his powers of memorising through the medium of the microphone, and his broadcast will be adapted accord-

ingly. He will give listeners a few points as to how he memorises, after which it is proposed to have visitors in the studio to ask Datas questions. These visitors will be complete strangers to him and none of the questions will be arranged previously. The B.B.C. vouches for the authenticity of the programme.

○○○○

A New Revue.

"Radio Radiance" and "Listening Time" have had their run, and the B.B.C. is now thinking of embarking on a new type of broadcast revue which shall have a definite plot as a background to the musical numbers and dialogue. This new series has been written by Mr. Ernest Longstaffe, who will also act as producer when the first performance is broadcast on May 29th. The title of the revue is to be "The Bee Bee Cabaret."

○○○○

Philemon.

I wonder if listeners noted the little anecdote related by "Philemon" in his farewell talk from the London studio on April 27th? It was just one more proof of the universal comradeship that broadcasting is establishing. He said that during a short holiday in Switzerland last winter he struck up acquaintances



WINNING RECRUITS BY WIRELESS. A scene on Wanstead Flats last week when the 54th Divisional (R.A.) Signals gave a wireless demonstration for the purpose of attracting recruits. A 30-watt transmitter was used, operating on 740 metres.

with another visitor at an adjoining table in the hotel where he was staying. They had exchanged scarcely half a dozen sentences when the other visitor said to him: "I have an idea that you are 'Philemon' of the British Broadcast." "Philemon" admitted his identity and asked: "How did you know?" "Simply by your voice," was the reply. "I have heard you broadcast so many times that I thought I could not be mistaken."

○○○○

What About the Music?

On the other side of the picture we have the obviously sceptical comment of a well-known musician when he was conducting a concert which was broadcast from Manchester recently. During an interval in the performance he addressed his unseen audience through the microphone and, by way of preface, suggested that probably many people who were listening knew him personally but would not believe that it was actually he who was speaking, owing to wireless distortion. The inference drawn by some listeners was that although he was conducting one of the leading orchestras in the country in what was an almost flawless performance, he had no more faith in the recording powers of the microphone as regards the music than he had in it as far as the timbre of his voice was concerned. It was not the happiest of moments for hypercriticism.

○○○○

Hidden Wires.

In the main ballroom of New Verrey's Restaurant, which was recently opened, and from which dance music is being broadcast at various dates this month, no lines are visible for the microphone connection, as they have all been enclosed in the walls and ceiling during the construction of the premises. The direct connecting wire for the microphone is drawn down from the plaster ornamentation in the ceiling whenever a broadcast is taking place, and is afterwards pushed back so that it is normally hidden.

○○○○

The Youngest Princess.

A listener has written to Savoy Hill suggesting that in view of the great national interest taken in T.R.H. the Duke and Duchess of York and in the baby Princess, the B.B.C. would be performing a service to millions of its listeners if it could obtain permission to take a microphone into the Royal nursery, so that the Princess could be invested with the added fame of being the youngest broadcaster on record. While there is no question that Royal babies perform a similar function of lung expansion to all other babies, this is not an excuse for notoriety.

○○○○

The Crystal Palace.

The suggestion has been revived that the new higher-power station for London should be erected at the Crystal Palace. If the idea is that this would make the Palace a public Mecca again, it is scarcely feasible. The Palace might be an ideal site for the transmitting aerial, as the towers are about 700 feet above

FUTURE FEATURES.

Sunday, May 9th.

LONDON.—Shakespeare's Heroines: "Lady Macbeth"—Mrs. Patrick Campbell.

MANCHESTER.—Mendelssohn's "Hymn of Praise."

Monday, May 10th.

LONDON.—"What Would You Do?" A competition organised by *Pearson's Weekly*.

GLASGOW.—The Pianoforte Sonatas of Beethoven.

Tuesday, May 11th.

LONDON.—Variety: Johnson and Grenop (Piano and Banjulele). Datas (The Man of Memory) "That Child" (IV.). John Henry from an Aeroplane.

BIRMINGHAM.—Musical Operetta: "Marriage by Lantern Light" (Offenbach). "The Sweep"—A Play in Two Scenes.

CARDIFF.—"Young England": A light opera in three acts, relayed from the Theatre Royal, Bristol.

MANCHESTER.—The Lure of the West Country.

Wednesday, May 12th.

LONDON.—The Wireless Follies Concert Party.

ABERDEEN.—Choral Music by The Aberdeen Railway Male Voice Choir.

BELFAST.—"The Wizard of Wireless"—a Play.

Thursday, May 13th.

LONDON.—Wynne Ajello (soprano), Roy Henderson (baritone), The Wireless Symphony Orchestra.

BIRMINGHAM.—Lightsome Programme.

BOURNEMOUTH.—A Sussex Evening. The Downland Musickers, relayed from Mansfield Hall, Worthing.

BELFAST.—Ascension Day Music. Short Plays and Orchestral Music.

NEWCASTLE.—Gems of Opera.

Friday, May 14th.

LONDON.—Brighton Competitive Musical Festival, relayed from the Dome, Brighton.

ABERDEEN.—The Aberdeen Radio Players in "Nettles"—a Rural Scotch Comedy.

CARDIFF.—Masters in Merry-making: Sterndale Bennett and Billy Leonard (Entertainers). The Station Orchestra.

MANCHESTER.—Band Items, Songs and a Play. The Tyldesley Temperance Prize Band.

NEWCASTLE.—A Brass Band Night. The Brancepeth Colliery Silver Prize Band.

sea level, with a span of about 1,000 feet, but the erection of an aerial there would not prove any attraction for the public. And the proximity of Croydon Aerodrome definitely ruled out this suggestion when it was put forward semi-officially. If, on the other hand, the

Palace were used for studio purposes, the aerial would have to be placed elsewhere, and so the advantage of height would be lost. Besides, the B.B.C. would not be likely to incur the expense of purchasing the Crystal Palace for the sole purpose of erecting a higher-power transmitter.

○○○○

B.B.C. Headquarters.

The only really useful purpose to which the Palace might be put in connection with broadcasting would be to make it the headquarters of the B.B.C., with studios, a public broadcasting theatre, a concert hall, ballroom, and other amenities as adjuncts to the administrative offices. Already, in spite of the three new studios opened only a few months ago at Savoy Hill, the cry is for more accommodation. On such a site as that occupied by the Palace there would be room for any developments that were necessary. We may hear more of this suggestion when sanction is received for the erection of a second London station. That, meanwhile, seems to be the first consideration.

○○○○

Trooping the Colour.

Some confusion has arisen over the proposal to broadcast the ceremony of Trooping the Colour which celebrates the King's birthday in June. A statement has been published (not in *The Wireless World*) to the effect that the broadcast last year was not a success. The truth is that no attempt was made last year to broadcast this function, and, if it takes place on June 5 next, it will be the first occasion on which it has been done. It has been stated further that the reason for last year's non-success was that the microphone was damaged, as well as other apparatus, during the evolutions of the troops. This is, of course, an inaccurate statement, and one is inclined to think that the writer had a very hazy recollection of something that occurred in connection with another and not entirely dissimilar event, viz., the Military Searchlight Tattoo at Aldershot. On that occasion the B.B.C. engineers had to haul the microphone into safety as one of the regiments taking part in the Tattoo bore down upon it in the course of their display, but certainly no damage was done.

○○○○

Radio Plays.

Curious how opinion respecting programme items varies. The receipt of a trenchant criticism of a Manchester station relay to Daventry, which was labelled as a "very mediocre play" extending "over two solid hours," prompted the Correspondence Department at Savoy Hill to analyse the letters received from other listeners on the same subject, and it was found that the files contained well over three hundred appreciative comments. The play referred to was "The Web," and, judged on its merits, it was deemed worthy of two hours of Daventry's transmission time. Moreover, it may be pointed out that it is in deference to the wish expressed by many listeners that the length of the radio play tends to increase.

RECEIVING AERIALS.

A Simple Theory of Induced Aerial Currents.

By F. M. COLEBROOK, B.Sc., D.I.C., A.C.G.I.

IN the course of various articles in *The Wireless World* the writer has had occasion to make certain assumptions as to the essential character of a receiving aerial from an electrical circuit point of view. In each case the assumptions were put forward tentatively as a simplification which appeared to be consistent with actual experience, though not based on a detailed analysis.

Since then the subject has been more thoroughly investigated from a theoretical point of view by two analytical methods. The first of these is the writer's own (as far as he is aware), but for the second and on the whole rather simpler method he is indebted to a publication by Mr. Moullin.²

As a result of this investigation the original assumptions with regard to a receiving aerial have not only been proved to be correct, but a number of other deductions have been made which have an important bearing on the design of receiving aerials, and the present paper aims at giving as simple an account as possible of these conclusions.

Field Surrounding a Receiving Aerial.

In the first place it will be well to outline the essential character of an aerial receiving system. In most practical cases the aerial will consist of two main parts, a more or less vertical down-lead joined at its upper end to a more or less horizontal wire or group of wires. The lower end of the down-lead is connected to some form of tuning circuit, consisting of any suitable arrangement of inductances and capacities. Some point of the tuning circuit is connected either to an earthing system, a water main, for instance, or in some cases to an earth screen. In the case of small aerials for broadcast reception the Post Office licence imposes the limit that the total length of the aerial from the earth connection to the end of the horizontal part, if any, shall not exceed 100ft.

This aerial is situated in an electromagnetic field which, at any given instant, is of an exceedingly complicated form, since it contains contributions from all the wireless transmitting stations in the world that happen to be in operation at that moment. The actual form of the electromagnetic field is thus quite beyond the powers of the mind to conceive, but actually all except a comparative few of these contributions will be exceedingly small, and in any case the contribution from each transmitting station can be considered to produce its own effect on the aerial system independently of the others. For the present purposes, therefore, it will be legitimate to assume that the only field present is that due to some particular transmitting station, the signals from which it is desired

to receive on the aerial. The electric field from this station will probably be sensibly uniform throughout the space occupied by the aerial, and will induce a certain electromotive force in each small element of length of the aerial. Even if the field is uniform, however, the aerial wires will not in general be quite symmetrically disposed with respect to the field, so that each equal element of length of the aerial will not necessarily have the same amount of electromotive force induced in it. Since the aerial wires are conductors of electricity, the induced electromotive forces will combine together to produce an alternating current flowing up and down the aerial and through the tuning circuit. As a circuit for electric currents, however, the aerial is by no means a simple conductor, since each element of its length can be considered to have a certain inductance, a certain resistance, and a certain capacity. These facts are, of course, quite familiar, but they are restated to emphasise the point that an aerial receiving signals from a distant station is an exceedingly complicated electrical system. A full analysis of the case will show, nevertheless, that from the point of view of any associated tuning or receiving circuit the aerial system and its induced electromotive forces can be represented in a perfectly simple and comprehensible manner. It can be shown, in fact, that when, as is usually the case, the aerial is receiving

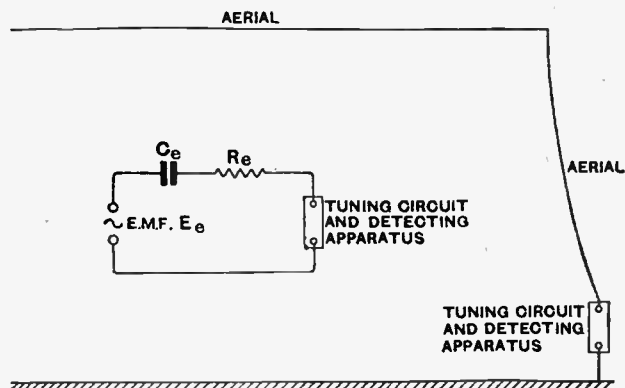

Fig. 1—Typical broadcast receiving aerial and its equivalent electrical circuit.

signals, the frequency of which is less than the natural frequency of the aerial, *i.e.*, of wavelength greater than the natural wavelength of the aerial, then the actual system, shown in Fig. 1, behaves with respect to the tuning circuit as if it were the simple series circuit shown in the same figure.

It will be seen that in the circuit the aerial and its induced electromotive forces are represented by three separate elements: (1) an alternating electromotive force which can be visualised as a little alternator, driving current through the circuit; (2) a pure capacity, represented by a small condenser; (3) a pure resistance. The tuning circuit, together with the load, if any, imposed on the system

¹ "More about Crystal Reception," *The Wireless World*, July 25th, 1924.

² "What is the Best Circuit for Crystal Reception?" *The Wireless World*, April 30th, 1924.

³ "On the Current Induced in a Wireless Telegraph Receiving Antenna." E. B. Moullin. Reprinted from Proc. Camb. Phil. Soc., Vol. XXII, Part 4.

Receiving Aerials.—

by the detecting apparatus, is represented as a certain effective inductance in series with a certain effective resistance. The process of tuning can be considered approximately as adjusting the effective inductance of the tuning circuit until the positive reactance that it opposes to the current flowing in the circuit is just equal to the negative reactance due to the effective aerial capacity. The current flowing through the tuning circuit then reaches its maximum value, the practical aspect of which condition is that the signals heard in the telephones reach their greatest intensity. The amplitude of the alternating current flowing through the tuning circuit can now be represented by the simple expression

$$I = \frac{E_c}{R_c + R}$$

where R is the effective resistance of the tuning circuit.

The above equivalent aerial quantities have definite values for a field of given intensity and given frequency. The actual order of these magnitudes, and the way they depend on the conditions of operation and the design of the aerial will now be considered separately.

Effective Aerial Capacity.

The natural wavelength of a 100-foot aerial will be somewhere in the neighbourhood of 120 metres. If the aerial is used for receiving signals, the wavelength of which is long compared with 120 metres, the effective aerial capacity will be practically constant with respect to frequency, and will be very nearly equal to the actual capacity of the aerial as determined either by calculation from the usual formulae, or by measurement. If C_0 be the actual aerial capacity, then the effective capacity C_e is given approximately by the formula

$$C_e = \frac{C_0}{(1 - 0.821 \lambda_0^2 / \lambda^2)}$$

where λ is the wavelength of the signals and λ_0 the natural wavelength of the aerial. Thus taking λ_0 as 120 metres, and λ as, say, 360 metres.

$$C_e = C_0 / (1 - 0.091) \\ = 1.09 C_0$$

The above formula is not exact, and only applies when λ is at least three times λ_0 . The formula shows, however, that if this condition is fulfilled, as it generally will be in cases of broadcast reception, then the effective aerial capacity will not vary greatly with frequency.

As an example of the general order of magnitude of this capacity C_e , we will take a single wire aerial consisting of a vertical part 30ft. long and a horizontal part 70ft. long, composed of, say, 3/19 copper wire. The calculated capacity for such an aerial will be about 170 micro-microfarads, and its negative reactance at a wavelength of 360 metres will be about 1,000 ohms. If the horizontal part consists of two widely spaced wires, each 70ft. long, the capacity will be increased by something from 60 to 70 per cent., and a positive reactance of about 600 ohms will be sufficient to tune to 360 metres. It should be pointed out, however, that for receiving a large aerial capacity is not in itself an advantage, except in so far as a smaller coil, with correspondingly lower resistance, is sufficient for tuning. A certain advantage is to

be derived from increasing the aerial capacity by doubling or trebling the top wires, but this is due to another reason which will appear later.

Before leaving the subject of the effective aerial capacity it should be noted that the negative reactance of the above aerial at the frequency corresponding to that, for instance, of the Daventry station will be between 4,000 and 5,000 ohms. It is difficult to introduce this amount of positive reactance into the circuit with a coil of reasonable size without also introducing a considerable resistance, with a consequent falling off in selectivity. This is a fact which has probably been generally observed, and it is hoped to return to it at some future date.

Effective Aerial Resistance.

As was pointed out in the introduction to this paper, any aerial structure will have a certain resistance per unit length. Under conditions of operation, with high-frequency currents flowing in the aerial, this resistance per unit length will be somewhat greater than the ordinary ohmic resistance of the conductor of which the aerial is composed, for two reasons. In the first place, the high frequency of operation is associated with what is known as the "skin effect," which means that the current flowing in the conductors is not uniformly distributed over the cross-section, but is confined to a thin surface layer. This will, of course, produce an increase in the resistance of the conductors as compared with their resistance at low frequencies or for continuous current. In the second place, there will be a certain amount of re-radiation from the aerial, the effect of which can be represented as a certain distributed radiation resistance. The latter effect will, however, be relatively small, except at frequencies in the neighbourhood of the natural frequency of the aerial.

Under reception conditions, therefore, the resistance of the aerial per unit length will consist of the high-frequency resistance of the conductor, plus a small additional term due to radiation resistance.

Importance of a Good Earth.

The analysis based on this assumption gave for the effective resistance term R_e an approximate expression applicable to all cases in which the wavelength of operation is at least three times the natural wavelength of the aerial:—

$$R_e = \frac{R_0}{3} \left(1 + 0.329 \frac{\lambda_0^2}{\lambda^2} \right)$$

where R_0 is the total resistance of the aerial, *i.e.*, in the case of a uniform single wire aerial the resistance per unit length multiplied by the length.

Now, some while ago the present writer, in conjunction with Dr. R. L. Smith-Rose, carried out some measurements of the effective resistance of various types of aerial structure with various forms of earthing systems at the frequency of the transmission from 2LO.¹ It was found that an aerial similar to that described above as a typical example, with an earth connection in the form of a large buried metal plate (about 20 sq. ft. of surface)

¹ "Some experiments with aerial and earth circuits." R. L. Smith-Rose and F. M. Colebrook. *Experimental Wireless*, January, 1925.

Receiving Aerials.—

appeared to have a resistance of over 30 ohms, which would indicate a resistance of about 0.9 ohm per foot for the aerial. Neither skin effect nor radiation resistance would be sufficient to account for so large a figure as this, so there must be some other source of resistance loss in the circuit (that due to the tuning coil was, of course, deducted in arriving at the above figure). It was found that by connecting the aerial to the water main system instead of to the buried plate earth, the resistance was brought down to about 25 ohms. (These figures will not be found in the article referred to above as they refer to certain preliminary measurements made with a single wire aerial. For the measurements described in the article a double wire aerial was used.) Finally, by connecting the aerial to an earth screen instead of earthing it in the ordinary way, the resistance was reduced to about 10 or 11 ohms. This, then, is the explanation of the apparent discrepancy between the observed resistance and that which would have been anticipated from the above formula. The actual equivalent aerial resistance is seen to consist of two parts. The first of these is derived from the high-frequency resistance and the radiation resistance of the actual aerial itself, these being considered as uniformly distributed throughout the length of the aerial (though not necessarily equal in both parts of the aerial). If R_0 be the total resistance of the aerial composed of these terms, the contribution of this factor to the equivalent aerial resistance R_e will be approximately $R_0/3$ for wavelengths which are fairly long compared with that of the aerial, and will not vary very much with frequency under the same conditions. The other, and probably the far larger term, consists of losses associated with the earth connection. It seems probable that the greater part of these is due to eddy currents in the earth in the neighbourhood of the aerial. This is suggested by the fact that the use of an earth screen, the function of which is, as its name implies, to screen the earth from the electric field in the neighbourhood of the aerial, greatly reduces the effective resistance of the aerial.

In the absence of further data, which it is hoped to obtain experimentally at some future date, this is all that can be said about the effective resistance term. It seems very probable, however, that the actual wire and radiation resistance of the aerial is not the most important part of the effective resistance of the aerial circuit. The practical aspect of this is that it is unlikely that anything material is to be gained by refinements of construction or the use of special and elaborate types of conductor which have as their object the reduction of the wire resistance of the aerial.

Effective Aerial Impedance.

The effective aerial impedance, from the point of view of the associated tuning circuit, can be considered as that due to a certain effective reactance in series with a certain effective resistance. In receiving wavelengths longer than the natural wavelength of the aerial, the effective reactance can be represented as that due to a capacity, the magnitude of which will not vary much with frequency if the wavelength of reception is at least three times the natural wavelength of the aerial. The reactance required to tune the aerial depends on this term alone.

On the other hand, the actual effectiveness of the aerial as a receiver of energy from the surrounding electromagnetic field, *i.e.*, from the wireless waves, will depend not at all on this effective reactance term, but on the other, *i.e.*, the effective resistance term. It can easily be shown that for a given effective E.M.F. E_e (R.M.S.), the maximum energy will be dissipated in the tuning circuit when the effective resistance of the latter (which includes, of course, the load effect of the detecting apparatus) is equal to R_e , and the amount of this maximum energy is $E_e^2/4R_e$. Thus R_e should be made as small as possible, but it appears that very little can be gained in this direction by reducing the wire resistance of the aerial, since the latter is not the most important part of the effective resistance term. It will be noted that the possibility of using valve retroaction as a means of reducing effective resistance is here left out of account. The latter is too big a subject to be treated in the present paper, which refers specifically to aerials *per se*. (The conditions of direct crystal reception are actually as described above, but if valve reception is used, the possibility of retroaction reduces the importance of the resistance term in aerial design.)

Calibration from a Local Source.

One other important point must be emphasised before the remaining term of the equivalent aerial circuit is considered.

The general expressions for the aerial impedance, of which the simple formulae given above are approximate forms, were deduced for the most general possible form of field distribution. It was found, however, that neither the magnitude nor the distribution of the electric field intensities entered into the expressions for the effective impedance at all. It appears, therefore, that the effective aerial impedance is independent of the manner in which the aerial is excited, whether the station concerned is near or remote, or whether the field is uniform or distorted. This has a very useful practical application, for it shows that the properties of the aerial, its range of tuning with given coils, etc., can be studied by means of a local source the frequency of which can be controlled to suit the measurements, and that the data so obtained will be applicable to the normal reception of distant stations.

Effective E.M.F. and Effective Height.

We now come to the last and most important of the terms of the equivalent aerial circuit.

For the sake of simplicity it will be assumed that the signal being received consists of a single pure frequency. In the case of a frequency band, such as that involved in telephony, the analysis will apply to each frequency considered separately.

The expression for the effective E.M.F. was calculated in the most general case, and it was found, as might be expected, that it depended on the constants and the form of the aerial and on the assumed distribution of the field, *i.e.*, the "shape" of the wireless waves at the situation of the aerial. It was quite independent, however, of the tuning circuit conditions, so that the tuning of the aerial does not in any way increase the E.M.F. acting in the aerial circuit. Another way of saying the

Receiving Aerials.—

same thing is that the effective height of the aerial is not altered by tuning it. For a given aerial and a given shape of wave the effective E.M.F. will be proportional to the strength of the field. This also is a result that one would naturally expect.

It is obviously desirable that for a given electric field this effective E.M.F. shall be as large as possible. The practical aspect of the matter is therefore to determine, from the way in which the effective E.M.F. depends on the form of the aerial, the most effective form of aerial structure. Actually it is not possible to give a perfectly general solution to this problem, as the most effective aerial form depends to a great extent on the actual shape of the field. However, in the great majority of practical cases there is good reason to believe that the field will be uniform and practically vertical. (It is never exactly vertical, and one of the most recent developments in reception is the use of an antenna which depends for its action on the fact that there is in general a slight forward tilt of the wave front. The directive properties of the Beverage antenna are due to this fact.) Assuming, then, a vertical field and an aerial consisting of a vertical part, parallel to the field, and a horizontal part, perpendicular to the field, quite definite conclusions can be drawn as to the most suitable form of aerial structure within, say, the limitations imposed by the Post Office licence. Under the assumed conditions it will be permissible and, in fact, preferable to make use of the term "effective height" rather than effective E.M.F.—preferable because the effective height is an actual property of the aerial, independent of the field, provided the latter is uniform and vertical. The term is derived in this way. If the amplitude of the uniform field intensity is e volts per unit length, and the effective E.M.F. induced by this field in the aerial is E_e , then the effective height of the aerial is that height which must be multiplied by the actual field intensity to give the effective E.M.F., i.e.:

$$H_e e = E_e.$$

The expression for the effective height in terms of the wavelength of operation and the constants of the aerial is a rather complicated one, particularly if the constants of the aerial are not the same in the two parts of it, as will be the case, for instance, if the top consists of more than one wire.

For a single straight vertical wire, however, the expression is comparatively simple if the wavelength of operation is long compared with the natural wavelength of the aerial, and is given very approximately by

$$H_e = \frac{H}{2} \left(1 + 0.206 \frac{\lambda_0^2}{\lambda^2} \right)$$

where H is the actual height of the aerial, and the other symbols have the same meaning as already defined. Thus the effective height of a plain vertical aerial is approximately one-half the actual height, and, under the conditions stated above, will not vary very much with the frequency of operation.

This case, however, is somewhat academic. The type of aerial more generally used is a more or less close approximation to the inverted L form. The actual expression corresponding to this case will not be given

as it is rather more complicated. It will be found in a fuller account of this subject which is being published elsewhere. As an example, however, we will take the typical case already described above, i.e., vertical height 30ft., horizontal length 70ft. The calculation in this case gives $H_e = 26.6$ ft. for a wavelength of about 350 metres. It will be seen that this is very nearly equal to the actual height.

Effect of the Horizontal Section.

The form of the general expression for the effective height of the inverted L type of aerial shows that although under the assumed conditions no E.M.F. is induced in the horizontal part by the electric field, the effect of the horizontal part is to increase the effective height from the lower limit of half the actual height. Thus, in the case quoted above, the effective height with-

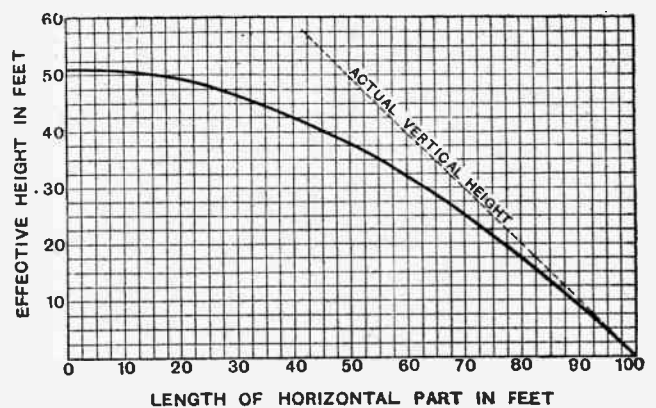

Fig. 2.—Curve showing the relation between the effective height and the length of the horizontal portion in a 100ft. single wire aerial.

out the horizontal part would be only 15ft., but the addition of the horizontal part increases this to nearly 27ft. The general expression also shows that the upper limit is when the effective height is equal to the actual height. Thus, in the present case, the doubling of the top wire to increase the effective top capacity could not increase the effective height, and thus the effective E.M.F., by more than 13 per cent.

Since the horizontal part has this effect of increasing the effective height, it might be thought that there would be some optimum distribution as between vertical height and horizontal length for a given total length of wire. The curve of Fig. 2, which refers to the typical roof-top single wire aerial taken as an example, shows that the best distribution is when the whole length is vertical.

Actual vertical height is thus the important consideration in erecting an aerial for reception, and the effect of a reduction in height cannot be compensated for completely by increasing the top capacity if the total length is fixed. For any given vertical height, however, the top capacity should be made as large as possible.

In conclusion, the writer would like to point out that though the principles described above are based on a purely theoretical analysis, they are nevertheless in good agreement with his experience with small receiving aerials, and are consistent with such actual measurements as he has made.

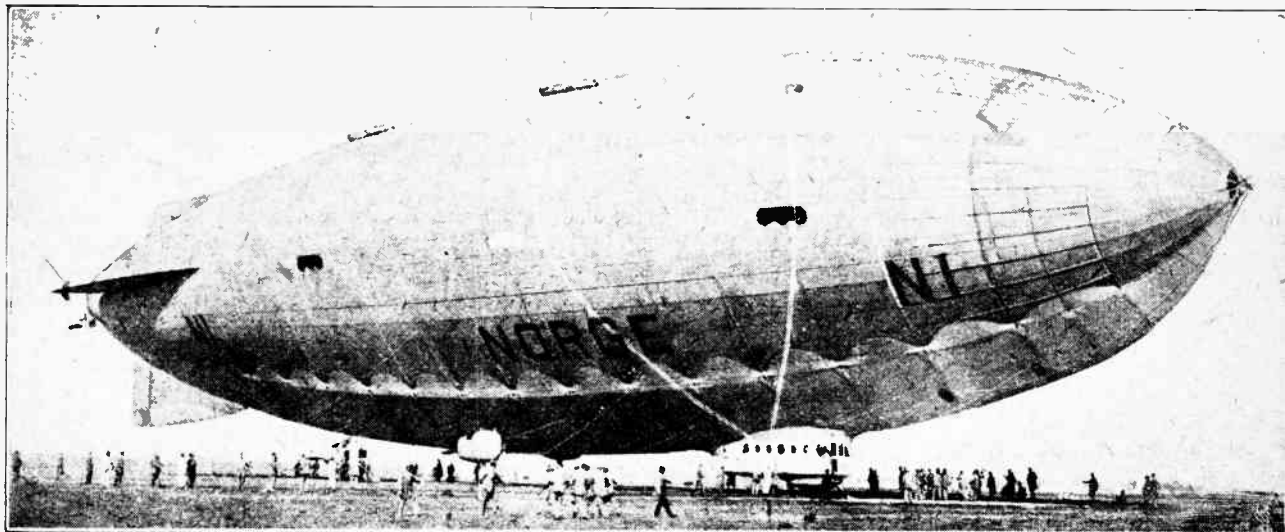

The airship "Norge" of the Amundsen-Ellsworth Expedition. The arrangement of the D.F. aeriels round the envelope is clearly distinguishable.

WIRELESS ON THE POLAR AIRSHIP.

Transmitting, Receiving and Direction-finding Equipment of the "Norge."

IN the past most expeditions to the Polar regions have had to undergo long periods of complete isolation from the outside world, since it has not been possible to carry the means of communicating with civilisation. In the case of the forthcoming Amundsen-Ellsworth Polar Expedition, however, arrangements have been made whereby the Marconi Company have equipped the airship *Norge* with special transmitting and receiving apparatus, which will enable the commander to keep in touch with either ship or land stations up to very considerable distances. The airship will, in fact, be in a position to maintain communication with the outside world throughout its entire voyage through Arctic solitudes. The range of the transmitter and receiver will probably be, in regions where interference is not great, anything up to 2,000 miles.

Preliminary Tests.

On the first stage of the airship's journey to the Pole, from Rome to Pulham, Norfolk, regular two-way communication with the Air Ministry, London, was established when the *Norge* was over the south coast of France, and was maintained throughout the remainder of the voyage. Reception appeared to be only limited by the interference of local stations. A good deal of interference can be eliminated by receiving on the D.F. loops and putting "minimum" on the interfering station. In the Arctic, where interference will be negligible, no difficulty at all should be experienced.

Of particular interest is the direction-finding system, which will enable the navigators accurately to determine their position and course without the aid of the compasses, which have reduced navigational value in the region of the Pole itself, due to the peculiar configuration of the earth's magnetic field.

The transmitter is an adaptation of the Marconi 0.5 kW. Type U set, and is suitable for continuous wave and tonic train signalling. In order to meet the special conditions obtaining in the airship and to utilise to the best advantage the very limited space available, the principal components are mounted on a light teak baseboard. These components comprise:—Two Type T 250 valves, H.F. choke, reaction condensers, "Send-Receive" switch, C.W.-I.C.W. switch, and measuring instruments for indicating aerial current, feed current, high-tension volts and filament volts.

The aerial tuning inductance and variometer form separate units, and, used in conjunction with the airship's trailing aerial, cover a wave-range of approximately 550 to 1,500 metres. On the transmitter 6 to 7 amps. may be obtained in the aerial on the optimum waves, and 4 to 5 on the extremes.

The two oscillating valves are connected in parallel, and continuous wave signalling is effected by a manipulating key connected in the grid circuit. For tonic train signalling the grid circuit is interrupted by a small rotary interrupter.

Wind-driven Generator.

Power for the anode circuits of the transmitting valves and for charging the filament lighting batteries is derived from a combined H.T. and L.T. direct current generator developing 133 milliamperes at 3,000 volts and 14 amperes at 14 volts.

The generator is fitted just astern of the wireless cabin on a locker, and is driven by an air-screw with a right-angled bevel drive. The centre of the propeller is about five feet from the side of the gondola, and the angle at which the propeller faces the air stream can be varied from inside the cabin by a special lever which may be

Wireless on the Polar Airship.—

adjusted and locked to suit the speed at which the ship is travelling or the rate required by the dynamo. The propeller is of the four-bladed type, and is capable of developing about 3 h.p.

For emergency purposes a horizontally opposed twin-cylinder petrol engine of $2\frac{3}{4}$ h.p. is mounted on a lightly constructed tubular steel framework which can be quickly fixed just outside the gondola. The generator that is driven from the air-screw can be quickly attached to this framework by means of wing nuts if the air power is insufficient.

A switchboard fitted with an automatic cut-out, ammeter, voltmeter, and "W/T - Charge" change-over switch, enables the low-tension batteries to float across the low-tension side of the generator during transmission or to be charged when the transmitter and receiver are not in use.

A special type of fairlead is fitted in the base of the gondola for the trailing aerial, which is 300ft. long. This fairlead enables a new aerial and weight to be fitted while the airship is in flight, should it be necessary. An ordinary Paxolin aerial winch with an expanding brake is supplied.

Special receiving apparatus is utilised both for direction-finding and for ordinary service reception. As in all aircraft, economy of space and the minimum of weight are essential features, and to meet these requirements several of the units are utilised both for

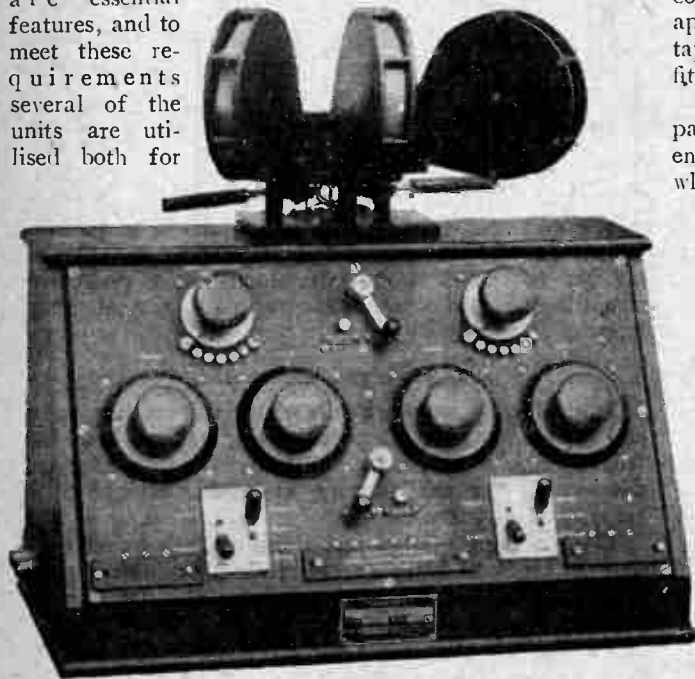

The tuner unit of the service receiver, which has a wavelength range of 300—25,000 metres.

direction-finding and service reception purposes; in particular the H.F. and L.F. amplifiers.

A Marconi short-wave two-valve receiver with a wavelength range of 10-100 metres is carried. This is intended for communication with Point Barrow, where a short-wave

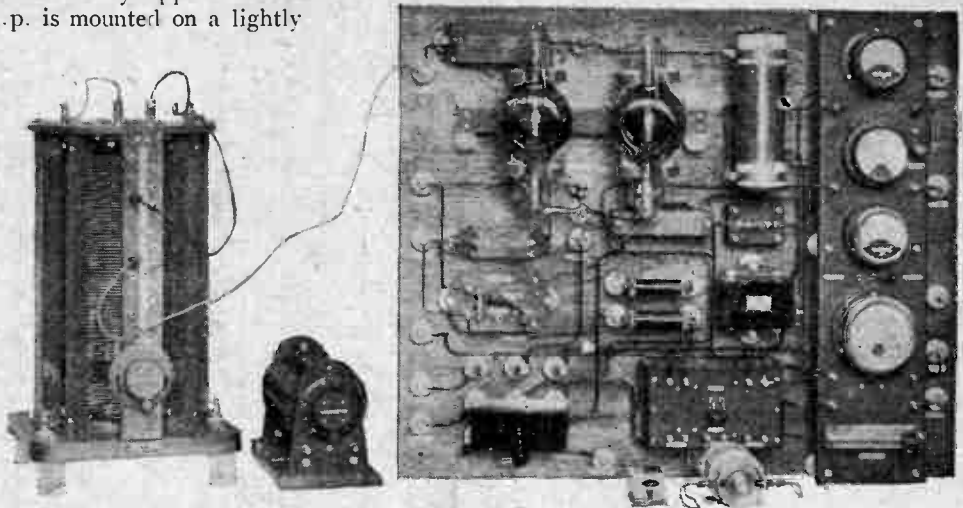

In order to utilise to the best advantage the space available the transmitting apparatus has been assembled on a teak baseboard. The A.T.I. and variometer are installed as separate units under the operator's writing table.

transmitter is installed. The aerial for this apparatus is a short length of wire fixed between the wireless cabin and one of the engine gondolas.

D.F. Aerials.

The direction-finder loops are fitted diagonally round the outside of the envelope, the centre of the loops coinciding with the lead-in to the wireless cabin. The loops consist of two turns of wire, spaced about nine inches apart. The loops are doped to the fabric with linen tape, forming a neat and unobtrusive but very efficient fitting.

Inside the cabin eight terminals are fitted on an ebonite panel to which the ends of the loops are connected. This enables the loops to be put in either parallel or series, whichever is found most advantageous on the wavelength being received.

Reception on the radiogoniometer utilises practically the same circuits as are used for service reception with the trailing aerial.

A radiogoniometer unit and a three-range transformer unit are used in conjunction with a high-frequency amplifying detector and a low-frequency magnifier. A low-frequency note filter is also provided, which can be inserted, when desired, into the circuit between the output terminals of the amplifier and the input terminals of the note magnifier. A local oscillator is provided to enable bearings to be taken on the long continuous-wave stations.

The transformer unit comprises three air core trans-

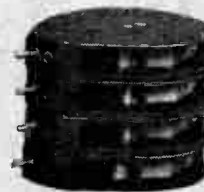

Wireless on the Polar Airship.—

formers with condensers for secondary circuit tuning covering wave ranges of 2,000 to 5,000, 4,000 to 10,000, and 10,000 to 25,000 metres.

The amplifier is provided with six type V24 valves with resistance-transformer coupling for high-frequency magnification and a type QX valve for rectification.

The note filter circuit is provided with a single type V24 valve and an oscillating circuit tuned by means of a variable condenser.

The low-frequency magnifier has two transformer-coupled type V24 valves, which can be switched into circuit according to the conditions of reception.

The local oscillation generator utilises one type V24 valve, which can be switched into circuit for receiving continuous-wave signals.

A 66-volt dry cell battery is tapped at suitable points for supply current to the anode circuits of the receiving valves. The valve filaments are run off the battery used for lighting the filaments of the transmitting valves.

Universal Tuner.

For the reception of continuous wave, spark, and telephone service messages a plug-in coil tuner covering a wave-range of 300 to 25,000 metres is connected to the high-frequency amplifier in place of the transformer and radiogoniometer units used for direction-finding.

The tuner is a coupled circuit instrument and is provided with reaction coupling to the grid circuit. Eleven plug-in coils are provided to cover the full wave-range, any one of which can be inserted in the aerial, grid, or reaction circuit according to the wavelength which is required.

The service receiver utilises the same aerial as that used for the transmitter, the aerial being connected either to the receiver or transmitter by means of the "Send-Receive" switch which is conveniently mounted on the transmitter panel.

The chief difficulty in fixing the apparatus in the wireless cabin of the *Verge* was lack of space, the operator's quarters being naturally somewhat cramped. In fixing the instruments it was necessary to give more attention to convenience of wiring than to appearance, but in spite of every economy in space and weight the general effect is very workmanlike. The whole forward wall of the cabin is taken up with the transmitter panel.

A narrow table is provided for the operator's writing and for the manipulating key on the starboard outside wall. Under the left-hand side of the table the transmitter inductance is fitted to the floor. A variometer for fine transmitter wave adjustments is also fitted on the left under the table. Next to these instruments, on the right-hand side, is fitted a small triangular cupboard for carrying spares.

The accumulators, of the thin-plate high-discharge type, and the dry batteries stand on the floor. A double-pole change-over switch is fitted in the cabin, and the 12-volt lighting mains for the ship are brought to this, as well as the wireless 12-volt supply. This enables the ship's accumulator and the wireless accumulator to be charged in parallel from the wireless generator, and if the ship's main gives out, current can be supplied from the wireless accumulator and *vice versa*.

WIRELESS PICTURE TRANSMISSION.

AN interesting talk was given by Mr. T. Thorne Baker at the Hotel Cecil on Tuesday afternoon, April 27th, when a demonstration of the Wireless Picture Transmission apparatus invented by him, which is now known under the name of "Izon," was arranged by Messrs. W. Watson and Sons, Ltd.

It will be remembered that this apparatus was described in detail in the issue of *The Wireless World* for March 24th, and at the demonstration an allusion was made to the first tests of wireless transmission by this method over a distance which was carried out by *The Wireless World*. The success of *The Wireless World* tests has had a sequel in the carrying out by the B.B.C. from 2I.O. of a number of experimental transmissions with the apparatus, and readers may have recently heard the distinctive signals from 2I.O. which were unintelligible to them, produced by these transmissions. It is understood that the receiving apparatus will shortly be on the market, and that the broadcasting of pictures may become a fairly regular item in the programmes from 2I.O.

Further developments in this interesting subject will be looked forward to with interest.

THE CASE FOR BROADCASTING.

TO the April number of *The London Mercury* Mr. David Cleghorn Thomson has contributed a thought-provoking article, entitled "The Case for Broadcasting," in which the progress of broadcasting is dealt with, particularly in its relation to music and the drama.

The broadcast studio (writes Mr. Thomson) gives ideal conditions for the performance of certain types of music—chamber music, for instance. It was once said that in reading a great lyric poem one felt that one was not so much hearing as overhearing what the poet was saying. Wireless transmission makes it possible thus to overhear a string quartet playing in surroundings unembarrassed by a capricious audience—as if in an artist's studio—we listen to "music at home." While the presence of a great and sympathetic audience may "key up" an orchestra to a greater brilliance of execution, in many instances chamber music rendered and received in this way retains the charm of a performance given by those taking part from the pure joy of expression—the charm of "home-made music."

Broadcasting serves as an excellent test of good music—sifting the wheat from the chaff. A catchy tune with nothing more "to it" spreads with the contagion of a prairie fire—but, if every crystal-user can hear that catchy tune twice or three times a week, it has a gay life but a short one. Transmission shortens the life of shallow music and cannot harm great music, whose appeal only grows the more it is heard.

A DUBILIER COMPETITION.

A CASH prize of £200 is to be awarded by the Dubilier Condenser Co., in a novel competition relating to the new multicapacity Dubilicon Condenser. The Dubilicon is a multiple condenser consisting of several sections, and competitors are required to estimate the number of capacity values obtainable by combining the sections together in a multiplicity of arrangements of series and parallel. Issued with the Dubilicon is a pamphlet showing how the combinations of capacity are arrived at.

With such a large cash prize it is to be expected that the competition will be exceedingly popular, particularly as it is of a technical nature, yet those possessing no wireless knowledge can compete on an equal footing with skilled enthusiasts.

NEW APPARATUS

A Review of the Latest Products of the Manufacturers.

DEVICON CONDENSER.

A robust form of variable condenser is offered at a popular price by the Radio Devices Co., Newdigate Street, Nottingham.

In general arrangement the design is similar to the now standard arrangement in which the moving plates are in contact with the end mounting plates, while the fixed plates are supported on bars of ebonite. The moving and fixed condenser plates are of aluminium, and the end mounting plates as well as the spacing washers are of nickel-plated brass.

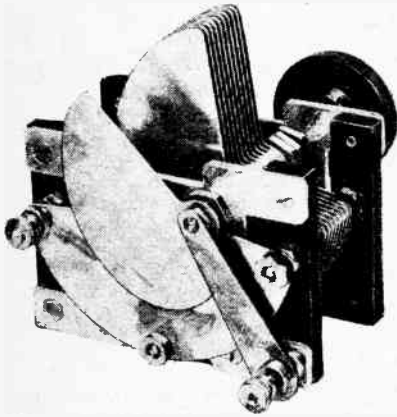

The Devicon condenser.

The vernier model is fitted with a single plate controlled by a small concentric knob, and is operated by a spindle passing through the centre of the main shaft, to which the moving plates are clamped. The moving plates are held in position by means of an adjusting screw at one end and a collar and spring washer at the other.

One-hole fixing is provided for securing the condenser to the instrument panel.

o o o o

A NEW COIL HOLDER.

In the products of the Athol Engineering Co., Ltd., Seymour Road, Crumpsall, Manchester, porcelain is employed as the insulating material. A new porcelain-mounted coil holder is now included in the range of Athol products, and is designed for baseboard mounting.

The plug and socket are attached to the porcelain mount by means of screws

inserted from the underside, which are carried in recessed holes so that the heads of the screws will not make contact with

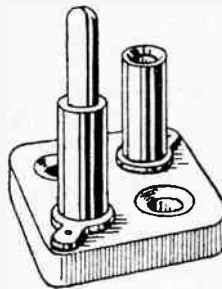

The Athol Tiger coil holder for baseboard mounting.

the wooden baseboard. The plug and socket are nickel plated and carry tinned soldering tags.

o o o o

COSMOS HYDROMETER.

The use of a hydrometer for examining the condition of an accumulator pro-

of the accumulator on full charge and complete discharge reveals any deterioration which may have set in, and it is most important in obtaining a long life for a cell that the gravity shall be kept critically adjusted to the correct density.

The Cosmos hydrometer is arranged so that acid can be sucked up out of the battery through the vent, whilst the hydrometer is prevented from adhering to the sides of the tube by indentations in the glass which serve as a guide to the indicating tube. This is a particularly useful form of hydrometer and convenient to operate, while any chance of acid becoming spilt is eliminated.

o o o

HAVA TWO-COIL HOLDER.

A simple form of two-coil holder is among the recent products of the Compton Wireless Manufacturing Co., 26-28, Bartholomew Square, London, E.C.1.

The side pieces as well as the coil holders themselves are cut from ebonite. Reduction gearing is obtained by means

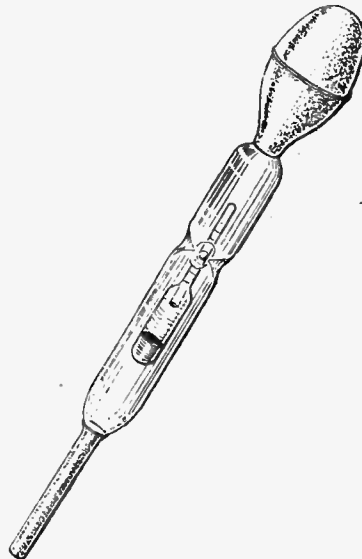

Cosmos hydrometer.

vides a better guide than can be obtained by applying a voltmeter across the terminals. An examination of the gravity

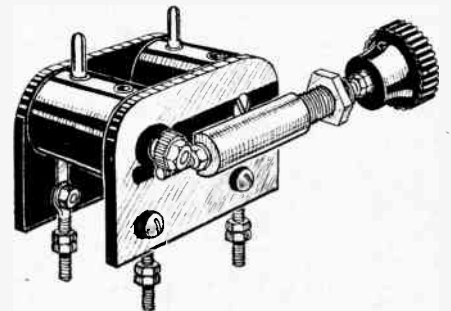

In the Hava coil holder a worm wheel is employed to obtain reduction gearing.

of a worm wheel, and the writer rather favours this system of gearing, as it not only provides a critical adjustment, but possesses very little backlash, and the friction is sufficient to prevent the movable coil holder from dropping out of position when carrying a heavy coil.

The Hava coil holder is designed for either baseboard or panel mounting, and the four bolts which serve as terminals may be used for attaching it if required to the side of a cabinet.

PRACTICAL HINTS AND TIPS

A Section Mainly for the New Reader.

ANODE RECTIFICATION.

It has frequently been pointed out that anode or "bottom bend" rectification is likely to introduce less distortion than is the more popular leaky grid condenser connection. As to whether the degree of distortion for which the latter method is responsible is really appreciable in actual practice we are not, for the moment, directly concerned, but it may be definitely stated that anode detection is considerably less sensitive as far as weak signals are concerned, and, moreover, that when dealing with small amplitudes rectification will no longer be distortionless.

In view of the foregoing, it is not hard to see why sets employing "bottom bend" rectification are usually intended primarily for high-quality loud-speaker reproduction of the local station. Working under these conditions, with large oscillations

rectification it may be possible to obtain a sufficient negative grid voltage from a suitable connection of potentiometer, filament rheostat, and L.T. battery; indeed, some of the valves are intended to work with a zero grid and low values of anode voltage. Unless using this latter kind of valve, it will generally be found best to adopt the scheme of connections shown in Fig. 1, whereby coarse adjustment is obtained by varying the voltage of the dry battery, and fine control of intermediate voltages by manipulation of the potentiometer. The arrangement is such that no current is passing through the potentiometer windings when the valve is switched off.

It should be realised that the voltage applied by the bias battery should be somewhat in excess of that actually required, as movement of the slider from the end connected to the negative end of the filament will *decrease* the total negative voltage applied to the grid. In other words, the grid voltage will not be *more* than that of the bias battery

REACTION COIL CONNECTIONS.

When wiring a new receiver it is usual to join up the reaction coil at random; if the sense of this winding is not correct, a simple reversal of connections is made. This somewhat haphazard method of procedure, while perhaps open to criticism, is, nevertheless, convenient, particularly when dealing with interchangeable plug-in coils. When constructing superheterodyne oscillators, wavemeters and various kinds of single-layer coils, it is generally quite easy to make the connections in the correct manner without any preliminary trial.

The rule for determining the correct direction of winding can easily be understood if when considering Fig. 2 (a) we assume that currents

are flowing outwards from the plate and grid and through the two coils. If this flow is in *opposite* directions, the connection is correct. In the diagram mentioned, the current in the plate coil is flowing in a clockwise direction, and counter-clockwise in

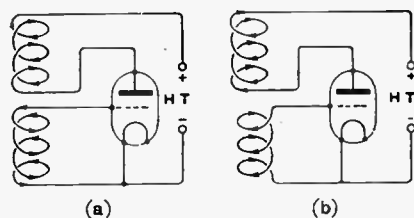

Fig. 2.—Reaction coil connections: (a) correct; (b) incorrect.

the grid coil. The reader should compare Fig. 2 (b), which shows the *incorrect* directions of windings.

It may be pointed out that this rule may also be applied to receivers using the "Reinartz" and "Weagant" systems of capacity-controlled reaction, with a variable condenser in series with the anode and coil.

CHARGING H.T. ACCUMULATORS.

It is generally admitted that the practice of charging the L.T. battery direct from D.C. mains is extremely extravagant, due to the fact that a large proportion of the energy consumed is wasted in heating the large resistance necessary to drop the very considerable surplus voltage. The charging of a battery of average capacity may, indeed, cost as much as three or four shillings.

The charging of H.T. accumulators from this source of supply is much more economical, as the voltage to be dropped in the resistance is considerably less. It is found, however, that considerable uncertainty exists as to the correct method of estimating the value of this series resistance. The internal resistance of the battery may be neglected, but it is not sufficient merely to calculate, from Ohm's law,

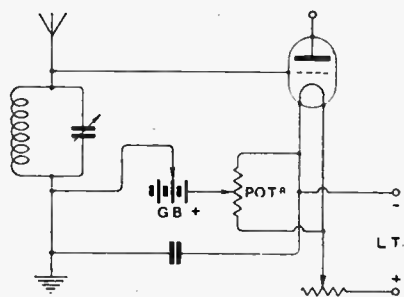

Fig. 1.—Fine control of grid bias for anode rectification.

tory voltages across grid and filament of the detector valve, a sufficiently fine adjustment of biasing voltage may be obtained by inserting in the circuit a small dry battery tapped at every cell. If, however, it is desired on occasion to use the set for the reception of distant stations, a finer control of grid voltage is necessary, and the inclusion of a potentiometer is desirable.

When the detector valve is of the type specially designed for anode

Practical Hints and Tips.—

the resistance necessary to pass the desired current at the voltage of the mains. As the E.M.F. of the battery will be in opposition to that of the charging source, it is necessary to subtract this before making the above calculation.

Taking the case of a 120-volt battery which is to be charged from 220-volt mains, we find that only 100 volts is available for driving current through the cells. Assuming a charging rate of 0.25 ampere, we find from the formula $R = \frac{E}{I}$ that a resistance of 400 ohms is required. This may be a wire-wound resistance, a lamp, or a combination of both. A method of determining the resistance of lamps was fully explained in the "Readers' Problems" section of *The Wireless World* for March 31st, 1926. It should be added that the resistance ascertained by this calculation will be that of the lamp when glowing at normal brilliancy.

REDUCING RESONANCE EFFECTS.

The practice of shunting the secondary of an L.F. transformer with a non-inductive resistance in order to flatten out the amplification curve is a fairly common one, and is quite permissible when dealing with components of the cheaper type, which often have a marked resonance point well within the band of audible frequencies dealt with by the average set. Unfortunately, even if the resistance has a very high value of the order of a megohm or more, amplification will be very appreciably reduced, but this reduction in signal strength will generally be preferable to distorted reproduction.

When noticing the effects resulting from the connection of a shunting resistance, the experimenter should not be misled by the fact that an evident improvement in quality may possibly be caused not so much by the flattening out of the resonance peak as to a reduction in the voltage overload previously applied to the grid fila-

ment of the succeeding valve. It would be best to make these tests when listening to a signal of moderate intensity, in order to avoid any risk of "amplitude" distortion, due to encroachment on to the lower bend, or the flow of grid currents, for which the resistance will not compensate, except in reducing input voltages, as already stated.

It may be also pointed out here that the shunting resistance may, in certain circumstances, be connected across an L.F. coupling choke with advantage as far as quality of reproduction is concerned, and is particularly likely to be useful when the choke of a comparatively low inductive value is used in the anode circuit of a high-impedance valve. To be effective, the resistance used in this case should generally have a lower value than that of 1 megohm usually suggested as a good average for connection across a transformer. If spring clips are fitted, it will be easy to observe the effect of various resistances.

DISSECTED DIAGRAMS.**No. 29.—Stage-by-Stage Tests of a Two-Valve Reflex Receiver.**

A consideration of the series of circuit diagrams given below will indicate an effective and logical course of procedure to be adopted in locating faults in a set which is totally or partially inoperative. This series of tests may obviously be applied with advantage to elaborations of this simple circuit, such as the "Reflex Neurodyne." Dotted lines indicate temporary short circuits.

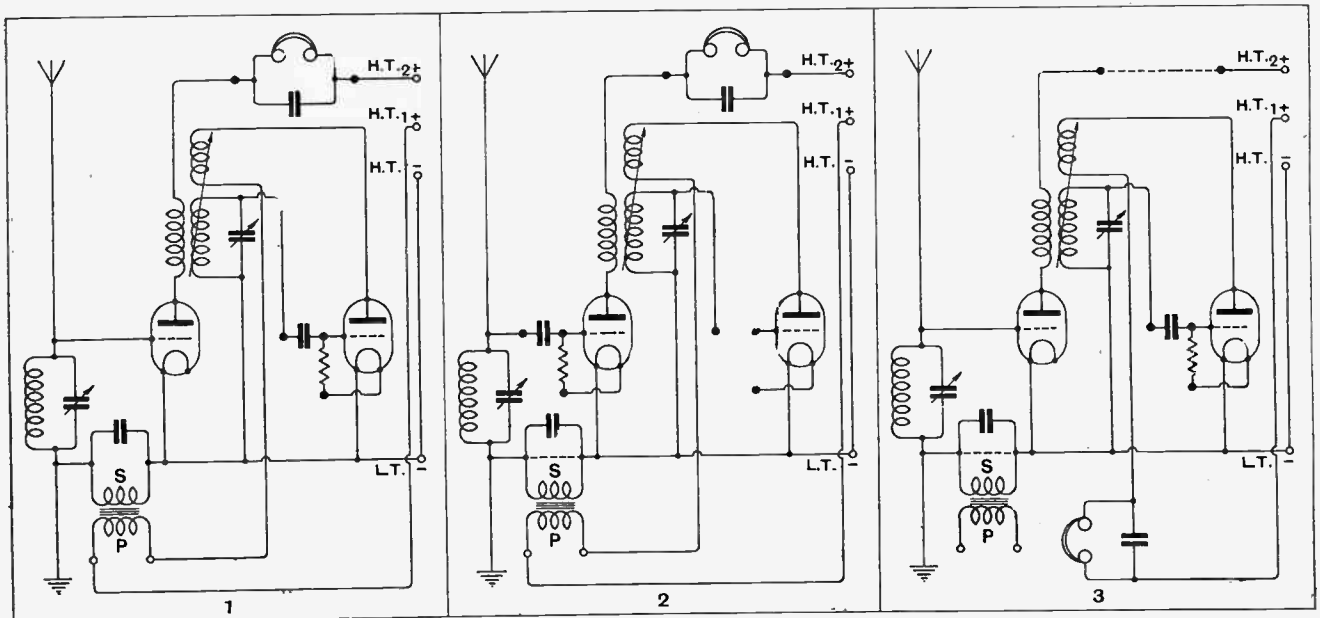

The complete circuit diagram of the receiver. It is assumed that the usual examination and simple tests have failed to reveal the source of the trouble. Either or both of the following tests may be applied. Filament circuits are omitted for the sake of simplicity.

The first (reflex) valve is converted to a detector by transferring the condenser and leak to its grid circuit. The L.F. transformer secondary is "shorted." Satisfactory signals will indicate that this valve, with its associated circuits, and aerial and earth, etc., are in order.

Phones are connected in place of the L.F. transformer primary. Failure to obtain good signals will indicate a fault in the H.F. transformer, in the detector valve, or its external anode circuit. Good results with this connection will suggest that the L.F. transformer is faulty.

WIRELESS CIRCUITS

in Theory and Practice.

11.—The Crystal Detector.

By S. O. PEARSON, B.Sc., A.M.I.E.E.

WHEN a crystal or combination of crystals is used as the detector in a wireless receiver, the choice of a suitable crystal depends on the conditions under which it is to be operated. For instance, in a simple receiver where no valves are employed, it is of paramount importance that the crystal should be as sensitive as possible, that is to say, the characteristics of the crystal should be such that the greatest possible fraction of the energy received by the aerial is transferred to the telephones, because there is no local source from which energy may be drawn. Thus the static characteristic curve should have as sharp a bend as possible, and the crystal should permit a minimum of negative current to pass.

For a receiver of this description to be sensitive the resonant voltage built up across the tuning inductance must be as large as possible for a given received signal, the value of this voltage depending chiefly upon the effective resistance of the tuned circuit. The crystal and telephones connected across the tuned circuit, or portion of it, constitute a "load" on the circuit, this being equivalent in effect to a certain resistance connected in series with the tuning coil. The lower the resistance of the shunt circuit (crystal and telephones) the greater is the equivalent series resistance. It has previously been shown¹ that the resonant voltage obtained across a tuned circuit was inversely proportional to the resistance of the circuit, and therefore it follows that the higher the resistance of the crystal and telephone circuit the greater will be the signal voltage obtainable. On the other hand, the power delivered to the telephones decreases as the resistance of the shunt circuit is increased, but is proportional to the *square* of the applied voltage.

From the foregoing it follows that the crystal-telephone circuit should be adapted to the resistance and other constants of the tuned circuit to obtain maximum signal strength. In general, a fairly high resistance crystal should be used in order that it shall not produce too heavy a load on the tuned circuit and so reduce the signal voltage and selectivity of the circuit.

Another point to be considered is the degree of distortion which may be introduced by the peculiar non-linear characteristics of the crystal if not operated over the correct portions.

Crystal Characteristics.

Various crystals and combinations of crystals possess the property of unilateral conductivity, but each arrangement has its own particular characteristics, some having high resistance and some low. For the present purpose it is sufficient to consider the properties of one particular type of crystal, and the one chosen is the Perikon detector,

which consists of a crystal of bornite in contact with one of zincite. This combination has the advantages that it possesses a fairly high resistance and that a good firm pressure can be used so that the setting is not appreciably affected by vibration. It is perhaps not quite so sensitive as some other types, such as the various forms of galena, where a "catwhisker" makes contact with the crystal.

The Perikon Detector.

Some actual measurements have been made on a Perikon crystal, and the results are given below. First, the current passed by the crystal was measured for various steady voltages applied across it in either direction, these figures giving the static characteristic curve shown in Fig. 1. The chief points to be noted are that the bend in the curve is fairly sharp, and occurs at the point on the horizontal axis where the applied voltage is very nearly zero.

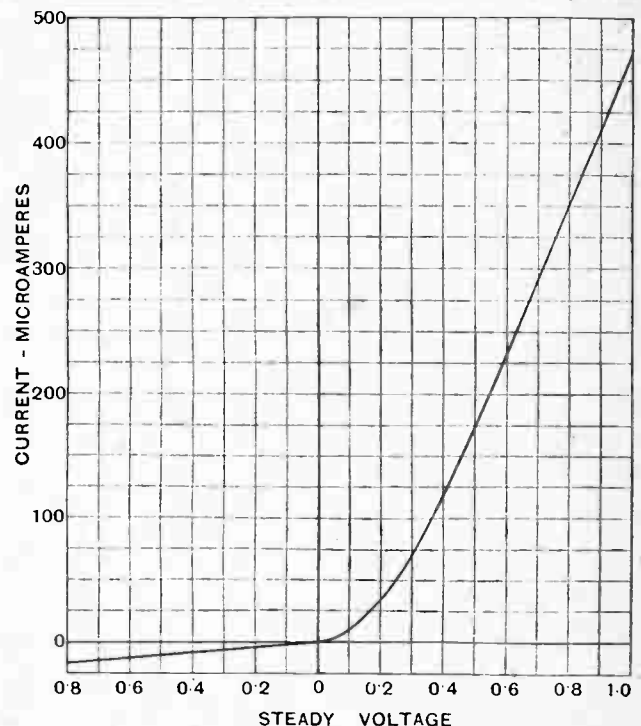

Fig. 1.—Static characteristic of Perikon crystal detector.

so that the local battery and potentiometer mentioned in the previous instalment will not be required. Secondly, that, apart from values near the bend, the curve is almost a straight line, both for positive and negative values; and, finally, the effective resistance offered to currents in the positive direction is only a small fraction of that

¹ *The Wireless World*, March 3rd, 1926.

Wireless Circuits in Theory and Practice.—

offered to currents in the opposite direction. For instance, when the applied voltage is one volt in a positive direction the current is 470 microamperes, giving an effective resistance of 2,130 ohms, and for one volt applied in the negative direction the current is only 22 microamperes, the resistance being therefore 45,500 ohms, which is more than 21 times as great as that offered to currents in the positive direction.

Dynamic Characteristic.

The performance of the crystal combination as a rectifier could be determined graphically from the static characteristic of Fig. 1, but the results are not so convincing as those obtained from actual measurements made when an alternating voltage is applied to the crystal. Consequently, these measurements have been made and the dynamic characteristic given in Fig. 3 obtained from the readings. It may be of some interest to give the actual method employed for effecting these measurements, and the following is a brief description: A known low-frequency (50 cycles per second) alternating pressure of about 2 volts R.M.S. value was applied to the ends of a resistance of, roughly, 20 ohms, divided into ten equal parts, each tapping being connected to a terminal. The crystal under test was connected in series with the microammeter between one end of the resistance and any desired one of the tappings, so that fractions of 1/10, 2/10, 3/10, etc., of the total voltage indicated by the voltmeter could be applied to the crystal. The R.M.S. voltage measured in each case was multiplied by $\sqrt{2}$ to give the amplitude, a sine wave of voltage being employed. The circuit arrangement is shown in Fig. 2.

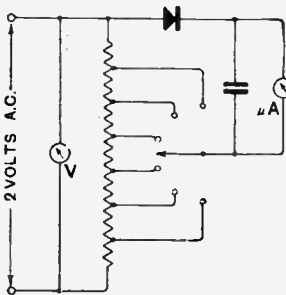

Fig. 2.—Circuit for obtaining the dynamic or A.C. characteristic of a crystal. The resistance of the potential divider must be low compared with that of the crystal.

The dynamic characteristic curve of Fig. 3 is more useful from the practical point of view than the static characteristic, because it shows us exactly what is taking place under the actual conditions of reception. It should first be noted that the curve is not nearly as steep as the static characteristic curve of Fig. 1, e.g., for 1 volt: (positive) under static conditions the current is 470 microamperes, whereas for 1 volt amplitude under the dynamic conditions the mean rectified current is only 125 microamperes. This is, of course, chiefly due to the fact that we are getting half-wave rectification only, and that a small amount of negative current is allowed to pass during each negative half-wave of voltage.

Conditions for Faithful Reproduction.

By inspection of the curve we see at once that for voltages of greater amplitude than about 0.8 volt the curve is practically a straight line. This is an extremely important property, and accounts for the well-known fact that a crystal gives very faithful reproduction of speech

and music under suitable conditions. It shows that for voltage amplitudes above 0.8 volt for this particular crystal the change of mean rectified current will be directly proportional to the change of amplitude of the

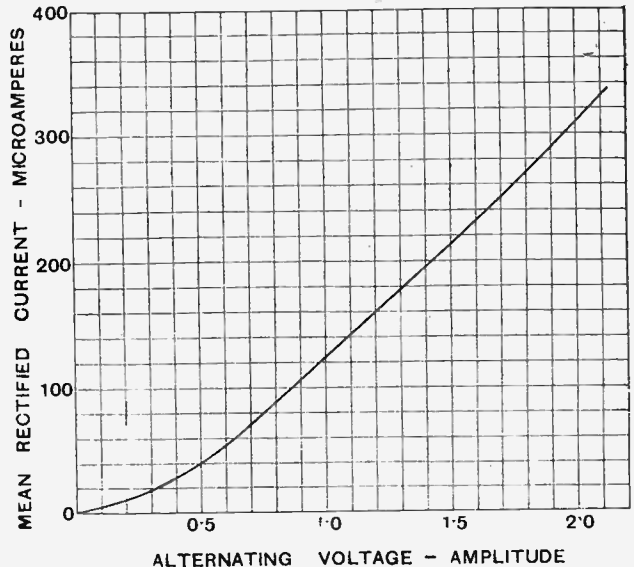

Fig. 3.—Dynamic characteristic curve of the Perikon detector.

applied alternating voltage, and therefore in receiving wireless telephony the rectified current in the telephones will vary in exact accordance with the variation of amplitude of the modulated carrier wave, provided, of course, that the high-frequency voltage is not modulated to values below 0.8 volt. The curve of Fig. 4 has been derived from the dynamic characteristic, and serves to show very clearly that linear rectification is obtained for signal amplitudes which do not fall below 0.8 volt. It shows that for amplitudes above 0.8 volt the ratio of the change of mean rectified current to the change of the amplitude of the high-frequency oscillations is a constant, this being the condition for distortionless rectification where the usual modulated carrier wave system is employed.

For ordinary broadcasting transmissions the modulation employed is never greater than about 20 per cent. for the

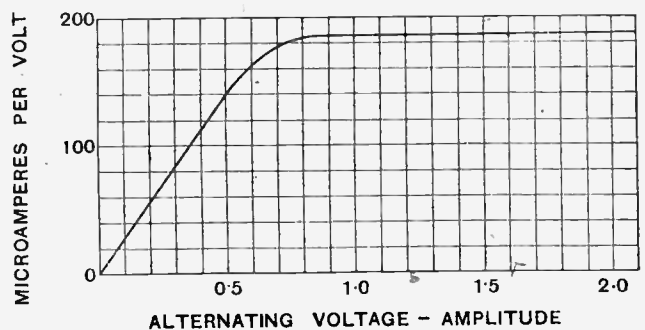

Fig. 4.—Curve showing slope of Perikon dynamic characteristic in microamperes per volt for various applied voltages.

loudest sounds transmitted, that is to say, the amplitude of the carrier wave never varies more than 20 per cent. above or below its normal or unmodulated value. This

Wireless Circuits in Theory and Practice. —

means that, for the particular Perikon crystal we are considering, the normal amplitude of the high-frequency voltage applied across the crystal should be at least 1 volt, so that for the highest degree of modulation the amplitude will never fall below 0.8 volt, and, so far as the crystal itself is concerned, no distortion will be introduced. These conditions are quite easily obtained when the receiver is situated within a few miles of the broadcasting station, but when located at a considerable distance from the station it is impossible to operate over the straight portion of the dynamic characteristic unless one or more stages of high-frequency amplification are employed to bring the signals up to the requisite strength before rectification. But, even if the signals are too weak to operate the crystal over the linear part of the characteristic, the distortion produced will not be excessive if the percentage modulation is small.

The Most Suitable Telephone Impedance.

It can be shown that for almost any piece of apparatus which gives out electrical energy the greatest output is obtained when the resistance of the load is of the same order as the internal resistance of the apparatus itself, provided the inductive effects are not large compared with the resistance. Thus the telephone to be used in conjunction with a crystal should have a resistance of the same order as the crystal resistance measured with current flowing in the positive direction.

As a telephone depends for its operation on its electromagnetic properties, it possesses considerable inductance, and the impedance at, say, 800 cycles may be three or four times as great as its resistance, and for this reason it is difficult to give any hard-and-fast rules as to the correct resistance which the telephones should possess.

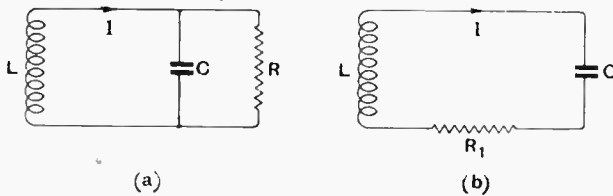

Fig. 5.—Tuned circuit (a) with high resistance R connected across it, and (b) the equivalent circuit as far as damping is concerned.

The telephone resistance itself plays no part in the actual conversion of the electrical energy into mechanical vibration of the diaphragms, but it serves a useful purpose in reducing the time constant and preventing violent electrical resonance at certain frequencies.

It is a fairly safe rule to employ telephones of about the same ohmic resistance as that of the crystal. It will be seen from the static curve of Fig. 1 that the effective resistance of the crystal begins to increase very rapidly as the applied pressure is reduced below about 0.2 volt, and therefore for listening to very weak signals higher resistance telephones should be employed. For the Perikon crystal 2,000-ohm telephones are suitable for strong signals if loudness is required, whereas 4,000-ohm or even 8,000-ohm telephones would be much more sensitive to weak signals.

The telephones in series with the crystal will, of course,

reduce the mean rectified current obtained as compared with the values given by the curve of Fig. 3, the ratio of currents being roughly in the proportion of the telephone impedance to the total impedance of the combination.

Crystal Loading of Tuned Circuits.

If a resistance of R ohms is connected across a tuned circuit, as shown in Fig. 5 (a), it will have a damping effect on the tuned circuit; that is to say, it will partly destroy the sharpness of tuning and lower the available

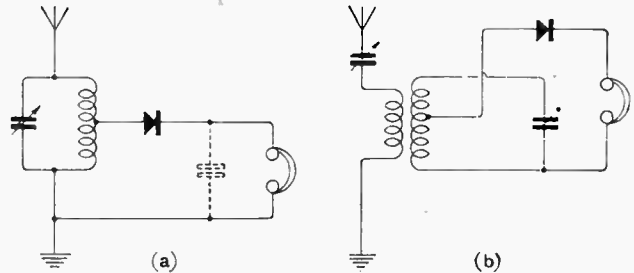

Fig. 6.—Methods of reducing damping and improving selectivity in crystal receiving circuits.

resonant voltage across the circuit. We saw in a previous section that the greatest sharpness of tuning and the maximum value of the resonant voltage were obtained in circuits which possessed a minimum of series resistance and therefore dissipated the smallest amount of energy. When a high resistance, R, is connected across a tuned circuit energy is expended in this resistance, and therefore it has exactly the same effect on the tuned circuit as a certain resistance, R₁, would have when connected in series as shown in Fig. 5 (b). The value of this equivalent series resistance depends not only upon the value of R, but also upon the capacity of the tuning condenser and the frequency of the oscillations. The equivalent series resistance R₁ may be defined as that resistance which would absorb the same power as the parallel resistance R. Thus if E is the voltage across the circuit and I the current we have:

$$I^2 R_1 = \frac{E^2}{R},$$

from which it can be shown that $R_1 = \frac{I}{\omega^2 C^2 R}$ ohms (approx), where $\omega = 2\pi \times$ frequency, and C is the capacity of the condenser in farads.

The effective resistance of the crystal is obviously a complicated quantity, as it is varying all the time as the current changes; but, assuming the crystal and telephones to have an effective resistance of 10,000 ohms and the tuning condenser to have a capacity of 0.0003 mfd., we find that the equivalent series resistance of the combination at 377 metres is 44.4 ohms. If the high-frequency resistance of the tuned circuit itself is, say, 11.1 ohms, the addition of the telephone and crystal will bring the signal voltage down to one-fifth of that obtainable without the shunt circuit. This example is given to show how serious the damping effects of the crystal circuit are, and the reader will realise at once that it would be futile to design a low-loss coil and then to shunt it with a crystal and telephones.

It will be found that the damping effects can be eli-

Wireless Circuits in Theory and Practice.—

minated to a large extent by connecting the crystal circuit across part only of the tuning coil, as shown in Fig 6 (a). The best fraction of the coil to be tapped depends entirely on the type of crystal in use, the lower the resistance of the crystal-telephone circuit the fewer will be the number of turns required between the tapping points. For quantitative measurements made in this respect the reader

is referred to two articles by W. H. F. Griffiths in *The Wireless World*, February 17th and 24th, 1926.

Naturally, the damping effects of a crystal will reduce the selectivity as well as the signal strength, and the usual method employed to improve the selectivity is to connect the crystal circuit to a separate tuned circuit loosely coupled to the aerial tuning inductance, one of the best arrangements being that shown in Fig. 6 (b).

REMOTE FILAMENT CONTROL.

A Useful Device for the Broadcast Listener.

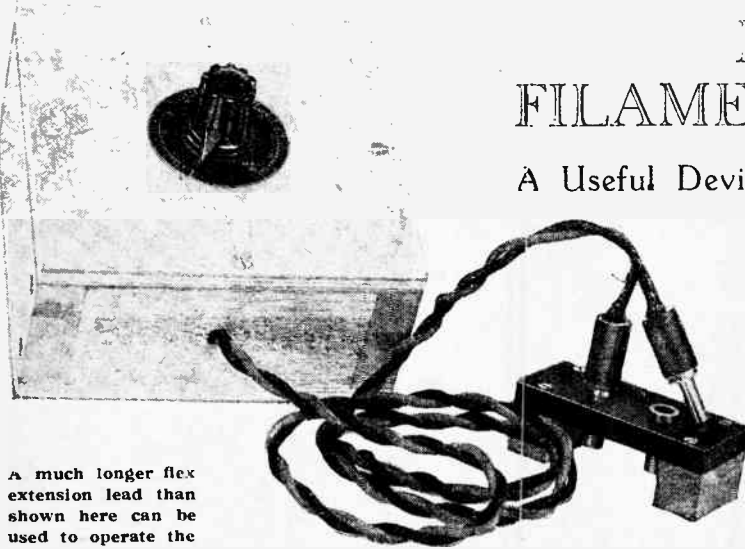

A much longer flex extension lead than shown here can be used to operate the resistance.

WHEN listening to broadcasting, it very seldom happens that the set is placed so near the arm-chair by the fire that it can be controlled without having to get up and cross the room, so that most people find that, whatever type of set they are using, it would be very convenient to have some means of switching the set off and on from whatever point in the room they may happen to be. The little accessory which is illustrated here is very convenient in such circumstances, and it is surprising how many people who are in a position to devise something of the kind for themselves do not seem to have taken up the idea, but still jump up to switch the set on or off as required.

Simple Construction.

The construction, of course, is very simple. It consists merely of a filament resistance mounted conveniently in a small box with a length of electric light flex which goes across the room to the set. Here a small strip of ebonite carrying two sockets is screwed to the side of the set or to any other convenient position, and one socket is connected to one terminal of the L.T. accumulator, and the other socket to one of the L.T. terminals of the set. The other terminal of the battery goes direct to the second L.T. terminal of the set, so that when the plugs are fitted into the sockets the filament resistance at the end of the lead is in series with the battery supplying the filament current to the valves. When all the resistance of the separate unit is cut out, *i.e.*, when it is fully on, the ordinary filament controls on the set should be adjusted, and the separate unit,

which can be put on the arm of the arm-chair, now provides a means of shutting off the accumulator at will. Of course, any ordinary switch would serve this purpose, but the use of a filament resistance has two distinct advantages. First of all, with some types of valves it is better not to click the battery current on and off suddenly, but instead to raise the temperature of the filaments gradually, and this can be done by means of this filament resistance. Again, as letters to the Press have so clearly indicated recently, all

the programme items do not please everybody all the time, and conversation in the room will often be regarded as preferable to certain items. Under these circumstances the filament resistance can be turned down until the broadcast item is so faint as not to interfere with conversation. Of course, this will impair the quality of the reproduction, but then if it is not desired to listen to the item the quality does not matter, whilst the fact that broadcasting can still just be heard prevents the possibility of missing the next item which may be thought good enough to listen to. With an ordinary switch it may often happen that the first part of something good is missed because the previous item has been switched off.

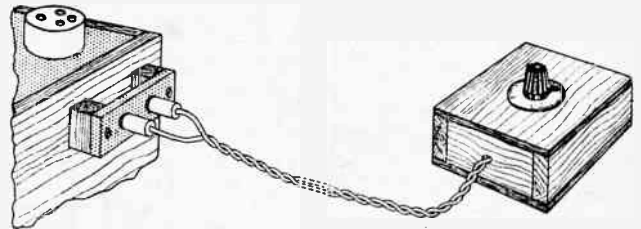

A method of attaching the sockets to the set.

In using a little device of this sort the leads from the set to the unit cannot be extended indefinitely, as otherwise the voltage drop will be considerable; but it is safe to assume that across the average room, using electric light flex, this trouble will not be encountered, except, perhaps, with two-volt valves and a two-volt accumulator.

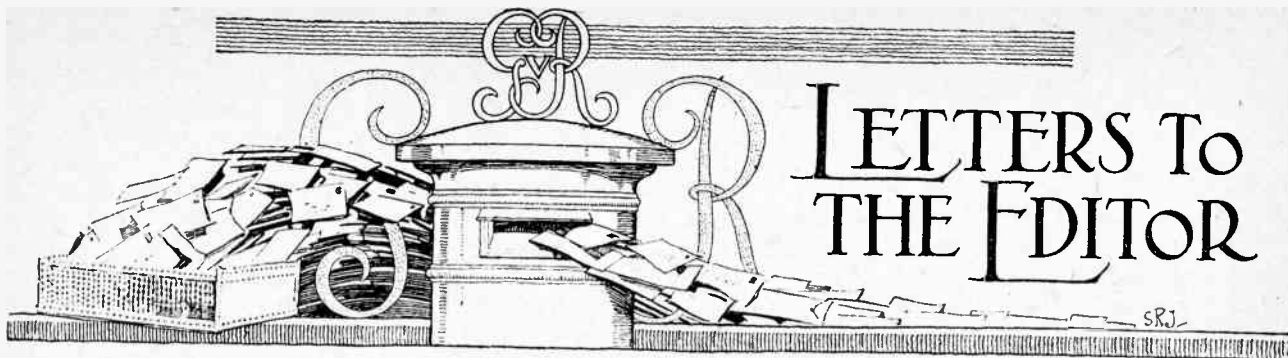

The Editor does not hold himself responsible for the opinions of his correspondents.

Correspondence should be addressed to the Editor, "The Wireless World" Directorate, 113, Tottenham Court Road, London, W.1, and must be accompanied by the writer's name and address.

BROADCASTING TO THE COLONIES.

Sir,—One is led to wonder if the B.B.C. can be induced to consider the short-wave broadcasting of their programmes?

In tropical countries it is quite out of the question to get, with any enjoyment, the broadcasting on the waves about 300 metres, because of the terrific atmospherics. (In the winter months it is quite possible to hear the Home stations at night time.)

On waves below 100 metres atmospherics never reach any strength worth worrying about even in our worst season for them, *viz.*, March, April, and May. Commercial stations on these short wavelengths come in at extraordinary strengths on as few as two valves. Such stations are 6XI, PULL, ANE, POW.

Assuming a "speech" strength of less than half any of the above, two valves would give enjoyable telephone strength in any country within seven or eight thousand miles of London.

There must be thousands of people living in such a radius who would very willingly pay ten times the British licence fee yearly for the privilege of getting the Home concerts and news. (The cost of a set's upkeep, plus the voluntary licence fee, would be a very small part of what some people in the tropics spend yearly on gramophone records.)

The set for general sale would need to be simple in its adjustments, with, it is suggested, a slow variation of ten metres either side of the modulation. It could be calibrated and be independent of any aerial effects on tuning were the aerial coupling to the grid coil made *via* a very small condenser.

It would have to be suitable for 0.06 valves and dry batteries for obvious reasons.

This letter is addressed to you in order that your readers abroad may write the B.B.C. and indicate their willingness to contribute towards the cost of the short-wave broadcast should the company feel disposed to undertake it.

May I therefore urge those of your readers who are interested to endeavour to interest others and let the B.B.C. have a few thousand letters to enable them to consider the idea seriously?

The initial cost of the two-valve set would be about £25.

The necessary dry batteries can be obtained in almost any tropical country nowadays.

G. E. HUGHES.

Kenya Colony.

INTERFERENCE AND "SUB-HARMONICS."

Sir,—The letter of your correspondent, Mr. J. H. Reeves, in your issue of April 14th, refers to so-called "sub-harmonics."

He appears to have overlooked the fact that the reception he describes may be explained if the local oscillation generates a second harmonic, as it invariably does (the "Tropadyne"), and if the frame tuned to 360 metres or so picks up a 180-metre transmission. Thus the discrimination between 360 metres and 180 metres is due entirely to the tuning characteristics of the frame.

I think it must be fairly clear that when a valve is oscillating steadily—excluding the initial transient state—the amplitudes of successive oscillations must be equal, and therefore so-called "sub-harmonics" cannot exist. Any heterodyne

is therefore due to harmonics of the receiver when the receiver is tuned to double the wavelength of the transmission.

That this is the true explanation is confirmed by the fact that the strength of reception on double the wavelength is increased when the reaction coupling is tightened while reception of the fundamental is strongest when the receiver is just oscillating.

F. AUGHTIE, B.Sc. (6AT).

Dudley, Wores.

AN INTERESTING VALVE FAILURE.

Sir,—With reference to the article by "E.M." in *The Wireless World* for April 21st on the above subject, I would like to point out that this is by no means a unique instance. As is admitted, the valve was badly over-run—dissipating 120 watts instead of 50. With this treatment the total collapse of the valve is just what one would expect.

What happened was possibly this—through over-running the temperature of the plate (which was probably of nickel) became so intense that it fused. The hot fused metal, propelled by the electrons from the filament, then shot on to the bulb, and thereby caused the glass to become soft. The vacuum in the valve then sucked the glass inwards at that particular spot. A hole was the result, then naturally air rushed in and burnt the filament out.

F. A. GOULDING.

Stoke Newington.

IMPORTANCE OF HEADPHONE INSULATION.

Sir,—In consequence of the increasing use of eliminators operating from the electric lighting circuit in place of high-tension dry batteries, I should like to suggest the desirability of your calling attention in your paper to the importance of good insulation on headphones should headphones be used in association with an eliminator.

I recently came across the case of a person who suffered a very severe nervous shock by reason of the fact that there was a low insulation between the coils on the head receiver and the metal headband.

Of course an unpleasant shock might equally have occurred had there been a high-tension battery of 100 volts or over used, but as an eliminator on a 200-volt circuit was used you can imagine that the effect was very unpleasant, and had the person had a weak heart the results might have been very serious.

I am aware that where eliminators are used it is generally in association with a loud-speaker; at the same time, in the interests of the wireless trade, it is necessary that attention should be called to the importance of good insulation of the headphones.

M. H. GOLDSTONE.

M. LÉON DELOY ON AMATEUR SHORT-WAVE DEVELOPMENT.

Sir,—I am just back home from a journey abroad, and one of the first articles I happen to read in back issues of *The Wireless World* is that entitled "The Amateur's Part in Short-Wave Development" on page 216 of the issue of February 10th last.

As you probably remember, I have reasons to be very keenly interested in the matter, and that is why I am writing the present letter, which I hope will receive the hospitality of your column.

The article above referred to contains a letter signed by Senator G. Marconi, and that of an answer to that letter signed by Mr. L. B. Turner.

In his letter Mr. Marconi claims that he and his engineers knew much about the possibilities of short waves long before the amateurs did, and he quotes different abstracts from papers and articles describing experiments on short waves which date back to 1916.

In his reply Mr. Turner remarks that all the experiments referred to by Mr. Marconi were experiments on short waves *directional short range* (less than 100 miles) communication which in no way disclosed the remarkable *long range* (world wide) *non-directional* possibilities of communication which make the immense value of short waves, except his paper before the Royal Society of Arts, published on July 25th, 1924, but, as Mr. Turner remarks, "the world did not await Mr. Marconi's Society of Arts paper to appreciate the astonishing qualities of short waves for long ranges." Mr. Turner then gives a list of some articles published in *The Wireless World* referring to long distance short-wave communications dating from April 23rd, 1924, to July 30th of the same year.

That list, although very impressive, might have been much more so if it had gone back all the way to November, 1923, when I had the good fortune of establishing the very first long distance short-wave communication, the results of which were published.

Let me quote part of your own Editorial published in the issue of December 19th, 1923, of *The Wireless World*, and entitled "Another Wireless Milestone."

"Whatever strides are being made in the commercial development of wireless, it is quite evident that the amateur has no intention of being left behind. Events which have transpired during the past week are of such outstanding importance that they must be described as a milestone in the history of wireless, and they serve once more to emphasise the importance of the work of the experimenter.

"At the time of going to press with the last issue, a report reached us that Mr. Léon Deloy (French 8AB), whose station is located at Nice, had been in regular telegraphic communication on successive nights with two American amateur stations, 1MO, operated by Mr. F. H. Schnell, Traffic Manager of the American Radio Relay League, and 1XAM, operated by John Reinartz.

"One naturally hesitates to give publication to reports of such a startling nature without confirmation, and, accordingly, rather than announce this information in the last issue, it was decided to communicate with Mr. Deloy for confirmation. Mr. Deloy's reply indicates that there is no doubt about the truth of the report. His signals have been heard by 1MO readable twenty feet from the 'phones, and have operated a loud-speaker at 1XAM.

"Next, after Mr. Deloy's achievement comes a report from Mr. J. A. Partridge, of Merton, London, in reference to two-way Morse working with 1MO, this time with Mr. K. B. Warner, secretary of the A.R.R.L., on the key. Mr. Partridge's station (2KF) first got into touch with 1MO with the assistance of 8AB on the morning of December 8th."

In short, the story of the communication referred to in your Editorial was as follows: As far back as the spring of 1923 I had made some experiments on waves of the order of 100 metres and below. Having obtained exceedingly encouraging results, I felt convinced that such waves could render immense and unsuspected service in long distance work. I was away from my station all the summer, and could resume my experiments only late in October of the same year. At that time I hastily rebuilt my station for 100 metres' work and I made a series of tests with G 20D. These tests gave results that strongly supported my most optimistic views. Consequently I arranged tests with 1MO, and they were an immediate success. On the first night (November 25th-26th, 1923) my signals were reported by 1MO as very steady and extremely strong. The report for the second night was the same, and two messages were received at the first sending. On the night of November 27th-28th 1MO and 1XAM had brought their waves down to 100 metres

and two-way transatlantic communication was established and maintained with them with the greatest ease.

I have every reason to believe these tests were the first of their kind, and that it is from their publication that the world learnt the immense value of short waves: the incredibly fast development of these waves from that date seems the best proof of it.

Now I would like to point out that I have the greatest respect and admiration for Mr. Marconi and his work. I consider him not only as a genius, but as one of the greatest benefactors of humanity. But Mr. Marconi is not only that, he is also a business man, and I believe it is the business man who inspired the letter which I summed up in my first lines, and which might lead people to think Mr. Marconi meant that he was the first to disclose to the world the possibilities of short waves in long distance communication.

That Mr. Marconi knew very much about short waves before I did is an affirmation which I will certainly not contradict. The contrary would have greatly surprised me, as I have not the least intention of comparing my small abilities with his nor my small research facilities with the wonderful and world wide organisation at his disposal, but it can be easily understood that from a business point of view Mr. Marconi had good reasons to keep his knowledge to himself until the proper time.

I, on the contrary, as all amateurs, always made it a point to give out immediately to the world any little result that might be of use to others. Naturally such a "milestone," to use your own word, as the result of my experiments of November, 1923, was immediately published, and the news spread around the world like a flash of lightning for the greater and immediate benefit of all "users" of wireless. It is very probable that such publication was unpleasant to several business interests for reasons that can be easily understood; if so I am sorry for it, but it just could not be helped.

As for Mr. Marconi, if these lines reach his eyes I am convinced he will understand my point; at the time of his early experiments he was also an amateur, and he knows what the amateur spirit is; if he was in my place he would surely defend the cause of the amateur as I do.

And now I must apologise for this long letter and for talking so much about my own work. In doing so I am trying to defend the cause of the whole amateur brotherhood much more than to remind readers of whatever little useful work it may have been my lot to accomplish. The amateur is too often considered as useless or even harmful by people who think so just because they don't know what he has done. None of us should neglect an opportunity to publicly state the facts and bring back to light those which might otherwise be eclipsed.

Nice.

LEON DELOY, F8AB.

LOW LOSS COIL TESTS.

Sir,—My attention has been called by the Radio Press, Ltd., to an article written to them by my son C. S. Endersby in February last and published in the *Wireless Weekly* regarding various tests of low loss coils. In the interests of both your readers and theirs, I feel obliged to give you the facts.

My son has for a long time been experimenting in low loss coils for the purpose of improving results on DX work, and has constructed and tested coils with various gauges of wire wound in various ways with excellent results.

Reading your article on test results of various coils, which in some cases correspond with his own figures, he conceived the idea of sending your figures to the *Wireless Weekly* with the object of obtaining their criticisms of same, and very wrongfully stating that they were his own results.

He had no idea that his letter would be published, otherwise he assures me that he would not have written in the manner stated.

Personally, I regret that he should have allowed his enthusiasm to have exceeded his veracity in the matter (he is 17 years of age), and shall be glad if you will publish this letter in order to correct any wrong impression given to the readers of the *Wireless Weekly* or *The Wireless World*.

Wandsworth, S.W.18.

S. J. ENDERSBY.

AMATEUR TRANSMITTERS.

Sir.—May I ask on what authority Mr. E. C. Chidwick, in writing re Mr. C. W. Railton's letter on the subject of amateur transmitters, refers to that gentleman's receiver as unselective? The receiver in question employs the most selective combination of balanced H.F. and wave trap, and is inferior only to a properly neutrodyned circuit with three stages of H.F. or to a good superheterodyne.

With regard to Mr. Chidwick's remark that amateur transmitters are at liberty to transmit during broadcast hours, does he really imagine he is at liberty to transmit *on the broadcast wavelengths* whenever he chooses. He will be wise not to attempt the experiment.

It is quite reasonable that genuine experimenters should have every facility possible, but the broadcast band is emphatically not the band for this purpose, and very few of the genuine experimenters now use it at all.

Unfortunately many of the amateurs who hold transmitting licences have no real qualifications, and are merely dabblers who have neither the ability nor the means to carry out anything in the nature of scientific experimental work of any value. They are simply out to amuse themselves with the latest toy available.

Experimenters' licences are intended to encourage research work, and a few holders of these licences have more than justified their right to hold them, and when they have been able to show their ability have frequently been granted much greater facilities.

It is certainly time that a thorough comb-out be made amongst the transmitters, and the "rabbits," who cause a great deal of jamming without the remotest chance of adding anything to scientific knowledge, be suppressed.

Alderley Edge.

W. S. WILLIAMSON.

Sir.—In view of the correspondence which has recently appeared in your columns as well as those of the London and provincial lay Press, may I appeal to amateurs, especially in the West of England, to cease polluting the ether with gramophone records. Our licences are granted to us for experimental purposes, and by no stretch of imagination can the appalling noise to which I refer, be called "experimenting." It is, of course, impossible to mention particular stations, but there are a good many within 50 miles of Salisbury, and others further away can be heard. Comments are constantly being made upon it, and, unfortunately, we all get classed alike. It is alienating all public sympathy, and not doing any good otherwise. Some of the piano noise (I cannot call it music) is bad enough, but worn out records are infinitely worse. It is a pity some of the transmitters cannot hear their own transmissions.

Salisbury.

W. ISON.

R.S.G.B. (T. & R.), G2FB.

Sir.—I fear that Mr. Railton's proposal further to tighten the already severe restrictions upon amateur transmission generally would, if carried into effect, merely inconvenience the serious worker who respects all regulations, while not in the least abating the nuisance caused by irresponsible and unqualified persons who already flout every regulation in existence.

Would not the problem be better dealt with by instituting a more searching and consistent enquiry into the qualifications and aims of the applicant for a transmitting licence before the granting of authority to transmit in the first place?

At present there seems to be no definite examination in force, and the obtaining of such authority appears to be merely a matter of time and a sufficient number of repetitions of one's original application, and the result of this system has proved to be the blocking and hindering of applications by many serious workers (in several cases distinguished scientists have suffered in this way) without ensuring in any way that authority to transmit shall not pass into incapable hands. I believe that the majority of serious experimenters would welcome some consistent system whereby they would gain an opportunity definitely and promptly to establish their claims to transmitting authority, and the abuse of the facilities by persons who create a nuisance to both listeners and experimenters alike be definitely prevented. It would be interesting to hear the views of other experimenters on the matter.

It appears to me to be a matter for great regret that the correspondence in this matter should have assumed a somewhat

acrimonious character on both sides, for this can only lead to such hasty expressions as those included in Mr. Williams' reference to Mr. Maurice Child, which are perhaps a little unfortunate in their application to a gentleman who is, I believe, acknowledged to be one of the foremost technical authorities in the Radio Society of Great Britain and a pioneer in the science of wireless telegraphy.

L. H. CARDER.

Kingstown, I.F.S.

Sir.—If the broadcast man would approach the offending transmitter, I think he would find in ninety-nine cases out of a hundred that he would meet with great courtesy and his trouble would soon be put right.

A man who buys a car and does not trouble to master the mechanism usually finds himself, sooner or later, 10 miles from anywhere, stranded, and very likely the defect could be cleared in two minutes, *if he only knew how!* My advice to every B.C.L. is: Learn a little about your receiver; you will then save paper and ink and a great deal of hot air.

Margate.

ARTHUR O. MILNE (2MI).

Sir.—In reply to Mr. Burstow, the wavelengths of the amateurs first referred to are 359 and 390 metres, but there are about ten others who work between 315 to 430 metres. Unselectivity is not the trouble; it is the heterodyning, as Mr. Fildes, who is 60 miles away, points out.

Surely Mr. Burstow would not call a superheterodyne unselective because it could not separate two stations heterodyning each other.

It is rather significant that most of the letters supporting the amateur have come from London, where they have no idea of the conditions round Manchester.

Of course, it is only fair to say that there are several who do some useful work, but I have never heard them on the broadcast band transmitting vile gramophone records.

Withington, Manchester.

G. N. WRIGHT.

Sir. As my name is mentioned by Mr. T. Burstow in the correspondence column this week, may I say a few final words in reply.

My second letter, published in the issue dated April 14th, makes clear the exact meaning of my earlier statement that many amateur transmitters in South Lancashire and Cheshire work on wavelengths between 300 and 500 metres. If my receiving set were so incredibly unselective that low-power transmitters from 40 to 70 miles distant, working between 150 and 200 metres, interfered with reception of broadcasting on 300 to 500 metres, I would make a bonfire of it promptly.

Judging from the addresses of the various letters published, the differences of opinion on this question are due to the fact that in the south-eastern part of England practically all the transmitting amateurs work on wavelengths below 200 metres, and some of those who reside in that district refuse to believe that a very different state of affairs can exist in other parts.

I do not try to discredit the statements of those who have written from the neighbourhood of London when they say that hardly any experimental transmissions can be heard above 200 metres, but accept them as true so far as that part of the country is concerned, and I fail to see why there should be a refusal to accept the statements of Mr. Railton, Mr. Arthur F. Williams, myself, and others, when speaking of what we know, not what we surmise. One might imagine, from some of the letters published, that the writers have an idea that residents in the North of England know hardly anything about wireless reception, and nothing at all about selectivity. It would be just about as sensible to suggest, in return, that the reason why those in the south hardly ever hear any experimental transmissions between 300 and 500 metres is because their receiving sets are so feeble that they cannot hear a low-power transmission if it is more than a mile or two distant, and that this has deluded them into believing that there cannot be any.

May I say, in conclusion, that I have the greatest admiration for the genuine experimental transmitter, and would be the last person to suggest that his valuable work should be further hampered by restrictions, but it is because I believe that the 300 to 500 metre gramophone fiends are likely to harm the genuine experimenter that I have "chipped in" on this controversy.

J. H. S. FILDERS.

Llandudno Junction, S.O., North Wales.



The following abstracts are prepared, with the permission of the Controller of H.M. Stationery Office, from Specifications obtainable at the Patent Office, 25, Southampton Buildings, London, W.C.2, price 1/- each.

Improvements in Receivers Employing the Heterodyne Principle. (No. 234,816.)

Convention date (United States): May 27th, 1924.

The Marconi's Wireless Telegraph Co., Ltd., describe in the above British patent specification a receiver employing the heterodyne principle, in which the fundamental frequency of the incoming wave (which may, if desired, be amplified) is heterodyned with local oscillations, the same oscillatory circuit serving both for controlling the frequency of the local oscillations and for coupling the incoming oscillations to the grid of the valve generating the local oscillations. The drawing shows a schematic diagram of a radio receiving system of the autodyne type, in which so-called full frequency is employed for producing the desired beat oscillations.

The loop antenna 1 is tuned to the incoming signal oscillations by means of the variable tuning condenser 2. Assume these oscillations to be at a frequency of, say, 600 kilocycles. These oscillations appear in the plate circuit of the radio frequency amplifier tube 3 greatly amplified, and are then impressed on the grid of the combined oscillating and detecting tube 5. The variable condenser 6 is so adjusted as to cause the tube 5 to generate oscillations at, say, a frequency of 560 kilocycles, which is very close to the 600 kilocycle signal oscillations.

However, owing to the fact that the grid and filament of tube 5 are connected across inductance 4, the voltage across these two elements will be the same as the voltage across inductance 4.

Therefore, even if the plate filament circuit of tube 3 is made resonant to the incoming signal, oscillations by means of

the condenser 6, the grid element of the tube 5 will not be robbed of the voltage swings of the signal oscillations in the plate filament-circuit of tube 3 with the result that the detection of the signal oscillations is not interfered with by the tuned coupling between the tubes 3 and 5.

Oscillating currents of a beat frequency of 40 kilocycles will pass through the secondary winding of transformer 7, the high-frequency current oscillations in the plate filament circuit of tube 5 being shunted away from the primary winding of transformer 7 by condenser 3. The tube 9 amplifies the beat frequency oscillation of 40 kilocycles, the amplified oscillations being impressed on the grid-filament circuit of the detector tube 10.

The plate-filament circuit of the detector tube 10 is then traversed by audio-frequency currents which in turn are sufficiently amplified by audio-frequency amplifying tubes 12 and 13.

The sound reproductive device 11 being connected in the plate filament circuit of audio-frequency amplifying tube 13 will consequently be responsive to the audio-frequency currents therein.

o o o o

Multilayer Coils. (No. 243,440.)

Application date: August 27th, 1924.

The above patent awarded to J. W. Combe describes an inductance coil consisting of a plurality of helical layers, all progressing in the same direction, in which, at the end of each layer, the wire is twisted round a pin at the edge thereof, traversed across the layer, and twisted round a second pin at the other edge, the pins being subsequently removed.

A coil complete with plug and socket,

but with part of the covering removed, is shown at (a) in the diagram, together with a coil (b) in the process of winding.

The coil former 1 is mounted on a mandril 2 adapted to receive removable pins 3.

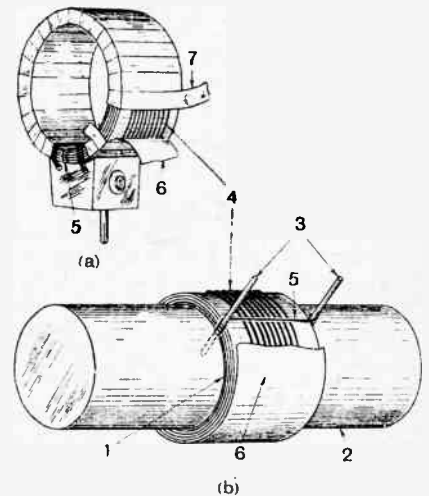

Multilayer coil construction. (No. 243,440.)

The wire is wound in concentric layers 4, each of which is a helix having spaces between consecutive turns.

Each layer is locked and completed at each end by twisting the wire round the pins 3. Between consecutive layers is a traverse 5 of the wire passing from one pin to the other, and the layers are separated by strips 6 of paper.

The pins are then removed and the coil taken off the mandril, bound with tape 7 and mounted with a plug and socket.

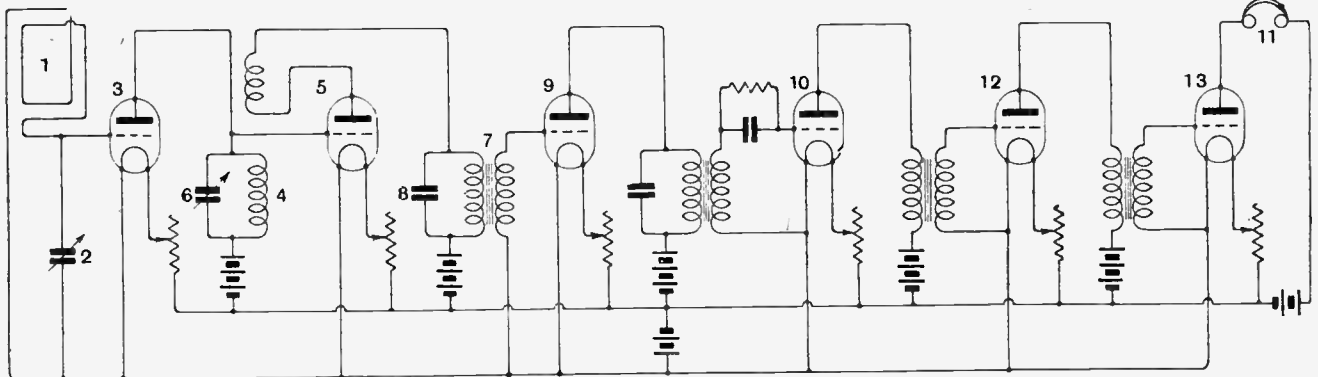

Heterodyne receiver circuit. (No. 234,816.)

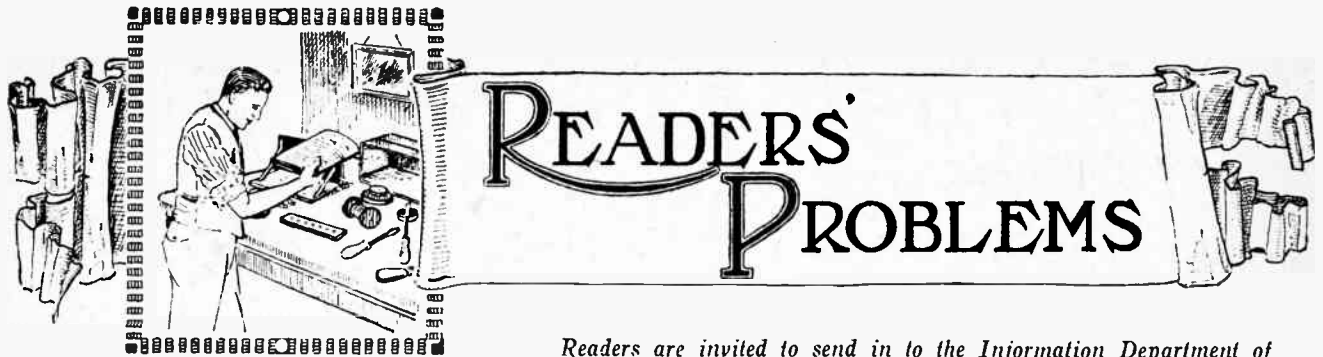

Readers are invited to send in to the Information Department of "The Wireless World" questions relating to their technical difficulties. Every question should be accompanied by a stamped addressed envelope for reply. No charge is made.

An Efficient Portable Receiver.

I wish to construct an efficient portable receiver employing three valves. My main desire is adequate loud-speaker signals, using a frame aerial, from both Daventry and the local station, both of which are near. At the same time, I should like to be able to receive other stations on the telephones.

P. J. L.

Under the circumstances, we think that by far the best arrangement for you to adopt is a regenerative detector and two transformer-coupled low-frequency stages, in accordance with the circuit given in Fig. 1. In order that we may bring in distant stations it is essential that a system of reaction be incorporated which does really give smooth control and

bring about very smooth reaction in conjunction with a frame aerial, without necessitating that any coil be coupled magnetically to the frame aerial, or that the tuning of the frame be upset in any way. This is the method known as tuned plate regeneration which was in almost universal use in American broadcast receivers prior to the advent of the "superhet," and achieved its popularity owing to the smooth control it gave over reaction, and also because, unlike the various systems of magnetic control, alteration of the reaction control calls for no readjustment of the tuning control, the reaction adjustment having little or no effect on tuning. This system of reaction is one which deserves to be more popular than it is among amateurs in this country and is specially suitable for port-

be found that the receiver reaches well above the Daventry wavelength. The frame may well consist of about one dozen turns on a former two feet square, and may, if desired, be arranged to fit in the lid of a suit case. The Daventry loading coil may consist of 200 turns of No. 26 D.S.C. on a 3 inch diameter former, or may be a No. 200 plug-in coil.

With regard to the variometer, this should be of a large type. The low-frequency portion of the receiver is perfectly conventional, and needs no comment. It might be thought that in a portable receiver which is necessarily designed to operate from a frame aerial a stage of H.F. might have been useful. Unfortunately, owing to the low damping of the frame aerial, if H.F. were included it would become necessary to use the neutrodyne system, otherwise the receiver will oscillate uncontrollably. This will, however, limit us in the matter of wavelength, and it will thus not be possible to receive Daventry. In any case the employment of a stage of H.F. is not, as many people seem to think, a *sine qua non* in a portable receiver, and provided that we have a really smooth control over regeneration a very large number of stations can be received with the added advantage of satisfied control and absolute stability. It should not be forgotten that the reaction variometer should in no case be placed in such a position that it is coupled magnetically with the frame, since the principle of reaction used does not depend on magnetic coupling. It depends on the fact that, when the plate circuit is tuned to the same wavelength as the frame circuit, energy is fed back through the inter-electrode capacity of the valve, and so causes a reaction effect, and when the plate circuit is completely in tune oscillation occurs.

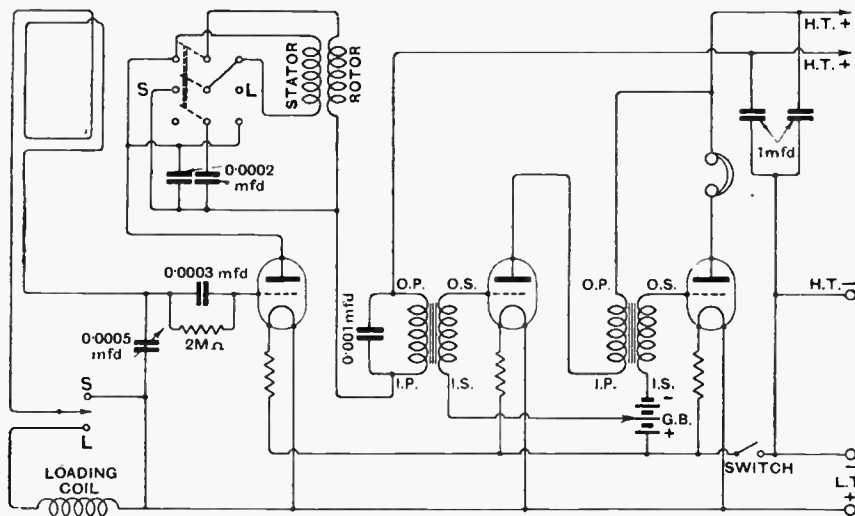

Fig. 1.—Portable receiver with tuned anode control of reaction.

enable the receiver to glide almost imperceptibly rather than to "flop" in and out of oscillation, as is characteristic of the swinging coil method. From all points of view moving coils are undesirable in a portable set. It is not an easy matter to apply reaction to a frame aerial using the more conventional method, but there is fortunately one method which will

able receivers. It will be found that when the plate of the detector valve is tuned to the same wavelength as the frame, oscillation will occur, and a very smooth reaction control can be obtained by rotating the variometer. By means of the switching arrangements on the variometer, and in conjunction with the loading coil on the frame aerial, it will

An Efficient Earth.

I wish to instal an efficient buried earth plate in my garden. Can you indicate to me a suitable method which will be simple to instal and at the same time inexpensive? C. R. L.

There are, of course, many methods adopted by amateurs, consisting in some cases of burying a mass of old wire

Readers' Problems.—

netting, an old biscuit tin, or a large metal plate, the earth wire being in each case soldered to the buried material. Probably, however, one of the best and cheapest methods of obtaining a really efficient buried earth system is to obtain a bucket and perforate it with a number of holes, fill it with coke, and bury it, having first soldered the earth lead in several places to the bucket. It should not be forgotten that the bucket should be thoroughly cleaned at those points where it is soldered to the earth wire. This applies particularly to aged and discarded household implements; probably, however, the purchase of a new bucket will be found well worth the expenditure, since they can be obtained very cheaply—far cheaper, in fact, than most of the earthing devices upon the market. The presence of the coke is for the purpose of attracting and holding moisture, but at the same time it is desirable, in very dry weather, occasionally to pour water over the spot where the earth is buried.

o o o o

Safety in a Thunderstorm.

In view of the approach of the season of lightning and tempest, I desire to equip my wireless installation with the type of earthing switch calculated to give the greatest factor of safety to my house, and should value your suggestions on this matter. I am told that the first essential is to have a switch outside the house.

W. W. J.

On the contrary, it will be found that a switch of any type is not likely to be of very great use in any arrangement designed for earthing the aerial in a manner most likely to give real safety in a lightning storm. In brief, there are two things which it is required to do in order to obtain an adequate factor of safety in the event of the aerial being struck by lightning. In the first place we require to provide a straight path of good conductivity to the earth, this path to be as direct as possible. This path, together with its earth plate, should always be outside the house. In the second place, we wish to remove any semblance of a conductor between the aerial and the receiver, or in other words, to completely disconnect the receiver from the house. We should, when designing lightning safety systems, always bear in mind the fact that lightning will always take a direct path to earth, even leaping across a considerable gap in the conductor in preference to turning corners, and taking its passage to earth by a devious route, even if it be of the best possible conducting material. It is of little use, therefore, to provide any switches or spark gaps on the actual set itself, or merely to remove the aerial and earth wires from the receiver and connect them together. Similarly, it is of very little use to use an earthing switch indoors, where it would be necessary for the lightning to take a right-angled bend to get into the house to the switch, and another right-angled turn to get out again to the earth. In such cases

BOOKS FOR WIRELESS BEGINNERS

Issued in conjunction with "The Wireless World."

- "YOUR FIRST STEPS IN WIRELESS," by HUGH S. FROCK. Price 9d. net. By Post, 11d.
- "WIRELESS TELEPHONY," by R. D. BANGAY. Price 2/6 net. By Post, 2/9.
- "THE WIRELESS TELEPHONE," by P. R. COURSEY B.Sc. Price 2/6 net. By Post, 2/9.
- "CAPT. ECKERSLEY EXPLAINS," by CAPT. P. P. ECKERSLEY. Price 2/- net. By Post, 2/2.
- "UNCLE JACK FROST'S WIRELESS YARNS ON GOOD RECEPTION AND HOW TO GET IT," by CAPT. C. C. J. FROST. Price 2/- net. By Post, 2/2.

Obtainable by post (remittance with order) from
ILIFFE & SONS LIMITED,
Dorset House, Tudor St., London, E.C.4,
or of booksellers and bookstalls.

the lightning will merely flash over outside the house, and a switch in such a position is merely an ornament (?). A switch outside the house is, on the contrary, doing useful service; but is really entirely unnecessary, since an automatic switch, i.e., a spark gap, will deal with the lightning equally as well, whilst not suffering from the defect of requiring that the window be opened and the switch be put at safety every night on closing down. It must not be thought that the actual spark gap will offer any appreciable barrier to the passage of lightning and is fully as "safe" as a closed switch.

It is very necessary, however, that arrangements be made at the point where the lead-in tube enters the earth for disconnecting the receiver entirely from the aerial. Many readers use a knife switch for this purpose. This is, of course,

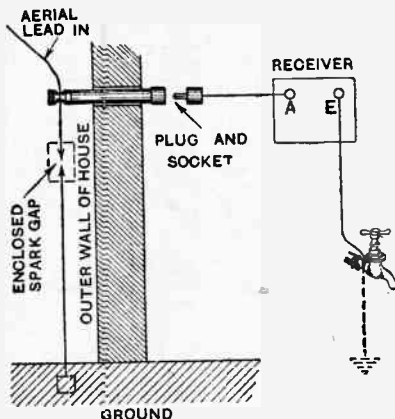

Fig. 2.—Correct connections for lightning safety gap.

quite useless, since when the knife switch is open it merely makes a gap of one inch or so in the lead to the receiver, which the lightning will have no difficulty in leaping. Other readers, equally optimistic, provide a small fuse in this position, which it is intended that the light-

ning shall blow. There is no doubt, of course, about the fuse blowing, but here again a gap of only about one inch will be made, which will not offer much barrier to the high voltage associated with lightning. It is necessary, therefore, to break this circuit completely, providing a gap of several feet, rather than an inch or so, and this is very conveniently done by making use of a plug and socket in accordance with the diagram in Fig. 2, a flexible wire connecting the plug to the aerial terminal of the receiver. This plug and socket need not be mounted on the end of the lead-in tube as shown, but can very conveniently consist of an ordinary electric light wall plug and socket, or any other similar device, mounted close up against the lead-in tube. With regard to the spark gap, it is essential that this be totally enclosed, otherwise the action of the atmosphere will quickly render it corroded and dirty, and although this will not reduce its efficiency as a lightning conductor it will, by providing a leakage path, considerably reduce signal strength. Fortunately, special enclosed spark gaps, designed for mounting outdoors, can be obtained from several reputable firms, such, for instance, as the G.E.C.

It will be noted that a separate earth is used for the receiver. This is highly desirable if maximum safety is to be attained. The earth terminal of the receiver should not be connected to the earth side of the spark gap, as obviously this will mean that after crossing the spark gap the lightning will have two alternative paths, one direct to earth and one along to the receiver via this wire, and though in all probability it will take the former path it is as well to be on the safe side, and earth the receiver either to the water tap or to a separate buried earth, as indicated by the dotted lines in the diagram. The wire connecting between lead-in tube and spark gap, and spark gap and earth, should be as stout and direct as possible. It may be said that the arrangement indicated in the diagram is one of the methods giving the greatest factor of safety in a storm, far better, in fact, than the usual arrangement of switches and fuses adopted by many readers. Furthermore, even if it should have been inadvertently forgotten to remove the plug or if the receiver were actually in use when a sudden and unexpected lightning flash struck the aerial, the chances of the lightning travelling along to the receiver in preference to taking the direct path to earth are really very remote.

o o o o

Function of the Extra Grid in a Four-Electrode Valve.

What is the main function of the extra grid in a four-electrode valve?

D. L. F.

The extra grid in a four-electrode valve is placed between the filament and the normal grid, and is usually connected direct to the H.T. + terminal, its purpose being to reduce the space charge, and so permit of the valve being operated with a comparatively low anode voltage.

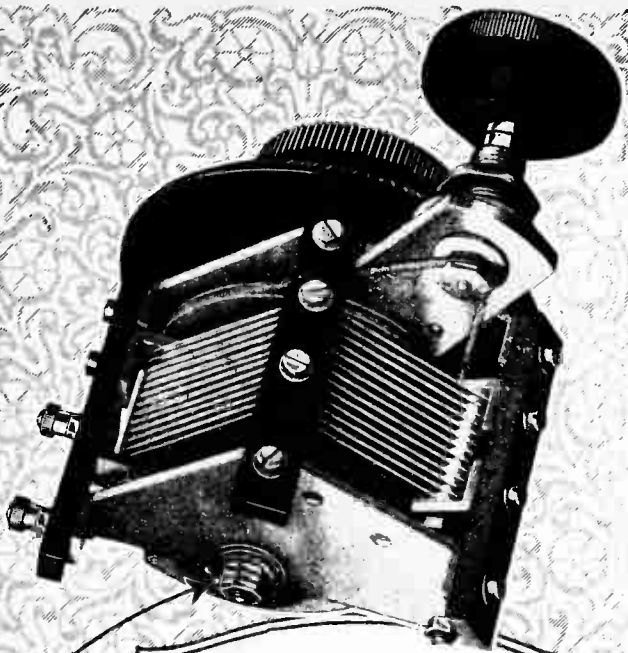

**LOW LOSS
SQUARE LAW
SLOW MOTION**

THE "Cosmos" Condenser is a slow motion condenser with absolutely no backlash either when new or after use. This desirable feature is accomplished by the use of a spring belt held in tension, which permits coarse tuning with the large knob, and a 10-1 slow motion with the small knob.

Cone bearings allow for adjustment and the slow motion bracket can be mounted for remote control as shown in the lower illustration.

The condenser for fine tuning.

METRO-VICK SUPPLIES LTD.

(Proprietors)

Metropolitan-Vickers Elec. Co. Ltd.,
Metro-Vick House, 145 Charing Cross
Road, London, W.C.2.

Prices:

Slow Motion	'00025 mtd.	14/9
"	'0005	15/6
Ordinary	'00025	12/-
"	'0005	13/-

COMPENSATED
SQUARE LAW
EFFECT

LOW LOSS

NO
BACK LASH

ADJUSTABLE
CONE BEARINGS

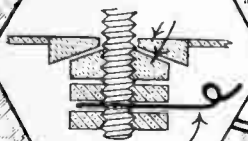

PIGTAIL CONNECTION

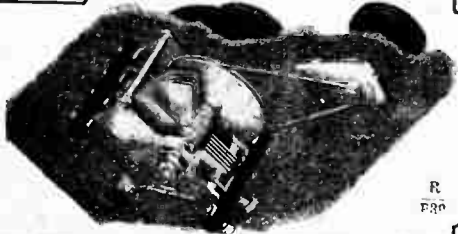

R
E.P.

COSMOS

1ST AND 2ND STAGE

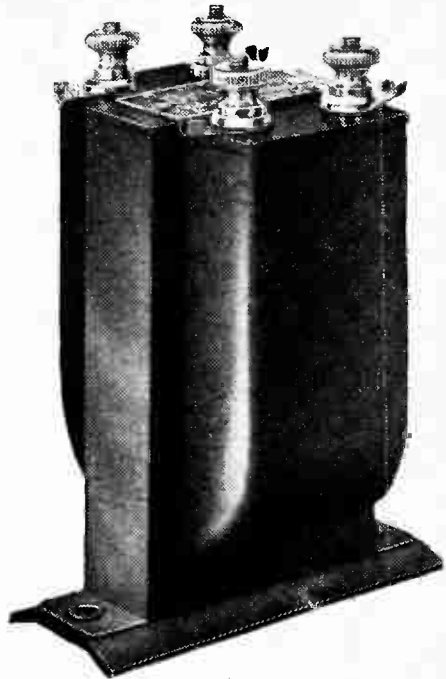

**THE AUDIO
TRANSFORMER**

Are you building? Do you want more power without choking the purity of those smooth, level tones? The Brandes 1st stage Transformer has a high voltage amplification ratio of 1.5. This, together with a straight line amplification curve, means that the amplification is constant over a wide band of frequencies, thus eliminating resonance. The 1.3 Transformer amplifies over speech, pianoforte and harmonic ranges equally well. Mechanically protected and shielded against interaction. Terminals and outside soldering tags.

17/6

Ratio 1.5 (black finish)	Ratio 1.3 (brown finish)
Table-Talker	Bandola
30/-	90/-
	Matched Tone Headphones, 20/-

Brandes

Brandes Limited, 296, Regent St., London, W.1

from any good Dealer.

ASTOUNDING REDUCTIONS IN CLARKE'S "ATLAS"

TUNING COILS AND FIXED CONDENSERS

The House of "Atlas" beg to announce that owing to the enormous sales of Coils and Condensers and consequent reduction in Production costs, they are now able to offer these articles at the following prices:



**ATLAS
COILS**
Patent No.
215,053.



FIXED CONDENSERS

Nos.	Retail Price ea.	Nos.	Retail Price ea.	Capacity	Retail Price
25-50	2/6	500	7/6	.0001-.0005 Mfd.	1/6 each
65	3/-	600	8/6	.001-.002	1/8 "
75-150	3/6	750	10/6	.0025-.004	2/- "
175-300	4/6	1000	12/6	.005-.007	2/6 "
400	5/6	1250	14/-	.01	3/6 "
		1500	15/6		

We are maintaining our Quality in every way, thus enabling us to still adopt our now World-wide Slogan

"We make them good—good judges make them famous."

Sole Manufacturers:

H. CLARKE & CO. (MCR.) LTD.
Atlas Works, Old Trafford, Manchester.



COMPONENTS

SUPER AUDIO CHOKE



PRICE

18/6

BEARD & FITCH LTD.
34, AYLESBURY STREET
LONDON, E.C.1

The Wireless World COUPON and Radio Review for

"HIDDEN ADVT." COMPETITION

This coupon is available until Monday 10 a.m., May 10, 1926

Clue No.	Name of Advertiser.	Page
1		
2		
3		
4		
5		
6		

I enter the above solution subject to the published rules.

Name _____
(Please write clearly)

Address _____

WIRELESS VALVE RECEIVERS & CIRCUITS IN PRINCIPLE AND PRACTICE

By R. D. BANGAY & N. ASHBRIDGE, B.Sc.

THIS BOOK will add to the pleasure of the amateur wireless experimenter by extending his theoretical knowledge of the whys and wherefores of valve receivers.

The subject is treated from a standpoint that will enable the home constructor to understand the working of any circuit which he may evolve, and he thus becomes independent of published diagrams and specifications. The volume is well illustrated.

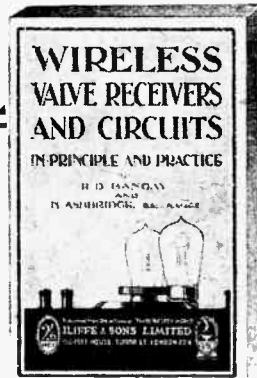

PRICE **2/6**
net
By Post 2/10

Obtainable from all leading booksellers, or direct from the publishers:

ELLIFFE & SONS LTD., Dorset House, Tudor St., London, E.C.4

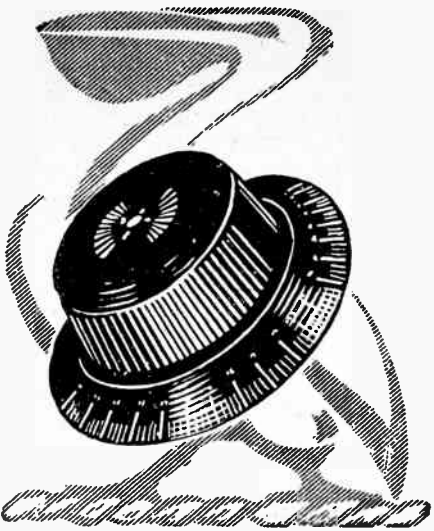

THE PELICAN UNIVERNIER

gives to the set owner that nicety of control which is needed to bring in those elusive stations.

The vernier control is secured through a mechanism which causes the rotation speed of the knob to be no less than twelve times that of the shaft.

The Pelican Univernier fits all sets; you simply replace your condenser dials with the Pelican.

Price 6 - Guaranteed throughout.
Obtainable from all Dealers.

WRITE FOR DETAILS OF THE "PELICAN" SELF-CONTAINED SETS. PRICES FROM £10 to £40 INCLUSIVE OF ROYALTIES.

CAHILL & COMPANY, LTD., 64, Newman Street, LONDON, W.1.

Parra Ad.

Your Loudspeaker

WILL SING

THE PRAISES OF

NELSON MULTI 3-FILAMENT VALVES



Here is a Valve giving you Finest Quality and Volume with Economy. It is of equally high grade as H.F. Detector, L.F., or Power Amplifier.

The little switch places at your command each of 3 Filaments separately, or any 2 in parallel for Power Amplification. Each Filament gives the Valve a New Life.

ALL VALVES are Guaranteed.

FOUR IMPROVED TYPES

- A. 4 to 5 VOLTS, 0.45 AMPS. per Filament - 1/9
- D.E.A. 2½ VOLTS, 0.18 AMPS. per Filament - 15-
- D.E.E. 1.8 to 2 VOLTS, 0.35 AMPS. per Filament - 15-
- D.E.OB. 3 VOLTS, 0.06 AMPS. per Filament - 15-

Obtainable at All London's Largest Stores.

If unable to obtain from your dealer, write direct:—
NELSON ELECTRIC COMPANY LIMITED,
Merton Park, London, S.W.19.

Telegrams: Valven-50, Whible, London.

Phone: Wimbledon 172



Take the speaker into the garden —leave the set indoors.



IGRANIC-PACENT JACKSET

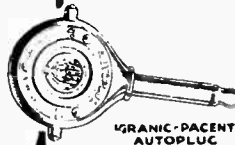

IGRANIC-PACENT AUTOPLUG



IGRANIC-PACENT UNIVERSAL PLUG



IGRANIC-PACENT OPEN CIRCUIT JACK



Exclusive Manufacturing Licensees of Patent Radio Essentials.

149 QUEEN VICTORIA ST., LONDON Works: BEDFORD.

Branches: Birmingham, Bristol, Cardiff, Glasgow, Leeds, Manchester, Newcastle.

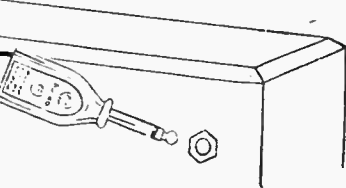

IGRANIC-PACENT UNIVERSAL PLUG

IGRANIC-PACENT UNIVERSAL PLUG

Advertisements for "The Wireless World" are only accepted from firms we believe to be thoroughly reliable.

"Japa" REGD

PLUG & SOCKET TERMINALS ARE THE FINEST TERMINALS IN THE WORLD FOR ALL WIRELESS CONNECTIONS.

BRITISH MADE.

If your Dealer cannot supply send direct to the Manufacturer through the post.

W. J. CHARLESWORTH, 88 & 89, Aston Street, BIRMINGHAM. — Established 1897 —

No bits of bent tin or brass, or screwed composition sleeves to make your connection, but a reliable mechanical article which has been copied by many but equalled by none.

Insist upon the genuine article.

6d. EACH Post free.

Made in Red, Black, Pale Blue, Green, Royal Blue, Amber, Yellow, Brown.

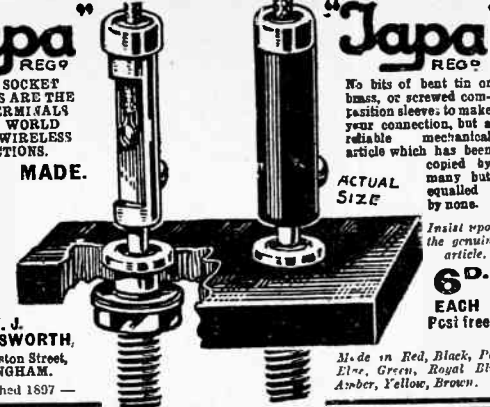

Athol TRADE MARK

For any circuit, any set, anywhere.

Bracket for back-of-panel mounting, 2d. each extra.

VALVE HOLDER

Gives perfect insulation, brass sockets almost entirely air-spaced, minimum capacity effects. One-hole fixing to base board, or above panel; easily mounted below the panel. Complete with soldering tags and fixing bolt.

ATHOL ENGINEERING CO., Seymour Road, Crumpsall, MANCHESTER.

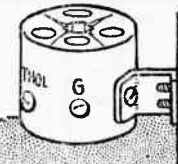

BREMER-TULLY : FOR BETTER TUNING

SHORT-WAVE OUTFITS.

The B-T short-wave outfits answer the requirements of those who wish to cover the full short-wave field. Interchangeable coils, covering 12½ to 25, 25 to 50, 50 to 100, and 100 to 200 metres, using B-T '000125 (type L7) Condensers. Price 41/6.

"LIFETIME" CONDENSERS (Square Law Type).

Designed and built to give the utmost satisfaction. Adjustable bearings, no springs, single hole three-point or combination mounting, pure aluminium plates.

L7-125 M.M.F. '000125, price 22/6
 L11-250 M.M.F. '00025, price 24/-
 L23-500 M.M.F. '0005, price 26/6
 L35-750 M.M.F. '00075, price 34/-

Send for the **Bremer-Tully** booklet "Better Tuning," price 6d., post free.

Fully illustrated 48 pp. list of American Apparatus free and post free on request.



Hamleys Estd 1700
 HAMLEY BROS. LTD.

200-202, Regent Street, London, W.1.

FERRANTI

L.F. TRANSFORMERS

Type AF 3 25/-

A TRADER WRITES :
 "Since using this Transformer the loud-speaker range of our Sets HAS BEEN DOUBLED."

FERRANTI LTD., HOLLINWOOD, LANCASHIRE.



The New **General Radio** ★

BROADCAST RECEIVER

Price £12 or £1 cash and 12 monthly payments of £1 each.

Absolutely complete, including Loud Speaker, Phones, D.E. Valves, Batteries, Lead., Aerial, etc., etc.

GENERAL RADIO COMPANY, LTD., 235, Regent Street, W.1.

Send for FREE Booklet describing this new powerful Loudspeaker Set.



TEN TO ONE HOME CONSTRUCTORS

SIMPLICON

To introduce a New Model of 'Simplicon Condensers' with a 10 to 1 reduction, specially adapted for Home Constructors and portable sets, we are offering these until May 31st at the following prices:

'0003 10/- Post Free.
 '0005 10/6 Post Free.

No backlash in gear or spindle, guaranteed precision finish. Direct from the Manufacturers:

WILLIAMS & MOFFATT LTD., Grange Road, Small Heath, Birmingham



UNDER ALL CONDITIONS

"Goltone"

British Made

Components

**MERIT CONFIDENCE AND
ENSURE MAXIMUM
EFFICIENCY.**

Fully illustrated 40-page Radio Catalogue free on request. "Goltone" Products are stocked by the Leading Radio Stores. Write direct if unobtainable.

TEST YOUR BATTERIES!
"Goltone"

Double Reading RADIO METERS

British Made. 10 Volts and 100 Volts

Insulated body. Perfectly reliable. Accurately calibrated. Side Reading Type. Price 8/6.

Centre Zero Reading Type as illustrated. Patent App. Price 10/6

Strong lined cases 1/6 Full particulars of Patent Mounting Meters on request.

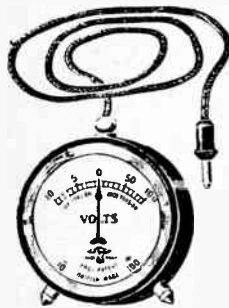

Volume of sound with Purity of Tone are the essentials which have made the "GOLTONE" LOW FREQUENCY TRANSFORMER the choice of Leading Experimenters.

Ratio 2 to 1 and 5 to 1

Price 17/6

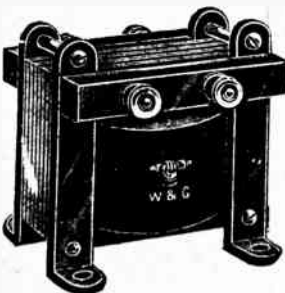

"Goltone" Micrometer Filament Rheostat.

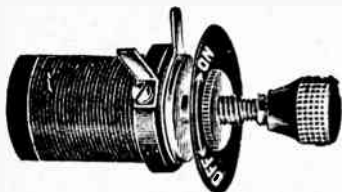

Smooth velvety action. Takes minimum space. Single hole fitting. Complete with Knob and Dial.

6 ohms 2/6 12 ohms 2/9 30 ohms 3/6

"Goltone" FIXED CONDENSERS.



Made from the finest materials and doubly laboratory tested before despatch.

Supplied in all standard capacities. Prices from 1/3 each.

Extract from "Wireless Weekly," Nov. 25th, 1925. "LABORATORY TESTS.—Rate of capacity correct." "Insulation Resistance infinite." "After exposure for two days in damp grass capacity and insulation unaltered." "Mechanically and Electrically sound."



GRAVES
SUPREME VALUE WIRELESS OFFER.

A highly efficient 1-Valve Set, built up entirely of components of undoubted quality and unchallengeable merit, offered at a Keen cut Price, on Easy and straightforward Terms.

SPECIFICATION:

Solid Oak Cabinet Polished Jacobean Finish.

'Utility' Low Loss Condenser (Square Law).

Two-way 'Aermonic' Coil-holder, Low Loss

Igranite Rheostat and 2 Igranite Coils.

'Cosmos' Valve (Metro-Vic) S.P.18 O.E. 2 volt.

General Radio Headphones

60 volt. H.T. Battery.

Exide 2-volt Accumulator.

Ebonite Panel, Post Office Grade A.

Solid Ebonite valve-holder **£6:0:0**

With complete Aerial Outfit & Accessories.

Each instrument incorporates the Marconi Patents in respect of which we pay a full

Royalty fee of 12/6 on every set that is produced

8/6 NOW

TERMS: 8/- now & balance in 14 monthly payments of 8/- if you are entirely satisfied Money refunded if disappointed.

CATALOGUE of Valve & Crystal Sets, &c. Post Free. Keenest Prices.

J. G. Graves Ltd. Sheffield.

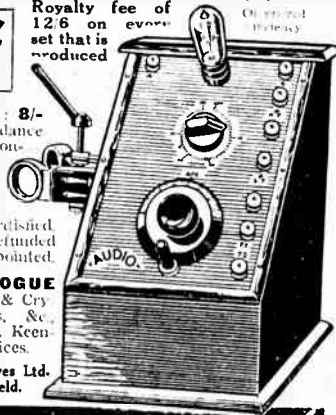

H.T. Accumulators 37/6
60 Volts. 3 Actual Amp.-hour

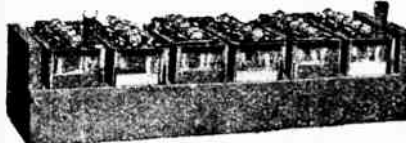

The finest H.T. Accumulator in the world

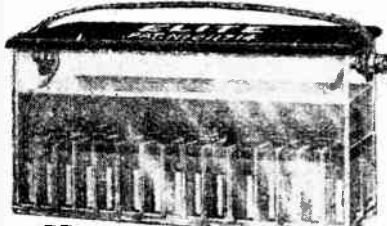

55 -

60-volt, 3-amp.-hour, oil submerged. Will last a lifetime. Write for descriptive folder. **MONEY RETURNED IF NOT SATISFIED.** Obtainable only from **ACCUMULATORS ELITE, 31, Waterhouse St., Halifax.** Trade Supplied. Telephone: 1394.

Lo! Hear the gentle lark

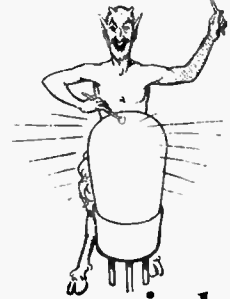

accompanied by the valve

"Accompanied by the piano," the programme said, but "accompanied by the Valve and piano" would be truer of songs heard on many sets. Every time the door shuts or a cart passes, or someone treads heavily, "Ping!" goes the valve and the best notes of your favourite melody are drowned.

But this unwanted accompaniment can very easily be stopped—by floating your valves in Benjamin Clearer Tone Valve Holders.

The extraordinary success of the Benjamin Clearer Tone Valve Holder is due to the fact that it is perfect in every detail. No loophole has been left where vibrations could possibly reach the filament—a fact you can judge for yourself from the accompanying brief descriptions of its construction.

There are terminal connections for the experimenter and soldering tags for the permanent set. The Benjamin Clearer Tone Valve Holder is easily cleaned—little or no dust can collect in the sockets. The springs themselves, as shown in the lower of the two diagrams, form the valve pin sockets. Nosoldering joints—all one solid metal piece from tags to valve leg. No flexible wire connections. The spring supports are not affected by stiff bus bar wiring.



2/9
each.

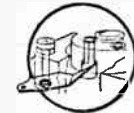

2/9 each

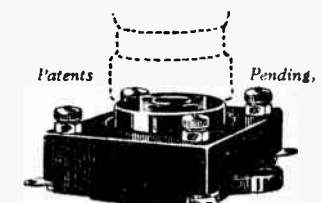

BRITISH BENJAMIN MADE CLEARER TONE VALVE HOLDER (ANTI-MICROPHONIC)

From your Dealer or Direct from THE BENJAMIN ELECTRIC Ltd., Brantwood Works, Tarriff Road, Tottenham, N.17.

The Benjamin Battery Switch gives perfect current control, 2/- each.

MISCELLANEOUS ADVERTISEMENTS.

NOTICES.

THE CHARGE FOR ADVERTISEMENTS in these columns is:

12 words or less, 1/- and 1d. for every additional word, e.g., 18 words 1/6; 24 words, 2/- Name and address must be counted.

SERIES DISCOUNTS are allowed to Trade Advertisers as follows on orders for consecutive insertions, provided a contract is placed in advance, and in the absence of fresh instructions the entire "copy" is repeated from the previous issue: 13 consecutive insertions, 5%; 28 consecutive, 10%; 52 consecutive, 15%.

ADVERTISEMENTS for these columns are accepted up to **FIRST POST ON THURSDAY MORNING** (previous to date of issue) at the Head Offices of "The Wireless World," Dorset House, Tudor Street, London, E.C.4, or on **WEDNESDAY MORNING** at the Branch Offices, 19, Hertford Street, Coventry; Guildhall Buildings, Navigation Street, Birmingham; 199, Deansgate, Manchester.

Advertisements that arrive too late for a particular issue will automatically be inserted in the following issue unless accompanied by instructions to the contrary. All advertisements in this section must be strictly prepaid.

Postal Orders and cheques sent in payment for advertisements should be made payable to ILLIFFE & SONS Ltd., and crossed & Co. Treasury Notes, being untraceable if lost in transit, should not be sent as remittances.

All letters relating to advertisements should quote the number which is printed at the end of each advertisement, and the date of the issue in which it appeared.

The proprietors are not responsible for clerical or printers' errors, although every care is taken to avoid mistakes.

NUMBERED ADDRESSES.

For the convenience of advertisers, letters may be addressed to numbers at "The Wireless World" Office. When this is desired, the sum of 6d. to defray the cost of registration and to cover postage on replies must be added to the advertisement charge, which must include the words Box 000, c/o "The Wireless World." Only the number will appear in the advertisement. All replies should be addressed No. 000, c/o "The Wireless World," Dorset House, Tudor Street, London, E.C.4. Readers who reply to Box No. advertisements are warned against sending remittance through the post except in registered envelopes; in all such cases the use of the Deposit System is recommended, and the envelope should be clearly marked "Deposit Department."

DEPOSIT SYSTEM.

Readers who hesitate to send money to unknown persons may deal in perfect safety by availing themselves of our Deposit System. If the money be deposited with "The Wireless World," both parties are advised of its receipt.

The time allowed for decision is three days, during which time, if the buyer decides not to retain the goods, they must be returned to the sender. If a sale is effected we remit the amount to the seller, but, if not, we return the amount to the depositor. Carriage is paid by the buyer, but in the event of no sale, and subject to there being no different arrangement between buyer and seller, each pays carriage one way. The seller takes the risk of loss or damage in transit, for which we take no responsibility. For all transactions up to £10, a deposit fee of 1/- is charged; on transactions over £10 and under £50, the fee is 2/6; over £50, 5/-. All deposit matters are dealt with at Dorset House, Tudor Street, London, E.C.4, and cheques and money orders should be made payable to Illiffe & Sons Limited.

THE SALE OF HOME-CONSTRUCTED UNLICENSED APPARATUS.

A New Service to our Readers.

We have made an arrangement with the Patentees whereby readers who wish to dispose of a home-constructed receiver not licensed under the patents made use of, can do so by means of the Deposit System referred to above.

The person desiring to sell, in sending us particulars for his advertisement, will in every case make use of a Box No., and should add to the price which he requires the amount of royalty customarily paid by manufacturers, viz. in the case of Marconi Patents the amount should be calculated at 12/6 per valve holder.

If the purchaser is satisfied with his purchase, the sum realised will be forwarded to the seller, less the amount due in respect of royalties, which amount will be paid by "The Wireless World" to the owners of the patents concerned and a certificate will be handed on to the purchaser of the set.

FOR SALE.

WOOD Horns for all speakers and gramophone attachments. There's one for Amplion Junior, ditto goose-neck bases. Lissensola, etc. There's only one best; it's the "All-woodorn."—Manufacturer: H. Maddison, 2A, Ronald's Road, Highbury, N.5. List free. (1914)

For Sale.—Contd.

OSCILLATING Zincite and Contact, 2s. 6d.; simple, original circuit, 1s.; excellent results; other parts stocked.—Ledsham's, 297, King Street, Hammersmith. (1888)

60-VOLT Wet H.T. Batteries, in wood case, no recharging, practically everlasting, Leclanché principle; 19s. 6d., cash on delivery, lists free.—Tennant's Wireless, Hylton Road, Sunderland. (1983)

EXPERIMENTER'S Annual Clearance.—Only best British components for sale, excellent condition. Send stamped addressed envelope for list.—Box 7737, WIRELESS WORLD Office. (2023)

COMplete Burndept Receiving Station, C wavelength range 150 to 6,000 metres, including Burndept Ultra IV. receiver, Mark IV. tuning panel, 8 Burndept coils, S.1 to 300, 2 pairs Sterling headphones, 2 accumulators (6v. Soamp.), Ethovox loud-speaker, aerial complete with switch, 4 Marconi R. valves, 1L.S.3 and 1L.S.5 power valves, any reasonable price accepted, what offers?—The Secretary, Reading Rooms, Rawcliffe, Yorks. (2025)

FIVE-VALVE (2 H.F.) Unit Set, Peto-Scott, given away at £4 15s.; 1-valve Flewelling, £1 15s.; Wates' 2-valve amplifier, £3. Numerous components. Stamp list.—Clark, 47, Daisy Bank Road, Manchester. (2038)

MARCONIPHONE V.2 long-range model, perfect order, enclosed H.T. battery, 2 new D.E.R. valves, all plugs and leads, 4 range blocks, 300 to 500, 1,300 to 2,100; £7.—Morgan, The Lodge, New Ossett, Birmingham. (2063)

VALVES!—Special offer of limited quantity only, 3v. .06 amp, 9s. each; 5v. .25 amp. power, 12s. each. Best make. Fully guaranteed.—F. Leng, 15a, Onslow Gardens, Wallington. (2062)

HAMS Look!—Solenide transmitting inductances, any size, 9d. per turn; low-loss receiving coils, tune 10 to 150 metres, air spaced, 7s. 6d. set; Vibroplex keys, 30s.; transmitters and receivers built to order. Any American apparatus supplied.—F. Walker, Radio Engineer, Crowmarsh, Wallingford. (2061)

ONE set of Magnadyne Super Het Transformers and interchangeable Oscillator, £3 10s.; 4 Igranic coils, 300, 400, 500, 600, £1 5s.—Box 7836, WIRELESS WORLD Office. (2060)

WIRELESS.—Marconiphone V.3 3-valve receiver in mahogany cabinet, 300-3,000 wavelength, with valves, cost £30, sell £15, new condition.—Fitch, London Road, Marks Tey. (2059)

EXPERIMENTER has for sale or exchange surplus apparatus. Wilson H.T. generator, Marconi hand generator, Brown microphone amplifier, 50s. Amplion, Brown H.2 phones, variometers, condensers, etc.—2B.J.O., Bright Street, Harworth, Keighley. (2058)

ESSENTIAL Kit.—Silver Six, including Davenport coils, new, cost £6, accept £4, also 3 .0003 G.E.C. slow-motion condensers, 35s.—113, Harlaxton Drive, Nottingham. (2056)

CROIX Transformers, 3.1 and 5.1, guaranteed genuine, 4s. each, post 4d.—Continental Supplies, 497, Old Ford Road, London, E. (2065)

For Sale.—Contd.

BURNDEPT Ethephone V.4 valve set, complete with all accessories, including Lucas 100 amp. hour accumulator (new) and Ethovox loud-speaker, condition perfect (set can be tested), reasonable offer.—Apply: E. R. T., 7, Lynmouth Road, Reading. (2051)

BBROWN'S Loud-speaker Crystavox, hardly used, perfect condition; £5 10s. or nearest offer.—P. G. C., Moor House, East Hanningfield, Essex. (2050)

POWERFUL 2-stage Radio Frequency Amplifier and Detector (described in March issues), first-class low-loss components; 8 guineas.—Blood, 5, Brynland Avenue, Bristol. (2049)

"TROPADYNE" Super Het Kit (4 Transformers, 1 oscillator coupler), new and unused, cost £8 5s., accept £5 15s.; "Geophone" 2-valve amplifier, less valves, £2 10s.; "Mellovox" loud-speaker, perfect, 35s.—T. B. W., 4, Berkeley Place, Camden Road, Bath. (2048)

GLAMBRELL, 4 valves, experimental set, complete, sacrifice, £15; Super Het parts and other gear.—12, Bideford Mansions, Roseberry Avenue, E.C.1. (2046)

2 R.I. L.F. Transformers, 12s. 6d. each; R.I. Anode reactance, 200-20,000, 10s. 6d.; Igranic coils, 1,500, 750, 600, 400, 2 300, 5s. 6d. each; Ducon, 5s.—67, Lucien Road, London, S.W.17. (2045)

TWO Mullard 0/50 Transmitting Valves New and in perfect condition. £3 17s. 6d. each.—BM/ADHS, London; W.C.1. (2066)

PORTABLES, Ultradynes, etc. Sets or parts. Cash or terms.—Bracey, Factory Square, Streatham. (2067)

WAVEMETER, station tester type, by Paul, 100-3,000 metres, 3-range, switch and crystal; also 2 H.F. ammeters by Johnson & Phillips, Sin. dials, all-ebonite cases, 0-5 and 0-5 amps.; 2 R.I. transformers; 2 Stirling S.L. .0005 Vernier condensers; Ericsson telephone transformers.—Offers to Paddock, Longton, Lancashire. (2068)

JACOBEEAN Oak Wireless Cabinets, direct from makers, 55s. Packed free. Carriage paid. Send for illustration, etc.—Wm. Nurse, Union Street Cabinet Works, King's Lynn. (2069)

FOUR-VALVE Set with valves (D.E.) for side (H.F., detector, 2 L.F.); £17.—Hanley, 18, Cecily Hill, Cirencester. (2070)

EXPERIMENTER'S Surplus.—Lissen re generative reactance, £2; Lissen reactance, 11-way, 10s.; Brown's Microphone Amplifier, 2,000 ohms, input and output, £3 10s. Polar Precision condenser, .0005, 8s.; 2 Lissen Vernier condensers, 7s. each; 4 Burndept broadcast coils, 5s.—Argent, 30, Gilpin Street Peterborough. (2071)

AMATEUR having large collection of valve and components wishes to exchange or sell half-price. List on application.—Kennedy, 28 Scarshale Villas, Kensington, W.8. (2072)

MISCELLANEOUS.

A WIRELESS Doctor.—If your set is giving trouble or you want advice a competent expert will call (anywhere in Great London) and put you right. No result, no charge.—Alexander Black, 2A, Woodvil Grove, N.16. Clissold 3687. (200)

Miscellaneous.—Contd.

LOOK—Why use H.T. Batteries if you have electric light in your homes? Make your own H.T. unit from either A.C. or D.C. —Write for full particulars and diagram, enclosing 1s.: Camberwell Electric Coil Winding Co., 35, Edmund Street, S.E.5. (2043)

PATENT AGENTS.

PATENTS and Trade Marks Obtained.—H. T. P. Gee, Patent Agent, Member R.S.G.B., A.M.I.R.E., 51-52, Chancery Lane, London, W.C.2. Phone: Holborn 1525. (0001)

KING'S PATENT AGENCY, LTD. (B. T. King, Registered Patent Agent, G.B., U.S., and Can.). Free "Advice Handbook" and Consultations. 40 years' references.—146A, Queen Victoria Street, London, E.C.4. (0002)

W. BRYSON, B.Sc., Chartered Patent Agent, 29, Southampton Buildings, W.C.2. Phone: Holborn 672. (2052)

REPAIRS.

TRANSFORMERS rewound to guaranteed efficiency for 12 months, 4s., or exchanged for another, any ratio, 5s.; iron core wire-wound chokes for L.F. amplifiers, 6s.—115, Links Road, Tooting. (0011)

TUITION.

MORSE Learnt Easily in One Hour, anyone, any age, anywhere, with "Simplet" apparatus. Cannot fail. Post free 2s. 6d.—Simplet Co., 44, Bedford Row, W.C.1. (2028)

WANTED.

WANTED.—Special Five or Anglo-American Six Set.—A. Davey, Moorland Road, St. Austell, Cornwall. (1996)

WANTED.—Super Het Kit and 10005 Slow-motion Condenser.—Box 7827, WIRELESS WORLD Office. (2054)

KONE Loud-speaker.—Particulars and lowest price to Dr. Roth, "Crouched Friars," Colchester. (2055)

AGENTS.—"Laker" Steel Masts; liberal A commission; exclusive territory.—Laker, Engineers, Beckenham, Kent. (2024)

GOOD ideas and patents required by responsible London Wireless Accessory Manufacturer who will purchase outright or manufacture under licence. Now preparing for coming season.—Box 7736, WIRELESS WORLD Office. (2018)

AGENCIES.

DUTCH firm, specialising in wireless apparatus and accessories, desires to represent in Holland first-class makers.—Reply for further details to Box R.2450, c/o Dawson's, 118, Cannon Street, London, E.C.4. (2057)

SITUATION VACANT.

CIVIL Service Commission.—Forthcoming Examination. Male Assistant Superintendent of Traffic (Class II.) in the London Telephone Service and Male Assistant Traffic Superintendent in the Provinces, General Post Office (18-23); regulations and particulars are obtainable from The Secretary, Civil Service Commission, Burlington Gardens, London, W.1, together with the form on which application must be made. The latest date for the receipt of application forms is June 2. (1938)

SITUATIONS WANTED.

WIRELESS Engineer, 8 years' experience, England and America, first class, first grade P.M.G., specialist on super heterodynes, desires position as manager or on technical staff; usual references given.—Box 7828, WIRELESS WORLD Office. (2053)

RADIO Engineer, A.M.I.R.E., 13 years' experience, spark arc valve, P.M.G. certificate, desires post responsibility home or abroad; knowledge 5 languages; disengaged September.—Box 7802, WIRELESS WORLD Office. (2047)

BOOKS.

HARMSWORTH'S Wireless Encyclopaedia in 3 bound volumes. Splendid condition. What offers?—Box 7787, WIRELESS WORLD Office. (2044)

FIRST three volumes "Modern Wireless," unbound, what offers.—Write Pullman, 11, Eliot Park, Lewisham. (2064)

TIME & WEATHER BY WIRELESS

By W. G. W. Mitchell, B.Sc., F.R.A.S., F.R.Met.S.

THE first half of the book sets out to explain how time signals are sent and how they may be received with the utmost accuracy. Accuracy is, in fact, the key-note of the time-signal section. The latter part, which is devoted to the weather, will enable the amateur to distinguish the different weather telegrams, and for this he must acquire a knowledge of slow Morse. (Our book, Perry Morse System, 7d. post free, is ideal for this purpose.) Simple diagrams and illustrations show clearly how the apparatus works and how you can fit up similar mechanism for home use. Crown 8vo. 125 pages. 66 diagrams and illustrations.

Price 3/6 net. By post, 3/9.

Obtainable from the Publishers of "The Wireless World" ILIFFE & SONS LTD., Dorset House, Tudor Street, London, E.C.4

W.W.16

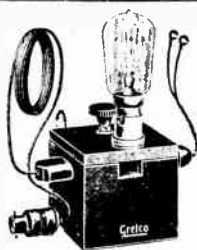

RECTIFIER FOR CHARGING H.T. ACCUMULATORS From Alternating Current Mains.

NO CHEMICALS TROUBLE MESS

State Frequency and Voltage when ordering. Will charge any Battery at from 20 up to 200 millamps. **25/- POST FREE.** Lamp EXTRA. Order direct from:

GRAFTON ELECTRIC CO., 54, Grafton St., W.1

WIRELESS EUNICE CABINETS

are solidly built of best quality wood, finely polished and well finished. Attention is paid to every detail and we guarantee complete satisfaction to every purchaser.

CAN YOU WISH FOR MORE?

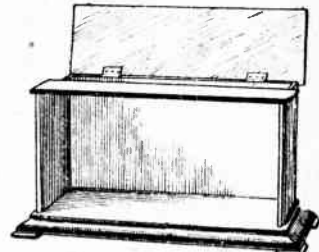

Panel size.	Depth.	Grade A.		Grade B.	
		1" Mah.	1" Oak.	1" Mah.	1" Oak.
12" x 7"	7 1/2"	18 -	16 8	13 -	12 -
16" x 7"	7 1/2"	24 -	21 8	16 8	15 -
21" x 7"	7 1/2"	30 -	26 8	24 -	21 -

Including Baseboard.

If fitted with Frame Panelled Doors, Mahogany 10/-, Oak 7/6 per pair extra.

All "Wireless World" Cabinets supplied at shortest notice. Special sizes and designs at reasonable prices.

Cash with order

Factors and Retailers please send for lists.

EUNICE WIRELESS CABINET WORKS,

8, 16 McCrath Place, Fox on St., London, N.1.

Phone: Clerkenwell 5324.

30% discount for you!

DURING the past 20 years we have supplied the wholesale trade only. We are now supplying direct to the public at prices previously charged to the trade. This means a saving to you of 30%, which in the ordinary way you would pay to your tailor.

LOUNGE SUITS from 3 to 6 GUINEAS

SUITS OVERCOATS and SPORTS WEAR

Fitted by experienced tailors and unconditionally guaranteed as to material, cut and finish. You are invited to call and examine our materials and workmanship.

The City Trade Tailors Assocn
6 LOVE LANE, WOOD ST., CHEAPSIDE, LONDON, E.C.2
Telephone: City 8612

Advertisements for "The Wireless World" are only accepted from firms we believe to be thoroughly reliable.

INDEX TO ADVERTISEMENTS.

Accumulators Elite	13	Ferranti, Ltd.	19	Midland Radiotelephone Manfs., Ltd.	3
Athol Engineering Co.	12	Forma Company	4	"Modern Science"	6
Audion Radio Co.	16	Fuller's United Electric Works, Ltd.	Cover ii	Moorhouse & Co.	16
Beard & Fitch, Ltd.	10	General Radio Co., Ltd.	19	Morser, H., & Co. (Wireless), Ltd.	4
Belling & Lee, Ltd.	5	Grafton Electric Co.	15	Nelson Electric Co., Ltd.	11
Benjamin Elec. Co., Ltd.	13	Graham, Alfred, & Co.	Cover ii	Oliver Pell Control, Ltd.	16
Brandes, Ltd.	9	Graves, J. G., Ltd.	13	Paragon Rubber Co., Ltd.	16
British L.M. Ericsson Mfg. Co., Ltd.	16	Hanley Bros., Ltd.	19	Pickett Bros.	16
Cahill & Co., Ltd.	11	Hough, J. E., Ltd.	13	Pugh's Wireless	16
Caxton Wood Turnery Co.	11	Ignatio Electric Co., Ltd.	11	Radiarc Electrical Co., Ltd.	3
Charlesworth, W. J.	12	Jones, Sydney & Co. (London), Ltd.	16	Radio Devices, Ltd.	16
Christie, James & Sons, Ltd.	16	Lisenin Wireless Co.	7	Radiations, Ltd.	16
City Trade Tailors' Association	15	London Elec. Wire Co. & Smiths, Ltd.	7	Sifam Electrical Inst. Co.	4
Clarke, H., & Co. (Manchester), Ltd.	10	Lustrolux, Ltd.	16	Telephono Manf. Co., Ltd.	5
Cleartron Radio, Ltd.	8	Marconiophone Co., Ltd., The	1	Ward & Goldstone, Ltd.	13
Dixon, Leslie, & Co.	16	McMichael, L., Ltd.	9	Watnal Wireless Co., Ltd., The	7
Dubilier Condenser Co. (1925), Ltd.	Cover iv	Metro-Vick Supplies, Ltd.	9	Wilkins & Wright, Ltd.	7
Ennio Wireless Cabinet Works	15			Williams & Moffatt, Ltd.	12

reproduction
—volume
—clarity

You get all these in Ericsson Super Tone Loudspeakers.

Made by a firm with a generation's experience in telephone research. No distortion. No rattle—just crystal-clear reproduction.

Put one to follow your pet power valve and you'll be amazed.

18" high on wood base. Very mellow and pure. 2400 ohms, 63/- Junior Super Tone for small rooms, 32/6.

Write for lists

The **BRITISH L.M. ERICSSON** Mfg. Co., Ltd., 67/78, Kingsway, London, W.C.2.



63/-

Ericsson

SUPER TONE LOUDSPEAKERS

AERMONIC

ANTI-CAPACITY AIR-SPACE VALVE HOLDER

Capacity and Voltage Leakage Losses cut down to the absolute minimum. Will improve any circuit.

Model "D" Base-Board Mounting 2/6 each.
Model "L" Back of Panel, 2/6 each.

Manufacturers and Distributors for London and South England:
JAMES CHRISTIE & SONS LTD., 246, West St., SHEFFIELD
London Agents: A. P. Bulgin & Co., 10 Curator Street, E.C.4.
Agents—Remainder British Isles
Messrs. V. R. Pleasance, 56, Fargate, Sheffield.



LISENIN

POSITIVE GRIP PLUGS & SOCKETS

Pat. No. 245586.

THERE can be few amateurs who have not been troubled with broken leads, or still hard things about faulty connections. Of the whole set there is probably no part which is so often abused as the connections. "Lisenin" Positive Grip Plugs alleviate this evil. They are designed to take the smallest flex up to 5 m/m cable. Sleeves and indication discs red and black. N. Plated.

PRICE 6^D.

Plug and socket complete, or Spade End Terminal. Obtainable of all dealers. Literal Trade Discount.

Sole Manufacturers and Patenters:—
THE LISENIN WIRELESS CO., 1d, Edgware Road, London, W.2.
Phone: Eaddington 2734.
Tel. Address: "Posgrip, Publ., London."



LUSTROLOX

Economy Valves for Portable Sets.
2v. '06 H.F., L.F., and 234 P.V.
LOUD SPEAKER RESULTS for '46 amps.
The Better British Valve.

Obtainable from Lewis's Ltd., Liverpool & Manchester, & LUSTROLOX LTD., West Rollington, Nr. Macclesfield.



YOU CAN TAKE IT FROM ME!

That our Summer Catalogue contains the finest Radio Bargains ever offered. 600 Illustrations of a wonderful selection of unique apparatus.

Send 4d. stamps.
ELECTRADIX RADIOS,
218, Upper Thames St., London, E.C.4.

CATALOGUE EVERYTHING ELECTRICAL
Electradix Radios
WE SUPPLY THE WORLD
218 UPPER THAMES STREET, LONDON E.C.4



Parrs Ad

VALVES Repaired Quick

Let our valve making plant repair your broken or burnt out valves efficiently & promptly (most makes). Guaranteed equal to new. Bright emitters 5; "D E's" 2 and 3v types; 7/6. Power valves slightly more; see list. No re-pairable—S. P. W. CO. v. 24.

RADION Polishing & Repairs
RADIONS Ltd., Bollington, Nr. Macclesfield, Ches.
Largest valve-repairing firm in the world. List Free.



BALL JOINTED COILHOLDER.

Reaction coil can be moved in ANY direction owing to unique ball joint. Smooth, even, efficient. Finished highly-polished ebonite block & handle, and heavily nickelled parts. Panel or metal board mounting. Post Free 4/8

Moorhouse & Co., 101 Bradford Road, SHIPLEY, Yorks.



HANDBOOKS

There is a handbook for every phase of Wireless. Send a post card for the complete list of books published in conjunction with

"THE WIRELESS WORLD"
Dorset House, Tudor St., London, E.C.4.
w.w.23

PICKETTS CABINETS Model-de-Lux. Polished.

Takes panel	Mahogany	Oak
12 x 9	25/-	20/-
12 x 12	35/-	30/-
12 x 15	40/-	35/-
12 x 18	45/-	40/-

Estimates—Per RETURN POST.
Send for cabinet designs and lists free.

Picketts Cabinet (W.W.) Works, Bexleyheath, S.E.



LOEWE AUDION D.E. VALVES
FOR BEST RESULTS AT LOWER COST!

Will give better results than many at nearly double the price: specially suitable for Super-het. Sets.
L.A. 75 '15 amp. 2 volt, 10/8 if your dealer L.A. 74 '06 amp. 3 volt, 11/8 (cannot supply)
L.A. 101, Power valve. 21/6 (only send p.p.s. to P.S. amp. 4 volt, 21/6) direct to

AUDION RADIO CO.,
52, Dorset Street, LONDON, W.1.



WIRELESS becomes much more interesting when you are able to read Morse. Now is your opportunity to acquire a knowledge of the Morse Code.

PERRY'S AUTO-TIME MORSE SYSTEM,
Price 6d. net. By post 7d., provides a ready means of becoming proficient in Morse reception.

Published from the
Offices of "The Wireless World,"
Dorset House, Tudor Street, London, E.C.4.
w.w.24

TROLITE PANELS

Mahogany Grain 3/6 lb.
Black Engraved wavy 3/9 lb.
Black plain polished 3/- lb.
Machine cut Tested to your own 50,000 Volts. measurements.

Free Samples on Request.
PUGH'S WIRELESS, 95-101, HOLLOWAY ROAD, LONDON, N.7.
ONLY.



BOOKS BY
J. A. Fleming
 M.A., D.Sc., F.R.S., M.I.E.E.,
*published from the offices of
 "The Wireless World"*

Dr. Fleming's name is known all over the world. His books will take their place among the classics of wireless literature. The following volumes are recommended to all who desire authoritative information upon wireless matters, presented in a singularly clear and attractive style.

Electrons, Electric Waves and Wireless Telephony. A brilliantly written treatise on the elementary principles of wireless telephony presented in a non-technical manner.
 Price 7/6 net. Post free 8 -.

The Thermionic Valve & its Development in Radio-Telegraphy and Telephony. A valuable book for all enthusiastic amateurs.
 Price 15 - net. Post free 15/9.

The Wireless Telegraphist's Pocket Book of Notes, Formulae and Calculations.
 Price 9/- net. Post free 9/5.

Fifty Years of Electricity: the Memories of an Electrical Engineer. A comprehensive review of the chief triumphs of electricity during the last half-century.
 Price 30/- net. Post free 30/9.

Obtainable from all leading booksellers or direct from the publishers:

ILIFFE & SONS LIMITED
 Dorset House, Tudor Street
 LONDON, E.C.4

w.w. 21

MODERN 1/- MONTHLY
Incorporating
CONQUEST SCIENCE
 A MAGAZINE OF PROGRESS, INVENTION AND DISCOVERY

"MODERN SCIENCE" is a monthly magazine which records recent advances and discoveries in all departments of science and industry: surveys technical and mechanical developments; and provides a forum for the interchange of information and views on all subjects coming within the scope of the journal.

Among the subjects within the range of "Modern Science" may be mentioned the following: the Physical Sciences, Psychology and Economics, Biology and Natural History, Medical Progress and Public Health, Archaeology and Exploration, Astronomy and Meteorology, Engineering and Industrial Advances, including Power, Fuel and Transport Developments.

It is essentially a magazine for all those who desire to be well-informed regarding contemporary progress.

SUBSCRIPTIONS: 14s. per annum, post free.

From all newsagents and bookstalls or direct from the Publishers:
 ILIFFE & SONS LTD., Dorset House, Tudor St., London, E.C.4.
 w.w.13

A Service that gives Security!

MANY readers naturally hesitate to send money to unknown persons. We have therefore adopted a Deposit System which gives complete security both to buyer and seller. If the money be deposited with "The Wireless World" both parties are advised of its receipt. The time allowed for decision is three days, after which time, if the buyer decides not to retain the goods, they must be returned to the sender. If

a sale is effected we remit the amount to the seller: but, if not, we return it to the depositor.

Full particulars may be found on the Miscellaneous advertisement page at the end of the book.

Use this service for your wireless requirements and avoid all risk! Sell the apparatus you no longer require! Write out your advertisement to-day and send to—

PREPAID ADVT. DEPT. "THE WIRELESS WORLD," DORSET HOUSE, TUDOR ST., LONDON, E.C.4.

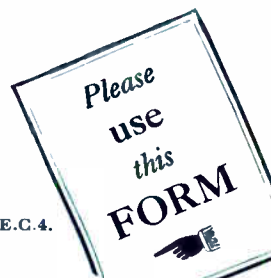

12
 Words
 or
 Less
 1/-

each
 additional
 word
 1d.

Advertiser's name and address must be counted. If a box number is required 6d. extra must be sent for postage on replies.

w.w.39

Advertisements for "The Wireless World" are only accepted from firms we believe to be thoroughly reliable.

ARE YOU A PATIENT MAN ?

£200

IF YOU ARE



"Let's see—five separate units give five capacities, taken singly. Then I can have the first two in series or parallel—total seven. Then the first three all in series or all in parallel—two more. The first and third and second and third in series, total 9. Ditto, in parallel, 11. First and second in series, and in parallel with the third—12 And the total number of different capacities with the five units is ——— ?" What is it ?

*If you get it right,
you win £200!*

Whatever your skill in counting capacities, however, the purchase of a Dubilicon will bring you one sure reward. The Dubilicon gives any capacity up to 0.011 mfd. simply by varying the connections of the eight unit capacities of which it is composed; so that by using the Dubilicon you will be able to select with unfailing certainty the best value of fixed capacity for any desired part of your circuit.

The Dubilicon is a multiple condenser containing eight separate units, the terminals of each unit being brought out to sockets on the lid. By using Clix plugs (made by Messrs. Autoveyors, Ltd., 84, Victoria Street, S.W.1) of which two are given with every Dubilicon, the units can be connected in a variety of series, parallel and combined series parallel arrangements giving a very large number of different capacities.

The uses and advantages of the Dubilicon, which we have summarised above, make it more than worth its low price of 30/-.

In addition, the purchase of a Dubilicon entitles you to enter for the £200 prize competition. All you have to do is to estimate the number of different capacities you can get by connecting up the first five units in various ways.

Ask your dealer about one to day—and mind you enter for the £200 competition! He will tell you all about it!

The Dubilicon

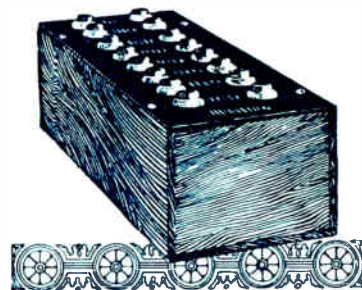

REGISTERED  TRADE MARK

DUBILIER

CONDENSER CO (1925) LTD

ADVERT. OF THE DUBILIER CONDENSER CO. (1925) LTD., DUCON WORKS, VICTORIA ROAD, N. ACTON, W.3. TELEPHONE: CHISWICK 2241-2-3. E.P.S. 153

Printed for the Publishers, ILIFFE & SONS LTD., Dorset House, Tudor Street, London, E.C.4, by The Cornwall Press Ltd., Paris Garden, Stamford Street, London, S.E.1

Colonial and Foreign Agents:
 UNITED STATES—The International News Co., 83-85, Duane Street, New York. FRANCE—W. H. Smith & Son, 248, Rue Rivoli, Paris; Hachette et Cie, Rue Réaumur, Paris.
 BELGIUM—W. H. Smith & Son, 78, Marche aux Herbes, Brussels. INDIA—A. H. Wheeler & Co., Bombay, Allahabad and Calcutta. SOUTH AFRICA—Central News Agency, Ltd.
 AUSTRALIA—Gordon & Gotch, Ltd., Melbourne (Victoria), Sydney (N.S.W.), Brisbane (Queensland), Adelaide (S.A.), Perth (W.A.) and Launceston (Tasmania).
 CANADA—The American News Co., Ltd., Toronto, Winnipeg, Vancouver, Montreal, Ottawa, St. John, Halifax, Hamilton; Gordon & Gotch, Ltd., Toronto; Imperial News Co., Toronto, Montreal, Winnipeg, Vancouver, Victoria. NEW ZEALAND—Gordon & Gotch Ltd., Wellington, Auckland, Christchurch and Dunedin.

The Wireless World

4^D

The Paper for Every Wireless Amateur

Wednesday, May 26th, 1926

DEVELOPMENT AND

RESEARCH DIVISION

AMERICAN TEL. & TEL. CO.
700 BROADWAY, NEW YORK, N. Y.



RANGE with ECONOMY

H.F. Coupling with tuned Intermediate Circuit

ARE YOU A PATIENT MAN ?

£200

IF YOU ARE



"Let's see—five separate units give five capacities, taken singly. Then I can have the first two in series or parallel—total seven. Then the first three all in series or all in parallel—two more. The first and third and second and third in series, total 9. Ditto, in parallel, 11. First and second in series, and in parallel with the third—12 And the total number of different capacities with the five units is ————?" What is it?

*If you get it right,
you win £200!*

Whatever your skill in counting capacities, however, the purchase of a Dubilicon will bring you one sure reward. The Dubilicon gives any capacity up to 0.011 mfd. simply by varying the connections of the eight unit capacities of which it is composed; so that by using the Dubilicon you will be able to select with unfailing certainty the best value of fixed capacity for any desired part of your circuit.

The Dubilicon is a multiple condenser containing eight separate units, the terminals of each unit being brought out to sockets on the lid. By using Clix plugs (made by Messrs. Autoveyors, Ltd., 84, Victoria Street, S.W.1) of which two are given with every Dubilicon, the units can be connected in a variety of series, parallel and combined series parallel arrangements giving a very large number of different capacities.

The uses and advantages of the Dubilicon, which we have summarised above, make it more than worth its low price of 30/-.

In addition, the purchase of a Dubilicon entitles you to enter for the £200 prize competition. All you have to do is to estimate the number of different capacities you can get by connecting up the first five units in various ways.

Ask your dealer about one to-day—and mind you enter for the £200 competition! He will tell you all about it!

*The
Dubilicon*

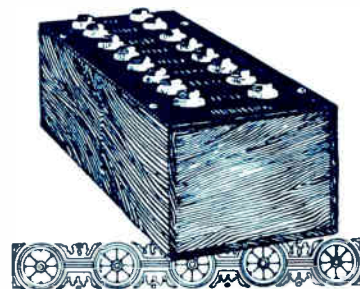

REGISTERED TRADE MARK

DUBILIER

CONDENSER CO (1925) LTD

ADVERT. OF THE DUBILIER CONDENSER CO. (1925) LTD., DUCON WORKS, VICTORIA ROAD, N. ACTON, W.3. TELEPHONE: CHISWICK 2241-2-3. E.P.S. 193

Mention of "The Wireless World," when writing to advertisers, will ensure prompt attention.

**STERLING
"DINKIE"**



"The little fellow with the loud voice." Comfortably loud for the average room, attractively finished in brown **30/-**

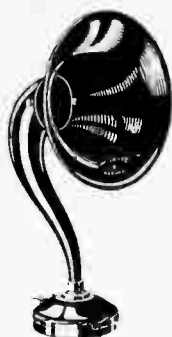

STERLING "BABY"

The best of all junior loud speakers. Ample in volume and perfect in tone. In black enamel or brown tinted finish **50/-**



**STERLING
"AUDIVOX II"**

For home or public use. Unsurpassed for tone fidelity and reproduction. In black enamel finish **90/-**

STERLING Loud Speakers



The STERLING MELLOVOX

The "Mellovox" is the sweetest toned loud-speaker. Faultless reproduction, mellow tone and extremely artistic in appearance. Finished in brown, blue, black or mauve with gold floral diaphragm, adjustable to any required angle. Price **48/-**

THE MARCONIPHONE Co., Ltd.

Sole Agents for Sterling Telephone & Electric Co., Ltd.

Head Office :
210-212 Tottenham Court Road,
LONDON, W.1.

Regd Office :
Marconi House, Strand,
LONDON, W.C.2.

**STERLING
"MELLOVOX"
and
LAMP SHADE
Combination**

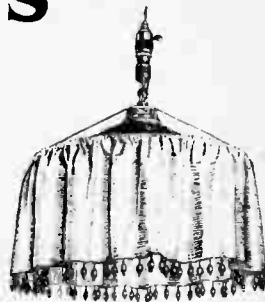

Consisting of the "Mellovox" combined with an adapter, complete with electric light fittings and attractively coloured silk shade. Can be suspended in a few seconds and the adapter plugged into an existing lamp holder. Price complete as shown **84/-**

**STERLING
"MELLOVOX"
(Hanging Type)**

For suspending from a ceiling or other point of vantage.

Price
£2 - 2 - 0



Write for Publication No. 300D containing full particulars and prices of the complete range of Sterling Loud Speakers.

BURNDEPT ACCESSORIES

are a compliment to *any* set

THE range of Burndept Accessories covers the whole sphere of Wireless reception. No matter what type of set you own, there is a Burndept appliance, which will enhance its efficiency.

The high standard of Quality which characterizes Burndept Radio Apparatus and Components, is also the outstanding feature of every Accessory.

Any Burndept dealer will be pleased to show you the complete range and give you advice as to the best means of ensuring perfect reception.

Telephone:
Gerrard 9072

Telegrams:
"Burndept, Westrand,
London."



Head Office: Aldine House, Bedford Street, Strand, W.C.2.

You can charge your batteries in 10 minutes

Yes—10 minutes and thereby dispense with the trouble of sending accumulators to be charged and missing the very part of the programme you wanted to hear.



How is this accomplished?

Well, by simply installing

DARIMONT "HOME-SERVICE" BATTERIES

with Dull Emitter Valves, and obtaining charges in cartons from your dealer.

When the cells have run down you empty the contents and refill with new solutions.

WRITE NOW for descriptive List and Valve Guide to:—

DARIMONT ELECTRIC BATTERIES Ltd.
Darimont Works, Abbey Road, Park Royal, London, N.W.10

Phone: Wembley 2807.

THE ONLY WAY—Scrap your old junk and fit—

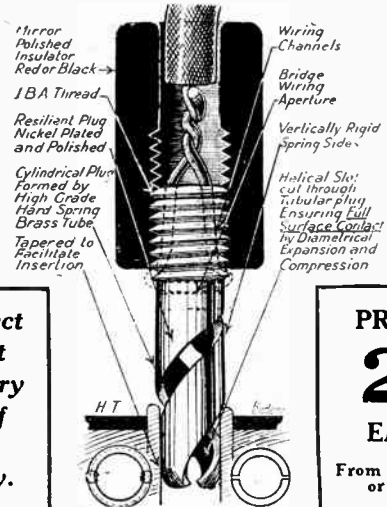

A perfect fitment for every type of H.T. Battery.

PRICE: 2D. EACH

From all traders or direct.

CLIX WANDER-PLUGS

REG^d TRADE MARK PATENTED
(NON-MICROPHONIC)

90% of the efficiency of a soldered joint. For all other connections use CLIX plug sockets and adapters.

From all traders or direct from
AUTOVEYORS LTD., 84 VICTORIA ST., LONDON, S.W.1



(Patent No. 235051)

“Wound on Air”

In this Igranic Variometer an entirely new principle of Variometer design has been evolved, inasmuch as the windings are made self-supporting without the aid of moulded insulation supports, and to all intents and purposes may be said to be wound on air.

This construction results in a Variometer which is extremely efficient and will be welcomed by those who are looking for something better in Variometer design. The self-capacity is very low and the mutual inductance high, thus giving remarkably selective tuning and good signal strength at all frequencies within their ranges.

A paxolin tube surrounds the windings to give mechanical protection and one-hole fixing is provided for.

Made in two types: Type B. for the Broadcasting Wave-lengths, and Type B.L. for Daventry, Radio-Paris, etc.

Type B. 280 to 650 metres. Price 12/6.

Type B.L. 700 to 2400 metres. Price 18/-.

This Variometer is one of the range of Igranic Radio Devices, which includes—“XLLOS” and Honeycomb Duolateral Coils, Variable Condensers, Fixed Condensers, Filament Rheostats, Intervalve Transformers, Variable Grid Leaks, Variometers, Vario Couplers, Coil Holders, Potentiometers, Combined Instruments, Vernier Tuning Devices, Anti-Microphonic Valve-Holders, Stand-off Insulators, Knobs and Dials, Switches, etc. etc. Also the Igranic Supersonic-Heterodyne Receiver Outfit.

All carry the IGRANIC guarantee.

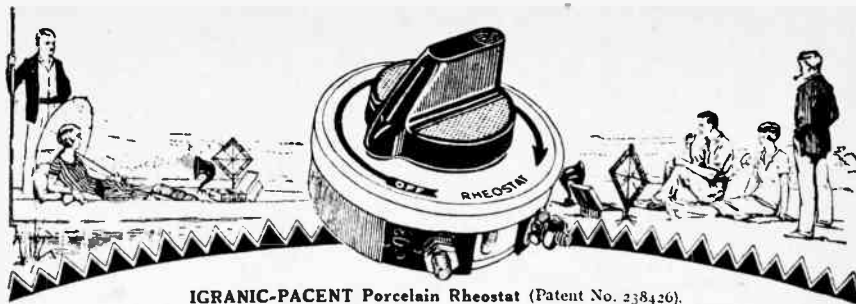

IGRANIC-PACENT Porcelain Rheostat (Patent No. 238426).

The Rheostat for Portable Sets

Why is the Igranic-Pacent Porcelain Rheostat so particularly suitable? The reason is obvious as soon as you examine it. The Igranic-Pacent Rheostat is thoroughly dependable—any amount of rough travelling will not put it out of adjustment.

Users of Igranic-Pacent Rheostats appreciate it as a well-made component, designed to do its job well and to keep on doing it under all sorts and conditions of service. It is compact too—it takes up very little space in a portable set.

Smoothness of control and quiet operation are additional advantages appreciated by users of all types of sets, portable or otherwise. The highly finished Bakelite knob and the attractive dial improve the appearance of any receiver.

Rheostats of 6, 10, 20, 30 and 50 ohms or a Potentiometer of 400 ohms are obtainable, and the price is the same for each—half-a-crown.

Ask your dealer to show you this and all Igranic-Pacent Radio Essentials.

Write for List U.168.



THE IGRANIC Instructional Carton

contains a comprehensive, fully illustrated descriptive handbook, full size general arrangement drawing, wiring diagrams and drilling template for constructing a six-valve Supersonic Heterodyne Receiver, according to the Igranic design. Obtain a copy from your dealer. PRICE 2/6.



Exclusive Manufacturing Licensees of PACENT RADIO ESSENTIALS.

149, QUEEN VICTORIA ST., LONDON.

Works: BEDFORD.

Branches: BIRMINGHAM. BRISTOL. CARDIFF. GLASGOW. LEEDS. MANCHESTER. NEWCASTLE.

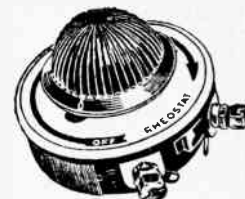

The Igranic-Pacent Rheostat

is also obtainable with Bakelite base, as illustrated above—in the same resistances at 4/- each.

TERMINALS

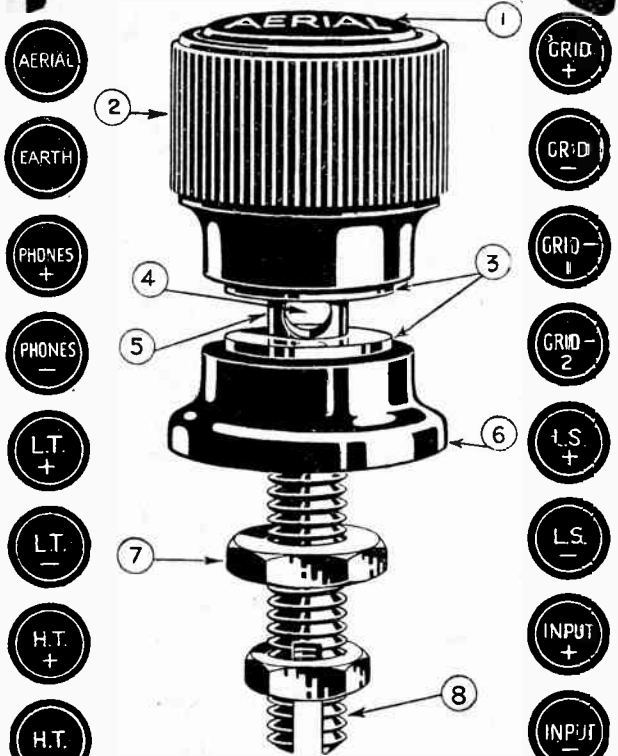

Patent No. 248921.
Registered Design No. 715424.

1. Non-rotating insulated engraved top.
2. Highly finished screw-action Bakelite insulated head.
3. Shielded metal clamping faces.
4. Cross hole for connections, flush with clamping face to avoid shearing of wire when the head is screwed down.
5. Smooth stem, ensuring that strands of connecting wire will not bind up with thread.
6. Highly finished Bakelite insulated collar.
7. Standard 2 B.A. stem with nut.
8. Transverse slot with clamping nut, eliminating soldering.

STANDARD MODEL (Bakelite insulated) (Type B)	POPULAR MODEL (Non-insulated) (Type M)
9d. each.	6d. each.

Ask your dealer for them, but if he cannot supply, send your order to us enclosing his name and address.

Illustrated catalogue free on request.

**BELLING-LEE, Queensway Works,
Ponders End, Middlesex.**

BELLING-LEE

L.P.8.7.

TANTALUM RECTIFIER

(Patent No. 235658).

AMATEURS who wish to construct a Tantalum Rectifier for Wireless or Motor Car Accumulator charging can obtain an envelope containing two strips of Tantalum, complete instructions for use and a licence under the above patent to construct one charger for their own use - - - Price **15/-**

Post free from the Sole British Licensees.

RADIO ACCESSORIES LTD.

9/13, Hythe Road,
WILLESDEN, N. W. 10.

ELECTRONS ELECTRIC WAVES AND WIRELESS TELEPHONY

By Dr. J. A. Fleming, F.R.S.

A course of popular lectures delivered by the author at the Royal Institute of Great Britain forms the basis of this work. By means of simple analogies, Dr Fleming paves the way to a discussion of the elements of electro-magnetism and an explanation of the scientific laws upon which wireless telephony depends.

The whole book is written in a singularly clear and fascinating manner, and all who are anxious to understand wireless cannot do better than read Dr. Fleming's able work. It is an excellent starting point for further studies.

A Guide to
**WIRELESS
LITERATURE**

This booklet, describing all books published in conjunction with "The Wireless World," including some other volumes by Dr. Fleming, will be sent **FREE** on REQUEST.

PRICE **7/6** NET
Post Free 8.-

Obtainable from all leading booksellers or direct from the publishers:

ELLIFF & SONS LIMITED
Dorset House, Tudor St., London, E.C.4

W.W.41.



Don't leave it to Chance

To buy a few components, mount them up and wire them together, may give you a wireless set, but will it give you reception of broadcast programmes just as you would like it?

Some of those components may be square pegs in round holes, not quite "in tune" with the rest of the circuit—transformers especially.

That is why there is such a large sale for the R.I. Multi-Ratio Transformer. It is absolutely at home in any circuit and with any valve; it is made by a firm whose products in the Radio Industry have never been excelled, and those products give you confidence.

Many conflicting statements have been made as to whether the impedance of a transformer should match that of the valve, but it is a fact that, whatever valve you may be using, one of the impedances available in the R.I. Multi-Ratio Transformer will be absolutely suitable.

You need leave nothing to chance; the R.I. Multi Ratio Transformer eliminates all risk of failure.

Price - 27/6

Write for Special Leaflet W.W.

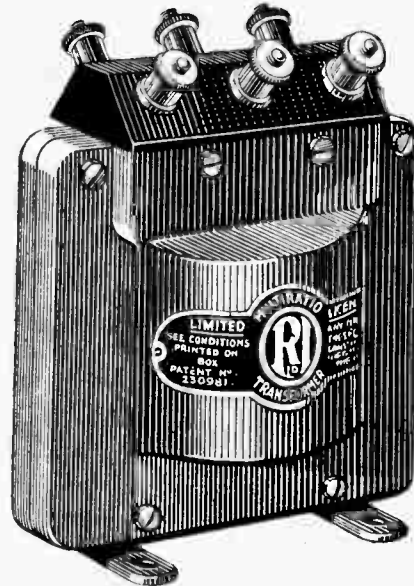

♦ THE MARK OF BETTER RADIO ♦



Adv. R.I. Ltd., 12, Hyde St., New Oxford St., London, W.C.1.

Advertisements for "The Wireless World" are only accepted from firms we believe to be thoroughly reliable.

IT CAN BE DEMONSTRATED THAT FERRANTI L.F. TRANSFORMERS ENHANCE THE VALUE OF ANY SET.

∴ SPECIFY



AF3, 25/-

WHEN YOU BUY A COMPLETE SET AND BUY THEM WHEN YOU BUILD ONE.

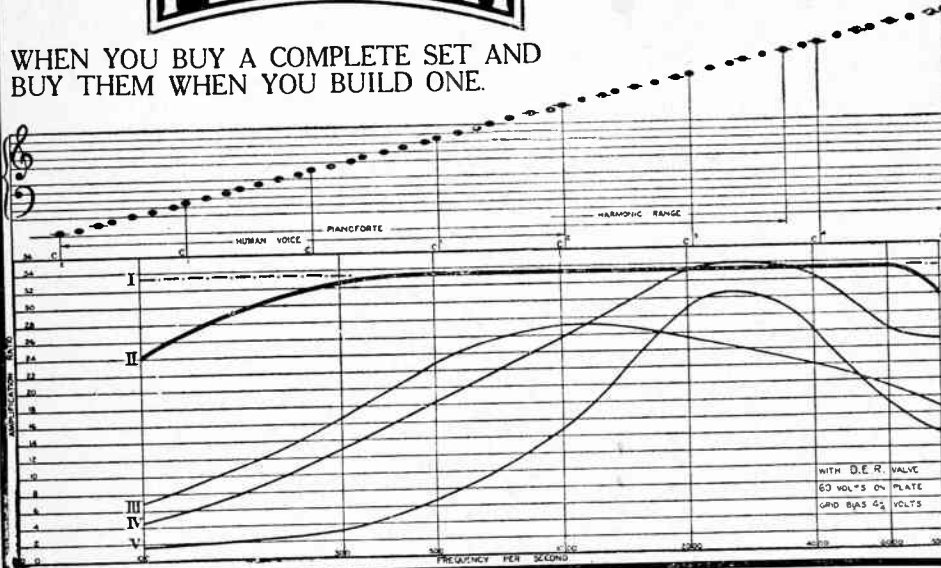

Curve I. Perfection.
Curve II. FERRANTI A.F.3. Very nearly perfect.
No better Transformer is available at any price.
Curves III, IV and V. Other transformers on the market.

Ask your Dealer for Leaflet Wa 401

FERRANTI Ltd.
HOLLINWOOD, ENGLAND.

ELECTRADIX RADIOS SUMMER WIRELESS BARGAIN SALE

SERVICE WAVEMETERS. N.P.L. Standardised Meters, 40/100 special Charts. Government tested meters are best. Celebrated Service 50 metre "Forward," £3; 80/10,000 metres, combined Send and Reception. New, neat and accurate to a fine degree. You need one, £6 10s. Famous Townsend. 120/4,000 Sullivan calibrated. Guaranteed. Our price, £5 10s. each. Broadcast Townsend, £3. A few "Paul's" Wavemeters, 100/3,000 available at £4 10s. 80/2,000 Heterodynes, £4 10s.

PRECISION INSTRUMENTS.—Finest stock in London, 2,000 to select from. Plate 0.5, 0.10 m/a and 0.25 m/a. etc. 22/6. Ammeters or Voltmeters, 5/-; Voltmeters, 6/120, 11/6; 0.30 volts, 10/-; 120 volts, 20/-; 600 volts, 55/-; 0.1,000 volts, £3; 1,500 volts, £4 10s.; 2,500 volts, £6. Suspended Coil Micro-ammeters, 45/-.

RADIO TEST SETS are a necessity. 7 Range Set, in Walnut case, 55/-; Elliott & Ferranti Laboratory. Millivolts to 250 volts. 1/10 Milliampers to 25 amperes, and all between. Half price, £5 10s. See List. 5-Range B8 Tester. 50/- in case with lid; 4-Range A.C. Test sets in case, 45/- All illustrated in Catalogue.

GALVANOMETERS.—Silvertown, 12/6 and 15/-; Reid's Reflect. 21/-; Gambell's Suspension Moving Coil, price £3. Electradix ditto, cost £12, Sale 40/-, 3-Range Milliammeter, 37/6.

G.P.O. 2-RANGE No. 146 TESTERS.—250 m/a and 2.3 volts. Brand new, 7/6 each. Capacity and Insulation Testers in stock, £7 10s. to £12.

RES. BRIDGES.—Paul & Pye .005 to 100 ohms, 40/-; G.P.O. .01 to 10 meg., £7 10s. Galvo Shunts, plug type, 45/-.

GYROSCOPES.—Navy Torpedo in mahogany cases. Beautiful workmanship. For Television experimenters. Cost £25. Price 15/-.

THE GENEROMETER superseded H.T. Batteries. Take your H.T. supply from D.C. Mains. Perfect control 40 to 120 volts for Plate, 30/-. The invention of the year. A.C. with Rectifying Valves, £5. 8-Terminal Rectif. Transformer, 25/-. Complete A.C. to D.C. circuit, £3 10s.

D.C. GENERATORS.—Shunt wound for charging 6.9 volts 8 amperes, ball bearing, enclosed, 50/-, cost £10. Auto Fitted cut-in-out, £3, 50/100 volts, 5 amperes, ditto, £4. 50/70 volts, 10 amperes, £9. 50/70 volt, 25 amperes, £11. 80/100 volts, 30 amperes £12. 220 volts, 12 amperes, £12. 12 volts, 20 amperes, Mackie, £4.

WESTINGHOUSE W.50 Motor Generators off 25 volts or 50 volts to give 350 volts 100 m/a for H.T., totally enclosed, very neat, £4. A.C. 220 volts to D.C. 8 volts 1 a. Motor Generator, 70/-.

AUTO CUT-OUTS.—Compound Lucas 12 volts, 6 amperes, 13/6.

CELL CHARGERS OFF A.C.—220 volts, 50 cycles to D.C. 6 volts, 6 amperes. Fully guaranteed, 70/-.

1,000 VOLT GEARED DRIVE MEGGER
DYNAMOS for H.T. or Testing. Cost £30, sale £3 10s., H.T. 1,200 volts, 80 m/a Mortley Sell exciting M.G., £20; Newton 1,500 volts, 250 m/a, £25; 10,000 volts, 1 kW. Motor Generator sets, £8 10s.; B.T.H., 6,600 volt, £12.

CONDENSERS.—2 mfd., ex-W.D., 2/6. New 1/2 mfd., T.C.C., 3/-; 1 mfd., 3/8; 2 mfd., 4/8; 4 mfd., 6/6; 2 mfd., tested 2,000 volts and guaranteed, 22/6

POWER TRANSFORMERS, 50/-.—H.T. Step-up to 1,000—0—1,000 volts from A.C. 220 volts to 3, 5, or 8 volts, 12/6. Double wound for Receiver H.T., from A.C. mains, for 220 volts, 40, 50, or 60 cycles, two centre tap secondaries for H.T. and L.T., 25/- each.

ELECTRIC HEATERS, best English, 200/250 volts. Toasters, Boilers, Hot-plates at 50 per cent. off list, 7/6 net.

INDUCTANCE BLOCKS or Het. Wavemeters or Super Hets., ebonite, enclosing two basket coils, 4/6.

PRIMS PLEATED PAPER, 2/3; BROWN'S PHONE, 15/-.

H.T. BATTERY BARGAINS.—80 volts, 1 amp. Accumulator in ebonite case, new, 42/6 sale price

Send 4d. Stamps for our new Summer Wireless Catalogue. 590 Illustrations.

3-VALVE No. 138a R.A.F. RECEIVERS.—Very compact. Cost £18. 1 H.F., 1 Det., 1 L.F., 3-valve holders, antipong mounted. Variable Condensers and Rheostats. Fine portable Set in canvas-covered case, with lid, with 3 new dull-emitter .06 valves, 4-volt Accumulator, 60-volt H.T. Battery, H.R. Headphones, etc., complete outfit as above, fitted 2-coil Holder, £5 5s. Packing and Carriage 3/-. See latest catalogue.

4-VALVE RADIO COM. SET FOR £5.—1 H.F., 1 Det. and 2 L.F. with Polar Coil Holder and Coils for B.B.C. and 5XX. In Vert. Pol. Mahog. Cabinet. £5. Carriage 4/-.

5-VALVE R.A.F. RECEIVERS.—2 H.F., 1 Det., 2 L.F. in portable case. Condenser and Valves, H.T. and L.T. Batteries and Headphones. Cost £25. Sale price £6. With D.E. Valves, £6 10s.

SUPERSONIC HETERODYNE SETS.—The cheapest solution is the R.A.F. 7-valve, 600/5,000 metre H.F. Transformers and 3 L.F., with plug switching, beautiful mahogany cabinet. Gets Daventry with no aerial. Your existing 2-valve set coupled to this makes a £35 Het. These R.A.F. Sets cost £40, and are a snip. Described in "Modern Wireless," £5 10s. Packing and carriage, 4/6.

VALVES.—New stock of Low Loss "C" at 6/-; "C.R.", 6/6; D.E.C., 25-amp., 9/-; Microsrix Famous French, .06 valves, 9/-; R.A.F. Rectifying 2-Electrode Power Valves, 8/6 each. American Transmitters, 17/6; 30-watt Short Wave, 25/-; AT40 Cossor 1,000-volt, 30 m/a, 15/- All new.

6-VALVE MARCONI RECEIVING SETS, with 2-valve Telephony Transmitters, Detector, 3 H.F. and 2 L.F. high-grade Intervalve Transformers, Tuning Coils, Condensers, etc. Siemens Telephony Microphone on arm, Mod. Transformer, Choke, 2 Potentiometers, Valve Holders, Weston combined Amp. and Milliammeter 0.6 amp., 0.120 milliamps. Instrument alone is worth £4. We offer the whole of the above, 6-valve Receiver and 2-valve Transmitter, in mahogany case, complete, tested. These sets cost £45. Our price £5; carriage 3/6.

ELECTRADIX RADIOS, 218, UPPER TAMES STREET, LONDON, E.C.4

Parrs Adv.

INTERFERENCE FROM ELECTRIC TRAINS AND TRAMS

All whose reception is spoiled through electrical discharges from train and tram services, etc., should profit through reading these letters.



THE BRETWOOD AUTO-AUDIO FREQUENCY AMPLIFIER

PRICE 20/- Guaranteed for three years. PRICE 20/-

Money refunded if not satisfied after a week's trial.

OBTAINABLE FROM MOST DEALERS, OR FROM THE SOLE MANUFACTURERS:

BRETWOOD, LTD.,
12-18, London Mews, Maple Street, London, W.1.

W. Stuart Clark, Esq., Balham, S.W.

12 18, London Mews, Maple Street, London, W.1.
March 26, 1926.

Re Interference from Electric Trains.
We have read your letter published in *The Wireless World* issue of March 24, and believing that our Amplifiers will assist you to overcome the interference complained of, we are sending you three which we suggest you use to replace those in your present set.

We shall greatly appreciate your reporting to us the results of these tests.

Yours faithfully,
BRETWOOD LIMITED,
Balham, S.W. April 10, 1926.

DEAR SIR,

Interference from Electric Trains.

Since the publication in *The Wireless World* on March 24 of my letter under the above heading, I have been able to conduct a series of interesting experiments with Bretwood Auto Frequency Amplifiers. The purity of amplification when 2LF stages are used is wonderful, and the silence of the "background," owing to successful elimination of atmospheric and "mush," is remarkable.

Yours faithfully,
(Signed) W. STUART CLARK,
Balham, London, S.W. April 28, 1926.

Messrs. Bretwood, Ltd.

DEAR SIR,

Interference from Electric Trains.

The publication of your letter in *The Wireless World* of to-day's date (on page 629) prompts me to write you again. I have this week experimented with a four-turn 2ft. frame aerial using a series aerial tuning coil to which the customary reaction is applied.

Following this with two L.F. stages coupled by Bretwood Auto Audio Amplifiers moderate loud-speaker signals were obtained without the slightest interference from the electric trains. A third stage was necessary for heavy loud-speaker work, but signals remained pure in tone.

Yours faithfully,
(Signed) W. STUART CLARK,
Exeter. April, 1926.

Messrs. Bretwood, Ltd.

SIR,

I have now given a pair of your Auto Audio Frequency Amplifiers a trial, and you may be interested to hear the result.

In the first place I tried them to cut out train noises; now if many B.C.L.'s were troubled to the same extent that I am in this direction, wireless would soon be dead.

I can say that in 99 cases your new Amplifier would clean out all ordinary power line and tram noises, and in the odd case, as in mine, will reduce interference by 80 per cent. In the place of a long tearing grind that I used to get all the time there was current in O.H. wires, the little noise I now get is hardly noticeable, and then only when a tram is within a few yards from the house. On that point I think your claims most fair.

The greatest surprise was to hear for the first time from any wireless set real music; I took out of my set two of the finest iron core Transformers made, and tried a pair of your new Amplifiers, and the difference was wonderful.

Yours faithfully,
(Signed) CHAS. L. WOOD,
Hull. March 22, 1926.

Messrs. Bretwood, Ltd., London.

DEAR SIR,

It is with the greatest pleasure I write this evening respecting two of your "Auto Audio Frequency Amplifiers" which I have installed in a four-valve set designed to give loud-speaker results of a great many stations.

The results obtained are far beyond expectations, and I am quite convinced that no method of amplification yet constructed can equal such volume and purity.

I have tested them separately in combination with five well-known makes of Low Frequency Transformers, also with one R. Capacity Unit, with the result that your Amplifiers stand alone for the class of reproduction we all wish to attain.

(Signed) THOMAS BUNDELL.

Parrs Ad.

ARE YOU USING

MELLOWTONE



Regd. Design.

COUPLERS?

YOU SHOULD BE—you will obtain far better results by doing so and also SAVE MONEY!

"MELLOWTONE" Couplers are specially designed to avoid distortion in telephony reception, they give excellent selectivity and perfectly smooth reaction control.

They plug into standard valve holders, take up small panel space, have small external field and high coupling ratio.

Obtainable from all reputable dealers. Write for Illustrated List of this and other Mellowtone Specialities—and if interested in QUALITY Receivers, ask for Catalogue of Mellowtone Two and Four Valve Sets.

AERIAL AND REACTION	
25	5/6
35 (B.B.C.)	5/6
50	5/6
75	5/6
Daventry	7/6
TUNED ANODE AND REACTION	
250-650	5/6
650-1650	7/6
1500-3000	10/6
(Daventry)	

REPLACE
COILS AND
HOLDERS
AT LESS
THAN HALF
THE COST

LONDON DEPOT: "MELLOWTONE,"
TRIUMPH HOUSE, 189, REGENT STREET, W.1.
Telephone: Regent 1660.

MELLOWTONE
MIDLAND RADIOTELEPHONE MFRS LTD.
BRETTELL LANE WORKS
STOURBRIDGE

Radia-Ads.

ANOTHER CLEARTRON PRODUCT

Rotor and Stator die-cast in one piece, affording results hitherto unattainable

Condensers :
 .0002 13 9
 .0003 14 3
 .0005 14,9

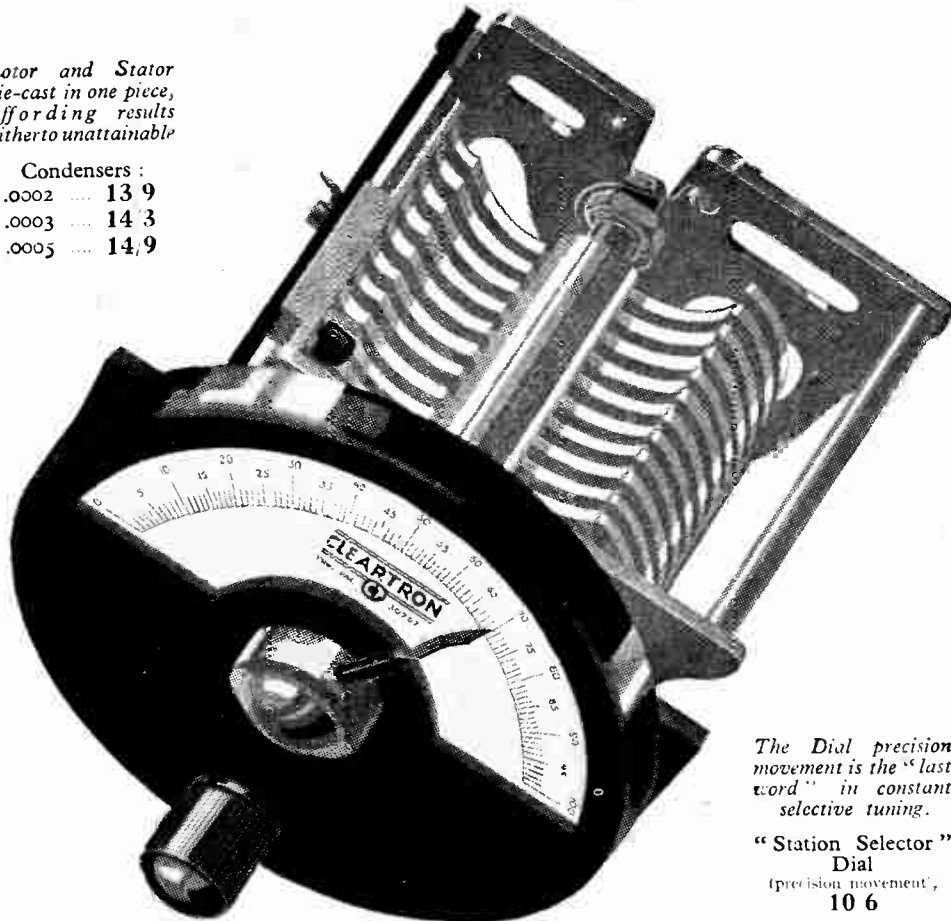

The Dial precision movement is the "last word" in constant selective tuning.

"Station Selector"
 Dial
 (precision movement),
 10 6

THE DI-KAST CONDENSER

A distinct innovation in Condenser design. Avoids the contact resistance losses experienced with separately assembled condensers. Rotor and Stator are die-cast in one, which means positive connection and perfectly matched characteristics. The specially designed vanes provide straight line reading, greater range, easy short wave

tuning and very low minimum capacity. Another feature of unusual interest is the MICRO STATION SELECTOR, a newly designed dial precision movement, allowing completely selective tuning and ten or more different adjustments between each degree. Play and back-lash entirely eliminated.

Send for complete explanatory leaflet to:

CLEARTRON RADIO LIMITED

ONE, CHARING CROSS, LONDON. (Works: BIRMINGHAM)
 Regent 2231/2. Cleartron, Westrand, London.

Cleartron: Radio Valves, Standard prices, 12/6 and 15/-



48/577 A.

The Wireless World

AND
RADIO REVIEW
(14th Year of Publication)

No. 352.

WEDNESDAY, MAY 26TH, 1926.

VOL. XVIII. No. 19.

Assistant Editor:
F. H. HAYNES.

Editor:
HUGH S. POCOCK.

Assistant Editor:
W. JAMES.

Editorial Offices: 139-40, FLEET STREET, LONDON, E.C.4

Telephone: City 4011 (3 lines).

Advertising and Publishing Offices: DORSET HOUSE, TUDOR STREET, LONDON, E.C.4.

Telephone: City 2847 (13 lines).

Telegrams: "Ethaworld, Fleet, London."

COVENTRY: Hertford Street.

BIRMINGHAM: Guildhall Buildings, Navigation Street.

MANCHESTER: 199, Deansgate.

Telegrams: "Cyclist Coventry."
Telephone: 10 Coventry.

Telegrams: "Anlopress, Birmingham."
Telephone: 2970 and 2971 Midland.

Telegrams: "Hiffe, Manchester."
Telephone: 8970 and 8971 City.

Subscription Rates: Home, £1 1s. 8d.; Canada, £1 1s. 8d.; other countries abroad, £1 3s. 10d. per annum.

As many of the circuits and apparatus described in these pages are covered by patents, readers are advised, before making use of them, to satisfy themselves that they would not be infringing patents.

IMPORTANCE OF BROADCASTING.

OUR last issue of *The Wireless World*, dated May 5th, was delayed in publication owing to the industrial crisis from which this country has just emerged. In that issue we commented editorially on the position of broadcasting in this country in relation to the newspaper Press, and we emphasised the fact that sooner or later the present artificial regulations limiting the use of broadcasting for announcing news and reporting topical events must ultimately break down when the possibilities of broadcasting as a means of disseminating news became more widely realised by the public, and we urged that the daily Press should recognise now the importance of broadcasting as an auxiliary means of conveying news rather than vainly endeavour to stave off the inevitable, fearing that the extended use of broadcasting for this purpose would injure the interests of the Press.

Little did we think, at the time that editorial was written, that within a day or two the significance of broadcasting would be made so evident, and its utility as a means of distributing essential news to the community made so unmistakably apparent. During the industrial crisis we had the opportunity of realising that broadcasting, under certain circumstances, was not merely an auxiliary service or an adjunct to the Press, but might well become the sole means for the rapid distribution of information. At the time of writing no information is available to indicate to what extent the indispensability of wireless was recognised by the public, and how far the stocks of

wireless apparatus were able to meet the increased demand for wireless receiving equipment, but there is little doubt that a very large number of people turned to wireless during those eventful days who hitherto had viewed it as little more than a toy.

We hope that this experience will have served to bring home to the public how important a service broadcasting really is, and that, with this appreciation firmly established, the Press of this country will adopt a more reasonable attitude towards the extension of facilities for the broadcasting of news, so that some arrangement satisfactory to both the Press and the broadcasting authorities may be made whereby, without encroaching unduly on the present privileges of the Press, broadcasting may be given the opportunity of fulfilling its functions adequately and providing general intelligence on topical matters with that promptness for which broadcasting is so eminently suited.

We urge that the Wireless League and all associations concerned in the interests of the listener, as well as individuals who have influence, should work together to attain this object in the interests of the community.

It would be truly regrettable if the lesson which we have learned should be forgotten, and that broadcasting should continue to be fettered in the way which it has been in the past, because interests of one section of an industry might be adversely affected to a very limited extent through the extension of facilities to broadcasting. Nothing should be allowed to interfere with progress where such progress is of benefit to the community.

CONTENTS.

	PAGE
EDITORIAL VIEWS	685
PICTURE TRANSMISSION BY THE RANGER SYSTEM	686
THREE-VALVE LONG RANGE RECEIVER	689
By W. James.	
HINTS AND TIPS FOR NEW READERS	693
INTERVALVE TRANSFORMERS	695
By R. L. Smith Rose.	
CURRENT TOPICS	699
COUPLING L.F. VALVES	701
By N. P. Vincer-Minter.	
REGENERATIVE VARIOMETER RECEIVER	705
By W. K. Alford.	
PIONEERS OF WIRELESS.	15.-
ALEXANDER GRAHAM BELL	707
By Ellison Hawks.	
BUYERS' GUIDE TO COMPONENT PARTS	709
CLUB REPORTS AND TOPICS	712
BROADCAST BREVITIES	713
WIRELESS CIRCUITS IN THEORY AND PRACTICE	715
By S. O. Pearson.	
THE DARIHONT CELL	718
LETTERS TO THE EDITOR	719
READERS' PROBLEMS	721

PICTURE TRANSMISSION

by the

RANGER SYSTEM



A commercial picture transmission service is now in operation between the Marconi wireless stations on both sides of the Atlantic. The system is reliable, and the pictures, either in the form of line drawings or photographs, have reached a high standard of perfection.

The image for transmission is in the form of a transparency, and is traversed by a pencil of light falling upon a photo-electric cell. Varying currents from the cell control the wireless transmitter. At the recorder an inked stylus traverses the paper in synchrony with the analysis of the picture at the transmitter.



Captain Ranger at the recording set installed in Radio House, London

THE steady development which has been moving towards the setting up of a picture transmission service operating over immense distances has reached maturity during the past weeks. A commercial picture transmission service has been inaugurated by the Marconi Company, and pictures for transatlantic transmission are accepted at the offices of the company both in London and New York. It is interesting to observe that the first picture transmission service between Europe and America has been accomplished by wireless, and that it has been left to a wireless concern to create a system which marks a gain in the fight for supremacy between cable and wireless communication.

The development of the system is due to Capt. R. H. Ranger, of the Radio Corporation of America. His apparatus first came before the public when, in the 1925 manoeuvres of the United States Army, photographs were transmitted over a distance of 5,136 miles from Honolulu to New York, an experiment conducted at the request of the United States War Department, which regards the wire and wireless transmission of pictures as a forthcoming military factor of first importance. It must be realised that wireless-transmitted messages can always be intercepted and deciphered, rendering wireless communication in cipher of very doubtful utility and likely to constitute a danger rather than an aid in times of war. In picture transmission is to be found the solution to the difficulty of obtaining secrecy, for the success of the system depends upon absolute synchronisation between the transmitting and receiving equipments.

Preparing the Picture for Transmission.

Two distinct methods have been applied for analysing the picture in the process of transmission. One arrangement consists of producing an image as a non-conducting deposit upon a metal foil which is traversed by a stylus causing interruptions in a current applied between the plate and the stylus, while the other method makes use of an opaque image deposited upon a transparent film which is traversed by a beam of light, the light



Dear Professor, -
 J. Mackin Day
 The congregation sends its
 love to you. Your message
 will be found and long
 in the Saviour!! I expect
 to write you in a day
 or two.
 Affectionately,
 J. M. D.

The degree of perfection reached by the system is shown in this line drawing and a letter in manuscript. The dots appearing on the white part of the paper are produced by atmospherics.

Picture Transmission by the Ranger System—

interruptions being recorded by a light sensitive cell.

Picture Analysis.

It is the latter method which is made use of in the Ranger system. The image is photographically recorded upon a celluloid sheet large enough to easily accommodate a picture of half-plate size. In the case of sketches and written messages the image for transmission is made directly by writing upon a piece of transparent film with a dense black ink. The image is then secured to the face of the glass cylinder, and, by means of a lamp, focussing lens, and reflecting prism, a narrow pencil of light is passed through the film. The cylinder is mounted on a carrier which is caused to move backwards and forwards so that the beam of light is concentrated in turn on all parts of the picture. As well as the traversing movement, a rotary action is applied, the cylinder being given a slight rotation when it completes each traverse movement.

Dual Transmitter.

An ingenious arrangement is introduced here to permit of the simultaneous transmission of two pictures. The cylinders are duplicated, though they are propelled and rotated by a mechanism which is common to both. When

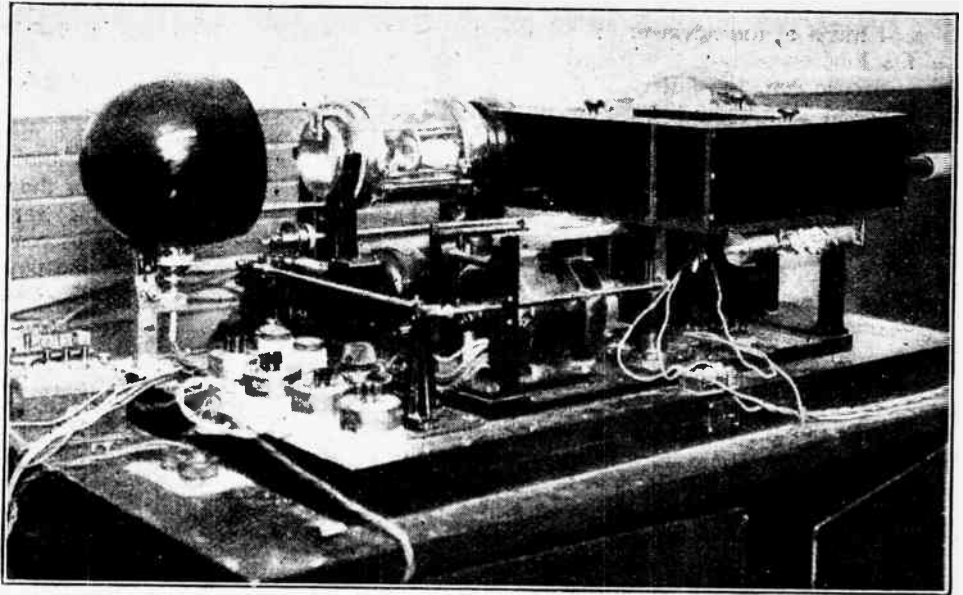

The transmitter at Radio House.

the carrier is travelling in one direction the beam of light passing through one of the cylinders is passed on to the photoelectric cell, whilst when the movement is reversed a small reflecting mirror is interposed in the path of the beam to pick up the light which is traversing the second cylinder. The mechanism for effecting this consists of a small oscillating mirror, which in one position cuts off the light from one of the cylinders and reflects from the other, whilst when turned through 45° the path of the light coming from one of the images is left unobstructed, while the other beam is reflected back. The reflecting mirror rocks by a simple action depending on the direc-

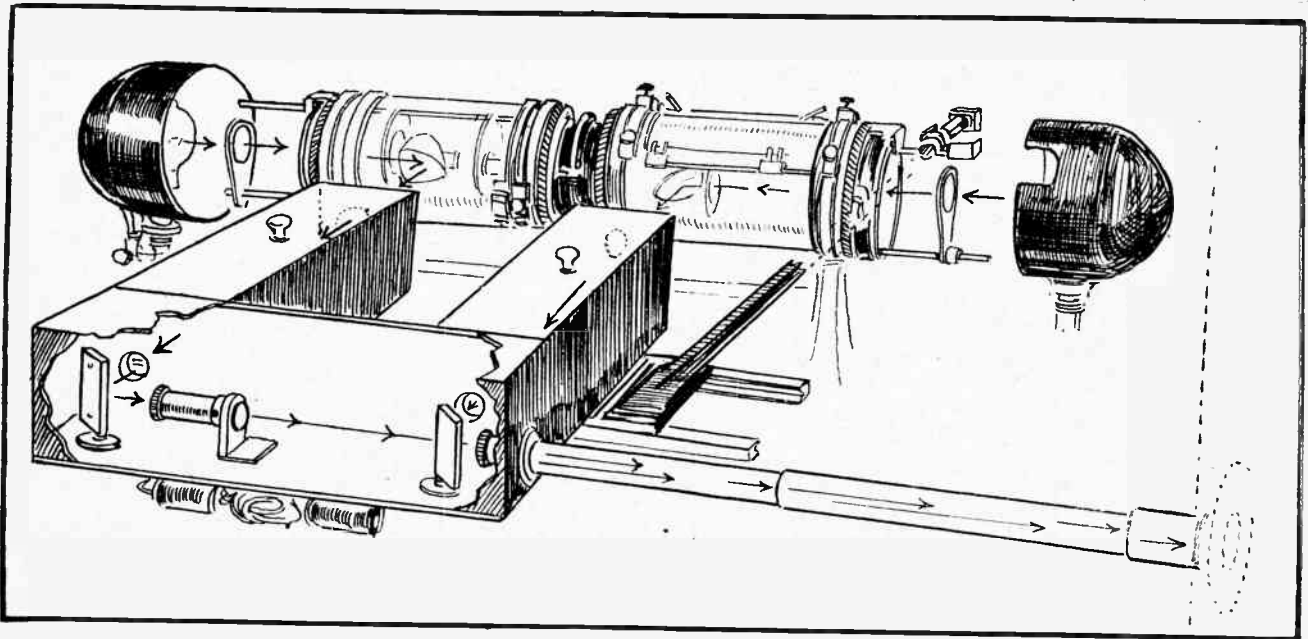

A pencil of light traverses the picture which is attached to the glass drum and is analysed by a slow rotating action as well as a backwards and forwards movement of the carrier. Two pictures may be transmitted at a time, a reflecting mirror diverting the path of the light at each movement of the carrier.

Picture Transmission by the Ranger System—

tion of travel of the carriage. A telescopic joint is made in the tube connecting the traversing carriage with the photoelectric cell, the latter, of course, being stationary and housed in a light tight chamber with its auxiliary amplifying apparatus.

Photoelectric Cell.

The photoelectric cell used in this instance has been developed by the General Electric Company of America. The inside of a spherical globe is coated with a light sensitive substance, which in this case is potassium hydroxide, the coating being connected to the grid of a valve, whilst an "electron collector" near the centre of the tube is joined to the plate of the first amplifier. When no light is falling on to the deposit on the inner surface of the globe, the grid acquires a negative charge stopping the flow of electrons between filament and plate, and hence no current will flow in the external circuit. The ray of light, however, causes an electron stream to flow between the coating and the collector, and since the coating is connected to the grid the electron flow constitutes a discharged circuit, so that the grid becomes less negative. The first amplifying valve is a direct current potentiometer coupled.

The grid and plate connections of the amplifier are connected across a condenser, which becomes discharged with the fall in the grid to plate resistance of the valve brought about by grid potential fluctuations. A charging circuit is connected to the condenser and is controlled by a valve the grid circuit of which operates by variations of the potential across the condenser. The charging current is fed through the plate circuit of this valve, in which a relay is connected which, working through other mechanical relays in cascade, controls the wireless transmitter.

Recording.

Wave trains from the transmitting station after detection and amplification are applied to the picture recorder. The recording mechanism, in order that it may be sensitive to exceedingly small currents, comprises a small moving coil in a magnetic field created by three electromagnets. The coil of wire, in moving in the field, as

the received fluctuating currents are applied through its winding, operates a stylus while travelling across the surface of the paper.

To prevent smearing, an ink consisting of coloured wax is employed. The ink is carried to the point of the stylus by means of a piece of wick which is enclosed in a heater coil to maintain the wax in a good condition. The stylus traverses the paper in perfect synchrony with the carriage of the transmitter, the paper being lifted each time the stylus completes a forward and backward movement across the paper. Synchronisation is effected by the tuning fork method, which controls the speed of

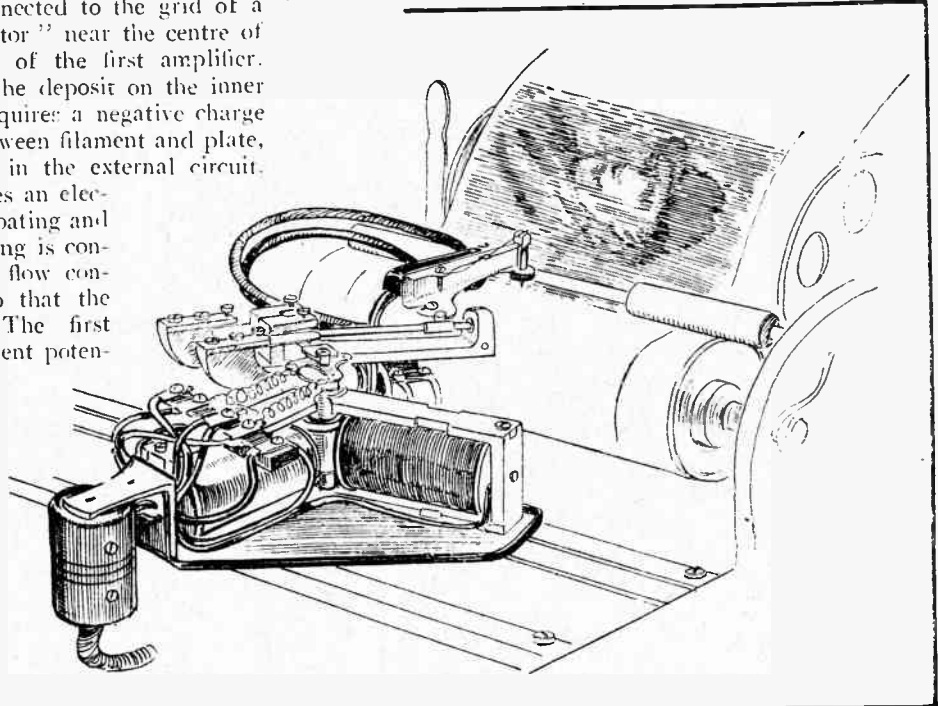

The recording mechanism of the receiver. Three electromagnets produce the magnetic field in which a moving coil controls the stylus. Like the transmitter, the receiving equipment is built in duplicate.

the electric driving motors. A small flashing neon lamp attached to end of the motor shaft is used to indicate the correct speed adjustment. Like the transmitter, the receiving apparatus is duplicated and the received current is switched between the two recorders, which are linked together on a common carrier, each time the direction of travel is changed. The stylus traces a line of varying density upon the paper, at times making a full black line, and at others leaving the paper white. The spacing of the lines brought about by the rate of revolution of the cylinder is 128 to the inch, which is sufficiently close to produce an image of good definition.

Owing to the General Strike, it was impossible for us to publish issues of THE WIRELESS WORLD for May 12th and May 19th. The strike now being over, publication will be continued as usual.

LONG RANGE THREE-VALVE RECEIVER.

Neutrodyne H.F. Coupling
with High Efficiency Coils.

We describe in the following article a three-valve receiver for 200-600 metres of remarkable efficiency, which we believe the beginner will have no difficulty in making up. One stage of H.F. is used, followed by a coupled circuit. Litz conductor is employed for the coils, which have a resistance, at 400 metres, of less than 2.3 ohms, making them without doubt the most efficient coils ever used in a broadcast receiver described in a wireless journal.

THERE are stories going the rounds just now to the effect that certain recent discoveries and improvements in design will enable us all to make our receivers non-radiating. These stories are not, we think, to be taken seriously, and our only excuse for mentioning the matter here is that we do not wish a new reader to think that the receiver illustrated and described below belongs to the class referred to. We have not suddenly made any remarkable discoveries; old readers will probably remember the number of receivers of the non-radiating type (generally called "Neutrodyne" receivers, although the word Neutrodyne is a trade name) which have been described from time to time in this paper. A five-valve Neutrodyne receiver, the first to be described in this country—it was also probably the first Neutrodyne receiver for broadcast reception made here—was built by the writer early in 1923, and full constructional details were given in *The Wireless World* for December 19th, 1923. This first five-valve Neutrodyne receiver, used with the valves available at that time (they were "R" type valves), was sensitive and selective, and, when properly set up according to the instructions given, would not generate oscillations. That was described three years ago, and since that time we have given constructional details of about fifteen others having from one to three high-frequency stages, the usual valve detector, and one or two stages of low-frequency magnification

Earlier Neutrodyne Receivers.

Anyone sufficiently interested in the subject of high-frequency amplification would find it instructive to spend an hour or two looking over these designs; he would notice the gradual changes which have taken place in the design of the high-frequency couplings, the modifications in the actual layout of parts, the improvement in the construction of the components used, and, probably, the gradual development of a more or less exact method of design will become evident. For it cannot be denied that, good as they were at the time and marking definite steps forward as they do, the earliest receivers of the type we are discussing were, shall we say, of an experimental nature

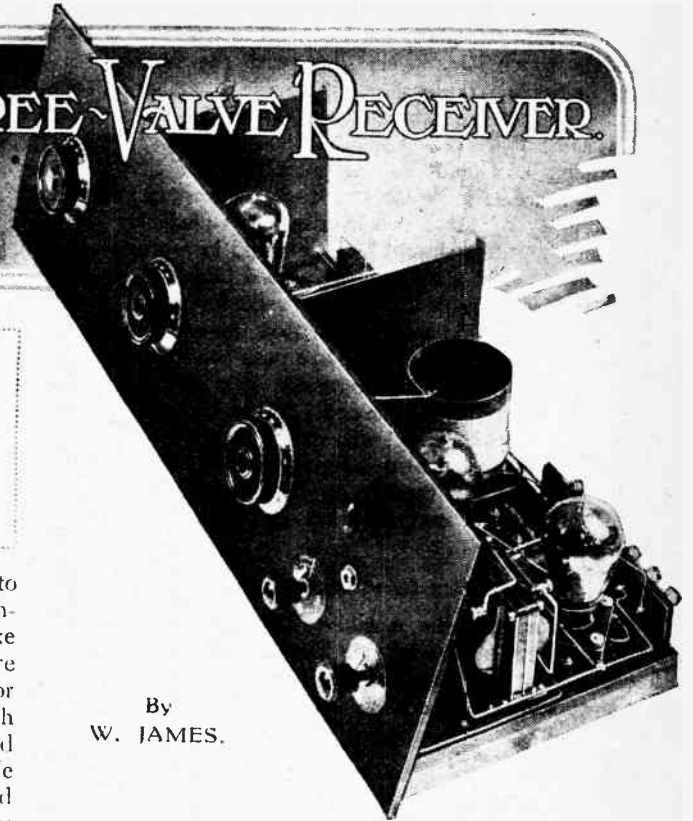

By
W. JAMES.

—rather crude affairs, in the light of present-day practice. They worked splendidly, but sometimes success only came after many trials.

But now these sets can be designed with exactness. When one is built it can be connected up, and a dozen or more stations tuned in on the loud-speaker in the first half-hour of its life.

Theory and Practice.

The closeness with which the practical results compare with those predicted is largely—in fact, almost entirely—a matter of how far we are prepared to go to make the receiver theoretically perfect. Take the case of the balancing or neutralising condenser. Only a few days ago it was said at a meeting of wireless people, many of them experts, that "you break one side of the filament circuit of the high-frequency valve, balance the stage by adjusting the receiver for minimum signal in the phones, restore the valve, and . . . the stage oscillates." We remain firm believers in this simple and admittedly old-fashioned method of adjusting the circuit, however. It is simply a matter of right design. The function of the balancing condenser is to balance out or to neutralise the capacity of the grid and plate of the valve, and it will perform this function exactly, provided the circuit is properly designed. Too often this poor little condenser is expected to balance out magnetic couplings between coils, capacitive couplings due to the proximity of coils and tuning condensers, conductive couplings due to the presence of resistance in the connecting wires and batteries, and generally to hold the receiver stable over a wide range of wavelengths regardless of the fact that

Long Range Three-valve Receiver.—

it was never intended to compensate for these stray couplings which, moreover, vary with the tuning.

The balancing condenser will provide a perfect balance, provided it has the same nature as the condenser to be neutralised, that the magnetic coupling between the neutralising coil and the plate coil (in a transformer stage) is extremely tight, and that the capacity due to the proximity of these two windings is sufficiently small. All other couplings should be eliminated in a proper way; for instance, coils should be so placed and screened that there is a negligible stray magnetic coupling, tuning condensers should be screened to stop the variable capacitive coupling between them, bye-pass condensers should be employed, and, where necessary, grid and plate connecting wires should be screened. When these things have been done, the receiver will more nearly resemble a balanced stage as drawn on paper, and, provided the design is faithfully copied, the beginner cannot fail to secure satisfactory magnification and selectivity without oscillation.

Litz Conductor Used.

Turning now to the receiver illustrated here, our aim was to produce a set with one high-frequency stage, valve detector, and one low-frequency magnifier which would give approximately the same results as the ordinary type

gauge copper wire. Each strand has a covering of single silk, and the cable has an outer covering of double silk. This wire was specially made up for us by the London Electric Wire Co., Ltd., and it is not very expensive. It can be obtained by anyone, and it should preferably be ordered in a length instead of by weight.

Electrical Properties of the Coils.

The first coils were wound with ebonite tube formers, but it was found that the resistance of the circuit comprising the coil, tuning condenser, connecting wires and detector valve at 400 metres was 3.4 ohms, as compared with 2.9 ohms when an identical coil, but wound on a Paxolin former, was used. The ebonite was, obviously, leaking a little, although it was of good quality, but the effect of the leakage was sufficient to increase the resistance of the circuit by 0.5 ohm. This effect is more pronounced the lower the resistance of the coil, and would be negligible with a coil having a resistance of about 5 or more ohms. Incidentally, it should be noticed that when truly low resistance coils are used, the insulation resistance of parts like condensers and valve holders should be extremely high, otherwise the effect of connecting them across the coil is to throw an appreciable load on the circuit, an effect which would be negligible with coils of higher resistance.

The use of low-loss coils introduces, then, fresh difficulties which, luckily, can usually be avoided with a little care.

The final coils as used in the receiver therefore have Litz secondaries of 55 turns, the Paxolin² tubes being 3in. in diameter, 3½in. long, with a wall 1/16in. thick: as the turns are wound touching the winding length is only about 2½in.

It was found that the resistance of a tuned circuit consisting of the coil, tuning condenser, and valve rapidly increased at the

shorter waves, the actual resistance values for the circuit being as follow:—

Wavelength of Circuit.	Effective Resistance of Circuit.
550 metres	2.0 ohms
500 ..	2.2 ..
450 ..	2.5 ..
400 ..	2.9 ..
350 ..	3.8 ..
300 ..	4.8 ..
250 ..	6.3 ..
200 ..	8.0 ..

This could have been avoided by a slight change in the coil constants if it were necessary to prevent the somewhat rapid rise in resistance at the higher frequencies, but, as a matter of fact, the coil was deliberately made as described because of certain advantages which accrue

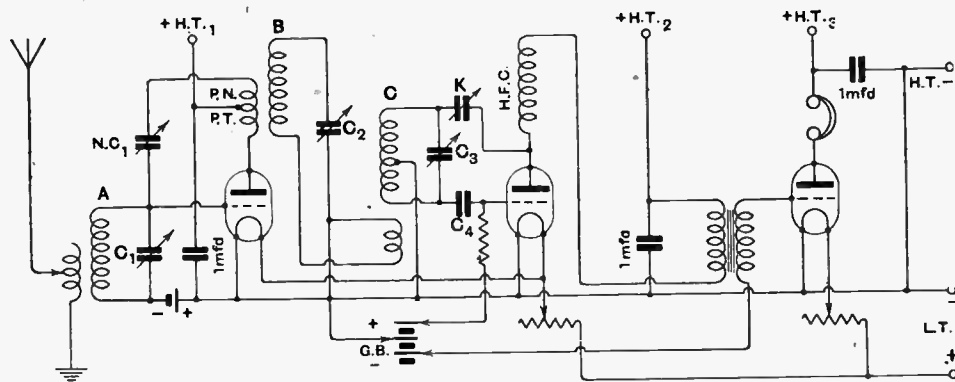

Fig. 1.—The circuit diagram. N.C.1 is the balancing condenser, and K the reaction condenser.

of Neutrodyne receiver, having a further stage of high-frequency magnification. We have, we think, successfully done this, and in doing it the whole field of high-frequency amplification at broadcast wavelengths was explored.

It was decided first that the secondary windings of the transformers should have an inductance of about 200 microhenries, and be tuned with 0.0005 mfd. variable condensers. This gives a working wavelength range of 200-600 metres. Coils were made up and their high-frequency resistance measured over this wave range, the object being to find a relatively compact coil with a low average resistance. The final coils are wound on Paxolin tubes, 3in. in diameter, and the windings have fifty-five turns of Litz,¹ there being twenty-seven strands of No. 42

¹Litz is quite easy to work with. The strands, having a covering of single silk, are easily cleaned and soldered together at the ends, but care should be taken not to break off any strands.

² Paxolin tubes are obtainable to order from the Micanite and Insulators Co., Ltd., Empire Works, Blackhorse Lane, Walthamstow.

Long Range Three-valve Receiver.—

when the coil is used as the secondary of a tuned transformer. A good deal of the increase is also due to the resistance of the tuning condenser.

In Fig. 1 the three coils which we have been discussing are shown tuned by 0.0005 mfd. condensers, and are marked A, B, and C.

Coil A is the secondary winding of the input transformer of the set, the primary being tapped and connected to the aerial and earth. The primary is tapped to enable selectivity and volume readily to be varied.

ample negative bias, and where the signal strength is practically the same as when the detector is connected across the whole coil.

Not that the detector circuit should be considered by itself; it should not be for the transformer winding P.T. connected in the plate circuit of the amplifying valve has to be proportioned, for the best results, according to the total effective resistance of its secondary circuit. Now, although we have the primary winding in the anode circuit of the amplifying valve coupled to the secondary winding B, this coil B is, in turn, coupled by

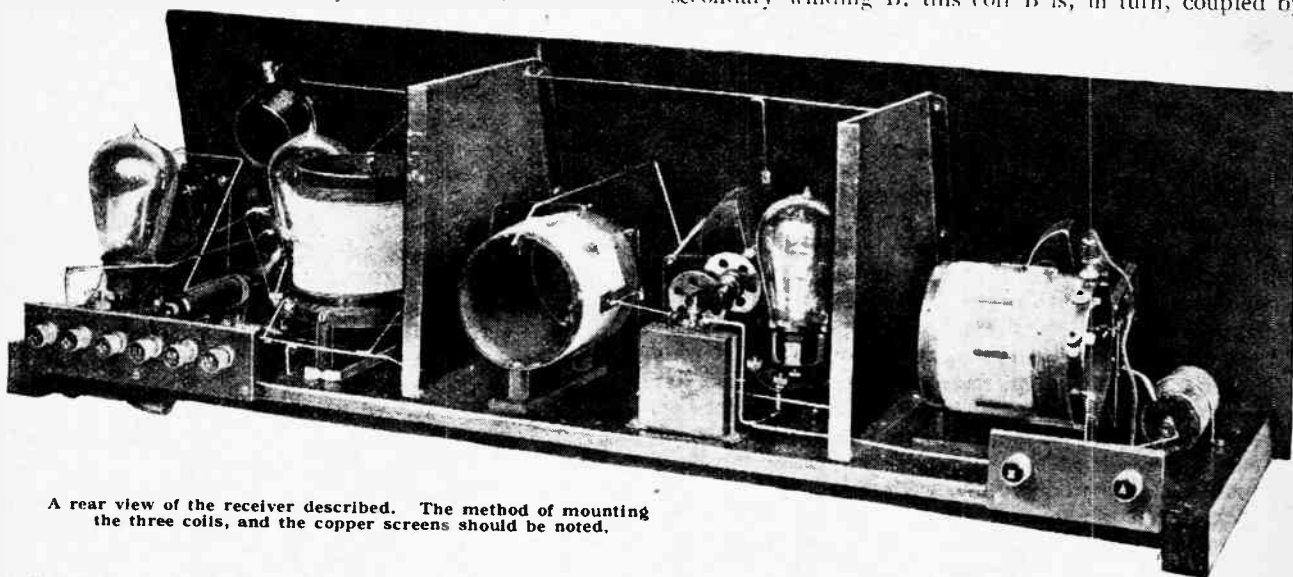

A rear view of the receiver described. The method of mounting the three coils, and the copper screens should be noted.

Coil B is the secondary of a transformer whose primary winding (P.T) is joined to the plate of the high-frequency valve. The third coil, C, is coupled to coil B by a few turns of wire, and its ends are connected to the detector valve. This coil, C, also has a tap which is joined to the filament; hence the detector is across part of the coil only, and the effect of the relatively low grid-filament resistance in impairing selectivity and signal strength is minimised. If the grid circuit of the detector is connected across the outer ends of the coil, the effective resistance of the circuit is very considerably increased. But as less and less of the coil is connected to the grid-filament of the detector, so the effect of the detector in raising the apparent resistance of the circuit becomes smaller and smaller. By varying the amount of the coil connected to the detector a point can be found where the selectivity is not much worse than that which obtains when the detector is used as an anode rectifier with

a few turns to coil C; hence the primary winding should be so proportioned and arranged relative to coil B that the loading due to coil C and the detector is allowed for. That is to say, the complete coupling between the high-frequency and detector valves should be considered as a whole, and the primary winding be so proportioned that it gives maximum amplification.

Important Considerations.

The magnification obtained due to pure radio frequency amplification—that is, when there is no reaction effect—depends on a number of things. It depends, for instance, on the inductance of the primary and secondary windings, their coupling, their losses, the capacity of the two windings, the wavelength, and the properties of the valve. The various values can all be measured.

A good thing to start with is the valve; the valve chosen for use in the high-frequency stage is of the 5-volt.

MATERIALS REQUIRED.

- 1 Ebonite panel, 30in. × 9in. × $\frac{1}{8}$ in.
- 1 Baseboard, 30in. × 9in. × $\frac{3}{8}$ in.
- 3 0.0005 mfd. tuning condensers (General Electric Co., Ltd.).
- 1 Micro condenser (Igranic Electric Co.)
- 3 Valve holders (Benjamin Electric Co.)
- 2 Rheostats (Cosmos, Metro-Vick Supplies, Ltd.).
- 1 Intervalve transformer, type AF3 (Ferranti, Ltd.).
- 1 0.0003 mfd. fixed condenser (Dubilier).
- 1 2-megohms grid leak and holder (Dubilier).

- 1 Telephone jack (Edison Bell, Ltd.).
- 1 Balancing condenser (Enlgin, Ltd.).
- 3 Paxolin tubes, 3in. diameter, 3 $\frac{1}{2}$ in. long, $\frac{1}{16}$ in. wall.
- 50 yards 27/42 Litz. each strand S.S.C., D.S.C. overall (London Electric Wire Co., Ltd.).
- 1 H.F. choke (Cosmos, Metro-Vick Supplies, Ltd.).
- 3 1 mfd. Mansbridge condensers (Telegraph Condenser Co.)
- Clip sockets and plug, terminals, wire, and a sheet of gauge No. 24 copper.

Long Range Three-valve Receiver.—

quarter-ampere type; average valves have an impedance of about 7,000 ohms and an amplification factor of 7 when the anode voltage is 90 and grid bias -1.5 . The valve actually used in the high-frequency stage is a Burndept I.525, and when measured its impedance was found to be 6,500 ohms and its amplification factor 6.5. The remainder of the circuit, except the primary winding, has already been dealt with. We have, therefore, to arrange for a primary winding which will give high amplification over the whole tuning range. With many transformers the amplification is much lower at 505 than at 300 metres. The transformer used in this receiver, however, has a relatively flat amplification curve over the whole range of wavelengths.

H.F. Magnification Obtained.

Before proceeding further with the design of the primary, the method of balancing the high-frequency valve must be mentioned. The circuit is shown in Fig. 1, where P.T is the primary winding and P.N the balancing winding. The secret of success here appears to be to make the magnetic coupling of coils P.T and P.N as tight as possible, while keeping the capacity of P.T. P.N negligibly low. It is evident, therefore, that either some form of electrostatic screening of coils P.T. P.N should be employed or the coils themselves should be physically small. Screening was tried and discarded because of the objectionable effects produced by the screen. Finally, coils P.T and P.N were wound with fine wire, as we have done before in earlier receivers of this type. It was found that with a double winding of eleven turns of No. 40 D.S.C. wire (a total of twenty-two turns), the desired uniformity of amplification was obtained. The pure radio frequency amplification of the single stage was measured and found to be as follows:—

Wavelength of Circuit in Metres.	Amplification.
180	18.0
230	19.3
290	20.0
350	21.6
410	21.9
470	22.0
520	22.5
590	20.7

The amplification is uniformly high. This is partly due to the close coupling of primary to secondary. Much higher amplification at the lower wavelengths can easily be obtained, but the amplification falls off by a serious amount at the longer waves, and it was thought better to be sure of a high average. These tests also showed that the selectivity would be quite satisfactory.

To receive distant stations satisfactorily a much higher magnification than 20 is required. Reaction is therefore applied from the detector valve to the coil C by means of a small variable condenser. The size of the reaction condenser required (K, Fig. 1) depends on quite a number of things, one of the most important being on the characteristics of the detector. It was found that a small condenser was sufficient to enable oscillations to be produced over the whole range when the filament tap was taken at the fifteenth turn from the end connected to the

reaction condenser, the detector valve being a Marconi or Osram D.E.5B. This valve has an amplification factor of 20 and an impedance of 30,000 ohms or more.

If a valve with a much lower amplification factor or a higher impedance is used, the tap would have to be placed lower down the coil—in fact, a tapping at the centre of the coil would be desirable.

Reaction, Used with Precaution.

With reaction applied as shown in the diagram, the effective resistance of the coils B and C is reduced, the selectivity is improved, and, of course, signals are considerably strengthened. It is found that the first valve does not oscillate when the detector circuit is made to oscillate weakly—in fact, the aerial circuit is not affected by adjusting the reaction condenser when the neutralising condenser is properly set. The receiver is, therefore, a perfectly safe one to use, for, once the first valve is balanced—an operation which takes only a minute or two—the set can be made to oscillate when tuning, and the oscillations will not reach the aerial provided the aerial is not laid near the coils B and C. If the aerial is laid near these coils, a certain amount of energy will pass from the coils B and C to the aerial because of the capacity coupling. The copper screens which can be seen in the illustrations are for the purpose of stopping couplings between the circuits, and not for screening the set from the aerial. Therefore, the aerial lead should run direct to the aerial terminal of the set, and the set be so placed that the aerial does not pass close to the coils. This precaution should, incidentally, be taken with any set. After all, we want the incoming signal to pass from the input of the set to the detector so as to take full advantage of its selective tuning circuits.

We wish to make it clear at this point that if the receiver is not properly made and set up, it will oscillate and radiate just like any other receiver, and beginners are warned to take great care not to work with the detector oscillating until they are satisfied that the set is properly balanced.

Constructional details for the building and operation of the receiver will be included in the next issue.

The next issue of THE WIRELESS WORLD, to be dated June 2nd, will contain a Supplement Portrait of Mr. J. C. W. Reith, Managing Director of the B.B.C., specially taken by THE WIRELESS WORLD. A note regarding the career of Mr. Reith will also appear in that issue, and no more opportune moment could be chosen than the present, when the triumph of broadcasting in connection with the recent industrial troubles has been so directly manifested.

This issue will also contain the monthly pages devoted to the interests of the Wireless League, and, in case there may be difficulty in obtaining copies of this issue, readers who do not place an order are advised to do so rather than chance being able to secure a copy at a bookstall.

HINTS and TIPS for NEW READERS

A Section Devoted to the Practical Assistance of the Beginner.

SINGLE-COIL OSCILLATORS.

It is often desirable to simplify the construction of an oscillator for use with a superheterodyne or super-regenerative receiver, or for other purposes, and in such circumstances the adoption of one of the many modifications of the so-called Hartley circuit will considerably facilitate the operation of winding suitable coils.

A somewhat unusual modification of this arrangement is shown in Fig. 1(a). This scheme of connections has the advantage that no high-frequency choke is required; a series condenser insulates the grid from the high-tension

circuit is shown in Fig. 1 (b). The fixed condenser connected between the anode and the coil serves to prevent a short-circuit of the high-tension battery. It should be noted that a certain amount of control of reaction in both these circuits may be obtained by varying the position of the filament tapping point on the coil, although it is, as a rule, better to connect to the centre point.

Fig. 1 (c) shows a form of oscillator in fairly common use in America as a generator of local oscillations for superheterodyne work. In this case an inductance in two sections is

CONSTRUCTING A FRAME AERIAL.

It is not easy to lay down a hard-and-fast rule as to the number of turns in a frame aerial designed to cover the normal broadcast wave-band, as the inductance of the winding will depend on several factors, such as the diameter and the spacing between adjacent turns. It may be said, however, that if a fairly conventional form of construction is adopted it will be found that a total length of wire of about 75ft. will give a suitable wavelength range when tuned by a variable condenser having a maximum capacity of 0.0005 mfd. It will thus be seen that, in the case of the usual rectangular winding having sides of 2ft. (i.e., 8ft. to a turn), about nine turns will be sufficient.

For tuning to the Daventry station, and others operating on similar wavelengths, it is found that a frame having about 260ft. of wire will be satisfactory in the majority of cases.

It will hardly be necessary to point out that it is generally easier to remove than to add wire to a completed frame, so the constructor is advised to err rather on the side of too many than too few turns.

.....

PROTECTING INDUCTIVE WINDINGS.

The amateur who wishes to reduce to a minimum the risk of burning out his telephone, loud-speaker, and transformer windings should observe the rule of never "breaking" or "making" an anode circuit containing such iron-core windings when the valve filament is glowing. It is safe to say that a large proportion of breakdowns are due to surges of current set up under these conditions

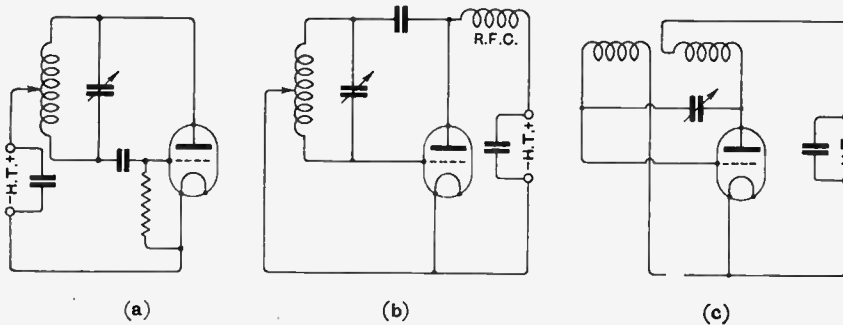

Fig. 1.—Single coil oscillators.

sion battery. It is not, however, a form of oscillator which can be recommended for general use, although it has certain applications. This same remark also applies to the simplest form of Hartley circuit, in which the high-tension battery is connected between the plate of the valve and one end of the inductance coil, for the reason that it is seldom desired to allot a separate battery to the oscillator valve alone, as is necessary if the high-tension battery is connected in this position.

The conventional and probably most popular form of single-coil cir-

used. As the by-pass condenser shunted across the high-tension battery is, in effect, connected across the break in the coil, and carries oscillatory currents, it should be of ample capacity, and mounted near the coil. If the coils are in the form of a continuous winding on the same former, with a break at the centre, the total inductance will be practically that of the two sections considered as one continuously wound coil.

A limited control of reaction is obtained in this circuit by varying the applied H.T. voltage and filament brilliancy.

rather than to the effect of the normal steady anode current.

It will be realised that when the valve is switched "on" or "off," whether suddenly or by means of a rheostat, the heating and cooling of the filament will occupy an appreciable

period of time; thus the increase and decrease of anode current will be a fairly gradual process, the back E.M.F. will be small, and heavy surges will not be set up.

These precautions are, of course, most necessary when large anode

currents are passed, and should always be observed when dealing with power valves. Needless to say, these remarks are not applicable to H.F. amplifiers, or to any valves not having iron-cored inductances in their anode circuits.

DISSECTED DIAGRAMS.

No. 30.—Stage-by-Stage Tests of a "2 H.F. Neutrodyne."

A consideration of the series of circuit diagrams given below will indicate an effective and logical course of procedure to be adopted in locating faults in a set which is totally or partially inoperative. It cannot be assumed, however, that these tests will conclusively prove that the receiver as a whole is in order, as a balance obtained with each individual stage may be upset by the addition of the second H.F. valve. Final adjustment of the neutralising condensers should be carried out in the manner described in various issues of this journal.

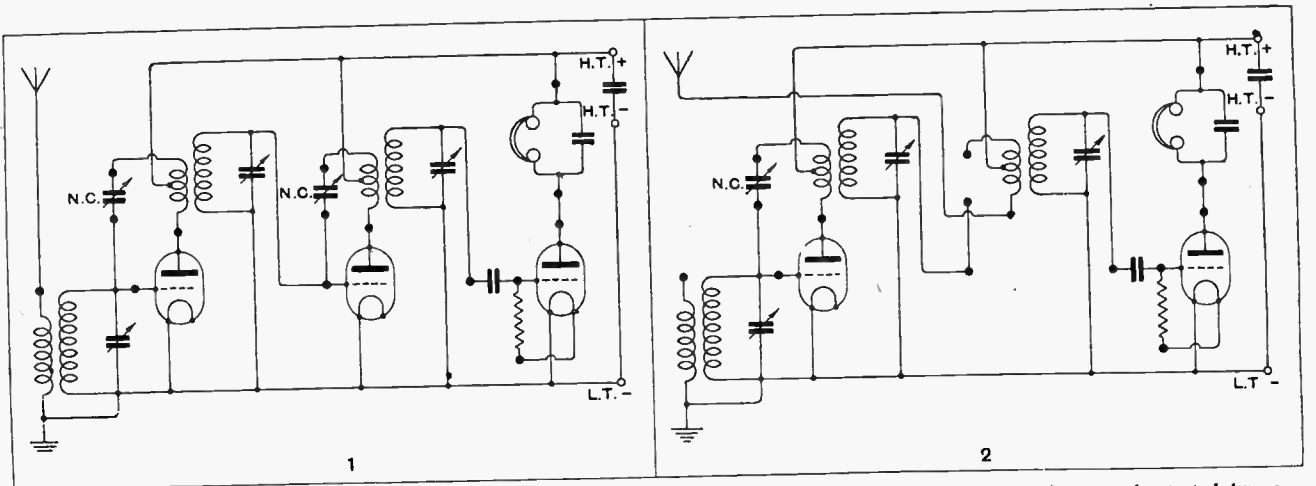

The complete circuit diagram of the receiver. It is assumed that the usual cursory examination and simple tests have failed to indicate any source of trouble. The following tests should be applied in the order given.

The detector and its associated circuits may be tested by removing the second H.F. valve and connecting the aerial lead-in wire to its anode socket. The neutralising condenser is removed or set at minimum capacity.

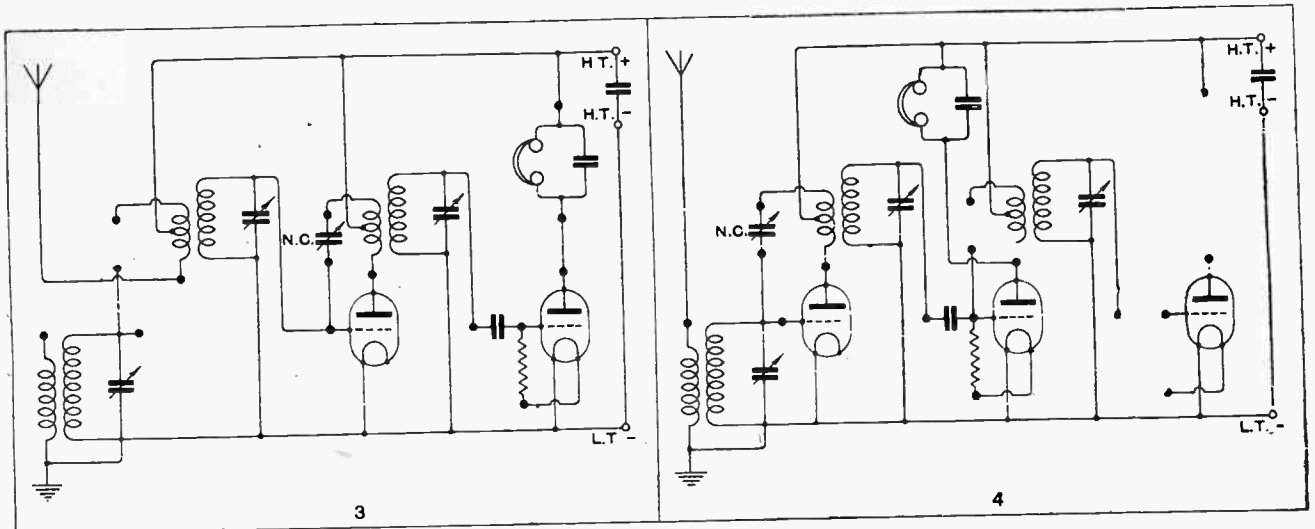

The second H.F. stage and the transformers are tested in a similar manner by removing the first valve and connecting the aerial to its plate socket. Note that for both the foregoing tests it is necessary that the low-tension battery should be earthed.

A test of the aerial-grid transformers and an additional check of the effectiveness of the first H.F. transformer is obtained by changing the position of the leaky grid condenser in order to convert the second valve to a detector.

THE WORLD'S STANDARD **AMPLION** WIRELESS LOUD SPEAKER

Natural Tone

RADIOLUX AMPLION
Type R.S.1.0
Price £7:7:0
Other Amplion Models from 38/-



The Radiolux AMPLION has many good points, but perhaps none is more striking than the quality of natural reproduction which it possesses to a remarkable degree.



Obtainable from **AMPLION STOCKISTS**, Radio Dealers or Stores.

Demonstrations gladly given during business hours at the **AMPLION Showrooms**:

25-26, Savile Row, London W.1. 10, Whitworth St. West, Manchester
78-82, High St., Clapham, S.W.4. 101, St. Vincent Street, Glasgow

There is no substitute for a genuine AMPLION

Advertisement of Alfred Graham & Co. (E. A. Graham), London, S.E.4

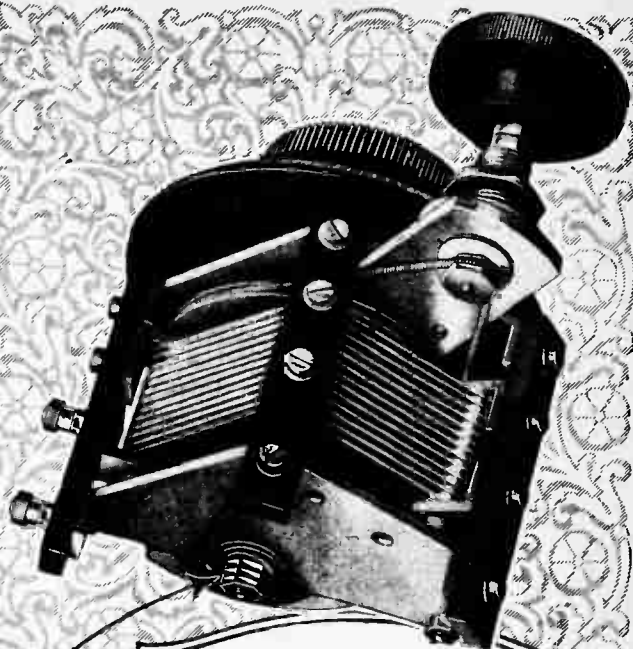

COMPENSATED SQUARE LAW EFFECT

LOW LOSS

NO BACK LASH

LOW LOSS SQUARE LAW SLOW MOTION

THE "Cosmos" Condenser is a slow motion condenser with absolutely no backlash either when new or after use. This desirable feature is accomplished by the use of a spring belt held in tension, which permits coarse tuning with the large knob, and a 10:1 slow motion with the small knob.

Cone bearings allow for adjustment and the slow motion bracket can be mounted for remote control as shown in the lower illustration.

The condenser for fine tuning. **METRO-VICK SUPPLIES LTD.**

(Proprietors) Metropolitan-Vickers Elec. Co. Ltd.)
Metro-Vick House, 145 Charing Cross Road, London, W.C.2.

Prices:

Slow Motion	00025 mfd.	14/9
"	0005	15/6
Ordinary,	00025	12/-
"	0005	13/-

ADJUSTABLE CONE BEARINGS

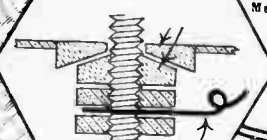

PIGTAIL CONNECTION



R F.38

COSMOS

**"Just listen to the difference
this LEWCOS Coil makes!"**



Each LEWCOS Coil is tested in our laboratory. It is then boxed and sealed up, and reaches you in perfect condition.

CLEAR as a bell the typical French Orchestra came through as the listener tuned in with his LEWCOS Coil. Coil after coil had been tried and discarded in an endeavour to realise that rare selectivity and fine tuning so essential to complete radio enjoyment. Test this new coil yourself. Be sure the LEW seal is unbroken. Ask your radio dealer for a demonstration.

No.	25	35	40	50	60	75	100	150	200	250	300
Price	4/6	4/6	4/6	5/-	5/6	5/6	6/9	7/6	8/6	9/-	10/-

LEWCOS

Inductance Coil



3 LEWCOS advantages:

- 1 High electrical efficiency with great mechanical strength.
- 2 Great selectivity resulting in extremely fine tuning.
- 3 Exceptionally low high frequency resistance with increased signal strength.

THE LONDON ELECTRIC WIRE CO. and SMITHS LTD.,
Manufacturers of Glazite
Playhouse Yard, Golden Lane, London, E.C.1.

Constructors!

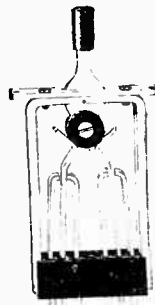

TMC

Low Capacity Keys

- combine
- Extreme Low self-capacity.
 - A positive locking action.
 - Rapid make and break.
 - Unvarying performance.
 - Adaptability to varied switching requirements.
 - Strong and accurate construction.
 - Pleasing appearance.

No. 1 T.M.C. L.C. Key. Price 7/-

They are designed by Radio engineers. The "Gold-Silver" contacts will not oxidise. The live parts of the key are insulated from the frame. Individual parts are machine made, ensuring accurate construction. Ends of the springs are tinned to facilitate soldering. Escutcheon plates and levers are polished and lacquered brass or bright nickel plate.

Made in Three Models.

- No. 1. 12 point, 3 position .. 7/-
- No. 2. 6 point, 2 position .. 6/-
- No. 3. 24 point, 3 position .. 15/6

Send for a copy of the T.M.C. Catalogue. It is free on request

If your dealer does not stock T.M.C. Goods we will supply you direct at the above prices, post free.

TELEPHONE MANUFACTURING CO., LTD.,
Hollingsworth Works,
WEST DULWICH, LONDON, S.E.21.

Phones: Sydenham 2460, 1.

REDUCTION OF PRICE

Our No. 3 Lightweight Headphone, inclusive of plush-lined case, is reduced to 19/6 as from May 17th

INTERVALVE TRANSFORMERS.

Some Notes on Their Development Since the War.

By R. L. SMITH ROSE, Ph.D., M.Sc., A.M.I.E.E.

WHEN the three-electrode valve first came into practical use, during the war, it was early applied as a low-frequency amplifier not only in connection with wireless reception, but also for earth-current telegraphy by means of power buzzers. Almost from the start iron-cored transformers were used as the intervalve couplings in these amplifiers. Under the stress of war conditions it was natural to find that these transformers were developed somewhat hurriedly on a "trial-and-error" basis rather than by a detailed analysis of the behaviour of its various component quantities.

At that time to obtain the maximum amplification at a conveniently audible frequency, such as 800 or 1,000 cycles per second, was more important than the present-day demand for uniform amplification at all frequencies.

Limitations of Early Designs

Another important point was the weight of the whole amplifying equipment, and since, owing to the inefficiency of the instrument, it was frequently found that three or four stages of L.F. amplification were being used, the weight of the individual transformers was very important. While some of these amplifiers are remembered as being fitted with transformers, each weighing several pounds, the general tendency was to produce a transformer which weighed only as many ounces. This consideration imposed two important limitations on the transformer, from which we are still struggling to obtain freedom at the present time. The first of these limitations was in regard to the quantity of iron that could be used; while the second was that the copper wire employed had to be of the smallest possible diameter, and covered with the minimum amount of insulation. It was realised in a general way that the primary winding should have an impedance of several thousand ohms at a convenient audible frequency, such as 800 or 1,000 cycles per second, and then in order to get any step-up effect in the transformer it was necessary that the number of secondary turns should be several times as great as that of the primary. As a result of these considerations a big demand arose for No. 47 S.W.G. copper wire, only two-thousandths of an inch in diameter. The technique of the production and handling of this fine wire was not widely known, although it had been previously used on a limited scale for the windings of high-resistance telephone receivers. In due course this material became available in sufficiently large quantities, but both the wire and its insulation were of a very varying quality. The properties of the iron cores were comparatively well known owing to the widespread use of induction and repeater coils in connection with land-line telephone practice. In the early stages of the production of intervalve transformers the core was frequently made up of soft iron wire as used in these telephone coils, but in other cases sheet-iron stampings were employed after the fashion prevailing in power transformers.

Although during the war it was common to speak of valve amplifiers which gave current or voltage amplifications of thousands or even millions of times, it was found later, when measurements became possible, that these figures were grossly exaggerated. Using the average wartime product of transformer with the standardised type of "R" valve, the voltage-amplification of the combination was found by measurement to be of the order of 8 to 14. Even when using several stages in cascade it was found to be difficult to reach an overall amplification exceeding 200. The limitation to the amplification obtainable was always set by the stability of the system as a whole.

The transformers in use to-day give, with the same type of "R" valve, a voltage amplification of between 25 and 35 at a frequency of 1,000 cycles per second; although by carefully adjusting the windings for resonance at this frequency a value of 60 may be reached. Still higher values may be obtained by using the special valves now available. By using two of the former stages in cascade, an overall amplification of the order of 1,000 may be obtained with the perfect stability and quiet background which is so necessary for the comfortable reception of faint signals in telephone receivers. For reception purposes nowadays it is doubtful if anything is to be gained by using more than two stages.

Uniform Amplification.

Having obtained the necessary amplification at a single frequency, the next step is so to design the transformer that this amplification is maintained as constant as possible over the whole range of audible frequencies—say, from 30 to 5,000 cycles per second. To assist in this matter, however, it is necessary to have some means of measuring the amplification. Several methods of accomplishing this have been devised and are in use. With the exception of those which require relatively large voltages to operate them, these methods employ a telephone to indicate either an equality of note intensity or a null point in a bridge balance. Now, anyone who has used a telephone for measurement purposes will be familiar with the fact that it is very difficult to work with notes of a pitch corresponding to the extremes of the audible scale. In particular it is very difficult to make accurate measurements at frequencies below about 250 cycles per second, a band which covers approximately the lower half of the musical scale.

Since the majority of transformer characteristic curves show a decided falling-off in amplification for frequencies of 250 and 500 cycles per second, it is evident that the region in which the characteristic requires to be improved is exactly that in which it is very difficult to make useful measurements.

In spite of this drawback, however, there has been a steady improvement in the performance of the *best* intervalve transformers. The italics are considered to be

Interval Transformers.—

necessary, since a large number of transformers are still far from even the approach to the ideal which can be practically realised. It is a curious thing that while the transformer is probably the most difficult component of a

limits our knowledge of the performance of the transformer; and secondly, of the extent to which the amplification must decrease for frequencies below 250 cycles per second. It is this last feature, common to all transformers, which causes many experimenters to favour the

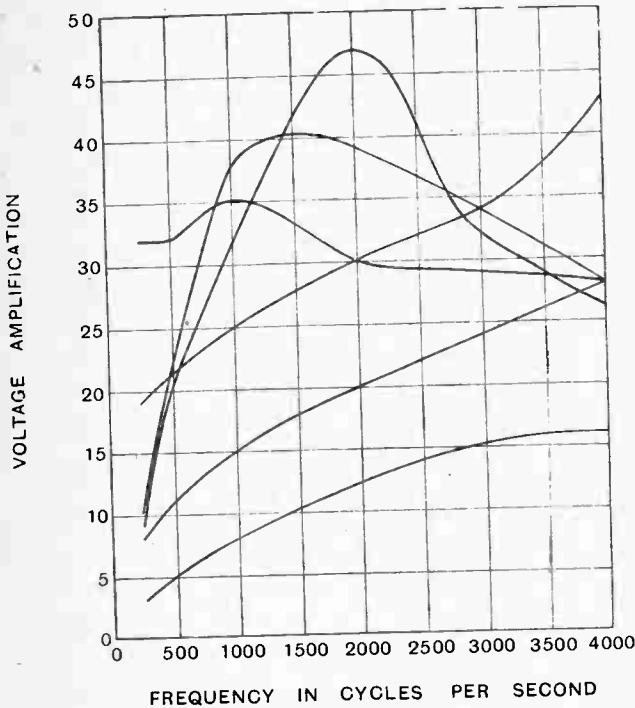

Fig. 1.—Frequency characteristics of six commercial transformers selected at random.

wireless receiver to design and construct, it is the first to which the majority of newcomers to the industry turn their attention; and they frequently begin by repeating most of the mistakes made by those who have gone before them.

Advantages of Low-Impedance Valves.

To give an idea of the characteristics which it is possible to realise in modern transformers, the results of tests on six of these selected at random is given in the accompanying Fig. 1. In considering these in relation to, say, those published by the writer about two years ago,¹ it must be remembered that part of the improvement which has resulted in the interval is due to the rapid development of the low-impedance valve, and Fig. 2 shows the amplification-frequency characteristics of three modern transformers used with low-impedance valves. In a previous article² it was shown that the performance of a transformer was more accurately represented by plotting its amplification-frequency characteristics on a "pitch" scale as the base line. For the transformers mentioned above this has been done in Figs 3 and 4. These diagrams give an excellent idea, first, of the manner in which the telephone method of measurement

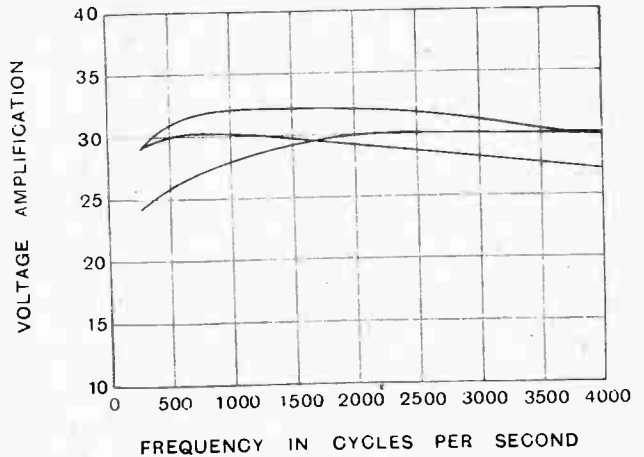

Fig. 2.—Characteristics of three carefully designed interval transformers operating in conjunction with low-impedance valves.

resistance-capacity coupling for audio-frequency amplifiers. This method, however, precludes the possibility of obtaining any effective step-up of voltage in passing from one valve to the next, and so entails the use of a larger number of valves to achieve the same result. It is probable that the best way out of all these difficulties is to adopt a combination of circuits in which the various

defects balance out. An excellent article describing experiments along these lines was published recently by Dr. N. W. McLachlan.³

³ *The Wireless World*, January 13th, 20th, and 27th, 1926.

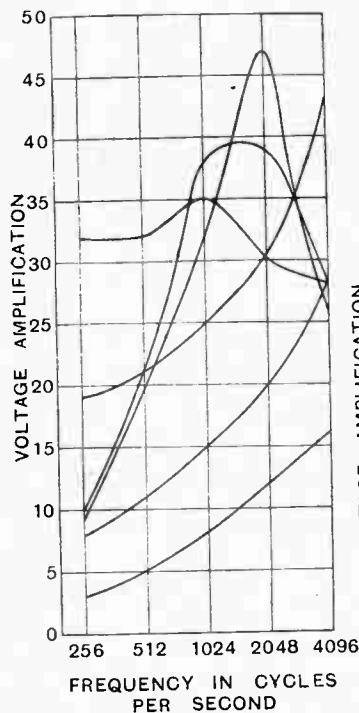

Fig. 3.—Curves of Figs. 1 and 2 respectively plotted to a "pitch" scale of frequency.

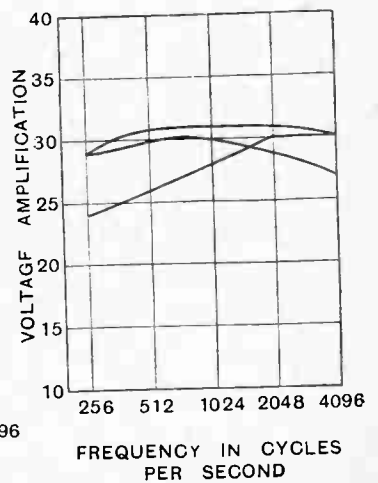

Fig. 4.

¹ *The Wireless World*, March 12th, 1924, p. 733.
² *The Wireless World*, April 15th, 1925, p. 329.

Interval Transformers.—

In concluding this section, it is worthy of note that the question of amplitude distortion in interval transformers appears so far to have received very little serious attention. In the complex wave-forms which a transformer is called upon to pass nowadays, it is evident that unless the amplitudes of the component frequencies are reproduced in strict relation to each other distortion must result; although to what extent this is serious, it is difficult to say at the present time.

The Life of an Interval Transformer.

The life of a piece of electrical apparatus is considered to be that period of time during which the apparatus will perform its allotted function efficiently. It is not necessarily the period which elapses up to the time that the apparatus ceases to be operative. For example, for test purposes, the life of an ordinary electric lamp is taken as the number of hours of burning which the lamp will give before its output of light falls to 80 per cent. of its initial value when used under the specified input conditions. This period may be only a small fraction of the total life of the filament, and is usually determined by the blackening of the bulb. Although for domestic purposes the lamp is not often withdrawn from use at this time it would probably be economical to replace it by a new lamp in many cases.

We may thus take the life of an interval transformer as the period during which it acts as an efficient means of coupling together two valves in an audio-frequency amplifier. It might be thought that it was easily possible nowadays to produce a solid piece of electrical apparatus like an interval transformer that would have an almost indefinite life. In the experience of the writer, however, and particularly during the last six years, nearly every transformer has a perfectly definite life, which is determined by the partial or complete breakdown of the primary winding. This defect is shared with the high resistance telephone receiver and, in some instances, with loud-speakers; and while it may be good for trade, or may not be considered very important during a stage in which continual improvements are being made and therefore all apparatus rapidly becomes obsolete, it is surely about time that some sort of reliability could be obtained. The writer has previously complained of this drawback of interval transformers in an article published about two years ago.¹ Since that date many other makes of transformer have been experimented with; and although the results have shown some improvement, due probably to the abandonment of No. 47 S.W.G. wire in most cases, there are still very few types which have given consistent service under normal conditions without resulting in a breakdown of the primary winding. The complete breakdown is usually preceded by a period of intermittent discontinuity, where the amplifier containing the faulty transformer is responsible for large crashing and grinding noises in the telephones or loud-speaker. Under these conditions it is frequently found that while the application of an E.M.F. of about one volt to the primary winding will not cause any measurable current to flow, the switching on of the high-tension supply at, say, 100 volts

immediately results in the passage of the normal current of a few milliamperes. This is evidently due to the existence of a minute gap in the winding, which can only be bridged by the application of an adequate potential difference. The intermittent nature of the contact across such a gap can easily be imagined as due to something in the nature of alternate fusing and re-welding of the contacts.

As a recent particular example of the breakdown of transformer windings, the following personal experience may be recorded. A crystal receiving set and a two-stage power amplifier is used to get loud-speaker reception from the London broadcasting station. The set has now been running for nearly two years and, excluding the maintenance of the batteries, has received no attention whatever—*except for the replacement of faulty transformers*. This last operation has been carried out on three occasions in the two years, the first-stage transformer having been replaced once and the second-stage transformer twice. The criticism that the breakdown is due to the application of excessive high-tension voltage is answered by the fact that the first transformer is merely a coupling between the crystal detector and the first valve, and is therefore not connected in any way with the high-tension supply. When receiving the carrier wave from the broadcasting station the steady current flowing through the primary winding is about 10 microamperes. The transformers installed in this set were among the most expensive obtainable, and as they are guaranteed indefinitely the writer has been fortunate in getting replacements free of charge. This return of the faulty components has been done not only on economic grounds, but also because it would seem to be the only effective way of making the manufacturers realise the defect, and to seek out and remove its cause. It seems hardly possible to believe, however, that all purchasers of this particular brand of transformer are following the writer's example in returning them for replacement at a rate of nearly two a year. For the only conclusions that it would seem possible to draw from such an event are either that the firm is, directly or indirectly, making an enormous profit on the original price of the transformer, or that it will soon be involved in bankruptcy proceedings.

Faulty Primary Windings.

As was mentioned above, the experience of several years ago showed that the high-resistance telephone receiver was similarly liable to breakdown. To obviate this trouble it was decided to install telephone transformers in all receiving sets and use 120-ohm telephones in place of those of 1,500 to 8,000 ohms resistance, as it was thought probable that the telephone transformer could be provided with a much more robust winding than that obtainable with the fine wire which it is necessary to use in the limited winding space of a telephone receiver. While this action considerably improved the state of affairs which previously prevailed, several cases have already occurred of the breakdown of the primary winding (*i.e.*, the winding connected to the valve) of the telephone transformer. In seeking to investigate the cause of the breakdown, it should be remembered that in every single instance it is the primary and not the secondary winding which has developed the fault. This may or may not be

¹The Wireless World, vol. 13, p. 734, March 12th, 1924.

Interval Transformers.—

due to the fact that the primary is usually the inner winding.

As to the causes of these breakdowns, the opinions of the experts seem to be varied and somewhat vague. In a few instances the fault is believed to have been definitely traced to a breakage of the fine wire by compression of the outer winding on to a sharp, splintered edge of the material of the former on which it is wound. In other cases it has been attributed directly to the heating effect of the steady anode current passing through the winding. While this is possibly true of the days when No. 47 S.W.G. wire was used carrying a current of a few milliamperes and with no means of securing a heat loss from the winding, it would hardly seem to be reasonable nowadays with the widespread use of much coarser wire. Also, as mentioned above, one case has been recorded in which the steady current through the primary winding was never greater than about 10 microamperes.

Corrosion of the Windings.

It is possible that the breakdown is due to corrosion caused by dampness in the winding and gradually reducing the diameter of the wire at one or more points until a complete fracture results. It is possible that such corrosion is assisted by electrolytic action when a steady current is passed through the winding. Such corrosion effects are well known to wire telephone engineers who have dealings with apparatus intended for use in moist, tropical areas. The difficulties of effectively drying out a closely wound coil of wire are also well known, as the

effects are still obtained when the winding is dried out in a vacuum at a high temperature and then impregnated with a waterproof varnish.

Short-circuited Turns.

In concluding this article, attention may be drawn to another defect which, while not causing a breakdown of a winding, may result in a considerable alteration in the performance characteristic of the transformer. This is due to the short-circuiting of some of the turns of the winding, which may occur during manufacture.¹ In the earlier days, and particularly with the use of No. 47 S.W.G. enamel insulated wire, it was frequently found that the individual turns or even whole layers of the winding became short-circuited due to the cracking and peeling of the enamel. With silk insulated wire a similar effect resulted from the frequent joints which were made in repairing breaks in the wire during winding. After the joint had been soldered it was necessary to ensure that the ends of wire were well covered so that there was no liability of their sticking through the insulation of neighbouring turns. The existence of such short-circuited turns has the effect of altering the electrical constants of the winding and so of the performance of the transformer in an amplifier. This change in constants fortunately provides a means of detecting the existence of the fault, and in practice each component is subjected to a simple test for the vector impedance, which is required to fall within certain definite limits.

¹ In some cases one or more short-circuited turns are used intentionally to improve the amplification-frequency characteristic.

Sheffield.

France: 8HM, 8FLY, FW, 8NA, 8NIL, 1CAF, 8GL, 8TK, 8LR, 8XP, 8UT, 8NK, FL, 8AL, 8HU, 8MJM, 8SAX, 8EZ, 8YOR, 8KB, 8IX, 8EU, OCNG, 8JF. U.S.A.: 8AOL, 2BM, 3AIB, 1BZ, 2SM, KDKA, WIZ, 1CAL, 2GP, 2SF, 2NAF, 1AAO, 2FO, 1AXA, 3CAH, 1BGW, 3LW, 1YB. Italy: 1GW, 1RM, 1BD, 1NC, 1LP, 1AY, ICE, 1AD, 1AX. Sweden: SMWF, SMVG. Germany: J1, 4IH, K5A, B5. Belgium: D4, R2, D2, C22, Z1, B2, U3, S1, X2, S5, S2, Z9, A44, S4. Holland: ORO, PC2, 0VN, 0PN, PCLL, 0PM, 0MSE, 0WB, 0WF. Scandinavia: 2CO, 5NF, Brazil: 1AO, 1IB. Canada: 1BG, Portugal: 3FZ. Spain: EAR22. Ireland: 6MU. Norway: LA12. Unknown: OLOK, MIG, KPL, DD7, GFI, ISG, SSMW, IRA, GBM, ST1, KPD, ICS, F18GR.

(0-v-0) 25 to 100 metres.

A. S. Williams.

Copenhagen.

(December 25th to February 20th.)

Great Britain: 2CC, 2DX, 2KW, 2DR, 2LZ, 2OM, 2XY, 2XV, 2GY, 2VO, 5HA, 5NR, 5QV, 5PM, 5XY, 5ZV, 5FQ, 6GH, 6LJ, 6PG, 6ZW, 6YV, 6FP, 6FD, BYC, BYX, GMB, GHB. Finland: 2CO, 2ND, 2NL, 2NM, 2NN, 2BS, 5NF, 5RF, Sweden: SMTX, SMUI, SMVJ, SMUA, SMVR, SMNT, SMNU, SMUK, SMZS, SMUV, SMSR, SMXU, SMTN, SMTQ, SMWU, SHNF. Italy: 1AU, 1BW, 1DH, 1RM, 1BB, 1NC,

Calls Heard.

Extracts from Readers' Logs.

1AD, 1CS. France: 8DK, 8JN, 8JVZ, 8RBP, 8UU, 8WW, 8JRK, 8JZ, 8NIL, 8JX, 8BBQ, 8YY, 8CAN, 8GST, 8MM, 8P1, 8XP, 8IP, 8PLA, 8CAN, OCTU, OCMV, FL, FW. Norway: NA1Q, NA1G, LA1F, LA1Q, LA1G, LA1A. Germany: 4KR, 4PF, 4GA, KW3, KWF, KPL, KY1, KY4, KY8, KL4, KK7, KB8, KWS, KAV. AGA. Belgium and Holland: OWB, N OF3, n2PZ, PC2, PC3, PCLL, B D4, 4J, Z1, B2, B O2, S5, S2, B S4, B U3, B R2, B P7, B 82, B C22, STB. Various: EAR9, H9LC, NRL, RRP, RCRL, NOT, PICW, P3CO, P3GB, PR4UR, U2NZ, U4RZ, Z2BA, U8, YBU3, WIR, WIZ, WQO, LPZ.

Borge Jorgensen.

Dulwich, S.E.24.

(March 14th to 18th.)

Great Britain: 2CC, 2CM, 2DA, 2LZ, 2OD, 2FM, 2RZ, 2ZB, 5YK, 5NN, 5HU, 5KV, 5HS, 5WV, 5MA, 5TZ, 6RM, 6PG, 6IA, 2KF, 2NJ, 6NF. Irish Free State: GI, 2IT. France: 8GS, 8PEP, 8OS, 8WAN, 8HY, 8SP, 8GSO, 8AWI, 8JM, 8PM, 8KB, OCNG, OCMV, FW, 8TR, FL, 8DGS, 8KOS, 8GI,

8TSU, 8FX. Belgium: CA3, XP7, C22, R2, S2, D4, O8. Holland: N N5, OHB, PCK4, PB7, STB. U.S.A.: WIZ, IGK. Germany: K7, R4, K8, 18. Spain: EAR9, EAR2, EAR24. Italy: 1AD, 1AA, 1AS, 1BD, 1RT, 1CR, 1BW. Philippine Islands: PIICW. Finland: 2CO, 2NZ, 5INN, 2ND. Yugo-Slavia: 7XX. Sweden: SGT, SDK. Austria: ÖUU. Various: GBM, F 8B, D AS, PAXT, TPAV, ISG, GAKB, POW, NOT, BYC, CNG.

(0-v-1.) (All below 90 metres.)

G. Rutherford (G6HU).

Washington, D.C.

Great Britain:—2CC, 2DX, 2IT, 2SF, 2KF, 2KW, 2KZ, 2LF, 2NB, 2NM, 2OD, 2SZ, 2WJ, 2XY, 5AR, 5AT, 5BV, 5DH, 5LJ, 5NN, 5PM, 5VQ, 5QV, 5NY, 6DO, 6IV, 6KK, 6LJ, 6NF, 6OX, 6RM, 6TD, 6VP, CGS. New Zealand:—1AX, 2AC, 2AE, 2XA, 4AR, 4AG, 4AK. Austrian:—2AX, 2YL. France:—3CA, 8AB, 8AC, 8AIX, 8AMC, 8AP, 8AY, 8CS, 8CZ, 8DP, 8EF, 8GI, 8GM, 8GO, 8GP, 8IP, 8JA, 8JC, 8JN, 8QQ, 88M, 8SSC, 8TH, 8TK, 8WA, 8YOR. Belgium:—B2, D4, 4RS, 4YZ. Holland:—PB3, PB7, PC2, PCJJ, PCUU. Italy:—1AS, 1AY, 1BO, 1CO, 1ER, 1GW, 1MT, 1OI, 1RG, 1RM. Germany:—K7, K4LV, South Africa:—OA3B, O4L, O6N, Spain:—EAR3, EAR9, EAR32. Denmark:—7EC. E. Grant

On 35 to 125 metres.

(U 310).



CURRENT TOPICS

Events of the Week in Brief Review.

PARIS AND PLYMOUTH.

Listeners on the outskirts of Paris are complaining that the transmissions from the *Petit Parisien* broadcasting station on 333 metres are badly interfered with by the B.B.C. station at Plymouth.

○○○○

AN INTERNATIONAL PROGRAMME

For the benefit of 150,000 Rotarians all over the world, the broadcasting station KOA, of Denver, Colorado, U.S.A., is to broadcast a special international programme on Thursday, May 27th, from 3 to 5 a.m. (B.S.T.) KOA, which transmits on 322.4 metres with a power of 5 kilowatts, hopes to be heard in all European countries.

○○○○

WIRELESS ON THE POLAR FLIGHT.

Excellent service was rendered by the wireless installation on the Amundsen airship "Norge," which crossed the North Pole at one o'clock on the morning of Wednesday, May 12th. The news that the expedition had achieved its purpose was received by wireless at Oslo soon after the event. The message stated that good weather was experienced up to 88.30 degrees, after which fog was troublesome. No land was discovered.

○○○○

RADIO ARGUMENT IN U.S.

An interesting situation has been created in America by the legal defeat of the Secretary of Commerce, Mr. Hoover, in his action against the Zenith Radio Corporation, of Chicago, for transmitting during unauthorised hours. According to Mr. Hoover, the decision will lead to chaos in the ether; on the other hand, a strong body of opinion is in favour of a radio commission consisting of not fewer than three men instead of the single-handed control hitherto wielded by the Secretary of Commerce. Mr. Hoover objects.

○○○○

WAVELENGTHS FOR DANISH TRANSMITTERS.

Amateur transmitters in Denmark have been allotted the following wavebands:— Below 15 metres; from 43 to 47 metres; from 70 to 75 metres, and from 95 to 115 metres.

The maximum power allowed is fixed at 100 watts.

BROADCASTING AND THE STRIKE.

The need of a wireless set in every home was emphasised during the strike, when owners of humble crystal sets assumed the importance of newspaper magnates in the eyes of neighbours who were unprovided with any means of obtaining news. In the lamentable event of another strike it seems likely that every citizen will be prudent enough to equip himself with a wireless receiver.

○○○○

SALVING A WIRELESS BOAT

Work is about to begin on the task of raising the *Commandant Tissot*, the experimental launch of the Société Française d'Etudes de Télégraphie et de Télégraphie sans Fil, which foundered and sank in the Seine in January last. While the launch will doubtless still yield good service, the valuable apparatus which it contained has been ruined by the long immersion.

It is hoped that the boat will again be serviceable by the autumn, so that transmitting experiments may be resumed.

LECTURE BY CAPTAIN ECKERSLEY.

A lecture entitled "Broadcast Reception" will be given this evening (Wednesday) by Captain P. P. Eckersley, chief engineer of the B.B.C., at an ordinary meeting of the Radio Society of Great Britain to be held at 6 p.m. (Tea at 5.30) at the Institution of Electrical Engineers, Savoy Place, W.C.2.

○○○○

AMATEUR TRANSMISSION BOOM IN AMERICA?

American transmitting amateurs are opening a campaign to encourage experimental listeners to build transmitters.

Commenting on the new movement, Mr. Hiram P. Maxim, President of the American Radio Relay League, said: "The radio public is just beginning to realise what has long been the keynote of amateur radio's popularity—that is, the tremendous fascination of being able to effect *two-way* communication with other individuals scattered the length and breadth of the earth, and this on apparatus of one's own construction."



THE THIRST FOR NEWS. An eager crowd on the Horse Guards' Parade, London, listens to the latest strike news broadcast from 2LO. The giant "Brown" loud-speaker seen in the photograph proved remarkably efficient for open-air work.

WHEN DX GOES TOO FAR.

"Amateur radio is suffering to-day because the hunger for super-distance contact has become a lust which has almost killed short-range friendly, casual contacts."—*Q.S.T.* for May.

WIRELESS FOR FRENCH TROOPS

French amateurs are being urged to present their obsolete wireless apparatus to an organisation in Paris which has been formed with the object of providing soldiers with broadcast receivers. Wireless concerts are greatly appreciated at lonely outposts in Morocco.

WIRELESS CHEQUE FROM AMERICA.

The first cheque to be transmitted by wireless from the United States to Great Britain was received a few days ago by the Photoradio Service at Radio House, London. Mr. Warwick Deeping, the novelist, received the cheque, which was for £513 17s. 6d., in payment of serial rights for a new novel. The transmission occupied about one hour and a half.

DANISH BROADCASTING CHANGES

Broadcasting in Denmark has now been taken over by the State and the authorities express their intention of taking strong measures against "pirates." Prior to April 1st some 35,000 licences had been issued, but the number is now estimated to be in the region of 100,000.

RECEPTION DIFFICULTIES AT COLOMBO

A stubborn problem is at present exercising the attention of the officer-in-charge at the Colombo wireless station, who is conducting experiments to determine why signals from his station are not received properly by steamers on the Far East routes. In these experiments signals from ships approaching from the east will be tested by the Colombo and Indian stations. In cases where signals are received at greater strength in India arrangements will be made for a relay service until the new station at Batticola, on the eastern side of Colombo, is put into operation.

SHORT WAVES FOR LONG DISTANCES.

To prove that the ultra-short wavelengths can render useful service in long-distance transmission, the U.S. Naval Research Laboratory at Bellevue, D.C., has been carrying out some interesting transcontinental tests in the region of 13 metres.

The experiments were carried out in broad daylight, between 2.30 and 3 p.m., between NKF at Bellevue, and G.E.C. receiving stations at Oakland, California, and Denver, Colo., respectively. On the first occasion NKF, using a quartz crystal-controlled $\frac{1}{4}$ kW. set, operated on 13.4 metres, and was received at satisfactory strength. Similarly successful results were obtained on 13.1 metres. According to Dr. Hoyt Taylor, superintendent of the laboratory, the effect of these successful transmissions is to dispel the belief that short waves cease to be

of value for long-distance working between 10 and 14 metres.

RECEPTION IN LABRADOR.

The reception in Labrador of British and German broadcasting is reported in a letter which has been received by the Zenith Radio Corporation, Chicago, from the Rev. H. H. Perrett, a missionary to the Eskimos at Hopedale, Labrador. "My farthest east has been Hamburg," writes the missionary, "while the farthest west has been a station in Nebraska. Unfortunately the nights are not at all favourable for reception, so we cannot depend upon receiving. The news bulletins are, of course, very interesting, as news per mail reaches us so very seldom and is so ancient by the time it arrives."



MUSIC ON THE NILE. The enterprising owner of this houseboat, which is moored on the banks of the Nile, has installed a receiver for picking up concerts from the new broadcasting station at Cairo.

FRENCH TIME SIGNALS.

The series of wireless time signals instituted by the International Time Bureau at Paris on January 1st, and transmitted from the stations Eiffel Tower (FI), Lafayette, and Bordeaux (LY) are being continued until further notice.

LECTURES ON VALVES AND CIRCUITS.

At the Polytechnic, 307-311, Regent Street, London, W.1, a course of six weekly lectures is to be given by Capt. W. H. Date, B.Sc., A.M.I.E.E., on "The Thermionic Valve and its Uses in Wireless Circuits." The first lecture being given on June 2nd. Full particulars may be obtained on application to the Electrical Engineering Department, 309, Regent Street, W.1.

CANADIAN TRAIN WIRELESS ACHIEVEMENT

An achievement in long distance wireless reception on a moving train has been carried out in Canada. According to a report received by the London Office of the Canadian National Railways, the "Continental Limited," while passing through Holden, Alberta, moving westwards to Edmonton a few days ago, picked up Vera Cruz, Mexico, and held it for 30 minutes. Vera Cruz is approximately 4,550 miles from Holden, itself 730 miles from Winnipeg, and 2,107 miles west of Montreal.

The operator's log reported fine weather conditions, no atmospheric interference, and a clear channel of reception from the Gulf of Mexico north-west and westwards. The train was equipped with a standard four-valve reflex neutrodyne receiving set.

WIRELESS AT WESTMINSTER.

BY OUR SPECIAL PARLIAMENTARY CORRESPONDENT.

Acceptance of Broadcasting Committee's Report.

On Tuesday, May 11th, Lieut.-Comm. Kenworthy asked the Postmaster-General whether he could say when action was to be taken on the Report of the Broadcasting Committee, and what action was contemplated? Lord Wolmer, the Assistant Postmaster-General, said the Government had decided to accept in general the recommendations of the Broadcasting Committee as to the constitution of a new authority to control the broadcasting services, and were now considering the method to be adopted to give effect to them. He was not in a position to say anything further at present.

Lord Wolmer informed Sir H. Brittain that he had seen a statement that there were wireless stations in Australia capable of telephonic communication with this country, and he had telegraphed to the Australian authorities asking for particulars and stating that, if suitable stations were available, the British Post Office would welcome the opportunity of conducting experiments in wireless telephony between Great Britain and Australia.

Replying to Mr. Day in the House of Commons last week Mr. Guinness said that no application had been received from the skippers of the Yarmouth and Lowestoft fishing smacks urging the B.B.C. to broadcast the daily state of the markets at the large ports, the catches landed, and the area where the fish had been caught. Before the English herring season commenced in the autumn he would make enquiries as to whether such a service could usefully be instituted, but so far as his present information went, the number of fishing vessels equipped with receiving sets was small.

A CORRECTION.

In Fig. 6, page 619, of the April 28th issue, the wire joining the lower end of the L.F. transformer primary winding to the filament should be omitted.

COUPLING L.F. VALVES.

Notes on Resistance, Choke and Transformer Connections.

By N. P. VINCER-MINTER.

IT is no exaggeration to say that, in constructing a wireless receiver for broadcast reception, one of the principal snares for the unwary lies in the choosing of the components for the L.F. amplifier. The amount of ignorance in this matter among even experienced constructors is really astonishing, and the writer proposes in this article to lay bare the many pitfalls which beset the would-be set builder. Two of the most puzzling points which many people are unable to fathom are whether in the case of a two-stage transformer-coupled amplifier it is correct to use a low ratio in the first stage and a high ratio in the second stage, or *vice versa*, and whether in the case of an amplifier embodying a resistance-coupled stage and a transformer-coupled stage it is correct to use the resistance first or last. Speaking generally, the low ratio transformer or the resistance-coupled stage should come first, although, unfortunately, popular opinion, fostered by an assiduous study of the advertisement rather than the technical pages of a wireless journal, thinks otherwise. Actually, of course, considering ratio purely as ratio, it is immaterial which comes first, since ratio is a secondary consideration depending upon other factors which we shall consider later.

One or Two Stages of L.F.?

Now let us imagine that we are building a receiver, and have got as far as the detector valve, and are about to tackle the L.F. amplifier. First, we must decide what volume we want. (It is taken for granted, of course, that good quality is desired.) Now the writer has found from experience that usually one stage of L.F. amplification, whatever the type of coupling used, does not really provide sufficient power for good loud-speaker volume, unless the receiver is situated very close to a broadcasting station or has several stages of H.F. amplification, both of which simply mean that the input to the L.F. amplifier will be large, since, of course, it is by no means impossible to operate a loud-speaker from a conventional detector and L.F. two-valve receiver up to a considerable distance from a broadcasting station, but only by pressing reaction to its limit and thus marring quality. In the writer's opinion, a receiver is only fitted for operating a loud-speaker from any given station when it is possible without unduly pressing reaction to produce perfect reproduction from the loud-speaker which is *too loud*, so much so, in fact, that some device is necessary to cut down the volume to the required value. Only in this manner, by having an adequate factor of safety can we assure ourselves of really good results on the loud-speaker. These requirements postulate more than one stage of L.F.

We have now to decide the nature of the coupling between the detector and the first L.F. valve. The detector is normally of high or medium impedance, partly because such a valve is usually a better rectifier than a low-

impedance valve, owing to the nature of its characteristic curve, and partly because the use of a low-impedance valve for rectification means a bigger plate current, and consequently a greater drain on the high-tension battery. Let us consider that the valve we are going to use has an impedance of 40,000 ohms and an amplification factor of 10, these being average figures for a general-purpose valve. Now it is known that, in order to get the utmost amplification out of the valve, it is necessary that in the anode circuit of the valve there must be inserted an impedance of the highest possible value. To attain the maximum amplification of 10, this impedance would have to be infinite, an obviously impossible condition. We can never get the full amplification of 10 out of the valve, but by using a high enough value of external impedance we can get 80 or 90 per cent of it.

A moment's thought will make it clear that the actual amplification obtained from any stage of L.F. amplification is equal to the ratio between the voltage developed across the grid and filament of the valve associated with the particular stage of amplification in question, and the voltage developed across the grid and filament of the succeeding valve. Now, it can be shown that the actual amplification obtained is, approximately, given

by the formula $A = \mu \times \left(\frac{R}{R_p + R} \right)$, where A = the voltage

amplification obtained, μ is the amplification factor of the valve, R_p the internal impedance of the valve, and R the value of the resistance connected in the anode circuit. It is obvious from this formula that if the external resistance is equal to the internal impedance of the valve, the amplification obtained will be equal to half the valve amplification factor. It is furthermore obvious that we shall obtain a greater amplification by employing a valve of high mutual conductance, by which is meant a valve having a high amplification factor in proportion to its internal impedance. It is equally obvious that the greater the value of the external resistance the greater the amplification. Now let us examine the curve in Fig. 1, which shows the relationship between amplification and external resistance, using a general-purpose valve of characteristics already stated in this article. It will be seen that the amplification increases rapidly at first with an increase of external resistance, but later the increase becomes more gradual. It can be seen at a glance from this curve that the external resistance must be ten times the internal valve impedance in order to obtain 90 per cent. of the valve amplification factor, although there is not much advantage to be obtained by using a larger value of resistance, and actually it would appear from the curve that not much advantage will accrue from using a larger value of resistance than five times the internal valve impedance.

It will be obvious that, by using a valve of higher mutual conductance, such as the D.F.5B., which has

Coupling L.F. Valves.—

an amplification factor of 20 and an internal impedance of 30,000 ohms, we can reduce the value of the external resistance and obtain an actually greater amplification. It is of little use, however, using a valve with a still higher amplification factor of 25, like the D.E.Q., since the amplification would be less unless we increased the value of the anode resistance to 1 megohm, since this valve is of low mutual conductance, having an internal impedance of 100,000 ohms.

Now let us consider the question of choke coupling. Here the amplification (when the D.C. resistance of the choke is comparatively small, as it usually is) is expressed by the formula: $A = \mu \times \left(\frac{X}{\sqrt{R^2 + X^2}} \right)$, X being the impedance of the choke at a given frequency, the other symbols being as before. Now, an examination of the curve in Fig. 2 will reveal the fact that, whereas the resistance had to be ten times the impedance of the valve in order to obtain 90 per cent. of the valve amplification factor, the choke impedance needs to be only twice the value of the internal valve impedance in order to produce the same amplification, the useful value which we defined as 5 in the case of a resistance being about 2 in the case of a choke. Now, a transformer of, say, 4 to 1 ratio may be considered as a choke with a separate additional winding of four times the number of turns superimposed, which has the effect of taking the amplification obtained by the choke and valve, and multiplying it by four, as it were, an 8 to 1 transformer multiplying it eight times. It would appear, therefore, that by far the best thing for us to do would be to employ a high ratio transformer, a low ratio transformer, a choke, and a resistance in the order named, in order to obtain maximum amplification. Actually, however, there is an important factor which we have not yet considered which completely reverses this order. We shall now consider this.

We know that a resistance offers the same impedance to all frequencies, and thus a note frequency of 1,000 is amplified to the same extent as a 200 cycle note. Actually, of course, there are various limiting factors which tend to modify this, such, for instance, as the self-capacity of the valve and that associated with

the resistance and its attendant wiring, which causes a decrease in the amplification of the higher musical frequencies. An inductive choke, however, offers a less impedance to a low musical frequency than it does to a note in the middle range, the reactance of a choke being

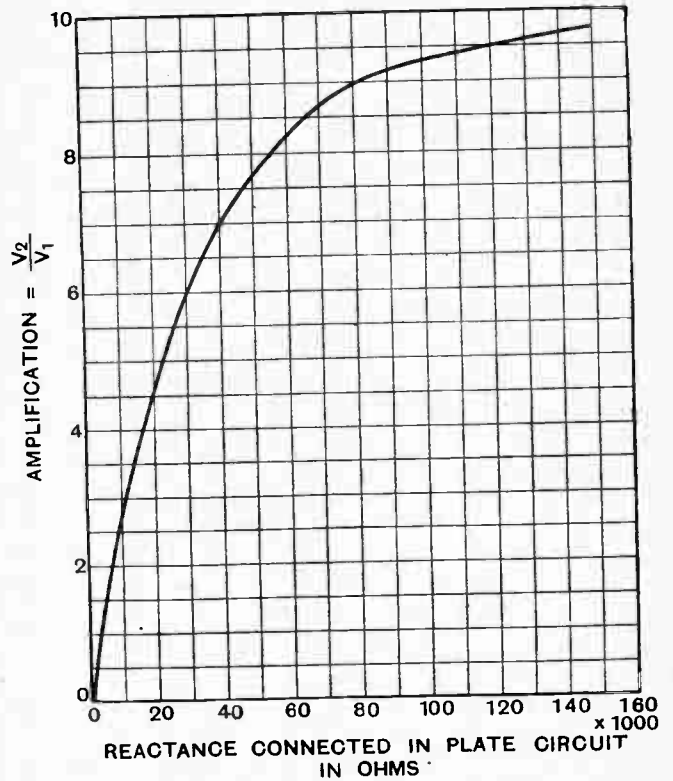

Fig. 2.—The variation of amplification with added plate circuit inductance.

equal to $2\pi nL$, where n is the frequency in cycles per second, and L is the inductance of the choke in henries. Thus there is likely to be distortion owing to one element of the signal being amplified more than another. For instance, if the choke has an inductance of 12.8 henries, at 500 cycles the impedance offered is 40,000 ohms, this giving from the curve in Fig. 2 an amplification of

7, and at 250 cycles an impedance of only 20,000 ohms, this giving an amplification of 4.5. However, by making the choke sufficiently large, say, 100 henries or so in the case of a general-purpose detector valve, we can make the amplification of the various frequencies only very slightly different. If the choke is made very large, its self-capacity may be quite high, which has the effect of reducing the amplification of the upper frequencies. A choke can never quite equal a resistance, therefore, from the point of view of good quality.

With a transformer matters tend to be even worse, since the secondary winding has far more turns than the primary according to the ratio, and, therefore, there is usually no room for a 100 henry primary. In the

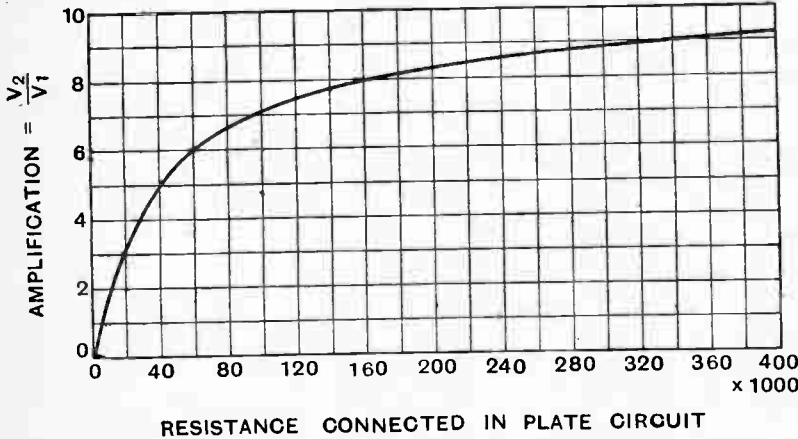

Fig. 1.—Showing the variation of amplification with added plate circuit resistance.

Coupling L.F. Valves.—

best makes of low ratio transformer having a 2.7 to 1 ratio, the primary inductance is only 50 henries. It may be asked why limit the number of turns on primary and secondary? Is there any "snag" besides excessive bulk? Unfortunately, there is. It lies in the fact that it would be impossible to construct a transformer of such bulk without excessive self-capacity, which, as we have already seen, reduces the amplification of the upper frequencies. But this is not all, and it is found that this self-capacity introduces a further difficulty, for if we increase the number of turns on the primary, in order to increase the amplification of the lower frequencies, the added self-capacity in shunt with the inductance often has the effect of actually tuning the transformer to a certain frequency, so that there may be a sudden upward hump in the curve. At the present time, the largest primary which the manufacturers find it possible to use without detrimental self-capacity effects is about 50 henries, and the maximum ratio it has been found possible to use with this primary and still avoid serious self-capacity effects is 2.7 to 1 in the case of most manufacturers. Of course, there is no *mechanical* obstacle to the construction of a 4 to 1 or higher ratio with such a big primary, but if this is done serious self-capacity effects are introduced. It is obvious, therefore, that a transformer of even the lowest ratio will give less satisfactory results than a choke of 100 henries inductance for the 40,000 ohms valve referred to. In the case of a 7,000 ohms valve, fairly even frequency amplification from about 50 cycles up can be obtained with a transformer having a very large primary, which, as we have seen, means a very low ratio, but we do not want to use a low-impedance detector valve for reasons stated earlier in this article.

The Coupling Condenser and Grid Leak.

Now, we have seen that, following a high-impedance detector valve such as the D.E.5B, we must use a 150,000 ohms resistance, or a choke of high inductance, about 100 henries being a satisfactory value, or a transformer with the biggest primary we can get. It might be thought that the advantages obtained by using the resistance would be offset by the higher H.T. value required to overcome the D.C. voltage dropped across it, since, of course, being a resistance, its D.C., as well as A.C., resistance at a given frequency is 150,000 ohms, whilst the choke may have an impedance of 40,000 ohms at a given A.C. frequency, and a D.C. resistance of only a few hundred ohms. In actual practice, however, the extra H.T. voltage required when using a resistance is not really so great as is popularly supposed, owing to the small plate current.

It should be briefly mentioned that the value of the coupling condenser associated with either a resistance or a choke-coupled amplifier must not be too small, or we shall fail to pass along the lower musical frequencies and thus set at nought advantages obtained by sacrificing the bigger amplification obtainable with a transformer. Experience dictates that the value of the condenser should be about 0.1 mfd., and the leak resistance 0.5 megohm. We must not use a much higher leak resistance, or we shall meet another trouble. It is advisable also that the condenser dielectric be of mica,

as it has to withstand the high voltage of the H.T. battery. Another point is that the anode resistance must be wire wound, since if made of graphite or similar material the passage of the steady anode current will eventually disintegrate the resistance material and give rise to crackling noises in the loud-speaker. Since both wire-wound resistances and mica-dielectric condensers are now cheaply obtainable, there is no excuse for not using them.

First and Second Stage Valves.

The first valve of the amplifier should usually be a low-impedance power valve such as the D.E.5. This is so whatever type of amplifier has been used preceding it, since a high-impedance valve such as the D.E.5B, has a very small, straight line portion of grid volts—anode current curve, and the grid swing would probably cause distortion by going outside these limits. A reference to the curves in Figs. 1 and 2 will at once reveal that, since the internal impedance of the valve has been reduced, we can safely reduce the value of the external impedance in the anode circuit without causing distortion. At this juncture, therefore, the transformer really comes into its own, as we can use the smaller impedance of the transformer primary and make use of the voltage step-up given by the ratio between the primary and secondary windings.

Our next valve, which will be the output valve, normally must be of necessity a valve capable of handling still greater power without being overloaded, and the D.E.5A, L.S.5, or some similar valve, will be needed. If, however, a further stage of amplification is needed, it is obvious that, since the valve impedance has been still further reduced, we can still further reduce the external impedance without ill-effect on quality. In other words, we can still further reduce the size of our transformer primary, and thus leave room for a bigger secondary, and, therefore, we can use a 4 or 6 to 1 ratio transformer. Our grid swing in the succeeding valve will now be very large, and we must use an L.S.5A valve.

Transformer Ratios.

From these considerations certain important points emerge. We first see the folly of putting the resistance stage last and the transformer stage first as many people do, and equally we see the folly of using the low ratio transformer last. A word of warning is necessary in this connection. As we have seen, the transformer ratio is incidental to the size of the primary, which is the important factor. Now, unfortunately, except in the case of reputable manufacturers, ratio is no guide to primary impedance. Obviously, a 2 to 1 transformer having a 20 henry primary is less suitable to use after a high-impedance valve than a 2.7 to 1 transformer having a 50 henry primary. In actual fact, there are 3 to 1 transformers upon the market having a smaller primary than a reputable transformer of 6 to 1 ratio. In many cases, transformers of 5 to 1 and 3 to 1 ratio are sold in which the primary is identical in each case, the smaller ratio being attained by cutting down the secondary turns. Many of the L.F. chokes on the market also which are sold as suitable for following a high-impedance detector valve have an inductance of only 20 henries, and yet

Coupling L.F. Valves.—

they claim to give better quality than a transformer with a 50 henry primary! It will be seen, therefore, how wary the home constructor must be in choosing his components and how necessary it is to deal with reputable firms whose transformers have been designed by competent engineers.

An examination of Fig. 3, which shows the amplification curves produced by using valves of different internal impedance in conjunction with transformers of different ratio, or, to be more correct, transformer of different primary impedance, clearly indicates the importance of primary impedance. Now, the four ratios which this well-known make of transformer are supplied, namely, 2.7 to 1, 4 to 1, 6 to 1, and 8 to 1, have primary impedances of approximately 50, 25, 12, and 7 henries respectively. The poor curve obtained by following the comparatively high-impedance "R" valve with a 25 henry inductance is seen. It will be obvious, therefore, that the results obtained by the use of a 20 henry choke or a "general-purpose" transformer of 5 to 1 ratio with a 10 henry primary will be infinitely worse. With regard to the 8 to 1 transformer this is primarily intended to follow a crystal receiver employing the usual galena-catwhisker combination. Since a galena crystal is of very low impedance, we do not want a high external impedance. If we use a crystal detector, therefore, a transformer with a 7 henry primary is ample. A Perikon detector employing the zincite and bornite combination is of higher resistance, and the transformer with the 25 henry primary should be used, whilst the carborundum detector falls in the same class. A point concerning which many people are woefully ignorant is that a stage of resistance coupling should never be used immediately following a crystal detector of any type.

Loud-speaker Connections.

There is another important point to remember in avoiding distortion in an L.F. amplifier, and that is that the loud-speaker should never be connected directly in the plate circuit of the output power valve, not because of the risk of the steady H.T. current damaging the windings, but because the magnet cores of the loud-speaker are, even in the largest types of loud-speaker, so small that they may become magnetically saturated under the influence of the large plate current associated with a power valve. If magnetic saturation is thus allowed to occur, both quality and volume will be sacrificed. Many amateurs spend considerable time and money on the construction of a "distortionless" amplifier, and then connect their loud-speaker directly in the plate circuit of the output valve, and are puzzled at not getting the quality and volume they anticipated. The cure is to keep the steady plate current out of the loud-speaker windings by employing a choke-filter circuit. Be careful, however, to use a choke having a core suitable for dealing with the magnetising force exerted by the steady plate current, or we shall merely be transferring the trouble from the loud-speaker to the choke. Remember we do not require a high inductance, since the impedance of the valve is low, and twenty or thirty henries is ample. We *do* want a properly designed one, however. It might be thought that here the small 20 henry choke selling at 10s. or so

will now come into its own, but this is not so, because in most cases the core is not at all suitable for the purpose. Chokes specially designed as output chokes may be obtained from several reputable firms, such as Messrs. W. G. Pye, Ltd., of Granta Works, Cambridge, whilst the makers of the well-known Amplion loud-speaker supply a special choke filter unit under the name of "Siftron."

Distortion in Loud-speaker Leads.

There is yet another cause of distortion due to the capacity existing between the customary twin flexible leads used to connect the loud-speaker to the receiver when these are of some length. This can be completely cured by using a single-wire loud-speaker extension in accordance with the instructions given by the present writer in an article specially devoted to this subject.¹ In a recent issue of this journal, the

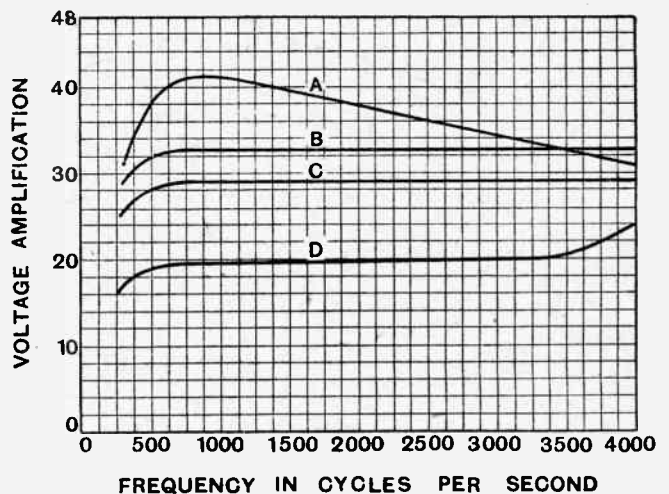

Fig. 3.—Amplification-frequency curves for well-known transformers.

writer gave full constructional details of a low-frequency amplifier designed to give very high quality in accordance with the theoretical considerations laid down in this article.² In this amplifier a special form of volume control was used, which enabled volume to be varied from full loud-speaker volume to weak headphone strength without in the slightest degree altering the tone. This volume control was placed in its correct position in front of the amplifier, and so enabled the volume from a nearby station to be kept within the limits of the particular values used. Obviously, if used after the amplifier, a volume control will certainly reduce the loud-speaker output, but will have no effect in preventing distortion caused by the overloading of the valves due to near-by signals of great magnitude. Readers are advised to make a study of these two articles very carefully before deciding definitely upon the details of any amplifier which they may contemplate constructing for the purpose of giving "distortionless" reproduction.

¹ *The Wireless World*, February 10th, 1926, page 217.

² *The Wireless World*, March 31st, 1926, page 480.

REGENERATIVE VARIOMETER RECEIVER

Combined Capacity
and Resistance Controlled
Reaction.

By W. K. ALFORD.

IN the modern design of wireless receivers it is rather strange how the variometer seems to be neglected as a means of tuning the various circuits, and the only use of this component appears to be in the simplest of crystal receivers.

Much comment has been made of late as to the best ratio of inductance to capacity to use in the various circuits, and it is generally thought that the maximum ratio is not by any means the best, although capacity in any form is always antagonistic to the formation of potential differences across inductances which we use to operate thermionic valves.

Advantages of Variometer Tuning.

Now the variometer, when efficiently designed, gives a very large L. C. ratio, and in the receiver herein described seems to contribute to a degree of selectivity which came as a very great surprise to the writer.

The circuit is not new by any means—very few are—but it seems to open up a very interesting field for the

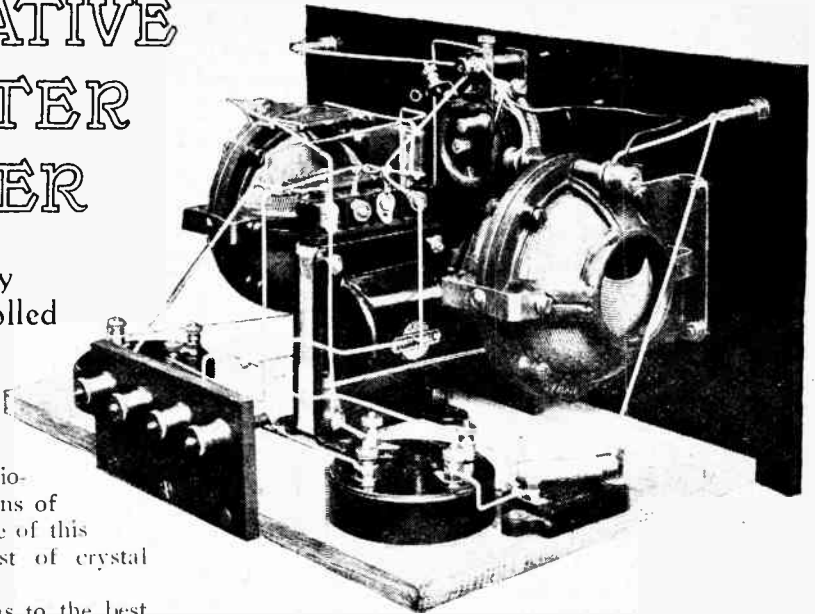

Back of panel view showing layout of components.

“experimental” type of constructor, and is shown in the simplest possible form.

The technical arrangement of the circuit is shown on the next page, and the two photographs clearly indicate how the components are assembled.

The tuned anode circuit, consisting of a variometer shunted by a fixed 0.0002 mfd. condenser, not only assists the detector valve in its partial function as a high-frequency amplifier, but also serves as a H.F. choke which diverts H.F. currents through the reaction condenser.

It will be noticed that a damping resistance is placed in shunt with the variometer tuning the aerial circuit, and this gives a very fine control over reaction, enabling the “threshold” to be reached without actually producing oscillation. Only a small variation of resistance is necessary in making this final adjustment, and it is advisable to work as near as possible to the high-resistance end of the scale. If the variable resistance is set at a low value, the damping resistance introduced into the aerial coil will be comparable to that of the aerial circuit itself, and selectivity will be greatly reduced.

The small variable condenser connecting the anode and aerial circuits forms

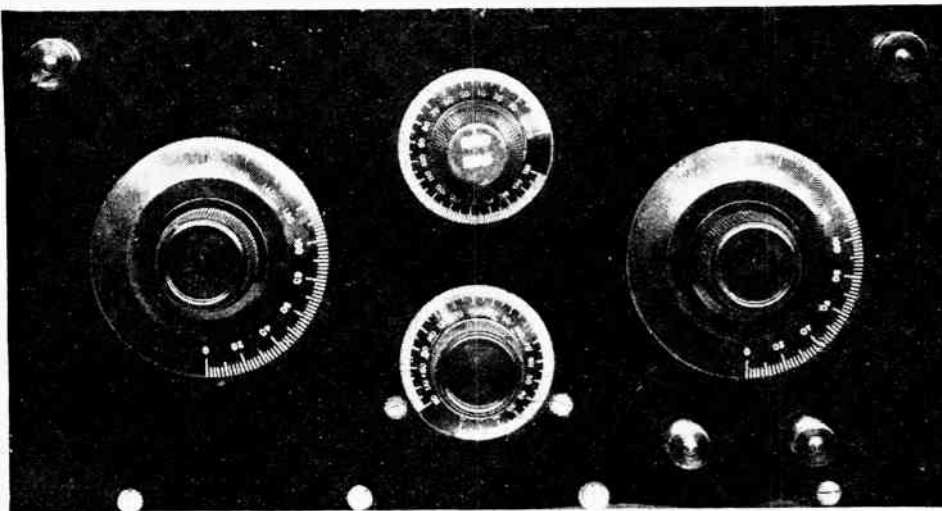

Front panel showing position of the various controls. The upper centre dial controls the filament current and variable reaction resistance while the lower centre dial controls the reaction condenser. The large dials at each side actuate the two variometers.

Regenerative Variometer Receiver.—

LIST OF COMPONENTS REQUIRED.

- 2 Variometers (Igranic "F" type).
2 Valve holders.
3 Fixed condensers, 0.0003, 0.0002 and 0.002 mfd.
1 Combined rheostat and H.R. potentiometer, 6 ohms and 30,000 ohms (Igranic).

- 1 Fixed grid leak, 2 megohms.
1 L.F. transformer.
1 Variable condenser, 0.00015 mfd.
8 Terminals.
Ebonite panel, 12in. × 7in. × ½in.

the means of producing oscillation, and owing to the fact that the setting of this condenser has an effect on the variometer settings for a given wavelength it is desirable to calibrate the receiver just on the verge of oscillation.

If any difficulty is experienced in making the set oscillate owing to individual aerial characteristics, a fixed capacity of, say, 0.0005 mfd. may be inserted, as shown dotted in the diagram.

As regards valves, the most suitable are a D.E.5B as detector, followed by a D.E.5 in the amplifier stage, with an anode voltage of about 80. This valve is necessarily a compromise between the best valves for rectification and amplification. It would be better, of course, to provide separate H.T. tappings for each valve, giving the detector 50-70 volts and the amplifier 90-120, according to conditions, but in the ordinary way the single H.T. battery will be found to give excellent results.

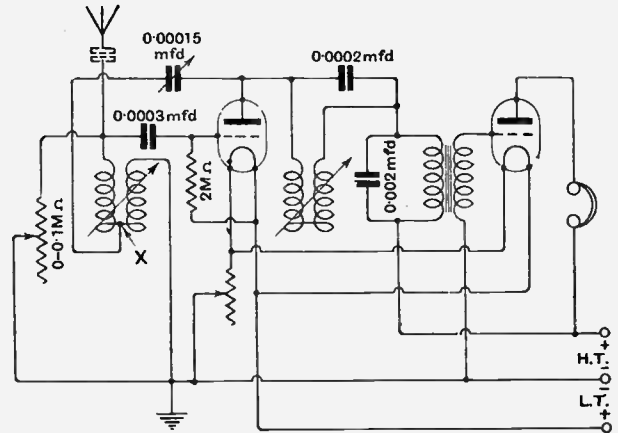

Circuit diagram. Reaction is controlled by a variable resistance in parallel with the aerial variometer

Mr. E. Megaw (GI 6MU), 3, Fortwilliam Drive, Belfast, tells us that he was in telephonic communication on April 21st with HBK, Kohat, India, at about 2120 G.M.T. He was using about 30 watts input and a Mullard 0/20 valve with plain grid modulation and no speech-amplifier. Speech was reported fairly strong and quite clear. This is believed to be the first telephony working between Ireland and India.

o o o o

Mr. E. Poulsen (D 7MT), 6, Virginiavej, Copenhagen, and Mr. H. Rafn (D 7EW), 8, Blytsvej, Copenhagen, will be making a series of tests to investigate signal strength and fading at different times of the day. Beginning on May 16th, D 7MT will transmit, on a wavelength of 43.5 metres and using about 4 watts, at 0800, 1000, 1200, 1400, 1600, 1800, 2200 and 2300 G.M.T. D 7EW will transmit at 0700, 0900, 1300, 1500, 1700, 2100 and 2200 G.M.T. on the same wavelength and with 12.5 watts. The form of each transmission will be QST. QST QST de aa (at 0800) ab (at 1000) ac, etc., and will conclude with "psc. report to QRA" These experimenters will welcome reports, which should state signal strength and fading effects at various times (e.g., QSS from cd to cl), weather conditions and nature of receiver.

o o o o

Norwegian Amateurs.

We understand from the President of the Norsk Amateur Sender Union that transmitting licences are now being issued to Norwegian subjects on the following

TRANSMITTING NOTES
AND QUERIES.

terms:—Wave-lengths allowed, 5.6, 29.35, 43.47, 69.75, and 100-120 metres. Aerial power not to exceed 20 watts. Transmitters which interfere unreasonably with other stations are prohibited. The licensee must possess certain technical qualifications and be able to send and receive at least 12 words per minute. The annual licence fee is fixed at 30 kroner. The nationality prefix will be LA. The President of the newly formed Norsk Amateur Sender Union—abbreviated to N.A.S.U.—is Mr. G. H. Petersen and the Hon. Sec. is Mr. H. Conradi. QSL cards will be forwarded if addressed to this Society at Oslo.

o o o o

U 7DF. Mr. C. M. Nagata, P. O. Box 815, Auburn, Washington, U.S.A., wishes to get into touch with British amateur transmitters.

o o o o

QRA's Wanted.

G 2BRD, G 2KI, G 2NC, G 2WS, G 5JI, G 5RS, G 5VT, G 6EQ, G 6JH, G 6LL, G 6VT, D 7BX, GBM, L 1JW, LA 1B, LA 4X, R 1FL, R 1ND, R 2NCN, Y 1CD, BZ 2PT, C 3XL, D 7WA, LA 1X, Q 2CL, S 2BS, U 2ARM, U 4HX, U 4XE, W 1MKC, X 3OK.

Amateur Transmitting Stations in New Zealand.

Further supplement to the lists published in the "Wireless Annual for Amateurs and Experimenters" and in "The Wireless World" for January 27th and March 31st, 1926.

AUCKLAND DISTRICT.

1AG.—F. Roberts, 24, Kimberley Road, Auckland.

1AY.—A. E. Bennett, 270, Great North Road, Auckland.

1FB.—G. T. Gulde, Bridge Street, Opotiki.

WELLINGTON DISTRICT.

2BD.—N. W. Cunningham, View Road, Karori, Wellington.

2BE.—S. W. S. Strong, Devonport Hotel, Powderham St., New Plymouth.

2BG.—J. G. Tinney, 74, Kaimi Road, Hataitai, Wellington.

2BK.—L. A. Hanson, 77, Linton St., Palmerston North.

2BN.—S. J. K. Hislop, 8, Fitzroy Road, Napier.

2BP.—W. N. Macklin, 75, Waipapa Road, Hataitai, Wellington.

2BR*.—K. A. Lambert, Belmont, Tayforth, Wanganui.

CANTERBURY DISTRICT.

3AA.—J. M. Bingham, 387, Gloucester St., Christchurch

3AD*.—A. C. L. Fooks, cr. Park and Peter Streets, Ashburton.

3AF*.—J. F. Donald, c/o Mr. J. Purser, Leeton.

Call-signs marked * indicate changes or corrections in addresses previously published in the *Wireless Annual* and *The Wireless World* of January 27th and March 31st, 1926.

PIONEERS of WIRELESS

BY ELLISON HAWKS F.R.A.S

15.—Alexander Graham Bell Invents the Telephone.

UNTIL 1876, when Alexander Graham Bell invented the telephone, the only known means of registering electrical signals was the telegraph or galvanometer, and it was these types of instruments that had necessarily been used in all experiments in wireless. The introduction of the telephone greatly assisted research in wireless communication, and much of the present-day success of radiotelephony is the result of Bell's pioneer accomplishments in wire-transmitted speech.

Steinheil had said that telegraphy without wires would be possible only when "we had the means that could stand in the same relation to electricity that the eye stands to light." Now, although Bell's telephone did not entirely fulfil this requirement, it placed in the hands of scientists a marvellously delicate instrument, infinitely more sensitive than any apparatus previously employed.

Alexander Graham Bell was born in Edinburgh on March 3rd, 1847. Both his father and his grandfather had attained some distinction as teachers of the deaf and dumb. Young Bell attended the Edinburgh High School, proceeding later to the Universities of Edinburgh and London. His father, who had previously visited America in connection with a system of "visible speech," or lip reading as it is sometimes called, removed to America in 1870. He was accompanied by his son, Alexander, who at that time was threatened with a serious illness.

The following year young Bell was appointed Professor of Vocal Physiology at Boston University, and later established a school where he taught his father's system of visible speech. In his spare time he experimented with tuning forks, magnets, and electrical batteries, and for three years he worked in this way. In 1874 he evolved what he called the "harmonic telegraph," a device for sending ten or twelve Morse signals over a single wire at the same time by utilising a peculiar phenomenon known as the law of sympathetic vibration.

It is a surprising fact that the means of transmitting sound over wires was discovered by Bell through the result of an accidental misadjustment of his telegraphic apparatus. This

happened one day in 1875 when, after a long series of experiments, one of the transmitter springs stuck, causing the magnetised steel to generate a current. Travelling over the wire this current caused a faint sound to be made in the receiver, and we can imagine the young scientist's excitement when he realised what this faint sound really meant. His dream of telephonic speech was within the bounds of possibility!

Although the world had been waiting for hundreds of years for the telephone, on February 14th, 1876, two men almost simultaneously patented a telephone. Bell filed his specification at the United States Patent Office on the morning of that day, and a few hours later Elisha Gray applied for protection for his design for a similar contrivance! Neither knew that he had a rival, and even more remarkable than the coincidence of date was the fact that the respective particulars were entered at the same office.

Once having established the principle, young Bell worked with a will to develop what he called the "talking telegraph." His idea was that by studying the vibrations the deaf could come to understand what sounds they represented, and thus could *see* what was said to them. The two needles vibrating in unison set his mind working in another direction, however, and well it was for humanity that this was the case.

Bell found that the path of the inventor is far from smooth, however, and his friends laughed at the idea of wire-transmitted speech. He had been financed in his experiments by two wealthy men, and they threatened to withdraw their support unless he reverted to his original telegraphic ideas. To crown all, his prospective father-in-law announced that he would refuse to allow the marriage to take place unless Bell abandoned "this foolish telephone!"

Nothing daunted, however, the young inventor, almost penniless now, for he had resigned his professorship at Boston to carry out his experiments, persevered for nearly a year, making improvement after improvement. At length his original crude instrument, which would do nothing but gasp and



Alexander Graham Bell

Pioneers of Wireless.—

make strange noises, became more powerful and the sounds more clear and distinct.

On March 10th, 1876, his efforts were crowned with success. On this memorable day Bell spoke into a telephone fixed in an attic:—

“ Mr. Watson, come here. I want you ! ”

In the basement at the other end of roof. of wire his assistant listened, and then came rushing into the attic, shouting excitedly:—

“ I heard you ; I could hear what you said ! ”

This is the story of the birth of the telephone, as it was simply told by Bell himself.

Experiments proceeded apace until, on October 9th, 1876, Bell held the first recorded long-distance telephone conversation over the telegraph line between Cambridge and Boston (U.S.A.). Soon after this achievement the Boston *Globe* transmitted by telephone the first Press report from Salem, Massachusetts, to Boston.

The public remained unmoved by the invention, and remarkable though it now seems. Bell was unable to interest anyone in his telephone. Often on approaching business men they turned him away saying that they had no time to bother with him or his “ fool talking-machine.”

At an exhibition held in 1876 at Philadelphia the invention was noticed by Dom Pedro, Emperor of Brazil. Asking the Emperor to place the receiver to his ear, Bell spoke into the transmitter at the other end of the Exhibition. “ My God ! it speaks ! ” the Emperor suddenly cried in amazement. Lord Kelvin followed the Emperor at the receiver and declared “ It does speak ! It is the most wonderful thing I have seen in America ! ”

Trelleborg Reorganisation.

Owing to the reorganisation of Messrs. Trelleborg Ebonite Works, Ltd., Mr. F. W. Lowenadler has resigned his connection with this company. Mr. P. C. Michell is now manager.

o o o o

Formo and Watmel Products.

Dealers in the North may be interested to learn that Mr. J. B. Levee, 23, Hartley Street, Levenshulme, Manchester, is sole agent in the Lancashire, Cheshire, and West Riding area for the Formo Company and Watmel Wireless Co., Ltd. He will be pleased to supply literature to dealers in that area.

o o o o

Change of Address.

Messrs. Anodon, Ltd., advise us that their new address is Commerce House, 72-86, Oxford Street, London, W.1.

o o o o

Price Reductions.

Messrs. the Radio Communication Co., Ltd., 34-35, Norfolk Street, W.C.2, announce many important price reductions, effective as from May 1st, particulars of which will be sent on application.

o o o o

Exide Service Agents.

A booklet (No. 4011) giving the names and addresses of skilled Exide Service

B 30

The incident of the Emperor and the telephone caught the popular fancy and drew more attention to the invention than all Bell's efforts with business men. Even then it was not until sixteen months after Bell had filed his patent specifications, when there were already 778 telephones in use, that the first telephone company was established. This was the Bell Telephone Association, formed in August, 1877, with no capital and only four members ! From that date the popularity of the telephone has continued to grow steadily, until to-day we find instruments installed in almost every office and place of business, and in numerous private houses.

Although the introduction and development of the telephone was one of the greatest triumphs of the twentieth century, Bell was never interested in the commercial side of his invention. “ It has always been that way,” he said, “ after I have made a discovery and got it under way, my interest in it lessens.” Indeed, almost before the first telephones were being manufactured the inventor himself struck off into new fields. It is amusing to find that towards the close of his life, Bell found the telephone such a source of annoyance that he had it removed from his room.

Dr. Bell died in the early hours of August 2nd, 1922, at his home near Baddeck, Nova Scotia. At his own request he was buried in a grave at the crest of Beinn Breagh Mountain, a spot that surely will be a shrine where thousands may pay homage to the man whose name will live as long as civilisation exists.

NEXT INSTALMENT.

Bell Invents the First Wireless Telephone.

TRADE NOTES.

Agents throughout the country will be forwarded free of charge on receipt of a postcard at the Head Office at Clifton Junction, near Manchester.

o o o o

Amplion in America.

Mr. M. H. Lynas, of Messrs. Alfred Graham and Co., is at present visiting the associated Amplion companies in Canada and the United States. He expects to be away until the end of June.

o o o o

Will Day's Catalogue for 1926.

The new catalogue for 1926 just issued by Messrs. Will Day, Ltd., covers, in addition to British apparatus, many of the leading lines now being imported from America. Handsomely illustrated and produced on art paper, the catalogue runs to 68 pages. It is obtainable from Will Day, Ltd., 19, Lisle Street, Leicester Square, London, W.C.2, at the price of 6d., which covers costs of postage and packing.

o o o o

New Works.

Messrs. Wright and Weaire, Ltd., manufacturers of “ Wearite ” wireless

components, have moved their works from 29, Halton Road, N., to more commodious premises at 174, High Road, Tottenham, N.

o o o o

C.A.V. Service Extension.

Messrs. C. A. Vandervell and Co., Ltd., of Warple Way, Acton, London, W.3, announce that stocks of all C.A.V. radio apparatus, including Radio accumulators, can now be obtained from the following depots of Joseph Lucas, Ltd., and Rotax (Motor Accessories), Ltd.:—

Joseph Lucas, Ltd., 224, Shaftesbury Avenue, London, W.1.
Joseph Lucas, Ltd., 68, St. Mary's Place, Newcastle-on-Tyne.
Joseph Lucas, Ltd., Great King Street, Birmingham.
Joseph Lucas, Ltd., 209, St. George's Road, Glasgow.
Rotax (Motor Accessories), Ltd., 117, Park Lane, Leeds.
Rotax (Motor Accessories), Ltd., 7, Temple Street, Bristol.

Messrs. C. A. Vandervell and Co., Ltd., hope that this extension of service will prove of assistance to their many friends in the radio trade.

o o o o

Philips Lamps in the West.

Owing to the increasing demand for their products in the West of England, Messrs. Philips Lamps, Ltd., have opened a new branch and distributing centre at 34, Marsh Street, Bristol.

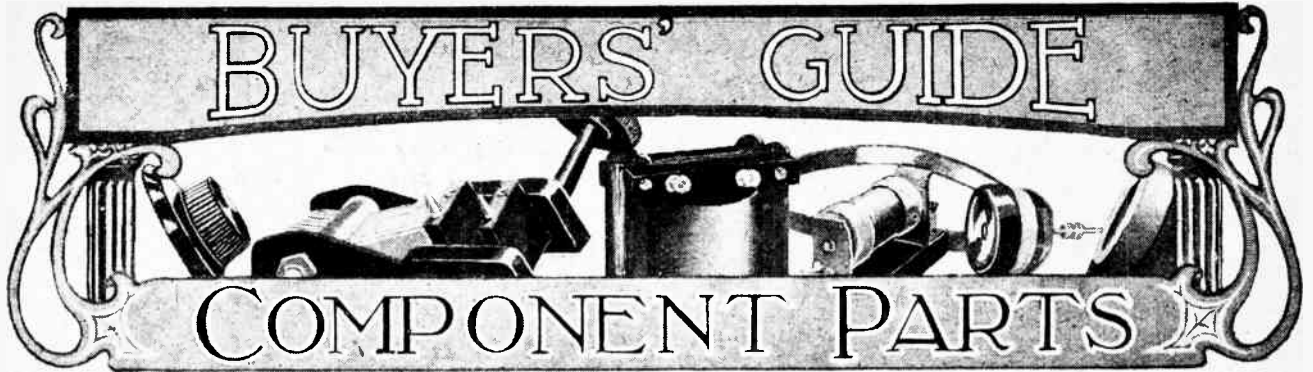

L.F. Transformers, L.F. Chokes and Anode Resistances.

THE very cordial reception accorded to the Buyers' Guides to Standard Receivers and to Portable Receivers which we have published in previous issues has encouraged us to bring out a similar guide to Standard Component Parts for the benefit of the amateur constructor. The preparation of this list has proved a somewhat more difficult task than that of the previous two guides, and it is not easy to specify in tabular form all the main features of each component. The information contained in this and lists to be published subsequently has been furnished by the respective manufacturers, to whom we have to express our cordial thanks for the able manner in which they have helped us.

The appliances and apparatus that may reasonably be described as component parts of wireless sets are so many and varied that we deemed it advisable to limit the list

to certain selected parts in common use, and, while indicating the principal data required, left the general description of each item to the good judgment of its manufacturer. In most cases the manufacturers have fully appreciated the nature of the information desired, and have furnished us with brief and compact descriptions of their goods. A few have been over-described and some under-described, while one or two sent in profuse descriptions of components and accessories which were not included in our selected list. We trust, however, that our efforts to tabulate the very varied data have produced a valuable list in which all essential particulars are clearly stated and no important point omitted, though we must admit that it has been difficult to condense the details into a common form applicable to every item in any particular class of component.

TRANSFORMERS (L.F.).

Manufacturer.	Name or Type.	Ratio.	Price.	Remarks.
Aeme Production Co., Ltd., Britannia Works, Engine Street, Smethwick, Birmingham.	Aeme A.2	1-1.25	£ s. d. 0 16 6	
Anderson's Wireless Sales Agency, 9 15, Oxford Street, London, W.1.	Argus	—	0 9 0	
Beard & Petch, Ltd., 31, Aylesbury Street, London, E.C.1.	Super Success	1-2.7 and 1-1	1 1 0	
	Silver Success	1-2½ and 1-3	1 1 0	
	Standard Success	1-3, 1-4, 1-5, etc.	0 16 0	
Renoit, M., 17, Ashchurch Park Villas, London, W.12.	Hamn	1-1	0 6 10½	Shrouded 3/- extra.
	"	1-3	0 7 7½	" 2/10½ ..
	"	1-4	0 8 3	" 3/- ..
	"	1-5	0 8 10½	" 2/10½ ..
Blackkadda Radio Co., Ltd., 18, Sadler Gate, Derby.	Adda	1-1	1 5 0	Shrouded in metal case.
Bobin, Maurice, 21, Warwick Lane, London, E.C.1.	F.A.R.	1-1	0 13 3	Shrouded in metal cover.
	"	1-3	0 14 3	"
	"	1-5	0 15 0	"
	"	1-10	0 16 0	"
Brandes, Ltd., 296, Regent Street, London, W.1.	Brandes	1-5	0 17 6	Black finish.
British L.M. Ericsson Manufacturing Co., Ltd., 67/73, Kingsway, London, W.C.2.	Ericsson	1-3	0 17 6	Brown finish.
	"	1-2 and 1-4	0 17 6	
Bulgin, A. F. & Co., 9/11, Corsitor Street, London, E.C.4.	Decko	1-3	0 16 0	
Burndept Wireless, Ltd., Aldine House, Bedford Street, London, W.C.2.	Burndept	1-4	1 1 0	
	"	1-2.6	1 1 0	
Bygrave, W. & Sons, 129, Constitution Hill, Birmingham.	Bygrave	1-2½, 1-3, 1-4, 1 5 and 1-6	1 5 0	
Clarke, H., & Co. (Manchester), Ltd., Atlas Works, Eastnor Street, Old Trafford, Manchester.	Atlas	1-4½	0 12 6	
Currys, Ltd., 24 28, Goswell Road, London, E.C.1.	Curry Junior		0 8 6	
	Belyoir		0 12 6	
	Curry Shrouded		0 15 0	Metal shrouded; impregnated windings.
	Curtis	1-3 and 1-5	1 1 0	
Curtis, Peter, Ltd., 11, Red Lion Square, London, W.C.1.	Ediswan	1-3	0 17 6	0.001 mfd. fixed condenser is permanently fixed across the primary winding.
Edison Swan Electric Co., Ltd., Ponders End, Middlesex.				

TRANSFORMERS (L.F.)—continued.

Manufacturer.	Name or Type.	Ratio.	Price.	Remarks.
Falk, Stadelmann & Co., Ltd., 89-93, Farringdon Road, London, E.C.1.	Efesca " B "	1-4	£ s. d. 1 1 0	One-hole fixing.
Ferranti, Ltd., Hollinwood, Lancashire.	" " C "	1-2	1 5 0	
	Ferranti A.F.3	1-3½	1 5 0	Shrouded steel case. By-pass condenser is incorporated. Primary inductance 80 henries; impedance at 100 cycles, 50,000 ohms; do. 500 cycles, 410,000 ohms.
" " " "	" " A.F.4	1-3½	0 17 6	Shrouded steel case. By-pass condenser is incorporated. Primary inductance 28 henries; impedance at 100 cycles, 17,500 ohms; do. 500 cycles, 90,000 ohms.
Formo Co., Crown Works, Cricklewood Lane, London, N.W.2.	Formo Perfection	1-1	1 1 0	
" " " "	" " Shrouded	1-1, 1-2, 1-3, 1-4, and 1-5	1 1 0 0 10 6	
General Electric Co., Ltd., Magnet House, Kingsway, London, W.C.2.	Gecophone B.C.869	1-1	1 5 0	
" " " "	" " B.C.870	1-2	1 2 6	
" " " "	" " B.C.720	1-2	1 2 6	
" " " "	" " B.C.725	1-1	1 5 0	New pattern.
General Itadio Co., Ltd., Radio House, Regent Street, London, W.	G.R.C.83	—	0 15 0	
Gent & Co., Ltd., Faraday Works, Leicester.	G.R.C.81	—	1 5 0	Power type.
" " " "	Tangent	1-3.33	0 12 6	Unshrouded.
" " " "	" "	1-3.33	0 14 6	Shrouded.
" " " "	" "	1-1	1 5 0	Suitable for D.E.5 or similar valve.
Gladwell & Kell, Ltd., 258, Gray's Inn Road, London, W.C.1.	Supertran	1-3½	0 19 6	Shrouded (unshrouded 1/- less).
Grafton Electric Co., 54, Grafton Street, London, W.1.	Greco Giant	1-5	0 19 6	
" " " "	" "	1-2, 1-4, 1-6 and 1-8	1 7 6	
H.T.C. Electrical Co., Ltd., 2, Boundaries Road, Balham, London, S.W.12.	H.T.C. Empire	1-1	0 7 6	
" " " "	H.T.C.	1-3 and 1-5	0 15 0	Also made as telephone transformer for 120-ohm phones or loud-speaker.
Hough, J. E., Ltd., Edison Bell Works, Glengall Road, London, S.E.15.	Edison Bell	—	1 1 0	Enamel wire.
" " " "	" "	—	1 7 6	Silk-wound.
India Rubber, Gutta Percha & Telegraph Works Co., Ltd. (The Silver-town Co.), Silvertown, E.16.	Silvertown	1-2, 1-3 and 1-1	1 1 0	
" " " "	" "	1-1 and 1-1	1 2 6	With centre tapping.
" " " "	" "	1-7	1 5 0	
Lamplugh, S. A., Ltd., King's Road, Tyseley, Birmingham.	Lamplugh	1-3 and 1-5	1 2 6	
Lever, Eric J., 33, Clerkenwell Green, London, E.C.1.	Trix	1-5	0 6 6	Shrouded.
Lissen, Ltd., Lissenium Works, Friars Lane, Richmond, Surrey.	Lissen T.1	1-2½	1 1 0	
" " " "	" " T.2	1-1	0 18 0	
" " " "	" " T.3	1-1	0 12 6	
McMichael, L., Ltd., Wexham Road, Slough, Bucks.	M.H.	—	1 1 0	With 0.001 mfd. fixed condenser 3/- extra.
Marconiphone Co., Ltd., 210-212, Tottenham Court Road, London, W.1.	Marconiphone	1-3	1 1 0	" Ideal Junior." Suitable to follow all detector valves.
" " " "	" "	1-2.7, 1-4, 1-6 and 1-8	1 10 0	" Ideal." Primary impedances, calibrated for all valves.
" " " "	" "	1-1	2 0 0	
Ormond Engineering Co., Ltd., 199-205, Pentonville Road, London, N.1.	Ormond	1-3	0 15 0	Shrouded.
Penton Engineering Co., 15, Cromer Street, London, W.C.1.	Penton	1-3 and 1-1	0 10 6	
Peto Scott Co., Ltd., 77, City Road, London, E.C.1.	Max-Amp	—	0 19 6	Reflex, first and second stages.
" " " "	" "	—	1 10 0	Power.
Portable Utilities Co., Ltd., Eureka House, Fisher Street, London, W.C.1.	Eureka Concert Grand	1-1	1 5 0	
" " " "	" "	1-3	1 1 0	
" " " "	Eureka Baby Grand	1-3 and 1-4½	0 15 0	
" " " "	Eureka Reflex	1-8	0 15 0	
" " " "	" "	—	1 10 0	
Radio Experimental Co., Ltd., Carver Street Works, Sheffield.	R.E.	1-4	1 5 0	
Radio Instruments, Ltd., 12, Hyde Street, London, W.C.1.	R.I.	1-4	1 5 0	
Ripaults, Ltd., King's Road, St. Pancras, London, N.W.1.	Ripaults	1-3	0 13 6	Shrouded.
" " " "	" "	1-5	0 14 6	
Rothermel Radio Corporation of Gt. Britain, Ltd., 24 and 26, Maddox Street, London, W.1.	Royal	1-3 and 1-1½	1 0 0	
" " " "	Karas Harmonik	—	1 17 6	
" " " "	Bremer Fully Euphonie	1-2.3	1 6 6	
" " " "	" "	1-1.7	1 9 6	
Telsen Electric Co., 207, Aston Road, Birmingham.	Telsen Shrouded	1-3 and 1-5	0 15 6	
" " " "	" " Popular	—	—	
" " " "	Telsen Standard Open Type	1-3 and 1-5	0 14 0	
" " " "	Telsen Ace	1-3 and 1-5	0 9 6	Shrouded.
" " " "	Croix	1-3 and 1-5	0 5 9	
Temant, F. M., 24, Hartley's Buildings, Hylton Road, Sunderland.	Renown	1-1, 1-2, 1-3, 1-4 and 1-5	0 8 4	
Transformer Repair Co., Hay Street, Portsmouth.	Era	—	0 12 6	
Vokes, C. G., & Co., 38, Conduit Street, London, W.1.	" " Concert Grand	—	1 1 0	
" " " "	" "	—	2 7 6	
" " " "	Regal	—	0 18 6	
" " " "	Precise	—	0 19 6	
" " " "	" " Comet	—	0 15 0	
" " " "	" " Super-size	—	1 7 6	
Ward & Goldstone, Ltd., Frederick Road (Pendleton), Manchester.	Golfoue	1-2 and 1-5	0 16 6	Non-terminal type. With terminals, 1/- extra.
Watson Jones, Ltd., St. Stephen's House, Victoria Embankment, London, S.W.1.	Westminster	1-5	0 9 6	
West Scientific Apparatus Co., Ltd., Premier Place, High Street, Putney, S.W.15.	The Melba	1-5	0 8 6	
Wootton, F. E., Ltd., 56, High Street, Oxford.	Wootophone	1-3 and 1-5	0 19 6	

CHOKES (L.F.), CHOKE-COUPLING UNITS, &c.

Manufacturer.	Name or Type.	Price.	Remarks.
Beard & Fitch, Ltd., 34, Aylesbury Street, London, E.C.1.	Success 1	£ 0 18 6	Inductance approximately 20 henries. Inductance approximately 8 henries. Amplifying unit.
	2	0 10 6	
Bretwood, Ltd., 12/18, London Mews, Maple Street, W.1.	Auto-Audio Frequency Amplifier.	1 0 0	
Burndept Wireless, Ltd., Aldine House, Bedford Street, London, W.C.2.	Burndept	1 10 0	20 henries 0.05 amps. for choke control transmitters and smoothing circuits.
Forno Co., Crown Works, Cricklewood Lane, London, N.W.2.	Forno	0 17 6	Choke capacity coupling unit, iron core, wire-wound choke with resistance and capacity elements incorporated in compact form and connections marked.
Grafton Electric Co., 51, Grafton Street, London, W.1.	Greleo	1 5 0	D.C. resistance 650 ohms.
Lissen, Ltd., Lissenium Works, Friars Lane, Richmond, Surrey.	Lissen	0 10 0	Inductance 20 henries, approximate D.C. resistance 2,000 ohms.
Ormond Engineering Co., Ltd., 199-205, Pentonville Road, London, N.1.	Ormond	0 15 0	Shielded.
Peto Scott Co., Ltd., 77, City Road, London, E.C.1	Keystone	0 10 6	A complete choke unit. No separate grid leak or condenser required.
Portable Utilities Co., Ltd., Eureka House, Fisher Street, London, W.C.1.	Eureka	1 5 0	
Radio Communication Co., Ltd., 31/35, Norfolk Street, W.C.2.	Polar	0 10 6	10,000 ohms for last stages.
Radio Instruments, Ltd., 12, Hyde Street, London, W.C.1.	R.I.	0 12 6	80,000 ohms for first stages.
Stevens, A. J. & Co. (1911), Ltd., Walsall Street, Wolverhampton.	A.J.S.	0 10 0	Ebonite end plates fitted with bracket for screwing down.
	0 15 0	Choke unit for first stage, comprising choke, by-pass, coupling condensers and grid leak.
	1 0 0	
Transformer Repair Co., Hay Street, Portsmouth	Renown	1 0 0	Ditto for second and subsequent stages (without by-pass).
Watmel Wireless Co., Ltd., 332a, Goswell Road, London, E.C.1.	Watmel	0 8 4	L.F. choke, 10,000 turn, 100 henries; for smoothing, filtering and coupling.
Western Laboratories, Ltd., 11, Hanbury Road, Acton, London, W.3.	W.L.L.	0 18 6	Auto-choke, fitted complete with the necessary coupling, condenser and grid leak, 2 fixing holes only required.
		0 8 9	Inductance 35 henries, low self capacity, completely covered iron area, open type iron core.

RESISTANCES (ANODE).

Manufacturer.	Name or Type.	Resistance.	Price.	Remarks.
Ashley Wireless Telephone Co. (1925), Ltd., Finch Place, Falkland Street, London Road, Liverpool.	Ashley	Ohms.	£ s. d.	Complete with clips.
	60,000	0 4 0	
	70,000	0 4 0	
	80,000-100,000	0 4 0	
Climax Radio Electric, Ltd., Quill Works, Putney, London, S.W.15.	Climax	25,000	0 5 0	Complete with holder.
	50,000	0 5 0	
	75,000	0 7 6	
	25,000	0 5 6	
Dubilier Condenser Co. (1925), Ltd., Ducon Works, Victoria Road, North Acton, London, W.3.	Dubilier	30,000	0 5 6	Spare cartridges 1/6. Micrometer type. Spare cartridges 1/3.
	40,000	0 5 6	
	50,000	0 5 6	
	60,000-100,000	0 5 6	
Enterprise Manufacturing Co., Ltd., Electric House, Grape Street, London, W.C.2.	E.M.C.	5,000-15,000	0 4 0	Variable.
	25,000-50,000	0 3 6	
	50,000-100,000	0 4 0	
	70,000-110,000	0 1 6	
Falk, Stadelmann & Co., Ltd., 89/93, Farringdon Road, London, E.C.1.	Efesa	0-100,000	0 3 0	Mounted on base, metallic elements.
Lever, Eric J., 33, Clerkenwell Green, London, E.C.1.	Trix Selenium	20,000-500,000	0 1 9	
Lissen, Ltd., Lissenium Works, Friars Lane, Richmond, Surrey.	Lissen	20,000-3,000,000	0 2 6	Non-inductive. Wire-wound type for resistance-capacity coupling.
	80,000 and 100,000	0 10 0	
McMichael, L., Ltd., Wexham Road, Slough, Bucks.	M.H.	10,000-150,000	0 1 6	Tested to working load of 2-3 milliamps. If mounted on ebonite base with terminals, 1 extra.
Metro-Vick Supplies, Ltd., Trafford Park, Manchester.	60,000-80,000, and 100,000	0 7 6	Wire-wound on Bakelite base, with terminals and clips.
Oliver "Bell Control," Ltd., Granville House, Arundel Street, London, W.C.2.	Varley	60,000, 80,000 and 100,000	0 6 0	Do., without base.
	0 7 6	Bi-duplex wire-wound, with clips and base.
Ripault's, Ltd., King's Road, St. Pancras, London, N.W.1.	Ripaults	50,000	0 6 0	Do., without clips and base.
	80,000	0 3 6	Complete with fixing brackets.
	100,000	0 3 6
Rothermel Radio Corporation of Gt. Britain, Ltd., 21 and 26, Maddox Street, London, W.1.	Electrad	1,500-100,000	0 8 0	Wire wound.
	500-50,000	0 8 0
	0-500,000	0 8 0
	Central Radio	0-500,000	0 10 6	Graphite resistance elements.
	0-50,000	0 10 6
	0-100,000	0 10 6
	0-200,000	0 10 6
	Bradley-ohms No. 5	1,000-10,000	0 9 6	Compression type; graphite discs.
 No. 10	10,000-100,000	0 9 6
 No. 25	25,000-250,000	0 9 6
 No. 50	50,000-500,000	0 9 6
Saxon Radio Co., Henry Street Works, South Shore, Blackpool, Lancs.	0 4 0	With base and clips, 1 extra.
Ward & Goldstone, Ltd., Frederick Road (Pendleton), Manchester.	Goltone	20,000-100,000	0 3 6	With nickel clips.
Watmel Wireless Co., Ltd., 332a, Goswell Road, London, E.C.1.	Watmel	50,000-100,000	0 3 6	Red knob. Single-hole fixing.
	10,000-75,000	0 3 6	Green knob. Single-hole fixing.
Wright & Weaire, Ltd., Halton Road, Canonbury, London, N.1.	Wearite	50,000	0 9 0	Non-inductive. If inductively wound, 6d. each less.
	60,000	0 9 0
	80,000-100,000	0 10 0
Zepith Manufacturing Co., Villiers Road, Willesden Green, N.W.2.	Zenite Resistance Units	80,000	1 2 6	Vitreous enamelled resistance rods.
	100,000	1 4 6
	120,000	1 5 6



CLUB REPORTS AND TOPICS

Bournemouth's Wireless Conference.

A conference of wireless organisations, promoted by the Bournemouth and District Radio Society, drew a large attendance at St. Peter's Hall on Wednesday, April 28th. Visitors came from as far afield as Exeter, Bristol, Newbury, Salisbury and Blandford.

Among the speakers were the Mayor (Councillor H. J. Thwaites), Sir Dan Godfrey, Rev. H. Wilbur Ennis, and Commander J. R. Schofield. At the evening meeting an interesting address was given by Professor A. M. Low. During the day a visit was paid to the Bournemouth broadcasting station.

○○○○

The Evolution of a Condenser.

The story of the condenser, its manufacture and use, was told to an interested audience of members of the Leeds Radio Society on April 9th by Mr. Haywood, of the Dubilier Company. After dealing briefly with the condenser theory, the lecturer took his hearers in imagination to the mica mines in India, where, with the assistance of lantern slides, the natives were seen at work obtaining the raw product. By easy stages the members were able to watch the evolution of the condenser, from the mica in its raw state to the finished article on the workbench.

Some interesting slides were shown depicting the giant mica condensers in use at the P.O. Station at Rugby. Each unit weighs 5 tons and contains 800,000 pieces!

Secretaries of Local Clubs are invited to send in for publication club news of general interest. All photographs published will be paid for.

New H.Q. at Manchester.

Improved facilities for experimentation are now available to members of the Manchester Radio Scientific Society, new headquarters having been acquired at 6, Booth Street East, Manchester. A work bench has been fitted up and lockers are provided for the use of each person. The members are at present actively engaged in fitting new equipment, and the society hopes shortly to resume its normal course and to continue to justify its reputation as one of the most active societies in the country.

○○○○

Broadcasting Trials and Triumphs.

In lecturing recently before the Golders Green and Hendon Radio Society Mr. J. A. H. Whitehouse, of the B.B.C., provided one of the most enjoyable evenings of the session. His subject was "Frequency in Relation to Broadcasting." With the assistance of lantern

slides showing the B.B.C. studios Mr. Whitehouse outlined the early struggles in the search for the perfect microphone, and described the different types that had been used. The story was told of the difficulties experienced in obtaining intelligible and natural reproduction, of the attempts to overcome the echo problem, and of how outside and relay broadcasting was carried out. Some interesting views were shown of the Daventry high power station.

Hon. secretary, Lt.-Col. H. A. Scarlett, 357a, Finchley Road, N.W.3.

○○○○

Controlling Oscillations by Light.

Before the Ilford and District Wireless Society on April 27th Mr. G. G. Blake gave a fascinating lecture and demonstration on "The control of Oscillating Current by Visible Light." Of the two methods of control, viz., the Widdington heterodyne and the Dowling zero shunt, the lecturer expressed a preference for the former, on account of its shorter time lag. Ordinary wireless circuits were used in both systems, and Mr. Blake's demonstration apparatus incorporated selenium cells in place of grid leaks. The cells in use were those of Dr. Fournier d'Albe.

Hon. secretary, Mr. D. S. Richards, Swinford, Empress Avenue, Ilford, Essex.

○○○○

"Resistance Losses in Coils."

A lecture on the above subject was recently given before the Oxford University Radio Society by Mr. R. J. Hardisty, B.A.

"Low loss" condensers, said the lecturer, had been manufactured for twenty years; as for coils, losses could only be cut down by using single-layer coils. The spacing was immaterial, as the magnetic losses outweighed completely the capacity losses.

The hon. secretary of the society for the present term is Mr. M. A. Spender, Balliol College.

○○○○

Tuning without Oscillation.

Mr. J. A. Whitehouse, of the B.B.C., gave a useful lecture on "Methods of Avoiding Oscillation" at a public meeting held under the auspices of the Norwich and District Radio Society on April 23rd.

After demonstrating with a broadcast receiver, Mr. Whitehouse answered numerous questions on the technical side of broadcasting. Capt. Hampson (G6JV), who moved a vote of thanks, said that the meeting constituted an effective reply to the scathing comments which had been made, suggesting that the society was apathetic on the question of oscillation in Norwich.

The new hon. secretary of the society is Mr. G. Bayes Hayden, 37, Sandringham Road, Norwich.



ENTHUSIASM AT BOURNEMOUTH. Some of the officials and visitors who attended the successful wireless conference recently organised by the Bournemouth and District Radio Society. Visitors came from as far afield as Exeter, Bristol, Newbury, and Salisbury.

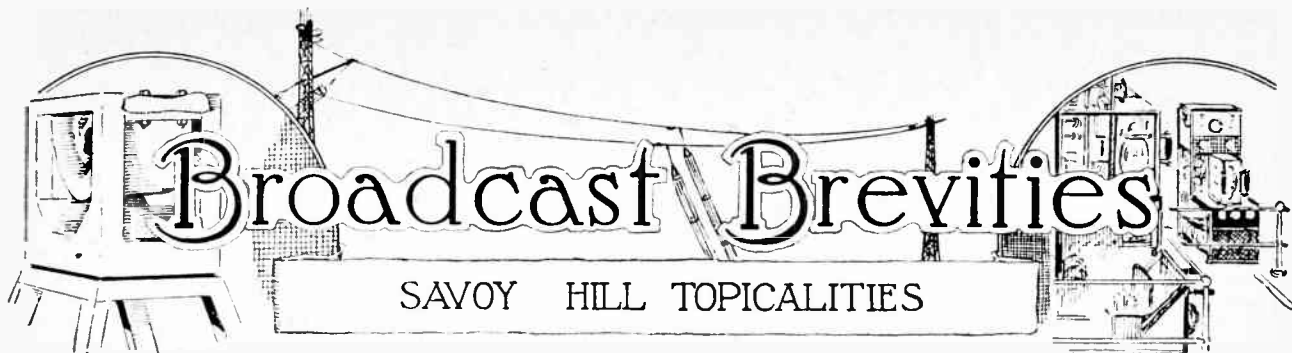

SAVOY HILL TOPICALITIES

By Our Special Correspondent.

The Future of Broadcasting.

In most respects the desire of the great industries is to let the dead past bury its dead, so far as the events and experiences of the general strike are concerned; but as regards broadcasting and its future status the lessons of the strike have opened up quite a new aspect and have brought home to everybody a truer idea of the possibilities of wireless and its part in the nation's life.

○○○○

Speeches in Parliament.

One important respect in which broadcasting is expected to be looked at from a different angle is in connection with broadcasts of the proceedings in Parliament on occasions of importance. Many M.P.'s who opposed the suggestion that was made a few weeks ago to broadcast the Budget speech are now understood to have changed their views; and as a result of the incalculable service rendered by wireless in the circulation of strike news, they would not now be averse from the idea of occasional broadcasts from the House of Commons.

○○○○

A Bill Before the House.

In Government circles, too, the part played by broadcasting during the strike will have some influence on the plans which are being prepared for the future conduct of the service. A short Bill of scarcely greater length than the Wireless Telegraphy (Explanation) Act of 1925, which consisted of two clauses only, may be expected just before the autumn recess. This Bill will not constitute a Government monopoly, but will merely ensure the use of the broadcasting machinery for definite official purposes, as and when required.

○○○○

A New B.B.C.

In short, Government control need not be looked for; rather, the procedure of the Companies Acts may be utilised and the new authority incorporated as a company, limited by guarantee. The Postmaster-General would in that case nominate the subscribers to the memorandum of association and places would be found either on the commission that will be established, or immediately under its control, for the officials of the present company who have done yeoman service during the recent industrial crisis. The line of the new legislation, about which

many elaborate speculations have been made, will be chiefly to prevent broadcasting from becoming a profit-making concern; to institute an incorporated body carrying on the work on much the same administrative lines as at present; for during the past two or three weeks the officials have shown that very little evolution in the service is necessary in the public interest, and that, after all, is all that the Government are concerned with.

○○○○

The Educational Side.

The educative influence of broadcasting is increasing, not only in this country, but also among other nationalities. This influence is being exerted by means of competitions in which listeners act in the capacities of both judge and prizewinner. Great Britain started the ball with "request" programmes and unnamed items; the work of selection in the former case being left to the listener's discrimination, while in the

latter case listeners were asked to distinguish musical items which were not previously announced. Then, prizes have been awarded to juvenile scholars for essays in connection with schools' transmissions.

○○○○

To Discover New Talent.

Other prizes have been given for the most fitting conclusion to mystery stories, the first part only of which has been broadcast, and for the correct description of various noises heard through the microphone. In addition, prizes have been awarded for choosing programmes based upon the public predilection; and, finally, there is the competition now being conducted with the object of discovering new musical talent specially suitable for the requirements of broadcasting.

○○○○

Wireless Shorthand Tests.

In the shorthand speed test, conducted some months ago from 2LO by Lord Riddell, no prize was given; but a New



SAVOY HILL AND THE STRIKE. That the authorities recognised the vital importance of safeguarding the broadcasting service during the strike is shown by this photograph, taken outside "No. 2" on one of the crucial days when no news meant anything but good news.

York station has gone one better and has awarded medals in a similar contest to shorthand writers who were able to take broadcast dictation at speeds of 80, 100, and 120 words a minute. The entrants had to take down and transcribe in the presence of reliable witnesses, who posted the transcripts to the broadcasting station with a certificate that the conditions had been fulfilled.

o o o o

A Wireless Man Hunt.

A feature that will test the ingenuity of listeners, who are to be offered prizes for correct solutions, will be a wireless man hunt, or voice hunt, which is being organised by the B.B.C. The hunted man will appear in the programme at intervals and in various places and will make some announcement or read an item. Listeners will be asked to give a full description of this man's movements from station to station.

o o o o

Melba to Broadcast.

It is good news that the Covent Garden Opera season will not pass without providing listeners with an opportunity of hearing Dame Melba in what are expected to be her last appearances on the operatic stage. No dates have yet been fixed, but it is believed that Dame Melba will have no objection to being broadcast in the opera in which she is appearing.

o o o o

Her First Broadcast.

I remember a humorous little interlude which occurred on the night of Melba's first broadcast at that tiny station at Writtle which Captain Eckersley conducted in the days when no one dreamed of broadcasting becoming the potent force that it now is. On arriving at the station, Melba glanced up at the aerial and said "And is it from there that my singing will be broadcast?" On being assured that it was, the great prima donna remarked, "Jolly good thing I haven't got to climb up there to sing."

o o o o

The Aldershot Searchlight Tattoo.

The arrangements for broadcasting the Aldershot Command Searchlight Tattoo have now been fixed, and the transmission will take place on June 15th from 9.20 to 10.33 and from 11.22 to 11.40 p.m. The skeleton programme provides for the broadcasting of the following items:—

- Entry of Massed Bands.
- First Post and Bugle Marches with band accompaniment.
- Pyramid of Searchlights and Lighting of Woods.
- Musical Drive by the 1st Brigade Royal Horse Artillery Massed Trumpeters.
- Entry of Massed Bands and Torch-bearers.

o o o o

Better than Wembley.

It is a pity that television has not yet advanced to that stage where it is possible to convey to listeners the magnificent spectacular effect of this Tattoo, which outrivals anything that Wembley could produce.

B 36

British Wavelengths.

Statements which have been made in certain quarters recently, purporting to represent proposed changes in the wavelengths of some of the British transmitting stations as a result of the Geneva Conference in March last, should be ignored. Numerous suggestions have been put forward in connection with the necessary forthcoming redistribution of European wavelengths. None has yet been approved, and announcements affecting any part of the proposals are conjectural and unauthorised.

FUTURE FEATURES.

Wednesday, May 26th.

LONDON.—Beating Retreat relayed from Marine Parade, Dover.

BOURNEMOUTH.—"The Wizard of Wireless"—a Romance of Radio.

CARDIFF.—The Versatile Entertainers in "A Wireless Broadcasting Rehearsal."

NEWCASTLE.—"A Little Fowl Play"—a Farce in One Act.

Thursday, May 27th.

LONDON.—The Variety Artists' Benevolent Fund Concert.

MANCHESTER.—"In a Persian Garden"—Song Cycle for Four Solo Voices.

Friday, May 28th.

LONDON.—The Kneller Hall Band.

GLASGOW.—Pianoforte Recital by Leff Pouishnoff.

MANCHESTER.—The Crosswell Colliery Institute Prize Band.

Saturday, May 29th.

LONDON.—"The Bee-Cabaret."

ABERDEEN.—"The May Queen"—a Pastoral for Choir and Orchestra.

CARDIFF.—The University of Bristol Department of Education Concert.

High-Power Stations.

Listeners should not be unnecessarily alarmed at the idea that when the higher power scheme of broadcasting is put in operation, those who live in proximity to one of the new stations will have their reception facilities spoiled so far as any other station is concerned, and that only those who are able to indulge in the expense of super-selective sets will get anything in the way of alternative programmes. If the B.B.C. had given way before the protests that greeted the opening of the new 2LO last year, on a power of 3 kW., development would have been crippled and the effective crystal range of the London station would still be limited to the old seventeen or eighteen miles, instead of twenty-five miles, as at present.

o o o o

Regional Transmitters.

America has already passed through the phase upon which we are entering. The Americans long ago realised that high power would tend to stimulate greater interest in broadcasting and sought for a release from restrictions upon power; the high-power stations were to be placed outside the towns or cities at distances varying according to empirical formula with the proposed power. The plan of dividing the country into zones, with so many super-power stations to each zone, is one which will be applied in a modified form to Great Britain. In the complete scheme to be prepared for this country there will be at least two high-power alternatives, and thus the swampy effect of one very strong station will be nullified, while atmospherics and other forms of interference will be overcome to a considerable extent. The higher-power stations will not be located in congested districts, and the service which they supply will be available on crystal sets to additional areas comprising a population of some 3½ millions. The designers of other types of receiver will soon set their energies to work to produce a receiving set that is adapted to the new conditions.

o o o o

A Diving Broadcast.

The diving novelty which was announced some time ago and postponed, has now been fixed to take place on June 21 next, when Mr. F. Shield, of Whitstable, will make a descent in the Thames. Mr. Shield has had nineteen years' experience of diving and suffers no illusions as to the nature of the work. He says that most people have no doubt heard, at some time or another, a deep, manly voice pouring forth a lot of "piffle" about "toiling for wealth on the brink of the grave." He thinks that "piffle" is the only word to use. The diver is certainly a toiler, but when at his work he is no nearer the brink of the grave than millions of other workers in mines, factories, etc., to say nothing of some singers on concert platforms. If anyone thinks of taking up diving as a means of getting rich quick, Mr. Shield is all against it. . . . But he will tell listeners, on June 21st, exactly what sort of life the diver leads.



NEWS! An announcer broadcasting a news bulletin from London and Daventry during the strike.

WIRELESS CIRCUITS

in Theory and Practice.

12.—Receiving Valves.

By S. O. PEARSON, B.Sc., A.M.I.E.E.

THE three-electrode valve, with its wonderful properties, is without a doubt the most important piece of apparatus employed in wireless telegraphy and telephony. It is due almost entirely to the perfection of the valve that wireless telephony has become so practicable, the development being greatly stimulated by necessity during the war.

The first thermionic valve was used by Professor J. A. Fleming in 1904. This was a two-electrode valve, or "diode," and consisted of a filament surrounded by a cylindrical metal sheath or "plate," the whole being enclosed in a glass bulb from which the air was exhausted, leads being brought out through the glass from the ends of the filament and from the sheath or plate. With such an arrangement it is found that when the filament is heated to incandescence by passing a current through it from a battery, and when the plate is given a positive potential with respect to the filament, a current passes between the plate and filament across the vacuum; but when the plate is made negative with respect to the filament no current whatever will flow. Thus the arrangement constitutes an electrical "non-return valve," and was used extensively as a rectifier or detector of high-frequency oscillations in wireless receivers before the advent of the three-electrode valve. The term "valve" has been retained, and is almost universally applied to the present-day modifications with three or more electrodes, although in the true sense of the word the latter are not used as valves at all.

Ionic Currents.

In order to understand the operation of a thermionic valve it is necessary to know the nature of the current passing between the filament and the plate. In the early days it was impossible to exhaust all of the air out of the bulb, some of the gas always being retained in a rarefied state. The result was that when the applied plate voltage was increased up to a certain point a blue glow appeared in the space between the filament and the plate, this being due to the fact that the rarefied gas became "ionised"—that is, converted into a conducting state. Under these conditions the gas is split up into minute particles called "ions" carrying charges of electricity. Those ions carrying positive charges are called positive ions, and those carrying negative charges are called negative ions. The origin of the name "thermionic" is thus quite clear.

At first it was thought that the current between the filament and the plate was entirely an ionic current conducted by the gas, but it was soon discovered that a

current could flow even if no gas were present at all in the bulb, and in nearly all modern valves the bulbs are exhausted to the greatest possible degree, and are called "hard valves." Those containing traces of gas are known as "soft" valves.

Electrons and Electronic Emission.

The nature of the current passing between the plate and the filament in a very highly exhausted bulb is quite different from that in a bulb where a considerable amount of gas is left. In a perfect vacuum there are no ions present to carry the charges of electricity across the gap, and in this case it is found that a stream of "electrons" is emitted from the hot filament and drawn across the vacuum by the positive potential of the plate. Now, an "electron" is the smallest charge of negative electricity believed to be capable of existing by itself, and according to the *electron theory* an atom of any particular substance is made up of a number of these negative electrons in motion round a positive charge called the nucleus. The nature of the atom depends on the number of electrons present and their arrangement about the nucleus. What concerns us here, however, is the fact that each atom is capable of holding a number of electrons over and above those determining its physical properties. Every atom is supposed to contain a number of these "loose" electrons, and by giving a body a positive charge of electricity, what we are really doing

is to take away some of these extra electrons. Similarly, when a number of electrons are added to an atom, the latter is given a negative charge. By the electron theory a current of electricity in a conductor is explained as a transference of electrons from one atom to another in the conductor, and, since under steady conditions of current, each atom remains at a constant potential, it follows that the number of electrons in each atom is always the same; thus, as an electron enters

an atom another electron must of necessity be shot off from the other side, this process going on all through the conductor. It is necessary to consider a current of electricity in this light in order to see what becomes of the stream of electrons from the heated filament of the valve when they enter the plate.

Consider a two-electrode valve in which the vacuum is assumed to be perfect, so that the current between the plate and the filament is in the nature of pure electronic emission from the filament. In Fig. 1 such a valve is shown connected, so that the voltage between the plate and the filament can be varied, a milliammeter being included in the plate lead to measure the current. It is

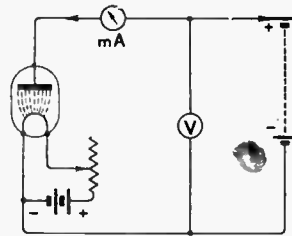

Fig. 1.—Diagram of connections for finding the characteristic curve of a two-electrode valve.

Wireless Circuits in Theory and Practice.—

found that current flows from the plate to the filament according to the usual notation of direction of a current; but it is known that the current in the vacuum between the plate and the filament consists of a stream of electrons being emitted from the hot filament and passing over to the plate, and this is why the electrons are said to be negative. The choice of sign in the first place was purely arbitrary, and it is unfortunate that the direction decided upon as positive happens to be opposed to the direction of motion of the electrons emitted from a hot body and to their direction of motion through a conductor.

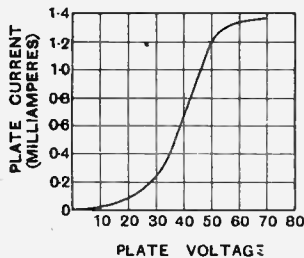

Fig. 2.—Typical characteristic curve of a two-electrode valve.

therefore, that each electron in the stream passing from the filament to the plate exerts a repulsive force on its neighbours. From this it follows that those electrons which have already got away from the filament are tending to drive back those which are just about to leave the filament. In other words, the electrons in the space between the filament and the plate constitute a negative charge of electricity whose electric field is in such a direction as to oppose the emission of any further electrons from the filament. This negative charge in the space surrounding the filament is known as the "space charge," and it is to overcome this that a fairly large positive potential has to be applied to the plate, otherwise no electrons would be emitted from the filament at all. The higher the plate potential the greater the number of electrons drawn off from the filament per second, until a limit is reached when the filament is incapable of giving any greater emission. Under these conditions the saturation point is said to have been reached. The maximum electron current available depends chiefly on the temperature of the filament, increasing very rapidly as the temperature is raised.

The general form of the characteristic curve for a hard valve showing the relation between the plate voltage and the current is indicated by the curve of Fig. 2. The curve rises very gradually at the lower end, due to the presence of the space charge, becoming steeper for higher values of plate voltage which more effectively neutralise the effects of the space charge. The position of the upper bend in the curve depends on the temperature of the filament and the material from which it is made. For a

soft valve where a small amount of gas is left in the bulb, the lower bend of the characteristic curve is very much sharper, the reason being that the gas becomes suddenly ionised at a more or less critical voltage. The ionisation of the gas is probably started by the bombarding effect of the true electrons on the molecules of the rarefied gas. Thus a soft valve is very much more sensitive as a detector or rectifier of weak signals than a hard one. On the other hand, in a soft valve the filament is being continually bombarded by the positive ions and is soon disintegrated, having a comparatively short life.

The introduction of a third electrode between the plate and filament of Fleming's valve was effected by de Forest in America in 1907. This third electrode took the form of a wire mesh or grid, de Forest's object being to provide a means of controlling the stream of electrons passing from the filament to the plate by varying the electric field between those two electrodes; for, instance, giving the grid a slight positive potential with respect to the filament would partly neutralise the effects of the space charge, and so allow more electrons to pass to the plate. The third electrode had to be made in the form of an open mesh to allow a free passage for the electrons passing from the filament to the plate. Although the three-electrode valve was evolved at such an early date, it did not come into general use until the time of the war, since many improvements and modifications have been effected, but the principle remains the same, although there is a considerable difference in the shapes and construction of valves made by different manufacturers. In the most common type the plate is cylindrical in form surrounding a short, straight

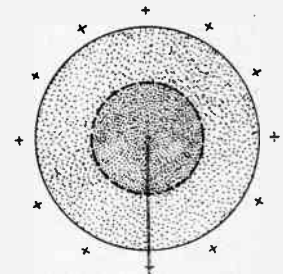
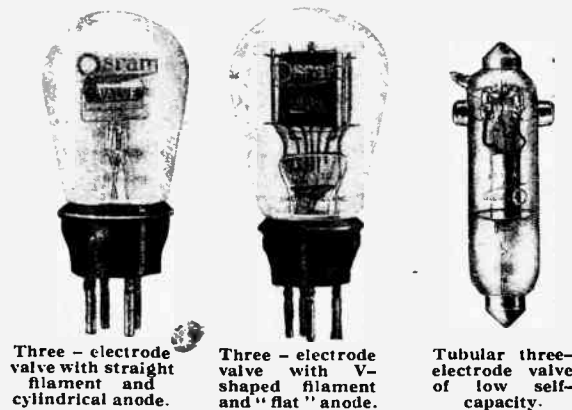

Fig. 3.—Diagram showing action of grid in a three-electrode valve.



Three - electrode valve with straight filament and cylindrical anode.

Three - electrode valve with V-shaped filament and "flat" anode.

Tubular three-electrode valve of low self-capacity.

filament, and the grid takes the form of an open wire spiral placed concentrically within the anode or plate. Another type has a V-shaped filament enclosed by a flat-shaped anode and grid. As far as filaments are concerned, valves may be divided into two classes, namely, "bright emitters" and "dull emitters." To the former class belong valves with pure tungsten filaments which require to be heated to a white heat in order to get sufficient emission of electrons, and to the latter class valves with specially treated filaments capable of giving a large emission when heated to a dull red heat only. Great progress has been made in this respect, and it is not beyond speculation to anticipate the discovery of a cold emitter which will operate at atmospheric temperature.

Wireless Circuits in Theory and Practice.—

We now come to consider the operation and general properties of the three-electrode valve. Before proceeding to discuss the characteristics it is necessary to obtain a clear idea of the function of the grid and the manner in which it controls the stream of electrons issuing from the filament. Fig. 3 gives diagrammatically an end view of a straight filament surrounded by a cylindrical plate and wire spiral grid. When the filament is heated and the plate is given a moderately large positive potential with respect to the filament, electrons are drawn across the vacuum and pass between the turns of the wire grid which is denoted by the dotted circle in the diagram.

Action of the Grid.

We have already seen that those electrons in the space surrounding the filament constitute a negative space charge and produce an electric field tending to prevent any more from leaving the filament. If now the grid is given a slightly positive potential with respect to the filament it will produce a counter electric field which neutralises the space charge to a degree depending on the potential of the grid, thus allowing a larger electron current to flow. The electrons leaving the filament are emitted with high velocity, and, provided the potential of the grid is not too highly positive, very few of them will be absorbed by the grid, nearly all of them being drawn between the meshes or turns by the higher potential of the plate. If the grid potential is made appreciably large in the positive direction, it will exert an attractive force on the electrons in the vacuum and itself absorb large numbers, resulting in a considerable grid current passing between the grid and filament round the external circuit.

When the grid is given a negative potential with respect to the filament it assists the space charge in repelling back those electrons about to leave the filament, and so reduces the value of the anode current. In fact, if the grid is given a sufficiently large negative potential it will allow no electrons whatever to leave the filament and no plate current will be obtained.

The chief characteristic curve of a valve is that showing the relation between the anode current and the grid voltage with respect to the filament when the latter is heated to the normal operating temperature, and with a constant positive potential applied to the anode. This is called the *anode characteristic* curve for the particular potential at which the plate is maintained. There is a separate curve for each value of the plate potential. It

must be realised that since the filament is heated electrically its potential is not the same along the whole of its length, but drops uniformly from one end to the other. Thus, when stating that either of the other electrodes has such and such a potential with respect to the filament, it is necessary to refer this potential to one end of the filament, and for this purpose the negative end is always chosen. For instance, in stating that the plate voltage is 50 and the grid voltage zero, we mean that the former is 50 volts above that of the negative leg of the filament and that the grid is at the same potential as the negative leg of the filament.

Plotting Characteristic Curves.

The usual method of finding the static characteristic curves of a valve is indicated by the diagram of connections of Fig. 4. The correct voltage is applied to the ends of the filament from a low voltage or *low tension*

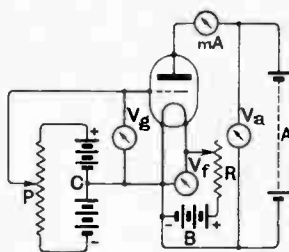

Fig. 4.—Circuit for plotting the anode characteristics of a three-electrode valve.

battery, A, a suitable voltmeter V_f being connected across the filament legs, the controlling rheostat R being adjusted until the voltmeter reads the required value. It is very important that the filament voltage should be kept constant during the tests. A high voltage or *high tension* battery B is connected with its negative pole to the negative leg of the filament, and its positive pole to the plate of the valve, a milliammeter being included in the circuit as shown. The plate potential is measured by a high resistance voltmeter V_a connected across the H.T. battery. It is important that the positive terminal of the voltmeter should be connected between the positive pole of the battery and the milliammeter, and not between the milliammeter and the plate, because in the latter case the milliammeter would read not only the anode current, but also the current taken by the voltmeter.

In order to vary the potential applied to the grid over a range of both positive and negative values, a potentiometer P may be connected across a battery C, the centre point of which is connected to the negative leg of the filament, as shown in the diagram. The grid is connected to the slider and a voltmeter V_g is provided for measuring the grid potential, being connected between the grid and the negative leg of the filament. Readings of the milliammeter are obtained for various values of V_g , making sure that V_a and V_f are kept constant for one set of readings. Further sets of readings can be taken with other fixed values of V_a , and a series of curves obtained. The characteristic curves of a valve obtained in this manner will be discussed in the next instalment.

HIDDEN ADVERTISEMENTS COMPETITION.

The following are the correct solutions of THE WIRELESS WORLD Hidden Advertisements Competition for the issue of April 28th.

Class No.	Name of Advertiser	Page.
1.	Brandes, Ltd.	9
2.	Caxton Wood Turnery Co.	ii.
3.	Mullard Wireless Service Co., Ltd.	7
4.	Electrodix Radios.	13
5.	Bretwood, Ltd.	11
6.	Telephone Manufacturing Co., Ltd.	ii.

The following are the prizewinners:—

M. Warner, Clapham Junction, S.W.11	..	£5
J. W. Robinson, Junr., Manchester	..	£2
Thos. E. Solomon, Brighton	..	£1

Ten Shillings each to the following:—

T. M. Salmund, Glasgow.	Capt. K. J. Lee, Bedford.
B. W. Reed, Southampton.	(Mrs.) C. Mills, Oxford.

THE DARIMONT CELL.

A Rechargeable Primary Battery for Filament Heating.

IT is difficult to find a solution to the battery problem in districts remote from public electric supply and generating plants. To adopt dull-emitter valves of high filament efficiency deriving current from dry cells cannot be regarded as entirely satisfactory.

With a view to considering the suitability of dry batteries for running various types of valves in parallel the writer made reference to the lists of several battery manufacturers. The absence of information from which one can determine the normal working life of a dry battery is rather remarkable, the available data being limited practically to battery voltage and overall dimensions. One does not expect to find the approximate ampere-hour capacity stated, for this changes within limits depending upon the rate of discharge, and, moreover, the total ampere-hour capacity of a battery for complete discharge is no indication of the hours of life obtainable for filament heating. The voltage of a dry battery on discharge steadily falls, and if the approximate ampere-hour capacity between certain voltage limits were available, the working life of a battery could be readily estimated. No comparison of running costs can, therefore, be made between the dry cell and other types of batteries for filament heating. The principal criticism of the dry battery is that when discharged it must be discarded, thus comparing unfavourably with the rechargeable wet battery, where only a small expense is incurred for reconditioning. Wet cells of the Leclanché type have acquired no degree of popularity for filament current supply.

Constant Voltage on Heavy Discharge.

The "Darimont" wet cell, which is capable of giving comparatively heavy discharge, and is recharged by renewing the solution, promises to prove a boon to country users without accumulator charging facilities.

The cells are available in four sizes, and the manufacturer's data are given below:—

Type.	Capacity (Amp.-hrs.).	Maximum Discharge (Amperes).	Internal Resistance (Ohms).	Dimensions (Inches).
No. 2½	12½—14	0.4	1.1 —1.4	3½ × 4½ × 6
No. 5	22 —24	0.5	0.8 —1.0	3½ × 4½ × 7½
No. 10	40 —44	0.7	0.6 —0.75	5 × 5½ × 8
No. 15	63 —67	1.2	0.34—0.45	6 × 6 × 9½

The working life for a few typical receiving sets can be taken as follows:—

B 40

No. and Type of Valves.	No. and Type of Cells.	Life of Charge (Hours).
1 D.E.11	1 T.5	93
2 D.E.2	2 T.10	170
2 .06 type	3 T.2½	110

The important merit of the "Darimont" cell is its property to maintain a constant voltage during discharge, and thus no inappreciable voltage rise results when the battery is left standing, a property which renders it superior to the dry cell. Recuperation while not in use is the chief cause of filament burn-out when running dull-emitter valves from a dry battery.

Result of Test.

On test, the type No. 10 cell discharging through a resistance of 5 ohms gave a potential of 1.4 volts at the commencement, and after 100 hours fell to 1.25 volts. After 140 hours the voltage dropped to 1.2, still a satisfactory working potential, and during the next ten hours rapidly fell to below one volt, the internal resistance which had remained practically constant at 0.5 ohm rapidly rising after 154 hours' discharge to nearly one ohm, indicating that the depolarising compound was exhausted. The watt-hour output in relation to the ampere-hour capacity is thus exceedingly high. The measured ampere-hour capacity of the smallest type cell, No. 2½, was found to be 13.7 on an overload test, starting with a discharge rate 1.2 ampere, whilst on a normal discharge of 0.1 ampere a capacity of 14.5 ampere-hours was obtained, which reveals the capability of the "Darimont" cell to maintain its full capacity on excessive load. These figures compare favourably with small type secondary batteries, and contrast with the dry cell.

In construction the "Darimont" cell makes use of a rectangle glass container. It is a two-solution cell with a porous cylinder, in which a membrane is deposited preventing diffusion. The positive plates are of carbon and the negative a folded zinc sheet. The top is neatly filled in with pitch, and a porcelain cover fits over the inner receptacle. The cell is rendered active by the addition of solutions made up from substances supplied in dry form, and after filling can be brought in action almost at once. The charges are supplied in clean, compact cartons, which may be kept in stock without deterioration.

The "Darimont" battery goes a long way towards bringing the valve receiving set within the province of those possessing no charging facilities, and can be considered a true "home service" battery—a term applied to it by the manufacturers.

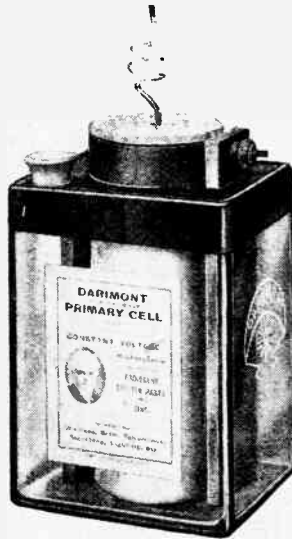



The Editor does not hold himself responsible for the opinions of his correspondents.

Correspondence should be addressed to the Editor, "The Wireless World," Dorset House, Tudor Street, E.C.4, and must be accompanied by the writer's name and address.

'BRETWOOD AUTO AUDIO FREQUENCY AMPLIFIER.'

Sir,—In your issue of April 28th, you publish a letter under the heading of "Bretwood Auto Audio Frequency Amplifier" in which your correspondent states that: "In general electrical technology transformer is understood to be an apparatus which is capable, we say, of changing direct into alternating, or the reverse, or really transforming one current into that of a different character. In a low-frequency transformer there is no such transformation of current, but there is merely a step-up effect taking place, and therefore you will see the reasons why that under no circumstances would we have called our component a transformer."

Surely this is an error on his part, since in power electrical engineering the term "transformer" is used in reference to an apparatus for obtaining a change of voltage on an alternating current supply, whilst for converting from alternating current to direct current, such apparatus as "rotary converters," "motor converters," "motor generators" or "arc rectifiers" is required.

If you can find space for this letter in your journal it may possibly prevent some of your readers being led to a misuse of terms, which unfortunately appears to be a common failing with amateurs.

R. G. TORRY, B.Sc.

Newcastle-on-Tyne.

Sir,—In your issue of April 28th you publish a letter from Messrs. Bretwood on the above subject. On the greater part of this letter I am not qualified to comment, as I do not know the terms of your letter to which they refer.

In the penultimate paragraph, however, there is a statement to which I take exception, namely, "... a transformer ... is not the right name for the ordinary low-frequency transformer. In general electrical technology transformer is understood to be an apparatus which is capable, we say, of converting direct into alternating, or the reverse, or really of transforming one current into that of a different character."

Will you permit me to point out that in "general electrical technology" the word "transformer" means nothing of the sort.

A piece of apparatus which receives an alternating current at one voltage and delivers an alternating current at some other voltage—either higher or lower—is called a "static transformer," or, more simply, a "transformer." It always has been so called.

A machine which receives direct current at one voltage and delivers it at another voltage is sometimes called a "D.C. transformer"; more generally a "rotary transformer"; and, if it has but a single armature, it is almost invariably termed a "rotary converter."

A machine having revolving parts, which converts from D.C. to A.C., or the reverse, is never called a transformer. Depending upon its nature, such a machine is either a "motor generator," or a "rotary converter."

An apparatus having no moving parts, which converts from A.C. to D.C., is also never called a transformer. It is called a "rectifier" or a "valve."

I put this point forward as I feel that in wireless work, where

so many very keen men have not had the time or opportunity for a preliminary electrical training, absolute accuracy is essential in the use of technical words. Further, many of us are apt to judge the value and the accuracy of the whole of a statement from our knowledge of the accuracy of part of it.

F. T. FAWCETT, M.A., D.Sc.

Woodford Green, Essex.

Sir,—Keats (who only held a poet's licence) remarked that "heard melodies are sweet, but those unheard are sweeter."

Surely this must apply to the letter which was sent by you to Messrs. Bretwood, Ltd., but *not* published in your last issue. There can be little doubt that it expressed the feelings of many of your readers.

GEORGE M. MEYER.

Gateshead.

Sir,—The publication in *The Wireless World*, on page 659, of a letter from Messrs. Bretwood prompts me to write you again on the above subject.

I have this week experimented with a four-turn, 2ft. frame aerial using a series aerial tuning coil, to which the customary reaction is applied.

Following this with two I.F. stages coupled by Bretwood Auto Audio amplifiers moderate loud-speaker signals were obtained *without the slightest interference from the electric trains*. A third stage was necessary for heavy loud-speaker work, but signals remained pure in tone.

"Crackles" caused by the sparking of the overhead electric trains have been particularly bad since the introduction of the additional services, the vivid sparks illuminating the room after dark like lightning. I feel there must be many other suffering readers who would be interested to hear of this success.

Balham.

W. STUART CLARK.

POINTS ABOUT PORTABLE RECEIVERS.

Sir,—In reply to Mr. L. W. Ruskham's strictures on my article about portable receivers, he is, of course, entitled to his opinions, and I shall only reply on matters of fact.

(1.) Nobody wants to be bothered with a separate aerial if they can get results with a small frame inside the case. The trouble is that there is only one commercial low-priced portable which achieves such results. I will avail myself of Mr. Ruskham's invitation to sample his three-valver; but its range is inadequate for general motoring purposes.

(2.) There is at least one commercial superheterodyne, which scales no more than 32lb. complete, and is quite efficient. This is on the heavy side for some people, but is perfectly reasonable for motoring work.

(3.) The 0.06 filament is not remarkably robust, and some of the two-volt valves are much sturdier. But the 0.06 type is practically indispensable on a portable superheterodyne, and Mr. Ruskham is in error in fancying that numerous casualties are inevitable. It all depends on the type of valve holder employed.

(4.) I disagree profoundly with his views on valve holders. Rigid sockets lead to broken filaments. Solid ebonite sockets suspended in wobbly fashion accentuate vibration, and the

valves jump out unless padded in position. But a holder with four separate legs, individually sprung, not only protects the filament, but locks the valve in position.

THE WANDERER.

Sir,—I have read Mr. L. W. Ruskham's interesting letter on portable receivers, and find myself in disagreement with a good deal that he says. A set that requires the rigging of an aerial or that carries its batteries or loud-speaker in separate cases, I would not call a portable set, and I think we can agree to rule it out of the discussion. I think I have probably covered a good many more miles with portable sets than any one else in this country, and my conclusions are the result of hard practical experience. Two constructional points that have been brought home to me are (a) that not only are spring valve holders out of the question but the valves should be rigidly held down in rigid sockets, and (b) that soldered joints do not stand vibration anything like so well as a good screwed connection. I have sufficient evidence on both these points to put the matter as far as I am concerned quite beyond the pale of argument. As regards 0.06 valves, if one gets the right sort they are most suitable.

"Barring absolutely the superheterodyne," says Mr. Ruskham; but it seems a pity to kick off by barring the one and only system which has made the portable set a really practicable proposition. To my mind the "super-het." has no *raison d'être* as a domestic set, or anywhere where an outside aerial is available, but for portable sets it stands absolutely in a class by itself. To begin with, it extracts results from that appallingly inefficient type of frame aerial which is contained in the lid of a box in a manner which no other system can begin to approach. Moreover, owing to the fact that oscillations at the pestilential frequency employed in local broadcasting are eliminated at the source, the rest of the apparatus can be crowded in a way that is quite impossible in a straight high-frequency set. My own set measures 13in. x 7in. x 6in., and employs six valves, with provision for a seventh, a second L.F. stage which has not been found necessary. The whole case measures outside 14in. square by 8in. deep, and contains its own aerial, loud-speaker, and 2 pairs of telephones, and, of course, all batteries. This is the smallest portable I have succeeded in making, and so much more efficient than any previous model that comparison is ridiculous. Indeed, the performance of any "super-het." that has been really carefully "hotted up" is to me more than incredible; it is uncanny, and I can find nothing in the theory of the instrument really to account for it.

Mr. Ruskham considers the construction of a portable set a job quite unsuitable for the amateur, and here I differ from him absolutely. Assuming the amateur to be a neat and accurate workman he is the only one who can make the set he wants. He has the time available, which the manufacturer has not, and

if he cannot eventually provide himself with a very much better portable set than any of the commercial varieties that I happen to know of he must be well below the average in intellect.

London, S.W.1.

JOHN KENNEDY.

REMARKABLE RECEPTION ON A CRYSTAL.

Sir,—Last September you were good enough to publish a list of stations (22) picked up on a plain crystal during the Geneva wave tests. I now give a list of stations heard to date on a plain crystal without any amplification.

2RN (4 miles off) works a loud-speaker comfortably—in fact, it is audible at 75 ft. Frequently I have demonstrated Daventry off the loud-speaker (audible at 9 or 10 feet) during the winter to sceptics, and only the other day invited some members of the Wireless Society of Ireland out to hear loud-speaker reproduction from 2RN and surprised them.

I identified one American station and heard (I think) another, but I had to wait up 36 nights to get them. WBZ came in faintly for about 10 or 15 seconds, and then faded out completely for about 25 minutes, and then on again for another 10 seconds and so on.

I notice the German stations come in in spasms, one week much stronger than another, and I think the volume all round is less than last year, although occasionally a single station will come in at good strength. I notice the Spaniards are strong and easy to fish for this winter, whilst the Parisians have dropped away, excepting Radio-Paris.

I have not yet got a Welsh, Dutch, or Swedish station on the crystal.

Stations heard on loud-speaker:—2RN (loud), 5XX (faint).

On two pairs of telephones:—2ZY, 2BM, 2LO, 6LV, 5SC, 2BO, Oslo and Hamburg.

On one pair of telephones:—Belfast, Newcastle, Nottingham, Edinburgh, Stoke, Madrid (Iberica), Madrid (Union), San Sebastian, Barcelona, Bilbao, Valencia, Toulouse, Radio-Paris, Petit Parisien, Lyons, Zurich, Berne, Rome, Milan (testing on 340 metres), Königsburg, Bremen, Breslau, Königswusterhausen (1,400), Hanover, Leipzig, Dortmund, Munster, Elberfeld, Murenburg, Stuttgart, Munich, Vienna, WBZ (Springfield, Mass.), and an amateur in Liverpool on recent Sunday mornings.

WILLIAM F. WARREN.

Sandymount.

P.S.—I am troubled by the unselectiveness of the crystal, as stations such as 2LO, 2ZY, 2BM, Oslo, and Hamburg all come in together, and jam each other unrecognisably. I have tried loose coupling and wave traps, special circuits, etc., but the results are not what were to be expected, as signal weakening took place to too great an extent.

Gambrell Bros., Ltd. (75, Victoria-st., S.W.1). Data concerning Gambrell Coils (sizes, inductance, self-capacity, etc.); also Gambrell "Efficiency" productions for wireless.

Carfax Company, Ltd. (312, Deansgate, Manchester). Pamphlet describing Battery Charging Equipment for A.C. Circuits.

Automatic Coil Winder and Electrical Equipment Co., Ltd. (Wellington House, Buckingham Gate, London, S.W.1). Folder descriptive of "Slektum" Inductance Coils.

General Electric Co., Ltd. (Magnet House, Kingsway, London, W.C.2.). Pamphlet dealing with D.E.2 H.F. and L.F. Valves, giving suitable circuits and useful data.

Stratton and Co., Ltd. (Balmoral Works, Birmingham). Illustrated catalogue of "Eddystone" Receivers, Loud-Speakers, Transformers, etc., etc.

Marconi's Wireless Telegraph Co., Ltd. (Marconi House, Strand). Leaflet No.

CATALOGUES RECEIVED.

1055, describing the Marconi 25-40 watt Portable Station, Type S.A.1. Supplementary to Pamphlet No. 234.

Zenith Manufacturing Co. (Zenith Works, Villiers Road, Willesden Green, N.W.2.). New catalogue of Zenith Regulating Resistances, Zenite Units, and Small Transformers.

Electrolix Radios (218, Upper Thames Street, E.C.4.). Catalogue of "Everything Electrical," including Wireless Apparatus and Accessories. With 590 illustrations.

Batteries, Limited (Crabbs Cross, Redditch). List No. 2, detailing reduced prices and giving spare part list of the "NIFE" Nickel Steel Alkaline Accumulator.

Marconiphone Company, Limited (210-212, Tottenham Court Road, W.1.). Publication No. 428A, relative to the range of Marconiphone Amplifiers.

Power Equipment Co., Ltd. (Kingsbury Works, The Hyde, Hendon, N.W.9.). Pamphlet describing "Powquip" Inductance Coils. Also, "Notes for the Amateur Experimenter," price 3d.

Fuller's United Electric Works, Ltd. (Woodland Works, Chadwell Heath, Essex). Lists No. 260 and 261, dealing with "Sparta" Radio Accumulators.

Eagle Engineering Co., Ltd. (Eagle Works, Warwick). Abridged Price List No. 26w, of "Chakophone" Wireless Receivers, Accessories, and Components.

Trelleborg Ebonite Works, Ltd. (Audrey House, Ely Place, E.C.1.). Panel Price List of Trelleborg Ebonite, giving sizes, thickness, etc., etc.

Automatic Telephone Manufacturing Co., Ltd. (Liverpool). Illustrated Booklet No. 71, descriptive of "Claritone" Loud-Speakers and Headphones.

READERS' PROBLEMS

"The Wireless World" Information Department Conducts a Free Service of Replies to Readers' Queries.

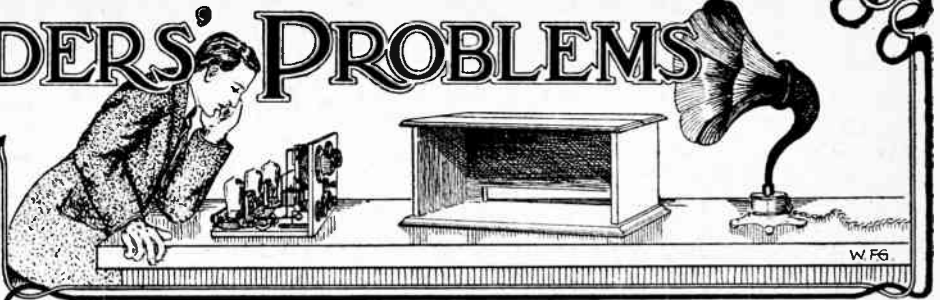

Questions should be concisely worded, and headed "Information Department." Each separate question must be accompanied by a stamped addressed envelope for postal reply.

Methods of Rectifying.

I understand that there are three different ways in which a valve can act as a rectifier of wireless signals. I am at present using my valve as a rectifier by employing the conventional grid leak and condenser, but should like to try the other methods if possible. E. D. S.

The usual method of using a valve as a rectifier by employing a grid condenser and leak is the most sensitive one. It is usually known as "cumulative grid rectification" or more shortly "grid rectification." It has the disadvantage of decreasing selectivity due to the flow of grid current, this applying especially when too much positive bias is used. Another disadvantage is that a certain amount of distortion is introduced, especially on strong signals, and also in cases where too high a value of grid leak is used. A high value of grid leak is, however, desirable when searching for weak signals. A valve may also be caused to rectify on the bottom bend of its grid-volts-anode current characteristic curve, this being usually known as "bottom bend" or "anode" rectification. This method eliminates the distortion associated with grid rectification, but is very insensitive to weak signals, unless a special type of valve specially designed for anode rectification is used, typical examples of such valves being the Marconi Q.X and D.E.Q and the Mullard S.6. Using ordinary valves the system can only be used following several stages of H.F. amplification, or in those cases where the receiver is to be used at very close range to a broadcasting station.

A valve can also be used to rectify on the top bend of its characteristic curve by applying a small positive bias to the grid instead of a negative bias as in the case of "bottom bend" rectification. The term "anode rectification" is in reality applicable to either top or bottom bend rectification, although it is more usually applied to the latter. Top bend rectification is strongly to be condemned and is never used under any circumstances, since it possesses all the disadvantages of flat tuning and poor quality, associated with grid rectification, but without the advantage of great sensitivity. In many cases where home constructors connect the grid return lead of their H.F. valve

to L.T.+ instead of to L.T.-, the valve acts as a top bend rectifier instead of as an H.F. amplifier. The effect is exactly the same when the potentiometer method of stabilising H.F. amplifiers is used. In H.F. amplifiers it is well to check any tendency to top bend rectification by giving the valve grids a small negative bias in order to keep the working point well away from the top bend. At the same time, if too much negative bias is used, the valve will commence to rectify on its bottom bend, and it is evident, therefore, that careful adjustment of this bias valve must be made. This applies with equal force when a valve is used in a reflex receiver for dual amplification.

o o o o

The Ultra-audion Circuit.

I understand that it is possible to construct an extremely efficient single-valve receiver by using the ultra-audion circuit. Will you please give the necessary circuit, together with a few notes on the circuit, stating whether or no it is of the super-regenerative type? H. T. B.

The de Forest Ultra-audion circuit does not belong to the super-regenerative class, but falls more properly into that

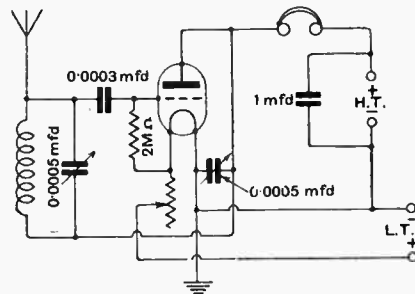

Fig. 1.—The de Forest Ultra-audion circuit.

class of circuit employing a special form of capacity reaction control, such for instance as the Hartley circuit, which was fully dealt with in a complete article published in our issue dated January 27th, 1926. The circuit diagram is given herewith in Fig. 1. The circuit gained immense popularity in America under the name of the "Cockaday" circuit. The actual Cockaday circuit employed

three valves, but the last two functioned merely as L.F. amplifiers using transformer coupling, whilst in the revised Cockaday receiver three resistance-capacity coupled L.F. valves were used. The reason for the popularity of this receiver is in its selectivity and sensitivity, which were of no mean order.

o o o o

Valve Impedance in H.F. Amplifiers.

It is frequently stated in designs of receivers embodying neutralised H.F. amplification, that the circuit has been designed specially for low- or high-impedance valves. What is the dividing line in ohms value between high- and low-impedance valves, which should be taken as a guide when choosing valves for different types of H.F. amplifiers? C. E. G.

No hard and fast rule can be laid down in this matter, and there is most certainly no definite value of impedance separating high from low impedance valves. Thus it is of little use saying that in H.F. amplifiers designed for low impedance valves it is necessary to use valves of not greater impedance than 10,000 ohms, whilst in designs of H.F. amplifiers intended for high impedance valves it is necessary to use valves of not less impedance than 10,000 ohms, because obviously a valve having an impedance of 11,000 ohms does not differ greatly from a valve of 9,000 ohms impedance, and in any circuit where it was specified that a valve having the latter value of impedance be used, it would be permissible to substitute a valve of the former impedance value, and still obtain good results.

An excellent rule to observe is that in those cases where the H.F. amplifier makes use of coupling transformers having, on the B.B.C. wavelengths, a small primary of about fifteen turns, and a tuned secondary of about 60 turns, and therefore requiring a low impedance valve, it is desirable to use a valve having a not greater impedance than 10,000 ohms. In this case a good valve to use would be 7,000 or 8,000 ohms, since valves having this impedance can be easily obtained. On the other hand, if the amplifier makes use of the tuned anode or resistance capacity system of coupling it is required that a high impedance valve be used which should, in general, be not less than 30,000 ohms.

The Multi-electrode Valve.

I notice you have recently described several receivers employing valves having four electrodes. I have also seen references to two-electrode valves which is rather confusing, and a brief explanation of the functions of these different types of valves would be greatly appreciated. F. D. F.

The original valve patented by Dr. Fleming in 1904 employed two electrodes, a filament and a plate or anode, and was used to rectify incoming wireless signals. This valve could not be used for amplification, however, and was superseded in popular favour by the crystal for rectification purposes, since the characteristic curve of the crystal was such that it gave better rectification than the valve. The only advantages gained by the valve was its constancy in operation, there being no question of losing the sensitive point by mechanical vibration as in the case of the crystal. Several years later De Forest inserted a grid between filament and anode, thus making the three-electrode valve. It was possible with this valve actually to amplify wireless signals, whilst at the same time, by employing cumulative grid rectification, a much more sensitive detector was available than the crystal. Later an extra grid was inserted between the existing grid and the filament, thus making a four-electrode valve. The advantage of this latter type of valve is that by connecting the inner grid to the positive side of the H.T. battery, the "space charge" is greatly reduced, and the valve will function on a very low anode voltage. Quite recently a five-electrode valve known as the "Pentatron" has been produced in Germany. It is claimed that with a single-valve set employing a valve of this type excellent volume is obtainable in the loud-speaker at a distance of 30 miles from a normal broadcasting station, and a number of broadcasting receivers are now on sale in that country employing this principle. It is well known that it is difficult to operate a loud-speaker with a receiver employing one valve only of the ordinary type, even at a very close range to a broadcasting station. It would appear, therefore, that the five-electrode valve has distinct possibilities, although no opportunity has yet been given for testing them in this country.

o o o o

An Easily Controlled Three-valve Set.

I wish to build a conventional 0-r-1 three-valve receiver, using tuned anode coupling with reaction on to the anode. I wish, however, to couple the reaction coil permanently to the anode coil and make use of the "Weagant" system of reaction control, described in conjunction with the "Home Broadcast Receiver," described in your April 28th issue. Will you, therefore, give me a diagram for this. H. B. R.

We give in Fig. 2 the complete diagram of connections of this receiver. It will be noticed that with the exception of the scheme of reaction control the circuit is

BOOKS ON THE WIRELESS VALVE

Issued in conjunction with "The Wireless World."

"WIRELESS TELEPHONY," by R. D. BANGAY. Price 2/6 net. By Post, 2/9.

"THE OSCILLATION VALVE—THE ELEMENTARY PRINCIPLES OF ITS APPLICATION TO WIRELESS TELEGRAPHY," by R. D. BANGAY. Price 6/- net. By Post, 6/3.

"WIRELESS VALVE RECEIVERS AND CIRCUITS IN PRINCIPLE AND PRACTICE," by R. D. BANGAY and N. ASHBIDGE, B.Sc. Price 2/6 net. By Post, 2/10.

"THE THERMIONIC VALVE AND ITS DEVELOPMENT IN RADIO TELEGRAPHY AND TELEPHONY," by Dr. J. A. FLEMING. Price 15/- net. By Post, 15/9.

"CONTINUOUS WAVE WIRELESS TELEGRAPHY," Part 1, by W. H. ECCLES, D.Sc. Price 25/- net. By Post, 25/9.

Obtainable by post (remittance with order) from
ILIFFE & SONS LIMITED
Dorset House, Tudor St., London, E.C.4
or of Booksellers and Bookstalls

perfectly conventional. The values of aerial and anode coil for any given wavelength will be the same as in any other type of three-valve receiver. The value of the reaction coil should be chosen experimentally, and should be of such a size that the receiver goes into oscillation when the reaction condenser is about

able will be far smoother than when the ordinary method is used, and the useful range of the receiver will be greatly increased, as is pointed out in the article on page 608 of our April 28th issue. You are advised to refer to this article for fuller instructions in the matter of tuning this receiver.

o o o o

Connecting Valves in Parallel.

What is the effect of connecting two valves in parallel? P. T. T.

The immediate effect is to halve the impedance and double the plate current, whilst the amplification factor is unchanged. It must not be thought that in this manner the impedance and emission of either individual valve is changed. This is not so, of course. The emission of each valve remains the same, but naturally the plate currents associated with each valve add themselves together in the external circuit, and so produce double the plate current of any one valve. Similarly, the effective impedance of the two valves in parallel is equivalent to half the impedance of either valve. This only holds good when both valves are of a similar type. In cases where dissimilar valves are used the resultant total plate current will always be greater, and the effective impedance always less than that of either individual valve, the exact value depending on the

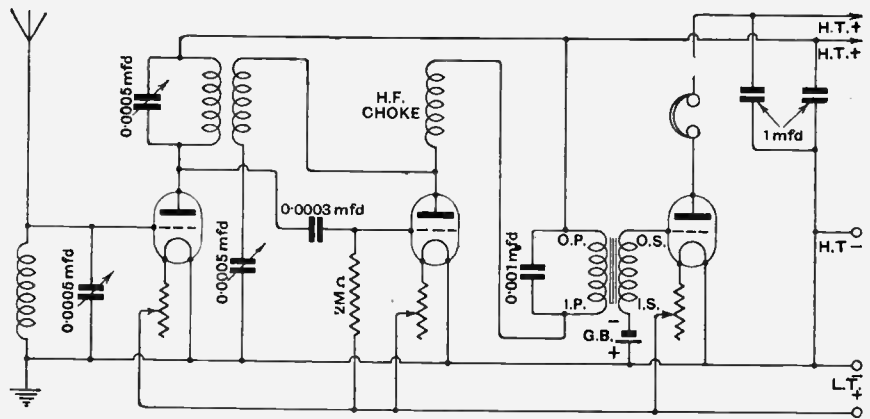
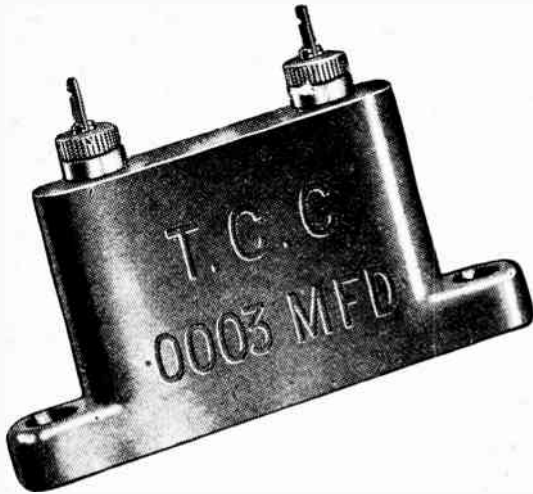

Fig. 2.—Three-valve circuit with capacity-controlled reaction coupled to the tuned anode circuit.

three-quarters of the way toward its maximum position. If too small a coil is used the receiver will not go into oscillation when the condenser is set at maximum, whilst if too large a coil is used the receiver will not stop oscillating even with the condenser at minimum. The smallest value of coil should be used with which it is possible to produce actual oscillation. If the receiver is to be placed in the hands of a novice, it is an excellent plan to make the reaction coil slightly too small to produce actual oscillation even with the condenser at maximum, since an extremely useful degree of reaction will then be obtainable, but it will be impossible to make the set oscillate. The reaction control obtain-

individual characteristics of each valve. Many readers mistakenly imagine that by connecting valves in parallel in this manner the same effect is produced as when the push-pull system is used. This is not so, of course, as in the push-pull system the straight line portion of the grid volts-anode current curve of each valve is added to that of the other valve, so doubling the working portion of the curve, whilst when valves are paralleled the working portion of the curve is no greater than that of either of the individual valves. By connecting three similar valves in parallel the total plate current is trebled, and the impedance is one-third of that of any one individual valve, and so *ad infinitum*.

The cheapest component in your set, yet the most vital of all— the Condenser



IF your set is not giving the results you expect from it, scan mentally the components you have used. Have you, for instance, exercised the same discrimination in selecting your condenser as you have in the case of your transformer? For your fixed condenser—on which so much depends—is one of the least expensive of all the components you buy. The difference in cost between a genuine T.C.C. and an un-named condenser is very slight; with the latter you are taking a risk—with T.C.C. you obtain a *permanent* assurance against breakdown.

Choose the T.C.C. Mica Condenser shown above. It embodies all the well-known T.C.C. features, and owing to its convenient shape takes up very little room on the panel: because it is sealed from below instead of from above it is proof against the heat of the soldering iron. For those who do not wish to solder their

connections a convenient milled head is provided to ensure a perfect electrical contact. Finally, because every T.C.C. Condenser—whether Mica or Mansbridge—has to pass so many tests before it is released for issue, you *know* that its accuracy within a very small percentage of error is a foregone conclusion.

Prices:

- No. 33, all capacities between '004
and '001 mfd. 2/4
No. 34, all capacities between '0009
and '0001 mfd. 2/4

From all Wireless Shops.

T. C. C.

CONDENSERS

(Mica & Mansbridge)

Advertisement of Telephatic Condenser Co., Ltd., Wobles Farm Road
N. Acton, W.3

Gilbert Ad. 5294

Advertisements for "The Wireless World" are only accepted from firms we believe to be thoroughly reliable.



MATCHED TONE HEADPHONES

IF you're fond of sitting up in the wee sma' hours to stretch a hand across the world, Matched Tone are extremely able confederates. With radio you span continents and with Matched Tone it becomes easier, "comfier" and much more efficacious. Distant signals stand out clearly; Matched Tone grope in the ether with unflinching accuracy. The specially matched receivers make them super-sensitive and tone perfect. You are logging a new call-sign every day with Matched Tone.

20/-

Table-Talker	Brandola	Audio Transformer
30/-	90/-	17/6

Brandes

Brandes Limited, 296, Regent Street, W.1.

From any good Dealer

12503.B.







SERVICE ADVERTISING

£10 Weekly in Cash Prizes

Simple Competition for all Readers of "The Wireless World" HIDDEN ADVERTISEMENTS

Below will be found six reproductions of fragments cut from the Advertisement pages of this issue of "The Wireless World." Each fragment is a clue. Can you from these clues identify the Advertisements? Seven cash prizes will be awarded to the first seven readers who send us correct solutions. No technical skill is required, merely observation. There are no restrictions or entry fees and the conditions are simple.

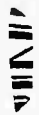
£5
for the first
correct solution
opened.

	
1	2
	
3	4
	
5	6

£1
for the third
correct solution
opened.

and
4
consolation
prizes of

10/-
Each
for the next four
correct solutions
opened.

£2
for the second
correct solution
opened.

CONDITIONS

1. All solutions must be written on the special coupon appearing on an advertisement page in this issue and addressed to *The Wireless World*, Dorset House, Tudor Street, London, E.C.4, and marked "Hidden Advs." in bottom left corner.
2. Clues will not, of necessity, appear in the same way as in the advertisement page, but may be inverted or placed in some other position.
3. In order that town and country readers may compete on equal terms, solutions will not be dealt with until 11 a.m. on Monday next. All solutions received before that date will be retained until Monday morning. Competitors may submit any

number of entries. Erasures or alterations on a coupon will disqualify the entry.

4. The first prize of £5 will be awarded for the first correct solution opened; the second prize of £2 to the next correct solution; the third prize of £1 for the third, and four consolation prizes of 10/- each for the next four correct answers. In the event of no readers sending correct solutions the prizes will be awarded to the competitors whose solutions are most nearly correct.

5. The decision of the Advertisement Manager of *The Wireless World* is final, and no correspondence can be entered into. Competitors enter on this distinct understanding. No member of the staff of the paper is permitted to compete.

No Wireless Library Complete
without the **SIFAM** Book
of RADIO MEASURING INSTRUMENTS

Send for FREE Copy to-day.

SIFAM ELECTRICAL CO.
INSTRUMENT CO.

Dept. W.1, 95, Queen Victoria St., London, E.C.4

EBONITE OF THE
FINEST
QUALITY

**SHEETS
RODS &
TUBES.**

PANELS CUT ANY
SIZE AND ANY
THICKNESS.

Egg Shell Matt or Polished
Surface.

**LARGE STOCKS. IMMEDIATE
DELIVERY.**

Awarded Silver Medal for
Ebonite, Crystal Palace Electrical
Exhibition, 1912.

BRITKAM-EBONITE (Britannia Rubber &
Kamptulicon Co. Ltd.)
7, NEWGATE STREET, LONDON, E.C.1.

Telephone: Central 2168 (2 lines).

Telegrams: Britannia, London.

**BREMER-
TULLY** for **BETTER
TUNING**



**B-T TANDEM
CONDENSERS.**

Produced to meet the modern
demand for reduction in the
number of tuning dials. Gives
dual control from a single dial.
Close balance effected by
small trimming condensers.
Type LD13 (00025 ea.) price 47 -
Type LD17 (00035 ea.) price 49 6

**B-T STRAIGHT-LINE FRE-
QUENCY CONDENSERS.**

Designed to aid in separating low
wavelength stations. Type SLF 17
covers the Broadcast range with
"Torostyle" Inductances. Type
SLF 13 does the same with Type
B Tuner.

S.L.F.-13 (00025)	PRICE
S.L.F.-17 (00035)	28 -
S.L.F.-23 (0005)	30 -
	30 -

Send for the
Bremer-Tully
booklet "Bet-
ter Tuning,"
price 6d. post
free.



Fully illustrated
48 pp. list of
American Appar-
atus free and post
free on request.

Hamleys
ESTD 1760
HAMLEY BROS LTD

200-202, REGENT STREET, LONDON, W.1.

FOR REAL COMFORT
DURING BROADCASTING
HOURS THERE IS NO
OTHER CRYSTAL QUITE
SO GOOD AS
RUSSELL'S PURPLE
HERTZITE LABEL

AN ULTRA SENSITIVE SPOT AT THE FIRST ATTEMPT -
UNRIVALLED FOR VOLUME AND RANGE

16

L.C. RUSSELL LABORATORIES 16 HILL ST
BIRMINGHAM

"Japa"
REGD

PLUG & SOCKET
TERMINALS ARE THE
FINEST TERMINALS
IN THE WORLD
FOR ALL WIRELESS
CONNECTIONS.

BRITISH MADE.

If your
Dealer
cannot
supply send
direct to
the Manu-
facturer
through this
post.

W. J.
CHARLESWORTH,
88 & 89, Aston Street,
BIRMINGHAM.

— Established 1897 —

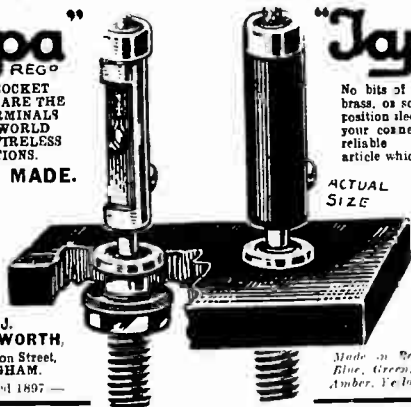

"Japa"
REGD

No bits of bent tin or
brass, or screwed com-
position sleeves to make
your connection, but a
reliable mechanical
article which has been
copied by
many but
equalled
by none.

Insist upon
the genuine
article.

**6d.
EACH
Post free.**

Made in Red, Black, Pal-
Blue, Green, Royal Blue,
Amber, Yellow, Brown.

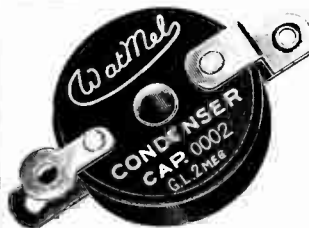

Two in One!

Here's a splendid little component,
the Watmel combined Grid Con-
denser and Fixed Grid Leak.
Saves space, time and money.
Built to allow the Grid Leak to
be connected either across the
condenser or direct to the filament
of the detector valve.

Price **2/6** each.

Send a postcard for full details of the
various Watmel products.

The Watmel Wireless Co. Ltd.,
332a, Goswell Rd., London, E.C.1.

Representative for Lancashire & Cheshire:
Mr. T. B. Lovell, 23, Hartley Street,
Levenshulme, Manchester.

For trouble-free condenser efficiency
always specify the famous round
Watmel fixed condenser.

Sizes up to '002 2 -
Size: '0025 to '006 2 6

RAPID RADIO BUILDING IN THE BLACKADDA WAY

Building Table, Price 3/6

Blackadda Components and adaptors all fit the table and allow any circuit to be quickly erected or dismantled.

NO TOOLS REQUIRED.

Write for booklet describing the system.

THE BLACKADDA RADIO CO., LTD.

Sadler Gate, Derby.

Telephone: Derby 1820. Telegrams: "Blackadda, Derby."

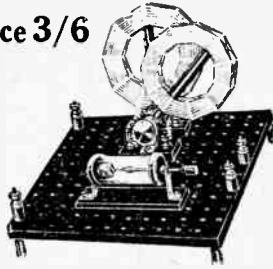

To get pure EBONITE, ask for



It is made from finest rubber and sulphur and is guaranteed free from surface leakage.

Registered Trade Mark.

**QUALITY
EBONITE**

It proves its quality in every test. Its polish will also please you—ask to see it.

RODS. TUBES. SHEETS. PANELS. MOULDINGS

Ask your dealer for "BECOL"

THE BRITISH EBONITE CO., Ltd., HANWELL, LONDON, W.

The Wireless World COUPON for "HIDDEN ADVT." COMPETITION

This coupon is available until Monday 10 a.m., May 31, 1926

Clue No.	Name of Advertiser.	Page
1		
2		
3		
4		
5		
6		

I enter the above solution subject to the published rules.

Name _____
(Please write clearly)

Address _____

THE WIRELESS ANNUAL

FOR AMATEURS AND EXPERIMENTERS 1926

"The WIRELESS ANNUAL" is a volume of particular interest to every wireless enthusiast. It contains a mass of interesting and valuable information, which can be relied upon to be thoroughly accurate and dependable. Amongst many other features may be noted the following special items:

PRINCIPAL CONTENTS:
CALL SIGNS of ALL KNOWN AMATEUR TRANSMITTING

STATIONS in Great Britain, France, Holland, Germany, Sweden, Finland, Italy, Spain, South Africa, India, Australia, New Zealand, and South America: **REGULAR TRANSMISSIONS** (Morse and telephony): **RECEIVER CIRCUITS** (16 pages of diagrams and notes): **GLOSSARY OF TECHNICAL TERMS:** **CLASSIFIED DIRECTORY OF MANUFACTURERS:** **VALVE DATA, USEFUL TABLES, FORMULÆ and INFORMATION** on all subjects of interest to **AMATEURS.**

This book will be of very real assistance in your wireless studies. No amateur worker should be without it. Get your copy to-day!

Obtainable from all booksellers or direct from the offices of "The Wireless World," Dorset House, Tudor St., London, E.C.4



Price 2/6 net. By Post 2/8½.

.w.8b

THE 'DYNIC' D.C. REGULATOR
for using current from D.C. mains

DOES AWAY WITH THE NECESSITY FOR HT BATTERIES

Single tapping models, price	£2. 7. 6
5 " " " from	£3. 0. 0
10 " " " " "	£3. 10. 0
Super Heterodyne " " "	£5. 15. 0
Special Model for Marconi- phone Straight Eight, price	£6. 10. 0

(Postage 1/-)
Infinitesimal running costs.
JONES & STEWART,
247a, St. Vincent Street, GLASGOW, CE.
Phone: Cent. 4392. Telegrams: "Gadgets."



TRADE ENQUIRIES INVITED.

PERFEX AERIALS

INCREASE SELECTIVITY, VOLUME & RANGE OF RECEPTION & REDUCE INTERFERENCE.
Claims proved by thousands of Users in many different countries.
ASK THOSE WHO USE THEM.

36 inch 75/-, 20 inch 58 6/, complete with download.
Masts—16 ft. 20/-, 22 ft. 30/-, Brackets 25/- pair.

Obtainable from all branches of the General Electric Co., Ltd. and the Marconi-Phone Co., Ltd., and all good Wireless Manufacturers and Dealers.

WIRELESS APPARATUS LTD., 35, Panton Street, Haymarket, London, S.W.1



"STALLOY"
(REGD. BRAND)

THE ONLY MATERIAL
for
TRANSFORMERS
and
DIAPHRAGMS.

INSIST ON HAVING IT

JOSEPH SANKEY & SONS, LTD.
BILSTON.
STAFFS.

LONDON:—168, REGENT STREET, W.1.



CONTROL VOLUME WITH THIS NEW MODULATOR PLUG.

With your Receiver operating under full power, you can now regulate tone and volume to suit your taste by simply turning the knob on this new C.R.L. Modulator Plug.

The C.R.L. Plug provides perfect control of volume from a whisper to maximum without touching the tuning dial or rheostats.

List Price 13/- each.

Write for full list of C.R.L. Modulators and Resistances.

The second edition of our 1926 catalogue of high class American Radio Components is now ready. Send 9d. in stamps to cover cost of postage.

ROTHERMEL RADIO CORPORATION OF GREAT BRITAIN LTD.
24-26, Maddox Street, Regent Street, LONDON, W.1.
Telephone: Mayfair 578-9. Telegrams: Rothermel, "Wesdo," London

TIME & WEATHER
by **WIRELESS**
By W. G. W. MITCHELL,
B. Sc., F. R. A. S., F. R. Met. S.

The first half of this book explains how time-signals are sent and how they may be received with the utmost accuracy.
The latter part, devoted to the weather, will enable the amateur to distinguish the different weather telegrams. Crown 8vo. 125 pages. 66 diagrams and illustrations.

Price 3/6 net By post, 3/9

Obtainable from the publishers of "The Wireless World,"
LILIFFE & SONS LTD., Dorset House, Tudor Street, London, E.C.4,
and all leading booksellers. w.w.110

SECURE AGAINST LOSS

Netaglass TRADE MARK

The "NETAGLASS"

VALVE HOLDER with resistor template for Panel or Baseboard.
The New Valve Holder with the Glass Base and a dielectric constant of 5 to 7 and fitted with 3-way channel tags.

PRICE 3/- Post Free.
(Entirely British)

E. A. WOOD 100 Aston Road - - BIRMINGHAM.
80 Belgrave Gate - - LEICESTER.
77 Gallowgate - - GLASGOW.

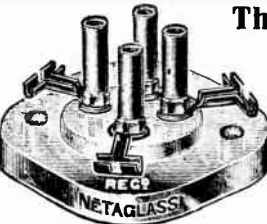

MISCELLANEOUS ADVERTISEMENTS.

NOTICES.

THE CHARGE FOR ADVERTISEMENTS in these columns is:

12 words or less, 1/- and 1d. for every additional word, e.g., 18 words 1/6; 24 words, 2/- Name and address must be counted.

SERIES DISCOUNTS are allowed to Trade Advertisers as follows on orders for consecutive insertions, provided a contract is placed in advance, and in the absence of fresh instructions the entire "copy" is repeated from the previous issue: 13 consecutive insertions 5%; 28 consecutive, 10%; 52 consecutive, 15%.

ADVERTISEMENTS for these columns are accepted up to **FIRST POST ON THURSDAY MORNING** (previous to date of issue) at the Head Offices of "The Wireless World," Dorset House, Tudor Street, London, E.C.4, or on **WEDNESDAY MORNING** at the Branch Offices, 19, Hertford Street, Coventry; Guildhall Buildings, Navigation Street, Birmingham; 189, Deansgate, Manchester.

Advertisements that arrive too late for a particular issue will automatically be inserted in the following issue unless accompanied by instructions to the contrary. All advertisements in this section must be strictly prepaid.

Postal Orders and Cheques sent in payment for advertisements should be made payable to **ILLIFFE & SONS Ltd.**, and crossed **& Co. Treasury Notes**, being untraceable if lost in transit, should not be sent as remittances.

All letters relating to advertisements should quote the number which is printed at the end of each advertisement, and the date of the issue in which it appeared.

The proprietors are not responsible for clerical or printers' errors, although every care is taken to avoid mistakes.

NUMBERED ADDRESSES.

For the convenience of advertisers, letters may be addressed to numbers at "The Wireless World" Office. When this is desired, the sum of 6d. to defray the cost of registration and to cover postage on replies must be added to the advertisement charge, which must include the words Box 000, c/o "The Wireless World." Only the number will appear in the advertisement. All replies should be addressed No. 000, c/o "The Wireless World," Dorset House, Tudor Street, London, E.C.4. Readers who reply to Box No. advertisements are warned against sending remittance through the post except in registered envelopes; in all such cases the use of the Deposit System is recommended, and the envelope should be clearly marked "Deposit Department."

DEPOSIT SYSTEM.

Readers who hesitate to send money to unknown persons may deal in perfect safety by availing themselves of our Deposit System. If the money be deposited with "The Wireless World," both parties are advised of its receipt.

The time allowed for decision is three days, during which time, if the buyer decides not to retain the goods, they must be returned to the sender. If a sale is effected we remit the amount to the seller, but, if not, we return the amount to the depositor. Carriage is paid by the buyer, but in the event of no sale, and subject to there being no different arrangement between buyer and seller, each pays carriage one way. The seller takes the risk of loss or damage in transit, for which we take no responsibility. For all transactions up to £10, a deposit fee of 1/- is charged; on transactions over £10 and under £50, the fee is 2/6; over £50, 5/-. All deposit matters are dealt with at Dorset House, Tudor Street, London, E.C.4, and cheques and money orders should be made payable to Illiffe & Sons Limited.

THE SALE OF HOME-CONSTRUCTED UNLICENSED APPARATUS.

A New Service to our Readers.

We have made an arrangement with the Patentees whereby readers who wish to dispose of a home-constructed receiver not licensed under the patents made use of, can do so by means of the Deposit System referred to above.

The person desiring to sell, in sending us particulars for his advertisement, will in every case make use of a Box No., and should add to the price which he requires the amount of royalty customarily paid by manufacturers, viz. in the case of Marconi Patents the amount should be calculated at 12/6 per valve holder.

If the purchaser is satisfied with his purchase, the sum realised will be forwarded to the seller, less the amount due in respect of royalties, which amount will be paid by "The Wireless World" to the owners of the patents concerned, and a certificate will be handed on to the purchaser of the set.

FOR SALE.

EXPERIMENTER'S Annual Clearance.—Only best British components for sale, excellent condition. Send stamped addressed envelope for list.—Box 7737, WIRELESS WORLD Office. (2023)

PORTABLES. Ultradynes, etc. Sets or P parts. Cash or terms.—Bracey, Factory Square, Streatham. (2067)

For Sale.—Contd.

WOOD Horns for all speakers and gramophone attachments. There's one for Amplion Junior, ditto goose-neck bases, Lissenola, etc. There's only one best; it's the "Allwoodorn."—Manufacturer: H. Maddison, 2A, Ronald's Road, Highbury, N.5. List free. (1914)

OSCILLATING Zincite and Contact, 2s. 6d.; simple, original circuit, 1s.; excellent results; other parts stocked.—Ledsham's, 297, King Street, Hammersmith. (1888)

VALVES!—Special offer of limited quantity only, 3v. .06 amp, 9s. each; 5v. .25 amp. power, 12s. each. Best make. Fully guaranteed.—F. Leng, 15A, Onslow Gardens, Wallington. (2062)

JACOBEAN Oak Wireless Cabinets, direct from makers, 55s. Packed free. Carriage paid. Send for illustration, etc.—Wm. Nurse, Union Street Cabinet Works, King's Lynn. (2069)

FOUR-VALVE Set with valves (D.E.) for sale (H.F., detector, 2 L.F.); £17.—Hanley, 18, Cecily Hill, Cirencester. (2070)

KONE amplifier with valves and loud-speaker. Nearly new. £13. Old type Celestion 30s., Primax £3.—Col. Bayldon, Beaulieu, Hants. (2086)

FOR Sale.—One Burne-Jones Plug-in Oscillator Coupler, 300/600 metres, with base, 12s. 6d.; one Curtis Aperiodic H.F. transformer, B.B.C. wavelengths, 12s. 6d.; One Lissenola loud-speaker unit, complete with reed, 12s. 6d. All in new condition.—Box 7935, WIRELESS WORLD Office. (2083)

POLAR-BLOK, frames, legs, and oxy-stallene panel, value 126s. List on application. Sell 40s.—Shelley, Meadowcroft, Trentham. (2082)

A.C. Transformer, heavily built, 240 v. to 25 v., centre, tapping on secondary. £4 or offer. "Etruria," Ruislip. (2081)

MARCONI type 55F. 7-valve H.F. Amplifier, 500-3,000 metres. Complete with valves. Not W.D. Offers.—Box 7921, WIRELESS WORLD Office. (2080)

SALE.—3-valve Reinartz o-v-2, per "Modern Wireless," complete, valves (one power), batteries, speaker, mahogany cabinet; any station. £10 or offer; astounding bargain.—Temple, 38, London Road, Bromley, Kent. (2079)

EXPERIMENTER'S SURPLUS.—Polar variable mica condenser, 10s.; O-6 Ammeter, 7s. 6d.; Brown's Featherweight Telephones, 12s. 6d.; Burndep L.F. Transformer, 12s. 6d.; all perfect condition.—Hallam, 47, Forest Road, Moseley, Birmingham. (2078)

HOME Construction.—Accessories. List post free from Radio Supplies, 51, Eden Street, Kingston-on-Thames. (2074)

SET of eight Daniell Cells with chemicals; will charge four-volt accumulator.—Savage, 33, Estelle Road, Gospel Oak, N.W.3. (2075)

PATENTS.

PATENTS and Designs Acts, 1907 and 1919.—The Proprietors of British Patent No. 200643 are prepared to sell the patent or to licence British manufacturers to work thereunder. It relates to means for telegraphically reproducing stationary or moving pictures, scenes and the like.—Address B.W. & T., 112, Hatton Garden, London, E.C.1. (2077)

PATENT AGENTS.

PATENTS and Trade Marks Obtained.—H. T. P. Gee, Patent Agent, Member R.S.G.B., A.M.I.R.E., 51-52, Chancery Lane, London, W.C.2. Phone: Holborn 1525. (0001)

W. BRYSON, B.Sc., Chartered Patent Agent, 29, Southampton Buildings, W.C.2. Phone: Holborn 672. (2052)

MISCELLANEOUS.

A WIRELESS Doctor.—If your set is giving trouble or you want advice a competent expert will call (anywhere in Greater London) and put you right. No result, no charge.—Alexander Black, 2A, Woodville Grove, N.16. Clissold 3687. (2002)

LOOK!—Why use H.T. Batteries if you have electric light in your homes? Make your own H.T. unit from either A.C. or D.C.—Write for full particulars and diagram, enclosing 1s.: Camberwell Electric Coil Winding Co., 35, Edmund Street, S.E.5. (2043)

CHARGE Your Own Accumulator.—Send 3d. stamp to-day for lists of our small gas and petrol engines and dynamos, and complete charging sets, from 20 to 160 watts.—Tom Senior, Cleckheaton, Yorks. (0013)

REPAIRS.

TRANSFORMERS rewound to guaranteed efficiency for 12 months, 4s., or exchanged for another, any ratio, 5s.; iron core wire-wound chokes for L.F. amplifiers, 6s.—115, Links Road, Tooting. (0011)

WANTED.

AGENTS.—"Laker" Steel Masts; liberal commission; exclusive territory.—Laker, Engineers, Beckenham, Kent. (2024)

WANTED.—Advanced Text Books—Physics, Wireless. Prices reasonable. Grey Friars, Kingsdown, Deal. (2085)

AGENCIES.

DUTCH firm, specialising in wireless apparatus and accessories, desires to represent in Holland first-class makers.—Reply for further details to Box R.2450, c/o Dawson's, 118, Cannon Street, London, E.C.4. (2057)

SITUATIONS WANTED.

RADIO Engineer, A.M.I.R.E., 13 years' experience, spark arc valve, P.M.G. certificate, desires post responsibility home or abroad; knowledge 5 languages; disengaged September.—Box 7802, WIRELESS WORLD Office. (2047)

WIRELESS.—Commercially experienced, designing and wiring of sets, with practical knowledge of installations, requires situation; good references.—Box 7936, WIRELESS WORLD Office. (2084)

BOOKS.

VOLUMES XIII., XIV. "Wireless World," complete, 7s. 6d. each; four valve receiver, mahogany sloping cabinet, coils 130-5,000 metres. £12. Amplion Junior Loud-speaker, 15s.; two Amplion Dragonfly Loud-speakers, 30s.; four-valve "Chakophone" Receiver, B.B.C. and Daventry coils, £10; two-valve Receiver (Det. L.F.), £2.—Box 7847, WIRELESS WORLD Office. (2073)

BUSINESSES & PROPERTY FOR SALE, TO BE LET, OR WANTED.
 SOUTH Coast.—Established Radio, Elect., etc., progressive town; living accommodation; freehold, goodwill, stock, all at about £1,100. Family reasons selling.—Box 7911, WIRELESS WORLD Office. (2076)

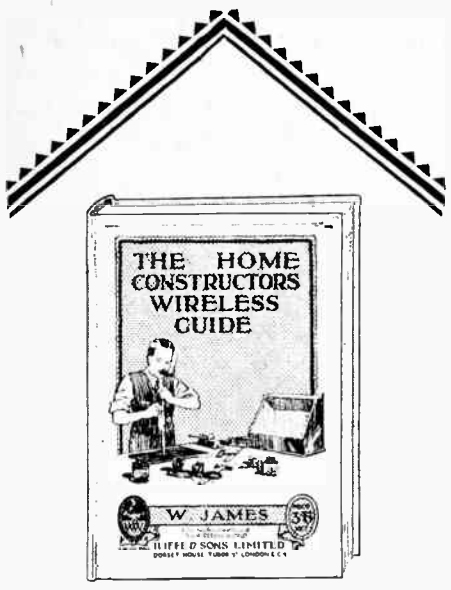

The
Home Constructors' Wireless Guide
 by W. James.

THIS BOOK forms a most convenient little encyclopædia of wireless technology; the kind of volume to refer to when in difficulties. It solves them for you.

A few of the main features:
 Outdoor, Indoor and Frame Aerials; Earths; Variometers for Broadcast Wavelengths; Basket Coils, Plug-in Coils, etc.; Coupled Circuits; Common Faults in Tuners; Reaction and Self-Oscillation; Special Chapter on Sensitive Single-Valve Receivers; Double Magnification; Points on Dry Cells and Accumulators, etc., etc.

PRICE 3/6 NET.
 By post, 3/10.

Obtainable from all Booksellers, or direct from the Publishers of "The Wireless World."

ILLIFFE & SONS LTD.,
 Dorset House,
 Tudor Street,
 LONDON
 E.C.4

W.W.10

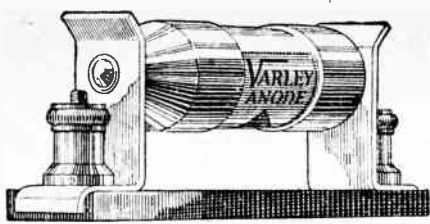

The Varley Constant Wire Wound Anode Resistance.

Where Resistance Capacity is concerned—and this is the ideal form of intervalve coupling—the Varley has no equal. Non-inductively wire wound on the famous Varley Bi-Duplex system, with turns silk separated, this resistance is **absolutely constant** under all atmospheric conditions, and ensures a wonderful purity of tone. A specialist's job—that's what the Varley is. A coil winding job, scientifically designed and constructed by experts who for 27 years have been engaged in every form of accurate and intricate coil winding. **If you value permanence and reliability insist on a Varley.**

Complete with Clips and Base 7/6
 Without Clips and Base 6/-
 60,000 ohms, 80,000 ohms, 100,000 ohms.
 Write for Leaflet.



THE VARLEY MAGNET Co., WOOLWICH S.E.18.
 (Proprietors: Oliver Pell Control, Ltd.)
 Telephones: Woolwich 885, 889

H.T. Accumulators 37/6
 60 Volts. 3 Actual Amp.-hour



The finest H.T. Accumulator in the world.

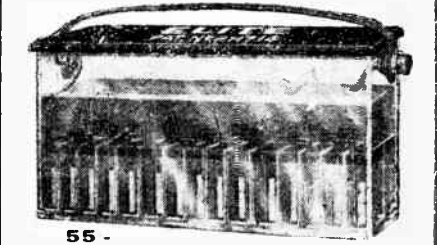

65 -
 60-volt, 3-amp.-hour, oil submerged. Will last a lifetime. Write for descriptive Folder.
MONEY RETURNED IF NOT SATISFIED. Obtainable only from ACCUMULATORS ELITE, 31, Waterhouse St., Halifax.
 Trade Supplied Telephone: 1394.

REPAIRS

Headphones, Loud Speakers and Transformers re-wound and reconditioned

EQUAL TO NEW
 and returned the same day on C.O.D. system. A customer writes: "—thanks to the excellent manner in which it was reconditioned, the results achieved have been astounding"



All Post Free At Callers Prices

S.O.S. BATTERY TESTER		COIL FORMER.	
3-Head Type Only tells immediately if full or empty 3/6	The Reliability Mark	46 Spoke Type with instructions 1/3	

Square Law Var. Condenser	British Wires.	Ebonite Panels.
With Knob and Dial 18	1 1/2 3/6	Matt. 1 3/10
1001 Panel type 6 6	2 1/2 4/6	12" x 8" 4/6 3/9
0003 5 2/2	2 6 4/6	12" x 12" 5/9 5/-
0003 4 6/2	2 11 5/6	12" x 9" 5/6 4/9
Vernier Blue extra 4 2/6	3 4 5/9	12" x 12" 7/8 5/8
Duteller McMichael 2/8	3 3 6/6	12" x 4" 5/6 6/6
Hobson Bell. Issing 3/0	4 10 7/6	7 1/2" x 1 1/4 1/2
Mullard (usual prices) 3/2	5 6 8/6	6" x 6" 1/2 10d.
New Mansfield 3/6	8 - 1/2	Any size cut.
2 mat. 3 0. 1 mat. 2 6/0	40 17 - 20	See list 1d. 1d.

Coil Holders.	Transformers L.T.	Special Values.
Reliability Verrier 3/6	Radio Inst. 25 - 27 6	Watts Microstat 28 8
Lotus 2-way 7	Ignition 21 - 22 10 0	H.T. Detector 6
Neve's 2-way 6 6	Gamma, No. 2 21	Liberty Detector 3 6
L. A. P. 2-way 8 9	Comport 2nd 25	Lambson Unit 13 6
Polar 2-way 6	Baby Grand 15	Antiphon Valve-holder 1 6
Cam Verrier 6	Ferranti A.F. 4 17 6	
Goldtone 6	A.F. 3 25	
Verrier 7	H.T. Changer 17 6	H.T. Batteries
Back of Panel 6	Formo-Sir led 10	With Wandler Plug 6/6
Aerial Wire 2 2/2	McMichael H.P. 10	any 1 1/2, 6/6, 7 6
Phono. Bracket 4 6/2	Union Coil 10	3/6, 4 6/6, 5 1/2, 1 10
100ft. 3 3, 2 3, 1 1	Valve Holders.	43, 1 1/2, 1 1/2, 1 1/2, 4d.
do. Electron 1 8	Type A 7d. Polar 1 3	20v., 12v., 16v., 3 8
Shell Insulators 3d.	Screwed 8 nuts 6d	Slender's source price.
Lead-in Tube 1 1	Ebonite 10d	Lambson 11 6
	Antiphon 1 6	
	Security Type 1 6	
	Sullivan's 120-ohm Paones, ex-Govt. 4 6	

J.H. TAYLOR & CO.
 2 RADIO HOUSE,
 MACAULAY ST., HUDDERSFIELD
 Tel. 5-91 Grams: THOROUGH HUDDERSFIELD

Stop that corrosion!
BECKOREM VASELINE CUPS



A welcome device for all accumulator users. Effectually prevents corrosion and is easily fitted in one minute to any size accumulator. Supplied with Red and Black ivoryine discs.

FREE COUPON. To the first 100 "Wireless World" readers sending this coupon, together with name and address, we will forward, free of charge, a pair of Beckorem Vaseline Cups. A postcard will do.

Sole Manufacturers,
A. F. BULGIN & CO. 9, 10, 11 Corsitor Street,
 Radio Manufacturers Chancery Lane, London, E.C.4

The **Wireless**
AND RADIO REVIEW **World**

INDEX TO ADVERTISEMENTS.

	PAGE		PAGE		PAGE
Accumulators Elite	17	Dubilier Condenser Co. (1925), Ltd.	Cover ii.	Moorhouse & Co.	18
Audion Radio Co.	18	Edison Swan Electric Co., Ltd.	Cover iv.	Oliver Pell Control, Ltd.	14 & 17
Autoveyors, Ltd.	2	Ferranti, Ltd.	6	Pugh's Wireless	18
Belling & Lee, Ltd.	4	Finston Manf. Co., Ltd.	18	Radio Accessories, Ltd.	4
Blackadda Radio Co., Ltd.	15	Graham, Alfred, & Co.	9	Radio Devices, Ltd.	Cover iii.
Bretwood, Ltd.	11	Hamley Bros., Ltd.	13	Radio Instruments, Ltd.	18
Britannic Rubber & Kamptuli Co., Ltd.	13	Hildick & Hildick	18	Radios, Ltd.	18
British Elionite Co., Ltd.	14	Hunt, A. H., Ltd.	Cover iii.	Rothermel Radio Corp. of Gt. Britain, Ltd.	15
British L.M. Ericsson Mfg. Co., Ltd.	18	Jeranic Electric Co., Ltd.	3	Sankey, Joseph, & Son, Ltd.	15
Bulgin, A. E., & Co.	17	Jones & Stewart	15	Sifam Electrical Inst. Co.	13
Burndept Wireless, Ltd.	2	L.G. Russell Laboratories	13	Taylor, J. H., & Co.	14
Caxton Wood Turnery Co.	Cover iii.	Lisenin Wireless Co.	18	Telegraph Condenser Co., Ltd.	11
Charlesworth, W. J.	13	London Elec. Wire Co. & Smiths, Ltd.	10	Telephone Manf. Co., Ltd.	10
Cleartron Radio, Ltd.	8	Lustrolox, Ltd.	18	Varley Magnet Co.	17
Darimont Electric Batteries, Ltd.	2	Marconiphone Co., Ltd., The	1	Watmel Wireless Co., Ltd., The	13
Dixon, Leslie, & Co.	6	Metro-Vick Supplies, Ltd.	9	Wireless Apparatus, Ltd.	15
		Midland Radiotelephone Manfs., Ltd.	7	Wood, E. A.	15
				Wooding & Co.	18

LISENIN

POSITIVE GRIP PLUGS & SOCKETS

Pat. No. 245586.



THERE can be few amateurs who have not been troubled with broken leads, or said hard things about faulty connections, of the whole set, there is probably no part which is so often abused as the connections. "Lisenin" Positive Grip Plugs alleviate this evil. They are designed to take the smallest flex up to 5 m/m cable. Sleeves and indication discs red and black. N. Plated.

PRICE 6D.

Plug and socket complete, or Spade End Terminal. Obtainable of all dealers. Liberal Trade Discount.

Sole Manufacturers and Patented by—

THE LISENNIN WIRELESS CO.,
1d, Edgware Road, London, W.2.
Phone: Taddington 2734.

Tel. Address:
"Posgrip, Padd., London."

Plug and Socket or Spade End, 6d. each.

2-Volt Power Valve 12/6

This is a REAL power valve—British Made—Radion Guaranteed—and far less money than other leading makes. From **untied dealers or direct.**
RADION save you money but beware of imitations. Write for free book. RADIONS Ltd.—Belling-on Nr. Macclesfield, CHESTRE

WIRELESS MASTS. GALVANIZED TUBULAR TELESCOPIC.

Complete with base plate, ground pegs, stay wires, straining screws, pulley and cleat.
35ft. High £3 2 6 soft High £8 15 0
HILDICK & HILDICK, Pleck Road, Walsall.

TROLITE PANELS

Mahogany Grain 3/6 lb.
Black Engraved wavy 3/8 lb.
Black plain polished 3/- lb.
Machine cut Tested to your own measurements. 50,000 Volts.
Free Samples on Request.
PUGH'S WIRELESS, 95-101, Holloway Road, London, N.7

reproduction
—volume
—clarity

You get all these in Ericsson Super Tone Loudspeakers.

Made by a firm with a generation's experience in telephone research. No distortion. No rattle—just crystal-clear reproduction.

Put one to follow your pet power valve and you'll be amazed.

18" high on wood base. Very melow and pure. 2400 ohms, 63/- Junior Super Tone for small rooms, 32/6.

Write for lists

The BRITISH L.M. ERICSSON Mfg. Co., Ltd., 87/73, Kingsway, London, W.C.2.

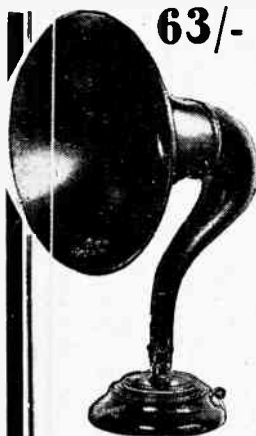

Ericsson
SUPER TONE LOUD SPEAKERS

UNIVERSAL FINE TUNING ATTACHMENT

ALL Stations obtained by fine tuning for the cost of 2/-, will attach to any Set, and with a three inch dial gives a reduction of 20 to 1.
Post Free 2/- from the manufacturers.
"Imperial Condensers"
(Agencies Vacant in Certain Districts)
WOODING & CO.,
105, The Wells Road, NOTTINGHAM.

finston SUPER COILS

Totally enclosed in moulded Bakelite cases giving mechanical strength without impairing their efficiency. The coils have been so constructed that the centres are always in alignment when two or more are used, thereby getting maximum results from their magnetic field. All connections are soldered so as to give constant electrical continuity throughout. A loose plug is provided so that the winding of the coils can be reversed if so desired.

PRICES: 25, 35, 40; 2/8 each. 50, 60; 3/- each. 75, 100, 150, 3/6 each. 175, 200; 4/- each. 250, 300; 4/8 each.

From all Dealers.
FINSTON MANUFACTURING CO., LTD.,
45, Horseferry Road, Westminster, London, S.W.1.

LOEWE AUDION O.E. VALVES FOR BEST RESULTS AT LOWER COST!

Will give better results than many at nearly double the price: especially suitable for Super-bet. Sets.
L.A.75-16 amp. 2 volt, 10/8. If your dealer L.A.74-06 amp. 3 volt, 11/8 (cannot sup. L.A.101, Power valve. ply send p.o. 0/8 amp. 4 volt, 21/- direct to **AUDION RADIO CO.,** 52, Dorset Street, LONDON, W.1.

BALL JOINTED COILHOLDER.

Reaction coil can be moved in ANY direction owing to unique ball joint. Smooth, even, efficient. Finished highly-polished ebonite block & handle, and heavily nickelled parts. Panel or metal board mounting. Post Free 4/8
Moorhouse & Co., 101 Bradford Road, SHIPLEY, Yorks.

THE MOTOR CYCLE

The Motor Cyclists' Newspaper
EVERY THURSDAY — 3d.

Publishers: ILIFFE & SONS LTD., Dorset House, Tudor Street, London, E.C.4. W.W.15

LUSTROLOX

Economy Valves for Portable Sets.
2v. '06 H.F., L.F., and 234 P.V.
LOUD SPEAKER RESULTS for '46 amps.
The Better British Valve.
Obtainable from Lewis's Ltd., Liverpool & Manchester, & **LUSTROLOX LTD.,** West Bollington, Nr. Macclesfield.

VERNIER ATTACHMENT GIVING
ADDITIONAL SLOW MOTION.

DIAL 0 TO 340. MOVEMENT
OF CONDENSER 2 TO 1

SUPPORTING
SHOULDER PIECE
NO END PLATES USED.

MOVABLE STOP,
NO BACK LASH.

EXTRA HARD
FRICTION DISC.

FRICTION
WHEEL

NOTE POSITION
OF VANES TO PANEL.

EXTRA SUPPORT.

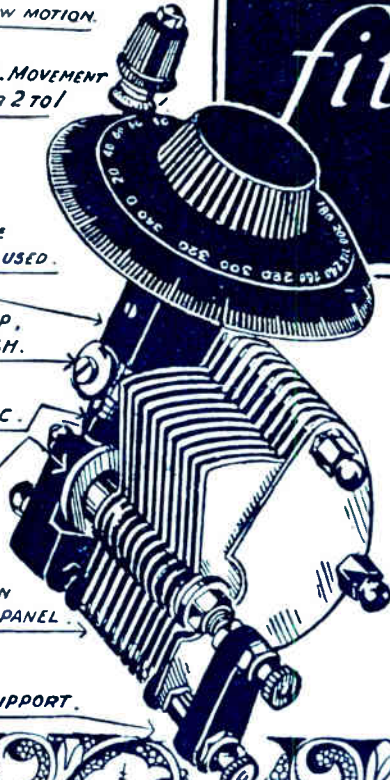

fit "DEVICON" CONDENSERS to your Set

The shortcomings of Condensers as a whole have been met in this the latest type.

The new "DEVICON" TRUE SCALE FRICTION CONDENSER

(Patent App'n. No. 1990/26)

has a 2 to 1 movement with additional slow motion device attached. One drilling hole in panel is all that is necessary. See the diagram at the side and note the improvements.

Supplied in the following sizes

001 - 15/6	0003 - 14/-
0005 - 14/6	0002 - 13/6

Other Models obtainable are the "Devicon" Bridge Condenser — "Devicon" Model 2 type (Nickel Finish, insulated end plates) and the "Devicon" Model 3 Low Loss

Manufactured and fully guaranteed by

Ask your Dealer about it.

THE RADIO DEVICES CO.,
Newdigate Street Telephone: 6798,
Nottingham. Telegrams: "Devicon."

"YOU'LL CONVERT YOUR RIGID HOLDERS NOW"



Fig. 975.
Code Word
"WOBBLERS"
Per 1/6 Set of 4
(3 black, 1 red)



Full Size Illustration.

Fig. 976.
Code "DUAL" Word
PURPOSE.
DOUBLE-ENDED. Price 1/9 each.
THE FOOL-PROOF HOLDER

FOR BASE OR PANEL FITTING
OR IN ANY OTHER POSITION.

The smallest and neatest combined holder on the market. No joints because the soldering tag is the same piece of wire as the spring. Show cards and display cards free.

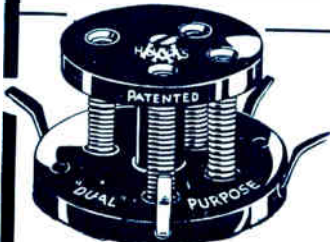

Full Size Illustration.

Fig. 974.
Code "WOBBLY" Word.
PRICE 2/3 each.

THE IDEAL
EXPERIMENTER'S HOLDER
TOO SIMPLE TO IMPROVE

For the genuine experimenter who must have a holder without capacity, and perfectly sprung. Hunt's "WOBBLY" is ideal. It is impossible to have fewer parts, or to better insulate, separate or spring them. Separately sprung legs are far more effective than a closed-in solid spring top.

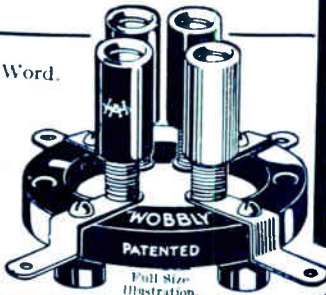

Full Size Illustration.

Made under Patent 242057/24. Prov. Pat. 30870/25 and 40'26. by —
A. H. HUNT, Ltd. (Dept. 1), Croydon, Surrey.

CAXTON 4-VALVE CABINET

Made for Sets "All Concert Receiver,"
"Fieldless Coil Three Valve Set."
"Any Valve Low Frequency Amplifier."
Special Cabinets made to customer's measurements.
Prices Quoted.

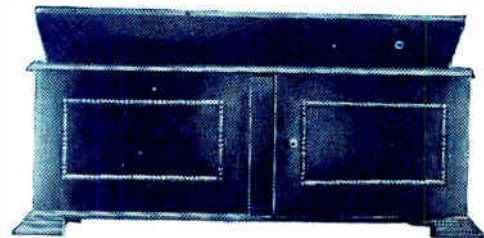

Cash with Order. Fumed Oak ...	£1 5 0
Dark or Jacobean Oak ...	£1 10 0
Real Mahogany ...	£1 14 0

Detachable 7" deep Base Board to mount 16" by 8" panel to slide out of Cabinet front.

The two beaded front doors as illustrated, placed 2 ins. in front of the enclosed panel at 10/- extra.

Ebonite or Radion Panels Supplied and perfectly Fitted at low extra cost.

All Polished with the new enamel that gives a glass hard surface that cannot be soiled or scratched. SENT FREE.—Catalogue of standard Wireless Cabinets in various sizes and woods.

Packed and delivered free in U.K.

No. C2

CAXTON WOOD TURNERY CO., Market Harborough

The Nation's Gratitude

THE whole nation emerged from industrial chaos with feelings of thankful relief and deep gratitude to Broadcasting.

As Mercury the Messenger served the gods in fable, so Wireless served the nation in fact.

By the dissemination of authoritative news and entertainment, broadcasting earned the gratitude of the whole British Public. The hiatus of administrative silence was safely crossed by the invisible bridge of Broadcasting.

To the pioneers—to the builders of this bridge—and to all who have contributed to the present-day development of Wireless, the nation's gratitude is as freely given as it is richly deserved.

The *first* Thermionic Valve was produced in the Ediswan Laboratories.

Remember!

"Ediswan" signifies British excellence and efficiency, best expressed in "Ediswan" Valves.

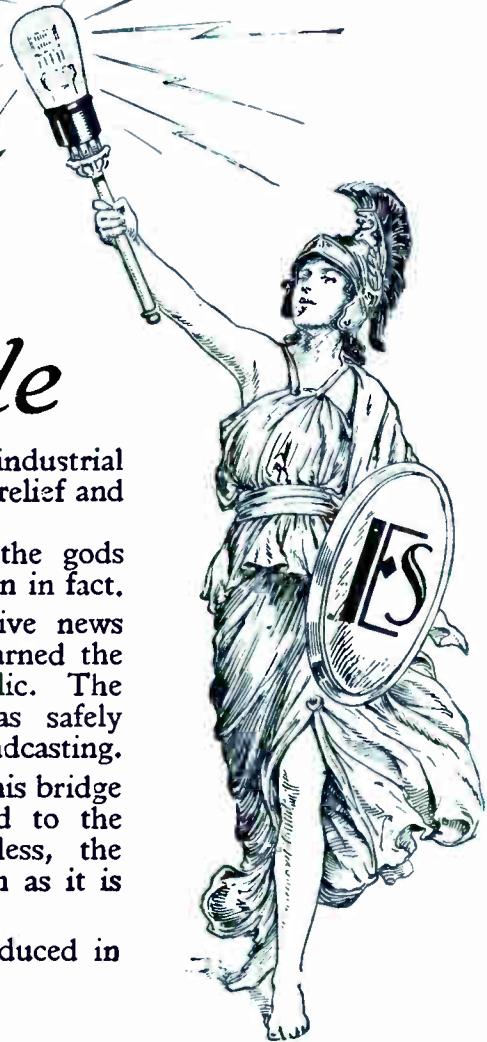

EDISWAN

THE VALVE THAT MADE BROADCASTING POSSIBLE.

THE EDISON SWAN ELECTRIC CO. LTD., 123-5 QUEEN VICTORIA ST., LONDON. E.C. 4.



Printed for the Publishers, ILLIFFE & SONS LTD., Dorset House, Tudor Street, London, E.C.4, by The Cornwall Press Ltd., Paris Garden, Stamford Street, London, S.E.1.

Colonial and Foreign Agents:
 UNITED STATES—The International News Co., 83-85, Duane Street, New York. FRANCE—W. H. Smith & Son, 248, Rue Rivoli, Paris; Hachette et Cie, Rue Réaumur, Paris.
 BELGIUM—W. H. Smith & Son, 78, Marche aux Herbes, Brussels. INDIA—A. H. Wheeler & Co, Bombay, Allahabad and Calcutta. SOUTH AFRICA—Central News Agency, Ltd.
 AUSTRALIA—Gordon & Gotch, Ltd., Melbourne (Victoria), Sydney (N.S.W.), Brisbane (Queensland), Adelaide (S.A.), Perth (W.A.) and Launceston (Tasmania).
 CANADA—The American News Co., Ltd., Toronto, Winnipeg, Vancouver, Montreal, Ottawa, St. John, Halifax, Hamilton; Gordon & Gotch, Ltd., Toronto; Imperial News Co., Toronto, Montreal, Winnipeg, Vancouver, Victoria. NEW ZEALAND—Gordon & Gotch Ltd., Wellington, Auckland, Christchurch and Dunedin.