

FOUR-ELECTRODE VALVE RECEIVER

4^D

The Wireless World

AND RADIO REVIEW

The Paper for Every Wireless Amateur

Wednesday, April 7th, 1926

RUGBY ~ An Aerial View ~

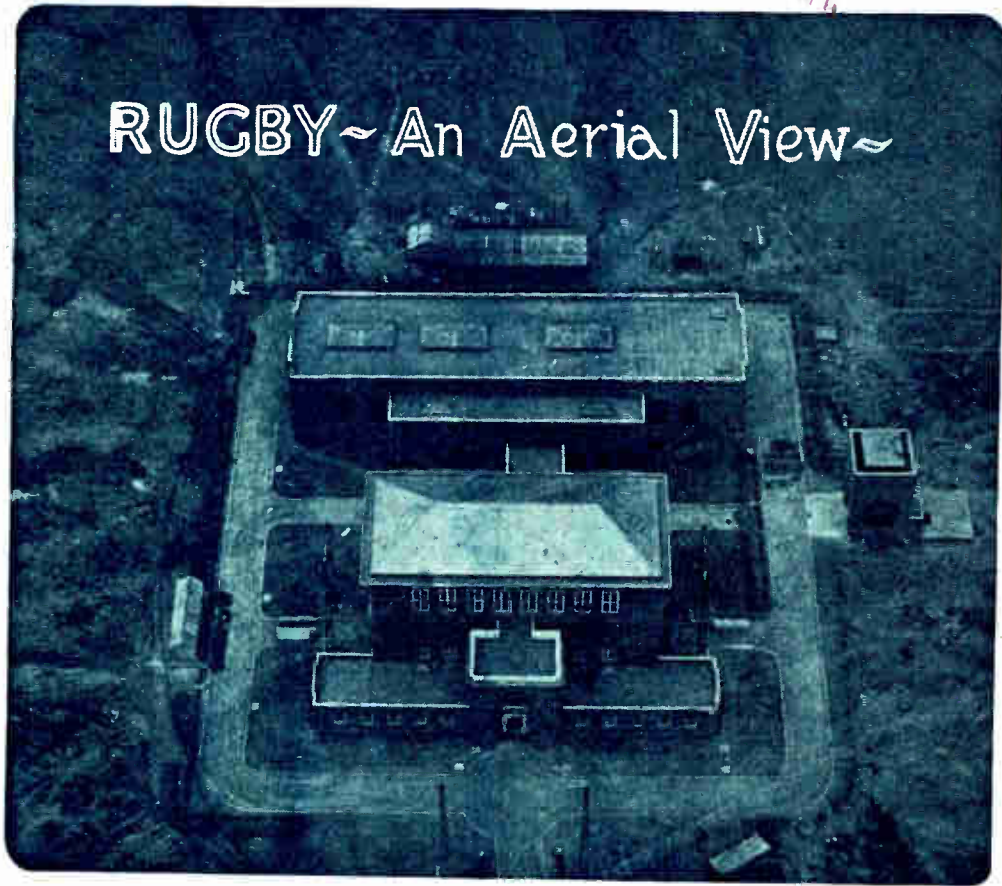

Less than the price of good Phones!

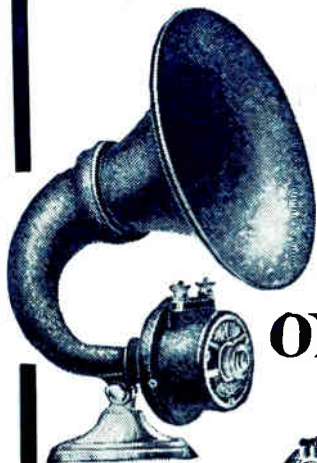

"Dragonfly"
Type A.R. 102.

Do not forget that the famous Dragonfly AMPLION is now

ONLY 17/6



Products of The House of Graham



gives your loud speaker a better chance

With a Siftron in circuit the steady component of current from the H.T. Battery is effectively side-tracked and the loud speaker is fed with speech currents only

The Siftron Price 33/-

Obtainable from AMPLION STOCKISTS, Radio Dealers or Stores.

Demonstrations gladly given during business hours at the AMPLION Showrooms:—

25, Savile Row, London, W.1.
79, High St., Clapham, S.W.4.

10, Whitworth St. West, Manchester.
101, St. Vincent Street, Glasgow.

There is no substitute for a genuine AMPLION

Announcement of Alfred Graham & Co. (E. A. Graham), London, S.E.A.

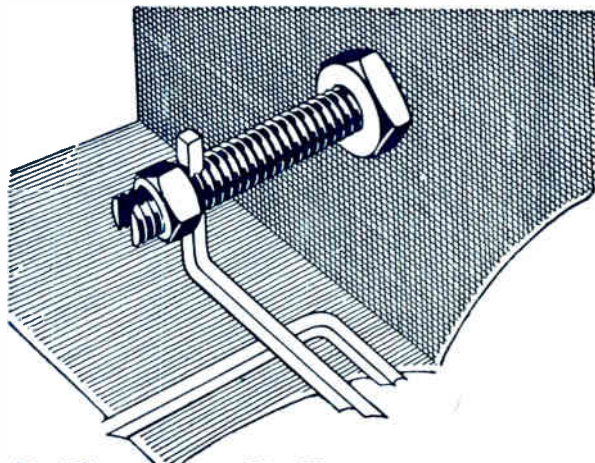

No soldering needed here!!

The stem of a Belling-Lee Terminal is slotted as shown. The wire is clamped tight by means of the nut and a perfect connection achieved without trouble, or risk of future trouble. You begin to understand the popularity of Belling-Lee Terminals! They bristle with unique features and they give finish and distinction to the set. They are made with twenty-eight engravings.

Moral: If you're proud of your set, give it Belling-Lee Terminals.

BELLING-LEE PRODUCTS.

Terminals, Plugs and Sockets, Couplers, Double Sockets, Sub-connectors, Dial Indicators, Air Space Wire, Coil Holders, Variometers, Detectors, Distribution Boards, Crystal Sets.

Illustrated Catalogue post free on request.

Standard (Bakelite-insulated) (Type B) . . . 9d. each.
Popular (Non-Insulated) (Type M) 6d. each.

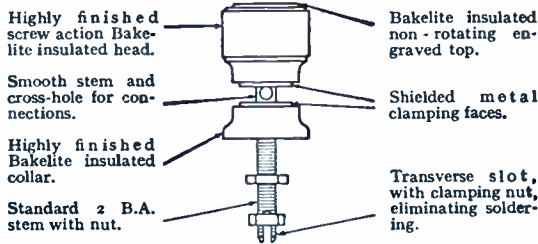

Patent Application No. 5954125.

BELLING-LEE PANEL FITTINGS

QUEENSWAY WORKS PONDERS END, MIDDLESEX.

Telephone: Enfield 498

E.P.S.2

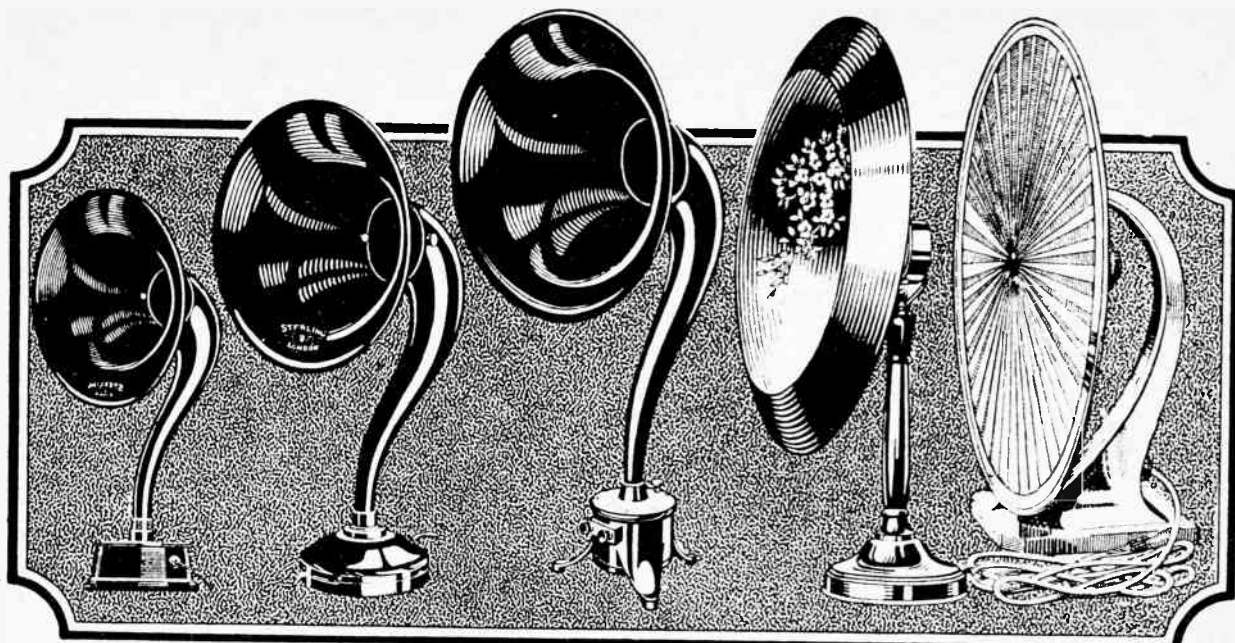

"DINKIE" "BABY" "AUDIVOX II" "MELLOVOX" "PRIMAX"

Each one the best in its class for tone and volume

THE fundamental principle embodied in the design of a loud speaker is similar to a telephone receiver. Sterling Telephones have been foremost for over a quarter of a century, and the loud speakers illustrated incorporate the vast experience gained during that period—that is why each Sterling Loud Speaker is the best in its class. They reproduce music, song and speech in all their *natural* forms. For tone, volume, design and exquisite finish they are unparalleled.

Write for descriptive folder No. 390D.

STERLING Loud Speakers

THE MARCONIPHONE COMPANY LIMITED

(Sole Agents for Sterling Telephone & Electric Co. Ltd.)

Head Office: 210-212, Tottenham Court Road, London, W.1.

Regd. Office: Marconi House, Strand, W.C.2.

STERLING "DINKIE"

"The little fellow with the loud voice." Comfortably loud for the average room, attractively finished in brown **30/-**

STERLING "BABY"

The best of all junior loud speakers. Ample in volume and perfect in tone. In black enamel or brown tinted finish **50/-**

STERLING "AUDIVOX II"

For home or public use. Unsurpassed for tone fidelity and reproduction. In black enamel finish **£4:10:0**

STERLING "MELLOVOX"

The popular hornless model. Faultless reproduction, mellow in tone, extremely artistic. Brown, blue, mauve or black with gold floral diaphragm **48/-**

STERLING "PRIMAX"

The loud speaker "de luxe," "The Very Soul of Music." Bronze finish **£6:0:0**



COSMOS PERMACONS

FIXED CONDENSERS GIVING FIXED RESULTS

The "Cosmos" Permacon is an ideal fixed condenser, being light in weight, of guaranteed accurate capacity and having the lowest possible losses.

The dielectric is mica and each condenser is tested at 500 Volts during inspection. Nickel plated cases give them a particularly neat appearance.

'0001 mfd	1/6
'0002	1/6
'0005	1/6
0003 ..	(with clip for grid leak)	1 8
'001	1 8
'002	1 10
'005	2 8
'01	3 9

"COSMOS" GRID LEAKS

are uniform and permanent.
 † 1, 2 and 3 megohms, each 1/6

Ask for copy of the Cosmos Components Brochure.

MEIRO-VICK SUPPLIES LTD.
 (Proprietors Metrovick-Vickers Elec. Co. Ltd.)
 4 Central Buildings, Westminster,
 LONDON, S.W.1

R 129

- MICA DIELECTRIC
- GUARANTEED ACCURATE CAPACITY
- LOW LOSS
- TESTED AT 500 VOLTS



TMC Low Capacity Keys

combine

- Extreme Low self-capacity.
- A positive locking action.
- Rapid make and break.
- Unvarying performance.
- Adaptability to varied switching requirements.
- Strong and accurate construction.
- Pleasing appearance.



All the live parts of the key are efficiently insulated from the frame. Individual parts are machine-made, ensuring accurate construction. The "gold-silver" contacts are always clean. The ends of the springs are tuned to facilitate soldering. Escutcheon plates and levers are of polished and lacquered brass or finished in bright nickel plate.

T.M.C. Low Capacity Keys are made in 3 models :

- No. 1. 12 point, 3 position .. 7/-
- No. 2. 6 point, 2 position .. 6/-
- No. 3. 24 point, 3 position .. 15/6

Have you sent for your copy of the interesting T.M.C. Catalogue?

It is free on request.

Telephone Manufacturing Co., Ltd.,

Hollingsworth Works,
 West Dulwich,
 London, S.E.21.

If your dealer does not stock T.M.C. Goods we will supply you direct at the above prices, post free.

DUBILIER CONDENSERS

Are used in many famous sets
e.g. STANDARD ♦ BURNDIPT
B·T·H ♦ POLAR ♦ ETC
See that they are in your set



REGISTERED  TRADE MARK

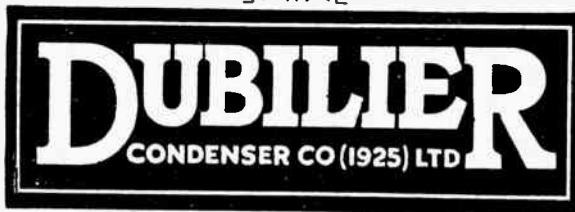

ADVERT. OF THE DUBILIER CONDENSER CO. (1925) LTD., DUCON WORKS,
VICTORIA RD., NORTH ACTON. W.3 TELEPHONE: CHISWICK 2241-2-3.

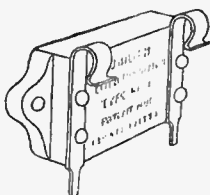

Type 600

A Mica Condenser for
all purposes.
0·0001-0·0009 mfd., 2/6
0·001 -0·006 mfd., 3/-
(With or without grid-
leak clips.)

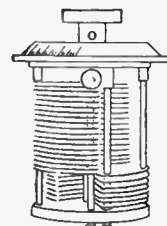

The Duwatcon

A Special Variable Con-
denser giving a very wide
tuning range with only
one coil.
0·0007 mfd - - 30/-

E.P.S.181



Choose your Valves by comparison—

1. Compare the characteristics of the S.P. 18 Valves with the published figures of other makers. Take the Voltage Amplification Factor, multiply it by the Mutual Conductance in micromhos. The square root of the product is the figure to use when comparing the relative merits of valves.
2. Compare the filament details. How many cells are
3. Compare the prices. [required?]
4. Compare the actual results, tone, quality, volume, etc.

These particulars for "Cosmos" SHORTPATH Valves are given in the adjoining panel.

METRO-VIC SUPPLIES LTD.,

(Proprietors, Metropolitan-Vicker Electric Co. Ltd.)

4, Central Buildings, Westminster, London, S.W.1

R 733

The characteristics of S.P. 18 Valves are:—

	RED SPOT.	GREEN SPOT.
Voltage Amplification Factor	7	15
Impedance	7,000	17,000
Mutual Conductance Micromhos	1,000	650
Figure of Merit	84	113

2. S.P. 18 Valves consume only 0.3 Amp. at from 1.6 to 1.8 Volts, and require only a single cell 2 Volt Accumulator.
3. S.P. 18 Valves cost only **12/6** each. Red Spot or Green Spot.
4. S.P. 18 Valves provide a SHORTPATH to better results.

Cosmos

RADIO VALVES

EDISON BELL RADIO

PERFECT RECEPTION ASSURED BY USING—

—AN EDISON BELL "BIJOU" 2-VALVE SET

SPECIFICATION

Size 12 x 10 x 10 in. deep, ebonite panel with nickel-plated fittings. Handsome cabinet, desk pattern, highly polished.

This is a very efficient 2-Valve Set and will give good Loud Speaker results at 25 to 30 miles, it having one Detector and one Low Frequency Stage.

It is built into a desk pattern cabinet, enabling it to be closed when desired. Reaction is controlled by moving the side of the cabinet on a nickel-plated arm, which can be locked in any position.

Supplied complete with coils from 300 to 500 metres. Coils for the high power station at additional cost.

Price £3 : 15 : 0

(Valves, Batteries and Marconi Licence extra.)

Manufactured by the ALL-BRITISH FIRM with OVER THIRTY YEARS' REPUTATION for QUALITY.

J. E. HOUGH LTD., Edison Bell Works, LONDON, S.E.15,



Loud Speaker results
30 MILES

Read this extract from Radio Press Test:—

"With a very inefficient indoor aerial we obtained full loud speaker strength, etc., and the maker's claim, 'loud speaker results 30 miles,' is well substantiated."

Ask your dealer for attractive catalogues, if unable to obtain write direct.

Price £3 : 15 : 0

(Valves, Batteries and Marconi Licence extra.)

and at HUNTINGDON.

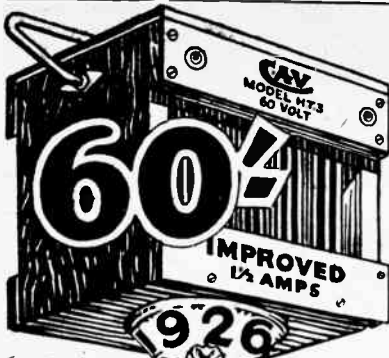

Car Equipment
Manufacturers by
Appointment to
H.M. THE KING.

Pedestal of 35 Years Experience

C.A.V. H.T. ACCUMULATORS are not built of the ordinary test tubes, but tubes of special design and material assembled to eliminate intercell current leakage, which is so common amongst block form accumulators of much greater capacity; which large capacity is, in many cases, superfluous. An H.T. Accumulator need not necessarily have a large ampere hour capacity, because the current taken by the average broadcast receiver is comparatively small, and therefore the greatest feature must be the absence of intercell current leakage and consequent maximum retention of charge. The C.A.V. H.T. ACCUMULATOR possesses this most important feature, the path of possible intercell leakage being more than 9in.—an exclusive design. Ask your local expert to explain.

That is why the leading experimenters, such as—
Mr. W. K. Alford, radio 2 DX.
Mr. V. E. M. Oliver, B.A., A.M.I.E.E., radio 6 BV.
Mr. J. A. Partridge, radio 2 KF.
Mr. E. J. Simmonds, M.I.R.E., F.R.S.A.,
radio 2 O.D.

use them when carrying out noteworthy experiments.
C.A.V. H.T.3.—60 Volts **60/-** C.A.V. H.T.4.—30 Volts **30/-**
All C.A.V. H.T. Accumulators are supplied fully charged
(First charge free.)

For your L.T. supply— "ACTON" ACCUMULATORS in glass.

The specially designed stout moulded glass jar has many important features in addition to its transparency. It prevents the risk of fire, eliminates frothing, is clean and of good appearance. No separators are fitted between the plates, which are correctly spaced by grooves moulded in the sides of glass jar. The plate sections are suspended from the ebonite lid which is sealed in position. Screwed vent plugs are made of porcelain and therefore easily cleaned.

2-VOLT SINGLE CELLS.

TESTED CAPACITY, IGNITION, ACTUAL	WEIGHT, LBS.		PRICE, s. d.
	DRY.	WET.	
60	30	7 8	13 6
80	40	9 10½	16 0

4 and 6-volt assemblies at proportionate prices.



Inspect them at your local radio dealer or any
C.A.V. Service Station.

C.A. Vandervell & Co., Ltd.
ACTON VALE, LONDON, W. 3.

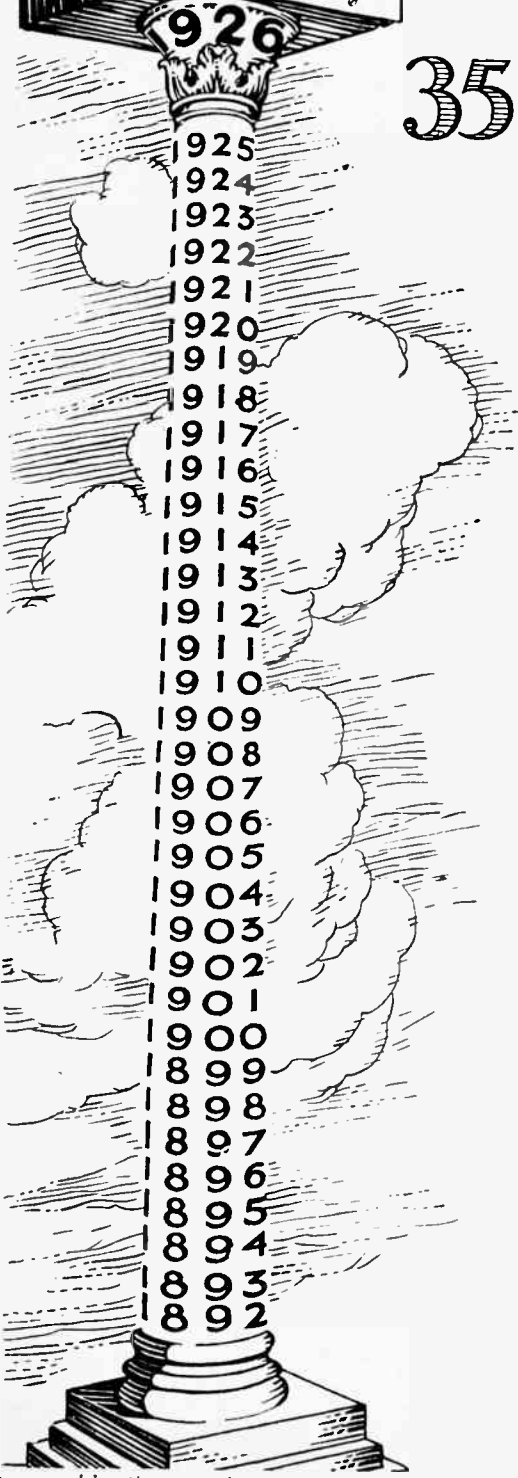



“A silent worker”— giving big results

Having a high amplification factor, the Igranitic E. type Audio Frequency Transformer gives a large volume of distortionless speech and music, with an entire absence of parasitic noises.

Much wire and good wire is built into it, and the iron is the best for transformer construction. Therein lies the reason for the fine performance of the E. type—its high amplification over a very wide range of frequencies. It is made in two types—E.1, with a ratio of 1 to 5 for first and single stages, and E.2, having a 1 to 3 ratio for second and subsequent stages.

E.1 costs 21/-. E.2 costs 19/6.

Both types are shrouded and can be mounted closely without interaction.

Ask your dealer about the Igranitic E. Type

Write for List U163



Exclusive Manufacturing Licenses
of PACENT Radio Essentials

149, Queen Victoria St., London

Works: BEDFORD

The IGRANITIC Instructional Carton

for constructing a 6-valve Supersonic Heterodyne Receiver according to the Igranitic design, contains a comprehensive, fully illustrated descriptive handbook, full-size general arrangement drawings, wiring diagrams and drilling template. Obtain a copy from your dealer.

PRICE 2/6.

Plug in a LEWCOS Coil — and listen!

THAT'S the test. It makes *all* the difference when you tune in with a LEWCOS Coil. Listeners everywhere have been quick to realise the quality and advantages of this guaranteed coil.



Ask your dealer for a demonstration. Each LEWCOS Coil is tested in our laboratory. It is then boxed, sealed up, and reaches you in perfect condition. Be sure the LEW seal is unbroken.

LEWCOS Inductance Coil



3 LEWCOS advantages:

- 1 High electrical efficiency with great mechanical strength.
- 2 Great selectivity resulting in extremely fine tuning.
- 3 Exceptionally low high frequency resistance with increased signal strength.

THE
LONDON ELECTRIC WIRE
CO. and SMITHS LTD.,
Manufacturers of Glazite
Playhouse Yard, Golden
Lane, London, E.C.1.

JUDD.

THE TRUTH ABOUT L.F. TRANSFORMER IMPEDANCE

(a) Amplification with any valve and transformer depends greatly on the transformer impedance; the higher the transformer impedance the better the reproduction, particularly of the lower notes.

HENCE IT IS UNNECESSARY TO VARY THE IMPEDANCE OF THE TRANSFORMER TO MATCH THAT OF THE VALVE USED; ON THE CONTRARY, THE HIGHEST POSSIBLE TRANSFORMER IMPEDANCE SHOULD BE USED AT EVERY STAGE.

(b) IMPEDANCE DEPENDS ON FREQUENCY, AND TO STATE TRANSFORMER IMPEDANCE WITHOUT STATING THE FREQUENCY AT WHICH IT IS MEASURED CONVEYS NOTHING.

A good transformer has a high impedance even at low frequencies to reproduce low notes satisfactorily. A transformer may have a high impedance at a comparatively high frequency, say, 500, and yet be a bad transformer because the whole range of male and female speaking voices, as well as most of the fundamental musical notes, are at frequencies below 500.

FERRANTI INTERVALVE TRANSFORMERS TYPE AF3

HAVE THE FOLLOWING IMPEDANCES

At 100 Periods **50,000 OHMS**

At 500 Periods **410,000 OHMS**

**NO BETTER TRANSFORMER
IS AVAILABLE AT ANY PRICE**

Ask your Dealer for Leaflet Wa401

❑ ❑ ❑

FERRANTI Ltd. HOLLINWOOD
LANCASHIRE.



25/- NETT.

**RATIO 3.5 to 1
FOR USE IN BOTH
FIRST AND SECOND
STAGES.**

Your Valve Pins!

Another Unique Feature
of the

Osram D.E. 2

H.F. and L.F. (for 2-Volt Accumulators)

HOLLOW CROSS-CUT PINS

However good the valve, you cannot get best results unless the greatest thought is given to the construction of every detail. Another instance of painstaking attention to details is the introduction of the HOLLOW CROSS-CUT PIN fitted for the first time to D.E.2. OSRAM VALVES.

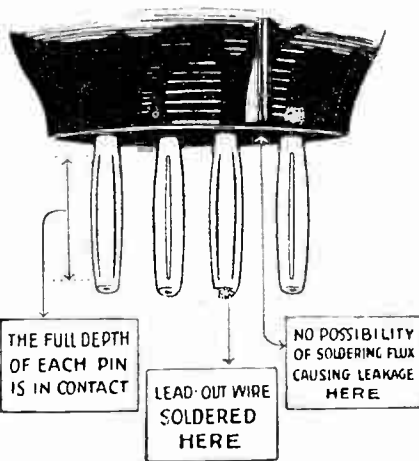

READ HOW THESE PINS IMPROVE PERFORMANCE

The full depth of each pin is in contact. They can be inserted and removed thousands of times without spoiling the contact.

Pins enable valve to be driven home so that base is flush with socket, and therefore valve takes up less room in your set.

High insulation. When the leading-out wires are soldered to the top of ordinary split pins, as in the case of the majority of valves, there is a danger of the soldering flux spreading over the bottom of the base. This is a frequent cause of leakage between the pins. In the OSRAM VALVE Hollow Cross-cut pin, the leading-out wires are soldered to the *bottom* of the pins and perfect insulation is thereby ensured.

Osram Valves

for Broadcasting

The G.E.C. - your guarantee

The Wireless World

AND
RADIO REVIEW
(14th Year of Publication)

No. 347.

WEDNESDAY, APRIL 7TH, 1926.

VOL. XVIII. No. 14.

Assistant Editor:

F. H. HAYNES.

Editorial Offices: 139-40, FLEET STREET, LONDON, E.C.4

Advertising and Publishing Offices: DORSET HOUSE, TUDOR STREET, LONDON, E.C.4.

Telegrams: "Ethaworld, Fleet, London."

COVENTRY: Hertford Street.

Telegrams: "Cyclot Coventry."
Telephone: 10 Coventry.

BIRMINGHAM: Guildhall Buildings, Navigation Street.

Telegrams: "Autopress, Birmingham."
Telephone: 2970 and 2971 Midland.

Assistant Editor:

W. JAMES.

Telephone: City 4011 (3 lines).

Telephone: City 2847 (13 lines).

MANCHESTER: 199, Deansgate.

Telegrams: "111166, Manchester."
Telephone: 8970 and 8971 City.

Subscription Rates: Home, £1 1s. 8d.; Canada, £1 1s. 8d.; other countries abroad, £1 3s. 10d. per annum.

As many of the circuits and apparatus described in these pages are covered by patents, readers are advised, before making use of them, to satisfy themselves that they would not be infringing patents.

CARELESSNESS IN MANUFACTURE.

EVERY manufacturer of repute takes pride in the quality of his products, and one usually finds that in a well-conducted business this pride is reflected in the work of the entire staff. There are instances, however, when it seems that some unaccountable slackness develops in the organisation, which permits of very serious deviation from the standard of quality which the manufacturer has set up. We would urge manufacturers of wireless apparatus to pay greater attention than is done at present to checking the standard of their products. Several instances have come to our notice recently which indicate that even amongst the best-known firms, really serious cases of carelessness can occur. As one example, we have information that out of a certain order placed with a responsible firm for a dozen grid leaks of stated value, no less than four out of the dozen proved to be blanks; in other words, the resistance value was practically infinity. Imagine the annoyance and trouble that might well be caused to some unsuspecting purchaser of such an article, especially if he were not in a position to detect the fault for himself. One serious disappointment in the quality of apparatus purchased will scarcely be overlooked by the victim, even though he may have had long and satisfactory dealings previously with the same firm. Confidence once lost is not easily regained.

We hope that, by timely notice, steps will be taken by manufacturers to see that no occasion will arise in the future for drawing further attention to the matter.

OSCILLATION: IS THERE A CURE?

WE were sorry to see, some days ago, an unauthorised statement in the daily Press regarding a wireless invention which, it was stated, was due to Sir Oliver Lodge. Fortunately, attention was drawn to it

in time and a correction was issued in most sections of the Press on the following day.

Sir Oliver Lodge is, apparently, at work on the interesting problem of the prevention of radiation from receivers. The statements made in the Press would have led one to believe that no receiver capable of producing this desirable result had so far been developed. This, of course, is not the case. We know that in the early days of broadcasting the Postmaster-General prohibited the sale of sets capable of causing interference in this way, whilst very many devices have been described in *The Wireless World* from time to time which provide a means of achieving the same end, even though the receiver itself may be in a state of oscillation. The reason that sets incapable of causing interference have not come on the market is that some loss in efficiency results from the introduction of methods

to combat the evil or else an additional valve stage is required. If Sir Oliver Lodge's experiments produce a circuit which is effective, with even a single-valve oscillating set, then he will have contributed another important invention to the progress of wireless, but unless such a scheme is applicable to simple sets without expense or complication, we believe that we shall still be as far off from a solution of receiver oscillation troubles as we are to-day.

CONTENTS.

	PAGE
EDITORIAL VIEWS	511
BROADCAST RECEPTION WITH FOUR-ELECTRODE VALVES	512
By F. L. Devereux.	
TELEPHONY ON TRAINS	517
READERS' NOVELTIES	520
CURRENT TOPICS	521
PORTABLE RECEIVERS	523
By The Wanderer.	
PRACTICAL HINTS AND TIPS	525
LOUD-SPEAKER CONNECTIONS	527
By A. P. Castellain.	
SINGLE SIDE-BAND TRANSMISSION (Continued)	529
By E. K. Sandeman.	
BROADCAST BREVITIES	533
NEW APPARATUS	535
WIRELESS CIRCUITS IN THEORY AND PRACTICE	537
By S. O. Pearson.	
LETTERS TO THE EDITOR	540
READERS' PROBLEMS	541

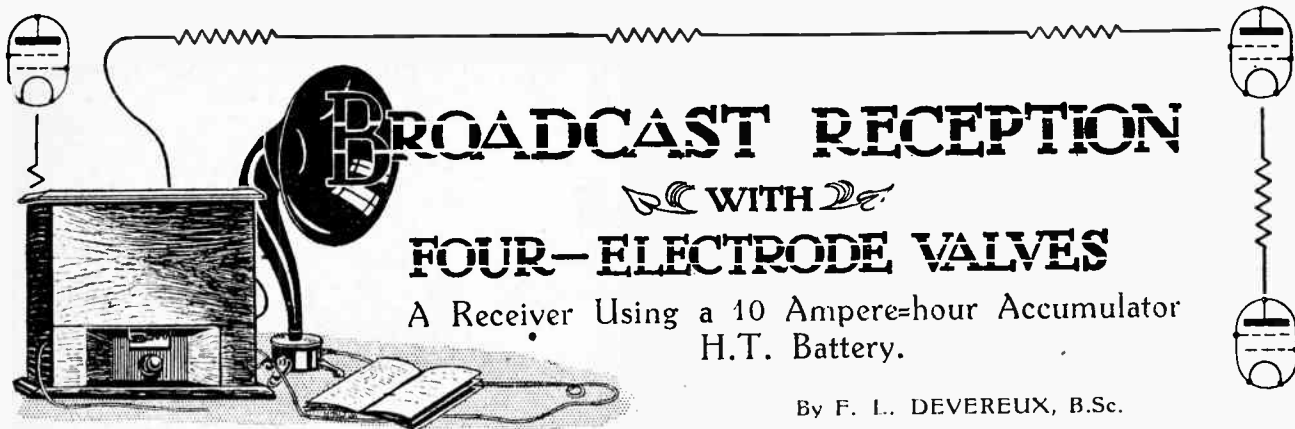

By F. L. DEVEREUX, B.Sc.

THE high-tension battery introduces an element of uncertainty into the otherwise satisfactory performance of the modern broadcast receiver. Quality of reception is good, valves are reliable, and the charging of the filament battery every week or so is now taken as a matter of course; but unless one is fortunate in having D.C. lighting mains at hand, the H.T. supply after the experience of the first two or three breakdowns becomes to the listener a never-ending source of anxiety. It is true that the larger firms who have been specialising in the production of dry cells for many years are able to produce a reasonably reliable battery, albeit at rather high cost to the consumer. This cannot be said of the average dry battery with small cells, which is highly unsatisfactory; you may get one to last six months, but more often than not it will break down after six days due to a faulty cell.

H.T. Accumulators.

As an alternative, the H.T. accumulator may be considered. In general the cells are too small, and if power valves are used the H.T. accumulator will need charging every time the filament battery is recharged. Careless charging will soon ruin these small batteries and in any

case there is the question of transport to the charging station, to say nothing of the high initial cost.

The use of 4-electrode valves, which, when suitably connected, require a maximum H.T. voltage of only 15 volts, puts quite a different complexion on the matter. Only seven or eight cells are required instead of sixty, and it is possible to increase the capacity of the cells tenfold without producing a battery of undue weight or cost. D.T.G. cells lend themselves admirably for this purpose; a battery of eight cells costs 36s. (less than the cost of a 120-volt dry battery of first-class quality), and in the receiver about to be described gives 2,000 hours' service on a single charge. It can then be recharged at a cost which ought not to exceed 2s. 6d., and, owing to the special nature of the plates, will last almost indefinitely.

Here, then, is one solution of the H.T. problem. Let us now turn our attention to the design of a broadcast receiver employing 4-electrode valves and an H.T. battery of D.T.G. cells.

General Design

As reliability is more important to the broadcast listener than to the experimental amateur, the requirements of the former have been kept in mind and the receiver has been

designed with the object of keeping the number of adjustments as small as possible. A sketch of the complete receiver as it appears when finished is included in the title of this article. It will be seen that the only controls which are visible are the key switch for changing over from the local station to Daventry, and a push-pull switch for the filament current. The tuning and reaction controls, once set, require no further attention so long as the wavelengths of the stations remain constant. Two small doors have therefore been pro-

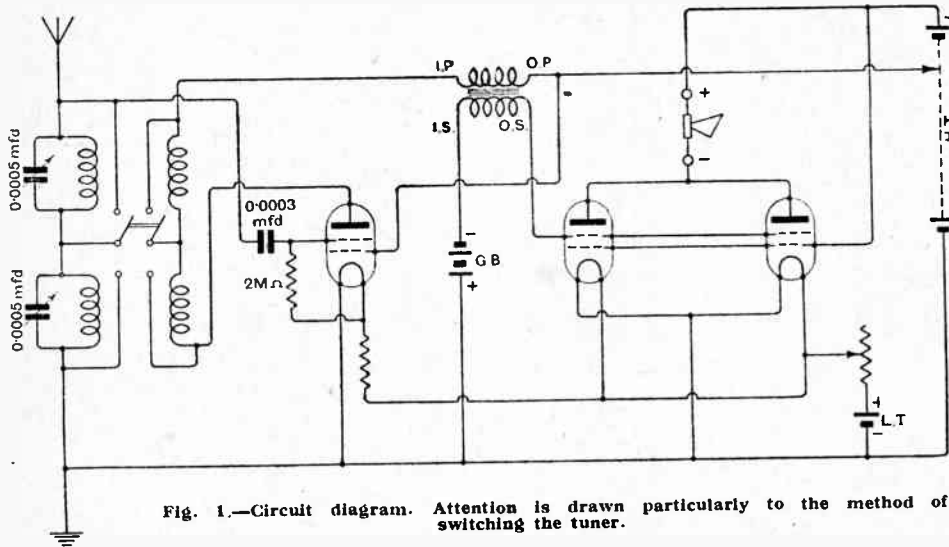

Fig. 1.—Circuit diagram. Attention is drawn particularly to the method of switching the tuner.

Broadcast Reception with Four-electrode Valves.—

vided to cover the tuning dials with which one might be tempted to interfere were they visible. Removal of the back of the cabinet reveals the three valves which are in a compartment to themselves, and above them another compartment containing the L.T. battery. The receiver may therefore be operated, the L.T. battery charged, and valves renewed without interfering in any way with other parts of the receiver.

The Circuit.

In order to tune to the local station and also to Daventry, two separate tuned circuits are connected in series in the aerial circuit.

Corresponding reaction coils are connected in series in the plate circuit of the detector valve, and a double-pole change-over switch is arranged to short-circuit either pair of coils when not in use. The short-wave coils for the local station are the upper pair in the circuit diagram, thus the connection to the grid of the detector valve is taken directly from one end of the short-wave tuner, the short-circuited Daventry coil being at earth potential. On the Daventry wavelength capacity effects due to the short-circuited short-wave coil will not adversely affect the efficiency of the receiver. The tuner is connected to the outer grid of the first valve through the usual 0.0003 mfd. condenser and 2 megohm grid leak, the lower end of which is connected to the positive end of the filament. A fixed resistance is connected in the positive filament lead of this valve to reduce the filament

and a considerable step-up of voltage between the detector and L.F. stages is thereby obtained. No by-pass condenser is shown, but one having a value of 0.001 mfd. may be connected across the primary winding if there is any difficulty in making the receiver oscillate on the Daventry wavelength.

An examination of the characteristic curves of the D.E.7 four-electrode valve reveals that with the maximum

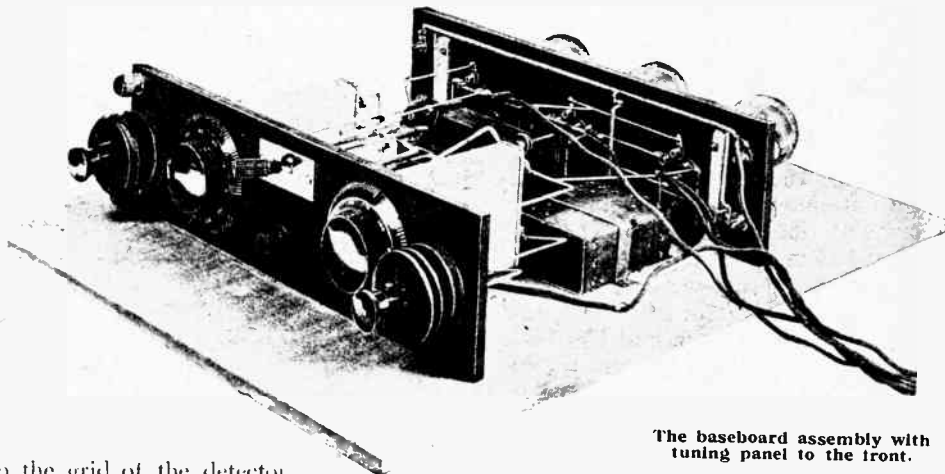

The baseboard assembly with tuning panel to the front.

H.T. voltage of 15 or 16 volts, the correct grid bias is approximately -3 volts, permitting a maximum input swing of 6 volts on the grid of the amplifying valves. The significance of this is that with normal reception only one stage of amplification is permissible; a swing in excess of 6 volts would be obtained even with weak signals were two stages to be employed. On the other hand, the power handled by the D.E.7 valve is comparatively small, and to obtain satisfactory results even with a small loud-speaker it is advisable to connect two of these valves in parallel in the low-frequency stage. The normal anode current with 16 volts on the plate and in the grid, and with a grid bias of -3 volts, is approximately 1.5 mA. per valve.

The filament current is switched on and off by a combined switch and filament resistance connected in the positive L.T. lead.

It will be seen that no reservoir condenser is connected across the H.T. battery, the reason for this being that the battery actually used in the receiver has an extremely low internal resistance, and a reservoir condenser is only necessary in cases where the internal resistance is high.

Choice of Components.

Polar tuner units which include an adjustable reaction coil lend themselves admirably to this circuit. They are

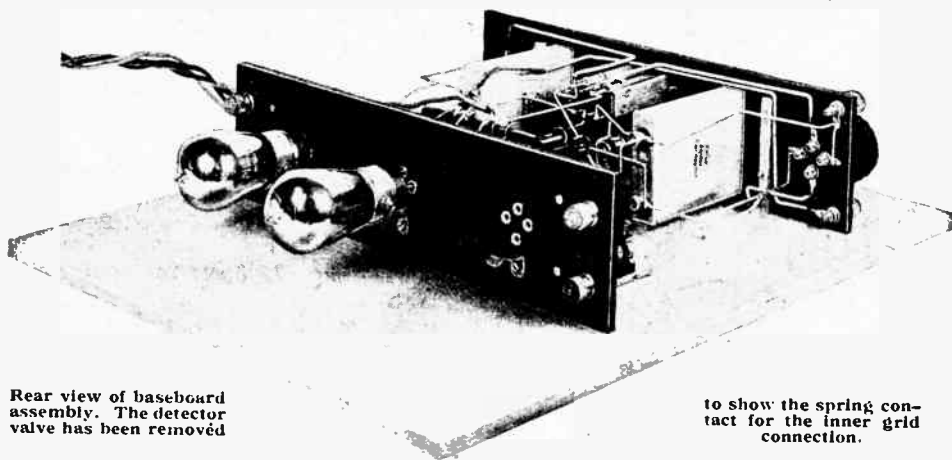

Rear view of baseboard assembly. The detector valve has been removed

to show the spring contact for the inner grid connection.

current slightly below that of the two L.F. valves. This precaution is taken because a lower H.T. voltage is used for the detector than for the L.F. valves.

Four-electrode valves have a comparatively low impedance, and it is therefore possible to employ a high-ratio transformer between the detector and amplifying valves. In this case a transformer having a 6 : 1 ratio was chosen.

Broadcast Reception with Four-electrode Valves.—

tuned by two Polar Junior condensers which are both cheap and compact, and once set to the wavelength of the station to be received require no further adjustment. The change-over switch associated with the tuned circuits is manufactured by the Dubilier Condenser Co., Ltd., under the name of the "Minicap" switch. The grid condenser and leak is also manufactured by the same company, the latter being the new type in glass container known as the "Dumetohm."

A Pye 6:1 ratio transformer was chosen from among the half-dozen best makes of intervalve transformer on account of its small overall height, which is less than the height of the two ebonite panels of the receiver.

As reliability is of the utmost importance in this receiver, the grid bias batteries must be chosen with great care as they will be fitted in an inaccessible position and must retain their E.M.F. for at least a year. Siemens "T" type cells were chosen, as they have not only proved to be reliable, but are of a convenient shape for fixing to the baseboard.

Constructional Details.

The framework of the receiver consists of two parallel boards, the lower of which measures 18in. x 14in. x 1/2in., and forms the base of the cabinet. The upper board, 16in. x 12in. x 1/2in., exactly fits inside the cabinet, and supports the H.T. and L.T. accumulator cells. The

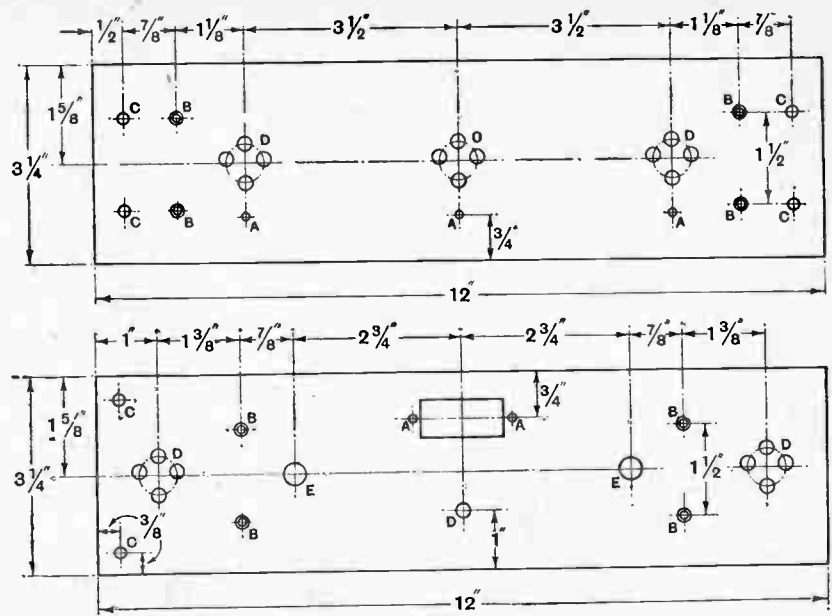

Fig. 2.—Drilling details of the ebonite panels. Sizes of holes are as follow: A, 1/16 in. dia.; B, 1/8 in. dia., countersunk for No 6 B.A. screws; C, 1/16 in. dia.; D, 1/16 in. dia.; E, 3/16 in. dia.

battery board is supported from the base on two parallel ebonite panels, which are fixed vertically to the baseboard by means of cast aluminium brackets. The top edges of the ebonite panels are drilled and tapped No. 6 B.A. for the screws holding down the battery board. It will be seen that the space between the two boards is divided into three compartments by the ebonite panels. The front compartment contains the tuning adjustments, the centre compartment the main components of the receiver, and the rear compartment the three valves.

The front panel, drilling details of which are given in Fig. 2, carries the aerial and earth terminals, the "on" and "off" switch, the wavelength change-over switch, and the tuner units and condensers. The back panel carries the valve sockets and loud-speaker terminals. Drilling details are also given in Fig. 2, which shows the position of the holes for securing the phosphor-bronze spring contacts by means of which connection is made to the metal base of the valves. It is to this metal base that the inner grid connection of the valve is made. Terminals are provided on the side of the valve base for this connection, but spring contacts have been used to facilitate the removal of the valves in the somewhat limited space available in the valve compartment.

A dimensioned drawing of the baseboard, showing the position of components fixed thereto, is given in Fig. 3. This drawing also gives the dimensions

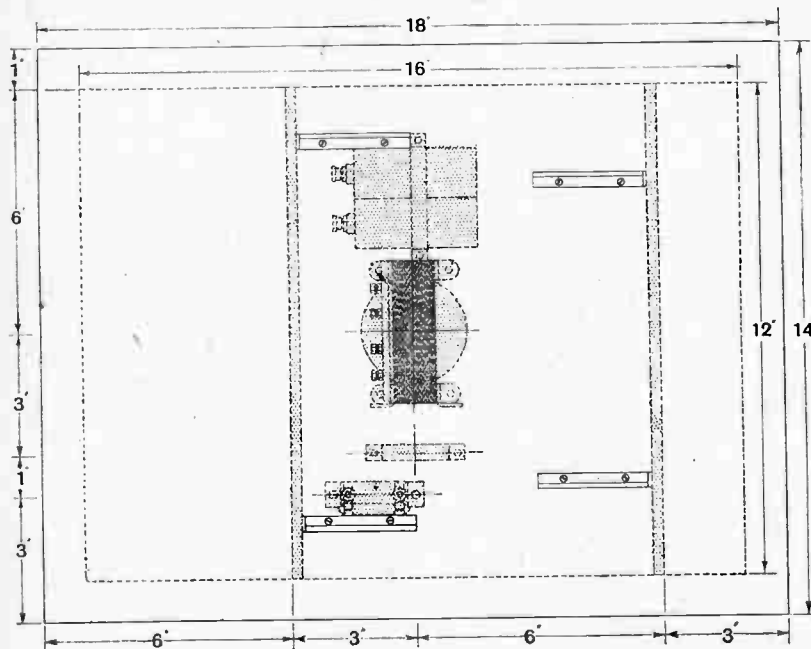

Fig. 3.—Baseboard dimensions and positions of the transformer grid batteries and grid condenser and leak.

LIST OF COMPONENTS.

- 2 Ebonite panels, 12in. × 3¼in. × ¼in.
- 2 Tuner units (Polar C.P. 8883, C.P. 8889).
- 2 Variable condensers (Polar Junior).
- 1 D.P.D.T. switch (Dubilier "Minicap").
- 1 Fixed condenser, 0.0003 mfd. (Dubilier).
- 1 Grid leak and holder, 2MΩ (Dubilier "Dumetohm").
- 1 Intervalve transformer, ratio 6:1 (Pye).
- 1 Combined rheostat and switch (Argonaut).

- 8 2-volt cells (Exide D.T.G.).
- 1 2-volt accumulator in glass case, 48 A.H. (C.A.V.).
- 2 Grid cells, 1½ volt (Siemens, "T" type).
- 3 Four-electrode valves (Marconi or Osram D.E.7).
- 2 pairs aluminium brackets (A. J. Dew & Co.).
- 6 Terminals, "M" type (Belling & Lee).
- Mahogany, thickness ½in., for baseboards and cabinet.
- Wire, screws, etc.

Approximate cost, excluding loud-speaker, £10 10s. od.

of the upper baseboard supporting the batteries and the positions of the two ebonite panels.

The wiring is carried out in accordance with Fig. 4. Wiring associated with the H.T. and L.T. batteries has

flex of specially thick cross-section to reduce resistance losses which would otherwise be serious in the two-volt filament circuit. The normal filament drawn from the L.T. battery when three valves are in use is 1.2 amps.,

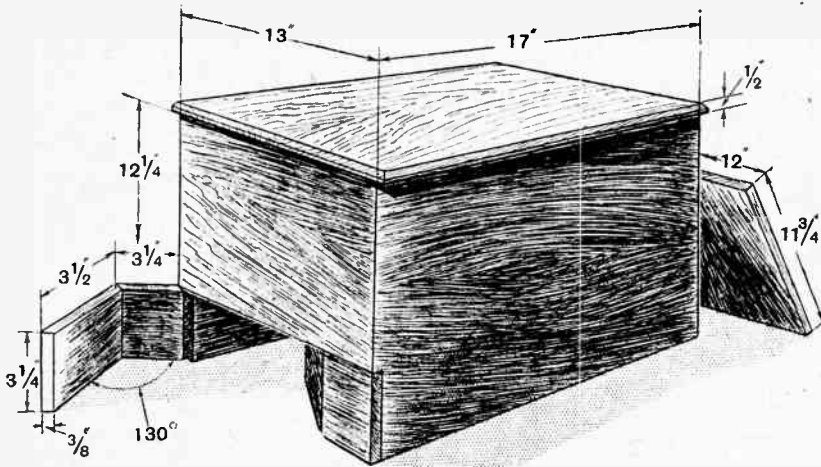

Fig. 5.—Leading dimensions of the cabinet cover.

been carried out with rubber-covered No. 16 S.W.G. tinned copper wire. The remainder of the wiring is carried out with bare tinned copper wire.

Wiring the Change-over Switch.

If the wavelength change-over switch is wired exactly in accordance with the diagram, the operating lever will automatically point towards the tuner unit in circuit. When the switch is moved over to the left-hand side, for instance, the centre contacts will be connected through to corresponding contacts on the right-hand side of the switch. It will be seen from the wiring diagram that the tuner and reaction coils in the right-hand socket are short-circuited in this position; thus the receiver is being tuned by the left-hand condenser and unit towards which the lever is pointing.

The fixed resistance in series with the filament of the detector valve consists of a piece of No. 36 S.W.G. Eureka wire, 1¼in. in length, which actually forms part of the wiring of the receiver.

The connections to the H.T. and L.T. batteries are made with flex, the L.T. leads consisting of

flex of specially thick cross-section to reduce resistance losses which would otherwise be serious in the two-volt filament circuit. The normal filament drawn from the L.T. battery when three valves are in use is 1.2 amps., and since a drop of only 0.1 volt in the connections is sufficient to limit the useful discharge period obtainable from the battery, a resistance in excess of 0.1 ohm in the external filament circuit cannot be tolerated. It was this consideration which led to the choice of the "Argonaut" filament resistance and switch; the contact ring at the end of the switch ensures that no part of the resistance wire remains in circuit in the full "on" position. The importance of keeping the resistance of the filament circuit low when 2-volt valves are used cannot be over-emphasised; any latitude which might be allowed for 6-volt valves would probably prevent the receiver from working if 2-volt valves were substituted in the same circuit.

The wiring having been completed, the battery board is screwed in position and a vertical partition, 5in. high, is fitted between the H.T. and L.T. batteries. This partition not only serves to isolate the L.T. battery,

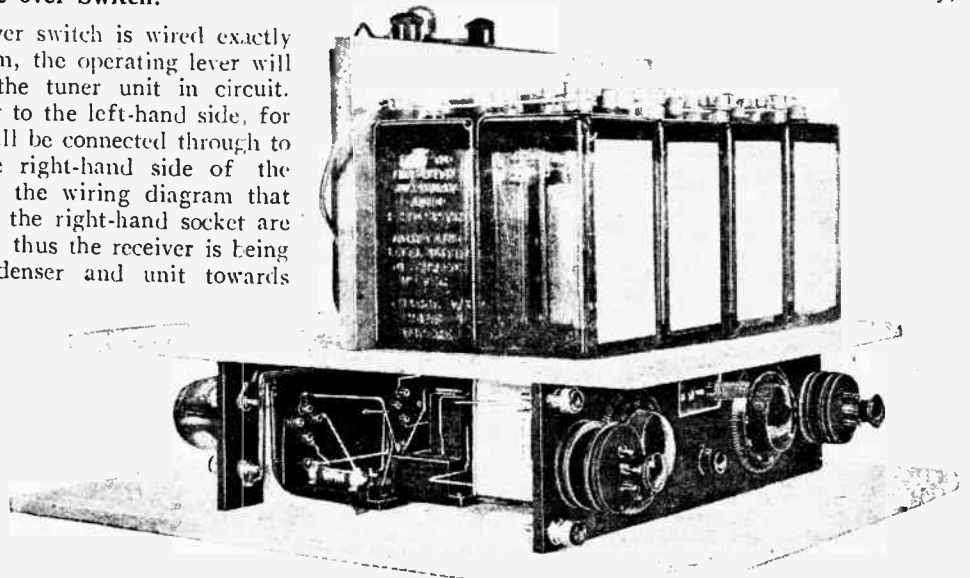

The complete receiver as it appears with the cover removed.

**Broadcast Reception with
Four-electrode Valves.—**

thereby preventing interference with the H.T. battery when the door at the back of the cabinet is removed, but also serves as a support for the H.T. and L.T. leads which pass up from the lower compartment through holes in the battery board.

The leading dimensions of the cabinet are given in Fig. 5. This slips over the receiver, when completely assembled as in the photograph on the same page, and need only be removed every six months for recharging the H.T. accumulators. Even after six months' use the cells will be by no means completely discharged, and the recharging is only done to keep them in good condition.

On test it was found that 16 volts gave best results for the L.F. valves, and 10 volts for the detector. At four miles from the local station (Z.I.O) and 65 miles from Daventry adequate results were obtained from an Amplion Junior loud-speaker. Of course, the volume is not as good as that obtainable with 3-electrode valves and higher valves of H.F., but is quite sufficient for a small living room, and those who value reliability more than excessive volume will find this receiver suited to their needs.

It is to be hoped that the advantages which are afforded

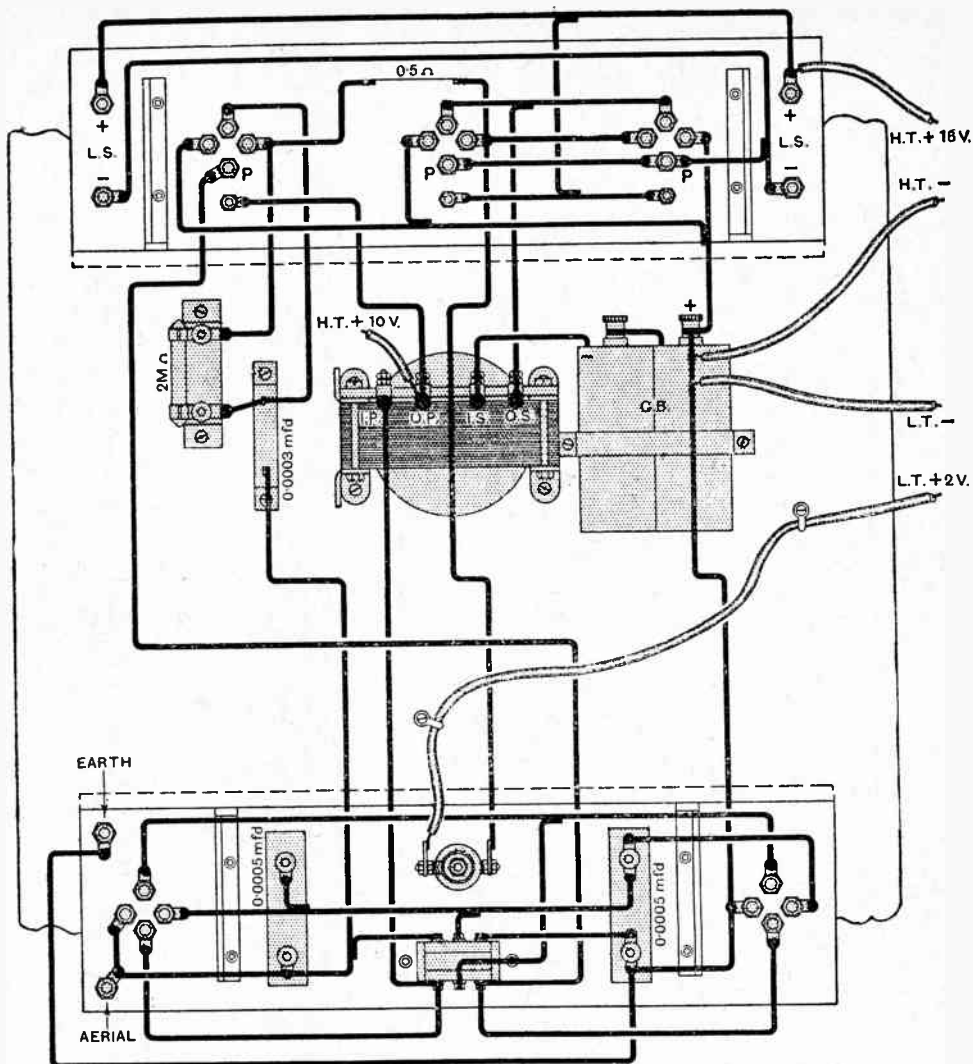

Fig. 4.—Complete wiring diagram.

by 4-electrode valves will soon stimulate public interest and thereby make it worth the while of the manufacturers to produce larger valves with a higher filament emission from which we can obtain adequate loud-speaker volume without the necessity of paralleling.

EXPERIMENTAL TRANSMISSION STATIONS.

South Africa.

We print below the call-signs and addresses of amateurs in South Africa which we have ascertained since the publication of the "Wireless Annual" for 1926 and the supplementary lists which appeared in our issues of January 27th (p. 144) and February 3rd (p. 189). For this information we are indebted to our South African contemporary *Radio*.

UNION OF SOUTH AFRICA.

Changes of Address.

A 3M J. A. Hegarty, Main Rd., Observatory, Capetown.
A 90 M. E. Smith, "Electron," Indaas Rd., Natal.
A 3V W. E. Dixon Bennett (Div. Hon. Sec. O.F.S., Div. 4), 5, First St., Bloemfontein.

A 4R J. M. Goodman, c/o Auto Electric Supplies, Aliwal St., Durban.
A 4V I. E. Green (S.A.R.R.L. Headquarters Stn.), c/o Box 7007, Johannesburg.
A 5J H. W. Heywood (Hon. Sec.), Official Relay Station, S.A.R.R.L., Natal, Div. 5.
A 6B R. G. Beard, King's View, Bluff, Durban.
A 6C W. G. Yapp, 1, Single Quarters, V.F.P., Box 27, Vereeniging.

New Call Signs.

A 7G V. K. Vyvyan, Richmond, Natal.
A 7H E. Levine, 20, Powell Rd., Durban.
A 7K D. L. Gordon, 17, Richmond Drive, Johannesburg.
A 7X Portable Station of A 5X (Experimental Beam Station), A. J. Jacobs, 1, Loch Ave., Parktown West, Johannesburg.

BRITISH EAST AFRICA.

KY1VP L. J. Hughes, c/o Mombasa Radio Station.

RHODESIA.

1 SR J. M. Davidson (Div. Hon. Sec., Div. 12), Box 580, Salisbury.
2 SR G. Musgrave (Div. Hon. Sec., Div. 9), Box 38, Selukwe.
5 SR The Rev. — Whiteside, St. George's School, Bulawayo.
6 SR H. le P. Heaume, P.O., Selukwe.
7 SR A. Pryce-Williams, Antelope Mine, Matopos.
8 SR J. van Rynveld, Shepherd's Reef, Hartley.
9 SR S. Emptage, Salcombe, Plumtree.
SR Captain Douglas Mail, c/o Div. Headquarters, Box 38, Selukwe.

SOUTH WEST AFRICA.

Z 3A L. Robinson (Div. Hon. Sec., Div. 13), Box 88, Luderitz.

PORTUGUESE EAST AFRICA.

CVPE A. Gariso (Div. Hon. Sec., Div. 10), B.M.R. Telegraphs, Villa Pery.

Telephony on Trains

New Wireless Telephony Equipment now Working on the German Railways.

ENDEAVOURS have been made almost since telegraphs were first introduced to establish communication with moving trains. At the onset the object of experimental work probably had not in view the setting up of a public telephone service with trains in motion, but systems were developed essentially for communication with the train staff in connection with signalling.

Inductive Telephony.

Induction methods making use of wire loops encircling the train track and also wires running along the side of the route formed the basis of most of the early experiments, and although some measure of success was achieved this arrangement was not considered sufficiently promising for the development of a train telephony system on a commercial basis.

A system of this kind was developed in Sweden by Werner Warfvinge and Thörnblad, and the installation was set up on a railway line near Stockholm. In this instance communication with the moving train was produced entirely by the property of induction, and for this purpose large loops were supported about the track, being carried by masts on both sides. The coaches were similarly equipped with large inductive loops. Strong microphone currents were applied, producing a fluctuating magnetic field of sufficient intensity to bridge the few yards between the windings round the coaches and the loops encircling the track.

It is stated that German railway engineers investigated the possibility of this method of communication, and the experience gained from an experimental installation

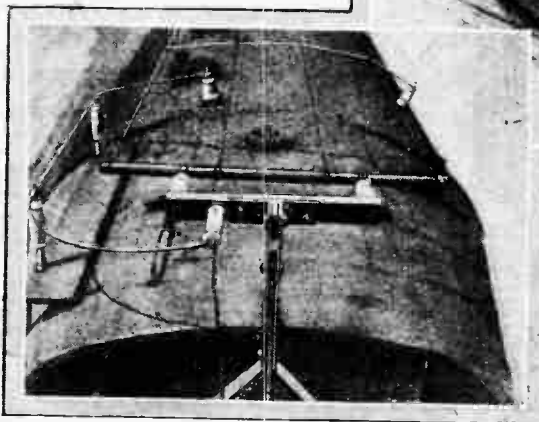
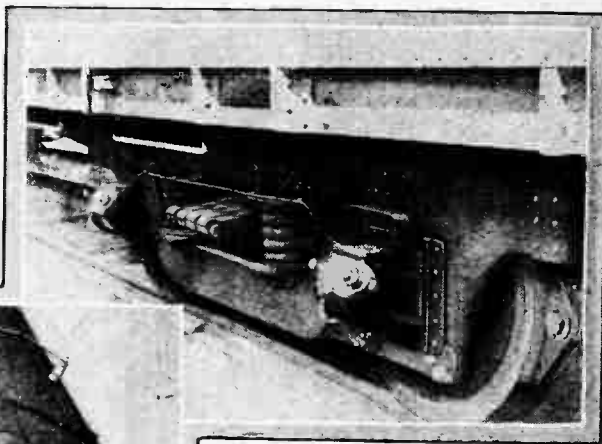

The earth connection is made by linking together several of the axle boxes in which an actual contact is made with the shaft of the wheels. Method of erecting the aerial above the roof of the coach.

on the railway line between Marienfelde and Zossen revealed that the system of inductive train telephony offered too many difficulties for its adoption as a public

means of communication.

At the end of 1918 it was decided to abandon the inductive system, and development work with a view to designing wireless gear was undertaken by the firm of Goertz on a section of their private railway between

Lichterfelde West and Tetlow Schönow. In these new tests purely wireless methods were adopted, the apparatus on the train consisting of a wireless telephony set used in conjunction with an external aerial erected on the roof of the coach. The usual form of telegraph line running along the side of the track was made use of as the stationary aerial.

By the beginning of 1921 a good measure of success

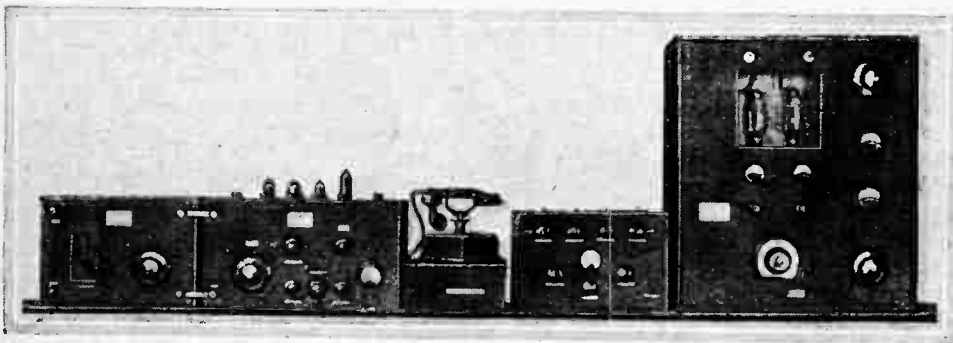

The complete transmitting and receiving equipment installed at the railway telephone exchanges for communicating with trains

Telephony on Trains.—

had been attained, and a duplex telephony system making use of two wavelengths and embodying suitable filter circuits was brought into commercial operation. Communication could be established with moving trains on the Goertz railway from any postal telephone within the district of greater Berlin.

It was from a demonstration of this experimental installation that the German authorities decided to investigate the possibilities of extending the system and adopting it on main-line routes. Similar equipment was therefore set up along the track between Hamburg and Berlin, the experimental equipment being installed at Spandau West. Another station was subsequently installed at

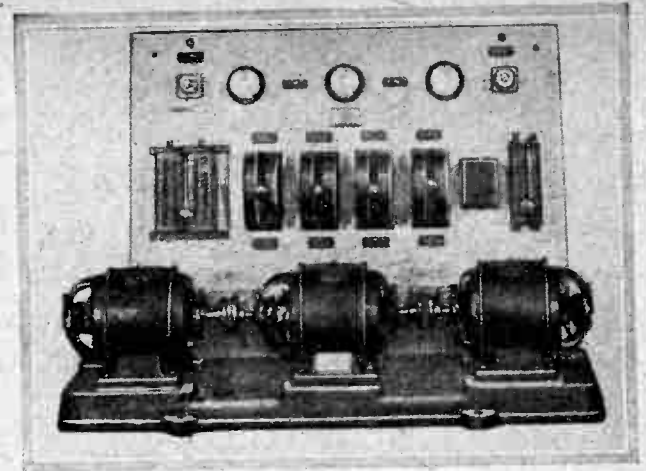

The power plant. The motor generator set supplies high tension current as well as direct current for battery charging.

install systems on the Berlin-Hamburg and the Berlin-Munich routes, and whilst the latter circuit is not yet completed, the Hamburg-Berlin installation was opened for public use on January 7th last, and is probably the first commercial train telephony service to be brought into operation.

Telephoning from the Train.

The compartment on the train in which the apparatus is installed is divided so as to provide accommodation for the operator and also a small sound-proof room in which is a telephone hand set for the use of passengers. The walls of both rooms are liberally padded in a similar manner to the draping in our broadcasting studios, but in this instance

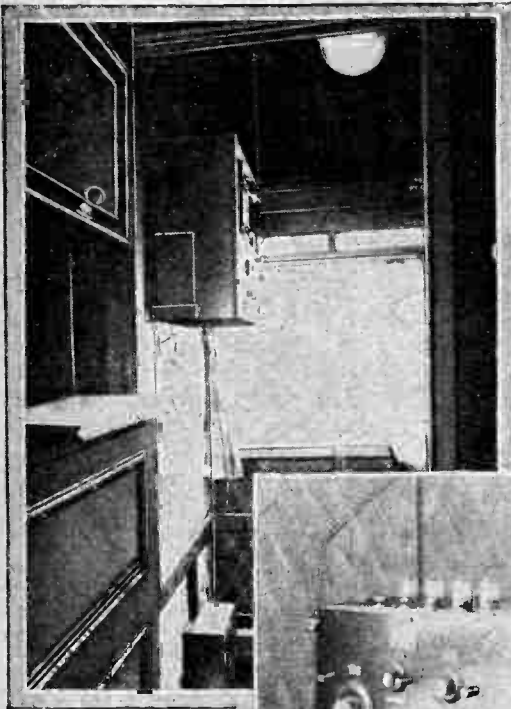

Transmitting set on the train installed in the operator's compartment



Train receiving set and throwover switch for bringing in circuit the telephone instrument used by passengers.

Bergedorf, near Hamburg. The system showed so much promise as regards practicability that an arrangement was made with the firm of Dr. Erich F. Huth to erect and work installations for the transmission of messages on moving trains, and it is interesting to note that the agreement entered into expressly stated that the traffic would not be confined solely to the transmission of telephone calls, but would also embrace the delivery of telegrams and the transmission of broadcast entertainments and news.

A company was subsequently formed for the purpose of introducing and working train telephony on the German railway lines. The new company at once commenced to



View of the wireless equipment in a railway telephone exchange.

Telephony on Trains.—

the draping is intended only for the exclusion of train noises. The two sections of the compartment are connected by a window, so that the operator can advise a passenger when a call is through, and draw his attention to any irregularities in the working of the system.

A single aerial system is used both for transmission and reception, and the aerial is excited by the transmitter even when it is being simultaneously used for reception. Filter



Telephone room on the train. The small window connects with the operator's compartment.

circuits are in use to accomplish this, giving reliable duplex working, so that the passenger making use of the apparatus experiences no difference between it and the ordinary telephone service. The aerial is rigidly supported over the roof of the coach, while the earth wire is connected right to the shaft of the wheels. To avoid any variation in the resistance of the earth connection, leads

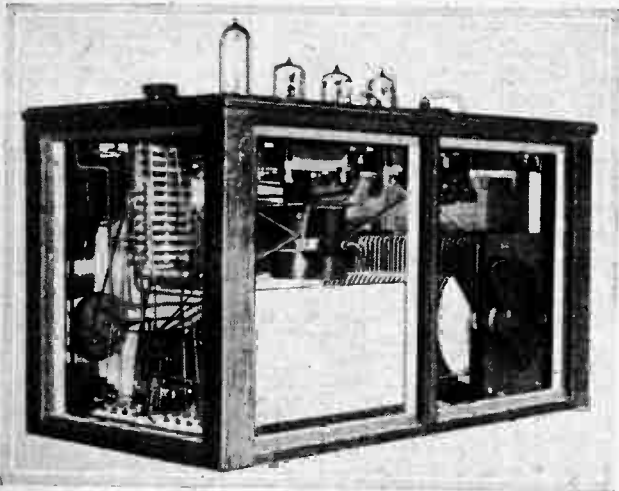

One of the receiving sets. It is manufactured by the German firm of Dr. Erich F. Huth.

are taken to several of the wheel-shafts and bonded together.

A telegraph line is provided on the telegraph routes adjoining the track for communicating with the train, and an interesting feature is the inclusion of choke coils in all line circuits before connecting up with cables. The pick-up line, moreover, does not form part of any of the cable connections, and is run as an elevated wire throughout the whole of the distance over which communication with the train is possible.

Transmitting and receiving equipments are installed at both ends of the wire and also at junction points where branch lines occur. The equipment used in conjunction with the line circuit is undoubtedly complicated, for not only has duplex communication to be established, but several trains may be traversing the same section of track, and, so that each may make use of the system, different wavelengths are allocated. An involved system of filter circuits must therefore be employed.

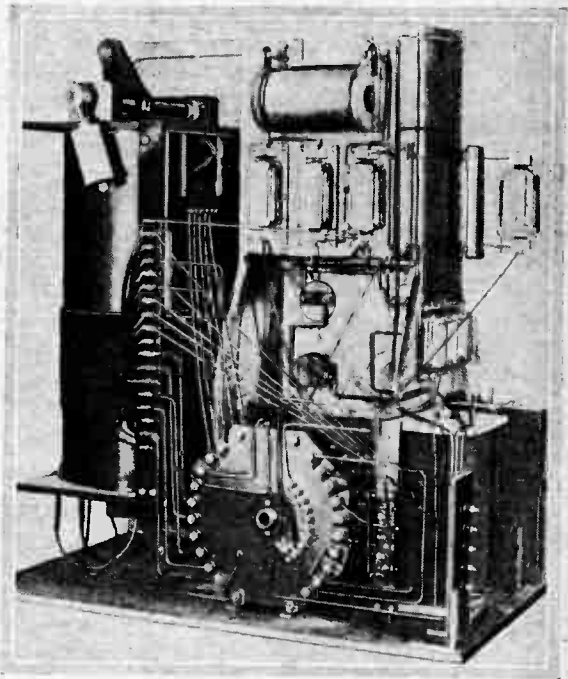

A rear view of the transmitter.

The equipment so far installed is apparently being worked with success, and the Postal Department have issued instructions with regard to the despatch of telephone messages and telegrams. Telegrams are, in fact, accepted by all telegraph offices and at the railway telephone exchanges, and must, of course, be addressed in such a way as to make it possible to find the addressee without difficulty. The charge for a telephone call is about four shillings, in addition to the usual land line charge.

It is understood that a considerable amount of traffic is being handled, and it is to be expected with the apparatus in use on a commercial basis that the technical development will be rapid as well as creating a new service of considerable value to the public.

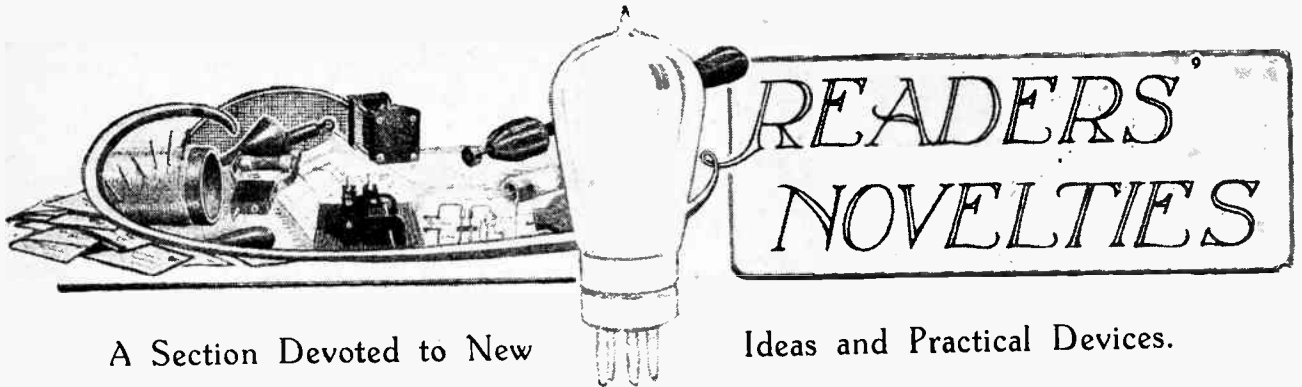

A Section Devoted to New

Ideas and Practical Devices.

LOW-CAPACITY VALVE HOLDER.

The valve holder is built up in an ebonite block $\frac{3}{8}$ in. in thickness and $2\frac{1}{2}$ in. square, in the centre of which a $1\frac{1}{4}$ in. diameter hole is cut. Four holes are drilled at suitable intervals about $\frac{1}{4}$ in. from the circumference of the central hole. These are opened out for half their depth to a diameter suitable for the contact clips, the lower half of the hole being tapped No. 4B.A. The contacts are made from phosphor-bronze or brass strip $\frac{1}{4}$ in. wide, one end being shaped to form a soldering tag. The contacts are then inserted in slots cut

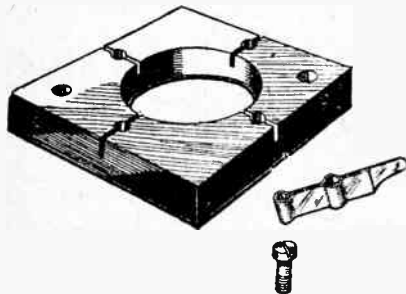

Low-capacity valve holder.

radially through the centre of the No. 4B.A. holes. The valve holder, be sides being rigid in construction, has a low self-capacity.—A. S.

o o o o

LONG-WAVE RECEPTION.

Most amateurs possess a series of plug-in coils suitable for the lower broadcast band of wavelengths. These may be adapted for use on long waves by means of the unit shown in the diagram. A series of plugs and sockets is mounted at suitable intervals on an ebonite strip which is fixed at right angles to a coil plug. Plugs and sockets are connected in series according to the wiring diagram, which shows the

underside of the panel. This will ensure that the inductances of the separate units add together.

The unit with the coils inserted may then be plugged into the fixed socket of a variable two-coil holder, the first coil of the series being re-acted upon in the ordinary way.

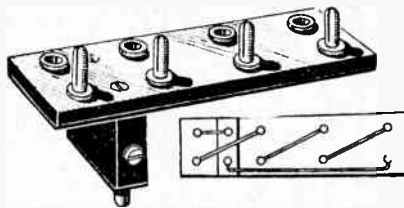

Coil adaptor for long-wave-reception.

Coils of the same make should be used, if possible, in order that the direction of winding may be the same in each case.—L. J. Y.

o o o o

VARIABLE COIL HOLDER.

Following standard practice the coil holder is built up between two parallel ebonite strips, the one coil holder serving to fix the spacing between the strips. The moving coil holder is pivoted in the usual way and a bell crank is attached to one end of the spindle. At the other end of the coil holder a spindle is mounted in brass bearing bushes and fitted with an ebonite adjusting knob. A length of fine cat-gut or string is

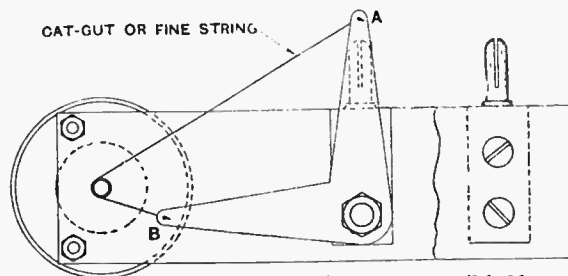

Slow motion coil holder.

given several turns round the spindle and then attached to the ends A and B of the bell crank. On rotating the spindle a slow motion will be imparted to the moving coil holder. If the proportions shown in the diagram are adhered to, no difficulty will be experienced through the controlling string becoming slack in the middle of its travel.—W. A. S.

o o o o

CARBORUNDUM DETECTOR.

The diagram of this detector is self-explanatory. The steel contact is a ball bearing which is held in position over the crystal by a short length of glass tubing fixed over the crystal

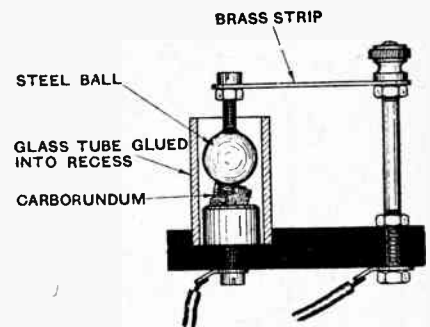

Carborundum steel detector.

cup. To find a fresh contact, all that it is necessary to do is to lift the brass spring, shake the detector once or twice and replace the spring.—S. C. J.

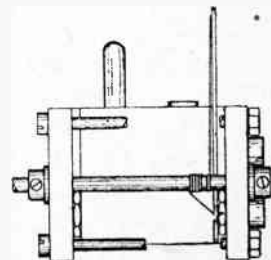



CURRENT TOPICS

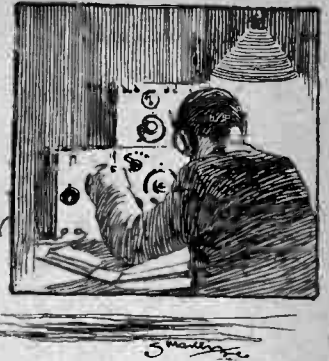

Events of the Week in Brief Review.

DEPOSITS ON WIRELESS AERIALS.

Tenants of the Council houses on the Buddicombe Park estate, near Chester, are resenting the imposition of a deposit fee on each wireless aerial erected.

o o o o

FRENCH LESSONS BY BROADCAST.

The London Elementary Education Sub-committee recommend that, as an experiment, central schools where French is taught may listen on Fridays until the summer holidays to broadcast lessons in French.

o o o o

BERLIN RELAYS DAVENTRY.

The B.B.C. engineers are not alone in attempts at relaying Continental programmes. Similar experiments are being conducted by the engineers of the Federal Telegraph Office in Berlin, who are relaying Daventry's transmissions from the Savoy Hotel.

o o o o

NEW PROBLEM FOR INDIAN AMATEURS.

The pending arrival of a general scheme of broadcasting in India has prompted an investigation of amateur transmitting licences. At present several radio clubs hold licences to broadcast, but whether this privilege will remain in their hands is open to doubt. Many individual amateurs hold licences for experimental transmission, whilst being forbidden to transmit anything in the nature of a broadcast programme.

o o o o

PEACE IN THE EUROPEAN ETHER?

The knotty question of European broadcast wavelengths is being approached in a new fashion by the International Radiotelephony Council, the result of whose deliberations at Geneva is the formulation of a fresh plan, dividing stations into two classes. Under the first class come those stations using comparatively high power; these will be entitled to an exclusive wavelength each. The second class embraces low power stations which will employ a common wavelength. The wavelengths will be calibrated by a wave-meter common to all countries, and each station will be required to keep rigidly to its allotted wavelength. Three technical committees have been formed to superintend the enactment of these proposals.

DEATH OF "LUSITANIA" OPERATOR.

An echo of the sinking of the "Lusitania" was provided last week by the death of Mr. A. E. Sargent, of Rushden, who was first wireless operator on the ill-fated vessel.

o o o o

WIRELESS IN SAHARA.

A proposal to carry wireless into the heart of the Sahara Desert has been made by the third North African Conference, which has just concluded its sitting in Tunis. The suggestion is to equip the two isolated outposts of Wallen and Tessalit, on the desert route from Colomb Becher to the Niger, with transmitting as well as receiving apparatus. This would link up Northern with French Western Africa by means of a wireless chain across the Sahara.

WIRELESS AT BORSTAL.

The Home Secretary has given his consent to a proposal to install a wireless set and loud-speaker at the Borstal school. The apparatus will, we understand, be provided by *The Daily News*.

o o o o

ANNUAL DINNER OF THE WIRELESS LEAGUE.

The Wireless League dinner, to which attention was drawn in our issue of March 24th, is to be held on April 23rd at the Royal Automobile Club. In our previous note it was erroneously stated that the price of tickets would be 8s. 6d. The charge is only 7s. 6d., and this is, of course, exclusive of wines, etc. The presence of many prominent personalities in the sphere of wireless should ensure a large gathering, so that members wish-

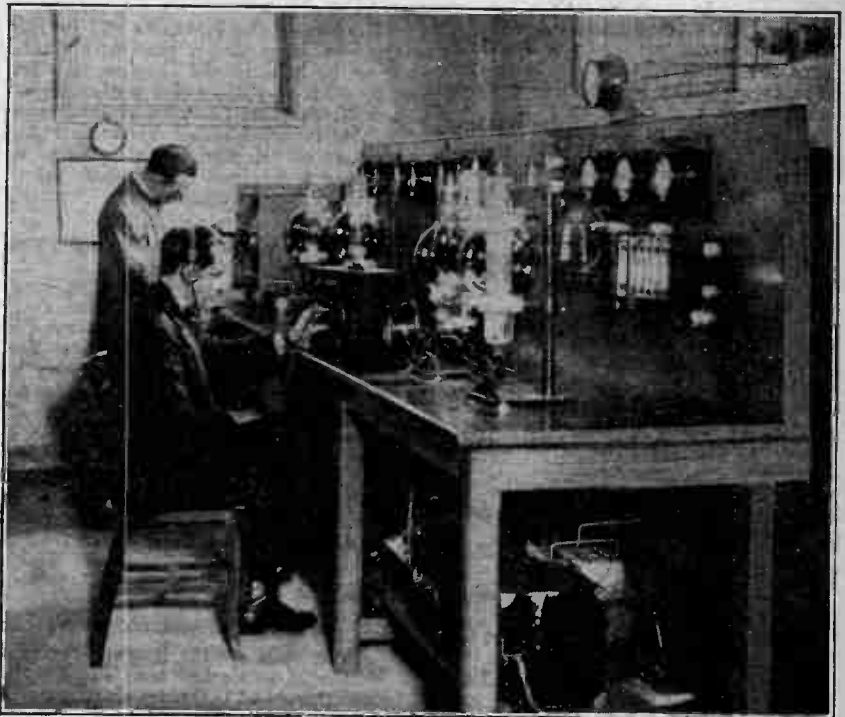

A FAMOUS FRENCH BROADCASTING STATION Engineers in the control room of Radio Paris during the transmission of a programme.

ing to attend are advised to make early application to the Secretary, Wireless League, Chandos House, Palmer Street, S.W.1.

○○○○

FOOLING THE LISTENER.

Listeners to the WLW broadcasting station at Cincinnati, Ohio, had to be on their guard on April 1st, when a special "April Fool Programme" was transmitted for their benefit.

○○○○

LUCKLESS WIGHT.

Isle of Wight listeners are complaining that their broadcast programmes are being interfered with by spark signals from French trawlers.

○○○○

IRISH LISTENERS' LEAGUE.

Emulating their British cousins, wireless enthusiasts in the Irish Free State are considering the formation of a Listeners' League.

○○○○

BROADCASTING: NEW STYLE.

From a Belgian contemporary: "The station at Dorchester is actually one of the most powerful broadcasting installations; it has at present 800 transmitters."

Doubtless the ideal arrangement would be to provide one transmitter for each listener.

○○○○

NO HOWLING IN HUNGARY.

A decree has been issued in Hungary forbidding the use of re-radiating receivers. It is also enjoined that "radio apparatus may be constructed, procured, owned, transferred, traded in or imported only by persons to whom such permission has been granted by the Hungarian Chamber of Commerce."

○○○○

R.A.F. CADETSHIPS.

Vacancies now exist in the Royal Air Force for flying officers, facilities being given to specialise in wireless, engineering, gunnery and other subjects. The next examination of candidates for entry as flight cadets to the R.A.F. College, Cranwell, in September next will begin on June 22nd. Forms of entry, which can be obtained from the Secretary, Civil Service Commission, Burlington Gardens, W.1, will not be accepted later than May 6th. Candidates must be between the ages of 17½ and 19½.

○○○○

SHIP WORKING WITH LOW POWER.

Some surprising results with a ½kW. set manufactured by the Radio Communication Co., Ltd., are reported by the operator on board the s.s. *Queenswood*, which has recently been fitted with the apparatus.

The following extracts from the operator's log relate to performances during broad daylight:—

January 10th.—Worked San Paulo, Brazil, at 700 miles.

January 12th.—Worked another ship at distance of 800 miles.

February 13th.—Worked Otchishi Radio, distance 800 miles.

February 18th.—Worked San Paulo, Brazil, at 540 miles.

To cover these distances in daylight it has generally been necessary to employ sets ranging up to 1½ kilowatts.

A 20



AT RADIO PARIS. A peep in the studio of the famous French station. It would appear that the stone pillars are an encumbrance, quite apart from any influence they may have on the acoustics of the studio.

HIGHER POWER IN AUSTRALIA.

The well-known broadcasting station 2FC at Sydney has increased its power from five to ten kilowatts. The transmitter has been moved from Willoughby to Pennant Hill.

○○○○

WHITSUN WIRELESS EXHIBITION IN BIRMINGHAM.

Readers in the Midlands will be interested to learn that a wireless exhibition is to be held in the Bingley Hall from May 19th to 26th, under the auspices of the Birmingham Chamber of Commerce.

It is reported that the National Association of Radio Manufacturers and Traders has given permission for its members to participate.

○○○○

SHORT WAVE BROADCASTING TESTS FROM U.S.

A special series of short-wave broadcasting tests is being conducted during the present month by the General Electric Company at Schenectady, New York.

Every evening except Wednesday and Sunday (Thursday a.m. and Monday a.m. G.M.T.), 2NK will transmit on 65.5 metres, while 2XAF will operate at the same time on 32.79 metres, both broadcasting the ordinary programme of WGY. Telegraphy tests will also be carried out on 15, 26.4, and 50.2 metres.

Report forms can be obtained from the Radio Department, General Electric Company, Schenectady, N.Y.

○○○○

LOUD-SPEAKERS ON SHIPS.

A new field for the loud-speaker reproduction of music has been found in the requirements of passenger ships for music and entertainment. In order to cater for the pleasure of passengers and to supplement the usual musical arrangements, a

number of ships are now being equipped with Marconi orchestra repeater installations. Music from the ship's orchestra or from a gramophone, or received by wireless, can be reproduced in any part of the ship by means of this installation.

○○○○

TROTSKI'S RADIO PREDICTION.

A prophecy involving the seizure of the Eiffel Tower wireless station by revolutionaries was made by Leon Trotski in addressing the society known as the "Friends of Radio," in Moscow, on March 2nd.

After emphasising the importance of radio as a means of binding together Russian cities and villages, M. Trotski said: "We must be prepared for the moment when the French proletariat will seize the Eiffel Tower and proclaim itself master in all civilised languages. Then we must answer: 'We hear you and are ready to help you'!"

Change of Address.

Mr. J. Nelson, M.I.E.E., advises us that after more than twenty-two years' service with British Insulated Cables he has now left that company and has opened an office in Bristol at 9, Denmark Street.

○○○○

The Hava Micrometer Dial.

In the recent description of the Hava dial the manufacturer was given as Halladay's, Limited, 12 to 18, Geach Street, Birmingham. This is an error, the Hava dial being made by the Comton Wireless Manufacturing Co., 26-28, Bartholomew Square, London, E.C.1. Messrs. Halladay's, however, also produce an instrument dial which is provided with a reduction gearing.

PORTABLE RECEIVERS.

Some General Considerations Discussed.

By THE WANDERER.

MOST trade experts and a vast majority of amateur listeners perceive no future for portable receivers. They put forward two very damaging criticisms—that portable sets are far too bulky, and that, even if they could be made light, portability is not an asset. No invention has been immune from criticism in its earlier crudities; the bicycle and the gramophone were ridiculed for several years before they entered every household. Many portable sets are still absurdly weighty and cumbersome; there is little of a really practical nature on the market which weighs less than 35 lb. or measures less than about 18in. square and at least 6in. thick. But their weight is steadily decreasing, and their power is always going up; the writer owns a small portable which measures very little over a foot square, and embodies within these dimensions its own batteries, aerial—everything except loud-speaker. He has listened to America on a single-valve super-regenerative set built into a half-plate camera case, and as radio is still in its teething stage there is absolutely no question but that bulk and weight will presently be cut down to rational figures.

Size and Weight.

No thoughtful student can seriously question the value of portability. A radio set is really a kind of hybrid between a daily paper and a gramophone. If the *Daily Mail* were engraved on brick tablets in Babylonian fashion it would never achieve a million sale, simply because it would cease to be portable. Gramophones the size of a "Compacton" would be a drug on the market. Similarly, the radio set must ultimately be portable. Our descendants will probably carry combined "send-and-receive" sets in their side pockets and be called up by anybody from anywhere at any time; they will mock at the clumsy non-portable telephone system of the bizarre twentieth century. But already the light, compact, self-contained set has real assets. The writer lives in a large, old-fashioned house in the country. Four of its rooms are variously occupied for living purposes, according to the time of year, coal economies, and so forth. It would be possible to wire all four rooms for wall-plugs at the cost of some disfigurement and with a probable loss of tonal purity; a portable receiver solves these problems. In the event of sickness, the portable can be taken to any of the eight bedrooms. It is equally available for the tennis lawn and impromptu summer evening dances thereon; for picnics; for the summer holiday or the week-end bungalow. The local parson occasionally places a similar receiver at the disposal of his sick poor. Admitting the weight, cost, and bulk of existing portables, any household which has transferred from a G.P.O. aerial and a "dog-kennel" set chained to a single input point must nevertheless vote for the portable.

As soon as the word "portable" is breathed, most trade designers and most amateur constructors jump at a frame aerial. There is a very widespread ignorance

on the subject of miniature or improvised energy collectors, as may be proved by a thoughtful study of some of the atrocities on the market or a few experiments with a little home-made apparatus. I will not give any technical data, but a few homely facts. The trade's ideal turns to a folding frame about 2ft. square or a loop wound in the lid of a cabinet. At my home station a good superheterodyne will bring in nearly all Europe on a frame 2ft. square, and on a good night most stations will come in at real loud-speaker strength. Transfer the same receiver to a low-loss and technically perfect frame 1ft. square; the "bag" will promptly shrink. On a low-loss frame 18in. x 18in. 5XX and the nearest main station will be comfortably audible, but no distant station can be picked up on a loud-speaker.

Turning to straight circuits, the writer has been busy for some time attempting to evolve a cheap portable set intended for headphone work only. At fifty miles from the nearest station a circuit consisting of three H.F. valves (with simple tuning) and a crystal is almost silent on a full-sized frame aerial. With a G.P.O. aerial and earth it is instantly converted into a most powerful receiver of immense range. With one end of a frame connected to the aerial terminal and the earth terminal coupled to a real earth it will bring in several stations at pleasant strength. On an improvised indoor aerial and earth, consisting of good lengths of flex slung over picture rails and lying on the floor, the receiver is quite powerful and gives good range. To sum up, the 1ft. frames to be found inside the lids of some portables are only fit for use under the shadow of a transmitter, unless the circuit and design of the set are exceptionally good. The powerful portable, such as the superheterodyne, is best served by a full-size collapsible frame of first-class design, and the portables with "straight" circuits need an improvised flex aerial, slung over trees or picture rails, in conjunction with a copper tube earth out of doors, or a pipe earth indoors. A very different story may come to be told if ever broadcasting is reorganised on very short waves; but we have to deal with our world as it is, not as it may be. For cheap portable service the writer has discarded the frame; with two H.F. and detector, packing into a small attaché case, he finds that flex brings in 5XX anywhere. He has equally discarded miniature frames for superhet. work, and prefers to carry a full-size collapsible frame, though it means carrying two packages instead of one.

The Accessories of the Portable.

It is obvious that even a wealthy enthusiast is hardly likely to furnish himself with two separate receivers, each costing upwards of £50, one intended for domestic use at a fixed station and the other for portable work. A single receiver must serve both purposes. This condition limits the circuit for the present to the superheterodyne, and to a very few superheterodynes. Thanks to unscreened intermediate amplifiers operating on commercial

Portable Receivers.—

frequencies, the majority of superheterodyne sets suffer from a mild welter of parasitic noises. In this respect two or three of the British kits display a very pleasant contrast in background with the average American set. It is possibly true they have less power and range, but every practised listener is aware that there are few golden nights in any year on which the really distant stations are worth listening to for any but boastful reasons; so a reduction of range is immaterial except to the stunt merchant. A superheterodyne with a first-class low-frequency amplifier and a silent background to its H.F. side is at present the portable *de luxe*. Such a set is easily accommodated in a cabinet measuring 15in. x 12in. x 7in. (less if the Tropadyne principle and special tuning condensers are employed).

The Portable Loud-speaker.

It will need the following accessories: A folding frame aerial of full size; two complete sets of batteries, such as an Exide P.M.2 for travel and any large accumulator for home use; a couple of 36-volt Ever-Ready H.T. batteries for travel, and a H.T. accumulator for home work. Fortunately, one and the same loud-speaker will serve equally well at home and on the move. The trade and the public for some mysterious reason regard the portable Amplion loud-speaker as an emergency makeshift. It probably furnishes slightly less volume than some of the very large horn, cone, or pleated diaphragm speakers; but its volume is ample for a really large room in which several people are reading, knitting, or playing cards; and its tone is superb. There is no real need to flank it with a gigantic trumpet for home use. We are still waiting for the ideal valve for these portable superheterodynes. The general purpose 0.06 valve will serve for the frequency-changing valve ("first detector," so-called), and perhaps for the first L.F. valve. The D.E.3b is good for the intermediate frequency amplifier. Small 0.12 power valves are desirable for the second detector and second L.F. stage. This entails a total consumption (for eight valves) of 0.66 ampere. A P.M.2 cell will stand this discharge. If D.T.G. cells are used, it is wise to use seven 0.06 valves and to limit the 0.12 power valve to the final socket, making a total discharge rate of 0.54 ampere. With suitable grid bias on the low-frequency amplifying valves, the H.T. drain can be kept inside 12 milliamps. Unfortunately the filaments of the 0.06 valves are extremely fragile, and a certain number of casualties must be expected even with spring sockets, especially if the set is taken in a fast car. Moreover, the best spring sockets cannot be absolutely trusted to retain their grip of a valve in motoring; it is wise to slip a pad of thick felt between the valve pips and the lid of the case. This will not only protect the valve from damage through vibration but will prevent breakages occurring when the valve is withdrawn from its socket. The two-volt valves have far stronger filaments. I have never yet damaged a Cossor valve whilst motoring, and Weco-

valves have been taken all over Europe on the running board of a car without casualties. But the consumption of eight two-volt valves is too heavy for any light accumulator. Eight Cossors take 2.4 amps., and one ampere is required by eight of the new D.E.2 Osrams. Such discharges can be borne by a motor car accumulator, but not by any miniature cells which can be packed inside a cabinet. A separate battery case of rather a heavy character is indicated if two-volt valves are preferred for the sake of their robustness.

Constructional Details.

It has already been suggested that no dependence can be placed on spring sockets to grip valves under heavy vibration; their overhead clearance must be felt-packed to stop them from jumping out. In addition, the sprung socket wobbles so widely that the valves—especially corpulent little power valves—must be widely spaced, or they will hit each other. Soft solder is regarded by jewellers as a "purser's job"; and the ordinary cabinet constructional soldering will fracture many joints in a rough season's motoring. The only safe

OUTDOOR WIRELESS.

Next week's issue of "The Wireless World" (April 14th) will be largely devoted to the subject of outdoor wireless and portable sets. The issue will include a guide to Portable Sets by the various makers, with descriptions to assist prospective purchasers.

plan is to use tinned soldering tags, curling the tongue clean round the end of the wire, bending over $\frac{1}{16}$ in. of the end of the wire at right angles, pinching the tag tightly round the wire, and finally soldering the joint. This is damage-proof. It is unwise to use bare wire.

Polished wood is wholly out of place in a portable, which may presently find itself on wet grass, in a railway van, or amidst the feet of passengers in a motor car. Cheap fibre suitcases are purchasable for about 15s. Into these can be packed the set, complete with self-contained batteries, a folding frame, and an Amplion box type loud-speaker. The case for the set then presents the amateur with no awkward problems of French polishing, or gluing on leatherette, or making a mackintosh cover. Its wood may be rough finished with any dark stain; and if the frame is built of $\frac{3}{8}$ in. wood of good quality, the panelling may be executed in $\frac{1}{8}$ in. plywood without loss of sturdiness and with some saving of weight.

An Aerial and Earth Advisable.

Turning now to portable headphone sets of a cheaper and simpler character, the conditions laid down for valves and constructional details apply with equal or greater force. In this case the circuit of the receiver is the real trouble. There are plenty of "stunt" circuits—reflex and the like—which can be operated at long range off a frame, but with most portables an aerial and earth are necessary. A three-valve dual is something of a handful for the average amateur listener to construct and to handle; and it becomes still more of a handful when it is compressed into a tiny cabinet, with its numerous fields of force overlapping each other. If we recognise that it takes a 30ft. frame to compete with a G.P.O. aerial in collecting energy, the thorny nature of cheap portable design is obvious.

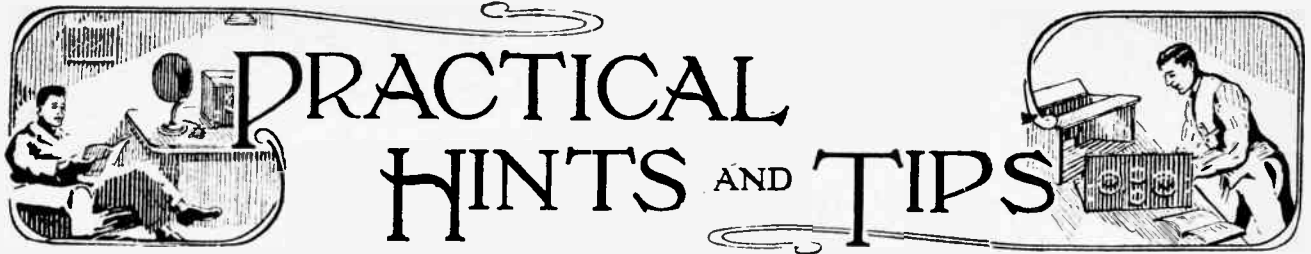

A Section Mainly for the New Reader.

A REACTION "VERNIER."

The practice of shunting the primary of the first L.F. transformer with a variable condenser instead of the customary fixed capacity, has been widely adopted by amateurs working on the very short wavelengths. By this expedient it is possible to obtain an extremely fine control of reaction, and the method might often with advantage be extended to the normal broadcast wavelengths, when a detector valve is used without H.F. amplification. The best method of operation is to set the dial of the variable condenser at about half its maximum capacity, and to make a rough adjustment by manipulating the usual reaction coil. The valve may then be brought into its most sensitive condition by increasing the capacity of the variable condenser, which has the

connections is suggested in Fig. 1. The variable condenser should have a somewhat lower maximum value than in the case of a transformer-coupled amplifier, and one of 0.0003 mfd. or even less will be found suitable for all-round work. The H.F. choke shown in the diagram is not absolutely necessary; its omission will not affect the control of reaction. If an anode resistance having an exceptionally high value is used, the condenser should be used at the lower part of its capacity range, in order to avoid a reduction of amplification or even the introduction of a form of distortion due to by-passing of the higher audible frequencies.

The choice of coupling devices to be adopted in succeeding stages will be governed largely by the power-handling capacity of the valves which are to be used. It should be remembered that large grid-voltage swings cannot be handled by the majority of valves sold as suitable for resistance coupling, and great care must be taken to prevent overloading. The characteristics of low-impedance power valves are greatly changed by the insertion of a high anode resistance, and, from the point of view of simplicity, transformers offer certain advantages.

o o o o

CHOICE OF GRID-LEAK VALUES.

A good deal of latitude is permissible in the value of grid-leak used in a resistance-coupled, low-frequency amplifier, particularly in the initial stages, where moderately small signal amplitudes are being dealt with. The function of this resistance is to allow

COMPOSITE L.F. AMPLIFICATION.

There is no reason why various systems of low-frequency intervalve coupling should not be used in combination in a set; indeed, there are sometimes distinct advantages in doing so, and some hints as to the order in which the different couplings should be used may be of interest.

The most efficient type of detector valve usually has a fairly closely wound grid, with, consequently, a rather high impedance. Difficulties are apt to arise in attempting to couple such a valve to a succeeding L.F. amplifier by the transformer method, and, in any case, a low-ratio instrument will be necessary. It would, therefore, seem better to use a resistance rather than a transformer in this position, particularly in view of the fact that variations of very small amplitude are passed on to the grid of the next valve more effectively by a resistance than by a transformer, or, indeed, an iron-cored choke. It is possible that very weak signal changes would not be handed on at all by a transformer, whereas the use of a resistance would enable them to be magnified up to good audibility by further stages of L.F. amplification.

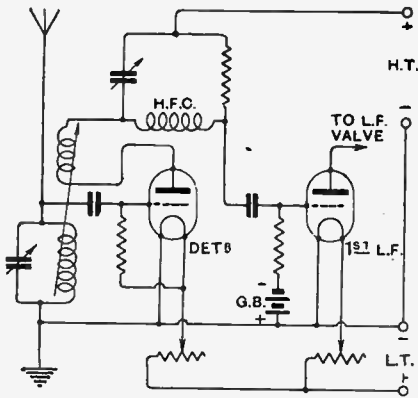

Fig. 1.—Critical adjustment of reaction.

effect of reducing resistance in the anode circuit of the detector valve. Very smooth and accurate adjustment is possible, and, as the wavelength to which the set is tuned is not altered appreciably, there is no risk of losing a weak signal.

The same method is applicable, with even greater advantage, when the detector valve is followed by resistance-capacity-coupled L.F. amplification, and a suitable scheme of

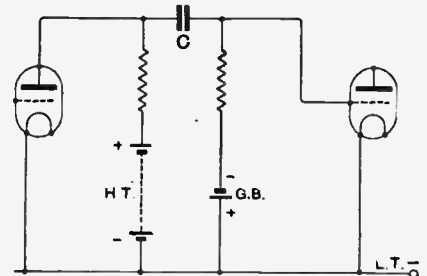

Fig. 2.—Parallel connection of anode and grid resistance.

charges on the grid condenser to leak away sufficiently rapidly to allow the grid to assume its normal working potential in the intervals between the arrivals of successive impulses. Its value will, therefore, be dependent on that of the grid condenser; if this is large, the leak must have a low resistance, and *vice versa*.

With a coupling capacity of 0.01 mfd. (the smallest usually recommended for use in conventional cir-

cuits), a leak of as high a value as 1 megohm will prove satisfactory. For condensers of 0.05 to 0.1 mfd. the resistance usually specified is about 0.5 megohm, while for considerably higher capacities 0.25 megohm will not be too low.

It should be realised that the choice of a leak should also be governed to a certain extent by the value of anode resistance in the circuit. The former should be high in comparison with the latter, or amplification will be reduced. Consideration of Fig. 2, which is the conventional circuit drawn in a somewhat unusual manner, will show that the two resistances are really connected in parallel, and that the leak, if of a comparatively low value, will act, in effect, as a partial short-circuit across the anode resistance, reducing the voltages applied to the grid.

INCREASING SELECTIVITY.

The first step to be taken in an attempt to increase the selectivity of an existing valve receiver of the simplest possible type will generally consist of the addition of a coupled aerial circuit. Although this alteration is not, as a rule, particularly difficult, in certain cases it may be found inconvenient to couple a second coil to the grid inductance, and it will almost

certainly not be easy to find room for an extra variable condenser for tuning purposes. This latter, however, is by no means necessary, particularly

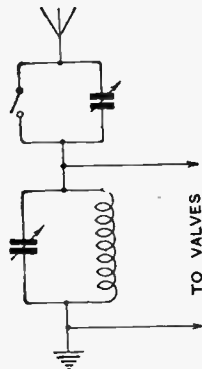

Fig. 3.—Combined series and parallel tuning condensers.

on the shorter (broadcast) wavelengths, as the "untuned aerial" system is certainly very effective.

Another method, giving in a lesser degree some of the advantages of a coupled circuit, is indicated in Fig. 3. Here the damping effect of the aerial load is reduced by the insertion of a series variable condenser which is provided with a short-circuiting switch. In the case of a receiver incorporating, say, a valve detector, with or without I.F. amplification, tuned by a parallel variable con-

denser, the conversion involves no internal alteration to the wiring, as the series condenser may be added as an entirely separate unit. A word of warning should be added here to the effect that if the set has a stage of tuned anode or tuned transformer-coupled H.F. amplification, it will probably be impossible to usefully reduce aerial damping without producing uncontrollable oscillation.

To obtain the utmost benefit as far as increased selectivity is concerned, it is essential that the series capacity should be small in proportion to that connected in parallel with the tuning coil, although a considerable reduction in the value of the former will have the effect of reducing signal strength. (Incidentally, a large parallel capacity will have the same effect.)

Here, as in the vast majority of similar wireless problems, it will be necessary to effect a compromise, and, as an infinite number of different adjustments for a given wavelength are possible, it will not be difficult to choose a combination giving the best results, selecting at the same time a value of inductance permitting the use of a suitable relation between the values of the two capacities.

DISSECTED DIAGRAMS.

No. 25.—Wiring a Valve-Crystal Reflex Receiver.

This series of sketches, originally intended to assist readers in understanding circuit diagrams, has been extended to show those connections which are at low oscillating potential and those at high potential; the latter require good spacing with respect to other leads.

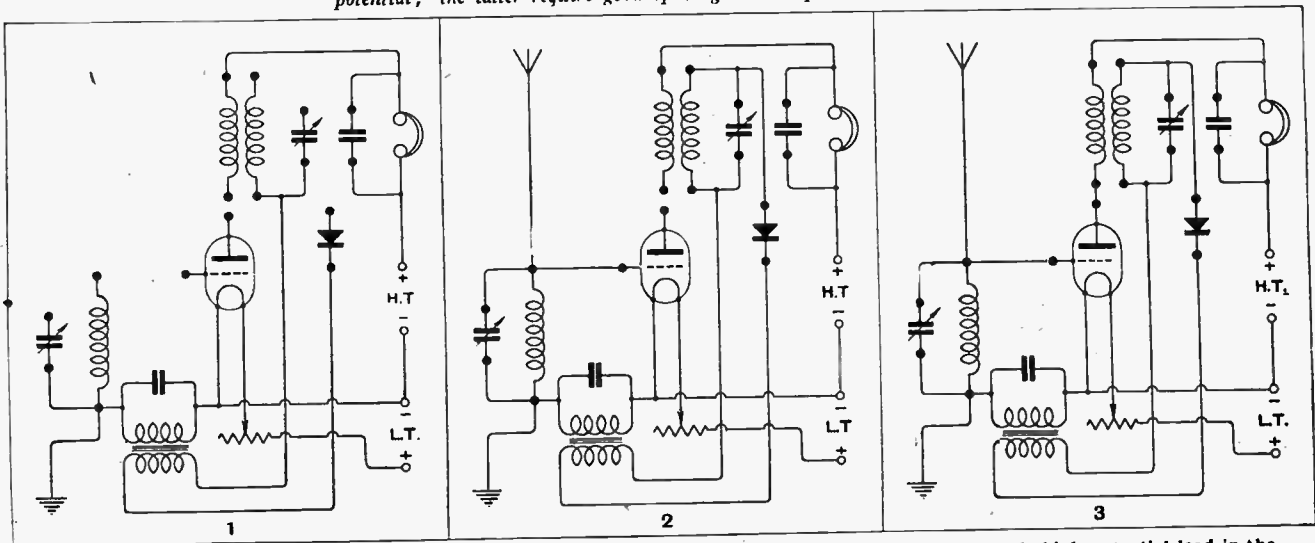

All filament and other low-potential leads are connected.

The grid circuit of the valve is completed.

The single high-potential lead in the plate is added.

LOUD-SPEAKER CONNECTIONS.

The Importance of Connecting the Positive and Negative Terminals Correctly.

By A. P. CASTELLAIN, B.Sc., D.I.C., A.C.G.I.

IT does not seem to be generally known that there is a right and a wrong way to connect a loud-speaker, or, if it is known, not much notice is taken of it.

Of course, if there is a telephone transformer or a choke and condenser arrangement in the plate circuit of the last valve of the set, then it does not matter which way round the loud-speaker is connected, as no steady plate current flows through it. In the majority of cases, however, the speaker is connected straight in the plate circuit of the last valve, in which case the connections are important.

In order to understand why this connection is important, it is necessary to examine the construction of a loud-speaker. The various essential parts of the "works" are shown in Fig. 1, and a diagrammatic representation in Fig. 2.

Function of the Permanent Magnet.

Normally, the diaphragm is under a continuous strain due to the pull of the permanent magnet. When a current flows round the coils, the soft iron cores are magnetised, and this extra magnetism will either help or hinder the magnetism of the permanent magnet, according to the direction of the current, and thus the pull on the diaphragm due to the resultant magnetism is either more or less than it was before. The effect of an alternating current through the windings, therefore, is alternately to increase or diminish the pull on the diaphragm, which accordingly vibrates at the frequency of the exciting current.

If there was no permanent magnet there at all, the pull on the diaphragm would be independent of the direction of the current, and would only depend on its magnitude. Thus an alternating current of frequency f (i.e., containing f positive and f negative half-waves per second) would vibrate the diaphragm $2f$ times per second, as each half-wave, positive or negative, has the same effect, and hence the loud-speaker would distort horribly by doubling every frequency applied to it.

As a matter of fact, this double frequency effect is present even when the permanent magnet is used, but in

this case the ratio of the fundamental frequency output (i.e., the frequency of the exciting current) to that of double frequency depends on the ratio of the permanent magnetism to that due to the current, and is, in fact, four times the latter ratio.

It is therefore obvious that the permanent magnet must be as strong as possible, so that the unwanted double frequency effect may be as small as possible compared with the fundamental frequencies.

Now let us return to the last valve in the set, which supplies the current for the loud-speaker.

This current may be regarded as being composed of two separate currents—the steady current when no signal is arriving, and the alternating current due to the signal, which is always less than the steady current if no distortion in the last valve is required.

Using the Steady Current.

This steady component of the current through the loud-speaker windings will assist or oppose the magnetism due to the permanent magnet according to the direction of the current, i.e., according to which way round the loud-speaker is connected. We have already seen that we want the permanent magnet to be as strong as possible, so we must obviously connect the speaker so that the steady current assists the permanent magnet.

If we connect the other way round, we shall not only get more unwanted double frequencies, but we shall permanently weaken the permanent magnet by partially demagnetising it. Also, the stronger the signal, the

more do the above remarks apply.

It has already been shown that, in order to obtain a large ratio of the fundamental frequency output from a loud-speaker to that of double frequency, the permanent magnet must be as strong as possible.

The actual value of the sound output of the fundamental frequency depends on the strength of the permanent magnet as well as on the current through the windings, while the sound output of double frequency depends only on the value of the current; so that from

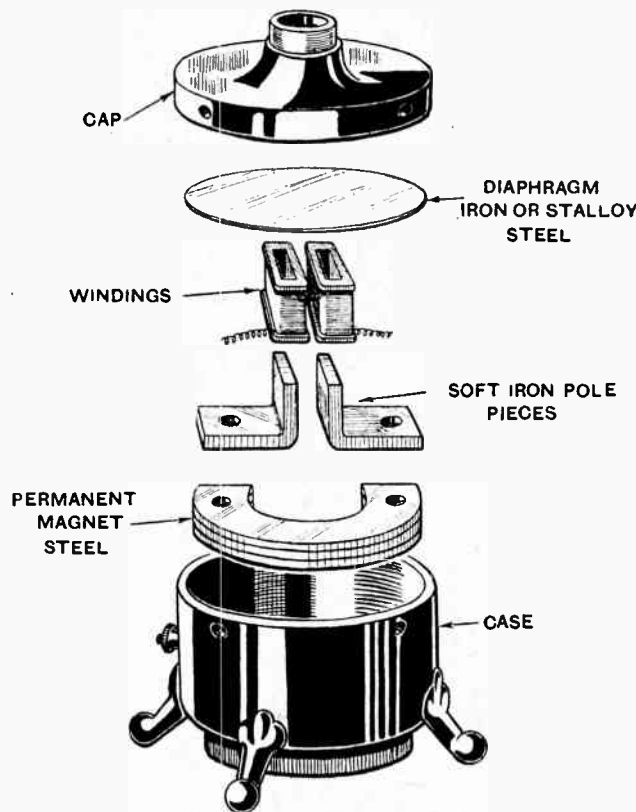

Fig. 1.—Showing the various parts of a loud-speaker in the order of their assembly.

Loud-Speaker Connections.—

the point of view of obtaining the greatest volume of sound of the correct frequency for a given current, the permanent magnet must also be as strong as possible.

The reader may now ask which way round should he connect his loud-speaker?

Most good loud-speakers are marked as to the direction of this steady current flow by + and -, or simply a minus on the appropriate terminal. According to the usual convention, current flows from the positive of the H.T. battery to the plate of the valve, so that + loud-speaker should go to + H.T., and - loud-speaker to the plate of the last valve.

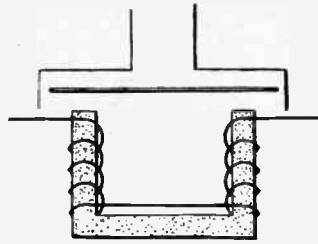

Fig. 2.—Diagrammatic representation of a loud-speaker, showing how the windings are arranged.

If the loud-speaker terminals are not marked at all, try disconnecting one lead to the speaker when no broadcast is being received, but with the last valve alight. If possible, cut out the grid bias on the valve for this test. A loud "plonk" will be heard in the loud-speaker when one lead is disconnected. Now reverse the leads and again disconnect one. The connection which gives the loudest "plonk" in the loud-speaker on disconnecting one lead is the correct one for reasons which will be obvious from the foregoing.

All that has been said above about loud-speaker connections applies to telephone receivers, though perhaps in a lesser degree, as the currents in the windings are smaller.

SHORT WAVES IN IRAQ.

By CAPT. R. F. DURRANT, A.F.C.

IN an article published in *The Wireless World* of December 23rd, 1925, I dealt with the history of my private station at Mosul and with some of the results obtained.

Since my return to Europe I have been greatly interested in the observation of short-wave phenomena now taking place in nearly every part of the globe.

Barometer Effects on Signals.

The barometer in Europe has a definite effect on the reception and transmission of distant signals. This effect is not so marked in Iraq. True, this instrument is not so fickle as in this country, and, though it dropped slightly when a burst of static came, reception from Europe was in no way affected, nor, according to reports, transmission. Fading was not apparent on 100, 90, 80, or 70 metres. The 23- to 45-metre band was found to be much less liable to interference from statics than the old 70 to 100 waveband, but the latter was always extremely useful for testing with the U.S.A.

The 23-metre wavelength was not in any way affected by the barometer. It was the only wave on which daylight testing with Europe could be carried out.

The following waveband was used in the summer (when the temperature averaged 110° by day and 90° by night). The observing station in England was G2LZ.

Continuous Communication.

We found we could communicate at any time during the twenty-four hours, from midnight until 5 a.m. G.M.T. on 30 or 37 metres, and from 5 a.m. until 6 p.m. G.M.T. on 23 metres. Thirty metres was readable up to midday, Iraq time; from thence onwards a shift to 23 metres was found to be essential at the Iraq end.

A point worthy of mention is that 23-metre transmission from England was readable any time during the twenty-four hours. Using 200 watts on this wave, G2LZ reported signals R7, full sunlight at both ends; 19 metres was inaudible.

Capt. Duncan Sinclair, during the discussion on his paper, "Some Facts and Notions about Short Waves"

(*Experimental Wireless*, February, 1926), mentions certain phenomena during sunset. I should like to emphasise a fact with regard to reception in Iraq. As the sun was setting, Australian and New Zealand stations came in with dramatic suddenness, but after ten to twelve minutes of R6 reception would disappear. This occurred only from December until the end of February on 80 metres. It was not noticeable on 80, 40, or 23 metres during subsequent months.

The sunsets over the desert were always characterised by vivid changes of colour, and I am inclined to the view that the varying angle of the sun's rays, which causes the spectrum, brought in these signals from the Antipodes. But why only on 80 metres and only during the winter months? Is it due to the position of the earth in its path round the sun?

Reception During Eclipse.

The total eclipse in England, the maximum effect of which took place at 1600 G.M.T., brought in, on 92 metres, signals from G2OD. It was broad daylight in Mosul, and nothing can normally be heard at this hour on this wave. G2OD was only readable during the twenty minutes or so of the semi-darkness in England. Reception was confirmed by G2KF and G5MO.

What might have turned out to be a very serious accident occurred to my assistant, Sergt. Hall, who, fortunately, was not in the line of fire. He was transmitting (H.T. voltage, etc., being normal), when there was a loud explosion, and the iron top of the Helsby condenser, which was across the H.T. mains, blew off and buried itself in the wall beyond. The sergeant, unperturbed, put the condenser back again in the circuit, and it continued to function perfectly.

The condenser was filled with oil, and I can only conclude the Iraq temperature proved too much for it.

During many months of experimental work Sergt. Hall was my only assistant, and to him I owe a debt of gratitude for his zeal and efficiency under very trying conditions. He is at present working EG1BH at Cairo on and around 40 metres.

SINGLE SIDE-BAND TRANSMISSION.

Technical Details of the System Used
in Transatlantic Telephony.

By E. K. SANDEMAN, B.Sc.

(Concluded from page 489 of the March 31st issue.)

LOUNDNESS is a very indeterminate quantity on which to observe, and is not directly proportional to the received power, as would appear to be a reasonable basis of assumption. Actually there is evidence to show that a sound increases by equal loudness intervals as the power is increased by equal percentages, and zero loudness is not at zero power, but at a definite value of power which varies with frequency and with different individuals and different telephone receivers. It is therefore more convenient to think in terms of audio-frequency voltages, assumed always to be generated in a circuit of constant resistance. To give some idea of the relation between loudness and power, it may be stated that the smallest change in power which can easily be noticed by direct comparison of steady frequencies is 10 per cent. The difference between the power required to operate a telephone receiver comfortably and a loud-speaker in an ordinary living room is of the order of 1,000 times.

An improvement in noise ratio on a voltage basis of 4 to 1 is equivalent to a power change of 16 to 1, which would make a considerable difference in loudness and a very large improvement in intelligibility at critical loudness levels.

Summary of the Characteristics of Single Side-band Transmission and Carrier Suppression.

- (i) The frequency range occupied by the side bands is halved, the energy radiated in the side-band frequencies being unaltered if the carrier is radiated as in the normal case, *i.e.*, the amplitude of the single side band is double the amplitude of either of the two side bands when radiated simultaneously.
- (ii) By suppressing the carrier the side-band amplitude may again be doubled.

The net result of the above changes is an improvement in noise ratio of 4 to 1 on a voltage basis.

- (iii) Since two side bands occupy half the frequency range occupied by one, it is possible to transmit each side-band frequency with more nearly the same attenuation; the deleterious effect of the tuning characteristics of the transmitting aerial are minimised. Alternatively, for a given distortion it is possible to operate with a more sharply tuned antenna.
- (iv) The frequency band width occupied in the ether is one-half that occupied by the normal system of transmission, so that twice as many channels of communication are made available.

A practical method of producing a single side band, which is actually in use at the present time, is described in a very complete paper by R. A. Heising.¹ A large part of the description below is taken verbatim from this paper, as are also Figs. 5 to 9.

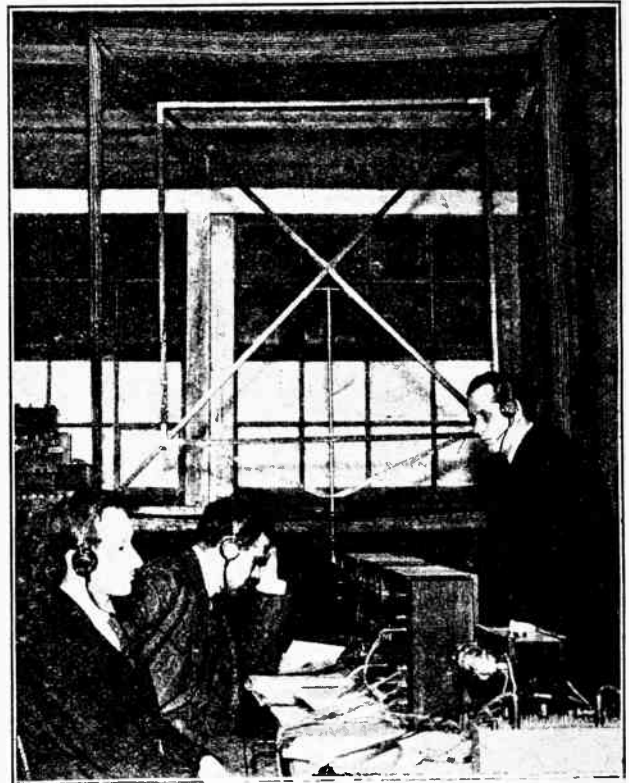

The receiving station during transatlantic telephony experiments in December, 1922, when single side-band transmission was employed.

It is possible to conceive a number of circuits which, when supplied with a voice frequency and a carrier frequency, deliver at some suitable point two side bands unaccompanied by the original carrier frequency. Since, however, the balanced modulator used in practice is as simple as any to describe, only this will be considered here.

Modulation, as we have already seen, is normally accomplished by making the amplitude of a carrier wave vary according to the amplitude of the original sound wave. A convenient method of accomplishing this is to supply both waves to the grid input of a valve having a curved plate current-grid voltage characteristic. In this case we may regard the low-frequency wave as varying the operation point of the valve and so varying its voltage amplification factor for the carrier wave. Now the slope of the plate current-grid voltage characteristic of a valve at any point represents its voltage amplification factor; hence, if we choose a valve such that the slope of the characteristic curve is directly proportional to the grid potential (*i.e.*, as the grid potential increases from some negative value to zero the slope increases from zero to some finite value), the variation in amplitude of the carrier wave reproduced in the plate circuit will be proportional

¹ Proc. A.I.R.E., June, 1925, p. 291, "Production of Single Side-band for Transatlantic Telephony."

Single Side-band Transmission.

to the amplitude of the audio-frequency wave at every instant. A curve of the above type is called a square law parabola, and the considerations below are in terms of valves having such parabolic characteristics.¹

On applying a voice wave of frequency f_v and/or carrier wave of frequency f_c to the grid input of a valve such as the above, operating on the curved portion of its plate current-grid voltage characteristic, the grid bias and A.C. voltage amplitudes being so adjusted that the plate current never reaches zero, the frequencies occurring

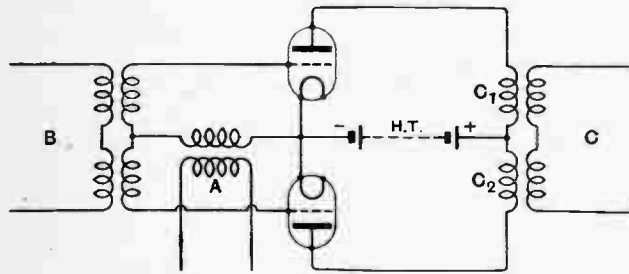

Fig. 5.—Balanced modulator circuit for the elimination of the carrier frequency in telephony transmission.

in the plate circuit are: f_c , f_c , $2f_c$, $2f_v$, $f_c + f_v$, and $f_c - f_v$. The last two frequencies represent the required side bands, the remaining frequencies being unwanted.

The balanced modulator is a device which takes advantage of certain phase oppositions to eliminate some of the unwanted frequencies. In Fig. 5 is shown the type of balanced modulator used at the transmitting station at Rocky Point.

The windings C_1 and C_2 are so arranged that currents in the same phase in the two plate circuits produce opposing E.M.F.s in Coil C, while currents in phase opposition in the two coils C_1 and C_2 produce additive E.M.F.s in coil C.

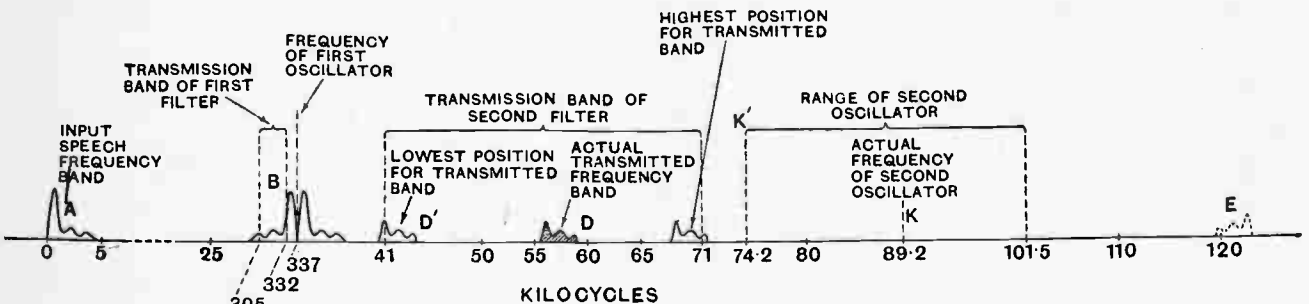

Fig. 6.—Relative positions of side bands and carrier frequencies in double modulation.

So that if a carrier wave is supplied at A it will produce voltage changes on the grids of the two valves which are in the same phase; hence the currents in the two coils C_1 and C_2 will be in phase. As a result, no carrier frequency will appear at C at all if the coils are accurately balanced. In practice a small amount of carrier leaks through, owing to unbalance, but the amount which does is very small. The double carrier frequency occurring

¹ Strictly speaking a "parabolic" valve characteristic curve conforms only to part of a parabola, but with the reservations made in this paper the conclusions drawn are true.

as a result of the curved valve characteristics is also suppressed.

If a voice frequency is supplied simultaneously at B, then it will appear at C, but the double voice frequency, although flowing in coils C_1 and C_2 , will be suppressed in coil C. The two side bands appear in coils C_1 and C_2 out of phase, and hence are reproduced at C. The frequencies appearing at C corresponding to a voice frequency, f_v , and a carrier frequency, f_c , are f_v , $f_c + f_v$, and $f_c - f_v$. It is a matter of comparative simplicity to separate the side bands from f_v , owing to their relatively wide distance apart in the frequency spectrum.

Double Modulation.

The question of separating the side bands one from another will be now dealt with by a quotation from Heising's original paper relating to the actual arrangement used at Rocky Point.

The principal reason why we do not use the more simple process of producing the single side band is that it is too expensive to build filters sufficiently sharp to separate one side band from another at carrier frequencies up in the neighbourhood of 60,000 cycles. In order to get a single side band at 60,000 we resort to the process of modulating twice. That is, we secure our single side band at a low enough frequency to separate it easily from the carrier and the other side band, and then by a second modulation process we move it to the desired point. This is represented in Fig. 6. The speech band represented by A is used first to modulate a carrier such as 33,700 cycles. There are then produced an upper and a lower side band at that frequency. It is comparatively easy to separate the bands at this frequency. In this particular case we pick out the lower side band—that is, we use a filter which transmits the frequencies running from 30,500 to 33,200. For this purpose the filter is built with a good steep slope on the upper side. The filter which we use has an attenuation characteristic as shown in Fig. 7. Now we take this desired side band located at B in Fig. 6 and put it into a second modulator where we modulate a second frequency of about 89,200 cycles. There will then be produced two new side bands, one shown at D running from 56,000 to 58,700, and one shown at E running from 119,700 to 122,400. The new D and E side bands are very far apart,

and also 30,000 cycles removed from the second carrier, and it becomes a very easy matter to build a filter which selects the desired band D and discriminates against the 89,200 cycle carrier and side band E. This filter does not have to have anywhere near the steepness of attenuation slope that the first one does because of the relatively greater separation between the bands and the carrier K. By this double modulation process we also provide ourselves with a flexibility in frequency range which we could not attain by the simple scheme except at prohibitive expense. That is, if we build our second filter to transmit frequencies between 71,000 and 41,000 cycles we can cause our desired band D to fall anywhere within this range such as D' by merely moving the second carrier K to K'. If that carrier is removed down to 74,000 the lower side band then falls

Single Side-band Transmission.

between 41,000 and 44,000. If we move the carrier K up to 101,000 the side band runs from 68,000 to 71,000. We thus secure a flexibility in frequency range for the placing of our side band D with the use of fixed frequency band filters, which for work such as we have been doing is of vital importance. The characteristics of the second filter are shown in Fig. 8.

The question may be asked why we picked the lower side band at 33,700 and used it to modulate another frequency, and then again picked the lower side band. The reasons for this are

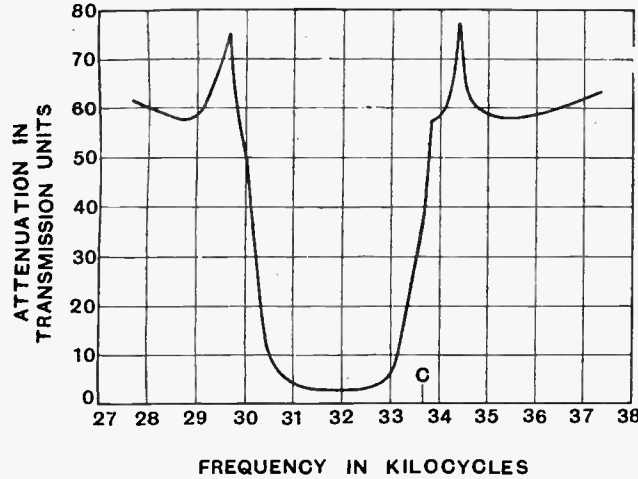

Fig. 7.—Attenuation curve of first filter.

partly circuitual and partly psychological. We could have picked the upper side band at 33,700 and then modulated about 93,000 cycles and located a side band in the same region where we have D as represented. In that case the side band would be reversed. There is no electrical reason for desiring the band as we have used it, over reversing the band, as either will give just as good quality, but it seemed simpler to maintain the frequency arrangement in the same order in which it occurs in the voice. There is an objection to producing the side band

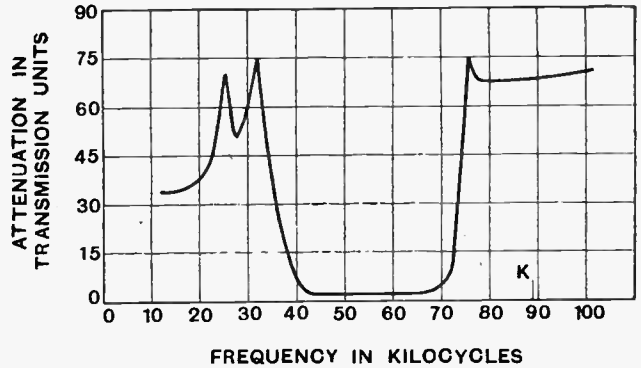

Fig. 8.—Attenuation curve of second filter

band in both cases, which, although it means turning the frequency band over twice, yet finally places it in the desired position and gives us the flexibility which is of value.

Replacing the Carrier.

At the receiving station it is necessary to replace the carrier. It is not necessary to replace the auxiliary carriers used at the transmitting station: 33,700 and 89,200, but only the resulting or final carrier, 55,500. It is interesting to note that this final carrier which is "eliminated" is not generated at the transmitting station at all. It is generated only if the first modulator is unbalanced and some of the first carrier gets into the second modulator. In practice the carrier is considered eliminated if reduced in amplitude to a few per cent. of its original value.

The accurate replacing of the carrier is sometimes of great importance. This is particularly true in receiving music, as otherwise overtones would not be overtones at all. As far as receiving speech goes, if the carrier is placed too close to the side band the voice sounds low and guttural, while if placed too far away it appears very high pitched, but in either case the articulation is reduced from what is secured when the carrier is correctly placed. It is, therefore, necessary for satisfactory operation to place the carrier as near as possible to the theoretical point.

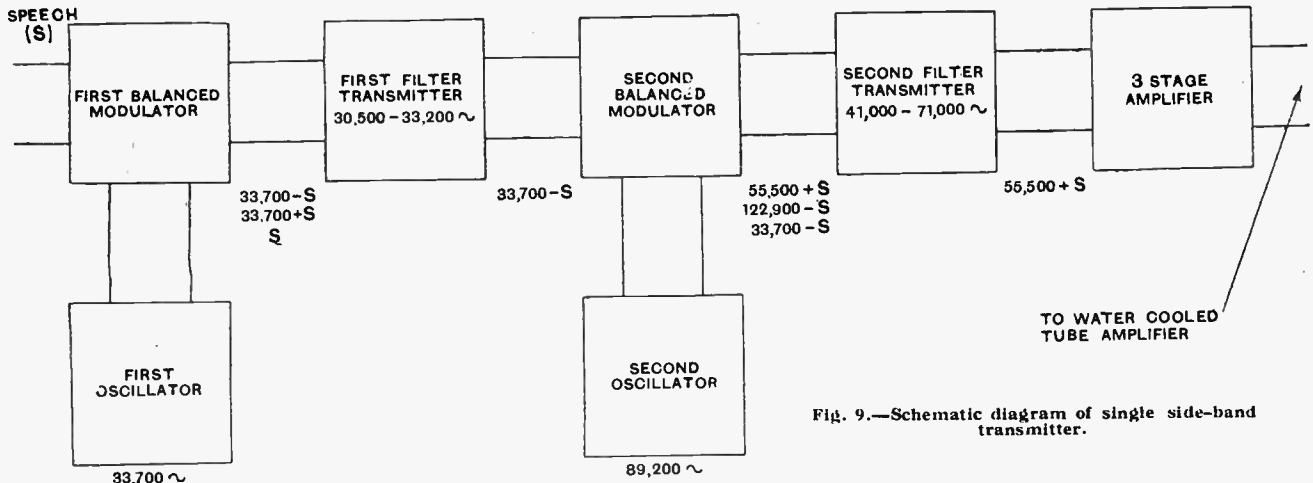

Fig. 9.—Schematic diagram of single side-band transmitter.

D by using one of the side bands near 33,700 to modulate a second carrier of about 21,800 which would again place the side band D in about the same position. The objection here lies in the fact that there is some likelihood of harmonics, especially second harmonics, giving some trouble if the balance is not perfect. It seemed desirable in a first experimental installation to keep all the frequencies and bands totally separate and not have them overlapping in such a way as possibly to give rise to any harmonic trouble. We therefore chose the lower side

If our carrier is to remain within, say, 20 cycles of the theoretical point, that means that both the suppressed carrier and the replaced carrier must remain constant within 10 cycles. If our carrier has a value of, say 55,500 cycles, and we wish to keep the frequency within 10 cycles, that means that it has to stay within 1-55th of one per cent. of the desired value at all times, even though temperatures in the room change or the voltage supply fluctuates slightly. To secure this constancy is a job all by itself. Ordinarily an oscillator changes its

Single Side-band Transmission.—

frequency when either the plate voltage or filament voltage changes, or when the temperature changes affect the constants in the circuit and steps had to be taken to prevent these changes or minimise the effects.

Heising then shows the block schematic diagram given in Fig. 9, which indicates the general arrangement of oscillators, balanced modulators, and filters to accomplish the double modulation described above, the figures between the blocks representing the balanced modulators, and amplifiers indicate the frequencies leaving each block and the frequencies entering the next block.

Explanation of Filter Characteristics.

It may be well to give a short explanation of the method of plotting the filter characteristics shown in Figs. 7 and 8. The curves shown are drawn by plotting at each frequency the attenuation. In transmission units, which is experienced by electrical power in traversing the filter in question. The behaviour of the filters might have been indicated by plotting the relative transmitted powers at each frequency, in which case curves the inverse of those shown in Figs. 7 and 8 would have been obtained. The disadvantage of plotting powers directly is that the transmitted powers vary in the ratio of 1 to 10 million between minimum and maximum for both filters, and hence it would only be possible to represent a very small part of the curve to scale with a reasonable percentage accuracy. The most obvious definition of attenuation is the fraction representing the ratio between the output power and the input power. For instance, in Fig. 7 on this basis the attenuation ratio at 34,000 cycles is $\frac{1}{10^5} = \frac{1}{100,000}$, while at 32,000 cycles it is approximately $\frac{1}{2}$. Again, the difficulty of plotting

such widely differing numbers with any reasonable degree of accuracy presents itself.

If we consider the denominator of the expressions above, then the transmission unit is defined so that an attenuation of n transmission units is equivalent to a value for the denominator of the attenuation ratio equal to $10^{\frac{n}{10}}$, that is, the value of 10 multiplied by itself $\frac{n}{10}$ times. We can juggle with this a little, and if r is the power attenuation ratio

$$r = \frac{I}{I_0} = 10^{-\frac{n}{10}} \therefore n = -10 \log_{10} r = -10 \log_{10} \frac{\text{Power output}}{\text{Power input}}$$

Below is given a table relating power ratios on the above basis and transmission units.

For consistency, therefore, attenuation in transmission units should be plotted as a negative quantity; provided, however, that the quantity plotted is clearly shown to indicate attenuation, this is usually considered not to be essential, and has not been done here.

Transmission units.	Power ratio.	Transmission units.	Power ratio.
1	1.259	9	7.943
2	1.585	10	10.0
3	1.995	15	31.62
4	2.512	20	10 ²
5	3.162	30	10 ³
6	3.981	40	10 ⁴
7	5.012	50	10 ⁵
8	6.310	100	10 ¹⁰

To find the power ratios equivalent to intermediate whole numbers of T.U.s, multiply the power ratios corresponding to the tens and the units. For example, 47 T.U. = 40 T.U. + 7 T.U., and is equivalent to a power ratio = $10^4 \times 5.012 = 50,120$.

General Notes.

In our issue of March 10th we mentioned the successful tests on the 23-metre wavelength carried out by Mr. E. J. Simmonds (G 20D) with a station in Egypt. We understand that he has now been successful in speaking with Mr. J. Maclurcan (A 2CM), a well-known amateur in Sydney, New South Wales. Mr. Simmonds was transmitting on Sunday, March 21st, with an input of 95 watts on a wavelength of 45.3 metres, and, to test the accuracy of reception of his signals, sent out a series of figures, including decimals. The entire message was reported in Morse from Sydney without error, and Mr. Maclurcan reported that every word came through distinctly on his loud-speaker.

Shortly before this test, Mr. J. A. Partridge (G 2KF) was also in communication with Mr. Maclurcan, from 6.10 p.m. to 7.10 p.m., during which time speech from 2KF was heard with remarkable clearness on a loud-speaker at the Sydney station. A 2CM was using a super-heterodyne receiver during the test which, although not previously arranged, was an entire success. Mr. Maclurcan also attempted telephony, but this, unfortunately, was not intelligible at this end, and his replies and reports were, therefore, sent in code. The wavelength employed by the Australian station was

TRANSMITTING NOTES AND QUERIES.

37 metres, and that by the British station 44.5 metres.

o o o o

Mr. M. H. Wynter-Blyth (G 6HF), Tankersley, near Barnsley, Yorks, informs us that on March 21st he established communication for over half-an-hour from 19.30 G.M.T. with Y 5BK in Kohat, India, when using 10 watts input from a Marconi ex-Government hand-generator. The wavelength used was 45 metres, and his signals were reported R4 and pure D.C.

o o o o

Mr. G. W. Thomas (G 5YK) states that on the night of Saturday, February 27th, he was in two-way communication with M 1DH in Baghdad for over an hour from 23.20 G.M.T. The input of 5YK was under 15 watts derived from A.C. mains, through a transformer, chemical rectifier and smoother. The wavelength of both stations was 45

metres, and signal strength was reported R6 to R8.

o o o o

BZ 1AW, V. Alven, Rua Riachuelo 89, CIV. Rio de Janeiro, is transmitting every night from 21.00 to 04.00 G.M.T., and will be glad if any British amateur will call him during this time. It is understood that he usually transmits on a wavelength of about 35 metres.

o o o o

QRA's Wanted.

G 5XQ, D 7AA, D 7MT, LA 4Z, R GA2, T PAV, ZHC.

o o o o

New Call-Signs Allotted and Stations Identified.

G 2HP (late 2BKI).—C. R. Waterer, 123, Upper Brockley Road, S.E.4. (This call-sign was formerly held by the Woodhall Wireless Mfg. Co., Euston, N.W.1.)

G 5UN.—The University of Birmingham Radio Society, Edgbaston, Birmingham, will transmit on 150-200 and 440 metres. (This station is not yet working regularly, and it is probable that the call-sign "5QN" may have been mistaken by some listeners for "5UN".)

G 5XO.—Capt. L. A. Bratt, Ravensdene, Holden Avenue, Woodside Park, N.12. (Change of address.)

G 6ZJ.—C. R. Hunt, Kensington House, Church Street, Sheringham, Norfolk, transmits on 45 and 150-200 metres.



Broadcast Brevities

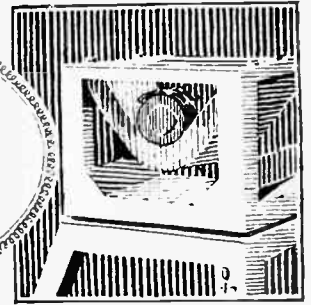

Savoy Hill Topicalities : By Our Special Correspondent.

Broadcasting from a Liner.

On the night of April 12th-13th dance music by Pilbeam's Band will be relayed from a ball in aid of the Royal South Hants and Southampton Hospital Extension Fund on board the White Star liner, R.M.S. "Majestic," in Southampton Docks, from 11 p.m. to 3 a.m., and will be broadcast from the Bournemouth station. This late transmission should be useful for Transatlantic experimental purposes.

o o o o

Warning to Experimenters.

Broadcasting enthusiasts who think that all the ether is theirs for experiment in transmission and reception should be very cautious nowadays in observing the terms of their licence. Articles have been published recently (not in *The Wireless World*) advising listeners how a Government radio station can be received. It may be the case that it is quite easy to intercept the signals of such a station; but broadcasting apparatus is not intended for this purpose, and it is understood that the Government will take very firm action in any case where a listener discloses the nature of the signals of a Government station.

o o o o

Newcomers to 2LO.

Three newcomers to broadcasting will appear in the programme on Monday next (April 12th). Miss Pat Reed should be particularly interesting, not only on account of her delightful method of delivering her songs and recitations, but because of her many broadcasts in Australia. Since Miss Reed arrived in England she has received many letters from children in the Commonwealth begging her to return to them, so she is obviously a favourite with young listeners as she is with adults in the Antipodes. Another newcomer is Mrs. Kilpatrick, whose short sketches of the ubiquitous kiddie have already been referred to in this page. The third novelty will be the appearance of Fred Rome and partner. Mr. Fred Rome is so well known as a concert party artist all over the country that listeners will no doubt

look forward to hearing him in two cameos of an amusing nature.

o o o o

New Radio Plays.

I mentioned recently that, in pursuance of the policy of broadcasting specially written radio plays of rather different type from those of twenty or thirty minutes' duration which have usually been given, the B.B.C. intended to transmit some of the familiar plays which have gained renown on the theatre stage during the past two or three decades. The first of such plays will appear in the 2LO and 5XX programmes on April 28th, when a curtailed version, lasting, nevertheless, a full hour, of Oscar Wilde's "Lady Windermere's Fan" will be given. The new feature will be repeated at intervals of about a month.

Women Announcers.

The prospect of women announcers' services being utilised at British broadcasting stations has been brought appreciably nearer, owing mainly to the success which attended Miss Kathleen Nesbitt's efforts in the role at 2LO on St. Patrick's Night. Manchester station has already taken a step forward by using a lady announcer occasionally for the afternoon programmes, and the station will probably develop the idea, while 2LO may also soon make a move in a similar direction.

o o o o

The Geneva Conference.

The outcome of the Geneva Conference of last month is that the international experts are uniformly agreed on the B.B.C. idea of building up broadcast



A HAVEN OF SELECTIVITY. The trials which beset the average listener who attempts to "separate" the different broadcasting stations are apparently absent in the Channel Islands, according to the report forwarded by this listener, who resides in Jersey. On the "Exclophone" receiver shown we are told it is possible to receive all British stations, cutting out those that are not required.

schemes along lines of higher power and the elimination of most of the low-power stations. The present system of building without regard for the limited capacity of the waveband available cannot, however, be changed at a moment's notice without causing a tremendous amount of dislocation and inconvenience to European listeners. By the duplication of wavelengths in suitably chosen zonal areas a good deal of the interference will be overcome, and attention can then be turned to the more delicate task of limiting the number of stations that is considered adequate for each of the broadcasting nations.

○○○○

New Continental Stations.

In the meantime further new stations are reported. The latest appears to be a French station on 291 metres, which interferes with Bournemouth. From Dorset it is reported to be a German or Dutch station; from Midhurst it is identified as French, and interfering more on Hamburg than on Bournemouth. Among other new stations are Reykjavik, 327 metres; Umea, on 215 metres; Antwerp, on 225 metres; Angers, on 250 metres; and Soro, which works not only on 2,400 metres but on 1,150 metres.

○○○○

Breaking the Wireless Laws.

In a recent case of infraction of the wireless regulations, a ship gave her call sign, in an endeavour to call up a British station, no fewer than 109 times, and gravely interfered with broadcasting. It is an international regulation that call signs should not be given more than three times without listening for a reply. In another case of interference by a French and Belgian steamer, the entire conversation between the two operators was recorded, which included, among other details, the time at which the Frenchman was going to dinner and exactly what he was going to have.

○○○○

Broadcasting from a Park.

A band performance from an L.C.C. park will be relayed to 2LO during the evening of May 6th. Vocal interludes from the studio will form part of the programme.

○○○○

The Nightingale.

The broadcasting of the song of the nightingale last year was not an unqualified success on the occasion of the first attempt at transmission on May 31st, although the arrangements were rather more elaborate than in previous years. This was because the last day of the month of flowers was more in keeping with a cold and blustering night in March. The second attempt to inveigle the birds in Oxted Woods into song was more successful. The B.B.C. has therefore decided this year to attempt to broadcast earlier in the season, viz., on May 1st, at which time, given normal weather conditions, the nightingales should be in good voice. Miss Beatrice Harrison's cello will again be the magnet to draw the birds into song.

A 32

FUTURE FEATURES.

Sunday, April 11th.

LONDON.—3.30 p.m., The Charles Burney Bicentenary. 9.15 a.m., Light Symphony Concert, conducted by Geoffrey Toye.

BIRMINGHAM.—3.30 p.m., Orchestral Concert.

BOURNEMOUTH.—3 p.m., Concert and Organ Recital, relayed from New Central Hall, Southampton.

Monday, April 12th.

LONDON.—8.30 p.m., The B.B. Spring Series of Chamber Concerts, relayed from Chenil Galleries, Chamber Music First Concert. The Virtuosi String Quartet.

CARDIFF.—8 p.m., The Besses of the Barn Band.

GLASGOW.—8 p.m., The Pianoforte Sonatas of Beethoven.

Tuesday, April 13th.

LONDON.—8 p.m., "My Mistake." 9.5 p.m., A Spring Programme.

DAVENTRY.—8 p.m., Concert Party. 9 p.m., Concert by the Hotel Majestic Celebrity Orchestra, relayed from the Hotel Majestic, St. Anne's-on-the-Sea.

ABERDEEN.—8 p.m., Recital under the auspices of the Scottish Association for the Speaking of Verse.

BELFAST.—8 p.m., Light Orchestral Programme.

MANCHESTER.—9 p.m., Concert relayed from the Hotel Majestic, St. Anne's-on-the-Sea.

Wednesday, April 14th.

LONDON.—7.30 p.m., Band of the Royal Marine (1st Division). Relay from the Dome, Brighton.

BIRMINGHAM.—7.30 p.m., Organ Recital relayed from the Town Hall.

NEWCASTLE.—8 p.m., A Popular Concert. The Besses of the Barn Band.

Thursday, April 15th.

LONDON.—8 p.m., The Roosters. ABERDEEN.—9.10 p.m., Special Feature: What Is It?

Friday, April 16th.

LONDON.—8 p.m., "La Traviata," a Lyric Drama in three acts by Giuseppe Verdi, relayed from the Chenil Galleries.

BOURNEMOUTH.—8 p.m., Mozart-Beethoven-Brahms.

Saturday, April 17th.

LONDON.—8 p.m., A Variety Programme relayed from the Chenil Galleries.

CARDIFF.—8 p.m., It's All Wrong. A Musical melodramatic Mixture, conducted by John Henry.

GLASGOW.—8 p.m., Musical Comedy Selections.

Miss Mabel Green to Broadcast.

One of the best known of musical comedy actresses of former days, Miss Mabel Green, will emerge from her retirement on Wednesday next (April 14th), when she will broadcast the comedy sketch, "The Poor Rich," which has been specially adapted for the microphone. It is some years since Miss Green was last heard in her great successes, "The Little Michius," "The Balkan Princess," etc.

○○○○

For Children of All Ages.

The Children's Corner—I am not sure that the term is rather a misnomer, as the feature attracts adolescents equally with the youngsters—is becoming one of the most difficult parts of the studio programmes to arrange. The policy is to provide a recreative programme, devoid of all appearance of education. This programme includes fairy stories, school stories, stories of adventure, legend and folk-lore, great men and their achievements, literature, music, everything in fact that appeals to the child mind.

○○○○

New Schemes.

While the older generation has accepted broadcasting as a novel means of instruction and entertainment, by the children it is accepted as one of the facts of life and for them it has the additional quality of drawing all classes and persuasions together; in a sense, of making the whole world of childhood kin. The hold that broadcasting has thus secured on the child mind is to be developed, and new plans are now being considered for co-ordinated programmes, incorporating balanced entertainment, so that every child in the wide clientele of the Children's Corner shall be catered for and interest shall not be allowed to flag. The latter is a very real danger where the aim is to interest children. Ask any broadcasting Aunt or Uncle whose creative and imaginative instincts have been put to the test.

○○○○

Broadcasting and Bacchus.

A question relating to loud-speakers in public houses was raised in Parliament last week by Sir Bertram Falle (Portsmouth N., U.), who asked the Secretary of State whether he was aware that orders had recently been issued by the police authorities forbidding the instalment of wireless sets in public houses unless such premises were licensed for music and singing. In his reply Sir W. Joynson-Hicks said that the question was one for the local authority and involves questions of law which can only be decided by the Courts.

○○○○

Hospital Programmes.

Many listeners will welcome the announcement that a special service for the sick is to be broadcast from all stations once a week. The B.B.C. finds that the day and time most convenient for hospitals in general are Thursday between 4 and 4.30 p.m., and the new feature will start as soon as the necessary arrangements can be made.



A Review of the Latest Products of the Manufacturers.

HALLADAY'S VERNIER DIAL.

Messrs. Halladay's, Ltd., Tame Road Works, Witton, Birmingham, have introduced a dial for critical condenser control embodying some entirely new features. The reduction gearing between the operating handle and the instrument shaft is obtained through pinions, but in this instance only two toothed wheels are employed, which possesses the advantage over the type fitted with a compound train of pinions inasmuch as backlash is imperceptible.

The reduction gear ratio obtained with a single pair of pinions would normally be insufficient to provide a satisfactory degree of critical control, and a novel feature is the fitting of a 6in. extension handle to the spindle of the smaller

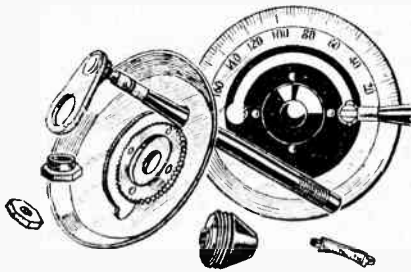

A new vernier dial in which quick adjustment is obtained with the operating extension handle in a vertical position, whilst by hinging it over to the horizontal an exceedingly fine control is produced.

wheel. This extension handle, which is of ebonite, and thus eliminates hand capacity, is hinged so that when raised to a vertical position a quick adjustment of the dial is obtained, but when the handle is bent over to the horizontal a comparatively large swing is needed to produce an exceedingly small rotation of the dial. Coarse tuning operates through a 6:1 reduction gear ratio.

The dial is well made in brass, has a bright silvered finish, with the numbers chemically engraved. The scratch lines indicating degrees are exceedingly fine, and in this respect the graduations are superior to the thick white lines so frequently found on the ebonite type of dial. Instead of the usual form of pointer a vernier plate is supplied, so that it is rendered a simple matter to read to the one-tenth part of a degree.

The movement is secured by making use of the one-hole fixing unit of the condenser, and the specimen examined was provided with a threaded bush for attachment to a 2 B.A. spindle.

o o o o

BATTERY CHARGING FROM D.C. MAINS.

When a direct current supply is available the filament battery is easily charged by connecting it in series with the lighting circuit either by breaking in on one of the main leads or merely severing a connection to one of the lamps and interposing the battery. It is not always convenient to charge through the entire house lighting circuit, which is attendant with many difficulties and some degree of risk, whilst to charge through a single lamp is exceedingly slow in the case of a large battery.

The General Electric Co., Ltd., Magnet House, Kingsway, London, W.C.2, now manufacture charging boards specially designed for use with wireless accumulators. For the charging of L.T. batteries a number of switchboards are available with outputs varying from 3 to 12 amperes and arranged for use on supply voltages of 50, 110, and 220. The equipment, which is mounted on a slate panel, includes moving iron oval pattern ammeter, double pole rotary type switch, main fuses, regulating switch resistance, and the necessary in-put and out-put terminals.

A special type of variable resistance is available for charging H.T. accumulator batteries and is shown in the accompanying illustration. The resistance unit consists of a slate former wound with resistance wire of ample rating with low temperature rise, the complete winding being treated with heat-resisting cement. The adjustable current regulator consists of a

self-aligning brush, the regulation obtained being suitable for controlling the charging of a 60, 100 or 150 volt battery at 140 milliamps from 110 or 220 volt D.C. supply. The ammeter, which is spring controlled, gives dead beat readings. The complete apparatus is self-contained with incoming and outgoing terminals and mounted between two cast-iron end plates with a black finished sheet-metal cover.

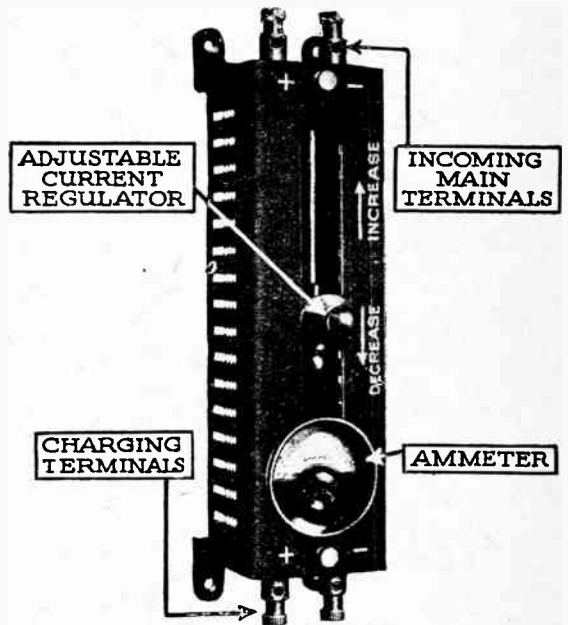

The new G.E.C. regulating resistance for charging H.T. accumulator batteries from direct current mains.

TWO USEFUL METERS.

Messrs. Crompton and Co., Ltd., of Chelmsford, have recently introduced two useful measuring instruments, the "Unique" cell tester and the "Alltest" multi-range moving coil meter.

The cell tester has been designed to meet the demand for a thoroughly reliable commercial instrument which is reasonable in price, light in weight, and easy to handle. The movement is of the moving coil type, is exceedingly light, but at the same time robust, and is fitted with an external zero adjusting screw,

the pivots operating in sapphire bearings. Pole pieces of special shape are employed to give wide divisions at the working parts of the scale in the neighbourhood

ing being of very high resistance so that an inappreciable current is taken from the cells on test, and contact errors are negligible. The instrument is supplied

high as 2 per cent. might be tolerated in a meter of this class, careful test revealed that the readings on the right-hand side of the scale were perfectly accurate, whilst an error in the left-hand readings did not exceed $\frac{1}{2}$ per cent.

Altogether this meter is an exceedingly useful instrument, and indispensable for battery testing and charging.

The "Alltest" moving coil meter has been developed as a portable D.C. testing instrument. The illustration shows this instrument in association with its shunts and resistance bobbin attachments by means of which the range of the scale readings becomes 15 mA, 5, 15, or 30 amperes, 75 mV, 3, 15, and 150 volts.

As a milliammeter the accuracy of the scale does not exceed 2 per cent., and on test scale reading at 2 mA was found to be 2 per cent high. At 4 to 8 mA the error was less than $\frac{1}{4}$ per cent. Again, between 12 and 15 mA the reading was $1\frac{1}{2}$ per cent. high. The voltage and current measurement making use of the shunts and resistances similarly possess these minor discrepancies.

The shunts are very neat and handy and of compact design. The movement, even on the milliampere scale, is particularly dead beat. There is no indication on the meter of the polarity of the terminals, though, of course, the user would soon become acquainted with the direction of connecting up.

This universal instrument should prove exceedingly useful for conducting tests in connection with constructional and experimental work.

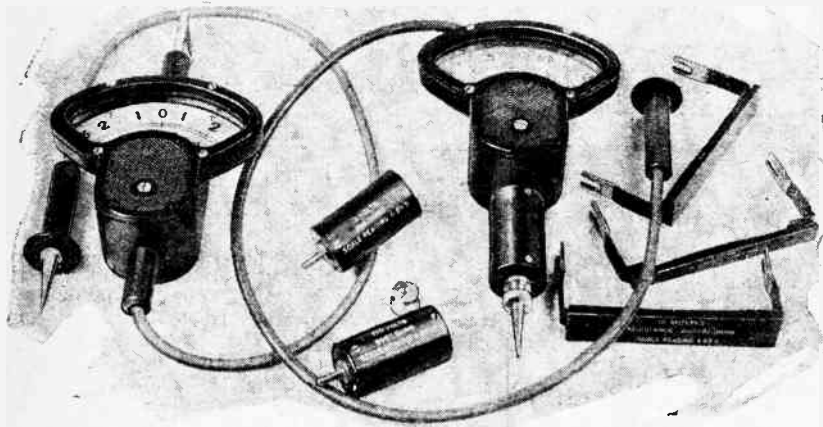

New Crompton testing instruments. On the left is the cell tester and on the right the universal instrument with its resistances in shunts

of 2 volts, the scale being divided into sixty parts, each division representing 0.1 volt.

On test it was found that a current of 4.65 mA. is required to swing the pointer through one volt on the scale, the wind-

ing with insulated spear points for making contact on the battery terminals, 2ft. of insulated flexible cable with ebonite hand guards being provided.

The instrument is one possessing extreme accuracy, and although an error as

"Stunt" Circuits.

Much-advertised circuits of the "stunt" variety came in for criticism at the hands of Mr. J. H. A. Whitehouse, of the B.B.C., who lectured before the Muswell Hill and District Radio Society on March 17th. A number of "stunt" circuits were shown on the screen, and the lecturer demonstrated very clearly that the majority embodied only slight modifications of standard practice.

On the question of broadcast reception Mr. Whitehouse emphasised the importance of working valves at their correct voltages and recommended the use of anode rectification. Methods were described for the easy control of reaction, attention being drawn to the advantages of controlling oscillation by fixing the reaction and having a variable high resistance in shunt with the A.T.I.

Hon. Secretary: Mr. Gerald S. Sessions, 20, Crasmere Road, N.10.

o o o o

A Motor Car Set.

A portable eight valve superheterodyne receiver, adapted for use on his car, was demonstrated with success by Mr. Johnson, a member of the Bristol and District Radio Society, on March 19th. Numerous types of aerials had been used by Mr. Johnson with varying success until he tried a wire spiral suspended from the car roof. This had been found to give the best results, no directional effects being observed.

A 24

NEWS FROM THE CLUBS.

The set was afterwards taken from the car and attached to a wire stretched across the club room, excellent reception being obtained.

Hon. Secretary: Mr. S. J. Hurley, 46, Cotswold Road, Bedminster, Bristol.

o o o o

How to Choose a Loud-speaker.

For those intending to purchase a loud-speaker the programme which was carried out recently by the Norwich and District Radio Society was of genuine assistance. A number of loud-speakers of different make, including the home-made variety, were placed behind a screen, and were operated in turn in conjunction with a Burndopt Ethophone V, which yielded plenty of distortionless volume.

As a result of a vote the premier place was assigned to an instrument of popular make, two other well-known loud-speakers being voted second and third. As a perfectly fair and dependable means of assessing the relative merits of the many instruments on the market, this method can be recommended to other

clubs whose members are still undecided on this important question.

Hon. Secretary: Mr. S. Hayward, 42, Surrey Street, Norwich.

FORTHCOMING EVENTS.

WEDNESDAY, APRIL 7th.

Tottenham Wireless Society. At 8 p.m. At 10, Bruce Grove. Demonstration of the "Keystone" Super Heterodyne Receiver by Messrs. Hughes and Moody.
Edinburgh and District Radio Society. At 117, George Street. Business Meeting and Questions Evening.

FRIDAY APRIL 9th.

Sheffield and District Wireless Society. At 7.30 p.m. At the Dept. of Applied Science, St. George's Square. Elementary Lecture (6): "More Complicated Valve Circuits."

MONDAY, APRIL 12th.

Institution of Electrical Engineers. Informal Meeting. At 7 p.m. At the Institution, Savoy Place, W.C.2. Discussion: "The Linking Together of Wireless and Wire Communication Systems." (Opened by Captain P. P. Eckersley.)

Ipswich and District Radio Society. In the Lecture Room, Museum, High Street. Lecture by Representative of the B.B.C.

Southport and District Radio Society. At 8 p.m. At St. Andrew's, Park Street. "Talk to Beginners," by Mr. G. E. C. Jarvis.

WEDNESDAY, APRIL 14th.

Institution of Electrical Engineers, Wireless Section. Lecture: "The Rugby Radio Telegraphy Station," by Mr. E. H. Shaughnessy, O.B.E.

WIRELESS CIRCUITS

in Theory and Practice.

9.—Aerial Tuning Circuits.

S. O. PEARSON, B.Sc., A.M.I.E.E.

THE wavelength to which an aerial responds when there is no added inductance or capacity in the circuit is called the *natural wavelength* of the aerial. If L_a is the aerial inductance in microhenries and C_a the aerial capacity in microfarads, the natural wavelength of the aerial will be:

$$\lambda_0 = 1885 \sqrt{L_a C_a} \text{ metres.}$$

Now, the inductance and the capacity are each roughly proportional to the length of the aerial measured from the far end to the earth connection, and therefore the natural wavelength of an aerial is approximately proportional to its length. A very rough idea of the natural wavelength in metres of a flat top aerial is obtained by multiplying the total length in feet by 1.5. For instance, an aerial 100ft. long from the earth connection to the far end will have a natural wavelength of about 150 metres. In general, an aerial operates most efficiently when tuned to a wavelength not far removed from the natural wavelength.

Methods of Increasing Aerial Wavelength.

For receiving purposes it is necessary to be able to tune the aerial to any wavelength over a considerable range, and various methods are available for doing this, these being discussed in turn below. It is usually necessary to be able to vary the wavelength continuously, *i.e.*, not in steps; and therefore it is essential to provide some means of varying the total inductance or capacity (or both) continuously through a certain range.

It is always necessary to have an inductance of some sort connected in the down lead for the purpose of transferring *some* of the received energy to the receiving apparatus, whether the receiver is directly connected or inductively coupled to the aerial circuit. Since the aerial capacity is distributed along the length of the aerial it follows that the current in the aerial will be greatest at the base, and will gradually diminish for points considered along the length of the aerial towards the elevated end, there being no current at all at the extremity. Thus in order to get maximum voltage built up by the signal across the series inductance, the latter should be connected in the circuit as near to the earth connection as possible. It is a mistake to have a very long earth lead running from the receiving apparatus to the earth connection.

For tuning purposes this coil itself may be designed so that its inductance is continuously variable over a considerable range. An early form of aerial tuning inductance consisted of a cylindrical single layer coil of enamelled copper wire with the enamel removed from the top surface of a strip parallel to the axis of the coil, a

slider making connection with any desired turn. This enabled the inductance to be varied in small steps, each step changing the inductance by the amount corresponding to that of one turn. This arrangement was quite practicable for receiving Morse signals of moderately long wavelength on a crystal receiver, but the tuning is not nearly critical enough for continuous waves and telephony, especially on the fairly short waves now used for broadcasting and other purposes. A variometer provides a means of changing the wavelength continuously, but has only a limited range. A good variometer would have an inductance ratio of about ten to one between maximum and minimum settings,¹ and, allowing for the inductance of the aerial itself, this would give a wavelength range of not more than about three to one. The disadvantage of a variometer is that when set at the lower inductance values, its effective resistance is unnecessarily high, partly due to the length of wire on it and partly due to the general design.

Loading Coils.

When a coil of inductance L microhenries is connected in series with the aerial near the base, the total inductance of the aerial circuit becomes $(L + L_a)$ microhenries, where L_a is the aerial inductance, and the wavelength to which it is tuned is given by

$$\lambda = 1885 \sqrt{(L + L_a) C_a} \text{ metres.}$$

This does not take into account the self-capacity of the inductance coil, this being assumed to be small compared with the aerial capacity C_a . We see from the above expression that the wavelength is increased by adding inductance in series, the wavelength being proportional to the square root of the total inductance. To obtain as large a fraction as possible of the available signal voltage across the series inductance, the latter should be fairly large compared with the inductance of the aerial itself. Fig. 1 (b), which is the equivalent circuit to the

actual aerial circuit shown at (a), will make the reason for this quite clear: the total voltage built up across the inductance portion of the circuit will be divided between the two inductances in the direct ratio of their values. Thus up to a certain point the larger the value of the series inductance the better, but, on the other hand, the receiving efficiency of the aerial is greatest at wavelengths near the natural wavelength, and when a short aerial is tuned by means of loading inductances to respond to waves ten or more times as long as the natural wavelength, the efficiency falls off considerably. Fortunately,

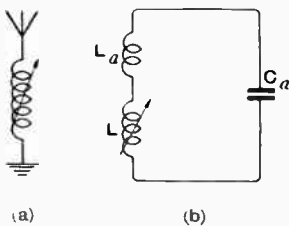

Fig. 1.—Aerial circuit (a) tuned by a variometer in series. The equivalent electrical circuit is shown at (b).

¹ See *The Wireless World*, Feb. 3rd, 1926, page 183.

Wireless Circuits in Theory and Practice.—

from the amateur point of view, nearly all of the most interesting transmissions to be listened to are of moderately short wavelength, and the maximum length of 100ft. permitted for amateur aerials by the Post Office gives very good efficiency on these wavelengths. The moderately long-wave transmissions from the broadcasting station at Daventry are conducted on such a high power that the inefficiency of a short aerial is immaterial.

The most convenient and practical method of tuning an aerial circuit is to have a fixed inductance in series with the aerial and to vary the capacity of the aerial circuit

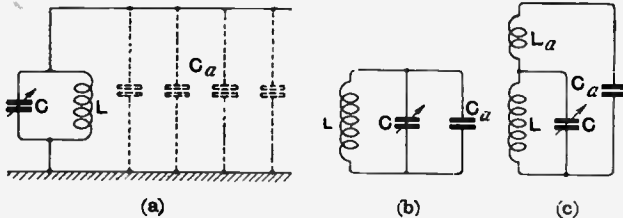

Fig. 2.—Aerial tuning by means of an inductance and variable condenser in parallel. The equivalent electrical circuit neglecting aerial inductance is shown at (b) and with the aerial inductance taken into account at (c)

by means of a variable condenser. One method is to connect the tuning condenser in parallel with the inductance coil as shown in Fig. 2 (a), where L is the inductance coil and C the added condenser. Assuming the aerial inductance to be small compared with the coil inductance L , the aerial circuit is electrically equivalent to the circuit of Fig. 2 (b). The two capacities C and C_a in parallel represent a total capacity of $(C + C_a)$ microfarads, and the wavelength is therefore given by:

$$\lambda = 1885 \sqrt{L(C + C_a)} \text{ metres,}$$

the addition of the parallel condenser thus increasing the wavelength. If the aerial inductance L_a is comparable with that of the coil L , and if L is assumed to be close to the earth connection, the equivalent circuit will be as shown in Fig. 2 (c). This is not a simple straightforward circuit, and the expression for the actual wavelength is more or less complicated; but it will be sufficiently accurate for our purpose if we assume that the added capacity is connected across the whole of the inductance $(L + L_a)$, giving a wavelength of:

$$\lambda = 1885 \sqrt{(L + L_a)(C + C_a)} \text{ metres.}$$

Actually, the wavelength will be somewhat less than this.

Wavelength with Parallel Tuning.

We saw in connection with tuned circuits that, in order to get a high signal voltage across the inductance or condenser, the ratio of inductance to capacity must be as high as possible, and the same rule applies here. For wavelengths ranging between 300 and 500 metres a variable condenser used in parallel in this manner should not have a greater maximum value of capacity than 0.0005 mfd., or, as a limit, not greater than 0.00075 mfd. For a given aerial the greatest voltage is obtained across the inductance coil when there is no condenser connected in parallel.

The average capacity of the standard type of P.M.G. aerial usually ranges between 0.0002 and 0.0003 mfd., and therefore a parallel condenser whose maximum capa-

city is 0.0005 mfd. gives a very limited wavelength range—less than two to one. For instance, with an aerial whose capacity is 0.00025 mfd., a variable condenser of 0.0005 mfd. capacity will tune the aerial from, say, 300 metres for minimum condenser reading to only about 500 metres for maximum condenser setting with a suitable inductance in circuit. Therefore, in order to cover a wide band of wavelengths it is necessary to have a series of inductance coils, any one of which can be connected in the aerial circuit. Each will give a definite band of wavelengths in conjunction with the condenser in the circuit. The series of coils must be so chosen that the highest wavelength given by any one coil is slightly greater than the lowest wavelength given by the next largest coil in the sequence, *i.e.*, the wave bands of the consecutive coils must overlap in order to leave no gaps in the complete range of wavelengths to be covered.

Tapped and Plug-in Coils.

The most convenient form of coil, from the point of view of interchangeability, is the plug-in type which fits into a coil holder connected permanently in the circuit as shown in Fig. 3 (a), and there are a large number of these on the market. Another means of covering a wide band of wavelengths, using a single coil only, is obtained by having tapings taken from various points in the coil so that, by means of a switch, part of the coil only may be used at a time. This arrangement is indicated in Fig. 3 (b). It has the advantage of rapid changing, and

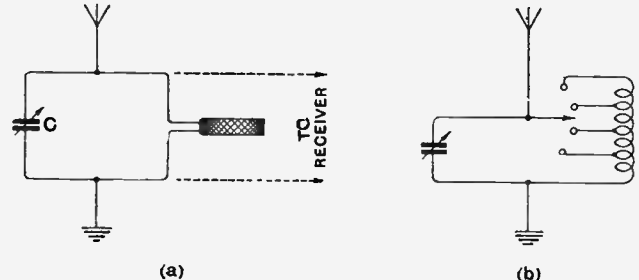

Fig. 3.—Types of aerial inductance coils: (a) the plug-in coil; (b) variable tapped coil.

the coil can be mounted inside a cabinet without the necessity of opening the same for changing the wavelength range. This advantage is, however, usually more than outweighed by the loss of efficiency experienced when only a few of the turns are in use. The unused turns are actually in the magnetic field produced by the useful turns in the circuit carrying the high-frequency currents. The result is that high-frequency electromotive forces are induced in the unused turns, or dead-end turns as they are called, and, due to the self-capacity between these turns, serious losses may occur. If there are many dead-end turns the self-capacity may be sufficient to tune the unused part of the coil to the same wavelength as the signals being received, in which case a large oscillating current will flow and introduce losses sufficiently great to reduce the strength of the received signal to a small fraction of what it would be if the dead-end turns were not present. On the whole, then, it is better to use a separate coil for each band of wavelengths. For ordinary broadcast reception one coil will cover the wavelengths used by the British stations except Daventry.

Wireless Circuits in Theory and Practice.—

An example is now given of an actual determination of the size of coil required to tune a given aerial over a wavelength range of, say, about 300 to 500 metres when a 0.0005 mfd. variable condenser is used in parallel with the coil. Suppose that the aerial is one of average size, and therefore having a capacity of about 0.00025 mfd. and a natural wavelength of, say, 140 metres. From the formula $\lambda = 1885\sqrt{L_a C_a}$, we find that the aerial in-

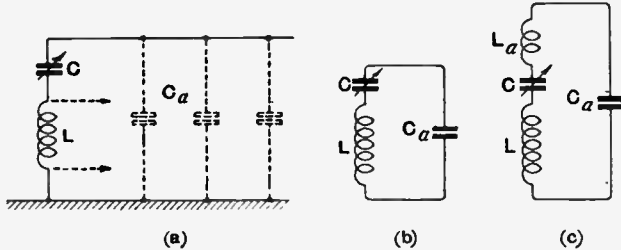

Fig. 4.—Aerial circuit tuned by a variable condenser in series. The equivalent circuits with and without the aerial inductance are shown at (b) and (c).

ductance L_a is about 22 microhenries. Let L_1 denote the total inductance of both the aerial and the coil; then the wavelength is given by:

$$\lambda = 1885\sqrt{L_1(C + C_a)} \text{ metres.}$$

where C = added capacity, and therefore for maximum condenser setting of 0.0005 mfd. we have:

$$500 = 1885\sqrt{L_1 \times 0.00075},$$

from which $L_1 = 94$ microhenries. Thus the coil inductance should be $94 - 22 = 72$ microhenries.

We must see now to what wavelength this coil will tune the aerial circuit when the condenser is set at its lowest value, which we shall assume gives a minimum capacity of 0.00001 mfd.

$$\begin{aligned} \text{We have } \lambda &= 1885\sqrt{L_1(C_0 + C_a)} \\ &= 1885\sqrt{94 \times 0.00026} \\ &= 294 \text{ metres.} \end{aligned}$$

Thus, with a 0.0005 mfd. variable condenser it is possible to cover the range from 300 to 500 metres. A later instalment will be devoted to the winding of inductance coils to a given value of inductance.

Tuning by Means of a Series Condenser

Both of the methods discussed above for tuning an aerial increased the wavelength above the natural value, and where it is desired to receive wavelengths near or even below the natural wavelength of the aerial both these methods are unsuitable; to lower the wavelength, it is necessary to decrease either the inductance or the capacity. It is physically impossible to lower the inductance below that of the aerial inductance itself; in fact, the total inductance *must* be greater than that of the aerial, as a series inductance is always necessary for connection to the receiver. Thus we are bound to lower the capacity of the aerial circuit, and this is effected by connecting a variable condenser in series with the aerial as shown in Fig. 4 (a). If we neglected the aerial inductance itself, the equivalent tuned circuit would be as shown at (b) in Fig. 4, so that, in effect, the added condenser is connected in series with the aerial capacity.

Now when two condensers of capacities C_1 and C_2 , respectively, are connected in series, the resulting capa-

city C is given by $\frac{1}{C} = \frac{1}{C_1} + \frac{1}{C_2}$, or $C = \frac{C_1 C_2}{C_1 + C_2}$. This

shows that for two condensers in series the resulting capacity is less than that of either of the individual condensers, and, therefore, when a condenser is connected in series with an aerial, the total capacity and the wavelength are reduced. The series condenser should be connected immediately above the inductance coil in the aerial lead, and when the earth lead is short the bulk of the aerial inductance will be between the condenser and the elevated portion of the aerial, and, therefore, the equivalent circuit will be as shown in Fig. 4 (c), the wavelength being given by $\lambda = 1885\sqrt{L_1 C_1}$ metres, where L_1 is the total inductance of coil and aerial, and C_1 is the resultant capacity $\frac{C C_a}{C + C_a}$ of the condenser and the aerial.

Wavelength of Series Tuned Circuit.

When the series capacity is reduced to a low value, a large proportion of the signal voltage is lost across this condenser, and, therefore, the efficiency of the aerial circuit begins to fall off as the capacity is lowered. Thus for series tuning it is better to use a variable condenser whose maximum capacity is considerably larger than that required for parallel tuning, and a condenser having a maximum value of from 0.001 to 0.0015 mfd. is to be recommended.

Taking the same aerial and coil as considered above for parallel tuning, and using a series condenser whose capacity ranges from 0.0001 to 0.001 mfd., we find that the total capacity with the condenser set at the full value is 0.0002 mfd., and, therefore, the maximum wavelength obtained is $1885\sqrt{94 \times 0.0002} = 258$ metres. For minimum setting of the condenser the total circuit capacity works out to 0.000071 mfd., or 71 microfarads, giving a minimum wavelength of 154 metres. We see, then, that, for this particular aerial and coil, tuning can be obtained from 300 metres upwards with a parallel condenser, and from 258 metres downwards with the series condenser. It will be noticed that there is a gap between the two wavelength ranges, namely, from 258 to 300 metres, which cannot

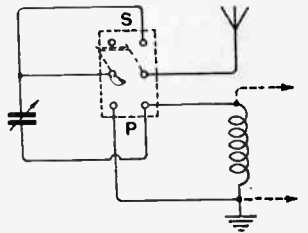

Fig. 5.—Switch connections for connecting the tuning condenser in series or parallel with the tuning coil.

be covered with the particular coil in use, and in order to tune to wavelengths within this gap it is necessary to employ another coil of different inductance value. For any coil whatever there is always a gap present between the series and the parallel tuning ranges.

When it is desired to receive over a wide band of wavelengths, it is a good plan to provide a switch in the circuit enabling the tuning condenser to be connected either in series with the aerial or in parallel with the tuning coil. An ordinary double-pole two-way switch is suitable, and a method of connecting it in the circuit is shown in Fig. 5. Where series-parallel tuning is provided in this manner a medium-sized condenser should be used, a suitable maximum value being 0.00075 mfd.



The Editor does not hold himself responsible for the opinions of his correspondents

Correspondence should be addressed to the Editor, "The Wireless World," Dorset House, Tudor Street, E.C.4 and must be accompanied by the writer's name and address.

EXPERIMENTERS AND THE PUBLIC.

The following letter has been sent to us for publication by Mr. Charles W. Railton. A similar letter appeared recently in *The Times* :—

Sir,—In reply to Mr. Maurice Child, whose indignation I regret to have aroused, may I say that I have every wish to give all due consideration to the experimental transmitter, who no doubt has in the past done good and valuable work? All I contend for is that the listeners, who, after all, form the vast majority of the people concerned, should have some small share of the precious silent hours on Sunday, free from all interference, in which to carry out operations as interesting to themselves as transmission is to the experimenter, and I still think that the two hours from 6 to 8 p.m. are a very modest and reasonable share to ask for.

I think also that the experimental transmitter may well bear in mind the possibility that in the natural progress of things his day may soon to a large extent be over. Most of the really necessary experimental work is now being done, and well done, by the P.B.C. engineers, and, with the enormous and rapid growth in the number and requirements of the listening public, the experimental transmitter may eventually find himself, especially if he prove unreasonable or unduly aggressive, practically frozen out.

May I also assure your correspondent that my sufferings at the hands of his friends are in no wise due on my part to faulty or inferior apparatus? The instrument I use is a particularly complete and effective one, with great selectivity, and was specially made for me by a past-master in the art. I may also claim, I think, after nearly two years' experience, that there is no lack of skill on the part of the user, as witnessed by the success with which I receive foreign transmission, aided by the ability to cut out home stations which my set gives me. I venture to think that it would tax the ingenuity of any radio society, local or otherwise, to improve my set in any way. All, however, is of little avail when once the light-hearted transmitter really gets going. What is happening all the time to the despised possessor of what Mr. Child lightly dismisses as "cheap, unselective apparatus" I shudder to think! As to experimental transmitters using only wavelengths of under 200 metres, it may be so in the London district. I can only say that in this part of the world the chief offenders work mainly on 290 to 300 metres, some even going up into the neighbourhood of 500. Could their activities be confined to the low wavelength mentioned by your correspondent, no reasonable complaint could be made. May one hope that this way possibly lies the solution of the difficulty?

Yours truly,

CHARLES W. RAILTON.

Cherry Tree House, Alderley Edge, Cheshire.
March 12.

Sir,—I think the letter from Mr. G. N. Wright in your issue of March 24th is not only a slur on the amateur transmitting fraternity of Manchester but also a slur on us all. Firstly, the amateur transmitters of Manchester are by no means "messers," as he calls it; not only I, but others as well, consider them to be among the best transmitters using the ether. G.N.W.'s receiver *must* be very selective if he can hear what a transmitter has to say when the wavelength used by that transmitter is heterodyned by another. As regards joining the local radio society, he remarks: "I know some of these gentlemen belong to it." Perhaps G.N.W. knows all there is as

regards radio, and in that case, of course, the Radio Society cannot help him. Can he operate a valve transmitter himself? If so he will know the difference that a .001 condenser will make in either short- or long-wave transmission.

If Mr. Wright only complained to the Manchester Radio Society I think he would at least receive a courteous reply. Instead, he prefers to write a letter in our foremost radio journal so that "all the world" may know that he is not quite such a capable operator as he supposes he is.

If some of our grumblers would only try their hand at transmitting, then I don't think they would be grumblers any more. The amateur has a lot to put up with at present without having his times of transmission limited any more. Mr. Maurice Child defended the amateur in a most commendable manner—not only the "real experimental transmitter," but also the man with limited means who has to do his experimental work without the help of quite a number of high-priced instruments for which he could find use if his pocket would allow.

East Aberthaw,
Cardiff, South Wales.

C. PROSSER (6YS).

Sir,—One is forcibly struck by the narrowed outlook of some of your correspondents.

If everyone would realise that each one of us has to concede a little to the "other man," and look at the whole subject of radio a little more broadly, it would surely be realised that the transmitting amateur and broadcast listener alike are equally important from a point of view of national progress.

Until the one recognises the other, and *vice versa*, we shall not make the progress we could.

We must bury our personal prejudices (this is, apparently, what Mr. G. N. Wright, who writes in your issue of March 24th, has not done) in favour of a wider outlook.

We want a co-operation between *everyone who uses the ether*, from the advanced experimenter to the school lad with his "one valver."

CHAS. E. BATEMAN (G2 AOL).

A NEGLECTED ACCUMULATOR.

Sir,—Under the above heading in your "Readers' Problems" in your issue of March 17th, page 433, a fallacy was recorded in S.B.S.'s query and your reply regarding the action of coloured beads or gravity balls in an accumulator, to the effect that the gravity ball "gradually sinks to the bottom during the course of discharge," and again, "as the acid density decreases in the course of normal discharge, the bead slowly sinks."

No single bead or gravity ball can serve the dual purpose of indicating full charge and full discharge. It is a case of floating or sinking beyond the limits of 0.002 sp. gr.

The ball can be designed to indicate when to recharge by floating at or about, say, 1.150 sp. gr., and sinking at 1.48 sp. gr., or alternatively it can be arranged to float in acid above, say, 1.240 sp. gr. As, however, the specific gravity of sulphuric acid is affected to the extent of one point for every 2½° rise or fall in specific gravity, it is clear that the function of the bead is easily affected, although as a hydrometer its action is unimpaired. If S.B.S.'s cells warm up appreciably on charge, the resulting temperature may be sufficient to prevent the bead from floating. This does not imply any neglect.

ERNEST C. MCKINNON, M.I.E.E.
Chief Engineer, Chloride Electrical Storage Co., Ltd
Clifton Junction, nr. Manchester.



READERS PROBLEMS

"The Wireless World" Information Department Conducts a Free Service of Replies to Readers' Queries.

Questions should be concisely worded, and headed "Information Department." Each separate question must be accompanied by a stamped addressed envelope for postal reply.

An Unusual Problem.

I have been reading with great interest the article on page 217 of your Feb. 10th issue describing how a loud-speaker may be used at a considerable distance from the receiver with only a single wire extension, and I am wondering if it can be adapted to meet my needs. I intend to give a loud-speaker demonstration in a small hall situated a few feet from my house. It is almost impossible to install the receiver (a single-valve instrument) in the hall, owing to the difficulties of erecting an aerial. On the other hand, my loud-speaker possesses a built-in amplifier which is inseparable from it. The question is, therefore, can I use the receiver in my house and the amplifier in the adjoining hall?

R. F. W.

The solution to your difficulty is, fortunately, simple. It is obvious in the first place that it would not be permissible to connect the input terminals of your amplifier to the telephone terminals of your receiver by a long length of "flex" since the capacity thus placed across the primary of the first transformer would give

used in the instrument described in the issue to which you have made reference. This scheme, of course, is equally applicable whether the distant receiver is a multi-valve H.F. receiver or a simple crystal set.

o o o o

Comparing Receiver Range.

I should like your help in clearing up a little argument between myself and a friend. It is realised, of course, that a 0-v-2 three-valve regenerative receiver will, when tuned to the signals of a nearby station, give far louder signals than an efficient three-valve set consisting of 1-v-1. The question is, which set would give the loudest signals when tuned to a distant station? It is desired simply to know which receiver would give the loudest signals under the above mentioned conditions, quality being ignored. It is assumed that the same aerial and earth system would be used in each case.

H. J. B.

Under these circumstances, it cannot be doubted that the 0-v-2 receiver will still give the loudest signals. That is to say,

time, a detector valve with smoothly controlled reaction is a very sensitive arrangement, and if at any time a given station was not receivable by it owing to extreme distance and very bad atmospheric conditions, we doubt very much whether the 1-v-1 receiver would make a much better showing.

o o o o

"H.F." or "L.F."?

I have constructed a four-valve set consisting of one stage of H.F. using the tuned anode system, a regenerative detector and two stages of resistance coupled L.F. amplification. I am in difficulty concerning the type of valves to purchase, as I notice that most manufacturers class their valves under the two separate headings of "H.F." and "L.F." I intend purchasing an "H.F." valve for the H.F. stage, and two "L.F." valves for the two L.F. stages, but require your aid in the matter of choice of a detector valve.

S. R. M.

In general, it may be said that those valves marked "H.F." are of higher impedance and have a higher magnification factor than those marked "L.F.", although, of course, they will handle less power. Since you are using the tuned anode method of H.F. coupling, a high impedance valve is required for the H.F. stage, and, therefore, it is correct to choose a valve marked "H.F.", which usually indicates high impedance. It must not be supposed, however, that it is always correct to use "H.F." valves for H.F. amplifiers, for in the case of many modern neutrodyne receivers, for instance, it is necessary that low impedance "L.F.", or, better still, small power valves, be used in the H.F. stages. The marking of valves with the indications of "H.F." and "L.F." is, therefore, apt to be misleading, and is consequently to be deplored. When manufacturers first produced distinctive types of valves to replace general purpose valves, the only method of H.F. coupling in general use in this country was the tuned anode method, or the tuned plug-in transformer method, which is, of course, the tuned anode system in disguise. Nowadays, however, with more modern designs, the terms "H.F." and "L.F." have rather outlived their usefulness, and some such marking as "H.I." and "L.I.", indicative of impedance, would be more suitable. That this is so is even more glaringly instanced in your particular case,

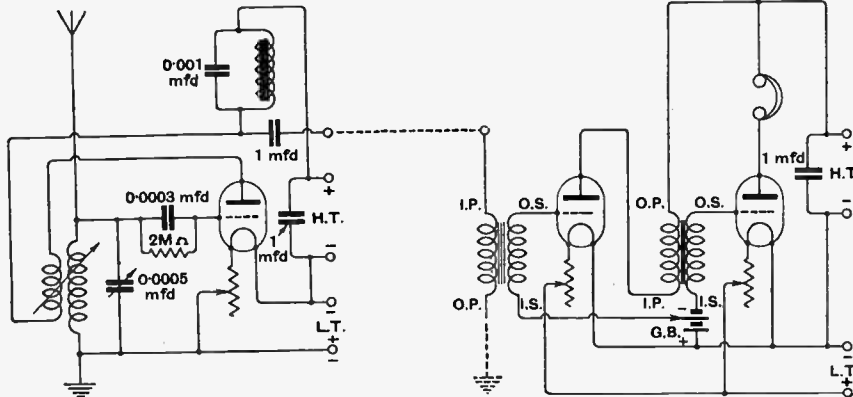

Fig. 1.—Operating an amplifier from a distant receiver.

an unintelligible muffling effect to speech, apart from seriously reducing volume. Your difficulty can fortunately be overcome by the method of using only a single wire connection between your receiver and amplifier in accordance with the scheme outlined on page 217 of our Feb. 10th issue. The full diagram of the necessary connections is given in Fig. 1. The choke in the plate circuit of the detector valve can consist of the same type of choke

that as long as this receiver is able to pick up any signals at all, it will give louder signals than the receiver employing only one L.F. stage. Of course, a very close setting of reaction might be called for, and, therefore, quality would not be good. The only case where the 1-v-1 receiver could score in giving louder signals is in the case of a very distant station, which was not receivable at all without an H.F. stage. At the same

for in the first L.F. stage it would not be correct to use an "L.F." valve, since you are using resistance coupling and require a valve with a high magnification factor rather than a valve capable of handling large power, and consequently it would be preferable to use an "H.F." rather than an "L.F." valve for this first stage of L.F., although if full efficiency be desired, it would be better to employ a valve with a really high magnification factor, such as the Cosmos S.P.18 Green Spot, the D.E.3B, or the D.E.5B., according to whether you are going to use a 2-, 4-, or 6-volt accumulator. The final valve should, of course, be an "L.F." valve, or preferably a small power valve. With regard to the detector valve, it can be stated definitely that it is usually preferable to use an H.F. valve in this position, more especially if it is to be followed by a stage of resistance, choke, or low-ratio transformer coupled amplification. If a transformer of high ratio is to be used immediately after the detector valve, however, it would be preferable, in the interests of good quality, to use an "L.F." valve for rectification.

○○○○

Increasing Selectivity in a Simple Manner.

I have frequently seen it advocated that in order to increase the selectivity of a good receiver and in order to reduce aerial damping it is desirable to use a loose-coupled aerial circuit. The so-called aperiodic aerial coupling consisting of a small number of turns connected in the aerial circuit coupled in close and fixed relationship to the grid coil is frequently advocated. I understand, however, that there is a simpler and equally effective manner of loosely coupling an aerial to a receiver, and I shall be glad if you can give me particulars of this.

G.P.K.

There is, as you suggest, an alternative method to the conventional "aperiodic" magnetic coupling, and this is known as capacitive coupling. The two systems are illustrated in Figs. 2a and 2b respectively. At first sight it might appear that Fig. 2b is nothing more or less than the old method of tuning the aerial circuit by means of a series condenser. This is not so, however, because in the series aerial tuning system we definitely make use of the condenser for tuning our aerial, and have no parallel condenser in circuit.

In the system illustrated in Fig. 2b, however, all the tuning should be done with the parallel condenser, and the series condenser should not be considered as part of the tuning arrangements, but should be considered purely and simply as a capacitive coupling between the aerial and the receiver, and this condenser should only be used at such a time as it is definitely desired to change the aerial coupling, and should never be used when it is merely desired to tune the receiver to a different wavelength, this being the function of the parallel condenser. Actually, on the normal B.B.C. wavelength, it is usually found that the best value at which to adjust this coupling condenser

BOOKS ON THE WIRELESS VALVE

Issued in conjunction with "The Wireless World."

"WIRELESS TELEPHONY," by R. D. BANGAY. Price 2/6 net. By Post, 2/9.

"THE OSCILLATION VALVE—THE ELEMENTARY PRINCIPLES OF ITS APPLICATION TO WIRELESS TELEGRAPHY," by R. D. BANGAY. Price 6/- net. By Post, 6/3.

"WIRELESS VALVE RECEIVERS AND CIRCUITS IN PRINCIPLE AND PRACTICE," by R. D. BANGAY and N. ASHBIDGE, B.Sc. Price 2/6 net. By Post, 2/10.

"THE THERMIONIC VALVE AND ITS DEVELOPMENT IN RADIO TELEGRAPHY AND TELEPHONY," by Dr. J. A. FLEMING. Price 15/- net. By Post, 15/9.

"CONTINUOUS WAVE WIRELESS TELEGRAPHY," Part 1, by W. H. ECCLES, D.Sc. Price 25/- net. By Post, 25/9.

Obtainable by post (remittance with order) from

LILFFE & SONS LIMITED
Dorset House, Tudor St., London, E.C.4
or of Booksellers and Bookstalls

is about 0.0001 mfd., although if extra selectivity is desired in order to cut out a nearby station the condenser can be set at a still lower value, but when the condenser is set at a lower value than 0.0001 mfd. selectivity will only be attained at some sacrifice of signal strength. The value of 0.0001 mfd. will give good selectivity without loss of signal strength. Of course on short wavelengths this value may be made very much lower, since the impedance of this condenser will be so much less on the lower wavelengths. On the contrary, when tuning in to Daventry, the impedance of the condenser when set

tivity conferred by the magnetically coupled circuit given in Fig. 2a, with the added advantage of flexibility. For instance, since the number of turns in the aerial circuit in Fig. 2a is fixed, there will be only a limited band of wavelengths over which it will be really efficient, whilst, owing to the capacitive coupling being variable, this disadvantage is eliminated. Furthermore, we can vary the degree of aerial coupling on a given wavelength in Fig. 2b, which we cannot do in Fig. 2a.

It should not be forgotten that in both Figs 2a and 2b, apart from the selectivity gained by the loose coupling, there is the secondary effect of reducing the aerial damping which, by the automatic stimulation of reaction, causes the tuning to be still further sharpened. By transferring the aerial to the top of the secondary coil in Fig. 2a or by short-circuiting the coupling condenser in Fig. 2b we can change back to direct coupling, and when we do this we must make a readjustment of our parallel tuning condenser. For instance, supposing that using direct coupling the reading of the parallel condenser in Figs. 2a and 2b was 40 deg. on the 2LO wavelength, when we change over to loose coupling we automatically remove the effect of the capacity of the aerial from the circuit, and shall probably have to readjust our variable condenser to, say, 70. Normally, if using plug-in coils, the value of the grid coil in both Figs. 2a and 2b when using a coupled aerial circuit will be a No. 50 or 60 coil on the 2LO wavelength, and a No. 250 on the Daventry wavelength, whilst, when direct coupling is used, the coil values will be a No. 25 or 35 on the 2LO wavelength and a No. 150 on the Daventry wavelength.

Another very important advantage pos

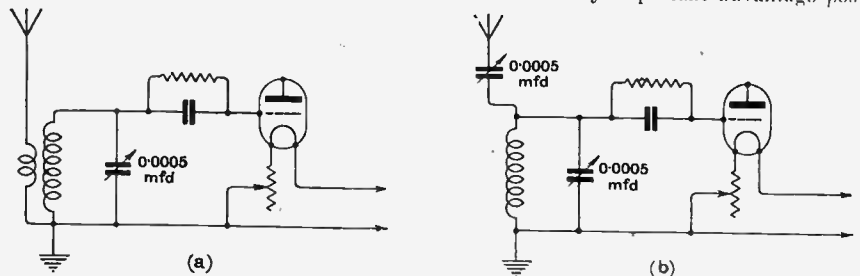

Fig. 2.—Alternative methods of aerial coupling.

at 0.0001 mfd. will be large, and loss of signal strength would result. The remedy of this wavelength is to increase the capacity of the condenser.

A further feature of this arrangement is that the calibration of the parallel tuning condenser over a given band of wavelengths is not appreciably changed when testing the receiver on different aerials. The use of a variable condenser in this position gives us all the advantages of the so-called constant aerial tuning system where a 0.0001 mfd fixed condenser is employed in this position, and at the same time gives us the added advantage that we can if desired attain still further selectivity by adjusting the value of this condenser.

This method of capacitatively coupling the aerial gives us all the benefits of selec-

ted by capacitive, as distinct from magnetic, loose coupling, is the immediate adaptability to existing direct-coupled circuits, the owners of which desire to improve their selectivity. In an existing receiver employing a coil and parallel condenser certain alterations would be needed, whilst if the receiver employed magnetic tuning it becomes almost impossible to adapt it to Fig. 2a without abandoning the use of the variometer. All that is necessary in the case of Fig. 2b, however, is that a 0.0005 mfd variable condenser be obtained and connected externally between the aerial lead-in and the aerial terminal of the set without the slightest alteration to the tuning of the set. Fig 2a is also easily adaptable to an existing crystal set for improving selectivity and signal strength.

A PERFECT VALVE

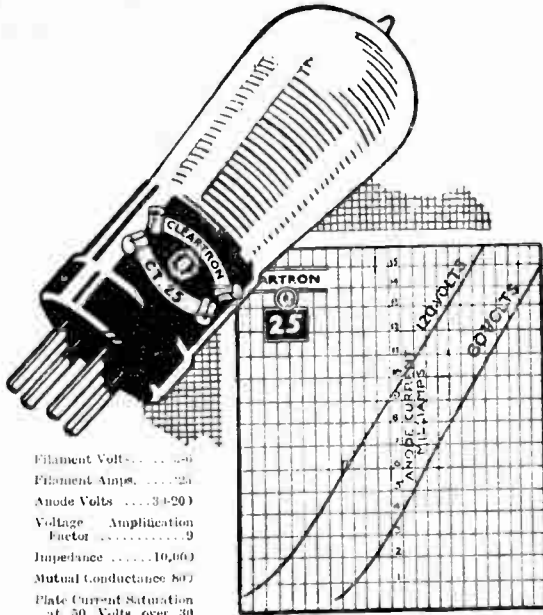

Filament Volts 250
 Filament Amps 25
 Anode Volts 200-250
 Voltage Amplification Factor 9
 Impedance 10,000
 Mutual Conductance 800
 Plate Current Saturation at 50 Volts over 30 milliamperes

YOU CANNOT obtain the supreme realisation of wireless—the generous volume, the pure and sonorous tone or longer distances—unless you use **CLEARTRON VALVES**

which are **REALLY** guaranteed, under Cleartron's

IRONCLAD GUARANTEE.

They are **ALL** Dull Emitters, with lowest current consumption, and sold at standard prices 12/6 & 15/- For 2, 3 and 5-6 v. Accumulators and Dry Cells, H.F. Detector and I.F.

America's foremost Valve—all British made.

CATALOGUE FROM YOUR DEALER, OR:

**CLEARTRON
 RADIOLIMITED**
 ONE CHARING CROSS, LONDON

Telephone : Regent 2231/2. Grams : Cleartron, Westrand, London.

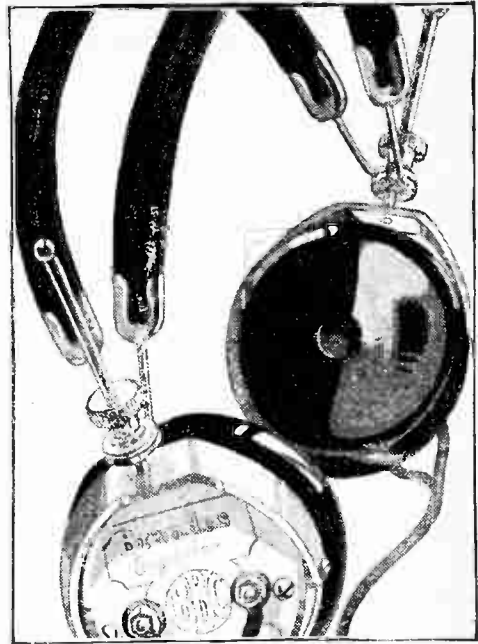

MATCHED TONE HEADPHONES

If you're fond of sitting up in the wee sma' hours to stretch a hand across the world, Matched Tone are extremely able confederates. With radio you span continents and with Matched Tone it becomes easier, "comfier" and much more efficacious. Distant signals stand out clearly; Matched Tone grope in the ether with unflinching accuracy. The specially matched receivers make them super-sensitive and tone perfect. You are logging a new call-sign every day with Matched Tone.

20/-

Table-Talker 30/- Brandola 90/- Audio Transformer 17/6

Brandes

Brandes Limited, 296, Regent Street, W.1.

From any good Dealer

Q/563.R.

SERVICE ADVERTISING

ANOTHER INTERESTING COMPETITION FOR "The Wireless World" READERS

£10 in Cash Prizes

First Prize £5
Second Prize £2

Third Prize £1
Four Consolation Prizes of 10/- each.

ALL YOU HAVE TO DO!

PLACE in the order of merit, according to your judgment, the nine most attractive and convincing advertisements in the current issue; classified as follows:—

1st, 2nd and 3rd most attractive whole pages.

1st, 2nd and 3rd most attractive half pages.

1st, 2nd and 3rd most attractive quarter pages, or smaller spaces.

The following considerations determine the real value of an advertisement:

- (1) **Its arresting character:** which depends upon its attractive arrangement, with or without illustration.
- (2) **Its obvious truthfulness:** truth in advertising is a sound business maxim, as well as an ethical necessity.
- (3) **The convincing quality of its descriptive matter:** an advertisement is of no value if it does not induce the reader to purchase the article advertised, when the need arises, on its merits as described.

VOTING COUPON

Whole Page Advertisements.		Half-Page Advertisements.		Quarter-Page or Smaller Adverts.	
Page No.	Name of Advertiser.	Page No.	Name of Advertiser.	Page No.	Name of Advertiser.
1st		1st		1st	
2nd		2nd		2nd	
3rd		3rd		3rd	

Name

(IN BLOCK LETTERS)

Address

WHEN you have filled in all the numbers on the coupon, write your name and address clearly in block letters in the space provided, and post the completed coupon to:

"The Wireless World,"

Dorset House, Tudor Street, London, E.C.4,

marked in bottom left-hand corner "Advertisement Competition."

ALL COUPONS MUST BE POSTED TO ARRIVE NOT LATER THAN APRIL 12th, 1926

RULES and CONDITIONS.

1. The decision of the Advertisement Manager of "The Wireless World" on any point connected with the competition must be accepted as final.
2. No responsibility can be accepted for any letters lost in the post or otherwise. Proof of posting cannot be taken as proof of delivery.
3. No member of the staff of "The Wireless World" or companion journals will be eligible to compete, nor to benefit in any way from the prizes offered.
4. Each prize-winner will be notified by post, and a list of the prize-winners will be published in "The Wireless World" as soon as convenient after the close of the Competition.
5. The Competition is to arrange the list of Advertisements in what is considered to be the order of merit. The correct order of merit will be obtained by counting the votes given by competitors.
6. The competitor whose list agrees, or most nearly agrees, with the popular order as indicated by the total votes will be awarded the First Prize, the next nearest the Second Prize, and so on.
7. Entry into this competition implies full acceptance of all the foregoing rules and conditions.

MELLOWTONE PRODUCTS

—ensure better reception!

Here are two fittings that will greatly add to the efficiency of your set and also save you money.

The MELLOWTONE COUPLER eliminates distortion, gives excellent selectivity and perfectly smooth reaction control. Plugs into standard valve holder, takes up small panel space and replaces coils and holders at half the cost.

The MELLOWTONE LOW LOSS VALVE HOLDER ensures perfect contact without soldering, and is absolutely vibrationless. Made from Turned Pure Grade A Post Office Quality Ebonite—its self-capacity is negligible and the di-electric losses virtually zero.

Obtainable from all reputable dealers. Write for Illustrated Lists of Receivers and Components.



Radio-Ads

MIDLAND RADIOTELEPHONE MFRS LTD.

BRETTELL LANE WORKS

LONDON DEPOT:
Triumph House,

STOURBRIDGE

189, Regent Street, W.1.

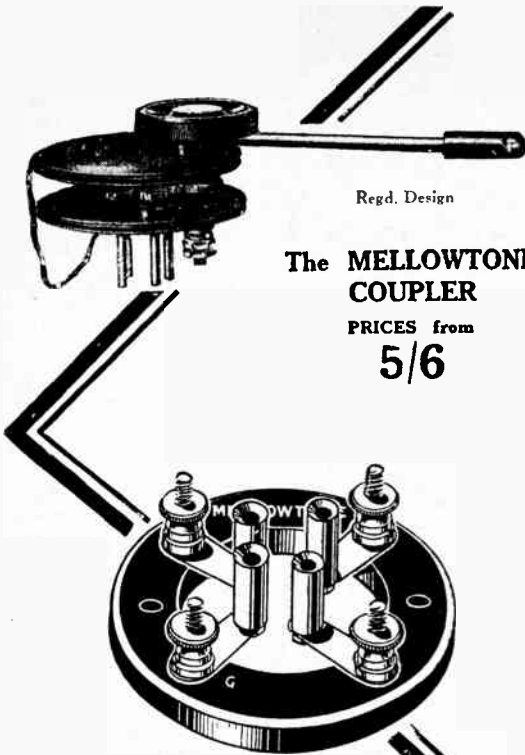

Regd. Design

The MELLOWTONE COUPLER

PRICES from
5/6

The MELLOWTONE LOW LOSS VALVE HOLDER

PRICE
3/3

LISENIN POSITIVE GRIP PLUGS & SOCKETS

Pat. No. 245586

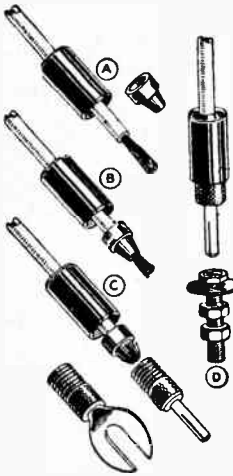

As supplied to the B.B.C.

THERE can be few experimentors who have not been troubled with broken leads, or said hard things about faulty connections. Of the whole set there is probably no part which is so often abused as the connections. "Lisenin" Positive Grip Plugs alleviate this evil. They are designed to take the smallest flex up to 5 m/m cable. Electron wire, phone and loud speaker leads.

"A" illustrates insulated sleeve, cable with ends bared and recessed cone.

"B." Cone section in position. Being concave, it allows smallest flex to fit up tight, precluding any possibility of bared wire breaking with continual use.

"C." Bared ends turned back; cone fits into concave recess in plug. Erinoid sleeve is then slipped down and plug screwed into it. A vice-like grip is made and an absolutely positive connection made without the use of solder or tiresome screws.

"D." Plug and socket complete with indication disc and nuts. Sleeves and indicators are made in red and black. Plugs and sockets N. Plated. SPADE END, POSITIVE GRIP terminals suitable for accumulator leads, etc., also supplied.

ELECTRICALLY MECHANICALLY **PERFECT**

Obtainable of your usual Dealer. Refuse substitutes. Write us if any difficulty in obtaining and state dealer's name and address.

Sole Manufacturers and Patentees:

THE LISENIN WIRELESS CO.,
1B, Edgware Road, London, W.2

Phone - - - PADDINGTON 2734
Grams - - - "POSCRIP PADD. LONDON"

Positive Grip Plug & Socket Complete **6d.**

Positive Grip Spade End Complete **6d.**

CAXTON 4-VALVE CABINET

Made for Sets, "As good as money can buy," "Harmony Four Receiver," "The Melody Three"

Special Cabinets made to Customer's measurements. Prices quoted.

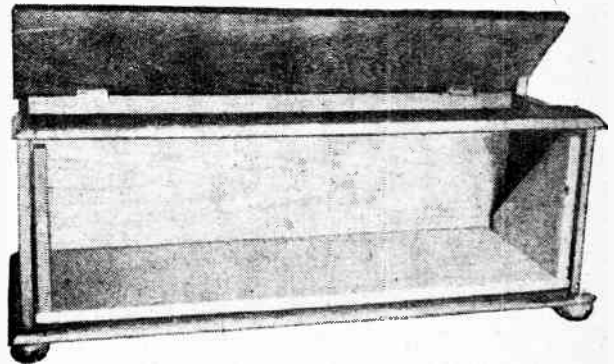

Cash with Order. Fumed Oak	...	£1 5 0
Dark or Jacobean Oak	...	£1 10 0
Real Mahogany	...	£1 14 0

Detachable 7" deep Base Board to mount 21" by 7" panel to slide out of Cabinet front. Also supplied at 10/- extra with two beaded front doors placed 2 ins. in front of the enclosed panel.

Ebonite or Radion Panels Supplied and perfectly Fitted at low extra cost. All Polished with the new enamel that gives a glass hard surface that cannot be soiled or scratched. SENT FREE.—Catalogue of standard Wireless Cabinets in various sizes and woods.

Packed and delivered free in U.K.

No. c3

CAXTON WOOD TURNERY CO., Market Harborough

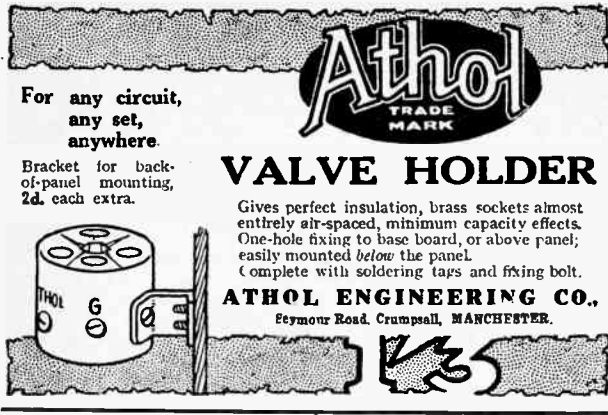

Athol
TRADE MARK

For any circuit, any set, anywhere.

Bracket for back-of-panel mounting, 2d. each extra.

VALVE HOLDER

Gives perfect insulation, brass sockets almost entirely air-spaced, minimum capacity effects. One-hole fixing to base board, or above panel; easily mounted below the panel. (Complete with soldering taps and fixing bolt.)

ATHOL ENGINEERING CO.,
Feymour Road, Crumpsall, MANCHESTER.

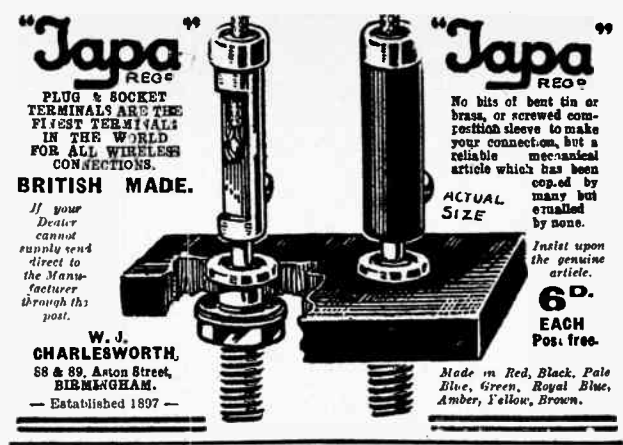

"Japa" REGD
PLUG & SOCKET TERMINALS ARE THE FIRST TERMinals IN THE WORLD FOR ALL WIRELESS CONNECTIONS.

BRITISH MADE.

If your Dealer cannot supply send direct to the Manufacturer through this post.

W. J. CHARLESWORTH,
58 & 59, Aston Street, BIRMINGHAM.
— Established 1897 —

No bits of bent tin or brass, or screwed position sleeve to make your connection, but a reliable mechanical article which has been copied by many but equalled by none.

ACTUAL SIZE

Inset upon the genuine article.

6D. EACH
Pos. free.

Made in Red, Black, Pale Blue, Green, Royal Blue, Amber, Yellow, Brown.



A STRANGER IN YOUR MIDST

ALTHOUGH there is little connection between our business and the wireless industry, we feel that the nature of our offer warrants our intrusion in "The Wireless World."

BY supplying direct we are able to pass to our customers the thirty per cent. discount usually given to the retail trade.

WE positively state that our four-guinea suits are equal in every respect to those usually sold at six guineas. We are not giving anything away, but simply supplying at wholesale prices, which is made possible by cutting out intermediate profits.

SUITS, OVERCOATS AND SPORTS WEAR

fitted by experienced tailors and unconditionally guaranteed as to material, cut and finish.

YOU are invited to call and examine our materials and workmanship.

Lounge Suits
from Three to Six Guineas.

The City Trade Tailors Assocn.
6, Love Lane, Wood St., Cheapside, London, E.C.2.
Phone: City 8612.



Quality
RADIO

VERNIER COIL HOLDER

Cam Operated

THIS COIL HOLDER is designed on the sound engineering theory that a cam action gives the smoothest possible action. Both coil sockets are movable. The right-hand one gives coarse tuning in the usual way, and the left-hand one, the usual fixed socket, is controlled by a cam operated by a separate knob. The latter gives a smooth and micrometric movement through 10 degrees in both directions.

Write for one of these holders and hear the difference.

Postage Ad. Price **5/6**
British— from start to finish

GOSWELL ENGINEERING CO., LTD.
97 WHITE LION STREET, LONDON, N.1
Telephone—North 3051.



FORMO

RADIO COMPONENTS OF ADVANCED DESIGN. NEW CATALOGUE NOW READY.

Straight Line Frequency. Ultra Low Loss Condenser. Micro-Vernier Dial. High Efficiency. Low Loss Variac-Coupler, etc.

The FORMO Company,
Crown Works, Cricklewood, N.W.2

10/6 Manchester: Mr. J. B. Levee, 23 Hartley St., Levenshulme.



COMBINATION CABINETS FOR THE HOME CONSTRUCTOR

Oak Cabinet 3' 6" high by 1' 9" wide by 1' 6" deep, with double doors. Correctly designed built-in wooden loud-speaker horn with attachment to take AMPLION or other loud-speaker unit. Pleated silk cover to loud-speaker aperture; accommodation for batteries, etc.

PRICE 5 gns.

Carriage paid, as illustrated, cash with order.

W. SANDERS, 35, Lyndon Road, Olton, Warwickshire.
Write for illustrated list.

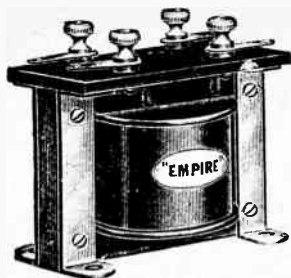

A thoroughly reliable British Transformer for 7/6

This transformer is a British Product that competes with foreign products in price and is far and away superior in quality. It is robust in construction, neat in form, and gives splendid amplification without parasitical noises or distortion. Ask your dealer or write for full particulars.

SPECIFICATION.—Insulation tested with 500 volts. Closed core formed of pure Stalloy stampings braced and held firmly together by nickel-plated angle piece. Can be used as efficient Choke. Standard ratio 4 : 1.

12 months guarantee

EMPIRE TRANSFORMER
THE H.T.C. ELECTRICAL CO. LTD.,
3, BOUNDARIES ROAD, BALHAM, S.W.12.
Phone: Battersea 374.

Your Loudspeaker

WILL SING

THE PRAISES OF

NELSON MULTI 3-FILAMENT VALVES



Here is a Valve giving you Finest Quality and Volume with Economy. It is of equally high grade as H.F. Detector, L.F., or Power Amplifier.

The little switch places at your command each of 3 Filaments separately, or any 2 in parallel for Power Amplification. Each Filament gives the Valve a New Life.

ALL VALVES are Guaranteed.

FOUR IMPROVED TYPES.

- | | | |
|---------|---|------|
| A. | 4 to 5 VOLTS, 0.45 AMPS. per Filament | 9/6 |
| D.E.A. | 2.6 VOLTS, 0.18 AMPS. per Filament | 15/- |
| D.E.2. | 1.8 to 2 VOLTS, 0.35 AMPS. per Filament | 15/- |
| D.E.05. | 3 VOLTS 0.06 AMPS. per Filament | 16/6 |

Obtainable at
All London's
Largest Stores

If unable to obtain from your dealer write direct :—
NELSON ELECTRIC COMPANY LIMITED,
Merton Park, London, S.W.19.

Telegrams: Valvenelco, Wemble, London.

Phone: Wimbledon 172.

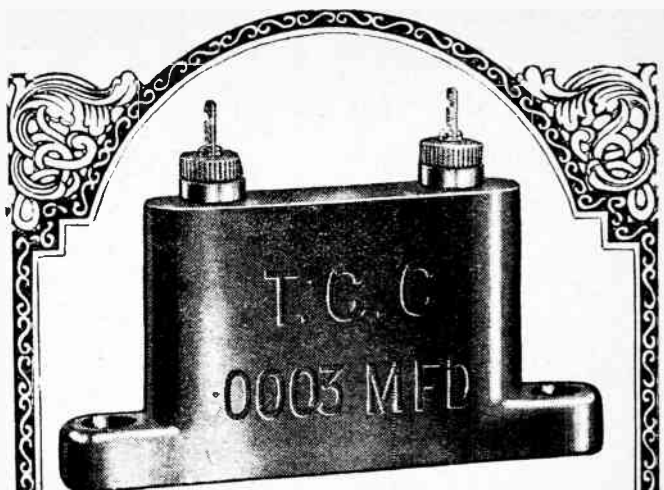

The new T.C.C. Mica Condenser

Here is the latest T.C.C. production—an accurate mica Condenser in a green moulded case with duplex terminals. Owing to its convenient shape it takes up very little room on the panel, and because it is sealed from below instead of from above it is proof against the heat of the soldering iron. For those who do not wish to solder their connections, a convenient milled head is provided to ensure a perfect electrical contact.

*No need to ask if it is accurate
—the name T.C.C. guarantees it.*

Every T.C.C. Condenser—whether Mica or Mansbridge—has to pass so many tests before it is released for issue that its accuracy within a very small percentage of error is a foregone conclusion.

Your fixed Condenser—on which so much depends—is one of the least expensive of all the components you buy. The difference in cost between one of doubtful reputation and a genuine T.C.C. may only be a copper

or two, yet the difference in results may be phenomenal. Experts say that the majority of faults in home built receivers are traceable to the use of inferior and badly insulated condensers.

If your own set is not giving the results you should expect, suspect the condensers—substitute T.C.C. Mica (for small values) and T.C.C. Mansbridge (for large values) and you obtain a permanent insurance against Condenser breakdown.

Prices:

- | | |
|---|-----|
| No. 33, all capacities between '004 and '001 mfd. | 2/4 |
| No. 34, all capacities between '0009 and '0001 mfd. | 2/4 |

From all Wireless Shops

T.C.C. Mica Condenser

Advertisement of Telegraph Condenser Co., Ltd., New, Surrey.

Illustration No. 4905.

MISCELLANEOUS ADVERTISEMENTS.

NOTICES.

THE CHARGE FOR ADVERTISEMENTS in these columns is:

12 words or less, 1/- and 1d. for every additional word, e.g., 18 words 1/6; 24 words, 2/- Name and address must be counted.

SERIES DISCOUNTS are allowed to Trade Advertisers as follows on orders for consecutive insertions, provided a contract is placed in advance, and in the absence of fresh instructions the entire "copy" is repeated from the previous issue: 13 consecutive insertions, 5%; 26 consecutive, 10%; 52 consecutive, 15%.

ADVERTISEMENTS for these columns are accepted up to **FIRST POST** on **THURSDAY MORNING** (previous to date of issue) at the Head Offices of "The Wireless World," Dorset House, Tudor Street, London, E.C.4, or on **WEDNESDAY MORNING** at the Branch Offices, 19, Hertford Street, Coventry; Guildhall Buildings, Navigation Street, Birmingham; 199, Deansgate, Manchester.

Advertisements that arrive too late for a particular issue will automatically be inserted in the following issue unless accompanied by instructions to the contrary. All advertisements in this section must be strictly prepaid.

Postal Orders and Cheques sent in payment for advertisements should be made payable to **ILIFFE & SONS Ltd.**, and crossed **& Co. Treasury Notes**, being untraceable if lost in transit, should not be sent as remittances.

All letters relating to advertisements should quote the number which is printed at the end of each advertisement, and the date of the issue in which it appeared.

The proprietors are not responsible for clerical or printers' errors, although every care is taken to avoid mistakes.

NUMBERED ADDRESSES.

For the convenience of advertisers, letters may be addressed to numbers at "The Wireless World" Office. When this is desired, the sum of 6d. to defray the cost of registration and to cover postage on replies must be added to the advertisement charge, which must include the words Box 000, c/o "The Wireless World." Only the number will appear in the advertisement. All replies should be addressed No. 00, c/o "The Wireless World," Dorset House, Tudor Street, London, E.C.4. Readers who reply to Box No. advertisements are warned against sending remittance through the post except in registered envelopes; in all such cases the use of the Deposit System is recommended, and the envelope should be clearly marked "Deposit Department."

DEPOSIT SYSTEM.

Readers who hesitate to send money to unknown persons may deal in perfect safety by availing themselves of our Deposit System. If the money be deposited with "The Wireless World," both parties are advised of its receipt.

The time allowed for decision is three days, during which time, if the buyer decides not to retain the goods, they must be returned to the sender. If a sale is effected we remit the amount to the seller, but, if not, we return the amount to the depositor. Carriage is paid by the buyer, but in the event of no sale, and subject to there being no different arrangement between buyer and seller, each pays carriage one way. The seller takes the risk of loss or damage in transit, for which we take no responsibility. For all transactions up to £10, a deposit fee of 1/- is charged; on transactions over £10 and under £50, the fee is 2/6; over £50, 5/-. All deposit matters are dealt with at Dorset House, Tudor Street, London, E.C.4, and cheques and money orders should be made payable to Iliffe & Sons Limited.

THE SALE OF HOME-CONSTRUCTED UNLICENSED APPARATUS.

A New Service to our Readers.

We have made an arrangement with the Patentees whereby readers who wish to dispose of a home-constructed receiver not licensed under the patents made use of, can do so by means of the Deposit System referred to above.

The person desiring to sell, in sending us particulars for his advertisement, will in every case make use of a Box No., and should add to the price which he requires the amount of royalty customarily paid by manufacturers, viz. in the case of Marconi Patents the amount should be calculated at 12/6 per valve holder.

If the purchaser is satisfied with his purchase, the sum realised will be forwarded to the seller, less the amount due in respect of royalties, which amount will be paid by "The Wireless World" to the owners of the patents concerned and a certificate will be handed on to the purchaser of the set.

FOR SALE.

FOR Sale.—4-valve Wireless Set, polished mahogany cabinet, "straight" circuit; £10.—Collier, 86A, Herbert Road, Plumstead, S.E.18. (1897)

3- and 4-valve Sets, specially selective, best components, handsome cabinets, very cheap.—Box 7325, WIRELESS WORLD Office. (1902)

For Sale.—Contd.

HIGH-TENSION Accumulators.—The Ideal Loud-speaker Battery, 60 volts, 35s.; 80 volts, 45s.; 100 volts, 55s.; guaranteed. Good trade terms.—Pearson, 110, Marston Lane, Bedworth, Nuneaton. (1882)

OSCILLATING Zincite and Contact, 2s. 6d.; simple, original circuit, 1s.; excellent results; other parts stocked.—Ledsham's, 207, King Street, Hammersmith. (1888)

TELEPHONES.—Brown's type A, 120 ohms, 2 Lissen T1 L.F. transformers, all perfect, offers.—14, Brook Avenue, Wembley. (1894)

WOOD Horns for all speakers and gramophone attachments. There's one for Amplion Junior, ditto goose-neck bases, Lissenola, etc. There's only one best; it's the "Allwoodorn."—Manufacturer: H. Maddison, 2A, Ronald's Road, Highbury, N.5. List free. (1914)

SUPERSONIC.—Set of McMichael's Tuned Transformers, 3 intermediate, 1 filter, and 1 oscillating unit, cost £5 5s., perfect condition, accept £2 10s., bona fide sacrifice.—Box 7429, WIRELESS WORLD Office. (1928)

2-VALVE Loud-speaker Receiver with automatic switching built with best components, price, including royalties, £6 5s.; 3-valve set, £7 17s. 6d.; Leclanché high-tension batteries, require no charging; headphones, 12s. 6d. pair. All parts stocked. List on application. Trade supplied.—G. Small, 161, Greenway Road, Taunton, Somerset. (1924)

VALVES, new, 3s. 6d., guaranteed good; tapped 60-volt batteries, 7s. 6d. All post free. Send for price list.—Withers, Riverside, Ringwood, Hants. (1919)

NUMBERING Machine, 1-99990, good order, cost 50s., take 20s.—Box 7501, WIRELESS WORLD Office. (1953)

HART COLLINS 8-valve Orthosonic Receiver, with frame aerial, used one week only, Bournemouth on loud-speaker, within 1 mile of L.O., cost £60, will accept £40.—Apply by letter, when test can be arranged, C. H. K., 25, Sussex Gardens, Hyde Park, W. (1951)

WHAT Offers?—Igranie 5 to 1 L.F. Transformer, Igranie Potentiometer, Polar Junior coil-holder, Dubilier 100,000 resistance, Burndept and R.I. crystal detectors, tapped anode resistance.—"Borrowdale," Warren Road, Blundellsands. (1950)

TWO-VALVE Set and 2-valve Amplifier, "straight" circuit, mahogany cabinets, with coils and DE valves; £10.—6, Abbots Road, King's Heath, Birmingham. (1940)

£5 5s.—Sterling Loud-speaker, as new, 50s.; Lissenola speaker, cardboard horn, 12s. 6d.—Percy Revell, 152, Elgin Avenue, Maida Vale. (1948)

FOR Sale.—A "Magnavox" Junior Loud-speaker, in good condition; offers!—Apply Wardell, "Brackenhill," Bromley Park, Kent. (1946)

MOTOR Generator, 12v. to 600v., and ammeter, etc., ideal for short waves, bargain; £3.—Box 7498, WIRELESS WORLD Office. (1943)

SLOPING Cabinet, made by Wright & Palmer, to take panel 24x10, French polished mahogany, as new; £1.—Apply: Heath, Stretchworth, Cambridgeshire. (1940)

For Sale.—Contd.

FIVE-VALVE "Transatlantic" Receiver, best components, perfect condition, including valves (power), 6 pairs matched H.F. transformers, 11 coils, large "Amplion" loud-speaker, bargain; £17 10s.—H. C., 137, Hornsey Lane, N.6. (1947)

MARCONI Hand Generator, 600v., 30ma., perfect condition; 70s.—5T.V., 27, Copthall Gardens, Twickenham. (1941)

CARVED Mahogany Pedestal Cabinet (claw and ball legs), dome lid, door in front, 36in. x 22in. x 38in. high, polished plum colour, £12 10s., plus carriage.—Bowler, Stelma, Carrington Road, High Wycombe. (1944)

FOR Sale.—New Marconiphone Power Transformer, specially designed for filament lighting from A.C. mains, input 240 volts 50 cycles, output 6 volts 5 amps; price 30s.—Box 7478, WIRELESS WORLD Office. (1939)

LARGE Burndept Ethervox Loud-speaker, 120 ohms, new condition; £4 or nearest offer.—Lane, 5, Peirith Road, New Malden. (1937)

TWO-VALVE Receiver, Set only, very selective, most reasonable offer accepted.—Rosby, 7, Regent Circus, Swindon, Wilts. (1936)

STERLING Dinkie Loud-speaker, 2,000 ohms, scarcely used; 20s.—Thomas, 10, Pakenham Road, Edgbaston, Birmingham. (1935)

EXPERIMENTER Selling Components Half-cost.—Transformers, R.I., 12s. 6d.; C.A. Co., 12s. 6d.; 2 T.M.C., 7s. 6d. each; condensers, Dual, .00025, 7s. 6d.; 2 .0005 Fallon 3s. 6d. each; coil-holders, "Quality," 4s.; panel mounting, 2s. 6d.; T.C.B. Potentiometer and filament resistance, 3s. each; Burndept detector, 2s. 6d.; 2 moulded knob dials, 2s. 6d. pair; lot £3; excellent condition.—Box 7458, WIRELESS WORLD Office. (1934)

P.R.F. Power Valves, filament 4 volt 0.3 amp., anode 60-200 volt, saturation current 25 m.a., amplification factor 0.5, impedance 7,000 ohms. Will handle up to 20 volts grid amplitude. Individual curves with each valve. Performance guaranteed or money refunded. Price 15s., post free.—H. E. Poole, Ltd., 79A, Queen Victoria Street, London, E.C.4. (1954)

MARCONI Power Valves, L.S.3, fil. 4v., plate 150v.; 16s. each.—Lyon, 72, Leo Street, Old Kent Road, S.E.15. 'Phone: New Cross 1702. (1932)

IDEALPHONE, 4,000 ohms., horn head bands or nickel, 7s. 6d., postage 6d.; crystal sets, nickel, oak finish, complete with phone, 14s. 6d. All goods on approval.—Nathan & Boas, 151, Kingsland Road, E.2. (1955)

FOUR-VALVE Wireless Set for Sale, complete with phones, valves, etc.—Write for particulars: Lane, High Street, Crediton. (1933)

FOUR-VALVE Set, loose, coupled circuit, cut London, gets other stations, guaranteed; £7; any evening after 8 or Sunday morning.—Louis, 90, Acre Lane, Brixton. (1930)

HOME Constructors.—Send for list of accessories, post free, from Radio Supplies, 51, Eden Street, Kingston-on-Thames, Surrey. (1929)

For Sale.—Contd.

POWERFUL 3-valves, exceptional loud-speaker range, coils, valves (power), good accumulators, 100 volt, H.T., and Amplion, also 100 wireless periodicals; £8.—Bramley, 31, Melrose Street, Hull. (1942)

TORDA Low-loss Neutroformers, designed for "Wireless World" Neutrodyne, plug-in types, for either Daventry or B.B.C. wavelengths, 15s. each, with base.—Stamp for illustrated details: Cotton & Clarke, Ltd., 55, 50, Lacy Road, Putney, S.W.15. (1001)

FINANCIAL PARTNERSHIP.

PARTNERSHIP wanted in Established Business by Wireless Operator (26); prepared invest £400.—Box 7500, WIRELESS WORLD Office. (1952)

MISCELLANEOUS.

DISTRIBUTORS wanted in all the important industrial centres for first-class line of matched Neutrodyne coils and other American components.—American Radio Co., 20, Grosvenor Gardens, London, S.W.1. (0014)

A WIRELESS Doctor.—If your set is giving trouble or you want advice a competent expert will call (anywhere in Greater London) and put you right. No result, no charge.—Alexander Black, 23, Woodville Grove, N.10. Clissold 3687. (1959)

PATENT AGENTS.

W. BRYSON, B.Sc., Chartered Patent Agent, 29, Southampton Buildings, W.C.2. Phone: Holborn 672. (1297)

PATENTS and Trade Marks Obtained.—H. T. P. Gee, Patent Agent, Member R.S.G.B., A.M.I.R.E., 51-52, Chancery Lane, London, W.C.2. Phone: Holborn 1525. (0001)

KING'S PATENT AGENCY, LTD. (B. T. King, Registered Patent Agent, G.B., U.S., and Can.). Free "Advice Handbook" and Consultations. 40 years' references.—140x, Queen Victoria Street, London, E.C.4. (0002)

REPAIRS.

TRANSFORMERS rewound to guaranteed efficiency for 12 months, 4s., or exchanged for another, any ratio, 5s.; iron core wire-wound chokes for L.F. amplifiers, 6s.—115, Links Road, Tooting. (0011)

WANTED.

COPIES of No. 307, Vol. XVII, No. 1, "Wireless World."—G. Brame, Diss, Norfolk. (1867)

SITUATION VACANT.

CIVIL Service Commission.—Forthcoming Examination: Male Assistant Superintendent of Traffic (Class II) in the London Telephone Service and Male Assistant Traffic Superintendent in the Provinces, General Post Office (18-23); regulations and particulars are obtainable from The Secretary, Civil Service Commission, Burlington Gardens, London, W.1, together with the form on which application must be made. The latest date for the receipt of application forms is June 2. (1938)

BOOKS.

FOR Sale.—Back Numbers of all Wireless Publications.—H. F. Davies, 5, High Holborn, W.C. (1945)

H.T. Accumulators 37/6

60 Volts. 3 Actual Amp.-hour



The finest H.T. Accumulator in the world.

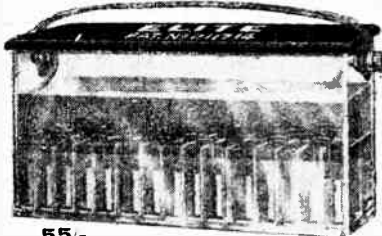

55/-

60-volt, 3-amp.-hour, oil submerged. Will last a lifetime. Write for descriptive Folder.

MONEY RETURNED IF NOT SATISFIED. Obtainable only from **ACCUMULATORS ELITE, 31, Waterhouse St., Halli. & Co.** Trade Suppl. Telephone: 1304.

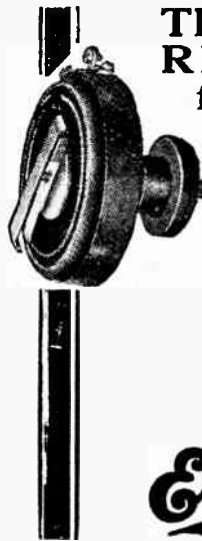

The ideal Rheostat for any valve.

Only the special spring arm, the perfected bearing and winding of the Ericsson Dual Rheostat permits such velvety smoothness.

By means of small auxiliary knob the resistance of 6 ohms can be altered to one of 60 ohms. Price complete with pointer, knob, scale and screws, 8/6.

Write for lists to-day. **THE BRITISH L.M. ERICSSON MFG. Co., Ltd.**, 67-73, Kings St. London, W.C.2.

Ericsson DUAL RHEOSTATS.

Electradix Radios

5-VALVE R.A.F., 19 RECEIVERS, 2 H.F., 1 Det., 2 L.F. in portable case. Condenser and Valves, H.T. and L.T. Batteries and Headphones. Cost £25. Sale price £6. With D.E. Valves £6 10s.

SUPERSONIC HETERODYNE Sets. The cheapest solution is the R.A.F. 7-valve 600/5,000 metre H.F. Transformers and 3 L.F., with plug switching. Beautiful mahogany cabinet. Gets Daventry with no aerial. Your existing 2-valve set can couple to this and make a £35 Het. These R.A.F. Sets cost £40, and are a snip. As described in "Modern Wireless." Instruction leaflet with each, £5 10s. Packing and carriage, 4/6.

HIGH-FREQUENCY AMPLIFIERS, 1,600/5,000 metres, 3-valve. Complete with Rheostat and Potentiometer. Price 30/- Marconi 7-valve, £7 10s.

New Enlarged Illustrated Catalogue sent Post Free for 4d. in stamps.

Goods promptly despatched all over the world. **LESLIE DIXON & CO.** Phone: City 191 218, Upper Thames Street, London, E.C.4

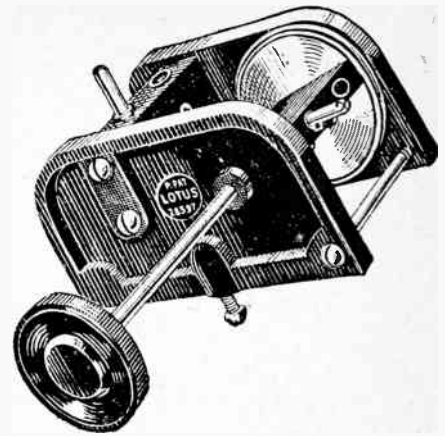

Tuning remains accurate because the Moving Block cannot fall back.

Do away with that irritating, time wasting, fading away of volume caused by the falling of your Moving Block

Fit a Lotus Geared Vernier Coil Holder and get really accurate tuning. The Lotus Moving Block cannot possibly fall back. Has an easy Vernier movement which reduces the speed by eight times, and stays where it's put—exactly! Fit in any position, with any weight of coil—you'll be satisfied with the results.

Bakelite mouldings for the side plates, coil blocks and knobs; heavy Nickel Plating for the metal parts.

LOTUS VERNIER COIL HOLDERS

From all reliable Radio Dealers. **GARNETT, WHITELEY & CO., LTD.**, Lotus Works, Broadgreen Road, Liverpool.

Makers of the famous Lotus Buoyancy Valve Holder

For outside panel mounting:
Two-way .. 7/-
Three-way .. 10/6
In-line .. 10/-
Inward mounting, with G.I. handle:
Two-way .. 8/-
Three-way .. 12/6

INDEX TO ADVERTISEMENTS.

	PAGE		PAGE		PAGE
Accumulators Elite	15	Forno Company	12	Midland Radiotelephono Manfs., Ltd.	11
Athol Engineering Co.	13	Fuller's United Electric Works, Ltd.	Cover ii.	Miller, J. W.	16
Belling & Lee, Ltd.	Cover ii.	Garnett, Whiteley & Co., Ltd.	15	Nelson Electric Co., Ltd.	13
Brandes, Ltd.	9	General Electric Co., Ltd.	8	Partridge & Wilson	16
British L.M. Ericsson Mfg. Co., Ltd.	15	General Radio Co., Ltd.	16	Pickett Bros.	16
Caxton Wood Turnery Co.	11	Gooswell Engineering Co., Ltd.	12	Pugh's Wireless	16
Charlesworth, W. J.	12	Graham, Alfred & Co.	Cover ii.	Radio Devices, Ltd.	Cover iii.
City Trade Tailors' Assoc.	12	Hough, J. E., Ltd.	11	Radions, Ltd.	16
Cleartron Radio, Ltd.	9	H.T.C. Electrical Co., Ltd.	13	Sanders, W.	12
Dixon, Leslie & Co.	15	Igranie Electric Co., Ltd.	11	Telegraph Condenser Co., Ltd.	13
Dubilier Condenser Co. (1925), Ltd.	3	Lisenin Wireless Co.	11	Telephone Manf. Co., Ltd.	2
Edison Swan Electric Co., Ltd.	Cover iv.	London Elec. Wire Co. & Smiths, Ltd.	6	Vandervell, C. A. & Co., Ltd.	5
Ferranti, Ltd.	7	Marconiphone Co., Ltd.	1	Watmel Wireless Co., Ltd.	The
Fitzpatrick, H. D., & Co.	16	Metro-Viek Supplies, Ltd.	2 & 4	Withers, J. S., & Spooner	16

Amateurs! Let us make your Cabinets

In Beautiful Polished Mahogany or Oak—
& SEW ON APPROVAL. De Luxe Models
—Parlour Models, etc. from 25/- to 25.
Crystal Cabinets from 1/6. Any size MADE
TO ORDER. Designs and Lists Free.
Estimates per Return Post. Panels and
Accessories Post Free.

Send to actual Makers: Pickett Brothers, Members
B.B.C. (W.W.) Cabinet Works, Bexley-heath.

It will repay!

TROLITE PANELS

Mahogany Grain 3/8 lb.
Black Engraved wavy 3/9 lb.
Black plain polished 3/- lb.
Machine cut Torted to
measurements. 50,000 Volts.
Free Samples on Request.

**PUGH'S WIRELESS, 95-101, 1 & 4
Holloway Road, London, N.7 ONLY.**

PATENTS, DESIGNS AND TRADE MARKS.

J. S. Withers & Spooner.

REGISTERED PATENT AGENTS.

STABLE HOUSE, 51 & 52, CHANCERY LANE, LONDON, W.C.

'Grams':—'IMPROVABLY, HOLB., LONDON.'

'Phone:—480 HOLBORN

21 INCHES!

That's the height of the "Hearth-side" Speaker. Don't mistake it for a "baby" because the price is low!

It gives full-size results with crystal-clear tone.

Send post card for new catalogue.

General Radio Co., Ltd., 235, Regent St., W.1.

General Radio

ALL GOOD DEALERS DEMONSTRATE—SEE IT TODAY

35/-

The "GRIPPLESHELL"

Registered design No. 716927.

A device for simplifying Aerial Erection
These brackets are made from 1" best quality
Wrought Iron painted with weather-proof enamel.

PRICES

Combined corner bracket, insulator & pulley	3/6
6" Hold-off bracket	3/-
9" "	3/-
12" "	3/6

FREE ON RAIL.

Manufactured by
PARTRIDGE & WILSON, ELECTRICAL ENGINEERS.
217a, Loughborough Road, LEICESTER.
Telephone 5812.

PATENTS, DESIGNS & TRADE MARKS.

H. D. FITZPATRICK & CO.
Chartered Patent Agents,
49, Chancery Lane, London, W.C.2
Phone: Holborn 459.

VALVES Repaired Quick

Let our valve making plant repair your broken or burnt out valves efficiently & promptly (most makes). Guaranteed equal to new. Bright emitters 5-: "DEs" 2 and 3v type; 7/6. Power valv a slight' mo., see list. No r pair-able: S. P. W. CO. v. 24.

RADION
Reliable Repairs

RADIONS Ltd., Bollington, Nr. MACCLESFIELD, Ches.
Largest valve-repairing firm in the world. List Free.

EARTH FAULTS ENDED

Entirely new method of Earth-system efficiency. 20% to 200% increase guaranteed. Vastly superior to all metal sulphates. Ideal for all outdoor Earths. 2/6 complete, post 6d. Cash on delivery if desired. Particulars free.

J. W. Miller, 68, Farringdon Street, E.C.4.
Phone: Cent. 1950.
Approved by Radio Association.

THE WIRELESS LEAGUE

MEMBERSHIP AND RENEWAL FORM.

To be filled in by readers who wish to become members of the League, or to renew their membership for a further twelve months as from 1st April.

To the Secretary, The Wireless League, Chandos House, Palmer Street, Victoria Street, S.W.1.

Please enrol me as a member / renew my membership of The Wireless League. I enclose P.O. for Two Shillings,† which entitles me to membership with all the privileges and rights as enumerated in the constitution of the League, including FREE Insurance, Free Legal Advice and Free Technical Advice.

* Cross out line not required.

† Keep the Counterfoil of your Postal Order.

WRITE IN CAPITAL LETTERS. Name (in full).....
(State whether Mr., Mrs. or Miss)
Address.....

My Membership No. is.....

(This is only applicable in the case of renewals)

Commencing with the first issue in May. "The Wireless World" will devote four pages in the first issue of each month to League Notes and News

Please enclose stamped addressed envelope.

SPARTA

Fuller
ALL BRITISH

LONG RANGE CONCERT RECEIVER

a 4 valve "all-stations receiver" for

This set provides a reliable "all stations" circuit at a really reasonable price. It is highly selective; distant stations can be tuned in without "local interference." The set is supplied in handsome polished oak case complete with grid bias battery FULLER'S UNITED ELECTRIC WORKS, LTD., CHADWELL HEATH ESSEX. Telegrams: "Fuller, Chadwell Heath." Telephone: Ilford 1200.

£16.16.0
ROYALTY
50/- EXTRA

Opal inspection windows for valves.

HF Amplifier Control.

Aerial Tuning Condenser Control.

Selector Tuning Switch.

Detector Control.

LF Control.

Anode Tuning Control.

Anode Reaction Control.

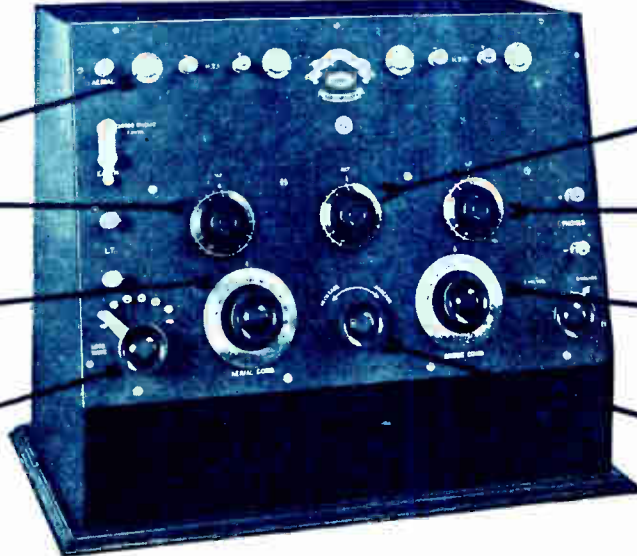

174/107.

VERNIER ATTACHMENT GIVING ADDITIONAL SLOW MOTION.

DIAL 0 TO 340. MOVEMENT OF CONDENSER 2 TO 1

SUPPORTING SHOULDER PIECE NO END PLATES USED.

MOVABLE STOP, NO BACK LASH.

EXTRA HARD FRICTION DISC.

FRICTION WHEEL

NOTE POSITION OF VANES TO PANEL

EXTRA SUPPORT.

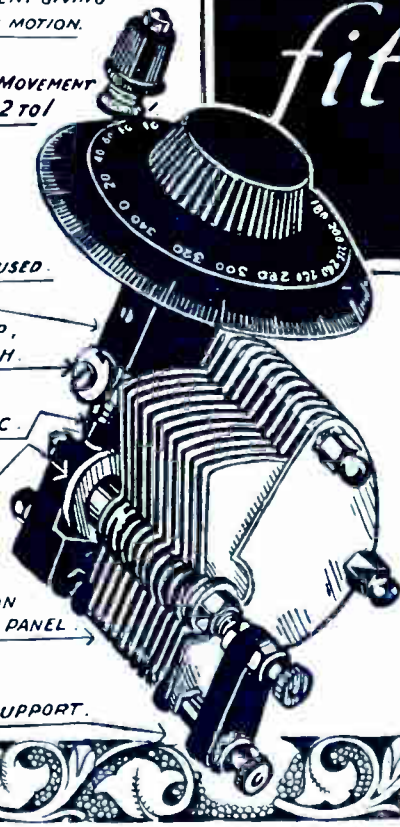

fit "DEVICON" CONDENSERS to your Set

The shortcomings of Condensers as a whole have been met in this the latest type.

The new "DEVICON" TRUE SCALE FRICTION CONDENSER

(Patent App'n. No. 1990/26)

has a 2 to 1 movement with additional slow motion device attached. One drilling hole in panel is all that is necessary. See the diagram at the side and note the improvements.

Supplied in the following sizes

'001 - 15/6	'0003 - 14/-
'0005 - 14/6	'0002 - 13/6

Ask your Dealer about it.

Manufactured and fully guaranteed by

THE RADIO DEVICES CO.,
Newdigate Street Telephone: 6798. Nottingham. Telegrams: "Devicon."

The Premier Pair—



Every night and on every kind of set they are giving wonderful service. Enthusiasts who have probed all the resources of their local dealer settle down at last to this very practical combination.

Their construction is based on cumulative experience that began with the beginning of wireless valves. They work well either individually or together. But excellently well together.

The valves illustrated are one of the well-known Ediswan pairs. If you have not tried them together you have still to discover the best that your set can give.

Ediswan Valves are entirely British made.

The following table indicates the combinations of Ediswan Valves that give the best results:—

Receiving.	Accumulator or Battery Volts.	Power.
AR	6	PV5
ARDE	2	PV6
AR'06	3	PV8

Ediswan ARDE is made to function either as a L.F. amplifier or detector (green line) or as a H.F. amplifier (red line). Ediswan P.V.6 (Loud Speaker Valve) is specially designed for use when ARDE is used in the preliminary stages.

With these groups and Ediswan H.T. and L.T. Accumulators the ideal is reached.

EDISWAN VALVES

The PIONEER VALVE

THE EDISON SWAN ELECTRIC CO., LTD.,
123-5, Queen Victoria Street, London, E.C.4.

PORTABLE SETS FOR SUMMER WIRELESS

4^D

The Wireless World

The Paper for Every Wireless Amateur

Wednesday, April 14th, 1926.



UNIVERSITY OF SCOTLAND
 EDINBURGH
 FEB 14 1927
 LIBRARY

THE UNIVERSITY OF SCOTLAND
 EDINBURGH
 FEB 14 1927
 LIBRARY

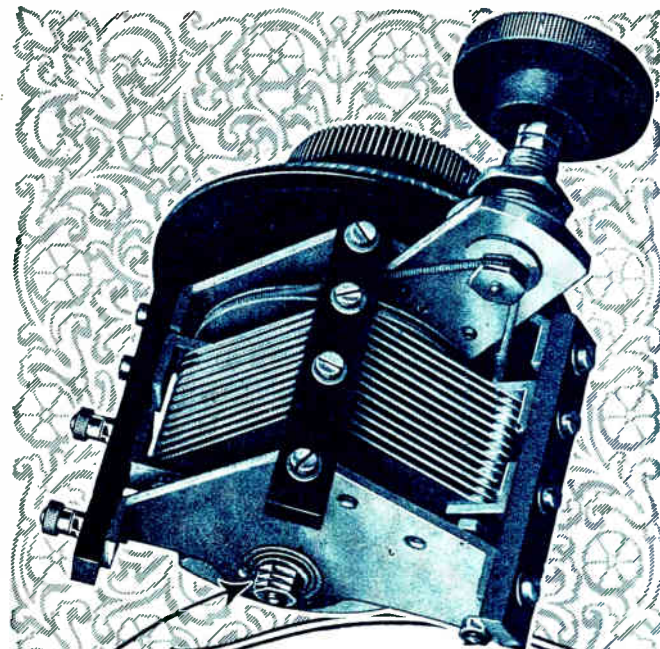

COMPENSATED
SQUARE LAW
EFFECT

LOW LOSS

NO
BACK LASH

**LOW LOSS
SQUARE LAW
SLOW MOTION**

THE "Cosmos" Condenser is a slow motion condenser with absolutely no backlash either when new or after use. This desirable feature is accomplished by the use of a spring belt held in tension, which permits coarse tuning with the large knob, and a 10' slow motion with the small knob. Cone bearings allow for adjustment and the slow motion bracket can be mounted for remote control as shown in the lower illustration. The condenser for fine tuning.

METRO-VICK SUPPLIES LTD.,

(Proprietors,
Metropolitan-Vickers Elec. Co. Ltd.)
4 Central Bldgs., Westminster, London, S.W.1.

Prices:

Slow Motion	00025 mfd.	14/9
"	0005 "	15/6
Ordinary	00025 "	12/-
"	0005 "	13/-

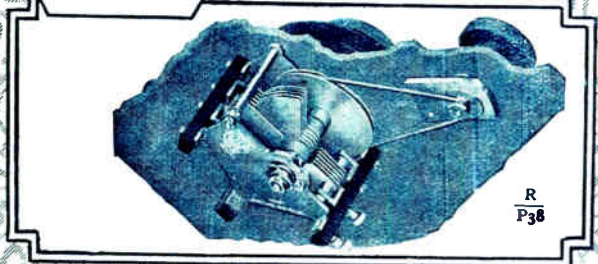
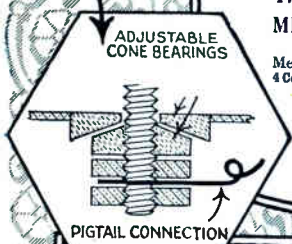

COSMOS

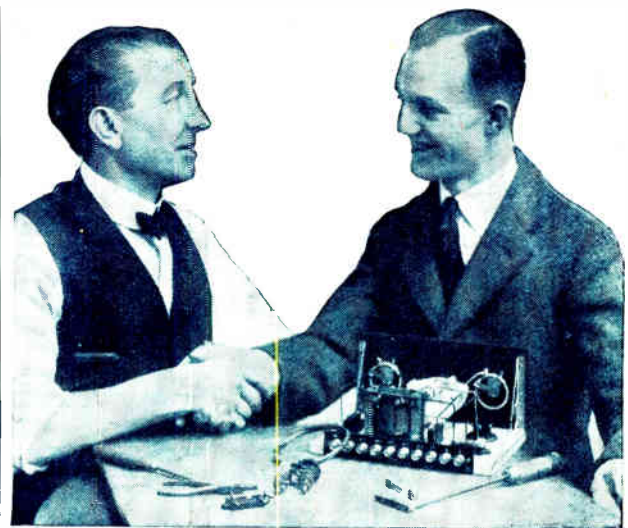

"...Yes, that's
the best set
I've made—
thanks to

GLAZITE
BRITISH MADE REGD.
COLOURED CONNECTING WIRE"
Red, Yellow, White,
Green, Blue and Black

10 ft. Coils
1/2 Per Coil
1/18 SWG

2ft. lengths
Per Packet
4 Assorted Colours **1/-**
1/16 SWG.

Obtainable from all dealers
Write for interesting descriptive leaflet.
**The LONDON ELECTRIC WIRE Co.
AND SMITHS Ltd.**
(Makers of Electric Wire for over 40 years.)
Playhouse Yard, Golden Lane, London, E.C.1

This mark



guarantees quality.

JUDD

Mention of "The Wireless World," when writing to advertisers, will ensure prompt attention.

MARCONI VALVES

for Distance Reception

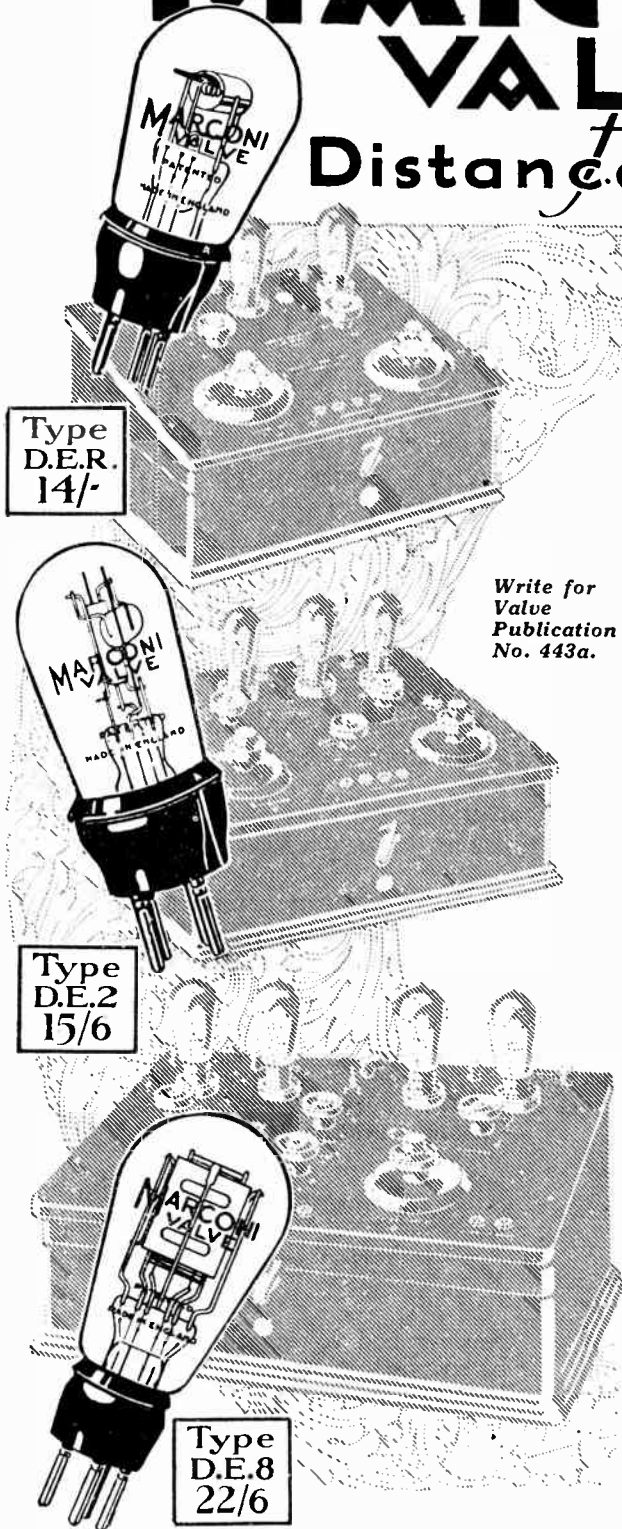

Type D.E.R. 14/-

Type D.E.2 15/6

Type D.E.8 22/6

Write for Value Publication No. 443a.

The following combinations of Marconi Valves are recommended by the Marconi Company's Engineers as being specially suitable for "reaching out." The name MARCONI on a Valve is a guarantee of outstanding performance. That is why the best known experimenters and the principal Broadcasting stations of the world use them.

	Type.	Position.	Fil. Amps.	Grid Bias Volts.	High Tension Volts.
2-Valve Sets	{ D.E.R.	H.F.	0.35	0	40
	{ D.E.R.	Det.	0.35	+2	40
	{ D.E.2H.F.	H.F.	0.12	0	60
	{ D.E.2H.F.	Det.	0.12	+2	60
	{ D.E.3B.	H.F.	0.06	0	60
	{ D.E.3B.	Det.	0.06	+2.8	60
3-Valve Sets	{ D.E.R.	H.F.	0.35	0	40
	{ D.E.R.	Det.	0.35	+2	40
	{ D.E.R.	L.F.	0.35	-3	80
	{ D.E.2H.F.	H.F.	0.12	0	60
	{ D.E.2H.F.	Det.	0.12	+2	60
	{ D.E.2L.F.	L.F.	0.12	-1.5	80
	{ D.E.3B.	H.F.	0.06	0	80
	{ D.E.3B.	Det.	0.06	+2.8	80
	{ D.E.3	L.F.	0.06	-3	80
	{ D.E.8H.F.	H.F.	0.12	0	80
	{ D.E.8H.F.	Det.	0.12	+2	80
	{ D.E.8L.F.	L.F.	0.12	-6	100
4-Valve Sets	{ D.E.R.	H.F.	0.35	0	40
	{ D.E.R.	Det.	0.35	+2	40
	{ D.E.R.	1 L.F.	0.35	-1.5	120
	{ D.E.6	2 L.F.	0.5	-9	120
	{ D.E.2H.F.	H.F.	0.12	0	60
	{ D.E.2H.F.	Det.	0.12	+2	60
	{ D.E.2L.F.	1 L.F.	0.12	-4.5	80
	{ D.E.6	2 L.F.	0.5	-9	120
	{ D.E.3B.	H.F.	0.06	0	80
	{ D.E.3B.	Det.	0.06	+2.8	80
	{ D.E.3	1 L.F.	0.06	-3	80
	{ D.E.4	2 L.F.	0.30	-7.5	120
	{ D.E.8H.F.	H.F.	0.12	0	80
	{ D.E.8H.F.	Det.	0.12	+2	80
	{ D.E.8L.F.	1 L.F.	0.12	-6	100
{ D.E.5	2 L.F.	0.25	-7.5	120	

THE MARCONIPHONE COMPANY, LIMITED,
 Reg. Office: Marconi House, Strand, London, W.C.2.
 Head Office: 210-212, Tottenham Court Road, London, W.1.

Exide

THE LONG-LIFE BATTERY

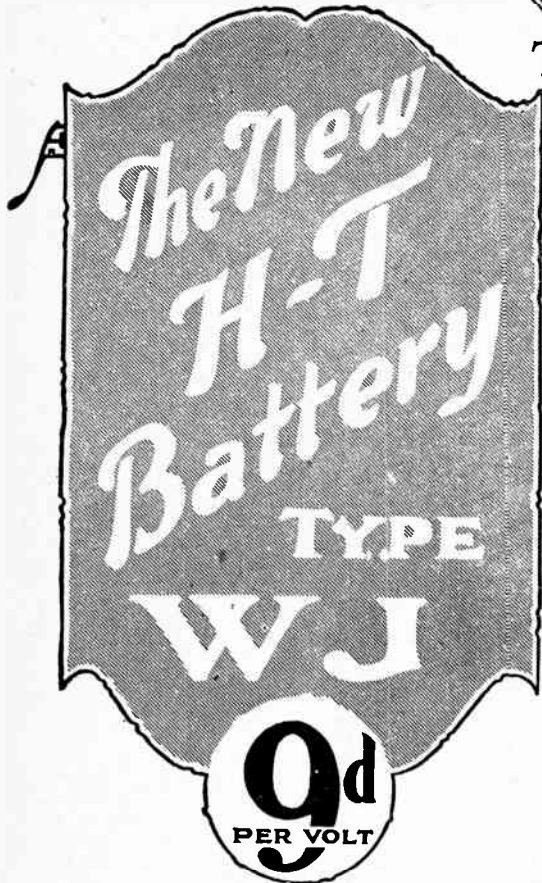

“ATMOSPHERICS” ELIMINATED

Only by using Accumulator high tension can you realise the purity of reception attained by cutting out the noises, due to partly run down dry batteries.

The silent background given by Exide H.T. batteries is almost uncanny, giving a freedom from the distortion due to “dry battery atmospherics,” that is a revelation and a delight.

Accumulator H.T. means music instead of noise and every word distinct.

The WJ type has a capacity of 2,500 milli-ampere hours, needs recharging only every six months and will last a lifetime.

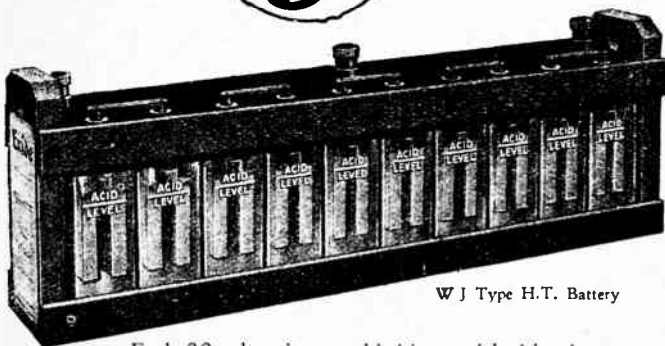

WJ Type H.T. Battery

Each 20 volt unit assembled in varnished hard-wood container.
Internal resistance negligible.
Voltage practically constant.
A third terminal gives 10 volt tapings.
Supplied ready charged, it can be used immediately on addition of “Accumulator” acid.

PRICE—

20-volt battery - 15/-
(without acid)

9d. per volt

Any required voltage can be obtained by coupling, in series, the appropriate number of 20-volt units.

Order from your usual dealer at once to ensure early delivery

Advertisement of THE CHLORIDE ELECTRICAL STORAGE CO. LTD., Clifton Junction, nr. Manchester

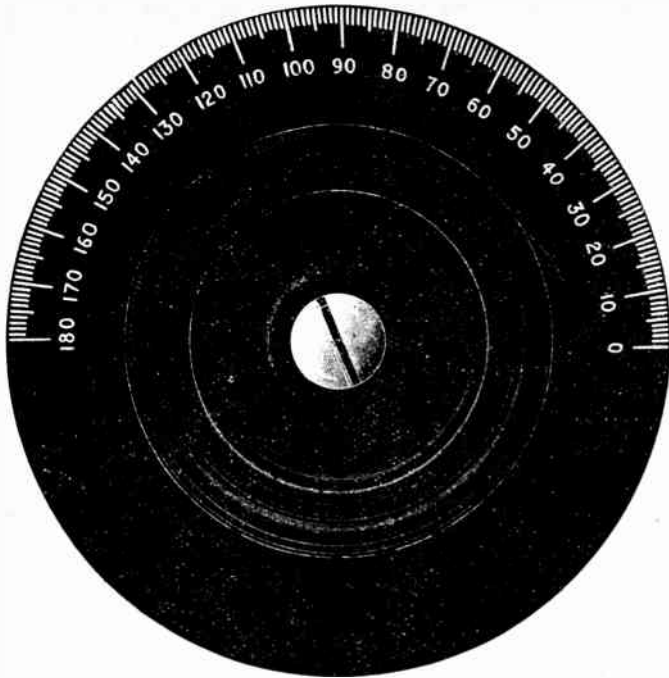

*The World's best SLOW MOTION DRIVE
For the World's most popular condenser.*

BALL BEARING
FRICTION DRIVE
SLOW MOTION
DIAL

Price 10/- Each

IDEAL RATIO 55-1

SPECIALLY DESIGNED FOR THE MILLION ORMOND LOW LOSS CONDENSERS ALREADY IN USE

THREE SELF-ADJUSTING BALL BEARINGS GUARAN-
TEE TOTAL ABSENCE OF BACKLASH—*PERMANENTLY*

RATIO High enough for finest tuning, low enough for
easy searching. Direct drive also for rough setting

Beautiful finish. Absolutely silent action and superlatively smooth.

FIXES AS SIMPLY AS STANDARD KNOB & DIAL
ESSENTIAL FOR PORTABLE SETS

ORMOND ENGINEERING CO. LTD.

199-205 Pentonville Road, King's Cross, LONDON, N.1.

Telephone: Clerkenwell 9344-5-6.

Telegrams: "Ormondengi, Kincross."

FACTORY: WHISKIN STREET, CLERKENWELL, E.C.1.

If you build your own sets you'll need this "Utility" NO-CAPACITY CHANGE-OVER Switch

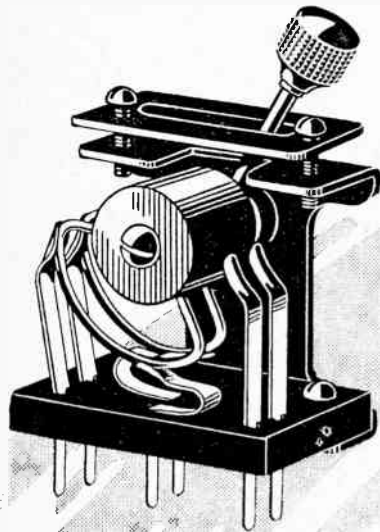

It has been designed by Electrical Engineers especially for Wireless apparatus. Loss has been practically eliminated and the contacts are *permanently* self-cleaning and therefore *permanently* effective to the fullest degree. This "Utility" Switch is available in six sizes changing over from one to six poles. Fit it to your set and ensure efficiency always.

Every switch—in fact every "Utility" Component—is guaranteed and will be replaced or repaired should any defect develop under reasonable conditions.

WILKINS & WRIGHT LTD
KENYON ST. *Utility* BIRMINGHAM

Utility
GUARANTEED
COMPONENTS

RAPID RADIO BUILDING IN THE BLACKADDA WAY.

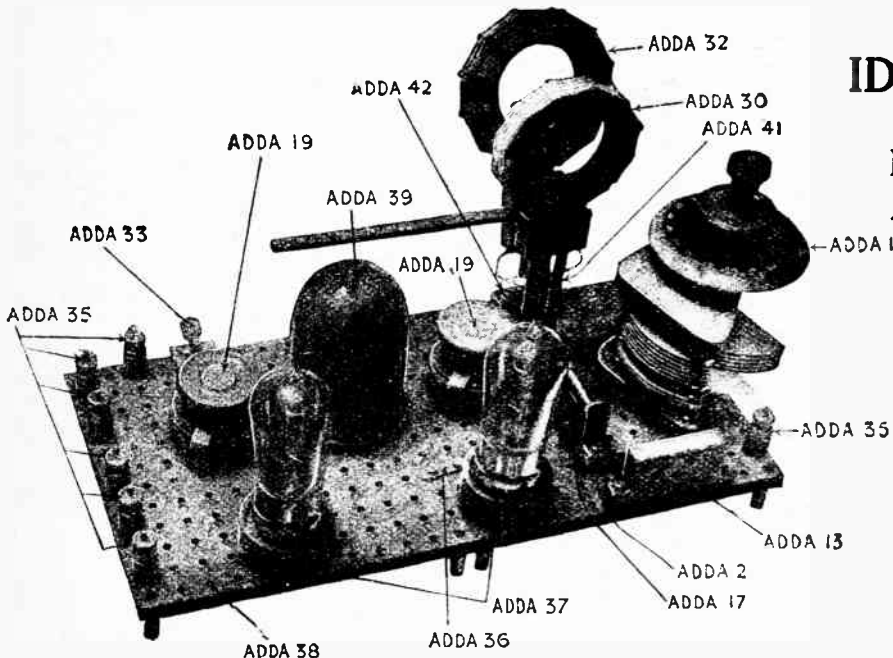

THE
IDEAL METHOD
FOR BOTH
EXPERIMENTER
AND BEGINNER

SETS CAN BE
ERECTED IN A
FEW MINUTES

BUILDS JUST
LIKE MECCANO

Write for descriptive
Booklet.

ILLUSTRATION OF A TWO-VALVE SET BUILT WITH "BLACKADDA" COMPONENTS.

THE BLACKADDA RADIO CO., LTD., SADLER GATE, DERBY.

Telephone:
DERBY 1920.

Telegrams:
"Blackadda, Derby."

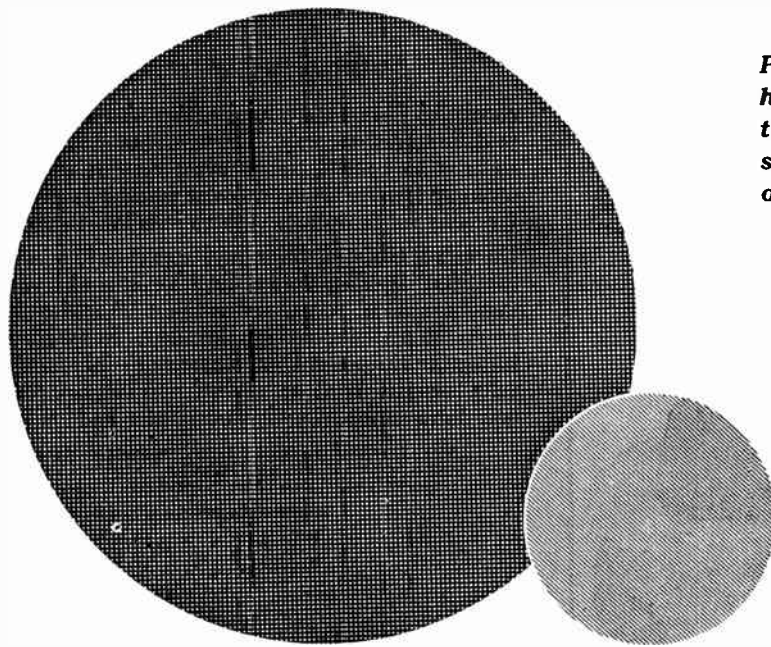

**Mullard
P.M. Filaments
have up to 5½
times the emis-
sion surfaces of
ordinary fila-
ments.**

More for Your Money

and why!

COMPARE the length of the Mullard P.M. filaments with any other. Compare the emission surface and you will realise the difference in proportions shown in the illustration.

This wonderful increase in emission surface allows the valve to operate at a temperature so low that

NO SIGN OF GLOW can be discerned.

A working temperature so low that the filament cannot lose its ductility as in other filaments with their consequent brittleness, and short life.

The special design of the filaments of Mullard P.M. Valves gives absolutely non-microphonic reception and reduces the current consumption to

ONLY ONE TENTH AMPERE

securing seven times the life from each accumulator charge.

Mullard P.M. filaments are *not* fragile. They cannot be broken even with the roughest handling

For 4-volt accumulators (or 3 dry cells)

ASK FOR THE P.M.3. 16/6 ASK FOR THE P.M.4 22/6

A general purpose valve for every circuit. The finest loud speaker valve ever produced.

GET THEM FROM YOUR RADIO DEALER

Mullard

THE · MASTER · VALVE



ADVT. THE MULLARD WIRELESS SERVICE CO., LTD., BALHAM, LONDON, S.W.12

BURNDEPT COMPONENTS

which ensure perfect filament control.

BURNDEPT FIXED RESISTORS

consist of fibre rods wound with resistance wire and adjusted accurately to definite resistances. They are intended for use either in place of a rheostat to control the filament current of valves or in series with an ordinary low-resistance rheostat when it is desired to modify an existing receiving set to operate with various low temperature valves.

On sets fitted with Shorting Plugs it only occupies a moment to replace the Shorting Plug with a fixed Resistor of a value suited to any valve it may be desired to use and without otherwise altering the set. Suitable screw holders for fixing Burndept Resistors may be obtained. By fitting the Burndept Dual Rheostat (5-30 ohms), a bright or dull emitter valve can be used as desired. This component is now made in a new form embodying improvements and suitable for one-hole fixing.

The Burndept range includes everything for efficient radio reception. Components, **GUARANTEED SUPER-VALVES**, and complete installations. Ask any Burndept Dealer to demonstrate them.

BURNDEPT

Telephone:
Gerrard
9072
(4 lines).

Aldine House, Bedford St., Strand, London, W.C.2.

Branches and Agents Everywhere.

Telegrams:
"Burndept
Westrand,
London."



BURNDEPT Fixed Resistors
From 75 ohm 2 amp. to 65 ohms 25 amp.
1/6 to 2/-



BURNDEPT Screw Holders
ready for mounting either on wood, ebonite, or behind a panel.
1/6 each.

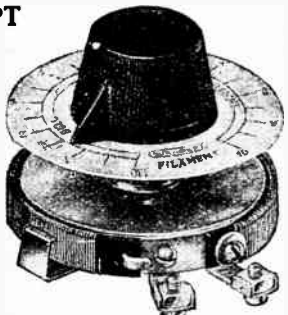

BURNDEPT Dual Rheostat
(5-30 ohms)
6/-

Because of their greater convenience the

DARIMONT BATTERIES

"HOME - SERVICE" BATTERIES are winning friends all over the country. They are free from parasitic noises, and give a steady current on continuous or intermittent discharge. Ideal for country districts because **YOU CHARGE THEM YOURSELF AT HOME** in a few minutes without any electric supply, and they are ready for use at once.



WRITE TO-DAY for List and Valve Guide.

DARIMONT ELECTRIC BATTERIES LTD.,
DARIMONT WORKS, ABBEY ROAD, PARK ROYAL,
LONDON, N.W.10. Telephone: Wembley 2807.

"YOU'LL CONVERT YOUR RIGID HOLDERS NOW"



Fig. 975.
Code Word **"WOBBLERS"**
Per 1/6 Set of 4 (3 black, 1 red)

Full Size Illustration.

Fig. 976.
Code **"DUAL"** Word **PURPOSE.**
DOUBLE-ENDED. Price 1/9 each.
THE FOOL-PROOF HOLDER
FOR BASE OR PANEL FITTING OR IN ANY OTHER POSITION.
The smallest and neatest combined holder on the market. No joints because the soldering lug is the same piece of wire as the spring. Show cards and display cards free.



Full Size Illustration.

Fig. 974.
Code **"WOBBLY"** Word.
PRICE ... 2/3 each.

THE IDEAL EXPERIMENTER'S HOLDER TOO SIMPLE TO IMPROVE

For the genuine experimenter who must have a holder without capacity, and perfectly sprung. Hunt's "WOBBLY" is ideal. It is impossible to have fewer parts, or to better insulate, separate or spring them. Separately sprung legs are far more effective than a closed-in solid spring top.



Full Size Illustration.

Made under Patent 242057/24, Prov. Pats. 30670/25 and 40,26, by—
A. H. HUNT, Ltd. (Dept. 1), Croydon, Surrey.

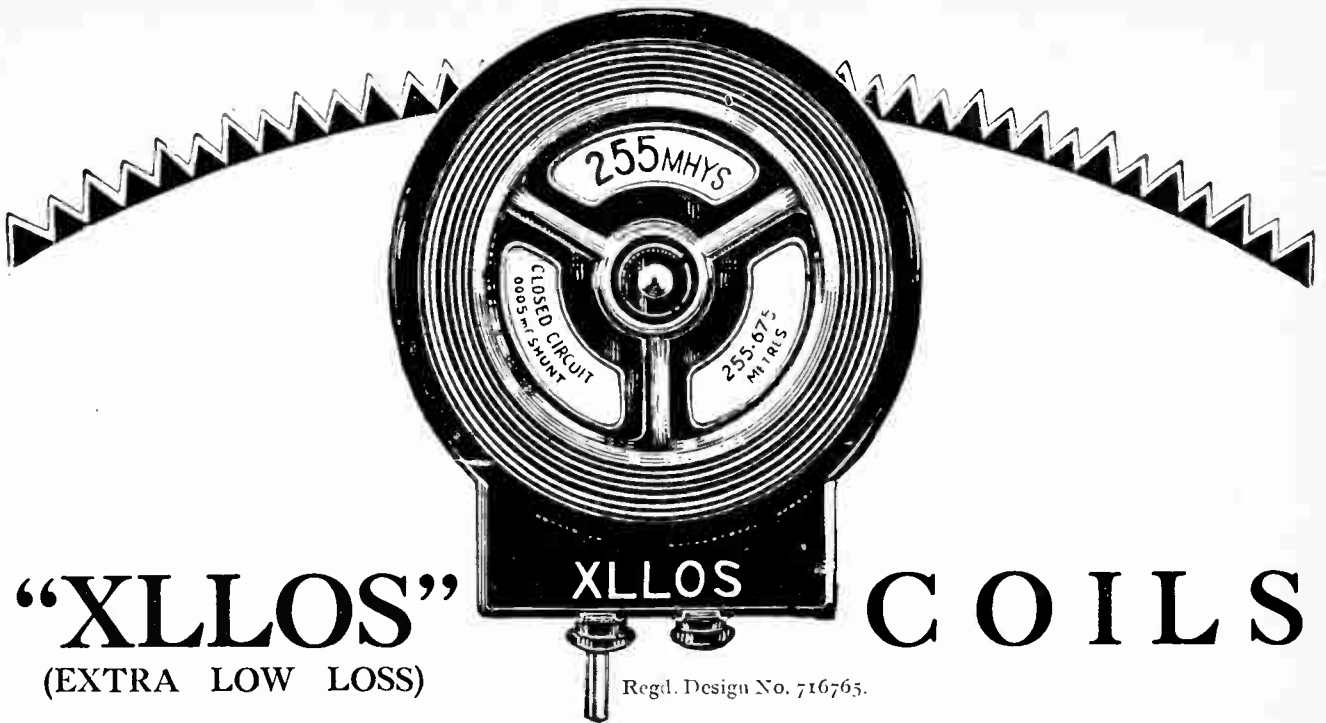

“XLLOS” COILS

(EXTRA LOW LOSS)

Coils that live up to their name.

EXTRA LOW LOSS—that is the keynote of the new Igranite “XLLOS” Coils. The special formation of the windings, the method of mounting and the absence of solid supporting material are all factors in making the coils highly efficient.

This latest Igranite achievement possesses electrical and mechanical features which are sought after by all discriminating radio experimenters. XLLOS Coils are highly selective and give increased signal strength and greater range of reception. They are extremely adaptable as regards mounting—a feature which is of special value, since it enables them to be used under the most efficient conditions and in many different types of coil-holders, especially where low capacity is essential to success. Two pins are supplied with each “XLLOS” Coil, permitting two pin, two socket, or pin and socket mounting.

Sizes and Wavelength ranges:

No. of Coil.	Inductance micro henries.	Self-capacity micro-mfd.	Natural wavelength metres.	Wavelength in metres when shunted by .0005 mfd. variable condenser.		Price.
				Aerial circuit using standard P.M.G. aerial.	Closed circuit.	
L. 25	29	12	39	220—280	85—225	5/-
L. 30	49	14	50	250—350	110—280	5/-
L. 40	60	16	72	350—400	155—400	5/2
L. 50	150	11	85	435—650	260—520	5/2
L. 75	255	13	109	550—635	255—675	5/6
L. 100	425	12	134	700—1000	325—865	7/-

One side of coil bears coil No. and approximate wavelength range in aerial circuit with .0005 mfd. condenser. On other side is stated inductance in micro-henries and wavelength range in closed circuit with .0005 mfd. condenser. Write for the Igranite leaflet U164 which describes the Igranite “XLLOS” Coil in detail, or see the coil at your dealers.

ADAPTABLE TO ALL METHODS OF MOUNTING

1. Contact pin and socket spaced for standard type coil holders.

2. Wide spacing of pin and socket for special low capacity coil holders

3. Double pin mounting; the pins may be spaced as desired.

4. Low capacity pivot mounting to provide angular adjustment of coupling.

Exclusive Manufacturing Licensees of

Patent Radio Essentials.

149, Queen Victoria Street, London Works: Bedford

The Igranite Instructional Carton for constructing a six-valve Supersonic Heterodyne Receiver according to the Igranite design contains a comprehensive, fully illustrated descriptive handbook, full-sized general arrangement drawings, wiring diagrams and drilling template. Obtain a copy from your dealer. Price - 2/6



*The Experimenter's
fixed Condenser*



Accuracy & Convenience!

MH Mica fixed condensers are designed for extreme accuracy—and what is more they are accurate, and stay accurate. Each condenser is guaranteed under all atmospheric conditions—neither intense heat or dampness will affect their capacities.

MH MICA DIELECTRIC FIXED CONDENSERS

are interchangeable, a fact which will be as readily appreciated by the serious experimenter as by the man who is doubtful as to the best value to employ.

Remember—fixed condensers can make all the difference, whatever the circuit, between a receiver that shows a consistently good performance and one that is as unreliable as the weather.

MH Condensers are made in all standard capacities, and are supplied with or without base and clips.

Demand of your dealer MH components—
They're British.

Telephone:
Slough 441-442.

L. M^c MICHAEL LTD

Manufacturers of Wireless and Scientific Apparatus
WEXHAM ROAD :: SLOUGH :: BUCKS.

Telegrams:
Radiether, Slough.

The MH

MICA FIXED CONDENSER

Prices (in Cartons). Unmounted.
(Two clips are supplied with each condenser.)

0'0001 to 0'0009 μ F. (030)	2/6 each.
0'001 to 0'01 μ F. (031)	3/- each.
0'015 to 0'02 μ F. (034)	4/- each.

Consistent in quality with the MH Mica Fixed Condensers other Components include :—

- MH GRID LEAKS (all values) supplied with two clips, 2/6 each.
- MH ANODE RESISTANCES. 40,000 to 100,000 ohms, supplied with two clips. 4/6 each.

Each of these three components if mounted on ebonite base with terminals, 1/- extra.



The Wireless World

AND
RADIO REVIEW
(14th Year of Publication)

No. 348.

WEDNESDAY, APRIL 14TH, 1926.

VOL. XVIII. No. 15.

Assistant Editor:
F. H. HAYNES.

Editor:
HUGH S. POCOCK.

Assistant Editor:
W. JAMES.

Editorial Offices: 139-40, FLEET STREET, LONDON, E.C.4

Telephone: City 4011 (3 lines).

Advertising and Publishing Offices: DORSET HOUSE, TUDOR STREET, LONDON, E.C.4.

Telephone: City 2847 (13 lines).

Telegrams: "Ethaworld, Fleet, London."

COVENTRY: Hertford Street.

BIRMINGHAM: Guildhall Buildings, Navigation Street.

MANCHESTER: 199, Deansgate.

Telegrams: "Cyclist Coventry."
Telephone: 10 Coventry.

Telegrams: "Autopress, Birmingham."
Telephone: 2970 and 2971 Midland.

Telegrams: "Hiffe, Manchester."
Telephone: 8970 and 8971 City.

Subscription Rates: Home, £1 1s. 8d.; Canada, £1 1s. 8d.; other countries abroad, £1 3s. 10d. per annum.

As many of the circuits and apparatus described in these pages are covered by patents, readers are advised, before making use of them, to satisfy themselves that they would not be infringing patents.

LINKING UP BY WIRELESS.

IN this issue a short article is contributed under the title of "England in the Colonies," and the subject matter of this contribution provides interesting food for thought. It is well that we should be reminded from time to time that the applications of broadcasting and the service which it can give have as yet by no means been exhausted. In the article in question a plea is made for the development of super-receiving equipment in far-off lands so that the broadcast transmissions of the home country can be received and the programmes re-transmitted on high power in order that it may be possible for isolated and news-starved settlers to listen in to 2LO or Daventry on simple receivers.

Technical Difficulties Almost Surmounted.

Our contributor, we think, rather overestimates the difficulties which may still lie in the way of the achievement of this goal, for it must be remembered that a good deal of experience has already been gained in this type of re-broadcasting in different parts of the world. Already in Canada certain stations of the United States are regularly received and re-broadcast for the benefit of the local listener, whilst in the States successful broadcasts of the Daventry programme have been carried out. It is understood that in South Africa also a fairly successful attempt has been made to achieve re-transmission of the home stations, whilst here the B.B.C. is able to give us programmes both from the Continent and from America.

It is interesting in this connection to note that the announcement has just been made that the B.B.C. hopes to receive transmissions regularly on Tuesday evenings from Schenectady, and will give listeners the benefit of the programme whenever the standard of reception is high enough. The B.B.C. also announce that the programmes of the Dutch station at Hilversum will shortly become an occasional feature of their transmissions.

International Broadcasting of the Future.

The time will no doubt come when every country will have a high-power broadcasting station which will put out programmes to be in turn picked up and re-broadcast all over the world, so that distance, in so far as communication is concerned, will no longer be recognised. How far-reaching an effect this will have in bringing the nations of the world into closer touch and harmony one with the other by cultivating a closer relationship and mutual understanding it is difficult to estimate, but that this influence will be sufficient to change for the better the atmosphere of international relationships there can be little doubt.

For some time to come, even after all technical obstacles have been surmounted, it is likely that artificial barriers will still stand for awhile to impede development owing to the difficulties in the way of suppressing international prejudices and jealousies, but ultimately, we may rest assured, progress will triumph, and the half-civilised conventions of civilisation will give place to the progress of science.

CONTENTS.

	PAGE
EDITORIAL VIEWS	543
FOUR-ELECTRODE PORTABLE RECEIVER	544
By F. L. Devereux.	
SUMMER WIRELESS	549
ENGLAND IN THE COLONIES	554
By H. A. Hankey.	
HINTS AND TIPS FOR NEW READERS	555
CURRENT TOPICS	557
PIONEERS OF WIRELESS. 13.—J. W. WILKINS	559
By Ellison Hawks.	
SELF-CONTAINED TWO-VALVE PORTABLE SET	561
By H. F. Smith.	
NEW APPARATUS	566
BROADCAST BREVITIES	567
RECEPTION AFLOAT	569
By A. G. Wood.	
THE EDITOR'S MAIL	571
READERS' PROBLEMS	574



A Self-contained Receiver for Use With or Without an Aerial and Earth.

THE success of a portable receiver depends not so much upon the use of any special circuit as upon the careful choice of components and their arrangement in the carrying case. In choosing the components, weight and electrical efficiency are of equal importance and must be considered together, in order that an effective compromise may be attained. As in aeroplane design, it is false economy to sacrifice everything to weight. Having considered each component independently, it then remains to arrange them in the smallest possible space, having due regard to the possible production of parasitic capacity effects and stray couplings between tuning coils. As a secondary consideration we have weight distribution: everyone is acquainted with the peculiar discomfort of carrying a bag in which the heavy articles have been packed at one end.

The H.T. and L.T. batteries constitute a considerable proportion of the total weight of the receiver, and should receive first attention in any campaign of weight reduction. The excessive weight of the normal H.T. battery can be eliminated by using 4-electrode valves; two 9-volt grid batteries will supply the H.T. current necessary for this type of valve. Unfortunately, 4-electrode valve design has stagnated somewhat in this country, the only dull emitter types available being fitted with 2-volt, 0.4 amp. filaments. These necessitate the use of accumulator L.T. cells of at least 10 ampere-hour capacity. The weight of the portable

set described in this article, for instance, would be halved if these cells could be eliminated. A 4-electrode valve known as the "Micro-bigril" is manufactured in France which requires a filament current of only 0.06 ampere at 3.8 volts; with two of these a dry battery weighing less than 1 lb., and costing 1s. 6d., could be used, and would give at least 20 hours' service. Unfortunately, valves of this type are not available in this country, and it is necessary to use either the Marconi-Osram D.E.7 or the Mullard 4-electrode valve with dull-emitter filament, which consumes 0.4 ampere at 1.8 volts.

Choice of Circuit.

However, it has been found possible to produce a set, even with these valves, of convenient size and weight. It is completely self-contained, and, wearing a pair of 'phones the set may be carried in the hand and broadcasting received while motoring or walking within a radius of 25 miles of a main broadcasting station. The complete receiver is depicted in the title of this article,

from which the size may be estimated by comparison with the headphones. The frame aerial, valves, and H.T. and L.T. batteries are all contained within the case, but provision is made for the attachment of an elevated aerial and earth if it is required to use the set more than 25 miles from a station.

The possibility of complications arising through coupling effects between coils in different parts of the cir-

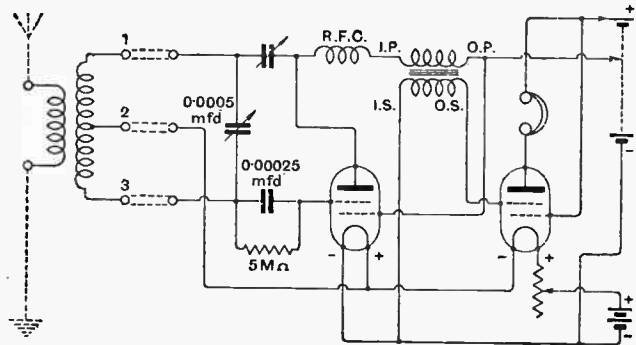

Fig. 1.—Circuit diagram showing method of attaching an aerial and earth.

Four-Electrode Portable Receiver.

cuit is avoided by making use of the well-known "Hartley" circuit. This consists of a single coil tuned by means of a 0.0005 mfd. variable condenser, which is connected between the grid and plate of the detector valve through the medium of a reaction condenser. The centre tapping of the coil is connected to a point of zero H.F. potential, in this case the positive side of the detector valve filament.

Receiving Aerials.

The tuning coil is wound as a frame aerial round the outside edge of the receiver case, which will pick up sufficient energy to give adequate results at distances up to 25 miles from a main broadcasting station. In order to receive signals from greater distances, an aerial and earth of the ordinary type may be coupled to the frame aerial through the medium of an "aperiodic" coil of a few turns wound over the outside of the frame winding.

The filaments of the two valves have been connected in series in order to take advantage of the fall of potential across each filament to provide suitable grid bias for the detector and L.F. valves. The grid bias of a valve is always measured with respect to the negative end of the filament. It will be seen, therefore, that by connecting the filament end of the secondary winding of the intervalve transformer to the negative end of the detector valve filament, a grid bias for the amplifying valve of -2 volts will be obtained. Similarly, a positive bias

of 2 volts for rectification will be obtained by connecting the centre tap of the frame aerial coil to the positive end of the detector valve filament. There are two incidental advantages obtained by making use of the series method of connection. Firstly, the discharge current from the L.T. accumulator is 0.4 instead of 0.8 ampere, thereby making the use of D.T.G. cells practicable; secondly, with two small cells instead of one large one a much better distribution of weight in the receiver can be obtained.

The remainder of the circuit is perfectly straightforward; it is only necessary to mention that there are two H.T. tappings, one for the detector and one for the L.F. valve, and that the inner grid terminals of each valve are connected to their respective + H.T. leads.

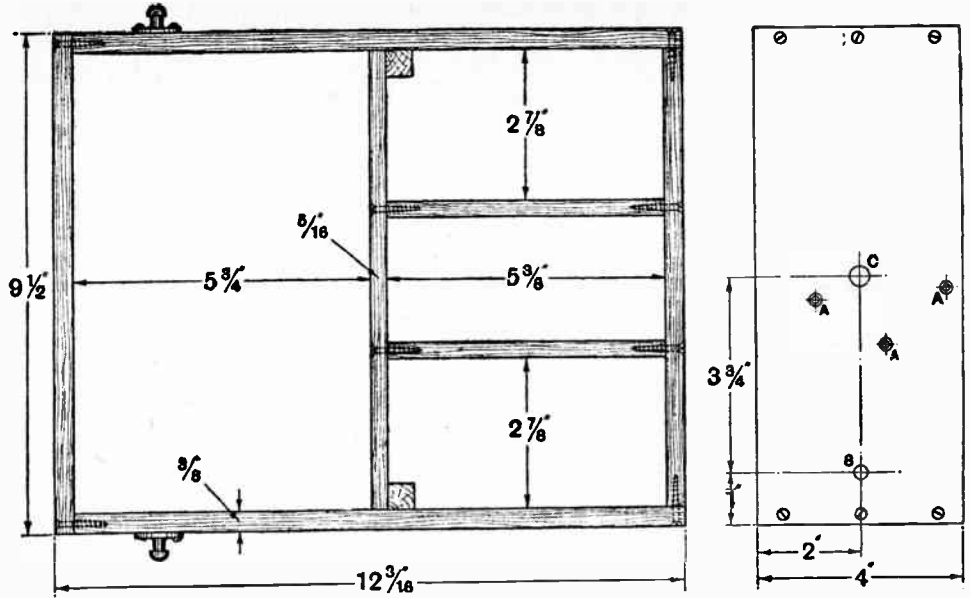

Fig. 2.—Dimensions of the container, showing position of holes for fixing the variable condenser and filament switch. A, 1/4 in. dia. countersunk for No. 6 B.A. screws; B, 1/4 in. dia.; C, 3/4 in. dia.

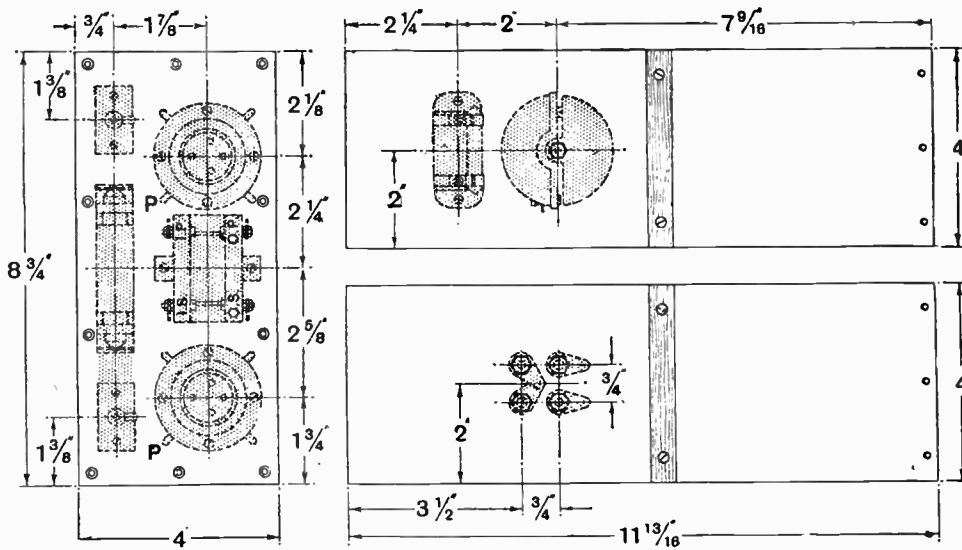

Fig. 3.—Layout of components in the top compartment of the case.

Choice of Components.

When receiving signals on the frame aerial at the extreme range of the receiver, critical tuning adjustments are necessary. It is therefore advisable to buy a tuning condenser of really first-class make, preferably with some form of vernier adjustment. There are plenty of compact tuning condensers on the market which, at first sight, would appear to be suitable for a portable receiver, but experience shows that it is better to use an ordinary moving vane air dielectric condenser of solid construction, the capacity of which is unaffected by side

Four-Electrode Portable Receiver.—

pressure on the spindle during adjustment. A vernier condenser having one fixed and one moving vane, such as the "Colvern" condenser, is recommended for the reaction control.

The radio-frequency choke is a Metro-Vick "Cosmos" which is well designed, and has been found to be equally effective on the short waves between 300 and 500 metres

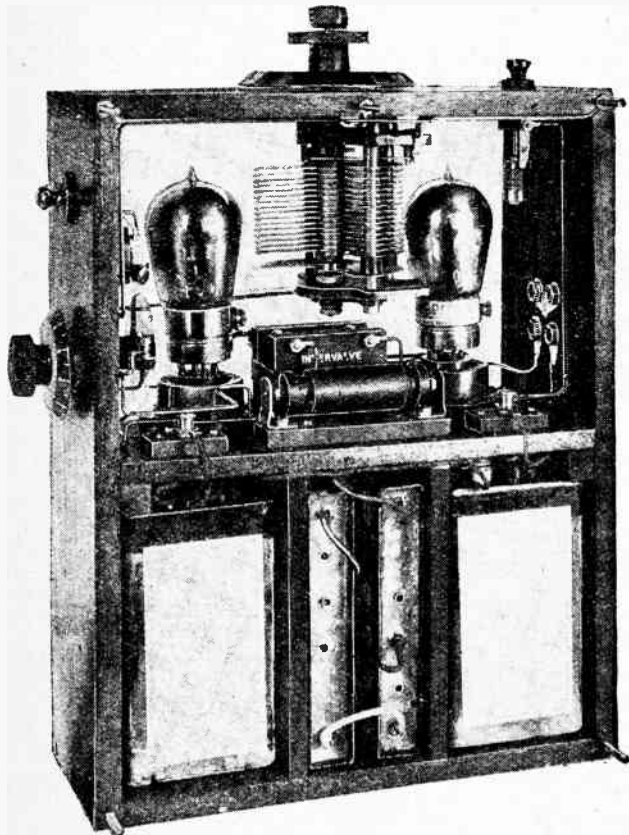

The finished receiver with both sides removed showing valves and batteries in position.

and on the wavelength of 1,600 metres used by Daventry.

An excellent compromise between size, weight and electrical efficiency has been effected in the "Ericsson" intervalve transformer, which has been utilised in this receiver. The 4:1 ratio transformer gives a slightly higher degree of amplification than the 2:1 ratio, and the quality is entirely satisfactory, due, no doubt, to the comparatively low impedance of the D.E.7 4-electrode valves.

Valve Protection.

The Sterling "Non-Pong" valve-holders were found to be absolutely non-microphonic, but they allow rather a large lateral movement of the valve, and it is advisable, if the set is to be carried in a car, to fix sponge rubber pads where the valve is likely to strike other components. A small rubber pad, fixed to the woodwork immediately above the pip of each valve, will often prevent breakage when removing a valve from a rather tight holder. The

L.T. and H.T. currents are supplied by D.T.G. cells and Siemens 9-volt grid bias batteries respectively, and an "Argonaut" combined filament resistance and switch is used to control the filament current.

General Design.

The components are built into a rectangular wooden frame 4in. wide and $\frac{1}{2}$ in. thick, measuring approximately $12\frac{1}{16}$ in. \times $9\frac{1}{2}$ in. Removable and interchangeable sides carrying the frame aerial windings are fitted to the frame to enclose the components and batteries. The carrying strap is fitted to the sides of the frame, and may conveniently consist of a short length of canvas belting. The strap shown in the photograph was taken off an accumulator carrying case.

A horizontal shelf mounted on fillets running across each side of the frame at a height of $5\frac{3}{8}$ in. from the bottom divides the set into two compartments, the space above the shelf being occupied by the H.F. and L.F. components of the receiver, and the lower half by the L.T. and H.T. batteries. Two vertical partitions are used in the lower compartment to separate the D.T.G. cells from the H.T. dry batteries which occupy the middle space so formed.

The arrangement of components in the upper compartment is clearly shown in the photographs, and a dimension layout is given in Fig. 3. The sequence of the circuit diagram in Fig. 1 has been followed as closely as possible. For instance, the detector valve which occupies the space at the left-hand side of the tuning condenser in the photograph on this page is surrounded by the tuning and rectifying components; thus the grid condenser and leak and reaction condenser are mounted on the left-hand side of the frame. The telephone plugs, on the other hand, are fitted in the right-hand side of the case adjacent to the amplifying valve, which is seen on the right-hand side of the same photograph. The space between the valve-holders is occupied by the coupling components, viz., the radio-frequency choke and intervalve transformer. It has been found possible to arrange for the O.P. and O.S. connections to be adjacent to the plate of the detector valve and grid of the amplifying valve respectively.

The filament switch is mounted in the top of the frame at the right-hand side of the tuning condenser, its position being shown at B in Fig. 2. Terminal blocks for the L.T. connections are screwed to the horizontal shelf immediately in front of the valve-holders, direct connec-

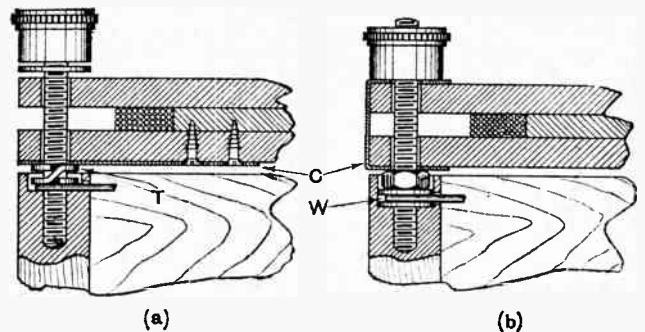

Fig. 4.—Alternative methods of making contact with the frame aerial windings.

LIST OF COMPONENTS.

2 Four-electrode valves (Marconi or Osram D.E.7).
 2 Valve-holders (Sterling "Non-Pong").
 1 Variable condenser, 0.0005 mfd. with vernier (Sterling).
 1 Vernier condenser (Collinson Precision Screw Co., Ltd.)
 1 Combined grid condenser and leak, 0.00025 mfd. and
 5 megohms (Dubilier).
 1 Radio-frequency choke (Cosmos).

1 Intervalve transformer, ratio 4 : 1 (Ericsson).
 2 Telephone plugs and sockets (Burndept).
 1 Combined filament resistance and switch (Argonaut).
 2 Grid batteries (for H.T.), 9-volt type (Siemens).
 2 D.T.G. cells (Exide).
 Mahogany, $\frac{1}{2}$ in. and $\frac{3}{8}$ in. thick for case; 3-ply wood for
 frame coils; Glazite connecting wire; terminals, screws, etc.

Approximate cost, excluding headphones, £7 os. od.

tions to the H.T. battery being made with flexible leads passing through slots cut in the edge of the horizontal shelf.

The three connections to the frame aerial are made through short lengths of No. 4 B.A. rod screwed into the top edge of the frame, the left-hand connection being No. 3, the centre No. 2, and the right-hand No. 1 in the circuit diagram. The No. 4 B.A. tapped hole in the wood has been opened out in each case, in order that a lock nut may be fitted flush with the edge of the frame to secure the wire connection, as shown at W in Fig. 4. An alternative method is to omit the lock nut and to use a spring washer for picking up contact with the frame as shown at (a) in Fig. 4.

This is, perhaps, an opportune moment to refer to the wood insulation which has been relied upon in many places in this receiver. This has proved perfectly satisfactory, but the wood used in the construction of the framework was very carefully chosen from a stock of well-seasoned mahogany. Everything depends upon the choice of the wood, and, if there is any doubt, ebonite insulation should be provided, at least for the high-frequency connections.

Wiring.

The sequence in the arrangement of the components already referred to greatly simplifies the wiring of the receiver. This should be carried out with the aid of the wiring supplement supplied with this issue. Two pairs of telephone plugs are used, and are so arranged that it is possible to use either a single pair of telephones or two pairs in series. When a single pair of telephones is used, the telephone plug is inserted horizontally in the lower pair of sockets, as shown in the title of the article. When two pairs are in use, however, the plugs are inserted vertically side by side. Assuming that high-resistance telephones are to be used, it would probably have been better, from the point of view of obtaining the maximum energy from the I.F. valve, to have arranged for the parallel method of connection; but unless telephones of exactly similar impedance are used, this advantage disappears, and it is, therefore, advisable to connect the two pairs in series in order to obtain the same current in both sets of windings.

The components in the top compartment have been wired with "Glazite," and the connections to the batteries have been made with flex. Plug connections can be made to the sockets in the H.T. batteries, but, in view of the fact that the set is likely to be subjected to a certain amount of vibration, soldered connections to the tapping points are recommended. These must be carried out rapidly with a very hot iron to avoid damage

to the internal connections of the battery through excessive heating of the brass sockets.

• Frame Construction.

The frame windings carried in the sides of the receiver consist of 24 turns of No. 30 S.W.G. D.S.C. wire for the 300-500-metre waveband, and 72 turns of the same gauge of wire for 5XX. A centre tap is taken

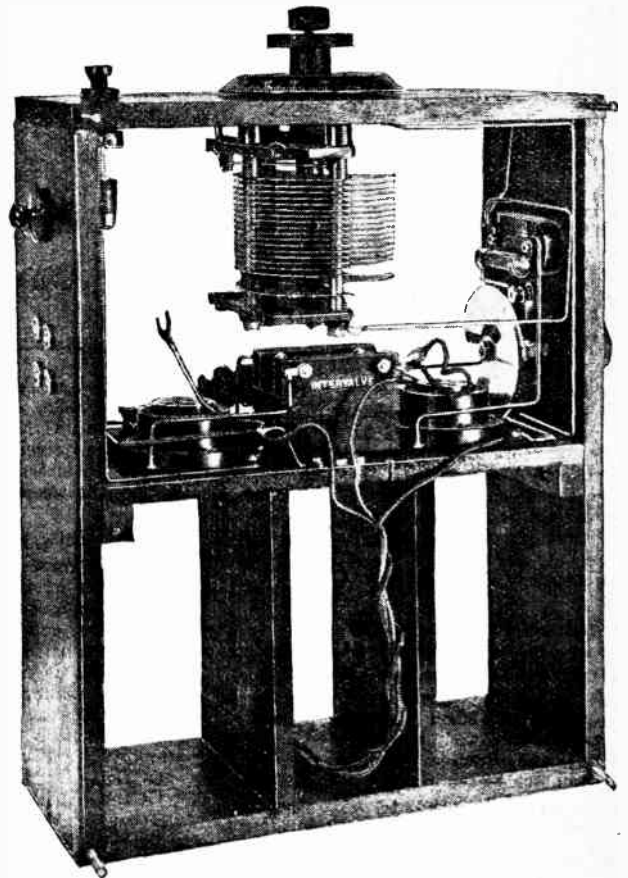

Another view of the receiver, with valves and batteries removed. The three leads to the H.T. battery and the spade terminal connections for the inner electrode terminal on the side of each valve will be readily identified.

in each case, and the three connections are brought out to copper contacts (C in Fig. 4), corresponding to the No. 4 B.A. terminal pegs on the receiver. Two alternative methods of picking up contact with the frame windings are shown in Fig. 4, the method actually used in the receiver being that shown at (b).

Two pieces of three-ply wood, $12\frac{3}{8}$ in. \times $9\frac{1}{2}$ in., are used in the construction of each frame, and are spaced

Four-Electrode Portable Receiver.—

apart to form a winding slot by means of rectangular spacing pieces measuring $11\frac{3}{16}$ in. \times $8\frac{3}{4}$ in. For the long-wave frame the spacing piece consists of $\frac{1}{2}$ in. three-ply wood, and in the case of the short-wave coil of a piece of Presspahn. It will be noticed that the dimensions of the spacing pieces give a depth of groove of $\frac{1}{2}$ in. at the sides and $\frac{1}{4}$ in. at the top and bottom, the extra depth of groove at the top and bottom being necessary on account of the centre contact, which might otherwise touch the winding.

In order to adapt the receiver for use with an ordinary aerial and earth system, a winding of three turns in the case of the short-wave frame and ten turns for the long-wave frame, are wound over each winding, and brought out to aerial and earth terminals, which are clearly shown in the photograph in the title of this article. Dummy pegs are fitted at the four corners of the reverse side of the receiver case, as shown in the photograph on page 547 to carry the frame aerial not actually in use. To change over from the local station to 5XX, it is only necessary to change over the sides of the container.

Sergt. H. W. Wilson, of the Fort Shafter Signal Corps, transmitting from the experimental station HU 6CDF in Honolulu, established communication for 35 minutes on a wavelength of 30.5 metres with O A4V, L. E. Green, in Johannesburg. The estimated distance is between 11,000 and 12,000 miles, and strong signals were reported by both stations.

o o o o

The secretary of the City of Leeds Y.M.C.A. wireless society informs us that their old station, G 6IW, which was licensed for artificial aerial only, has been closed down since the end of 1925, and the licence relinquished. He has, however, lately received cards from listeners purporting to have heard 6IW working, and will be glad to hear from the present owner of this call-sign

o o o o

With reference to G 5MU's claim to be the first station to work with an Austrian amateur, Mr. C. A. Jamblin (G 6BT) tells us that he worked OK at noon on January 26th, when his signals were reported as R5 with an input of only 15 watts; the Austrian, being unlicensed, was unable to give his full postal address, and the postmark on his QSL card was illegible. His wavelength was 45 metres.

o o o o

Mr. R. Pollock (G 5KU), 4, Glenhurst Avenue, N.W.5, is transmitting simultaneously on 45 and 23 metres at 18.15, 18.45, 19.15, 19.45 and 20.15, G.M.T., for the purpose of observing the fading effects round about sunset and nightfall, and will be glad to hear from listeners who will co-operate in these tests.

o o o o

Mr. R. S. Foskett, 48, Woodland Terrace, S.E.7, is willing to forward cards to any Dutch amateur, and states that he has QSL cards which he will forward to G 6ZO, 2BMA, X2M, GW 3ZZ, and G 3YZ if they will send their addresses

Within ten miles of 2LO loud signals are easily obtained in telephones on the frame aerial without critical adjustment either of tuning or reaction, and there is no necessity to have the frame pointing accurately towards the station. The receiver, therefore, can be carried while signals are being received. At distances of twenty-five miles from a main station, or sixty miles from 5XX, critical adjustment is necessary, and it is advisable to set the receiver on a table or other suitable support and to turn it carefully until maximum signals are obtained.

Reception with External Aerial.

An aerial and earth system greatly improves reception from 5XX, but is apt to reduce selectivity, so that it cannot be used successfully within, say, two miles of a main "short-wave" station. In such a situation it is better to use the frame for 5XX, and to sacrifice signal strength for selectivity.

Experiments with the grid condenser and leak proved that values of 0.00025 mfd. and 5 megohms gave best results. The best values of H.T. were 7 to 10 volts for the detector, and 12 to 16 volts for the amplifier.

TRANSMITTERS' NOTES AND QUERIES.

Mr. I. S. Calder informs us that since October, 1925, he has received 33 Australian and 27 New Zealand stations with an 0-v-1 receiver on wavelengths between 33 and 36 metres and at signal strengths varying between R3 and R7.

o o o o

French Military Short-wave Stations.

Several correspondents have asked for particulars of the O.C. (Ondes Courtes) stations, operated by the French military authorities, and we give below a list that may prove of service, though we are conscious that it is by no means complete. We shall welcome any information which will enable us to compile a full list of these stations with the wavelengths employed.

OCDB.—Djibouti, French Somaliland.

OCDJ.—Issy-les-Moulineaux, transmits weather reports, "Meteo-Europe" on 33 metres at 10.08 G.M.T.

OCMV.—Mont-Valerien, near Paris, transmits at 10.00, 11.00, 12.30, 13.30, 16.00, 19.00, 20.00, 21.00 and 22.00, G.M.T., on 30 to 45 metres.

OCNG.—Nogent-le-Rotrou.

OCTP.—Nogent-le-Rotrou.

OCTU.—Tunis la Casbah, transmits weather reports "Meteo-Tunis" on 45 metres at 21.30 G.M.T.

o o o o

New Call-Signs Allotted and Stations Identified.

G 2BPC.—(Art. A.), C. C. Stevens, Almora, Andover, Hants.

G 2ZS.—L. C. Patterson, 18, Lancaster Court, Newman Street, W.1. Transmits

on 45 metres (this call-sign was formerly owned by F. J. Dinsdale, Liverpool).

G 6BR.—G. H. Ramsden, Overdale, Ilkley, Yorkshire (change of address).

G 6IO (Late 2ATZ).—T. Woodhouse, 31, Treseo Road, Peckham Rye, S.E.15, transmits on 150-200 metres and 440 metres.

G 6NH.—J. W. Davies, Coopersale Hall, Epping, Essex (change of address).

G 6QH.—A. J. Baker, 67, First Avenue, Bush Hill Park, Enfield, transmits on 45 metres.

BZ SQ2.—Livio G. Moreira, Rua Paula Gomes 6, Curitiba, Brazil.

CH 2AR.—Carlos Reiher, Casilla 3062, Valparaiso, Chile.

CH 3AN.—Juan Gachelin, Maipú 636, Santiago, Chile.

D 7JS.—James Steffensen, Ehlersvej 8, Hellerup, nr. Copenhagen.

D 7BJ.—Börge Jørgensen, Brandes Alle 8 (IV), Copenhagen V.

EAR 23.—Juan Portela, Cervantes 10, Cadiz.

T PAI.—QSL via "Radio Amateur," Wilcza 30, Warsaw, Poland.

ANDIR.—The short-wave call of AND, the Bandoeng Aerodrome, Java. QSL via Soesterborg Aerodrome (STB), Holland. Reports should contain particulars of QRH, QSB, QSD, and QRK.

o o o o

QRA's Wanted.

G 2NX, G 5DA, G 5IH, G 5NM, G 6GG, GW 3XX, GW 3ZZ, BB1, BM2, CR 3SN, DA SP, X P7, PV Z, PI CD8, I 1CN, U 1DO, U 1CH, U 2AEV.

o o o o

A Correction.

With reference to the note on page 456 of our issue of March 24th, Mr. C. A. Jamblin asks us to correct a slight error. He is the Hon. Organiser only of the QRA and QSL section (T. & R.) of the R.S.G.B. and not of the whole T. & R. section.

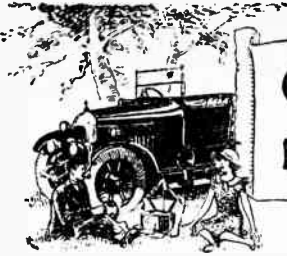

Summer Wireless

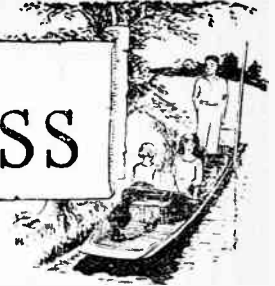

Notes on Portable Sets for Outdoor Use.

WHEN the practical application of wireless telegraphy to communication first became apparent, the most obvious and at the same time the most important use to which it was put was to establish communication between ships at sea and the shore. Telegraphic communication on land and between one country and another was already well established by the telegraph

travelling as they are in the home, and those who have become accustomed to the companionship of wireless dur-

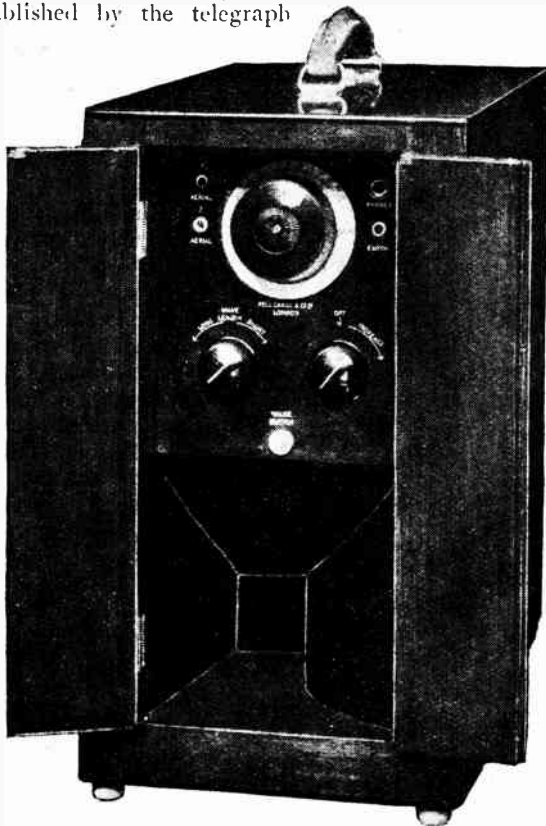

THE PELICAN SET, with loud-speaker, frame aerial and batteries, all contained in polished mahogany case.



Another type of the PELICAN SET.

ing the winter months must very naturally feel loath to part company with their receivers when the time comes for the enjoyment of the open-air life of the summer.

When we realise that the very characteristic of broadcasting is its non-directional property, making it equally



THE B.T.H. PORTABLE LOUD-SPEAKER SET, with two-valve amplifier. This receiver is fitted with an internal frame aerial, but can be easily adapted for an ordinary aerial if greater range is required.

and cable companies, and wireless could then be regarded as only a supplementary service if applied to such similar uses. Instead, an entirely fresh field was opened up, due to the applicability of wireless for communication between moving stations. With the advent of wireless telephony, the service of broadcasting, although equally suitable for use between stations moving from place to place, has been very little utilised for this purpose.

It would seem that a great field is still open for exploitation in this direction. Music and other forms of entertainment are just as acceptable out of doors or when

Summer Wireless—

available anywhere, we can readily see that we have so far neglected the use of broadcasting for outdoor reception to an extent which is scarcely pardonable. In addition, we know that the modern receiver can be built so as to be very compact, and whilst the term portable is a very elastic expression, especially as used by the manufacturers of so-called portable sets of a season or so ago, there is now very little in the way of portable sets on the market which is not actually suitable for transporting from place to place, even though the bulk and weight have not yet come down, in most cases, to anything like the value which should be possible to-day in view of the developments which have tended towards facilitating the design of compact instruments.

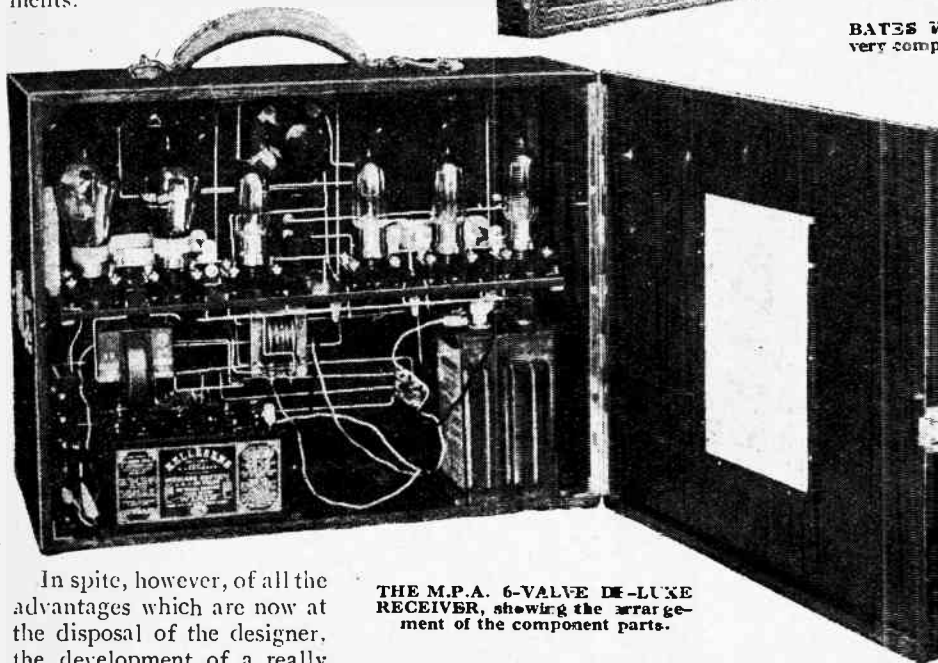

THE M.P.A. 6-VALVE DE-LUXE RECEIVER, showing the arrangement of the component parts.

In spite, however, of all the advantages which are now at the disposal of the designer, the development of a really portable receiver suitable for all purposes is probably still beyond reach. It is still necessary, as in fact it is with the design of any receiver, to compromise and content ourselves with a set suitable for a special requirement, but not of equal applicability to all purposes.

We consider first of all whether the set is to operate a loud-speaker or phones only, and next we must take into account whether the receiver is to be used near a broadcasting station or at some distance. It is probably impracticable to pro-

duce a receiver capable of giving loud-speaker reception at some distance and equally suitable for local work unless we are prepared to employ a fairly bulky and somewhat heavy outfit, which would be quite unnecessary for local reception. Very

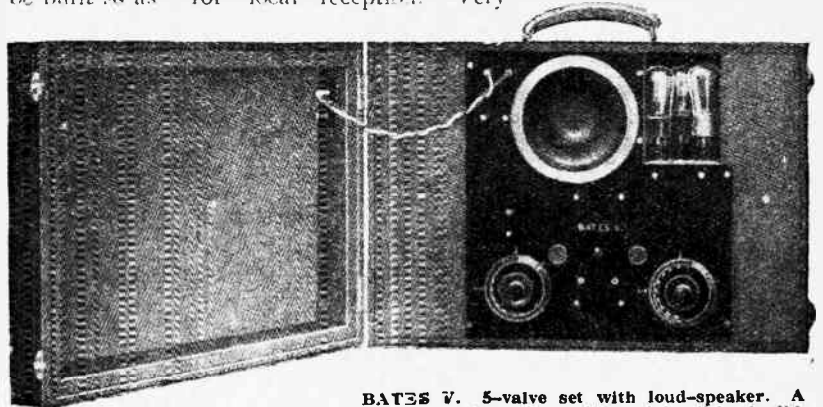

BATES V. 5-valve set with loud-speaker. A very compact receiver with aerial coil in the lid.

naturally, the superheterodyne asserts itself in our minds as almost the ideal portable set if its bulk is kept down to a minimum and low filament consumption valves are used. but for local work, where a small aerial can be put up easily, as, for instance, where it can be connected to a tree out of doors, the advantages inherent in the super are at a discount, and probably better reception will be obtained with a detector and one low-frequency stage.

The suitability of the four-electrode valve for portable sets seems hitherto to have been overlooked. By the employment of these valves we are able to dispense with

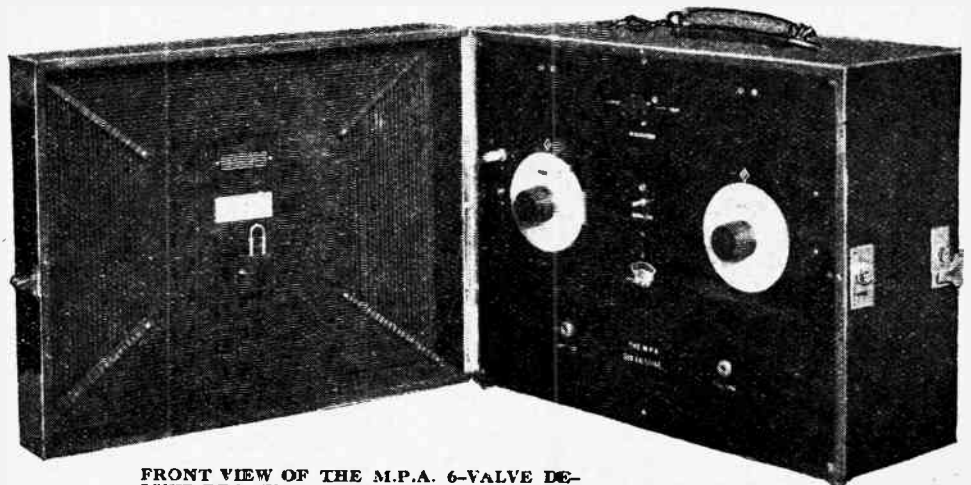

FRONT VIEW OF THE M.P.A. 6-VALVE DE-LUXE RECEIVER, showing frame aerial in lid

Summer Wireless—

a good deal of the bulk of high-tension batteries, but we must remember that in so doing we have to be prepared to dispense also with the loud-speaker. For telephone reception with a portable set, however, the four-electrode valve is probably ideal where we wish to cut down battery weight and bulk as much as possible.

When we desire a really portable receiver we must be

prepared to sacrifice something either in the way of strength or quality, or both, because bulk and weight are essential in the best receiver arrangements. We have also to consider the question of simplicity, because sets with elaborate and complicated wiring are scarcely suitable for transporting from place to place, especially when vibration will occur in transit, because we then run a very serious risk of breaking some connection *en route* and

“ WIRELESS WORLD ”
Buyer's Guide to Portable Receivers.

HEADPHONE SETS.

Manufacturer.	Name of Set.	Type of Case.	Nature of Aerial.	Valves.			Price (including Royalty).	General Remarks.
				H.F.	Det.	L.F.		
Cahill & Co., Ltd., 61, Newman St., London, W.1.	Pelican	Mahogany.....	Frame in set.	—	1	—	£ s. d. 10 0 0	Complete with valves, batteries, 1 pr. phones.
Climax Radio Electric, Ltd., Quill Works, Putney, London, S.W.15.	Climax Mono-valve.	Oak, with strap handle.	Folding frame " "	—	1	—	7 17 6 10 4 0	Including frame aerial only. Including dull-emitter valve, batteries and phones.
Marcophonie Co., Ltd., 210/212, Tottenham Court Rd., London, W.1.	Portable V.2 ..	Canvas case, with pocket bound leather, with leather shoulder straps and handle.	Portable, for suspension.	—	—	1	2 17 6 3 11 6 15 11 0	Amplifier for above. Do., including dull-emitter valve. Fitted to work from dry battery (contained in receiver). Complete with valves, batteries, aerial and earth equipment and 1 pr. phones.

LOUD-SPEAKER SETS.

Manufacturer.	Name of Set.	Type of Case.	Nature of Aerial.	Valves.			Price (including Royalty).	General Remarks.
				H.F.	Det.	L.F.		
Bates Motor Corporation, 26, Coventry St., London, W.1.	Bates V..... Bates Super V..	Leather, with straps.	Coil in lid ... " "	2	1	2	£ s. d. 27 6 0 31 13 0	Complete with valves, batteries and L.S.
British & Colonial Industries Association, Ltd., 317, High Holborn, London, W.C.1.	B.C.1 Portable Mark III. Receiver. " " Amplifier	Mahogany..... "	Folding hexagon Solenoid.	1	1	1	18 18 0 8 8 0	Complete with D.E. valves, batteries, 1 pr. phones and coil. Transformer coupled. Amplifier for above, including valve and batteries.
British Thomson-Houston Co., Ltd., Crown House, Aldwych, London, W.C.2.	B.T.H. 3V. Portable Receiver. B.T.H. Portable L.S. and Amplifier.	Leather cloth case, carrying handle, 2 front doors. As above, with enclosed L.S.	Internal, also frame, and can be adapted for suspended aerial.	—	—	2	26 5 0 28 15 0 22 15 0	Complete with 3 B.T.H. B.5 valves, H.T. and L.T. dry batteries and 1 pr. phones. Do., in polished mahogany case. Amplifier for above, including 2 B.T.H. B.6 valves, dry batteries and L.S.
Horne-Jones & Co., Ltd., 296, Borough High St., London, S.E.1.	Magnum " Portable.	Leather attaché case.	Portable for suspension.	1	1	2	24 15 0 15 15 0	Do., in polished mahogany case. Complete with valves, batteries, aerial equipment, 1 pr. phones and coils for 2L0 and 5XX.
Butterfields, Ltd., Levis Motor Works, Stechford, Birmingham.	Levis	Leather case, with handle.	" "	1	1	2	25 0 0	Leads only included.
C.A.C. Radio, Ltd., 10, Bangoon St., London, E.C.3.	C.A.C. Portable	Leather case, with lock and carrying handle.	Frame in set.	1	1	2	22 10 0	With L.T. non-spillable accum. and 60-v. H.T. battery.
Cahill & Co., Ltd., 61, Newman St., London, W.1.	Pelican	Mahogany.....	" "	1	1	2	25 4 0 20 0 0	As above, but including valves. With valves and batteries.
Colbery, C. T. & Co., Ltd., 8, St. James's Walk, London, E.C.1.	Ideal V.5	Black leather, with carrying handle.	" "	1	1	2	32 10 0 40 0 0 22 10 0	Complete with valves, batteries and self-contained L.S.
Curtis, Peter, Ltd., 11, Red Lion Sq., W.C.1.	Duodyne Portable III. Duodyne Portable IV. Curtis Portable Super-Het. S. Portable	Polished mahogany, with carrying strap. Polished teak or oak. Leatherette attaché case, with handle.	Internal " " Coiled in lid.	—	1	2	20 17 6 25 0 0 56 5 0 16 5 0	Complete with Vita valves, H.T. battery and L.T. accum. " " " " " "
Edison Swan Electric Co., Ltd., 123/125, Queen Victoria St., London, E.C.4.	Fellophone Portable Three.	Black leatherette suitcase.	" "	—	1	1	12 0 0	With H.T. and G.B. batteries, unspillable accum. and 2 prs phones. No valves.
Fellows Magneto Co., Ltd., Cumberland Ave., Park Royal, London, N.W.10.	" "	" "	" "	—	3	1	13 0 0	Complete with 3 Loudon 1-v. D.E. valves. H.T. battery, 4-v., unspillable accum. and 1 pr. phones.
" "	" "	" "	" "	—	3	1	13 0 0	In real cowhide covered suitcase.

LOUD-SPEAKER SETS—continued.

Manufacturer.	Name of Set.	Type of Case.	Nature of Aerial.	Valves.			Price (including Royalty).	General Remarks.
				H.F.	Det.	L.F.		
General Radio Co., Ltd., 235, Regent St., London, W.1.	Type 53	Teak	Enclosed loop	1	1	1	£ 18 s. 0 d.	Complete with valves, batteries phones, plug and enclosed L.S.
Gillilan Bros., Ltd. 63, High Holborn, London, W.C.1.	Gillan Ubique .	Leather case, with handle.	Internal aerial and provision for ordinary.	1	1	2	23 3 0	Complete with 4 D.E. valves H.T. and G.B. batteries, unspillable accum. and built-in L.S.
" " "	Gillan Ubique A	" " " " " "	" " " " " "	1	1	2	18 18 0	Similar, but without L.S.
Halcyon Wireless Supply Co., Ltd., 110, Knightsbridge, London, S.W.1.	Halcyon	Oak cabinet	None necessary.	4	1	2	25 0 0	Complete with 4 D.E.3 valves, 99-v. H.T. and G.B. batteries, 3 1½-v. L.T. Batteries, H.F. transformer and L.S. lead. H.F. transformer for 5XX 10s. extra. Reception without aerial or earth.
" " "	"	"	"	5	1	2	33 2 6	Complete with 5 D.E.3 valves, 99-v. H.T. battery, 9-v. G.B. battery, 25-30 a.h. unspillable accum. and L.S. lead. Reception without aerial or earth.
Hart Collins, Ltd., 38a, Bessborough St., London, S.W.1.	Hart Collins 4-Valve Portable Receiver.	Oak or leatherette	Internal, with provision for ordinary.	—	—	—	23 0 0	Receiver only, with L.S. and aerial embodied.
" " "	"	"	"	—	—	—	26 18 0	Complete with L.T. and H.T. batteries, grid battery and valves. Mahogany cabinet, £1 extra; lacquer cabinet, £1 extra.
M.P.A. Wireless (Proprietors, The M.P.A., Ltd.), 62, Conduit St., London, W.1.	The M.P.A. Inclusive Three Receiver.	Jacobean oak, with detachable handle.	Self-contained in lid.	—	1	2	19 19 0	Complete with valves, H.T. battery, accum., L.S. and 1 pr. phones.
" " "	The M.P.A. 5-Valve Super Portable Receiver.	Dull polished Honduras mahogany, with detachable handle.	" " " "	2	1	2	34 2 6	Complete with valves, H.T. battery, accum., 1 pr. phones and waterproof cover.
" " "	The M.P.A. 6-Valve Portable De Luxe Receiver.	" " " "	" " " "	2	1	3	42 15 0	" " " "
Neutron, Ltd., Sentinel House, Southampton Row, London, W.C.1.	Neutron Biltin.	Polished mahogany, with leather handle, L.S. built in.	Multi-strand square frame in door.	—	1	2	16 17 6	Complete with 4-v. unspillable accum., 60-v. H.T. battery, 3-cell G.B., 3 Neutron valves (0.06) and Amplion L.S.
Non-Aerial Wireless Manufacturing Co., 181, Shaftesbury Ave., London, W.C.2.	N-A Portable D Type.	Mahogany, with leather handle & Sterling Dinkie combined.	Frame inside case.	—	1	2	23 2 0	Complete with valves, batteries and L.S.
" " "	N-A Portable C Type.	Mahogany, with leather handle.	" " " "	—	1	2	18 18 0	Complete with valves, batteries and 1 pr. phones.
Radio Instruments, Ltd., 12, Hyde St., London, W.C.2.	Lyriancette	Polished mahogany.	None supplied	—	1	1	29 8 0	Complete with D.E. valves, H.T. and L.T. dry batteries and L.S. Loading coil for 5XX extra. Canvas carrying case £1 17s. 6d. extra.
Read & Morris, Ltd., 31, Eastcastle St., London, W.1.	Reamor Portable I.	Pigskin attaché ..	Self-contained	—	1	2	25 9 6	As above.
" " "	Reamor Portable II.	" " " "	" " " "	—	1	2	25 0 0	Complete with valves, batteries and L.S.
Rees, Mace Manufacturing Co., Ltd., 39a Welbeck St., London, W.1.	Rees-Mace All-in Portable Receiver.	Mahogany, with Rees-Mace Conc Speaker enclosed.	Frame	—	1	1	18 5 0	Complete with valves, batteries, or accum. and L.S. enclosed.
" " "	" " " "	" " " "	" " " "	1	1	1	22 17 6	" " " "
" " "	" " " "	" " " "	" " " "	1	1	2	22 17 6	" " " "
" " "	" " " "	" " " "	" " " "	1	1	2	26 10 0	" " " "
Reeves, A. W., 3, Edmund St., Birmingham.	Reeves-Roberts Baby Newt.	Imitation leather.	18ft. on reel, for suspension.	2	1	2	30 17 6	" " " "
" " "	" " " "	" " " "	" " " "	1	1	—	10 10 0	Complete with valves, batteries and 1 pr. phones. Double-scale voltmeter is embodied with plugs for H.F. and L.F. readings.
R.M. Radio, Ltd., 21, Garrick St., London, W.C.2.	R.M.R. Portable	Leather case, with carrying straps.	Coil in lid ...	—	1	2	19 19 0	Complete with valves, H.T. battery, L.T. accum. and 1 pr. phones.
Sherman, P., 12, River St., London, E.C.1.	Portable 3	Oak, with handle.	Portable, for suspension.	1	1	1	15 15 0	Complete with Darimont primary cell, aerial, earth spike, 2 prs. phones in separate case with leads for quick connections. Valves enclosed in set on sprung holders.
" " "	Portable 1	Oak case, with handle.	" " " "	1	1	2	20 0 0	As above.
" " "	Portable 5	Leather case, with handle.	Collapsible frame.	2	1	2	30 0 0	Complete with Darimont primary cell, 100-v. H.T. battery, Becc L.S., 1 pr. phones, 0.06 valves on sprung holders. Complete equipment contained in case.
Venus Radiophone Co., 1, Percy St., Fartown, Huddersfield.	V.R. IV. Portable.	Leather	Portable, for suspension.	1	1	2	25 10 0	Complete with valves, batteries, L.S. and aerial and earth equipment.
" " "	V.R. III. Portable.	" " " "	" " " "	—	1	2	20 0 0	" " " "
White & Ritchie, 104, Raeburn Place, Edinburgh.	D.S. 3 Portable.	Oak (batteries enclosed in case).	" " " "	2	1	2	37 10 0	Complete with aerial wire, earth mat, 3 0.3 valves, 100-v. H.T. battery, 2-v. Oldham unspillable L.T. accum., 9-v. grid battery and 2 prs. Brown A phones or Sercnado Model 30 L.S. at buyer's option.

Summer Wireless—

finding our receiver out of action at the end of our journey when we want to use it. Many designers will advise the use of flexible wire for all connections for a portable set. This may be a very sound policy, but it is also rather an indication of laziness or lack of confidence in the way in

we move farther afield, however, it becomes necessary to take our set with us, and many are the opportunities which present themselves for utilising a portable set out of doors. A lazy afternoon or evening on the river, a picnic party, or a dance on the lawn after tennis—all are excellent occasions when wireless can be called in to assist

Now a word as to the legal aspect of the use of a portable set. The Post Office requires to know the name and address of every user of a receiver. The address is essential in order that the Postmaster-General may have the information which he is required to record regarding the location of all wireless receiving apparatus. On this account the Post Office stipulates that a licence for a portable receiver will only be granted to persons already



THE DUODYNE PORTABLE IV. is entirely self-contained; no aerial, no earth and no exterior connections.

which the wiring is done. A really sound job in stiff wiring is probably preferable to using flexible wire, but the latter will obviate some trouble for those whose ability to solder well is in doubt.

The added enjoyment to be derived from the use of wireless out of doors during the summer months is un-



THE CURTIS PORTABLE SUPER-HET 8. Specially designed for the convenience of yachtsmen, explorers, travellers, motorists, &c., where compact design and portability are essential.

in possession of an ordinary fixed-station licence. The Post Office does not, however, demand that an additional licence should be taken out if the use of the portable receiver is only occasional. The portable receiver licence would become necessary if a set were regularly taken out with a car or under any circumstances when the use ceases to be "occasional." The special portable receiver licence can be obtained on application at any post office in the same way as the ordinary licence is acquired. As a word of advice to readers, it would be well when using a set away from the address at which the permanent set is registered to remember to carry the licence with you, because the police are authorised to make enquiries if they think fit where a set is seen in use out of doors, and the ability to produce a licence on the spot may save the user trouble or inconvenience.

Finally, we would strongly recommend our readers not to delay in the matter of acquiring a portable set. Many people must already have regretted that a portable set was not available for the Easter holidays. Whether your decision is to buy a portable set or to make your own, do it now, instead of delaying as you did last year, only to regret it when it was too late to be worth while.



THE MARCONIPHONE PORTABLE V2 is fitted with dry batteries and is provided with a portable aerial for suspending from a tree or post. Complete with one pair of headphones in canvas case.

limited. The sudden burst of fine weather which came with the Easter holidays must have made every devotee of broadcasting turn his thoughts to a portable set. For use at home, in the garden, portability of a set is probably not essential, because the loud-speaker or telephone leads can be extended from the set as required. When



By H. A. HANKEY.

A FEW years ago to many settlers in outlying parts of the world the only event which marked the passing of time, was the arrival of the mail. This was awaited for weeks; when it did arrive and had been consumed, the settler settled down once more to hope for the next. In the meantime, the news was discussed and handed round to neighbours. The man who usually received a large mail excited considerable, albeit concealed, envy. Residents without friends or relations in the Old Country would saunter nonchalantly to the letter rack and indolently scan the names of the fortunate ones.

During a long and varied career as a wireless engineer in all parts of the Empire I have had ample opportunity for gauging the value of wireless as a means of communication between "Home" and the outlying colonies.

The erection of large wireless telegraphy stations was the first step in annihilating the thousands of miles between home and "this God-forsaken hole." (Almost all distant places are given this title after a year or two of residence, when the glamour and novelty have worn off and the memories of cool, green England become insistent.) Many of these stations sent long Press messages at regular times, and were received by operators in many parts of the globe. Local papers printed them "verbatim," and as the local news could be sent up country with comparative rapidity, the isolated engineer, plantation manager, agent, and the men filling a thousand and one different occupations, were kept much better posted as to what was going on at home.

Difficulties of Morse Reception. *

Admittedly, these messages were sent through the uninspired medium of International Morse, at a speed much too high for the average man to receive without considerable practice; but still, a beginning was made.

A development which has proved an incalculable boon to many has been the broadcasting of news and programmes. Men visiting England on leave realised how the programmes would break up the tedium of long evenings in sweltering heat, and took receivers with them on their return. Many of them, unversed in wireless theory, experienced disappointment. They found many problems, not the least of which was the power supply. Dry cells, unless specially constructed, do not work well in the tropics. Another great drawback is the prevalence of atmospherics. Some who have taken sets abroad tell me that reception is possible for only two or three nights a week, and on these nights, for an hour or two only.

I had recently a letter from a man living in India. He said: "Here, on the edge of the Sind Desert, I receive excellent broadcasting three or four times a week, but generally marred by X's."

There is great work to be done in developing broadcasting in the Colonies. Where conditions are favourable, a few stations have been erected, but the programmes are limited to local talent, and an occasional celebrity or professional artist. These stations are doing good work, but cannot supply the demand for the link with home.

A Super Receiving Station.

What is now wanted is a super receiving station, capable of picking up most of the world's broadcast programmes. Elaborate "selective" and "filtering" apparatus will be necessary to keep relays free from interference and atmospherics, and a great deal of investigation will have to be carried out to find the best type of aerial. These difficulties are large but not insuperable, or greater than those usually encountered by pioneers.

The ever-progressive B.B.C. has installed a station somewhat on these lines at Keston, with the object of relaying Continental stations. British listeners with crystal sets have been enabled to listen to programmes transmitted many hundred miles. In the near future, it is not too much to hope that the Colonies will be in the same position.

There are still gaps in the chain, but I am sure that every British Colonist is looking forward to the time when he can regularly receive programmes from home, and when the possession of a wireless set will place in his hands a key that unlocks the door of a new world where all nations offer of their best for all who care to receive.

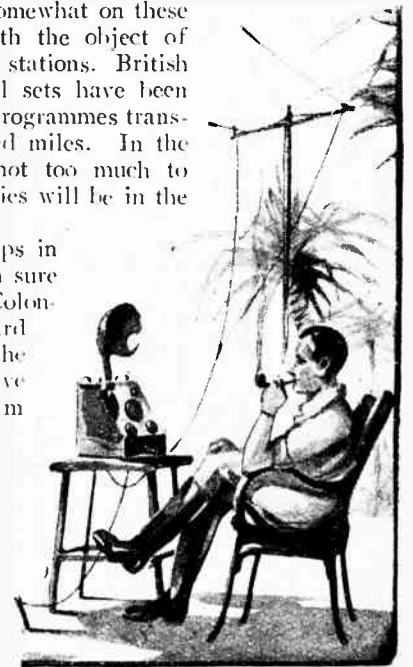

HINTS and TIPS for NEW READERS

A Section Devoted to the Practical Assistance of the Beginner.

REACTION ON A FRAME AERIAL.

There is generally some slight difficulty in applying reaction to a frame aerial circuit, as, in the majority of cases, the use of a movable plate coil is impracticable. It is, of course, possible to insert a small grid coil in series with the frame, but this plan usually calls for some reduction in the inductance of the latter. It is, however, a good method to adopt when receiving long waves on a frame designed for the 300-500 metre wave-band, as a loading coil will be required in any case.

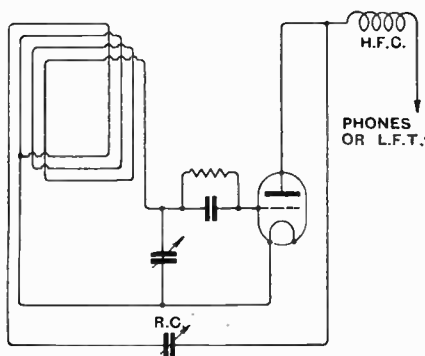

Fig. 1.—Reaction winding on a frame aerial.

Another alternative which permits of fine control of regeneration is suggested in Fig. 1. Here the reaction coil consists of a few turns of wire wound as a continuation of the end of the frame which connects to the filament end of the grid circuit. The degree of reaction is controlled by the setting of the condenser marked R.C. in the diagram, the arrangement closely resembling the well-known "Reinartz" circuit.

The number of extra turns required will depend on the degree of damping in the circuit, the size of the frame, the maximum value of the re-

action condenser, and the impedance of the H.F. choke, etc. With a condenser of 0.0002 mfd., about three turns will be ample under average conditions. This winding should be in the same direction as the grid section of the frame.

Both sides of the controlling condenser are at high oscillating potential, so an extension handle will be of assistance in reducing hand-capacity effects.

o o o o

ADDING L.F. AMPLIFICATION TO A CRYSTAL SET.

It is often suggested that users of crystal sets who wish to change over to loud-speaker reception from their local station should add a two-valve L.F. amplifier to the existing receiver. If the amplifier is of suitable design, such a course has many points in its favour, sufficient volume being obtained with excellent quality, provided that a fairly strong signal is available before amplification.

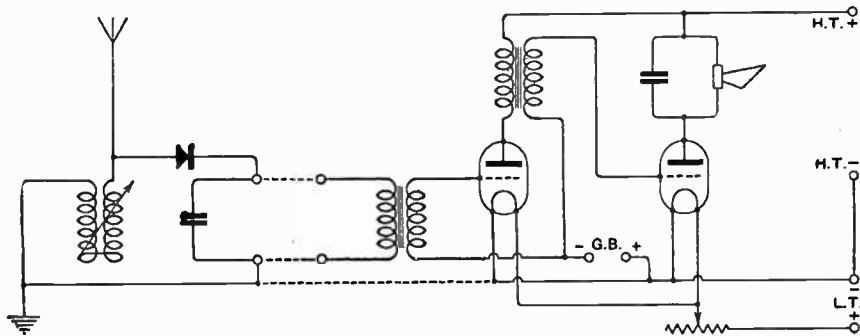

Fig. 2.—Earthing the L.T. battery.

Not infrequently, however, it will be found that a strong low-frequency howl is produced when the amplifier is connected up in the usual manner by joining the telephone terminals of the crystal set to the primary of the

first L.F. transformer. This trouble may generally be cured by earthing the negative side of the low-tension battery, as shown in dotted lines in Fig. 2. In any case, whether actual "howling" is produced or not, this connection should be added, as it will have the effect of keeping both batteries at earth potential.

o o o o

TESTING A NEUTRODYNE.

A fault in a receiver employing a circuit of some complexity can best be located by a systematic stage-by-stage test. Occasionally, when favoured by good luck, it is admitted that one is able to arrive at the source of the trouble by proceeding in a haphazard manner, but such a method is distinctly to be avoided, except, perhaps, when dealing with a set with which one is thoroughly familiar.

A case in point is that of a conventional neutrodyne with two H.F. stages, which cannot be stabilised, or

perhaps even worse, which refuses to oscillate or amplify. If the application of the usual and more obvious tests fails to reveal the trouble, it is advisable to test each amplifying stage separately, as in all probability

the transformers and other apparatus associated with each valve are similar, and when one stage is put right it should be comparatively easy to apply the knowledge gained to the other.

Luckily, this test may be made in a very simple manner, without in any way disturbing the wiring. It will be sufficient merely to withdraw the first valve from its holder, and to connect the aerial lead-in direct to the plate socket, at the same time setting the first neutralising condenser at minimum capacity. If the negative side of the L.T. battery is not already earthed, the necessary connection should be added.

An examination of the circuit diagram of a typical neutrodyne receiver under these conditions will show that the first H.F. valve is now eliminated, and that the primary of the first transformer is acting as an "untuned" aerial coil, the circuit to earth being completed through the H.T. battery or its shunting condenser. If this primary winding has a somewhat greater number of turns

than is usual, it will be desirable to connect a variable condenser, set at a low value, in series with the aerial, in order to reduce damping. The problem of putting the second stage in order may now be attacked.

If it is now found to be impossible to stabilise the receiver, connected up in this manner, it will clearly be a hopeless task to endeavour to obtain results when both H.F. valves are in circuit, and the effect of alterations to the primary and neutralising windings should be tried. It will also be possible to observe the effect of a change in the relative positions of the two coils, as magnetic interaction between them may very possibly be responsible for the trouble.

o o o o

GALVANOMETER INSULATION TESTS.

It is good practice to test across the H.T. terminals of a newly constructed receiver in order to make sure that the insulation is adequate, as the voltage applied will be fairly high and the results of a complete or partial short-circuit may be serious.

Even if there is only a small leakage the life of the high-tension battery will be considerably reduced.

This test may be carried out with a pair of headphones and a dry battery. If a galvanometer or microammeter is available, a much more accurate idea of the insulation resistance may be obtained, but care should be taken to avoid damaging the more sensitive type of instrument, which may be harmed by passing too heavy a current through it.

The H.T. terminals are usually shunted by a condenser of large capacity, and even if the insulation as a whole is beyond reproach, an excessive current may flow momentarily while this condenser is charging up. To avoid risk of damage, it will be advisable to short-circuit the testing instrument while the connections are being made, and to adopt the same precaution before disconnecting. It is assumed that before this test is made some rough-and-ready method of showing the absence of a complete short-circuit in the receiver will have been tried.

DISSECTED DIAGRAMS.

No. 26.—Wiring a "Reflex Neutrodyne."

This series of sketches, originally intended to assist readers in understanding circuit diagrams, has been extended to show those connections which are at low and high oscillating potential; the latter require good spacing with respect to other leads.

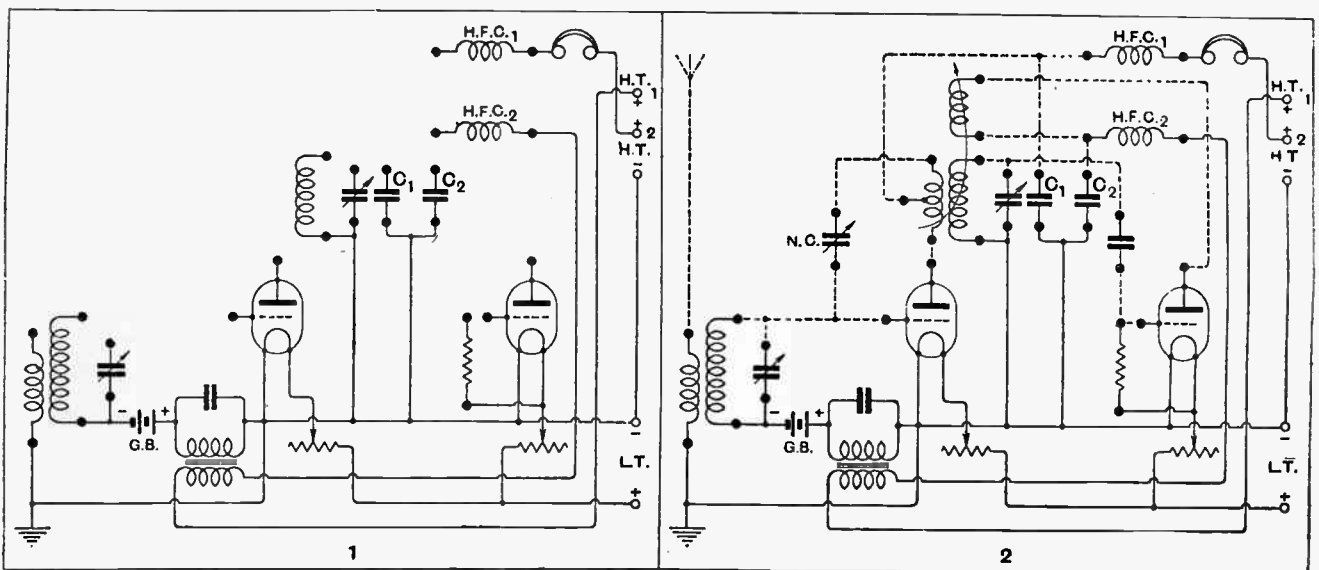

All filament and other low-potential leads are shown above.

The complete circuit diagram. The high potential leads are shown in dotted lines.

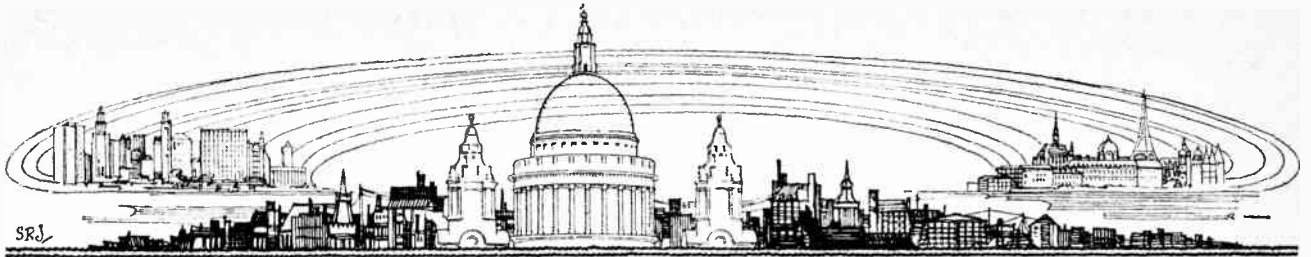

CURRENT TOPICS

Events of the Week in Brief Review.

POPOFF BROADCASTING STATION.

The name Popoff has been given to the new broadcasting station at Sokolonika, Moscow, in memory of the Russian wireless pioneer, Professor Popoff.

NO PEACE FOR THE PIRATE.

The career of the wireless pirate is being rendered increasingly perilous by the organised searches which are now being conducted by the postal authorities. Official visits to fourteen houses in Paglesham, Essex, have resulted in the discovery of four defaulters. Fines of 10s. were exacted in each case.

THE LIGHTNING DANGER.

The advent of warmer weather, and the consequent risk of thunderstorms, furnishes a reminder of the desirability of earthing the wireless receiver when not in use. During the Easter holiday a Romford house was set on fire by lightning, due to the fact, it is believed, that the wireless aerial had been struck. No shorting switch had been fitted.

FOUR WAVELENGTHS FROM BERLIN.

Four simultaneous broadcasts of the same programme are now carried out regularly from Berlin, the wavelengths being 1,300, 571, 540, and 100 metres. The 100-metre transmission is carried out from the Funk-Steinde station under the direction of the German Post Office, with the object, it is understood, of giving listeners both at home and abroad, some opportunity of making comparison between the long and short wavelength.

WIRELESS TRANSMISSION OF PICTURES.

A practical demonstration of the wireless transmission of photographs is to be given this evening (Wednesday) before the Tottenham Wireless Society, by Mr. F. H. Haynes, assistant editor of *The*

Wireless World. The meeting will be held at 10, Bruce Grove, Tottenham, and will open at 8 o'clock.

WIRELESS AT THE PARIS FAIR.

The majority of French wireless manufacturers will display their products at the Paris Annual Fair, which opens on

THE RUGBY WIRELESS STATION.

At this evening's meeting of the Wireless Section of the Institution of Electrical Engineers, to be held at the Institution, Savoy Place, W.C.2, at 6 o'clock, Mr. E. H. Shaughnessy, O.B.E., will give a lecture entitled "The Rugby Radio Telegraphy Station."

The Radio Society of Great Britain will hold an informal meeting at the Institution at 6 p.m.

A POLYGLOT STATION.

Attention is being drawn to the cosmopolitan character of the transmissions from the Dublin station. On a recent evening Irish, English, German and Latin were all featured, while items have also been given in French, Italian and Welsh.

NEW TRAFFIC MANAGER FOR A.R.R.L.

A successor to Mr. F. H. Schnell, late Traffic Manager of the American Radio Relay League, has been appointed in the person of Mr. F. E. Hlady (1 BDI), who served as acting traffic manager in 1925.

MESSAGES TO RUSSIA.

The Marconi Company announces that private and commercial telegrams will now be accepted for wireless transmission to Moscow or any part of Russia, facilities having been arranged for rapid distribution.

REPORTS INVITED ON AUSTRALIAN BROADCASTING.

The high power broadcasting station 2FC at Pennant Hill, Sydney, Australia, to which reference was made in these columns last week, has an aerial 400 ft. long. Reports from British listeners who hear this station's transmissions will be welcomed by the British Broadcasting Company, 2, Savoy Hill, W.C.2. We understand that 2FC operates on 1,100 metres.

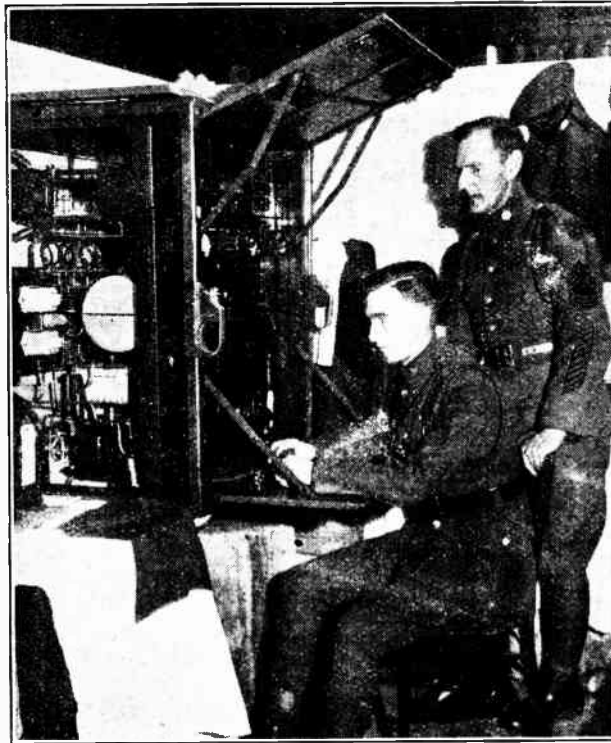

A HALF-KILOWATT PORTABLE. A photograph taken at the recent exhibition organised by the American Radio Relay League in New York, showing the latest type of U.S. Army portable telegraphy and telephony transmitter. Although employing a power of 500 watts, the set can be erected and put into operation in a very short space of time.

May 8th at the Porte de Versailles. It is stated that the radio section will be a great improvement on those of previous years.

There are distinct indications that the popularity of wireless in France is on the increase.

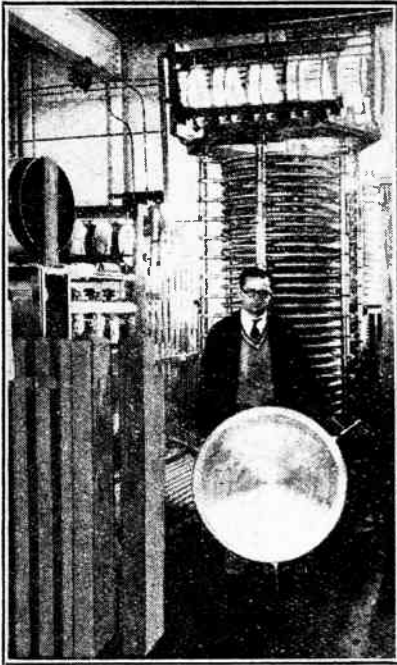

A CONDENSER PLATE AT WGY. The famous 50-kW. station at Schenectady, New York, employs concave condenser plates of the type shown to minimise capacity changes due to mechanical vibration.

WIRELESS: THE SCAPEGOAT.

In connection with the strange case of trance which has occupied public attention during the past fortnight, several correspondents in the daily Press have tried to place significance on the fact that the victim was listening-in at the time she fell into her long sleep. This is one more link in the chain of evidence showing that the "silly season" persists all the year round.

HIDDEN ADVERTISEMENTS COMPETITION.

In "The Wireless World" Hidden Advertisements Competition for the issue of March 31st no competitor gave the correct solution. The prizes are awarded to those competitors whose solutions were most nearly correct.

The following are the correct solutions:

Clue No.	Name of Advertiser.	Page
1	Dubilier Condenser Co. (1925), Ltd.	ii
2	Telephone Manufacturing Co., Ltd.	4
3	Igranic Electric Co., Ltd.	iv
4	British Electrical Sales Organisation.	7
5	London Electric Wire Co.	9
6	Bowyer Lowe Co., Ltd.	13

The following are the prizewinners:

N. L. Hammond, Gosport	£5
Mrs. Irene Kramer, Dunstable	£2
W. F. Howard, London, S.E.20	£1

Ten shillings each to the following:

W. J. Baden, Watermael, Belgium.
A. L. Rimer, Warkworth, Northumberland.
T. R. Scott Barrow-in-Furness.
A. Holmes, Crouch End, N.8.

FAILURES IN GERMAN WIRELESS INDUSTRY.

In spite of the widespread increase in the number of listeners in Germany, says the report of the Association of the Broadcasting Industry for 1925, numerous broadcasting undertakings failed owing to general trade depression.

IMPERIAL AIRWAYS WIRELESS.

The five new multi-engined Handley-Page air liners delivered to Imperial Airways, Limited, at Croydon, on March 30th, and christened by Lady Maud Hoare, are being equipped with standard type Marconi A.D.6 wireless installations for telephonic and telegraphic communication. This wireless apparatus is the standard fitting for all Imperial Airways passenger machines, and enables the pilots to keep in constant communication with the ground stations throughout their flights.

GETTING DOWN TO IT.

A listener at Manitou, Colorado, has discovered that, by taking his broadcast receiver 2,000 ft. down into a neighbouring cave, he eliminates atmospheric and interference from local oscillators. Unfortunately caves in Great Britain are few and far between.

PERSIAN WIRELESS STRIDES.

An unmistakable indication that Persia is endeavouring to keep abreast of Western civilisation is afforded by the news that the Government is erecting a large wireless station at Teheran, together with a chain of six smaller stations in other parts of the country. The Teheran station, it is hoped, will have a radius of communication extending as far as Paris.

The Persian War Ministry, which controls the stations, has established a large wireless training school.

CINEMATOGRAPHY AND TELEVISION.

In his course of lectures on Cinematography, before the Royal Scottish Society of Arts, Edinburgh, Captain James W. Barber, C.B.E. Managing Director of the Brownie Wireless Co. (Great Britain), Ltd., will draw attention to the possibilities of television.

The first lecture was given in the Music Hall, 54, George Street, Edinburgh, on Monday last, and the remaining two lectures will be delivered on April 26th and May 12th respectively. Full particulars are obtainable from the Secretary, Mr. C. Norman Kemp, at 117, George Street, Edinburgh.

ITALIAN STATE WIRELESS.

The Fascist regime in Italy, according to a report we have received from the Ministry of Ways and Communications, has brought about an immense improvement in the country's wireless service, the plant and service having been modernised in every possible direction. The report, in the form of a booklet, is

issued by the Italian State Railways, the London Agency being situated at 12, Waterloo Place, Regent Street, S.W.1.

THE DUBILICON.

In connection with the advertisement of Messrs. the Dubilier Condenser Co (1925), Ltd., appearing on the back cover of this issue, we are asked to state that, owing to unforeseen difficulties in packing, it has been found that "The Dubilicon" will not be available to the public for another ten days or so.

AMATEUR ACHIEVEMENT RECALLED.

The achievements of British amateurs in securing communication with the Hamilton Rice Expedition to Brazil in 1924 were recalled by Dr. Hamilton Rice in his recent lecture before the Royal Geographical Society.

A transmitter with a power of only 100 watts was carried by the expedition into the forests of Northern Brazil, and here they established touch with Mr. Gerald Marcuse (2NM), of Caterham. On one occasion, said Dr. Rice, when a private message was sent to England, a reply was received in seven and a half minutes.

FRENCH WIRELESS FROM WITHIN.

The French postal administration, it appears, is the butt of some unpleasant allegations which are being made by the *Echo de Paris*. This journal complains that the postal authorities have secretly devoted large sums of money for wireless construction without the consent of Parliament.

"The French nation," says the *Echo de Paris*, "has been presented with a chain of wireless stations that are the laughing stock of wireless enthusiasts and a discredit to French science and industry."

Some interesting details may come to light when the question is referred to the Government.

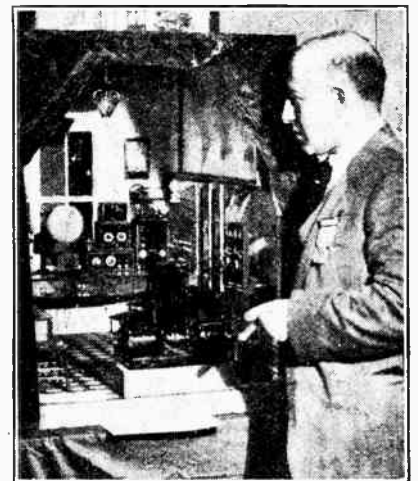

RADIO IN MINIATURE. An ingenious model of a completely equipped amateur transmitting plant, on view at the A.R.R.L. Exhibition in New York. The constructor, Mr. F. Frimerman (2FZ), is seen standing by his exhibit.

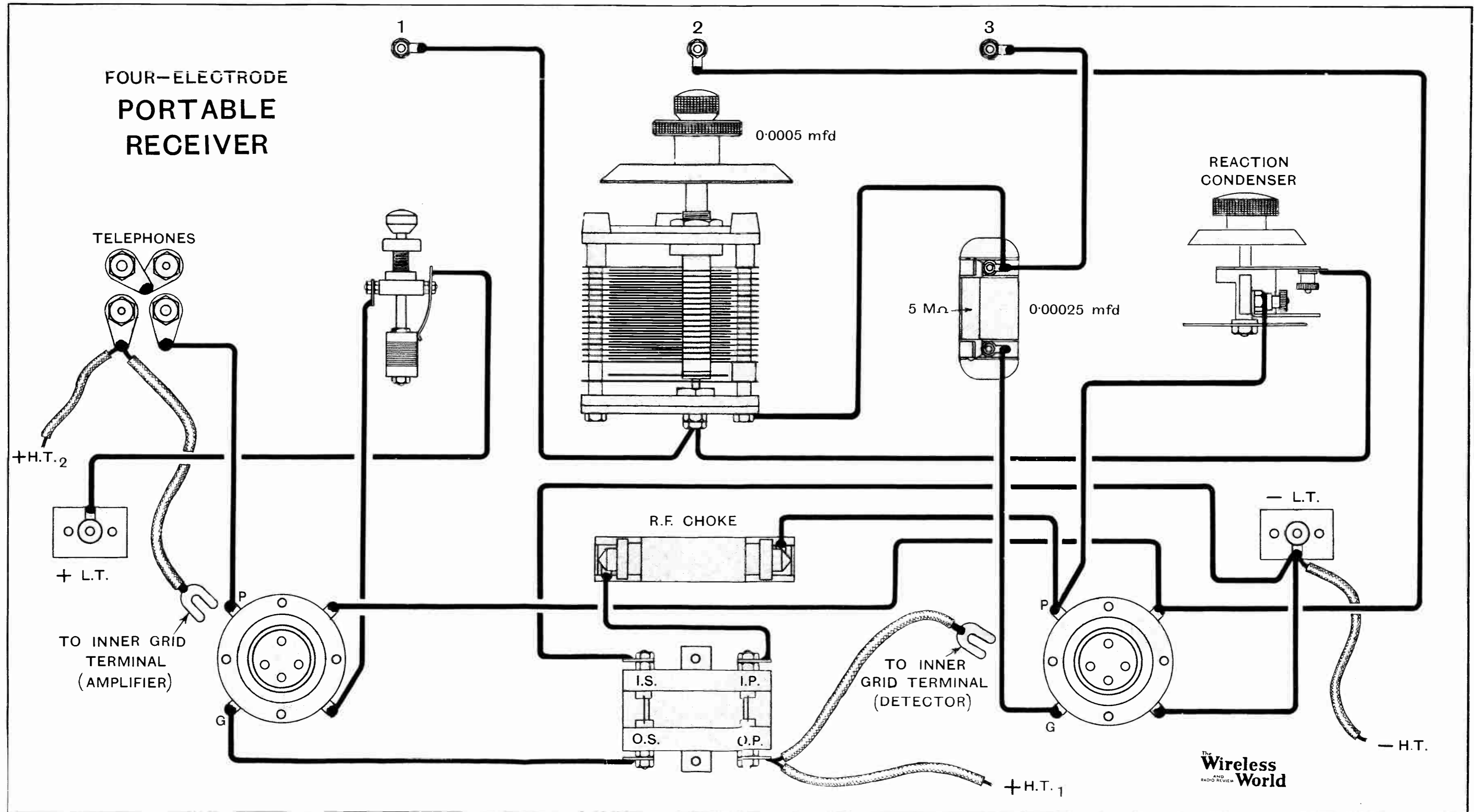



PIONEERS of WIRELESS

BY ELLISON HAWKS F.R.A.S.

13.—J. W. Wilkins Proposes Wireless Communication with France.

IT is the fate of many workers that their suggestions and inventions—though perhaps practical enough—do not always see the light of day at the time of their inception. In many cases this is not due to any fault of the inventor himself, who often enough is the victim of adverse circumstances and has not the means to back up his work. In many such cases the invention is cast aside and forgotten until years afterwards, when another worker in the same field stumbles across the same idea or independently produces a similar device. Naturally he is often chagrined to find the original inventor indignantly accusing him of piracy! In almost every branch of science such instances may be found, and wireless is no exception.

In the *New York Electrical Engineer* of May 29th, 1895, a claim was made that Professor Trowbridge was the first to telegraph without wires, in 1880. This announcement brought an indignant letter from J. W. Wilkins, an official of Messrs. Cooke and Wheatstone.

Wilkins pointed out that thirty years before Professor Trowbridge was stated to have made his experiments, he (Wilkins) had carried out experiments on the same subject and had published the result of his investigations in 1849 under the heading *Telegraph Communication between England and France*. He had then explained "as to how the thing was to be done."

It appears that he proposed to erect lengths of telegraph wires on the English and French coasts, with terminals dipping into the earth or sea, and as nearly parallel as possible to one another. He expressed the opinion that some part of a discharge of current through the circuit on one side of the water would flow through the intervening water from one pair of earth-plates—terminals of one circuit—to the second pair of earth-plates on the opposite shore.

His suggestions for telegraphing without wires between England and France were thus on similar lines to the well-known conduction systems of Sömmering, Morse, Lindsay, and others.

Wilkins relates that it was in the year 1845 that he came to

suppose telegraphy without wires would be possible. While engaged on the only long line of telegraph then existing in England—London to Gosport—his observations led him to question the accepted theory that a current of electricity, discharged into the earth at each end of a line of telegraph, sped in a direct course—instinctively, so to say—through the intervening mass of ground to meet another current or to find a corresponding earth-plate and so complete the circuit. He tells us that he could only bring himself to think that the earth acted as a reservoir or condenser, receiving and distributing electricity almost superficially for some certain or uncertain distance around the earth terminal.

A year later, while occupied with the installation of telegraphs for Messrs. Cooke and Wheatstone, he had a good opportunity of testing his theory on lengths of wire erected on both sides of a railway. To succeed in this experiment and to detect the very small amount of electricity likely to be available in such a case, he realised he must use a very sensitive galvanometer. He constructed such an instrument on the principle of the influence of magnetism upon a wire conveying an electric current, and with this instrument he succeeded in obtaining signals between lengths of elevated wires about 120ft. apart.

He believed that if the poles of a battery were connected to any extended conducting medium, the current would diffuse itself in radial lines between the poles, and that it might be "collected within a certain distance—focussed as it were—by the interposition of a metallic medium that shall offer less resistance than the water or earth; and, obviously, the nearer the battery, the greater the possibility of collecting them. I do not apprehend the distance of twenty miles being at all too much to collect a sufficient quantity of the electricity to be useful for telegraphic purposes. If, then, it is possible, as I believe, to collect in France some portion of the electricity that has been discharged from a battery in England, all that is required is to know how to deal with it so that it shall indicate its presence."

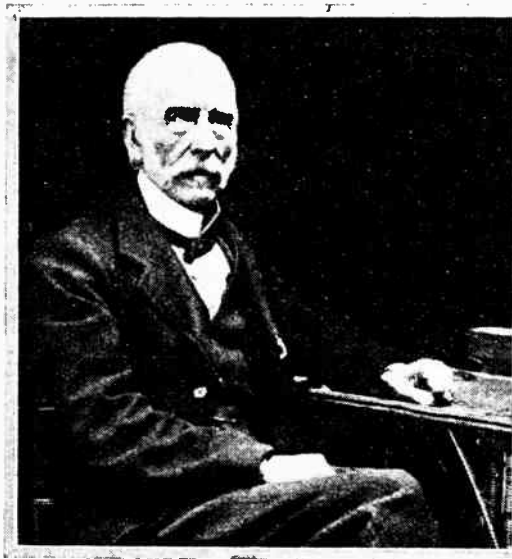

J. W. Wilkins.

Pioneers of Wireless.—

He proposed to have on the English shore a battery discharging into the earth or sea, with a distance between its poles of five, ten, or twenty miles. A similar length of wire was to be erected on the French coast, with its ends also dipping into the earth or sea. In this circuit was to be connected an instrument consisting of "ten or more round or square coils of the finest wire of the best conductivity" suspended between the poles of a magnet. Any current passing through the coil would be indicated by its moving or shifting its position with reference to the poles of the magnet, so constituting a receiving apparatus of a delicate character.

Discussing his proposals, Wilkins subsequently stated that all thought of induction was absent in his first experiments, and that although he modified his views a year or two later, he did not attach sufficient importance to the matter to follow up his previous published suggestions, especially as at that time a cable was actually laid across

the Channel. He pointed out also that whatever his opinion might have been originally as to the source of the current in the distant and disconnected circuit, the result was the same.

He claimed that the means he used to obtain his results were "the same in principle as those that make the matter an accomplished fact to-day, viz., elevated lengths of wire, and the discharge of electricity from the one to a delicate receiving apparatus in the circuit of the other."

Although nothing came of Wilkins' suggestions, it is only due to him that he is given a niche of honour among the "Pioneers of Wireless," for the germ of a practicable idea was undoubtedly present in his experiments.

It only remains to mention that his proposed receiving apparatus—a most delicate form of detector or galvanometer—was identical in principle with Lord Kelvin's apparatus for long cable working, which, in the specification of his siphon recorder patent, he claims to be as sensitive as his mirror galvanometer.

The Trend of Design.

The marked improvement in the quality of components now available to the public was one of the points stressed by Mr. G. F. Jones in his lecture before the Sheffield and District Wireless Society on March 12th.

Taking as his subject "The Trend of Modern Radio Design," the lecturer provided a reasoned survey of development in circuits, components, and complete receiving sets. The question of hornless loud-speakers mentioned by Mr. Jones provoked a lively discussion.

Hon. Secretary: Mr. T. A. W. Blower, 129, Ringinglow Road, Sheffield.

○○○○

Broadcasting from Within.

Mr. Alan Andrews, the Chief Engineer of the Belfast Broadcasting Station, entertained the members of the City of Belfast Y.M.C.A. Radio Club with a fascinating account of broadcasting methods on March 10th. The entire system of broadcasting was explained, from the studio to the aerial, the lecturer detailing the methods of control, amplification, etc., and the difficulties encountered in "outside" broadcasts. Mr. Andrews' lecture was illustrated by a number of excellent lantern slides and blackboard sketches.

Hon. Secretary: Mr. John J. Cowley, 4, St. Paul's Street, Belfast.

○○○○

New Appointments in North Middlesex Club.

At the annual general meeting of the North Middlesex Wireless Club, held on March 17th, Mr. F. T. Chapple was elected president, other appointments being as follow:—Hon. treasurer, Mr. H. A. Crouch; hon. secretary, Mr. H. A. Green; installation officer, Mr. W. Garland; and librarian, Mr. F. C. March.

The treasurer's report showed a favourable balance, and the balance sheet was unanimously adopted, while the secretary's comprehensive report of the society's activities during the year was also received with satisfaction.

A 26

NEWS FROM
THE CLUBS.**A Visit to the G.E.C. Laboratories.**

Mr. L. F. Fogarty, M.I.E.E., gave an instructive lecture on "Characteristic Valve Curves and their Interpretation" before the Golders Green and Hendon Radio Society on March 18th. A visit has been arranged to the G.E.C. Laboratories at Wembley for Saturday, April 24th, at 3 p.m. All members who intend to join the party are asked to notify

the hon. secretary, Lt.-Col. H. A. Scarlett, 357a, Finchley Road, N.W.3. The party will meet at the entrance to the Laboratories.

○○○○

A Radio Fellowship.

Several interesting meetings have marked the activities of the Oglander Radio Fellowship during the past month. Particular interest was aroused by Mr. Tibbetts' demonstration of a five-valve neurodyne on March 17th. On March 17th the society was presented with an excellent loud-speaker horn by Mr. A. Vigus. Work is now proceeding on the construction of a club set.

Hon. Secretary: Mr. James Sewell, Senr., 25, Wingfield Street, Maxted Road, Peckham, S.E.15.

○○○○

Bournemouth Wireless Conference.

Excellent progress is being made by the Bournemouth Radio Society in arrangements for a conference of wireless enthusiasts, to be held at Bournemouth on Monday, April 26th.

Not only is the Mayor of Bournemouth taking an active part, but Sir Henry Page Croft, Bart., M.P., C.M.G., also hopes to attend. Several interesting lectures have been arranged, the speakers being Sir Dan Godfrey and Prof. A. M. Low.

Particulars of the conference, and of arrangements made for the convenience of visitors, may be obtained from the Hon. Secretary, Mr. H. J. Bliss, 140, Old Christchurch Road, Bournemouth.

○○○○

A "Junk Sale."

The Inland Revenue Radio Society scored a record attendance on March 19th, when Mr. W. J. Ricketts, of Messrs. Alfred Graham and Co., gave an illustrated lecture on the manufacture and operation of loud-speakers. The society's annual general meeting is to be held on Friday, April 16th, and will be followed by a "Junk Sale."

Hon. Secretary: Mr. W. J. Tarring, C2, York House, Kingsway, W.C.2.

FORTHCOMING EVENTS.**WEDNESDAY, APRIL 14th.**

Institution of Electrical Engineers, Wireless Section. At 6 p.m. (Light refreshments at 5.30.) At the Institution, Savoy Place, W.C.2. Lecture: "The Rugby Radio Telegraphy Station," by Mr. E. H. Shaughnessy, O.B.E.
Radio Society of Great Britain, Informal Meeting. At 6 p.m. At the I.E.E. Burnley and District Wireless Association. At 8 p.m. At 22, Market Street.
Tottenham Wireless Society. At 8 p.m. At 10, Bruce Grove. Demonstration of Wireless Transmission of Pictures, by Mr. F. H. Haynes, Asst. Editor of "The Wireless World."
Edinburgh and District Radio Society. At 117, George Street. Lecture: "The Mullard Valve" (communicated).
Hackney and District Radio Society. At 8 p.m. Demonstration on Club's set.

THURSDAY, APRIL 15th.

Golders Green and Hendon Radio Society. At 8 p.m. At the Club House, Wiltid Way. Lecture: "Frequency in Relation to Broadcasting," by Mr. J. A. H. Whitehouse (of the B.B.C.).
Southport Radio Society. At 7.30 p.m. In the Temperance Institute, London Street. Lecture: "General Broadcasting," by Mr. Bird, of ZZY.

FRIDAY, APRIL 16th.

Sheffield and District Wireless Society. At 7.30 p.m. At the Dept. of Applied Science, St. George's Square. Lecture: "Selectivity," by Mr. Rayner.

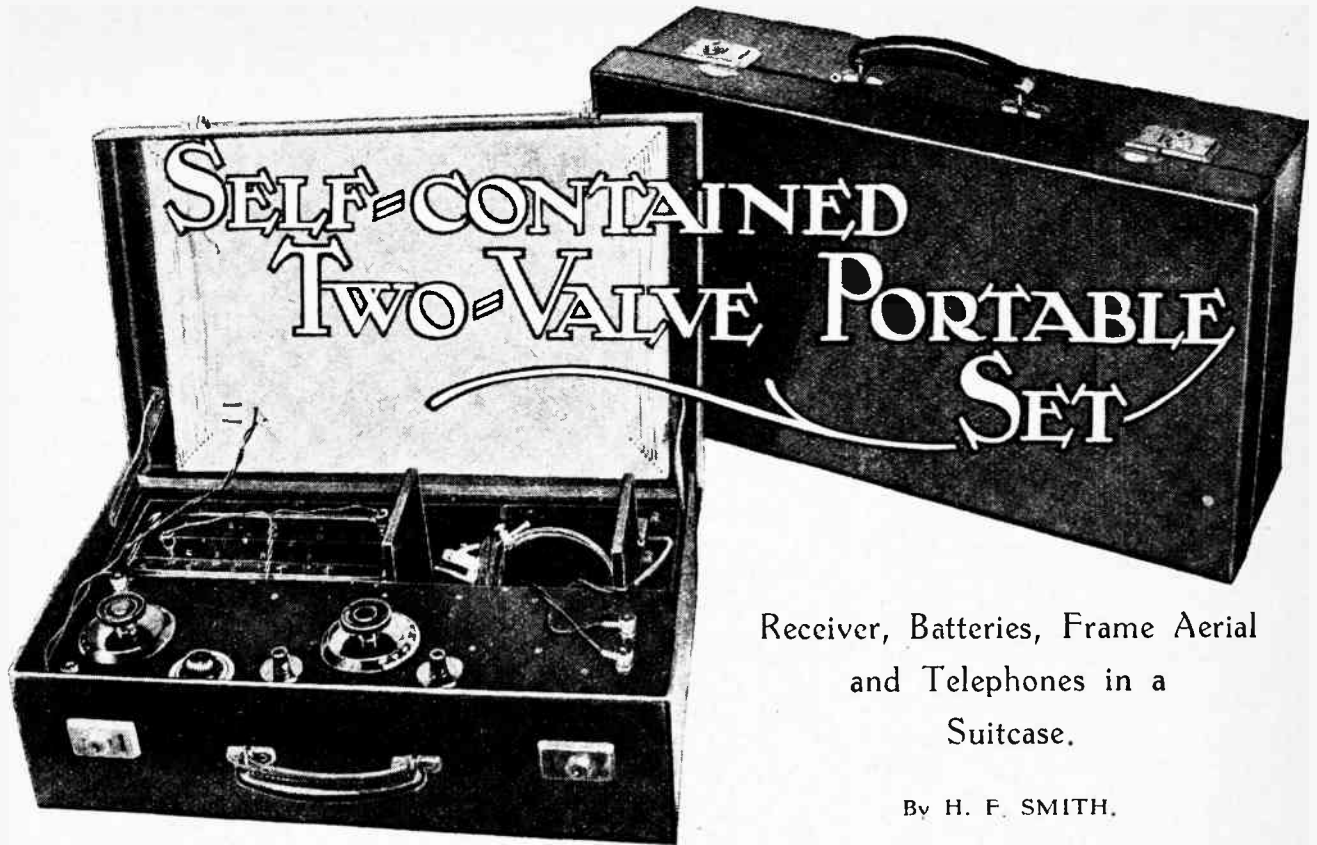

IT is fairly obvious that the most important considerations in the design of a portable receiver are light weight and compactness; a heavy and bulky outfit is likely to be of very limited utility, and to become, after a while, anything but a source of entertainment to its owner. These stipulations would seem at once to preclude any attempt to obtain loud-speaker reproduction, as the quality and volume which most of us expect cannot be achieved without the use of considerable high-tension voltages, with consequent increase in weight.

A possible exception to the above is the receiver intended primarily for use in a car, or at least to be carried in one. In this case the reduction of weight is not of prime importance, and in some circumstances it will be desirable to take advantage of the car battery as a source of filament current.

The majority of us, however, who feel the need for a portable set at all will require a light and entirely self-contained instrument giving reception of at least one broadcast programme with the minimum of trouble both as regards operation and transport. In this article it is proposed to de-

scribe a set of this type which seems to have the largest field of usefulness from the point of view of the average user.

If the full benefit of portability is to be obtained, it seems essential that the receiver should be really self-contained, and that the gain in efficiency resulting from the use of a large collapsible frame aerial is more than counterbalanced by difficulties in the carrying and setting-up of this accessory. It is realised, however, that long-range reception with an open aerial (improvised or otherwise) will occasionally be required, and arrangements have accordingly been made for this attachment.

As portables are not in common use at the present time, and are therefore apt to excite a good deal of curiosity, a certain amount of "camouflage" is of advantage if one is desirous of avoiding the sometimes rather embarrassing publicity brought about by the possession of an instrument whose function is obvious at a glance.

A simple two-valve circuit, with one H.F. stage and regenerative detector, is used. As the amount of damping imposed by the frame is negligible, the

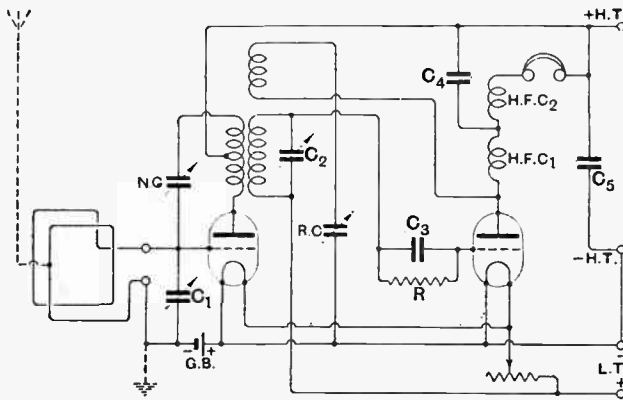

Fig. 1.—The circuit diagram of the receiver. $C_1, C_2=0.0003$ mfd.; $C_3=0.0003$ mfd.; $C_4=0.001$ mfd.; $C_5=1$ mfd.; $R=2$ megohms; N.C.=neodyne condenser; R.C.=reaction condenser, 0.00004 mfd.

Self-contained Two-valve Portable Set.—

adoption of the "neutrodyne" system of stabilising the high-frequency amplifying valve is regarded as essential if the necessary degree of sensitivity is to be obtained. Reaction is obtained by feeding back a proportion of the oscillatory anode current of the detector valve through a coil tightly coupled to its grid inductance; the actual degree of reaction is controlled by the setting of the small reaction condenser marked R.C. in Fig. 1, which shows the complete circuit diagram of the

components, and of a size suitable for fitting into a standard suitcase. The dimensions given can only be considered as a rough guide, and will, of course, depend on the inside measurements of the case actually used. That illustrated has internal dimensions of approximately 18½ in. × 11¼ in. × 5 in. deep, and may be considered as being of the minimum size permissible if the general layout as described is to be adopted. The panel and horizontal dividing partition carry all the components pertaining to the receiver itself, while the three compart-

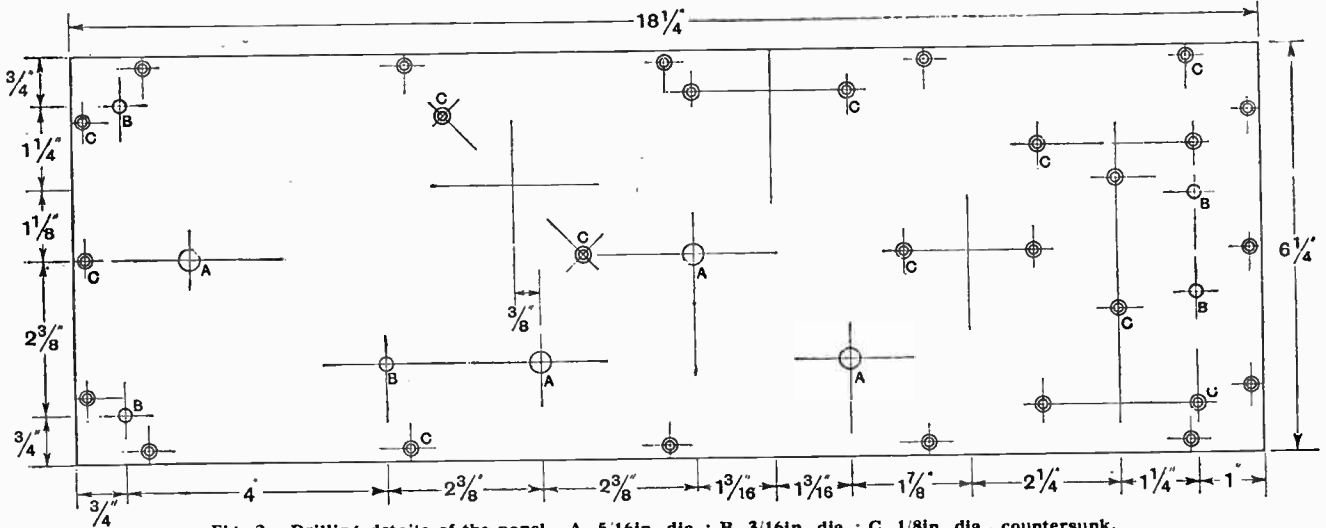

Fig. 2.—Drilling details of the panel. A, 5/16in. dia.; B, 3/16in. dia.; C, 1/8in. dia., countersunk.

receiver. It will be noticed that a single dry cell is inserted in the grid circuit of the H.F. valve in such a way as to impose a negative bias; this is added in order to effect an economy in anode current, as, from consideration of weight to be carried, the smallest commercially available high-tension cells are used. It may be omitted if desired, particularly if a low value of H.T. voltage is applied.

ments at the bottom are for the accommodation of the L.T. accumulator, phones, and H.T. battery. The actual sizes of these compartments will, again, depend on the particular types of batteries chosen. It will be seen that the dividing pieces on each side of the phone compartment are carried up sufficiently high to bear against the lid of the case when this is closed, in order to prevent risk of short-circuiting by the metal headbands, etc.

Reducing Capacity Effects.

Two high-frequency chokes are inserted in the anode circuit of the detector valve; the first (H.F.C.1) serves the usual purpose of deflecting H.F. currents through the reaction coil and condenser, while the second, in conjunction with the by-pass condenser C.4, prevents high-frequency currents from reaching the telephones. This very effectively reduces the bad effects of hand capacity, which are particularly apt to give trouble with an "unearthed" set when the operator's body is connected (through incidental capacities in the headphones) to the anode circuit of the detector valve. The grid return lead for this valve is joined to the positive side of the L.T. battery in order to impress a suitable bias for rectification.

In Fig. 6 is shown the construction of a wooden frame carrying all

Construction of the Framework.

The horizontal piece which forms the baseboard of the receiver proper is carried at each end between two wooden fillets, in order that it may be removed, together with the panel, when wiring up. All the wood used is ¾ in. mahogany, which may be obtained ready planed, thus considerably reducing the amount of work necessary. Brass screws are used throughout, and the woodwork is given a coat of stain followed by shellac varnish.

The H.F. transformer is the only home-made component used, and its construction is illustrated in Fig. 3 and in the photograph reproduced on page 565. It is similar in construction to others described recently in this journal. The secondary, consisting of 65 turns of No. 24 D.S.C. wire, is wound on an ebonite tube ¾ in.

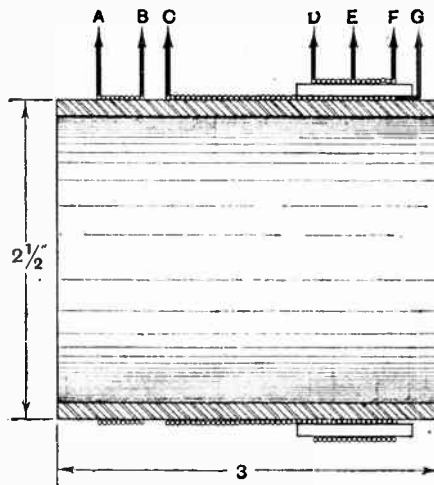

Fig. 3.—Sectional diagram of the H.F. transformer. The lettering corresponds to that in Fig. 5.

**Self-contained Two-valve
Portable Set.—**

long and $2\frac{1}{2}$ in. in diameter. Over the lower end of this winding are the primary and neutralising windings, each with 15 turns of No. 30 D.S.C. wire, separated by 12 equally spaced wooden sticks $\frac{1}{4}$ in. square in cross section and one inch long. The reaction winding, with 40 turns of No. 40 D.S.C. wire, is separated from the grid end of the secondary by $\frac{1}{4}$ in. All these windings are in the same direction.

Two light brass angle brackets are fitted for attachment to the panel, and seven No. 6 B.A. screws, with soldering tags, are inserted in holes drilled $\frac{1}{8}$ in. from the upper edge, and spaced equally around its circumference. The correct connections to these points will be clear from a consideration of Fig. 3 in conjunction with the practical wiring plan (Fig. 5), the same lettering having been adopted in both cases. Stiff wire bridging pieces are fitted for carrying the three connections from the combined primary and neutralising coil, the remainder being passed through small holes into the inside of the tube and thence to the inner ends of the terminal screws.

Assembling the Components.

The general idea of the layout of the main panel, the drilling diagram for which is shown in Fig. 2, should be followed, even if the use of a panel of some-

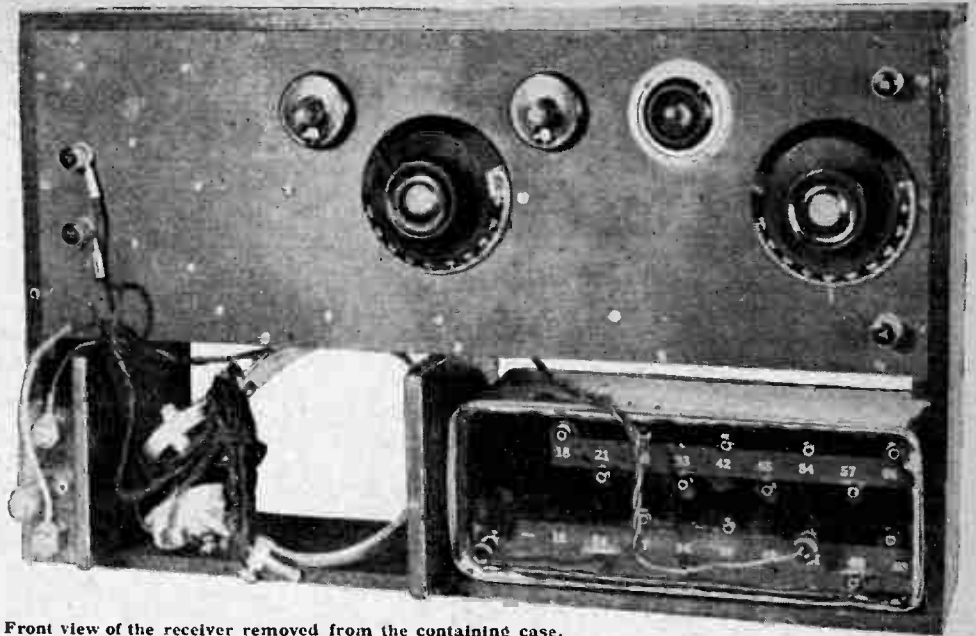

Front view of the receiver removed from the containing case.

what different shape is made necessary by the dimensions of the containing case.

The clips supporting the bias cell and the H.F. chokes are of the type obtainable from most dealers for a few pence, and are intended for the assembly of crystal detectors. If not available, they may be easily cut out of thin sheet brass. Those for the dry cell are mounted in the wooden framework by means of countersunk metal screws passing through the side.

A small ebonite terminal block, measuring $4\text{ in.} \times \frac{3}{8}\text{ in.} \times \frac{1}{4}\text{ in.}$, and carrying three double soldering tags, should be prepared. This, together with the two valve holders, are the only components mounted on the baseboard; their relative positions are indicated in Fig. 4. The use of shock-absorbing sockets is strongly recommended, as otherwise it might be necessary to remove the valves when the set is likely to be subjected to any rough treatment.

Wiring.

The wiring is carried out entirely with "Glazite" wire, No. 18 S.W.G., the insulated covering of which will minimise risk of short-circuiting if a lead should become displaced through the effects of a violent shock. Flexible leads are taken through the baseboard for connection to the H.T. and L.T. batteries; the same kind of wire is used for joining up the bias cell, in order that these leads may be easily removed if it is desired at any

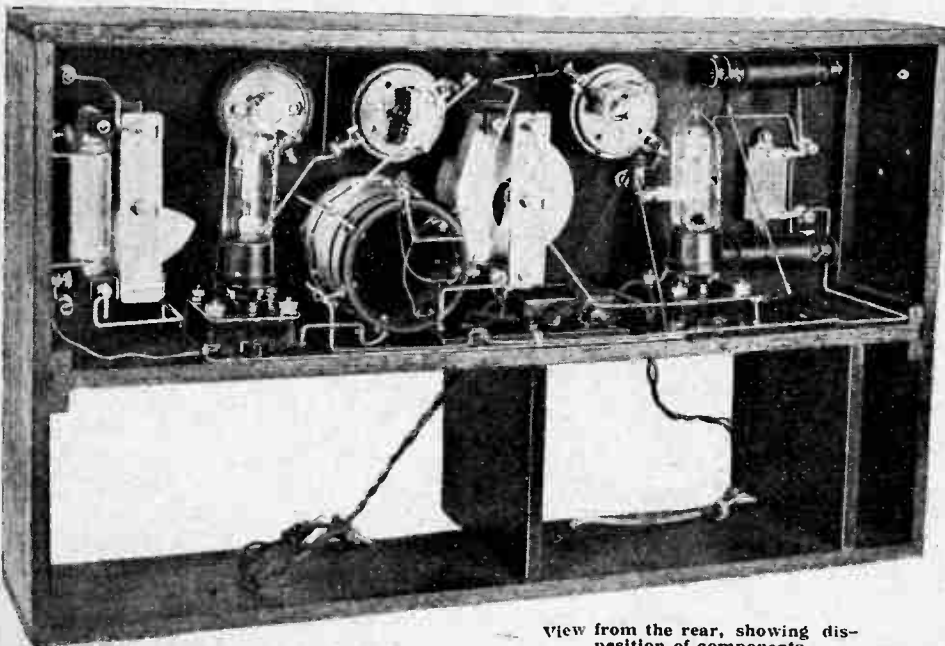

View from the rear, showing disposition of components.

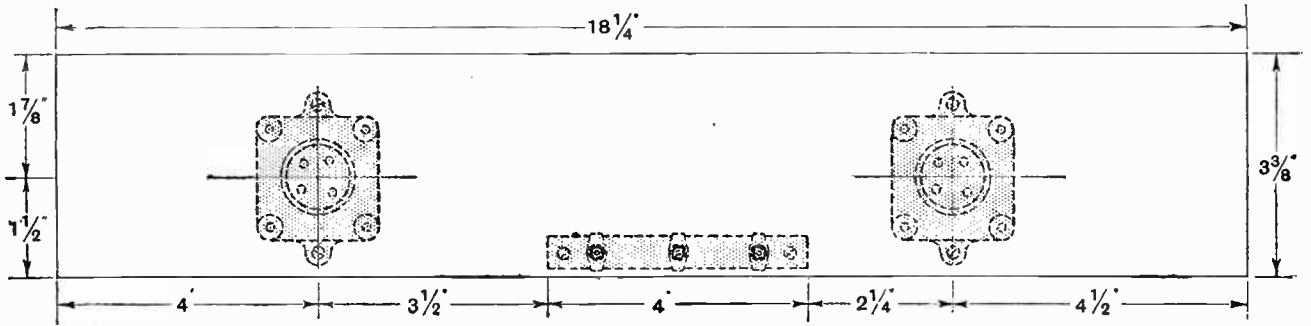

Fig. 4.—Layout of the baseboard.

time to withdraw the set from the wooden frame. A complete practical wiring plan is given in Fig. 5. This should be compared with the sectional diagram in Fig. 3.

Choice of Valves.

Choice of valves is somewhat limited as far as the actual set described is concerned, provision having been made for only a single-cell accumulator, which is of the unspillable "Exide" type M.P.2. It is essential that the first valve is of low impedance, so it is possible to use either the new Mullard P.M.2 in both positions, or a Cosmos S.P.18 Red Spot, as H.F. amplifier, and a "Green Spot" valve of the same make as detector. If two cells are used, P.M.4 valves would be suitable, while if separate rheostats are fitted, the range of choice can be extended considerably, and 0.06 amp. dull-emitters used in the detector socket with any 4-volt power valve. A high-tension pressure of 50 volts is recommended, but

this may be reduced without very greatly impairing the sensitivity of the receiver.

The construction of the frame aerial will be fairly evident from a consideration of the photograph appearing at the head of this article. It is wound with sixteen turns of No. 24 D.C.C. wire on a sheet of Presspahn measuring 17in. x 11 1/2 in., approximately 3/32 in. thick. Eight holes are drilled in each corner, spaced by 1 1/16 in. on a line at an angle of 45 degrees, with the edge. Two turns are threaded through each hole, and, in winding, it will be found easier if comparatively short lengths of wire are used, the new length being soldered on when the winding of the first has been completed. The ends of the frame are joined to flexible leads for connection to the terminals mounted on the left-hand side of the panel. A small terminal, mounted on the Presspahn sheet is connected to the third turn, counting from the inner end of the frame (that joined to negative L.T. through

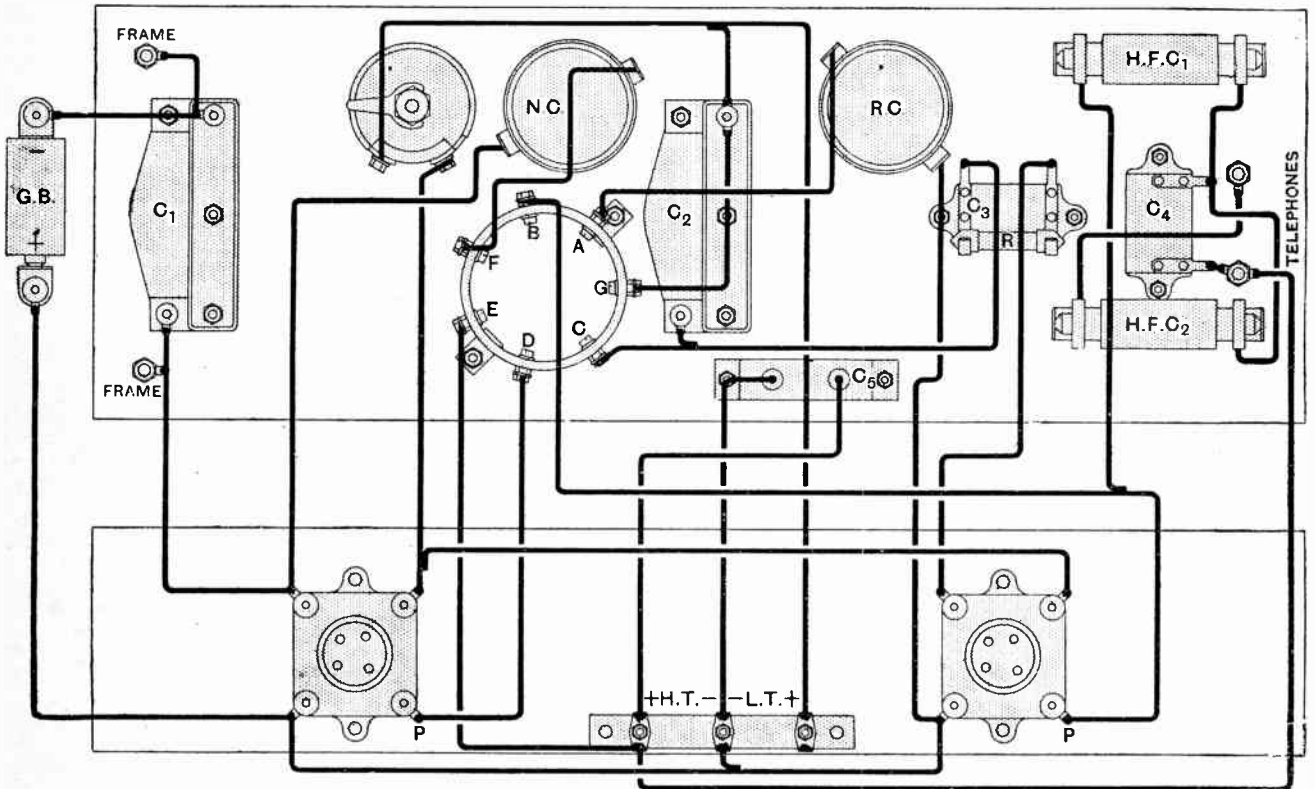

Fig. 5.—The practical wiring plan.

Self-contained Two-valve Portable Set.—

the bias battery). This terminal is for connection to an open aerial. When the set is used in this manner, the earth lead should be joined to the left-hand terminal nearest the front of the case, the actual circuit being shown in dotted lines in Fig. 1.

Neutralising.

To balance the receiver, it is advisable to temporarily disconnect the reaction condenser and to short-circuit the choke marked H.F.C.T. A signal should now be tuned in, with the neutralising condenser (N.C.) set at zero. Oscillation will normally be produced as the two tuned circuits come into resonance; the condenser should now be rotated until this ceases, and after a trial of several settings, one will be found which gives complete stability over the whole tuning range. If difficulty be experienced in balancing, it will be as well to try the effect of reversing the frame by turning it over, as there is naturally a certain amount of interaction between it and the

When the operation of balancing is completed, the reaction condenser may be re-connected, and its use will be found extremely useful in bringing up the strength of a weak signal. When maximum response is desired, it is possible to still further increase sensitivity by moving

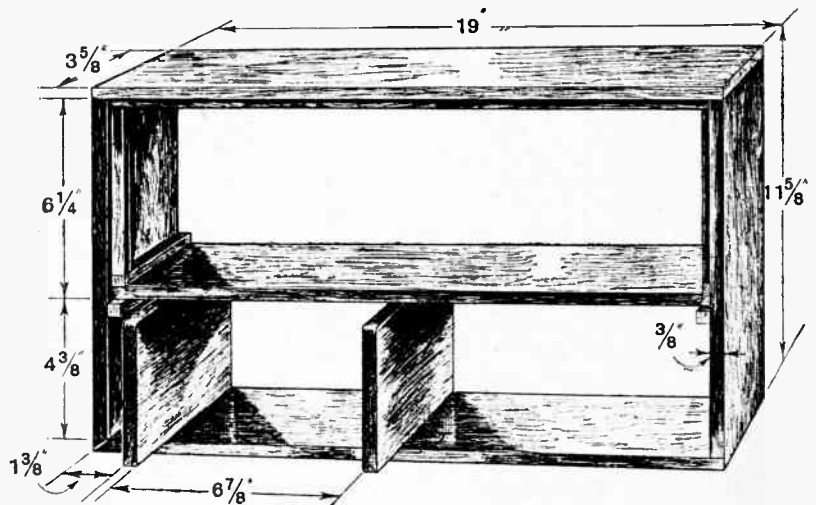

Fig. 6.—The wooden framework. The lower compartments are for the accommodation of accumulator, phones, and H.T. battery.

the neutrodyne condenser slightly away from the position giving a perfect balance.

The receiver, as described, has a wavelength range of from 250-550 metres, and under moderately favourable conditions should give comfortable 'phone signals from a main broadcasting station up to a distance of forty miles when operating on the frame alone. Naturally, a very great increase in range will result from the connection of even a moderately efficient aerial-earth system.

It should not be forgotten that even a small frame aerial, such as that described, is distinctly directional, although this effect is most marked about the position giving minimum signals.

Adding an Amplifier.

Should it be desired, at times, to operate a loud-speaker, it may be useful to know that a simple single-valve transformer-coupled L.F. magnifier may be constructed for fitting into the compartment normally occupied by the H.T. battery. This unit should be provided with two L.T. leads for connection to the common accumulator, and a positive H.T. lead, as a higher anode voltage will be necessary for the extra valve. The 'phone terminals of the receiver are connected to the input of the amplifier, which, needless to say, should include a grid bias battery.



The H.F. transformer

H.F. transformer, in spite of the fact that the disposition of the parts in the case is such as gives the maximum possible separation.

LIST OF PARTS.

- 2 Variable condensers, 0.0005 mfd. (Bowyer-Lowe).
- 2 Variable condensers, 0.00004 mfd. (Igranic Micro).
- 2 H.F. chokes (Cosmos).
- 1 Filament rheostat (Igranic Pacent).
- 1 Fixed condenser, 0.001 mfd. (Dubilier).
- 1 Fixed condenser, 0.0003 mfd. (Dubilier).
- 1 Fixed condenser, 1 mfd. (T.C.C.).

- 2 Valve holders (Benjamin).
- 1 Ebonite panel, 15in. x 6 1/2in. x 1/2in.
- 1 Ebonite tube, 3in. x 2 1/2in. dia.
- 1 Grid cell (Burndepl).
- 1 Grid leak (Dubilier).
- 1 Suitcase (Gamage).
- Wood, presspahn, wire, terminals, screws, etc.

Approximate cost, including case, but excluding valves and batteries - - £5 15s. od.



A Review of the Latest Products of the Manufacturers.

THE "BICO" VALVE SWITCH.

A new multi-contact switch of novel and intricate design has recently been placed on the market by The Burner Insulator Co., of Woolwich, London, S.E.18.

The specimen submitted was a four-position switch intended for introducing in the circuit stage by stage the L.F. amplifiers of a multi-valve receiver.

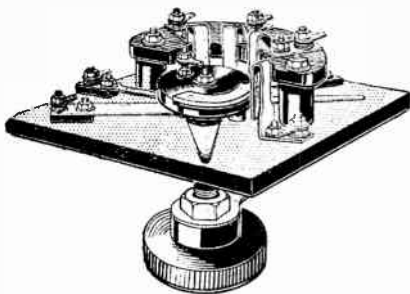

New multi-contact switch for controlling the stages of a valve receiver-amplifier.

Attached to a small platform which is raised from the main panel are three spring contacts making contact with a brass segment which is attached to a small ebonite disc on the switch spindle. This part of the switch is intended for controlling the filament circuits. Other sets of contacts are arranged on the base, and are brought into operation by a guide piece which is attached to the spindle, and also a contact which is attached to the revolving disc.

The switch is complicated in its construction, yet the high class workmanship, which more resembles the standard of a firm of watch makers than a wireless manufacturer, ensures reliable working. The spring plates are of German silver, finished bright and tipped with silver where necessary to ensure good contact.

The panel area occupied is about $2\frac{1}{2}$ in. \times $2\frac{1}{2}$ in., and the depth behind the panel is a little more than 1 in.

The experimenter will find many applications for this useful component for controlling circuits carrying either audio- or radio-frequency currents.

o o o o

GEE HAW DIAL

Instrument dials incorporating some form of reduction gearing are produced in great variety.

The earlier types usually embodied a

train of pinions, but frequently possessed the serious defect that backlash was present between the operating knob and the instrument spindle. Backlash is usually overcome by employing friction gears in place of toothed wheels, but in the Gee Haw dial, obtainable from Kothermel Radio Corporation of Great Britain, Ltd., 24-26, Maddox Street, Regent Street, London, W.1, an entirely new principle is adopted.

Under the dial is to be found a pair of serrated discs A and B, one having 99 grooves and the other 100. The fine control knob D carries an arm which in rotating presses the serrations of the upper disc into mesh with the under one. Were the two discs to possess exactly the same number of serrations no rotation would be produced, but as they do not exactly coincide a slight movement is obtained when the two discs are pressed into contact. Thus the under dial will rotate by a distance of one hundredth part of a revolution for every complete turn of the fine control knob.

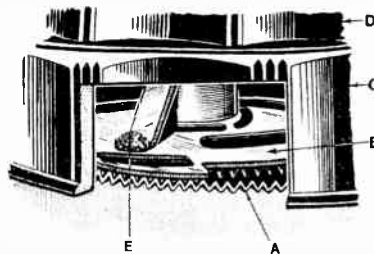

Reduction gearing in the Gee Haw dial is obtained by forcing into mesh two serrated discs, one carrying 99 and the other 100 notches, producing a reduction gearing of 100:1

This system is entirely free from backlash, and as a slightly imperfect fit is obtained between the two serrated discs, owing to slight difference in size of the grooves it will be apparent that the two plates are held firmly together. The dial is probably one of the most ingenious systems of reduction gearing yet devised.

o o o o

THE PARAGON CONDENSER.

A useful series of small fixed condensers is included among the specialties of The Paragon Rubber Manufacturing Co., Ltd., of 75a, Camden Rd., London, N.W.1. Mica is employed as the dielectric material, and the form of construction adopted produces a con-

denser which will retain its correct capacity value indefinitely.

The condenser proper is completely sealed in a moulded case, the insulating material being actually formed around the condenser, and the connecting screws

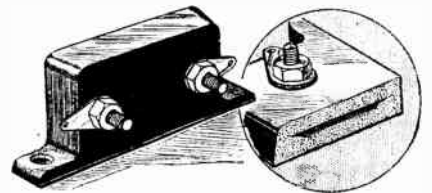

The plates of the Paragon fixed condensers are totally enclosed under pressure in a moulded insulating case. The capacity value is unaffected by external conditions.

held in position and prevented from rotating by being bedded in the moulding.

TRADE NOTES.

The King Filament Rheostat.

With reference to the description of the King Filament Rheostat on p. 299 of our issue of February 24th, we regret that a mistake occurred which has been brought to our attention by the importers, Gaston E. Marbaix, Ltd.

The King Rheostat employs one hole fixing, and the statement that this form of attachment had been abandoned was therefore erroneous.

o o o o

A Sign of Prosperity.

L. J. Hydellmann and Co., who are the sole agents in this country for the well-known "N. and K." loud-speakers and headphones, and also for the "Baltic" Low-Loss Coils, report that expansion of business has necessitated a removal to larger premises.

The company's new address is 12, Chapel Street, Fore Street, London, E.C.2.

o o o o

New Showrooms.

The Midland Radiotelephone Manufacturers, Ltd., of Stourbridge, have opened London showrooms under the title of "Mellowtone," at Triumph House, 189 and 191, Regent Street, W.

BROADCAST BREVITIES

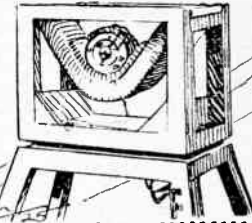

SAVOY HILL TOPICALITIES.

By OUR SPECIAL CORRESPONDENT.

Transatlantic Relays.

It must not be assumed that because dance music from Schenectady (WGY) was relayed to all B.B.C. stations from Keston last week with fair success, a similar transatlantic transmission will be a regular feature of the Tuesday evening programmes in future. The B.B.C.'s arrangement is that Keston will endeavour to receive the music broadcast by WGY on Tuesdays for experimental purposes. If the quality is sufficiently good, this dance music may occasionally be relayed to B.B.C. stations; but in any case it will not figure as an item in the programmes, at any rate until the quality of reception is greatly improved and there is less uncertainty about reception. In the meantime a specially designed super-het. set, with eight valves, is being used for these experiments at Keston, and improvements in the apparatus will be made from time to time.

○○○○

An Experiment that Failed.

By the way, these transatlantic experiments are not always arranged at the most convenient times for those who are expected to take part in them. For instance, on Saturday in Easter week an intimation was received from a prominent American film concern that a cinema star would broadcast on Easter Sunday on short waves for the benefit of British amateur experimenters, who were invited to ask any questions they liked by wireless, and the lady would reply. Owing to the short notice, it was impossible to get in touch with many amateur experimenters, and, in addition, a number of the more prominent amateurs were on holiday. This radio interview could have been made to yield some interesting Press material.

○○○○

Alteration of Wavelengths.

The main fact that emerged from the account broadcast by the Chief Engineer to the B.B.C. of what happened at Geneva in March is that listeners received renewed assurance that no revolutionary change is to be made in broadcast wavelengths so as to render existing apparatus obsolescent. If any British stations come down to 250 metres, little, if any, inconvenience should be experienced by listeners, as most receiving sets can be tuned down to that wavelength or even

tuned up to 550 metres if occasion demands. Any expansion of the waveband below 200 metres is improbable. I expect, however, to find some relay stations working on duplicate wavelengths in the coming summer, and changes, generally speaking of no considerable magnitude, being made in the wavelengths of some main stations. One has heard a wild rumour that Britain is to lose a station under the Geneva scheme. It is untrue.

○○○○

A Broadcast from Bridgwater.

Bridgwater claims to be the oldest borough in Great Britain, and to commemorate the granting of its charter in the year 1200 A.D. a special ceremony is being arranged for June 26th. This will consist of songs and other music and an account by the Mayor of how the charter was obtained. The ceremony will be broadcast from 5XX.

○○○○

Making Talks Interesting.

The Education Department of the B.B.C. while it must always remain a target for criticism, inasmuch as it has to perform the least popular of broad-

casting functions, has at any rate succeeded in securing as much variety as possible in the new series of talks beginning on Monday next (April 19th).

○○○○

A New Schedule.

"Old Trades and New Knowledge" is the title chosen by Sir William Bragg, F.R.S., for a series to be given on every alternate Wednesday, beginning on April 28th. These talks will be on the lines of those given by Sir William before the Royal Institution last year.

○○○○

Superstitions.

Queer beliefs of the ancient Egyptians respecting death, burial, and the after-life will form the subject of a series of broadcasts by Professor T. E. Peet, entitled "Ancient Egypt and the Burial of Kings," beginning on April 22nd. Another feature which merits attention will be a weekly Spanish talk to be relayed from Manchester through the Daventry station on Wednesdays, starting this evening (April 14th). These talks will be given by Mr. W. F. Bletcher.

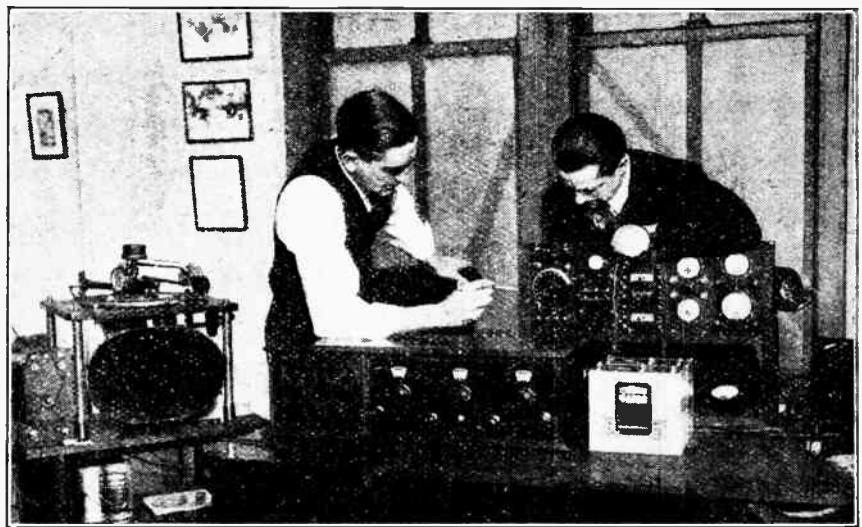

RECORDING BROADCAST PROGRAMMES. An interesting adjunct to a broadcast receiver has been patented in America by Mr. Francis R. Hoyt, who is seen on the left in the photograph. As will be seen, the device incorporates a gramophone recording mechanism.

Pep and Pepper.

Talks on music, animals, motoring, agriculture, flying, and health will also be included in the series; but the popular and topical talk will receive its due share of the programme-time, and care will be taken to avoid impairing the enjoyment of an entertainment programme by the intrusion of unsuitable matter in the shape of educational or propagandist talks. We listeners must, however, remember that the transmission of serious talks is in fulfilment of a public duty and broadcasting cannot depend upon a constant supply of thrills and stunts, either to create or pander to an appetite for sensation. As an official of the B.B.C. told me: "Waning appetites may be stimulated by occasional applications of hot pepper; publicity is readily obtainable for stunts; but it might be appropriate to quote the words of the repentant Bab-bitt: 'I sometimes wonder whether we boosters do not throw too many fits about pep.'"

o o o o

St. George's (and Shakespeare's) Day.

On St. George's Day, April 23rd, which synchronises with Shakespeare's birthday anniversary, luncheon speeches, in honour of the latter event, will be broadcast from the Town Hall, Stratford-on-Avon, under the auspices of the Shakespeare Club. The toast of "The Immortal Memory of Shakespeare" will be proposed by the Hon. James Beck, late Solicitor-General to the United States of America, and the toast of "The Drama" will be proposed by Mrs. Kendal, supported by Mr. Henry Ainley and Mr. W. Bridges Adams.

o o o o

A Programme by the Staff.

The B.B.C. is always on the look-out for new talent, but only those engaged in the search can know how difficult is the quest for suitable broadcasting qualities. No doubt much of the potential talent is rather at a loss to know precisely what kind of technical ability is necessary to success before the microphone; for all such persons the best practical lesson would be a demonstration by those whose work it is to engage wireless artists. Members of the B.B.C. staff have, for instance, shown on one or two occasions that they possess excellent voices, and I understand that a proposal that a special staff night should be given at intervals has been viewed with favour. This would be not only a novelty, but, as I have suggested, a guide to those with broadcasting ambitions. [What an opportunity for the programme critics.—Ed.]

o o o o

Aerial Congestion and Signal Strength.

A number of people are experiencing difficulty in congested districts owing to the erection of aerials very close to each other. One finds in the large towns row upon row of houses, each with its "L" type aerial, and all only a few feet apart. The result is that when one listener tunes in his set and settles down to listen to the

FUTURE FEATURES.**Sunday, April 18th.**

LONDON.—3.30 p.m., Handel Programme. 9.15 p.m., Casano Octet.
BIRMINGHAM.—3.30 p.m., Sterndale Bennett Programme.
BOURNEMOUTH.—3.30 p.m., Byrd-Purcell-Arne Programme.
MANCHESTER.—3.30 p.m., The Band of H.M. Royal Air Force.

Monday, April 19th.

LONDON.—7.25 p.m., Series: Mendelssohn (Selected Pianoforte Works) interpreted by Maurice Cole. 8 p.m., Chamber Music and Poetry: The Kutcher String Quartet.
DAVENTRY.—8.25 p.m., Concert relayed from Hilversum, Holland.
ABERDEEN.—8.38 p.m., "The Glass Panel"—A Play in One Act by Arthur Black.
NEWCASTLE.—10.30 p.m., A Mystery Half-Hour.

Tuesday, April 20th.

LONDON.—8 p.m., Cowboy Songs and Stories.
BELFAST.—8 p.m., Mozart Programme.
CARDIFF.—8 p.m., A Dvorak Recital: Preliminary Note on Dvorak by Paul Corder. The Music of Paul Corder.

Wednesday, April 21st.

LONDON.—8 p.m., Another Hour with Offenbach: Excerpts from "Barbe-Bleue" ("Bluebeard").
GLASGOW.—8 p.m., Popular Concert.
MANCHESTER.—8 p.m., Chamber Music.

Thursday, April 22nd.

LONDON.—8 p.m., "Semele" (first part)—A Secular Oratorio by Handel. Relayed from Bishops-gate Institute. 9 p.m., An Hour of Humour: Arranged and Introduced by Willie Reuse ("Wireless Willie").
BIRMINGHAM.—8 p.m., Grand Opera.
MANCHESTER.—8 p.m., Pat Ryan's Orchestra relayed from the City Hall.

Friday, April 23rd.

LONDON.—8 p.m., St. George's Day, 1926. Special Programme in Commemoration of Shakespeare and St. George.
BOURNEMOUTH.—8 p.m., St. George's Day Programme.
BELFAST.—8 p.m., St. George's Day Programme: Band of the 1st Battn. Durham Light Infantry.

Saturday, April 24th.

LONDON.—8 p.m., Regimental Reminiscences: Arranged by Amyas Young.
ABERDEEN.—8.20 p.m., The Bubbles Concert Party.

programme, he is often seriously disturbed by marked changes in the strength of reception, caused by his neighbours adjusting their sets. In most cases this is due to the fact that the aerials are electro-magnetically coupled; they may be likened to a number of closed circuits all coupled together.

o o o o

Fan-shaped Aerials.

When energy is introduced into all these circuits as a whole, the distribution of current, or signal strength, in any one circuit will be governed to some extent by the tuning and damping of the other circuits. The trouble is quite distinct from that of interference by oscillation, and is likely to be the cause of as much annoyance as oscillation unless remedial measures are adopted. The remedy is to erect one's aerial so that the greater part of its length is at right angles to the neighbouring aerials. A "T," or fan-shaped, aerial will often solve the difficulty. The chief point to bear in mind is to have as little length of wire parallel to the neighbouring aerials as possible.

o o o o

H.R.H. Prince of Wales to Broadcast.

The Prince of Wales's address at the Boys' Brigade demonstration in the Albert Hall on May 11th will be broadcast at 9 p.m., and will last for ten minutes.

o o o o

Protection from Lightning.

So much needless alarm would not be occasioned by the newspaper references to lightning as a causation of damage to receiving sets if listeners would only remember that the risk of damage is infinitely small if the aerial is properly earthed. In various issues of *The Wireless World* instructions from time to time have been given as to the precautions that should be taken; but I am asked by the officials at Savoy Hill to repeat here two little similes, viz.: The aerial is just a length of wire suspended between insulators. Similar wires, but a good deal longer and higher, are used for telephone and telegraph wires throughout the country, and yet one never hears of these wires being struck by lightning, because the proper safeguards are adopted. Again, the builders of a high chimney or church steeple never neglect to attach a lightning conductor. A lightning arrester, such as any wireless dealer sells, is just as necessary for a receiving set.

o o o o

Bluebeard.

The potted version of Offenbach's famous burlesque "Bluebeard," which is to be included in the London programme on April 21st, is to all intents and purposes a new item for radio listeners, and one piece has not been produced for some forty years, except in Glasgow three years ago, when Mr. Frank Mullins, who is appearing on April 21st, took the leading part in a performance produced by Mr. R. E. Jeffrey, now dramatic producer to the B.B.C.

RECEPTION AFLOAT.

Some Holiday Experiences on the Norfolk Broads.

By A. G. WOOD.

NOW that the summer is in sight, many of us will be making plans for our summer holidays, daily outings, and many of the outdoor attractions which make themselves felt in the fine weather. With the advent of the dull-emitter valve, the scope of a portable wireless set has been greatly increased, and it is the intention of the writer to give a few hints on this subject as well as a short description of a portable set operated on the Norfolk Broads last summer.

Results with a Straight Circuit.

The writer, together with two friends, spent a fortnight last summer on the Norfolk Broads and decided that wireless should accompany them. Consequently, a special set was built into a suit case and installed on board the yacht. The set consisted of a rectifier and two note magnifiers (Fig. 1), the first two valves being 2-volt dull-emitters and the last stage a Marconi D.E.3. All waves up to 600 metres and down to 40 metres were available, but it was found that in actual practice the shorter waves were not used very much. As regards the broadcast band, here we were met with disappointment. London could

The portable set is not solely a source of amusement and entertainment. This yacht, carrying a wireless receiver of home construction, was instrumental in delivering a distress call to a holiday-maker on the Norfolk Broads.

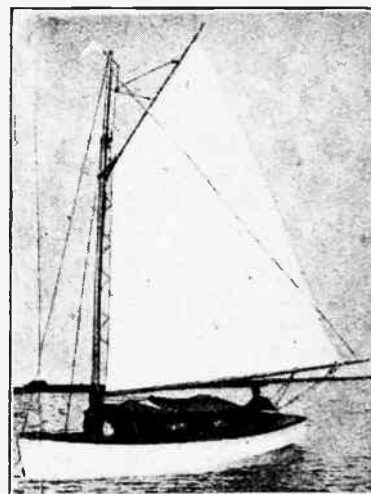

be heard, as well as several other stations, but ship traffic, atmospherics, and the actual strength of the signals prevented loud-speaker reproduction. This was with an aerial from the top of the 20ft. mast to a tree on the shore.

nected up the loud-speaker, and signals of excellent quality could be heard at a distance of 200 yards over water. The aerial then used—we were sailing at the time near Yarmouth—was a single wire from the top of the mast down to the end of the boom. The lead-in wire was taken from the top of the mast, down the side, and into a porthole with the earth wire attached to the metal keel, as indicated in Fig. 2.

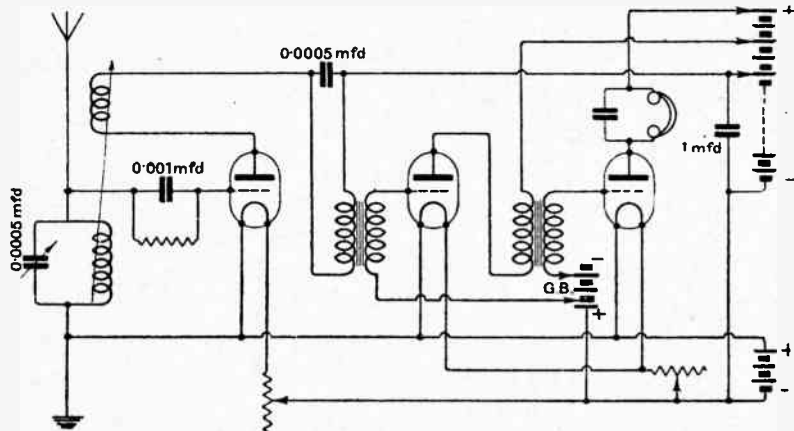

Fig. 1.—The original circuit used for the reception of 5XX.

just be heard, as well as several other stations, but ship traffic, atmospherics, and the actual strength of the signals prevented loud-speaker reproduction. This was with an aerial from the top of the 20ft. mast to a tree on the shore.

By chance a radio dealer in Yarmouth, who was questioned, mentioned that Chelmsford—now Daventry—was by far the best station to receive. Accordingly we invested in some spare wire and wound up a Chelmsford coil on an old jam-pot! Immediately upon switching on with headphones on, a station could be heard with that sort of sound which all amateurs know to be "good strength" even before tuning in. At this point it was found that the aerial was not attached! Upon switching in the aerial, the operator was nearly deafened by the terrific signals from 5XX. Overjoyed, he rapidly con-

It was therefore possible to keep in touch with the world whether sailing or anchored. In this connection it is interesting to relate an incident which occurred at Acle one evening. It was pouring with rain and we were sitting round the lamp, playing cards, with the loud-speaker on. Suddenly the announcer stated that he had an S O S to give, and this is what it was: "Will anyone knowing the whereabouts of Mr. — on the yacht — last heard of at Acle on the Norfolk Broads, please come quickly to his brother at — Hospital, who is lying dangerously ill." We looked at one another, and without a word dropped our cards and rushed on deck. We knew the yacht well, having raced with it earlier on in the day, but we did not know where she was lying. Accordingly we walked along

the river bank crying out the name of the yacht at intervals until an answering voice hailed us. The news was imparted, and we managed to get the unfortunate fellow a lift into Norwich, where he could catch the midnight train to London.

Reflex Reception on 1,600 Metres.

Making use of the experience gained last year, the reader is advised to dispense with all waves but Daventry. The extra room taken up by other coils is thus saved. Use valves of the 0.06 amp. class, now that there are several excellent types on the market: this means that a much smaller accumulator may be used for the whole time afloat.

Next, a reflex circuit is a practical proposition on the 1,600-metre wave, and will really give some good results.

Reception Afloat.—

The writer therefore suggests a circuit similar to Fig. 3. This will be seen to consist of a high-frequency valve reflexed, crystal detector, followed by a note magnifier and an optional second note magnifier. The transformers should be bridged with 0.0005 mfd. blocking condensers where shown, and, of course, it is possible to calibrate the inductance and capacity in the anode circuit to 1,600 metres before start-

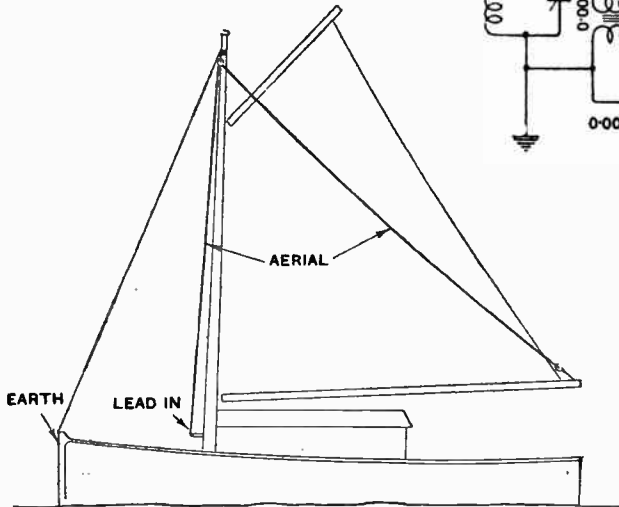

Fig. 2.—Aerial and lead-in wires and earth connection to metal keel.

ing on the trip. One can thus either dispense entirely with the tuning condenser or else set it and instal it in some out of the way part of the set. If the aerial coil is on the small side and the condenser larger—say, 0.001 mfd—the aerial tuning will alter very little with different types of antennæ, which are likely to be used from time to time. Filament resistances are fitted so that the first valve only is independently controlled. A small two-way switch is installed which will cut out the last valve when desired; a filament switch for this valve is omitted for the sake of space, as it is no trouble to remove the valve

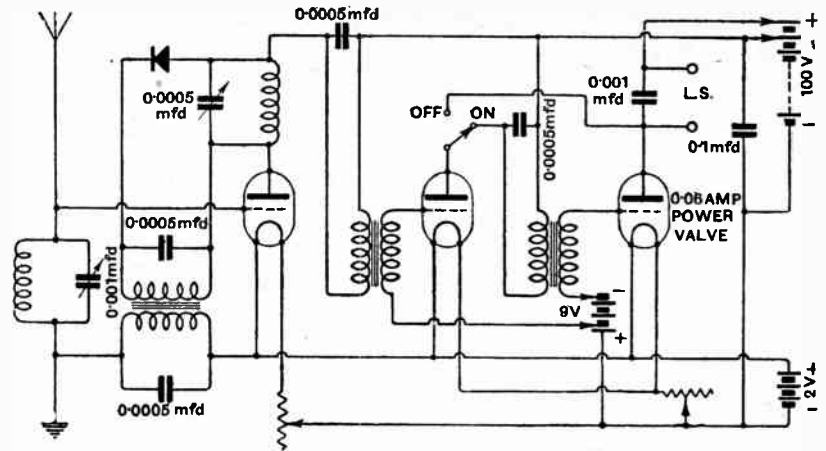

Fig. 3.—A three-valve reflex circuit suggested by the author.

itself or even leave it running, since it consumes so little current. Grid bias is a necessity and may be adjusted beforehand and set.

It will be seen that such a set can be constructed in a very small suit case, complete with high-tension batteries—100 volts advised—and all that is needed is the addition of a small 2- or 4-volt accumulator, aerial and earth and loud-speaker. Some loud-speakers on the market today are so designed that the owner makes his own horn and simply purchases the movement. Thus it is possible to include one of these instruments in the equipment and install it in a suitable position when necessary.

Rigid Wiring Necessary.

In conclusion, the writer cannot over-estimate the enjoyment obtained from such a set, either afloat or in the country; but let him give one word of warning. Be careful, in making the set, to use the best material; solder all the joints carefully and well, use stiff wire for connections, and give the set a test under approximately the same conditions you expect to encounter. By so doing one minimises the risk of a breakdown in some remote part of the country, far from soldering irons or repair shops.

LOUD-SPEAKERS OF YESTERDAY AND TO-DAY.

“Loud-speakers, their Construction, Performance, and Maintenance,” by C. M. R. Balbi, A.M.I.E.E., A.C.G.I., with foreword by Prof. G. W. O. Howe, D.Sc., M.I.E.E., pp. 96 with 57 illustrations and diagrams. Published by Sir Isaac Pitman and Sons, Ltd., London.

The raucous-voiced loud-speakers of the early days of broadcasting, which belled forth unmusical sounds in nasal tones, undoubtedly deterred many intending listeners from purchasing receiving sets, and it soon became apparent to manufacturers and experimenters that one of the most important problems to be

BOOK REVIEW.

tackled was the reproduction of sounds in a manner that does not put too severe a strain upon the imaginative faculties of the listener or the well-known ability of the human ear to disregard a certain amount of distortion.

In his interesting survey of the subject Mr. C. M. R. Balbi first defines the essential features of a loud-speaker as intensity of reproduction and accuracy. He then proceeds to outline the great improvements effected in recent years and to describe the standard types, classified

under three main heads: Electro-magnetic systems; semi-conductor and friction types; miscellaneous. It is in the latter group that the widest field for research is to be found. The author writes: “From the miscellany of half-tried experiments it is probable that the perfect loud-speaker of the future will be evolved; anyhow, these models show promise while the limitations of the more familiar types are, alas! too well known.”

The concluding chapters deal, in a simple manner, with testing, public address systems, and general advice to intending purchasers. A useful table of notes gives a list of all the standard makes, with brief remarks on their construction and suitability for rooms of different sizes, and a short summary of faults and their remedy.



The Editor does not hold himself responsible for the opinions of his correspondents.

Correspondence should be addressed to the Editor, "The Wireless World," Dorset House, Tudor Street, E.C.4, and must be accompanied by the writer's name and address

INTERFERENCE ON SHORT WAVES.

Sir,—With reference to Mr. A. E. Livesey's complaint of interference by commercial stations on the 30-40-metre band, I fear he does not realise the importance of these waves, and the great compliment that has been paid to the amateur in allowing him the temporary use of this valuable band. Such stations as PCLL are showing us that efficient commercial service is possible on these waves, and are no doubt carrying out experimental work of great importance; and, personally, I find it of great interest to receive spark transmissions from ships at Hong Kong, remembering that their normal range on 600 metres is only a few hundred miles.

I may also point out that the wave band allotted by the I.A.R.U. for the Inter-Continental tests of amateur stations not in Europe extends only from 43 to 35 metres. I have rarely heard a commercial station in this band, while most of the Italians are below 35 metres, although there are some very bad offenders.

The terms of my licence gives me to understand that the use of 45 and 23 metres by British amateurs is only a temporary concession, liable to withdrawal at any time, and I shall not be surprised if eventually we amateurs are *again* forced to descend to the comparatively unknown "short waves."

London, N.W.8. M. F. J. SAMUEL (5HS, I.A.R.U.).

Sir,—Mr. A. E. Livesey, who writes in your issue of March 24th, should also have joined the R.S.G.B. (T. and R.), and then he would have known that BYZ and BYC on 35 metres are *not* commercial stations!

My grouse is with the "ham" who sends CQ about 20 times, with the merry lad who finishes off with K.K. and forgets his call sign, with the key-tapper who calls a foreign "ham" and gives *both* call signs at least twelve times and the intermediary *once!* Still, though only a short wave receptionist, I find lots of fun in it.

Your correspondent, Mr. Meissner, regrets that his QSL cards do not always get QSL'd; well, neither do mine, and although I use a printed card, I have sent out 45 of these to countries *outside* Great Britain that have not been QSL'd. Still, perhaps they were not delivered, and even if they were, perhaps the "hams" are not interested to know that I've heard their jolly old signals.

W. H. TALBOT-SMITH, A.R.R.L., R.S.G.B. (T. and R.)
Coventry.

EXPERIMENTERS AND THE PUBLIC.

Sir,—Without wishing to doubt the disclaimer of 6LB. 6LL. 5ZG, in your issue of March 31st, I think it is possible that they may, without knowing the fact, be upsetting a "superhet" some 200 yards away *by means of a sub-harmonic*. Here I have several times read stations known to work only on 180±10 m. on a superheterodyne setting at about 2LO's wavelength.

May I in this connection repeat a story I once told to 2LO's microphone. A crystal user complained bitterly of interference from a multi-valve set in the same block of flats. He was advised to call on its owner in a conciliatory spirit. He went, and his report on the result can be put thus: "He turned out to be a decent man. We tried many experiments and ultimately traced the trouble to a fault in my own set. We are now great friends."

I suggest the moral of this story to the above three transmitters. Let one transmit in his normal way and the other two make the 200-yard journey and ask permission to listen in on the latest American superheterodyne. Even if my theory proves incorrect the superior knowledge of the two may help the other man to work his "superhet" more profitably, and I hope that once again the report may issue:

"We are all now great friends."

Earl's Court, S.W.5.

J. H. REEVES (6HQ).

Sir,—With reference to the letter from Mr. C. W. Railton, and the further correspondence in your issue of March 31st, regarding amateur transmitters, Mr. Railton is apparently unaware, when he pleads for further restrictions on the long-suffering amateur, that it is only out of consideration to B.C.L.'s with unselective receivers like his own that the amateur transmitter refrains from working his apparatus during programmes from the British stations.

When asking for further restrictions, Mr. Railton and his sympathisers should remember that the transmitter's licence allows him to transmit at any time during the twenty-four hours, and his indignation should be replaced by a feeling of gratitude to those who, from a sense of courtesy, make the unwritten law which allows others with unselective receivers to enjoy their programmes with the minimum amount of interference.

E. C. CHIDWICK (50W).

Clapton, E.5.

Sir,—As a long-standing reader of your valued paper, as well as being a B.C.L., may I protest against the attitude of certain correspondents with regard to experiments of amateur transmitters. To me, as well as to many of my friends, these amateur transmissions have for a long time been of the greatest interest. If such keen, genuine well-qualified experimenters (as I know personally many of them to be) are hounded off the ether completely, what scope is left for research except solely through professional channels (which I shudder to think of).

Many B.C.L.'s go so far as to report on transmissions in such detail as to be of material aid to experimenters; are these to be included in the category of the "suffering public"? After all, what is most desirable in our hobby is co-operation. Then this prodigy of the sciences will make its well-merited progress as the other sciences are doing.

Therefore let the experimenter retain what little freedom he has left, and "shake the ether" in the interests of mankind.

A. D. NARRAWAY.

Barrington, nr. Shrewsbury.

Sir,—In my humble opinion it should be merely a matter of give and take. Both the B.C.L.'s and transmitters have their duds. I know the old gramophone grind is terribly boring; in most cases it is not good enough to listen to with interest, and generally is of no experimental value. If an experimenter is really testing anything new as regards music broadcast, I should imagine he would use real music, not bottled stuff, as there is a certain amount of distortion with the average gramophone before one starts. It was all right in the old days before broadcasting, but to-day it is like entering an old penny-halfpenny cycle for the Tourist Trophy. Moreover, the few that do this sort of thing throw a bad light on the vast majority of amateur transmitters, who are so conscientious in their work that they cause no interference, and consequently the average B.C.L. never gets to hear anything about him.

On the other hand, the B.C.L. could use a little more discretion before shouting too much about the poor amateur transmitter. If they were to study the art of selectivity a little more they would be able to listen to any jolly old station they like without any interference from the amateur. I think that the chief interference on the broadcast band is oscillation, commercial Morse, and—broadcasting itself.

Before I close I should like, to make a little appeal to B.C.L.'s. Please don't blame us "hams" for everything in the way of interference. From my own unfortunate experience, if there happens to be any during broadcasting, and a man with a call sign lives round the corner, well, he gets it in the neck. When the Southern Railway commenced their elevated electric service in this district, I was actually blamed by some for the wonderful machine gun chatter caused when a train passed by. I often get a message passed to me through my sister or brother (but very rarely to myself direct) asking me to stop oscillating on 2LO, etc., etc.—all this when my broadcast set cannot oscillate and my transmitting experiments are practically always of the laboratory type.

My advice to all concerned is—B.C.L.'s learn a little more about radio, and transmitters reduce the gramophone stunts and really experiment.

S. W. BUTTERS (5VU).

West Croydon.

Sir,—In view of your editorial in the issue of March 31st concerning amateur transmitters, I beg to call your attention to the case of one in the London district.

Unfortunately I do not possess a wavemeter at present, but on a fairly selective set with a tuned H.F. stage in which an alteration of 5° of the A.T.C. will cut 2LO down to about 10 per cent. his signals are loudest at precisely 2LO's tuning. He broadcasts gramophone records on Sundays from 6 to 8 approximately—at least, that is the only time I have heard him—and invites listeners to call at his address, which he gives. This address is a wireless shop, outside which is an enormous loud-speaker, and, if one may judge by the noise, the owner of the shop can never even have heard of grid bias.

Incidentally, why are experimental transmitters always referred to as amateurs? Probably ninety per cent. of them are engaged in some way or other in the perfectly honourable trade of electrical engineering, of which wireless is surely a branch, or else receive money for writing articles on wireless in the semi-technical Press. Admittedly, the majority of these persons pay for their apparatus out of their own pockets, and carry out their experiments in their spare time, but if they stumbled on some new discovery would they not patent it rather than present it to the world?

In these days, when the trade of "amateur" sportsman is so much more paying than that of professional, let it be the aim of all experimenters to engage in genuine research, and let them combine to request the Post Office not to license "amateur" transmitting stations for any other purpose. The unfortunate broadcast listener would then have no grounds for complaint, as all these "ether hogs" would then be eliminated.

London, S.E.5.

L. P. CLARKE.

Sir,—We have noted with interest the various letters on the subject of "Experimenters and the Public," and should also like to give an opinion. With regard to foreign stations, these do not transmit for the benefit of "the suffering public" in England. If it is desired to listen to these, however, why not listen when the local station is on? But with their unselective receivers this may prove impossible to many B.C.L.'s, although we do not think they have demanded this station to close down. (We may mention here that certain B.C.L.'s wanted ship transmissions to cease during broadcasting hours. Evidently broadcasting is more important than lives at sea.) Then again, B.C.L.'s are not bound to listen to amateurs when broadcasting is not in progress and criticise their transmissions.

The amateur has very little time in which to carry out his experiments, unless he stops up half the night; therefore, Sunday is looked forward to by many for this purpose. Another point is that South-East London alone possesses more "hams" than any other town in England, and yet foreign stations can still be received on a suitable receiver when the majority of these are "on the air."

A 38

Lastly, transmission permits are not granted to all and sundry who apply; there are years of experience behind every one of them. These "hams," although in the minority, are bonded together throughout the world, and are not going to be trodden underfoot.

CYRIL R. WATERER (2HP).

London, S.E.4. ERNEST F. WITHERICK (2BMA).

Sir,—On Sunday, March 21st, amateur telephony transmissions were specially listened for on a "straight" 1-v-1 or 1-v-0 receiver, at various times, as specified below. On all occasions before 6 p.m. a large number of these stations were transmitting, and interference due to heterodyning between them, and to local oscillating receivers was troublesome. Many call signs were heard, but I prefer not to mention individual transmitters. Below are given the wavelengths on which these transmissions were heard. These are approximate only. They were not checked with a wave-meter, but by means of carefully plotted calibration curves for the receiving-set used. When checked, as they very frequently are, against transmissions of known wavelength, or when used for searching far distant stations from published wavelengths, these curves have always proved to be pretty accurate.

Approximate wavelengths in metres (listening times, 11.0-11.40, 1.10-1.25, 2.10-3.25): 320, 322, 325, 345, 346, 347, 363, 364, 370, 375, 377, 392, 397, 412, 415, 417, 437, 442, 445, 457, 460, 475, 487.

Some remarks overheard were interesting. One transmitter complained of the heterodyning that was making reception difficult. Another stated that "There are about thirty Manchester stations working, so it is nearly impossible to tune-in anything but a carrier." Another, transmitting on 475 metres, stated that he was closing down till 6 p.m., but would be on again then.

Approximate wavelengths in metres (heard between 6 p.m. and 8 p.m.): 342, 348, 350, 357, 388, 430, 445, 452, 455.

In a considerable number of cases foreign stations were definitely heterodyned by these amateur transmissions. The last was heard at 7.32 p.m., the amateur station being situated in Manchester. Reception was difficult. Foreign stations were everywhere, and in many cases these heterodyned each other more or less. Local oscillating receivers were a nuisance, and towards 7.30 p.m. atmospherics became a bit troublesome. There was, of course, Morse jamming at times.

The important point is that these results, while certainly open to criticism as regards a high degree of accuracy in measurement, are surely sufficient to prove that Mr. Maurice Child is in error in stating that there are very few amateur transmissions nowadays above 200 metres, at least so far as South Lancashire and Cheshire are concerned, and, further, that although the number in operation between 6 p.m. and 8 p.m. was, on this occasion, small in comparison with the earlier hours, there is clear evidence that Mr. Railton's complaint may have some justification, and at least cannot be summarily dismissed as unworthy of serious consideration.

It is perhaps worth mentioning that between 6 p.m. and 8 p.m. the operator of an amateur transmitting station working "duplex" with another amateur, on a wavelength of about 455 metres, was discussing the question as to whether their transmissions could be interfering with the reception of broadcasting.

J. H. S. FILDES.

Llandudno Junction, S.O., North Wales.

BROADCASTING PHOTOGRAPHS.

Sir,—I have been particularly interested to read your excellent description of a simple apparatus for the transmission of photographs by radio.

I note that reference is made to a novel method of coating a copper plate with a non-conducting film, using the high lights as relatively conducting portions of the picture. This method was fully patented by myself and put into use many years ago. The patent was originally secret, the number being 1117 dated 19/1/18 M.I.D. Sec. Ptnt. No. 58.

I do not for a moment suggest that improvements have not been achieved, but my claims at the time were specifically in reference to this particular method of transmission, and, in justice to those who assisted me during my experiments, it would seem courteous that some reference should be made to these facts.

Bedford Park, W.4.

A. M. LOW.

BELOW 100 METRES ON A FLEWELLING SUPER.

Sir,—Among the great variety of receivers evolved for short wave reception the Flewelling super-regenerative circuit has received scant attention. Yet this circuit, too often regarded as a "freak," is eminently suitable for short wave work. I should therefore like to describe the short wave receiver I use and to mention some of the excellent results obtained.

The circuit used consists of the modified Flewelling, in which only one large capacity fixed condenser is used.

Certain slight modifications have been made to facilitate short wave reception, but, taken as a whole, the circuit is of the standard Flewelling type. The components are mounted on an ebonite panel 39in. x 19in., this size ensuring ample spacing of parts, a most important factor. The coils used are mounted on ordinary coil plugs, and are of the basket weave type, made of No. 18 d.c.c. copper wire. The values used are:—Aperiodic aerial coil, tightly coupled to closed circuit coil 2 turns. Closed circuit coil 7 turns. Reaction 8 turns. By reference to the

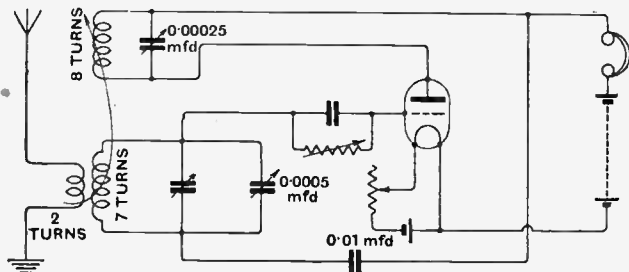

Flewelling circuit adapted by Mr. Chapman for very short waves.

circuit diagram it will be seen that the reaction is tuned with a 0.00025 mf. variable condenser, the closed circuit coil being tuned by a 0.0005 mf. condenser. These condensers are of the low loss square law pattern. A Lissen vernier condenser provides the fine tuning so essential in short wave work.

In place of the usual 0.006 mf. fixed condenser for super-regeneration a 0.01 mf. fixed condenser is used, as it has been found to give better results. An ordinary type valve holder is used, although an anti-capacity type would be better. A Burn-dept dual rheostat gives fine filament control, and a Marconi D.E.5b valve is used. The grid leak is variable, and the adjustment of this is very important if the correct Flewelling effect is to be obtained.

In many cases it will be found that an earth connection can be dispensed with. To operate this receiver the reaction coil and closed circuit coil are closely coupled until a shrill whistle is heard. This is the Flewelling effect, and unless this is heard the advantage of the Flewelling circuit will be lost. This effect can be controlled by the reaction condenser. Searching is then performed with A.T.C. and vernier.

The results obtained with this circuit have surpassed all expectations. The range covered is 150-30 metres, and over 200 amateurs have been logged during the last six months. French 8PX, 8AR, and American 2AFM have been received at great strength. In short, the results on C.W. are all that can be desired. On telephony 2SZ (45 metres) has been loudly heard at South Norwood on the single valve.

Most of these results have been obtained on a very poor aerial, and when a better can be erected better results still are expected. There is endless room for experiment on the lines of the Flewelling circuit, and the writer would be glad to hear of results from other experimenters. To those who try this circuit I say "good luck and signals R9."

East Croydon. B. THREADER CHAPMAN (2BHW).

4 DAVENTRY HARMONIC.

Sir,—Whilst trying out coil combinations to receive the Rugby-New York telephony, I stumbled across, presumably, a harmonic of Daventry, on about 8,000 metres. The strange thing to me was that reception was both stronger and purer than on the correct wavelength tuning. This latter I get best with a 200-turn coil, tuned by a 0.001 series condenser on the aerial side, with reaction, 250-turn coil also condenser

tuned. The harmonic tuning was with a 750-turn coil in the aerial, all other values identical with the 1,600-metre tuning. I found the harmonic tuning much sharper and more satisfactory in every way. It would be interesting to learn what others have experienced in this direction. I get the Rugby-New York telephony strong and clear from both stations, with a 600 turn coil in the aerial circuit, and all other values as above. I find that it is necessary to couple fairly close, to oscillate freely, and then gradually to work out the distortion. Eventually I get the speech equally as clear as any of our own broadcasting. New York reception is occasionally stronger than Rugby. The set used is a detector and two L.F. combination. E. G. GRINDROD.

Windy Gap, Aughton, nr. Ormskirk.

IGNORED QSL CARDS.

Sir,—In *The Wireless World* of March 24th issue I notice a letter from Mr. Meissner (DE0122) with regard to QSL cards, and so worded that one must assume that the British stations mentioned are those guilty of not replying to reports.

As my call-sign is mentioned, I must point out that all reports sent to me are answered, and this is the case with all "Gi" stations. We are all new stations, and this is one point that we are all agreed upon; I am not speaking officially for Ulster transmitters, but from a personal knowledge of their views.

I have had no report from DE0122, and I must assume that, like many Continental amateurs, he sends reports via the "Journal des 8," or some other paper. The papers hold the cards until they are applied for, and unless one is a subscriber one does not know that cards are waiting to be claimed. This means, then, that the stations concerned will be accused of shirking what is an obvious duty.

I was a listener to short wave signals for some time before I began transmitting, and found that approximately 95% of the British stations replied.

Cards for British stations should be sent to some British journal or amateur. If any station in Northern Ireland is heard but QRA is unknown, I shall be pleased to forward reports where possible.

It may be imposing on your kindness to add anything further to the letter, but I must add the "grouse" of this station to that of Mr. Livesey about the commercial interference on the amateur wavelengths. I need not say that with amateurs attempting to carry on tests while BYC is transmitting, the situation is impossible. Mr. Livesey says that BYC is on about 33 metres. I have heard BYC on six different wavelengths in that region simultaneously and on spark—yes, and this is 1926!

I should be very pleased to hear from listeners or transmitters who could arrange a schedule with me for carrying out tests on fading.

Thanking you for the space and information that you extend to the short wave enthusiasts.

T. P. ALLEN, B.Sc. (G1 6YW).

9, Ardgreenan Drive, Belfast.

Sir,—With reference to the letter from E. Meissner regarding transmitters who do not acknowledge QSL cards, I would say that, while quite agreeing with the practice of sending reports, so long as they are detailed or contain useful information, I think that there is another point of view. Lately I have received many QSL cards, amongst them being several worded more or less as follows: "Yr sigs received last Sunday after noon. Were you working? Yr QRH about 45? My receiver, etc. . . . Pse QSL." Such reports are of no use to anyone (except the G.P.O.), and unless B.C.L.'s can do something better they must expect to receive scant attention.

I should, however, like to add that I have received some very valuable data from B.C.L. reports, which I have been very pleased to confirm by means of a QSL card.

An excellent article on "Pse QSL Card" appears in the March issue of "Q.S.T." which might be read and followed by transmitter and B.C.L. alike—to the profit of both.

"Picture galleries" cost money, and many a transmitter can ill afford to pay for the decoration of other men's walls when he gets no return for his money. "Give value, and you'll get it returned" might be a good QSL motto.

G2ZC. (T. and R. Sect., R.S.G.B.).

Methods of Tone Control.

Can you indicate to me broadly the principles upon which tone control devices operate?
J.M.L.

When an orchestral piece, for instance, is broadcast a correct musical balance is effected by the conductor of the orchestra, and if we possessed a perfect transmitter and a perfect receiver so that all the musical frequencies emitted by the orchestra were transmitted, amplified and reproduced by the loud-speaker exactly as they were produced by the orchestra, then there would be no need of tone-control devices, except to fulfil the desires of those listeners who felt that they could improve upon the efforts of the conductor of the orchestra. Unfortunately, in the first place, the amplifying apparatus between microphone and transmitter does not faithfully preserve the musical balance delivered to the microphone, and so certain corrective devices have to be introduced so that the actual modulated energy radiated from the transmitting aerial is a faithful reproduction of the musical frequencies delivered to the microphone.

In a receiver-amplifier distortion is introduced, due to uneven amplification of the various musical frequencies. If, for instance, the detector valve is followed by an L.F. transformer of inefficient primary impedance, the lower musical tones are seriously under-amplified, and in the case of the very low musical frequencies, no amplification takes place at all. It is quite impossible to insert any device in the second stage of amplification which will recapture the lost frequencies, although if they are amplified sufficiently to reach the second stage, then we may insert a corrective device to balance matters up by deliberately shunting away some of the higher musical frequencies so that after passing this second stage the balance between the lower and upper musical frequencies is more or less equal. This is, however, a very inefficient manner in which to bring about the desired re-



"The Wireless World" Information Department
Conducts a Free Service of Replies to Readers' Queries.

Questions should be concisely worded, and headed "Information Department." Each separate question must be accompanied by a stamped addressed envelope for postal reply.

sults, because in any case the lowest musical frequencies are lost altogether by the primary of the first transformer. It is a far better plan to manage to have a suitable transformer in each stage so that all musical frequencies are as far as possible brought to the output circuit of the first valve, and then we can apply the little correction which is necessary.

It should not be forgotten that even when using a transformer with the highest primary impedance that can be obtained after the customary high-impedance detector valve, it will be usually found that the lower musical frequencies are still not amplified to the same extent as the middle range of musical frequencies, whilst, on the other hand, the use of reaction tends to emphasise the lower frequencies.

Possibly one of the simplest and most effective means of balancing up discrepancies in the amplification of the lower musical frequencies is to make use of the choke filter circuit illustrated in Fig. 2, page 953, of the Dec. 30th, 1925, issue of this journal. The first precaution to be taken is to use a choke with characteristics suitable for working in conjunction with the output power valve. Now, if we find that the higher musical frequencies are too predominant, we can effectively shunt some of them away by means of a small condenser in parallel with the choke, these frequencies passing through the condenser instead of setting up voltages across the choke by virtue of the fact that the condenser offers less impedance to their passage than does the choke.

If on the other hand, due, perhaps, to the use of considerable reaction necessary to bring in a distant station, the lower tones are too predominant, this can be corrected by lessening the capacity of the coupling condenser between choke and loud-speaker. A good arrangement is to use a number of large condensers in series, and arranging a stud switch so that more or less of the condensers could be brought into series. An alternative arrangement would be to use a number of small condensers with a special type of switch arranged to place more or less of them in parallel as required. The effect is the same in any case, namely, to "lose" a certain amount of the too predominant lower frequencies by lessening the capacity and so raising the impedance

of the coupling condenser to the passage of the lower musical frequencies.

o o o o

"Reflex" or "Reaction."

Recently perusing some "wireless notes" in a lay journal, I came across the expression "low-frequency reaction." As I have always understood that in the ordinary single-valve regenerative set it is high-frequency energy which is fed back into the grid circuit of the valve from the plate circuit, I shall be glad if you can explain the meaning of this term.
H.H.A.

In the ordinary single-valve set employing a reaction coil we obtain an increase of signal strength by feeding the magnified H.F. energy in the plate circuit back to the grid circuit. It would appear, then, that the word "reaction" or "regeneration" implies the feeding back of high-frequency energy. As the term is generally used this is so, of course, but a moment's thought will make it abundantly clear that it would also be possible to feed back low-frequency energy from the plate circuit to the grid circuit of the detector valve by the simple expedient of connecting the primary of an intervalve transformer in the plate circuit of the detector valve, the secondary being connected in the grid circuit. Such an arrangement is nothing more or less than low-frequency reaction, and is used in a large number of receivers, although such circuits are more usually referred to under the name of "reflex" or "dual" circuits. Strictly speaking, of course, there is no reason at all why the ordinary single-valve reaction should not be termed a "reflex" circuit, since energy is "reflexed" or thrown back again into the plate circuit. Usually the terms "reaction," "regeneration," or "retroaction" are applied to those circuits where the energy fed back is high-frequency energy, whilst the term "reflex circuit," or "throw-back circuit," are applied to those circuits in which the energy fed back is at low frequency, although this is only an arbitrary arrangement adopted by general custom and consent, and, strictly speaking, the words are all synonymous, since no prefix or suffix is attached to them to indicate specifically the frequency of the "reflexed" energy.

**BOOKS FOR THE
HOME CONSTRUCTOR**

Issued in conjunction with "The Wireless World."

"THE HOME CONSTRUCTOR'S EASY-TO-BUILD WIRELESS SETS," by F. H. HAYNES. Price 1/6 net. By Post, 1/9.

"TUNING COILS AND METHODS OF TUNING," by W. JAMES. Price 2/6 net. By Post, 2/10.

"HOW TO BUILD AMATEUR VALVE STATIONS," by P. R. COURSEY, B.Sc. Price 1/6 net. By Post, 1/8.

"THE CONSTRUCTION OF AMATEUR VALVE STATIONS," by Alan L. M. DOUGLAS. Price 1/6 net. By Post, 1/8.

"THE HOME CONSTRUCTOR'S WIRELESS GUIDE," by W. JAMES. Price 3/6 net. By Post, 3/9.

"MAST AND AERIAL CONSTRUCTION FOR AMATEURS," by F. J. AINSLEY, A.M.I.C.E. Price 1/6 net. By Post, 1/8.

Obtainable by post (remittance with order) from
ILIFFE & SONS LIMITED,
Dorset House, Tudor St., London E.C.4,
or of Booksellers and Bookstalls

TMC

Low Capacity Keys

combine

- Extreme Low self-capacity.
- A positive locking action.
- Rapid make and break.
- Unvarying performance.
- Adaptability to varied switching requirements.
- Strong and accurate construction.
- Pleasing appearance.



All the live parts of the key are efficiently insulated from the frame. Individual parts are machine-made, ensuring accurate construction. The "gold-silver" contacts are always clean. The ends of the springs are tinned to facilitate soldering. Escutcheon plates and levers are of polished and lacquered brass or finished in bright nickel plate.

T.M.C. Low Capacity Keys are made in 3 models :

- No. 1. 12 point, 3 position .. 7/-
- No. 2. 6 point, 2 position .. 6/-
- No. 3. 24 point, 3 position .. 15/6

Have you sent for your copy of the interesting T.M.C. Catalogue?

It is free on request.

Telephone Manufacturing Co., Ltd.,

Hollingsworth Works,
West Dulwich,
London, S.E.21.
Phones: Sydenham 2460/1.

If your dealer does not stock T.M.C. Goods we will supply you direct at the above prices, post free.

1ST AND 2ND STAGE

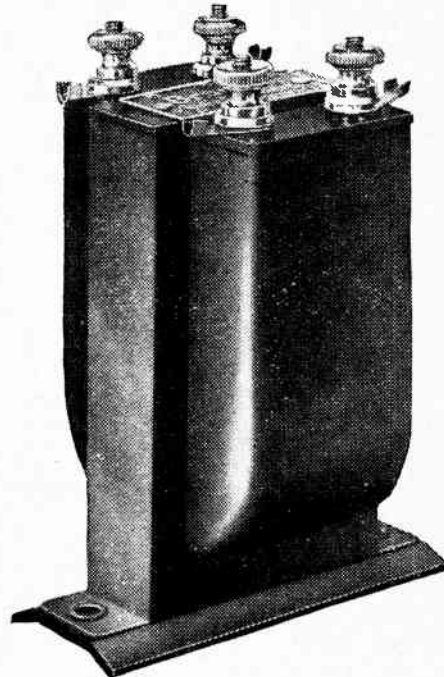

THE AUDIO TRANSFORMER

Are you building? Do you want more power without choking the purity of those smooth, level tones? The Brandes 1st stage Transformer has a high voltage amplification ratio of 1-5. This, together with a straight line amplification curve, means that the amplification is constant over a wide band of frequencies, thus eliminating resonance. The 1-3 Transformer amplifies over speech, pianoforte and harmonic ranges equally well. Mechanically protected and shielded against interaction. Terminals and outside soldering tags.

17/6

Ratio 1-5 (black finish). Table-Talker 30/-	Ratio 1-3 (brown finish). Brandola 90/-	Matched Tone Headphones, 20/-
---	---	----------------------------------

Brandes

Brandes Limited, 296, Regent St., London, W.1

from any good Dealer.

ANOTHER INTERESTING COMPETITION FOR "The Wireless World" READERS

£10 in Cash Prizes

First Prize £5
Second Prize £2

Third Prize £1
Four Consolation
Prizes of 10/- each.

ALL YOU HAVE TO DO!

PLACE in the order of merit, according to your judgment, the nine most attractive and convincing advertisements in the current issue; classified as follows:—

- 1st, 2nd and 3rd most attractive whole pages.
- 1st, 2nd and 3rd most attractive half pages.
- 1st, 2nd and 3rd most attractive quarter pages, or smaller spaces.

The following considerations determine the real value of an advertisement:

- (1) **Its arresting character:** which depends upon its attractive arrangement, with or without illustration.
- (2) **Its obvious truthfulness:** truth in advertising is a sound business maxim, as well as an ethical necessity.
- (3) **The convincing quality of its descriptive matter:** an advertisement is of no value if it does not induce the reader to purchase the article advertised, when the need arises, on its merits as described.

VOTING COUPON

Whole Page Advertisements.		Half-Page Advertisements.		Quarter-Page or Smaller Adverts.	
Page No.	Name of Advertiser.	Page No.	Name of Advertiser.	Page No.	Name of Advertiser.
1st		1st		1st	
2nd		2nd		2nd	
3rd		3rd		3rd	

Name Address

(IN BLOCK LETTERS)

WHEN you have filled in all the numbers on the coupon, write your name and address clearly in block letters in the space provided, and post the completed coupon to:

"The Wireless World,"

Dorset House, Tudor Street, London, E.C.4,

marked in bottom left-hand corner "Advertisement Competition."

ALL COUPONS MUST BE POSTED TO ARRIVE NOT LATER THAN APRIL 19th, 1926

RULES and CONDITIONS.

1. The decision of the Advertisement Manager of "The Wireless World" on any point connected with the competition must be accepted as final.
2. No responsibility can be accepted for any letters lost in the post or otherwise. Proof of posting cannot be taken as proof of delivery.
3. No member of the staff of "The Wireless World" or companion journals will be eligible to compete, nor to benefit in any way from the prizes offered.
4. Each prize-winner will be notified by post, and a list of the prize-winners will be published in "The Wireless World" as soon as convenient after the close of the Competition.
5. The Competition is to arrange the list of Advertisements in what is considered to be the order of merit. The correct order of merit will be obtained by counting the votes given by competitors.
6. The competitor whose list agrees, or most nearly agrees, with the popular order as indicated by the total votes will be awarded the First Prize, the next nearest the Second Prize, and so on.
7. Entry into this competition implies full acceptance of all the foregoing rules and conditions.

PERFECT Grid-Leak SERVICE

When you ask your Wireless Dealer for a grid-leak he will render you perfect service if you say you want a reliable one.

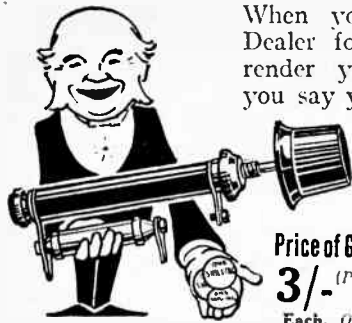

He will at once hand you a "Bretwood."

All "Bretwood" Products carry a Three Years Guarantee. Write for Complete List.

Price of GRID-LEAK or ANODE RESISTANCE

3/- (Price with Condenser as illustrated 4/-) Postage on either 3d. Each. Obtainable from most Wireless Dealers

BRETWOOD Ltd., 12-18 London Mews, Maple St., London, W.1

Parr's Ad.

IT IS TRUE !!!

that a good aerial and earth mean enormous improvement in reception. Have you overhauled yours this season?

- R.A.F. MASTS.**—2ft. 8in. Steel Tube, 1 1/2in. sockets, sections, 15ft., 7/6; 20ft., 10/-; and 30ft., 14/-. Fittings stocked. 4ft. 3in. Sections, 2 1/2in., 5/-.
- INSULATORS.**—The R.A.F. Light Weight Aerial Insulators, brass ring and screwed tension stem. Millions in use. 10,000 in stock, 1/- per dozen. Transmitting Insulators, 1/6.
- 5,000 PORCELAIN LEAD-IN TUBES.**—Straight or drip proof ends, 6d. and 9d. each. Egg or china reels, 1d., or 9d. per doz. Bullerdx Bell Aerial, 1/-; large, 1/3.
- AEROPLANE AERIALS.**—110ft. 7-strand hard drawn H.C. Copper wire wound on bobbins to run out freely. Sale price, 1/3. Post 3d.
- EARTH MATS.**—Galv. iron wave plate, with Electron wire riveted on, 2/-; post, 9d. Copper Mesh Earth for short waves, 12/6 each. Earth spikes, 1/3.
- EARTH WIRE.**—Flex rubbered, 1/- dozen yards; 100 yards coil, cheap, 6/6.
- WIRE.**—New 22 Gauge cotton-enamel covered, 1/6 lb., cut price. Two tons all gauges in stock. Navy 7/22 Enam. Aerials Superflux, 3/- 100ft.; Electronic Aerial, 100ft., 1/3; 500 doz. reels 28 gauge S.C.C. wire makes two Broadcast Coils, 4d. each. Vulcanised Flexible Cord, 1/- doz. yards. Catalogue, 4d.
- PORTABLE FRAME AERIALS, 21'.**—Ducons, 10'.
- LOUD SPEAKER EXTENSION WIRE.**—6-, 100 yards. Transformer Coil Wire, 1/3 lb.
- MICA SHEETS.**—Best Ruby Mica for Condensers, .002, 2 by 2 by .002 thick, 1/- per dozen.
- SPARK SETS.**—Sterling Coil wound 3lb. fine wire. Oscill. adj. Spark Gap on ebonite. Tapped Helix 5 to 600 metres. H.T. Mica Condenser, Terminals and fittings on ebonite, fine panelled case. Cost £15, and given away at 12/- each. Post 1/6.
- PRECISION INSTRUMENTS.**—Finest stock in London, 2,000 to select from. Plate 0.5, 0.10 m/a and 0.25 m/a, etc., 22/6. Ammeter or Voltmeters, 5/-; Voltmeters, 6/120, 11/6; 0.30 volts, 10/-; 120 volts, 20/-; 600 volts, 55/-; 0.1,000 volts, £3; 1,500 volts, £4 10/-; 2,500 volts, £6. Moving Coil Micro-ammeters, 45/-. Central zero, 35/-.
- RADIO TEST SETS** are a necessity.—7 Range Set, in Walnut case, 57/6. Elliott & Ferranti Laboratory. Millivolts to 250 volts, 1/10 Milliamperes to 25 amps., and all between. Half price, £5 10s. 2-Range A.C. Testers in Walnut case. Capacity and Insulation Testers, £7 10s.

SEND 4d. STAM-8 FOR ENLARGED ILLUSTRATED CATALOGUE and full list of Radio Bargains

ELECTRADIX RADIOS, 218, Upper Thames St., E.C.4.

Phone: City 0181.

Parr's Ad.

Scrap your H.T. Batteries!!

Use your Electric Lighting Mains!—With the "DYNIC" D.C. REGULATOR

It plugs into any convenient lamp socket and provides a smooth H.T. Supply, in 5 voltages, from any D.C. mains above 100. Type X.—For General Use. Price, £3 0 0 to H.T. —Uses the Mains as Aerial and Earth to addition to H.T. Price, £3 10 0 Type G.—Provides 6 tapplings for negative Grid Bias in addition to H.T. Price, £4 0 0 Type G.N.—Combines N, and G. Price, £4 10 0 All Models in De Luxe finish to instructions Postage 1/- at £1 extra.

Send for Folder and state your Mains Voltage.

JONES & STEWART
59, Robertson Street, GLASGOW, C.2.
Telegrams: "Gadgets," Glasgow. Phone: Central 4393.
Please mention this Journal.



BECOL —the dependable **EBONITE**

(REGISTERED TRADE MARK) "BECOL" is more than a trade mark—it is your protection. It stands for all that is best in ebonite manufacture—it is a positive guarantee of panels free from surface leakage. That's why the expert, wherever he may be, says "BECOL." He knows from experience there is no better ebonite in the world.

RODS, TUBES, SHEETS, MOULDINGS.
Always ask for "BECOL"
THE BRITISH EBONITE Co. Ltd., Hanwell, LONDON, W.7.

The March of THE PELICAN UNIVERNIER

The Pelican Univernier is steadily moving on to more panels because it gives to the set owner that nicety of control which is needed to bring in those elusive stations.

The vernier control is secured through a mechanism which causes the rotation speed of the knob to be no less than twelve times that of the shaft.

The Pelican Univernier fits all sets, you simply replace the old dials with the Pelican.

PRICE 6/-

Guaranteed throughout.

Obtainable from most Dealers.

Write for details of the "Pelican" Self-contained Sets. Prices from £10 to £40 inclusive of Royalties.



CAHILL & COMPANY LTD.

64, Newman Street, London, W.1.

Phone: Museum 9236.

Parr's Ad.

FULL SIZE RESULTS HALF SIZE COST!

The secret of the crystal-clear reproduction is the new cast-in diaphragm. Fully guaranteed.

Send for your FREE copy of our new catalogue.

General Radio Co. Ltd, 235, Regent St., W.1.

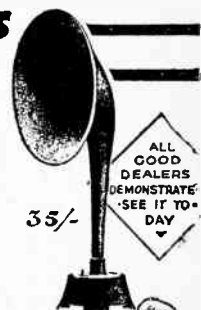



Geared Skeleton Coil Holder

Buy this Quality coil holder and have a *real* low loss component. Stripped of all superfluous material this holder has a negligible amount of self capacity and the geared action gives wonderful control of the moving coil through an arc of over 90 degrees.

PRICE 3/- Three-way holders of this type can also be supplied.
as illustrated
 Postage 4d. **BRITISH—FROM START TO FINISH**

Quality
RADIO

GOSWELL ENGINEERING CO., LTD.,
 97, WHITE LION STREET, LONDON, N.1.
 Telephone—North 3051.

Your Loudspeaker

WILL SING

THE PRAISES OF

NELSON MULTI 3-FILAMENT VALVES



Here is a Valve giving you Finest Quality and Volume with Economy. It is of equally high grade as H.F., Detector, L.F., or Power Amplifier.

The little switch places at your command each of 3 Filaments separately, or any 2 in parallel for Power Amplification. Each Filament gives the Valve a New Life.

ALL VALVES are Guaranteed.

FOUR IMPROVED TYPES,

Obtainable at
 All London's
 Largest Stores.

A.	4 to 5 VOLTS, 0.45 AMPS. per Filament	9/6
D.E.A.	2.6 VOLTS, 0.18 AMPS. per Filament	15/-
D.E.2.	1.8 to 2 VOLTS, 0.35 AMPS. per Filament	15/-
D.E.03.	3 VOLTS, 0.08 AMPS. per Filament	16/6

If unable to obtain from your dealer write direct to:
NELSON ELECTRIC COMPANY LIMITED,
 Merton Park, London, S.W.19.

Telegram: Valvesels, Wimble, London.

Phone: Wimbledon 173.

THE WIRELESS ANNUAL

FOR AMATEURS AND EXPERIMENTERS 1926

"The WIRELESS ANNUAL" is a volume of particular interest to every wireless enthusiast. It contains a mass of interesting and valuable information, which can be relied upon to be thoroughly accurate and dependable. Amongst many other features may be noted the following special items:

PRINCIPAL CONTENTS:
 CALL SIGNS of ALL KNOWN AMATEUR TRANSMITTING

STATIONS in Great Britain, France, Holland, Germany, Sweden, Finland, Italy, Spain, South Africa, India, Australia, New Zealand, and South America: **REGULAR TRANSMISSIONS** (Morse and telephony); **RECEIVER CIRCUITS** (16 pages of diagrams and notes); **GLOSSARY OF TECHNICAL TERMS**; **CLASSIFIED DIRECTORY OF MANUFACTURERS**; **VALVE DATA, USEFUL TABLES, FORMULÆ and INFORMATION** on all subjects of interest to **AMATEURS.**

This book will be of very real assistance in your wireless studies. No amateur worker should be without it. Get your copy to-day!

Obtainable from all booksellers or direct from: the offices of "The Wireless World," Dorset House, Tudor St., London, E.C.4

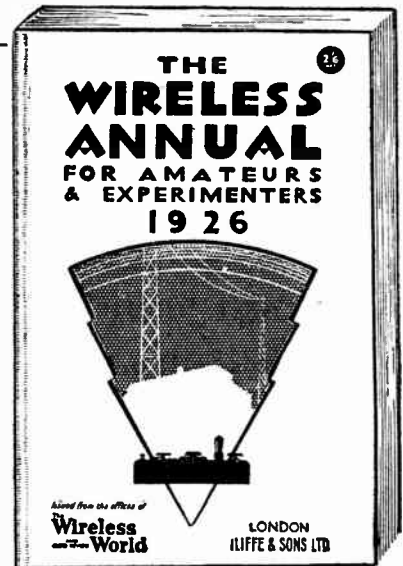

Price 2/6 net. By Post 2/8½.

.w.8b



Two in One!

Here's a splendid little component, the Watmel combined Grid Condenser and Fixed Grid Leak. Saves space, time and money. Built to allow the Grid Leak to be connected either across the condenser or direct to the filament of the detector valve.

Price 2/6 each.

Send a postcard for full details of the various Watmel products.

The Watmel Wireless Co. Ltd.,
332a, Goswell Rd., London, E.C.1.
Representative for Lancashire & Cheshire:
Mr. J. B. Lavee, 23, Hartley Street,
Levenshulme, Manchester.

For trouble-free condenser efficiency always specify the famous round Watmel fixed condenser.

Sizes up to '002 19.
Sizes '0025 to '008 23



PANELS AND CONDENSERS

1st ASK THE TECHNICAL EXPERTS.
2nd ASK YOUR DEALER,
but if you experience difficulty in securing supplies write direct to us giving dealer's name.

PARAGON RUBBER MANUFACTURING Co. Ltd.,
SCULCOATES, HULL.

CAXTON 4-VALVE CABINET

Made for Sets "All Concert Receiver,"
"Fieldless Coil Three Valve Set."
"Any Valve Low Frequency Amplifier."
Special Cabinets made to customer's measurements.
Prices Quoted.

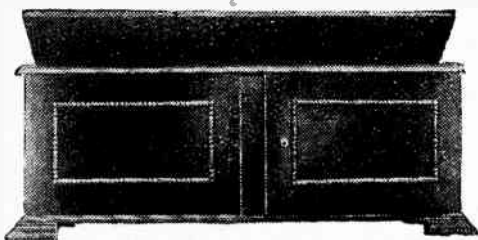

Cash with Order. Fumed Oak £1 5 0
Dark or Jacobean Oak £1 10 0
Real Mahogany £1 14 0

Detachable 7" deep Base Board to mount 16" by 8" panel to slide out of Cabinet front.
The two beaded front doors as illustrated, placed 2 ins. in front of the enclosed panel at 10/- extra.

Ebonite or Radion Panels Supplied and perfectly Fitted at low extra cost.

All Polished with the new enamel that gives a glass hard surface that cannot be soiled or scratched. **SENT FREE.**—Catalogue of standard Wireless Cabinets in various sizes and woods.

Packed and delivered free in U.K. No. C2

CAXTON WOOD TURNERY CO., Market Harborough

Really Portable!



The **BODINE** Folding Loop. Size when erected 2' 0" square. When folded, goes into a box 18" x 3 1/2" x 6".

Pivot bearing in base. Satin Silver Dial for logging.

PRICES

With centre tap and extension handle (as illustrated) . . . 45/-
With 5 point switch but no handle . . . 52/6

SEND NO CASH

Use the new C.O.D. System. We pay P.O. charges on goods value 20/- and upwards.



48-page list of American Apparatus free and post free.

Hawley's
HAWLEY BROS LTD

Telephone: 200-202-RECENT STREET LONDON W.L. Telegrams: "Pleasingly, Picky."

MODERN SCIENCE 1/- MONTHLY

Incorporating **CONQUEST SCIENCE**

A MAGAZINE OF PROGRESS, INVENTION AND DISCOVERY

"MODERN SCIENCE" is a monthly magazine which records recent advances and discoveries in all departments of science and industry: surveys technical and mechanical developments; and provides a forum for the interchange of information and views on all subjects coming within the scope of the journal.

SUBSCRIPTION: 14s. per annum, post free.

From all newsagents and bookstalls or direct from the Publishers: ILIFFE & SONS LTD., Dorset House, Tudor St., London, E.C.4.

The "**GRIPPLESHELL**"

Registered design No. 716927.

A device for simplifying Aerial Erection

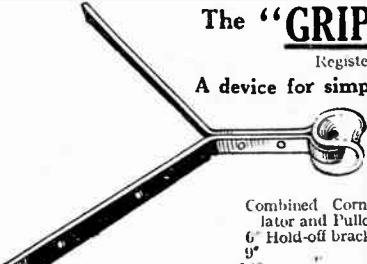

These brackets are made from 1" best quality Wrought Iron painted with weather-proof enamel.

PRICES

Combined Corner bracket, Insulator and Pulley 3/6
6" Hold-off bracket 3/-
9" 3/6
12" 3/6

Manufactured by **PARTRIDGE & WILSON, ELECTRICAL ENGINEERS,**
217a, Loughborough Road, LEICESTER.
Telephone 5812.

MISCELLANEOUS ADVERTISEMENTS.

NOTICES.

THE CHARGE FOR ADVERTISEMENTS in these columns is:

12 words or less, 1/- and 1d. for every additional word, e.g., 18 words 1/6; 24 words, 2/- Name and address must be counted.

SERIES DISCOUNTS are allowed to Trade Advertisers as follows on orders for consecutive insertions, provided a contract is placed in advance, and in the absence of fresh instructions the entire "copy" is repeated from the previous issue: 13 consecutive insertions, 5%; 26 consecutive, 10%; 52 consecutive, 15%.

ADVERTISEMENTS for these columns are accepted up to **FIRST POST ON THURSDAY MORNING** (previous to date of issue) at the Head Offices of "The Wireless World," Dorset House, Tudor Street, London, E.C.4, or on **WEDNESDAY MORNING** at the Branch Offices, 19, Hertford Street, Coventry; Guildhall Buildings, Navigation Street, Birmingham; 199, Deansgate, Manchester.

Advertisements that arrive too late for a particular issue will automatically be inserted in the following issue unless accompanied by instructions to the contrary. All advertisements in this section must be strictly prepaid.

Postal Orders and Cheques sent in payment for advertisements should be made payable to **LIFFE & SONS Ltd.**, and crossed **& Co. Treasury Notes**, being untraceable if lost in transit, should not be sent as remittances.

All letters relating to advertisements should quote the number which is printed at the end of each advertisement, and the date of the issue in which it appeared.

The proprietors are not responsible for clerical or printers' errors, although every care is taken to avoid mistakes.

NUMBERED ADDRESSES.

For the convenience of advertisers, letters may be addressed to numbers at "The Wireless World" Office. When this is desired, the sum of 6d. to defray the cost of registration and to cover postage on replies must be added to the advertisement charge, which must include the words Box 000, c/o "The Wireless World." Only the number will appear in the advertisement. All replies should be addressed No. 000, c/o "The Wireless World," Dorset House, Tudor Street, London, E.C.4. *Readers who reply to Box No. advertisements are warned against scolding remittance through the post except in registered envelopes; in all such cases the use of the Deposit System is recommended, and the envelope should be clearly marked "Deposit Department."*

DEPOSIT SYSTEM.

Readers who hesitate to send money to unknown persons may deal in perfect safety by availing themselves of our Deposit System. If the money be deposited with "The Wireless World," both parties are advised of its receipt.

The time allowed for decision is three days, during which time, if the buyer decides not to retain the goods, they must be returned to the sender. If a sale is effected we remit the amount to the seller, but, if not, we return the amount to the depositor. Carriage is paid by the buyer, but in the event of no sale, and subject to there being no different arrangement between buyer and seller, each pays carriage one way. The seller takes the risk of loss or damage in transit, for which we take no responsibility. For all transactions up to £10, a deposit fee of 1/- is charged; on transactions over £10 and under £50, the fee is 2/6; over £50, 5/-. All deposit matters are dealt with at Dorset House, Tudor Street, London, E.C.4, and cheques and money orders should be made payable to Liffe & Sons Limited.

THE SALE OF HOME-CONSTRUCTED UNLICENSED APPARATUS.

A New Service to our Readers.

We have made an arrangement with the Patentees whereby readers who wish to dispose of a home-constructed receiver not licensed under the patents made use of, can do so by means of the Deposit System referred to above.

The person desiring to sell, in sending us particulars for his advertisement, will in every case make use of a Box No., and should add to the price which he requires the amount of royalty customarily paid by manufacturers, viz. in the case of Marconi Patents the amount should be calculated at 12/6 per valve holder.

If the purchaser is satisfied with his purchase, the sum realised will be forwarded to the seller, less the amount due in respect of royalties, which amount will be paid by "The Wireless World" to the owners of the patents concerned and a certificate will be handed on to the purchaser of the set.

FOR SALE.

3- and 4-valve Sets, specially selective, best components, handsome cabinets, very cheap.—Box 7325, WIRELESS WORLD Office. (1902)

VALVES, new, 3s. 6d., guaranteed good; tapped 60-volt batteries, 7s. 6d. All post free. Send for price list.—Withers, Riverside, Ringwood, Hants. (1919)

A46

Mention of "The Wireless

For Sale.—Contd.

HIGH-TENSION Accumulators.—The Ideal Loud-speaker Battery, 60 volts, 35s.; 80 volts, 45s.; 100 volts, 55s.; guaranteed. Good trade terms.—Pearson, 110, Marston Lane, Bedworth, Nuneaton. (1882)

OSCILLATING Zincite and Contact, 2s. 6d.; simple, original circuit, 1s.; excellent results; other parts stocked.—Ledsham's, 297, King Street, Hammersmith. (1888)

WOOD Horns for all speakers and gramophone attachments. There's one for Amplion Junior, ditto goose-neck bases, Liscenola, etc. There's only one best; it's the "Allwoodorn."—Manufacturer: H. Maddison, 2A, Ronald's Road, Highbury, N.5. List free. (1914)

HOME Constructors.—Send for list of accessories, post free, from Radio Supplies, 51, Eden Street, Kingston-on-Thames, Surrey. (1929)

MARCONIPHONE Multivalve and Amplifier combined, using 5DEV, 1DEQ, 1R, 1LS3, contained in a handsome polished walnut cabinet, standing nearly 5ft. high, which contains all batteries, can be used with either frame or open aerial, phones, or loud-speaker, bargain, with H.T.s, 2 accumulators, 2 pairs telephones, £30 complete; also V2 receiver and A2 amplifier, phones, 2 2-volt accumulators, valves, copper earth mat, range blocks, and regenerator units, from about 300 to 3,000 metres, both sets in new condition, £20 complete.—Brigadier-General Sir Alfred Balfour, The Mount House, Brasted, Kent. (1963)

SURPLUS Apparatus from 2JJ Station.—110-volt D.C. ¼ h.p. motor, with D.C. current converter for charging, £8; 0-20 A.C. voltmeter, 15s.; 150-200 metres transmitting helix, with grid coil, 30s.; 200-400 metres transmitting variometer, 30s.; Mark III., ex W.D., tapped tuning coil, 0-3,000 metres, 25s.; G.P.O. polarised relay, with platinum contacts, 40s.; G.P.O. Morse sounder, 7s. 6d.; signalling lamp, 5s.; loud-speaker, 2,000 ohms, 20s.; 1 pair 250 ohms phones, 5s.; transmitting variable condenser, 20s.; motor spark coil, 5s.; microphone, voltmeter, ammeter, wirewound grid-leak, switches, etc.—Apply: Radio 2JJ, 370, Old Kent Road, S.E.1. (1961)

A MATEUR changing Superhet offers newly-constructed, powerful, handsome 3-valve, exceptional loud-speaker range, complete, coils, valves (power), 2 Exide accumulators, 100-volt H.T. and Amplion, also 100 wireless periodicals, sacrifice; £8.—Bramley, 31, Melrose Street, Hull. (1958)

TORDA Low-loss Neutroformers.—Most efficient coupling available for B.B.C. or Daventry wave-lengths. Full technical data for stamp. Neutroformer with "plug-in" base 15s.—Cotton & Clarke, Ltd., 55-59, Lacy Road, Putney, S.W.15. (1899)

SET Intermediate Transformers, complete with filter and No. 2 oscillator, also two .0005 SL Sterling condensers with vernier plates; £4 the lot, new condition.—Johnson, 154, Warwick Street, Pimlico, S.W.1. (1968)

TWO-VALVE Set, Cossor "Wuncells," 5 coils, H.T., L.T., "Sterling" loud-speaker, etc., bargain; £6 10s., or offer.—9, Ebbsfleet Road, Cricklewood, N.W.2. View by appointment. (1967)

For Sale.—Contd.

TWO-VALVE Duplex-Burndept, 3 only, shop-soiled, at half maker's price, also 2-valve "Goldtone" and several others; Brown loud-speaker and microphone amplifier, 2,000 ohms, 8-valve, Burne-Jones superhet, etc.—Send for particulars: Newport, Westbury, Sherborne. (1966)

SUPER Heterodyne Components.—Various complete sets, slightly shop-soiled, at bargain prices.—Write for list, free: Fairbairn, 181, High Street, Ayr. (1964)

TWO-VOLT 100-ampere Accumulators in Tebonite cases, absolutely brand new and unused, satisfaction guaranteed or money back. Price 16s. each, carriage paid. Other sizes in proportion.—Wolfson Electric Battery Co., 114, Stocks Street, Cheetham, Manchester. (1959)

FOR SALE.—Marconi "Ideal" transformers, 2.7 and 4 to 1; "Grelco" transformer, 4 to 1; Marconiphone variometer; Sterling dual condenser; "Magnum" No. 3, matched H.F. transformers; Bullphone "De Luxe" loud-speaker. All guaranteed perfect. What reasonable offers? List of other components upon request.—Box 7565, WIRELESS WORLD Office. (1977)

LOUD - SPEAKERS, Second-hand. —"Kone," £4 10s.; "Sterling Baby," black, 27s. 6d.; gold, 30s.—Tyers, 77, High Street, Watford. (1969)

MORSE learnt in 1 hour with the "Simple" Mnemo-Visual Apparatus. How to synchronise sight and sound. Simple and infallible. Post free 2s. 6d.—Simple Co., 44, Bedford Row, W.C.1. (1971)

ZEAL 60-volt H.T. guaranteed Batteries. Tapped every 3 volts. 7s. 10d., C.O.D.—Newport, Westbury, Sherborne. (1972)

PRIMAX Loud-speaker, bronzed finish, perfect condition; £3 10s.—Shelley, Meadowcroft, Trentham, Staffs. (1973)

NEW R.I. Multi-Ratio Transformer, 21s.; 2 new Cosmos S.P. 18 Green Spect valves, 9s. each; new Lucas 6-volt 6-amp. dynamo, £3 3s.; 250-volt ¼ h.p. D.C. motor, ball bearings, £3 10s.; Igranite S.R. variometer, 4in. dial, 7s. 6d.; Igranite potentiometer, 3s. 6d.—15, Clifton Avenue, Finchley, N.3. (1974)

A MATEUR has for disposal R.I. L.F. transformer, 12s. 6d.; R.I. anode reactance unit, 300-4,000 metres, 10s.; 2 R.I. dual rheostats, 4s. 6d. each; Sterling .0005 square-law condenser, with vernier, 10s.; amplior swan-neck, mahogany speaker, £2; Igranite telephone, 1-1 transformer, 2,000 ohms 7s. 6d. Other small components.—Faudell 31, Fenwick Road, S.E.15. (1975)

MISCELLANEOUS.

CHARGE Your Own Accumulator.—Send 3d stamp to-day for lists of our small gas and petrol engines and dynamos, and complete charging sets, from 20 to 160 watts.—Ton Senior, Cleckheaton, Yorks. (0013)

A WIRELESS Doctor.—If your set is giving trouble or you want advice a competent expert will call (anywhere in Great London) and put you right. No result, no charge.—Alexander Black, 2A, Woodville Grove, N.16. Clissold 3687. (1976)

World," when writing to advertisers, will ensure prompt attention.

PATENT AGENTS.

W. BRYSON, B.Sc., Chartered Patent Agent, 29, Southampton Buildings, W.C.2. 'Phone: Holborn 672. (1297)

PATENTS and Trade Marks Obtained.—**H. T. P. Gee, Patent Agent, Member R.S.G.B., A.M.I.R.E.,** 51-52, Chancery Lane, London, W.C.2. 'Phone: Holborn 1525. (0001)

REPAIRS.

TRANSFORMERS rewound to guaranteed efficiency for 12 months, 4s., or exchanged for another, any ratio, 5s.; iron core wire-wound chokes for L.F. amplifiers, 6s.—115, Links Road, Tooting. (0011)

ACCUMULATORS.—Send your repairs to the firm who specialise.—**Wolfson Electric Battery Co.,** 114, Stocks Street, Cheetham, Manchester. (1960)

TUITION.

INSTRUCTION in Morse, day or evening, easy terms.—**Telegraph School,** 29, Talfourd Road, Peckham, S.E. (1957)

WANTED.

COPIES of No. 397, Vol. XVII., No. 1, "Wireless World."—**G. Brame, Diss,** Norfolk. (1867)

SITUATIONS VACANT.

BRADFORD Education Committee Technical College.—Applications are invited for the appointment of Lecturer in the Department of Electrical Engineering in the College; salary according to Burnham Technical Award; candidates should preferably possess special qualifications in high-frequency and thermionic work.—Full particulars of the appointment and forms of application may be obtained from the Principal of the College, to whom the completed application should be returned not later than April 21, 1926. **N. L. Fleming, Town Clerk.** (1065)

AGENTS wanted by well-known firm (spare or whole time) to sell high-class complete Crystal Sets and Components; excellent profits can be made by smart men; send stamp for full particulars.—**Box 7560, WIRELESS WORLD Office.** (1070)

BOOKS.

FOR Sale. Back Numbers of all Wireless Publications. **H. F. Davies,** 5, High Holborn, W.C. (1945)

"WIRELESS WORLD," Volumes XI. to XIV., bound, excellent condition; offers?—**Abbott,** 31, Green Road, Hall Green, Birmingham. (1962)

PATENTS, DESIGNS AND TRADE MARKS.

J. S. Withers & Spooner.

CHARTERED PATENT AGENTS.

SEARLE HOUSE, 61 & 62, CHANCERY LANE, LONDON, W.C. 'Grams'—IMPROVING, HOLB., LONDON. 'Phone:—450 HOLBORN

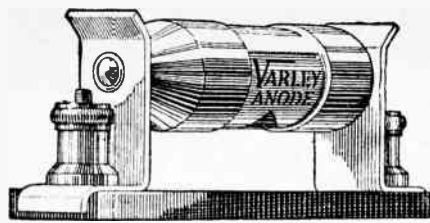

The Varley Bi-Duplex Anode Resistance.

The famous Bi-Duplex system of non-inductive wire winding has placed the Varley Anode Resistance far ahead of any other make for silence in working, purity of tone and absolute constancy under all atmospheric conditions.

The Varley Magnet Co's. 27 years' experience in all matters relative to intricate and accurate wire-winding is a sound guarantee of satisfaction.

Complete with Clips and base **7/6**
Without Clips and base **6/-**

60,000, 80,000 and 100,000 ohms.

Write for Leaflet.



Oliver Pell Control Ltd.
Woolwich, S.E.18.
Telephones: Woolwich 888, 889.



Tested low-loss condensers

Constructors! For your D.X. work pump for Ericsson Tested Condensers. They're the last word in accuracy. Losses are kept down to zero. Stout vanes accurately spaced—engineer-built all through. They pull their weight in long-distance work. Template Supplied. Ebromite end plates.

Write for lists to-day.
Prices
'0005 10 6
'001 12 6
The BRITISH L.M. ERICSSON
Mfr. Co. Ltd.,
67 73, Kingway, London, W.C.2.



EARTH FAULTS ENDED

Entirely new method of Earth-system efficiency. 20% to 200% increase guaranteed. Vastly superior to all metal sulphates. Ideal for all outdoor Earths. 2/6 complete, post 6d. Cash on delivery if desired. Particulars free.

J. W. Miller, 68, Farringdon Street, E.C.4.
'Phone: Cent. 1950.
Approved by Radio Association.

Absorbs shock—Protects your valves

You know it's good —because of the name LOTUS.

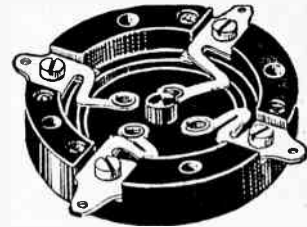

UNDERSIDE SHOWING SPRINGS.

Don't have your valves spoiled by shock. The Lotus Valve Holder has been specially designed to counteract the microphonic elements that are so injurious to the delicate valve filaments.

The unique and original springs of the Lotus Valve Holder absorb any shock and eliminate all microphonic noises.

Protect YOUR Valves by fitting the Lotus Holder

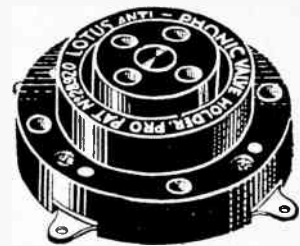

TOP VIEW.

Valve sockets and springs are locked together by a mechanical process, making a definite and permanent connection. Bakelite mouldings, nickel silver springs and phosphor bronze valve sockets. Nickel-plated.



GARNETT, WHITELEY & CO., LTD.,
Lotus Works,
Broadgreen Road, Liverpool

Makers of the famous Lotus Verner Coil Holder.

2/3

With Terminals 2/6

The **Wireless**
AND
RADIO REVIEW **World**

INDEX TO ADVERTISEMENTS.

Accumulators Elite	16	Dixon, Leslie & Co.	11	Miller, J. W.	15
A.J.S. & Co. (1914), Ltd.	16	Dubilier Condenser Co. (1925), Ltd. ...	Cover iv	Mullard Wireless Service Co., Ltd., The	5
Audion Radio Co.	16	Finston Manf. Co., Ltd.	16	Nelson Electric Co., Ltd.	12
Autoveyors, Ltd.	4	Fitzpatrick, H. D., & Co.	16	Ormond Engineering Co., Ltd.	3
Blackadda Radio Co., Ltd.	4	Garrett, Whiteley & Co., Ltd.	15	Paragon Rubber Manf. Co., Ltd.	13
Bowyer-Lowe Co., Ltd.	9	General Radio Co., Ltd.	11	Partridge & Wilson	13
Brandes, Ltd.	9	Goswell Engineering Co., Ltd.	12	Pugh Bros	16
Bretwood, Ltd.	11	Graham, Alfred, & Co.	13	Radi-ars Electrical Co., Ltd., The	16
Britannia Rubber & Kamptulicon Co., Ltd.	11	Hamley Bros., Ltd.	13	Radiations, Ltd.	16
British Ebonite Co., Ltd.	11	Hildiek & Hildiek	16	Sifam Elec. Inst. Co.	15
British L.M. Ericsson Manf. Co., Ltd. ...	15	Hunt, A. H., Ltd.	6	Taylor, J. H., & Co.	15
Burndep Wireless, Ltd.	6	Igranic Electric Co., Ltd.	7	Telegraph Condenser Co., Ltd.	9
Cahill & Co., Ltd.	11	Jones & Stewart	11	Telephone Manf. Co., Ltd.	9
Cambridge Correspondence College, Ltd.	13	Lissen, Ltd.	11	Varley Magnet Co., Ltd.	15
Caxton Wood Turnery Co.	13	London Elec. Wire Co. & Smiths, Ltd.	Cover ii	Watnial Wireless Co., Ltd., The	13
Charlesworth, W. J.	6	Marconiphone Co., Ltd., The	1	Wilkins & Wright, Ltd.	4
Chloride Electrical Storage Co., Ltd. ...	2	McMichael, L., Ltd.	8	Withers, J. S., & Spooner	15
Darimont Electric Batteries, Ltd.	6	Metro-Vick Supplies, Ltd.	Cover ii	Zealand & Co.	16

2-Volt Power Valve 12/6

This is a REAL power valve—British Made—Radion Guaranteed—and far less money than other leading makes. From **untied dealers or direct.**

RADION save you money but beware of imitations. Write for free book. RADIONS Ltd., — Bollington, Nr. Macclesfield, CHESHIRE



H.T. Accumulators 37/6

60 Volts. 3 Actual Amp.-hour



The finest H.T. Accumulator in the world.

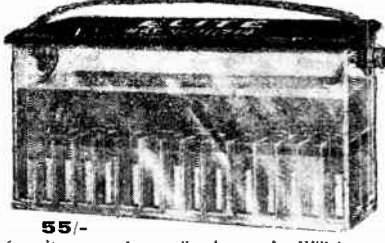

55/-

60-volt, 3-amp.-hour, oil submerged. Will last a lifetime. Write for descriptive folder.

MONEY RETURNED IF NOT SATISFIED. Obtainable only from ACCUMULATORS ELITE, 31, Waterhouse St., Halifax.

Trade supplied. Telephone: 1394.

LOWE AUDION VALVES

FOR BEST RESULTS AT LOWER COST!

Will give better results than many at nearly double the price: specially suitable for Super-het. Sets.

L.A. 75 15 amp. 2 volt, 10/8 if your dealer
L.A. 74 00 amp. 3 volt, 11/8 (cannot see)
L.A. 191, Power valve, 1/2ly send post.
0.3 amp. 4 volt, 21/- direct to

AUDION RADIO CO.,
52, Dorset Street, LONDON, W 1.



PATENTS, DESIGNS & TRADE MARKS.

H. D. FITZPATRICK & CO.
Chartered Patent Agents,
49, Chancery Lane, London, W.C.2
Phone: Holborn 459.

TROLITE PANELS

Mahogany Grain 3/6 lb.
Black Engraved wavy 3/9 lb.
Black plain polished 3/- lb.
Machine cut Tested to your own 50,000 Volts. measurements.

Free Samples on Request.

PUGH'S WIRELESS, 95-101, Holloway Road, London, N.7

1 & 3 ONLY.



WIRELESS MASTS.

GALVANIZED TUBULAR TELESCOPIC.

Complete with base plate, ground pegs, stay wires, straining screws, pulley and cleat.

35ft. High £3 2 6 50ft High £6 15 0

HILDICK & HILDICK, Pleck Road, Walsall.

Valves, Batteries

'Radio Micro' Special Valves. 3.5 Volt. 0.06. 8 3
'Radio M.R.3.' 3 Volt. 0.06. 5 9
Fama' Power Valve . 4-6 Volt. 3 Amps. 7 9

All English & Continental Valves Stocked. Prices Post Free.

'ZREAL' Guaranteed 60 Volt H.T. Battery. Tapped every 3 volts. Silent in use. Even and steady discharge. Exceptionally long life. 7/9 post free.

Write for list Wireless Components. Trade enquiries invited
H. D. Zealand & Co., St. John's Esq., Minorities, London, E.1

THE WIRELESS LEAGUE
MEMBERSHIP AND RENEWAL FORM.

To be filled in by readers who wish to become members of the League, or to renew their membership for a further twelve months as from 1st April.

To the Secretary, The Wireless League, Chandos House, Palmer Street, Victoria Street, S.W.1.

Please *enrol me as a member / renew my membership of The Wireless League. I enclose P.O. for Two Shillings,† which entitles me to membership with all the privileges and rights as enumerated in the constitution of the League, including FREE Insurance, Free Legal Advice and Free Technical Advice.

* Cross out lines not required.

† Keep the Counterfoil of your Postal Order.

WRITE IN CAPITAL LETTERS. Name (in full).....
(State whether Mr., Mrs. or Miss)

Address.....

My Membership No. is.....
This is only applicable in the case of renewals

Please enclose stamped addressed envelope.

Commencing with the first issue in May. "The Wireless World" will devote four pages in the first issue of each month to League Notes and News.

WIRELESS VALVE RECEIVERS & CIRCUITS IN PRINCIPLE AND PRACTICE

By R. D. BANGAY & N. ASHBRIDGE, B.Sc.

THIS BOOK will add to the pleasure of the amateur wireless experimenter by extending his theoretical knowledge of the whys and wherefores of valve receivers.

The subject is treated from a standpoint that will enable the home constructor to understand the working of any circuit which he may evolve, and he thus becomes independent of published diagrams and specifications. The volume is well illustrated.

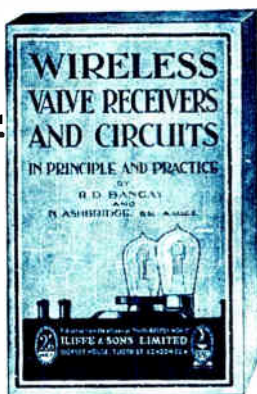

PRICE **2/6**
net
By Post **2/10**

Obtainable from all leading booksellers, or direct from the publishers:

ILIFFE & SONS LTD., Dorset House, Tudor St., London, E.C.4

W.W.40

15 Replies—and a satisfactory exchange!

"I have had fifteen replies in all to my advertisement in 'The Wireless World,' and I have sent a postcard to each, although I had made a satisfactory exchange with the first enquirer, who wrote immediately the advertisement was published.

"I am glad to note that your advertising charges are reduced.

"Best wishes to 'The Wireless World.'

ALEX. A. LATTIMER,
'The Croft,' Newton Mearns,
Renfrewshire."

For the disposal or purchase of spare wireless apparatus, there is no surer or speedier way than that afforded by the Miscellaneous Advertisement Columns of "The Wireless World."

w.w.43

A Service that gives Security!

MANY readers naturally hesitate to send money to unknown persons. We have therefore adopted a Deposit System which gives complete security both to buyer and seller. If the money be deposited with "The Wireless World" both parties are advised of its receipt. The time allowed for decision is three days, after which time, if the buyer decides not to retain the goods, they must be returned to the sender. If

a sale is effected we remit the amount to the seller; but, if not, we return it to the depositor.

Full particulars may be found on the Miscellaneous advertisement page at the end of the book.

Use this service for your wireless requirements and avoid all risk! Sell the apparatus you no longer require! Write out your advertisement to-day and send to—

PREPAID ADVT. DEPT., "THE WIRELESS WORLD," DORSET HOUSE, TUDOR ST., LONDON, E.C.4.

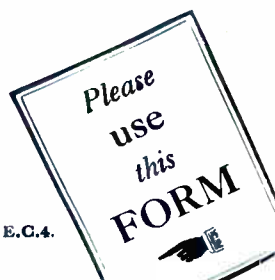

12
Words
or
Less
1/-

each
addi-
tional
word
1d.

Advertiser's name and address must be counted. If a box number is required 6d. extra must be sent for postage on replies.

w.w.39

Advertisements for "The Wireless World" are only accepted from firms we believe to be thoroughly reliable.

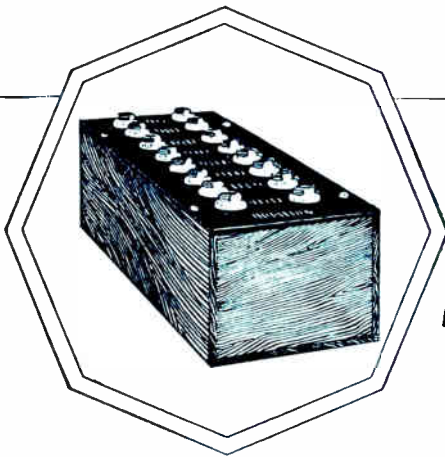

The Dubilicon 30/-

A DUBILIER MONEY SAVER!

The Dubilicon is a remarkably useful invention. It will save you money and at the same time enable you to be quite sure you have the best values of fixed condensers in every part of your circuit.

The Dubilicon consists of eight condenser units, which by means of Clix plugs (made by Messrs. Autoveyors, Ltd., 84, Victoria Street, S.W.1) of which two are given with every Dubilicon, can be connected to give a very large number of different capacities, ranging from 0'0001 to 0'011 mfd.

If, for example, you want to find the best capacity to use in a grid circuit, all you do is try various values with the Dubilicon in circuit until you have the right one. You note the value, and then buy a Dubilier Mica Condenser of that value, and there you are!

That is why we tell you that, instead of buying a large number of unnecessary condensers of different values, and trying each one, you should buy one Dubilicon for 30/- and save money!

£200 cash prize

In connection with the Dubilicon, there is an interesting little problem. How many different capacities can be obtained by using it? For example, taking the first two units only, you get two values by using each separately, one by using them in parallel, and another when they are in series. Total 4. How many arrangements are possible by using the first five units, both separately and in various combinations?

To the purchaser of a Dubilicon who sends in a correct estimate, we will award a cash prize of £200.

If two or more competitors send in a correct solution, this prize will be divided equally among them, while if no correct solution is forthcoming, the prize will be awarded to the competitor furnishing a figure most closely approximating the correct estimate, or divided among them equally if more than one is included in this category.

By courtesy of the Trader Publishing Co., Ltd., the competition will be judged by the Editor of the "Wireless Trader," whose decision will be final.

All you have to do is to purchase a Dubilicon from your Wireless Dealer. It will be given to you in a sealed box containing a numbered

entry form, and full particulars of the competition as well as instructions for the use of the Dubilicon.

N.B.—You must purchase from a Wireless Dealer, and the seal on the box must be unbroken. We cannot supply direct.

We would like you to remember that only a limited number of Dubilicons are being made, so you will be well advised to buy quickly.

Don't forget that you will be purchasing the most useful condenser ever made, as well as a chance of winning £200 outright!

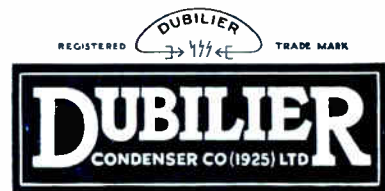

ADVERT. OF THE DUBILIER CONDENSER CO. (1925) LTD., DUCON WORKS, VICTORIA ROAD, NORTH ACTON, W. 3. TELEPHONE: CHISWICK 2241-2-3. K.P.S. 184

THE WIRELESS WORLD AND RADIO REVIEW, APRIL 21ST 1926.
NEON WAVEMETER FOR TRANSMITTERS

4p

Wireless World

AND
RADIO REVIEW

The Paper for Every Wireless Amateur

Wednesday, April 21st, 1926.

AMERICAN LIBRARY
AMERICAN TEL. & TEL. CO.
195 B'WAY, NEW YORK, N. Y.



**"Just listen to the difference
this LEWCOS Coil makes!"**



CLEAR as a bell the typical French Orchestra came through as the listener tuned in with his LEWCOS Coil. Coil after coil had been tried and discarded in an endeavour to realise that rare selectivity and fine tuning so essential to complete radio enjoyment.

Test this new coil yourself. Each LEWCOS Coil is tested in our laboratory. It is then boxed and sealed up, and reaches you in perfect condition. Be sure the LEW seal is unbroken. Ask your radio dealer for a demonstration.

LEWCOS

Inductance Coil



3 LEWCOS advantages:

- 1 High electrical efficiency with great mechanical strength.
- 2 Great selectivity resulting in extremely fine tuning.
- 3 Exceptionally low high frequency resistance with increased signal strength.

THE LONDON ELECTRIC WIRE CO. and SMITHS LTD.,
Manufacturers of Glazite
Playhouse Yard, Golden Lane, London, E.C.1.

JUDD

Mention of "The Wireless World." when writing to advertisers, will ensure prompt attention.

AN AMPLION *improves* ANY PROGRAMME

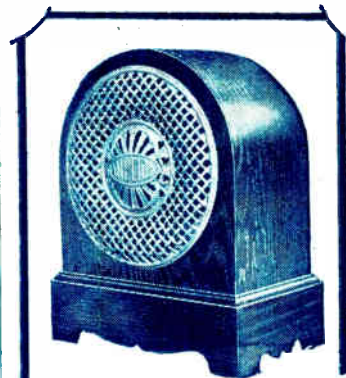

Model R.S.2.
Oak - £5-10-0
Mahogany £6-6-0

The
AMPLION
Series

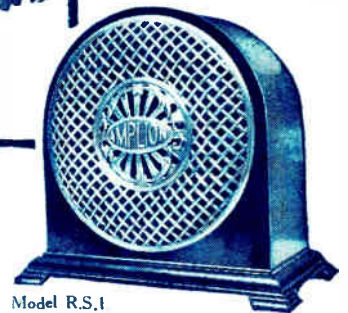

Model R.S.1

Oak - - - - - £7-7-0
Mahogany - - - - - £8-8-0

*The
Natural
Tone
Loud
Speaker*

*There is no substitute
for a genuine Amplion*



Obtainable from AMPLION STOCKISTS Radio Dealers or Stores.
Demonstrations gladly given during business hours at the AMPLION Showrooms:
25-26, Savile Row, London, W.1. 10, Whitworth St. West, Manchester.
79-82, High Street, Clapham, S.W.4. 101, St. Vincent Street, Glasgow.

SIR HARRY LAUDER
writes in the April issue of the
AMPLION MAGAZINE
"The Radio Monthly de Luxe"—One Shilling.

Announcement of Alfred Graham & Co. (E. A. Graham), Crofton Park, S.E.A.

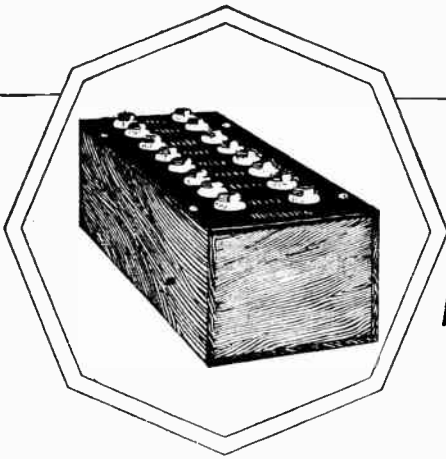

The Dubilicon 30/-

A DUBILIER MONEY SAVER!

The Dubilicon is a remarkably useful invention. It will save you money and at the same time enable you to be quite sure you have the best values of fixed condensers in every part of your circuit.

The Dubilicon consists of eight condenser units, which by means of Clix plugs (made by Messrs. Autoveyors, Ltd., 84, Victoria Street, S.W.1) of which two are given with every Dubilicon, can be connected to give a very large number of different capacities, ranging up to 0.011 mfd.

If, for example, you want to find the best capacity to use in a grid circuit, all you do is try various values with the Dubilicon in circuit until you have the right one. You note the value, and then buy a Dubilier Mica Condenser of that value, and there you are!

That is why we tell you that, instead of buying a large number of unnecessary condensers of different values, and trying each one, you should buy one Dubilicon for 30/- and save money!

£200

cash prize

In connection with the Dubilicon, there is an interesting little problem. How many different capacities can be obtained by using it? For example, taking the first two units only, you get two values by using each separately, one by using them in parallel, and another when they are in series. Total 4. How many arrangements are possible by using the first five units, both separately and in various combinations?

To the purchaser of a Dubilicon who sends in a correct estimate, we will award a cash prize of £200.

If two or more competitors send in a correct solution, this prize will be divided equally among them, while if no correct solution is forthcoming, the prize will be awarded to the competitor furnishing a figure most closely approximating the correct estimate, or divided among them equally if more than one is included in this category.

By courtesy of the Trader Publishing Co. Ltd., the competition will be judged by the Editor of the "Wireless Trader," whose decision will be final.

All you have to do is purchase a Dubilicon from your Wireless Dealer. It will be given to you in a sealed box containing a numbered

entry form, and full particulars of the competition as well as instructions for the use of the Dubilicon.

N.B.—You must purchase from a Wireless Dealer, and the seal on the box must be unbroken. We cannot supply direct.

We would like you to remember that only a limited number of Dubilicons are being made, so you will be well advised to buy quickly.

Don't forget that you will be purchasing the most useful condenser ever made, as well as a chance of winning £200 outright!



ADVERT. OF THE DUBILIER CONDENSER CO. (1925) LTD., DUCON WORKS, VICTORIA ROAD, NORTH ACTON, W. 3. TELEPHONE: CHISWICK 2241-2-3. E.P.S. 184

ANOTHER INTERESTING COMPETITION FOR "The Wireless World" READERS

£10 in Cash Prizes

First Prize £5

Third Prize £1

Second Prize £2

Four Consolation Prizes of 10/- each.

ALL YOU HAVE TO DO!

PLACE in the order of merit, according to your judgment, the nine most attractive and convincing advertisements in the current issue; classified as follows:---

1st, 2nd and 3rd most attractive whole pages.

1st, 2nd and 3rd most attractive half pages.

1st, 2nd and 3rd most attractive quarter pages, or smaller spaces.

The following considerations determine the real value of an advertisement:

- (1) Its **arresting character**: which depends upon its attractive arrangement, with or without illustration.
- (2) Its **obvious truthfulness**: truth in advertising is a sound business maxim, as well as an ethical necessity.
- (3) The **convincing quality of its descriptive matter**: an advertisement is of no value if it does not induce the reader to purchase the article advertised, when the need arises, on its merits as described.

VOTING COUPON

Whole Page Advertisements.		Half-Page Advertisements.		Quarter-Page or Smaller Adverts.	
Page No.	Name of Advertiser.	Page No.	Name of Advertiser.	Page No.	Name of Advertiser.
1st		1st		1st	
2nd		2nd		2nd	
3rd		3rd		3rd	

Name
(IN BLOCK LETTERS)

Address

WHEN you have filled in all the numbers on the coupon, write your name and address clearly in block letters in the space provided, and post the completed coupon to:

"The Wireless World,"

Dorset House, Tudor Street, London, E.C.4,

marked in bottom left-hand corner "Advertisement Competition."

ALL COUPONS MUST BE POSTED TO ARRIVE NOT LATER THAN APRIL 26th, 1926

RULES and CONDITIONS.

1. The decision of the Advertisement Manager of "The Wireless World" on any point connected with the competition must be accepted as final.
2. No responsibility can be accepted for any letters lost in the post or otherwise. Proof of posting cannot be taken as proof of delivery.
3. No member of the staff of "The Wireless World" or companion journals will be eligible to compete, nor to benefit in any way from the prizes offered.
4. Each prize-winner will be notified by post, and a list of the prize-winners will be published in "The Wireless World" as soon as convenient after the close of the Competition.
5. The Competition is to arrange the list of Advertisements in what is considered to be the order of merit. The correct order of merit will be obtained by counting the votes given by competitors.
6. The competitor whose list agrees, or most nearly agrees, with the popular order as indicated by the total votes will be awarded the First Prize, the next nearest the Second Prize, and so on.
7. Entry into this competition implies full acceptance of all the foregoing rules and conditions.

Sparta sales are built on a reputation for good tone. That fine full voice is a secret shared by no other loud speaker. The new patent magnetic compensator gives a remarkably distinct rendering. The tone modulator in the base gives the right interpretation to every item.

SPARTA Fuller

LOUD SPEAKER

FULLER'S UNITED
ELECTRIC WORKS, LIMITED,
Chadwell Heath, Essex.

Telephone: Word 1200.
Telegrams: Fuller, Chadwell Heath.
LONDON DEPOT:
176, Tottenham Court Road, W.1
Telephone: Museum 9008.

For 1-3 valves: Types HHA, HHB, or HHJ.
For 3-5 valves: Types HA or HB.
For 5 valves or more: Types A or B.
Types A, HA, HHA £4 15 0
Type B .. 25 15 0
Types HB, HHB .. 26 0 0
Type HHJ .. 22 10 0
Type B models fitted with both volume and tone control.

*The Secret
is in the
Base*

USE
FULLER
Ebonite

174-50*

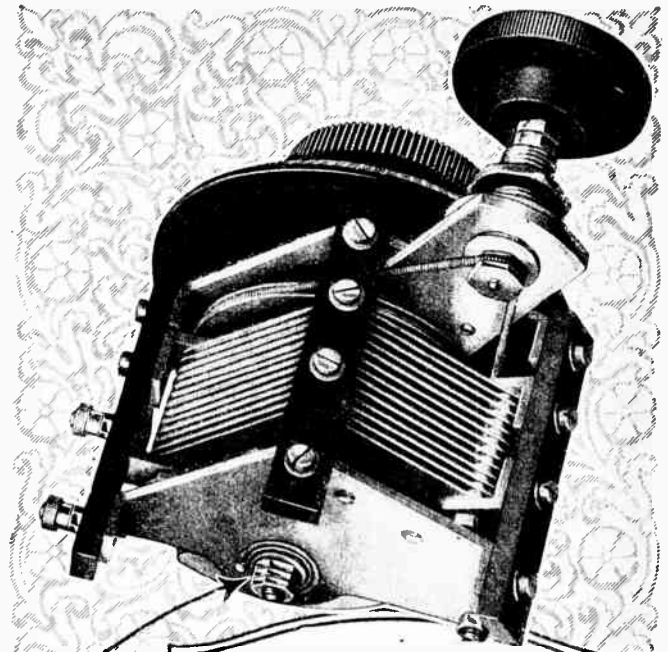
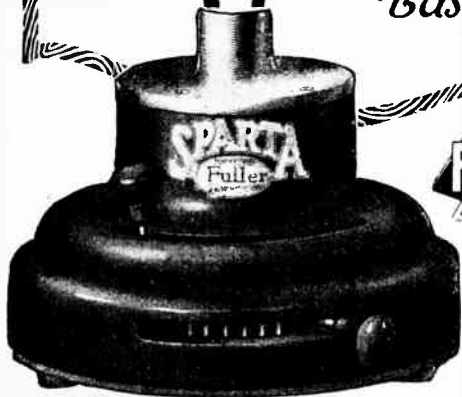

COMPENSATED
SQUARE LAW
EFFECT

LOW LOSS

NO
BACK LASH

LOW LOSS SQUARE LAW SLOW MOTION

THE "Cosmos" Condenser is a slow motion condenser with absolutely no backlash either when new or after use. This desirable feature is accomplished by the use of a spring belt held in tension, which permits coarse tuning with the large knob, and a 10:1 slow motion with the small knob.

Cone bearings allow for adjustment and the slow motion bracket can be mounted for remote control as shown in the lower illustration.

The condenser for fine tuning.
METRO-VICK SUPPLIES LTD.,

(Proprietors)
Metropolitan-Vickers Elec. Co. Ltd.)
Metro-Vick House, 146 Charing Cross
Road, London, W.C.2.

Prices:

Slow Motion	'00025 mfd.	14/9
	'0005	15/6
Ordinary	'00025	12/-
	'0005	13/-

ADJUSTABLE
CONE BEARINGS

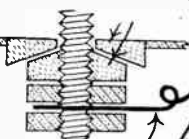

PIGTAIL CONNECTION

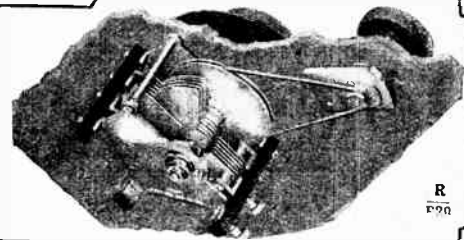

R
E98

COSMOS



IGRANIC-PACENT
True Straight Line
Frequency Variable Condenser.

Summer Reception calls for high efficiency

The best period of the year for long-distance reception is passing. With the advance of Summer it will be more difficult to tune in those distant stations which were picked up so easily a short time ago.

Only by using highly-efficient components in your receiver can a really satisfactory standard of performance be maintained throughout the year. A great deal depends upon the efficiency of tuning devices—for it is in the tuning circuits of a receiver that losses are most detrimental—the available energy is small and must be carefully conserved.

Build the Igranic-Pacent True Straight Line Frequency Variable Condenser into your receiver and you may feel confident that the energy in your aerial is being utilised to the best possible advantage—not dissipated in wasteful losses.

Further, the perfect ease of tuning afforded by the even distribution of stations over your condenser dial will make reception a real pleasure.

Dust-proof bearing gives silky tuning movement and one or three-hole fixing is provided for.

No better straight-line variable condenser can be obtained at the price.

00035 mfd. 14/6 0005 mfd. 18/6

Ask your dealer to show you.

Write for List U. 165.



Exclusive
Manufacturing
Licenses of

Pacent
Radio
Essentials.

149, Queen Victoria St., London. Works: Bedford.

Branches: Birmingham, Bristol, Cardiff, Glasgow, Leeds, Manchester, Newcastle.



Make your choice!

Watmel products offer you two choices for leaky grid rectification—each serving their particular purpose as only Watmel products can. Firstly there is the famous Watmel Variable Grid Leak—used with the unique round Watmel Fixed Condensers. By its use the experimenter can apply the exactly correct grid leak valve to the detector—varying it for different valves and throughout his experiments enjoying the certainty that by virtue of its ingenious construction, the Watmel Variable Grid Leak maintains any particular valve indefinitely. Then there is the Watmel Combined Grid Condenser and Fixed Grid Leak. Saves time and space and is so constructed to allow the Grid Leak to be connected across the condenser or direct to the filament of the detector valve. It can be supplied in any combination and resistance. *Send a card for illustrated booklet and ask your Dealer to show you these interesting Watmel products.*



New Condenser Prices.
Sizes up to '002 ... 2/-
Sizes '0025 to '006 ... 2/6
Variable Grid Leak.
'5 to 5 megohms ... 2/6

Anode Resistance.
50,000-100,000 ohms 3/6
Combined Fixed Grid Leak and Condenser 2/6

WatMel

THE WATMEL WIRELESS COMPANY LIMITED.
332a, Goswell Road, London, E.C.1.
Representative for Lancashire and Cheshire:
Mr. J. B. Levee, 23, Hartley St., Levenshulme, Manchester.

LOUD SPEAKERS

ARE
CLEAR
SPEAKERS

WHEN



FERRANTI

INTERVALVE
TRANSFORMERS
ARE USED

Type AF4	-	-	17/6
Type AF3	-	-	25/-

The Nearly Perfect Transformer.

Ask for Leaflets Wa401 and Wa402.

FERRANTI LTD., Hollinwood, Lancashire

TMC

Low Capacity Keys

combine

- Extreme Low self-capacity.
- A positive locking action.
- Rapid make and break.
- Unvarying performance.
- Adaptability to varied switching requirements.
- Strong and accurate construction.
- Pleasing appearance.



All the live parts of the key are efficiently insulated from the frame. Individual parts are machine-made, ensuring accurate construction. The "gold-silver" contacts are always clean. The ends of the springs are tinned to facilitate soldering. Escutcheon plates and levers are of polished and lacquered brass or finished in bright nickel plate.

T.M.C. Low Capacity Keys are made in 3 models :

- No. 1. 12 point, 3 position .. 7/-
- No. 2. 6 point, 2 position .. 6/-
- No. 3. 24 point, 3 position .. 15/6

Have you sent for your copy of the interesting T.M.C. Catalogue?

It is free on request

Telephone Manufacturing Co., Ltd.,

Hollingsworth Works,
West Dulwich,
London, S.E.21.
Phones: Sydenham 2460/1.

If your dealer does not stock T.M.C. Goods we will supply you direct at the above prices, post free.

TERMINALS

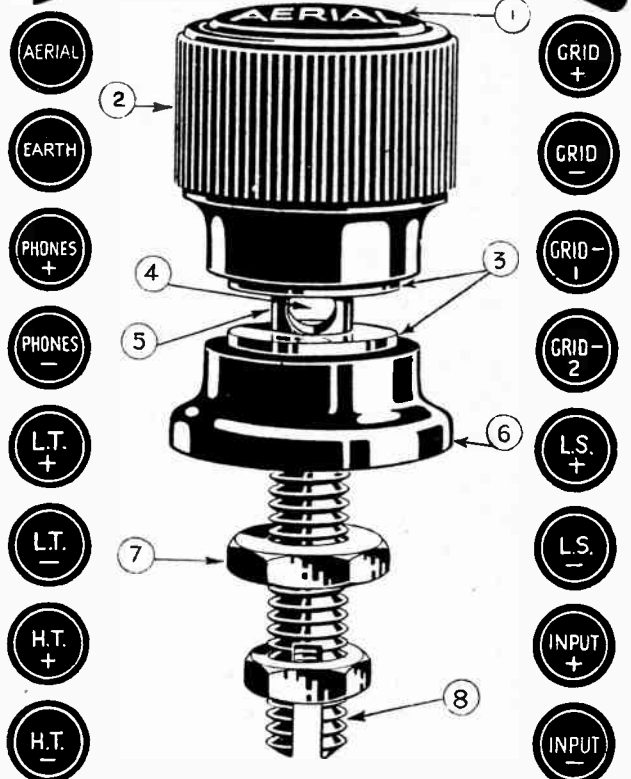

Patent No. 2489219
Registered Design No. 715424.

1. Non-rotating insulated engraved top.
2. Highly finished screw-action Bakelite insulated head.
3. Shielded metal clamping faces.
4. Cross hole for connections, flush with clamping face to avoid shearing of wire when the head is screwed down.
5. Smooth stem, ensuring that strands of connecting wire will not bind up with thread.
6. Highly finished Bakelite insulated collar.
7. Standard 2 B.A. stem with nut.
8. Transverse slot with clamping nut, eliminating soldering.

STANDARD MODEL (Bakelite insulated) (Type B) 9d. each.	POPULAR MODEL (Non-insulated) (Type M) 6d. each.
---	---

Ask your dealer for them, but if he cannot supply, send your order to us enclosing his name and address.

Illustrated catalogue free on request.

**BELLING-LEE, Queensway Works,
Ponders End, Middlesex.**

BELLING-LEE

E.P.8.7.

*VERNIER ATTACHMENT GIVING
ADDITIONAL SLOW MOTION.*

*DIAL 0 TO 340. MOVEMENT
OF CONDENSER 2 TO 1*

*SUPPORTING
SHOULDER PIECE
NO END PLATES USED.*

*MOVABLE STOP,
NO BACK LASH.*

*EXTRA HARD
FRICTION DISC.*

*FRICTION
WHEEL*

*NOTE POSITION
OF VANES TO PANEL.*

EXTRA SUPPORT.

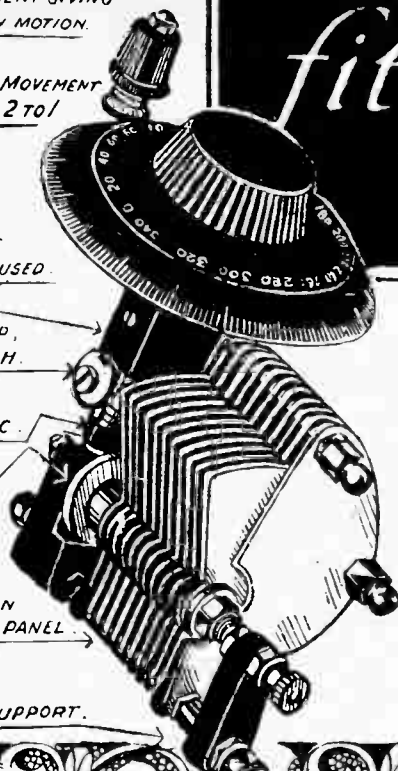

fit "DEVICON" CONDENSERS to your Set

The shortcomings of Condensers as a whole have been met in this the latest type.

The new "DEVICON" TRUE SCALE FRICTION CONDENSER

(Patent App'n. No. 1990,26)

has a 2 to 1 movement with additional slow motion device attached. One drilling hole in panel is all that is necessary. See the diagram at the side and note the improvements.

Supplied in the following sizes

'001 - 15/6	'0003 - 14/-
'0005 - 14/6	'0002 - 13/6

Ask your Dealer about it.

Manufactured and fully
guaranteed by

THE RADIO DEVICES CO.,
Newdigate Street
Telephone: 6798.
Telegrams: "Devicon."
Nottingham.



ADVERTISEMENT COMPETITION RESULTS

The following are the prizewinners in the Advertisement Competition announced in the issue of "The Wireless World" dated April 7th, 1926.

First Prize £5

W. H. LANT, 143, Hillside,
Harlesden, London, N.W.10.

Third Prize £1

A. L. OLDACRE, 130, Princes
Road, Hartshill, Stoke-on-Trent.

Second Prize £2

R. H. STANSWOOD, 18, Fairfield
Lane, Barrow-in-Furness.

Four Consolation Prizes of 10/- each:

H. W. SMITH, 185, St. Augustine Road, Southsea, Hants. ERNEST PERCY, 18, Hunsdon Road, New Cross, London, S.E. G. W. WILKINS, 163, Green Lane, Norbury, London, S.W. 16. E. W. J. CAMBRIDGE, 8, Glenavon Road, Stratford, London, E.8.

CHEQUES HAVE BEEN DISPATCHED TO THE PRIZEWINNERS.

The WINNING ORDER for the nine advertisers was as follows:

Whole Page Advertisements.			Half-Page Advertisements.			Quarter-Page or Smaller Adverts.		
	Page No.	Name of Advertiser.		Page No.	Name of Advertiser.		Page No.	Name of Advertiser.
1st	5	A. Vandervell & Co., Ltd.	1st	ii	Belling-Lee.	1st	11	Lisenin Wireless Co.
2nd	7	Ferranti, Ltd.	2nd	iii	Radio Devices Co.	2nd	13	Nelson Electric Co., Ltd.
3rd	1	The Marconiphone Co., Ltd.	3rd	4	Metro-Vic Supplies, Ltd.	3rd	12	Goswell Engineering Co., Ltd.

EDISON BELL RADIO

THE FINEST FIXED CONDENSERS MONEY CAN BUY OR SCIENCE PRODUCE.
FIT THEM TO YOUR SET AND BE SATISFIED.

CAT. No. 130/325.
E.B. FLAT TYPE
fitted with GRID LEAK IN SERIES.
PRICE 2/3

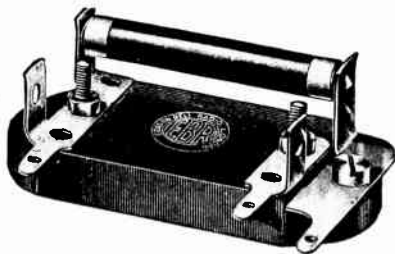

Ask your Dealer for Catalogues and list R.I.E. 341. If unable to obtain write direct to Manufacturers—
J.E. HOUGH Ltd.
Edison Bell Works,
LONDON, S.E. 15.
and at Huntingdon.

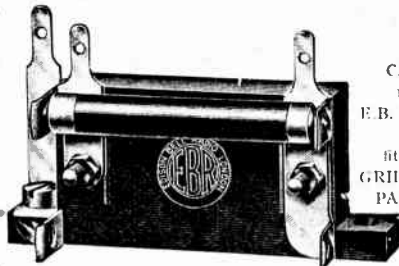

CAT. No. 130/325.
E.B. UPRIGHT TYPE
fitted with GRID LEAK IN PARALLEL.
PRICE 2/3

In these condensers the two clips used when the grid leak is in parallel are fitted under the terminals. The third clip is supplied loose and should be held in position by the screw which holds the condenser to the panel. The exact position of the third clip is clearly indicated in the above illustration, and full directions are supplied with each condenser. The parallel connection is usual in valve detectors, and the series arrangement is used in tuned anode and resistance couplings, etc.

The above can be supplied with or without grid leaks fitted.

TESTED 500 VOLTS
FLAT TYPE



TESTED 500 VOLTS
UPRIGHT TYPE



INSIST ON EDISON BELL CONDENSERS

THEY ARE BRITISH MADE AND GUARANTEED BY A NAME WITH 30 YEARS REPUTATION BEHIND IT

ARE YOU USING

MELLOWTONE

COUPLERS?

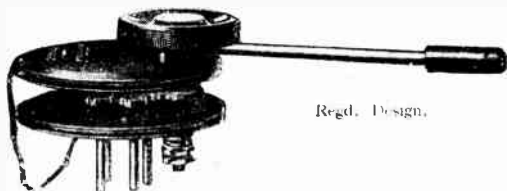

Regd. Design.

AERIAL AND REACTION	
25	5/6
35 (B.B.C.)	5/6
50	5/6
75	5/6
Daventry	7/6
TUNED ANODE AND REACTION	
250-650	5/6
650-1650	7/6
1500-3000	10/6
(Daventry)	

**REPLACE
COILS AND
HOLDERS
AT LESS
THAN HALF
THE COST.**

YOU SHOULD BE—you will obtain far better results by doing so and also SAVE MONEY!

"MELLOWTONE" Couplers are specially designed to avoid distortion in telephony reception, they give excellent selectivity and perfectly smooth reaction control.

They plug into standard valve holders, take up small panel space, have small external field and high coupling ratio.

Obtainable from all reputable dealers. Write for Illustrated List of this and other Mellowtone Specialities—and if interested in QUALITY Receivers, ask for Catalogue of Mellowtone Two and Four Valve Sets.

LONDON DEPOT: "MELLOWTONE,"
TRIUMPH HOUSE, 189, REGENT STREET, W.1.
Telephone: Regent 1660.

MELLOWTONE
MIDLAND RADIOTELEPHONE MFRS LTD.
BRETTELL LANE WORKS
STOURBRIDGE

Radio-Ads.

Osram Valves

for Broadcasting

Osram
D.E.2
H.F. & L.F.

Only .12 Amp. filament Current Consumption at 1.8 Volts

Wireless users all over the country are welcoming the new D.E.2 OSRAM VALVES. Their introduction spells *cheaper wireless without loss of efficiency*. Accumulator charges are halved or reduced by a third on account of the markedly low current consumption of the D.E.2. Expressions of opinion continue to pour in:

Better in clarity and strength of signal.

Frank B. Sawyer.

I could not wish for better results.

Fred. Gomershall,

Hon. Sec. Dewsbury and District Wireless Society.

Delighted with performance. It is my intention to replace my present valves with OSRAMS.

N. J. Hignett.

Delighted with the excellent results. I can safely say that 25 users have now in use the OSRAM D.E.2 through my recommendation.

H. Burnley.

Performance beyond reproach. For general all-round listening we thoroughly recommend these two new OSRAM VALVES.

"Electrical Industries."

2-VOLT VALVES
with a 6-Volt Result

PRICE 15/6 EACH

The G.E.C. - your guarantee

The Wireless World

AND
RADIO REVIEW
(14th Year of Publication)

No. 349.

WEDNESDAY, APRIL 21ST, 1926.

VOL. XVIII. No. 16.

Assistant Editor:
F. H. HAYNES.

Editor:
HUGH S. POCKOCK.

Assistant Editor:
W. JAMES.

Editorial Offices: 139-40, FLEET STREET, LONDON, E.C.4

Telephone: City 4011 (3 lines).

Advertising and Publishing Offices: DORSET HOUSE, TUDOR STREET, LONDON, E.C.4.

Telephone: City 2847 (13 lines).

Telegrams: "Ethaworld, Fleet, London."

COVENTRY: Hertford Street.

BIRMINGHAM: Guildhall Buildings, Navigation Street.

MANCHESTER: 199, Deansgate.

Telegrams: "Cyclist Coventry."
Telephone: 10 Coventry.

Telegrams: "Autopress, Birmingham."
Telephone: 2970 and 2971 Midland.

Telegrams: "Iliffe, Manchester."
Telephone: 8970 and 8971 City.

Subscription Rates: Home, £1 1s. 8d.; Canada, £1 1s. 8d.; other countries abroad, £1 3s. 10d. per annum.

As many of the circuits and apparatus described in these pages are covered by patents, readers are advised, before making use of them, to satisfy themselves that they would not be infringing patents.

CRITICS OF RUGBY POLICY.

IT could hardly have been expected that the Post Office would escape from criticism, from one direction or another, in connection with the establishment of the Rugby station, and the remarkable efficiency of the station seems to have been provocative of stronger expressions of dissatisfaction than would probably have been the case if the station had been less successful. But the most remarkable outburst against the Post Office policy which has yet come to our notice emanates from Mr. E. T. Fisk, the managing director of Amalgamated Wireless (Australasia), Ltd. Mr. Fisk, interviewed by the Press, is reported to have stated that the only reason he can suggest as to why the British Post Office authorities are not attempting direct wireless communication with Australia is that transatlantic telephony has been developed under the control of a foreign concern, and that for this reason the Dominions are being neglected in favour of the United States.

If Mr. Fisk had hoped to impress those who would read his statement in print with the sincerity of his concern in matters of Empire welfare, he should have been diplomatic enough to omit the further statement which he is reported to have made, that he believes "beam" stations will ultimately provide an excellent telephone service linking up the telephone exchanges of Australian cities with the telephone network of London.

The company which Mr. Fisk represents is intimately

concerned with the development of beam stations, whilst his company has no share in the control of the principle of "side-band" telephony, which has made transatlantic telephony possible. The Post Office has made it abundantly clear that the transatlantic telephony trials which they are now conducting are in the nature only of experiments. At the time Rugby station was put in hand there was no system of long-distance telephony except that which the Post Office decided to adopt, nor has this state of affairs changed during the several years that Rugby has been under construction, so that the only alternative to adopting a system developed in the United States would have been to adopt no system at all and to abandon all efforts at establishing long-distance wireless telephony until some British system should chance to be developed in the future.

As a practice ground for experimental development, why should not the span of the Atlantic be as good as any other, especially since at either end exist all the facilities both of material and skilled *personnel* for carrying out the project? Having once developed transatlantic telephony the erection of Dominions stations

is but a question of duplicating equipment, and, undoubtedly, the Post Office has this end in view.

We sincerely hope that the Post Office will treat Mr. Fisk's outburst to no more consideration than it merits, and will continue the policy of adopting the best systems, whether of British or foreign origin, and so serve the best interests of Empire by speeding up the practical solution of inter-Empire communication.

CONTENTS.

	PAGE
EDITORIAL VIEWS	575
NEON WAVEMETER	576
By A. P. Castellain.	
READERS' NOVELTIES	580
OBSERVATION OF FADING EFFECTS	581
By Prof. E. V. Appleton.	
PRACTICAL HINTS AND TIPS	583
MARINE WIRELESS EQUIPMENT	585
CURRENT TOPICS	589
REVIEW OF APPARATUS	591
NEW MAINS RECEIVER	593
WIRELESS CIRCUITS IN THEORY AND PRACTICE	595
By S. O. Pearson.	
BROADCAST BREVITIES	599
VALVES WE HAVE TESTED	601
NEWS FROM THE CLUBS	603
LETTERS TO THE EDITOR	604
READERS' PROBLEMS	605

NEON WAVEMETER

A Simple, Inexpensive Instrument
for the Transmitter.

By A. P. CASTELLAIN, B.Sc., A.C.G.I., D.I.C.

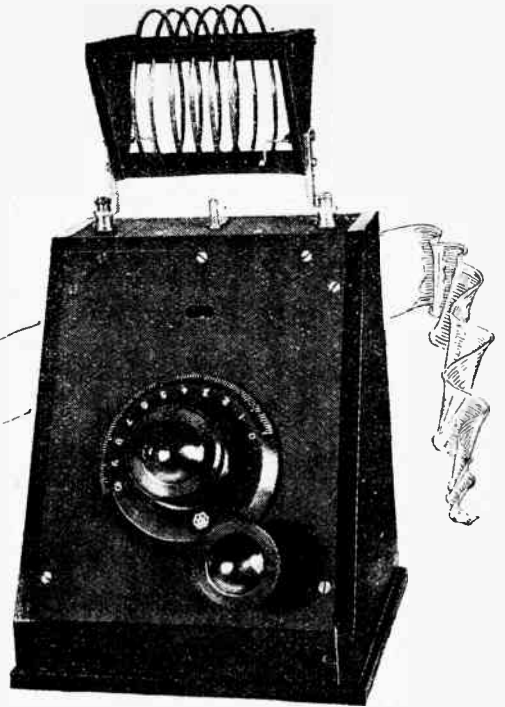

EVERY amateur who works a transmitting set should have a wavemeter, in order that he may be able to keep to the wavelengths allotted to him in his licence. When experimenting with a set it is very easy to get off these wavelengths, especially on the 23 and 46 metres range, and nothing causes so much friction between the amateur and the Powers that be than this.

Transmitting wavemeters in general use fall into three classes: the heterodyne or valve wavemeter, the crystal and galvanometer absorption wavemeter, and the neon wavemeter. The first type—the heterodyne wavemeter—is rather apt to be a snare and a delusion for transmitting work except in the hands of an experienced worker (who would not use it for preference), owing to the number of harmonics of both transmitter and wavemeter giving beat notes at many points on the wavemeter scale, so that the actual wavelength becomes a matter of doubt.

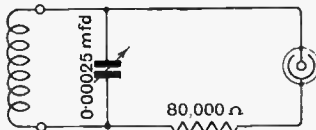

Fig. 1 — The circuit of the neon wavemeter.

Another snag in this type of wavemeter is the ease with which its valve “pulls into step” (*i.e.*, oscillates at the same frequency) with the transmitter if the latter is at all powerful, so that no beat note at all is heard unless the wavemeter is taken some considerable distance away.

The second type of wavemeter has not the ambiguity of wavelength like the first, but its calibration is rather apt to depend to some extent on the adjustment of the crystal, and has the further disadvantage that a sensitive galvanometer, which is an expensive item, must be used.

Principle of the Neon Wavemeter.

The third type—the neon wavemeter—depends for its action on the fact that if a potential of about 170 volts is applied between two electrodes in neon gas, the gas becomes conducting and luminous and remains luminous while the potential is reduced, until about 140 volts is reached, when it becomes dark again. This wavemeter (Fig. 1) consists essentially of a tuned circuit with a neon lamp in parallel to indicate when the circuit is in

resonance with the transmitter, and its actual operation may be studied in reference to Fig. 2.

In Fig. 2 are shown three voltage resonance curves, *a*, *b*, and *c*, the resonance curve, of course, being the relation between voltage across the tuned circuit and the tuning capacity when power at a definite frequency is being absorbed.

When a tuned circuit is placed near even quite a small transmitter of only a few watts, very large potential differences are set up across the tuning condenser, giving voltages of the order of hundreds. Now it has already been said that a neon lamp will glow when about 170 volts are applied to its electrodes, so that the neon lamp will indicate when the voltage across the tuning condenser reaches this value.

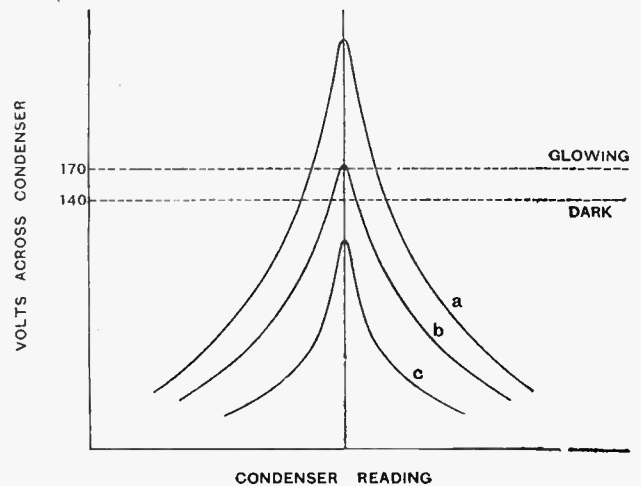

Fig. 2—Showing the resonance curves obtained with various degrees of coupling between wavemeter and transmitter and their effect on the glowing of the neon lamp.

Neon Wavemeter.

The three curves in Fig. 2 show the voltages obtained across the tuning condenser for various degrees of coupling between wavemeter and transmitter, curve (a) being for a tighter coupling than (b) or (c).

If the coupling is too loose (i.e., if the wavemeter is too far away from the transmitter), as in curve (c), the

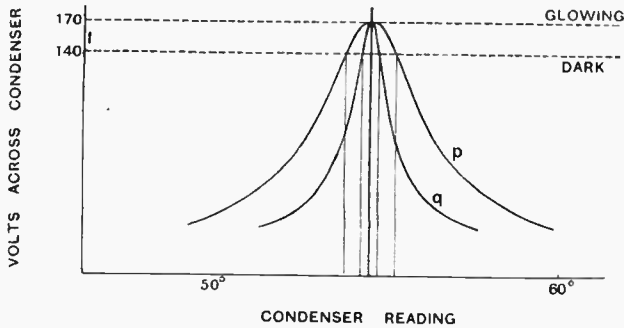

Fig. 3 — Showing that a low resistance circuit is necessary for the wavemeter in order to give accurate readings.

maximum voltage across the condenser will be too small to operate the neon lamp. On the other hand, if the coupling is too tight [curve (a)] the neon lamp will light over quite a large range of the tuning condenser, and thus the actual tuning capacity for resonance with the transmitter becomes a little doubtful, although the neon will glow more brightly as the voltage increases over 170 and thus approximately indicate the resonance point.

Optimum Coupling.

However, there is another drawback to coupling the wavemeter too tightly to the transmitter if the latter is

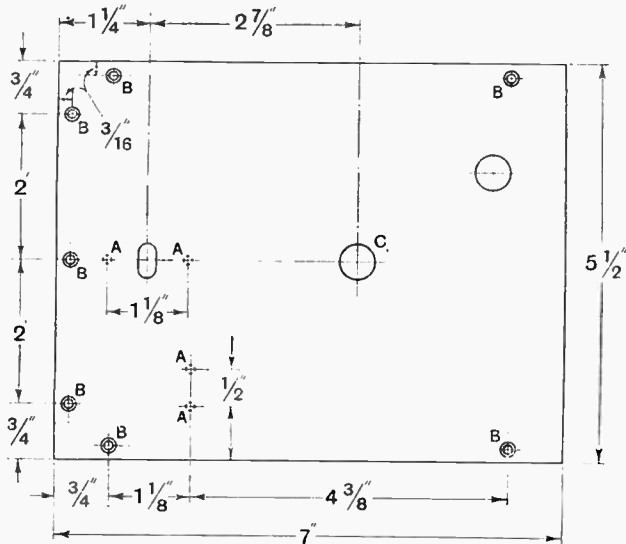

Fig. 4.—Dimensions and drilling of front panel. A, 6B.A. blind tap on underside; B, 1/8 in. diameter countersunk for No. 4 wood screws; C, 1/2 in. diameter hole.

of very low power, and that is the fact that the wavemeter absorbs a certain amount of power, partly for coil and condenser losses, but mainly for lighting the neon lamp, and this power naturally increases with increase of coupling. The best value of coupling, as indicated

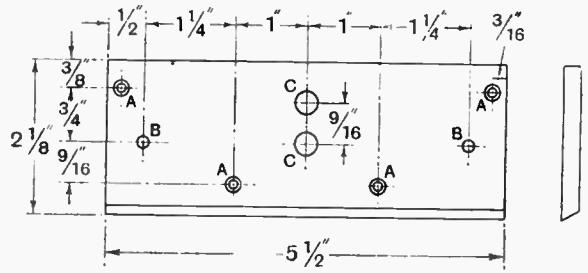
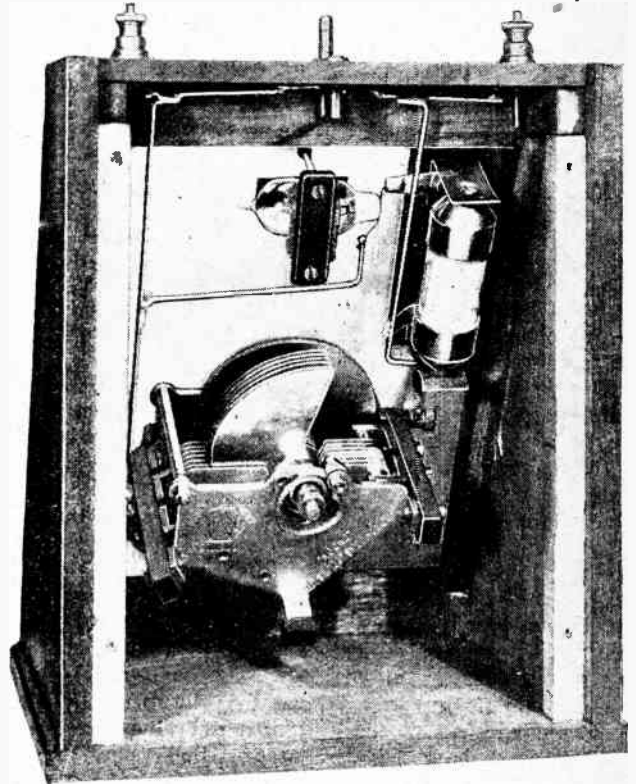

Fig. 5.—Dimensions and drilling of coil panel. A, 1/8 in. diameter countersunk for No. 4 wood screws; B, 5/32 in. diameter; C, 5/16 in. diameter.

in curve (b), Fig. 2, is that which gives a resonance voltage of just over 170 volts, i.e., just over the striking voltage of the neon lamp.

Once the neon lamp has been made to light, it will continue to glow until the extinguishing voltage is reached. This voltage varies with the shape of the electrodes and on the pressure and purity of the gas in the lamp, but



Back view of wavemeter with the cover removed

for the average run of lamps is round about 140 volts, so that as the wavemeter condenser is moved through resonance the lamp will continue to glow over a short range of movement and should thus give rather doubtful readings on the wavemeter.

In practice, however, it is possible by suitable design to make the resistance of the wavemeter circuit very low, and so make the resonance curve very sharp,¹ which in

¹ See an article by the writer on H.F. resistance in *The Wireless World* of May 13th, 1925.

Neon Wavemeter.—

itself will increase considerably the accuracy of readings—so much so that in practice some form of slow-motion gearing for the wavemeter condenser is found to be necessary. Fig. 3 shows the above point quite clearly, curve p being that of a higher resistance circuit than the circuit for which q is the resonance curve.

The neon lamp, being in parallel with the tuned circuit, will increase the resistance of that circuit to some extent when glowing—*i.e.*, it will flatten the resonance

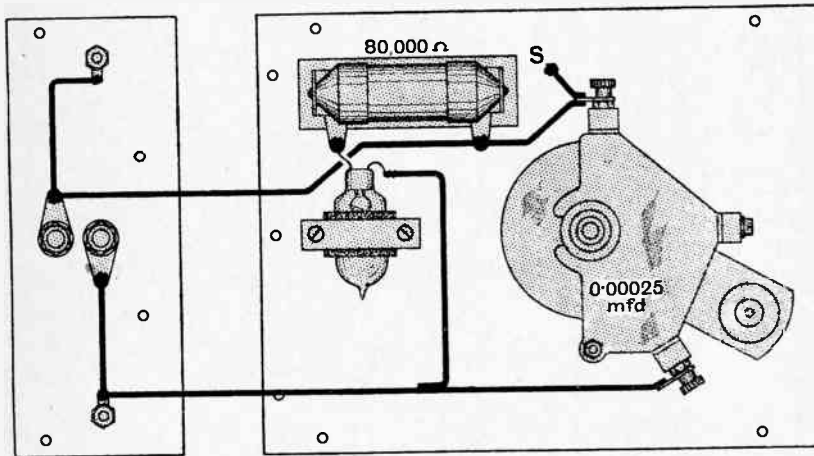

Fig. 6.—The wiring diagram of the wavemeter. The moving plates (Cosmos condenser) are connected to the screen at S.

curve. One way of improving this trouble is to connect the neon lamp in series with a high resistance of, say, 80,000 ohms to a megohm, and to place the two across the circuit.

This is really a refinement, as in practice tuning is quite sharp enough without this resistance, though its use certainly improves the sharpness—in fact, the use of the resistance is *not* advised for *low power* transmitters as more power is absorbed by the wavemeter, but it is advised for higher power (over 10 watts) transmitters.

Construction of Wavemeter.

Practically all the information necessary for the construction of a suitable wavemeter may be obtained from the photographs and drawings given in Figs. 4 and 5 and wiring diagram in Fig. 6.

The neon lamp used is one that is made by the Economic Electric Co. as part of a lightning arrester—the lamps may be obtained separately, however, and cost 2s. 6d. each. It will be seen on reference to the photograph that the screw cap has been removed from the lamp in order to reduce stray capacities, and also in order to increase the insulation, since it is very easy to get a conducting path of flux between the contacts when soldering. To remove the cap, all that is necessary is to file the patches where the two wires are soldered—

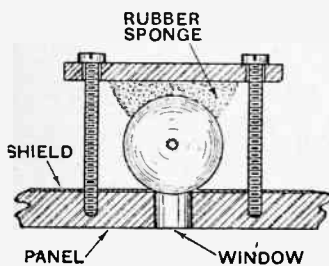

Fig. 7.—Showing the method of mounting the neon lamp behind the window in the panel.

these will be obvious on inspection—until the wires are free, and then to soak the cap in methylated spirits for about five minutes in order to soften the plaster, when it will be found quite easy to withdraw the lamp by hand. The lamp is mounted under a little ebonite clamp, as shown in Fig. 7, faced with a piece of Sorbo rubber to prevent damage when the clamp is tightened.

Choice of Condenser.

The maximum value of the variable condenser is 0.00025 mfd., and any *good* make will do provided it fulfils the following conditions: *Fixed* plates insulated with strips of ebonite, *or* moving plates insulated with top and bottom end plates of ebonite—but *not* the usual type with metal end plates and small ebonite bushes. It should be remembered that there will be nearly 200 volts between the fixed and moving plates, so that the insulation must be of the best. Once the insulation of a condenser has broken down, it will only give endless trouble, so that the consideration of good insulation is of primary importance. It is also very advisable to have some form of slow motion arrangement for turning the condenser.

A metal screen—copper or aluminium—is incorporated in the wavemeter behind the panel in order to remove any hand effects that otherwise might be present. This screen is connected to the moving plates of the condenser (the fixed being insulated), and to one side of the resistance if this is included.

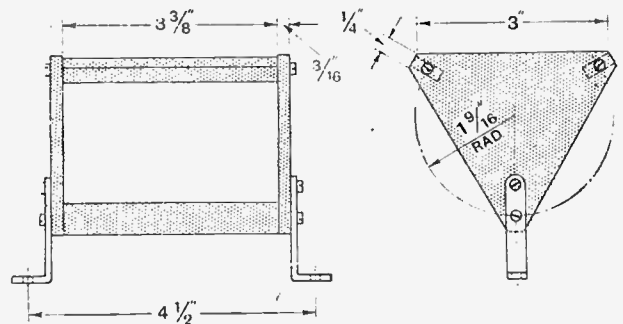

Fig. 8.—Dimensions of the ebonite former for the short-wave coil

A little point to be noticed is that the slot in the screen, corresponding to the slot in the panel through which the lamp is viewed, should be larger than the latter, so that the lamp does not bear on the sharp metal edge, and so get cracked when the clamp is tightened.

The coils used in the wavemeter are as follows: the special coil shown in the photograph at the head of this article has a range of from below 20 metres to just over 50 metres; a Gambrell $a/2$ plug-in coil gives from 45 to 125 metres, and the A coil from 90 to 255 metres—while if it is desired to cover 400 metres a B coil must be used.

Constructional details for the former of the special short wave coil are given in Fig. 8. Twelve gauge phos-

Neon Wavemeter.—

phor-bronze wire is used, with six turns and a spacing of $\frac{3}{16}$ in. between turns. The method of making such a coil has been described many times in *The Wireless World* so that it will not be elaborated here. It will be found that the former used to hold the coil gives a very rigid mounting indeed, which is a desirable feature in any wavemeter coil, and an absolute necessity in a short wave coil, especially when it is removable—since any

change or distortion in the coil will lead to errors in calibration.

Neon wavemeters made according to the above design may be calibrated by sending them carefully packed to the calibration department of *Experimental Wireless*, together with a calibration coupon which will be found in each issue of *Experimental Wireless*. The wavemeter should be tested on the transmitter before sending in, to make sure that the neon lamp will glow.

TRANSMITTERS' NOTES AND QUERIES.

General Notes.

Mr. A. Kofes (K KB7), Cauerstr. 19, Charlottenburg, Berlin, is conducting a series of tests to investigate the strength of short-wave signals under various weather conditions. He is transmitting every night from 2300 to 2315, G.M.T., and will welcome reports, preferably weekly, stating the meteorological conditions at the receiving stations.

○○○○

Mr. W. R. Clark (G 2VX), 3, Caroline Place, Aberdeen, was in two-way communication with BZ 6QA on Sunday, March 27th. The Brazilian station, operated by Mr. A. Santos, in Maranhão, a distance of 4,000 miles from Aberdeen, reported the signals as R5 on a 2-valve receiver and easy to read despite strong atmospherics. G 2VX was transmitting with an input of 12 watts D.C., 400 volts. The apparent aerial current was 0.25 amps., working on the third harmonic of the aerial system and on a wavelength of 45 metres, while BZ 6QA was using 50 watts I.C.W. on a wavelength of 38 metres.

○○○○

Mr. Georg Holmlund (SMZN), Rosenhundsgatan 3, Göteborg, Sweden, has started transmitting again, after a year's silence, on 44 metres. He is usually to be heard on Saturdays after 2300 G.M.T., on Sundays after 0600 G.M.T., and on other days before 1800 G.M.T., and after broadcasting hours. His new transmitter, a three coil Meisner, is at present taking its input from an A.C. supply, but he hopes soon to instal a rectifier. The aerial current is about 0.75 amps. SMZN was one of the first Swedish stations to be licensed, and Mr. Holmlund will welcome reports from British amateurs.

○○○○

Messrs. T. A. and F. C. Studley (G 5TD), 6, Rutland Road, Harrow, inform us that on Monday, 5th April, they logged 170 transatlantic stations between 0000 and 0630 G.M.T., including every district in U.S.A., stations in Canada, Brazil, Mexico, and Porto Rico; also some in New Zealand. The receiving set was a one-valve Reinartz, and the wavelengths varied between 35 and 42 metres; conditions were generally favourable, though at times atmospherics were bad.

○○○○

Mr. L. H. Thomas (G 6QB), 33, Harpenden Road, West Norwood, S.E.27,

has been in communication with U 2CVJ, Mr. Robert Hart, Elm Street, Hartsdale, N.Y., with an input of 10 watts only, supplied from an M.L. Anode converter, and using an Osram L.S.5 valve, the filament voltage being rated at 4.5 volts.

○○○○

Mr. B. W. Warren (G 6C1), 19, Melville Road, Coventry, is conducting very low power tests on a wavelength of 45 metres, and will be glad if anyone who has heard his signals will send a QSL card giving details of reception.

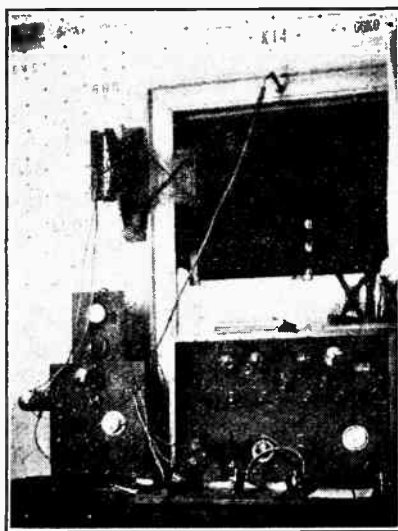

A well-known station on the South coast G 2MI, owned and operated by Mr. A O Milne at 41, Victoria Avenue, Northdown, Margate. The transmitter is shown on the left with its tuning coils above. Two D.E.4 valves are used in parallel with 220 volts on the anodes. Mr. Milne's transmissions have been heard in North Sweden and in Spain.

Mr. F. H. Mardon (U 2CWR), 1309, West Farms Road, Bronx, New York, assistant division manager, A.R.R.L., will be glad to receive reports on his signals from British amateurs.

○○○○

With reference to the observations and records of long-distance signal strengths and their relation to varying weather conditions described by Mr. H. N. Ryan (5BV) in the February number of *Experimental Wireless*, Mr.

F. Weir-Mitchell, of the Government Radio Station, Maymyo, Burma, asks us to state that he has been experimenting on this subject for some time, and would like the help of a few transmitting amateurs in various countries. The Monsoon season in Burma will soon begin, and Mr. Weir-Mitchell will particularly welcome weekly weather reports from all parts of the world.

○○○○

New Call-signs Allotted and Stations Identified.

2 BQU.—R. Warrener, "Inwood," 3, St. Mary's Road, Tonbridge.

G 2BRP.—L. W. Humphreys, 7, Pinehurst Road, Swindon.

G 50M.—D. E. Osman, 44, Cambridge Park, Wanstead, E.11. (Change of address from Leigh-on-Sea, Essex.)

G 6FZ.—H. E. F. Taylor, Abbots Terrace, Abbotswood, Guildford (transmits on 45, 90 and 150-200 metres).

F 8BU.—L. Ledeur, 17, Grande Rue, Lure, Haute-Saône.

F 8KB.—A. Grégoire, Pont d'Avignon, Gard.

I 1CU.—Alfonso Marullo, Via XX Settembre 89, Rome 50.

N PC2.—The Radio Laboratory, Technischehoogeschool, Delft, Holland.

○○○○

QRA's Wanted.

G 2AH, G 2EC, G 2EM, G 2EW, G 5TB.

BOOKS RECEIVED.

"Convention Télégraphique Internationale et Règlement y Annexé, Revision de Paris, 1925." pp. 178, comprising the text of the Telegraphic Convention of St. Petersburg, 1875, and the Regulations for International Telegraphic Service based thereon, and revised in Paris in October, 1925, which will come into force on November 1st, 1926; with explanatory note by the International Telegraph Bureau, Berne, and an appendix amplifying and explaining certain of the articles. Published by Le Bureau International de l'Union Télégraphique, Berne, 1926.

"Wörterbuch der Elektrischen Nachrichtentechnik," by O. Sattelberg. Part II, German—English. A Dictionary of Technical Terms used in Electrical Communication, pp. 519. Published by Julius Springer, Berlin; price 12 Reichsmark.

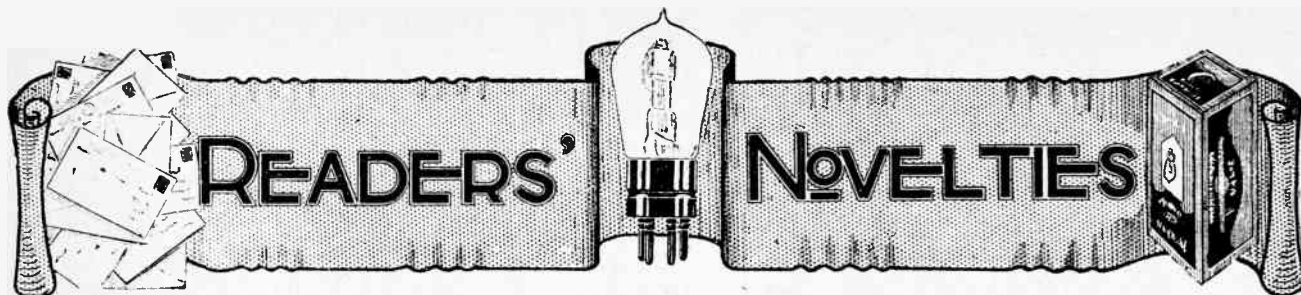

A Section Devoted to New Ideas and Practical Devices.

SOLDERING HINT.

A chemical Bunsen burner is very convenient for heating small soldering irons for use in wiring a receiver. The iron is generally supported on a block of wood, so that the bolt is just above the blue inner cone of the flame. Anyone who has tried this method of supporting the iron, however, knows that there is a tendency for the iron to roll away from the flame when one's back is turned, and it is very annoying to find it stone cold just as one has manoeuvred an awkward wire into position. At the present time there are large quantities of horseshoe magnets from telephone ringer magnetos on the market which can be obtained for a few pence. If one of these is fixed to the

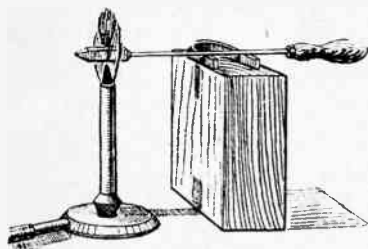

Soldering iron support.

wood block, and if the iron is laid across the open end of the magnet in the manner shown in the diagram, its position can be easily adjusted, and there will be no tendency for movement.—R. Y.

o o o o

CRYSTAL DETECTOR.

The sketch shows the construction of a special type of crystal detector capable of extremely fine adjustment. An arm A cut from sheet metal is pivoted at P to a support adjustable for height. In the centre of the triangular hole cut in the arm is a cat-whisker which is suspended by short wires W, giving a certain degree of resilience to the contact point. The extremity of the arm is depressed by

means of a knurled terminal which is screwed down against the pressure of a coil spring. The crystal itself is

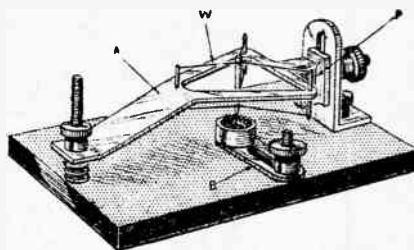

An excellent method of obtaining critical adjustment of contact pressure in a crystal detector.

mounted on a slotted arm B, which gives a universal movement and enables all parts of the crystal surface to be explored.—J. P.

o o o o

REWINDING TELEPHONES.

In rewinding telephones with No. 47 S.W.G. wire breakages are frequent, and the soldering of the joints is not an easy matter when an iron is used. A very convenient method and one which is used in other electrical work, such as armature winding, is to take a strip of sheet copper, $\frac{1}{2}$ in. wide and $\frac{1}{4}$ in. or $\frac{1}{2}$ in. long, and to bend a "V" shaped hollow at one end. This is tinned and a small piece of solder inserted so that it

forms a small crucible. The ends of the wire are then cleaned, twisted together, and touched with a spot of resin flux. The end of the copper strip is then heated and the "V" shaped nick applied to the wire, when a perfectly soldered joint will be obtained.—A. E. D.

o o o o

H.F. TRANSFORMER.

The new ebomite or moulded bases which are now being fitted to valves lend themselves admirably to the construction of H.F. transformers. The base can be removed from a broken valve by immersing for a few minutes in methylated spirit. This breaks up the substance used for securing the glass to the base and permits its easy removal.

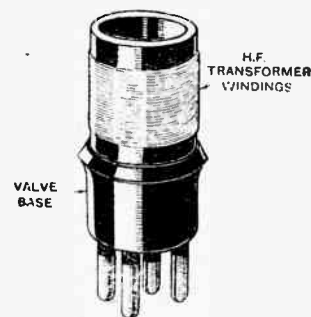

H.F. transformer mounting.

A short piece of ebomite tubing of suitable diameter is then fitted to the base and secured, if necessary, with a little shellac varnish. The transformer windings are then wound on the ebomite tube as single layers, either side by side or with the secondary wound over the primary after first covering the primary with a layer of waxed paper or other suitable insulating material. The ends of the windings are then soldered to the valve pins, the primary winding being connected to the "grid" and "anode" pins and the secondary to the "filament" pins.—S. A. H.

VALVES FOR IDEAS.

Readers are invited to submit brief details, with rough sketches, where necessary, of devices of experimental interest for inclusion in this section. A receiving valve will be despatched to every reader whose idea is accepted for publication.

Letters should be addressed to the Editor, "Wireless World and Radio Review," Dorset House, Tudor Street, London, E.C.4, and marked "Ideas."

THE OBSERVATION OF FADING EFFECTS.

Measurement of Signal Strength with Simple Apparatus.

By PROF. E. V. APPLETON, M.A., D.Sc.

MOST broadcast listeners are aware that the signals received from distant stations at night very often undergo marked and sensibly periodic changes in intensity. To this phenomenon the name of "signal fading" has been given. These signal variations have been shown to be due to the variable nature of the rays returned to the ground by the ionised layer of the upper atmosphere (the so-called Kennelly-Heaviside layer), and it seems quite certain that a detailed study of fading will yield very important information regarding the nature of the ionised layer and the variation of its properties throughout day and night. This article is written with the idea of interesting experimenters in the subject, and of asking them to co-operate in an attempt to obtain really reliable information on signal fading.

Aural Observations Unreliable.

It ought to be mentioned that American experimenters have tackled this problem under the direction of the Bureau of Standards, and in No. 476, Vol. 19, of the "Scientific Papers of the Bureau of Standards" will be found an account of the analysis of the data. Unfortunately, very little in the way of definite results emerged from this analysis, so that there is a very open field for British experimenters. Of course, it is easy to be wise after the event, but I think that the American investigators failed because they relied on aural observations. The ear is a very poor guide in judging changes of signal intensity, as I hope to show later in this article. To get accurate readings of signal intensities we must have re-

in a wireless receiver means endless complications, but this is not the case. If the observer feels that he does not wish to be troubled with the vagaries of a mirror galvanometer, a simple table galvanometer may be used.

Let us now consider the type of circuit most suitable for the study of signal fading. It should be mentioned at the outset that the results are most easily interpreted if a loop aerial or a purely vertical aerial is used, but if an L aerial must perforce be used very little difference between the fading on it and on a purely vertical aerial will be noticeable if the horizontal portion is not

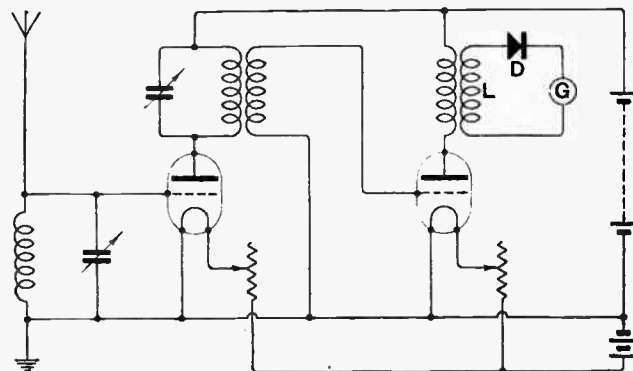

Fig. 1.—A simple circuit suitable for making observations on the fading of wireless signals.

course to some objective method, such as the use of a galvanometer. The galvanometric method is at once more accurate and much more sensitive than the audibility method, signal variations being registered which are quite undetectable in telephones. Many experimenters may feel that the introduction of a sensitive galvanometer

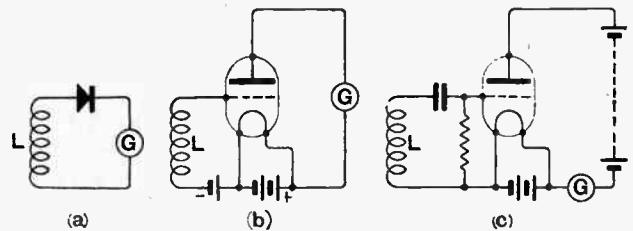

Fig. 2.—Alternative methods of obtaining a rectified galvanometer current.

too high and not too long. The receiver must be a high-frequency amplifier with as little rectification in the stages as possible. The circuit mainly used at Cambridge by Mr. Barnett and the writer is shown in Fig. 1.

This circuit will be well known to most readers of *The Wireless World*, and presents no new feature except that to the secondary L of the high-frequency transformer of the second valve is connected a stable crystal detector D and galvanometer G. Another circuit which has been found extremely useful is the two-valve neutrodyne, described in *The Wireless World* of October 21st, 1925. But there are many other types of high-frequency amplifiers (e.g., the superheterodyne) which we have found will answer just as well, or even better, for the measurement of the signals from distant stations. The main point is that no audio-frequency stages should be introduced before the galvanometer stage.

Choice of a Galvanometer.

I now come to the discussion of the measuring circuit, which consists of a rectifier and a galvanometer. Here we have a choice of three different types of rectification, which are illustrated in Fig. 2. In each case the coil L is coupled electromagnetically to the last stage of the high-frequency amplifier.

The simple crystal rectifier shown in Fig. 2 (a) is, in many ways, the most suitable, in that no current flows through the galvanometer in the absence of signals. In this case a very sensitive galvanometer can be used, and the variations of weak signals studied. But it may be difficult to get a crystal detector sufficiently stable for a long period of readings, in which case the valve voltmeters shown in Figs. 2 (b) and 2 (c) may be tried. In

¹ Appleton and Barnett, Proc. Roy. Soc., Dec., 1925.

The Observation of Fading Effects.—

In the circuit 2 (b) anode rectification is used, signals resulting in an increase of anode current. In the case of the circuit 2 (c) cumulative grid rectification is used, there being a steady current through the galvanometer, which is reduced when a high-frequency electromotive force is induced in the coil L. The advantage of circuits 2 (b) and 2 (c) is that they both may be calibrated (as is the case with the Moullin voltmeters), using low-frequency electromotive forces. But the experimenter will find the crystal rectifier the simplest for most purposes.

The next point to be considered is the choice of galvanometer, and here expense may be a deciding factor. There are, however, very satisfactory galvanometers on the market, at a very reasonable figure, which are specially suitable for this kind of work. If a mirror galvanometer is used I recommend the Student's Galvanometer No. 7926 (price £3 3s.), made by W. G. Pye, of Cambridge, which is dead-beat and is quite rapid enough in action for most purposes. It has a sensitivity of 120 mm. per microampere when the scale is 1 metre from the galvanometer. If a table galvanometer is required I recommend Pye's Table Galvanometer No. 7957 (price £3 3s.), which is also dead-beat and has a sensitivity of about 4 divisions per microampere. Both of these instruments are very robust and are provided with safety clamps. These instruments have been used in almost all of the work at Cambridge on signal fading.

Accurate Tuning Essential.

When the amplifier has been built and the galvanometer set up it will be found most useful to tune in a particular station, using telephones instead of the galvanometer as indicator; and here the circuit shown in Fig. 3 may be helpful to the beginner. It is simply the rectifier circuit of Fig. 2 (a), with the introduction of a change-over switch and telephones. If the telephones are put into circuit the reaction coupling of the amplifier may be adjusted until a telephone signal of the required intensity is obtained. This signal should be of comfort-

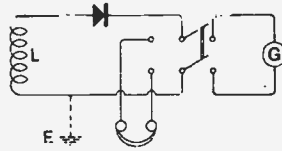

Fig. 3.—Change-over switch connections to substitute telephones for the galvanometer.

able strength and not too loud. When tuning adjustments have been made as accurately as possible, using telephones, the galvanometer should be put in circuit, and it will be found that a signal of normal telephone strength will give a suitable reading of 20 to 30 microamperes on the galvanometer. If the table galvanometer is used this will give a full-scale deflection, while if the more sensitive mirror galvanometer is used a shunt may be necessary. In either case the deflection can be increased or decreased by altering the coupling between the coil L and the amplifier. If an earth, E (Fig. 3) is connected to the coil L it may not always be necessary to retune when the galvanometer is switched into circuit, but in every case I recommend such an adjustment as a precaution. The tuning of the amplifier and aerial circuit should be altered until the maximum galvanometer deflection is obtainable. It is *absolutely essential* to have accurate tuning. The galvanometer deflection may then be taken as proportional to the square of the amplitude of the carrier wave.

Effect of Modulation.

Observations should first be made on a broadcasting station 80-120 miles away, and it will be found that at night signal variations are always taking place, the galvanometer showing variations even when such variations are not audible. In fact, it will be found that the galvanometer deflection has to fall almost down to zero before a marked audible reduction in intensity is noticed, so insensitive is the ear to changes of sound intensity.

A careful watch should be made to test whether the modulation of the telephony station affects the galvanometer deflection. With the signals received from the B.B.C. station (excepting Daventry), accurate tuning reduces the effect of modulation to a negligible amount, but a watch should always be kept for such effects, which might possibly be mistaken for signal fading.

In some future articles I hope to describe some of the results which have been recently obtained at Cambridge, using the galvanometer method of studying fading. These results include the direct experimental proof of the existence of the Heaviside layer and the first determination of its height. Suggestions will also be made regarding the way in which amateurs may co-operate in attempting to solve some of the problems still before us.

NEW YORK'S WIRELESS HOUSE.

BY pressing a key in Radio House, London, the main Marconi telegraph office, early last Friday morning, Captain P. P. Eckersley, Chief Engineer of the British Broadcasting Company, opened the most up-to-date wireless-fitted house in America. This house is located at Saint George, Staten Island, a residential suburb of New York. In the construction of the building, the wireless aerial and all the wires for connecting up receivers and loud-speakers to supply every room with wireless have been built into the walls. Not a single wire is visible throughout the house.

Captain Eckersley closed the circuit of the Marconi high-speed transatlantic wireless transmitter communicating with New York. The signal was intercepted at Long Island, New York, and automatically relayed to Staten

Island, where it closed the circuit to the loud-speakers and other electrical contrivances for the operation of wireless reception in the house.

A master receiver on the first floor operates three loud-speakers downstairs; another supplies the first floor, and a third feeds loud-speakers in the three bedrooms. Master controls up and down stairs transfer the output from the various receivers to different loud-speakers, so that all loud-speakers can be operated separately or together, and the receiving sets themselves can be operated from distant points by switches mounted on the walls.

The object of this demonstration house, the wireless equipment of which has been designed by the Radio Corporation of America, is to give the American public a new and broader conception of radio service in the home.

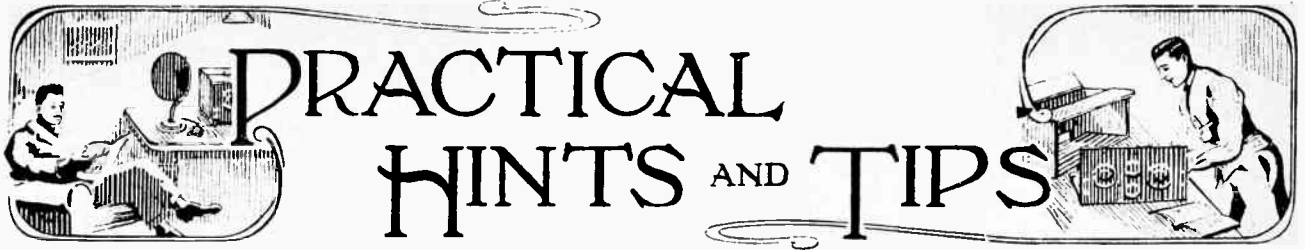

A Section Mainly for the New Reader.

VALVE ECONOMY.

There still seems to be a mistaken idea in some quarters that the dull emitter valve is by way of being somewhat of a luxury on account of its higher initial cost. Actually, assuming that accumulator charging has to be paid for at even the lowest current rate, the average dull emitter at its present price is cheaper in the long run than the bright emitter, even if the latter were actually given away!

It is realised that, in exceptional cases, where accumulators are charged by the owners at negligible cost, perhaps by connecting them in series with a lighting or power circuit, circumstances may arise where the use of bright emitters is advantageous, but this is an exception to the general rule.

Even in the matter of initial cost, providing both valves and L.T. battery are to be acquired, no real saving is effected by purchasing bright valves, as, in order to obtain the same number of burning hours per charge, a much larger and more expensive battery is required.

GRID-LEAK VALUES.

In this section of the April 7th issue of *The Wireless World* it was shown that, in a resistance-coupled amplifier, the anode and grid resistances are, in effect, connected in parallel, and therefore the resistance of the latter should be high compared with that of the former, unless amplification is to be sacrificed. These remarks apply equally to high- and low-frequency amplifiers, and also show why the method of amplification using very high anode resistances (up to 3 megohms), due to von Ardenne and Heinert, is likely to be unsuccessful when applied to an H.F. amplifier followed by leaky grid condenser rectification.

If the detector grid leak is of a value sufficiently low for satisfactory performance of its function, it may very possibly be comparable with the preceding anode resistance, in which case only some 50 per cent. of the possible amplification from this stage will be obtained.

Clearly, therefore, it would be better to use anode or "bottom bend" rectification, or else to precede the detector by one of the more conventional intervalve couplings.

TESTING L.F. TRANSFORMERS.

Noise in an L.F. amplifier is often traceable to a partial disconnection in the windings (generally the primary) of one of the transformers. It occasionally happens that the nature of this break is such that it is not revealed by the ordinary tests, particularly if these are carried out in haste and without due care.

If a galvanometer and battery are used, these should be connected in series with each winding in turn, and the needle should be carefully watched for some appreciable time; any movement will indicate an intermittent connection. In the case of the more elusive kind of fault, the use of a pair of headphones and a battery is likely to prove more effective. The method of testing shown

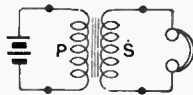

Connections for testing an L.F. transformer.

in Fig. 1 may be used as an alternative to the more usual series connection. As the battery connection is made and broken, loud clicks should be heard in the telephones, indicating continuity of both windings, but not intermittency. To test for the latter, it is necessary to listen intently for some minutes, preferably in a quiet room. The slightest sound in the

phones will show a defective winding. When making this and similar tests, it should be unnecessary to add that the phones and cells themselves should also be tested previously; no noise should be heard while a steady current is passing. It is as well to use an accumulator battery, with a voltage of from four to six, in preference to dry cells.

If a fault is found it will, in the great majority of cases, be located in the primary winding.

SOLDERING FLUX.

The use of a non-corrosive soldering flux such as resin is frequently advocated. Unfortunately, this is much more difficult to work with than are most of the proprietary fluxes, which, when applied sparingly and with care, are quite suitable for the majority of purposes, and have the advantage that the work does not require such a thorough preliminary cleaning. In certain cases where special care is necessary, it will be undesirable to run any risk of leakage between connections, and it may be worth while to make up an entirely non-corrosive flux by dissolving one part (by bulk) of powdered resin in three parts of ether. This liquid should be applied with a brush, and the surfaces to be joined together should be filed or rubbed with emery-cloth before soldering. Ether is obtainable from any chemist; it is highly volatile and subject to rapid evaporation. The flux should be kept in a wide-mouthed bottle, and a brush may be fitted through the cork.

"TWO-VOLT" VALVES.

A word of warning should be given to those who are contemplating the use of valves requiring some 1.8 volts on the filament in a superheterodyne

receiver. In actual practice it will generally be found that the maximum number of such valves which can be run from a single accumulator cell will not exceed five or six, and if more are used a second cell will be needed. In this case it will be convenient to arrange to feed the filaments of half the total number of

valves from each cell separately, providing a common negative connection.

When six valves, taking 0.35 amp. at 1.8 volts, are connected in parallel, it will be seen that the permissible external resistance in circuit must not exceed about 0.1 amp. This will necessitate the use of extremely short and heavy leads in the filament circuit,

clean connections, a fully charged accumulator, and particularly of a rheostat having a "zero" minimum resistance. Unless one is willing to take these special precautions, it would be wiser to restrict the number of valves supplied by a single cell to five only, or to adopt those taking a lower filament current.

DISSECTED DIAGRAMS.

No. 27.—Stage-by-Stage Tests of a Standard 1-V-2 Receiver.

A consideration of the series of circuit diagrams given below will indicate an effective and logical course of procedure in locating faults in a set which is totally or partially inoperative. Modifications of the method shown are obviously applicable to all multi-valve receivers. Dotted lines indicate temporary short circuits.

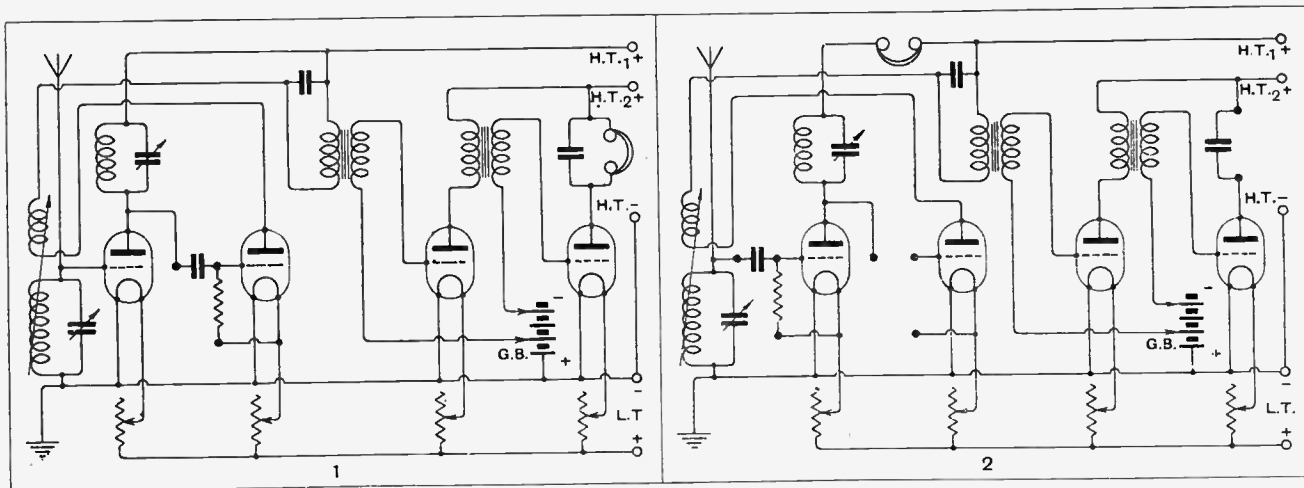

The circuit diagram of the complete receiver. It is assumed that the valve filaments light properly and that a superficial examination has failed to reveal any of the more obvious causes of failure

The first valve (H.F.) is converted to a detector by transference of leaky grid condenser and phones. Satisfactory signals will indicate that this valve with its associated circuits, aerial, earth, &c., are in order

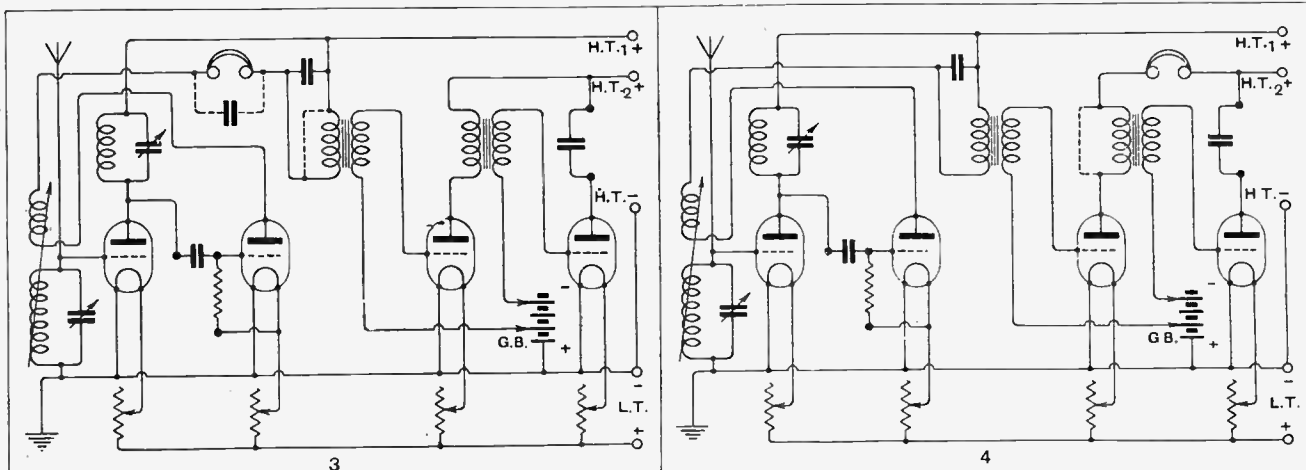

Condenser and leak are restored to their normal positions, the phones being transferred to the anode circuit of the detector. This connection provides a test for the H.F. coupling, reaction, the valve itself, and the connections to it.

The transformer and first L.F. valve are tested by inserting phones between anode and H.T. battery as shown. If the set is in order up to this point, the fault will be found in the last valve or second L.F. transformer.

The DIMIC and H.F. RESISTANCE.

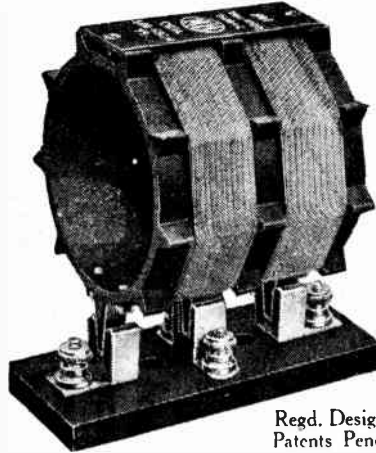

Regd. Design. No. 717674
Patents Pending.

THE question of the High Frequency resistance of Coils is one of great interest at the present moment, and as a result certain Coils offered to the public are advertised with figures for the H.F. resistance which we unhesitatingly challenge. We claim that, whilst our engineers have designed the "DIMIC" to have a High Frequency resistance which will give selectivity without loss of the side-bands so essential to perfect reception, the MH "DIMIC" has the lowest H.F. resistance of any coil offered to the public.

In all cases the figures we shall publish will be at the Middle frequency for which the Coil is normally used, and as taken by the NATIONAL PHYSICAL LABORATORY.

The H.F. resistance of "DIMIC" No. 1 is 5.25 ohms at a frequency corresponding to 400 m., i.e., .026 ohms per μ F.

Its H.F. resistance is the least of its many virtues, and it is the Coil **you** will ultimately use. Ask your dealer to show you one and give you details of its application, or write us direct.

We are always wishful to extend "the helping hand."

Telephone:
Slough 441-442

L. M. MICHAEL LTD
Manufacturers of Wireless and Scientific Apparatus
WEXHAM ROAD :: SLOUGH :: BUCKS

Telegrams:
Radiether, Slough



Choose your Valves by comparison—

1. Compare the characteristics of the S.P. 18 Valves with the published figures of other makers. Take the Voltage Amplification Factor, multiply it by the Mutual Conductance in micromhos. The square root of the product is the figure to use when comparing the relative merits of valves.
2. Compare the filament details. How many cells are
3. Compare the prices. [required?]
4. Compare the actual results, tone, quality, volume, etc.

These particulars for "Cosmos" SHORTPATH Valves are given in the adjoining page.

METRO-VICK SUPPLIES LTD.,

(Proprietors, Metropolitan-Vickers Electrical Co. Ltd.)

Metro-Vick House, 145 Charing Cross Road, London, W.C.2.

R
V33

1. The characteristics of S.P. 18 Valves are:—

	RED SPOT.	GREEN SPOT.
Voltage Amplification Factor	7	15
Impedance	7,000	17,000
Mutual Conductance Micromhos	1,000	850
Figure of Merit ..	84	118

2. S.P. 18 Valves consume only 0.3 Amp. at from 1.6 to 1.8 Volts, and require only a single cell 2 Volt Accumulator.

3. S.P. 18 Valves cost only **12/6** each. Red Spot or Green Spot.

4. S.P. 18 Valves provide a SHORTPATH to better results.

6 Volt
Bright Valve
A 45
7/6

Cosmos

RADIO VALVES

1.1 Volt
Dry Cell Valve
D.E. 11
12/6



THE WIRELESS LEAGUE

MEMBERSHIP AND RENEWAL FORM.

To be filled in by readers who wish to become members of the League, or to renew their membership for a further twelve months as from 1st April.

To the Secretary, the Wireless League, Chandos House,
Palmer Street, Victoria Street, S.W. 1.

..... 19

Please enrol me as a member of the Wireless League. I enclose P.O. for Two Shillings,† which renew my membership entitles me to membership with all the privileges and rights as enumerated in the constitution of the League, including **FREE Insurance, Free Legal Advice and Free Technical Advice.**

* Cross out Line not required.

† Keep the Counterfoil of your Postal Order.

WRITE IN CAPITAL LETTERS, Name (in full).....
(State whether Mr., Mrs. or Miss)
Address.....

Please enclose stamped addressed envelope.

My Membership No. is.....
(This is only applicable in the case of renewals.)

C Commencing with the first issue in May, "The Wireless World" will devote four pages in the first issue of each month to League Notes and News.

MARINE WIRELESS EQUIPMENT.

Modern Practice Exemplified by Siemens Transmitting and Receiving Apparatus.

THROUGH the courtesy of Messrs. Siemens Brothers and Co., Ltd., we were recently afforded an opportunity of inspecting their marine wireless equipment, and it is thought that the following notes will be of interest to our readers. The marine equipment comprises $\frac{1}{4}$ kW., $\frac{1}{2}$ kW., and $1\frac{1}{2}$ kW. spark sets, a $1\frac{1}{2}$ kW. C.W. set, direction-finding equipment, and a small lifeboat installation.

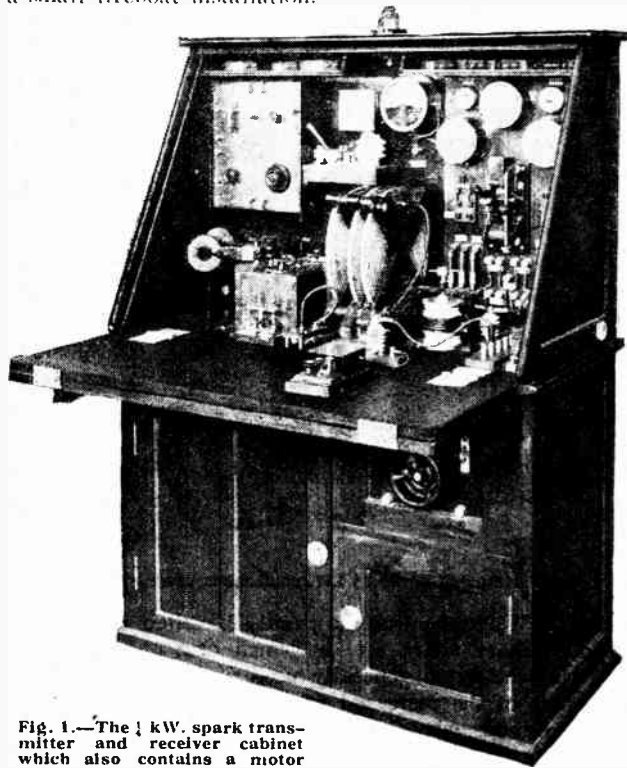

Fig. 1.—The $\frac{1}{4}$ kW. spark transmitter and receiver cabinet which also contains a motor generator and transformer for power supply

It is frequently stated that simplicity is the keynote of efficiency, and possibly no better example of this can be found than in the design of the apparatus which we inspected. A ship's wireless set must be capable of being used at a moment's notice, and also for long periods without the fear of breakdown. Hence the desirability of making every part of the apparatus as simple and as foolproof as possible. Anything in the nature of complicated or intricate mechanism would appear to be out of place.

The Spark Sets.

There is little difference between the $\frac{1}{4}$ kW. and $\frac{1}{2}$ kW. transmitting sets, and accordingly we confined our inspection to the $\frac{1}{4}$ kW. transmitter, since this is produced as a complete unit in a cabinet. The accompanying illustration, Fig. 1, shows the arrangement of the apparatus. The bottom part of the cabinet contains the generator, transformers, and closed circuit inductances. The power supplying the set is obtained from the mains

or from a 50-volt battery, placed outside the wireless cabin, which operates a motor generator of the inductor type, which, of course, has no complicated brush gear or slip rings, which might give rise to trouble. This supplies the power transformer at 500 cycles, the transformer being wound on a closed core, and mounted in a metal tank. In order to deaden the noise the generator is placed on a felt mat at the bottom of the left-hand cupboard. The excitation circuit consists of the usual inductances and capacity in series with a quenched gap across the transformer secondary. The inductance and capacity are contained in the right-hand compartment, and the leads from the inductance are brought out to sockets which will be noticed to the extreme right of the quenched gap. A circular handle will also be seen on the front of the top of the right-hand cupboard. This is the motor starter, while on the extreme right of the cabinet is a resistance in the field circuit of the alternator for regulating the output of the transmitter.

Controls.

The main vertical panel on the right carries the battery charging cut-out and the usual meters for control of the machines charging the cells, while the aerial radiation meter can be seen in the middle of the vertical panel, below which is the send-receive change-over switch. The three spiral inductances seen in the middle of the apparatus comprise the coupling between the closed circuit and the aerial circuit, and also the variometer tuning arrangement of the aerial. The quenched gap will be seen to the right of the inductances. Owing to the complete nature of the quenching the aerial circuit is direct coupled.

The quenched gap is composed of copper plates, which are faced with pure silver, the surface being rubbed down and made perfectly flat. The plates are separated by annular washers of the very best quality mica, the success of the gap depending upon the correct alignment of the silver-faced plates and the perfect insulation of the

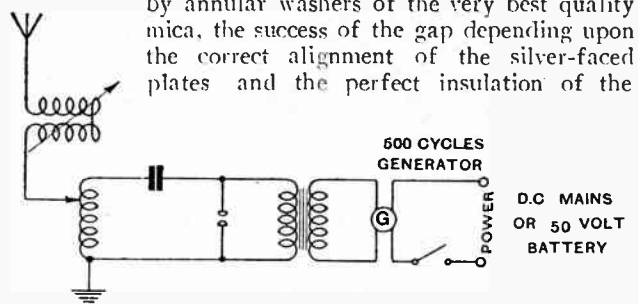

Fig. 2(a).—Basic circuit of the $\frac{1}{4}$ kW. spark transmitter.

mica washers. The plates are assembled between two insulators, and also held rigidly together by means of an end plate controlled by a thumb screw.

The receiver supplied as a standard with the $\frac{1}{4}$ kW. size is contained in the left-hand portion of the cabinet, and comprises a three-circuit tuner, which will be seen on the table, and a valve and crystal detector mounted on the vertical panel. Plug-in coils are used in the three-circuit tuner, which comprises an ordinary aerial

Marine Wireless Equipment.—

tuning circuit, closed circuit and reaction. A twin crystal detector will be noticed in front of the tuner unit. It is probably well known that the regulations require the use of a crystal detector as an emergency stand-by. In order that the crystal may always be in a suitable working condition, the receiver employs a reflex circuit in which the crystal is used as a detector. Further, in the event of a valve failing, the circuit can be changed over to an ordinary crystal receiver by moving a simple switch. The advantages obtained by using high-frequency amplification in front of the crystal are too well known to need further emphasis; the arrangement gives a receiver which is more efficient than the ordinary type, both from the point of view of sensitivity and selectivity. The basic circuit of the transmitter and receiver is shown in Figs. 2(a) and 2(b).

The C.W. Transmitter.

The continuous wave transmitter is as simple and straightforward as the spark transmitters, and a general idea of the apparatus will be gathered by reference to Fig. 3. The apparatus is mounted in a rectangular frame, three valves being placed in the middle, the inductances on top of the frame, and the other components of the circuit below and behind the valves. It is interesting to note that when this transmitter was evolved it was

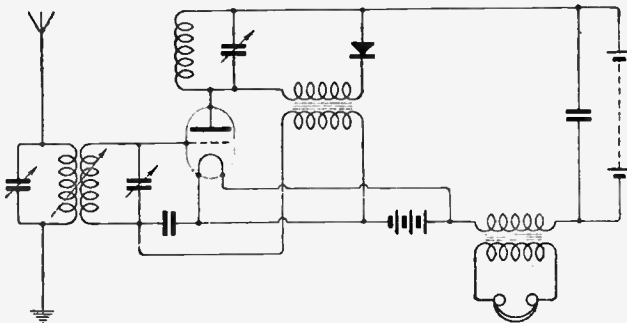

Fig. 2(b).—Single valve and crystal reflex receiver complementary to the $\frac{1}{4}$ kW. transmitter.

found that greater and greater efficiency was obtained as the insulation was made more perfect. The massive insulators which support the valve panel and also the inductance unit at the top of the frame are a good indication of what has been found necessary.

The basic circuit of the transmitter is shown in Fig. 4, and again appears as being perfectly simple and straightforward. The main oscillator valve is seen on the left of the panel in Fig. 3, and is an M.T.4, while the two valves to the right are the rectifiers, the rectifier filament voltmeter being located directly below them. The two other meters on the lower panel are the transmitter filament voltmeter and the main feed current milliammeter. A rheostat, seen on the extreme left, is used to control the transmitter filament voltage, while the central rotary switch adjusts the filament voltage of the rectifiers, which are supplied, of course, from a transformer. The power is obtained from the 500-cycle generator which supplies the spark set, the voltage of which is stepped up to about 20,000. Working at 500 cycles makes the problem of smoothing

very simple, and accordingly a very pure note is easily obtained. The grid leak, which, of course, is wire wound, and the fixed condensers are mounted behind the valve panel.

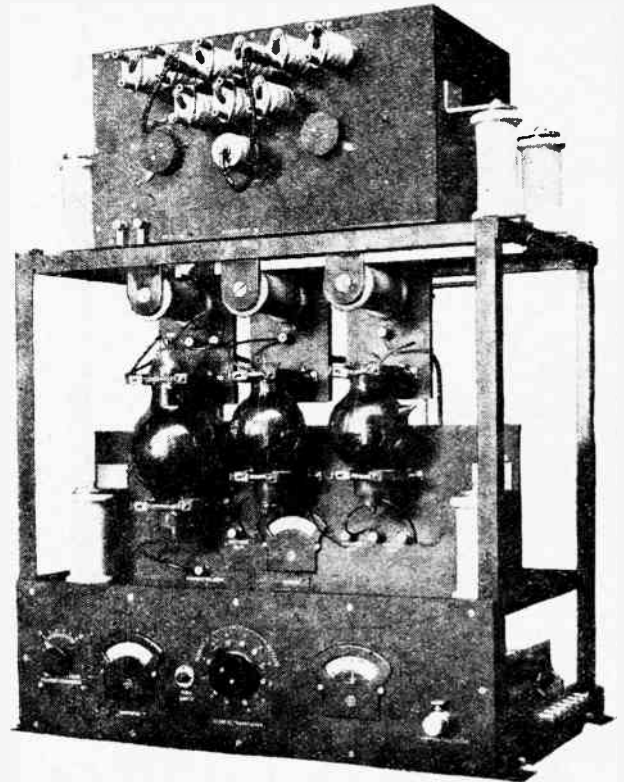

Fig. 3.—Valve panel of the $\frac{1}{4}$ kW. continuous wave transmitter.

The C.W. transmitter is usually installed in addition to an ordinary spark set, in which case an even more sensitive receiver is generally used in order to take full advantage of the increased range obtained by employing the continuous wave system. Several other types of receivers and tuners are made, particularly for the purpose of receiving the longer wavelength continuous wave signals. Fig. 5 shows a simple receiver which can be employed in conjunction with any of the tuners. It consists of a detector valve and two low-frequency valves of the V 24 type, with provision for switching out any of the valves or substituting the crystal detector for the first rectifying valve. Another three-valve receiver employs one stage of high frequency, one detector, and one low-frequency valve, which again can be used with any of the tuners.

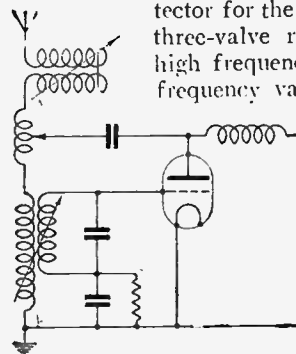

Fig. 4.—Basic circuit of the $\frac{1}{4}$ kW. C.W. transmitter.

For long-wave reception a separate heterodyne unit is employed, consisting of an oscillator valve, which is coupled into the closed circuit of the tuner. Fig. 6 illustrates an alternative type of tuner, of a very compact nature, covering all wavelengths from 300

Marine Wireless Equipment.—

to 20,000 metres. The inductances are wound in a number of slotted insulating formers, and are connected in circuit by means of special switches so as to eliminate any dead-end effect. The switches are of the "Dewar" type, the plungers of which are attached to a chain in which the slackness is such that on pressing down any plunger the chain becomes perfectly tight. If, now, another plunger is pressed the limited amount of freedom of the chain causes the first plunger to be withdrawn, thereby ensuring that only one section of the inductance is in circuit at a time. Thus it will be seen that it is possible to change from one wavelength range to another merely by press-

ment is the direction-finder, which we had an opportunity of working. It is well known that the chief sources of

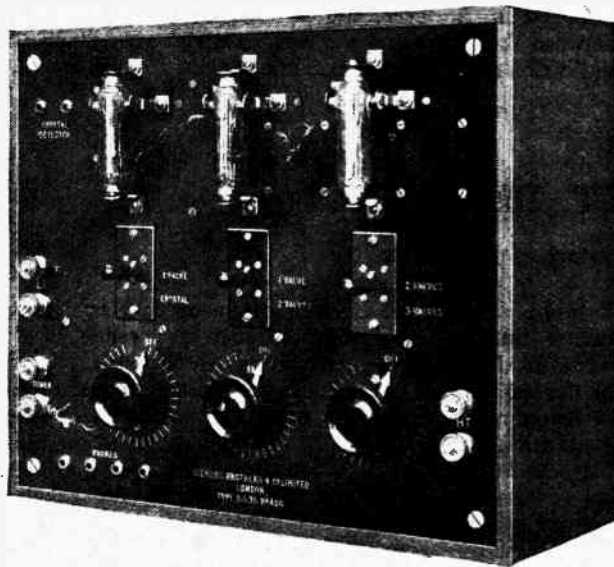

Fig. 5.—Three-valve receiver (detector and 2 L.F.) for general reception.

ing the desired key. The plungers or keys will be clearly seen arranged along the bottom of the tuner in Fig. 6. An additional feature of the tuners is the inclusion of a vacuum type lightning arrester, which, in this case, will be seen above the aerial condenser.

Perhaps the most interesting part of the marine equip-

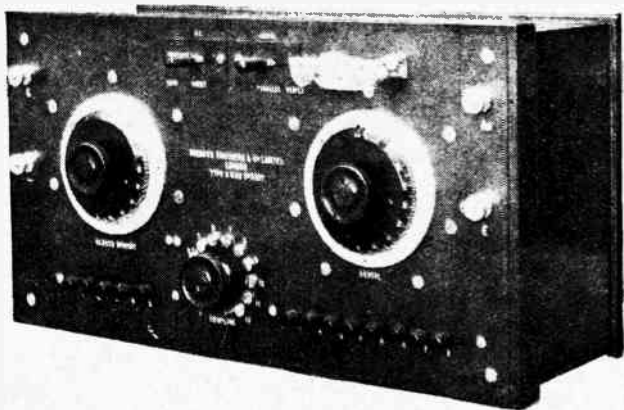

Fig. 6.—The universal tuner which employs a series of special dead-end switches.

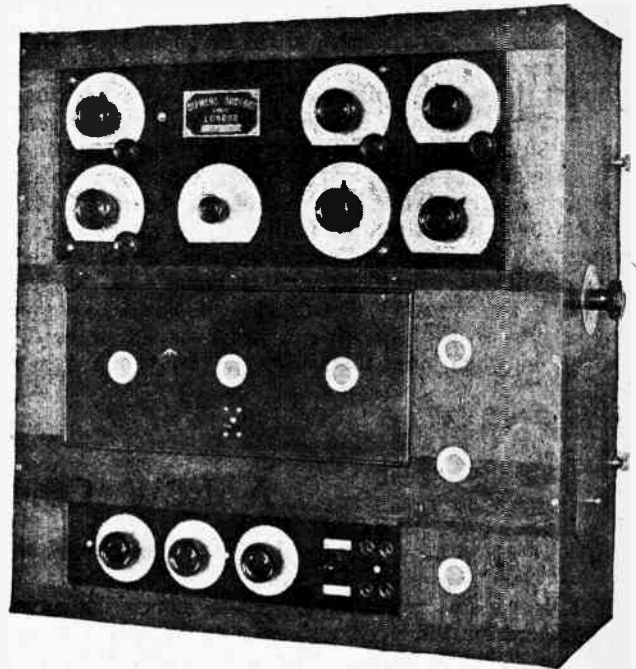

Fig. 7.—The direction-finding receiver cabinet.

error in a direction-finder are due to vertical effects and direct reception. Both these causes of trouble have been overcome, and whereas on other types of receiver we have found that to take bearings we may require to swing through 20 or 30 degrees, we found that bearings accurate to within less than 1 degree could be obtained. Figs. 7 and 8 show the receiver and the aerial arrangement respectively. The aerial consists of a rigid frame about three feet in diameter, which is totally enclosed, and screened by a circular brass tube mounted on a vertical brass pillar. Rigid leads are taken through the base of the pillar to the receiver, and the frame is rotated by driving the pillar. This is connected by means of steel cables to a hand wheel provided with a large-sized scale marked in degrees. It is interesting to note that, although the weight of the rotating aerial is very considerable, it is possible to control the hand wheel with one finger.

The receiver shown in Fig. 8 is completely screened, and comprises a seven-valve high-frequency amplifier, a detector.

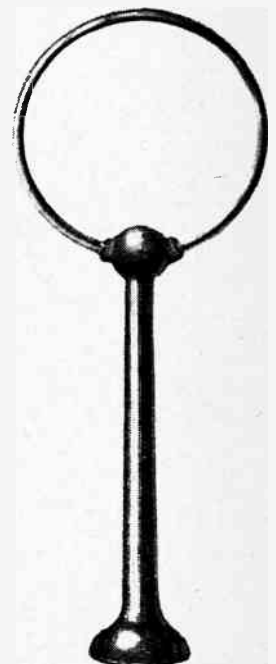

Fig. 8.—The direction-finding loop is of massive construction suitable for shipboard use.

Marine Wireless Equipment.—

two low-frequency amplifiers, and the local oscillator for C.W. work. All the condensers are mounted with vernier controls, enabling them to be adjusted to one-tenth of a degree. The screening of the aerial and the receiver eliminates any inaccuracies due to direct reception of incoming signals by "pick-up" in the coils and wiring.

In order to overcome the vertical effect, the receiver is always used in conjunction with a small open aerial, and is provided with a coupling coil, which can be coupled to the other half of the frame. When a bearing is to be taken the frame is rotated until a rough minimum is obtained, the bearing then being sharpened up by adjusting the coupling between the vertical aerial and the frame aerial. The "sense" of a bearing can easily be obtained by means of the well known heart-shaped or cardioid effect, in which case the vertical aerial is tuned to the

same wavelength as the station which is being observed by means of an additional variable condenser, the sense again being read on a minimum. It was very interesting to notice the sunset effect, when considerable change of wave-front and other modifications seemed to occur. It was found exceedingly difficult to sharpen up certain bearings, which would swing through as much as 20 degrees in some cases. One very important feature of this direction-finder is that the presence of night effect is easily indicated owing to the inability to sharpen up a bearing with the compensating device. With the ordinary type of direction-finder it is usual to take the mean of the positions of swing, and if night effect or sunset effect is present there is really no means of determining it. With this system, however, the position of the coupling coil between the frame and the vertical aerial gives immediate indication of a doubtful bearing.

P. D. T.

A NEW CONTACT DETECTOR.

The Johnsen-Rahbek Contact as a Rectifier.

IT is widely known that when a metal conductor is placed into close contact with a semi-conductor (agate, for example) a very strong electrostatic attraction is set up, as was first discovered by Johnsen and Rahbek. It has, however, been discovered recently that such a combination also functions as a rectifier, in that it permits the passage of a stronger current from the semi-conductor to the metal than in the reverse direction.

Characteristic curves of a combination of iron and agate investigated by W. Kramer are shown in the diagram. Curve A represents the relation of current to applied voltage through a combination of iron and agate, in the direction of the iron, whilst curve B shows the same current in the direction of the agate. It will be seen that the two plates in combination constitute a rectifier, but the current intensities are at present so small that the new detector could hardly compete with the present-day detectors. It is not unlikely, however, that if this phenomenon were pursued further very useful technical advantages could be obtained, not the least noteworthy of which would be the elimination of the necessity to seek for a suitable point of contact. On the other hand, it is necessary for the surface of the two plates to be ground down so as to fit each other perfectly, and for them to be fastened together as firmly as possible. It is also advisable for the under side of the agate plate to be thickly silvered in order that the current may be freely conducted to it.

The phenomenon is revealed in combinations of substances other than agate with iron; instead of the latter, galena, molybdenum, copper pyrites and similar minerals can be used, such minerals being known scientifically as *electron conductors*. These materials, in fact, conduct the electric current, as do metals, by movable electrons. In opposition to these, agate and similar semi-conductors are called *ion conductors*, i.e., the current is established in them by the movement of ionised atoms. Therefore, the prerequisite for securing the detector effect seems to

be the placing of an electron conductor and an ion conductor into the most intimate contact possible, and it seems likely that this is also necessary for the elucidation of the familiar crystal detector. In order to pass electric current through the points of contact of the two stages electrons must pass across from one material to the other. Very little more work is necessary, however, to release an electron from the electron conductor, for example,

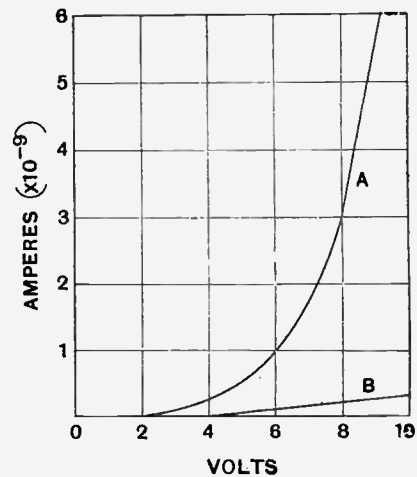

Characteristic curves of the agate-iron contact detector.

from the iron plate, and to conduct it to the agate, where the electron then causes the ionisation of an atom, which then further gives rise to the passage of the current. On this assumption the detector effect rests upon the difference of the work which is necessary for the separation of an electron in both materials. This explanation is not new, but it is certainly supported by these observations of Kramer regarding the detector effect of the Johnsen-Rahbek relay.

H. K.



Events of the Week in Brief Review.

WARSAW CALLING.

On Sunday last the Polish Prime Minister, Count Skrzynski, opened a new broadcasting station at Warsaw.

○○○○

WIRELESS AND BUSH FIRES.

Bush fires in the State forests of Western Australia during the recent hot season have been curbed to a great extent by the use of wireless communication.

○○○○

WIRELESS VILLAINY.

"Aldershot is suffering from an epidemic of thefts of bulbs from lamp standards, carried out, it is thought, by listeners-in in search of cheap power cables."—"Daily Express."

The italics are ours.

○○○○

FIRST WOMAN PIRATE?

The doubtful honour of being the first woman wireless "pirate" to be discovered by the Post Office probably goes to Mrs. Jane Phillips, of Shirley, Warwickshire, who was fined £1 a few days ago by the Henley-in-Arden magistrates for working a set without a licence.

○○○○

THE WIRELESS LEAGUE DINNER.

As already announced, the annual dinner of the Wireless League is to be held on Friday next, April 23rd, at the Royal Automobile Club.

A large gathering is expected, and many well-known personalities in the world of wireless will be present. Sir Arthur Stanley will preside.

○○○○

ARCTIC SIGNALS ON 13.1 METRES.

Readers who, during the next few months, succeed in picking up the call sign KE6K, on the extremely low wavelength of 13.1 metres, will be listening to signals from the Arctic expedition led by Commander R. E. Byrd, of the U.S. Navy. Besides this wavelength the station on board the exploration ship "Chautier" will also transmit on 20, 40 and 80 metres.

Although the number of listeners on 13.1 metres is likely to be small, at least two receivers will be tuned in to the signals. One of these sets is in the Naval Research Laboratory (NUF) at Bellevue, D.C.; the other is being built by the Marine Corps at Quantico, Va.

WHERE PHONES ARE SCARCE.

Ninety-one per cent. of the broadcast listeners in Milwaukee make use of loud-speakers, according to a trade survey. Purchased sets are in a majority over the home-built variety to the extent of 18 per cent.

SEAMEN DEMAND WIRELESS PROTECTION.

The Australian Seamen's Unions are demanding that wireless be installed on all vessels, irrespective of tonnage.

○○○○

RADIO REPARATIONS

To cover reparations due, the Japanese Government has decided to accept £4,000,000 from Germany in the form of Telefunken wireless apparatus.

○○○○

DIRECTION FINDING OFF HOLLAND.

PCMS and PCYM are the call signs of two new wireless "lighthouses" established on the Dutch coast at Maasluis and Ymuiden respectively.

○○○○

BRAZILIAN WIRELESS DEVELOPMENT.

The opening of the new wireless station at Rio de Janeiro, which takes place to-day (Wednesday), inaugurates a new service between Brazil and the United States, France, Great Britain, Germany and Italy.

○○○○

SOVIET WIRELESS EXPANSION.

Kabul, the capital of Afghanistan, will soon be connected with the Soviet chain of radio stations, writes an Indian correspondent. Wireless is being thoroughly exploited by the Soviet Government, which is constructing several powerful stations in Siberia and the Kamchatka.

○○○○

PLAIN SPEAKING IN ABERDEEN.

The Sheriff of Aberdeen struck just the right note in his warning to wireless pirates in the "granite city" a few days ago. In fining two offenders under the Wireless Act, the Sheriff said he would take good care that those who failed to have licences would have to pay a great deal more than the cost of the licence. Aberdonians are now following the more economical course.

○○○○

SHORT WAVES FOR INDIAN AMATEURS.

Seventy-nine private individuals at present hold transmitting licences in India, according to a statement made in the Legislative Assembly at Delhi by Sir B. N. Mitra. Eight of these licences entitle the holders to transmit musical programmes. Holders of non-commercial licences are now allowed to transmit on 45 metres and below.



PICTURE TRANSMISSION BY WIRELESS. Captain R. H. Ranger, of the Radio Corporation of America, is at present in this country for the purpose of demonstrating the commercial practicability of transmitting pictures by wireless across the Atlantic. Captain Ranger (left) is seen on the roof of Marconi House planning an aerial system.

NEUTRODYNE PROGRESS IN U.S.A.

The popularity of the neutrodyne in America may be gauged from the announcement that the Freed-Eisemann Radio Corporation, which holds a licence under the Hazeltine patents and introduced the neutrodyne to American listeners, has just opened a seven-floor factory in the heart of New York.

The Corporation hopes to increase its exports to Europe.

DX RECORD FOR SOUTH AFRICA.

South African amateurs are proud of the feat performed by a Durban experimenter, Mr. H. W. Heywood (A3E), who has succeeded in establishing two-way communication with a Californian amateur station, 1'6HM, owned by Mr. Clair Foster, of Carnival. A remarkable feature of the achievement is the fact that signals were exchanged both ways round the world. Mr. Heywood's wavelength was 35.5 metres.

SHORT WAVE EXPERIMENTS IN RUSSIA.

Experiments which have recently been conducted in the Soviet Laboratory at Nishni-Novgorod have resulted in the transmission of short wave messages on 83, 102 and 104 metres to Chile and Porto Rico.

The real object of the tests is to find a practicable form of radio communication with the remote parts of Russia which are not provided with telegraphic communication.

WIRELESS GOODS FOR TRACKING CULPRIT.

A reward consisting of wireless goods to the value of two guineas is being offered by a Midland wireless firm, Messrs. Mellowtone, of Stourbridge, for information leading to the detection of a person stated to be making illegal use of the firm's call sign, 2WQ.

Several reports, one coming from New Zealand, have been received stating that 2WQ had been heard on 40 metres. Actually 2WQ has been out of action for six months!

ECHO IN THE STUDIO

"To muffle or not to muffle" is the question which has prompted some interesting broadcast studio experiments in Berlin. A studio hitherto draped with

heavy cloth has been "re-clothed" with a special kind of wood which, according to reports, not only improves the quality of received music, but is more agreeable to the performers.

Many listeners in Great Britain are by no means satisfied that the B.B.C. have reached finality in the acoustic design of studios.

BROADCASTING MORALS.

In raising the question of morals in broadcasting, Cardinal Dubois, Archbishop of Paris, reminds programme compilers that the songs and speeches they send out reach the ears of small children and of a public whose scruples of conscience and morality are entitled to respect. The worthy Prelate's admonition serves as a reminder that the policy of the B.B.C., however much it has been criticised, has never been assailed on grounds of morality. Not all countries enjoy the benefit of a healthy broadcasting control such as that obtaining in Great Britain.

CUP TIE RELAY TO LANCASHIRE.

During the playing of the Cup-tie match at the Stadium on Saturday next, many thousands of Lancashire supporters who are unable to attend the game will be afforded some measure of consolation through the arrangements for a land line relay which are being carried out by the Marconiphone Company in conjunction with the *Daily Mail*.

Microphones will be placed in the Stadium in such positions that they will pick up band music and cheers from the crowd, while an observer in a sound proof cabinet will give a running description of the game as it proceeds. The signals will be taken through A. and B. amplifiers and relayed to Manchester and Bolton over Post Office land lines;

in the two northern towns eager crowds will hear the proceedings on loud-speakers.



WIRELESS ON AMUNDSEN EXPEDITION. Commander F. Gottwaldt, who is in charge of the Marconi installation on board the "Norge," the airship in which Amundsen and his party are proceeding to the North Pole.

DISTANCE AND SIGNAL STRENGTH.

That wireless signals are stronger 600 miles from a broadcast transmitter than they are at 300 miles is the conclusion arrived at by engineers of the radio department of the General Electric Company, New York.

For several weeks past thousands of listeners in the United States have been co-operating with the General Electric Company by reporting on reception of signals on broadcast bands. The engineers do not claim that the conclusions are absolute, and caution that more exhaustive investigation may reveal some facts not yet apparent.

In observing the variation of signal strength, it was found that the strength of the signal drops off rapidly during the first 300 miles from the station, and that, contrary to what might be expected, the signal strength actually increases and is apparently a little stronger at 600 miles than at 300 miles. Beyond the 600-mile point the strength decreases again slowly to the limit of the range of the station. These distances are not definite values; they are averages from a large number of reception reports.

A study of the zones in which fading occurs shows that it is worst at about 200 to 500 miles from the station, and this zone, from 200 to 500 miles, is the territory in which there is the greatest percentage of rapid-fading reports. Broadcast service is better at 600 miles than at 500 miles from a station because fading is less pronounced and the signal strength is slightly greater.

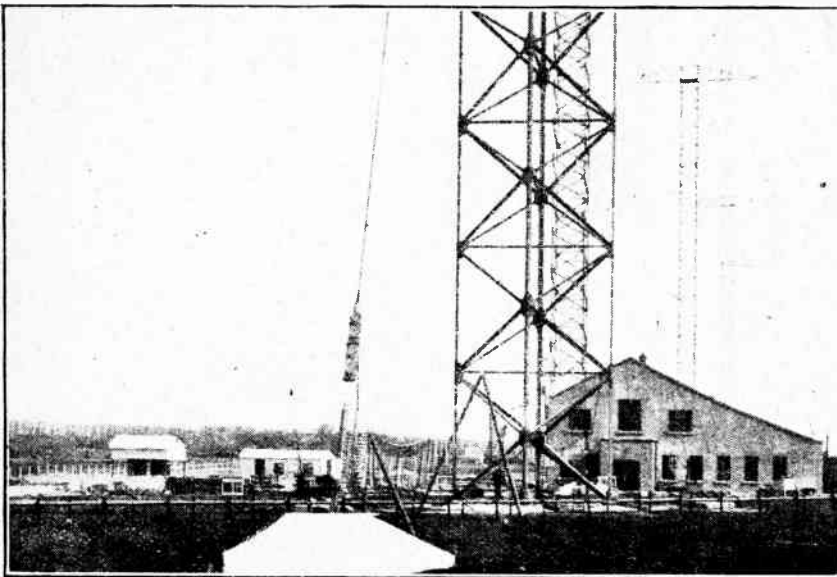

PROGRESS AT BODMIN. As is shown by this photograph, taken last week, constructional work on the new beam station at Bodmin is nearly completed. Bodmin is the transmitting station for Canada and South Africa.



REVIEW of APPARATUS

A Review of the Latest Products of the Manufacturers.

MARCONIPHONE VARIABLE HIGH RESISTANCE.

The demand for a smooth-running high value variable resistance has now been met by the production of a new Marconiphone accessory. The resistance material, which is essentially graphite, is carried on an ebonite base and is arranged in the form of two raised concentric rings which

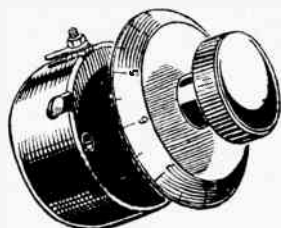

Marconiphone variable high resistance, useful as a reaction control or for regulating the output of an L.F. amplifier.

are bridged by a rotating metal bar carrying a pair of spring mounted graphite brushes.

This accessory is manufactured in two resistance values, with 500,000 and 40,000 ohms maximum. The former is a useful unit for incorporation in L.F. amplifiers for providing a volume control by shunting the secondary of an L.F. transformer while the damping thus obtained flattens out the transformer curve, producing an improvement in reproduction. The latter type, having a low maximum value, is intended for use as a reaction control, the reaction coil being fixed in position with regard to the inductance in the grid circuit and the damping varied by connecting the resistance across the reaction winding.

Readers will appreciate the need for resistances of this type, and being aware of the difficulties of construction may be in some doubt as to the reliability of this class of component. It may be said that when used as a shunt in either the H.F. or L.F. circuit of a receiver that variations in resistance value are obtained without the slightest noise arising from intermittent or microphonic contact whilst the specimen submitted was subjected to continuous rotation without an appreciable change in resistance value arising.

D.C. MAINS UNIT.

The usual method of obtaining suitable plate potentials for operating receiving sets from D.C. mains consists of bridging the supply with a resistance and tapping off suitable voltages along it.

The Tudoradio Co., Ltd., Tudor Works, Park Royal, London, N.W.10. have designed a simple unit for effecting this in which part of the resistance consists of a lamp and is combined with



Tudoradio D.C. mains unit for obtaining H.T. potentials for receiver operation from direct current supply mains.

a smoothing circuit between the potentiometer and the output terminals. The unit can be relied upon to give good performance, although it may be pointed out that D.C. supply mains in certain

districts possess a ripple that may be difficult to remove.

o o o o

"ABSORBOS" SHOCK ABSORBERS.

To eliminate the microphonic effect so often experienced with receiving sets employing dull emitter valves amateurs frequently have recourse to insert some form of shock-absorbing material under the feet of the set.

The use of "Sorbo" balls for provid-

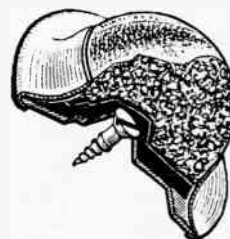

"Absorbos" shock absorbing buffer for eliminating valve microphonic noises.

ing a non-microphonic support is a method which is not only well known to amateurs but is one which is very effective. Stratton and Co., Ltd., Balmoral Works, Bromsgrove Street, Birmingham, have introduced a form of screw-on foot in which a "Sorbo" india-rubber cushion carried in a metal rim can be easily attached to the receiving instrument.

The metal mount is attached with a centre screw and the indiarubber cushion which is exceedingly pliable, is inserted by being compressed and then being allowed to expand on to the metal rim. The rubber cushion is nearly one inch in radius, giving ample support to a heavy set, and is entirely effective in preventing the transference of microphonic vibrations between the table and the set.

These shock absorbing buffers are supplied in sets of four.

o o o o

COSMOS RHEOSTAT.

A departure from the usual form of filament resistance is to be found in the Cosmos rheostat, a product of Metro-Vick Supplies, Ltd., 4, Central Buildings, Westminster, London, S.W.1.

This rheostat incorporates two windings, so that it can be used with any type

of bright or dull emitter valve, the windings having resistance values of 18 and 2 ohms. The resistance wire is carried on a fibre strip and is much wider than the formers usually employed for carrying rheostat windings. A greater length of wire is consequently accommodated, and as a result a moderately heavy gauge can be employed to give the required resistance value, having the advantages of liberal current carrying capacity and mechanical durability under the rubbing action of the sliding contact. A strip of spring forms the contact, and in shape is

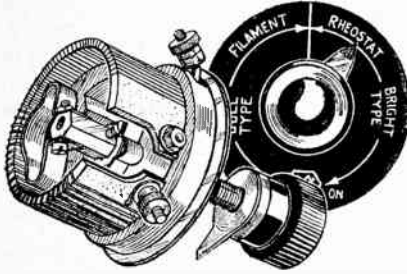

Two-range Cosmos rheostat.

an improvement on the usual form, inasmuch as it is supported at both ends so that a hard contact is obtained which cannot be forced out of position so as to require readjustment of the tension.

The body of the rheostat is of white glazed porcelain with a bush passing through the centre to provide one-hole fixing. The knob, which measures only about 3/8 in. across, is turned and polished, having a neat and well-finished appearance. The scale is of aluminium with cleanly printed lettering on a black ground. Substantial knurled terminals are fitted.

o o o

THE DIALITE INSTRUMENT LAMP.

Adequate illumination of the instrument dials is essential for obtaining critical settings. A small lamp fitting is obtainable from A. F. Bulgin & Co., 9-11, Cursitor Street, Chancery Lane, London, E.C.4, designed for panel mounting and fitted with a plated metal shade so as to concentrate the light obtainable from a

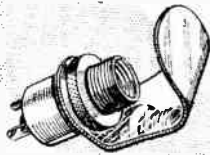

Dialite panel lamp for illuminating instrument scales

small screw-in lamp on to a condenser or other instrument scale.

Marketed under the name of Dialite, this attachment is secured by means of one-hole fixing, and the shade is carried under a knurled metal ring.

This useful component gives a very attractive appearance to an instrument panel, and the small lamp required is, of course, operated from the L.T. supply.

HOBBIES CABINETS.

Cabinet making is undoubtedly the most difficult job which the amateur encounters in the making-up of receiving sets. It is by no means easy to plane up rough boards, and many amateurs adopt

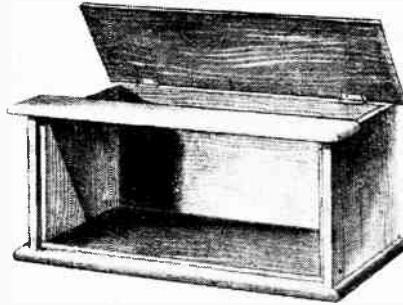

Hobbies American-type cabinet, which is assembled and finished from pieces of wood supplied accurately machined to size.

the practice of purchasing wood accurately planed to the required thickness. Even with planed boards cabinet-making is not easy owing to the difficulty of finishing the ends and edges perfectly square.

A great deal of trouble can be saved by adopting the "ready to make" wireless cabinets marketed by Hobbies, Ltd., which comprise all the necessary pieces of wood accurately machined to size and ready for fitting up. In design the cabinets follow American practice, with vertical front panel and divided, hinged top, 3/4 in. mahogany boards being employed.

The stock sizes are 16 in. x 8 in. x 8 in. deep, 12 in. x 6 in. x 6 in. deep and 9 in. x 6 in. x 6 in. deep.

o o o

SWITCH SPADE TERMINAL.

The provision of a switch in the stem of a spade terminal is a useful feature to be found in the Sirrel connector, manufactured by C. W. Garrett, 318, Sentinel House, Southampton Row, London, W.C.1.

The stem is of ebonite and is pierced through the centre with a hole into which is fitted a small bar composed half of

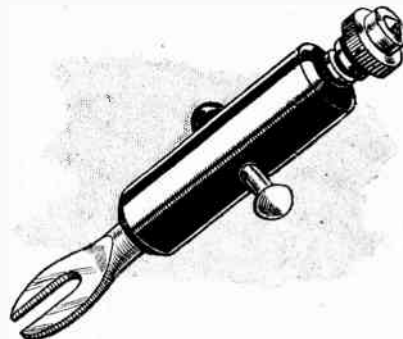

The Sirrel spade terminal incorporates a simple form of break switch.

ebonite and half of metal. The bar makes contact with spring-operated surfaces on either side of the hole, and the circuit is completed when the hole is bridged by the metal end of the bar.

The spade connector is of heavy construction, and the screw top is of a good design providing easy and reliable contact with a stranded flexible lead.

S.L.F. DIAL.

Among the American components handled by the Rothermel Radio Corporation of Great Britain, Ltd., 24-26, Maddox Street, Regent Street, London, W.1, is a geared dial possessing unusual features.

It is essentially intended for converting a condenser having plates of the straight line wavelength type to function as a straight line frequency condenser in

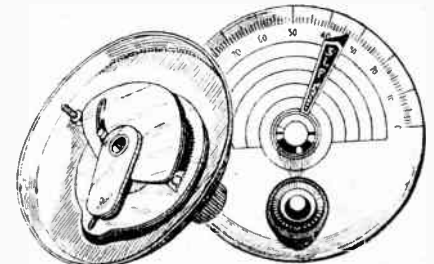

Geared dial for obtaining straight line frequency tuning with condensers having plates of the square law type.

so far as that the dial settings bear a simple direct relationship to frequency. By means of an auxiliary knob operating on a pinion and toothed segment a reduction ratio is obtained for giving critical control of tuning, yet the drive to the central shaft is not a direct one and is applied through a pin travelling in a slot so that the rotation is not uniform for any given propulsion by the pinion and segment. The movement is of durable construction, the brass plates being substantial in thickness and the guide pin, which is of hardened steel, is made a good fit in the slot.

The dull silver finish gives a good appearance, and the graduations are chemically engraved.

o o o

NEW COIL MOUNT.

An improved form of coil mount is obtainable from the Reflex Radio Co., 45, Stamford Hill, London, N.16. and con-



A new coil mount of moulded Bakelite.

sists of a clean Bakelite moulding with detachable pin.

In appearance this coil holder is an advancement on the earlier types consisting of a machined and drilled ebonite block. The two sockets are fitted with brass liners and connection is made by means of a pair of recessed screws.

Capacity between the pins is reduced by an air gap between the sockets.



The Gambrell Baby Grand.

trations serve to show the compactness of the set and the arrangement of the components. Photographed in use with an Amplion "Radiolux," one obtains a good idea of the comparative size.

The Mains Unit.

The photograph taken of the instrument with the lid open shows the resistance unit for dropping the potential of the mains to the required values. Terminals are provided, as shown, on the left of the

ONE is often inclined to wonder how important a part is played by the necessity for the use of batteries and accumulators in limiting the use and popularity of valve receivers. Probably if from the time that broadcasting started in this country it had been possible to dispense altogether with H.T. batteries and accumulators, then loud-speaker sets would to-day have been in far more general use and the crystal receiver would be almost a rarity. But perhaps the very fact that those who have used valve receivers have learnt that the associated batteries can be something more than a trial at times only adds to the interest attaching to receivers designed to operate from electric light mains where one is fortunate enough to have the electric supply in the home.

Progress in Mains Receiver Design.

During the last couple of years a good deal of progress has been made in the direction of eliminating batteries where electric supply is available, and many experimenters have had such a system in use for a long while past. It is comparatively recently, however, that sets have appeared on the market embodying the necessary equipment to provide L.T. and H.T. current from the mains.

An interesting little set operating from direct current mains has lately been produced by Messrs. Gambrell Bros., Ltd., and is called the "Baby Grand." This is a two-valve set, consisting of a detector valve with reaction and one stage of low-frequency amplification. By interchange of coils long-wave stations can be received as well as the ordinary broadcast band at suitable ranges.

The valves used are 60 milliamper types, viz., the B.T.H., "B.5," and "B.7," the latter being used, of course, for the low-frequency stage. The illus-

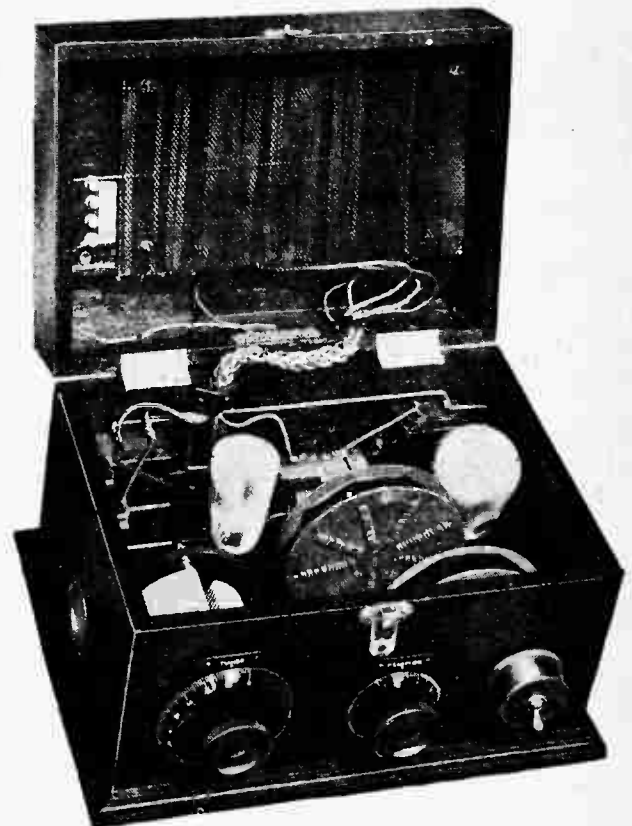

View of the receiver with the lid open. The resistance unit can be seen in the lid.

A New Mains Receiver.—

resistance unit in the lid, so that connection can be made to suit the voltage of the mains with which the receiver is to be used. The smoothing unit, consisting of condensers and a choke, is incorporated in the box behind the valves, and, as a precaution, a fixed condenser is inserted both in the aerial and earth leads. The mains connection is made into an ordinary lamp-holder, and the aerial, earth and loud-speaker connections are made to terminals at the back of the set in the usual way. The valve filament circuits are arranged so that no adjustable filament resistance is required, the correct resistance value having been chosen, and the two valves operate in series, thus effecting an economy in current consumption, the required drop in mains voltage being less.

Results of Test.

Using this set at some little distance from London, ample volume was obtained both from 2L.O and Daventry with a standard aerial. London could also be received

with a small indoor aerial with adequate loud-speaker volume up to distances of 3 to 5 miles, but this does not indicate the limit of range.

For those with direct current lighting supply who want a simple broadcast receiver without the trouble of batteries, the set can be thoroughly recommended. There is, whilst the set is in operation, a trace of commutator ripple still present, which varies in intensity, depending on the conditions at the power supply station; but when the transmission is actually in progress this hum is not noticeable. The presence of a very slight trace of hum when no broadcasting is on is, perhaps, an advantage rather than an objection because it indicates that the set is switched on, and because of the simplicity of the arrangement it might be very easy to leave the set running in the absence of some such indication that the valves were in use. We think, however, that there is still room for some improvement in the smoothing unit, and no doubt the designers will take this into consideration in future editions.

AMATEUR STATION 2JB.

SITUATED in North-west London, this station is frequently to be heard on short wavelengths with an input power between 3 and 6 watts.

The transmitter, which employs the well-known loose-coupled Hartley circuit, is shown at the right-hand side of the photograph. An L.S.5 valve is used as an oscillator, and modulation is effected by the much-maligned grid system, an ordinary receiving valve being connected across the grid circuit for this purpose, with its plate joined to the grid of the oscillator. While it is probable that this system would be unsatisfactory on higher powers, complete success has been achieved on powers of 3 to 6 watts. For Morse transmission the filament of the modulator is merely switched off. Power is obtained from the 240-volt D.C. lighting mains.

On the receiving side several sets are used. The receiver shown on the left of the table is a replica of that described by Mr. W. James in the December 23rd, 1925, issue of this journal. Its flexibility is extraordinary, and Australian signals have been received when using a few feet of wire across the room as an aerial.

Some experiments have been conducted with the object of finding the optimum wavelength for long-distance communication with low power,

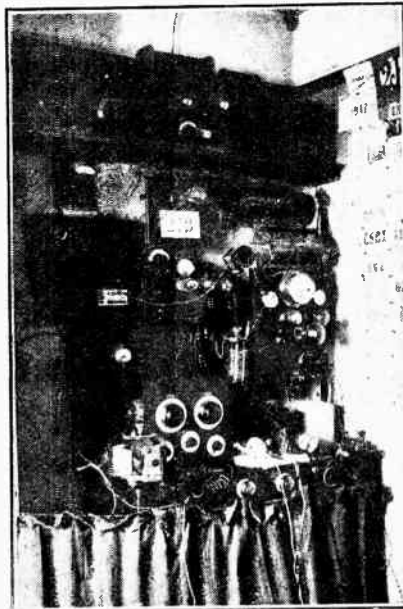

The low-power experimental station 2JB operated at Brondesbury by Mr. John C. Bird.

and some interesting results have been obtained. For instance, on a wavelength of 189 metres the greatest distance from which a report was received was Cambridge. On descending to 90 metres, reports came in from France, Belgium, and Holland, while the longest distance previously obtained was trebled by using the 45-metre wave.

When transmitting telephony, re-

ception at R6 to R7, with excellent quality, has been reported by an amateur at Cologne.

TRADE NOTES.**Condenser Truths.**

"A radio receiver can be no better than its variable condensers," is one of the axioms laid down in an informative little book entitled: "The Truth about Variable Condensers," which has been produced by the General Radio Company, of Cambridge, Massachusetts. This publication, which is admirably illustrated, describes a wide range of instruments now finding a market in this country. The company's British representative, from whom copies of the booklet may be obtained, is Claude Lyons, 76, Old Hall Street, Liverpool. ○○○○

Wireless in the West.

A large factory, solely for the manufacture of wireless sets and components, is in course of construction at Bedminster, Bristol, by Automobile Accessories (Bristol), Ltd. A separate factory will devote its efforts to the manufacture of cabinets, accumulator cases, crates, and all types of woodwork used by the radio trade. The company hopes that both factories will be in full swing by the end of this month. ○○○○

The Social Side.

More than seventy members and friends of the staff of Messrs. L. McMichael, Ltd., were entertained at a successful dance held recently at the Royal Hotel, Slough. The staff were happy to have among them Mr. Leslie McMichael, managing director, Miss McMichael, and Mr. B. Hesketh, B.Sc., director and works manager.

WIRELESS CIRCUITS

in Theory and Practice.

10.—Detection of High-Frequency Oscillations.

By S. O. PEARSON, B.Sc., A.M.I.E.E.

IN this series we are chiefly concerned with the reception of radiotelephony, and the action of a detector is considered from this point of view. The energy of sound is conveyed to the drum of the ear by waves of compression and rarefaction of the surrounding atmosphere, a given pitch of sound being produced by some definite frequency of vibration. The band of frequencies representing audible sound is more or less limited, the upper and lower limits not being quite the same for all individuals; but, in general, the audible band of frequencies ranges from about 25 cycles per second to an upper limit of about 10,000 cycles per second. However, the range of frequencies chiefly used in ordinary telephony is only from about 100 to 3,000 cycles per second. Frequencies of currents, etc., within the audible limits are referred to as audio-frequency or low-frequency (L.F.) currents to distinguish them from the higher frequencies used for wireless communication.

The actual wave shapes of sound vibrations are usually of very complex form, but it can be shown that any alternating wave, however complex in shape, can be resolved into a number of pure sine waves whose sum will give the wave-shape in question. The principal sine wave obtained in this manner, which has the same frequency as the original wave, is called the *fundamental* wave, and the remaining sine waves, whose frequencies are all exact multiples of the fundamental frequency, are called *harmonics*, or, in the case of sound, *overtones*. In the case of a sound wave the pitch is determined by the frequency of the fundamental, and the quality or tone by the number of harmonics present and by their amplitudes relative to that of the fundamental.

Transmission Frequencies.

In transmitting speech and music by wireless, the sound vibrations have to be converted into electrical variations of corresponding wave-shape and transmitted through space to the receiving apparatus, there to be reconverted into sound waves of as nearly as possible the same shape as the original ones which actuated the microphone at the transmitting station. Now, since the energy radiated per second by a transmitting aerial is proportional to the square of the frequency or inversely proportional to the square of the wavelength, it is necessary to employ frequencies which

are far higher than any of those within the audible range in order to obtain efficient transmission. Thus, in order to convey the frequencies of speech and music, a high-frequency oscillation or wave must be used to act as a carrier, the high-frequency wave being for this reason called the *carrier wave*.

Modulation.

At the transmitting station the speech frequencies are superimposed on the high-frequency oscillation, that is to say, the audio-frequency currents from the microphone are caused to vary the *amplitude* of the high-frequency oscillations in the aerial circuit in accordance with the waveshape of the sound vibrations. A high-frequency oscillation which has its amplitude regulated in this manner is said to be *modulated*, and the corresponding wave transmitted is called a modulated wave. The principle involved will be clearly seen from the diagrams of Fig. 1, where the upper curve is a low-frequency "wave," and the lower curve a high-frequency oscillation modulated in accordance with the variations of the upper curve. Note that the contour of the peak values of the high-frequency oscillations is exactly the same shape as the wave form of the low-frequency curve. The first part of the lower curve represents the pure carrier wave when not being modulated. It will be seen from the diagram that at no time must the amplitude of the low-frequency wave be greater than or even equal to the amplitude of the carrier wave, otherwise the wave form will not be maintained, and the high-frequency oscillations would cease altogether during any intervals when these conditions existed. In fact, in practice the amplitude of the low-frequency wave must be quite a small percentage of that of the carrier wave if true

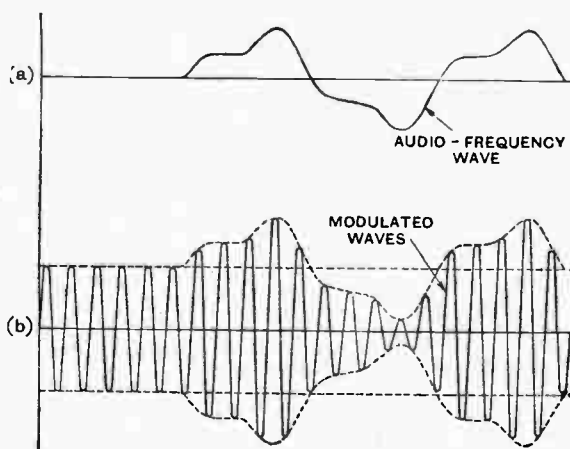

Fig. 1.—High-frequency oscillations modulated by an audio-frequency vibration in telephony transmission.

proportionality is to be maintained, that is to say, the percentage modulation must not be too great. Another reason for this will be seen below in connection with the detector.

The longest waves used for radio communication are about 25,000 metres, corresponding to an oscillation frequency of 12,000 cycles per second, or 12 kilocycles. The band of wavelengths chiefly used for broadcasting purposes in this country lies between 300 and 500 metres, corresponding to a band of frequencies between 1,000,000

Wireless Circuits in Theory and Practice.—

and 600,000 cycles per second, *i.e.*, between 1,000 and 600 kilocycles, the only broadcasting station at present operating outside this band being Daventry. It should be noted that all of these frequencies are a long way above the highest audible frequency.

Separating the Audio-frequencies from the Carrier Wave at the Receiver.

The modulated high-frequency oscillations are picked up by the receiving aerial, and in order that the telephone or loud-speaker connected to the receiving apparatus shall reproduce the sounds actuating the transmitting microphone it is necessary that the current in the telephones shall have as nearly as possible the same wave-shape as the current in the transmitting microphone.

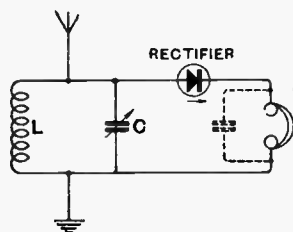

Fig. 2.—Plain aerial circuit with rectifier and telephones connected across the loading inductance and capacity.

separated from the carrier wave again, and this is the function of the detector. The aerial and receiving circuits are tuned to the frequency of the carrier wave, and the resulting modulated high-frequency voltage built up across some part of the circuit is caused to operate the receiver. As a simple case we shall consider a plain aerial circuit with parallel tuning as shown in Fig. 2.

Suppose that for a given short interval the modulated wave being received is the same as that shown in Fig. 1. The voltage built up across the inductance and condenser will obey the same law, and the curve is reproduced in Fig. 3(a). Now if we connected a pair of telephones across the condenser practically no current would flow through these telephones, because the impedance offered to currents at the frequency of the carrier wave would be very great indeed. But even if some current did flow, no sounds would be produced in the telephones! Referring to the upper curve of Fig. 3, it will be seen that although the amplitude of the voltage across the circuit is varying at an audio-frequency, its *mean value is always zero*,

being quite independent of the modulation. Thus the average value of the current through the telephone will not be in any way affected by the modulation, with the result that no audible sound will be produced. What is necessary is that the mean value of the current through the telephones shall vary in accordance with the ampli-

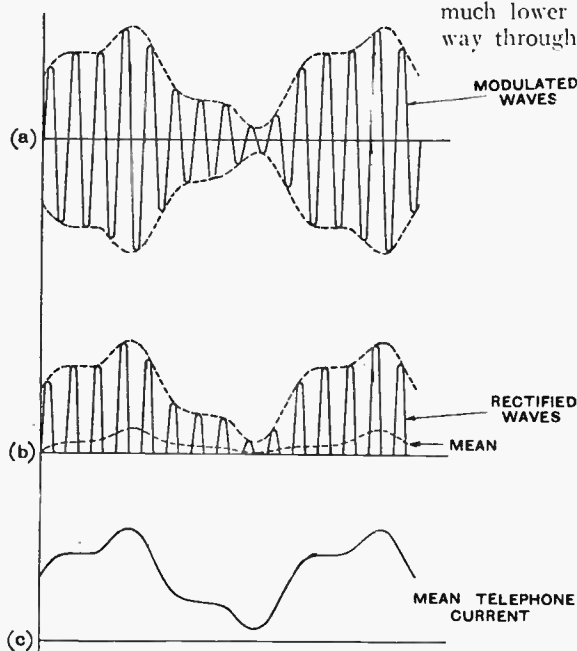

Fig. 3.—Curves showing the action of a perfect rectifier.

tude of the high-frequency oscillating voltage across I.C. The necessary conditions can be obtained by connecting in series with the telephones some device which will cut off completely all the negative half-waves of the current, allowing the positive half-waves to pass.

The Use of a Rectifier.

An arrangement allowing current to pass freely in one direction but not in the opposite direction, is said to possess unilateral conductivity and is called a rectifier. A perfect rectifier would be one which allowed no current whatever to pass in one direction and offered a constant resistance to currents in the other direction.

If a curve is plotted showing the relation between the voltage applied in either direction across a perfect rectifier and the current passed by it a straight line curve is obtained, as shown in Fig. 4, for all positive voltages, there being no current at all for all negative voltages.

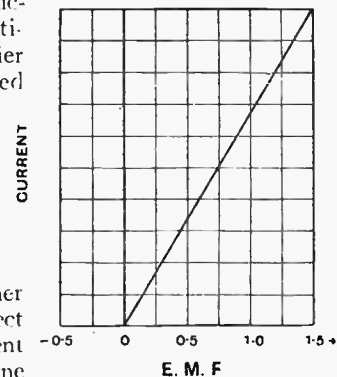

Fig. 4.—Characteristic curve of a perfect rectifier. The current obeys a straight line law for positive voltages and no current flows for negative voltages.

In practice a perfect rectifier has not yet been found, but there are a number of devices which offer a much lower resistance to currents passed one way through them than to currents passed in the opposite direction. Chief among these is the crystal detector.

The Mean Telephone Current.

Let us first consider what happens when a perfect rectifier is connected in series with the telephones, the pair then being connected across the tuning inductance and condenser of Fig. 2. Suppose that all the negative half-waves of the current are completely suppressed and that the positive half-waves are allowed to pass freely. The resulting current through the rectifier and telephones would then be as shown at (b) in Fig. 3, *i.e.*, it would be a pulsating current but unidirectional. Thus the mean value of the current flowing through the rectifier and telephone circuit will be proportional to the amplitude of the high-frequency oscillations, and the mean value of the current through the telephone will have the same wave-shape as the contour of the modulated high-frequency wave. Curve (c) shows the mean value of the telephone current measured over intervals small compared with the time

Wireless Circuits in Theory and Practice.

of one cycle of the audio-frequency wave and at least as great as the time of one cycle of the carrier wave. For transmission on a wavelength of 300 metres the carrier wave has a frequency of a million cycles per second, and when this is being modulated by a low-frequency wave of, say, 800 cycles per second, we see that there are 1.250 high-frequency oscillations during each single cycle of the low-frequency current. As a telephone offers a very high impedance to these high-frequency currents it is necessary to shunt it with a small condenser which will offer a fairly low reactance path for the high-frequency alternating component, and at the same time offer a high impedance to the audio-frequency currents so that these are made to pass through the telephone.

It should be pointed out here that the mean value of the current through the telephone has a value very much less than the amplitude of the half-waves of current which the rectifier allows to pass; it was shown in a previous section that the mean value of a half-wave was 0.637 of the amplitude for sine waves. In the arrangement under consideration only the alternate half-waves are present, and therefore the telephone current during any short interval of time will be equal to only 0.318 of the amplitude of the high-frequency pulsations during that time.

The Crystal Detector.

The simplest rectifier for receiving purposes is the crystal detector, which employs the peculiar property of the contact between two crystals of different materials, or between a crystal and a metal, of possessing unilateral conductivity to a marked degree. But no combination discovered as yet provides a perfect rectifier, that is to say, no crystal arrangement will completely cut off the negative half-waves of a high-frequency oscillation, the action being merely to allow much more current to flow in one direction than in the other when an alternating voltage is applied across it, and further, the mean value of the current allowed to pass is not directly propor-

typical curves are given in Fig. 5. Considering the Perikon detector whose static characteristic curve is shown at (a) it will be noted that some current is allowed to flow even when the applied voltage is negative and that the bend in the curve is not a sharp corner but rounded off. The sharper the bend and the smaller the amount of negative current allowed to pass the better will be the action of the crystal as a rectifier. The fact that some negative current flows means that only partial rectification will take place, and, due to the gradual

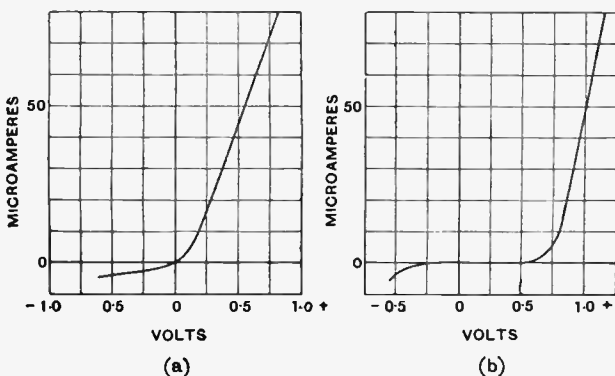

Fig. 5.—Characteristic curves of typical crystals. (a) Zincite-bornite or Perikon detector and (b) carborundum-steel detector.

tional to the applied voltage; in fact, it is nearly proportional to the square of the applied voltage for small values of voltage.

The characteristic curves showing the relation between the steady voltage applied across the detector and the current are different for different combinations, and two

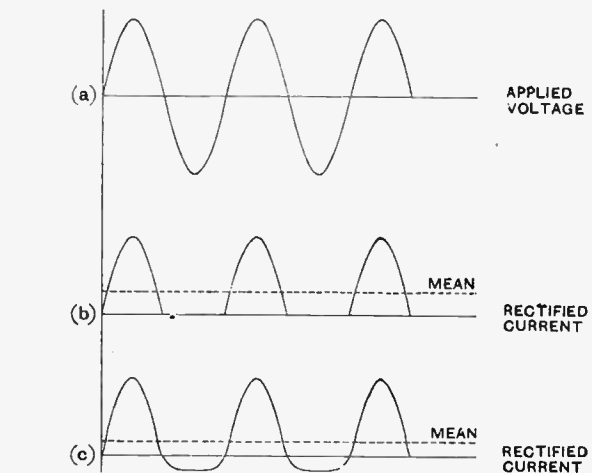

Fig. 6.—Comparison between the rectified current (b) in a perfect rectifier and (c) in a crystal detector.

bend in the curve, the ratio of mean rectified current to the amplitude of the applied voltage will begin to fall off rapidly as the voltage becomes smaller and approaches zero.

The curves of Fig. 6 are given to show the effects of an imperfect rectifier, such as the Perikon detector, as compared with the perfect or ideal conditions. The upper curve (a) represents the high-frequency voltage applied to the rectifier; the second curve (b) gives the rectified current which would be obtained from a perfect rectifier with a characteristic curve like that shown in Fig. 4, and the lower curve represents the rectified current obtained from the crystal rectifier. It will be noted that the mean value of the current passed by the crystal is very much below that given by the ideal rectifier, and that the current impulses are no longer sine shaped half-waves.

This point will be referred to again in connection with the distortion which it may produce when receiving speech and music under certain conditions.

Referring again to the curves of Fig. 5, it is important to notice that for the Perikon detector the bend in the curve occurs just at the point where the voltage is zero, whereas for the carborundum detector the bend in the curve occurs where the voltage is +0.7 volt. This means that for the Perikon detector rectification would com-

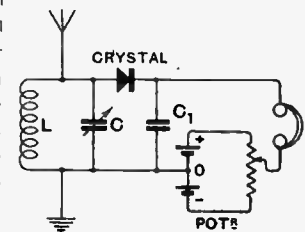

Fig. 7.—Circuit diagram showing the use of a potentiometer to adjust the steady voltage applied to a crystal detector.

Wireless Circuits in Theory and Practice.

mence for very small values of applied voltage, whereas for the carborundum no rectification would take place at all until the amplitude of the applied voltage had reached at least 0.7 volt. To overcome this difficulty, which arises when using carborundum crystals and certain other types of crystal, a steady voltage must be applied to the crystal from a local battery in order to operate at the bend in the characteristic curve. For the carborundum crystal whose curve is given the applied voltage would have to be 0.7. This is easily effected by using a couple of cells across which is connected a potentiometer having a fairly high resistance, the com-

bination being connected in the circuit as shown in Fig. 7. With this arrangement the voltage applied to the crystal can be varied over a range from minus to plus the voltage of one of the cells, and it is particularly useful where it is required to interchange crystals.

[In the next instalment some actual measurements will be given on the characteristics of crystals, including dynamic measurements. From the results it will be shown how the percentage modulation of the carrier wave affects the quality of the reproduction. The various methods of connecting crystal detectors in the circuits will be given, and the damping effects, etc., on the tuned circuits discussed.]

AN INTERESTING VALVE FAILURE.

THE photographs show a small transmitting valve which had "burnt out" while taking static characteristic curves. The valve was being badly overrun—120 watts were being dissipated at the plate instead of the normal 50—when there was a flash, and the filament had gone. An inwardly directed hole

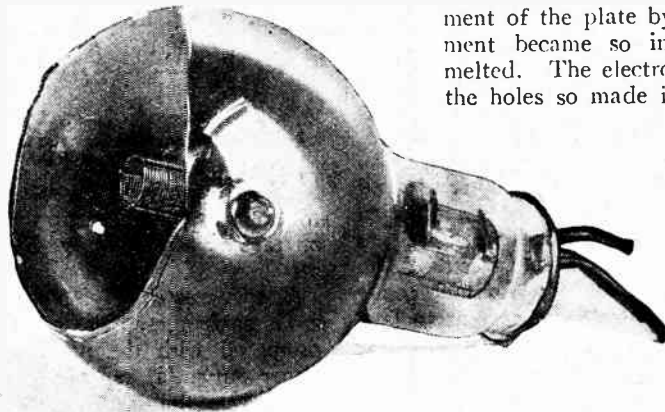
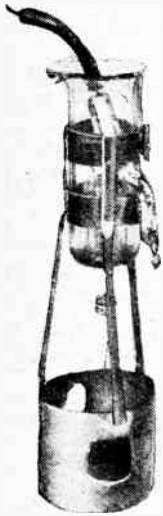

was apparent in the glass, which can be seen in the photograph. The top of the valve was removed exposing the cylindrical plate, and it was seen that two holes opposite each other had been melted in the plate and that the hole in the glass was opposite one of these holes. Opposite the other hole the glass was blackened.

When a valve burns out it is always interesting to investigate the cause, and much more so if it is a transmitting valve, which is, of course, an expensive item as compared with receiving valves. Probably more than one theory could be advanced as to the exact cause of the initial stage of the effect which produced the breakdown in this particular instance, but, in all probability, the sequence of events in the burning out of the valve was as follows:—The bombardment of the plate by the electrons from the filament became so intensive that the plate was melted. The electrons now rushed right through the holes so made in the plate, and bombarded the glass. The glass became melted in its turn, and the air rushed in through the soft glass, thus destroying the vacuum. Finally, the tungsten filament burnt out in the air.

It would be interesting to know whether readers have had similar experiences or whether this is a somewhat unique instance.

Of course, it is fairly well known that intense emission can take place with a coated filament where the coating has been uneven and the proportion of thorium in any spot on the coating is unusually high, but this is a defect in manufacture which would probably seldom occur in modern valve manufacture.

F. M.

The Formo Co., Ltd. (Crown Works, Cricklewood Lane, N.W.2). Shrouded L.F. Transformer. Choke-capacity coupling unit; Variable Condensers; Low-loss Couplers and Heterodyne Oscillators.

General Electric Co., Ltd. (Magnet House, Kingsway, W.C.2). Folder B.C. 3991, describing and illustrating "Geophone" wireless components and accessories, including the low-loss slow-motion variable condenser, universal filament rheostat, anode resistance unit, etc., and Leaflet No. 4064, with specification and price of D.C. charging resistance for H.T. accumulators.

The Marconiphone Co., Ltd. (210-212, Tottenham Court Road, W.1). Leaflets with particulars and prices of Stirling

Catalogues Received.

Non-Pong Valve Holders, Square-Law Variable Condensers, Headphones and Loud-speakers.

Igranic Electric Co., Ltd. (147, Queen Victoria Street, E.C.1). Catalogue No. 5213, of Radio Accessories, including Tuning Coils, Variometers, Transformers, Condensers, Switches and Rheostats; also their Multi-circuit Folder of pictorial and theoretical circuits.

Marconi's Wireless Telegraph Co., Ltd. (Marconi House, Strand, W.C.2).

Leaflet No. 1053, illustrating and describing their extra-selective Receiver, Type R.G.6A, and Leaflet No. 1054, giving particulars of the wireless "Call" apparatus, Type C.G.3, suitable for either loud-speaker or electric bell.

Spencers (Scotland), Ltd. (119, George Street, Edinburgh). Catalogue of Wireless Receivers, Valves, and all kind of accessories.

Midland Radiotelephone Manufacturers, Ltd. (Brettall Lane Works, Stourbridge). Catalogue of "Mellowtone" Receiving Sets and Components.

The Radio Devices Co. (Newdigate Street, Nottingham). "Devicon" Low-Loss and Standard Condensers. Switch Coil-Plug and On-and-off Plug Switches.



Broadcast Brevities

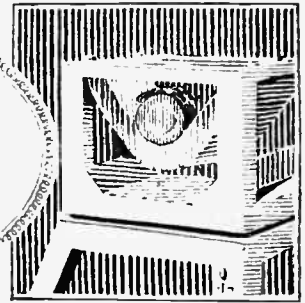

Savoy Hill Topicalities : By Our Special Correspondent.

Relaying America.

The Keston station has been getting some particularly good quality reception from the Schenectady station (WGY) on 32 metres during the past ten days, the week-end period, April 10-12, being exceptionally encouraging from the point of view of experiments. As listeners will readily understand, however, it is not possible to interrupt the ordinary 2LO programmes and substitute the American transmissions, even when the quality of the latter is considered satisfactory enough for relaying; but no doubt the time is approaching when British programmes will be so arranged that international broadcasts can be sandwiched in at odd times, as a prelude to the period when reception becomes so reliable that American programmes can be announced definitely beforehand.

o o o o

An Eight-valve "Super Het."

It is unfortunate for British listeners that the introduction of summer-time in this country will debar them from hearing, at a reasonable hour, further relays of American programmes of the excellent quality of that which was broadcast by Schenectady (WGY) on Tuesday of last week. The engineers at Keston had been experimenting to good purpose. They had installed a new eight-valve set constructed on the super-het. principle, and had brought a "broomstick" aerial into use. This aerial was only four feet from the ground and 300 yards long; and the quality of reception proved that Capt. West and his assistants are evidently working along the right lines. Listeners heard for themselves the music played by the Porter E. Potts orchestra at the Hotel Van Curler, Schenectady, and there is therefore little need to do more here than draw attention to its superior quality, both as regards melody and rhythm, when compared with the stuff put on the ether by some British dance bands.

o o o o

Writing for the Microphone.

I understand that an eminent composer and an equally famous author and poet are being approached by the broadcasting officials with the object of inducing them

to co-operate in preparing specially for broadcast performance a new opera, song cycle, or similar work in which their brilliant talents may be adapted for the medium which neither has yet touched.

o o o o

Problems to Solve.

In music of a complex nature, the intentions of the great composers can never, perhaps, be reproduced. This is due to a large extent to the fact that none of the

form can be conveyed without flaw, certain elements in existing musical compositions are lacking from a broadcast performance, and it is becoming evident that there is a new field for musical compositions specially written to convey a fully satisfactory reproduction of the author's ideas. Some of the great living composers realise this, and will, it is hoped, set themselves to overcome the problem.

o o o o

Too Many Characters.

A listener writes to me pointing out that a certain confusion is sometimes caused in following a radio play by a rather bewildering number of persons appearing in the cast. He pleads for some simplification of his task of identifying each separate character as he or she speaks. I think that what my correspondent has in mind is the facility with which Mr. R. A. Roberts assumes all the characters in his "Dick Turpin" sketch; Mr. Percy Edgar, the Birmingham station director, does precisely the same thing in his Protean interludes. It would be, perhaps, a useful development of the radio drama if the B.B.C. could broadcast some one-act plays in which all the characters were assumed by one individual, or at all events, by very few artists. Not everyone, of course, can emulate the bountiful personality of a Bernard Shaw, that would enable them to talk in four voices and sing a song as he did in his reading of "O'Flaherty, V.C."; but the call of the microphone is insistent for personality in each individual character broadcast, and the artist who can introduce the distinctive note will make a name for himself.

o o o o

Anzac Day.

Next Sunday, April 25th, is Anzac Day, and in commemoration General Sir Ian Hamilton will broadcast a brief description of the landing at Gallipoli in 1915.

o o o o

The Pilgrims Society.

The Pilgrims Society are giving a dinner to the Earl of Reading on Wednesday next (April 28th) on his retirement from the office of Viceroy of India.

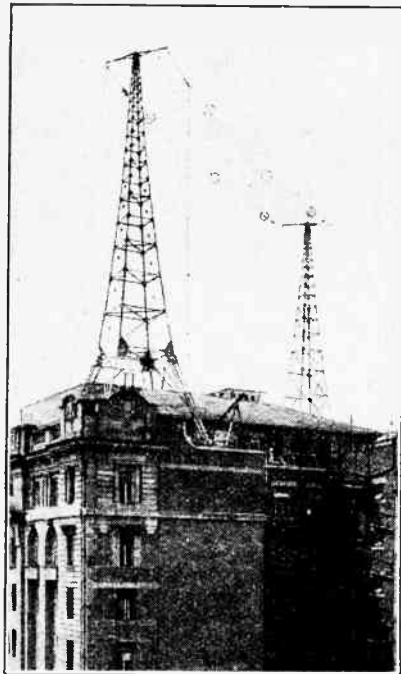

BRISBANE CALLING. In external appearance, the new Queensland broadcasting station at Brisbane (4QG) has points of resemblance with 2LO, London. The station transmits on 385 metres.

old masters contemplated the use of such a medium as radio for the interpretation of their works. Experience has shown that while melody, rhythm, and musical

where his work for the Empire has been signally successful. At 9.30 p.m. on the day named, listeners will hear the toast of Lord Reading's health, proposed by Lord Birkenhead, Secretary for India, and the ex-Viceroy's reply.

o o o o

Broadcasting from Theatres.

When the B.B.C. entered into an agreement with the theatrical interest for broadcasting from the stage, the number of excerpts from stage performances was limited to twenty-six per annum. This was to be the maximum, and it was not contemplated that the full number would necessarily be reached. As things have turned out, Savoy Hill is pretty well up to schedule: for since the agreement came into force in June, 1925, eighteen stage broadcasts have taken place, and the negotiations for two more are practically complete.

o o o o

The List.

The full list of such broadcasts is now as follows:—June 23rd, "The Beggar's Opera"; 25th, "Tell Me More"; July 31st, "Charlot's Revue"; August 14th, "By the Way"; September 10th, "Co-Optimists"; October 16th, "Dear Little Billy"; 31st, "Tess of the D'Urbervilles"; November 14th, "Co-Optimists"; 25th, "Tell Me More"; December 11th, "Lionel and Clarissa"; 11th, Press Fund Charity Matinee, Lyceum Theatre; January 1st, "Bluebell in Fairyland"; 15th, "Mercenary Mary"; February 13th, "The Ghost Train"; 26th, "Henry VIII."; March 12th, "No. No. Nanette"; 26th, "The Student Prince"; April 9th, "Wildflower."

o o o o

B.B.C. and the Managers.

Although managers are entitled to decline to broadcast, and the B.B.C. may similarly decline any excerpts offered to them, there have been no cases of friction; the only occasions on which broadcasts fell through being the proposed transmission of "Betty in Mayfair" from the Adelphi Theatre owing to the action of the Musicians' Union, and that of "The Blue Kitten" from the Gaiety Theatre, where it was discovered that difficulty would arise owing to the fact that the consent of several persons in this country and abroad would first have been necessary.

o o o o

Abandon Hope—!

After their 2LO broadcast on April 21st, John Henry and Blossom will not be heard again from the broadcasting studio for some time to come, as they are about to begin their summer season of seaside performances. Broadcasting's loss will thus be Ramsgate's gain, but it is desirable that J.H. should be given a period of respite from broadcasting. The premier of laughter-makers to the B.B.C., as he has been called, counts his first appearance before the microphone as one of the worst moments of his life. He has been first turn in a music hall in that Yorkshire city that's known as the Grave of Comedians, but even then he

FUTURE FEATURES.

Sunday, April 25th.

LONDON.—3.30 p.m., Tchaikovsky Programme. 9.15 p.m., Albert Sandler and the Grand Hotel, Eastbourne, Orchestra.

BIRMINGHAM.—3.30 p.m., American Programme.

BOURNEMOUTH.—3.30 p.m., Light Symphony Programme.

MANCHESTER.—3.30 p.m., Coleridge-Taylor's Lesser Known Works.

Monday, April 26th.

LONDON.—8.30 p.m., The B.B.C. Spring Series of Chamber Concerts. 1st Concert, relayed from Chenil Galleries, Chelsea. London Chamber Orchestra, conducted by Anthony Bernard.

ABERDEEN.—8.30 p.m., Remnant Acre, a Play in one act by Dion Titheradge.

NEWCASTLE.—8 p.m., "Scandinavia."

Tuesday, April 27th.

LONDON.—9 p.m., Speech by the Rt. Hon. David Lloyd George at the tenth annual dinner of the London Head Teachers' Association, relayed from the King's Hall, Holborn Restaurant.

DAVENTRY.—8 p.m., Request Programme by "The Foosters."

CARDIFF.—10.15 p.m., "The Caretaker Calling"—Some Impressions by George Erbort.

GLASGOW.—10 p.m., Popular Song Recital.

Wednesday, April 28th.

BOURNEMOUTH.—8 p.m., Grand Concert relayed from the New Central Hall, Southampton.

BELFAST.—8 p.m., Concert (including "The Blessed Damozel," by Ernest Farrar).

MANCHESTER.—8 p.m., Violin Recital by Don Hyden

Thursday, April 29th.

LONDON.—8.15 p.m., "Lady Windermere's Fan," by Oscar Wilde.

ABERDEEN.—8 p.m., Nautical Programme.

BIRMINGHAM.—8 p.m., "Maritana."

CARDIFF.—8 p.m., Music of Dame Ethel Smyth, including "The Boatman's Mate."

Friday, April 30th.

LONDON.—7 p.m., Daily Graphic Concert.

Saturday, May 1st.

LONDON.—8 p.m., "May Day," a Musical Farce in One Act.

BELFAST.—8 p.m., "Polyglot," a Competition. 10 p.m., Piano and Song Recital.

EDINBURGH.—8 p.m., Celebration of the Second Birthday of 2EH.

GLASGOW.—8 p.m., "Listening Time."

did not experience anything quite so hopeless as when he first entered a broadcasting studio. I think that most listeners can sympathise with any humorist who is trying to "get it across" in that atmosphere of loneliness.

o o o o

Artists' Contracts.

In various branches of the entertainment world feeling still runs high against broadcasting. Artists find that their contracts are drawn up so drastically as to preclude them from appearing before the microphone, even at times when their services are not directly required by their employers. Two cases of the kind have occurred within the past few days. In one case the artist did not feel equal to "facing the music," and his broadcast engagement was cancelled at the eleventh hour, to the intense disappointment of an audience which would have numbered tens of thousands more than actually did hear him at the hall where he was billed to appear. In the other case the artist decided to risk the consequences and broadcast, in spite of the contractual interdict.

o o o o

Defensive Measures.

The main point is that sooner or later the B.B.C. will in its own defence be forced to adopt similar tactics in respect of broadcasting stars and introduce into its contracts an option on a star's services and material; this is becoming necessary, as other branches of the entertainment world are showing an increasing disposition to engage artists on account of their broadcasting reputations.

o o o o

Lectures and Counter-lectures.

Listeners are advised to spare the time to tune in at 5.30 on Tuesdays to hear the lectures and counter-lectures which are being given in the Great Hall of the London School of Economics in aid of King Edward's Hospital Fund for London. The subjects of debate cover a wide field of human interest, ranging from the amount of serious attention that should be paid to critics, to an inquiry whether woman is becoming too obtrusive or not. The list of speakers includes Miss Sheila Kaye Smith, Miss Ellen Wilkinson, M.P., the Right Hon. J. H. Thomas, M.P., and Mr. G. K. Chesterton, and among the distinguished men and women who will act as chairmen are the Right Hon. D. Lloyd George, M.P., Miss Irene Vanbrugh, and Mr. W. B. Maxwell.

o o o o

To What Base Uses.

I heard the other day of a listener who makes a practice of switching on the loud-speaker whenever he leaves his house unoccupied, in order that his dog shall have the companionship of the music and voices and not disturb the neighbours by howling. Another listener has now written to the B.B.C. to say that he places the loud speaker near his parrot's cage in the hope that the bird may be induced to talk and sing—a better training school than many people realise.

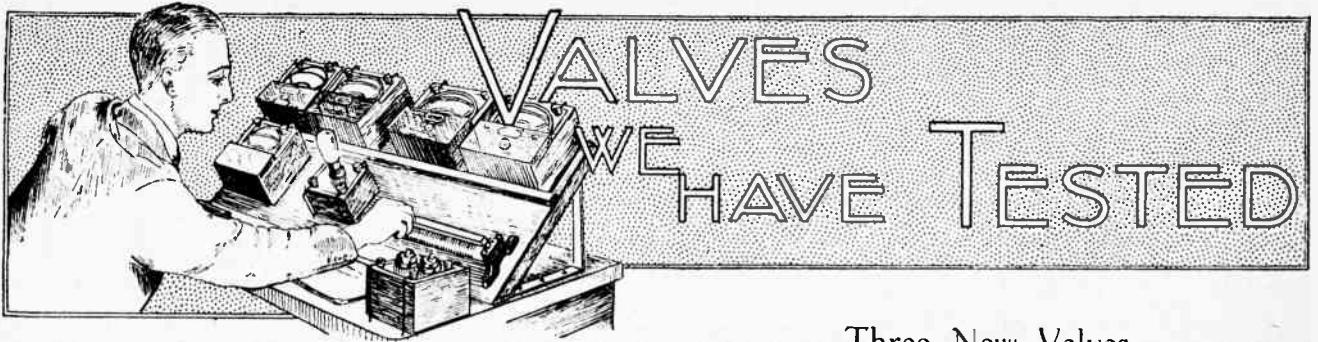

Three New Valves.

The Mullard P.M.3.

THIS week we have three new valves, and they are all of the low current consumption type. We tested first of all the Mullard P.M.3 valve, which is rated to consume a filament-heating current of 0.1 ampere at 3 to 3.7 volts. The valve is said to be suitable for detection, H.F. and L.F. amplification; we would, therefore, expect the anode impedance and amplification factor to be moderately high. According to the makers, an average valve has an anode impedance of 16,000 ohms and an amplification factor of 13.5 measured with an anode voltage of 75 with zero grid volts.

Test Results.

Test results are given below, from which it will be seen that the valve tested was a fairly good specimen, its average impedance being about 18,000 ohms and amplification factor 13. Valves of this type when used as a detector should have the grid leak return wire connected to the positive side of the filament, and a grid leak of 2 megohms is suitable. For L.F. and H.F.



Mullard P.M.3.

amplification, a negative grid bias should be used and the values at which the measurements were taken may be used as a guide. The valve cannot strictly be said to be a power valve, i.e., a valve suitable for working into a loud-speaker, its anode impedance being too high; a transformer could be used, but this is not really satisfactory.

Neutron Valves.

Two types were submitted for test, an H.406 and an I.406. Type H.406 is intended for high-frequency amplification and for any purpose where a valve with a fairly high amplification factor is required, for instance, for resistance H.F. or L.F. amplification. Its filament rating is 4 volts at 0.06 ampere. The valve of this series intended for L.F. amplification is the I.406, which differs from the H.406 in that its amplification factor and impedance



Neutron Type 406.

is lower. Both valves are similar in appearance to the one illustrated above, the bulbs having the usual silvery coating. On test both valves were found satisfactory, the amplification factor and anode impedance of the

MULLARD P.M.3 VALVE.

Filament volts,	3.0.	3.2.	3.4.	3.7.	Filament current,	.097 ampere.	.100 "	.102 "	.104 "
-----------------	------	------	------	------	-------------------	--------------	--------	--------	--------

Anode Voltage.	Actual Anode Current.		Anode Current at Zero Grid Volts.	Negative Grid Bias.	Amplification Factor.	Anode Impedance.
	Milliamperes.	Milliamperes.				
48	1.1	1.1	0	0	12.5	22,000
60	1.37	1.69	0.5	0.5	13.3	19,300
72	1.62	2.36	1.0	1.0	12.9	17,700
84	1.95	3.16	1.5	1.5	12.4	16,200
96	2.22	3.98	2.0	2.0	11.6	15,000

NEUTRON VALVE. TYPE H. 406.

Filament volts,	4.	4.	4.	4.	Filament current,	0.037 ampere.	0.037 ampere.	0.037 ampere.	0.037 ampere.
-----------------	----	----	----	----	-------------------	---------------	---------------	---------------	---------------

Anode Voltage.	Actual Anode Current.		Anode Current at Zero Grid Volts.	Negative Grid Bias.	Amplification Factor.	Anode Impedance.
	Milliamperes.	Milliamperes.				
60	3.00	3.71	1.5	1.5	9.5	17,250
72	3.50	4.30	2.0	2.0	7.8	20,400
84	3.99	4.98	3.0	3.0	8.4	23,100
96	4.36	5.05	4.0	4.0	9.0	25,900

Valves We Have Tested—

H.406 averaging 8.5 and 23,000 ohms respectively, and of the L.406, 4.75 and 12,000 ohms. The H.406 is the better valve for detection, and should be coupled by a resistance or choke of high value or by a low ratio transformer, a suitable ratio being 3:1. When the L.406 valve is used in an L.F. amplifier, a transformer of a little higher ratio, such as 4:1, may be used with satisfaction.

NEUTRON VALVE. TYPE L. 406.

Filament volts, 4.		Filament current, 0.057 ampere.			
Ano Je Voltage.	Actual Anode Current.	Anode Current at Zero Grid Volts.	Negative Grid Bias.	Amplification Factor.	Anode Impedance.
	Milliamperes.	Milliamperes.	Volts.		Ohms.
60	2.34	4.2	3	5.0	10,000
72	2.96	4.55	4	4.75	10,300
84	3.65	5.2	5	4.75	12,100
96	4.16	5.5	6	4.95	15,000

London, W.2.

(February 24th to March 20th.)
 Great Britain.—2XP, 2NH, 2VL, 2WJ, 2ZC, 2HQ, 2IH, 2RO, 2TA, 2QV, 2FM, 2NM, 2OJ, 2DR, 2BZ, 2OQ, 2DA, 2CC, 2WW, 5DH, 5LS, 5YG, 5MD, 5FM, 5HU, 5KO, 5MB, 5KU, 5MA, 5SZ, 5GS, 5EA, 6DA, 6MX, 6FA, 6OP, 6YG, 6YD, 6UZ, 6DO, 6HF, 6JV, 6TD, 6BJ, GFP. Ireland: 5NJ, 6MU. France: 8NK, 8NN, 8ZSM, 8JF, 8HU, 8EU, 8DGS, 8IX, 8JZ, 8GRA, 8SSS, 8EZ, 8RX, 8CS, 8SST, 8JRK, 8GI, 8FK, 8JMS, 8GSM, 8TIS, 8RL, 8CC, 8CM, 8EE, 8GR, 8BU, 8HM, 8TVI, 8BRN, 8MWB, 8HC, 8DK, 8DDH, 8RF, OCNG, OCDJ. Germany: C4, K7, I4, W9, 4AL, 4CL, 4CN, 4PF. Belgium: A44, B2, K5, K44, 08, S1, S4, V2, W4. Holland: OFP, OGM, OHR, OKS, ORB, ORW, OWB, OWR, PC1, PC2. Italy: 1NC, 1AT, 1AY, 1BW, 1CH, 1CR, 1AX, 1MA, 1MT. Spain: EAR10, EAR20, EAR21, EAR23, EAR24. Sweden: SMSS, SMUA, SMUV. Finland: 2CO, 2ND. Norway: Lala, La4x. Madeira: 3FZ. Morocco: MAROC. Egypt: EGFH. Palestine: 6ZK. U.S.A.: 1ACI, 1CAL, 1CD, 1MY, 1CKM, 1JY, 1SW, 1AKZ, 1AOF, 1AHB, 1AEP, 1BZ, 1RD, 1AAO, 1AJX, 1BVL, 1APU, 1APZ, 1CH, 1RR, 1ANE, 1VY, 1CKP, 1XM, 1BLB, 1ANA, 1CK, 2MM, 2AHM, 2AGQ, 2OR, 2BG, 2ARM, 2CXL, 2AWE, 2CHG, 2CVJ, 2CWR, 2PF, 2CYX, 2ZV, 2BUM, 2ACW, 2AIM, 3AHA, 3AB, 3CJN, 4GY, 4FT, 4AC, 4RM, 4HX, 4SI, 4PI, 4BL, 4DJ, 8KC, 8XE, 8ADG, 8ALY, 9BPB, 9BHT. Brazil: 1IB, 1AE, 1IC, 1AL, 1A, 1AC, 1AB, 1AF, 1AN, 1AP, 1AO, 5AA, 5AB, 6QA. Unknown: B82, KP68, 3WQ. M. Williams.
 (0-v-1) on 30 to 100 metres.

London, S.W.11.

(January 1st to March 14th.)
 U.S.A.: 1AKZ, 1AW, 1AAO, 1ADI, 1AHB, 1BKE, 1CAL, 1CKP, 1CH, 1CMF, 1CF, 1GNP, 1CMX, 1CJC, 1GA, 1MY, 1NT, 1OR, 1SW, 1UW, 1VY, 1XAM, 1XAE, 1YD, 1YB, 2AMJ, 2AEV, 2AHM, 2BW, 2BUV, 2BC, 2CTY, 2CVJ, 2FO, 2GP, 2JN, 2MK, 3BTA, 3BWT, 3CJN, 3DH, 3HG, 4RZ, 8ADG, 8BTH, 8BZ, 8CCR, 8ER, 8GZ, 8XE, 8XQ, 9ADK, NKF, NOT, NTT. Canada: 1AR, 2AX, 2BE, 2FO. Brazil: 1AB, 1AC, 1AF, 1AL, 1AO, 1AN, 1AQ, 1AR, 1AX, 1AY, 1JA, 1JB, 1IC, 2AF, 6QA, S91. Chile: 2LD. Cuba: 2MK. Porto Rico: 4JE, 4KT, 4UR. Aus-

Calls Heard. Extracts from Readers' Logs.

tria: OAA. Italy: 1AD, 1AN, 1CO, 1ER, 1MA, 1NO, 1RT. Sweden: SMAX, SMSG, SMUI, SMUK, SMVL. Finland: 2BS, 2CO. Yugo-Slavia: 7XX. Algeria: 8IP. French Indo-China: 8QQ, Egypt: EGBH, Mexico: 1A. South Africa: A4Z, A6N. Russia: NRL. Germany: K YS, K YB. India: HBK, Spain: EAR10, EAR20, EAR21, EAR23. Palestine: 6ZK. Misc.: 1ZA, EA 4LA. KPL, POW, GHA, STB.
 (0-v-1.) C. W. Picken.

London, N.10.

Great Britain: 2BI, 2CMA, 2FB, 2FK, 2FM, 2GN, 2IA, 2IH, 2JC, 2JD, 2LF, 2MA, 2NH, 2NM ('phone), 2NT, 2OD ('phone), 2OF, 2PO, 2QM, 2QV, 2RB, 2SQ, 2TN, 2TO, 2UV ('phone), 2VS, 2VN, 2WQ, 2WW, 2XP, 2XU, 2XV ('phone), 2XX, 2YG, 2YO, 2ZA, 2ZC, 2ZH, 2ZM ('phone). 5BA ('phone), 5CX, 5DA, 5FA, 5FQ, 5GQ, 5GW, 5HA, 5HS, 5IA, 5LB, 5LS, 5MB, 5MQ, 5NM, 5NZ ('phone), 5OC, 5PO, 5PZ, 5QZ, 5RZ, 5SI, 5SO, 5SZ, 5TG, 5TN, 5TZ, 5US, 5VL, 5WH, 5WP, 5WV, 5YI, 5YZ, 5ZA, 6BR, 6GG, 6GW, 6HF, 6IA, 6IZ, 6JH, 6KO, 6MB, 6NK, 6RY ('phone), 6SU, 6UP, 6UZ, 6VO, 6YD, 6YG, ('phone), 6YK, 6YQ, 6YR, 6YU, ('phone), 6YZ, 6ZC. Northern Ireland: 2IT, 2WK, 5NJ, 5YY, 6SQ, 6TB, 6YW. France: 8ARM, 8AT, 8BF, 8BP, 8CA, 8DK, 8EU, 8FF, 8FU, 8FX, 8GRA, 8HU, 8IK, 8IL, 8JF, 8JJ, 8JMS, 8JYZ, 8KB, 8MA, 8MAC, 8NN, 8OB, 8OC, 8OI, 8OT, 8PEP, 8PL, 8QC, 8RZ, 8SSC, 8TM, 8UOU, 8UX, 8VEM, 8VO, 8WK, 8YNB, 8YOR, 8ZEB. Spain: EAR1, EAR2, EAR6, EAR9, EAR10, EAR12, EAR21. Italy: 1AM, 1AR, 1AS, 1AT, 1BB, 1BD, 1BW, 1GN, 1GW, 1HT, 1HZ, 1JQ, 1MA, 1RB, 1RG ('phone), 1RT, 1SS, 3BD, 3TR, 3UB. Sweden: SMSP, SMSR, SMIG, SMUA, SMUI, SMUK, SMVG, SMVJ, SMVW, SMWE, SMWS, SMXG, SMZS. Norway: 1A, 1B, 3K, 4Z, 6N. Denmark: 7BN, 7ZM. Holland: OAA, OAW, OFP, OHB, OKS,

OKV, ONM, OPM, OPX, ORE, ORP, OVN, OWB, OWC. Belgium: A4, B9, C11, D3, E5, E9, H6, H9, K44, P5, P7, R5, R6, R9, S4, S5, U2, U22, U3, WI, WII, XII, Z22, Finland: 2NX, 2NM, 2NN, 2CO, 3NU, 5NM, 6NX, 6NZ. Miscellaneous: YS 7XX, WIR, WIZ, UICH, K Y5, PE 6ZK, PE 6ZL, EG EH, SDK, SGT, NEQQ, NERG, GFUO, GFUP, NAI, FI 8QQ, GAV (calling SG 2ZB), CBF, CDR, FC4, GFC, GFD, GFP, OCNG, OCNM. J. Hum.
 (0-v-0, 0-v-1, on 8 to 50 metres.)

Cowes, I.W.

(January 18th-February 28th.)
 Australia: 2CM, 2YI, 3NO. South Africa: A3B, A6N. Brazil: 1AB, 1AC, 1AF, 1AW, 1CC, 1IA, 1IB, 1NC, 2AF, 3DO. China: GFUP, FI8QQ. India: 1WP. Palestine: 6YX ('phone), 6ZK. New Zealand: 2AE, 2AQ, 2XA, 4AC, 4AK, 4AR, 4AS. Porto Rico: 4JE, 4KT, 4SA. U.S.A.: 1AAO, 1AIU, 1AKM, 1ALD, 1APV, 1APZ, 1AXA, 1BDX, 1BGC, 1BIA, 1BVL, 1BZ, 1CH, 1CKP, 1CMP, 1CMX, 1GA, 1GL, 1SW, 1SZ, 1UW, 1VC, 1XAM, 2AEV, 2AHM, 2ALL, 2AMJ, 2ARM, 2BGI, 2BUY, 2CFT, 2CJJ, 2CRB, 2CVJ, 2CZY, 2DN, 2GK, 2IHM, 2KR, 2KU, 2KN, 2MK, 2NZ, 2WH, 3AHA, 3APV, 3CC, 3HG, 3LD, 3LW, 4GQ, 4MD, 4RZ, 4UX, 5ATX, 5FC, 5YB, 7EK, 8ADG, 8ALF, 8AVK, 8BPL, 8BTQ, 8JQ, 8XE, 9AOT, 9XI, 9ZT. Various: P3FZ, CLAK, CIAM, C2BF, EG EH, GEFT, GHA, GFD, GFP, GBL, PMNI, NOT, WVC.
 (0-v-1) on 30-45 metres. E. Matthews.

Acocks Green, Birmingham.

(February.)
 Chile: 3IJ. Argentina: GA2, FA3. India: 2BG, HBK. Philippine Islands: PI 3AA. Palestine: 6ZK, 6YX ('phone). Canada: 2AX, 3HE. U.S.A.: 5AC, 5ACL, 5ALZ, 5ATV, 5ATX, 5JF, 5YD, 5ZAI, 9ADK, 9ADG, 9AIZ, 9AOL, 9BJF, 9BZI, 9CZ, 9CYW, 9DYE, 9EBJ, 9EJI, 9XI, 9ZT. Australia: 2YI, 2CM, 3BD, 3HL, 3QH. U.S.A. Ships: NOT, NTT. Swedish Ships: SAB, SDK, SWS. Norway: LA4Z. New Zealand: 3AF. With Indoor Aerial—Egypt: EGFH. Cuba: 2IC. Indo-China: FI 8QQ. Palestine: 6ZK. Yugo Slavia: 7XX. Italy: 1BD, 1RT. Madeira: P3FZ. U.S.A.: 1CMX, 1SW, 2CVJ, 2GK, 2IP, 2APD, 3LD, 3LW. Porto Rico: 4JE. Brazil: 1AN, 1IB, 1AO, 1BD, SNI. Denmark: 7MT. Germany: KM7.
 (0-v-1.) 35-45 metres. F. J. Taylor.



NEWS from the CLUBS



Secretaries of Local Clubs are invited to send in for publication club news of general interest. All photographs published will be paid for.

"Things to Know in Radio."

A very extensive survey of wireless was given to Mr. Rickett (of Messrs. Alfred Graham, Ltd.) in his recent lecture before the Lewisham and Bellingham Radio Society. Under the ambitious title of "Things to Know in Radio," the lecture dealt with the following subjects: "Future Developments in Radio," "The Application of Radio to Everyday Life," "The Use of Radio Frequency Currents in Metal Working," "Television," and "Difficulties of Transmitting Power."

Particulars of membership of the society may be obtained from the joint Hon. Secretary, Mr. J. A. Clark, 35, Boones Road, Lee, S.E.13.

o o o o

Badly Rectified A.C.

An entertaining talk on amateur transmission was given by Mr. Nickless before the South Woodford and District Radio Society on March 22nd. As an indication of the number of amateurs now working, Mr. Nickless mentioned that it was often possible to hear as many as six of them within 1° of the tuning condenser! Some transmitters, mostly Continental, were working on A.C. 50 cycle 205 volts, badly rectified.

Hon. Secretary: Mr. E. J. Turbeyfield, 42, Alexandra Road, South Woodford.

FORTHCOMING EVENTS.

WEDNESDAY, APRIL 21st.

Hullfax Wireless Club, Discussion Evening, opened by Mr. Lightowler.
Muswell Hill and District Radio Society, At St. James's Schools, Fortis Green. Demonstration by Capt. H. J. Rownd, M.C., A.M.I.E.E.
Barnsley and District Wireless Association, At 9 p.m. At 22, Market Street. Transmitting Demonstration.
Edinburgh and District Radio Society, At 117, George Street. Lecture: "Electrical Resonance and its Application," by Mr. W. Watson, M.A., B.Sc.
Tottenham Wireless Society, At 8 p.m. At 10, Bruce Grove, N.17. Lecture: "Design of Short-wave Receivers," by Mr. E. S. Usher.

SATURDAY APRIL 24th.

Golders Green and Hendon Radio Society, Visit to G.E.C. Laboratories at Wembley.

MONDAY, APRIL 26th.

Hackney and District Radio Society, Public meeting, At 8 p.m. At Hackney Electricity Showrooms. Lecture: "The Art of Broadcasting," by Mr. J. H. A. Whitehouse, of the B.B.C.
Swansea Radio Society, General Meeting.
Bournemouth Radio Society, Conference of Societies, Meet at Central Station at 11.25 a.m.

Valve Characteristics.

Mr. E. J. Hubbard, an authority on valve construction, provided a helpful lecture at the last meeting of the Manchester Radio Scientific Society, when he dealt with the characteristics of valves,

explaining the meaning of the data issued by the various manufacturers.

Hon. Secretary: Mr. Geo. C. Murphy, Meadow View, The Cliff, Higher Broughton, Manchester.

o o o o

Wireless Films.

Thanks to the active co-operation of Mr. F. H. Haynes, the technical committee of the Tottenham Wireless Society were able to entertain the members to a two-hour programme of technical films on Wednesday, March 24th. "The Englishman and His Home," a G.E.C. film, proved to be very diverting. A film illustrating diagrammatically the action of the famous "Standard" loud-speaker and also a pair of head telephones was very interesting and instructive, while "The Andion," arranged by the Standard Telephone Co., explained in an exceedingly clear manner, what actually goes on inside a valve.

o o o o

A.C. Mains for Reception.

A two-valve set obtaining all power from the A.C. mains, and designed for loud-speaker reception from 2LO and 5XX, was described by Mr. A. J. Webb, M.A., B.Sc., at the meeting of the Croxson Wireless Society on March 29th.

For the L.T. supply chemical rectification was employed, obtained by means of cells containing sulphuric acid with tantalum and lead electrodes. The H.T. supply was obtained by means of a centrally tapped transformer, followed by suitable chokes and condensers. After Mr. Webb's description of his installation, the members availed themselves of his kind invitation to inspect the set at his private residence. Excellent reception was obtained and A.C. hum was noticeably absent.

Visitors are heartily welcomed at the society's meetings. The Hon. Secretary is Mr. H. T. P. Gee, 51-52, Chancery Lane, W.C.2.

o o o o

An Active Month.

During the past month items on the programme of the Stretford and District Radio Society have included a practical transmitting demonstration by the operator of 6HS; a lecture by Mr. Bird, chief engineer of the Manchester Broadcasting Station, and an eight-valve "Superhet" demonstration by 2VA.

Morse classes are held every Monday. Full particulars of the society's activities may be obtained from the Hon. Secretary, Mr. W. Hurdingham, 21, Burleigh Street, Stretford, Manchester.



A SCHOOL WIRELESS SOCIETY. Of the numerous wireless societies attached to schools throughout the country, one of the most thriving is that at the Royal Grammar School, High Wycombe. The members are seen testing newly built sets.

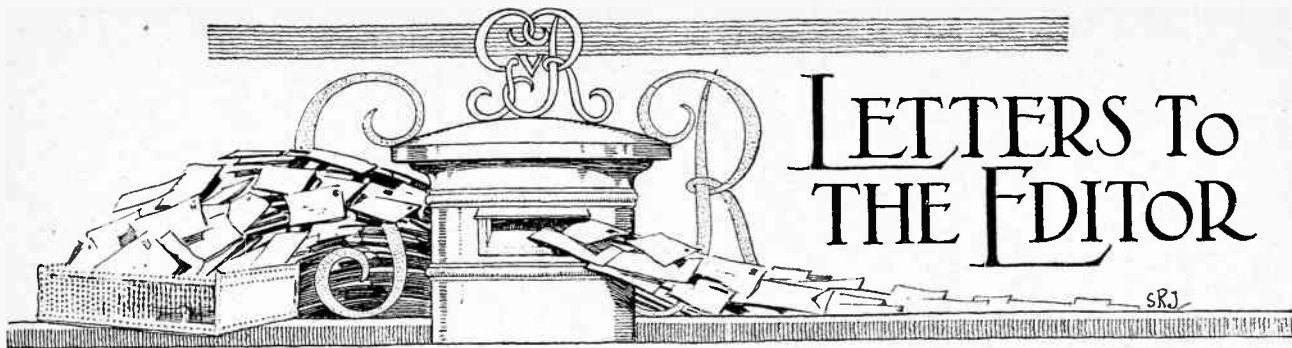

LETTERS TO THE EDITOR

The Editor does not hold himself responsible for the opinions of his correspondents.

Correspondence should be addressed to the Editor, "The Wireless World," Dorset House, Tudor Street, E.C.4, and must be accompanied by the writer's name and address.

COMMERCIAL INTERFERENCE ON SHORT WAVELENGTHS.

Sir,—In your issue of March 24th a correspondent complains of interference by commercials on 30-40 metres.

There are only about three commercials who use the wave-band 30 to 40 metres. One is PCLL, who uses 35 metres occasionally but does not seem to enjoy his spell on this wave. FW is a constant user (38 metres), as is also WIZ (40-1 metres).

If your correspondent has been jammed by PKX (Java, Batavia) he must have a good receiver, because I have heard PCLL ask PKX to send his words twice or even three times each (ZWT GA 12—which, deciphered, means "Send your words twice at 12 words per minute"). PKX usually works on 26 metres, approximately.

Also, does your correspondent know that the calls SP and ICS are used by one station, viz., Spezia (Italy), which is operated by the Italian Navy? I have often read him on 32 metres. He has a very good note, clear and as musical as NKF or NIDK.

BYC and BYZ are operated by the Navy—BYC at Portsmouth and BYZ at Malta. They use, I believe, interrupted continuous wave—which undoubtedly gives a rather low note.

I have read BZ1AC, BZ11B, NZ, 2AC, A3BM, while these various "commercials" have been working, so I cannot see where the interference really comes from.

I do not own a transmitter, but if ever I do it will be after the NKF style.

H. E. TONER

London. N.1

THE LANGUAGE OF THE FUTURE?

Sir,—The claims of English, French, Esperanto, and Ido to be the coming international language appear in danger of being rivalled by "Radiese." I fully appreciate the value of the international "Q" codes, and those Anglo-American abbreviations commonly used as a kind of shorthand in Morse transmission, but deplore their use by embryo operators in written correspondence.

The recognised Morse abbreviations are probably convenient on "QSL" postcards, especially if there is uncertainty as to whether the recipient understands the native tongue of the sender, though the intermixture of courtly French or ponderous German with chippy "Radiese" has a distinctly ludicrous effect in some of the cards I have seen.

There is a growing tendency on the part of amateurs who have lately acquired transmitting licences to display their knowledge of the Morse code and its attendant conventionalities by the indiscriminate use of these uncouth abbreviations in their general correspondence till their letters resemble the short advertisements for board and lodging in the daily Press. The excuse offered is saving of time, but a moment's consideration will dispose of this plea. It is obviously quicker to write "reply" than the three capitals "QSL," and any fraction of a second which may possibly be saved by writing "ur" for "your" or "sum" for "some" is more than balanced by such superfluous interjections as "O.M." and "Hi."

This objectionable and slipshod style is mainly prevalent among the newest arrivals to the band of amateur transmitters:

the older members generally conduct their written correspondence in decent English, and I trust that it will be long before either "Radiese" or the "nu spellin" takes the place of our own or any other historical and established language.

London. W.4.

W. HEATH.

IGNORED QSL CARDS.

Sir,—With reference to the letter from DE0122, in *The Wireless World* for March 24th, concerning ignored reception reports, I consider that the case of the transmitting amateur, to whom such reports are addressed, should also be stated. I think I can confidently say that these nearby reception reports are one of the bugbears of the transmitting amateur. It is common knowledge that a reasonably efficient station can obtain a range of seven hundred miles on short waves on a power of less than 5 watts. As most transmitting stations use more than 5 watts, what is the use in receiving reports from receivers within seven hundred miles? All amateurs are overjoyed to receive DX reports of reception, and, I feel sure, would answer them. But if the amateur has continually to reply to hundreds of short range reception reports he would soon have to choose between getting his "juice-box" charged and buying some more postage stamps. I have no hesitation in saying which he would choose.

I also note that the transmitter is once again being hauled over the coals, as he is accused of interference with broadcast.

I consider that the average amateur exercises great forbearance, and very rarely transmits during broadcast. The usual hours of amateur transmitters are 6-7 p.m. and 11 p.m. onwards on week-days, and 2-8 p.m. on Sundays. I would suggest that the B.C.L.'s leave us this time free, and in return they would have the remainder of the time uninterrupted.

In conclusion, and as an example of the forethought of the transmitter for the B.C.L., I would point out that in other countries and America in particular the amateurs start transmitting about 5 p.m., and work steadily through to the small hours of the next morning.

TRANSMITTER.

Bristol.

AMATEUR TRANSMITTERS.

Sir,—While agreeing with your editorial note on the above subject in *The Wireless World* for March 31st, I cannot agree with your correspondents. In my opinion the correspondence points to the fact that selectivity in a wireless receiver is a question requiring more attention.

I should like to ask Mr. G. N. Wright, who writes in your issue of March 24th, whether he has measured the wavelength of the amateur he complains of? That he can receive 2LO without interference from 2ZY is no proof of a selective receiver for all frequencies. The same question also applies to Messrs. J. H. B. Fildes and Arthur F. Williams writing in your issue of March 31st. In these letters the offending stations are said to be working on between 300-500 metres, a statement which to my mind points to unselectivity. Also I question the last paragraph of Mr. Williams' letter.

S. Croydon.

T. BURSTOW.

READERS' PROBLEMS

Readers are invited to send in to the Information Department of "The Wireless World" questions relating to their technical difficulties. Every question should be accompanied by a stamped addressed envelope for reply. No charge is made.

Dispensing with the Grid Battery.

I wish to build a three-valve set using a detector valve with reaction in conjunction with two stages of transformer-coupled amplification, my main design being ample volume coupled with reasonable purity. I understand that it is possible to obtain grid bias automatically by means of the voltage drop across the valve filaments, thus dispensing with the need of a separate grid bias battery, and should like this arrangement incorporated in the receiver if possible.
P. W. D.

It is possible by running the valve filaments in series to obtain automatic grid bias in accordance with the diagram shown in Fig. 1. Here we are using three 2-volt valves with their filaments connected in series across a 6-volt accumulator. The voltage drop across each valve is therefore approximately two volts, which is correct for filament operation. Now, taking the case of the final L.F. valve, it is obvious that the negative or far side of the preceding valve is two volts more negative than the negative side of its own filament, and similarly, the negative or far side of the first or detector valve filament is 4 volts more negative than the negative side of the filament of the final valve. Thus, if we want to give a 2-volt negative bias to the grid of the first valve, we can return its grid return lead, or, in other words, the lead coming from "I.S." of the second transformer to the junction between the filaments of the first and second valves, and if a 4-volt bias were required the grid return lead could be connected to the other side of the detector valve filament. A glance at the diagram in Fig. 1 will make this quite clear. We can if we wish to give a permanent negative bias of 2 or 4 volts, to the grid of the final valve, make this connection permanent, but perhaps it would be more convenient to use a simple stud switch so that we can choose our grid bias at will.

Another method of applying an automatic variable grid bias would be to shunt a potentiometer across the L.T. terminals and connect the grid return lead to the slider. It would then be possible to give to the grid any value of bias between 2 volts positive and 4 volts negative in very fine graduations, as distinct from the 2-volt steps given by the stud switch. Since, however, the value of grid bias on an L.F. valve is by no means critical, to a volt or so, it would probably be preferable to use the stud switch, since then

one definitely knows the value of bias given by each stud. In the case of the first L.F. valve, we can only move the grid lead across to the other side of the detector valve, and so obtain a 2-volt negative bias. This is quite in order, fortunately, because naturally the first L.F. valve in any receiver will not be required to handle the same amount of power as the final or output valve, and therefore does not require so large a value of grid bias. It is important that alternate blank studs be used in the switch in order to obviate the short-circuiting of the valve filaments when in the process of changing from one stud to another the switch is momentarily in contact with two studs simultaneously. Since the detector valve requires a positive bias of 2

S.P. 18 Red Spot valves as L.F. amplifiers, would make an excellent combination, although other valves with similar characteristics would do equally well. Although these valves each consume 0.3 amperes, it should not be forgotten that the filament consumption of all these valves is still no greater than that of one valve, namely, 0.3 amperes. Since the L.F. valves we have referred to are power valves, it is obvious that we have a very efficient arrangement in cases where it is desired to keep down the filament current.

If we care to use an 18-volt L.T. battery in conjunction with three such valves, as the D.E.5 B., D.E.5, and D.E.5 A., in the order named, we shall be enabled to handle a very great power without distur-

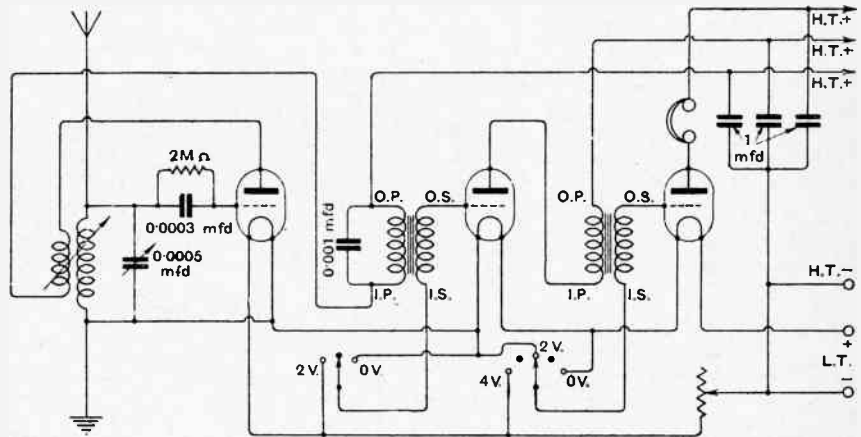

Fig. 1.—Grid bias from the filament circuit.

volts for rectification purposes it is obvious that this may be obtained by taking advantage of the 2-volt drop across the detector valve, and returning the bottom end of the aerial coil to the positive side of this filament. It should not be connected direct to L.T.+, since obviously this will give a positive bias of 6 volts, which is far too much for a 2-volt or, indeed, any normal valve for grid rectification purposes. The experimenter may, if he so desires, provide another stud switch, so that he may apply positive voltages of 2, 4 or 6 volts to the detector valve grid, and he could, for this purpose, make use of a potentiometer shunted across the L.T. battery. It is essential that 2-volt valves be employed in conjunction with a 6-volt accumulator, and it is suggested that a Cosmos S.P.18 Green Spot as detector, with two Cosmos

tion using this arrangement, whilst an automatic bias of 6 volts can be applied to the D.E.5 and 12 to the D.E.5 A., which is fortunately just about correct for the valves mentioned, and, furthermore, the total filament consumption of these three valves will be the same as for one of them, namely, 0.25 amps.

o o o o

The Meaning of Constant Aerial Tuning.

Can you tell me why it is that when a small fixed condenser of 100 micro-microfarads capacity is placed permanently in series with the aerial tuning circuit of a receiver the calibration of the aerial tuning condenser remains fairly constant when tested on different aerials.
T.S.J.

When inserting this small condenser we must remember that we are in-

serting it in series with an already existing capacity, namely, the aerial system which usually has a capacity of about .0003 mfd. For the sake of argument we can consider the aerial purely as a .0003 mfd. fixed condenser in parallel with the tuning coil and any existing parallel tuning condenser. Now if we place in series with this condenser another condenser of .0001 mfd. capacity, it is at once obvious that we should have reduced the total capacity of the system to something below .0001 mfd. Actually it is approximately .00007 mfd.

Now let us suppose that we move our receiver to a larger aerial which has a capacity of .0004 mfd. By putting in the same series fixed condenser, the total capacity is increased to approximately .00038 mfd. If, on the other hand, we have a somewhat smaller aerial than usual whose capacity may only be .0002 mfd., the resultant capacity will only be about .00006 mfd.

In the case of the conventional receiver employing a plug-in coil and parallel .0005 mfd. tuning condenser, tuned to, say, the wavelength of 2L0, the variable condenser will be set at a fairly high value if the inductance used is not a very large one.

Let us assume that the variable condenser is almost fully in, so that the actual capacity is .0004 mfd. Now, when a small aerial of .0002 mfd. capacity, having inserted in it a series .0001 mfd. condenser is connected to the receiver the total capacity shunting the tuning coil is the .0004 mfd. provided by the variable condenser plus .00006 mfd. provided by the aerial system. Thus the total capacity shunting the tuning coil is now .00046 mfd. If we now transfer the receiver to a larger aerial of .0003 mfd. capacity the total capacity across the coil will be .00047 mfd., and if we again transfer to a third aerial of .0004 capacity, the total value of the capacity across the coil will be .00048 mfd. Thus whichever of the three aeriels we use, the total capacity across the coil will vary by only .00001 or .00002 mfd. If we now repeat our experiments without the small series condenser the figures will be vastly different, namely, a total capacity across the coil of .0006 mfd. instead of .00046 mfd. in the case of the first aerial, .0007 mfd. instead of .00047 in the case of the second aerial, and .0008 mfd. instead of .00048 in the case of the third aerial.

In each of the three aeriels it will now be seen that the total capacity across the tuning coil will vary by either .0001 mfd. or .0002 mfd., as we ring the changes on the three aeriels. In other words, by abandoning the use of the small series condenser the effect on the total capacity across the coil will be ten times as much as if we used the small series condenser.

Now the wavelength to which a coil will resonate when shunted by a capacity of .00046 mfd. is not very greatly different to the wavelength to which it will resonate when shunted by a capacity of .00047 mfd. or .00048 mfd., but the wavelength to which it will resonate when shunted by a capacity of .0006 mfd. is appreciably different to the wavelength to which it will resonate when shunted by a capacity of .0007 or .0008 mfd. Thus if we still

keep our receiver tuned in to 2L0 we shall have to make quite a relatively large compensating movement with our variable condenser when changing aeriels, whilst in the latter case, since the capacity change caused by the different aeriels is ten times less, a scarcely perceptible balancing movement of the variable condenser will be required. Thus it is no misnomer to call this system constant aerial tuning (usually abbreviated to C.A.T.) since, in spite of the use of aeriels of different dimensions, the setting of the aerial tuning control is not appreciably altered.

It must not be forgotten, also, that the use of constant aerial tuning greatly enhances selectivity since we are virtually making use of a capacity-coupled aerial circuit. This matter was fully dealt with in a reply to "G.P.K." in our issue dated April 7th, to which you should refer.

BOOKS FOR THE WIRELESS EXPERIMENTER

Issued in conjunction with "The Wireless World."

"THE AMATEUR'S BOOK OF WIRELESS CIRCUITS," by F. H. HAYNES. Price 3/6 net. By Post, 4/-.
"TUNING COILS AND METHODS OF TUNING," by W. JAMES. Price 2/6 net. By Post, 2/10.

"WIRELESS VALVE RECEIVERS AND CIRCUITS IN PRINCIPLE AND PRACTICE," by R. D. BANGAY and N. ASHBRIDGE, B.Sc. Price 2/6 net. By Post, 2/10.
"WIRELESS VALVE TRANSMITTERS—THE DESIGN AND OPERATION OF SMALL POWER APPARATUS," by W. JAMES. Price 9/- net. By Post, 9/6.

"DIRECTION AND POSITION FINDING IN WIRELESS," by R. KEEN, B.Sc. Price 9/- net. By Post, 9/6.
"THE RADIO EXPERIMENTER'S HANDBOOK," Parts 1 & 2, by P. R. COURSELY, B.Sc. Price 3/6 net. By Post, 3/10.

Obtainable by post (remittance with order) from
ILIFFE & SONS LIMITED,
Dorset House, Tudor St., London, E.C.4,
or of Booksellers and Bookstalls.

Operating a Receiver from A.C. Mains.

I intend to construct a circuit for the purpose of obtaining both H.T. and L.T. supply for my three-valve set from A.C. mains in accordance with the diagram and instructions given in your "Readers' Problems" section for Nov. 25th and Dec. 30th, 1925. I am using dull emitter valves of the .05 amp. class. Can you tell me if there are any special precautions I should take with these valves?

R.J.B.

It is definitely not advised that you attempt to take L.T. from A.C. mains if using these valves, although H.T. may be successfully obtained. The reason is that it will be almost impossible to enjoy the broadcasting programmes owing to the severe hum which will be present with these valves, and, indeed, any valves of the dull-emitter class.

As explained in the Nov. 25th issue, that portion of the hum which is due to grid and plate potential fluctuations can

be very easily balanced out by means of the potentiometer, but there is another cause of hum which cannot be eliminated in this manner. The actual current flowing through the filament is, of course, A.C., and in the case of .06 amp. valves, owing to the thinness of the filament, its temperature will not remain constant, but will tend to vary up and down in sympathy with the A.C. pulses, which, by producing a sympathetic fluctuation of the plate current, will cause a very healthy roar in the loud-speaker. Using valves of the 2-volt type which consume about .35 amps, the filament is much thicker, and therefore the temperature is more constant in spite of the A.C. pulses, and the hum will be distinctly less.

It is not, however, until we use a valve having a still heavier current consumption, and, therefore, a still thicker filament, namely, bright emitters, that the hum is reduced to such a reasonably small value that the scheme becomes feasible, whilst the use of valves of the L.S.5 type, which have very thick filaments, enable really good results to be obtained. Even with these valves, however, the hum is still in evidence, and we would only recommend the scheme for loud-speaker work on the local station. What is wanted, in order to eliminate the hum entirely, is a valve having an enormously thick filament, so that no temperature variation occurs in spite of the A.C. pulses. For instance, a valve taking 10 amps. at .05 volts, should be suitable.

At first sight it might seem that such a valve would be intolerably extravagant, and the electric light bill would be overwhelming. A moment's thought, however, will make it clear that the power consumption of such a valve would be .5 watts. Now a D.E.R. valve taking .35 amps. at 2 volts represents a power of .7 watts, and so, assuming for the moment that our step-down transformer was of 100 per cent. efficiency, the cost of operating this 10-ampere valve from the mains would actually be less than that of running a D.E.R. from a 2-volt accumulator. By working somewhat along these lines, special valves have been produced in America which run from A.C. mains, which are in almost universal use in America.

Owing to the fact that an A.C. supply is by no means universal in this country, it is unlikely that such valves will appear upon the market, although already these American valves have made their appearance in this country. In the matter of H.T. from A.C. mains, however, the problem is somewhat simpler, and you can either make use of the valve rectifier arrangement, of which full constructional details were given in *The Wireless World* for June 17th, 1925, or you could adopt the Noden rectifier system. The former method possesses the disadvantage of considerable expenditure in initial outlay whilst the latter method is cheap and reliable provided care is exercised in constructing the rectifier. In connection with the latter we would refer to the November, 1925, issue of our companion monthly journal, *Experimental Wireless*, where full constructional details were given.

F A M E

NELSON'S column symbolises a mighty achievement. It signifies the undying fame of a man, frail in physique, but of indomitable courage and resolution. Its presence, and what it stands for, has become part of our daily life.

CLEARTRON valves are carving their niche in radio history. There will always be CLEARTRON valves as part and parcel of radio and there never will be better. They are all dull emitters with a settled reputation for vastly increased volume, far greater distance, operatic purity of tone and keener selectivity. Each valve is backed by an Ironclad Guarantee and sold at standard prices, 12/6 and 15/-.

Illustrated Catalogue from your Dealer or:
CLEARTRON RADIO LTD.
One, Charing Cross, London.

Works: Birmingham.

Telephone Regent 2231/2.
Grams Cleartron, Westrand, London.

TYPE.	Acc. or Battery.	PRICE.
C.T.08	Dry Cells	12/6
C.T.15	2 Volt	12/6
C.T.25	6 Volt	15/-

Filament Volts. 5.6
 Filament Amps. 0.25
 Anode Volts. 90-200
 Voltage Amplification Factor 20
 Impedance. 20,000
 Power Amplification Factor 20
 Mutual Conductance. 1,000
 Plate Current Saturation at 50 Volts over 30 milliamperes.
A wonderful detector valve.

C.T. 25B 15/-

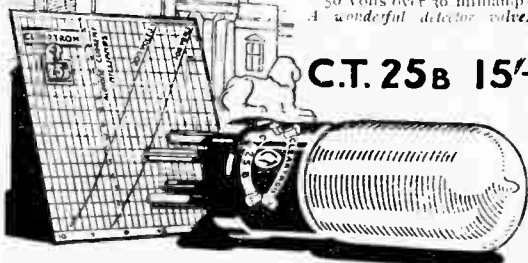

CLEARTRON RADIO LIMITED

ONE, CHARING CROSS, LONDON,
(Works: BIRMINGHAM)

Regent 2231/2.

Cleartron, Westrand, London.



MATCHED TONE HEADPHONES

IF you're fond of sitting up in the wee sma' hours to stretch a hand across the world, Matched Tone are extremely able confederates. With radio you span continents and with Matched Tone it becomes easier, "comfier" and much more efficacious. Distant signals stand out clearly; Matched Tone grope in the ether with unflinching accuracy. The specially matched receivers make them super-sensitive and tone perfect. You are logging a new call-sign every day with Matched Tone.

20/-

Table-Talker 30/- Brandola 90/- Audio Transformer 17/6

Brandes

Brandes Limited, 206, Regent Street, W.1.

From any good Dealer

VOLUME

Ample volume, but clear as crystal—full, round, natural tone—that's the "Hearthside" Speaker. With the new cast-in diaphragm and non-resonant horn. You must hear it—to-day! Fully guaranteed.

Send now for your FREE copy of our new catalogue.

General Radio Co. Ltd., 235, Regent St., W.1.



35/-



PANELS & CONDENSERS ARE GUARANTEED

Then Why be Content with Inferior Substitutes? Ask your dealer or write to us direct.

PARAGON RUBBER MANUFACTURING CO. LTD. SCULCOATES HULL



"Japa" REGD

PLUG & SOCKET TERMINALS ARE THE FINEST TERMINALS IN THE WORLD FOR ALL WIRELESS CONNECTIONS.

BRITISH MADE. If your Dealer cannot supply send direct to the Manufacturer through the post.

W. J. CHARLESWORTH 88 & 89, Aston Street, BIRMINGHAM. — Established 1897 —

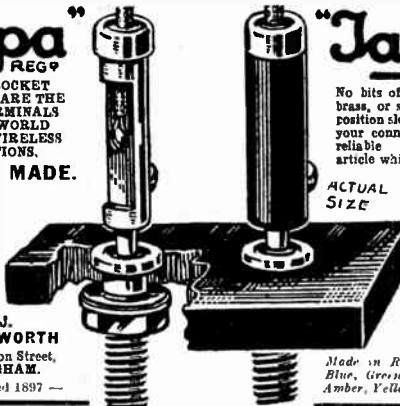

"Japa" REGD

No bits of bent tin or brass, or screwed composition sleeves to make your connection, but a reliable mechanical article which has been copied by many but equalled by none.

ACTUAL SIZE

Insist upon the genuine article.

6D EACH Post free.

Made in Red, Black, Pale Blue, Green, Royal Blue, Amber, Yellow, Brown.

15 Replies—and a satisfactory exchange!

"I have had fifteen replies in all to my advertisement in 'The Wireless World,' and I have sent a postcard to each, although I had made a satisfactory exchange with the first enquirer, who wrote immediately the advertisement was published.

"I am glad to note that your advertising charges are reduced.

"Best wishes to 'The Wireless World.'"

ALEX. A. LATTIMER, 'The Croft,' Newton Mearns, Renfrewshire."

For the disposal or purchase of spare wireless apparatus, there is no surer or speedier way than that afforded by the Miscellaneous Advertisement Columns of "The Wireless World."

W.W.13

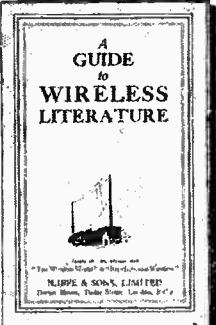

A Guide to WIRELESS LITERATURE

THE NUMBER and importance of the books published in conjunction with "The Wireless World" have led to the compilation of a booklet entitled "A Guide to Wireless Literature." Upon request, a copy will be sent to you FREE.

by "The Wireless World" are in the highest degree accurate and dependable. They are written by men of wide experience and long acquaintance with the fundamental problems of the science of wireless.

RELIABLE books which trace the progress and explain the mysteries of wireless are indispensable to every enthusiastic amateur who wishes to get the greatest pleasure from his hobby and the best results from his set. All volumes published

EVERY wireless worker is catered for. There are books for the beginner, the home-constructor, the advanced amateur, and the wireless engineer. One or two of these volumes will undoubtedly be of special interest to you. They may be obtained from leading booksellers or direct from the publishers.

WRITE FOR YOUR FREE COPY TO-DAY!

Publishers of "The Wireless World":
ILIFFE & SONS LIMITED
Dorset House, Tudor Street, London, E.C.4

W.W.38



RADIO COMPONENTS OF ADVANCED DESIGN. NEW CATALOGUE NOW READY. Straight Line Frequency. Ultra Low Loss Condenser. Micro-Vermier Dial. High Efficiency. Low Loss Variocoupler, etc.

The FORMO Company, Crown Works, Cricklewood, N.W.2

10/6 Manchester: Mr. J. B. Levee, 23 Hartley St., Levenshulme.

Your Loudspeaker

WILL SING

THE PRAISES OF

NELSON MULTI 3-FILAMENT VALVES



Here is a Valve giving you Finest Quality and Volume with Economy. It is of equally high grade as H.F. Detector, L.F., or Power Amplifier.

The little switch places at your command each of 3 Filaments separately, or any 2 in parallel for Power Amplification. Each Filament gives the Valve a New Life.

ALL VALVES are Guaranteed.

FOUR IMPROVED TYPES

- A. 4 to 5 VOLTS, 0.45 AMPS. per Filament - 9/8
- D.E.A. 2.6 VOLTS, 0.18 AMPS. per Filament - 15/-
- D.E.2. 1.8 to 2 VOLTS, 0.35 AMPS. per Filament - 15/-
- D.E.06. 3 VOLTS, 0.06 AMPS. per Filament - 16/8

Obtainable at
All London's
Largest Stores.

If unable to obtain from your dealer, write direct :-

NELSON ELECTRIC COMPANY LIMITED,
Merton Park, London, S.W.19.

Telegram: Valvenelco, Wimble, London.

Phone: Wimbledon 172.

CAXTON 4-VALVE CABINET

Made for Sets, "As good as money can buy,"
"Harmony Four Receiver," "The Melody Three"

Special Cabinets made to Customer's measurements. Prices quoted.

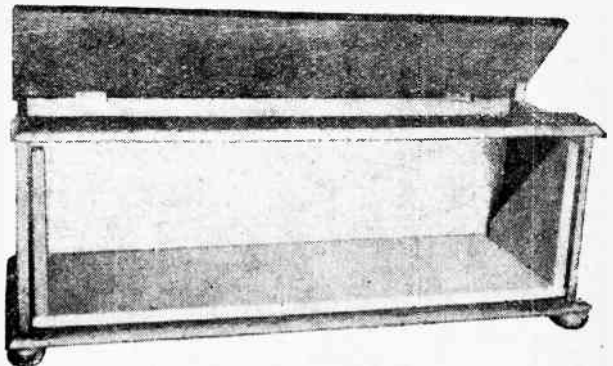

- Cash with Order. Fumed Oak ... £1 5 0
- Dark or Jacobean Oak ... £1 10 0
- Real Mahogany ... £1 14 0

Detachable 7" deep Base Board to mount 21" by 7" panel to slide out of Cabinet front.
Also supplied at 10/- extra with two beaded front doors placed 2 ins. in front of the enclosed panel.

Ebonite or Radion Panels Supplied and perfectly Fitted at low extra cost.

All Polished with the new enamel that gives a glass hard surface that cannot be soiled or scratched. SENT FREE.—Catalogue of standard Wireless Cabinets in various sizes and woods.

Packed and delivered free in U.K.

No. C3

CAXTON WOOD TURNERY CO., Market Harborough

LIBERTY SUPERSONIC UNITS

(Pro. Pat.)

Comprising 3 intermediate matched transformers, filter, long and short wave oscillator, reactor and mechanical balancing devices, enabling all stations 250/3,000 to be received. Any unwanted stations entirely cut out.

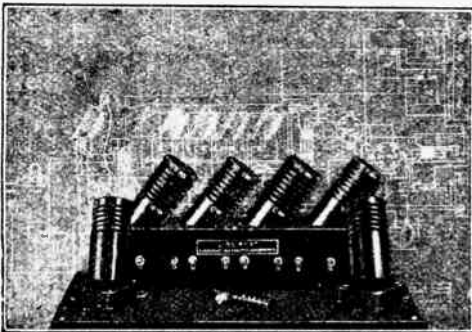

March 1st, 1926.

I am pleased to say I managed to log 72 stations in 3 hours at terrific loud speaker strength, 4 of these being "Yanks."

(Signed) G. E. C.

PRICE £5 complete set with theoretical and pictorial wiring diagrams and list of other components required.

Each transformer matched to half a turn

Air cored, no iron being used, thus the sharpest uniform peak obtained.

Ensures ultra-selectivity. Delivers maximum signal strength to detector valve. Send for illustrated descriptive leaflet

Sole Manufacturers—

RADIARC ELECTRICAL CO., LTD.
Bennett Street, LONDON, W.4.

Phone: Chiswick 1634.

TONE

FROM YOUR LISSENOA.

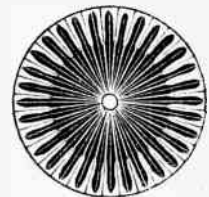

12" diameter,
6/- Retail.

The "JAY" DIAPHRAGM is the result of months of research and experiment and is not a haphazard production. Fit one to your Lissenola and you will agree that the RESULT IS "TOPPING."

BE SURE IT IS MARKED "JAY" AND YOU WILL BE SAFE.

"JAY" NEATAG.

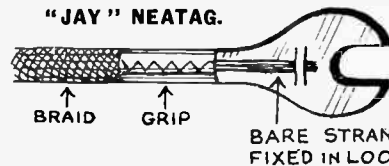

The new terminal for flex. A good solid tag. Easy to fit. Requires NO SOLDER, and once fitted makes a perfect fitting that will last.

6d. per dozen.

"JAY" EYELETS

For Square Wire.

Simplifies wiring.



3d. per dozen.

Ask for particulars of the new BICO Switch.

If your Retailer does not stock these refer him to

SYDNEY JONES & Co. (London) Ltd.

Wireless Wholesalers,

DUDLEY HOUSE, 28, ENDELL ST., LONDON, W.C.2

Gerard 7411.

MISCELLANEOUS ADVERTISEMENTS.

NOTICES.

THE CHARGE FOR ADVERTISEMENTS in these columns is:

12 words or less, 1/- and 1d. for every additional word, e.g., 18 words 1/6; 24 words, 2/- Name and address must be counted.

SERIES DISCOUNTS are allowed to Trade Advertisers as follows on orders for consecutive insertions, provided a contract is placed in advance, and in the absence of fresh instructions the entire "copy" is repeated from the previous issue: 13 consecutive insertions, 5%: 26 consecutive, 10%: 52 consecutive, 15%.

ADVERTISEMENTS for these columns are accepted up to **FIRST POST ON THURSDAY MORNING** (previous to date of issue) at the Head Offices of "The Wireless World," Dorset House, Tudor Street, London, E.C.4, or on **WEDNESDAY MORNING** at the Branch Offices, 19, Hertford Street, Coventry; Guildhall Buildings, Navigation Street, Birmingham; 199, Deansgate, Manchester.

Advertisements that arrive too late for a particular issue will automatically be inserted in the following issue unless accompanied by instructions to the contrary. All advertisements in this section must be strictly prepaid. Postal Orders and Cheques sent in payment for advertisements should be made payable to **LIFFE & SONS Ltd., and crossed & Co. Treasury Notes**, being untraceable if lost in transit, should not be sent as remittances.

All letters relating to advertisements should quote the number which is printed at the end of each advertisement, and the date of the issue in which it appeared. The proprietors are not responsible for clerical or printers' errors, although every care is taken to avoid mistakes.

NUMBERED ADDRESSES.

For the convenience of advertisers, letters may be addressed to numbers at "The Wireless World" Office. When this is desired, the sum of 6d. to defray the cost of registration and to cover postage on replies must be added to the advertisement charge, which must include the words Box 000, c/o "The Wireless World." Only the number will appear in the advertisement. All replies should be addressed No. 000, c/o "The Wireless World," Dorset House, Tudor Street, London, E.C.4. Readers who reply to Box No. advertisements are warned against sending remittance through the post except in registered envelopes; in all such cases the use of the Deposit System is recommended, and the envelope should be clearly marked "Deposit Department."

DEPOSIT SYSTEM.

Readers who hesitate to send money to unknown persons may deal in perfect safety by availing themselves of our Deposit System. If the money be deposited with "The Wireless World," both parties are advised of its receipt. The time allowed for decision is three days, during which time, if the buyer decides not to retain the goods, they must be returned to the sender. If a sale is effected we remit the amount to the seller, but, if not, we return the amount to the depositor. Carriage is paid by the buyer, but in the event of no sale, and subject to there being no different arrangement between buyer and seller, each pays carriage one way. The seller takes the risk of loss or damage in transit, for which we take no responsibility. For all transactions up to £10, a deposit fee of 1/- is charged; on transactions over £10 and under £50, the fee is 2/6; over £50, 5/-. All deposit matters are dealt with at Dorset House, Tudor Street, London, E.C.4, and cheques and money orders should be made payable to Liffe & Sons Limited.

THE SALE OF HOME-CONSTRUCTED UNLICENSED APPARATUS.

A New Service to our Readers.

We have made an arrangement with the Patentees whereby readers who wish to dispose of a home-constructed receiver not licensed under the patents made use of, can do so by means of the Deposit System referred to above.

The person desiring to sell, in sending us particulars for his advertisement, will in every case make use of a Box No., and should add to the price which he requires the amount of royalty customarily paid by manufacturers, viz. in the case of Marconi Patents the amount should be calculated at 12/6 per valve holder.

If the purchaser is satisfied with his purchase, the sum realised will be forwarded to the seller, less the amount due in respect of royalties, which amount will be paid by "The Wireless World" to the owners of the patents concerned, and a certificate will be handed on to the purchaser of the set.

FOR SALE.

WOOD Horns for all speakers and gramophone attachments. There's one for Amplion Junior, ditto goose-neck bases, Lisensola, etc. There's only one best; it's the "Allwoodorn."—Manufacturer: H. Maddison, 2A, Ronald's Road, Highbury, N.5. List free. (1914)

Mention of "The Wireless

For Sale.—Contd.

HIGH-TENSION Accumulators.—The Ideal Loud-speaker Battery, 60 volts, 35s.; 80 volts, 45s.; 100 volts, 55s.; guaranteed. Good trade terms.—Pearson, 110, Marston Lane, Bedworth, Nuneaton. (1882)

OSCILLATING Zincite and Contact, 2s. 6d.; simple, original circuit, 1s.; excellent results; other parts stocked.—Ladsham's, 297, King Street, Hammersmith. (1888)

MORSE learnt in 1 hour with the "Simple" "Mnemo-Visual Apparatus. How to synchronise sight and sound. Simple and infallible. Post free 2s. 6d.—Simple Co., 44, Bedford Row, W.C.1. (1971)

MOSTLY New.—Lotus 2-coil holder, 4s. 6d.; ditto, three, 7s.; Polar resistance unit, 10s.; Burndept crystal, 2s. 6d.; McMichael broadcast transformer, 4s.; Ducon aerial, 7s.; Gawbrell, Polar, and Colvern neotroverners, 1s., 3s. 6d., and 1s.; Cecophone, 0.0003, slow-motion condenser, 15s.—5, Salcombe Road, Sidmouth. (1980)

2-VALVE Loud-speaker Receiver with automatic switching built with best components, price, including royalties, £6 5s.; 3-valve set, £7 17s. 6d.; Leclanché high-tension batteries, require no charging; headphones, 12s. 6d. pair. All parts stocked. List on application. Trade supplied.—G. Small, 101, Greenway Road, Taunton, Somerset. (1976)

FOUR-VALVE A.J.S. Wireless Set, including Daventry coils, £11 10s.; also 1-valve L.F. amplifier, same make, new this year, £3.—W. E. Clarke, 67, Asquith Street, Gainsboro. (1978)

FOR Sale.—Two Sterling high-grade Variometers, 10s. each, new condition.—Ewen, 16, North St. Andrews Street, Edinburgh. (1982)

60-VOLT Wet H.T. Batteries, in wood case, no recharging, practically everlasting, Leclanché principle; 19s. 6d., cash on delivery, lists free.—Tonnat's Wireless, Hylton Road, Sunderland. (1983)

BURNDEPT Ethophone V. 4-valve Receiver, £12; Western Electric loud-speaking equipment, with double-power amplifier, £10; Western Electric 3-valve H.F. receiver, with frame aerial, £6. Surplus demonstration models.—H. J. Cash & Co., Ltd., Caxton House, Westminster. (1984)

FOR Sale.—Duodyne 5-valve Long-distance Receiver (2 H.F.), cost 18 guineas, offered at £9 9s., practically new.—Box 7619, WIRELESS WORLD Office. (1985)

"MELLOVOX" Loud-speaker, slightly damaged, 25s.; 3 Myers' D.E. valves, little used, 20s.; Mullard, B.T.H., D.E., power, 12s. 6d. each.—Twigg, King Edward's Drive, Harrogate. (1987)

"EFESAPHONE" 1-valve Crystal Set, licensed, Cossor 2-volt valve, plug for higher wavelengths, cost £6 10, wanted £4.—Box 7645, WIRELESS WORLD Office. (1989)

ALL Concert, 3-valve, enclosed oak desk, all accessories, 11 guineas or offer.—Box 7644, WIRELESS WORLD Office. (1990)

FIVE-VALVE "Transatlantic" Receiver, best components, perfect condition, including valves (power), 6 pairs matched H.F. transformers, 11 coils, large "Amplion" loud-speaker, bargain; £17 10s.—H. C., 137, Hornsey Lane, N.6. (2000)

For Sale.—Contd.

HIGH-FREQUENCY Transformer for 2s. 6d. Beat the man next door with a Neu-Magna high-frequency transformer. New design. Specially insulated wires. No ebony losses. Suitable for Neutrodyne experiments.—Send P.O. 2s. 6d. to Magna Radio Co., Magna House, Fore Street, St. Clement's, Ipswich. (1998)

WHAT Offers?—Gambrel Tuner, type B, 3-way coil-holder, 3 condensers, all calibrated, series parallel switch, single circuit, double circuit, switch, as new, cost £12 10s.—Paul Lyndhurst, Ebbw Vale, Mon. (1999)

THREE-VALVE Commercial Receiver, complete with valves, batteries, and phones, cost £17 10s., sell £9. Approval.—Box 7640, WIRELESS WORLD Office. (1994)

SILVER Marshal 7-valve Superhet, very powerful and extremely selective, complete with valves and Exide high- and low-tension batteries, frame aerial, etc., cost £60, accept £35.—Apply by letter to C. H. K., 25, Sussex Gardens, Hyde Park, W. (1981)

FOUR-VALVE Set, loose, coupled circuit, cut London, gets other stations, guaranteed; £7; any evening after 8 or Sunday morning.—Louis, 98, Acre Lane, Brixton. (2001)

DISPOSAL.—The Marconi Co. have at their works, Chelmsford, a quantity of Second-hand Wireless Gear, etc., for sale, inspection invited.—Apply, Works Manager, Chelmsford. (2003)

"OMNI Receiver," constructed "Modern Wireless" specification, best components, engraved panels, cost £15, offer wanted; also several new components at one-third cost. List sent on receipt of stamp.—B., 10, Parsifal Road, Hampstead, N.W.6. (2004)

H.T. from A.C. Mains.—Our rectifiers are suitable for all valve sets (2 to 8 valves), price complete £3 10s., or with 45-volt tap for detector and H.F. valves £3 15s. Cash with order. State supply voltage and periodicity. Satisfaction certain.—Davy, 80, Essendine Mansions, Maida Vale, London, W.9. (2005)

FOR Sale.—3-valve Set (1 H.F. det., 1 power), 2-valve set (crystal, 2 power), 1 crystal set, 1 valve amplified; all in handsome cabinets, almost new; £11 the lot for quick sale. A real bargain.—Robinson, 134, Ardgowan Road, Catford, London. (2006)

NEW Power Transformer, input 230v., output 500-0-500 at 100 m/a, and 6-0-6v. at 3 amps.; £3 10s. or nearest offer.—Apply: Parry, Huddersfield Road, Barnsley. (2007)

VIBROPLEX Keys.—Makes sending easier and faster. Sends perfect Morse, 30s. each. Transmitters and receivers made to order. Also wavemeters and all experimental apparatus.—F. Walker, Radio Engineer, Crowmarsh, Wallingford. (2008)

FOR Sale.—Exide Batteries, wet, six new 2-volt, at 16s. each.—Tomlinson, 10, Lansdowne Place, S.E.10. (2009)

CROIX Transformers, 3.1 and 5.1. Guaranteed genuine. 4s. each, post 4d.—Continental Supplies, 497, Old Ford Road, London, E. (2010)

MISCELLANEOUS.

WIRELESS Engineer, 10 years' practical experience, undertakes complete overhauls, rebuilding, or assembling. Any type of receiver built to order. Patent rights security under "Wireless World" scheme.—Box 7647, WIRELESS WORLD Office. (1095)

LOOK!—Why use H.T. batteries if you have electric light in your homes? Make your own H.T. unit from either A.C. or D.C.—Write for full particulars and diagram, enclosing 1s.: Camberwell Electric Coil Winding Co., 35, Edmund Street, S.E.5. (1986)

A WIRELESS Doctor.—If your set is giving trouble or you want advice a competent expert will call (anywhere in Greater London) and put you right. No result, no charge.—Alexander Black, 2A, Woodville Grove, N.16. Clissold 3687. (2002)

PATENT AGENTS.

W. BRYSON, B.Sc., Chartered Patent Agent, 29, Southampton Buildings, W.C.2 Phone: Holborn 672. (1297)

PATENTS and Trade Marks Obtained.—H. T. P. Gee, Patent Agent, Member R.S.G.B., A.M.I.R.E., 51/52, Chancery Lane, London, W.C.2. Phone: Holborn 1525. (6001)

KING'S PATENT AGENCY, LTD. (B. T. King, Registered Patent Agent, G.B., U.S., and Can.). Free "Advice Handbook" and Consultations. 40 years' references.—146A, Queen Victoria Street, London, E.C.4. (10021)

REPAIRS.

TRANSFORMERS rewound to guaranteed efficiency for 12 months, 4s., or exchanged for another, any ratio, 5s.; iron core wire-wound chokes for L.F. amplifiers, 6s. 11s. Links Road, Tooting. (10011)

AGENCIES.

ONE Sole Agent required in each county to sell well-advertised loud-speaker to traders; liberal commission to men with connections.—Box 7649, WIRELESS WORLD Office. (1097)

WANTED.

WANTED.—Special Five or Anglo-American Six Set.—A. Davey, Moorland Road, St. Austell, Cornwall. (1096)

SITUATIONS WANTED.

WIRELESS Engineer (23), 7 years' business and practical experience, Public School, ambitious, desires responsible position; England or South Africa.—Box 7642, WIRELESS WORLD Office. (1093)

EX-WIRELESS Manager and Consulting Engineer seeks responsible position with established firm; wide experience all branches; splendid testimonials.—Box 7643, WIRELESS WORLD Office. (1091)

INSTRUCTORSHIP desired by advertiser; late wireless technical instructor R.C.O.S., etc.; fluent speaker and writer; exceptional references; first-class P.M.G., of course. "Wireless," 32, Montpellier Terrace, Cheltenham. (1092)

BOOKS.

FOR Sale.—Back Numbers of all Wireless Publications.—H. F. Davies, 5, High Holborn, W.C. (1945)

VOLUME 3 "W. & A. T. Review," bound in cloth, perfect, 10s.; also about 600 numbers Wireless Publications, half-price. State requirements.—Box 7648, WIRELESS WORLD Office. (1988)

GARNETT'S SUPREME VALUE WIRELESS OFFER.

A highly efficient 1-Valve Set, built up entirely of components of undoubted quality and unchallengeable merit, offered at a Keen cut Price, on Easy and straightforward Terms.

SPECIFICATION:

- Solid Oak Cabinet Polished Jacobean Finish.
- 'Utility' Low Loss Condenser (Square Law).
- Two-way 'Aermonic' Coil-holder, Low Loss
- Igranite Rheostat and 2 Igranite Coils.
- 'Cosmos' Valve (Metro-Vic) S.P.18 D.E. 2 volt.
- General Radio Headphones
- 60-volt. H.T. Battery.
- Exide 2 volt Accumulator.
- Ebonite Panel, Post Office Grade A.
- Solid Ebonite valve-holder

With complete Aerial Unit, & Accessories.

£6:0:0

Each instrument incorporates the Marconi Patents in respect of which we pay a full Royalty fee of 12/6 on every set that is produced

8' NOW

TERMS: 8/- now & balance in 14 monthly payments of 8/- 11/- you are entirely satisfied Money refunded if disappointed.

CATALOGUE of Valve & Crystal Sets, &c., Post Free, Keenest Prices. J. G. Graves Ltd. Sheffield.

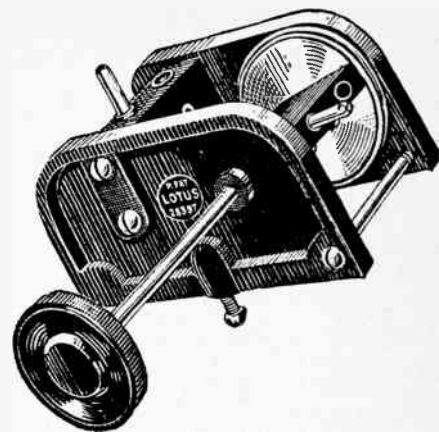
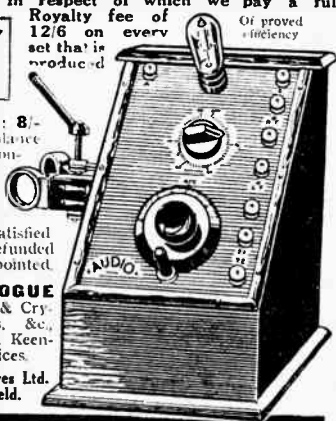

Tuning remains accurate because the Moving Block cannot fall back.

Do away with that irritating, time wasting, fading away of volume caused by the falling of your Moving Block.

Fit a Lotus Geared Vernier Coil Holder and get really accurate tuning. The Lotus Moving Block cannot possibly fall back. Has an easy Vernier movement which reduces the speed by eight times, and stays where it's put—exactly!

Fit in any position, with any weight of coil—you'll be satisfied with the results.

Bakelite mouldings for the side plates, coil blocks and knobs; heavy Nickel Plating for the metal parts.

LOTUS VERNIER COIL HOLDERS

From all reliable Radio Dealers. GARNETT, WHITELEY & CO., LTD., Lotus Works, Broadgreen Road, Liverpool.

Makers of the famous Lotus Buoyancy Valve Holder

For outside panel mounting: Two-way .. 7/6 Three-way .. 10/6 or inside base or more mounting with 6in. handle: Two-way .. 8/6 Three-way .. 12/6

LISENIN POSITIVE GRIP PLUGS & SOCKETS

Pat. No. 215586.



THERE can be few amateurs who have not been troubled with broken leads, or said hard things about faulty connections. Of the whole set there is probably no part which is so often abused as the connections. "Lisenin" Positive Grip Plugs obviate this evil. They are designed to take the smallest flex up to 5/16 in. cable sleeves and insulation does not slip back. N. Plated.

PRICE 6D.

Plug and socket complete, or Spade End Terminal, obtainable of all dealers. Liberal Trade Discount.

Sole Manufacturers and Patentees: THE LISENIN WIRELESS CO., 1d, Edgware Road, London, W.2.

Phone: Eddington 2734. Tel. Address: "Pos-grip, Field., London."

Plug and Socket or Spade End, 6d. each.

INDEX TO ADVERTISEMENTS.

	PAGE		PAGE		PAGE
Accumulators Elite	16	Garnett, Whiteley & Co., Ltd.	15	Millard Radiotelephone Manfs., Ltd.	7
Athol Engineering Co.	16	General Electric Co., Ltd., The	8	Miller, J. W.	16
Audion Radio Co.	5	General Radio Co., Ltd.	12	Nelson Electric Co., Ltd.	13
Belling & Lee, Ltd.	11	Goswell Engineering Co., Ltd.	Cover II	Oliver Pell Control, Ltd.	16
Brandes, Ltd.	11	Graham, Alfred, & Co.	Cover II	Paragon Rubber Co., Ltd.	12
British L.M. Ericsson Mfg. Co., Ltd.	16	Graves, J. G., Ltd.	15	Pickett Bros.	16
Caxton Wood Turnery Co.	13	Hough, J. E., Ltd.	7	Pugh's Wireless	16
Charlesworth, W. J.	12	H.T.C. Electrical Co., Ltd.	4	Radiare Electrical Co., Ltd.	13
Cleartron Radio, Ltd.	11	Igranic Electric Co., Ltd.	4	Radio Devices, Ltd.	6
Dixon, Leslie, & Co.	16	Jones, Sydney & Co. (London), Ltd.	13	Ratlions, Ltd.	16
Dubilier Condenser Co. (1925), Ltd.	1	Lisenin Wireless Co.	15	Sanders, W.	16
Ferranti, Ltd.	4	London Elec. Wire Co. & Smiths Ltd.	Cover II	Telegraph Condenser Co., Ltd.	16
Fitzpatrick, H. D., & Co.	16	Marconiphone Co., Ltd., The	Cover IV	Telephone Manf. Co., Ltd.	5
Forno Company	12	McMichael, L., Ltd.	9	Watnell Wireless Co., Ltd., The	4
Fuller's United Electric Works, Ltd.	3	Metre-Vick Supplies, Ltd.	3 & 10	Withers, J. S., & Spooner	16

H.T. Accumulators 37/6

60 Volts. 3 Actual Amp.-hour



The finest H.T. Accumulator in the world.



55/-
60-volt, 3-amp.-hour, oil submerged. Will last a lifetime. Write for descriptive folder.
MONEY RETURNED IF NOT SATISFIED. Obtainable only from ACCUMULATORS ELITE, 31, Waterhouse St., Halifax.
Trade Supplied. Telephone: 1394.

YOU CAN TAKE IT FROM ME!



That the Summer Edition of Electradix Radios Catalogue contains the finest Bargains ever offered. 600 Illustrations of a wonderful selection of unique gadgets.

Send 4d. stamps.
ELECTRADIX RADIOS,
218, Upper Thames St., E.C.4.
Parrs Ad.

reproduction

—volume
—clarity

You get all these in Ericsson Super Tone Loudspeakers.

Made by a firm with a generation's experience in telephone research. No distortion. No rattle—just crystal-clear reproduction.

Put one to follow your pet power valve and you'll be amazed.

18" high on wood base. Very mellow and pure. 2400 ohms. 63". Junior Super Tone for small rooms, 32/6.

Write for lists



63/-

The BRITISH L.M. ERICSSON Mfg. Co., Ltd., 67/73, Kingsway, London, W.C.2.

Ericsson
SUPER TONE LOUDSPEAKERS

VALVES Repaired Quick

Let our valve making plant repair your broken or burnt out valves efficiently & promptly (most makes). Guaranteed equal to new. Bright emitters 5-; "DE's" 2 and 3v types, 7/6. Power valves slightly more, see list. Not repairable: S.P.'s WECO v.34.

RADION Reliable Repairs
RADIONS Ltd., Bollington, Nr. MACCLESFIELD, Ches.
Largest valve-repairing firm in the world. List Free.

REPAIRS

Headphones, Loud Speakers and Transformers rewound and reconditioned

EQUAL TO NEW

and returned the same day on C.O.D. system. A customer writes: "—thanks to the excellent manner in which it was reconditioned, the results achieved have been astounding."

VARLEY Magnet Co.
Phone Dept., Woolwich S.E.19.

Proprietors: Oliver Pitt, Control, Ltd.

TROLITE PANELS

Mahogany Grain 3/6 lb.
Black Engraved wavy 3/0 lb.
Black plain polished 3/- lb.

Machine cut Tested to your own measurements. 50,000 Volts. Free Samples on Request.

PUGH'S WIRELESS, 95-101, Holloway Road, London, N.7 1 & 2 ONLY.

Amateurs! let us make your Cabinets

In Beautiful Polished Mahogany or Oak—& SENT ON APPROVAL. De Luxe Models—Parlour Models, etc. from 25/- to 85. Crystal Cabinets from 1/6. Any size MADE TO ORDER. Designs and Lists Free. Estimates per Return Post. Panels and Accessories Post Free.

Send to actual Makers: Pickett Brothers, Members B.B.C. (W.W.) Cabinet Works, Bexley-heath. It will repay!

LOEWE AUDION D.E. VALVES

FOR BEST RESULTS AT LOWER COST!

Will give better results than many at nearly double the price: specially suitable for Super-het. Sets.

L.A.76. 15 amp. 2 volt. 10/6 If your dealer L.A.74. 96 amp. 3 volt. 11/6 cannot supply send p.o. L.A.101. Power valve. 1/6ly send p.o. 0/3 amp. 4 volt. 2/1 direct to **AUDION RADIO CO., 52, Dorset Street, LONDON, W.1.**



PATENTS, DESIGNS AND TRADE MARKS.

J. S. Withers & Spooner.
CHARTERED PATENT AGENTS.

STAPLE HOUSE, 51 & 52, CHANCERY LANE, LONDON, W.C. 'Grams:—IMPROVABLY, HOLR., LONDON.' 'Phone:—480 HULBORN

PATENTS, DESIGNS & TRADE MARKS.

H. D. FITZPATRICK & CO.
Chartered Patent Agents,
49, Chancery Lane, London, W.C.2
Phone: Holborn 469.

THE MOTOR CYCLE

The Motor Cyclists' Newspaper

EVERY WEDNESDAY — 3d.

Publishers: ILIFFE & SONS LTD., Dorset House, Tudor Street, London, E.C.4. w.w.15

EARTH FAULTS ENDED

Entirely new method of Earth-system efficiency. 20% to 200% increase guaranteed. Vastly superior to all metal sulphates. Ideal for all outdoor Earths. 2/6 complete, post 6d. Cash on delivery if desired. Particulars free.

J. W. Miller, 68, Farringdon Street, E.C.4.
Phone: Cent. 1990.
Approved by Radio Association.



TUNING COILS and METHODS of TUNING

By W. JAMES

A VERY useful manual giving the maximum of information on the subject. Following a simple explanation of the principles of wireless, the author discusses the many methods of tuning circuits, with explanations of spade, condenser and variometer tuning. Other chapters treat in detail of the choice, construction and design of coils, and give particulars as to size of coil required, the best shape, size of wire type of insulation, and special uses of the various coils.

Price 2/6 net By Post 2/10

Obtainable from all booksellers or direct from the Publishers: ILIFFE & SONS LTD., Dorset House, Tudor St., London, E.C.4.

ELECTRONS

ELECTRIC WAVES AND WIRELESS TELEPHONY

By Dr. J. A. Fleming, F.R.S.

A course of popular lectures delivered by the author at the Royal Institute of Great Britain forms the basis of this work. By means of simple analogies, Dr Fleming paves the way to a discussion of the elements of electromagnetism and an explanation of the scientific laws upon which wireless telephony depends.

The whole book is written in a singularly clear and fascinating manner, and all who are anxious to understand wireless cannot do better than read Dr Fleming's able work. It is an excellent starting point for further studies.

PRICE 7/6 NET
Post Free 8/-

Obtainable from all leading booksellers or direct from the publishers:

ILIFFE & SONS LIMITED
Dorset House, Tudor St., London, E.C.4

A Guide to WIRELESS LITERATURE

This booklet, describing all books published in conjunction with "The Wireless World," including some other volumes by Dr. Fleming, will be sent FREE on REQUEST.

W.W.41.

A real Service to Readers!

Please
.....
use
.....
this
.....
FORM
.....
↓

THERE are three ways in which "The Wireless World" can be of real service to all readers

NUMBERED ADDRESSES.

(1) The miscellaneous advertisement columns provide a convenient and profitable way of buying, selling or exchanging wireless apparatus. By means of Box Numbers letters can be sent to "The Wireless World" office and forwarded to your own address. A few of 6d. covers this service.

DEPOSIT SYSTEM.

(2) Readers who do not wish to send money to unknown persons may deal in

perfect safety by availing themselves of our special Deposit System. Full particulars are given under the Miscellaneous Advertisement Notices.

SALE OF UNLICENSED SETS.

(3) Special arrangements are also made for the sale of readers' home-constructed unlicensed apparatus through the medium of "The Wireless World," which arranges all details connected with royalties. See details on First Miscellaneous Advertisement page.

Make use of this service. Write out your advertisement NOW, and post to

PREPAID ADVT. DEPT., "THE WIRELESS WORLD," DORSET HOUSE, TUDOR ST., LONDON, E.C.4.

12
Words
or
Less
1/-

each
additional
word
1d.

Advertiser's name and address must be counted. If a box number is required, 6d. extra must be sent for postage on replies.

W.W.35

Advertisements for "The Wireless World" are only accepted from firms we believe to be thoroughly reliable.

A few recommended combinations of MARCONI VALVES (for 6 volt Accumulators)

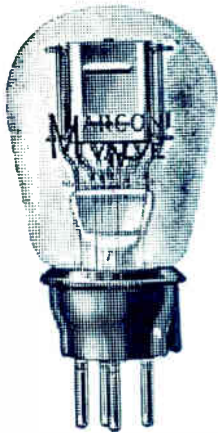

Marconi Power Valves

Types
D.E.5 and D.E.5 B,
Price **22/6** each.

Type
D.E.5 A,
Price **26/-**

Type	Position	Filament Amps	Grid Bias Volts	High Tension Volts
(2-valve sets.)				
{ D.E. 8 H.F.	Det.	0.12	+2	80
{ D.E. 5	L.F.	0.25	-7.5	120
{ D.E. 8 H.F.	Det.	0.12	+2	60
{ D.E. 5 A	L.F.	0.25	-6	60
{ D.E. 5 B	Det.	0.25	+2	60
{ D.E. 5	L.F.	0.25	-7.5	120
(3-valve sets.)				
{ D.E. 8 H.F.	Det.	0.12	+2	80
{ D.E. 8 L.F.	1 L.F.	0.12	-6	100
{ D.E. 5	2 L.F.	0.25	-6	100
{ D.E. 8 H.F.	Det.	0.12	+2	80
{ D.E. 5	1 L.F.	0.25	-7.5	120
{ D.E. 5	2 L.F.	0.25	-7.5	120
{ D.E. 8 H.F.	Det.	0.12	+2	60
{ D.E. 8 L.F.	1 L.F.	0.12	-1.5	60
{ D.E. 5 A.	2 L.F.	0.25	-6	60
(4-valve sets.)				
{ D.E. 8 H.F.	H.F.	0.12	0	80
{ D.E. 8 H.F.	Det.	0.12	+2	80
{ D.E. 5	1 L.F.	0.25	-7.5	120
{ D.E. 5 A	2 L.F.	0.25	-16.5	120

Write for Valve Publication No. 443A
THE MARCONIPHONE COMPANY, LTD.,
Regd. Office: Marconi House, Strand, London, W.C.2



Marconi Power Valves

Types
D.E.8 L.F.
and
D.E.8 H.F.
Price **22/6** each.

The most efficient intervalve transformers ~ human skill and ingenuity have yet devised

The heaviest transformer on the market. The great amount of the highest grade material necessary to ensure perfect results makes the "Ideal" higher in price than other less efficient Intervalve Transformers. The method of winding is covered by a patent, without which it is impossible to get the same results.

Supplied in four ratios, viz. 27 to 1, 4 to 1, 6 to 1 and 8 to 1. **Ideal (Junior Model) Ratio 3 to 1.**
Price **30/-** each. **21/-**

Mr. H. H. Wheat, 11 Bridge Street, Runcorn, writes :-
"I am using two Marconiphone 'Ideal' Transformers in a four-valve set, and would like to express my appreciation of the quality of these wonderful instruments. My first stage employs the 2:7 to 1 transformer, and the second stage the 6 to 1, and I am delighted with the wonderful volume and tone of the set."

10th February, 1926.

Marconiphone "IDEAL" Transformers

Write for supply of Publication No. 425a.

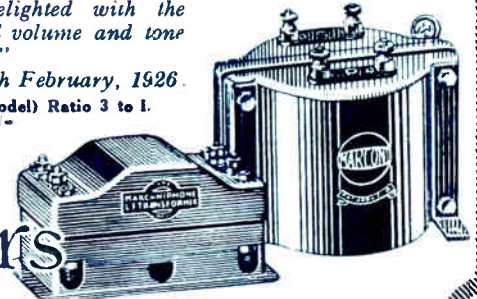

Printed for the Publishers, LIFFE & SONS LTD., Dorset House, Tudor Street, London, E.C.4, by The Cornwall Press Ltd., Paris Garden, Stamford Street, London, S.E.1.

Colonial and Foreign Agents:
UNITED STATES—The International News Co., 83-85, Duane Street, New York. FRANCE—W. H. Smith & Son, 248, Rue Rivoli, Paris. Hachette et Cie, Rue Réaumur, Paris.
BELGIUM—W. H. Smith & Son, 78, Marche aux Herbes, Brussels. INDIA—A. B. Wheeler & Co., Bombay, Allahabad and Calcutta. SOUTH AFRICA—Central News Agency, Ltd.
AUSTRALIA—Gordon & Gotch, Ltd., Melbourne (Victoria), Sydney (N.S.W.), Brisbane (Queensland), Adelaide (S.A.), Perth (W.A.) and Launceston (Tasmania).
CANADA—The American News Co., Ltd., Toronto, Winnipeg, Vancouver, Montreal, Ottawa, St. John, Halifax, Hamilton; Gordon & Gotch, Ltd., Toronto; Imperial News Co., Toronto, Montreal, Winnipeg, Vancouver, Victoria. NEW ZEALAND—Gordon & Gotch Ltd., Wellington, Auckland, Christchurch and Dunedin.

The Wireless World

4^D

The Paper for Every Wireless Amateur

Wednesday, April 28th. 1926.

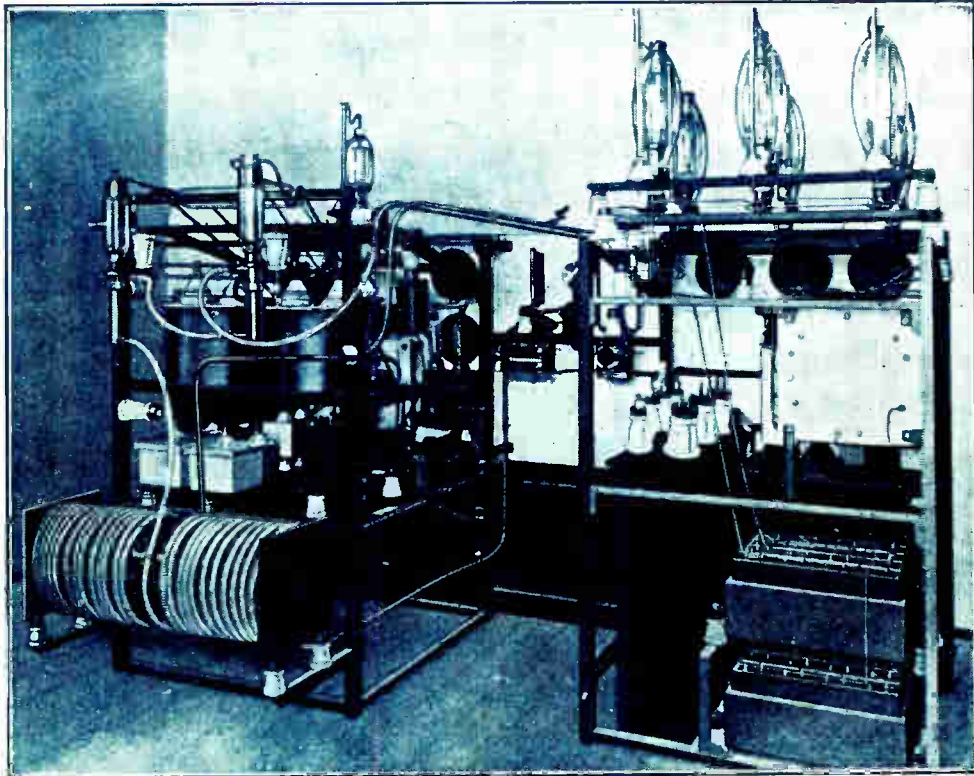

VIENNA'S NEW BROADCASTING STATION

TMC

Low Capacity Keys

combine

- Extreme Low self-capacity.
- A positive locking action.
- Rapid make and break.
- Unvarying performance.
- Adaptability to varied switching requirements.
- Strong and accurate construction.
- Pleasing appearance.



All the live parts of the key are efficiently insulated from the frame. Individual parts are machine-made, ensuring accurate construction. The "gold-silver" contacts are always clean. The ends of the springs are tinned to facilitate soldering. Escutcheon plates and levers are of polished and lacquered brass or finished in bright nickel plate.

T.M.C. Low Capacity Keys are made in 3 models :

- No. 1. 12 point, 3 position ... 7/-
- No. 2. 6 point, 2 position .. 6/-
- No. 3. 24 point, 3 position .. 15/6

Have you sent for your copy of the interesting T.M.C. Catalogue?

It is free on request.

Telephone Manufacturing Co., Ltd.,

Hollingsworth Works,
West Dulwich,
London, S.E.21.

'Phones: Sydenham 2460/1.

If your dealer does not stock T.M.C. Goods we will supply you direct at the above prices, post free.

THE ONLY WAY— Scrap your old junk and fit—

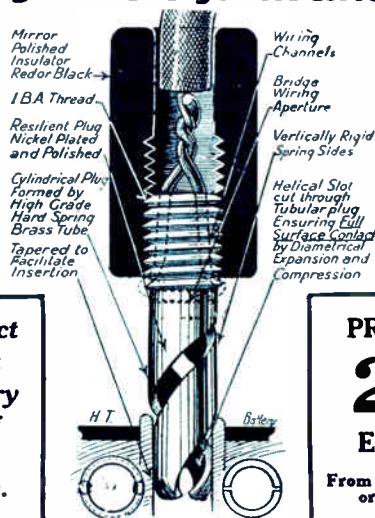

A perfect fitment for every type of H.T. Battery.

**PRICE :
2^D.
EACH**

From all traders or direct.

CLIX

REGD TRADE MARK

WANDER-PLUGS

(NON-MICROPHONIC) PATENTED

90% of the efficiency of a soldered joint.
For all other connections use CLIX plug sockets and adapters.

From all traders or direct from:

AUTOVEYORS LTD., 84 VICTORIA ST., LONDON, S.W.1

Special Wireless Cabinets to Customer's orders

Cabinets that at any time are illustrated or described by the Editor of this Journal we can make to order. Ask for prices. Delivered free anywhere in the United Kingdom.

Hundreds of readers of this Journal have expressed their satisfaction with workmanship and price of our cabinets

*Specialist makers of Wireless Cabinets
Caxton Wood Turnery Co.
Market Harborough*

Essential Units for TONE, VOLUME and DISTANCE

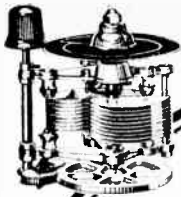

Sterling "Miniloss" Square Law Variable Air Condensers
Ratio 7 to 1.

The end plate eddy current losses are negligible. In three capacities:
"00025 mfd. £1 1s.;
"0005, £1 4s.;
"001, £1 10s.

Sterling 'NON PONG' VALVE HOLDER

Does away entirely with all microphonic noises and mechanical shocks. Price 3/6.

ADAPTER for use with above. Price 4/-

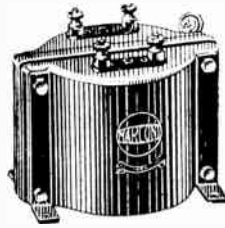
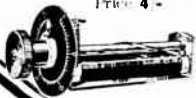

MARCONIPHONE "IDEAL" Transformers

The most dependable and efficient Intervalve Transformer that human skill and ingenuity has yet devised.

The "IDEAL" is guaranteed to amplify without distortion at all frequencies. Each transformer is subjected to a series of exacting tests, and is impregnated with a specially prepared insulating medium called "Marconite" which protects the windings from breakdown and corrosion. Every "IDEAL" is unconditionally guaranteed for a year from date of purchase.

The "IDEAL" is produced in four ratios, viz.: 2.7 to 1, 4 to 1, 6 to 1, and 8 to 1.
Price 30/- each.

"IDEAL" (Junior Model), ratio 3 to 1. New Reduced Price 21/-

Marconiphone Auto Series Parallel VARIOMETER

Without any condenser and connected to roof, aerial, it covers wave-lengths 230-1630 metres. With a .001 condenser in parallel, wave-lengths up to 3380 metres may be received.



Price 16/-

STERLING COIL HOLDERS

Prices: Double 16/6. Triple (for mounting on either side of a panel) 20/-. Triple (mounted on base) 22/6.



Marconiphone "Velvact" POTENTIOMETER.

Perfectly silent and smooth in operation. Price 9/-

Marconiphone H. F. CHOKE

For coupling I.L.F. Circuits. Suitable for all wave-lengths up to 4000 metres. Price 10/6.

Write for Publication No. 364F, dealing with the complete range of Marconiphone and Sterling Radio Equipment.

Marconiphone and STERLING Radio Components

THE MARCONIPHONE COMPANY LTD.,

Head Office:
210-212 Tottenham Court Road, London, W.1.

A Four-Valve Combination with a Minimum Current Consumption.

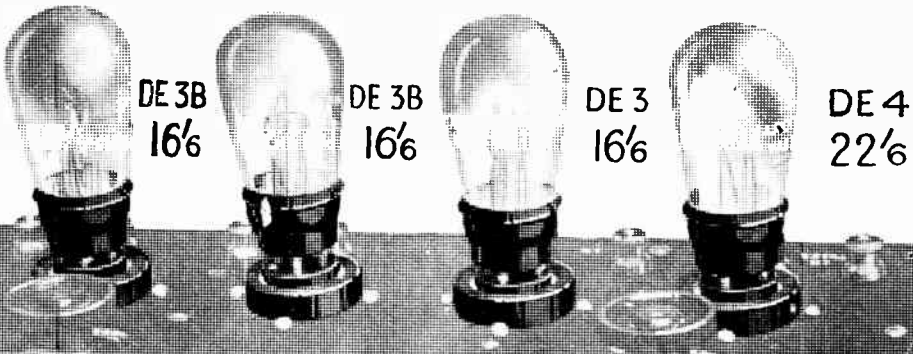

Accompanying combination of Marconi Valves for a four-valve receiver will give good results for long-distance or broadcast reception on both headphones and loud speaker, using a 4-volt accumulator or 3 dry cells.

Type of Marconi Valve	Position	Filament		Grid Bias Volts	High Tension	
		Volts	Amps.		Volts	M. Amps
DE 3B	H.F.	2.8	0.06	0	80	1.0
DE 3B	DET.	2.8	0.06	+2.8	80	1.25
D.E.3	I.L.F.	2.8	0.06	-3	80	1.5
D.E.4	2.L.F.	3.8	0.30	-7.5	120	3.0

MARCONI VALVES

IN THE PURPLE BOX

Various recommended Combinations for 2, 3 and 4 Valve sets are given in Marconi Valve publication No. 443a—sent on request to The Marconiphone Company, Ltd., Marconi House, Strand, London, W.C.2.

£10 Weekly in Cash Prizes





Simple Competition
for all Readers of "The Wireless World"

HIDDEN ADVERTISEMENTS

Below will be found six reproductions of fragments cut from the Advertisement pages of this issue of "The Wireless World." Each fragment is a clue. Can you from these clues identify the Advertisements? Seven cash prizes will be awarded to the first seven readers who send us correct solutions. No technical skill is required, merely observation. There are no restrictions or entry fees and the conditions are simple.

£5
for the first
correct solution
opened.

£2
for the second
correct solution
opened.

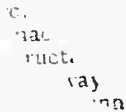
	
1	2
	
3	4
	
5	6

£1
for the third
correct solution
opened.

and
4
consolation
prizes of

10/-
Each
for the next four
correct solutions
opened.

CONDITIONS

1. All solutions must be written on the special coupon appearing on an advertisement page in this issue and addressed to *The Wireless World*, Dorset House, Tudor Street, London, E.C.4, and marked "Hidden Advs." in bottom left corner.

2. Clues will not, of necessity, appear in the same way as in the advertisement page, but may be inverted or placed in some other position.

3. In order that town and country readers may compete on equal terms, solutions will not be dealt with until 10 a.m. on Monday next. All solutions received before that date will be retained until Monday morning. Competitors may submit any

number of entries. Erasures or alterations on a coupon will disqualify the entry.

4. The first prize of £5 will be awarded for the first correct solution opened; the second prize of £2 to the next correct solution; the third prize of £1 for the third, and four consolation prizes of 10/- each for the next four correct answers. In the event of no readers sending correct solutions the prizes will be awarded to the competitors whose solutions are most nearly correct.

5. The decision of the Advertisement Manager of *The Wireless World* is final, and no correspondence can be entered into. Competitors enter on this distinct understanding. No member of the staff of the paper is permitted to compete.

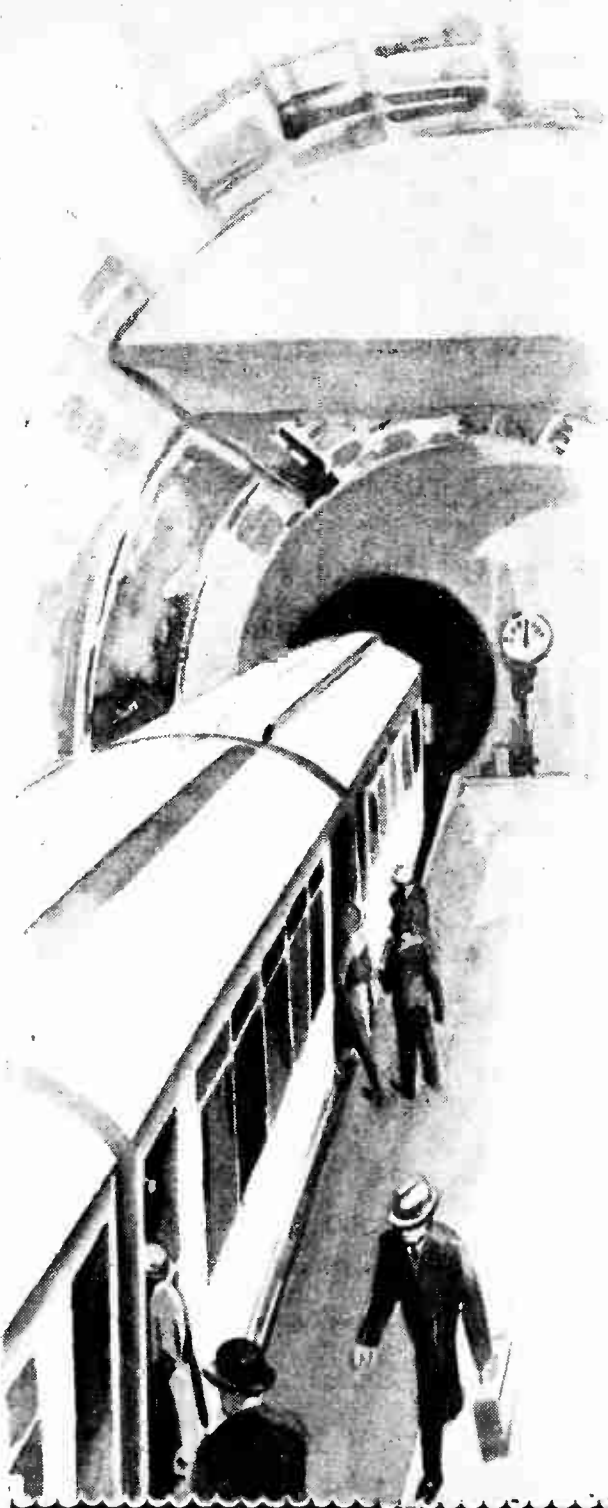

INNER CIRCLE ← I

Why keep to the inner circle?

THE "Inner Circle," though excellent in its way, can never take you farther afield than London. And so it is with many condensers: they never get you past 2 LO—or whatever may be your local station.

Now real radio travel, getting distant stations, demands a really good condenser—one that, in addition to many other perfections, has a very sensitive "slow motion" control.

Such a condenser is very costly to manufacture, and cannot be sold at a popular price unless it enjoys extraordinarily big sales. It is solely because of the enormous demand that the Ormond Friction Drive Condenser, with an ideal "slow motion" ratio of 55=1, can possibly be sold at the following surprisingly low prices:—

·0005, 15/-; ·0003, 14/6; ·00025, 13/6
Complete with Knob and Dial.

Brass End Plates. Highly Nickelled Finish.



199-205, Pentonville Road, King's Cross, N.1
 'Phone: Clerkenwell 9344-5-6. 'Grams: "Ormondengi, Kincross."
 FACTORY: WHISKIN STREET, CLERKENWELL, E.C.1

LET ORMOND TAKE YOU FARTHER AFIELD

ADVERTISEMENT COMPETITION RESULTS

The following are the prizewinners in the Advertisement Competition announced in the issue of "The Wireless World" dated April 14th, 1926.

First Prize £5

A. BALLANTYNE, 47, Bellwood Street, Glasgow, S.1.

Second Prize £2

J. E. CLINARD, North of England Bank, Ltd., 25-31, Moorgate, E.C.2.

Third Prize £1

G. W. WILKINS, 163, Green Lane, Norbury, London, S.W.16.

Four Consolation Prizes of 10/- each:

W. WHITLAM, 10, Marshfield Avenue, Goole. H. C. MARGRETT, 23, Ensmore Gardens, East Sheen, London, S.W.14. C. D. BUZZA, 130, Staines Road, Twickenham, Middlesex. H. CARDWELL-HILL, 39, Waverley Road, Kenilworth.

CHEQUES HAVE BEEN DISPATCHED TO THE PRIZEWINNERS.

The WINNING ORDER for the nine advertisers was as follows:

Whole Page Advertisements.			Half-Page Advertisements.			Quarter-Page or Smaller Adverts.		
	Page No.	Name of Advertiser.		Page No.	Name of Advertiser.		Page No.	Name of Advertiser.
1st	5	The Mullard Wireless Service Co., Ltd.	1st	ii	Metro-Vick Supplies Ltd.	1st	6	A. H. Hunt, Ltd.
2nd	1	The Marconiphone Co., Ltd.	2nd	ii	The London Electric Wire Co.	2nd	12	Nelson Electric Co., Ltd.
3rd	8	L. McMichael, Ltd.	3rd	4	Wilkins & Wright, Ltd.	3rd	15	Garnett, Whiteley & Co., Ltd.



THE WIRELESS LEAGUE

MEMBERSHIP AND RENEWAL FORM.

To be filled in by readers who wish to become members of the League, or to renew their membership for a further twelve months as from 1st April.

To the Secretary, the Wireless League, Chandos House,
Palmer Street, Victoria Street, S.W. 1.

..... 19

Please *enrol me as a member of the Wireless League. I enclose P.O. for Two Shillings,† which renew my membership entitles me to membership with all the privileges and rights as enumerated in the constitution of the League, including FREE Insurance, Free Legal Advice and Free Technical Advice.

* Cross out Line not required.

† Keep the Counterfoil of your Postal Order.

WRITE IN Name (in full).....
CAPITAL (State whether Mr., Mrs. or Miss)
LETTERS. Address

Please enclose stamped addressed envelope.

My Membership No. is
(This is only applicable in the case of renewals.)

C Commencing with the first issue in May, "The Wireless World" will devote four pages in the first issue of each month to League Notes and News.

Mention of "The Wireless World," when writing to advertisers, will ensure prompt attention.

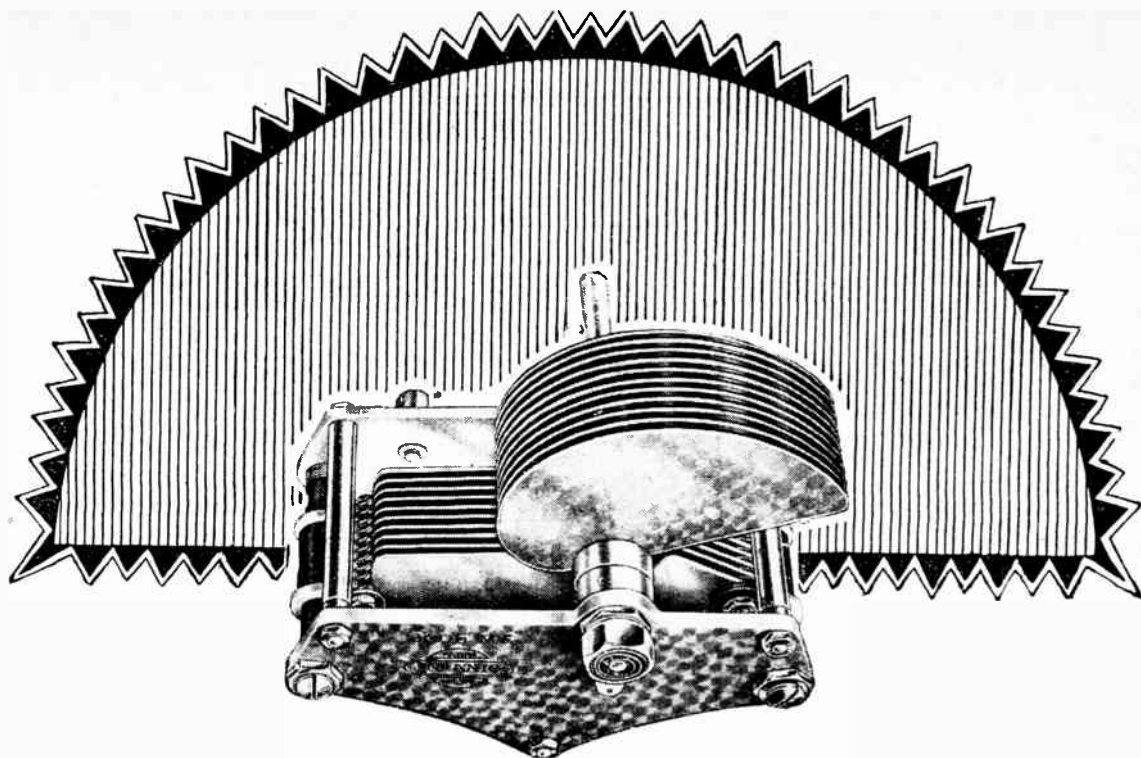

Designers specify it— Constructors prefer it.

Even Transmitters build it into their apparatus. Undoubtedly the Square Law Variable Condenser success of 1925 was the Igranic Low Loss model—and it has no equal yet. Refer to past issues of your wireless publications and you will find that those circuits which have been notable for their efficiency, range, selectivity and smoothness of control have invariably the Igranic Low Loss Square Law Variable Condenser built into them.

Follow the experts' choice—build with Igranic.

Write for List U.166 which illustrates the entire range.

Igranic Low Loss
Square Law Vari-
able Condenser.

Prices :

·001	-	-	27/6
·0005	-	-	24/-
·0003	-	-	21/-
·00015	-	-	19/6

with 1/4-inch knob and dial.



Exclusive Manufacturing Licensees of Patent Radio Essentials.

Works : BEDFORD.

Branches :

Birmingham. Bristol. Carlisle. Glasgow
Leeds. Manchester. Newcastle.

149, Queen Victoria Street, London.

The IGRANIC
Supersonic In-
structional Carton

for constructing a six-valve Super Heterodyne Receiver according to the Igranic system, complete with full sized general arrangement drawing, wiring and drilling diagrams, and fully illustrated descriptive handbook can be obtained from your dealer.

Price - 2s. 6d.

THE HOME CONSTRUCTOR'S WIRELESS GUIDE. By W. James. A useful little encyclopedia of wireless technology which will solve difficulties met with in practical work.

PRICE
3/6
By post 3/10

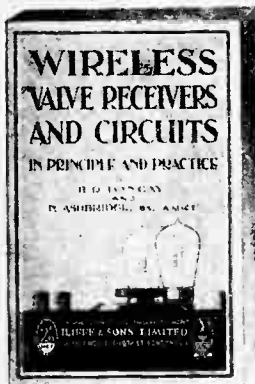
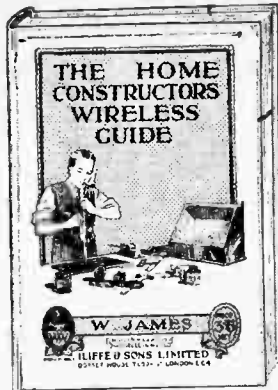

WIRELESS VALVE RECEIVERS AND CIRCUITS. In Principle and Practice. By R. D. Bangay and N. Ashbridge, B.Sc. Written to enable the amateur to understand the working of any circuit he constructs.

PRICE
2/6
By post 2/10

THE HOME CONSTRUCTOR'S EASY TO BUILD WIRELESS SETS. By F. H. Haynes. Well illustrated with working drawings and diagrams.

PRICE
1/6
By post 1/9



TUNING COILS AND METHODS OF TUNING. By W. James. A manual discussing the principles and practice of tuning coils, with explanations of spade, condenser and variometer tuning.

PRICE
2/6
By post 2/10

Get to the Root of the Subject!

THOSE wireless workers who get to the root of the subject derive the greatest pleasure and profit from their hobby. Many are content to dabble in wireless without ever really understanding the whys and the wherefores of things. They do not know what they miss! By reading practical books, by recognised authorities on wireless matters, a wide field of new interests is opened up for the amateur.

This FREE Booklet helps you to select the best books.

A postcard will bring you our FREE Booklet: "A Guide to Wireless Literature." This list gives particulars of a very extensive range of wireless books issued in conjunction with "The Wireless World" and "Experimental Wireless."

There is a book for every phase of wireless and for every wireless worker. A few of the volumes are illustrated on this page. General headings—under which the library is classified—are "Explanatory Books": "Home Constructional Books": "Books for the Amateur": "Books for Experimenters": "Miscellaneous Books." These indicate the extensive ground which is covered.

Write for your copy to-day!

ILIFFE & SONS LIMITED
Dorset House, Tudor Street,
LONDON, E.C.4

W.W.42

There!



A Filament that can be tied in knots after 1000 hours life

A FILAMENT that remains ductile so that it can be tied in a knot after 1000 hours life is an achievement that assures **VASTLY INCREASED VALVE LIFE**

This wonderful filament is the key feature of Mullard P.M. Valves. In Mullard P.M. Valves the filaments are so economical that no glow is visible during operation, and they require

ONLY ONE-TENTH AMPERE

In addition the reception they give is free from all microphonic noises.

If you use a 4-volt accumulator or 3 dry cells

ASK FOR THE P.M.3 16/6

A general purpose valve for every circuit

ASK FOR THE P.M.4 22/6

The finest loudspeaker valve ever produced

GET THEM FROM YOUR RADIO DEALER



Mullard P.M. Filaments cannot be broken except by the very roughest handling.

Mullard

THE MASTER VALVE

ADVT., THE MULLARD WIRELESS SERVICE CO., LTD., NIGHTINGALE LANE, BALHAM, LONDON, S.W.12

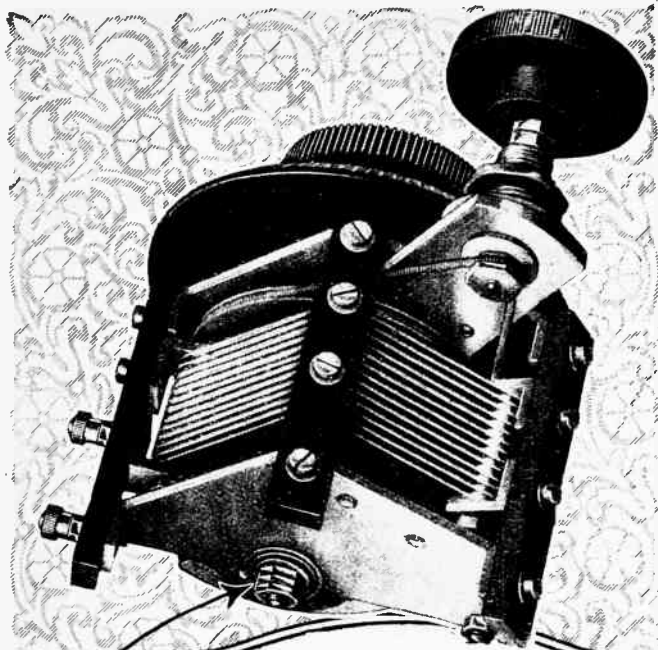

COMPENSATED
SQUARE LAW
EFFECT

LOW LOSS

NO
BACK LASH

**LOW LOSS
SQUARE LAW
SLOW MOTION**

THE "Cosmos" Condenser is a slow motion condenser with absolutely no backlash either when new or after use. This desirable feature is accomplished by the use of a spring belt held in tension, which permits coarse tuning with the large knob, and a 10:1 slow motion with the small knob.

Cone bearings allow for adjustment and the slow motion bracket can be mounted for remote control as shown in the lower illustration.

The condenser for fine tuning.
METRO-VICK SUPPLIES LTD.,

(Proprietors)
Metropolitan-Vickers Elec. Co. Ltd)
Metro-Vick House, 145 Charing Cross
Road, London. W.C.2.

Prices:

Slow Motion	'00025 mfd	14/3
"	'0005	15/3
Ordinary,	'00025	12.-
"	'0005	13/-

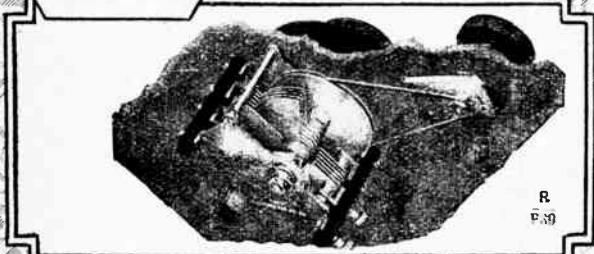
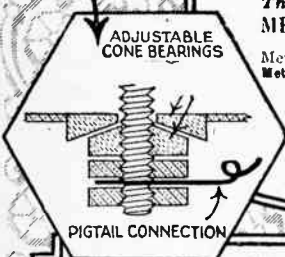

COSMOS

The cheapest component
in your set, yet the
most vital of all—
the Condenser

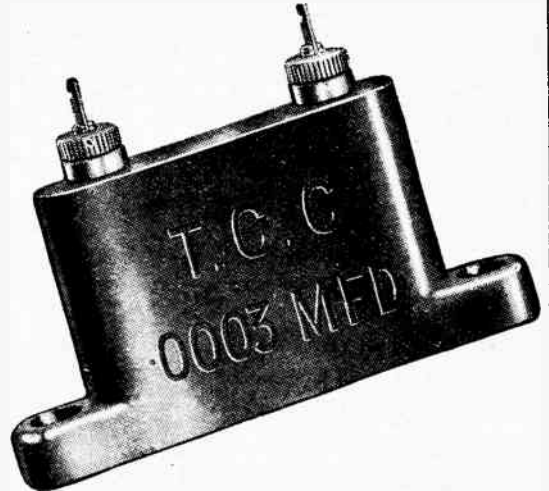

If your set is not giving the results you expect from it, scan mentally the components you have used. Have you, for instance, exercised the same discrimination in selecting your condenser as you have in the case of your transformer? For your fixed condenser—on which so much depends—is one of the least expensive of all the components you buy. The difference in cost between a genuine T.C.C. and an un-named condenser is very slight; with the latter you are taking a risk—with T.C.C. you obtain a permanent assurance against breakdown.

Choose the T.C.C. Mica Condenser shown above. It embodies all the well-known T.C.C. features, and owing to its convenient shape takes up very little room on the panel: because it is sealed from below instead of from above it is proof against the heat of the soldering iron. For those who do not wish to solder their

connections a convenient milled head is provided to ensure a perfect electrical contact. Finally, because every T.C.C. Condenser—whether Mica or Mansbridge—has to pass so many tests before it is released for issue, you know that its accuracy within a very small percentage of error is a foregone conclusion.

Prices:

No. 33, all capacities between	'004 and '001 mfd.	2/4
No. 34, all capacities between	'0009 and '0001 mfd.	2/4

From all Wireless Shops.

**T. C. C.
CONDENSERS
(Mica & Mansbridge)**

Advertisement of Telegraph Condenser Co., Ltd., Wales Farm Road, N. Acton, W.3.

Gilbert Ad. 5082.

The Wireless World

AND
RADIO REVIEW
(14th Year of Publication)

No. 350.

WEDNESDAY, APRIL 28TH, 1926.

VOL. XVIII. No. 17.

Assistant Editor:
F. H. HAYNES.

Editor:
HUGH S. POCOCK.

Assistant Editor:
W. JAMES.

Editorial Offices: 139-40, FLEET STREET, LONDON, E.C.4

Telephone: City 4011 (3 lines).

Advertising and Publishing Offices: DORSET HOUSE, TUDOR STREET, LONDON, E.C.4.

Telephone: City 2847 (13 lines).

Telegrams: "Ethaworld, Fleet, London."

COVENTRY: Hertford Street.

BIRMINGHAM: Guildhall Buildings, Navigation Street.

MANCHESTER: 199, Deansgate.

Telegrams: "Cyclist Coventry."
Telephones: 10 Coventry.

Telegrams: "Autopress, Birmingham."
Telephone: 2970 and 2971 Midland.

Telegrams: "Hiffe, Manchester."
Telephone: 8970 and 8971 City.

Subscription Rates: Home, £1 1s. 8d.; Canada, £1 1s. 8d.; other countries abroad, £1 3s. 10d. per annum.

As many of the circuits and apparatus described in these pages are covered by patents, readers are advised, before making use of them, to satisfy themselves that they would not be infringing patents.

ANOTHER SINK FOR PUBLIC MONEY.

PERIODICALLY the smouldering interest in the subject of interference from oscillating receivers is fanned into a blaze of activity, and for a while, in the Press and in wireless circles, the problem is discussed at length. Time-honoured observations on the subject are quoted as if they were being expressed for the very first time. Circuits for non-oscillating sets are re-produced and demonstrated to bewildered representatives of the lay Press who are all too ready to interpret everything wireless they see or hear as epoch-making inventions which will make good "copy" for the moment, even if they are destined never to find a more useful application.

But time goes on and still the problem remains unsolved—not because non-oscillating receiver sets cannot be produced, for numerous circuit arrangements have been described which will give the desired result, but for the reason that these circuits introduce some additional complication or a reduction in efficiency which are themselves sufficient causes for preventing the devices from appearing on the market to compete in price and performance with straight circuits capable of oscillating.

So long as the choice remains with the public, the cheaper sets will find favour, even if their use entails some risk of the owner interfering with his neighbour's reception; human nature is too selfish for individuals to make sacrifices in the interest of the community. The fear of reprisal may, however, produce the necessary influence, but here again the wild statements which are

made with regard to the practicability of tracking down oscillation offenders cannot be allowed to pass without challenge.

In the daily Press recently statements have appeared to the effect that the Government is about to take delivery of motor vans equipped with wireless direction-finding apparatus with which it is suggested the location of oscillators will be effected with comparative ease.

If the time of Government officials and Government money has got to be spent unproductively, then one can scarcely imagine a more suitable opportunity than to chase oscillators with portable direction-finding equipment. When we consider the nature of the signal or disturbance produced by an oscillating receiver, the futility of trying to recognise and locate the source must be apparent. There are probably very few people who, in using their sets, are steadily transmitting on a definite wavelength without altering the tuning; the offenders are those who swing their dials from one position to another oscillating in the meantime, perhaps only momentarily, but still quite enough to interfere with the neighbours. There is nothing distinctive about

these interferences, and it would be next to impossible to recognise repetitions of interference from the same station from moment to moment.

If the Government proposes to use portable direction-finding equipment for locating illicit transmitters, that, of course, is quite another matter, but to contemplate the use of such sets for locating oscillators is, in our opinion, little short of ridiculous.

CONTENTS.

	PAGE
EDITORIAL VIEWS	607
HOME BROADCAST RECEIVER By N. P. Vincof-Minter.	608
NOVELTIES FROM OUR READERS	614
WIRELESS ON CANADIAN TRAINS By E. C. Thomson.	615
HIGH-FREQUENCY RESISTANCE By E. Mallett.	618
CURRENT TOPICS	621
PIONEERS OF WIRELESS.—14. HENRY HIGHTON By Ellison Hawks.	623
THE NEW VIENNA HIGH-POWER STATION By Paul S. Gordon Fischel.	625
AUTOMATIC VALVE REPLACEMENT By N. W. McLachlan.	630
HINTS AND TIPS FOR NEW READERS	633
BROADCAST BREVITIES	635
REVIEW OF APPARATUS	637
THE EDITOR'S MAIL	638
READERS' PROBLEMS	640

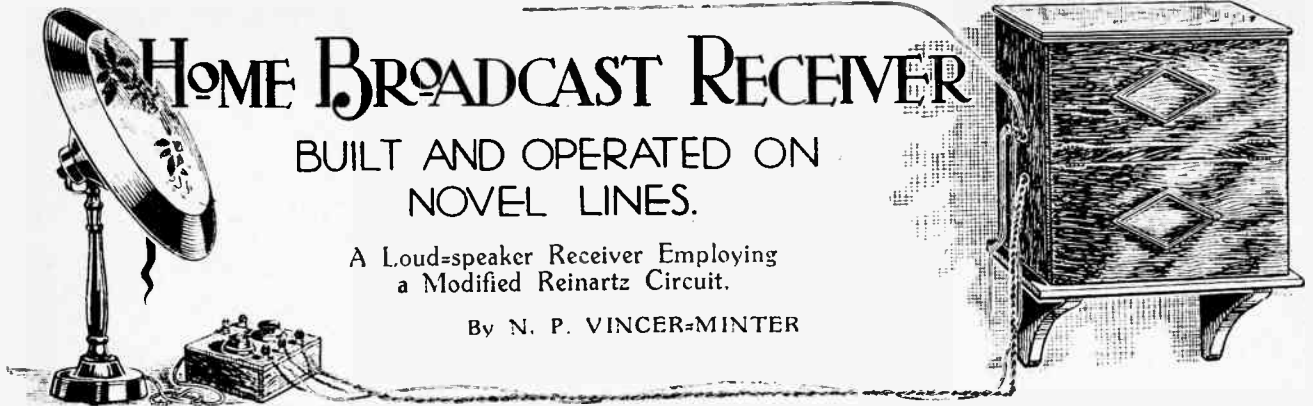

HOME BROADCAST RECEIVER

BUILT AND OPERATED ON
NOVEL LINES.

A Loud-speaker Receiver Employing
a Modified Reinartz Circuit.

By N. P. VINCER-MINTER

IT is becoming increasingly evident to those members of the public who take interest in wireless reception that the enjoyment which the possession of a wireless receiver is capable of giving to its owner falls under two distinct headings. The first of these pleasures is purely and simply that of the entertainment which the receiver is capable of bringing into the home in the form of music and song. The second lies in obtaining experimental reception of distant stations. There are many people, indeed, who take no interest whatever in listening to the local station, no matter how excellent the programme, the chief use to which they put their receiver being that of searching for distant stations, and of logging the largest possible number of them. They give no heed to the nature of the programme received, whether it is good, bad, or indifferent, and only stay on the wavelength of a station long enough to definitely identify it.

Motives of the Home Constructor.

Many of these people take pleasure in the actual construction of their receiver, although in the majority of cases this is somewhat to be doubted. Probably the real reason which prompts many of them to undertake constructional work is the inability to obtain a factory-made multi-valve receiver at a reasonable price. There are other people, on the contrary, who find no pleasure whatever in the actual mechanism of their wireless receiver, and regard

it merely as a necessary and troublesome adjunct to their entertainment. Their sole desire is for simplicity, reliability, and reasonably good quality.

Requirements of the Majority of Listeners.

There is, however, another great section of the community who obtain their chief pleasure from their receiver in the form of musical entertainment from the local station, but occasionally they like to use it for the purpose of obtaining the thrill which comes to everybody who successfully tunes in a distant station. This latter class of people have been sadly neglected, and it is the purpose of the writer to come to their assistance by describing a receiver which is really suited to their needs. This receiver comprises two valves only, and is therefore not expensive to construct and maintain; it is capable of giving ample loud-speaker volume, with good quality, from a local main station at a distance of 20 miles, and from the Daventry station at a distance of 100 miles. Also by using the headphones it is possible by careful tuning, and a certain amount of acquired skill, to log quite a considerable number of distant stations, although great care should be exercised in using reaction in order to avoid oscillation, and it is really best to avoid searching for distant stations during broadcasting hours. There are only two tuning dials, and no moving coils, and the result is that the receiver is exceptionally simple to adjust, and the moderate amount of skill required to receive distant stations is easily acquired by careful practice.

Now it is well known that the ordinary detector valve with reaction is an exceedingly sensitive arrangement, so much so, in fact, that, provided our control over reaction is sufficiently smooth to enable us to adjust the valve to the very threshold of oscillation, without actually oscillating, it will respond to an infinitely weak signal. Unfortunately, however, the ordinary system of

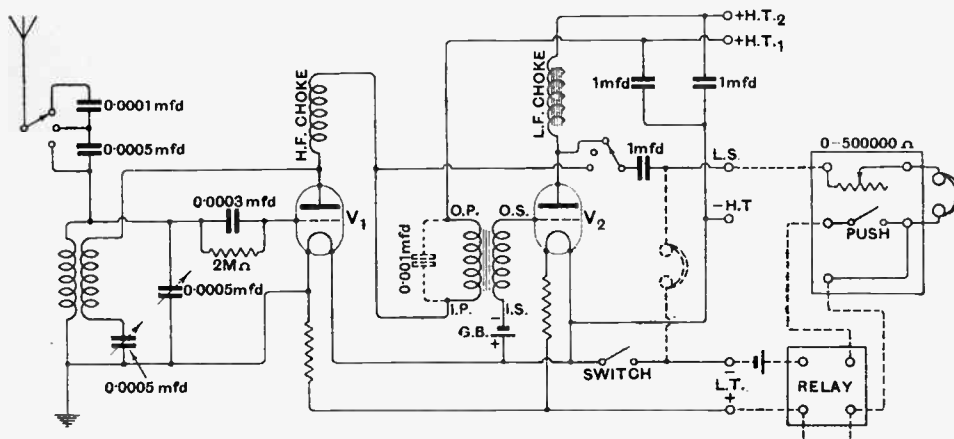

Fig. 1.—The theoretical connections of the receiver. Note especially the arrangement of the relay and remote control unit.

Home Broadcast Receiver.—

reaction employing a swinging coil is very far from being smooth. By adjusting the reaction coil to the best of our ability we can bring the valve to a fairly sensitive condition, but if we attempt to make the valve still more sensitive by further manipulation of the reaction coil, it will be found that the merest fractional movement of the coil is sufficient to cause the valve to go into actual oscillation, whilst if we do not touch the reaction coil the valve is still very far from the threshold of oscillation. A minute movement of the coil holder, therefore, is sufficient to sweep the valve, as it were, from a condition of comparative insensitivity to a point far beyond the brink of oscillation. If we could obtain a vernier coil holder which by a comparatively coarse movement of the adjusting knob would impart a minute movement to the actual coil, we should have achieved our object. Unfortunately, however, it is quite beyond our ability to devise such an instrument. The ordinary vernier coil holder is quite useless for the purpose. We are thus baulked of achieving our object mechanically, but fortunately, owing to the efforts of John L. Reinartz, an enterprising American amateur, the difficulty was overcome by the simple expedient of fixing the position of the reaction coil, and regulating the amount of oscillating current passing through

the reaction coil by means of a condenser, thus performing electrically what was mechanically impracticable.

The Reinartz Circuit.

It was found by Reinartz that quite a large movement of the reaction condenser dial was required to produce the same effect as a minute movement of the coil holder. Therefore, by adjusting the condenser, it was possible to bring the valve up to the threshold of oscillation without it actually bursting with oscillation. A useful analogy is to consider that it is required to roll a large stone to the very brink of a cliff, and to poise it there in such a position that it is almost, but not quite, falling over. With the ordinary coil holder adjusted as best we can, the stone is still as it were several feet from the brink of the cliff, whilst a minute movement of the reaction coil is in reality so coarse that it sends the stone flying over the edge of the cliff. With the Reinartz method of reaction, however, we can gently roll the stone up to the edge of the cliff, and poise it trembling on the brink, almost, but not quite, toppling over into the abyss of oscillation. Now when a detector valve is thus adjusted to the threshold of oscillation it is in a very

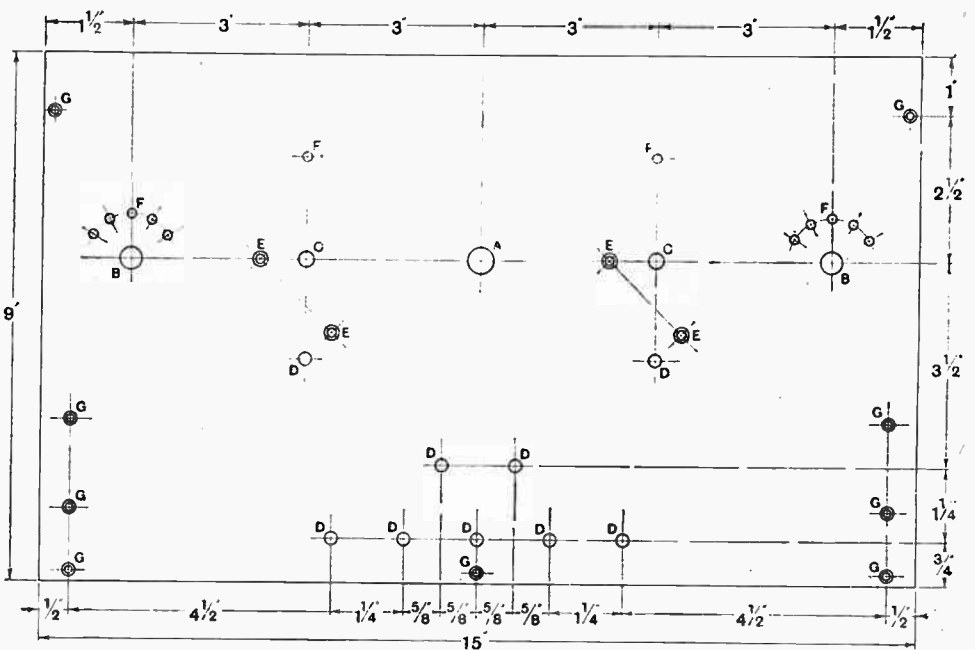

Fig. 2.—Dimensional details of the front panel. Drilling sizes A, 7/16 in. dia.; B, 3/8 in. dia.; C, 1/4 in. dia.; D, 7/64 in. dia.; E, 5/32 in. dia. and countersunk for No. 4 B.A.; F, 5/32 in. dia.; G, 1/8 in. dia. and countersunk for No. 4 wood screws.

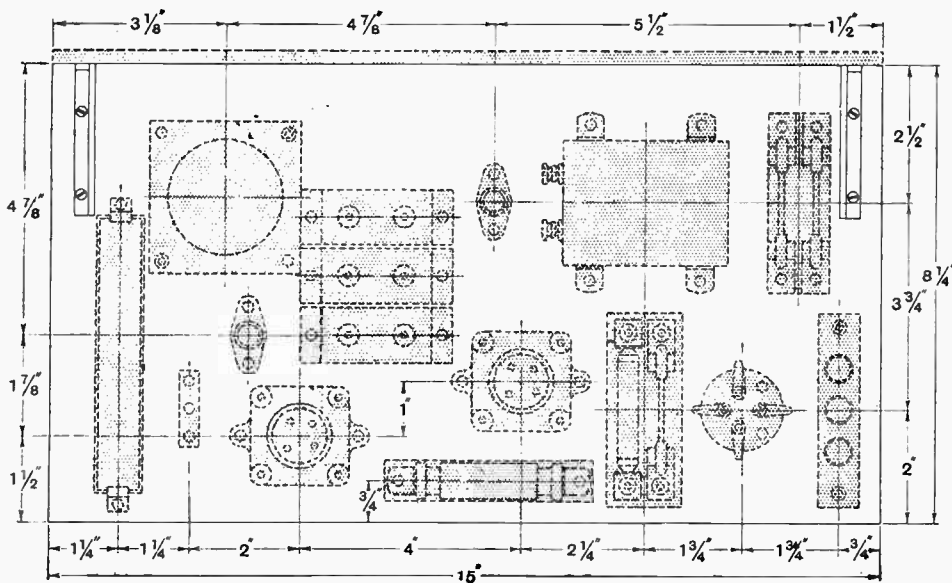

Fig. 3.—Layout of baseboard.

Home Broadcast Receiver.—

sensitive condition indeed, and *apparently*, therefore, the Reinartz receiver has a very much greater range than the more conventional arrangement. Actually, of course, its true range must be the same as in the conventional arrangement, because it is merely a detector with reaction as before. The true explanation of the fact that there is such a great apparent increase of range in a Reinartz receiver is that in the usual arrangement we are in reality

number of enthusiastic letters written by people who have built a Reinartz receiver, their letters being written in such glowing terms that the ordinary layman might be led to believe that there was something mysterious and wonderful about this circuit. There is no magic in it, as we have seen, but merely an efficient control over reaction.

The writer has so designed this receiver that not only are all batteries housed within it, thus protecting them from dust, but the cabinet closes up completely, even the panel being enclosed. It is thus possible to store the receiver away in any convenient place, such as in the loft of a house, and provided it is left tuned to the local station, to switch it on and off in various rooms as desired. Now, as is well known, the best place for the receiver is close to the aerial lead-in, the closer the better for efficiency. The usual expedient of placing the receiver near to the loud-speaker and trailing the aerial lead-in through the house, is the cause of great inefficiency and loss of range and volume in many installations. In this receiver, therefore, provision is made for installing the receiver close to the aerial lead-in, whilst the loud-speaker may be placed in any room desired, together with the remote control switch for switching the receiver on and off from a distance, concerning which more will be said later.

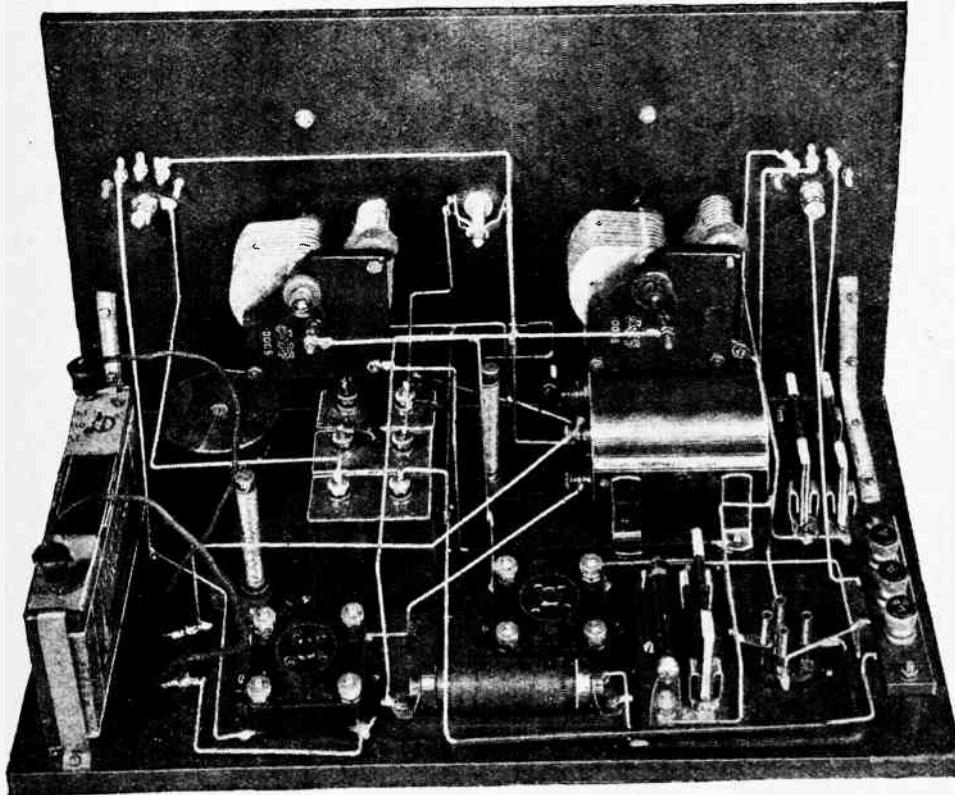

A view of the interior showing aerial, earth, and loud-speaker terminals.

obtaining a very low percentage of the possible range of the instrument. In the Reinartz we have a really efficient control over reaction, and thus obtain a far greater efficiency from the instrument. This accounts for the large

Now, in a recent article, the writer pointed out that if a loud-speaker were operated at a considerable distance from the receiver, it was often found that very bad distortion occurred owing to the capacity existing between

LIST OF COMPONENTS.

- 1 Ebonite panel, 15in. × 9in. × ¼in.
- 1 Baseboard, 15in. × 8½in.
- 2 Angle brackets.
- 1 Cabinet to dimensions given.
- 1 Filament relay (A. W. Gamage, Ltd.).
- 2 0.0005 mfd. variable condensers with vernier control (A. J. Stevens).
- 1 L.F. transformer (Eureka Baby Grand).
- 1 L.F. choke (Success).
- 2 Antiphonic valve holders (Benjamin).
- 1 Baseboard mounting valve holder (Lampugh).
- 1 "Transadapta" (Gambrell).
- 1 H.F. choke (Metrovick).
- 1 Grid condenser and leak (McMichael).

- 1 0.0001 mfd. fixed condenser (McMichael).
- 1 0.0005 mfd. fixed condenser (McMichael).
- 3 1 mfd. condensers (T.C.C.).
- 2 Fixed resistors holders (Burndepl).
- 2 Fixed resistors or short-circuiting plugs (Burndepl).
- 2 Stud switches for panel mounting (Bowyer Lowe).
- 1 Filament switch (Lissen).
- 1 9-volt tapped grid battery (Lissen).
- 14 Indicating terminals (Belling Lee).
- 1 0-500,000 ohms variable resistance (Marconiophone).
- 1 Electric bell push.
- 1 Box for remote control, to dimensions given.
- 2 Wander plugs.
- Length of red and black flex.

Approximate cost of materials required - £7 0 0

Home Broadcast Receiver.—

the two leads of the usual "flex" used. In this article¹ the writer described a method whereby this difficulty would be overcome by using a single-wire loud-speaker connection. If readers have not already studied this article, it is strongly advised that they do so in order to obtain a better understanding of the method whereby the loud-speaker operates. In the original article an earth return was used for the loud-speaker. Since in this receiver we already have another wire going to the filament relay in

in a small wooden box, and should be placed close by the loud-speaker.

It may be asked: "Why use a relay? Why not merely extend the filament leads to the distant room?" This question is perfectly justifiable, and, indeed, if we are going to use a six-volt accumulator with valves taking five volts, we can afford to do so, because we have a volt to spare. If we desire to use two-volt valves with a two-volt accumulator, however, we cannot spare any voltage to be wastefully dropped in the resistance of the long

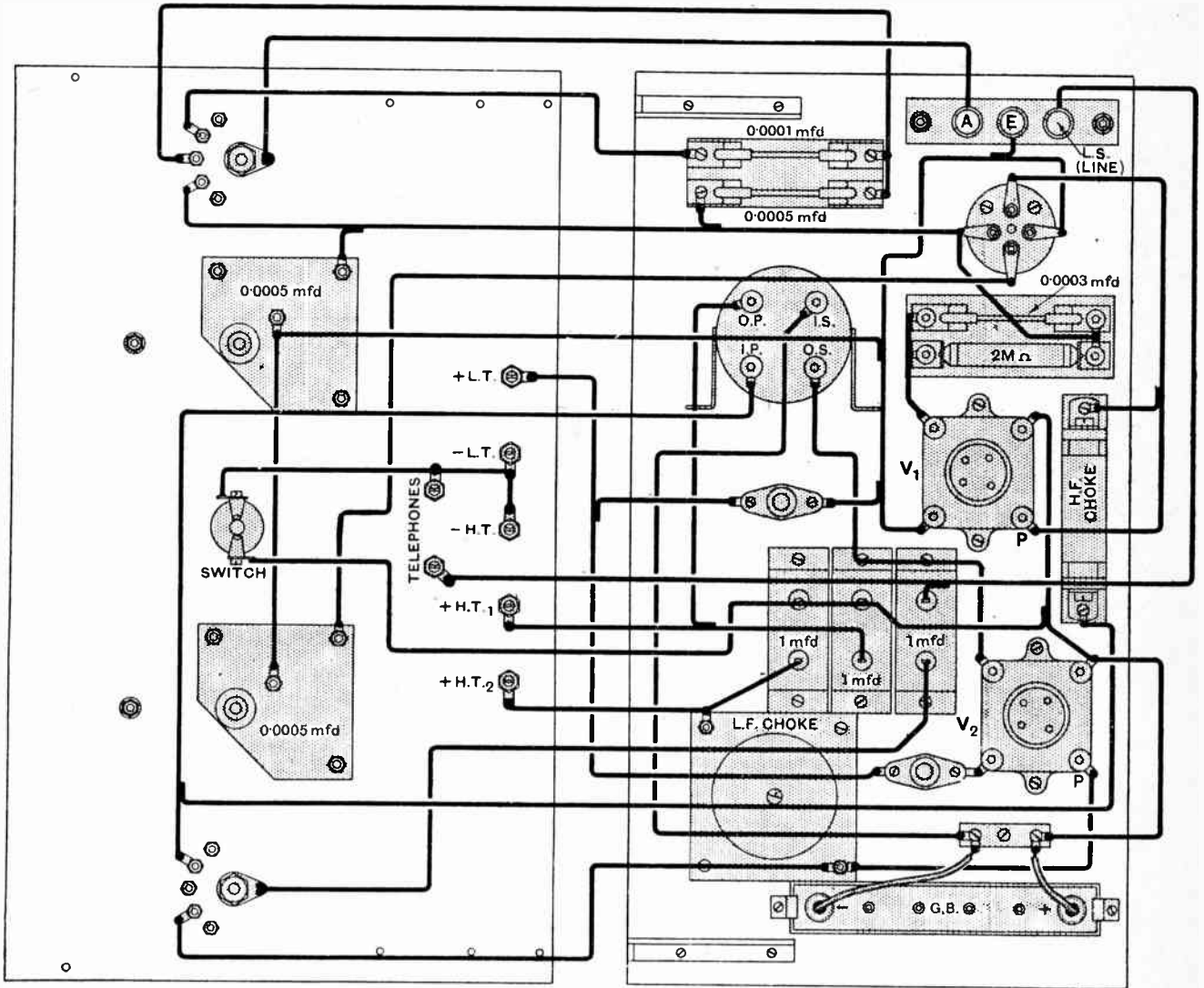

Fig. 4.—The practical wiring diagram.

the receiver, we can very well make use of this as the return wire of our loud-speaker. Looking at the theoretical diagram, we see that there is a 0.500,000 ohms variable resistance in series with the loud-speaker. It will be found that this gives an extremely pleasing and smooth control over volume. This resistance, together with the push controlling the filament relay, is mounted

filament extension leads, and, therefore, we use a relay. The particular type of relay used is of an exceedingly sensitive and reliable type. It has a small battery concealed in its base, whilst on top, in addition to the mechanism, are four terminals, two of which are connected in series to either the L.T. + or L.T. - leads between receiver and accumulator, the remaining two being connected to an ordinary bell push by a length of flex. Current only flows in the relay at the moment the

¹ *The Wireless World*, February 10th, 1926, p. 217.

Home Broadcast Receiver.—

push is depressed, alternate depressions of the push turning the filaments on and off respectively. In order to use the relay wire as a loud-speaker return lead, and thus connect the loud-speaker to the L.T. + terminal, it will be necessary to bridge one input and one output terminal of the relay as shown by dotted lines in Fig. 1. This will not affect the operation of the relay in any way. The bottom portion of the cabinet is sufficiently large to house a 6-volt 30 actual ampere-hour accumulator, two 60-volt "Ever-Ready" or similar type batteries, and the relay, the grid battery being in the top compartment with the baseboard of the actual receiver. The relay can be seen plainly in the photograph, its cover having been removed for photographing. All battery terminals are mounted in a line at the extreme bottom edge of the front panel underneath the two telephone terminals, and are

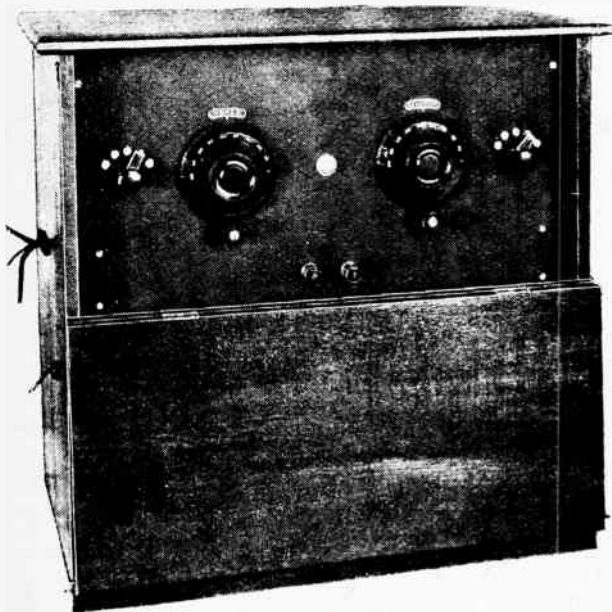

A front view of the instrument showing panel exposed by dropping upper flap.

invisible in the photographs. In this manner, short and direct leads can be made to the batteries. With regard to the H.F. choke, it is most essential that for good results this component be not omitted. The type used covers all wavelengths from 200 to 4,000 metres, and need not, therefore, be interchangeable. Do *not* attempt to use a plug-in coil as an H.F. choke or there will probably be trouble due to the large external magnetic field of the coil. A 0.0005 mfd. or 0.001 mfd. fixed condenser can be placed across the transformer primary if desired.

Choice of Coils.

To operate the receiver, the left-hand stud switch should just be placed to the right, and for the local station the same value of coil should be used for aerial tuning as in the case of the ordinary type of receiver, namely, a No. 35 or a Gambrell A. The local station will probably be heard without the reaction coil, since the withdrawal of the reaction coil does not break the

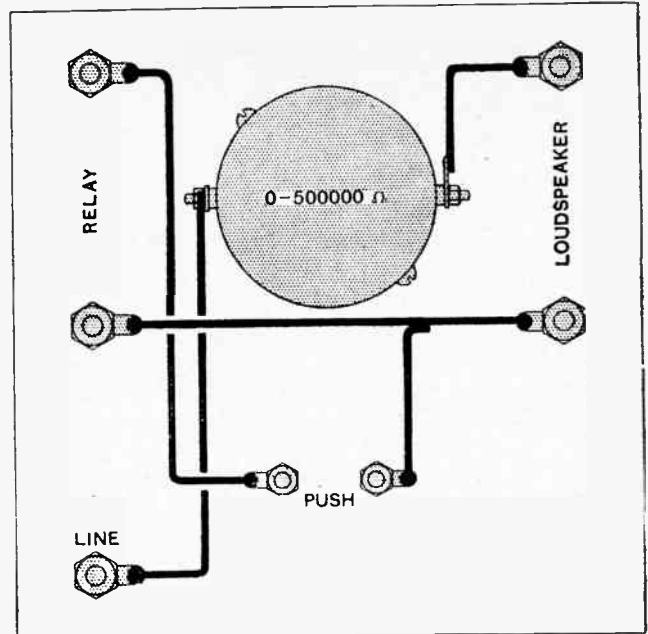
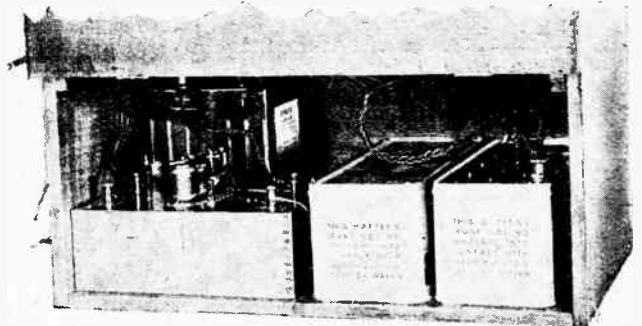

Fig. 5.—Practical wiring diagram of remote control unit.

plate circuit as in the ordinary type of circuit. The reaction coil should be chosen experimentally with great care. It should be the smallest with which it is possible to produce oscillation. It should be of such a size that the receiver oscillates when the reaction condenser is rather more than three-quarters of the way in. If too small a coil is used, oscillation will not be produced, even if the condenser is at maximum, whilst the use of too large a coil will mean that control over reaction will be far from smooth.

Tuning for Selectivity.

When selectivity is desired, the switch should be moved to the *first* stud, the aerial coil replaced by a coil one size larger, and the reaction coil by a size smaller. For receiving Daventry, the switch should first be placed on the right-hand stud as before, the aerial coil should be a No. 150 or Gambrell E, and the reaction coil chosen experimentally as before. To secure greater selectivity on the Daventry wavelength, place the switch on the *centre* stud, and use a No. 200 or Gambrell E coil for the aerial tuning.



The lower part of cabinet exposed by raising lower flap. Note the relay in front of the accumulator.

Home Broadcast Receiver.—

In order that a really smooth control be had over reaction, it is most essential that the plate voltage of the detector valve be adjusted carefully. In nearly all cases it will be found that a voltage in the neighbourhood of 40 to 45 will be correct. It is absolutely impossible to tune in distant stations until all reaction backlash is absent, and this can only be brought about by careful adjusting of the detector plate voltage. When correctly adjusted, this receiver will be found to glide almost imperceptibly into oscillation instead of "flopping" in and out as is often the case. When it is in such a condition the most skilled tuning will be unable to adjust the valve to the threshold of oscillation. It is essential, also, that both aerial and reaction condenser be fitted with some form of vernier in the same manner as the actual condensers used in the receiver.

The method of mounting the two plug-in coils needs a little explanation. The coils can, if desired, be mounted in two ordinary single coil holders placed side by side and 1½ in. apart. The "Transadapta" actually used, however, possesses many advantages, one being that a rapid change can be made from, say, London to Davenry by the ability to withdraw both coils simultaneously. A further advantage is that the instrument possesses a small switch in its base which will be con-

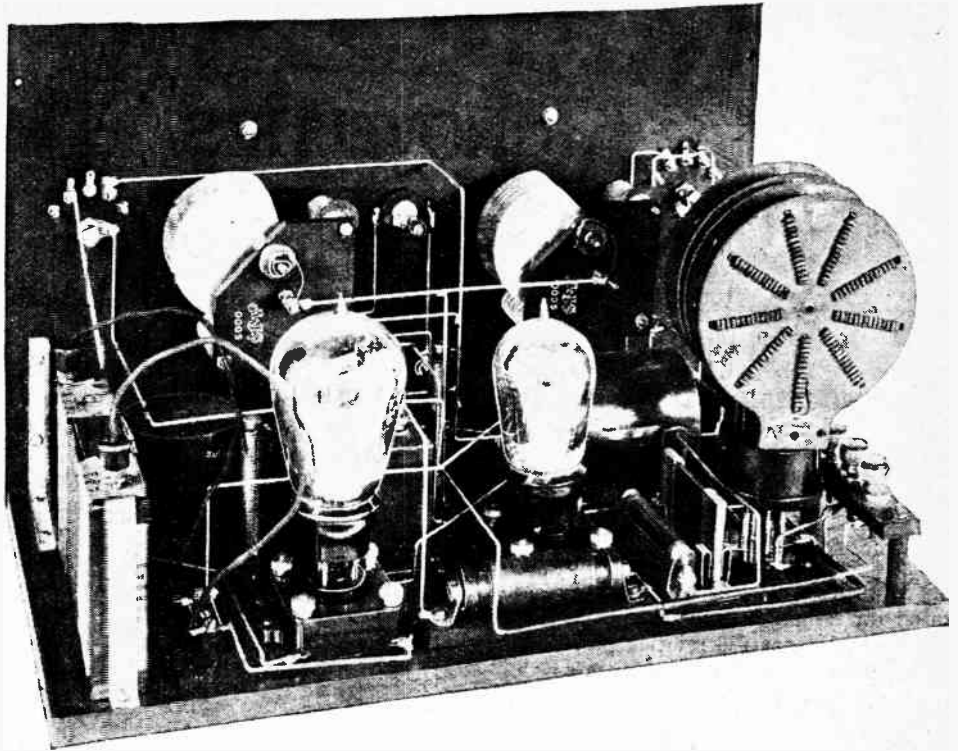

A further view of the interior showing coils and valves in position

venient for reversing the reaction coil. The "Transadapta" can be obtained in two types, one for mounting directly on the baseboard, the other fitted with four pins for plugging into a valve holder. The latter is used in this receiver, although either type is equally suitable. The valve holder must be of the rigid, and not of the "antiphonic" type. Remember that the "filament" sockets are connected in the aerial circuit, and the "grid" and "plate" sockets in the plate circuit. In the photograph on this page the reaction coil is the one nearest to the receiver panel.

With regard to valves, the writer has found that, from the point of view of efficiency combined with economy, a Marconi D.E.2 as detector, and a Mullard P.M.2 as L.F., gave most excellent results, the total filament current consumption being only 0.27 amps. Thus, using the receiver four hours a day, a 2-volt 40-a.h. accumulator will give a month's service on one charge.

Please Don't Do It!

It is most important that searching for distant stations be carried out during those hours when the B.B.C. stations are closed down, in order to avoid interfering with one's neighbours by oscillation. It is just as criminal from a moral point of view for a novice to search for distant stations with a regenerative receiver whilst home broadcasting is in progress as it is for a would-be motorist to make his first attempt at handling a car in Piccadilly Circus at midday.

In conclusion the writer would say that readers who decide to construct this receiver will find that their efforts will have been well rewarded the first time they put the receiver "on the air."



A view of the remote control unit.

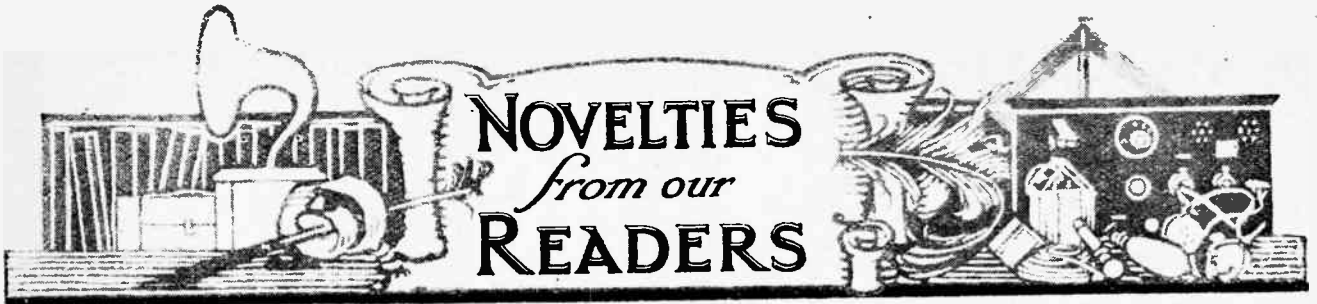

A Section Devoted to New Ideas and Practical Devices.

WIRING MODEL.

In wiring a receiver for exhibition purposes where it is essential that every wire should be accurately bent to shape it is very convenient to construct a rough wooden model of the baseboard with the various components in position. Nails may be substituted for terminals, soldering tags, etc., and as long as the relative positions of the points of connection are strictly adhered to the remainder of the construction may be quite rough. Not only does this method of wiring ensure a neat appearance of the finished receiver, but it enables a series of experiments to be carried out to ascertain the system which will give the shortest and most direct wiring.—B. R.

o o o o

POINTER.

The diagram shows how a well-known type of paper fastener may be used as a pointer for certain types of condenser dial which stand a short distance above the level of the panel. One of the blades is bent over at right angles and the other shortened and

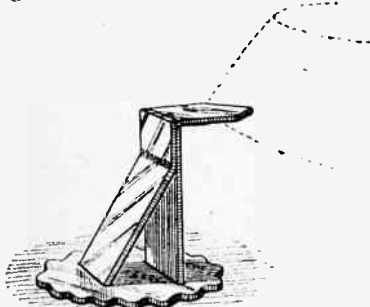

Condenser dial indicator.

soldered to it to act as a support and give rigidity. The head of the paper fastener may then be secured to the panel in a suitable position by means of a small touch of glue or Chatterton compound.—W. H. W.

COIL HOLDER CONTACTS.

Having experienced considerable trouble with flexible connections to the moving coils of a three-coil holder the writer devised a method shown in the accompanying diagram.

Pairs of brass blocks $\frac{1}{4}$ in. thick were filed out to a suitable radius and screwed to the base of the coil holder immediately beneath the moving coil

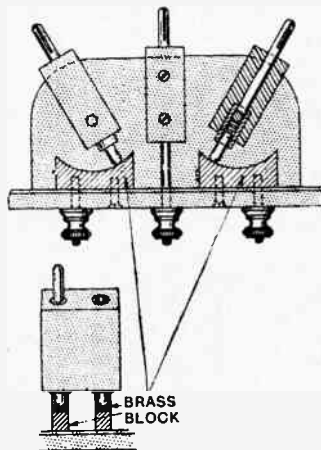

Spring contacts for moving coil holders.

plugs. The brass blocks were spaced to correspond with the distance between the plug and socket in each coil holder. The plug and socket in each case were removed and fitted with spring plunger contacts. These may either be constructed specially, or they may be obtained from ordinary electric lamp sockets and modified to fit the coil plug. By this means an efficient and silent contact is obtained which will last indefinitely.—W. H.

o o o o

DRY BATTERY HINT.

The life of a H.T. battery constructed with flash lamp battery units will be greatly extended if the batteries are treated in the following manner before assembly.

The paper cover of each battery is

pierced in several places in the spaces between the cells. Each battery is then dipped in a bath of molten paraffin wax (not too hot) until fully saturated. Not only will the wax improve the insulation and prevent leakage currents from flowing between different parts of the battery, but should one of the zinc containers become eaten away towards the end of the useful life of the battery the trouble will be isolated by the wax and prevented from spreading to other cells.—H. Y. F.

o o o o

AERIAL LEAD-IN.

To keep the aerial lead-in clear of the eaves and walls of the house, a wooden arm 2 or 3ft. in length should be fitted immediately above the lead-in insulator. The end of the arm is fitted with a porcelain insulated hook through which the lead-in wire is passed. Before attaching the

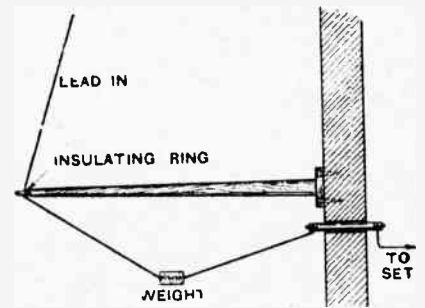

Aerial lead-in

aerial wire to the lead-in insulator a small weight, such as a pipe coupling, is slipped over the end. This will not only take up slack in the down lead, but will also serve to drain off water before it reaches the lead-in terminal. Incidentally, it may be mentioned that this terminal is to a certain extent sheltered by the projecting wood arm.—S. F. H.

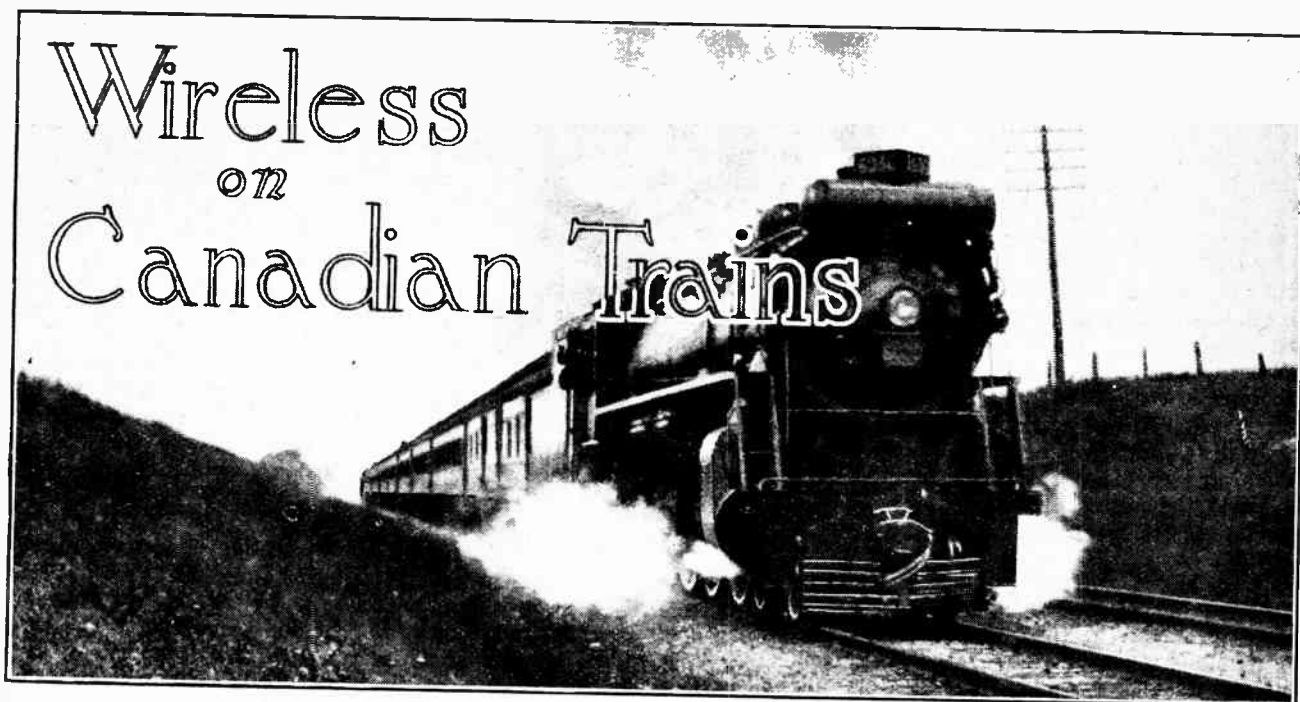

Brightening the Journey from Quebec to Vancouver.

By E. C. THOMSON.

WHEN we reflect that there are people who can plumb the uttermost depths of boredom during the short run from London to Brighton, we can appreciate, vaguely, perhaps, the horrors that may lie in wait for the same sort of traveller in Canada. To journey on the Canadian National Railways from Halifax to Vancouver is to cover no fewer than 3,778 miles, and the trip will consume four and a half days. Not that the route covered by the Canadian National Railways is intrinsically uninteresting—the exact contrary is the case; but enough is as good as a feast, and after a time the finest profusion of mountain, forest, and torrent will begin to cloy.

The value of wireless in relieving the tedium of these long journeys was early recognised by the management of the Canadian National Railways, with the result that train radio in Canada is no longer in the experimental stage—it is an integral part of the railway equipment, and the wireless *personnel* fulfils its functions with the same punctiliousness as marks the activities of the staff in the saloon. The operation of all wireless equipment is entrusted to uniformed attendants specially trained to the work. These operators, who also act as touring representatives on behalf of the railway, are responsible to a supervisor of operators, whose office is at Montreal, or to his assistant supervisors.

A Chain of Stations.

To ensure reliable reception at any point on the nearly 4,000-mile route from Halifax to Vancouver, a chain of broadcasting stations has been effected, stretching from end to end of the Dominion, and their familiar "CNR"

call signs will be well known to many British amateurs. The ten stations comprising the chain are situated at Moncton, Montreal, Ottawa, Toronto, Winnipeg, Regina, Saskatoon, Edmonton, Calgary, and Vancouver. The magnitude of this broadcasting system will be the better understood when we realise that it serves to supply news and entertainment not only to express trains speeding across the Dominion, but to the railway hotels and to the homes of many thousands of employees.

Canada's Lead.

Every train is thus in touch with at least one broadcasting station, and generally two or three, while the passengers, besides hearing light musical concerts ("heavy stuff" is banned), enjoy the benefits of a red-hot news service even when travelling in the remotest parts of the Dominion.

It is worth while recording that the Canadian National Railways, in providing such a service, are ahead of any other railway in the world. Experiments in broadcast reception have been conducted on most lines, in this country and abroad, but the credit for establishing a permanent wireless service for the benefit of passengers undoubtedly belongs to Canada.

The receiving apparatus on the trains is installed in the reading or library car, whither travellers can repair when the demon of boredom threatens. Loud-speakers and head phones are both available, and would-be listeners can generally take their choice from the programmes offered by the nearest stations.

In designing a suitable aerial the chief difficulty with which the engineers had to contend was presented by the

Wireless on Canadian Trains.—

track clearances, which impose a strict limit on the height to which the aerial can extend. Bridges, tunnels, and the height of the railbed all have to be taken into account. The most efficient form of aerial was found to be that shown in the photograph on page 617. The height of this aerial is 15.7ft. above the track. It consists of approximately 200ft. of No. 14 R.C. stranded wire, made up in the form of a closed loop with the lead-in taken off at a suitable point near the receiver. Four steel brackets on each side of the car support glass pony insulators, which in turn hold the aerial wire. Directional effects are practically absent with this form of antenna, a very important factor in connection with reception on a car which may be constantly changing its direction on curved portions of the line.

In their search for the best form of earth the engineers discovered that best results were obtained by bonding together the steam and water pipes and by using the steel underframe of the car.

The Standard Receiver.

The standard receiver used on the trains is based on the neutrolyne principle. An additional power amplifier is provided for loud-speaker work, while the telephone circuit provides for 12 to 24 pairs of 'phones. The whole unit is assembled in a mahogany cabinet, more than 5ft. high and about 2ft. wide, the woodwork being finished to match the interior of the car. To avoid vibration, the set is mounted on rubber sponges and each unit is contained in a separate compartment.

The circuit design of the neutrolyne receiver is of undoubted interest. The first H.F. valve is reflexed. Break jacks are provided between the various amplifying stages to permit of breaking in for the purpose of verifying the performance of the H.F. amplifier. Break jacks also facilitate the tuning of the set, for by increasing the number of amplifying stages step by step the intermediate circuits can be set to the best tuning adjustment. Reflexing is carried out by the series method, and the secondary of the transformer, which feeds back to the grid circuit of the first valve, is shunted with a resistance having a value of 0.25 megohms. Leaky grid condenser rectification is employed.

Contrary to what might be expected, the car lighting batteries are not employed for obtaining plate and filament current, this arrangement being impracticable for maintenance purposes. Storage batteries are therefore used for L.T. supply and ordinary dry batteries for H.T.

Trouble with Lighting Equipment.

With certain types of car lighting equipment, trouble has been experienced during reception from high-frequency currents produced by arcking between the brushes and commutator of the generator. The same form of annoyance, it may be remembered, was encountered on the Great Western Railway in March last, when a superheterodyne was installed on the Cornish Riviera express. Strangely enough it has been found on the Canadian National Railways that when the cars are of steel construction, the interference is not so apparent, due, no doubt, to a shielding effect. The use of covered

wire has also helped to mitigate the nuisance. To overcome the trouble completely a low pass filter was inserted between the brush leads and the rocker arm of the switch, *i.e.*, in series with the output of the generator.

Fading.

A more baffling form of disturbance to reception is caused by tunnels, cuttings, and bridges. Very often signals fade entirely, and while the man who is trying to read in the farthest corner of the car may count this a merciful respite, there are other passengers whose pleasure is rudely interrupted. To overcome fading of this kind the use of super-sensitive apparatus has been suggested; but while it is certainly possible to "boost up" signals to average strength, local disturbances are also exaggerated to a pitch which may be unendurable.

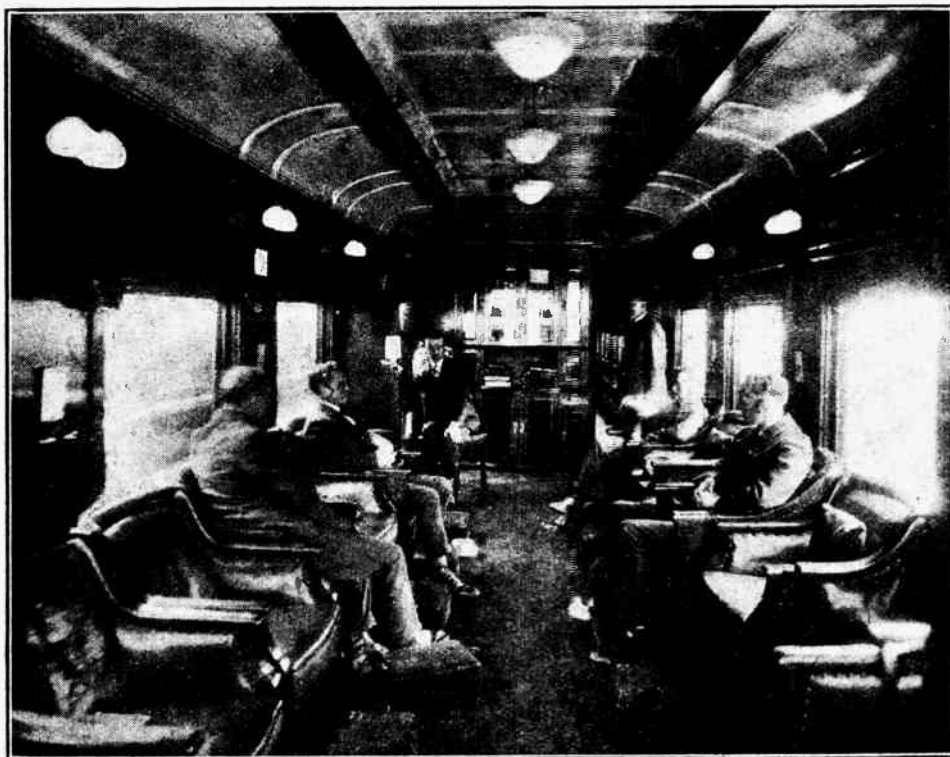

WIRELESS EN ROUTE. Passengers enjoying broadcast reception in the library car of a C.N.R. express. Wireless is installed on all long distance trains on the Canadian National Railways

Wireless on Canadian Trains —

An Efficient Maintenance Service.

Finally, there is the question of maintenance. This work has been entrusted to the engineering department, to whom a general foreman of installation is responsible. On the shoulders of this official lies the onus for ensuring that the receiving equipment is in good order when handed over to the uniformed operators. The charging of storage batteries, the testing and replacement of equipment, and similar tasks which may be necessary while the trains are *en route*, are the duty of local representatives at Moncton, Montreal, Toronto, Winnipeg, and Vancouver. At each of these "ports of call" detail test reports are kept to enable the engineering department to maintain a close survey over all equipment with the object of obtaining ever-increasing efficiency.

Among the important trains which carry radio equipment may be mentioned "The International Limited," travelling daily over the 818 miles between Chicago and Montreal; "The Continental Limited," running from Vancouver to Montreal, a distance of 3,091 miles; and "The National," which links Vancouver with Toronto, covering a distance of 2,774 miles.

A Lesson for British Railways.

In the face of Canada's enterprise may it not be asked why wireless is absent on British railways? In

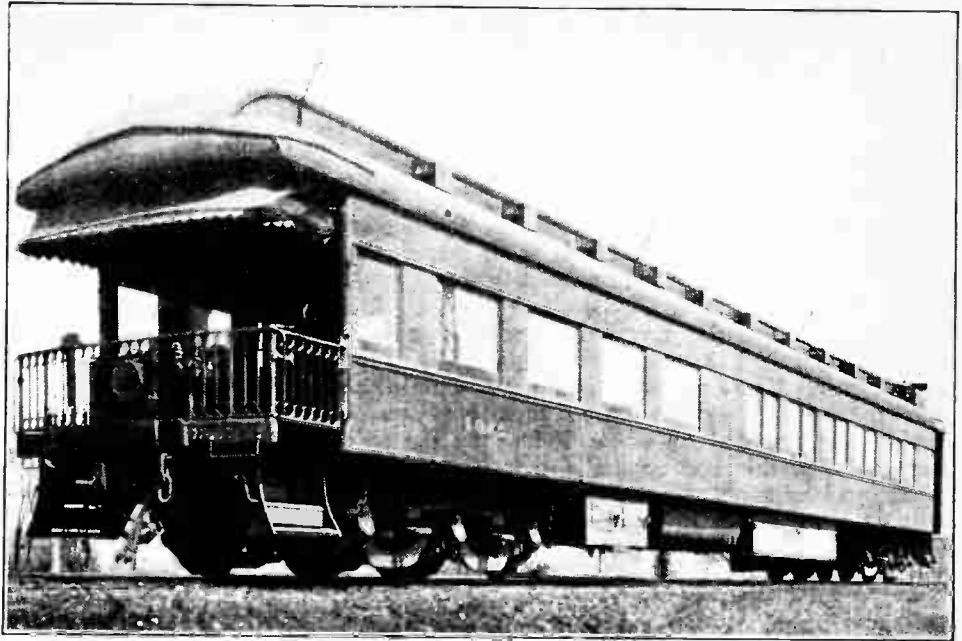

A TRAIN ANTENNA SYSTEM. A typical car on the Canadian National Railways, showing the neat form of aerial employed. Directional effects are said to be almost entirely avoided.

matters of railway speed and punctuality Great Britain is supreme.

It may be urged as an excuse that the journeys undertaken by expresses in this country are relatively short, but the excuse is inadequate. The recent experiments on the Great Western Railway proved conclusively that broadcast reception is by no means unwelcome to the jaded traveller. The combined attractions of passing scenery, popular magazines, and meals in the restaurant car remain insufficient compensation for a state which, viewed in the most favourable light, can only be regarded as comfortable imprisonment. At the risk of being platitudinous, we may say that wireless on a train is a link with the outside world *Verb. sap!*

Northampton.

(During February.)

Great Britain: 2BAX, 2CC, 2DQ, 2QO, 2YQ, 2FL, 2LF, 2OD, 2GO, 2FT, 2SO, 5RZ, 5UY, 5KU, 5WQ, 5RD, 5NY, 5KZ, 5VZ, 5VL, 5GS, 6AL, 6OU, 6UZ, 6DO, 6YX, 6VP, 6PG, 6ZL, 6KK, 6YF, 6JV. France: 8BF, 8DK, 8DL, 8BD, 8ER, 8EF, 8EN, 8FD, 8GRA, 8HBK, 8HFD, 8HS, 8IP, 8IX, 8IN, 8IL, 8TMS, 8KK, 8LDR, 8MB, 8NOS, 8NSD, 8NS, 8PLA, 8SSY, 8TY, 8USS, 8UWA, 8CYJ, 8NP. Belgium: A44, D4, K5, M2, P2, P7, S2, S5, U3, V1, Z22, 4GR, 4RS. Germany: K7, Y4, Y8, Y6, L4, 4CL, 4CN, 4VR. Italy: 1AY, 1BD, 1CE, 1GR, 1MB, 1NC, 1RT. Sweden: SMWS, SMWT, SMNT, SMZZ. Spain: EAR1, EAR9, EAR21, EA4SN? Holland: 0WC, 0PM, 0WB, 0CX. Finland: 2ND, 2NS. Miscellaneous: KDZ1, WWO, WIR, WIZ, NI20, 4TT, GBM, OCNG, TETW, FW,

Calls Heard.

Extracts from Readers' Logs.

AGA, POW, FL, 4YN, EAVA, DCN, GBO, U4IG.

(0-v-0) between 20 and 100 metres.

E. S. Smith.

Punjab, India.

Great Britain: 2CO, 2FA, 2LF, 2XP, 2XY, 5DH, 5FF, 5HA, 5NN, 6AF, 6AF, 6MU, 6RM, 6ZK, 6NY, 6YF. France: 8AX, 8AJ, 8DX, 8FA, 8FR, 8HFY, 8HU, 8HSF, 8JN, 8LB, 8NN, 8ND, 5NF, 8QQ, 8QRV, 8TK, 8YOR, 8UY, FW, FL, MAROC. U.S.A.: 1CMP, 1TRM, 2AMJ, 2LD, 3XO, 4SA, 4RM, 4RU, 5PC, 5UK,

NPL, NRRL, WAP, WIZ, WQO, KYH, KDKA (telephony). Australia: 1AM, 2NR, 2YI, 2CG, 3BD, 5BM, 5EF, 4ZT, 6AG, 6AY. New Zealand: 1AC, 1AS, 2AQ, 5GD, 4AV, 8DB. South Africa: A3E, A4Z, A3B, A5X. Scandinavia: SMTN, SSMZ, SMST, SVNR, SSMX, SMTM. Holland: PCLL, PCJJ, PCUU, PCMM. Russia: RDW, RCRL, RDB, RDZ, RNRL, RJM, RRP. Belgium: B2, P2, D4, O22, 4YZ. Brazil: 1IC, 1AB. Finland: 2CO, 2ND, 2NN. Japan: 1PP (telephony), JDNA, JDES, JRFV. Unclassified: TOGN, 2CS, 2AYC, 2BS, 4XA, 2AHM, 6CK, 1SR, 1DH, 8YQ, WASHE, 6AKX, 8WA, 5YX, 6AFF, 2VR, 5GC, G8Y, 1FX, 6BAJ, 7GR, 3HE, FI8QQ, 8CR, EAR6, KY5, 1CFO, 4D1, 6YN, 8UGY, H3Q, 8BMD.

All below 60 metres.

(0-v-0, Armstrong Super Regenerative, indoor aerial, no earth.)

W. S. Wilkinson and F. Skelton.

HIGH-FREQUENCY RESISTANCE.

Damping Effects in Receiving Circuits, and How They May be Reduced by Reaction.

By E. MALLETT, M.Sc., M.I.E.E.

WHAT are these low-loss coils and low-loss condensers one reads so much about in the advertisements? Are these of such great advantage as they are generally used?

These queries depend for the answer upon a knowledge of what high-frequency resistance really is and how it arises. Every reader by now knows Ohm's Law, which states that the direct current through a circuit is equal to the potential difference divided by the resistance, and that this law applies also to a tuned high-frequency circuit; but the resistance to be used in estimating the current is by no means the resistance that would be measured at low frequencies or on a Wheatstone bridge, but something which is usually many times greater. The reasons for its being so much greater are not simple. The skin effect is well understood, that is, the fact that the current is carried by only a small portion of the wire on its surface, and, in the case of a coil, on the inside surface only; but the increases of resistance found at high frequencies are greater than can be explained in this way. Another factor which enters is the dielectric losses in the insulation between the various turns of wire and in the stray capacities, which cause an increase in the effective resistance. The effective or high-frequency resistance, in fact, is the figure by which the square of the current must be multiplied in order to give the power in watts dissipated in heat.

Selectivity.

When the circuit is detuned a little the currents flowing with a given electromotive force and, therefore, the voltages available for producing audible signals are reduced, and the same is true if the frequency or wavelength of the electromotive forces is altered. In order



Fig. 1.—Tuned aerial circuit (a) loaded by power absorbing detector and (b) the equivalent electrical circuit.

to obtain selectivity, this reduction for a given alteration of wavelength must be as great as possible, and it will be greater the lower the high-frequency resistance.

Evidently, then, on both accounts, in order to obtain strong signals and in order to obtain selectivity, our circuits should have small high-frequency resistance; but we do not achieve this desirable end by just buying "low-loss" coils and condensers, because, generally speaking, when we build up these coils and condensers to make a receiving set we introduce high-frequency resistance,

which is very much greater than that of one special "low-loss" apparatus, so that a few ohms more or less in the latter is of relatively small effect.

Damping Introduced by the Detector.

For instance, a very usual arrangement is to place a parallel coil and condenser in an aerial and connect a detector, say, crystal or grid leak valve rectifier, across them as shown in Fig. 1 (a). In effect now we have shunted our parallel circuit with a series condenser and resistance corresponding to the aerial, and a resistance corresponding to the detector, and on each account the effective high-frequency resistance of the parallel coil and condenser will be increased, and, with the aerials and detectors in common use, very considerably increased. Then, again, the panels on which the condenser is mounted, or the coil holder or the valve from pin to pin, may through dust or moisture or stray Fluxite become dirty and show low insulation resistance. A megohm will introduce about an ohm in receiving London and about 10 ohms in Daventry with the usual broadcast receiving condensers.

Another instance is the tuned anode arrangement in which the parallel coil and condenser are shunted by the valve. The resistance introduced in this way will be about 50 ohms for London and 500 ohms for Daventry, and clearly it is out of all proportion to strive after a reduction of the coil and condenser resistance by an ohm or two. The resistance introduced in this manner is greater the greater the inductance value and the smaller the condenser value for a given wavelength, so one should keep the condenser values as large as possible.

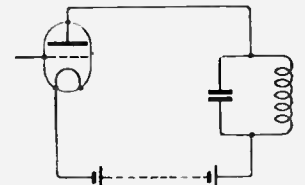

Fig. 2.—In a tuned anode circuit the internal resistance of the valve is in parallel with the tuned circuit.

In all these cases, where a large increase of effective resistance is caused by shunting some necessary apparatus across the oscillatory circuit, an improvement can be effected by shunting only a portion of the coil of the oscillatory circuit, as is indicated in Fig. 3, where (a) shows the "anode tap" and (b) shows an oscillatory circuit with two "taps," one to the aerial and the other to the detector. It might be thought at first sight that as only a portion of the inductance is being used, the voltage obtained must necessarily be smaller than the whole voltage across the coil, but it must be remembered that the currents flowing and therefore the voltages available are greater the smaller the high-frequency resistance, so that there will be in each circuit a best position for the tapping point. It can be shown that the best arrangement is that which makes the effective resistance added to the oscillatory circuit by the shunting apparatus equal to that of the oscillatory circuit alone.

High-frequency Resistance.—

Now comes the question of how to arrange this tapping in practice. With the usual plug-in coils so much in favour to-day it is admittedly difficult; the only way would be to bring out one or two leads from suitable points to separate terminals; but with the old arrangement of a cylindrical coil with a sliding contact it is comparatively simple. Here, however, another difficulty arises. The sliding contact usually touches at least two and sometimes more wires, so that turns are shorted, with

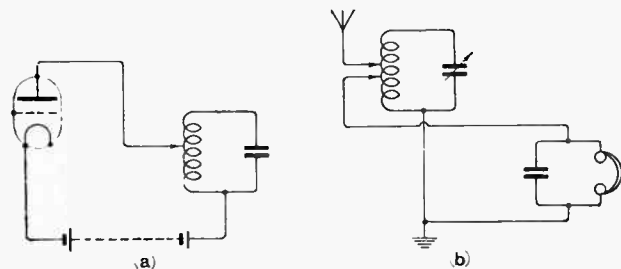

Fig. 3.—By connecting the loading resistance across a part only of the inductance, the damping in an oscillatory circuit may be reduced.

the result that the effective inductance is reduced and high-frequency resistance is again introduced. There are, however, coils where this disadvantage is not experienced. One arrangement which successfully overcomes the difficulty is a split contact—a contact made half of insulating and half of conducting material, as indicated in Fig. 4. The top of the contact is square in a square hole to prevent rotation. With two such contacts on a cylindrical coil the best positions for the aerial tap and detector tap can easily be found. Incidentally the single-layer cylindrical coil is the best form from the point of view of low resistance.

Reduction of High-frequency Resistance by Valves.

With valves the effective high-frequency resistance of an oscillatory circuit can be reduced to a very small figure. In fact, it can be made "negative" when high-frequency currents flow in the circuit without any applied high-frequency electromotive force; the arrangement oscillates by itself. The reduction of high-frequency resistance can be carried out in two ways; by connecting the oscillatory circuit whose resistance is to be reduced across the grid and filament of the valve, and coupling back from the plate circuit; and, second,

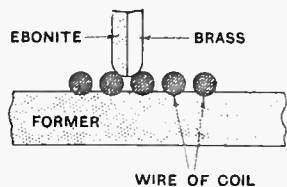

Fig. 4.—Special contact which does not short-circuit turns in the coil winding.

latory circuit to the plate and coupling back to the grid. These arrangements are shown in Figs. 5 (a) and (b), where the coupling shown is by mutual inductance. There are other ways as by common inductances or condensers, but mutual inductance is generally most convenient.

The reduction of resistance actually effected depends upon the valve and the batteries and upon the value of mutual inductance. As the latter is increased the effective resistance is reduced (provided, of course, that the coils are connected the right way round—if one coil is reversed, the effective resistance will be increased), and

finally the circuit will oscillate. The limit to which the resistance can be reduced depends upon the stability of the circuit. The greater the coupling required to reduce the resistance to a certain figure, the more likely is the circuit to burst into oscillations with small changes in the circuit conditions, such as alterations of battery voltages or valve alterations. The smaller the initial high-frequency resistance the smaller is the coupling required. On this account the circuit (a) has an advantage over the circuit (b), since the former with suitable grid bias is not initially damped by the valve, as is the latter.

Crystal Circuits.

Fig. 6 shows a very popular receiving circuit in which the high-frequency resistance of the aerial circuit is reduced by the detecting valve itself in accordance with the scheme of Fig. 5 (a). The primary of the low-frequency transformer (or the headphones) is shunted by a condenser in order to offer only a small impedance to the high-frequency currents which are flowing.

In Fig. 6 the valve is used for two purposes—amplification and detection—and very good results can be obtained by this arrangement. But the best conditions for high-frequency resistance reduction or amplification are not

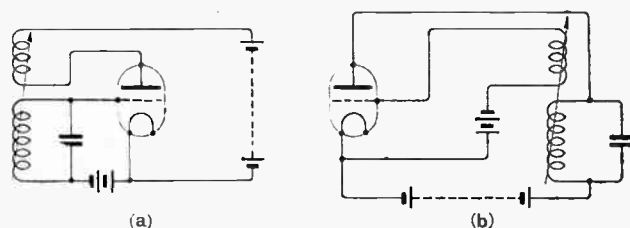

Fig. 5.—Reduction of high-frequency resistance by reaction.

the same as those for detection, and better reproduction would be expected by using separate devices for each purpose.

The crystal detector is admittedly capable of giving very excellent results. In fact, it is probably better than any other arrangement for dealing with large signals without distortion. But it seriously increases the high-frequency resistance of any oscillatory circuit across which it is shunted. This, however, can be overcome by means of a valve. Fig. 7 shows two schemes for doing this, based on the schemes (a) and (b) of Fig. 5. In each the resistance of the aerial circuit shunted by the crystal detector and phones (or primary of intervalve transformer) is reduced by the valve. The arrangements shown are those that would be employed in using plug-in coils. It would be better to use tapping points on a cylindrical coil, as described previously, obtaining the reaction by means of a small rotating coil within the cylinder. These arrangements give very pure reproduction. They have

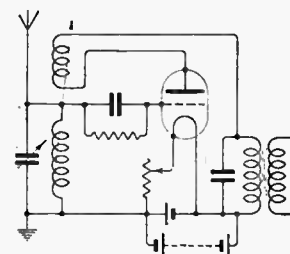

Fig. 6.—Valve detector circuit in which the high-frequency resistance of the aerial circuit is reduced by reaction.

High-frequency Resistance.—

another advantage. It often happens that one's battery is exhausted when one is particularly anxious to receive a time signal. With these arrangements, even though the

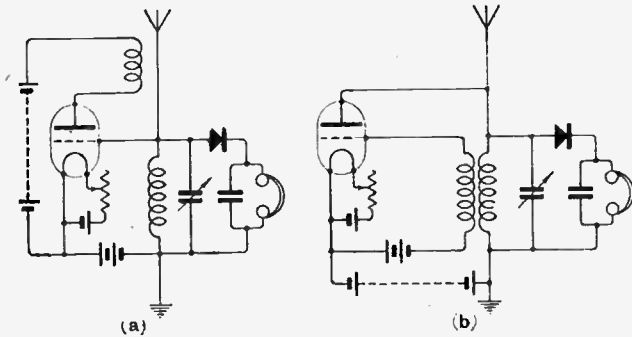

Fig. 7.—Selective valve-crystal circuits.

valve is not alight, signals are still received without any circuit modifications. The valve when in operation simply reduces the high-frequency resistance of the circuit, and thus increases the loudness of the signals and improves the selectivity.

A Reflex Circuit.

Since the valve is used as a resistance reducer only, and the adjustment for this purpose is exactly the same as that for low-frequency amplification, the arrangements of Fig. 7 lend themselves very well to a reflex modifi-

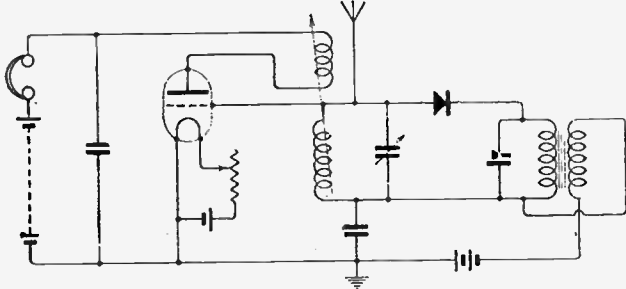

Fig. 8.—Reflex circuit developed from circuit in Fig. 7 (a).

cation, by means of which the valve can be used over again to give a low-frequency amplification. Such a modification made on the circuit of Fig. 7 (a) is shown

in Fig. 8. The primary of an intervalve transformer replaces the headphones, and the secondary of the transformer is put across the grid and filament of the valve by placing a condenser in the aerial circuit. The phones (or loud-speaker) are placed in the plate circuit of the valve, and they must be shunted by a condenser in order to pass the high-frequency currents, or, better still, the condenser may be placed across both battery and phones, as shown. The grid biasing battery is placed as shown in the transformer secondary circuit.

Crystal as a Stand-by.

If a receiving set is built on these lines and it is required to receive signals when the valve has failed, all that is necessary is to arrange to plug in the telephone in place of the transformer primary.

An advantage of this reflex circuit over some that are in use is that the further stages of low-frequency amplification can be added without difficulty. One additional stage added is shown in Fig. 9.

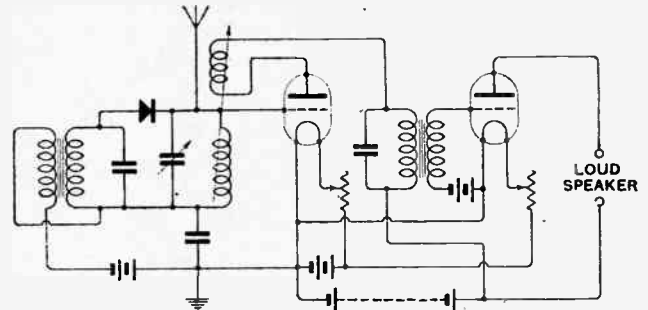

Fig. 9.—The circuit of Fig. 8 with the addition of a stage of L.F. amplification.

In the arrangements of Fig. 8 and Fig. 9 it would be better to have the aerial and the crystal detector tapped on to the tuning coil at suitable points closer to the earth end, as explained before, but the grid tap can be at the end as shown, as, using negative bias on the grid, the valve itself should not introduce any high-frequency resistance. If variometer tuning of the aerial is employed the variable condenser is simply omitted and the tappings made on the variometer stator.

With signals barely audible on headphones with the crystal detector alone, the arrangement of Fig. 9 gives quite fair strength on a loud-speaker.

BOOK REVIEW.**KELLY'S DIRECTORY OF THE ELECTRICAL INDUSTRY, WIRELESS AND ALLIED TRADES, 1926.**

THIS excellent directory is indispensable to all those who wish to keep in touch with wireless manufacturers, consulting electrical engineers, or power, lighting, and traction undertakings. The high standard noticeable in previous years is fully maintained in the 1926 edition, and it is evident that no pains have been spared to bring the varied information up to date. The area covered includes Great Britain, the principal industrial centres of Ireland, the Channel Islands, and the Isle of Man.

As in previous issues, it comprises (1) a Geographical Section in which particulars of electrical supply undertakings, and the names and addresses of engineers and traders are

arranged alphabetically according to counties; (2) an alphabetical list of public lighting, power, and traction undertakings; (3) electrical engineers and traders in the London area, arranged both alphabetically and classified under their respective trades or professions; (4) similar lists for country districts, including Ireland, the Channel Islands, and the Isle of Man; and (5) a useful list of proprietary articles and trade names.

A proof of the thoroughness with which this directory has been compiled is the fact that it contains the names and addresses of some 4,500 wireless retailers. The price of the directory is 30s., post free, and the publishers are Kelly's Directories, Ltd., 186, Strand, London, W.C.2.

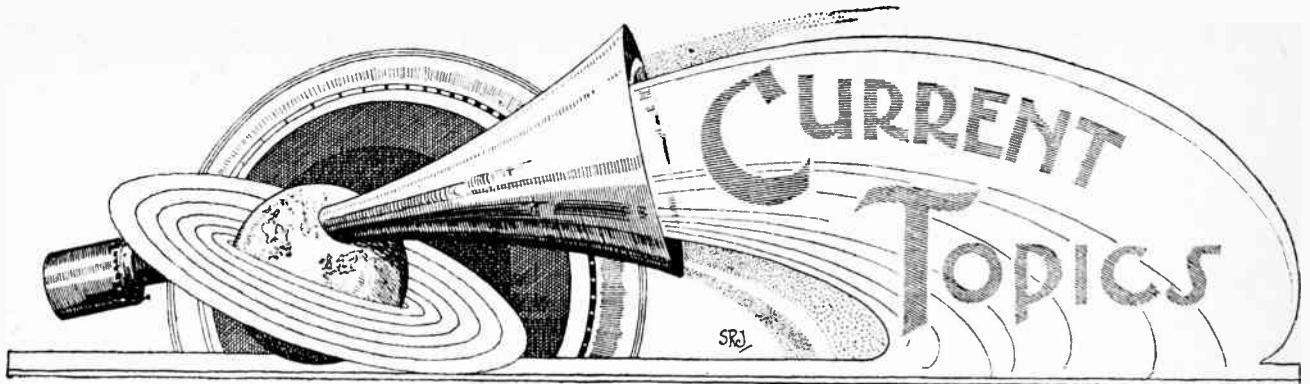

Events of the Week in Brief Review.

HAPPY MOSCOW.

Public reading rooms in Moscow have been equipped with broadcast receivers so that poor persons unable to purchase a set are able to listen.

○○○○

INCREASED POWER AT ECOLE SUPÉRIEURE.

Many listeners will learn with pleasure that the popular Paris broadcasting station, Ecole Supérieure des P.T.T., is increasing its power to 10 kilowatts.

The French postal authorities announce the early opening of new stations at Bordeaux, Lille, Angers, and Strasbourg.

○○○○

TRACKING BANDITS BY WIRELESS.

In Burma, which would appear to be the criminal's paradise—326 murders were committed in the first quarter of this year—wireless is being resorted to as a means of tracking offenders. Portable wireless installations, says a Rangoon message, are proving of inestimable value in locating wandering Dacoit bands on the frontier.

○○○○

NEW WIRELESS WONDER ?

A writer in the daily Press last week described a wireless-controlled aeroplane now "taking shape" which will enable operators on the ground to see, by means of television, the same view as would be obtained if they were seated in the cockpit of the aeroplane. Fortunately for the wireless pirates there is no suggestion that the device will be used by the P.M.G.

○○○○

"AIR PIRACY" IN AMERICA.

The lengthy dispute between the Zenith broadcasting station W.J.A.Z., Chicago, and the U.S. Government on the question of transmission hours has ended with a victory for the broadcasting station. For transmitting at times other than the one hour a week allowed by the State, the Zenith officials had been charged with "air piracy." The legal decision against the Government denies that Secretary Hoover has the power to regulate the ether, and unless new legislation is enacted by Congress, the American ether may become even more chaotic than it is at present.

ONLY ONE MISS!

By the middle of this month proceedings had been taken against 135 persons for installing wireless sets without a licence, stated the Postmaster-General. 134 convictions had been secured.

○○○○

AUSTRALIAN GOVERNMENT AND WIRELESS.

A Melbourne message states that the Commonwealth Government is likely to take over the whole of the broadcasting operations in Australia in the near future.

○○○○

BROADCASTING AND ULSTER CENSUS

Broadcasting was enlisted as an aid to the authorities during the census of population taken in Ulster last week. Prior to the Census minute instructions for filling up the forms were given from the Belfast broadcasting station.

ANOTHER BEAM STATION.

The beam transmitting station at Grimsby is scheduled for completion on June 11th.

○○○○

ABANDONED WIRELESS EXHIBITION.

From the Birmingham Chamber of Commerce we learn that the arrangements for a wireless exhibition at Bingley Hall, Birmingham, from May 19th to 29th, in connection with the Queen's Hospital Extension Fund, have been abandoned owing to insufficient trade support.

○○○○

NOTES ON INTERVALVE COUPLING.

At the ordinary meeting of the Radio Society of Great Britain, to be held this evening (Wednesday) at the Institution of Electrical Engineers, Savoy Place, W.C.2, at 6 o'clock (tea at 5.30), Mr. H. L. Kirke, M.I.Rad.E. (of the B.B.C.), will deliver a lecture entitled "Some Notes on Intervalve Coupling."

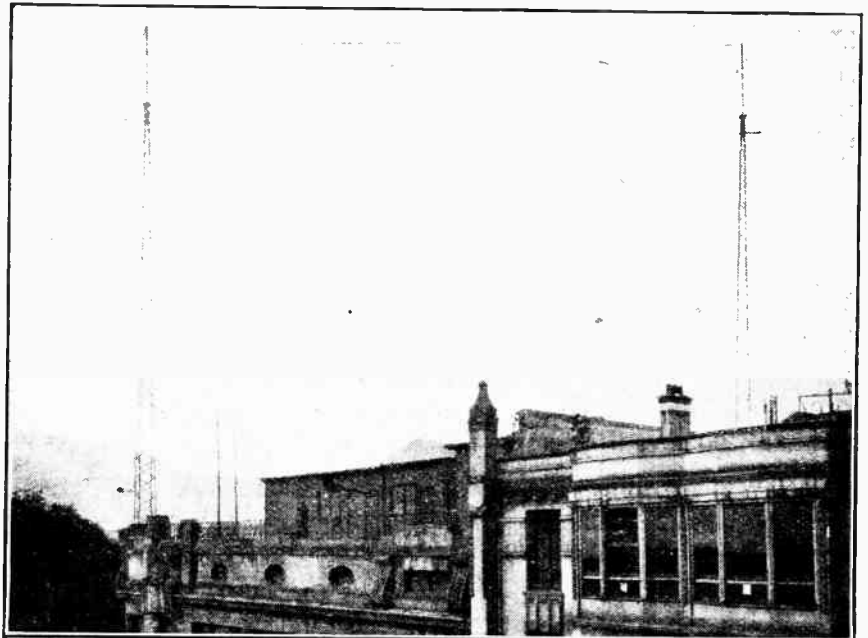

IN SUNNY SPAIN. The Bilbao broadcasting station EAJ11, with its picturesque background of hills. Note the loud-speaker on the balcony, enabling passers-by to hear the concerts.

Current Topics.—

IF SUMMER COMES . . .

The crystal user whose distance from a broadcasting station results in inferior reception during the hours of daylight may have reason to lament the advent of Summer Time. The only appropriate advice seems to be: "Clean the set and have patience." ○○○○

INTERNATIONAL WIRELESS COMPETITIONS.

"Some of the strangest-looking and yet most effective receivers ever dreamed of" are to appear at the Radio World's Fair in New York during the autumn, according to a prophecy made by the promoters.

Of pre-eminent interest is to be the International Home Construction Contest, in which amateurs all over the world are invited to compete. The competition will be open for broadcast receivers as well as short-wave sets.

During the display international competitions will be conducted in code transmission between amateurs on both sides of the Atlantic.

○○○○

BROADCASTING COPYRIGHT IN U.S.A.

In giving evidence recently before the joint committee on Patents of the Federal Senate and House of Representatives (says *The Times*), Mr. W. E. Harkness, a vice-president of the American Telephone and Telegraph Company, gave the following table of fees paid for broadcasting copyright music controlled by the American Society of Authors, Composers, and Publishers, which had been charged

with holding a monopoly on productions: With an hour cost of 12 cents to \$1.60, stations of 500 watts pay fees ranging from \$100 to \$2,500 per annum; stations of 1,000 watts, with an hour cost of 12 to 60 cents, pay from \$200 to \$1,000 per annum; with an hour cost of 33 cents to \$1.92, stations of 1,500 watts power pay from \$500 to \$3,000 per annum, and stations of 5,000 watts, with an hour cost of 23 cents to \$1.16, pay from \$300 to \$2,500 per annum.

"WIRELESS WORLD" READERS' BALLOT.

We print below the list of successful entrants in *The Wireless World* Readers' Ballot in connection with the issue of March 24th. This feature proved exceedingly popular, and the keenness of the ballot may be judged from the fact that most of the prizes are divided.

1st Prize, £20.

Dr. C. B. Childs, Edinburgh.

2nd Prize, £10.—3 competitors tie. Amount divided, £3 6s. 8d. each.

Charles F. Crompton, Tadworth, Surrey.

George Henry Dew, Brixton, S.W.9.

E. T. Tregenza, Wallasey, Cheshire.

3rd Prize, £5.—2 competitors tie. Amount divided, £2 10s. each.

H. W. Kendall, Dulwich, S.E.22

Ernest E. Uppington, Blyth Road, W.14.

15 Prizes of £1 each.—29 competitors tie. The combined amount is divided amongst them as prizes of 10s. 6d. each.

The following are prize-winners:—

- J. Andrew, Clayton, Manchester.
- Lt.-Commander W. T. Bagot, London, S.W.7.
- Bertrand William Bairston, Farnboro', Hants.
- George W. Blow, c/o Forrest, Dundee.
- Norman W. D'Arcy, London, N.W.3.
- William Dickens, Loughborough, Leicestershire.
- Charles Edwards, London, S.E.17.
- W. D. Fisher, Holloway, N.7.
- J. S. Hasdell, Tottenham, N.17.
- W. H. Judges, London, N.W.1.
- B. Kaplan, London, S.E.1.
- C. F. Keller, Bournemouth.
- Reginald S. Kelway, Milford Haven, S. Wales.
- A. W. King, Woodbridge, Suffolk.
- G. S. Luke, Chelsea, S.W.10.
- E. Mace, Maidstone, Kent.
- W. Morley, Portsmouth.
- G. O. Phillips, London, S.W.2.
- A. R. Porter, Poole, Dorset.
- William Pulling, Portsmouth.
- E. J. F. Pulling, Reigate, Surrey.
- William Raybould, jun., Walsall, Staffordshire.
- W. Redfern, Ore, Hastings.
- G. Sharnan, Staines.
- A. G. Smeeton, Sheffield.
- Granville Smethurst, Westthoughton, Lancs.
- James B. Smith, Glasgow.
- E. S. R. Thorne, West Worthing, Sussex.
- Ernest Wainwright, Lincoln.

TRANSATLANTIC PICTURE TRANSMISSION.

PICTURE transmitting equipment has now been installed at Radio House, the central telegraph office of the Marconi Company. The system employed has been developed by Mr. R. H. Ranger, and was recently fully described in the pages of this journal. The image is recorded on transparent celluloid, and is analysed by a narrow beam of light while a photo-electric cell converts the fluctuating light intensities into an interrupted current which in turn is caused to break up the continuous waves of the transmitting station into a series of wave trains. The transmitting and receiving sets are synchronised by means of tuning forks. Our illustration is a reproduction of a cheque recently transmitted across the Atlantic.

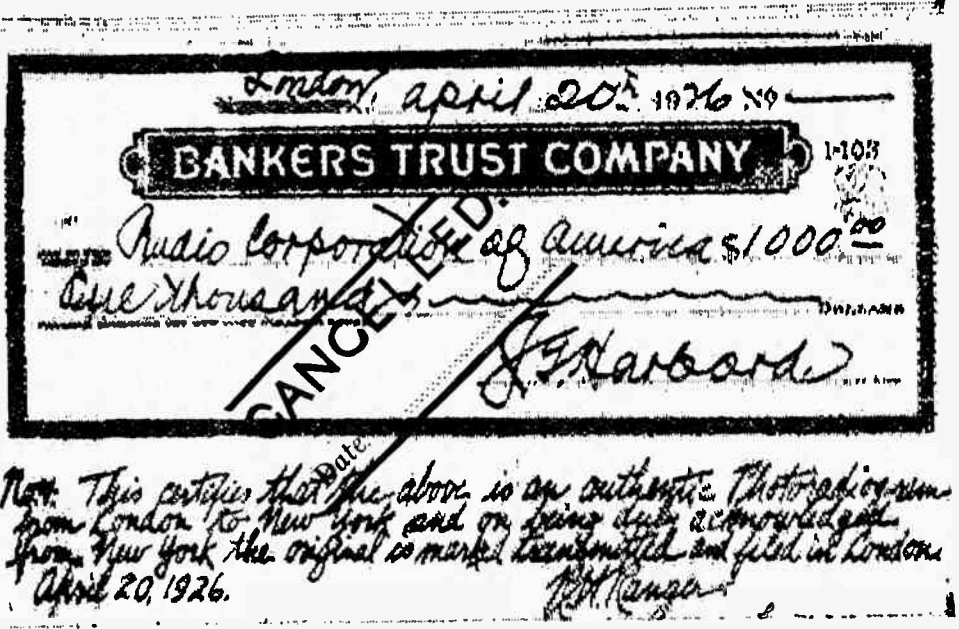

General Harbord's cheque transmitted by wireless.

PIONEERS of WIRELESS

BY ELLISON HAWKS F.R.A.S.

14.—Highton and Other Pioneers.

HENRY HIGHTON (1816-1874), who, with his brother Edward, carried out many experiments in wireless telegraphy, was educated under the famous Dr. Arnold, of Rugby, and was appointed Principal of Cheltenham College in 1859.

About 1852 he succeeded in communicating over a distance of about a quarter of a mile with bare wires sunk in canals. "The result," wrote Edward, "has been to prove that telegraphic communications could not be sent to any considerable distance without the employment of an insulated medium."

His brother Henry was more optimistic, however, and, believing in the practicability of the scheme, continued his experiments on the banks of the Thames. In a paper, read before the Society of Arts in 1872, he stated that for many years he had "been convinced of the possibility of telegraphing for long distances without insulation, or with wires very imperfectly insulated; but till lately I had not the leisure or opportunity of trying sufficient experiments bearing on the subject. I need hardly say that the idea has been pronounced on all hands to be entirely visionary and impossible, and I have been warned of the folly of incurring any outlay in a matter where every attempt had hitherto failed. But I was so thoroughly convinced of the soundness of my views, and of the certainty of being able to go a considerable distance without any insulation, and any distance with very imperfect insulation, that I commenced, some three or four months since, a systematic series of experiments with a view to testing my ideas practically."

In these experiments Henry Highton transmitted signals from various lengths of wire, submerged in the Thames, and found that he could, without difficulty, exceed the limits that had previously been supposed to be practicable. He next tried transmitting with wires laid across the Thames, but had them broken five or six times by the strength of the current and by barges dragging their anchors across them.

Subsequently he placed the receiving instrument in a room in his house on the banks of the river, and sent a boat down stream with trailing wire and a battery. Signals were made at different distances, and so successful was the experiment that he obtained leave to lay wires in Wimbledon Lake, where further experiments were carried out.

The result of all this work was that Highton found water to be "so perfect an insulator for electricity of low tension that wires charged with it retained the charge with the utmost obstinacy; and, whether from the effect of polarisation (so-called), or, as I am inclined to suppose, from electrification of the successive strata of water surrounding the wire, a long wire, brought to a state of low electrical tension, will retain that tension for minutes, or even hours. Notwithstanding attempts to discharge the wire every five seconds, I have found that a copper surface of ten or twelve square feet in fresh water will retain a very appreciable charge for a quarter of an hour. Even when we attempt to discharge it continuously through a resistance of about thirty units [ohms] it will retain an appreciable, though gradually decreasing, charge for five or six minutes."

His experiments as to what extent the "principle of non-insulation" could be carried led him to state that "though there are difficulties in very long depths absolutely uninsulated, yet it is quite feasible to telegraph even across the Atlantic . . ."

He proposed to use a "gold-leaf instrument, constructed by me for telegraphic purposes twenty-six years ago, acted upon by a powerful electromagnet, and with its motions optically enlarged."

He was very optimistic of success, as may be gathered from his statement that "I do not hesitate to say that it is possible, by erecting a very thick line wire from the Hebrides to Cornwall, by the use of enormous plates at each extremity, and by an enormous amount of battery power—*i.e.*, as regards quantity—to transmit a current which would be sensibly per-



Henry Highton.

Pioneers of Wireless.—

ceived in a similar line of very thick wire, with very large plates, on the other side of the Atlantic." He pointed out, however, that "the trouble and expense would probably be much greater than that of laying a wire across the ocean."

* * * * *

The experiments of Morse, Lindsay, and the Hightons, had now become common knowledge, and as a result of the publicity given, many additional workers were attracted by the subject, both in this country and abroad. Bonelli in Italy; Gintl, the inventor of a duplex telegraph, in Austria; and Bouchotte and Douat in France, engaged themselves in experiments. As their researches do not show any striking advances on the methods of which Morse may be regarded as the pioneer, we shall pass them by.

It may be interesting, however, to mention in passing that during the winter of 1870-1, when Paris was besieged by the Germans, a French electrician named Bourbouze proposed to re-establish communication between Paris and the provinces by sending strong electric currents into the River Seine, at a point outside the German lines. He suggested that, by means of a metal plate sunk in the river, these currents could be picked up in Paris with a delicate galvanometer. After experimenting successfully, another worker left the besieged city by balloon, and, descending outside the enemy's lines, proceeded to Havre to order the necessary apparatus from England. When this reached France, however, the Seine was completely frozen over, and before a thaw set in an armistice was declared, and the project was abandoned.

The Experiments of Mahlon Loomis.

In conclusion, mention must be made of the experiments of a remarkable man—Mahlon Loomis, an American dentist. In 1872 he proposed to draw electricity from the higher atmosphere, and to use the currents so obtained for telegraphic purposes. Loomis based his proposal on the suggestion that the earth's atmosphere is charged with electricity, the strength of which increases with the height. He assumed that this atmospheric electricity might be drawn without difficulty from any particular stratum, and that thus an aerial telegraph might be established. He experimented in Virginia, selecting for the purpose two lofty mountain peaks, ten miles apart. From here he sent up two kites, connected to the ground by fine copper wires. To one he connected a detector, and

to the other a switch that, when closed, connected the wire to the earth. We are told that the experiment was successful, and that by making and breaking the earth connection messages were sent and received, a result that created a considerable sensation in America.

Doubtful Results.

The following curious story from the *New York Journal of the Telegraph* (March 15th, 1877) shows, however, that the technical world never took the proposal very seriously:—

"The never-ending procession of the would-be inventors—who from day to day haunt the corridors and offices of our Electrician's Department—was varied the other day by the appearance of a veritable lunatic. He announced that the much-talked-of discovery of a few years ago, aerial telegraphy, was in actual operation here in New York. A. M. Palmer, of the Union Square Theatre, together with one of his confederates, alone possessed the secret, he said. They had, unfortunately, chosen to use it for illegitimate purposes, and our visitor felt it to be his solemn duty to expose them. By means of a \$60,000 battery they transmitted the subtle fluid through the aerial spaces, read people's secret thoughts and knocked them senseless in the street. They could even burn a man to a crisp, miles and miles away, and he no more knew what had hurt him than if he had been struck by a flash of lightning—as indeed he had! The object of our mad friend in dropping in was merely to ascertain how he could protect himself from Palmer's illegitimate thunderbolts.

"Here our legal gentleman, lifting his eyes from *Curtis on Patents*, remarked, 'Now, I'll tell you what to do. Bring a suit against Palmer for infringement of Mahlon Loomis's patent. Here it is—No. 129,971. That'll fix Palmer!'

"But the madman protested that this would take too long, and meanwhile he was in danger of his life every minute. He casually remarked that it had occurred to him that by appearing in the streets in a robe of pea-green corded silk, guttapercha boots, and a magenta satin hat with a blue glass skylight in the top of it, he would be effectually protected from injury during his daily perambulations!"

We may quite imagine that the sensation-loving American journalists were disposed to agree. Whether or not the madman ever appeared in public in this extraordinary costume the story does not say!

NEW CLIX WANDER PLUGS.

IT is a common occurrence to find that the wander plugs used for tapping off suitable H.T. potentials may provide a good fitting into the sockets of one high-tension battery, yet with another are loose and give an intermittent contact. This difficulty is overcome in the wander plug recently introduced by Autoveyors, Ltd., 84, Victoria Street, Westminster, London, S.W.1.

The wander plug is hollow, and is cut through in the form of a double spiral, which permits of the plug being com-



The new CLIX wander plugs will make a tight fit into the sockets of almost any type of high-tension battery.

pressed to a smaller diameter so that it can accommodate itself to the small size socket fitted to certain types of high-tension batteries. A hard contact is made with the socket, and a liberal area of contact is obtained.

The flexible lead is attached by inserting the strands of wire in a pair of grooves and screwing down the insulating sleeve.

This wander plug is a considerable improvement on the tapering solid plug or split pin connector.

THE NEW VIENNA HIGH-POWER STATION.

A Description of Austria's "Daventry."

By PAUL S. GORDON FISCHEL.

THE erection of a high-power broadcasting transmitter for Vienna was planned by the Austrian broadcasting company, the "Österreichische Radio Verkehrs A.G. (Ravag)," at its foundation. To gain experience, the old spark transmitter in the former Marine Ministry was replaced by a Telefunken telephony transmitter of 2 kW. (about 700 watts in the aerial), which works satisfactorily for Vienna and its immediate surroundings. Independent of this first station and its various relay stations (Graz, Innsbruck, Salzburg, and Klagenfurt), the high-power transmitter will serve crystal receivers in areas hitherto not reached by the original broadcasting system.

It was first planned to erect the new transmitter on ground between the Danube and its back-waters, to ensure a good earth connection, but as the town, with all its mist and steam, would have come between the station and the western part of Austria, where the majority of the country listeners-in are situated, a hill called "Rosenhügel," lying to the south of Vienna, was finally chosen.

The station house and the aerial system are erected on top of the great reservoir tanks for Vienna's drinking-water supply.

The Aerial System.

The aerial is supported by three lattice steel masts, each 280ft. high; the concrete foundation of two of the masts is placed directly on the tank walls (see Fig. 1). The

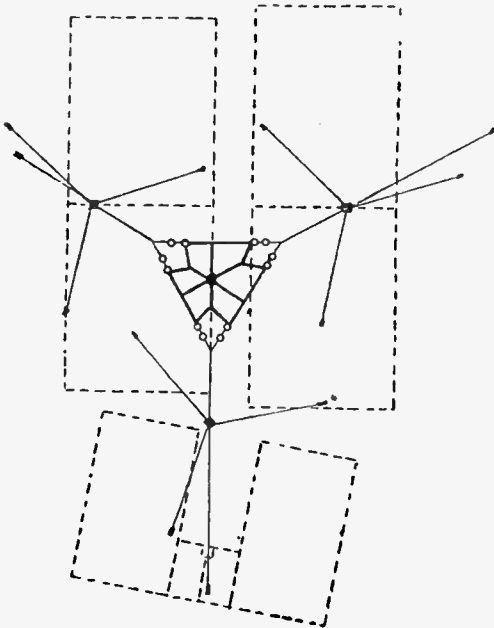

Fig. 1.—Plan of the aerial system. The dotted lines indicate the position of underground water tanks.

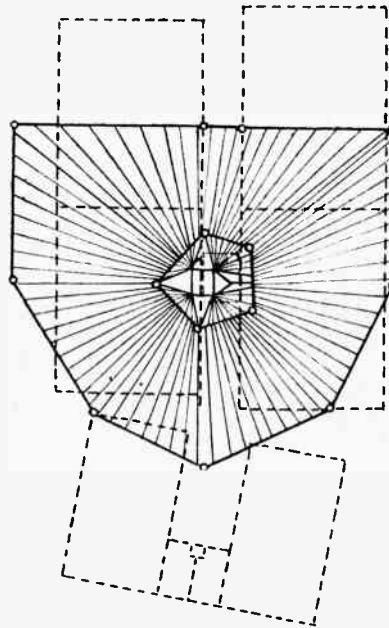
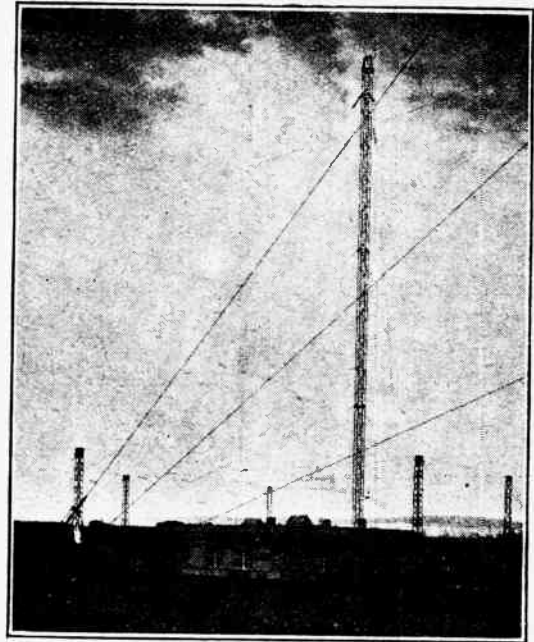

Fig. 2.—Layout of the counterpoise. The aerial and masts have been omitted for the sake of clearness.



section of these masts is a square with a side length of 4ft. 7in.; each of them has an approximate weight of 50 tons. They are held by treble stay wires on three sides, and are connected with their foundation by steel joints and special porcelain insulators. The three masts are placed 400ft. apart. In the centre of the triangle so formed stands the station building. The unusual form of the aerial is shown in Fig. 1. It is constructed of

stranded phosphor-bronze wire, and is held as far as possible from the masts. The six-wire cage lead-in is fastened to the aerial in the centre of its plane. The capacity of the aerial is approximately 0.003 mfd., and its natural wavelength about 500 metres.

Counterpoise Earth.

The counterpoise is suspended on fourteen masts, 33ft. high, and its shape may be seen from Fig. 2. To avoid changes in the aerial capacity when the whole system swings in storm, the plane directly beneath the aerial triangle is left free. The five centre masts allow a quick opening of a part of the counterpoise when the aerial has to be pulled down for repair work.

A large lead-in insulator connects the six-wire cage with the transmitter. For the counterpoise lead-in a smaller insulator is provided. Various switches connect the aerial, the counterpoise, and the different masts with the

The New Vienna High-power Station.—

earth—that is to say, the water in the tanks beneath the station, if required.

The Power Supply.

The public supply system of Vienna serves the station with three-phase alternating current at a potential of 220 volts and a frequency of 50 cycles. The usual method of high-tension supply for the transmitting valves through high-frequency alternators has been avoided, and a special transformer is connected directly to the 220-volt A.C. lines. On its secondary side, the three phases are divided into six, each of which is rectified by a separate valve, and has a potential of 10,000 volts (see circuit, Fig. 3). The A.C. ripple is thus reduced to a minimum. A separate input transformer lowers the input voltage in steps from 220 volts to 90 volts when it is desired to work the transmitter at less than full power, when it is being adjusted, and to allow a gradual starting up of the gear. The rectifier consists of six air-cooled high-vacuum rectifier valves designed for an anode potential of 10,000 volts. They may be seen on top of the power supply panel in

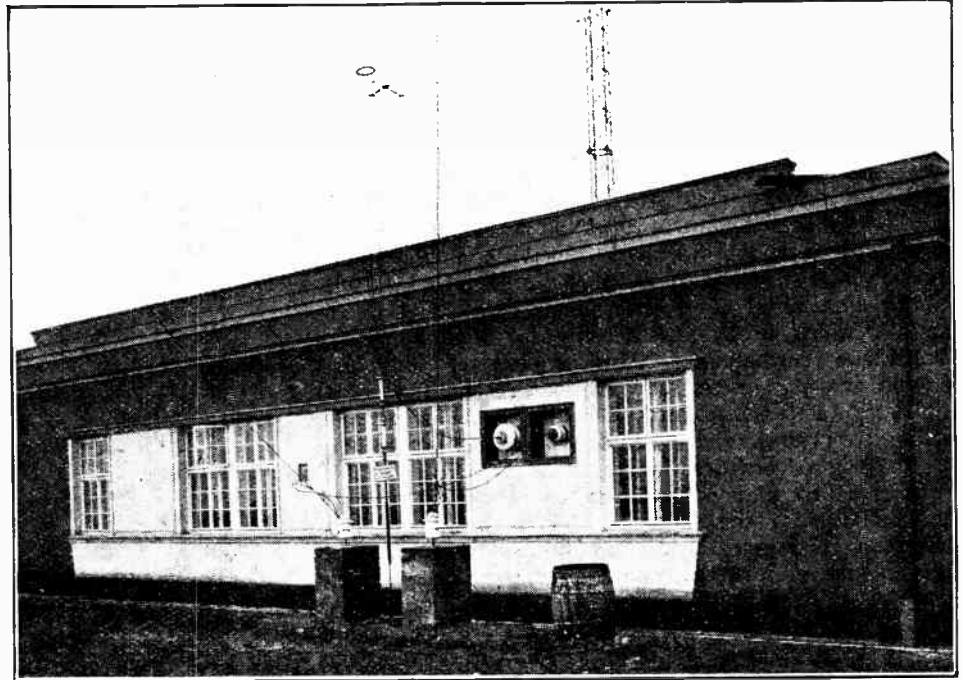

Lead-in insulators for the aerial and counterpoise.

the photographs. These valves are of the Telefunken RG6r type, and give an emission of about 3 amperes from a filament rated at 32 volts and 16 amperes. The D.C. consumption (input) of the transmitter is 28 kilowatts—that is to say, 2.8 amperes at 10,000 volts. Although each valve gives only about 0.47 ampere, its emission has to be high, as it works only over a small part of the whole A.C. period. The A.C. current for heating the filaments of the rectifier valves is supplied through a transformer from the public supply lines.

Safety Devices.

The power supply panel contains an ammeter to measure the anode current of the valves, two voltmeters, one for the potential of the supply lines and one for the plate voltage of the rectifier. a step switch for the input transformer, a switch for the filament transformer, and finally the master switch. The latter is closed by hand and opened automatically by a press-button; safety switches at the door to the inside of the transmitter and at other places, and panels

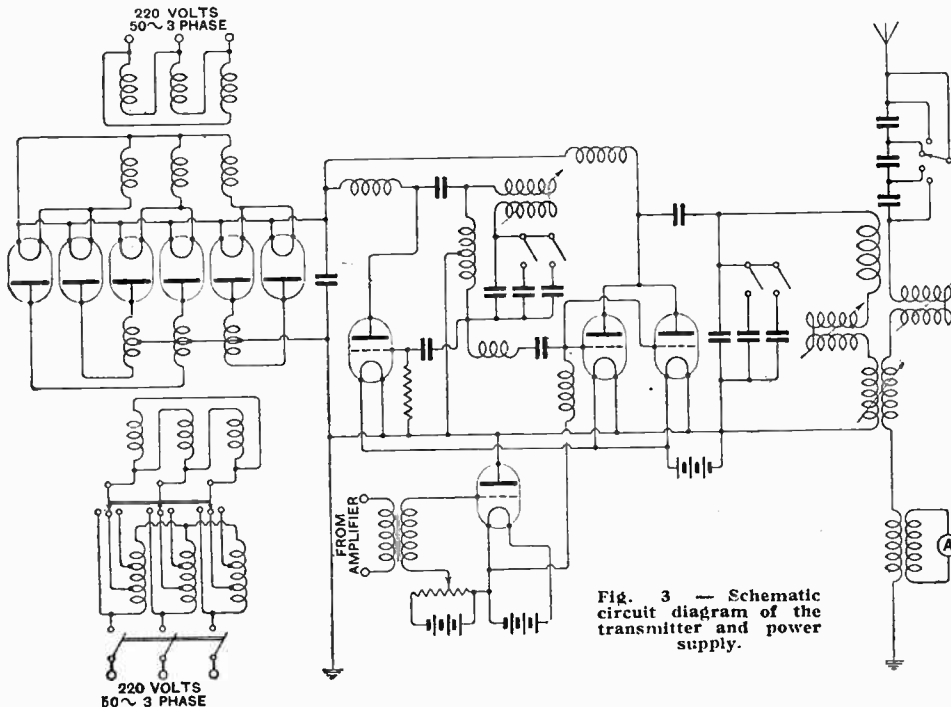
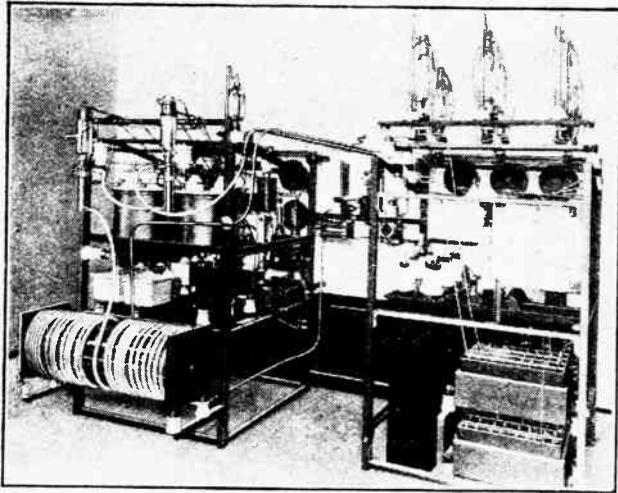

Fig. 3 — Schematic circuit diagram of the transmitter and power supply.

The New Vienna High-power Station. -

safeguard the engineer on duty from approaching danger points whilst power is on, and protect the valuable transmitting valves from being destroyed.

A filter circuit for smoothing the A.C. ripple (not shown in Fig. 3) couples the rectifier to the transmitter. It consists of two banks of condensers of 4 microfarads each (seen in the bottom right-hand corner of the photograph below) and of a special iron-core choke.



Rear view of the master oscillator, modulator and power amplifier panel (left) and the rectifier panel (right).

As may be seen from the circuit in Fig. 3, the transmitter works on the independent drive system. The master oscillator comprises an air-cooled Telefunken 7 kW. valve of the R.S.-47 type. The filament current of 8 amperes and 16 volts is taken from the filament battery for the power amplifier. As this battery supplies 40 volts, a suitable resistance is put in series with the filament. The anode potential of 10,000 volts is supplied by the above described rectifier. The valve may be seen in the lower photograph on top of the stand for the master oscillator, the modulator, and the power amplifier valves. The oscillatory circuit is tuned by a fixed inductance, a series of Dubilier condensers, and a variometer for fine tuning, which are adjusted to the desired wavelength. The master oscillator, which generates, for the grid excitation of the power amplifier, a radio frequency voltage of approximately 600 is connected with the latter by a special coupling condenser. A particular advantage of

this gear is the use of only two main transmitting valves at an output energy as high as 25 kilowatts. The transmission of harmonics is thus reduced to a minimum. Two Telefunken R.S.204 valves, with water-cooled anodes, are arranged in parallel. As the power of the transmitter, curiously enough, proved insufficient for different parts of Vienna, experiments are being made at present with the use of three such valves. They are constructed for an output power of 10 kilowatts each, at an anode potential of 10,000 volts. The filament consumes a current of 25 amps. at 35 volts, and gives an emission of about 6 amps.

Water Cooling System.

As the dissipation of heat at the anodes of these valves is very great, a water cooling device is used to carry away the heat energy lost on the copper plates; the output of the valves is thus materially increased. The water jackets, in which the cylindrical plates of the valves are clamped in position, are arranged in series with the water supply pipes. Since the jackets are at the high plate potential of 10,000 volts, it is necessary to insulate the water supply, which is achieved by connecting the jackets to the supply pipes by means of rubber tubing, conveniently arranged in coils. The two amplifier valves and the hose coil may be seen at the back of the master oscillator-modulator panel. As the Vienna drinking water has sufficient pressure, no pumping device is needed. At a small board beside the power control panel, the valves for regulating the flow of water are arranged; they are adjusted to allow about 30 gallons per minute to flow through the cooling system. A manometer on the same board indicates the actual pressure, and by an automatic device immediately opens the master switch, if the pressure fails. Two thermometers indicate the temperature of the cooling water before and after passing the jackets.

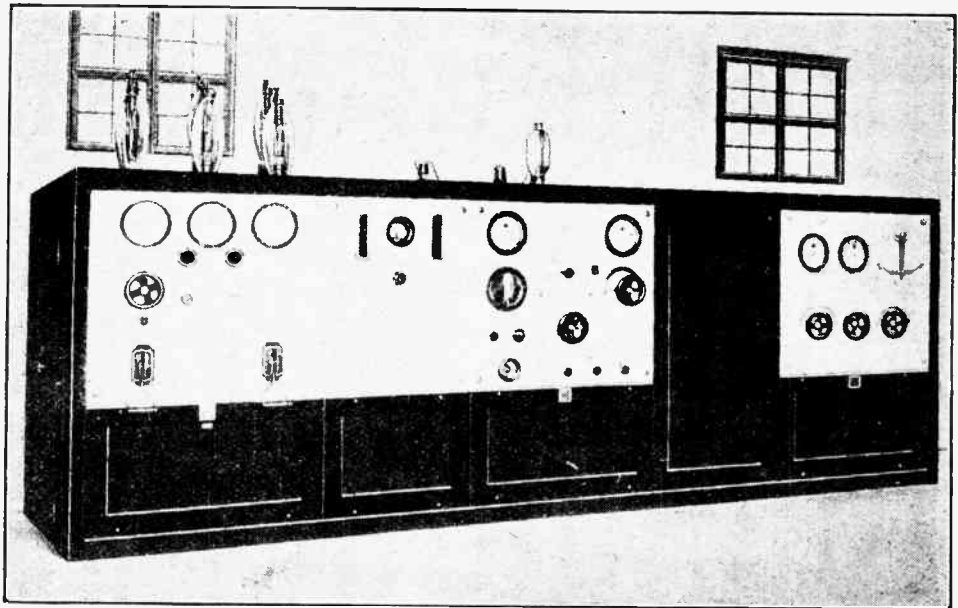

Front view of transmitter showing (left to right) the power supply and rectifier panel; water cooling supply panel; master oscillator and modulator panel; door giving access to gear; and on the extreme right, the aerial tuning panel.

The New Vienna High-power Station.—

Modulation is accomplished by connecting the anode circuit of two parallel amplifier valves (the circuit Fig. 3 shows only one) in the grid return circuit of the power amplifier. The grid bias for the modulator is obtained from a 100-volt accumulator battery, accurate adjustment being made by a potentiometer. A large grid sweep during modulation thus results, and there is no danger of distortion due to grid current. The speech currents, amplified by the sub-modulator, are superimposed on the grid bias through an input transformer connected in the grid circuit of the two modulator valves. These are of the Telefunken R.V.24 type, and are heated by a separate accumulator battery. The modulator apparatus is arranged on the same panel as the master oscillator and the amplifier valves. The control panel contains an ammeter for measuring the anode current of the power amplifier, three voltmeters, one for the modulator grid bias, one for the filament potential of each valve, and one for measuring the radio-frequency input grid voltage of the power amplifier. Further, it contains the handle for the variometer, the handle for the step switch controlling the Dubilier condensers in the driver circuit, and, finally, the handles of the potentiometer and the different filament rheostats.

A specially loaded cable, with a length of about 6 miles, connects the input transformer of the modulator to the

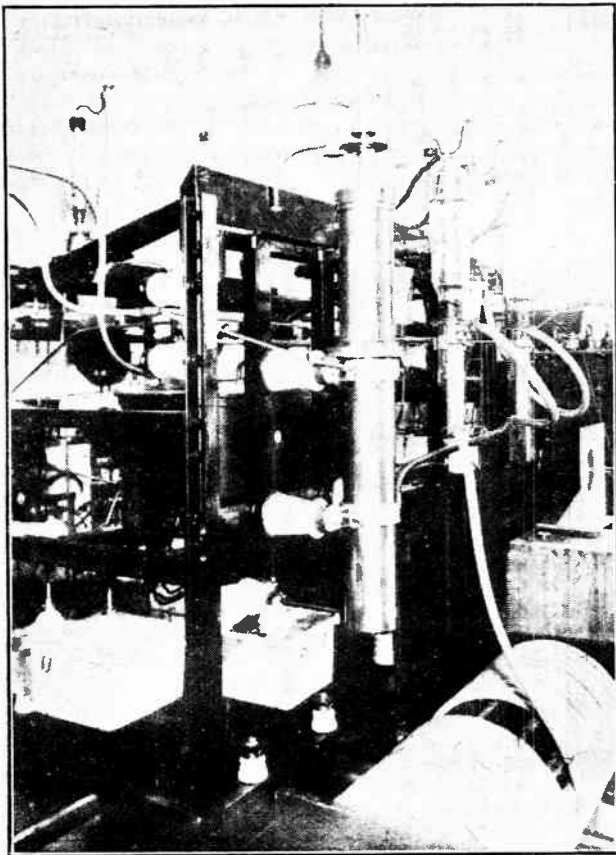

Water-cooled modulator and power amplifier valves and, in the left-hand top corner, the master oscillator valve.

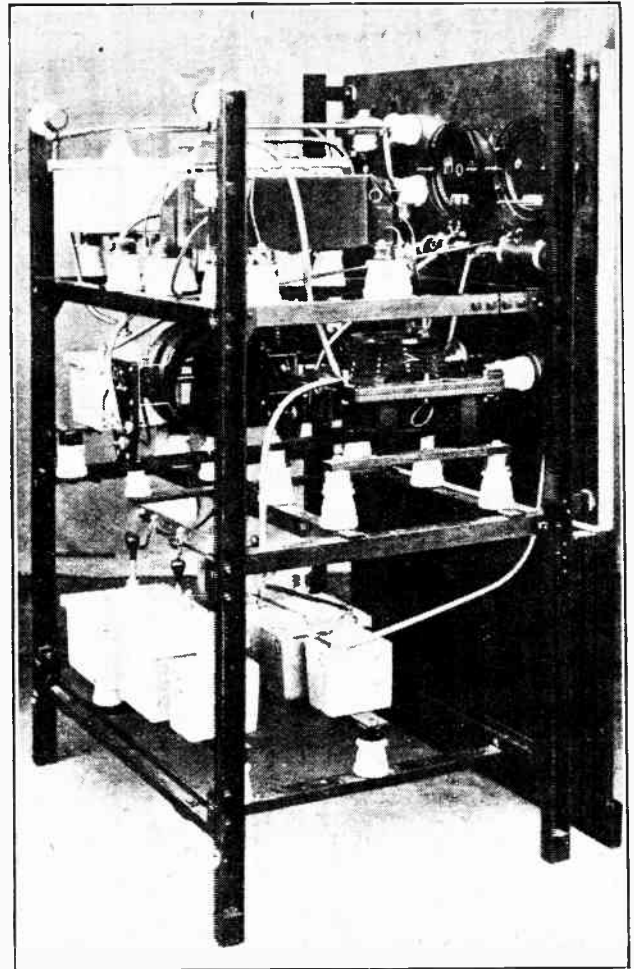

Aerial tuning panel. The toroidal loading coil is lying horizontally on porcelain insulators on the upper shelf.

sub-modulator, which is located in the control room of the studio in the city. The sub-modulator contains one R.E.24 valve, and the "sub-sub-modulator" three B.O. valves, which are all arranged with resistance-capacity coupling. The speech amplifiers, as well as the transmission gear itself, are here controlled by special instruments, containing chiefly Moullin voltmeters. The sub-sub-modulator may either be connected to the microphone in the neighbouring studio, or to different concert-halls, opera-houses, and theatres in Vienna.

The Aerial Circuit.

Next to the main oscillator panel comes a door to the interior of the transmitter, which has to be closed when the latter is put in action, or else an automatic device blocks the master switch. The last panel contains the necessary control apparatus for the open aerial circuit and the closed circuit of the power amplifier. The latter consists of a fixed inductance, which is constructed as a toroidal coil to reduce the external field to a minimum, a variometer for fine tuning, the primary of the variocoupler to the aerial circuit, and a bank of parallel condensers of the Dubilier type for coarse tuning. They

The New Vienna High-power Station.—

are connected in circuit by means of plugs which can clearly be distinguished at the bottom of the stand in the photograph on page 628. The same picture shows also the variometer and the variocoupler in the centre part and the toroidal coil in the upper part of the stand. The aerial circuit comprises a series of Dubilier aerial shortening condensers, an aerial variometer, the secondary of the variocoupler, and a transformer for the radio-frequency aerial ammeter. All inductors, as coils, variometers, etc., are wound with stranded high-frequency cable. On the front panel of this unit may be seen three handles for the two variometers and the variocoupler, the step switch for the aerial shortening condensers, the aerial ammeter and a D.C. meter for the amplifier plate current. Strong copper tubes connect this apparatus with the aerial and counterpoise lead-in insulators in the background of the gear. The fundamental wave of the aerial is very near the actual transmitted wave of 582.5 metres, but experiments are being carried out at present to raise the wave to 700 or 800 metres, as it is claimed that the transmitter would then work more efficiently. The gear is constructed for a wave-range from 450 to 900 metres.

The Storage Batteries.

A separate room of the station building contains the different accumulators. The valves of the power amplifier and of the master oscillator are heated by two 40-volt batteries, which are alternatively used and loaded. Each of them has a capacity of about 1,000 ampere-hours, and can be used fifteen hours in succession. Two batteries are provided for the filament current of the modulator valves, and each of them gives approximately 110 ampere-hours at 16 volts, and may also be in constant use through fifteen hours. A 100-volt accumulator serves the modu-

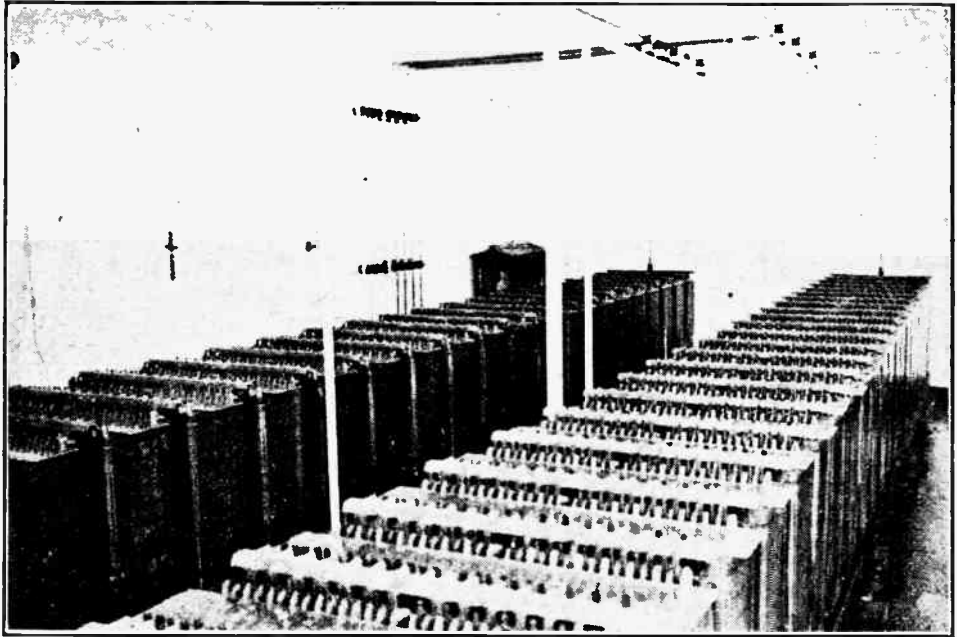

Accumulator room containing the batteries for filament heating.

lator with negative grid bias. A motor generator in a separate room of the station building delivers the necessary charging current for the batteries, and is so constructed that both groups of filament accumulators may be recharged in five hours. The control board for batteries and charging plant is fixed on a side wall of the transmitter room, to enable the engineer-in-charge to have a central control of all instruments and an easy handling of the whole station. The apparatus, which contains several new and interesting features, was designed and manufactured by the Telefunken Wireless Telegraph Company in Berlin.

As mentioned before, the station works at present on a wavelength of 582.5 metres, and may easily be received in this country. Until further notice, it will relay every evening the programme of Vienna's low-power station, and the call is: "Hallo! hallo! hier Radio-Wien. Sender Rosenhügel auf Welle fünfhundertzweiundachtzig einhalb und (for announcing the old transmitter, which works at 531 metres). Sender Stubenring auf Welle fünfhundert-einunddreissig!"

SHORT WAVE EXPERIMENTS AT JENA.

UNDER the direction of Professor Esau, the chairman of the "Deutscher Funktechnischer Verband," experiments are now being carried out at Jena with wavelengths as short as 1.5 metres. With the use of one valve it has been found possible to radiate an energy of 500 watts on this short wavelength.

It has been found that the radiation of a transmitter inside a building is rather small and that uneven land

renders the diffusion of the waves more difficult. The erection of a transmitter at the top of a mountain was found to be specially favourable, and a range of 20 kilometres was obtained. In this respect it was found that with increasing distance from the transmitter there is an increase in the receiving strength. Atmospheric interferences are also present, but are extremely weak in comparison with the longer waves.

H. K.

AUTOMATIC VALVE REPLACEMENT.

Auxiliary Valve Circuits for Remote Control.

By N. W. McLACHLAN, D.Sc., M.I.E.E., F.Inst.P.

WHEN one is called upon to design a valve-operated relay circuit for remote control work the problem is usually accompanied by certain captious conditions which demand careful consideration. For example, in almost every case there is a serious limitation due to a rather mistaken economical attitude regarding high- and low-tension batteries and the number of valves used in a receiver. Consequently, there are too few designs in which a reasonable factor of safety is provided. Although these accessories affect the prime cost, and augment the maintenance bill, a slight addition is of little moment compared with the gain in reliability, especially where human life is concerned.

In the remote control problem there are two salient conditions which need to be considered:—(1) The apparatus may not be isolated, there always being someone near at hand. Also, under these circumstances, the gear will probably be in frequent use, so that faults will be rectified as they arise. (2) The apparatus may be installed in some remote and relatively inaccessible part. Visitation for renewing batteries, valves, etc., may occur seldom, say, once in two or three months, and the usage of the apparatus may be of an occasional or emergency character. It is comparatively easy to design a receiver to comply with condition (1), but the second condition is in a class by itself, for the design of the apparatus, although quite difficult enough with economy limitations, is fundamentally a battle for reliability. On this score whatever type of valve circuit is adopted there are numerous prominent causes of failure, some of which are enumerated below:—

Causes of Failure.

- (1) A gradual reduction in electron emission with time, thereby entailing reduced magnification and ultimate failure.
- (2) Burnt-out or broken filaments.
- (3) Deterioration of H.T. and L.T. batteries, especially after prolonged working.
- (4) Broken or burnt-out primary transformer windings.
- (5) Leakage over panels and valve holders, etc., due to damp, thereby affecting amplification, and sometimes enabling the H.T. battery to put a large positive bias on valve grids.
- (6) General deterioration of products of manufacture due to atmospheric conditions, including outside aerials (if used for sensitivity).

Taking case (2) where the apparatus is unattended and left entirely alone for two months. So long as the batteries are properly charged at a slow rate and adequate precautions taken to avoid leakage of acid, there ought to be no trouble experienced in this direction. When we come to valves the issue is quite different. So long

as each valve is carefully tested before use, it would appear that no difficulty should arise. But the operating conditions are actually somewhat severe. In the average broadcasting set valves are used rather *intermittently*, whereas in the instance now under consideration not only the valves but the whole apparatus is in *continuous* expectancy of operation for two months—without attention. The severity of this condition cannot well be appreciated unless the reader tries the experiment himself. Even then there are additional conditions in the way of stormy weather, inaccessibility of the site, space restrictions, and such like, which often call for impossible feats. These serve to surround a comparatively homely receiving circuit with a quixotic halo.

Choice of Valves.

To keep the size of the battery within reasonable limits it is imperative to employ valves whose filament current is very small. At the moment our choice is confined to filaments of the 0.06 ampere dull-emitter class. Otherwise the battery would be several times the size of the receiver. To cite a case in point: With four R.5v. valves three two-volt accumulators of the slow discharge type with a capacity of over 1,000 ampere-hours each would be required. If the reader multiplies the number of cells he usually employs by about thirty he will approximate to the size of battery to be installed. On the other hand, with 0.06 ampere filaments the battery voltage is only 4 volts, so that the energy supplied is only one-eighteenth that with R.5v. valves. This is one side of the situation, but as usual there is a catch. The slender thoriated filaments of 0.06 dull-emitter valves, in addition to being microphonic, lose their emission after several weeks' *continuous* use, and are rendered well-nigh useless. The net result is to reduce the magnification to such a value that the receiver is rendered *hors de combat*.

There are two modes of overcoming this difficulty:—(1) To use 0.06 valves with carbonised filaments; (2) to incorporate a relay switching arrangement whereby a new valve is brought into action before the operating valve is on the point of failing to do its duty.

Valve Protection.

Although the latter scheme was applied with considerable success to a four-valve set, and worked unattended without the slightest trouble for many months, it is hardly a weapon to be left to the tender mercies of the uninitiated. Where *one* valve only is concerned, it is a feasible proposition, but the first proposal of using carbonised filaments is the more practical. Of course, so

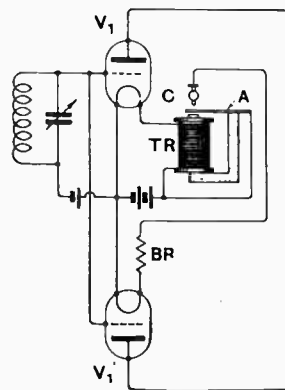

Fig. 1.—Automatic switching circuit for dealing with a broken filament.

Automatic Valve Replacement.—

far as the valves are involved, a combination of the two methods would be almost immune from failure.

We have postulated an attendant unskilled in the radio art so that the changing of valves and batteries is practically the only work of note which he has to perform. It may be just as well to point out that under this condition the remainder of the set must be well-nigh perfect.

Leakage can be avoided by proper housing of the various components and the use of quicklime in trays.

Jarring of the valves and receiver in general can be reduced to a minimum by "anti-pong" sockets and the liberal use of shock-absorber mounting. Then, lastly, where wire-wound resistances and transformers are concerned, we are all alive to the peculiarities in this direction. Valves are replaced every two or three months. Why not the transformers and resistances? To secure reliability it is better to effect such replacement. But what of the cost? Well, a carbonised filament valve is just as expensive as a transformer or a resistance

—sometimes more expensive—so that there would in a four-valve set be the equivalent replacement of six valves. In making this suggestion it has been assumed that ordinary stock or standard transformers are used, thereby reducing the size of the receiver. It is a better proposition—although a more expensive one—to design a large transformer using a primary with silk-covered wire of reasonable diameter so that breaks do not occur.

Automatic Switching of Auxiliary Valves for Filament Failure.

I now propose to describe, step by step, the circuit used to automatically replace faulty valves. There are two salient precautions to be taken: (1) When a filament breaks or burns out. (2) when the filament electron emission falls below a certain value.

In Fig. 1 is indicated diagrammatically the first step in the procedure. Here we have an ordinary telephone relay TR costing a few shillings, with a winding of about 15 to 18 ohms resistance in series with a 4-volt battery, and the 0.06 amp. filament of valve V_1 . The resistance of the relay winding is fixed by conditions. It may be necessary to allow for volt drop in the connecting leads, or a decay in battery voltage with time. The proper course to pursue is to use a battery which will not drop below 3.9 volts, thereby ensuring that the valves need not be overrun when the battery is fresh. Having fixed the resistance of the winding, due regard being paid to the ampere-turns to get the desired action of the relay, a ballast resistance, BR, equal to that of the relay is inserted in the filament of an auxiliary valve, V_1' . The action is as follows: When the battery is connected, current flows through the winding R, thereby

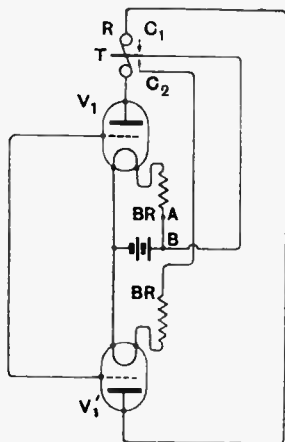

Fig. 2.—Circuit for dealing with burnt out filament or reduced electron emission

energising the magnetic circuit so that the armature A is pulled down on to the iron core. This opens the contacts C, thereby isolating valve V_1 . If the filament of V_1 burns out or breaks, the contacts C close, and the battery sends a current through the filament of valve V_1' . Clearly the resetting of this device is automatic, for a new valve in place of V_1 will light up, and extinguish V_1 . Another feature of importance in high-frequency magnification is the absence of effect on the tuning, since the grids and anodes still remain paralleled. In very short wave work the relay winding can be split if desired, half being in each leg. Also, for the sake of symmetry, the ballast resistance may be replaced by a relay with the contacts disconnected. This relay may be in two parts as mentioned above if desired.

Although the device described has been associated with a 0.06 dull emitter valve, it is obviously applicable to any other valve or circuit, whether receiver or transmitter.

Automatic Switching for Emission Failure.

The next phase is associated with failure of the electron emission from the filament. To cope with this feature another relay is essential.

With a large emission any of the known coarse relays will serve, but where dull emitter filaments are concerned the emission falls to 0.6 mA. or even less. Thus a sensitive relay is necessary. A very convenient type is the well-known Weston moving coil relay. On the average this instrument when properly adjusted can be taken to function on a current change of 50 to 100 microamperes. This gives a wide margin and allows for the influence of prolonged use and inattention. The first step in the arrangement is depicted in Fig. 2.

Here we have a ballast resistance, BR, in each filament leg and a Weston relay in the anode circuit of V_1 .

With an electron emission exceeding a predetermined value, the torque of the relay is held on the contact C_1 . When, however, the emission falls below a certain value, the tongue T moves over to contact C_2 and completes the filament circuit of V_1' , thus bringing it into operation. The same action occurs if the filament of V_1 burns out. This arrangement is defective from the point of view of filament current consumption, since both filaments are now lighted. Since a small battery was stipulated, some device must be incorporated to extinguish V_1 . At first sight one might feel inclined to make a symmetrical connection of the relay contacts by omitting the wire AB and joining C_1 to A. If the reader draws a diagram he will see that the symmetry is upset by the relay being in one valve anode circuit only, and the device will not automatically reset itself when V_1 is

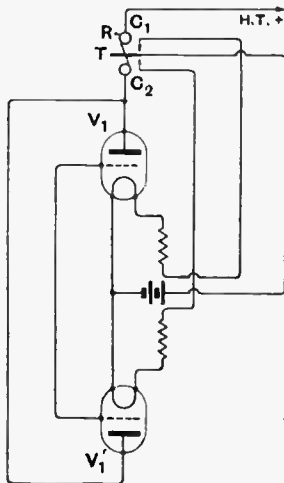

Fig. 3.—Symmetrical circuit developed from Fig. 2.

Automatic Valve Replacement.—

extinguished. Another point to be observed is that the anodes of V_1 and V_1' are connected *via* the relay. This obviates the necessity for the anode current of V_1' flowing through the relay when V_1 is extinguished. An interesting case arises here by means of which a continuous oscillation can be secured.

Continuous Oscillation Circuit.

Suppose the battery in Fig. 3 is switched on, then T rests on C_2 and V_1' will light. Now connect the + H.T., and the anode current of V_1' will flow through R, thereby drawing T towards C_1 . But when T breaks contact at C_2 , it extinguishes V_1' , so that the anode current through R is zero. Thus the removal of the current torque on the relay means that T falls back again on C_2 , and the process is repeated, yielding a continuous oscillation. This is avoided by using the connection of Fig. 2.

If we had commenced with the torque on C_1 there would have been no oscillation until V_1 failed, when it would commence. It should be clear that only one valve is involved in the oscillation, and Fig. 4 displays a re-arrangement yielding oscillations with one valve. The

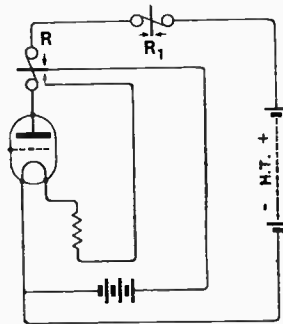

Fig. 4.—Circuit for obtaining electro-mechanical oscillations.

grids of the valves have been shown floating in space, but in practice the grid-filament circuit would be connected in the usual way. In Fig. 4 the grid may be given a suitable potential, e.g., connected to anode. By connecting another relay, R_1 , in series with R, a series of current pulses will actuate it which can be used for sending an interrupted current *via* the contacts. R_1 may be replaced by any electric component, e.g., a resistance which in turn is connected to a valve, thereby giving amplified current pulses. By mounting a mirror on the relay R and playing reflected light on to a moving band, the waveform of the mechanical oscillation will be seen. The fundamental frequency depends upon the inertia of the coil and the stiffness of the relay control spring.

Automatic Switching for both Filament and Emission Failure.

The next phase of the problem is to add a device which will automatically extinguish V_1 in Fig. 2 when V_1' is brought into action. This is exhibited in Fig. 5. The filament circuit of V_1 contains a ballast resistance, BR, equal in value to that of the telephone relay in the filament circuit of V_1' . There is also a high resistance, HR, of from 2,000 to 3,000 ohms in series with TR to prevent sparking at the relay contacts C_2T . When V_1 is lighted, the filament battery sends a very small current through HR and the relay winding. The armature A is in the release position, so that contacts C_3C_4 are touching. Now there are two defects to be defeated: (1) broken filament, (2) reduced emission. Let the fila-

ment ceases, and the spring causes T and C_2 to make contact. This short-circuits HR and allows the normal current to flow through the telephone relay TR, so that V_1' begins to function. Suppose the emission of V_1 falls below a certain value, then T makes contact with C_2 and V_1' again lights. But at the same time the current in TR pulls the armature A to the core, thereby breaking C_3C_4 and extinguishing V_1 .

The arrangement of Fig. 5 is evidently the combination of Figs. 1 and 2, excepting that the positions of BR and TR are reversed and HR has been added. If the energy in the filament circuit were not so limited, HR could be replaced by an anti-sparking resistance across TR. This, however, in our case, would mean a smaller current through TR, and the relay would not function with precision. Moreover, if a resistance were used across TR, the battery voltage would have to be augmented, but by hypothesis this is inadmissible.

Filament Touching Grid.

There is a third salient manner in which a valve may fail. This occurs when the filament touches the grid. The introduction of a device to cope with this defect is difficult. The valve and its auxiliary are both put out of action when the grid touches the filament, but so long as the filament remains, so also does the emission. Thus the arrangement of Fig. 5 would be abortive in this case. But if the filament should burn out, there would or would not be a happy ending. Provided the filament break was such that

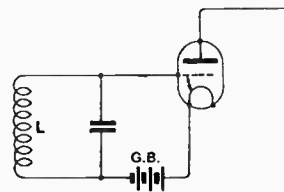

Fig. 6.—Circuit for coping with a short-circuit between grid and filament.

the grid was free of bias from the battery, all would be well. Otherwise, the hand of fate might be heavy, and the negative leg of the filament get on to the grid.

To rectify this the only course is to automatically apply an auxiliary battery to burn out the filament completely. A rough idea of the method is indicated in Fig. 6. Extra grid bias and greater H.T. are used.

If the filament gets on the grid, the biasing battery G.B. sends a current through the low-resistance coil L and burns the filament out. This is clearly out of the question when the resistance of L is large, e.g., the secondary of an audio-frequency transformer.

I will conclude, therefore, by leaving the reader to obtain the complete solution to this little conundrum himself. My own view is that valve manufacture should be such that the filament does not get on to the grid, and I think this is a practical solution of the problem.

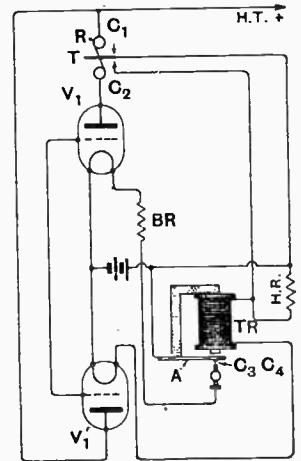

Fig. 5.—Circuit for introducing new valve and extinguishing the defective valve when emission is low or the filament fails.

HINTS and TIPS for NEW READERS

A Section Devoted to the Practical Assistance of the Beginner.

SOFT VALVES.

Although valve manufacture is now on a well-established basis, with standardised processes and a properly organised system of testing, a specimen with a defective vacuum is occasionally encountered, and unless this fault is at once detected unusual and puzzling effects are likely to be noticed.

The great majority of modern circuits are primarily designed to operate with highly exhausted valves, and, although those with some residual gas content will, under certain conditions, function exceptionally well as a detector, their performance even in this capacity is apt to be too uncertain and unreliable for general use.

Excessive "softness" or poor vacuum may as a rule be detected by the presence of a blue glow between the electrodes, which will increase as the high-tension voltage is raised. In many valves the space between plate and filament is almost invisible, due to the presence on the glass bulb of metal deposited during the "gettering" process; it is generally possible, however, to see a small part of the filament, and, if softness is suspected, it is easiest to decide if blue glow is present by intermittently completing the H.T. circuit, at the same time carefully observing the filament-anode space.

An accurate quantitative test of vacuum is by no means difficult if suitable measuring instruments are available; failing these it is necessary to rely on the visual indication afforded by the presence of the glow mentioned above. If a milliammeter is available, it should be inserted in the anode circuit of the valve under suspicion; if this is soft, a consider-

ably greater current will be passed than will be indicated when a valve of the same type, and in good condition, is substituted.

o o o o

A LONG-WAVE FRAME AERIAL RECEIVER.

In cases where the erection of an aerial of even moderate efficiency is impossible, and where the nearest short-wave broadcasting station is situated at some considerable distance, it may be advisable to concentrate on reception of the high-power Daventry station. The reason is that this station operates on a long wavelength, thus enabling the necessary

used, with reaction between the anode circuit of the detector and a coil inserted in series with the frame. It will be noticed that the grids of both the amplifying valves are given a slight negative bias, in order to prevent clamping due to the flow of grid currents. Low-frequency amplification may, of course, be added for loud-speaker work in the normal manner.

o o o o

RESISTANCE-COUPLED H.F. AMPLIFICATION.

It is frequently (and correctly) stated that the resistance-capacity method of coupling H.F. amplifying

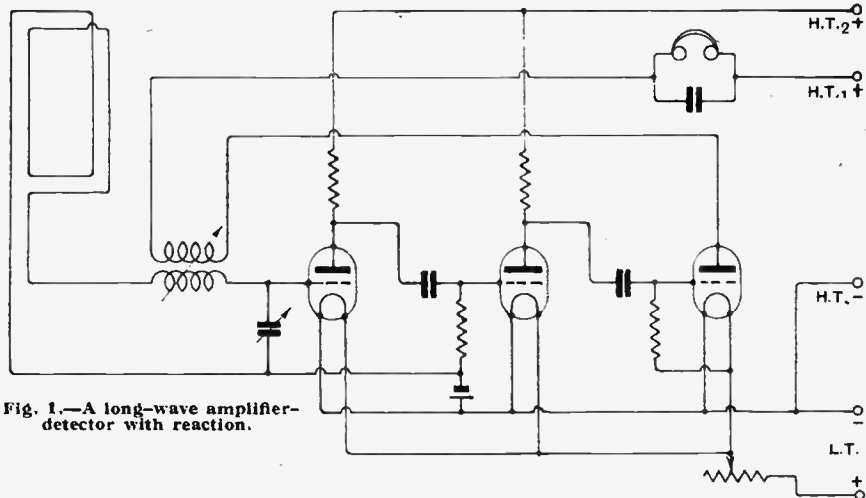

Fig. 1.—A long-wave amplifier-detector with reaction.

degree of high-frequency amplification to be obtained without taking the elaborate precautions necessary on the higher frequencies.

A form of H.F. amplifier-detector which can be recommended for use with a frame aerial of reasonable size is shown in Fig. 1. Two stages of resistance-capacity coupling are

valves is inefficient on the shorter broadcast wavelengths, and that the full benefit of the system is not attained until we come to deal with frequencies corresponding to 1,000 metres or over. Except on the very long wavelengths, very special precautions are necessary to avoid serious loss of amplification, due to inci-

dental capacities, and a consideration of the real reason for the failure of this method on the higher frequencies will indicate where an attempt should be made to reduce these capacity losses which still give rise to inefficiency on the longer waves.

It has already been pointed out in these notes that when dealing with an L.F. amplifier operating on the same principle, the grid leak may be considered as being connected in parallel with the anode resistance, and, unless of considerably greater value, will cause an appreciable falling-off in amplification. Capacity effects may generally be ignored when low-frequency currents are being handled, but are of vital importance in H.F. work, and reference to Fig. 2 will show that the incidental filament-anode capacity of the valve is also in parallel with the anode resistance; this capacity is shown as a condenser with its connections in dotted lines.

Assuming an average value for the capacity of the valve and its holder, the effective resistance or reactance of this condenser to currents of a

frequency corresponding to the middle of the broadcast band will be only some 25,000 ohms; a value very much less than that of the usual 80,000 ohms anode resistance, and also in all probability less than the internal resistance of the valve itself. In fact, the valve capacity is acting more or

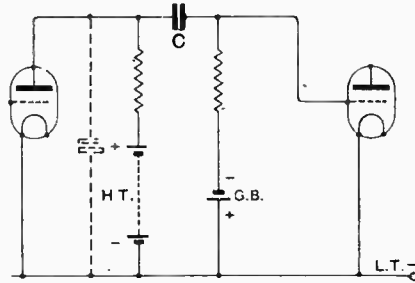

Fig. 2.—The effect of incidental filament-anode capacities.

less as a partial short-circuit, and it is clear that only a small voltage will be set up across the anode resistance for transference to the grid of the succeeding valve.

Taking the case of a receiver operating on the wavelength of the Daventry station (1.600 metres), we

find that the valve capacity mentioned behaves as a parallel resistance of about 150,000 ohms. This is a much more reasonable figure, as it is fairly large in comparison with both valve and anode resistances. It would, however, be desirable to increase it still further; this can be done by reducing to a minimum the capacity of the valve, its holder, and of the wiring. In this connection, a consideration of the circuit diagram will show that the reduction of stray capacities is equally desirable in the case of the second valve, whatever its function may happen to be, as its filament-grid capacity is, in effect, added to the filament-anode capacity of the first valve.

These incidental capacities, of course, account for most of the difficulties experienced in obtaining a good measure of high-frequency amplification on the shorter wavelengths, no matter which system of intervalve coupling may be employed, but their effects are generally more serious when the resistance method is used.

DISSECTED DIAGRAMS.

No. 26.—Stage-by-Stage Tests of a Standard Valve-Crystal Reflex Receiver.

A consideration of the series of circuit diagrams given below will indicate an effective and logical course of procedure to be adopted in locating faults in a set which is totally or partially inoperative. Modifications of this method are obviously applicable to all types of receivers. Dotted lines indicate temporary short circuits.

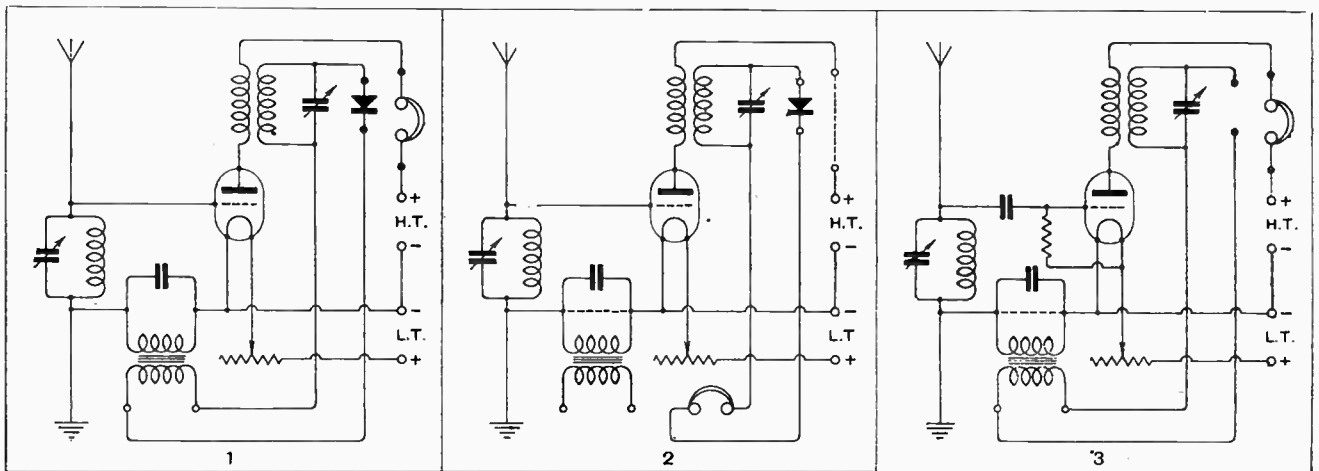

The complete circuit diagram of the receiver. It is assumed that the usual simple tests have failed to reveal the source of the trouble, and that there is no obvious cause for failure. Either or both of the following tests may be applied.

The aerial-earth system, valve, H.F. coupling, and crystal are tested by connecting the telephones in place of the primary of the "feed-back" transformer, the secondary of which is short-circuited. The receiver is now operating as an H.F. and crystal set. If this test—

—fails to indicate the fault, the set may be converted to a simple valve detector by insertion of a leaky grid condenser. Note that the crystal detector is disconnected. Correct operation will suggest a fault in H.F. transformer, L.F. transformer, or crystal.

BROADCAST BREVITIES

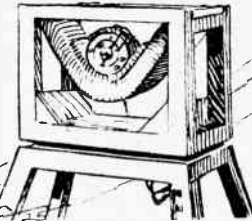

SAVOY HILL TOPICALITIES. BY OUR SPECIAL CORRESPONDENT.

2LO's Breakdown.

It was particularly unfortunate that 2LO should have gone out of action, owing to a broken condenser, on the night that the opera "Traviata" was relayed from the New Chenil Galleries, with the result that listeners in the metropolitan area who could not tune in to 5XX, or to any other station which was transmitting the same programme, missed a good half-hour of Verdi's great work. Marconi House was brought into service as soon as possible, although it, too, came very near to mishap.

The Marconi House Transmitter.

Many listeners have wondered why Marconi House cannot be kept constantly ready for emergency service whenever the Oxford Street station is out of action. The reason is that the 2LO transmitter had originally to be removed in order to avoid interference with Government and other wireless services in the vicinity of Marconi House. The Air Ministry had, for instance, to adopt special measures to shield its own aerial when broadcast transmissions took place regularly from the Strand, only a hundred yards away; and a certain amount of interference is still caused when the B.B.C. has to get permission to go back to the old aerial while repairs are being effected to the regular plant. It says much for the courtesy of the Air Ministry and Post Office officials that the old aerial is still allowed to be used, even in an emergency. The problem of uninterrupted service will be solved when London is granted the boon of a second broadcasting station.

Lady Announcers.

Listeners have been glad to note that Miss Cathleen Nesbitt repeated, on April 20th, when she again assumed the duties of commere, or announcer, as I would prefer the B.B.C. to term it, her success in that rôle a month previously. A personality of her type would be a decided asset to the small band of male announcers at 2LO, and, as I stated in these notes recently, I have reason to believe that Savoy Hill is of the same mind. Miss Nesbitt, by the way, will be the Lady Windermere of the broadcast version of "Lady Windermere's Fan," which is to be given to-morrow (April 29th).

Howling ad Nauseam.

In one of the cases of oscillation brought to the notice of the B.B.C. it transpired that a man left a receiving set howling for two hours, while he went to the pictures. In another case a deaf man had apparently been recommended to take up wireless for his deafness, with the result that the whole district was plagued with a particularly bad spasm of howling.

A Resignation.

So Mr. C. A. Lewis has resigned his appointment as Chairman of the Programme Board of the B.B.C.—within a week of the announcement that his father, known to all listeners as "Philemon," would cease to broadcast after April 27th. "C.A.L." was one of the Big Six who formed the nucleus of the present broadcasting staff of 600, his first job being that of Deputy Director of Programmes, with Mr. Arthur Burrows, now in charge of the Office Internationale de Radiophonie at Geneva, as Director. The fascination of the work in those early days has been indicated by Mr. Lewis in his story of broadcasting from within.

Improvisation.

As he said, there is something very attractive about unorganised methods—and they were extremely casual methods at that time—when they are handled by intelligent people. A microphone tied up with bits of string, switches falling to pieces, gadgets that wouldn't work unless they were coaxed—out of these things broadcasting grew through a lusty infancy to its present state of development in Great Britain. And Lewis was one of the small band of men to whom the success of broadcasting is due. It is gratifying to know that he will still be available in a consultative capacity.

The Time Schedule.

A noticeable change of attitude has taken place as regards programme timing and the weather forecast and news are not now given with the punctuality formerly observed. As usual, when a slight deviation occurs in the time schedule, a few listeners have protested against this interference with routine arrangements.

When Not to Break In.

On the whole, the time calculations are very infrequently upset, and a studio programme is only permitted to exceed the schedule when it is considered that, in view of the quality of the performance, the bulk of listeners are not likely to object to a few minutes' continuance beyond the proper time. In the case of



Photo : E.S.A. Radio, Ltd.
THE LISTEN INN The landlord of this ancient hostelry, near Shaftesbury, is evidently abreast of the times!

Manchester Cathedral.

For the first time the bells and service at Manchester Cathedral will be relayed from the Manchester station on May 2nd. The Cathedral bells are believed to contain metal which formed part of the pre-Reformation bells of Manchester, and are tuned on the "Five-tone Simpson Principle," which ensures that each bell is in tune with the others of the peal, as well as being itself in tune. The weight of the tenor is 27½ cwt., its note is D, and the total weight of the peal is 5 tons 15 cwt. As a percussion instrument, the bell is admittedly one of the best sound-producers for broadcasting purposes.

outside broadcasts, such as "Kitesh" and "Der Rosenkavalier," the necessity of greater latitude is obvious; but always the announcer must pay some attention to the æsthetic aspect of the broadcast and not bring it to an abrupt conclusion in his endeavour to adhere rigidly to the time schedule.

o o o o

Open Air Broadcasts.

Music relayed from open-air handstands was found last summer to make an effective broadcast, and the B.B.C. hopes to show that they profited by the experiment by relaying, in the coming season, the band music from a number of parks and open spaces.

o o o o

The Chenil Galleries.

I was amused by the criticism contributed by its wireless correspondent to a London evening newspaper last week, *apropos* an hour's variety programme which was advertised to be relayed from the New Chenil Galleries. After congratulating the B.B.C. on having found an outside hall "which possesses those peculiar properties called for by the microphone when an enjoyable relay is to be provided," he stated that the search for such a building had been in progress for so long that one had almost begun to despair of the engineers being successful. Probably the engineers themselves despaired of finding an outside hall which would "fill the bill," for the particular broadcast referred to did not take place from the New Chenil Galleries but from 2LO's old studio, which provided the engineers with some of their earliest experiments in the transmission of sound. Thus we move in an ever-narrowing circle.

o o o o

Shakespeare's Heroines.

The series of weekly broadcasts illustrating, by excerpts from the plays, the characters of some of Shakespeare's heroines, will begin on May 2nd. The parts will be taken by well-known actresses of the English stage. The first character in the series is that of Rosalind, the heroine of "As You Like It," and the Rosalind of the ether will be Miss Edith Evans, who gave a memorable performance last year in "A Midsummer Night's Dream."

o o o o

Covent Garden Operas.

"Figaro," the first opera which is to be broadcast in the coming Covent Garden season, on May 10th, was completed by Mozart on April 29th, 1786, and the first performance took place two days later in Vienna. The whole composition had taken only six weeks. The Irish tenor, Michael Kelly, took part, and has recorded the enthusiasm of performers and audience. Even at the final rehearsal, all present were roused to enthusiasm, and when Benucci came to the fine passage, "Cherubino, alla Vittoria, alla gloria militar," which he gave with stentorian lungs, the whole of the performers and orchestra joined in the applause.

FUTURE FEATURES.

Sunday, May 2nd.

LONDON.—3.30 p.m., Choral Service relayed from King's College Chapel, Cambridge. 8.40 p.m., The United Choirs of New College, Magdalen and Christ Church, Oxford.
BIRMINGHAM.—3.30 p.m., Grieg Programme.
GLASGOW.—9 p.m., Act I of Wagner's "Parsifal."
MANCHESTER.—4.40 p.m., The Lancashire Military Band.

Monday, May 3rd.

LONDON.—8.30 p.m., Chenils Concert. The Music Society String Quartet.
DVENTRY.—8.30 p.m., Speeches and Musical Programme at the Annual Dinner of The Society of Dorset Men in London, relayed from the Holborn Restaurant.
ABERDEEN.—8 p.m., Scottish Programme.

Tuesday, May 4th.

BOURNEMOUTH.—8 p.m., "Conviviality."
CARDIFF.—8 p.m., The Choir of the Merthyr Tydfil Operatic Society.

Wednesday, May 5th.

LONDON.—8 p.m., "Dido and Æneas" (Edward Purcell). 10 p.m., Excerpts from the Revue: "Bubbly" (Philip Braham).
NEWCASTLE.—8 p.m., "Acis and Galatea" (Handel).

Thursday, May 6th.

LONDON. 10 p.m., Pianoforte Recital by Frederic Lamond.
ABERDEEN.—8 p.m., Symphony Concert.
BIRMINGHAM.—8 p.m., Comic Opera: "Les Cloches de Corneville."
GLASGOW.—8 p.m., Programme commemorating the accession of King George V.

Friday, May 7th.

LONDON.—10 p.m., Brahmi's Commemoration.
BIRMINGHAM.—8 p.m., Playlets.
BELFAST.—8.15 p.m., Belfast Radio Players in "A Mid-Victoria Hour."

Saturday, May 8th.

LONDON.—8 p.m., Students' Choruses. 10 p.m., Vivian Foster (The "Vicar of Mirth").
BIRMINGHAM.—8 p.m., Popular Programme.
BOURNEMOUTH.—8 p.m., Winter Gardens Night.
NEWCASTLE.—8 p.m., A Saturday Night Concert.

Most Popular Broadcasts.

An analysis of listeners' opinions of the past three months' programmes transmitted from 5XX and 2LO show that Sir Harry Lauder's last broadcast came first in order of merit among general entertainers. The 7.25 classics came first among musical performances. Among the vocalists Mr. R. F. Palmer's singing met with most appreciation, and next to Sir Harry Lauder the most popular entertainer was John Henry. "Philemon," Sir H. Walford Davies, Prof. Julian Huxley, and Father Ronald Knox were at the head of the list, in the order named, among about a hundred speakers and Sandler, Colombo and De Groot were first among the bands and orchestras, with the London Radio Dance Band included in the first eight. "The Quest of Elizabeth" received more than three times as many appreciations as criticisms.

o o o o

International Relays.

After numerous public announcements of the projected interchange of programmes between 5XX and Hilyversum once fortnightly, it was a pity that the excellent programme which the Dutch station transmitted to give the innovation a good send-off should have suffered so many interruptions. It seems strange that the hour fixed for this broadcast should have been chosen for official wireless meteorological experiments. The view taken by listeners is that some collaboration should be possible between the B.B.C. and Government departments whenever an international relay of such importance is fixed up; and I understand that the company's engineers will in future take steps to notify other wireless interests, so that interference may by mutual arrangement be avoided except in cases of extreme urgency.

o o o o

Regular Transmissions.

In the meantime I am able to state that a considerable extension of the time devoted to international relays will shortly become a regular feature of the programmes.

o o o o

The Oscillation Evil.

It is no unusual thing to find that in the day's postbag of Savoy Hill 60 per cent. of the correspondence deals with oscillation. The majority of the complaints come from small country towns where the question of dealing with oscillation should be much easier than in the vast cities. The policy of calling the names of offending towns over the ether has proved effective in a number of cases, and the B.B.C. will continue to do this where the complaints appear to justify such a measure. But apart from this method of calling attention to the evil, Savoy Hill intends to pursue a policy of educating listeners, and especially the one-valve users, in the orthodox use of a receiving set in order to effect a remedy. The B.B.C. takes the charitable view that much of the howling is due to sheer ignorance.

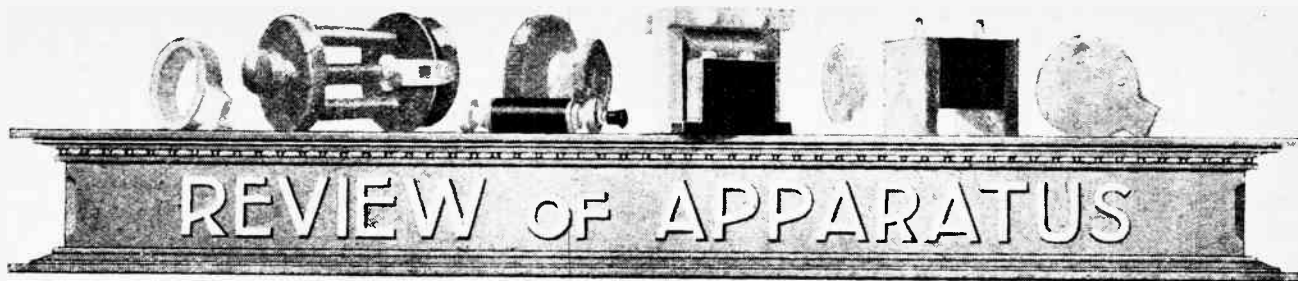

Latest Products of the Manufacturers.

THE RATHBUN VERNIER DIAL.

A wide range of vernier dials has appeared on the American market, and the Rathbun dial, which is of somewhat unusual design, is exceedingly popular.

Like many other American geared dials, the mechanism not only provides for giving critical control, but is arranged to convert the ordinary type of condenser fitted with square law plates to be equivalent as regards rotation of the dial to one possessing straight line frequency tuning.

A particular merit of the Rathbun dial is that it contains no pinions, which invariably give rise to some degree of backlash, the reduction gearing being obtained by means of an arm running in a cam, the contour providing the necessary conversion to straight line frequency tuning.

The operating dial is of entirely new design, and a particularly attractive appearance is obtained by moulding in Bakelite. The operating knob is 3½ in. in diameter, the large diameter faci-

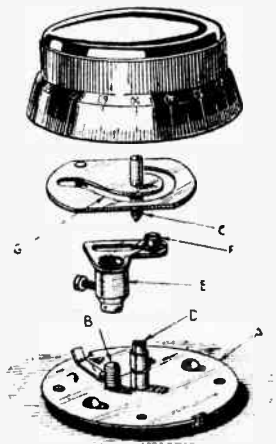

Rathbun straight line frequency converter. A, the base plate. B, shaft of the variable condenser, which is off set from the centre of the dial. C and D, spindle and bearing. E and F, eccentric arm and guide pin. G, converter cam.

tating critical adjustment, while the scale is not less than 2 in. in depth, the divisions being conspicuous and easy to read.

The Rathbun dial is imported by the Rothermel Radio Corporation of Great Britain, Ltd., 24-26, Maddox Street, Regent Street, London, W.1.

WOOTOPHONE VARIABLE CONDENSER.

Messrs. F. E. Wootton, Ltd., 56, High Street, Oxford, include among their range of component parts a variable condenser of low loss design.

The end plates are substantial, and are pressed from aluminium sheet almost ¼ in. in thickness. The fixed and moving plates are of brass, and accurate spacing

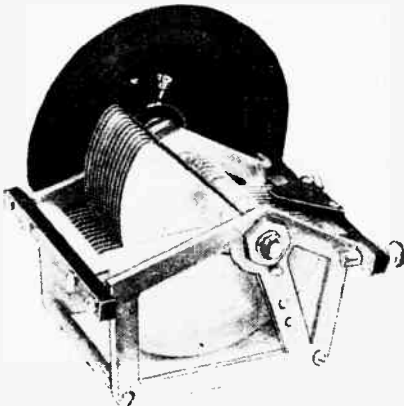

The Wootophone low loss condenser is provided with substantial aluminium end plates, while the fixed and moving plates are of brass bonded together by soldering.

is obtained for the moving plates by means of brass washers, while the fixed plates are carried in slots along the sides of ¼ in. square section brass bars. A good feature is that all plates are soldered in position, ensuring good electrical connection, while positive contact is made with the moving plates by means of a copper spiral pigtail connector.

The method of holding the moving plates centrally in position between the fixed plates is unusual, as a raised collar is not left standing on the main spindle, neither is a spiral spring washer employed. A stiff bronze spring is mounted on each of the end plates, which are adjusted by means of tension screws to exert a hard pressure on the spacing washers at either end of the fixed plates. The springs thus hold the fixed plates in position, and at first sight one is a little doubtful as to whether this method is satisfactory, for any weakening of the springs which may result in the course of time would bring about a displacement of the plates. The springs are, however, exceedingly stiff, and in consequence it

is not possible to displace the moving plates by applying pressure to the end of the spindle.

The dial has a particularly fine appearance, being a clean moulding in Radion.

COSMOS MICROMETER 2-COIL HOLDER.

The Metro-Vick Supplies, Ltd., 4, Central Buildings, Westminster, London, S.W.1, have designed a new type of two-coil holder intended for baseboard mounting. The base piece is a moulding of insulating material possessing a remarkably clean finish. One of the coil holders is permanently screwed in position, while the other is carried on a vertical spindle and is rotatable by means of an extension handle.

As well as the swinging movement of the extension handle, which is provided for obtaining quick adjustment, the knob can be rotated. The spindle of the operating handle carries an eccentric cam which, revolving in a slot, imparts a critical movement to the moving coil holder. The design is very ingenious, and the rotation action for obtaining fine adjustment is un-

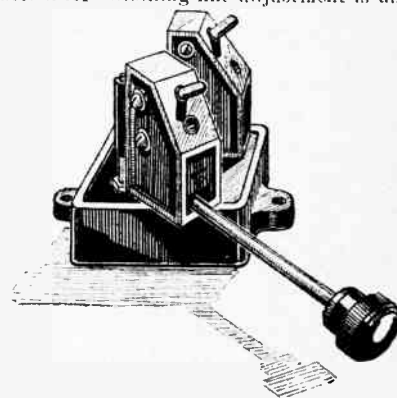

Cosmos micrometer coil holder.

doubtedly useful for obtaining critical control. The fine adjustment obtained by rotating the handle, however, depends upon keeping the knob in one position as it revolves, and it would seem that it is almost as easy to give a small degree of movement to the extension handle as it is to hold it critically in a stationary position and to apply a rotating movement.

The clean, dull matt finish of the moulded parts renders the appearance of this coil holder far superior to the more usual types cut from thick ebonite sheet.



The Editor does not hold himself responsible for the opinions of his correspondents.

Correspondence should be addressed to the Editor, "The Wireless World," Dorset House, Tudor Street, E.C.4, and must be accompanied by the writer's name and address.

POINTS ABOUT PORTABLE RECEIVERS.

Sir,—I read with considerable interest the general notes on the subject of portable receivers by "The Wanderer" in your issue of April 7th, and feel bound to disagree with the body of his remarks.

Firstly the portable that requires a separate antenna is, and always will be, commercially a failure. Only the most fiery enthusiast is likely to bother about hanging wire on a tree wherever he goes, and in any case such preparations usually attract a horde of gaping sightseers whose presence is objectionable.

Barring absolutely the superheterodyne, which as a portable must either weigh about fifty pounds or be a dismal failure, it is possible to produce a set that operates satisfactorily with a frame of modest dimensions. The contention that it must be used "under the transmitter" is a fallacy.

Regarding valves, the 0.06 type is unsatisfactory; preferably use a valve with filament of adequate strength in conjunction with an unspillable accumulator; the weight will not exceed that of a dry battery.

Spring valve holders are worse than useless, whilst the rigid type are consistent filament breakers; use holders bedded in sponge rubber and of suitably limited movement.

The place for the loud-speaker is inside the set, although I agree that the atrocities fitted into present commercial portables would deter any but the bravest.

To sum up, the totally enclosed portable is a possible proposition, but a most unsuitable job for the amateur to attempt.

If of sufficient interest, I should be happy to show your contributor my idea of a portable, when I feel assured of obtaining a convert. It measures 16in. x 10in. x 8in., weighs about 16 lb., contains absolutely everything, including properly designed loud-speaker, and has range of at least 100 miles from Daventry or 40 miles from normal station; I may add the number of valves is three.

L. W. RUSKHAM.

London, E.15.

A USEFUL METER.

Sir,—In spite of the valuable educational work done by *The Wireless World* and other periodicals much amateur wireless practice still has an empiric and casual character as a natural result of its sudden popularity among millions uninitiated in the principles of electrical science, and in particular, ignorant of, or indifferent to, its quantitative laws.

Your first leaderette in the issue of April 7th indicates one result of this in its reference to the danger of faulty apparatus. You indicate the remedy on pages 535-6 of the same issue. An amateur equipped with the Alltest meter there described has no fear of being palmed off with a "dud" grid leak. Given this instrument and its simple and wonderfully cheap accessories, he is able to test H.T. and L.T. battery voltages, apply exactly the grid voltage recommended by the valve maker and so eliminate distortion, regulate potentiometer and filament resistances, check the values of all resistances, trace faulty connections and leaks, measure filament and plate current, and, in short, make every kind of measurement necessary in D.C. work.

He can build a set that will "come in" at first trial, for he can make the correct choice of each of the bewildering multitude of factors whose permutations and combinations affect reception. He will in the long run save money, and get improved results. As he works he will insensibly, almost, be comparing cause and effect, and acquiring an insight into the

natural laws upon which the art of wireless telephony depends. The results would be worth the price of the set of expensive instruments hitherto required, much less the negligible cost of this single meter.

GEO. W. BAKER, B.A., B.Sc.

AMATEUR TRANSMITTERS.

Sir,—Is not the essential point that transmission on unauthorised wavelengths is a violation of the licence terms and thus brings to disrepute amateur work in general, and endangers the licences which are issued to men obviously more qualified to possess them?

I have measured amateur wavelengths in this district during the past few days, and it is common to find 310, 320 metres and similar frequencies in use. With regard to the critics' recent remarks, I agree with them. Undoubtedly the microphone appears to be the only instrument used for the purposes of experiment. Perhaps the simple nature of its construction and operation particularly adapts it to the use of those who are unable to differentiate between 440 metres and 310 metres transmission wavelength. If the offenders are members of a radio society surely control can be exercised—if not, the society could use some of the energy popularly supposed to be given to tracking down "howlers" to compiling black lists of irresponsible amateur transmitters. In any case, an explanation appears due from local societies in the area under discussion.

I for one do not propose to allow these illegitimate transmissions to jeopardise the facilities granted to some of us who have, I hope, some claim to them (otherwise than as a "microphone" expert) if a list of offending stations sent to the authorities will prevent it.

CHAS. M. DENNY (6DN).

Cheadle Hulme.

Sir,—I have read with interest the correspondence in your columns regarding amateur transmitters and the public, and would like to give you my views on the subject as regards the Manchester district. In the first place let me say that I have no prejudice whatever against the genuine licensed amateur transmitter, and think that he is sufficiently haudicapped for time already, without being deprived of a further two hours on Sundays. The "gentlemen" who are really to be complained of in this district are not the bona-fide licensed transmitters, but a clique of unlicensed transmitters who seem to think that they own the ether, and who know no more about what they are doing than the man in the moon.

From investigations which I have made recently I can confidently say that more than half of the amateur transmissions in this district at the present time emanate from unlicensed stations with false call-signs. Perhaps it is this type of individual that some of your correspondents refer to.

I hope no licensed transmitters will take this letter as being a slur on them, as I quite agree with Mr. Prosser (6YS) that there are some of the best transmitters in the country in the Manchester district.

I think it is high time that the radio societies were doing something to put an end to all these unlicensed transmissions, and if any of the amateurs concerned with the transmissions read this, I might warn them that any of their addresses which fall into my hands will be reported to the G.P.O., as they are a positive nuisance, and it is this type of gentleman that earns a bad name for the bona-fide transmitters.

I might say that one of these "pirates" cannot even control his own tongue, much less a transmitting station, as one Sunday

The Editor's Mail.—

evening, two or three weeks ago, he was heard swearing over the ether about someone who was heterodyning and so spoiling his "experiments." I hope that after reading this you will realise what things really are like in Manchester, and that something ought to be done to put an end to this sort of thing, for the sake of the licensed transmitters, of whom there are quite a number in the district, doing very good work, and who should be encouraged in every way and highly respected.

Chorlton-cum-Hardy, Manchester.

A. NIXON.

Sir,—On opening my copy of *The Wireless World* for April 7th I saw before me a most enjoyable criticism of myself by Mr. Prosser (6YS), of East Aberthaw, Cardiff.

I must say Manchester amateurs have found a champion in South Wales!

Will Mr. Prosser let us know which Manchester amateurs he has worked with on telephony between 300-390 metres, as those are the ones I was complaining about?

When you are listening to a foreign station 200 miles or more away, and an amateur starts up a few miles away, the distant station is blotted out and you *can* hear what he is talking about, though it is naturally very distorted. Of course, when the amateur is more distant you cannot make out a word.

I can assure Mr. Prosser that I do not "know all there is as regards radio," but some day I hope to know as much as he does. "Can I operate a valve transmitter?" No! but I do not think I could produce worse sounds than some transmitters do. The remarks about a .001 variable condenser related to short wave reception, not transmission. If I have annoyed South Wales so much, I fear to think of what might happen if I complained to the Manchester Radio Society.

I do not think anybody would want to limit amateur transmission if they would only work away from the foreign stations, but it is very annoying, especially when listening to Madrid at midnight, to have it heterodyned when the rest of the wave-band is empty.

Could not the amateur listen in for a bit and adjust his transmitter to a wavelength that will not interfere?

Withington, Manchester.

G. N. WRIGHT.

IGNORED QSL CARDS.

Sir,—I note with interest the reply to Mr. Meissner from the pen of Mr. T. P. Allen in your issue of April 14th. I wish to corroborate Mr. Allen's statements on the attitude of "G" and "Gi" stations towards the QSL card, for out of 126 British stations worked and QSL'd by this station up to April 2nd replies have been received from 123.

Moreover, his assumption that report cards from Mr. Meissner (DE0122) are sent *via* "Journal des 8" is correct, and a personal experience of the methods of this concern in dealing with cards addressed to non-subscribers may afford some consolation to a number of amateurs who have distributed far more "wallpaper" than they have received.

On the morning of April 14th a collection of 19 report cards from Continental "hams," including one from DE0122—Mr. Meissner, please note!—was received by me from the T. and R. Section QRA Bureau, to whom they had been forwarded by the "Journal des 8." Eighteen of these cards concerned transmissions which were made from this station during November and December, 1925!

The reports were chiefly from French stations and had been dated by the operators within a day or two of the date of the transmission to which they referred; since which time they have apparently reposed in the archives of the "Journal." No responsibility for the delay is attached to the T. and R. Bureau, as in a communication dated March 25th I was informed by the hon. organiser of that department that he had no further cards for me at that time.

I give this experience for two reasons, firstly, in the hope that it will dispel the idea, prevalent amongst a number of our British transmitters, that the average French "ham" is extremely reluctant to part with his QSL cards; secondly, with the object of impressing upon foreign amateurs the desirability of sending their reports for British stations either direct to those stations, to a British journal, or to any British amateur whose QRA they know.

I should like to associate my name with that of Mr. Allen

in his offer to forward QSL cards from any foreign amateur, and to assure Mr. Meissner that it is safe to assume that 99 per cent. of his reports to British stations will be replied to immediately they are received from the "Journal des 8."

Prestatyn, North Wales. GEO. A. MASSEY (G6YQ).

BRETWOOD "AUTO AUDIO FREQUENCY AMPLIFIER."

Samples of the Bretwood "Auto Audio Frequency Amplifier" were sent us for test, and we subsequently wrote to the manufacturers making certain observations on the instrument. The following letter, which we are authorised to publish, was sent us in reply.

Sir,—With reference to your esteemed favour of the 15th inst., addressed to our Mr. Le Breton, we beg to say that we are very much surprised with the contents of same.

First of all, let us point out to you that our amplifier is not a choke, nor have we ever called it a transformer. You will notice that we never use the word "transformer" in our literature, or on the instrument itself, but only the word "amplifier."

With reference to your tests made as to any reduction in interference from atmospherics as compared with results obtained from other forms of choke coupling, we must say that we are afraid you could not have given same a fair test, and in accordance with the numerous testimonials we have received from all parts of the country. In fact, if you are still not convinced, we could possibly at some future date arrange a demonstration when atmospheric conditions are very bad, to prove that our component is better than any transformer or choke, in that it *does* greatly reduce interference.

Regarding your third paragraph, we wish to point out that we did not originally set out to design this instrument with a view of eliminating atmospherics, but our aim was to find an instrument which combined the advantages of the transformer with those of the choke, but which was neither, and in so doing we discovered from numerous tests made in London and in the country, that whenever other people suffered from atmospherics and similar disturbances, reception on our component was comparatively free, and it is only because this has been proved in numerous other quarters that we felt justified in claiming that it was possible to reduce atmospherics.

We repeat that this is all the more noticeable when more than one or two stages are used, and we hope you will consider us, under the circumstances, justified in making these claims, which we are prepared to back up by a week or fortnight's trial, as well as a three years' guarantee. Surely this could not be a fairer proposition to the public, and we have still to find another firm who will go to the same length.

We are surprised that you have thought it necessary to break open one of the samples submitted. You could have saved yourself all that trouble if you had sent your representative to the works, where you could have seen these amplifiers in the course of assembly. We could have then fully explained the matter by way of diagrams, which has been done to a number of people who are well versed in wireless theory and practice, and who all agree that the special construction of our amplifiers leads one to suppose that an automatic pressure tuning action takes place in the condenser, which lies within the field of the primary and secondary coils.

As was pointed out to us by Mr. Kemp, of Manchester, this particular arrangement constitutes really a filter circuit, and makes it possible to eliminate any frequencies except those to which the circuit is tuned, and that is why we gave our amplifier the name of the "Auto Audio Frequency." In any case, to call our component a transformer would be a misnomer, as this is not the right name for the ordinary low frequency transformer. In general electrical technology, transformer is understood to be an apparatus which is capable, we say, of converting direct into alternating, or the reverse, or really transforming one current into that of a different character. In a low frequency transformer there is no such transformation of current, but there is merely a step-up effect taking place, and therefore you will see the reasons why that under no circumstances would we have called our component a transformer.

If you, therefore, would like personally at any time to go into the matter, we should be glad to see you, or your representative, so that any misconception on your part may be cleared away.

BRETWOOD, LTD.

London, W.1.

W. H. le Breton, Director.

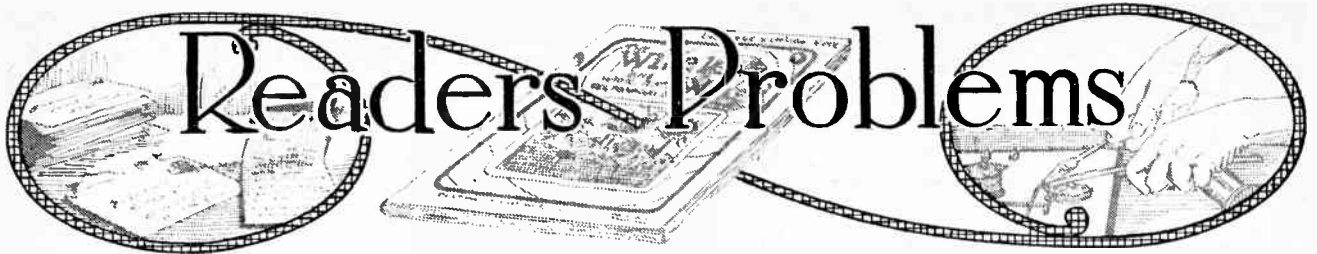

"The Wireless World" Information Department Conducts a Free Service of Replies to Readers' Queries.

Questions should be concisely worded, and headed "Information Department." Each separate question must be accompanied by a stamped addressed envelope for postal reply.

Improving the "Safety Four."

Some time ago I built the four-valve safety receiver described in your issue of August 19th, 1925, and am well pleased with the results obtained, the instrument fully coming up to the claims made for it in the article in respect of absolute "fool-proofness," but I should like, if it is at all possible, to arrange to increase the range and selectivity of the instrument in order to listen to more distant stations without interference from nearby stations. As, however, the receiver is intended for the use of my family at such times as I am away from home, it is essential that the "foolproof" properties of the receiver be not impaired, and if it is impossible to effect this without drastically altering the normal functioning of the receiver I will abandon the idea. A.M.F.

This receiver was essentially designed to give good loud-speaker results on the high-powered station up to a distance of about 150 miles, and from main broadcasting stations at approximately 50 miles, and at the same time to be absolutely constant in the settings of its two dials for any given wavelength. It was, moreover, so designed that no juggling with plug-in coils was necessary for tuning even up to the Eiffel Tower wavelength, and it was not possible to cause the set to oscillate. In order to effect this, a direct-coupled aerial circuit was used in connection with an H.F. stage, variometers with special switching arrangements being incorporated and the use of reaction was eschewed. In order to increase the sensitivity of the arrangement, therefore, it would be necessary to introduce reaction, which itself would cause some improvement in selectivity, whilst it would be desirable to use a coupled aerial circuit in order to bring about a really high degree of selectivity.

Now in the first place the incorporation of reaction would completely upset the dial calibration and render the receiver no longer foolproof, quite apart from the difficulty of adding the ordinary magnetic reaction or even the ordinary magnetic aerial coupling to a receiver incorporating variometer tuning. Fortunately, it is a fairly simple matter to overcome all these difficulties by the expedient of constructing a simple additional unit consisting of a 0.0005 mfd. variable condenser and a switch, this unit being quickly coupled up to the set when it is desired to eliminate local interference and receive distant

transmissions. By removing the unit, the status of the receiver as a foolproof instrument is at once restored. The necessary connections, which are quite simple, are shown in Fig. 1. Here is illustrated the tuning arrangements associated with the first valve of the receiver. It will be seen that the additional unit is coupled between the aerial lead-in and the aerial terminal of the receiver.

Now, it is equally possible to couple the aerial capacitatively to the closed grid circuit of the first valve of any radio receiver as it is to couple it by the more conventional magnetic method, whilst selectivity is equally as good, with the additional advantage of greater simplicity and flexibility, and if on the broadcast wavelength the coupling condenser has a value of 0.0001 mfd. excellent selectivity without loss of signal strength will be attained.

On the Daventry wavelength this coupling condenser requires to be somewhat higher, this increase being very simply provided for by using a 0.0005 mfd. variable coupling condenser. It should be

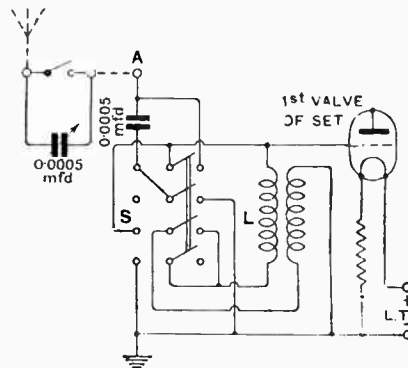

Fig. 1.—An efficient method of increasing range.

pointed out that this condenser should be considered purely as a variable capacitive coupling between the aerial and the grid circuit of the first valve, and should not be regarded as part of the tuning system. This matter is, however, fully gone into in the reply to G.P.K. in the April 7th issue, to which you should refer.

When desiring to receive a distant station, therefore, the coupling condenser should be set at a value where the receiver is just off the oscillation point, and then it will be found that sensitivity and selectivity are both very good. When the receiver is in this condition, of course, a slight movement of the coupling condenser

will cause the receiver to oscillate if it is desired to search round for the carrier wave of a distant station after the B.B.C. stations have closed down. Since the coupling condenser will always be at a fairly low value, slight movements on it will have no appreciable effect on the setting of the aerial variometer. Of course in the first place the reading of the aerial variometer will be higher than when using direct-coupled aerial owing to the removal of the effect of the aerial capacity.

For a fuller explanation of this, you are again referred to the reply to G.P.K. (April 7th issue). This method of tuned plate reaction is very greatly used in American commercial receivers. The short-circuiting switch is for the purpose of making a rapid change back to direct coupling when desired. When leaving home for a period, however, you are advised to remove this additional unit altogether.

o o o o

Using a Milliammeter as a Voltmeter.

I understand that it is possible to use a milliammeter as a voltmeter. I have a moving coil milliammeter reading from 0 to 25 m.A., and should like to adapt it so that I could use it as a voltmeter in conjunction with my 120-volt H.T. battery. Will you please inform me how to do this? P. R. C.

Since you require to measure the voltage of a 120 volt battery, a good maximum voltage reading to aim at is 125 volts. This will mean that every division on your dial reading 1 m.A. will be used to represent 5 volts. Now briefly, your requirements are that your milliammeter should read 1 m.A. when a pressure of 5 volts is applied across it, and thus 125 volts will cause the maximum deflection of 25 milliamperes. Now Ohm's Law tells us that if an E.M.F. of 5 volts causes a current of 1 milliampere to flow through a conductor, then the resistance of that conductor is 5,000 ohms, and similarly the resistance will be 5,000 ohms if the voltage is raised to 125 volts, and the current to 25 milliamperes.

The resistance of the milliammeter windings as at present will naturally be very considerably less than this, the actual resistance of the windings of a medium-priced instrument being about 400 ohms, and therefore we must add an external series resistance. It is obvious then, that if we find the actual resistance of the milliammeter windings, a very simple sum in subtraction will give us the value of the resistance to be added.

DARIMONT HOME SERVICE BATTERIES

(Patented)



FOR
DULL EMITTER VALVES

WRITE NOW for List, with Valve Guide, to :

DARIMONT ELECTRIC BATTERIES Ltd.
DARIMONT WORKS, ABBEY RD., PARK ROYAL,
LONDON, N.W.10. 'Phone : Wembley 2807.

Your Loudspeaker

WILL SING

THE PRAISES OF

NELSON MULTI 3-FILAMENT VALVES



Here is a Valve giving you Finest Quality and Volume with Economy. It is of equally high grade as H.F. Detector, L.F., or Power Amplifier.

The little switch places at your command each of 3 Filaments separately, or any 2 in parallel for Power Amplification. Each Filament gives the Valve a New Life.

ALL VALVES are Guaranteed.

FOUR IMPROVED TYPES

- A. 4 to 5 VOLTS, 0.15 AMPS. per Filament 9/6
- D.E.A. 2.6 VOLTS, 0.18 AMPS. per Filament 15/-
- D.E.2. 1.8 to 2 VOLTS, 0.36 AMPS. per Filament 15/-
- D.E.08. 3 VOLTS, 0.06 AMPS. per Filament 18/6

Obtainable at
All London's
Largest Stores.

If unable to obtain from your dealer, write direct :—
NELSON ELECTRIC COMPANY LIMITED,
Merton Park, London, S.W.19.

Telegrams: Valvenclo, Wimbale, London.

'Phone: Wimbledon 172.



MATCHED TONE HEADPHONES

If you're fond of sitting up in the wee sma' hours to stretch a hand across the world, Matched Tone are extremely able confederates. With radio you span continents and with Matched Tone it becomes easier, "comfier" and much more efficacious. Distant signals stand out clearly; Matched Tone grope in the ether with unflinching accuracy. The specially matched receivers make them super-sensitive and tone perfect. You are logging a new call-sign every day with Matched Tone.

20/-

Table-Talker 30/- Brandola 90/- Audio Transformer 17/6

Brandes

Brandes Limited, 296, Regent Street, W.1.

From any good Dealer

U/563.B.

SERVICE ADVERTISING

To get pure EBONITE, ask for



It is made from finest rubber and sulphur and is guaranteed free from surface leakage. **Registered Trade Mark.** **QUALITY EBONITE** It proves its quality in every test. Its polish will also please you—ask to see it.
RODS, TUBES, SHEETS, PANELS, MOULDINGS
 Ask your dealer for "BECOL"
THE BRITISH EBONITE CO., Ltd., HANWELL, LONDON, W.

WIRELESS VALVE TRANSMITTERS

The Design and Operation of Small Power Apparatus.

Obtainable from Booksellers or direct from the Publishers,

Price 9/- net. By post, 9/9.

ILIFFE & SONS LTD., Dorset House, Tudor Street, LONDON, E.C.4.

W.W.9

The Wireless World COUPON for

"HIDDEN ADVT." COMPETITION

This coupon is available until Monday 10 a.m., May 3, 1926

Clue No.	Name of Advertiser.	Page
1		
2		
3		
4		
5		
6		

I enter the above solution subject to the published rules.

Name
 (Please write clearly)

Address

APRIL ISSUE NOW ON SALE.

1s. 3d. post free

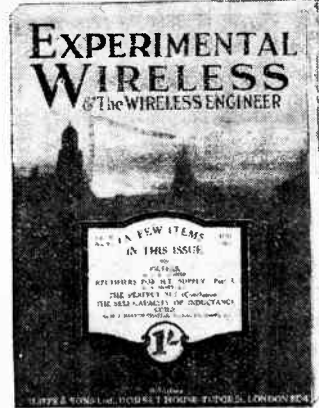

READERS who are interested in the more advanced technical aspects of wireless will find much to interest and instruct them in "EXPERIMENTAL WIRELESS," a monthly magazine of radio research and progress. Its articles are contributed by men who have made special studies in wireless work and are acknowledged leaders in the experimental field.

ONE SHILLING MONTHLY

SUBSCRIPTION: 14s. per annum

ILIFFE & SONS LTD., Dorset House, Tudor Street, London, E.C.4

W.W.2a.

ELECTRONS ELECTRIC WAVES AND WIRELESS TELEPHONY

By Dr. J. A. Fleming, F.R.S.

A course of popular lectures delivered by the author at the Royal Institute of Great Britain forms the basis of this work. By means of simple analogies, Dr Fleming paves the way to a discussion of the elements of electromagnetism and an explanation of the scientific laws upon which wireless telephony depends.

The whole book is written in a singularly clear and fascinating manner, and all who are anxious to understand wireless cannot do better than read Dr. Fleming's able work. It is an excellent starting point for further studies.

PRICE **7/6** NET
 Post Free 8/-

Obtainable from all leading booksellers or direct from the publishers:

ILIFFE & SONS LIMITED
 Dorset House, Tudor St., London, E.C.4

A Guide to WIRELESS LITERATURE

This booklet, describing all books published in conjunction with "The Wireless World," including some other volumes by Dr. Fleming, will be sent **FREE** on REQUEST.

W.W.41.

EBONITE OF THE FINEST QUALITY

**SHEETS
RODS &
TUBES.**

PANELS CUT ANY
SIZE AND ANY
THICKNESS.

Egg Shell Matt or Polished
Surface.
**LARGE STOCKS. IMMEDIATE
DELIVERY.**

Awarded Silver Medal for
Ebonite, Crystal Palace Electrical
Exhibition, 1892.

BRITKAM-EBONITE (Britannia Rubber &
Kamputicon Co. Ltd.)
7, NEWGATE STREET, LONDON, E.C.1.

Telephone: Central 2168 (2 lines).

Telegrams: Britannia, London.

PERFECT Grid-Leak SERVICE



When you ask your Wireless Dealer for a grid-leak he will render you perfect service if you say you want a reliable one.

He will at once hand you a "Bretwood."

All "Bretwood" Products carry a Three Years Guarantee. Write for Complete List.

Price of GRID-LEAK or ANODE RESISTANCE

3/-

(Price with Condenser as illustrated 4/- Postage on either 3d.

Each. Obtainable from most Wireless Dealers

BRETWOOD Ltd., 12-18 London Mews, Maple St., London, W.1

Patrs. Ad.

Finston

FILAMENT RESISTANCES
On Bakelite Mouldings.

7 ohms	-	2/3
15 ohms	-	2/6
30 ohms	-	2/6

Obtainable from all dealers.

FINSTON MANUFACTURING CO., LTD.,
45, Horseferry Road, LONDON, S.W.
Phone: Victoria 1044

The Varley Bi-Duplex Anode Resistance.

The famous Bi-Duplex system of non-inductive wire winding has placed the Varley Anode Resistance far ahead of any other make for silence in working, purity of tone and absolute constancy under all atmospheric conditions.

The Varley Magnet Co.'s 27 years' experience in all matters relative to intricate and accurate wire winding is a sound guarantee of satisfaction.

Complete with Clips and base **7/6**
Without Clips and base **6/-**

60,000, 80,000 and 100,000 ohms.

Write for Leaflet.

Constant always

THE VARLEY MAGNET Co., WOOLWICH,
(Proprietors: Oliver Peil Control, Ltd.) S.E.18.
Telephones: Woolwich 888, P.S.

All Post Free & At Callers Prices

0-5 Voltmeter 	Izion Hand Drill
RELIABLE INSTRUMENT ONLY 3/6	TAKES DRILLS UP TO 5/16 in. SIX DRILLS - 1/1
SQUARE LAW VAR. CONDENSER With Knob and Dial "001 Panel type 6/6 "0005 5 - "0003 4/6 Vernier Blade ex. 1/4 Dial 1 1/2 in. x 1 1/2 in. McMichael, Edison Bell, Liscen, Mul- lard (usual prices). New Mansbridge 2/6 mid. 3/6; 1 inf. 2/6	BRITISH WIRES 8wg. dec. dec. 18 .. 1/11 3/6 20 .. 2/2 4/2 22 .. 2/8 4/7 24 .. 2 11 8/- 26 .. 3/4 5/9 28 .. 3/9 6/8 30 .. 4 10 7/6 32 .. 5/6 8/9 36 .. 8/- 12/- 40 .. 17/- 20/-
COIL HOLDERS. Reliability Ver- nier 3/6 "Lotus" 2-way 7/- "Newey" 2-way 6/- "L. & P." 2-way 8/6 "Polar" 2-way Cam vernier 6/-	TRANSFORMERS. L.F. Radio Inst. 25/- 27/6 "Ironic" 21 - 4 20 Eureka, No. 2 21/- "Concert" Grid. 25/- "Baby Grand 15/- Ferranti A.P. 4 17/8 "A.F. 3 25/-
VARIABLE LEAKS Filtrol 0.7 meg. 3/- Watmel 0.5 .. 2/6 Liscen Type .. 2/6 Bretwood .. 3/-	H.T. BATTERIES With Wandler Plugs 90v., 11 - 60v., 7/6; 36v., 4/6; 15v., 1 10; 44v., 1 1/2. Battery, 6d.; 60v. Ever ready, 12/6; 36v., 7/-; Siemens stocked.
RELIABILITY GUIDE, No. 2 Free on request.	7 22A AERIAL WIRE Knam Bright 4strd. 100', 3/3, 2/3 1/1 150', Electron 1/8 Lead-in 4d. yard.
J. H. TAYLOR & Co. A RADIO HOUSE. MACAULAY ST., HUDDERSFIELD Tel. 591 Grams: THOROUGH HUDDERSFIELD	Orders 5/6 value. Carriage paid. (Under 5/6 add. per lb. for packing.)

Two in One!

Here's a splendid little component, the Watmel combined Grid Condenser and Fixed Grid Leak. Saves space, time and money. Built to allow the Grid Leak to be connected either across the condenser or direct to the filament of the detector valve.

Price **2/6** each.

Send a postcard for full details of the various Watmel products.

The Watmel Wireless Co. Ltd.,
332a, Goswell Rd., London, E.C.1.

Representative for Lancashire & Cheshire:
Mr. J. B. Lever, 23, Hartley Street,
Lancaster, Manchester.

For trouble-free condenser efficiency always specify the famous round Watmel fixed condenser.

Sizes up to '002 .. 2/-
SIZES '0025 to '006 .. 2/6

"CAST-IN"

The diaphragm of the "Hearthside" Speaker is die-cast into a solid ring—that means no "rattle" or "overload." The horn is non-resonant—that means "tone." A new magnetic system—that means "volume."

You must hear this new Speaker—**35/-** to-day!

Send now for your **FREE** copy of our new catalog.

General Radio Co Ltd., 235, Regent St., W.1

ALL GOOD DEALERS DEMONSTRATE - SEE IT TO-DAY

General Radio

Advertisements for "The Wireless World" are only accepted from firms we believe to be thoroughly reliable.

MISCELLANEOUS ADVERTISEMENTS.

NOTICES.

THE CHARGE FOR ADVERTISEMENTS in these columns is:

12 words or less, 1/- and 1d. for every additional word, e.g., 18 words 1/6; 24 words, 2/- Name and address must be counted.

SERIES DISCOUNTS are allowed to Trade Advertisers as follows on orders for consecutive insertions, provided a contract is placed in advance, and in the absence of fresh instructions the entire "copy" is repeated from the previous issue: 13 consecutive insertions, 5%; 28 consecutive, 10%; 52 consecutive, 15%.

ADVERTISEMENTS for these columns are accepted up to **FIRST POST ON THURSDAY MORNING** (previous to date of issue) at the Head Offices of "The Wireless World," Dorset House, Tudor Street, London, E.C.4, or on **WEDNESDAY MORNING** at the Branch Offices, 19, Hertford Street, Coventry; Guildhall Buildings, Navigation Street, Birmingham; 199, Deansgate, Manchester.

Advertisements that arrive too late for a particular issue will automatically be inserted in the following issue unless accompanied by instructions to the contrary. All advertisements in this section must be strictly prepaid.

Postal Orders and Cheques sent in payment for advertisements should be made payable to **ILLIFFE & SONS Ltd.**, and crossed **& Co. Treasury Notes**, being untraceable if lost in transit, should not be sent as remittances.

All letters relating to advertisements should quote the number which is printed at the end of each advertisement, and the date of the issue in which it appeared.

The proprietors are not responsible for clerical or printers' errors, although every care is taken to avoid mistakes.

NUMBERED ADDRESSES.

For the convenience of advertisers, letters may be addressed to numbers at "The Wireless World" Office. When this is desired, the sum of 6d. to defray the cost of registration and to cover postage on replies must be added to the advertisement charge, which must include the words Box 000, c/o "The Wireless World." Only the number will appear in the advertisement. All replies should be addressed No. 000, c/o "The Wireless World," Dorset House, Tudor Street, London, E.C.4. Readers who reply to Box No. advertisements are warned against sending remittance through the post except in registered envelopes; in all such cases the use of the Deposit System is recommended, and the envelope should be clearly marked "Deposit Department."

DEPOSIT SYSTEM.

Readers who hesitate to send money to unknown persons may deal in perfect safety by availing themselves of our Deposit System. If the money be deposited with "The Wireless World," both parties are advised of its receipt.

The time allowed for decision is three days, during which time, if the buyer decides not to retain the goods, they must be returned to the sender. If a sale is effected we remit the amount to the seller, but, if not, we return the amount to the depositor. Carriage is paid by the buyer, but in the event of no sale, and subject to there being no different arrangement between buyer and seller, each pays carriage one way. The seller takes the risk of loss or damage in transit, for which we take no responsibility. For all transactions up to £10, a deposit fee of 1/- is charged; on transactions over £10 and under £50, the fee is 2/6; over £50, 5/-. All deposit matters are dealt with at Dorset House, Tudor Street, London, E.C.4, and cheques and money orders should be made payable to Illiffe & Sons Limited.

THE SALE OF HOME-CONSTRUCTED UNLICENSED APPARATUS.

A New Service to our Readers.

We have made an arrangement with the Patentees whereby readers who wish to dispose of a home-constructed receiver not licensed under the patents made use of, can do so by means of the Deposit System referred to above.

The person desiring to sell, in sending us particulars for his advertisement, will in every case make use of a Box No., and should add to the price which he requires the amount of royalty customarily paid by manufacturers, viz. in the case of Marconi Patents the amount should be calculated at 12/6 per valve holder.

If the purchaser is satisfied with his purchase, the sum realised will be forwarded to the seller, less the amount due in respect of royalties, which amount will be paid by "The Wireless World" to the owners of the patents concerned, and a certificate will be handed on to the purchaser of the set.

FOR SALE.

WOOD Horns for all speakers and gramophone attachments. There's one for Amplion Junior, ditto goose-neck bases, Lisenola, etc. There's only one best; it's the "Allwoodorn."—Manufacturer: H. Maddison, 2A, Ronald's Road, Highbury, N.5. List free. (1914)

For Sale.—Contd.

OSCILLATING Zincite and Contact, 2s. 6d.; simple, original circuit, 1s.; excellent results; other parts stocked.—Ledsham's, 207, King Street, Hammersmith. (1888)

2-VALVE Loud-speaker Receiver with automatic switching built with best components, price, including royalties, £6 5s.; 3-valve set, £7 17s. 6d.; Leclanché high-tension batteries, require no charging; headphones, 12s. 6d. pair. All parts stocked. List on application. Trade supplied.—G. Small, 161, Greenway Road, Taunton, Somerset. (1970)

60-VOLT Wet H.T. Batteries, in wood case, no recharging, practically everlasting, Leclanché principle; 19s. 6d., cash on delivery, lists free.—Tennant's Wireless, Hylton Road, Sunderland. (1983)

WESTERN Electric £8 Loud-speaker, used few months; what offers?—35, Belmont Road, St. Andrews, Bristol. (2011)

NEW Apparatus, guaranteed, 4-valve set, complete; 120v. Hart accumulator; 6v. 80 Hart; Polar loud-speaker; detail on request; £39; cost £50.—226, Warwick Road, Greet, Birmingham. (2013)

THREE McMichael, tuned, Intermediate Superstern Transformers and tuned filter; £2.—Box 7707, WIRELESS WORLD Office. (2014)

THREE .0025 Sterling S.L. Condensers, without dials, 10s. each; Igranite 3-1 transformer, 10s.; Polar R.C.C. unit, 7s. 6d.; Burndeft 3-way coil-holder, 10s.; Amplion Junior loud-speaker, 2,000 ohms, 35s.; 2 Peto-Scott H.F. low-loss transformers, 250-550, 15s.; 2 McMichael H.F. transformers, 300-600, 1,100-3,000, 7s. 6d.; all in new condition and guaranteed perfect.—Box 7708, WIRELESS WORLD Office. (2015)

BURNDIPT Ethophone Grand 5-valve Receiver, cabinet by Broadwood, cost £120, receive all British, Continental stations on speaker, perfect condition, receiver, valves, batteries, speaker, and special enclosed table; £47; will sell separately.—"Dalmeny," Woodberry Grove, North Finchley, N.12. 'Phone: Finchley 0984. (2016)

SET 5 H.F. Transformers; 10s.; C.O.D.—Whitehead, 13, Kitchener Road, Ipswich. (2017)

BARGAIN.—Fada, latest model, long-short, 5-valve Neutrodyne receiver, as new, complete with valves, gets almost anything with perfect reproduction, heard any evening; £30, no offers.—Edwards, 111, Leaside Crescent, Golders Green. 'Phone: Speedwell 3395. (2019)

MCMICHAEL H.F. Detector and 2 L.F. in 2 mahogany cabinets and C.A.V. accumulator, trial against deposit, guaranteed perfect; £12 10s.—Baker, 8, The Hythe, Staines. (2020)

LISSEN Regenerative Reactance, unused, 20s.; also complete set of Fellows coils (11), 30s.—29, Colonnade, Russell Square, London, W.C.1. (2021)

EXPERIMENTER'S Annual Clearance.—Only best British components for sale, excellent condition. Send stamped addressed envelope for list.—Box 7737, WIRELESS WORLD Office. (2023)

FOR Sale.—Marconi Straight Eight, absolutely new. Will take £50 cash, including H.T. batteries and valves.—Ault, Ashley, Church Hill, Purley, Surrey. (2036)

For Sale.—Contd.

COMPLET^E Burndeft Receiving Station, wavelength range 150 to 6,000 metres, including Burndeft Ultra IV. receiver, Mark IV. tuning panel, 8 Burndeft coils, S.1 to 300, 2 pairs Sterling headphones, 2 accumulators (6v. 80amp.), Ethovox loud-speaker, aerial complete with switch, 4 Marconi R. valves, 1L.S.5 and 1L.S.5 power valves, any reasonable price accepted; what offers?—The Secretary, Reading Rooms, Rawcliffe, Yorks. (2025)

EXCEPTIONAL Offer!—Complete set M.H. Tuned Supersonic Units (150-2,000 metres), Autodynes 0, 1 and 2 reactors, etc., 90s.; Weston flush panel type amp. meter (12 10), 40s.; "Primax" loud speaker, 95.—BM BSKF, London, W.C.1. (2041)

AN Absolute Bargain!—Complete Short-wave Transmitter and Receiver and Accessories, cost £58, for sale. Would accept £35 or sell separately. Also broadcasting apparatus. All perfect condition and first-class workmanship.—Box 7755, WIRELESS WORLD Office. (2042)

HETERODYNE Wavemeter, 114-220 metres, calibrated at N.P.L., complete with valve and original calibration chart, bargain, £5 10s.; 4-valve receiving set, H.F. det., 2 L.F., requires one L.F. transformer, mahogany cabinet, G.E.C. slow-motion aerial condenser, £9; R.I. tuner, as new, 25s.; Polar precision condenser, .0005, 8s. 6d.; 2 intervalve transformers, 10s. each.—6AU, Eastcliffe, East Bank Road, Sheffield. (2040)

2,800-VOLT Generator, Amplion Radiolux loud-speaker, new, large oak model; 2 Hart 60-volt accumulators, new; 12in. spark coil; 3 H.F. Igranite transformers; broadcast range, new; Atlas vario-meter; Silvertown transformer, etc. Best offers. Also choke control aircraft telephony transmitter.—Aspden, 6, Southport Road, Chorley. (2039)

FIVE-VALVE (2 H.F.) Unit Set, Peto Scott, given away at £4 15s.; 1-valve Flewelling, £1 15s.; Wates' 2-valve amplifier, £3. Numerous components. Stamp list.—Clark, 47, Daisy Bank Road, Manchester. (2038)

CLEARANCE Bargains.—(20-ohm) headphones, 4s. 6d. pair; microphones, 1s. 6d.; small transformers, 2s. 6d.; Jack plug, 6ft. cord, 2s.; 4-pin plug, 5ft. cord, 1s. 6d.; fan motors, any voltage, 10s.; Marconi variable condensers, 4s. 6d.; Morse transmitting sets, ex R.A.F., 7s. 6d.; hand telephones, 3s.; ½ h.p. electric motors, with blowers, 100 volts D.C., 50s.; ear phones, L.R., 1s. 6d.; G.P.O. hand phones, 2s.; ½ mfd. mica condensers, H.T., 5s.; ¼ h.p. motor, 100 volts D.C., £6; ditto, ½ h.p., 90s.; .025 Mansbridge condensers, 6d. each; 1,000-ohm chokes, 1s. 6d. modulation transformers, 5s.; large horse shoe magnets, 1s. each. Post extra each item.—Galpin, 16, Loampit Hill, Lewisham London, S.E.13. (2037)

LONG-RANGE Marconiphone, V.2 receive for sale. Latest long-range model with rotary tuning. All B.B.C. and Continenta wavelengths, including Daventry and Radi Paris, perfect condition, £7 or near offer.—Peter, 19, Meadow Way, Wembley. (2031)

TRANSMIT wireless from one room to another via your bell wires. No extra wiring necessary. New system. Condenser plaque, etc., and full instructions, 6s.—Box 7748, WIRELESS WORLD Office. (203)

For Sale.—Contd.

TWO unused Brown's amplifiers, £2 each; one double Brown's relay, £5; unused V24 and QX valves, 13s. 6d. each; .00025 Sterling square-law condensers, 10s. each.—Bushell, 50, Shaftesbury Road, Hammer-smith, W.6. (2032)

HIGH-TENSION Accumulators.—Less than half cost of dry batteries. Simple building and charging instructions, plus one fully-assembled sample cell, 2s.—Box 7747, WIRELESS WORLD Office. (2029)

MARK III. Tuner, 300-3,000 metres, contains two .0015 variable condensers, tapped Litzendraht coils, crystals, etc., perfect condition, 55s.; also G.P.O. polarised relay, rewound, 2,000 ohms, 25s. Can be seen evening after 7.—Holman, 41, York Street, Baker Street, W.1. (2034)

EXCHANGE.

STERLING Mellovox, exchange for Volt-meter or anything useful.—C. E. Moore, St. Neots, Hunts. (2033)

FINANCIAL PARTNERSHIPS.

PARTNERSHIP.—Radio Engineer in Paris seeks active partner with some capital to extend business.—Write: Radio BV, 41, Rue de Liège, Paris, 8e. (2027)

MISCELLANEOUS.

A WIRELESS Doctor.—If your set is giving trouble or you want advice a competent expert will call (anywhere in Greater London) and put you right. No result, no charge.—Alexander Black, 2A, Woodville Grove, N.16. Clissold 3687. (2002)

CHARGE Your Own Accumulator.—Send 3d. stamp to-day for lists of our small gas and petrol engines and dynamos, and complete charging sets, from 20 to 160 watts.—Tom Senior, Cleckheaton, Yorks. (2013)

PATENT AGENTS.

W. BRYSON, B.Sc., Chartered Patent Agent, 20, Southampton Buildings, W.C.2. Phone: Holborn 672. (1207)

PATENTS and Trade Marks Obtained.—H. T. P. Gee, Patent Agent, Member R.S.G.B., A.M.I.R.E., 51-52, Chancery Lane, London, W.C.2. Phone: Holborn 1525. (2001)

REPAIRS.

TRANSFORMERS rewound to guaranteed efficiency for 12 months, 4s., or exchanged for another, any ratio, 5s.; iron core wire-wound chokes for L.F. amplifiers, 6s.—115, Links Road, Tooting. (2011)

TUITION.

MORSE Learnt Easily in One Hour, anyone, any age, anywhere, with "Simplete" apparatus. Cannot fail. Post free 2s. 6d.—Simplete Co., 44, Bedford Row, W.C.1. (2028)

WANTED.

WANTED.—Special Five or Anglo-American Six Set.—A. Davey, Moorland Road, St. Austell, Cornwall. (1996)

AGENTS.—"Laker" Steel Masts; liberal commission; exclusive territory.—Laker, Engineers, Beckenham, Kent. (2024)

GOODS ideas and patents required by responsible London Wireless Accessory Manufacturer who will purchase outright or manufacture under licence. Now preparing for coming season.—Box 7736, WIRELESS WORLD Office. (2018)

WANTED.—High-tension Dynamo for 10-watt transmitter.—Llewellyn, Baldock Road, Letchworth. (2035)

Wanted.—Contd.

WANTED.—Magnavox Loud-speaker, any condition, horn not necessary.—Radio Electric, 57, Holdenhurst Road, Bournemouth. (2026)

BUSINESSES & PROPERTY FOR SALE, TO BE LET, OR WANTED.

FOR Sale.—Little goldmine; thriving town; Essex; smart shop, workroom over; smart man could make £10 weekly.—Underwood, 57, Panton Street, Cambridge. (2022)

SITUATION VACANT.

SUDAN Government.—Vacancies exist for Telegraph and Wireless Inspectors in the Engineering Branch of the Posts and Telegraphs Department, Sudan Government; pay £E.300 to £E.324 on 2 years' probation, after which permanent service may be offered; age 23 years upward; single men preferred.—Full particulars on application in writing to Controller, Sudan Government London Office, Wellington House, Buckingham Gate, S.W.1, marking envelope "Telegraph Inspector" or "Wireless Inspector." (2012)

AUCTION SALES.

Owner Giving Up Business. Without Reserve. To ELECTRICAL, WIRELESS GOODS, AND MACHINERY DEALERS.

3, 5 AND 7 SOUTHVILLE, WANDSWORTH ROAD, S.W.

(Short tram ride from Vauxhall Station.)

HENRY J. SHAW

Is Instructed to Sell by Auction, on the premises, on

TUESDAY, MAY 4TH, AT 12.30 PROMPT, The Whole of the Stock, Plant, Machinery, and Fixtures, including a New Drummond 5in. Centre S.S. & S.C. Lathe, Capstan Lathe, Saw Bench, Power Drilling Machine, 3 h.p. 220-volt D.C. Motor, Avery 10-cwt. Platform Scales, Tools, Belting, etc.

Wireless Material includes 700 pairs Head-phones, Crystal, 1-, 2-, 3-, and 4-valve Sets, 400 Coil-holders, 1,000 Cabinets, 1,000 Aerial Winders, Loud-speakers, 300 Coils Single Flex, Aerial Wire, Ebonite Sheet Sound-boxes, Tuners, Galvanometers, etc.

Electrical Material includes Cable, Distribution Boards, Accumulators, 200 Car Accumulator Cases, Jars, all kinds of Accessories and Fittings.

1,000 Lenses, 10,000 Rubber Grips, Counters, Counter Cases, Office Furniture, etc.

On View Day Previous and Morning of Sale. Catalogues from THE AUCTIONEER, 85, NEWINGTON CAUSEWAY, S.E.1. Phone: Hop 3862.

YOU CAN TAKE IT FROM ME!

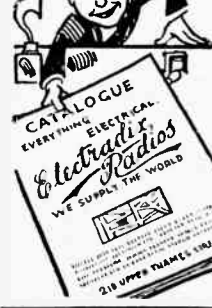

That our Summer Catalogue contains the finest Radio Bargains ever offered. 600 Illustrations of a wonderful selection of unique apparatus.

Send 4d. stamps. **ELECTRADIX RADIOS,**

18, Upper Thames St., London, E.C.4.

Paris Ad

Auction Sales.—Contd.

TO WIRELESS AND ELECTRICAL GOODS EXPORTERS, MANUFACTURERS, FACTORS, RETAILERS, ETC. WITHOUT RESERVE.

13, HIGH HOLBORN, LONDON, W.C.1.

HENRY J. SHAW

Is Instructed to Sell by Auction on THURSDAY, MAY 6TH, AND FOLLOWING DAY, AT 11.30 EACH DAY

Various Stocks, including Polar Blok Crystal and 1- to 8-valve Sets, 1,700 Polar Precision Condensers, immense quantities of P.B. Coil-holders, Holderstats, Rheostats, Anode Resistance-holders, Penut Valve-holders and Lissenstat, ditto and Rheostat, Gambrell, Shroud-d, and Interval Transformers, Terminal Panels, Variometers, Valve-holders, Labels, Terminal Boards, 23,500 O.B.A. Knobs, Multiple Terminals, Crystal Detectors, Loud-speakers, Mullard Condensers, Dubilier Resistances, Igranite Transformers and Variometers, Jacks, Polar Coils, Switches, 22,000 Fuses, Fuse-holders, etc.

C.A.C. Valve and Crystal Sets, Marconi Sets, Buzzers, Headphones, Ormond Condensers, etc.

200 Magnavox Loud-speakers, 300 Crystal and 1-valve Amplifiers, 2,000 M.F. Fixed Condensers, 50 New 6-volt 40-amp. Accumulators, Microphone 1-valve Sets, Ebonite Panels, Formers Valve Legs, Dubilier Grid-leaks, Knife Switches, General Radio Co.'s 1-, 2-, 3-, and 4-valve Sets, Amplifiers, etc.

Polar Blok Sets in Adams, Chippendale, and Jacobean Cabinets, 1,000 Reels Tinned Copper Wire, Coils and Drums of D.C.C. Wire, 2,000 Coils Tinned Copper Aerial, 240 Coils Maroon Flex, 150 Coils Rubber-covered Flex, 150 Coils Aerial Wire, 50 Coils 1/20 Twin-twisted V.I.R. Wire, 250 Fuller's Sparta Crystal Outfits with Phones, complete, 400 .10-12-amp. Ironclad Switches, Fuses, etc (Pinnacle), 214 dozen 5-amp. Switches (also by the Pinnacle Co.), Distribution Boards, Bell Pushes, 700 New Fuller Plate Type Accumulators (2, 4, and 6 volts up to 200 amps.), and large quantities of Electrical Goods and Material.

On View Day Previous and Mornings of Sale. Catalogues upon Application to THE AUCTIONEER, 85, NEWINGTON CAUSEWAY, S.E.1. Phone: Hop 3862.

H.T. Accumulators 37/6

60 Volts. 3 Actual Amp.-hour



The finest H.T. Accumulator in the world.

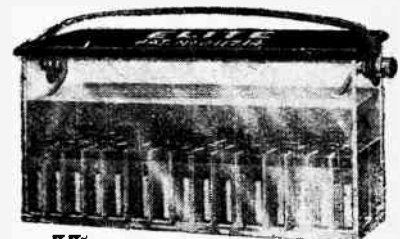

55/-

60-volt, 3-amp.-hour, oil submerged. Will last a lifetime. Write for descriptive Folder.

MONEY RETURNED IF NOT SATISFIED, obtainable only from ACCUMULATORS ELITE, 31, Waterhouse St., Halifax.

Trade Supplied.

Telephone: 1304.

INDEX TO ADVERTISEMENTS.

	PAGE		PAGE		PAGE
Accumulators Elite	13	Dubilier Condenser Co. (1925), Ltd.	11	Metro-Vick Supplies, Ltd.	8
A.J.S. & Co. (1911), Ltd.	14	Finston Manf. Co., Ltd.	11	Miller, J. W.	14
Audion Radio Co.	Cover ii	Fitzpatrick, H. D., & Co., Ltd.	11	Mullard Wireless Service Co., Ltd., The	7
Autoveyors, Ltd.	9	Garnett, Whiteley & Co., Ltd.	11	Nelson Electric Co., Ltd.	9
Bowyer-Lowe Co., Ltd.	9	General Radio Co., Ltd.	11	Ormond Engineering Co., Ltd.	3
Brandes, Ltd.	11	Goswell Engineering Co., Ltd.	14	Paragon Rubber Manf. Co., Ltd.	14
Bretwood, Ltd.	11	Grafton Elec. Co.	14	Pugh Bros.	14
Britannia Rubber & Kaupituleon Co., Ltd.	11	Graham, Alfred, & Co.	14	Radi-arc Electrical Co., Ltd., The	14
British Ebonite Co., Ltd.	10	Hamley Bros., Ltd.	14	Radians, Ltd.	14
British L.M. Ericsson Manf. Co., Ltd.	14	Hildick & Hildick	14	Shaw, H. J.	13
Buradepht Wireless, Ltd.	14	Hunt, A. H., Ltd.	5	Sifam Elec. Inst. Co.	8
Cahill & Co., Ltd.	Cover ii.	Igranie Electric Co., Ltd.	5	Taylor, J. H., & Co.	8
Caxton Wood Turnery Co.	Cover ii.	Jones & Stewart	14	Telegraph Condenser Co., Ltd.	Cover ii.
Charlesworth, W. J.	Cover iv.	Lissen, Ltd.	14	Telephone Manf. Co., Ltd.	11
Chloride Electrical Storage Co., Ltd.	Cover iv.	London Elec. Wire Co. & Smiths, Ltd.	14	Varley Magnet Co., Ltd.	11
Crompton & Co., Ltd.	9	Lustralux, Ltd.	1	Wanmel Wireless Co., Ltd., The	11
Darimont Electric Batteries, Ltd.	13	Macomphone Co., Ltd., The	1	Wilkins & Wright, Ltd.	11
Dixon, Leslie & Co.	13	McMichael, L., Ltd.	1	Withers, J. S., & Spooner	11

•06 DE'S 10/6

Our Valves are admitted to be the best British made valves on the market. 3 Volt '06 L.F. or H.F. only 10/6. 2 Volt '34 only 10/6. Power Valves from 12/6. Write at once for our FREE BOOK and get full particulars. If your dealer is "tied" we supply direct. **RADIONS LTD.** Radion Works, BOLLINGTON, Macclesfield, England.



EARTH FAULTS ENDED

Entirely new method of Earth-system efficiency. 20% to 200% increase guaranteed. Vastly superior to all metal sulphates. Ideal for all outdoor Earths. 2/6 complete, post 6d. Cash on delivery if desired. Particulars free.

J. W. Miller, 68, Farringdon Street, E.C.4.
Phone: Cent. 1950.

Approved by Radio Association.

LOEWE AUDION D.E. VALVES

FOR BEST RESULTS AT LOWER COST!
Will give better results than many at nearly double the price: specially suitable for Super-het. Sets.

L.A.75 '15 amp. 2 volt, 20.8 (if your dealer L.A.74-06 amp. 3 volt, 11.6 cannot supply L.A.101, Power valve. 21.7) direct to

AUDION RADIO CO.,
52, Dorset Street, LONDON, W.1.



WIRELESS MASTS.
GALVANIZED TUBULAR TELESCOPIC.

Complete with base plate, ground pegs, stay wires, straining screws, pulley and cleat.

35ft. High £3 2 6 50ft High £8 15 0

HILDICK & HILDICK, Pleck Road, Walsall.

LUSTROLOX

WIRELESS VALVES.
THE ECONOMIC COMBINATION

2v. '06 H.F. & L.F. 9/- 2v. '34 P.V. 11/-

Obtainable from *Loewe's Ltd., Liverpool and Manchester, and*

LUSTROLOX LTD.,
West Bollington, Near Macclesfield.

H.T. Accumulators.

10 VOLT 6/- Post
20 " 12/- 6d.
2,000 Milliamp. Hr.

Moulded Mono Block Units in thick glass. No Intercell Leaks.

FREE. 100 VOLTS SENT FULLY CHARGED WITH ACID IF REQUIRED.

See Illustrated Catalogue.

GRAFTON ELECTRIC Co., 54, Grafton Street, W.1.

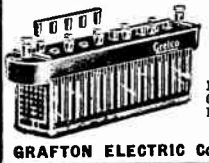

TIME & WEATHER BY WIRELESS

By W. G. W. Mitchell, B.Sc., F.R.A.S., F.R.Met.S.

THE first half of the book sets out to explain how time signals are sent and how they may be received with the utmost accuracy. Accuracy is, in fact, the key-note of the time-signal section. The latter part, which is devoted to the weather, will enable the amateur to distinguish the different weather telegrams, and for this he must acquire a knowledge of slow Morse. (Our book, Perry Morse System, 7d. post free, is ideal for this purpose.) Simple diagrams and illustrations show clearly how the apparatus works and how you can fit up similar mechanism for home use. Crown 8vo. 125 pages. 60 diagrams and illustrations.

Price **3/6** net. By post, **3/9**.

Obtainable from the Publishers of "The Wireless World"
ILIFFE & SONS LTD.,
Dorset House, Tudor Street, London, E.C.4

W.W.16

reproduction
—volume
—clarity

You get all these in Ericsson Super Tone Loudspeakers.

Made by a firm with a generation's experience in telephone work. No distortion. No rattle—just crystal-clear reproduction.

Put one to follow your pet power valve and you'll be amazed.

18" high on wood base. Very melodic and pure. 2400 ohms, 63.- Junior Super Tone for small rooms, 32/6.

Write for lists

The **BRITISH L.M. ERICSSON** Mfg. Co., Ltd., 67/73, Kingsway, London, W.C.2.



63/-

Ericsson
SUPER TONE LOUDSPEAKER

The **Home Constructor's Wireless Guide**

by W. JAMES

THIS book forms a most convenient little encyclopædia of wireless technology: the kind of volume to refer to when in difficulties. It solves them for you.

A few of the main features:

Outdoor, Indoor and Frame Aerials; Earths, Variometers (or Broadcast Wavelengths; Basket Coils, Plug-in Coils, etc.); Coupled Circuits; Common Faults in Tuners; Reaction and Self-Oscillation; Special Chapter on Sensitive Single-Valve Receivers; Double Magnification; Points on Dry Cells and Accumulators, etc., etc.

PRICE **3/6** NETT.
By post, 3/10.

Obtainable from Booksellers, or direct from the Publishers of "The Wireless World,"

ILIFFE & SONS LTD.,
Dorset House, Tudor Street, London, E.C.4.

W.W.10

TROLITE PANELS

Mahogany Grain 3/6 lb
Black Engraved wavy 3/9 lb
Black plain polished 3/- lb

Machine cut Treated to your own measurements. 50,000 Volts.

Free Samples on Request.

PUGH'S WIRELESS, 95-101, Holloway Road, London, N.7.

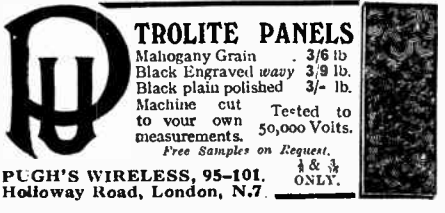

Your First Steps in Wireless

By **HUGH S. POCOCK**
Editor of "The Wireless World"

A most helpful little book for those who are beginning to study wireless. It explains technical difficulties by simple analogies.

Price **9d** By Post **11d**

From **ILIFFE & SONS LIMITED**
Dorset House, Tudor Street, London, E.C.4
and leading booksellers. W.W.14

"The Joy of the Genuine Experimenter" —

PRICE 3/6 NET
per volume.
By Post
3/10
each.

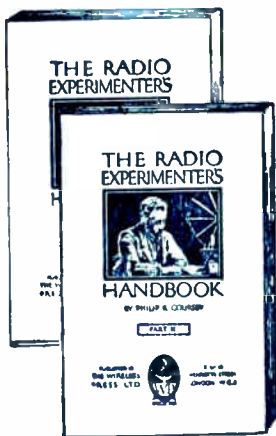

is to be found in designing and building a set to his own particular requirements.

'The Radio Experimenter's Handbook,' in two volumes, by **Philip R. Coursey, B.Sc.**, furnishes all the information necessary. They explain the principles of wireless telegraphy and constitute a reliable guide to working practice. Get your copy to-day! Second edition, revised and brought right up to date, now on sale.

Part One deals with the general principles underlying the design of radio receiving equipment.

Part Two is devoted to data and actual quantitative design.

Obtainable from the Publishers of "The Wireless World."

W.W.5
ILIFFE & SONS LTD., Dorset House, Tudor Street, London, E.C.4

The EZI-WIRING Series

will be appreciated by all amateurs who are anxious to make trouble-free sets this winter. Each volume gives complete working instructions, detailed measurements and explanations of the components necessary for building highly efficient sets at moderate cost. A four-colour wiring diagram enables you to build the set without any possibility of incorrect wiring.

w.w.6

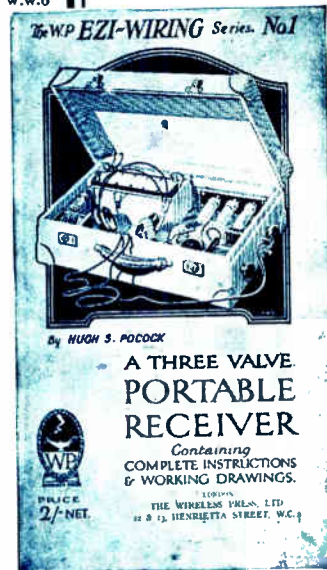

No. 1.
A Three-Valve Portable Receiver
By **Hugh S. Pocock**.

No. 2.
A Three-Valve Receiver
By **F. H. Haynes**.

No. 3.
A Two-Valve & Crystal Reflex Receiver
By **W. James**.

No. 4.
A Four-Valve Combination Set
By **W. James**.

PRICE 2/- NET
each volume.
By Post 2/2 each.

Obtainable from the publishers of "The Wireless World,"
ILIFFE & SONS LTD.,
Dorset House, Tudor Street,
LONDON, E.C.4.

4-Colour Wiring Diagram

A Service that gives Security!

MANY readers naturally hesitate to send money to unknown persons. We have therefore adopted a Deposit System which gives complete security both to buyer and seller.

If the money be deposited with "The Wireless World" both parties are advised of its receipt. The time allowed for decision is three days, after which time, if the buyer decides not to retain the goods, they must be returned to the sender. If

a sale is effected we remit the amount to the seller; but, if not, we return it to the depositor.

Full particulars may be found on the Miscellaneous advertisement page at the end of the book.

Use this service for your wireless requirements and avoid all risk! Sell the apparatus you no longer require! Write out your advertisement to-day and send to—

PREPAID ADVT. DEPT., "THE WIRELESS WORLD," DORSET HOUSE, TUDOR ST., LONDON, E.C.4.

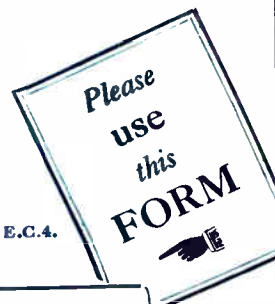

12
Words
or
Less
1/-

each
additional
word
1d.

Advertiser's name and address must be counted. If a box number is required 6d. extra must be sent for postage on replies.

w.w.39

Advertisements for "The Wireless World" are only accepted from firms we believe to be thoroughly reliable.

EVERY D.C. TEST CAN BE MADE WITH
THE
"ALLTEST"

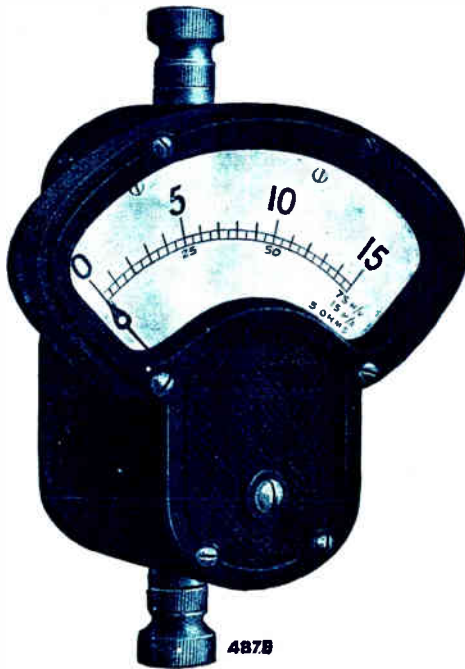

487B

Registered Design. $\frac{3}{4}$ Full Size. Accurate within 1%

SCALE: 2 1/2" LONG. WEIGHT 12 OZS.

CAN BE USED AS A:—

- MILLI-AMMETER,
- MILLI-VOLTMETER,
- AMMETER,
- VOLTMETER,
- CELL TESTER.

RANGE OF READINGS:—

- 0.00025 TO 30 AMPS.
- 0.001 TO 600 VOLTS.

PRICES:
INDICATOR
ONLY

47/6

Ampere Attachments 5/- Each.
Volt Attachments . . . 9/6 Each.
(Subject)

0/75 M/V & 0/15 M/A

Write for Descriptive Booklet.

CROMPTON & Co., Ltd.,
CHELMSFORD, ENG.



"Going to make a set?
Don't forget to use

GLAZITE
BRITISH MADE REGD.

COLOURED CONNECTING WIRE"

Red, Yellow, Green,
White, Blue and Black

**10 foot
COILS**

Be sure to
see the
LEW seal

Per 1/2 Coil

**2 foot
LENGTHS**

Four assorted
colours in
an envelope

Per 1/- 1/2.

Obtainable from all dealers

Write for interesting descriptive leaflet

THE LONDON ELECTRIC WIRE CO. AND SMITHS LTD.

(Makers of Electric Wire for over 40 years.)

Playhouse Yard, Golden Lane, London, E.C.1

This mark



guarantees quality.

JUDD