

4^D

The Wireless World

AND RADIO REVIEW

The Paper for Every Wireless Amateur

Wednesday, February 3rd, 1926.

**SPECIAL 3 VALVE
REFLEX SET**

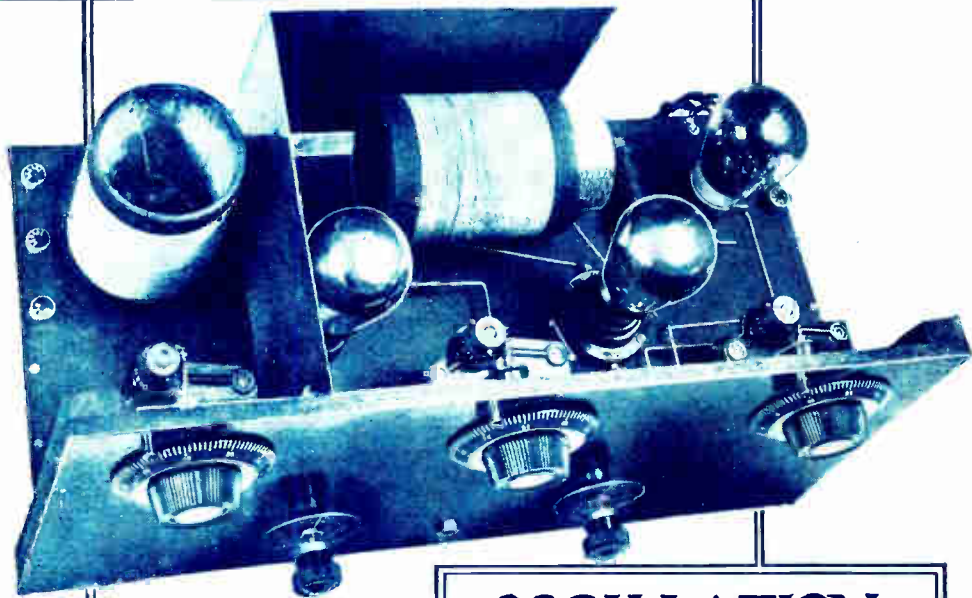

**OSCILLATION
WITHOUT
RADIATION.**

AMPLION WEEK

February 8th to 13th.

The House of Graham

has arranged that Free Demonstrations shall be given on AMPLION Loud Speakers during this period at AMPLION STOCKISTS, and all Radio Dealers of repute, also in the AMPLION Showrooms at

25, Savile Row, London, W.1
79, High St., Clapham, S.W.4

10, Whitworth St. West, Manchester
101, St. Vincent Street, Glasgow

In the interests of

Better Radio Reproduction

Do not miss your Demonstration



The name and address of the nearest AMPLION STOCKIST will be gladly supplied upon request by the Patentees and Manufacturers, Alfred Graham & Co. (E. A. Graham), St. Andrew's Works, Crofton Park, London, S.E.4.

There's life in the family now!



WHAT a difference broadcasting has made to family life; for indoor days no longer bore, but are filled with brightness and gaiety now that all the charm of radio music, song and interest is available through the medium of a good receiving set and loud speaker.

Greater still becomes the charm with the supremely perfect Sterling "Mellovox," the latest and most popular hornless type of loud speaker. A perfect reproducer, artistic in appearance and ample in volume for all home requirements.

Hear the "Mellovox" at your radio dealer's, then add the pleasures of true reproduction of broadcasting to the family circle.

STERLING MELLOVOX Loud Speaker.

Write for a copy of Publication No. W.W. 439.

THE MARCONIPHONE COMPANY, LTD.

Sole Agents for **STERLING TELEPHONE & ELECTRIC CO., LTD.**

Registered Office: Marconi House, Strand, London, W.C.2

Head Office: 210-212 Tottenham Court Rd., London, W.1

Branches: Aberdeen, Bristol, Birmingham, Belfast, Cardiff, Cheltenham, Dublin, Glasgow, Leeds, Liverpool, Manchester, Newcastle, Nottingham, Southampton, Swansea.

STERLING "MELLOVOX" HORNLESS LOUD SPEAKER

In brown, blue, mauve or black with gold floral diaphragm. PRICE 48/-

An Innovation

STERLING "MELLOVOX" and LAMP SHADE COMBINATION

Consisting of the "Mellovox" combined with an adapter, complete with electric light fittings and attractively coloured silk shade. Can be suspended in a few seconds and the adapter plugged into an existing lamp-holder.

PRICE Complete as shown £4:4:0

Shade and Adapter only £2:2:0





The Slope

OF THE
SP-18 Valve

is remarkably steep, indicating a very high degree of amplification, and, by reason of the long straight portion of the curve, freedom from distortion over a very wide range of grid potential variation.

The "Cosmos" **SHORTPATH** SP.18 Valve works on 17 to 18 volts and consumes .29 to .3 ampere. It is eminently suitable for use with a 2 VOLT ACCUMULATOR.

PRICE 12/6 EACH.

Made in two styles designated RED SPJT and GREEN SPOT and recommended for use as follows:—

COUPLING.	* H.F.	Detector.	L.F. First Stage.	L.F. Inter-mediate.	L.F. Last Stage.
TRANSFORMER	Green -	Green ●	Green ●	Red ●	Red ●
RESISTANCE	- Green ●	Green ●	Green ●	Green ●	Red ●

* If set oscillates use Red ● for H.F. Stages.

Publication 7117/5 "A Talk to Valve Users" gives exhaustive details and should be in the hands of all interested:

METRO-VICK SUPPLIES LTD.

(Proprietors: Metropolitan-Vickers Electrical Co., Ltd.)

4, Central Bldgs., Westminster, London, S.W.1

Cosmos

SP.18 SHORTPATH VALVES
GIVE POWER AND PURE TONE.

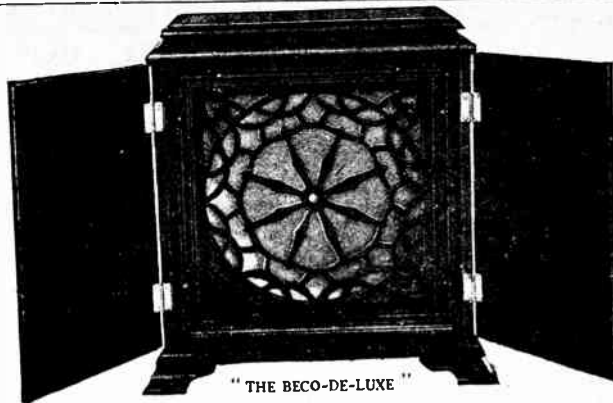

Loud Speaking Excellence

FOR excellent volume, with exceptional purity of tone and clarity, the "Beco" Hornless Loud Speaker is infinitely superior to previous loud speakers. The "Beco-de-Luxe" (British made) is an artistic piece of furniture for any home, and the volume from it will fill a large hall. Obtainable fitted in either oak or mahogany cabinet. Height 13".

Oak, £5 : 0 : 0. Mahogany, £5 : 5 : 0

BECO

HORNLESS LOUD SPEAKER

Extract from "BROADCASTER": "We can unhesitatingly recommend the new 'Beco-de-Luxe' Loud Speaker, for we are of the opinion that on account of its exceptionally pleasing appearance and splendid qualities as a reproducing instrument it has a great future before it."

THE small 1926 "BECO"—
a very efficient and attractive model—gives unusual volume, with crystal clarity. Height 6".

Nickel Plated **52/6** Oxydised Silver or Copper **55/-**



Dept. W., British Electrical Sales Organisation,
623, Australia House, Strand, W.C.2.



Telephone:
CITY 7665



An Igranic-Pacent Engineering Achievement

A True Straight-Line Frequency Condenser.

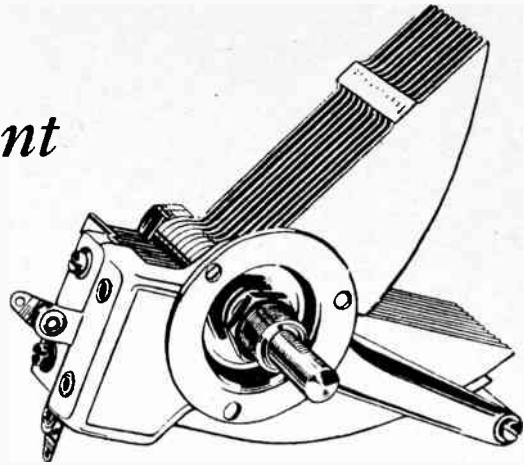

The
Best
of two
Countries.



Pacent Radio Essentials have won such renown in America as to be made standard equipment by over 40 leading manufacturers of receivers.

Igranic Radio Devices are known the world over as the highest standard of British components.

The arrangements by which the Igranic Electric Co. become sole manufacturing licensees of Pacent Radio Essentials make available to the constructor a range of components representing the best of two countries.

Igranic and Igranic-Pacent Radio Essentials meet every requirement in the construction of modern receivers of the highest efficiency.

Features which make the Igranic - Pacent Straight - Line Frequency Condenser distinctive

1. True straight line frequency tuning.
2. Negligible losses.
3. Perfect insulation, properly placed.
4. Brass plates, riveted and soldered.
5. Rigid channel frame construction.
6. Permanent plate alignment.
7. Extra tie bars.
8. Large dust-proof bearing.
9. Positive enclosed stop.
10. One or three-hole mounting.
11. Tandem mounting to form dual condenser.
12. Distinctive, compact, sturdy.
13. Price of .00035 condenser only 14/6.
14. Price of .0005 condenser only 18/6.

Send for List No. P.37 giving particulars of Igranic and Igranic-Pacent Radio Essentials.

Exclusive Manufacturing Licensees.

**149, QUEEN VICTORIA
STREET, LONDON.**

BRANCHES: BIRMINGHAM, BRISTOL,



Exclusive Manufacturing Licensees.

**Works:
Elstow Rd., BEDFORD.**

LEEDS, MANCHESTER, NEWCASTLE.

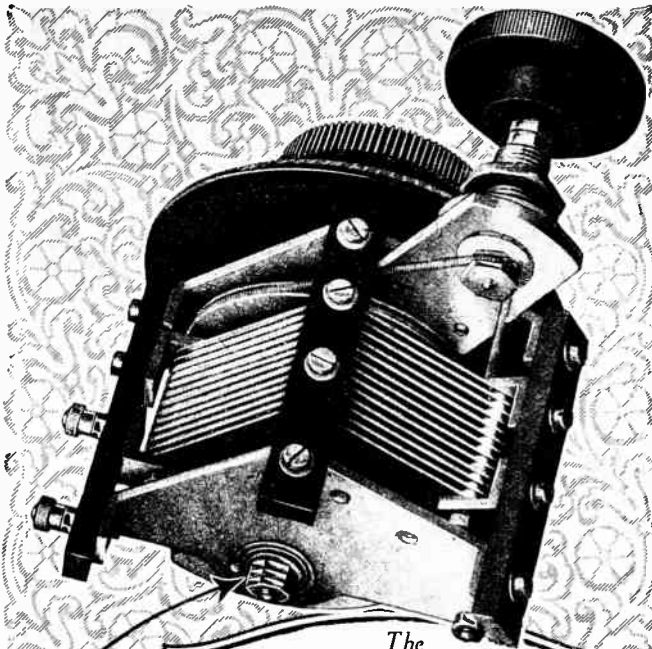

The
**"COSMOS"
SLOW MOTION
CONDENSER**

**COMPENSATED
SQUARE LAW
EFFECT**

LOW LOSS

**NO
BACK LASH**

with its ratio of 10 to 1 makes it possible to dispense entirely with the customary vernier and its attendant losses. Particular stations can be logged. Backlash is avoided, not temporarily but permanently, and movement is smooth, permitting fine adjustment. This model can also be arranged for remote control, as shown in the illustration below. Also supplied without slow motion feature when the condenser is one-hole fixed. Both models are constructed to eliminate hand capacity, for low loss, and to give a compensated square law effect. Cone bearings of hardened steel ensure constant calibration and a pigtail connection gives permanent positive contact.

Metro-Vick Supplies Ltd.
4, Central Buildings, S.W.1

Prices:
Ordinary. Slow Motion.
14/025n til. 0005mfd. 00025mfd. 0005mfd
15/- 17/6 19/- 21/6

ADJUSTABLE
CONE BEARINGS
OF HARDENED
STEEL

PIGTAIL CONNECTION

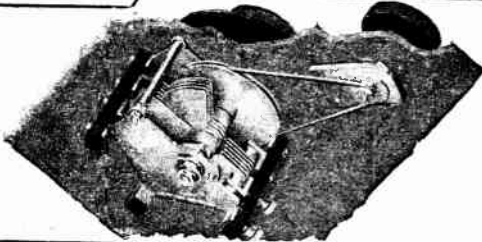

COSMOS

A4

Mention of "The Wireless World," when writing to advertisers, will ensure prompt attention.

AT LAST!

A Buzzer that Buzzes

Built especially for Wavemeter work, this buzzer really buzzes. A simple turn of the knob adjusts it in a moment, and it gives a clear steady note. No delicate handling is necessary, no tinkering or fiddling with screws has to be done to persuade the instrument to work.

Contacts are of pure platinum; the instrument is rigidly built, guaranteed for a year, and supplied complete with Operating Knob and screws for mounting below panel. With this Buzzer, wavemeter operation is a quick, simple and certain business. Order it from your dealer or direct.

PRICE **15/-**

**The Bowyer-Lowe
PRECISION BUZZER**

Bowyer-Lowe
Co., Ltd.

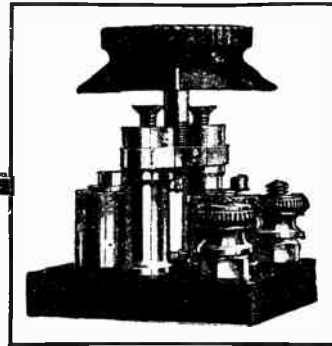

Radio Works,
Letchworth.

LOOK WHO'S HERE!

BRIGHTSON'S

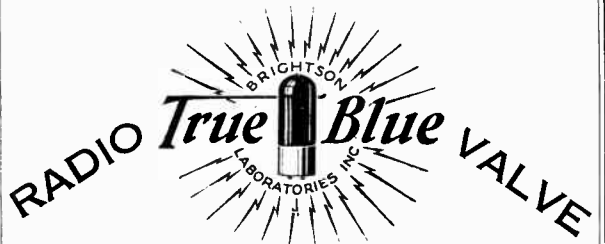

(N.Y., U.S.A.)

True Blues consume one-half the amount of H.T. battery current required by Valves of other makes. This can readily be shown by placing a milliammeter in positive lead of H.T. battery and taking the comparative readings of True Blues as against other Valves. H.T. battery will last twice as long with True Blue Valves in the receiving set.

6 Volt 0.25 Amp. PRICE - - - **£1-1-6**

J. Y. SELLAR

Distributor for the British Isles.

Room 43, POLAND HOUSE, 167, OXFORD ST., W.1

Phone: Regent 5606



**Never
missed
one!**

Can you juggle with foreign stations as successfully as this? No? Then simply install an Ormond Condenser in your radio set and the trick is learnt!

For 25 years ORMOND PRODUCTS have led in performance. Notably so with Condensers. You can get any types you want at your Dealers at the following remarkably low prices:—

BALL-BEARING FRICTION CONTROL CONDENSER

·0005	-	-	15/-
·0003	-	-	14/6
·00025	-	-	13/6

Ideal Ratio - - - 15 - 1.

Brass End Plates, highly nickelled finish.



199-205, Pentonville Road, King's Cross, London, N.1.

'Phone: Clerkenwell 9344, 5 and 6.
'Grams: "Ormondengl, Kincross."

Factory: Whiskin Street, Clerkenwell, E.C.1

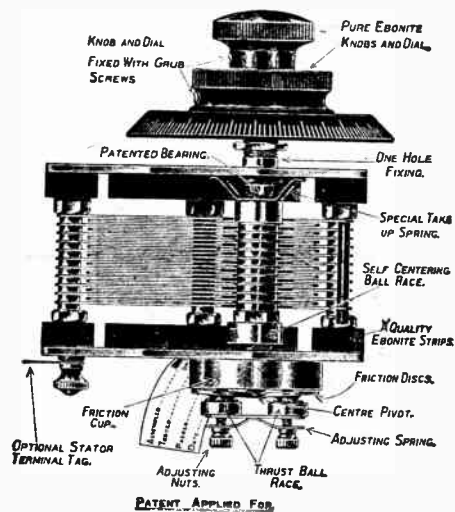

PRICE & PERFORMANCE



The SUPERTRAN TRANSFORMER at 19/6

makes a strong appeal because it puts up a performance which is equal to that of the more expensive transformers on the market.

THE APPEARANCE of the Supertran is very attractive and it looks the high-class component it undoubtedly is.

THE GRAPH shown below is **not** a theoretical curve showing what the transformer is designed to do, **but it is** the actual laboratory curve recorded upon testing a Supertran Transformer taken at random from stock.

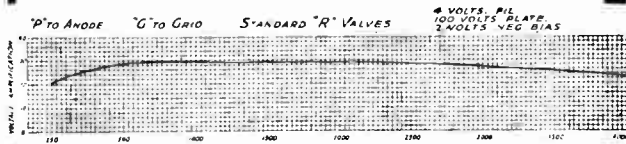

We strongly recommend the use of the 3½ to 1 ratio to follow the detector valve and the 5 to 1 for power stages or following a crystal.

5 to 1
or
3½ to 1

Guaranteed against mechanical and electrical breakdown



SHROUDED
only
19/6
each

UNSHROUDED
18/6
each

GLADWELL & KELL, LTD.,
258, GRAY'S INN RD., LONDON, W.C.1.
Phone: Museum 7367-7368.

WRITE FOR OUR INTERESTING CATALOGUE.



COSMOS PERMACONS

FIXED CONDENSERS GIVING FIXED RESULTS

The "Cosmos" Permacon is an ideal fixed condenser, being light in weight, of guaranteed accurate capacity, and having the lowest possible losses.

The dielectric is mica and each condenser is tested at 500 Volts during inspection. Nickel plated cases give them a particularly neat appearance.

'0001 mfd	1/6
'0002 " " " " " "	1/6
'0005 " " " " " "	1/6
'0003 " (with clip for grid leak)	1/8
'001 " " " " " "	1/8
'002 " " " " " "	1/10
'005 " " " " " "	2/8
'01 " " " " " "	3/9

"COSMOS" GRID LEAKS

are uniform and permanent.
½, 1, 2 and 3 megohms, each 1/6

Ask for copy of the *Cosmos Components Brochure.*

METRO-VICK SUPPLIES LTD.
(Proprietors Metropolitan-Vickers Elec. Co. Ltd.)
4 Central Buildings, Westminster,
LONDON, S.W.1

R 1.9

- MICA DIELECTRIC
- GUARANTEED ACCURATE CAPACITY
- LOW LOSS
- TESTED AT 500 VOLTS



THE HAPPY FAMILY

"Affinities"

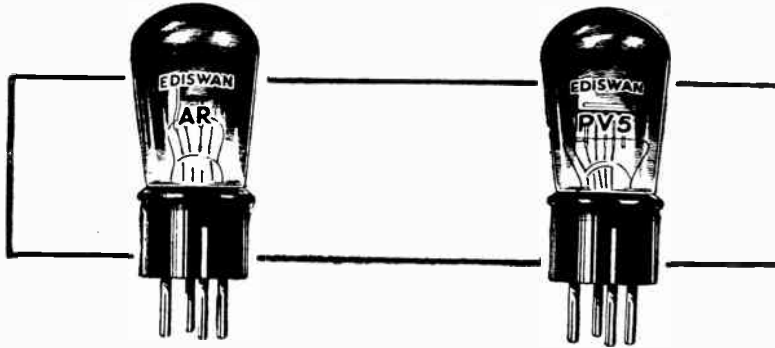

There is a decided affinity, a quite definite link between each Edison Receiving valve and Edison Power valve. The Receiving valves are supplied either H.F. or L.F. and the best Power valve to use is shown in the table opposite.

They always get on well together. It's like that in every large family. Always two that will work—or play—better with one another than with anybody else. Every Edison valve has its family affinity. It gives good service in any conditions — the best service when it is employed with its "twin."

The Valves to use.

Receiving.	Accumulator or Battery Volts.	Power.
AR	6	PV5
ARDE	2	PV6
AR'06	3	PV8

With these groups and Edison H.T. and L.T. Accumulators the ideal is attained.

THE EDISON SWAN ELECTRIC CO. Ltd.,
123-5, Queen Victoria Street, London, E.C.4.

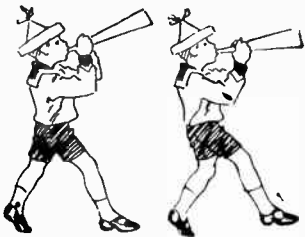

EDISWAN VALVES

Will Improve ANY Set



Ediswan Valves are entirely British made.

Improve your L.T. and H.T. supply



The Balkite Battery Charger will enable you to charge your accumulator at home in a very simple manner. You just put a plug into the lamp socket, connect two clips to the accumulator, and switch on. The appliance, which is noiseless in operation, charges an accumulator for about 8d. It has no valves or moving parts and gives full-wave rectification.

No. 491, for 200-240 volts, 50-60 cycles, £4-15-0.

No. 492, for 100-115 volts, 50-60 cycles, £4-15-0.

The Burndeft Super Radio Battery will work a four-valve set used four hours a day for at least six months. It is constructed of large, seamless cells and is contained in a strong box, made to resemble mahogany. The top of the battery is covered with a dull red insulating compound—there is no messy wax—and screw terminals are provided.

No. 202. Burndeft Super Radio Battery, tapped at 20, 25, 28 and 50 volts, in sealed carton, 24s.

Further particulars of these Burndeft products will be sent on request. The Burndeft range includes everything for radio reception, from components to complete installations.

HEAD OFFICE: Aldine House, Bedford St., Strand, London, W.C.2

Branches and Agents Everywhere.

Telephone: Gerrard 9072.

BURNDEPT

Telegrams: BURNDEPT, WESTRAN, LONDON.

C.F.H.

NEW LAMPLUGH

STRAIGHT LINE CONDENSER LOW LOSS

PRICE
11/- .0005 MF.
10/6 .0003 MF.
10/- .0002 MF.

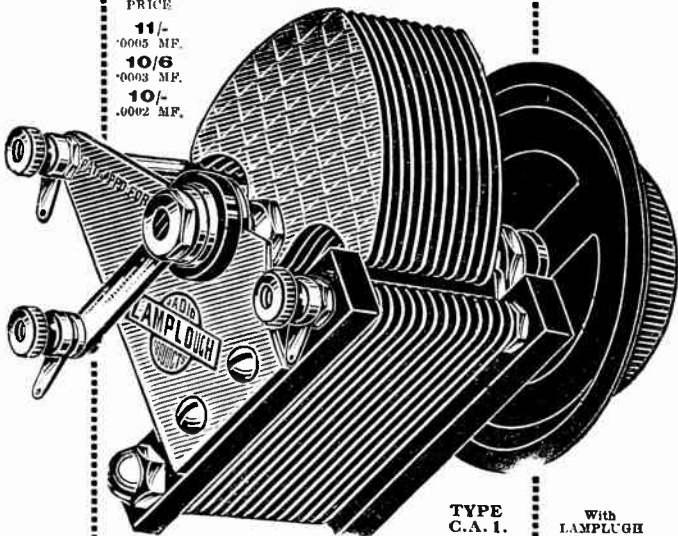

TYPE C.A. 1.

With LAMPLUGH Grip-dial. Minimum capacity — 5 pF — Micro-Micro Farads.

Produced in response to numerous requests for a cheaper condenser having the same electrical qualities as the De Luxe model.

If your dealer cannot supply we can. Send for list.

S. A. LAMPLUGH, Ltd., King's Road, Tyseley, BIRMINGHAM.

HAVE YOU GOT YOUR COPY YET?

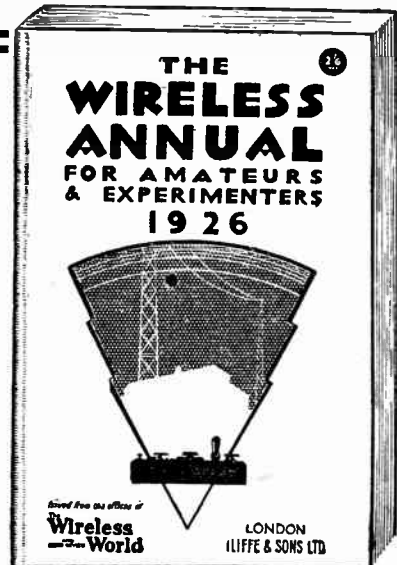

An indispensable volume of information for every enthusiastic radio amateur.

Price 2/6 net. By Post 2/8½

From all booksellers or direct from: LILFEE & SONS LIMITED Dorset House, Tudor Street, London, E.C.4

w.w.8

BETTER THAN THREE



A new general purpose Valve with the wonderful "N" filament

YOU can now have the advantages of the unique "N" filament for every valve in your receiver!

The New P.M.3

1. Better than three "R" type valves because the ample proportions of the "N" filament are equivalent to three ordinary filaments.
2. Requires ONLY ONE-TENTH AMPERE filament current. A saving of over 85% of your accumulator energy giving each charge SEVEN TIMES THE LIFE.
3. Is so economical of heating power that no sign of glow can be discerned.
4. Will operate from either dry cells or accumulator. From 3 to 4 Volts may be used with perfect safety.
5. Free from all microphonic disturbances.

The P.M.3 16/6

Suitable for all stages of amplification in any circuit.

THE IDEAL COMBINATION for any receiver — P.M.3. valves followed by a P.M.4. for POWER AMPLIFICATION with loud speakers.

The Finest Loud Speaker Valve, the P.M.4. 22/6

GET ONE FROM YOUR RADIO DEALER.

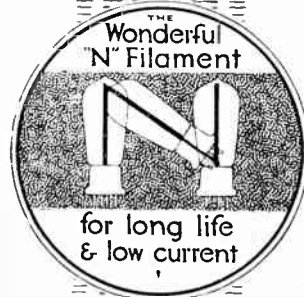

Mullard

THE MASTER VALVE

ADVT. THE MULLARD WIRELESS SERVICE CO., LTD., BALHAM, LONDON, S.W.12.

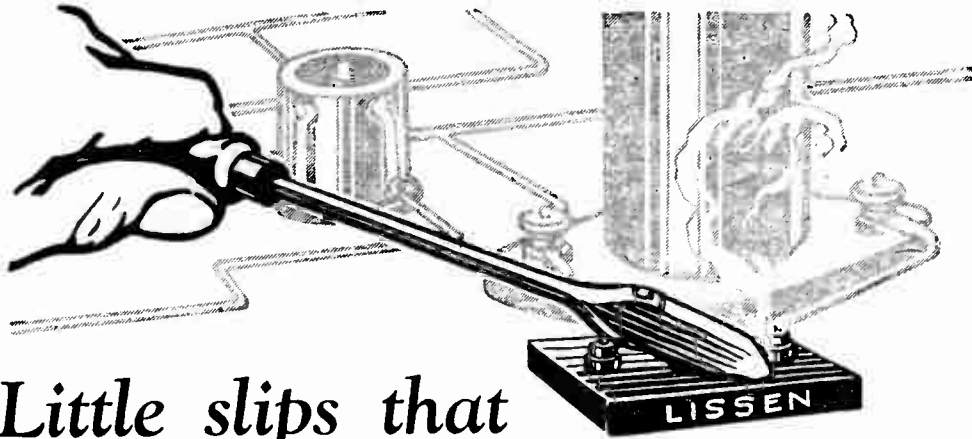

Little slips that prove "Lissen" efficiency

Lissen Fixed Condensers are made very accurate—to within 5% of their marked capacities—and, also, no matter what the temperature conditions behind the panel may be, they will never vary and will not leak.

If, when soldering a connexion to your Lissen Fixed Condenser, the iron should slip and burn the outside case, you will find on testing that the capacity has not altered at all. Heat cannot affect a "Lissen"—its internal construction is too good—fit Lissen and make sure you are using trouble-free Condensers, and NOTE THE NEW PRICES.

.0001—.001 ... 1/3
.002—.006 ... 2/-
Mica dielectric.

(With each .0002 and .0003 there is included free a pair of clips to take a grid leak.)

The Lissen Fixed Grid Leak goes a long way towards making a

silent circuit. Noise in a receiver is often caused by the varying resistance of a supposedly fixed grid leak. The Lissen Fixed Grid Leak is unalterable, because its resistance is settled. Fit one and be still more sure of your circuit, Price 2/6.

In certain critical circuits a Variable Grid Leak is essential. With a Lissen you can obtain any resistance between $\frac{1}{2}$ and 15 megohms, smoothly, gradually and *noiselessly*. When using a Choke Coupled Amplifier it is always advisable to use the Lissen Variable Grid Leak. One hole fixing, of course. Price 2/6.

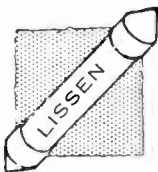

LISSEN

THERE IS NO 'WEAKEST LINK' IN THIS LISSEN CHAIN
Lissen Limited, 21-25, Friars Lane, Richmond, Surrey

'Phone: Richmond 2285 (4 lines).

'Grams: "Lissenium, Phone, London."

The Wireless World

AND
RADIO REVIEW
(13th Year of Publication)

No. 338

WEDNESDAY, FEBRUARY 3RD, 1926.

VOL. XVIII. No. 5.

Assistant Editor:
F. H. HAYNES.

Editor:
HUGH S. POCOCK.

Assistant Editor:
W. JAMES.

Editorial Offices: 139-40, FLEET STREET, LONDON, E.C.4

Telephone: City 4011 (3 lines).

Advertising and Publishing Offices: DORSET HOUSE, TUDOR STREET, LONDON, E.C.4.

Telephone: City 2847 (13 lines).

Telegrams: "Ethaworld, Fleet, London."

COVENTRY: Hertford Street.

BIRMINGHAM: Guildhall Buildings, Navigation Street.

MANCHESTER: 199, Deansgate.

Telegrams: "Cyclot Coventry."
Telephone: 10 Coventry.

Telegrams: "Autopress, Birmingham."
Telephone: 2970 and 2971 Midland.

Telegrams: "Hiffe, Manchester."
Telephone: 8970 and 8971 City.

Subscription Rates: Home, £1 1s. 8d.; Canada, £1 1s. 8d.; other countries abroad, £1 3s. 10d. per annum.

As many of the circuits and apparatus described in these pages are covered by patents, readers are advised, before making use of them, to satisfy themselves that they would not be infringing patents.

DRASTIC PROPOSALS.

MOST of the evidence which has been submitted to date to the Broadcasting Committee of Enquiry has either been in the nature of criticism of the organisation and the conduct of broadcasting, or it has been "defensive" evidence, such, for instance, as that tendered by the newspaper interests, having for its object the safeguarding from competition, in any future broadcasting arrangements, of the interests of the party submitting evidence.

The evidence given recently by the wireless traders was, in some respects, a welcome change from the type of evidence hitherto submitted, because whilst the manufacturers put their own interests first, as might naturally be expected, yet their evidence contained some definite constructive suggestions as to ways and means whereby, in their opinion, the wireless trading interests in this country might be assisted.

The outstanding proposal made by the traders is certainly most drastic in character. The suggestion is that, instead of a number of medium-powered transmitters dotted about the country as at present, these should be superseded by six or seven high-powered broadcasting stations, which they claim would serve the whole country more efficiently than the present network, whilst, in addition, giving the alternative of two or three distinct programmes in nearly every part of the country. It was suggested also that each station might transmit a particular type of programme.

From the point of view of the public, it is quite evident

that every possible step should be taken to give alternative programmes to listeners, and until this can be done there will always be a perpetual subject for grouse, because no one programme can possibly satisfy all tastes. As things are at present, the average listener using the average set has only a choice of programmes if he happens

to be located more or less equidistant from two or more stations, except in cases where the more selective types of receivers are in use. We are, however, afraid that the ever-present complaint of so many listeners that if they are located anywhere near a broadcasting station they are swamped by the power of that station and so prevented from getting other transmissions, will only be accentuated if the power is substantially increased. A partial solution might be found if at the same time arrangements could be made for these few stations to work with a much greater wavelength spacing, but it is questionable whether this could be done without an extension of the present wave-band.

It is difficult to say, without a thorough investigation, how far such changes would land the B.B.C. in heavy additional expenditure in providing new equipment. There is also the question of whether the present locations could be utilised if the total number of stations in the country were restricted to, say, six or seven of high power. But even if this proposal could only be carried out at great cost and with considerable difficulty it is still well worth careful consideration if it is going to provide a solution to the problem of alternative programmes.

CONTENTS.

	PAGE
EDITORIAL VIEWS	153
OSCILLATION WITHOUT RADIATION	154
By W. James.	
MULTIPLEX DIRECTIONAL RECEPTION	162
By R. Keen.	
GERMAN VALVE MANUFACTURE	166
By A. Dinsdale.	
HINTS AND TIPS FOR NEW READERS	169
CURRENT TOPICS	171
VALVES WE HAVE TESTED. RADION VALVES	173
PIONEERS OF WIRELESS. 5.—ARAGO	175
By Ellison Hawks.	
BROADCAST BREVITIES	177
BROADCASTING PROBLEMS IN AMERICA	179
WIRELESS CIRCUITS IN THEORY AND PRACTICE	181
By S. O. Pearson.	
NEWS FROM THE CLUBS	184
NEW APPARATUS	185
LETTERS TO THE EDITOR	187
DICTIONARY OF TECHNICAL TERMS	190
READERS' PROBLEMS	191

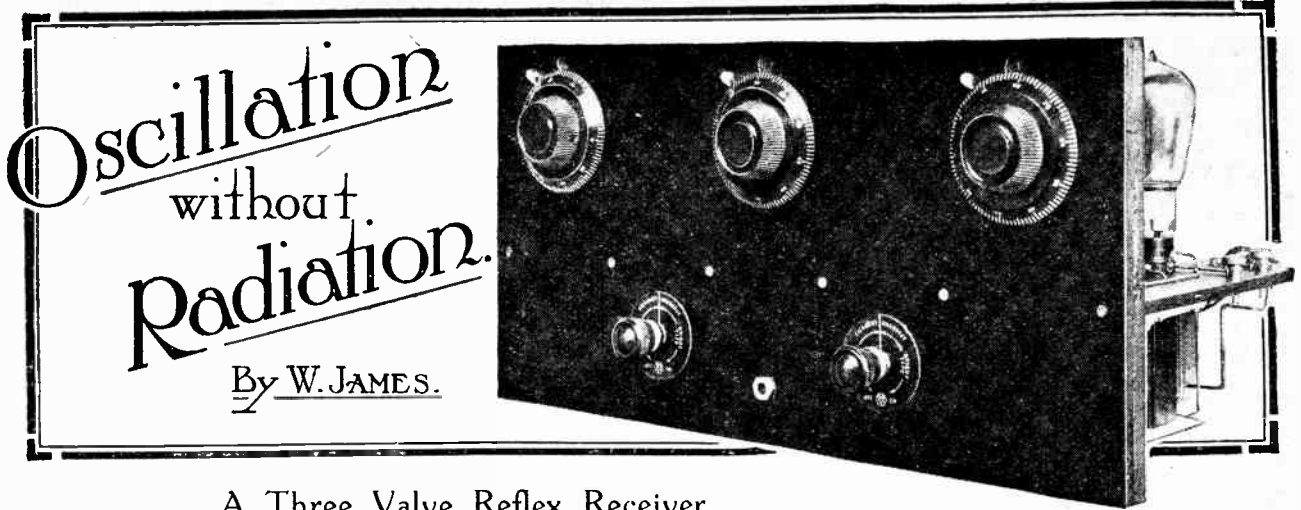

A Three Valve Reflex Receiver.

JUST lately we have heard a good deal of the disadvantages of reaction. We have been told that a set with reaction is a nuisance because it radiates and disturbs other people, that reaction spoils the quality of the broadcast transmission, and so on. With these statements we mostly agree, especially when the reaction is applied direct to the aerial circuit of the receiver, while we do not forget the fact that the majority of our great British wireless manufacturers are selling as hard as they can two-, three- and four-valve receivers which make use of reaction to get those distant stations they claim to get in their catalogues.¹

We have also been told at many different times that reflex sets are no good—that a valve cannot work well as a high-frequency and as a low-frequency magnifier, and that the devices employed to separate the high- and low-frequency currents are bound to distort the signals.

Reacting and Reflexing.

The gentlemen who believe in this no reaction, no reflex, business are going to get a shock, for I propose to show that both reaction and reflexing can be used in such a way that the quality obtained is quite as good as that obtained from the best of commercial sets, while the range and selectivity of the set described are better than can be obtained from a

¹ Apparently it is largely being left to the American manufacturer to produce non-interfering sets.

The receiver has three valves, the first acting as a H.F. and L.F. magnifier, the second as a reacting detector, and the third as a straight L.F. magnifier. Reaction is used on the circuit between the first and second valves; and as the first valve is balanced, and direct coupling between its input and output circuits is prevented, the aerial circuit cannot have locally generated oscillations set up in it. Loud-speaker reception of some twelve to fifteen stations is normally obtained.

set using reaction on the aerial (detector and 2L.F.) or reaction coupled to a tuned anode (H.F. detector and 2L.F.). In addition, the set illustrated here has the enormous advantage that it can be used in the condition of critical reaction, and can be made to oscillate without setting up oscillations in the aerial circuit.

How to Get Selectivity.

The first step in the design of the set we have in mind is to choose the number of valves, and we will choose three, with the object of using one as a detector, one as a low-frequency amplifier, and one as a combined H.F. and L.F. amplifier.

Then there is the question of selectivity to be considered. As we can make single layer coils which have a lower H.F. resistance than most commercial coils of the same inductance, single layer coils will be used. A single layer coil of 250 microhenries can easily be made to have a H.F. resistance at 400 metres as low as 4 to 5 ohms. But a good coil such as this would give no better results than a bad coil if it were connected directly to the aerial circuit or to the anode circuit of a valve.

Thus it can be shown that a circuit comprising a condenser of low losses and the 5 ohm coil just referred to, connected to the anode of a 20,000 ohm valve, acts as though it had a loss resistance of about 25 ohms so far as the tuning—that is, the selectivity—is concerned, while a 15 ohm

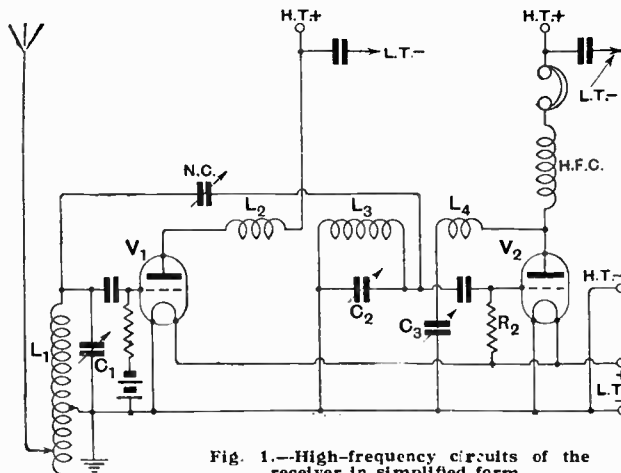

Fig. 1.—High-frequency circuits of the receiver in simplified form.

Oscillation without Radiation.—

coil in the same circuit would act as though it had a resistance of 35 ohms, which is not so much in proportion. The magnification obtained would not be very much different in the two cases.

We must therefore so connect our tuning coils that damping due to the aerial and valve respectively are reduced to a reasonable figure, for then we shall be taking full advantage of the selective properties of low-loss components. The two tuning coils are therefore connected to the grids of the H.F. valve and of the detector, the two coils being marked L_1 and L_2 in Fig. 1. It should be remembered that the signal strength and the selectivity we shall get from the two valves employing two low-loss coils (ignoring reaction) will depend entirely on how the two coils are coupled to the circuit, and further, that signal strength and selectivity depend on one another, extreme selectivity being obtained at the expense of signal strength.

Aerial-grid Coupling.

So far as the aerial circuit is concerned, in the design as presented here it is easy to provide for two degrees of selectivity and signal strength in the aerial-grid circuit by coupling the aerial to the grid coil through a coil having a tapping. Then when the full number of turns are included in the aerial circuit the signal strength will be a maximum and the selectivity not quite so good as when only part of the aerial coil is connected in the circuit. Connecting the whole of the aerial coil in circuit, therefore, gives maximum signal strength, while when part of the aerial coil is connected the selectivity is improved at the expense of signal strength.¹ This arrangement is a valuable one, as it enables us to make the tuner as selective as possible when receiving a station working on a wavelength near that of the local station, while the full aerial coil can be used when receiving a station so separated in wavelength that the local station does not provide a background. For instance, to receive Bournemouth, at a place $2\frac{1}{2}$ miles from London with the latter station working, the part of the coil included between earth and the tap is used; to receive Newcastle, the full coil is employed.

¹ These statements apply exactly to the design as given here, and to most receivers employing a similar aerial-grid circuit, but would not apply if the aerial coil had almost as many turns as the grid coil.

Intervalve Coupling.

Now for the output circuit of the first valve. We have seen that a "low-loss" coil connected directly to the anode circuit to form the familiar though usually inefficient tuned anode coupling, will not give us any better results to speak of than a "high-loss" coil (when using an ordinary receiving valve of, say, 20,000 ohms anode impedance), but obviously there are advantages to be gained from the use of a circuit with low losses. One way of making good use of the properties of a low-loss tuned circuit would be to pick out a valve having an impedance of some fraction of a megohm with the largest possible magnification factor,² but valves of this type cannot ordinarily be obtained, and in any case would not suit our purpose. For reasons which will be explained directly, we must use a grid bias of negative 6 to 7.5 volts, which at once fixes the type of valve to be used if we wish to employ the moderate H.T. voltage of 120. Suitable valves for this stage are the B.T.H.B.4, Mullard D.F.A.1, Marconi or Osram D.E.5 or D.E.8 L.F., or the Cosmos S.P.18, Red Spot. These

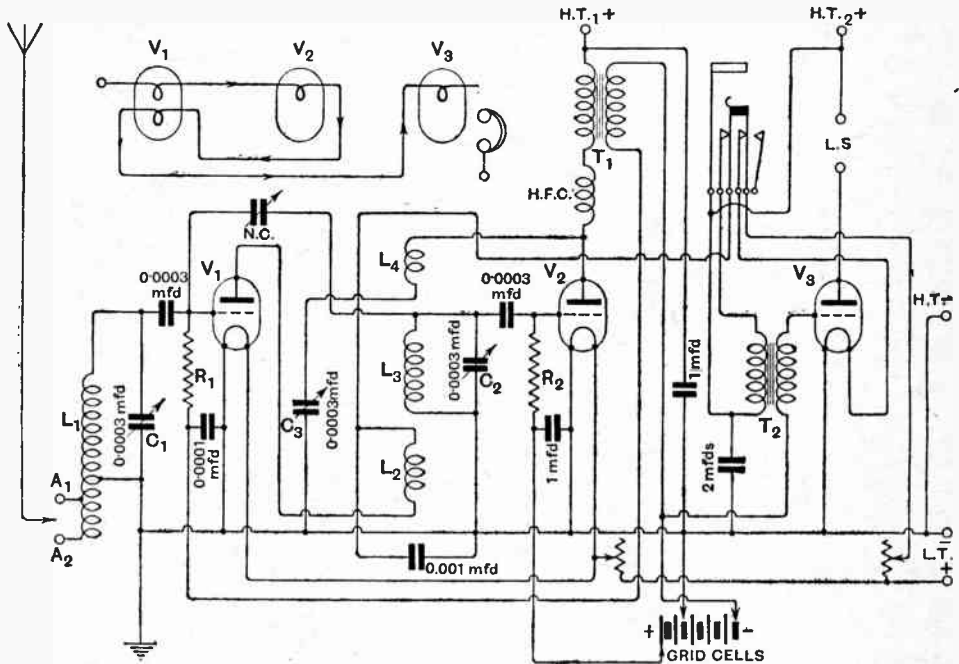

Fig. 2.—Complete circuit diagram. The sequence of amplification is indicated diagrammatically in the top left corner.

valves have, roughly, an anode impedance of 10,000 ohms and an amplification factor of 7. As a matter of fact, one of the new Marconi or Osram D.E.8 L.F. valves, which take a filament current of 0.12 ampere at 6 volts is recommended for this stage in the receiver.

We have therefore to consider how best to couple a 10,000 ohms valve to a circuit with a loss resistance of 5 ohms (we are neglecting the detector for the moment),

² Those with the receiver having a tuned anode circuit might remember this. For maximum selectivity, use a high impedance valve in the tuned anode circuit. The Americans have never used tuned anode couplings to any extent, probably for this very reason—that the valves on the American market are low impedance ones.

Oscillation without Radiation.—

bearing in mind that as there are only two tuned circuits the selectivity must be as good as is consistent with reasonable amplification in order that by pure tuning the local station shall be eliminated within a reasonable wave band.³

What we have to do is so to arrange the circuit that the amount of the resistance the valve puts in the tuned circuit is approximately equal to the loss resistance of the tuned circuit. Put in another form, the valve should be connected to the grid circuit in such a way that the resistance of the portion of the circuit connected directly to the valve is practically the same as the anode impedance of the valve.

H.F. Transformer Ratio.

This can be done by connecting the tuned grid coil to the anode of the H.F. valve as an auto-transformer, or by using the tuned grid coil as a secondary of a transformer whose primary is so tightly coupled that it is tuned by the grid condenser, and connecting this primary winding to the anode of the valve. Approximately, the best ratio of primary to secondary is given by $\sqrt{\frac{R_p}{Z}}$, where R_p is the anode impedance of the valve and Z is the impedance of the whole tuned grid circuit, that is, the complete secondary circuit. In our case, with a 5-ohm

³ It will be noticed that the word "reasonable" has entered the discussion several times, from which it may be concluded that the best arrangement depends largely upon circumstances, a man living near a station and wanting a set which will get distant stations at any price having to make his set more selective (and pay for it by losing a certain amount of signal strength) than someone else situated a few miles from the station.

coil (at 400 metres) of 250 microhenries, the best ratio from the point of view of signal strength is nearly 5—the primary winding having one-fifth as many turns as there are in the secondary—the assumption still being made that the primary is actually part of the secondary as in the case of an auto-transformer or that the primary is a separate winding so closely coupled to the secondary that it is tuned by the condenser shunting the grid coil.

Amplification Obtainable.

The theoretical amplification obtained from the valve and transformer under these conditions is 17 which compares with the maximum of 7 obtainable from the plain tuned anode coupling. We have also considerably increased the sharpness of tuning, as now the resistance added to the grid coil by the valve is approximately equal to that due to the loss of the grid coil itself. But although the condition where the impedance of the output circuit is equal to the anode impedance of the valve gives the maximum amplification (and incidentally quite good selectivity in our case) it is possible to reduce the impedance of the output (primary) circuit still further and so to gain in selectivity at the expense, however, of magnification.

But the gain in selectivity is, in our case, where we have only two tuned couplings, of great importance as compared with the reduction in signal strength from the maximum obtainable, and therefore in the final arrangement used, a certain amount of signal strength is deliberately thrown away in order to get the tuning characteristics which the writer found by experiment were desirable at the place where he uses the set—2½ miles from 2I.O. For those readers who live at a greater distance from a main B.B.C. station, a transformer having a smaller ratio, that is, a larger primary, will give louder signals with

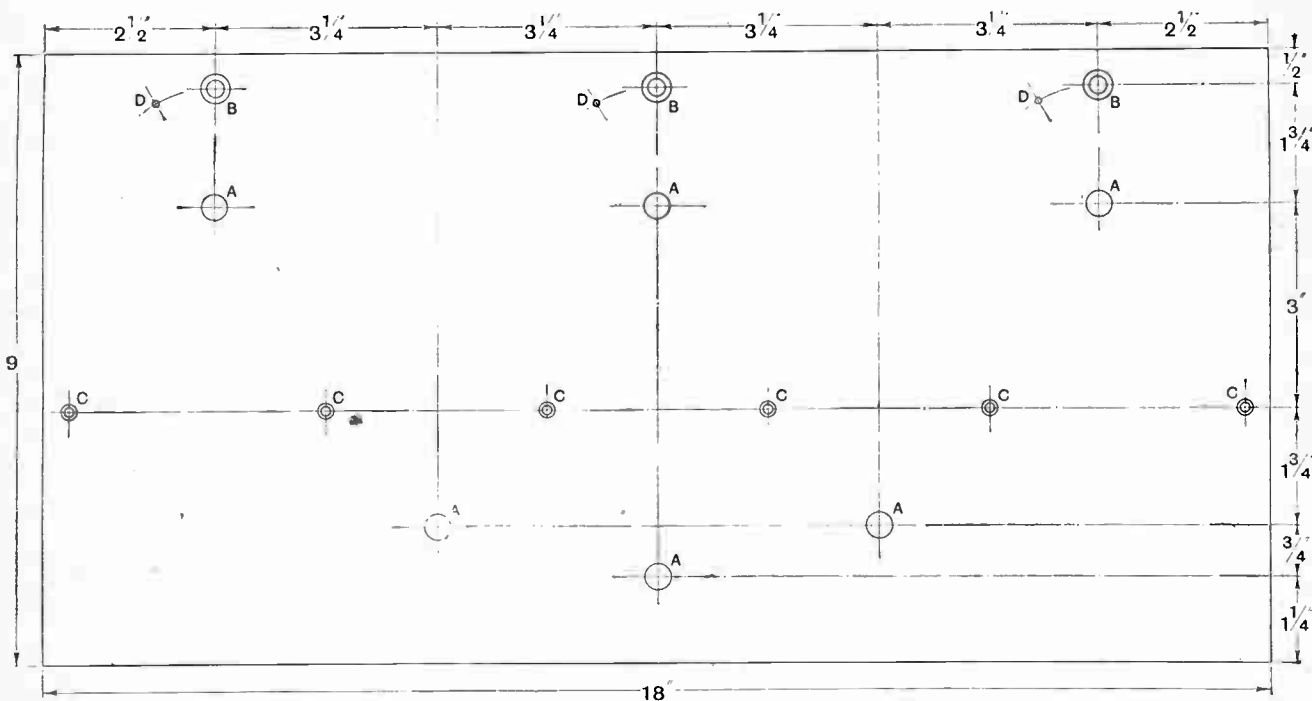

Fig. 3.—Dimensions of the wood front panel. Sizes of holes are as follow: A, 3/8in. dia.; B, 1/4in. dia., countersunk to 7/16in. dia.; C, 1/8in. dia., and countersunk for No. 4 wood screws; D, 3/32in. dia.

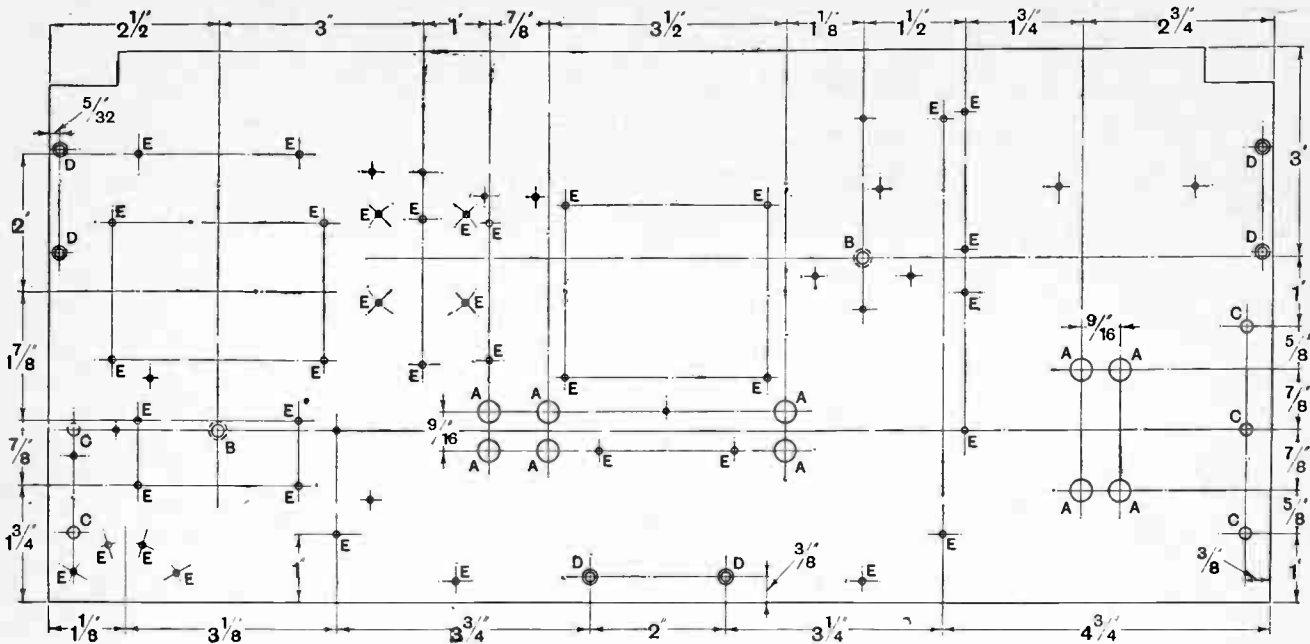

Fig. 4.—Drilling details of ebonite sub-panel. Sizes of holes are as follow: A, 9/16in. dia.; B, 5/32in. dia., countersunk for No. 4 B.A. screws; C, 5/32in. dia.; D, 1/8in. dia., countersunk for No. 4 wood screws; E, 0.089in. dia., tapped No. 6 B.A.

sufficient selectivity, while those living in the country may very well use a ratio of about 5 as determined by the method given above.⁴

Grid and Anode Rectification.

Having now discussed the design of a suitable coupling between the H.F. and detector valves, it remains to be said that a transformer is employed in the set illustrated here, because the first valve is used as a reflex stage, and also that in the above discussion no notice has been taken of the nature of the grid circuit connected across the tuned grid coil. With anode bend rectification, the constants of the tuned grid circuit are not altered very much when the valve is connected, provided ample negative grid bias is used, but when leaky grid rectification is employed, the grid-filament part of the rectifier conducts, and therefore throws a load on the tuned circuit. Provision is made for leaky grid or anode rectification to be used in the set illustrated here, it only being necessary to connect the return end of the grid leak to a point of suitable potential on the grid bias battery provided on the set. Thus, if the grid leak return (Fig. 2) is connected to -6 volts and the anode of the valve is given a suitable voltage, we get anode rectification, while if the grid return wire is joined to a positive potential, the valve rectifies on the leaky grid principle. The best operating conditions can be found by trial, and with the D.E.8 H.F. valve (normal impedance 25,000 ohms, amplification factor 16), best all round results are obtained with the grid return joined to positive 1.5 volts, with an anode voltage of about 80. The grid circuit then throws a load on the tuned transformer and slightly reduces the amplification and selectivity, but the low-frequency output is usually louder than when anode rectification is employed, even though in the latter case the grid voltage is higher.

⁴ Details will be given in the section describing the construction of the transformer.

The H.F. stage would normally oscillate; therefore a balancing condenser is connected between the grid end of the secondary of the transformer and the grid of the first valve. When this condenser, which has an exceedingly small capacity, is properly adjusted, the circuit will not start the aerial oscillating.

Reaction Effects.

We now come to what is perhaps the most important part of the receiver, and that is the reaction circuit, but before explaining the means for obtaining reaction it might be as well to discuss the effect of reaction and to see how reaction will benefit us. We have to bear in mind that when we apply reaction to the grid coil we also apply it to the anode coil of the H.F. valve, and so modify the characteristics of the whole transformer. The first thing to note is that reaction causes a magnification of jamming signals as well as the signal to which the receiver is tuned, the amount depending on the selectivity of the receiver. This is why such attention was given to the question of selectivity, for if we are tuned to Bournemouth and the London station is coming in as a background so that with moderate reaction both signals are of about the same strength, or London is stronger, it is pretty well hopeless to try to eliminate London by applying more reaction. But if by the circuit design London is reduced in strength by pure tuning so that Bournemouth can be brought up in strength (by applying reaction up to the limit), to several times the strength of London, Bournemouth will be received free from London, and, what is more, will not be distorted to any noticeable extent by using critical reaction. The effect of reaction in this example is thus enormously to increase the selectivity without impairing the quality of reception. As we tune further away from London (or the local station which tends to jam us) tuning becomes easier, and reception perfectly free from London is obtained.

Oscillation without Radiation.—

Without discussing the mechanism of reaction we may say that, provided our control over the reaction is sufficiently good, we can improve the selectivity of the set and increase the signal strength by a very large amount. The actual magnification produced by the reaction depends on the design of the circuit and on the strength of the signal. It would also appear that louder signals are obtained from a transformer with small losses than from one having larger losses, while weak signals are magnified by critical reaction much more than stronger signals. Thus with reaction properly arranged and skilfully applied, we can receive very weak signals.

As to the method of applying reaction, it has been found by experiment that a very easy way to get smooth reaction is by the arrangement shown in Fig. 1. A coil

properly chosen, adjustment of the reaction condenser has no noticeable effect on the tuning of the grid circuit, reaction control is very smooth, and the setting of the reaction condenser can be calibrated just as accurately as the tuning condensers.

Reflexing the First Valve.

The capabilities and limitations of an ordinary set with detector and L.F. using critically adjustable reaction are very well known. By using an additional tuned circuit as here described, the performance of the set is greatly improved, and by the use of the balanced circuit properly adjusted, it will not be possible to generate oscillation in the aerial circuit. This removes at once the main disadvantage of reaction, because unskilled persons can use the set and not be troublesome.

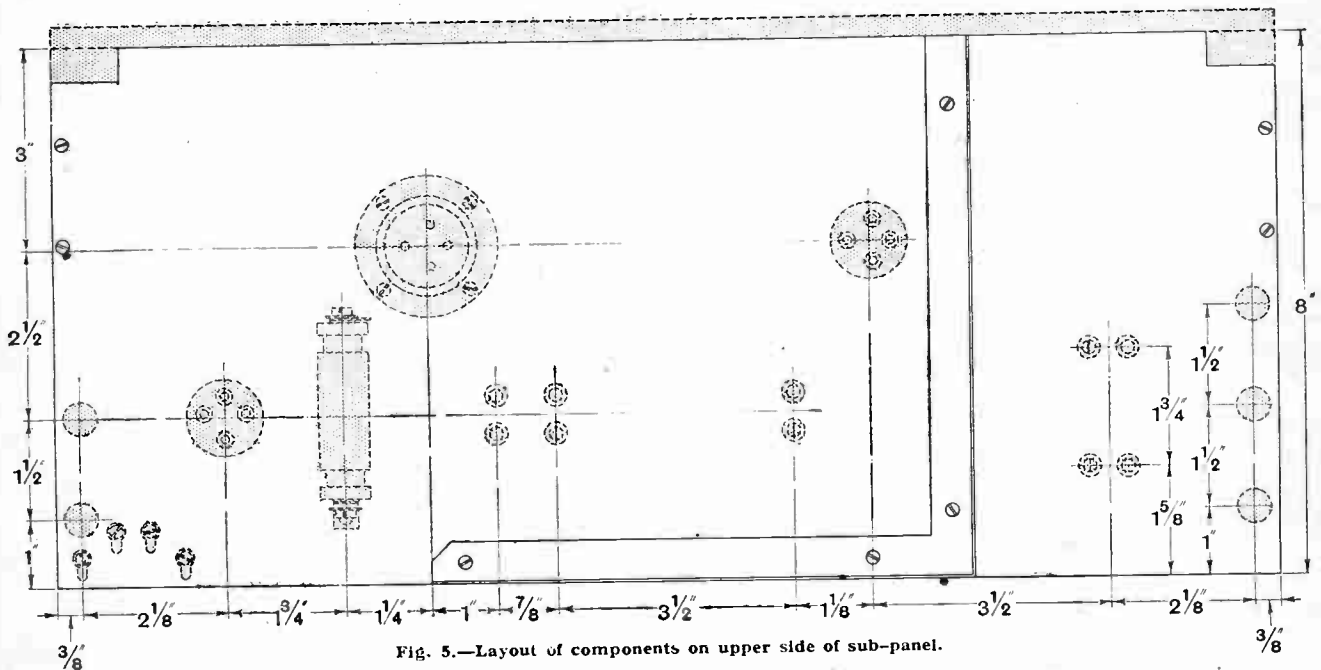

Fig. 5.—Layout of components on upper side of sub-panel.

and condenser, L_4 , C_3 , connected in series are joined between the anode of the detector and the filament, while a high-frequency choke coil, H.F.C., is connected between the anode and the primary of the L.F. transformer or telephones. This H.F.C. prevents high-frequency currents entering the transformer or telephones and forces them to take the path provided by the reaction coil and the tuning condenser. The reaction coil is fixed in position near the grid end of the H.F. transformer and the amount of H.F. current passing through it, and therefore the reaction effect is varied by adjusting the tuning condenser. With the condenser set at minimum, the reaction effect is small; as the condenser is turned to increase its capacity the current passing through it and the reaction coil increases, increasing reaction.

Reaction Coil Adjustment.

It is best so to arrange the reaction coil that with the grid circuit condenser set at maximum, the circuit will just oscillate with the reaction condenser at maximum.

If the distance separating the reaction and grid coils is

The use of a stage of H.F. to effectively isolate the oscillating circuit from the aerial is more than sufficient justification for its inclusion in a set, and when it can be used to effect a big improvement in the selectivity and signal strength, and so to add to the number of stations which we can usefully receive, we might well feel that this stage is doing all that can reasonably be expected of it. But no, we can reflex it. That is to say, we can pass the L.F. output from the detector (see Fig. 2) to the grid of the first valve, and then couple the anode of this valve to the grid of the third valve. To do this we have to arrange the circuit in such a way that the H.F. currents do not flow through the transformer and so reach the anode circuit of the detector where they would cause trouble, and we also have to take care not to spoil the quality by shunting the L.F. transformer with capacities of too large a value.

We therefore break the grid circuit of the first valve so far as L.F. currents are concerned, by putting in a fixed condenser (0.0003 mfd) and connect the transformer through a grid leak, R_1 , to the grid of the valve. As to

Oscillation without Radiation.—

the H.F. currents, their path is not changed in the least by the alteration, because they are not affected by a fixed condenser (0.0003 mfd.), and the resistance of the grid leak does not lower the impedance of the grid-filament path by a very great amount. A 0.5 megohm grid leak is used, and this, being in shunt with the tuned grid coil will have the effect of slightly damping it—to the extent of about 2 ohms on the lower B.B.C. band. Of course, a good H.F. choke could be used instead of the grid leak, but it is doubtful whether the choke would offer an impedance of 0.5 megohm to the H.F. currents.

The choke would, however, be a very much smaller resistance in series with the L.F. transformer than a grid leak, and we would also benefit should grid current start through strong signals.

Loud-Speaker Reception.

Now the reason for the insistence on using a 6- or 7.5-volt negative grid bias is clear, for it is to prevent the possibility of grid current flowing in this circuit which would cause distortion and also to enable us to deal with large L.F. amplitudes. With the first valve having a bias of negative 7.5 volts when it is working at full load, a comfortable loud-speaker volume is obtained, and that with the two valves, the detector and

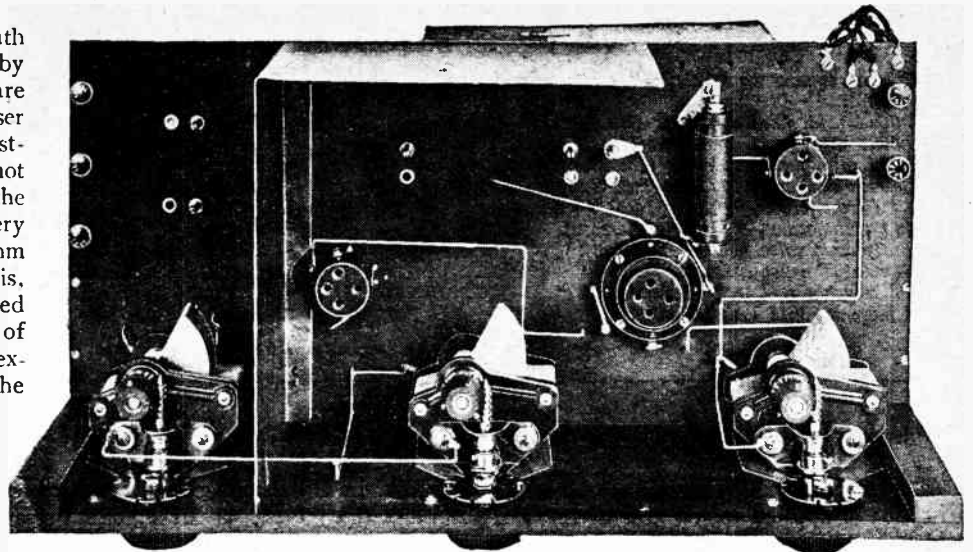

Plan view of sub-panel, showing position of capacity shield.

reflex stage. Provision is therefore made for connecting the loud-speaker or telephones to the anode of the first valve, and our standard of loud-speaker strength is that which will fully load a valve having this grid bias. The last valve is connected to the same grid bias and H.T. voltage, and is used for receiving signals that are at telephone strength on the two valves.

It should be noticed that the bottom of the grid leak is connected by a 0.0001 mfd. fixed condenser to the negative side of the filament, and its purpose is to act as a shunt across the transformer secondary to H.F. currents which pass through the grid leak. These are of very small magnitude, and the condenser is hardly required, but is used for safety. It does not affect the quality

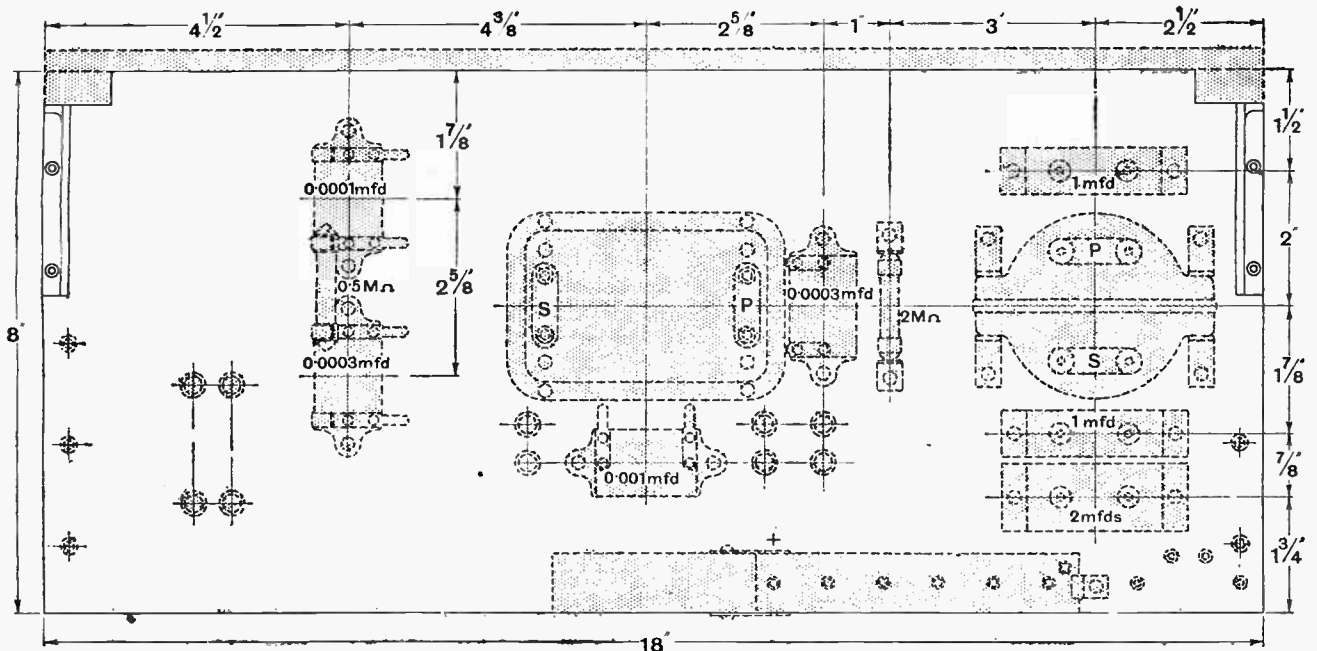

Fig. 6.—Layout of components on lower side of sub-panel.

LIST OF MATERIALS.

3 Colvern square-law "Selector" condensers, capacity 0.0003 mfd.
 1 0.0001 mfd. fixed condenser (Dubilier).
 2 0.0003 mfd. fixed condensers (Dubilier).
 1 0.001 mfd. fixed condenser (Dubilier).
 1 Cosmos H.F. choke (Metro-Vick Supplies, Ltd.).
 1 3 : 1 transformer, "Junior Ideal" (Marconi).
 1 4 : 1 transformer, "Ideal" (Marconi).
 1 Antiphonic valve holder (Burndept).
 2 "Quality" valve holders.
 1 0.5 megohm grid leak (Dubilier).
 1 2 megohms grid leak (Dubilier).

1 2 mfd. fixed condenser (T.C.C.).
 2 1 mfd. fixed condensers (T.C.C.).
 1 Tapped 9-volt grid battery, type G.B.4 (Ever Ready).
 1 Edison Bell No. 5 jack with plug.
 1 Pair aluminium brackets (A. J. Dew & Co.).
 2 Cosmos filament rheostats (Metro-Vick Supplies, Ltd.).
 13 Pairs of coil plugs and sockets (Dayzite, Ltd.).
 1 Mahogany panel, 18in. × 9in. × $\frac{3}{4}$ in.
 1 Ebonite panel, 18in. × 8in. × $\frac{1}{4}$ in.
 1 Compton Cabinet No. 403 (Compton Electrical and Radio Trades Supplies).
 4 Lengths ebonite tube $\frac{1}{4}$ in. wall, 3in. dia. 4 $\frac{1}{4}$ in. long.

Approximate cost: £10, excluding cabinet, valves, etc.

of the signals for the transformer has a ratio of only 3 : 1.

Another point which should be noticed is the way the grid bias is applied to the grid of the valve through the grid leak and transformer secondary. The method is a very good one to use, apart from any consideration as to reflexing the first stage, for it biases the grid without adding any disadvantages worth considering. We can earth the negative side of the filament battery, and any leakage of the grid battery is of no account so far as the circuit is concerned, because its potential is applied directly between grid and filament. When we add the reflex transformer we gain a valve, saving its filament and H.T. current, less the slight loss in L.F. amplification caused by the L.F. voltages being impressed on the grid of the valve through a 0.5 megohm grid leak. This loss is very slight, if indeed it exists, as it is difficult to detect by hearing whether any change in strength is produced by connecting the O.S. terminal of a L.F. transformer in an ordinary straight set to the grid of the valve through a 0.5 megohm resistance or direct.

Automatic Indication of Grid Current.

Having explained at some length the reasons underlying the design of the circuit and its components, I hope the reader will agree with me that the reflex stage will do the work of two straight valves, less, perhaps, 10 per cent., which can be allowed for the effect of the grid leak (although I do not admit it) without adding any complications and without impairing the quality in the least. If the L.F. input to the reflex valve is too great, as it will be in the case of those who normally receive the local station on the loud-speaker with a two- or three-valve set, an automatic buzzer will start off and warn them that grid current is flowing in the grid circuit of the reflex valve. The remedy is to increase the grid bias and the H.T. when they will receive louder signals, or

to reduce the input by cutting down reaction. This buzzing⁵ which starts with grid current, as can be seen by connecting a microammeter in series with the grid leak, is an excellent feature, for if the grid current flowed and there were no buzz, the signals would be distorted, and might lead some to put it down to the reflex-

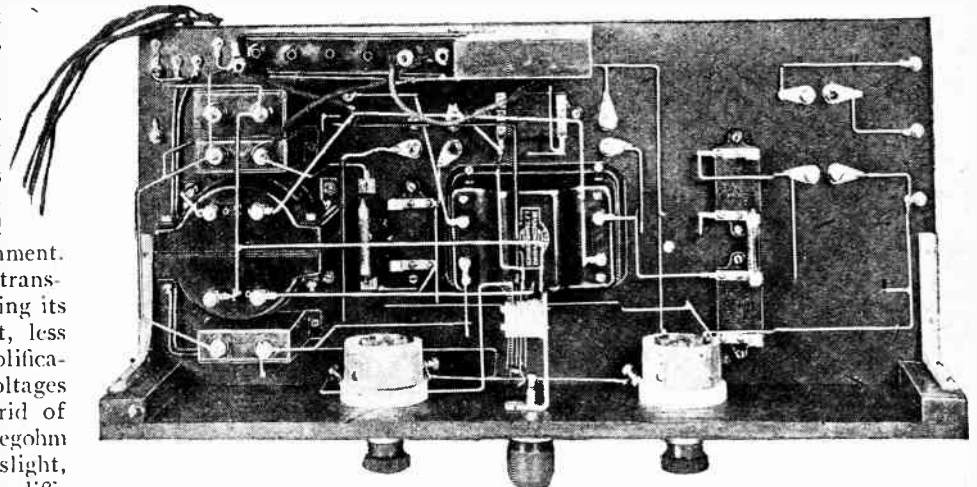

Components associated with the low-frequency portions of the circuit and mounted on the underside of the ebonite sub-panel.

ing. In a sense they would be right, too, for the reflex stage is a powerful magnifier, although, incidentally, it is as distortionless as the characteristic of the valves and L.F. transformer will allow it to be.

Much more could be said in the way of the detailed design of the set, but we will pass on to a consideration of the circuit of the complete receiver. This is given in Fig. 2, where the reflex valve is V_1 , the detector V_2 , and the L.F. amplifier V_3 . The jack is connected in the anode circuit of the first valve, and when the telephone plug is inserted the third valve is disconnected.

⁵When grid current flows, the grid isolating condenser, Fig. 2, charges up, and the currents cannot leak away fast enough through the grid leak and transformer in series, hence the buzz as the combination charges and discharges. An H.F. choke instead of the leak will cure this, but would lower the efficiency of the tuner a little, although no one should tolerate grid current. It is therefore just as well to keep to the grid leak, as it is cheaper than a good choke.

Oscillation without Radiation.—

while a 0.001 mfd. fixed condenser is shunted across the L.F. portion of the output circuit of V_1 to prevent H.F. currents passing through the telephones or the transformer T_2 . Interchangeable aerial and anode transformers are employed to give a tuning range of 200 to 530 metres and 700 to 1,850 metres, and two reaction coils are required.

The three tuning condensers are of 0.0003 mfd. capacity. A common grid bias battery is included in the set and condensers are provided to shunt the H.T. battery. Valves V_1 and V_2 are controlled by a common rheostat of low resistance, while V_3 has its own rheostat.

Arrangement of the Receiver.

The receiver has been built up in such a way that the coils and valves can be easily handled, while the parts which do not have to be disturbed are placed below a panel. They are arranged to facilitate wiring and to give live wires, short, clear paths. Usually in reflex sets several rather long connecting wires are to be found, but in the arrangement adopted here the apparatus is advantageously placed.

A front panel of polished mahogany is used to carry the three variable condensers, two filament rheostats, and jack, and they are arranged on the panel as shown in Fig. 3 and the photographs. The mahogany panel measures 18in. x 9in. x $\frac{3}{8}$ in., and has a batten at each end, a wooden panel being used because all the parts on it are connected to earth except the jack, which is joined to positive H.T. All the remaining apparatus is assembled on an ebonite panel, which is held by means of two brackets screwed to the front panel, and by a block of wood screwed to the back edge, the bottom of which rests on the floor of the cabinet.

Mounted on the top of the ebonite panel are the three valve holders, the holder for the detector being of the anti-noise type, the plugs and sockets for the interchangeable aerial and intervalve transformers and reaction coil, the H.F. choke, terminals for the aerial, earth and loud-speaker, and connections for the battery wires.

It should be noticed that the aerial-grid transformer stands vertically, while the anode grid transformer is mounted in line and horizontally. This is to reduce magnetic coupling between the aerial and detector circuit, to eliminate the last trace of magnetic coupling, and to prevent capacitative coupling a copper sheet is fixed to the panel as shown. This copper screen is important, for not only does it remove all coupling between the aerial and detector circuits and so enable us to obtain a good balance by adjusting the neutralising condenser, but it

tends to prevent direct coupling between the aerial lead-in wire and the detector circuit.

If we are to prevent the oscillating detector circuit from energising the aerial it is absolutely necessary to remove all possible couplings. This is done by placing the aerial and earth terminal on the left-hand edge of the ebonite panel, so that the earthed screen is between the aerial lead-in and earth wires, and the oscillating detector circuit. What we require is that the first valve shall act as a true one-way repeater; that voltages applied to its grid shall influence the anode circuit while the currents flowing in the anode circuit do not produce any currents

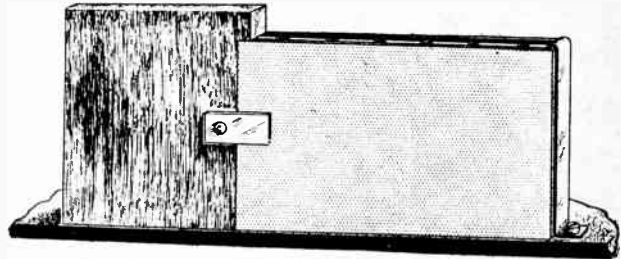

Fig. 7.—Method of supporting grid battery.

in the grid circuit. This requirement can only be met by removing all couplings except that through the valve, and this can be balanced out by the neutralising condenser.

Great care should be taken to place the parts in their correct position, as shown in Fig. 5, particular care being given to the arrangement of the plugs and sockets for the coils. Fig. 6 shows the arrangement of the parts on the underside of the ebonite panel. These include the two transformers, grid condensers, grid leaks, by-pass condensers, and grid battery, and they are fixed by drilling and tapping the ebonite and fitting in most instances No. 6 B.A. brass screws. Exact dimensions are given in Fig. 6, and if this drawing is followed it will be found that when the parts are assembled they have ample room. Some of the holes indicated in Fig. 6 are for connecting wires.

The grid battery is held at one end by a brass clip, and at the other by the block of wood which is cut away to allow the battery to fit. Details are given in the sketch of Fig. 7. After the components have been fitted the panel should be screwed together to make quite sure that everything is satisfactory. Then connecting tags can be fitted to the terminals where necessary, those for the coil sockets and plugs being cut from thin tinned sheet iron.

(To be concluded.)

BUYERS' GUIDE NUMBER.

Our experience shows that a very large proportion of those who contemplate the purchase of wireless sets do so only after seeking technical advice. The feature of next week's issue will be the inclusion of brief technical details of the sets available on the market to-day.

Our Buyers' Guide Number is being compiled to assist readers in selecting and comparing the many receivers and will be invaluable for reference.

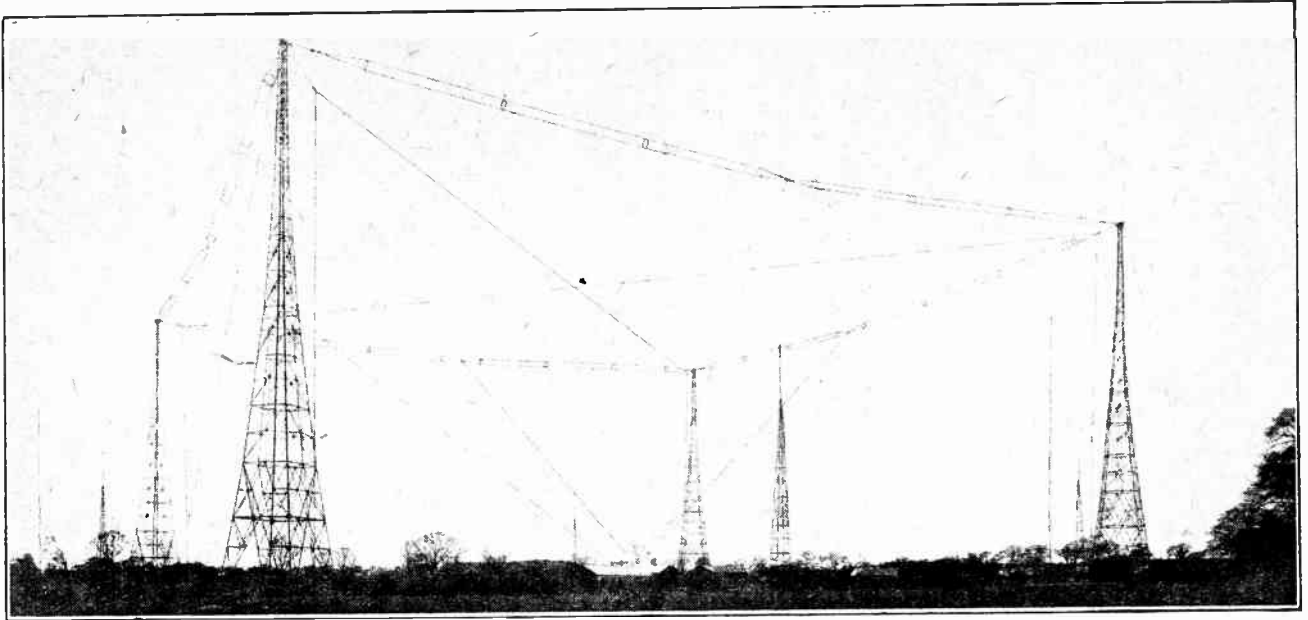

MULTIPLEX DIRECTIONAL RECEPTION.

An Account of the Receiving Equipment at Brentwood.

By R. KEEN, B.Eng., A.M.I.E.E.

IN the choice of a receiving aerial system for the terminal station of a number of commercial wireless services on wavelengths of 2,000 up to 20,000 metres a number of alternatives present themselves, and a variety of methods have been adopted by the several large foreign wireless companies. The following is a brief description of the multiplex system which has been in use for some time at the Marconi Co.'s receiving station at Brentwood, in Essex.

From the time of the introduction of the Bellini-Tosi system of directional reception in 1907 until about 1922, no really successful attempt had been made to use more than one radiogoniometer on any one pair of fixed loop aeriels, except by the employment of such loosely coupled radiogoniometers that interference between the receiving circuits was reduced to a reasonably small amount. Even in this case the wavelengths of the received signals had to be fairly widely separated.

In view of this difficulty, provision was made in laying out the Brentwood station in 1921 for a final complement of eight Bellini-Tosi aerial systems for Continental reception, four of which were erected to accommodate the services with Paris, Berne, and Madrid, leaving one spare aerial. The arrangement of one of these aerial systems with its length of transposed "leading-in" wires is shown in Fig. 1.

In 1923, since the number of

Continental services was increasing, the importance of finding a method of using one Bellini-Tosi aerial system for a number of directional receivers became more acute, in order to avoid, if possible, the necessity for constructing additional towers and aeriels. The use of loosely coupled radiogoniometers was ruled out, because the "aperiodic aerial" system had become practically universal, and this makes tight coupling of the radiogoniometer advisable.

Aperiodic Aerial: Bellini-Tosi System.

The aperiodic aerial system has been described a number of times in these pages, and is shown diagrammatically in Fig. 2, where the two fixed frames at right angles to each other are seen to be connected to the two field coils of the radiogoniometer, these coils being also mutually at right angles and having an exploring coil mounted so as to rotate about their common axis. This exploring or search coil circuit is tuned by means of a variable condenser and coupled to the high-frequency circuit of the receiver. A further coil may also be included in the search coil circuit for coupling to an open aerial, in order to get a cardioid diagram of reception if required. It will be noticed that the aerial loops and their

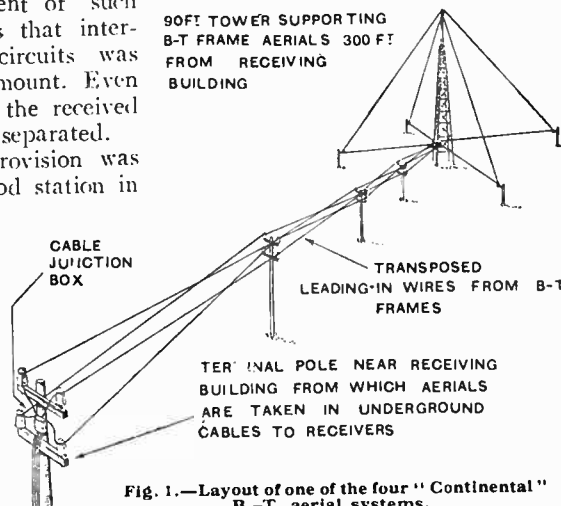

Fig. 1.—Layout of one of the four "Continental" B.-T. aerial systems.

Multiplex Directional Reception.—

respective field coils form untuned inductive circuits, but, owing to the tight coupling between the search coil and the field coils, there is an appreciable element of tuning introduced to the aerial circuit from the tuned search coil circuit, thus making the whole combination far more simple than the original "tuned aerial" Bellini-Tosi system, in which each aerial loop had to be separately

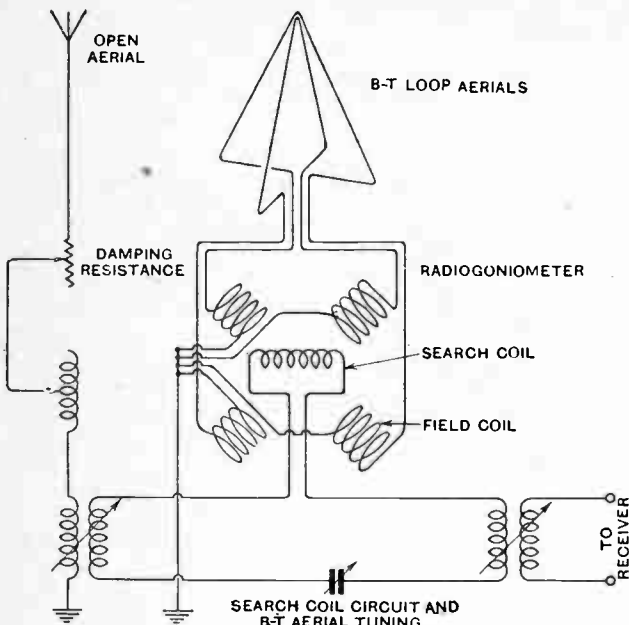
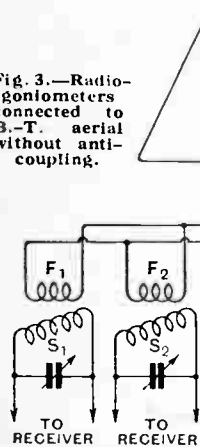

Fig. 2.—Aperiodic aerial: Bellini-Tosi system.

tuned and the phases of the currents in the two aeri- als synchronised. A radiogoniometer may be said to be tightly coupled when the coefficient of coupling between a field coil and the search coil approaches 80 per cent. This tight coupling involves the search coil and field coils having a very small clearance. Owing to the capacity between them, there is a tendency for the whole aerial system to oscillate as an open aerial resulting in a non-directional component of E.M.F. in the receiver which distorts the normal "figure eight" polar diagram of reception of the frame system. This is reduced to a negligible amount by connecting to earth the mid-point of the field coils and also by using a loose magnetic coupling between the search coil circuit and the receiver, as in Fig. 2.

Fig. 3.—Radio-goniometers connected to B.-T. aerial without anti-coupling.



Now note the effect of connecting a number of such radio-goniometers to one pair of aeri- als, using the aperiodic system. In Fig. 3, F_1 is a field coil of a radiogoniometer, and S_1 a search coil with tuning condenser and leads to an associated receiver. The field coil is shown connected to one loop of an aperiodic Bellini-Tosi aerial system, in parallel

with which is the field coil F_2 of a second radiogoniometer. The other two field coils are similarly connected in parallel across the second aerial loop, but are not illustrated. It is easy to see that these two radiogoniometers cannot be worked independently, for any current in the search coil S_1 due to a signal will result in interference in the search coil S_2 , owing to the tight coupling via F_1 and F_2 . Similarly, any signal in S_2 will interfere with the first receiver. Provision must therefore be made that any coupling from S_1 to S_2 is neutralised, and one method of doing this is shown in Fig. 4. Each radiogoniometer is now a double instrument having two search coils S_1 and s_1 connected in series and which are fitted on the same spindle and rotate together, as in Fig. 5. Each search coil has two sets of field coils, those belonging to one radiogoniometer being connected in parallel across the main aerial loops, whilst those of the other radiogoniometer are connected in series with "dummy aeri- als," which consist of coils wound on small formers and having an inductance which is a function of the field coil and frame aerial inductances. Again, only one aerial loop and one dummy aerial are illustrated for the sake of simplifying the diagram.

Anti-coupling.

If, now, the arrow (1) in the search

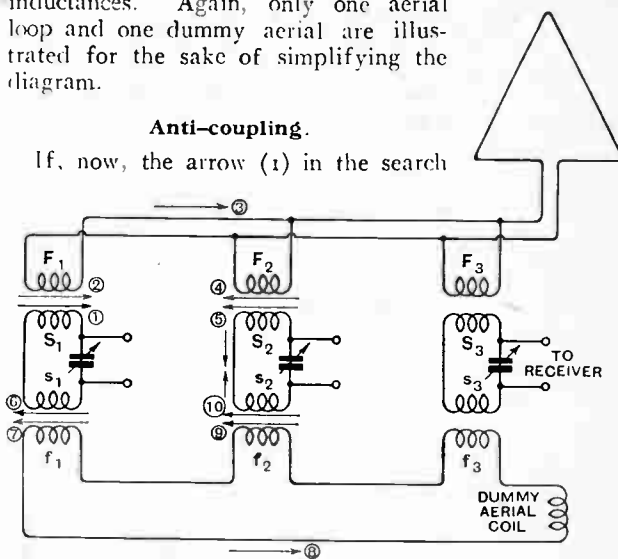

Fig. 4.—Three radiogoniometers connected to a B.-T. aerial with "dummy aerial" anti-coupling.

coil S_1 represents the instantaneous direction of the current due to a signal, it only remains to find out whether the effect of this in the search coil S_2 can be neutralised. Suppose the current represented by the arrow (1) causes an E.M.F. in the field coil F_1 , shown by the arrow (2), then the resulting current will flow as shown by the arrows (2), (3) and (4), and will induce an E.M.F. in S_2 as indicated by the arrow (5). Returning to the first circuit again, the S_1 current flowing through s_1 as shown by arrow (6) will induce an E.M.F. (7) and a current (7), (8) and (9) in the dummy field coil circuit, and the E.M.F. (10) induced in s_2 will be in the opposite direction round the search coil circuit to the E.M.F. (5) induced in S_2 . The dummy aerial circuit therefore anti-couples the search coil circuits, and it will be found that any number of receivers may be added, and all the search coils are anti-coupled one from another. In such a series-parallel arrangement it is

Multiplex Directional Reception.—

preferable to maintain the parallel connection in the active aerial in order that the mid-points of the field coils may be earth-connected for the purpose already mentioned.

Practical Precautions.

Fig. 6 shows the complete aerial circuits for a set of directional receivers in which the dummy aerial circuit is

900 mhs. The cage aerials between the towers are a part of the open aerial system for obtaining cardioid diagrams of reception on the Transatlantic receivers. These are omitted from Fig. 7. Six directional receivers are fed from the large loops; they are all identical and have a wavelength range of 6,000 to 30,000 metres.

These receivers are frequently all in use during busy periods corresponding to the peak of New York traffic, and though they are normally all on different wavelengths there may, at times, be two receivers taking the same New York station for purposes of comparison. In any case, each receiver is quite independent of the remainder, and any radiogoniometer can be rotated, without affecting the rest of the circuits, to cut out interference due to a jamming station, or to reduce the strength of atmospherics when, as is usually the case, the bulk of atmospherics are arriving from the same direction.

Open Aerial Multiplex Reception.

In the aperiodic Bellini-Tosi system the normal method of obtaining the necessary circle diagram of reception for combination with the figure eight diagram to give a cardioid is by means of an open aerial which has been

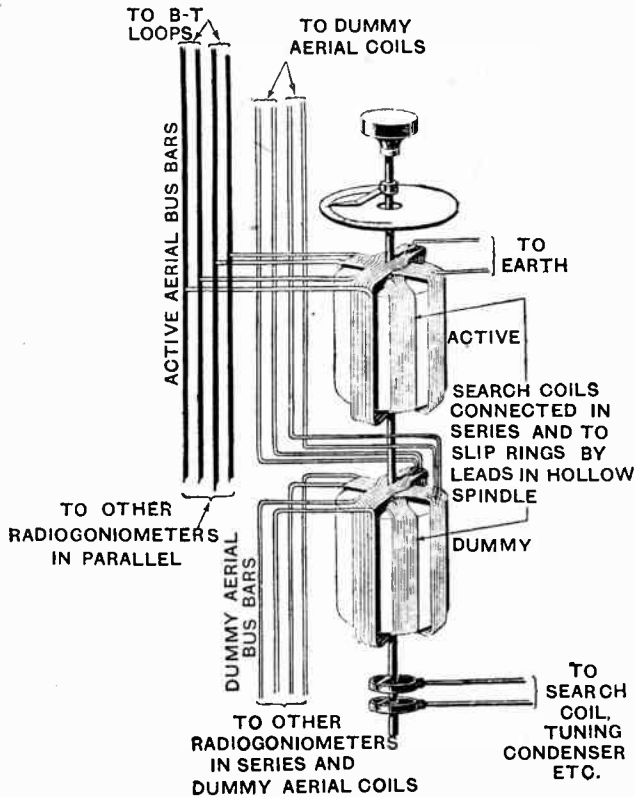

Fig. 5.—Connections of double radiogoniometer.

rendered as symmetrical as possible by winding the field coils in two halves, as in the case of the active field coils, and by also winding the dummy aerial coils in two halves and connecting them as shown. It will be noted that the dummy aerial coils are disposed at right angles to one another to prevent mutual induction between them.

Aerial Towers.

By means of the above scheme the four Bellini-Tosi aerial systems originally erected at Brentwood now each supply two receivers, these eight receivers being used for the services with Paris, Berne, Madrid, Barcelona, and Vienna, with spare receivers for additional channels as required. The aerials are each supported by a 70ft. tower with a 20ft. topmast, and these can be seen in the photograph reproduced at the beginning of this article and the plan of Fig. 7.

The four 200ft. towers were erected in 1923 for the Transatlantic reception from New York and Glace Bay (Canada), and these support a Bellini-Tosi aerial system composed of two rectangular loops each about 180ft. high by 600ft. in width, and having an inductance of

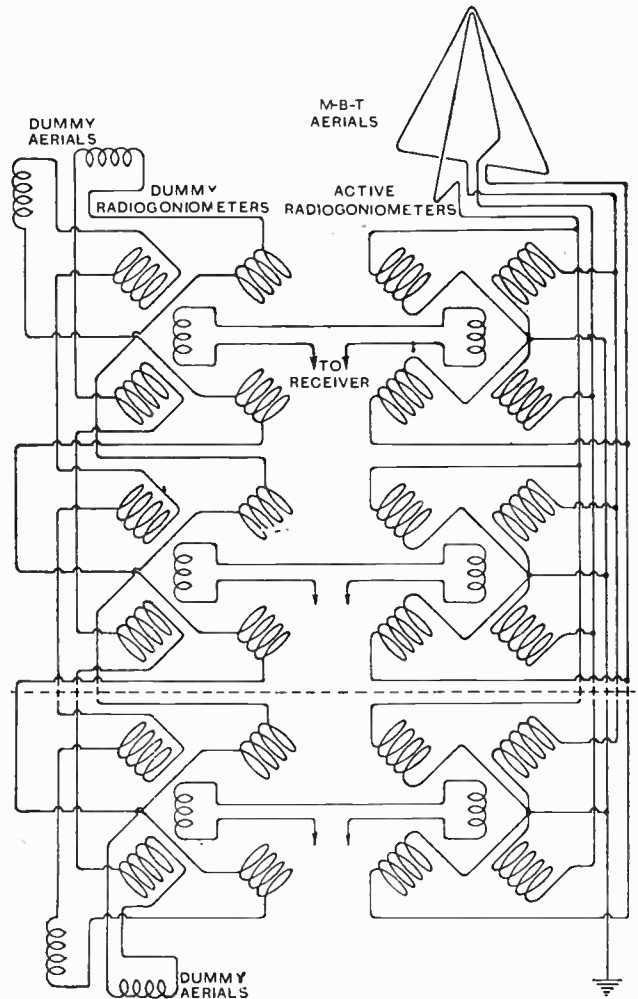

Fig. 6.—Complete circuit diagram of arrangement shown in Fig. 5.

Multiplex Directional Reception.—

approximately tuned to the incoming wave and then rendered almost aperiodic by the insertion of several thousand ohms in series with it, as in Fig. 2. This maintains the open aerial current and E.M.F. in the correct phase relation to give a cardioid balance in the search coil circuit when combined with the E.M.F. due to the frame current, and also renders the balance less sensitive to small changes in wavelength than in the case where the open aerial is of the low-resistance tuned type.¹ It appears, then, that in the case of multiplex directional reception the number of open aerials will have to be the same as the number of receivers, unless some method of using a single open aerial can be found which does not cause mutual interference between the receivers.

Valve Coupling to Aperiodic Open Aerial.

The open aerial in the diagram in Fig. 8 is connected to earth through a resistance of about 100,000 ohms, and the top point of this resistance is taken to the grid of a valve, the values of plate current and grid bias having been so arranged that the valve is working on the straight part of its plate current—grid volt curve—and

ling valve" and the search coil circuit, a correct cardioid balance can be got with very little trouble. Since it has been arranged that there shall be no grid current in the coupling valve, the receiving circuit is "potential operated," and cannot exert any damping effect on the open aerial, or affect it in any way, and there is no reason why any number of coupling valves and receivers should not be connected across the same open aerial as shown, the various search coil circuits selecting from the anode circuits

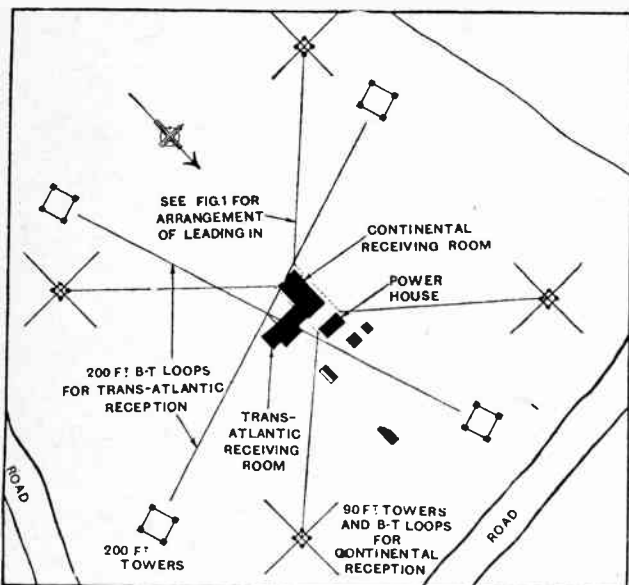

Fig. 7.—Plan of site, showing layout of aerials and supporting towers.

is not passing grid current at any time. The anode circuit of the valve contains the coupling coil to the search coil circuit of a directional receiver. Now, clearly, this arrangement is almost aperiodic, and all the oscillations taking place in the open aerial will cause corresponding fluctuations in potential of the grid of the valve, due to the varying potential drop across the 100,000-ohm. resistance. These oscillations will be repeated in the anode circuit, and the search coil circuit will respond to that frequency to which it has been tuned. By adjusting the coupling between the open aerial "cou-

¹The theory of the aperiodic system was briefly described by the present writer in *The Wireless World* of April 2nd, 9th, and 16th, 1924.

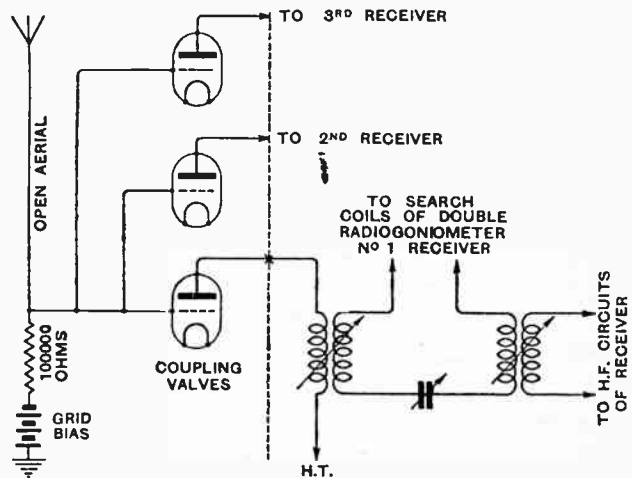

Fig. 8.—Connections of coupling valves for operating more than one receiver on an open aerial.

of their coupling valves those frequencies with which they are in resonance. This simple circuit has to be slightly modified in practice. Owing to the very high resistance in the open aerial, any charge imparted to the aerial will take an appreciable time to leak away, and during a storm of rain from an electrically charged cloud a large positive or negative charge will collect on the aerial and will have the effect of sweeping all the coupling valves either up their curves to saturation, or down them to zero anode current. The circuit of Fig. 9 provides capacity coupling between the aerial and the valves, so that whilst the grids of the coupling valves will still follow the fluctuations of potential across the aerial resistance, they will not be affected by a static charge.

Other Similar European Stations.

The Bellini-Tosi system with double radiogoniometers thus provides a solution of the problem of multiplex directional reception with a comparatively simple aerial system and a reasonably small receiving site. In addition to the Brentwood station, similar though less extensive installations are also in use at the Laerberg receiving station of the Radio - Austria Company, Ltd., near Vienna, and at Riedern, the terminal receiving station of the Radio-Marconi Société Anonyme Berne, Switzerland.

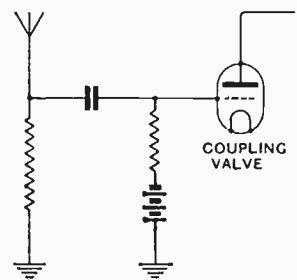

Fig. 9.—Capacity coupling to eliminate effect of static charges on the open aerial.

GERMAN VALVE MANUFACTURE.

Methods Employed in the Radioroehrenfabrik Factory at Hamburg.

By A. DINSDALE.

IN the pages of this journal¹ the methods and processes employed by some leading British valve manufacturers were described and illustrated. It is thought, therefore, that the following description of the author's tour of a foreign factory may be of interest, because, although the general principles of valve manufacture are much the same everywhere, the individual methods and processes of different makers vary considerably.

The factory visited was that of the Radioroehrenfabrik G.m.b.H., of Hamburg, Germany, the parent firm of which has been established for many years in the manufacture of X-ray tubes and associated apparatus. They are at present engaged in the production of seven different types of receiving valves, covering all purposes, and also transmitting valves of various powers up to 500 watts. In all cases, but particularly in the case of the transmitting valves, the writer was struck by the extraordinary neatness, strength, and regularity of construction.

Gauging the Bulbs.

The receiving valves are all of the pipless variety, with the sole exception of the loud-speaker power valve, thus making them particularly attractive in appearance, and less liable to damage. The necessary glassware is supplied to the factory in three forms: the bulbs, blown approximately to required size and shape; long lengths of tubing, about five-eighths of an inch in diameter for making the "foot"; and lengths of quarter-inch tubing for sealing the bulbs to the pumps. Lead glass is used throughout, and it is annealed after each heat process.

The first operation in connection with the bulbs, as

¹ *The Wireless World*, Sept. 30th, 1925.

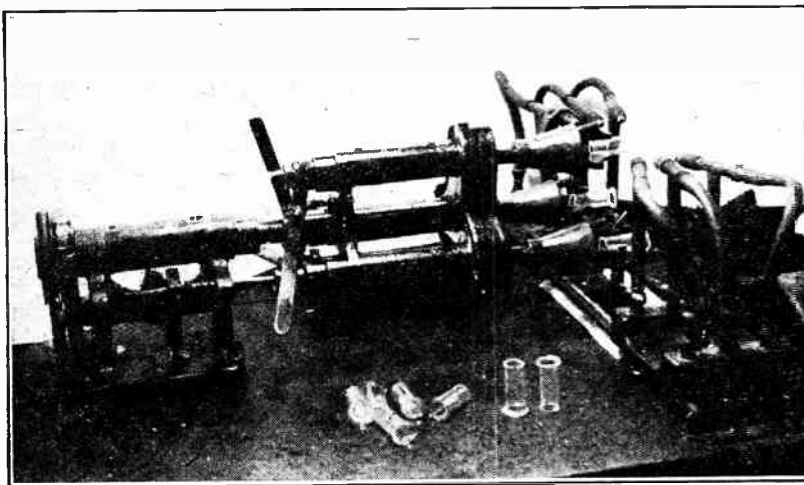

Fig. 1—New machinery is constantly being designed for use in valve manufacture. This machine automatically cuts the foot tube to size and bells out the ends.

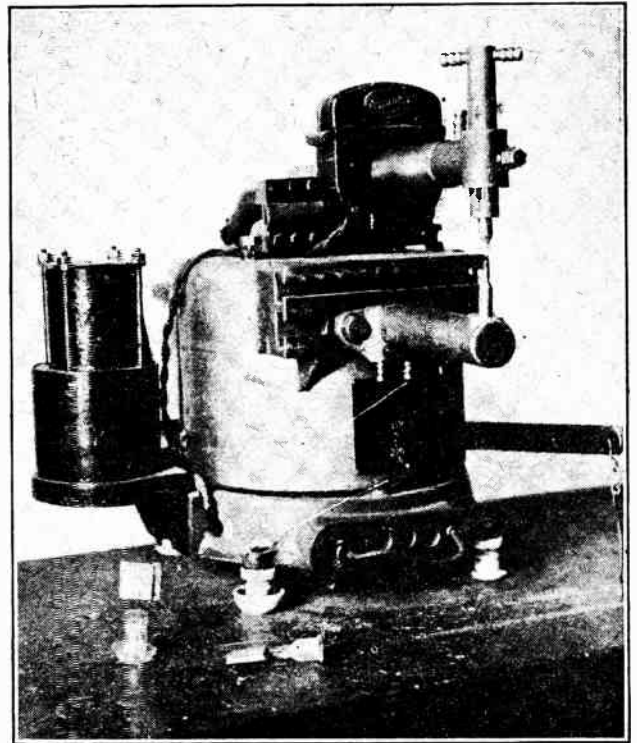

Fig. 2.—Electric welding machine for fixing anodes and grids to their supports.

received from the glass-blower, is to wash them in water to free them from accumulated dust and dirt. The next operation is to reduce or extend the opening into which the foot is inserted, till it is of the correct size. This could, of course, be done by the glass-blower at the time of manufacture, but to ensure that every bulb shall be blown to just the exact size would prove too expensive a matter, and the process of correcting irregularly shaped bulbs is a simple one. The bulb is mounted in a kind of lathe, and, whilst the foot opening is being heated in a gas flame, the bulb is slowly rotated and the operator either distends or contracts the opening by pressing against either the inside or outside with a metal rod.

The Foot Tube.

Meanwhile the tubing for the foot is being cut up into lengths about 2½ in. long. These lengths are then mounted in the machine shown in Fig. 1, which slowly rotates the tube, whilst the end projects

German Valve Manufacture.—

into the concentrated flame of the six gas jets which can be seen in the picture. When the correct temperature has been reached, the operator then bells out the end to the correct size for entering the bulb opening by holding against it a curved metal rod. The process is similar to metal turning in a lathe, only instead of the work being cut to size and shape, it is pressed whilst in a semi-molten state.

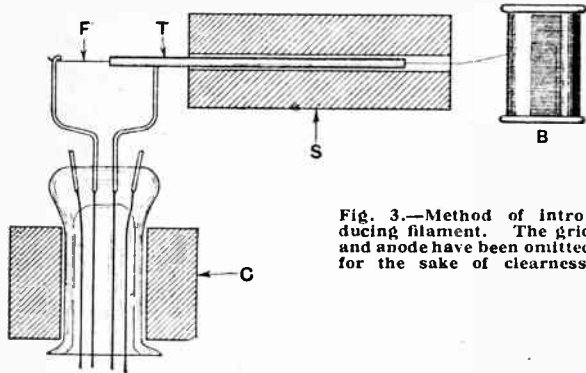

Fig. 3.—Method of introducing filament. The grid and anode have been omitted for the sake of clearness.

The next step is the insertion and sealing into the foot of the connecting wires, and, in the case of pipless valves, the thin tube used for sealing the completed valve on to the pumps.

Foot Tube Making Machinery.

The machine used for this purpose is circular in shape, rotatable, and about eight feet in diameter, and is controlled by three operators.

The revolving table moves on at regular intervals for a short distance, and then stops for about a minute, or less. The movements are under the control of the operator in charge. Round the edge of the machine are regularly spaced holders, or jigs, which accommodate the tubes and connecting wires. As they regularly revolve from one series of fixed gas jets to another, the tubes become shaped and finally pinched into the completed foot. In the case of pipless valves, the attachment of the exhausting tube is the final process performed in this machine.

To do this, the gas jets are trained on a spot just below the pinch, whilst the thin tubing to be attached is introduced inside the foot. Within a short space of time, sufficient heat is brought to bear to cause fusion between the tube and the foot, and, in order to clear an air passage through this point, a blast of compressed air is blown up through the thin tubing. This air blast blows a small hole through the molten glass at the point of fusion.

The final process in the manufacture of the foot is the finishing of the supporting wires. The operator first bends the filament, grid and plate supporting wires to the correct angles, and then cuts them off to exactly the required length by means of shear tools in a hand press.

The anodes for the valves made in this

German factory are either cylindrical or rectangular, and in each case they are stamped from the sheet nickel and rolled to shape.

The grids also are either cylindrical or rectangular, but in each case the method of winding is the same. The requisite number of turns is wound upon a former, cylindrical or rectangular as the case may be, the winding machine being arranged to stop automatically when the required number of turns has been wound. The spacing is arranged for by feeding the wire from the bobbin through a slot in a block which moves along a threaded rod, the threads of which are arranged to give the requisite spacing.

Mounting the Electrodes.

Before the wire is cut and the tension relieved, the strengthening rib or ribs are laid along the winding and welded to each turn separately. The former, by a special arrangement, is then slightly contracted in diameter, and the completed grid slipped off.

At the assembly benches the filaments and completed grids and anodes are then welded to their supports by means of the electric welding machine shown in Fig. 2. This machine is foot operated, so that the operator may have both hands free to arrange the parts in their proper position on the lower welding electrode. On pressing the foot pedal, the top electrode comes down and the joint is instantly welded.

The dull-emitters made by the Radioroehrenfabrik have grids and anodes of the cylindrical type, and these two elements are fitted to the foot first; the introduction of the filament is the last operation.

The foot is held by means of supporting blocks, C, so that the grid and its encircling anode lie in a horizontal position in the welding machine. On the right of the machine is a bobbin B of filament wire. For dull-emitters this wire is of the order of 0.015 mm. thick, so that its fragility, and the difficulty of handling it, may well be appreciated.

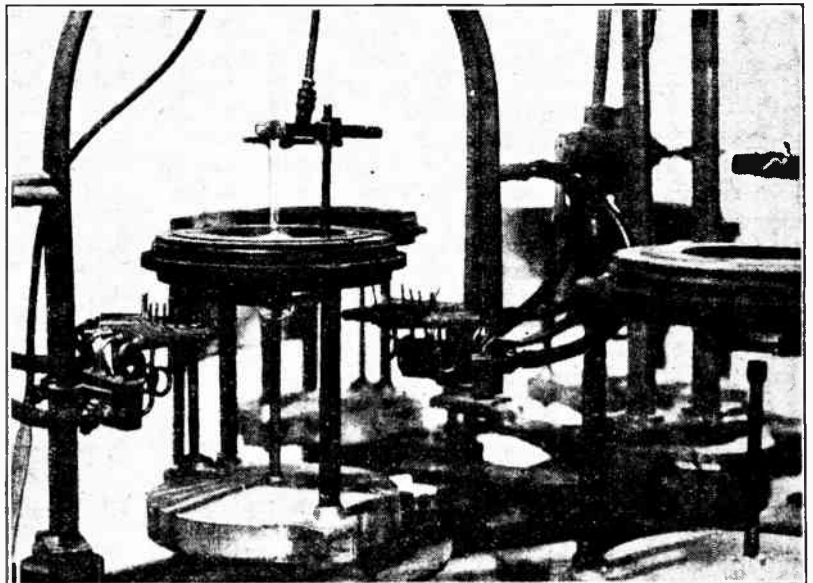

Fig. 4.—The battery of gas jets is directed on the junction of the foot tube and bulb until fusion takes place.

German Valve Manufacture.

The end of the wire is kept threaded through a thin steel tube T (Fig. 3), in appearance like an over-sized darning needle. This tube is introduced into the space enclosed by the grid, and, by means of it, the projecting end of filament wire F is held in contact with the left-hand filament support. The operator then depresses the foot pedal, and that end of the filament is welded to its support. The tube is then withdrawn through the channelled supporting block S until the filament wire can be brought in contact with the right-hand support and welded. The wire is then cut off, close to the support, but in such a manner as to leave a short length projecting ready for the next operation.

We now come to the last operation in connection with the glass-work: that of introducing the foot, complete with filament, grid, and plate, into the bulb and welding the two together. This operation is carried out by the machine shown in Fig. 4. The foot is slipped over the central iron rod, and the bulb is placed over it and held there in a jig which grips the exhausting tube. In the pipless type of valve, the central iron rod carrying the foot takes the form of a tube, into which the exhausting tube is inserted to protect it from the heat, whilst the bulb is held by a different form of jig.

When the parts are in position, the table is moved round so that gas jets play on the bulb at the point where fusion is to take place. There are eight such jigs on this machine, and as they are loaded up with valves, so the table rotates them from one set of gas jets to another, until, by the time they have nearly completed one revolution, the glass has been sufficiently heated to cause fusion between the belled out portion of the foot and the encircling lower edge of the bulb. Whilst still in the semi-molten state, an operator pulls away the surplus glass with a thin iron rod, and thus the joint is left clean and free from jagged edges.

The Pumping Process.

The valves are now ready for exhaustion, and are passed on to the pumping room. Here the thin exhausting tubes are sealed on to the pump mains, and pumping commenced. When the vacuum has reached a certain degree of hardness, the filaments of the bright-emitter class of valve are heated to a high temperature and a high voltage connected to the plate and grid. By this means a powerful bombardment of the grid and plate is set up, which raises the plate to a dull red heat and drives off all the occluded gas in the metal.

In the case of dull-emitters, however, such a process would be harmful to the fine wire filament, and the elements of this class of valve are heated by means of induction from high-frequency coils which are placed over them. From time to time the operator tests the degree of vacuum by bringing into contact with the feed tubes a highly charged rod. This rod has an insulated handle to protect the user from shocks, and is fed from an induction coil. On coming into contact with the glass tubes leading to the valves, a glow occurs within them, such as is familiar to those who have experimented with neon or Geissler tubes, and this glow indicates to the operator in a rough-and-ready fashion how much gas is still left in the valves.

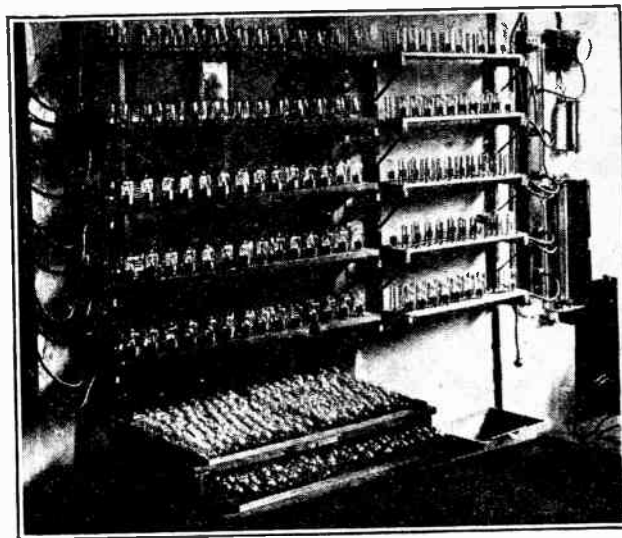

Fig. 5.—Ageing racks where valves are run for some time under normal conditions to stabilise their characteristics.

In the final stages, in the case of dull-emitters, a piece of magnesium, previously welded to the plate, is fired to hasten the removal of the last traces of gas. When finally exhausted, the thin tube connecting the valve to the pumps is heated near the bulb and the valve sealed off. This process leaves the valve with the well-known pip on the top. In the case of pipless valves, the pip is concealed within the foot.

The valve is now ready for mounting in its base. After the leads from the valve have been soldered to the pins, the base is sealed to the bulb by means of a special compound which is supplied from an electrical heater.

The next process is that of ageing the valve. This process consists simply of running the valve under its normal operating conditions in order that it may attain stability. For this purpose the valves are put into racks, as shown in Fig. 5.

The final operation in the manufacturing process is that of testing. In the factory herein described, every valve is tested before being sent out, to ensure that each and every one of them shall possess the required standard characteristics.

This firm has also produced a special form of low-loss socket, in which the base of the valve is made of insulating material. The leads from the interior are brought out to narrow strips of metal which are bent round and fixed vertically on the outside of the base. The socket used in conjunction with this arrangement consists of a short cylinder of insulating material having contact strips running vertically down inside it, so that when the valve is pushed into it, the strips on the base make contact with those in the socket. A reduction in self-capacity of 25 per cent. is claimed for this device.

It is only a few years ago that Germany was very far behind us in the matter of valve manufacture, but the writer came away from the above-described factory convinced that great strides have been made since broadcasting was first inaugurated in Germany. To-day, a wide range of valves of very good quality can be obtained without difficulty.

HINTS and TIPS for NEW READERS

A Section Devoted to the Practical Assistance of the Beginner.

ADDING H.F. AMPLIFICATION.

The addition of a stage of low-frequency amplification to an existing receiver usually presents no difficulty, as the ends of the primary winding of the input transformer are merely connected across the telephone terminals of the set. If it is desired to add an H.F. amplifier, however, the solution of the problem is not so simple, and in many cases certain alterations in the wiring will be necessary.

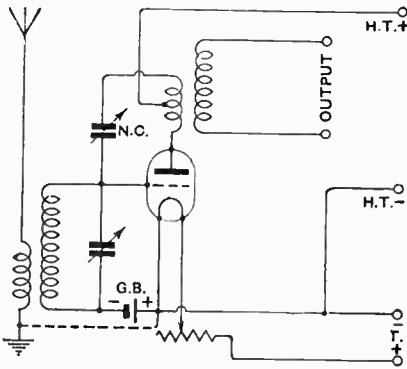

Fig. 1.—A neutralised H.F. amplifying unit. The variable condenser of the set with which it is used will shunt the output terminals.

Luckily, it is fairly easy to make this addition to the conventional receiver containing a simple detector valve directly coupled to a plug-in aerial coil, and having perhaps one or two stages of low-frequency amplification. In Fig. 1 is shown the circuit diagram of a single-valve "neutrodyne" H.F. amplifier for the 250-550 metre broadcast wave-band, suitable for connection to a set of this description without undue complication. It will be found convenient to mount the unit in a case of similar shape to that housing the receiver itself.

The aerial coil of the unit is not separately tuned, and is fairly tightly

coupled to the grid coil, which is shunted by a 0.0005 mfd. variable condenser, and has about 65 turns of No. 20 or 22 D.C.C. wire on a 3in. former. The aerial winding consists of 10 to 15 turns of wire wound either over the earthed end of this coil, or as a continuation to it. Alternatively, one of the many "fixed couplers" on the market may be used.

It is suggested that a small negative bias be applied to the grid as shown, although this is not absolutely necessary. Its use, however, helps to reduce the drain on the H.T. battery, and damping, due to the flow of grid currents, will be reduced.

Various types of neutralised H.F. transformers have been described in recent issues of *The Wireless World*, and the prospective constructor may make his own choice in this matter, always bearing in mind that a given design will only be suitable for the type of valve specified, or for one of another make having similar characteristics. In most cases it will be found easy to construct the transformers shown in Fig. 1, the general arrangement of which has already been described. Some further hints as to construction may be of value.

The secondary winding consists of 65 turns of No. 24 D.C.C. wire on

a former 2½in. in diameter and 3in. long. Thin ebonite tube is probably the best material for this former, but cardboard tube, if carefully dried, treated with shellac or paraffin wax, and finally baked (if shellac is used) is an effective substitute.

The number of turns in the primary winding will depend on the impedance of the valve in the anode circuit of which it is to be connected. Low-impedance valves are always to be recommended in neutrodyne circuits, and, acting on the assumption that one of these will be used, the primary winding may consist of 15 turns of No. 30 D.C.C. or D.S.C. wire, which will be found to be a good average value. This coil, together with the neutralising winding, is separated from the secondary by 15 ebonite or wooden strips, nearly an inch long, and about ¼in. square in cross section. Match sticks have been suggested for this purpose, and are quite suitable, as the wood is usually dry, and is often impregnated with paraffin wax. Some difficulty is generally experienced in keeping these spacing pieces in position while the winding is being commenced, but if a tightly fitting indiarubber band is used in the manner shown in Fig. 2 the process will be found quite easy. The band is removed as soon as sufficient turns to secure the spacers have been put on.

A tapping point is prepared at the fifteenth turn, by scraping away the insulation and soldering on a short length of wire. This section completes the neutralising

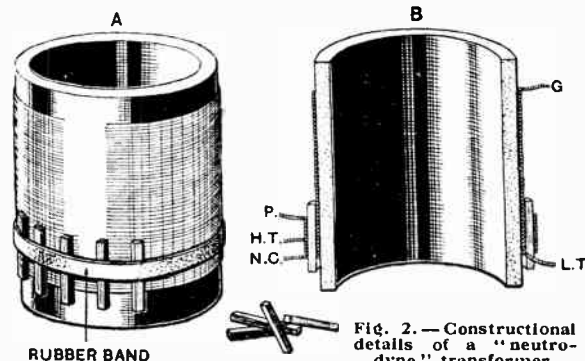

Fig. 2.—Constructional details of a "neutrodyne" transformer.

winding, and the primary, which is wound continuously with it, as stated above, has the same number of turns, the end being secured by a few turns of thread, or it may be held in position with a touch of Chatterton's compound or similar adhesive. A slight spacing between the turns of the primary winding is recommended. The external connections are shown in Fig. 2; P being joined to plate of the H.F. valve, H.T. to the positive terminal of the high-tension battery, N.C. to neutrodyne condenser, G to grid of the detector valve, and L.T. either to the negative or positive low-tension battery bus-bar.

It is intended that the batteries supplying the set should also feed the H.F. unit, and a system of plug and socket connections should be used, rather than terminals, for ease and quickness in changing over. Before connecting up, special care should be taken to see that the system of H.T. and L.T. connections of the set

(- H.T. to either - or + L.T.) corresponds to that adopted in the unit, and, if necessary, the appropriate change must be made, or a short-circuit of the L.T. battery will result.

As already stated, the transformer as described is suitable for a low-impedance valve. If it is desired to use one of the general-purpose four-pin type, the primary and neutralising windings should each have about 30 turns of No. 36 D.S.C. wire. Such a transformer will give moderately good results in a single-stage amplifier, but it is recommended that low-impedance valves should always be used in a set incorporating two neutralised H.F. amplifiers.

o o o o

CLEANING VARIABLE CONDENSERS.

Particles of dust between the plates of variable condensers often give rise to peculiar "scratching" noises, which are sometimes wrongly attri-

buted to atmospherics. This dust may be removed with the aid of a pipe-cleaner, but the process, particularly in the case of a large condenser, is a rather laborious one; and, if the vanes are thin and easily bent, damage may be done by introducing a short-circuit.

A bicycle or motor pump will be found most useful for blowing away any accumulations. By its use, a strong blast of air may be directed between the vanes, without any risk of doing harm. It will also be found useful in removing dust from any inaccessible corners of the receiver.

The experimenter who habitually uses a quantity of apparatus connected up in a temporary manner, and unprotected from dust, will probably find it worth his while to construct a special long nozzle for the pump, preferably made of some insulating material, such as ebonite tube, in order that it may be used when the batteries are connected without risk of short-circuiting.

DISSECTED DIAGRAMS.

No. 16.—A "Tropadyne" Superheterodyne.

For the benefit of readers who find difficulty in reading circuit diagrams, we are giving weekly a series of sketches showing how the complete circuits of typical wireless receivers are built up step by step. Below are shown the connections of the combined detector-oscillator valve of a "Tropadyne" superheterodyne. A suitable intermediate-frequency amplifier-detector was shown in "Dissected Diagrams," No. 14b.

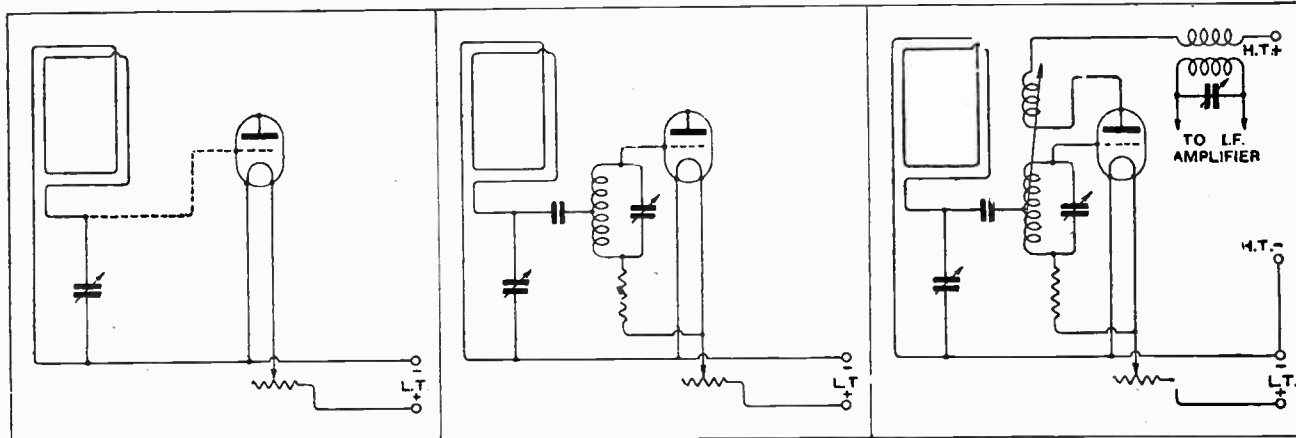

A frame aerial, tuned by a variable condenser, is connected between grid and filament of a valve, the filament of which is heated by an L.T. battery through a variable resistance. The frame is sometimes replaced by an aerial-grid coil.

A grid condenser, leak, and a circuit tuned to a frequency differing from that of the incoming signal by a value sufficient to set up a beat frequency equal to that of the intermediate frequency amplifier are inserted.

Connection is made to the centre point of this inductance. To it is coupled the reaction coil, the plate circuit being completed through the primary of a transformer with its secondary connected to grid and filament of the first I.F. valve.

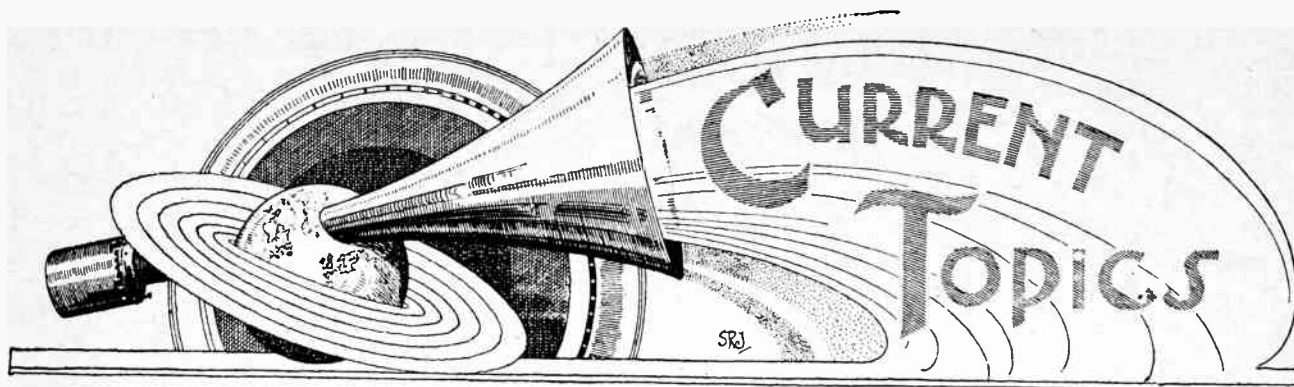

News of the Week in Brief Review.

GERMANY'S FIRST MILLION.

A Berlin correspondent informs us that at the end of 1925 the number of broadcast listeners passed the one million mark.

o o o o

WIRELESS THE INDISPENSABLE.

Ships in the Atlantic, particularly on the lines to the West Indies, are benefiting by the re-opening of the Terceira station, Azores, the recent closing of which caused great inconvenience to many vessels.

o o o o

CRAOIBHSCAOILEACHAIN I

A Wigan listener is understood to have thought he had picked up a Fiji Island broadcasting station the other evening when he heard this announcement: "Stasiun Craoibhseaoileachain Ath Cliath calling."

He should have known, of course, that this is one way of proclaiming the identity of 2RN, the Free State broadcasting station in Dublin.

o o o o

TALK ON ELECTRICAL CONDUCTORS.

At an informal meeting of the Radio Society of Great Britain, to be held at 6 p.m. at the Institution of Electrical Engineers on Wednesday next (February 10th), Mr. E. L. Wildy will give a talk entitled, "The Manufacture and Properties of Electrical Conductors."

o o o o

WIRELESS FOR WORLD PEACE.

Mr. Eric H. Palmer, an official of the Freed-Eisemann Radio Corporation in the United States, has arrived at Geneva for the purpose of submitting his plans to the League of Nations for the establishment of an International Radio Tribunal.

For some time past Sir Eric Drummond and other League officers have been interested in an International Educational programme suitable for broadcasting.

o o o o

HIGH VOLTAGE TRAGEDY.

By touching a cable carrying a voltage of 20,000 at the Horsea naval wireless station last week, Herbert Charles Taylor (20), a telegraphist, was instantly killed. It is thought that the deceased had been attempting to make adjustments behind the transmitting panel.

RADARIO.

"I guess last night's radario was the goods," is what they now say in New York.

"Radario" is the latest addition to the American language. It signifies "broadcast programme."

o o o o

CUTTING OUT THE CACKLE.

The Radio Vigilance scheme, fostered by the American Radio Relay League, is having fruitful results in locating and suppressing sources of interference to radio reception.

In Vancouver radio interference has been practically eliminated by the efforts of the Committee in that district, and similar reports have come from many other busy centres in the United States and Canada.

WIRELESS TORPEDO WONDERS.

New rumours are afloat in the daily Press concerning "hush hush" work which is being conducted in Britain, France and America in the development of the wireless-controlled instruments of war.

One report, by far the most perturbing, comes from the United States and concerns a "flying bomb" which is said to have been successfully directed by wireless to previously-indicated spots 30, 60 and 90 miles away from the point of launching. France, apparently, is concentrating on the pilotless bombing aeroplane, while British researches also tend in this direction.

The secret nature of all these experiments should be remembered, however, and new rumours should be accepted with a degree of caution.

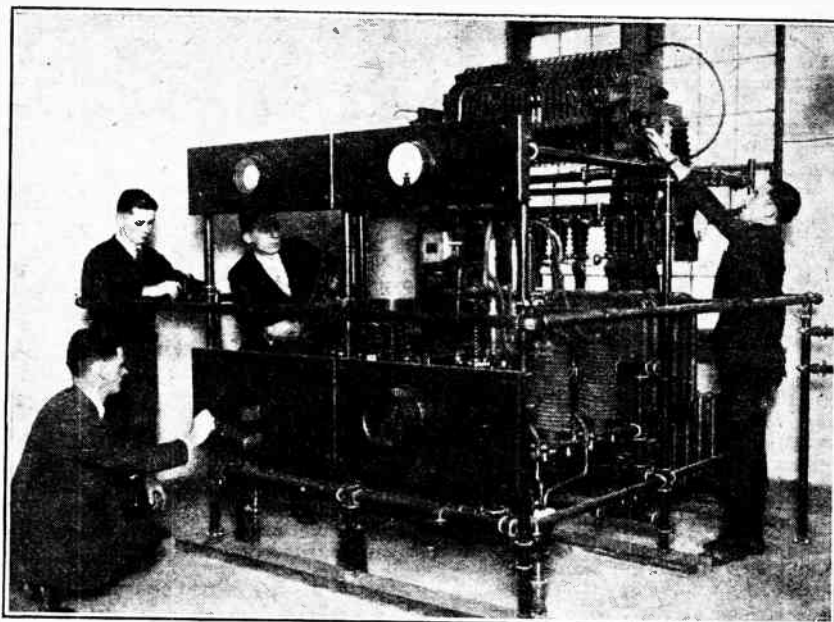

HIGH POWER BROADCASTING. A new photograph of one of the transmitters at WJZ, the 50-kilowatt broadcasting station recently opened at Bound Brook, N.J. The new station, which participated in last week's experimental transmissions to Europe, has been designed to overcome the atmospheric and interference prevalent in North America.

THE GREATER TEMPTATION.

A burglary in which the sole object of the intruders was the theft of a wireless set took place last week at the Regent's Park Club, Hanover Gate.

The instrument, containing five valves and valued at £50, was taken from a conservatory adjoining the ball-room. The burglars had passed through the ball-room, where tables were laid for meals, without touching the silver or plate.

o o o o

EXPERIMENTAL BROADCAST TRANSMISSIONS.

From reports gathered at the time of writing, the experimental transmissions between European and American broadcasting stations have been crowned with only moderate success.

Early in the week the American transmissions suffered a check through the sending of an SOS call from a ship in distress, involving an enforced silence for a considerable period. Several British and Continental stations were heard in the U.S.A., including London, Bournemouth, Daventry, Cardiff and Barcelona. Reception of the South American stations appears to have been unexpectedly good in New York, listeners reporting clear signals from Buenos Aires, Lima, and Mexico City.

Reports of the reception of American stations in this country were generally disappointing, though towards the end of the week American listeners had greater success in picking up Europe. Among the stations successfully heard in New York were Hamburg, Madrid, Brussels, Prague, Breslau, Birmingham, Vienna, and even Moscow.

o o o o

NEW RUSSIAN BROADCASTING STATION.

Using the call sign RAW, a new broadcasting station is carrying out test transmissions at Tsapse, in Russia. The power is 4 kilowatts, and we understand that the experimental wavelengths vary between 1,200 and 1,800 metres.

o o o o

WIRELESS AT BRITISH INDUSTRIES FAIR.

Wireless enthusiasts will find much to interest them at the White City from February 15th to 26th, when the British Industries Fair will be open to the public daily from 5 to 8 p.m. The wireless section, which constitutes an exhibition in itself, will contain representative exhibits of the leading manufacturers.

o o o o

WIRELESS AND WEATHER FORECASTS

A highly efficient wireless installation has been erected at the Kovno meteorological station in Lithuania for the purpose of preparing weather bulletins. The aim of the officials is to prepare weather forecasts for several days ahead, and it is believed that this undertaking will be materially assisted by the use of wireless.

OSCILLATOR HUNT IN LEEDS.

A short but thrilling hunt for the owner of an oscillating receiver has been carried out by members of the Leeds Radio Society, according to the *Leeds Mercury*.

Complaints were received of incessant interference to broadcast reception in one of the suburbs. The Society was informed, and a number of "detectives" formed into three parties, set out in motor cars provided with frame aerials. Bearings were taken and, by a stroke of luck, the offender was found to be within the triangle formed by the three parties. Further bearings were taken, until the culprit was traced to a certain street containing several aerials. At length,

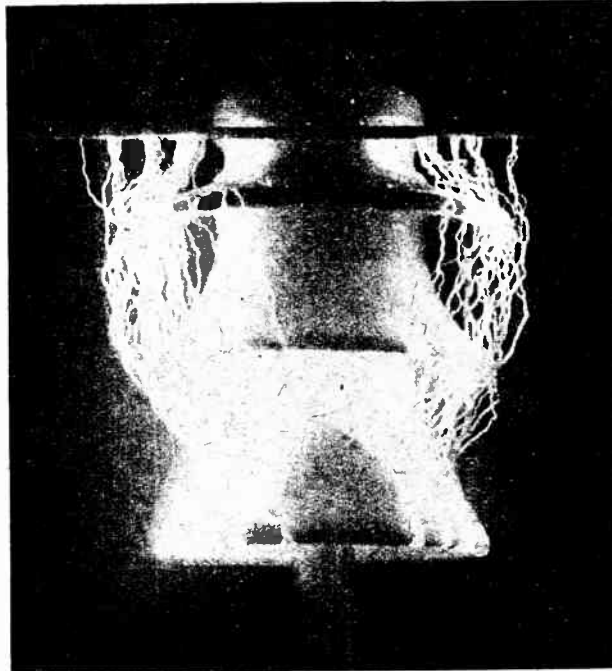

PUTTING IT ACROSS. A power line insulator undergoing a breakdown test in a German research laboratory. The voltage used averages between 80,000 and 120,000!

after another observation, the oscillator was definitely located.

The owner of the offending set—a badly adjusted neodydne—had been in blissful ignorance of the trouble created, and to show his appreciation of the Society's efforts, applied for membership on the spot!

o o o o

MORE LICENCES IN BELGIUM.

The announcement of the pending erection of a new broadcasting station in the Antwerp Zoological Gardens is said to have resulted in an increased demand for receiving licences.

o o o o

NEW RUGBY SHIP SERVICE.

A high power wireless service from the Rugby station to ships at sea opened on Saturday last.

The service of long-distance radiotelegrams to ships too far away to reply has hitherto been conducted from the Oxford wireless station, and has been

limited to a range of 3,000 miles. The transfer of the service to the Rugby station, the range of which is world-wide, will permit of communication to any point on the high seas, however remote.

Ships listen for Rugby daily at 12.55 a.m. and (except on Sundays) at 12.55 p.m. They cannot, of course, reply; but in view of the possibility that atmospheric conditions may sometimes hinder reception, the Rugby station repeats each message during the next period of transmission, i.e., messages first sent at 12.55 a.m. are repeated at 12.55 p.m.

The new service, which is intended for communication with ships more than 1,500 miles distant, is available to the public at 1s. 6d. a word.

o o o o

MOVE TO END WIRELESS STRIKE.

Negotiations are on foot, through the instrumentality of the Ministry of Labour, for the settlement of the strike of marine wireless operators (says *The Times* Labour correspondent). The Ministry has obtained proposed terms of settlement from the employers and has submitted them to the Association of Wireless and Cable Telegraphists.

o o o o

TALKING FILMS DEMONSTRATED.

A private demonstration of De Forest Phonofilms, in which a photo-electric cell is used to synchronise sound and pictures, was given at the Holborn Empire on Thursday last. Among the subjects seen and heard with success were an episode from "Rigoletto" and life in a farmyard. The sounds were projected from loud-speakers near the screen.

o o o o

CANADIAN POLICE AND WIRELESS.

A wireless patrol service is the new project of the police at Victoria, B.C. A transmitter and receiver would be installed at headquarters for communication with two wireless cars, which would be kept in direct touch with the police station.

o o o o

BAD OUTLOOK FOR GERMAN EXPERIMENTERS.

An announcement that wireless experimenters are causing much annoyance to private individuals has been made by the German Post Office, which has ordered that experiments must cease for the time being. In the meantime experimental transmitters are limited to telegraphic work on 100 metres only. An enquiry is being held with regard to future regulations for private experiments.

o o o o

LICENCES IN AUSTRALIA.

Although there was a considerable increase in the number of receiving licences taken out in Australia during 1925 as compared with 1924, no fewer than 3,513 licences were cancelled.

OURSELVES AND THE ELECTRICAL IMPULSE

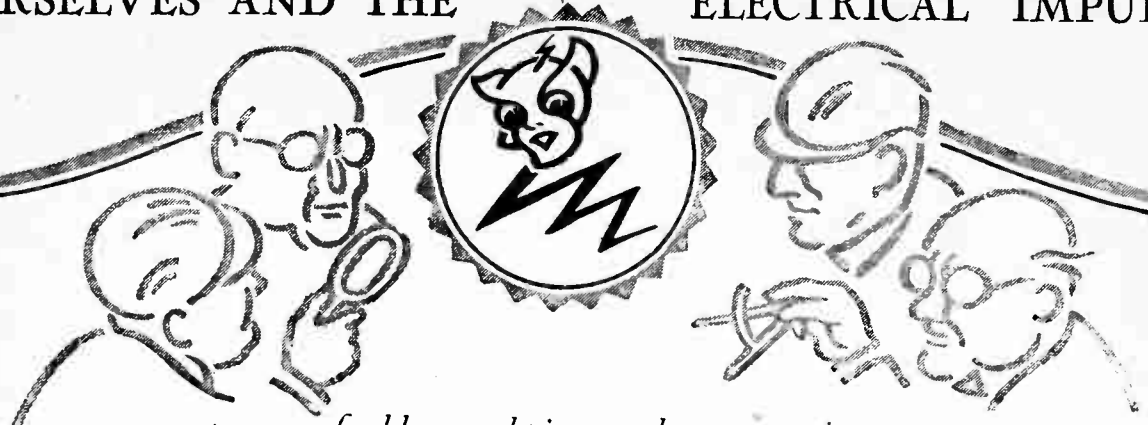

—a carefully cultivated acquaintance

Certain of our technical experts, having foregathered in the sanctum of our chief-of-staff, did ponder with deliberation on the wisdom of his discourse. "Now gentlemen," he said, "you will have to exercise considerable mental brilliance and thoughtful friendliness in pursuit of the electrical impulse. We know that he is the electrical energy which quickens the radio receiver into pulsating life; our job is to tempt him just a little further without fraying his temper. That is, to transform him into voice and music with radio instruments having the correct scientific elements for a really natural transformation. Build, gentlemen," he added, "and remember, he is to be carefully cultivated." But that was long ago. After seventeen years' peaceful penetration in the Brandes laboratories, we are perfectly acquainted with the best methods of effectually harnessing the properties of this elusive spirit of radio sound. Get Brandes radio instruments, built by master craftsmen and scientists in the reproduction of radio sound.

Any good dealer stocks Brandes.

THE TABLE-TALKER

The new goose-neck design is the result of research in radio acoustics, which definitely establishes its value in relation to the diaphragm fitted. Tulent material used in the construction of the horn eliminates metallic harshness. Volume and sensitivity controlled with small lever located at the rear of the base. Elegantly shaped, tasteful neutral brown finish, felt-padded base. Height 18 ins., bell 10 ins.

30/-

MATCHED TONE HEADPHONES

The whole secret of Matched Tone is that one receiver refuses to have any quarrel with its twin. Ably schooled in these generous sentiments by our specially erected Matched Tone apparatus, their synchronised effort discovers greater sensitivity and volume and truer tone. There is no possibility of the sound from one earpiece being half a tone lower than its mate.

20/-

THE AUDIO TRANSFORMER

Ratio 1 to 5. The main objects in view are high amplification of applied voltage, together with a straight line amplification-frequency curve. That is to say, for a given input voltage, the amplification is constant over a wide band of frequencies, thus eliminating resonance. Mechanically protected and shielded so that the transformers may be placed close together without interaction.

17/6

THE BRANDOLA

Specially built to bring greater volume with minimum current input and exceptional clarity over the full frequency range. A large diaphragm gives new rounded fulness to the low registers and new clarified lightness to the high. Reproduction controlled by a thumb screw on the base. Polished walnut plinth with electro-plated fittings. Height 26 ins., bell 12 ins.

90/-

Brandes Limited, 246 Regent Street, W.1. Hooks—Slough, Bucks.

Brandes

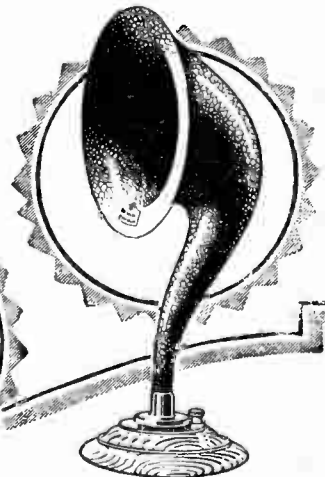
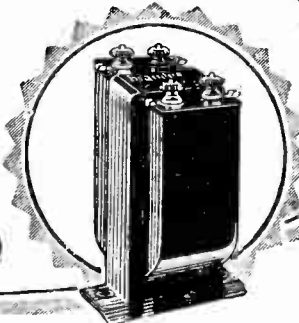
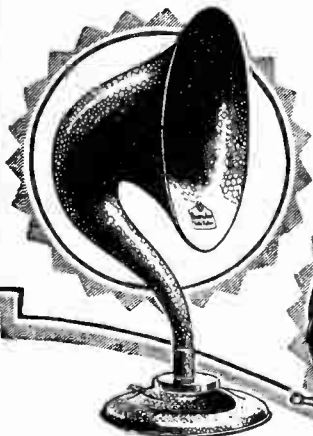

EXPERTS IN RADIO ACOUSTICS SINCE 1908

DORTMUND (Germany)
288 METRES

GOTHENBURG (Sweden)
286 METRES

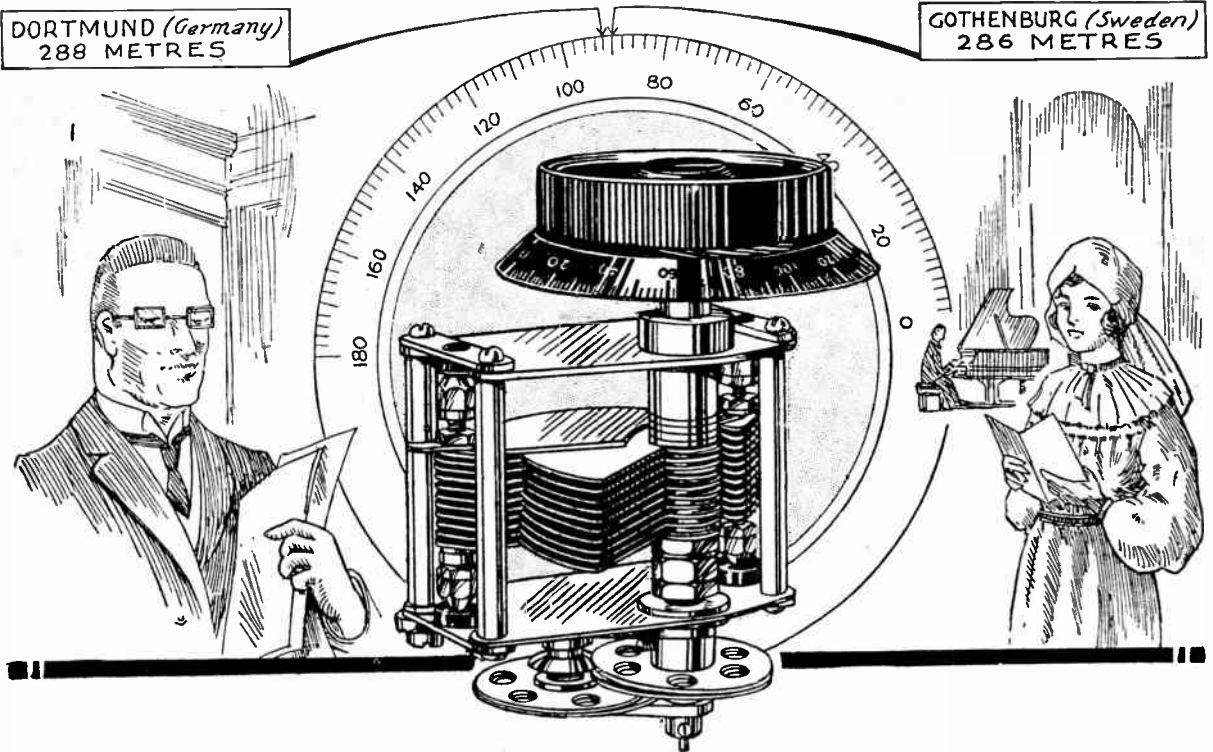

You CAN get those Elusive Stations!

Dial readings can be adjusted by the hundredth of an inch with the GECOPHONE Condenser! Stations of close wave-length are separated easily with knife-edge tuning. The exclusive friction-drive micrometer adjustment mechanism gives this marvellous selectivity, and dead silent velvety operation, free from the slightest backlash. Prove for yourself that the GECOPHONE Condenser will tune-in more elusive stations—and get 'easy' stations more easily—than any condenser on the market.

GECOPHONE

(REGISTERED TRADE MARK)

LOW LOSS-SLOW MOTION VARIABLE CONDENSER

*The G.E.C.
your guarantee*

Capacity	Price
mfd.	
.0002	22/-
.00025	23/-
.0003	24/-
.0005	27/6
.001	32/6

Your wireless dealer sells it!

Adot. of The General Electric Co., Ltd., Magnet House, Kingsway, London, W.C.2.

KEEP YOUR WIRELESS
SET IN "TUNE"

Osram Valves

for Broadcasting

The G. E. C. - your guarantee

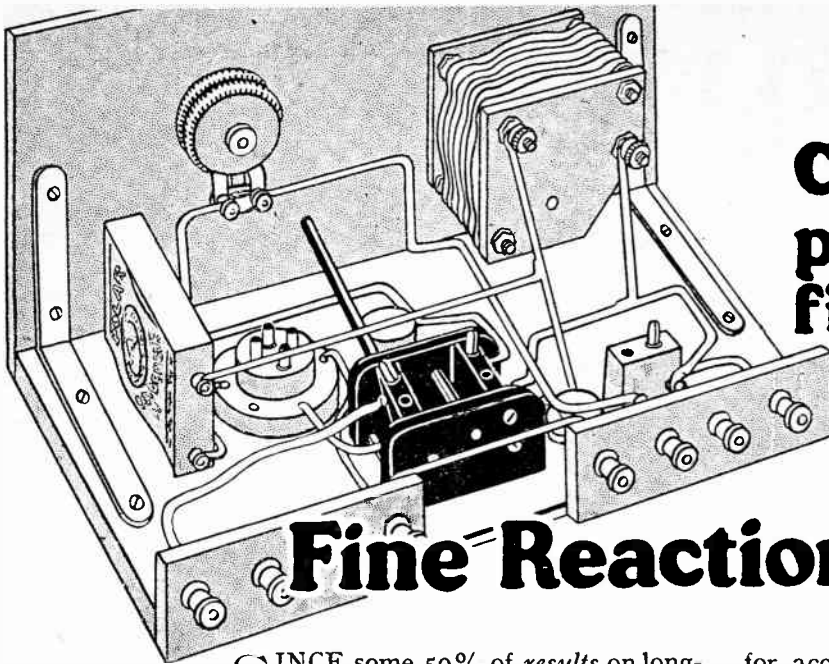

Cam Vernier provides the first step to efficiency

Fine Reaction Control

SINCE some 50% of results on long-distance work are due to the use of reaction, use the only Coil-Holder that you *know* will give you efficient control. The "Polar" Cam-Vernier Coil-Holder means fine adjustment—smooth, precise and delicate.

for accommodating the heaviest Coil without danger of dropping; the high finish and sound mechanical design common to all "Polar" Components; and a firm guarantee—these very real advantages are to be found only in "Polar" coil-holders.

PRICES

POLAR Cam-Vernier "N" Type, 2-way Coil-Holder .. 11/-

POLAR Cam-Vernier "N" Type, 3-way Coil-Holder .. 17/-

POLAR Cam-Vernier "J" Type, 2-way Coil-Holder .. 6/-
With long handle 6/9

POLAR Cam-Vernier "J" Type, 3-way Coil-Holder .. 9/6

Vernier movement of 10 degrees over any portion of the "sweep," by means of the patent "Polar" "Cam-Vernier" device; absence of gearing and NO BACKLASH; provision made

The "Polar" 'J' Type Coil-Holder is now available with long extension handle for back-of-panel mounting—a further advantage in avoiding hand-capacity effects in 'lively' circuits.



The 'Polar' Cam - Vernier Coil-holder

Wireless Operators still wanted. There are now vacancies on our Sea-going Staff for Junior Wireless Operators, trained on our apparatus. Youths of good education, preferably between 17 and 25 years of age, wishing to enter the Wireless Profession, should communicate with the Managing Director, London Radio College, 82-83, High Street, Brentford, Middlesex, who will be pleased to furnish particulars of the training course necessary to qualify for our Service.

Has no Gears—thus obviating Backlash.

Moving Coil cannot fall.

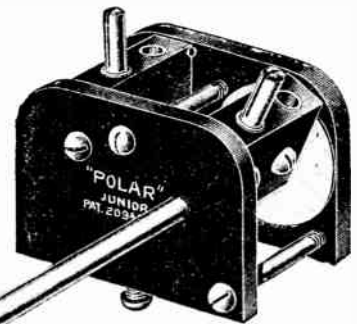
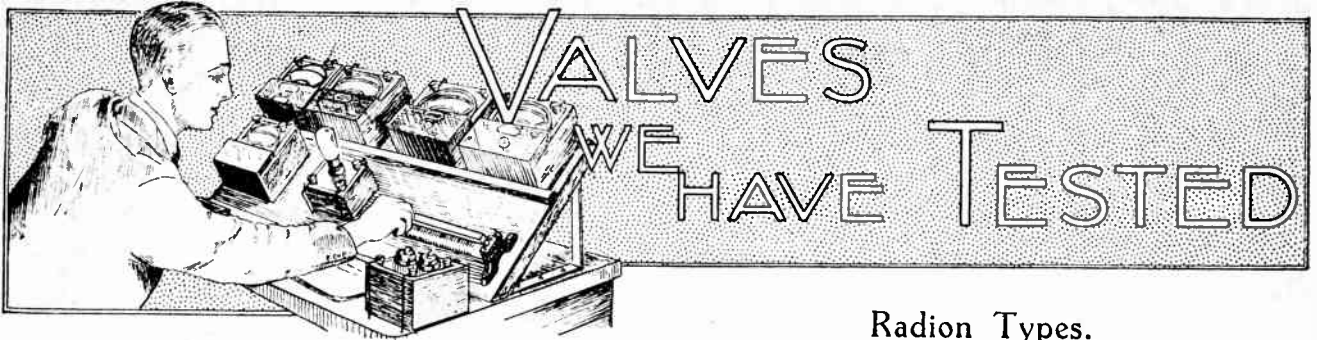

Illustration 1/2 actual size.

Polar Components are available from all Reputable Radio Dealers. In case of difficulty write direct to:



**Radio Communication Co., Ltd.,
34-35, Norfolk St., Strand, London, W.C.2.**



WE have recently had the opportunity of testing samples of the Radion series of valves. Three types were tested, the DE.06, the DE.34, and the Pyramid (1). The DE.06 and the DE.34 are similar in appearance and of about the same size as valves of the .06 class of other makes, while the Pyramid (1) has a much larger bulb and actually is a little larger than the usual $\frac{1}{4}$ ampere power valve. The bulbs of all the samples tested have a silvery coating which effectually prevents an examination of the interior, and each of the bulbs has a brown and blue patch which is a characteristic of Radion valves. All samples had

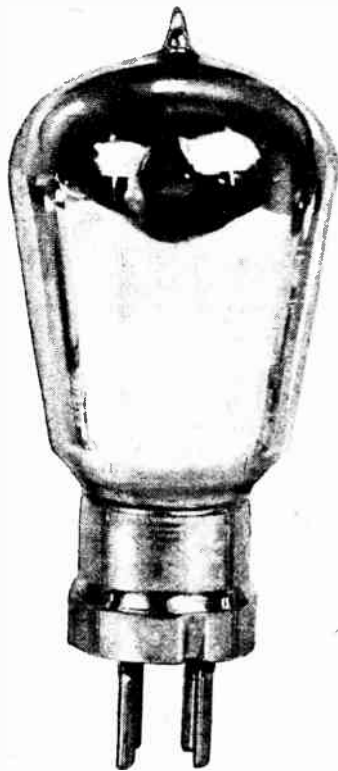

Radion Pyramid Power Valve.



Radion DE. Type.

a base of moulded insulating materials with a metal shell with contacts of the split pin type.

Type DE.06.

The filament of this valve is rated at 3 volts (maximum), 0.06 ampere, as would be expected from its name, and the range of anode volts is from 30 to 90. Printed

on the box in which the valve is packed is a statement to the effect that the valve is suitable for either H.F., detector, or L.F. positions. We would, therefore, expect the valve to have a medium amplification factor, and on test the average value under operating conditions was found to be about 6.5. The amplification factor showed a remarkably small change for different combinations of grid and anode voltages, while the anode impedance averages 30,000 ohms. The actual figures obtained are given in the accompanying table, and show the valve to be rather better than many similar valves of other makes.

Radion Types.

RADION VALVE.

TYPE DE.34.

Filament characteristics : 1.6 volts. 0.29 ampere.
1.8 volts. 0.31 ampere.
2.0 volts. 0.33 ampere.
Total emission, 10.5 milliamperes.

Anode Volts.	Anode Current at zero Grid Volts. Milliamperes.	Actual Anode Current. Milliamperes.	Grid Bias. Volts.	Amplification Factor.	Anode Impedance. Ohms.
30	0.6	0.6	0	8.2	39,000
45	1.02	0.76	-1	7.3	32,400
60	1.5	0.96	-2	7.3	30,400
75	2.04	1.20	-3	7.4	30,400
90	2.6	1.34	-4.5	7.7	27,800

Used with an anode voltage of 75 and a grid bias of - 3, the valve will work well in a high-frequency amplifier having tuned transformer couplings, and will be very suitable for the first stage of L.F. amplification for loud telephone signals. A small loud-speaker could be operated quite comfortably from two of the valves connected in parallel in the last stage of the amplifier.

RADION VALVE.

TYPE DE.06.

Filament characteristics : 2.6 volts. 0.07 ampere.
2.8 volts. 0.073 ampere.
3.0 volts. 0.076 ampere.
Total emission, 7.5 milliamperes.

Anode Volts.	Anode Current at zero Grid Volts. Milliamperes.	Actual Anode Current. Milliamperes.	Grid Bias. Volts.	Amplification Factor.	Anode Impedance. Ohms.
30	0.55	0.55	0	6.6	36,600
45	1.0	0.78	-1	6.4	30,600
60	1.54	1.05	-2	6.4	29,200
75	2.14	1.34	-3	6.5	26,200
90	2.78	1.56	-4.5	6.5	26,000

Type DE.34.

This valve is designed to work from a 2-volt accumulator, and is rated at 1.6 to 2 volts, 0.34 ampere, with an anode voltage of from 20 to 80. Details of the results obtained are given in the table, which shows the amplification factor to average 7.5 and the impedance 30,000 ohms—satisfactory values for a valve of this type.

Type Pyramid (1).

This is a power valve taking a filament heating current of 5.5 volts at 0.26 ampere, and is capable of dealing with sufficient power for satisfactory loud-speaker operation. The total emission obtained was 27 milliamperes.

A stamped and addressed postcard is included in each box with the valve, which the purchaser is asked to fill in and post. Results of our tests are given in the table. The amplification factor averages 7.35 with an anode impedance of about 8,500 ohms. These values remain

practically constant over the working range of the valve, and we have no hesitation in recommending this valve to our readers.

RADION VALVE.**TYPE PYRAMID (1).**

Filament characteristics 5.0 volts. 0.24 ampere.
5.5 volts. 0.26 ampere.

Total emission, 27 milliamperes.

Anode Volts.	Anode Current at zero Grid Volts. Milliamperes.	Actual* Anode Current. Milliamperes.	Grid Bias. Volts.	Amplification Factor.	Anode Impedance. Ohms.
48	2.39	2.39	0	7.85	9,800
60	3.7	2.85	-1	8.1	9,800
72	5.4	3.34	-2	7.35	8,900
84	7.1	3.9	-3	7.35	8,600
96	9.0	4.5	-4	7.35	7,300
108	11.2	5.2	-5	7.35	7,100

NEW MARCONI STATEMENT ON ROYALTIES.

SOME little while ago a Warning Notice was inserted in the Press generally by the Marconi Co. regarding the use of Marconi patents, and, as a result, a good deal of correspondence was received from readers on the matter.

The following is the text of a letter we received, dated January 11th, 1926, which is typical of many others:—

With reference to the recent advertisement of the Marconi Co. regarding infringement of their patents by amateur constructors, I should like to ask, in the interests of constructors generally:—

- (1) What constitutes a Marconi patent?
- (2) If I purchase, say, a couple of Mullard valves, an R.I. transformer, Dubilier grid leak and condenser, Igranic coils, etc., etc., and wire up a straight circuit, two-valve set, am I infringing any Marconi patent?
- (3) What constitutes a sale of apparatus by an amateur? If I make up a set for a friend and charge him the bare cost of material and parts as far as can be calculated, that is, he buys the parts and I do the work, am I selling a set? The actual money received by me may be half a crown more or half a crown less than the actual cost.

We forwarded a copy of this letter to the Marconi Co. with a suggestion that they might like to answer the points raised, and below we reproduce their reply:—

DEAR SIR,—We acknowledge receipt of your letter, Ref. HSP/ES, of the 13th inst., enclosing copy of a letter which you have received from a correspondent. We appreciate the point which you raise, and have pleasure in replying to the various questions in the order in which they occur.

- (1) The meaning of this question is not clear to us. A Marconi patent is, of course, any patent owned or controlled by Marconi's Wireless Telegraph Company, Ltd.
- (2) Yes.
- (3) We have no means of knowing whether or not profit is made upon such a transaction, and if the use of our patents is involved, royalty is payable.

As there seems to exist considerable misunderstanding regarding the position of private persons who make up their own receivers, the circuits of which involve the use of Marconi patents, we should like to take this opportunity of clearing up the matter. As far back as 1922 the Marconi Company placed at the disposal of the *bona fide* experimenter (or wireless amateur, as he is often styled) the use of their patents. Whilst we have no intention of withdrawing this, we are afraid, however, that a large number of people who do not come within the designation of "wireless amateur," even upon the widest interpretation of that term, have assumed that the Company's concession is applicable to them. Upon that assumption they consider themselves exempt from the payment of royalty upon receivers constructed by them at home, exclusively for the purpose of obtaining amusement from the broadcast programmes. Such construction, as everyone knows, does not now require any knowledge of wireless, and consists merely in the wiring up of components by closely following the instructions which can be obtained from various sources.

It is obvious, of course, that this could never have been the intention, as in that case the royalty would reduce itself to an unfair penalty imposed upon the manufacturer, who has to bear besides heavy overhead charges.

The class of home constructor referred to has multiplied very much, and the Company, not only to safeguard their own interests, but also for the protection of the legitimate trader, wish to make it known that, while they have no wish to influence the public as to whether a set shall be bought complete or constructed, royalties must be paid in either case.

Many firms are licensed for the sale of complete sets of parts for the home construction of various receivers and will supply the necessary licence plate upon payment of royalties.

Yours faithfully,

MARCONI'S WIRELESS TELEGRAPH COMPANY, LTD.

(Signed) I. SJOENBERG,
Joint General Manager.

PIONEERS OF WIRELESS.

By ELLISON HAWKS, F.R.A.S.

5.—Arago.

IN the previous article in this series we learned how Ampère, the distinguished French mathematician and physicist, discovered that a conductor when carrying an electric current is surrounded by an electric field. We saw, too, that Ampère showed that parallel conductors of electricity will repel or attract each other, according to whether the currents they carry are flowing in similar or opposite directions. Because of his work in this connection, Ampère's name is perpetuated for all time in the "ampere," the electrical unit of current.

Whilst Ampère was working out more fully the relationship between electricity and magnetism, and pursuing his investigations into the behaviour of the magnetic needle, his illustrious countryman Arago was at work studying the state of a wire through which an electric current was transmitted.

Early Life of Arago.

Dominique François Arago was born on February 26th, 1786, at Estagel, a little town at the eastern end of the Pyrenees. He died on October 2nd, 1853, in Paris, after a remarkable life, and one that was more in keeping with that of a merchant-adventurer or explorer than that usually associated with a famous savant and scientist.

In his autobiography (which unfortunately extends only to the year 1830) Arago tells us how, in the first place, he contended successfully against all the influences of home, rejecting the course of life for which his father—a prominent lawyer and landowner—intended him, and adhered unwaveringly to his own inclination to become a soldier. At that time officers were not commissioned in the French army unless the individuals had passed with credit the scientific and military courses of the Polytechnic. Admission to this famous school was not open, however, and candidates were required to undergo a severe and searching entrance examination. This did not deter young Arago, who threw himself into the study of mathematics with characteristic impetuosity. At the age of 17 he was commended by his examiner, the

illustrious Monge, and soon after entered the school. Later he was examined by Legendre, one of the foremost geometers of the century, in which test he acquitted himself with honour. He passed through the Polytechnic with the greatest distinction, having gained in the meantime the friendship of the most eminent men in Paris.

When 19 years of age he was appointed secretary of the Paris Observatory. He assisted Biot in attempts to determine the refracting properties of different gases, and out of this association there sprang another of greater scientific importance—that of meridional measurements. Arago was selected, with Biot and two Spanish commissioners, to carry out a geodetic survey in the Balearic Islands. This work resulted in considerable hardship and danger, for Arago had to make his observations from the summit of one of the loftiest of the Catalanian Pyrenees and suffered considerably from exposure.

Adventures in the Mediterranean.

While Arago was in Majorca the French armies entered Spain. The inhabitants imagined that the geodetic signals were those of a spy, and he was compelled to take refuge from their fury in the castle of Belver. From here, after a narrow escape from death by poisoning at the hands of a furious and rascally priest, he escaped to Algiers, disguised as a peasant. Embarking for Marseilles in an Algerine vessel he was captured in the Gulf of Lyons by a Spanish corsair, carried to Rosas, and brought back to Spain. Here he was confined first in a windmill, but later transferred to the hulks of Palamos, where he was mercilessly ill-treated and suffered very considerably.

At last he was ransomed by a friendly chieftain and again set sail, but as the ship drew near the French coast it was driven southward on to the African shore, where once again Arago was forced to land, this time three days' journey from Algiers. In the meantime his benefactor had been beheaded and his cruel successor was on the point of throwing Arago into a slave prison when he



Dominique François Arago

Pioneers of Wireless.—

was, very opportunely, himself hanged at the hands of some of his mutinous followers!

After an interval of six months Arago again embarked, this time safely reaching Marseilles (on July 2nd, 1809) with his instruments and charts complete and uninjured. He returned to Paris, where he was received with acclamation. He was elected a member of the Academy of Sciences at the early age of 23, a thing previously unheard of, and appointed a professor at the Polytechnic. In 1830 he became the Academy's secretary, and subsequently contributed a multitude of treatises on almost every aspect of physical science.

It was Arago's work at the Observatory that led him to investigate magnetic phenomena. He was the first to show a connection between the aurora and magnetic storms, and later a connection between electricity and terrestrial magnetism.

Working on Oersted's original discovery, Arago directed his own enquiries to endeavouring to determine the state of a wire through which a current was being

transmitted, so as to discover whether every part of its surface was endowed with similar magnetic properties. He placed iron filings around the wire, and found that it attracted them so long as the current flowed, and that they fell away instantly when the current was broken. He also found that if an electric current is passed through a coil of wire in which is placed a steel needle, the needle is not only attracted but is permanently magnetised. These discoveries were also made independently by Davy in England at about the same time.

Arago was the first to perform an experiment with an induced current. At the time this experiment could not be explained, but it subsequently afforded a starting point for Faraday's epoch-making researches in this field. Altogether, Arago's studies in electro-magnetism were of great value to those who immediately followed him.

In addition to his electrical and magnetic researches he investigated the nature of light, and determined that it consists of vibrations or undulations in the ether. He also invented the polariscope, which was the starting point of a great advance in the science of optics.

BUYING WIRELESS COMPONENTS.

Legal Position of the Purchaser in Cases of Misrepresentation.

MOST of us will have to admit that at some time or other we have been "had" over the purchase of a wonderful patent which was going to make our two-valve set much superior to our neighbour's four-valve, but which, unfortunately, didn't quite work as we expected it to. Perhaps we were too proud of our technical knowledge to take the marvel back to the shopkeeper and tell him we couldn't make it work, or if it was taken back the shopman would probably put off his disappointed customer by such a statement as: "It was in perfect order when it left the shop, sir, otherwise . . ." (we are left to guess the rest). Now if we knew what view the law took of such a case we should probably refuse to be put off by such a statement, and perhaps forget our technical knowledge for a while if it was for our financial benefit.

Implied Conditions of Sale.

The general rule in connection with the buying and selling of goods is expressed in that well-known legal maxim, *caveat emptor*—let the buyer look after himself—but to such a sweeping general rule as this there must necessarily be some important exceptions. The first exception is where the buyer makes known to the shopman the use to which he proposes to put the article, in such a way as to show that he relies on the shopman's skill and judgment, and the article is one of a kind which it is in the course of the shopman's business to supply; then it is an implied condition to the sale that the article is fit for the purpose stated. So if a man walks into a wireless supply shop and asks for a valve suitable for a set of well-known make and he is supplied with one which is no more use than a cake of soft soap,

he has a legal right to be supplied with one which will operate in the set he names.

How to Give an Order.

But to this exception there is, unfortunately, another exception, and this is where an article is sold under its patent or other trade name, and here there is *no* implied condition as to its fitness for any particular purpose. The exact meaning of the sale of an article under a patent or trade name is a field of much controversy among legalists, but from the latest reports it appears clear that if a man goes into a shop and says that he hears that the two-valve "Wonder" set is capable of getting 2LO from that place, and if this is so he will buy one, and the shopman sells him one without disputing the statement, then, if when he gets home it turns out that 2LO is much beyond the limits of the "Wonder," although the set was brought under its trade name, the buyer should still have a legal right against the shopkeeper.

If, however, the buyer goes into a shop and says, "I hear that the 'Wonder' set will reach 2LO: please sell me a two-valve 'Wonder' set," he would have a very poor chance of getting his money back if it turned out he had been misinformed.

Although we have quoted the legal maxim *caveat emptor*, we would remind our readers of another: possession is nine-tenths of the law; so, where possible, deal with a firm with whom you have an account, and then, if your purchase turns out a failure, a seller who has not actually got your money is much more likely to take back a useless article, than one with whom you have made a "cash deal."

H. A. S.



Broadcast Brevities

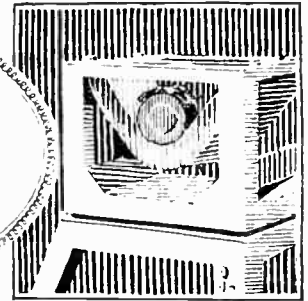

Savoy Hill Topicalities : By Our Special Correspondent.

Higher-power Stations.

Reports such as that circulated in the North of England last week that the Sheffield station is to be closed down and a higher-power station erected about twenty-five miles away should not be regarded too seriously at the moment, as no scheme has yet been put forward by the B.B.C. for the transformation of the present system. Rumours that the closing of any station is contemplated may therefore be dismissed as absolutely without foundation.

○○○○

Regional Stations.

The rapid changes in the broadcasting situation make it impossible to predict exactly what scheme the Post Office will be asked to sanction; but it may be said definitely that, in the development of the broadcasting service, the plan is to provide listeners with improved alternative facilities, and to that end a number of new high-power regional transmitters will be necessary. The industrial areas of the North will benefit considerably; but if the changes involve the removal of transmitters to other sites, away from centres of population and industry, so as to secure improvement in quality and range, the studios will not be closed but will remain where they are at present.

○○○○

Great Changes Coming.

That, broadly, is a forecast of a scheme which may come into operation in a year or so. It may prove to be only a very small part of the revolution in wireless which is going to take place; and when it comes we may even find another station within a short distance of London operating on a power at least three times as great as the present 2LO, while Daventry may be devoted entirely to short-wave transmissions.

○○○○

"Hullo!"

Listeners to Daventry, especially in the Midlands, have noticed what appears to be telephone conversation on the lines. The call "Hullo!" has been reported occasionally, and the engineers at Savoy Hill are conducting an investigation. It is presumed to be another case of telephone induction on aerials.

Telephonic Interference.

Apropos the question of telephonic interference, a listener in a provincial town installed a crystal set some time ago and shortly afterwards his neighbour in the flat underneath had a telephone installed. The telephone wires pass within ten feet of the aerial, with the result that reception on the crystal set has been entirely eliminated and a one-valve set is cut down to crystal strength.

○○○○

Dance Music.

If the purpose of broadcasting dance music were simply to appeal to the ear of the listener, one could believe that disappointment will be caused to a great number of people by the cessation of the Savoy bands on February 27th; but if dance music is broadcast solely for the convenience of dancers, it would seem that there is really no widespread demand for broadcasting into the small hours of the morning.

○○○○

Late Broadcasts.

This has been put to the test during one of the late transmissions from Daventry. A request was broadcast at

about 1 a.m. that listeners who were dancing at that hour should communicate with the B.B.C. Some forty persons responded, a number of the replies coming from the Continent. One may assume that the response represented only a percentage of the dancers, some of whom would not trouble to write; but even so the need for transmissions later than midnight does not seem to be conclusive.

○○○○

Special Dance Nights.

The matter is receiving consideration at Savoy Hill; but I am told that meanwhile a new arrangement will be introduced into the Daventry programme as from February 27th, when 5XX will begin a monthly series of dance nights. The times are 8 to 10 p.m. and 10.10 to midnight, the interval of ten minutes being occupied with the time signal, weather and news bulletin.

○○○○

A New Radio Revue.

The first variation of the improved Radio Revue, entitled "Listening Time," will be broadcast on February 13th. This revue will take the place of "Radio Radiance," which had its final performance last month.



A BROADCAST LESSON. A typical scene in a Wolverhampton school, where the pupils listen regularly to the educational talks from the Birmingham station. At the conclusion of the transmission the children write essays upon what they have heard.

"Which?"

Another serial is to be broadcast next month. When "The Mayfair Mystery" was given in December it was recognised that the intervals of about a week between the episodes were too long. Hence the new serial will be broadcast on March 1st, 3rd and 6th, all three episodes being given at 10.30 p.m. The title of the story is "Which?" This is the plot:—

After a disastrous shipwreck a woman, gently nurtured, beautiful, and essentially human, is cast adrift in a ship's boat with three men of widely differing types, sharing vicissitudes that fling them near to death. They reach a deserted island in mid-Pacific. The men are all in love with the girl. One man is a big, arrogant millionaire, who has thrust his way to the forefront by indomitable perseverance and relentless fighting against heavy odds—the cave-man type, with primitive passions. Another, a dilettante society man, who has never lifted a hand to help himself since the day he was born. The third is an ordinary seaman, one of the wreck's crew.

○○○○

The Unexpected.

Great hostility grows between the three men as to which shall win the girl's favour, and there are no social restrictions to hamper them. They must make their own laws. They act according to their original natures. The play provides an unexpected solution that much careful knowledge of human nature under exceptional circumstances will be required to reach. Will the veneer of social conventions survive the extraordinary conditions in which the protagonists of this moving comedy are placed?

○○○○

The Prince of Wales.

The Prince of Wales's speech at the Mansion House on February 15th, when H.R.H. will propose the toast of "The British Industries Fair" at the B.I.F. banquet, will be broadcast from 2L.O. The Prince's speech will be the only speech broadcast in connection with this function.

○○○○

A Distorted Sense of Humour.

A gross libel was perpetrated on a certain section of listeners when it was suggested recently that, owing to their non-appreciation of Father Ronald Knox's "London Revolution" skit, they had no sense of humour. I should say that it is these same listeners who have been practising their particular line of humour on the B.B.C., by posing as children and sending in requests to be included in the birthday greetings broadcast in the Children's Corner from 2L.O.

○○○○

Advertising?

Attempts have also been made by playing on words to introduce such names as "Olof Meeling of Ealing," "Ida Down, look under Mummy's eiderdown." These may, or may not, be genuine, but seeing that as many as 350 names are sometimes sent in, and there is never time for the inclusion of more than 200, the omis-

FUTURE FEATURES.**Sunday, February 7th.**

LONDON.—3.30 p.m., The Band of the 12th Royal Lancers (Prince of Wales). 9.15 p.m., The Choir of Christ Church, Oxford.

BOURNEMOUTH.—9.15 p.m., Light Symphony.

CARDIFF.—8.10 p.m., Concert in Conjunction with the Cardiff Musical Society.

NEWCASTLE.—9.15 p.m., Hadyn: The Station Symphony Orchestra.

Monday, February 8th.

LONDON.—8 p.m., A Light Symphony Concert: The Wireless Symphony Orchestra conducted by Percy Pitt.

5XX.—8 p.m., The Band of H.M. Royal Air Force.

MANCHESTER.—8 p.m., Grand Guignol, No. 1. "In the Library" (W. W. Jacobs).

BELFAST.—8 p.m., Band of the 1st Battn. The Highland Light Infantry.

Tuesday, February 9th.

LONDON.—8.40 p.m., Act. II. of the Opera, "The Magic Flute" (Mozart). Performed by the B.N.O.C.

ABERDEEN.—9.10 p.m., Chamber Music.

GLASGOW.—8 p.m., Charles Dickens and Old London.

Wednesday, February 10th.

LONDON.—8 p.m., Dale Smith (baritone). Song Cycle: "Maud." 9 p.m., Requests and favourites.

BIRMINGHAM.—8 p.m., A Popular Concert in aid of a well-known Birmingham and Midland Society, relayed from the Town Hall.

NEWCASTLE.—9 p.m., Scenes from "Faust."

ABERDEEN.—8 p.m., Scottish Choral Concert under the auspices of the Peterhead Choral Society.

Thursday, February 11th.

BIRMINGHAM AND 5XX.—8 p.m., "Phillida," a Light Operetta in Two Acts, affording a very humorous selection.

MANCHESTER.—8 p.m., Lancashire Talent Series: A Contribution by Burnley.

Friday, February 12th.

LONDON.—8.30 p.m., Speeches at the Civil Service Dinner, relayed from the Connaught Rooms. 10.35 p.m., "The Blue Kitten" relayed from the Gaiety Theatre.

BIRMINGHAM.—8 p.m., Chamber Music: Winifred Small (violin) and Maurice Cole (piano).

Saturday, February 13th.

LONDON.—8 p.m., Popular Orchestral Concert.

CARDIFF.—Birthday Programme. "No. No, Nunkie," by the Station Aunties and Uncles.

sion of "doubtful" from broadcast greetings can be understood. More palpable indiscretions on the part of would-be hoaxers are the colourable imitations of trade names associated with articles of apparel, but the B.B.C. is on the alert against attempts to introduce advertising matter, however skillfully they may be made. The Uncles and Aunts are also alive to the possibility that these "names" are submitted by hostile critics who hope subsequently to make "copy" out of the "ineptitude" of broadcasting officials in allowing themselves to be victimised.

○○○○

Strict Censorship of Greetings.

I find that a strict censorship is exercised over the birthday greetings feature, and all possible precautions are taken to prevent a slip-up, but if many more attempts are apparent to play the puerile joke of submitting fictitious names there is a likelihood that the feature will be discontinued. The little ones who take a genuine delight in receiving birthday greetings from their broadcast uncles and aunts will in that event be the sufferers, and it is to be hoped therefore that the hoaxers will not persist in their foolishness.

○○○○

The Schoolboys' Concert.

The Bermondsey Central School for Boys, which is going to broadcast a concert on February 16th, takes in boys from thirty-five London County Council schools—boys who have failed to win admission to a secondary school—for a four-year course. As I indicated in last week's Brevities, listeners will have the opportunity of judging and comparing the musical ability of the pupils of a school situated in the heart of London with that of the Marlborough College boys, whose end-of-term concert was broadcast a few weeks ago.

○○○○

The Programme.

The programme to be relayed to 2L.O. from Bermondsey will consist of the following items:—"The Monnow Song," words and air by Dr. Robert Jones, setting by J. Manning Hughes; "Youth and War: A Song Sequence," words by Dr. Robert Jones, music and orchestration by J. A. Phillips; and "Ships of London Town," words and air by Dr. Robert Jones, setting by J. A. Phillips. The latter will act as conductor, while the choir-master will be Mr. F. L. Keefe, L.R.A.M., the pianist, Mr. T. Scott, L.R.A.M., and the 'cellist, Mr. F. L. Keefe. All the names mentioned are those of present or recent masters at the school.

○○○○

Daventry Heard 1,398 Miles Away.

A letter to Savoy Hill from s.s. "Pipestone County" reports reception on board that vessel of 5XX at 1,398 miles on a journey across the Atlantic. This, says the writer of the letter, compares very well indeed with American stations, none of which has been received at a greater distance than 800 miles, and in the majority of cases not more than 400 miles.

BROADCASTING PROBLEMS IN AMERICA.

Questions of Finance, Talent and Power.

IN the United States the question of broadcasting development has to be regarded from a point of view differing vastly from any survey of broadcasting in this country. We have to remember that American listeners are served by a galaxy of nearly 600 stations, mostly of low power, which are sponsored by private enterprise for the purpose of indirect advertisement or propaganda. Therefore it is hardly surprising that, with the departure of the first thrill of novelty in broadcasting, American listeners are now asking for better programmes. This raises a problem of the first magnitude. Who is to pay?

A note of optimism has been struck by Mr. David Sarnoff, Vice-President and General Manager of the Radio Corporation of America. In a recent address before the Boston Chamber of Commerce, Mr. Sarnoff cheerfully declared that the problem of economic support of broadcasting is solving itself.

"Notwithstanding the fact that most broadcasters have found no way of obtaining direct returns from the listening public," he remarked, "the indirect returns are, in many cases, sufficiently impelling motives for the continuance of broadcasting. Already there is a waiting list for the privileges of the air."

The two main sources of economic support, he be-

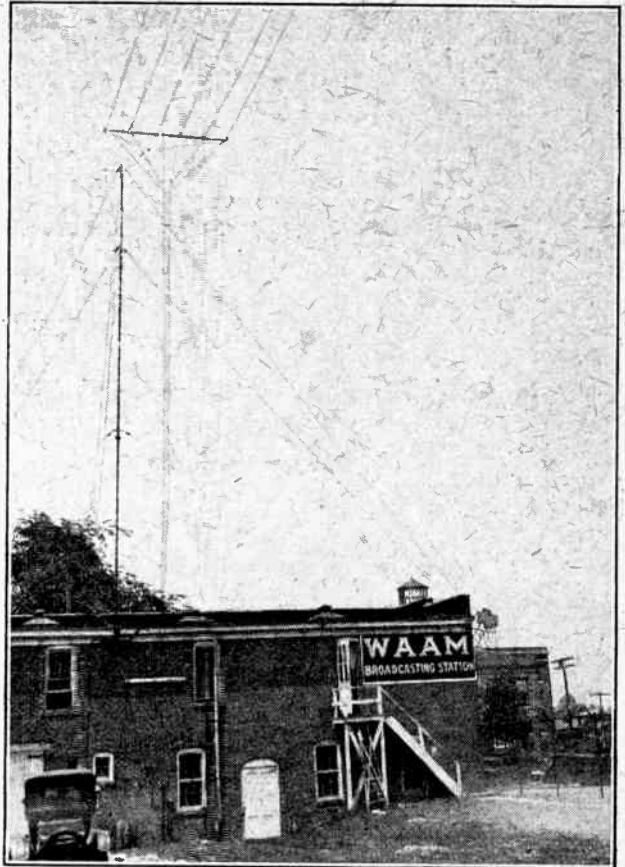

ONE OF THE SIX HUNDRED. A typical low-power broadcasting station in America, of the kind which, it is urged, should be supplemented by a chain of high-power stations.



AN AMERICAN HIGH-POWER STATION. America's ambitions in broadcasting are indicated by the construction of WJZ, Bound Brook, N.J., operating with a power of 50 kW. The above photograph was taken in the transmitting room, which actually contains three 50 kW. instruments, including an emergency transmitter and a short-wave set.

lieved, would come from the radio industry and from commercial broadcasting, although it was apparent that help would also be forthcoming from educational and social interests.

When Broadcasting Calls the Tune.

On the questions of broadcast talent and the supply of suitable programmes, Mr. Sarnoff propounded an interesting possibility. Up to the present broadcasting has had to seek programme features from the opera, the concert hall, the orchestra, and the stage. "The day may come," he said, "when the relationship may be reversed—when the broadcasting station will comb the field of original talent; when broadcasting will create new reputations

Broadcasting Problems in America.—

instead of capitalising old ones; when broadcasters will compete with music publishers for original compositions, and not only buy, but sell, music publishing rights."

Mr. Sarnoff reminded his audience that broadcasting, although it must be essentially popular in its appeal, was not to be limited to the sphere of entertainment. Service was its true mission, of which entertainment was but a part.

It is interesting to note that, after alluding to the educational value of broadcasting, the speaker referred to its powerful influence in the realm of politics. Popular interest in government, he asserted, would be enormously increased by the broadcasting of important Congress debates.

High-Power Broadcasting.

The international aspect of the subject was also referred to, and the speaker claimed that a chain of high-

power stations was necessary in the United States. The local stations (and America is well served in this respect) would always remain as a permanent institution, but Mr. Sarnoff declared that there was a need for a system of national broadcasting with facilities to cover the entire country and to span the ocean if desired.

"We cannot expect," he added, "to receive regularly organised programmes broadcast to us through the powerful stations of Europe unless our own voice is strong enough to span the Atlantic with reciprocal programmes."

Mr. Sarnoff concluded his address with an intriguing forecast regarding the wireless transmission of pictures:—

"Already the Radio Corporation of America are operating photo-radiogram circuits from Honolulu to San Francisco, and from San Francisco to New York daily for test purposes; very soon service by this method to and from Europe will be opened upon a commercial scale."

TRANSMITTERS' NOTES AND QUERIES.**General Notes.**

Mr. C. H. Targett (G6PG), 21, High Street, Dartford, is conducting experiments with an underground aerial on 23, 45 and 90 metres, and will welcome reports on his transmission.

o o o o

We understand that Mr. E. Van Vianen (NPC2), The Hague, is experimenting on a wavelength of 3.75 metres.

o o o o

Communications for Swiss amateurs, H9BB, H9XB, H9RNA, H9WWZ and H9NAZ may be sent c/o Dr. W. Merz, President S.V.A.S., Berne-Bumplitz.

o o o o

Communications for F8LDR and F8JD may be sent via Mr. W. Bakewell (G6UZ), Yeovil House, Regent Street, Stoke-on-Trent.

o o o o

A Belgian station, BW5, works on a wave-band of 180-200 metres after 2200 G.M.T. on weekdays and between 0900 and 1300 on Sundays, and wishes to get into communication with British amateurs. He asks, however, that any transmitters who reply to his call, unless they speak French, will speak very slowly. His signals have been heard by Mr. A. G. Binnie, 1, Cromford Road, West Hill, S.W.18, who reports their strength to be about R7-8.

o o o o

Mr. Gerald Marcuse, while experimenting with some new Marconi transmitting valves, succeeded in speaking to Mr. Reid (8AR), in St. John's, Newfoundland, at about 6 p.m. on Sunday, January 10th, on a wavelength of 45 metres.

o o o o

Mr. H. W. Heywood (OA3E), 91, Berea Park Road, Durban, Natal, gives the following schedule of times when British amateurs should look out for South Africans: Monday, Wednesday, Friday, 1530-1630 G.M.T.; Tuesday, 1530-1830 G.M.T.; Saturday and Sunday, 1530-1700 G.M.T.; and daily at 2030 and 0300 G.M.T.

Mr. A. E. Livesey, Stourton Hall, Horncastle, Lincs., states that he received Uruguay JCP on January 19th at 1.0 a.m. on a wavelength of 30 metres, signal strength about R3, and asks if any other amateur has heard this station.

o o o o

New Call Signs and Stations Identified.

N PA9.—Technische Hoogeschool, Kanaalweg 26, Delft, Holland (communications for PA9a, PA9b, PA9c, etc., may be addressed to the Radio Laboratory at this address).

G 2AHH.—K. R. Brecknell, 27, Carisbrooke Road, Edgbaston, Birmingham.

G 2BDP.—(Art. A), A. Berry, Haute Croix, St. Johns, Jersey.

G 2BLV.—L. White, 22, Reynolds Close, Hampstead Way, N.W.11 (Art. A).

G 5BD.—C. E. Bradford and A. C. Simons, Empire Buildings, Mablethorpe, Lincs., transmit on 45 metres.

F 8AIX.—P. Longayron, 10, Rue Nelson, Cherico, Algiers.

KFUH.—U.S. S3S "Kaimiloa," c/o Messrs. Heintz and Kohlmoos Inc., 219, Natoma Street, San Francisco, Calif.

PR 4KD.—U.S. Naval Radio Station, San Juan, Porto Rico.

SMSR.—P. H. Svensson, Lindgatan 6, Liljeholm, nr. Stockholm.

o o o o

QRA's Wanted.

G 2AH, G 2BI, G 2ST, G 2ZA, G 5TD, G 5UN, G 6MB, G 6RA, G 5SO, G 6LL, AN 3FZ, BZ PT2, CH 3AT, CRP (India), F 8HFD, F 8NN, F 8RF, F 8RX, GFP, P18, 1FN, R DD7, R DG2, U NOT, X 3YY, 82E.

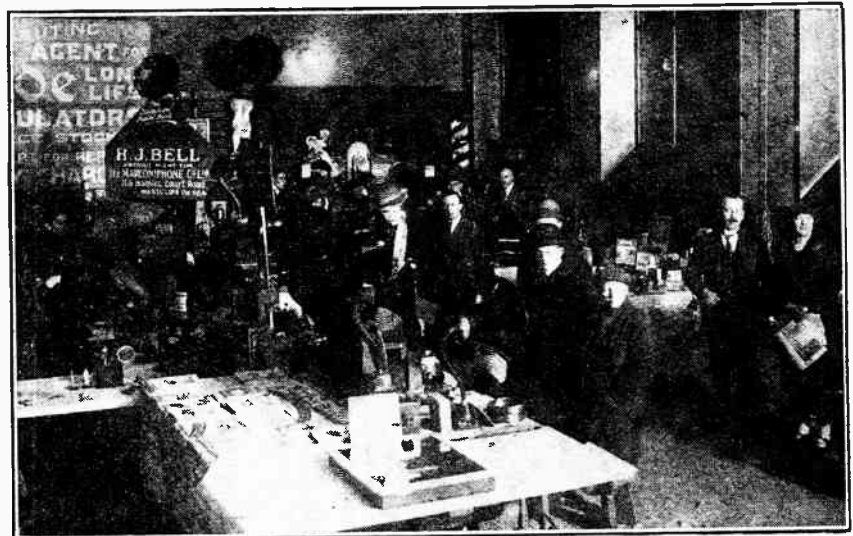

SOUTHEND WIRELESS EXHIBITION. Great success attended the exhibition recently held under the auspices of the Southend and District Radio Society. The photograph shows a number of interested visitors and, incidentally, the popularity of the modern loud-speaker!

WIRELESS CIRCUITS

in Theory and Practice.

3.—Growth and Decay of Current in Inductive Circuits.

S. O. PEARSON, B.Sc., A.M.I.E.E.

CONSIDER a circuit whose inductance is L henries and whose resistance is R ohms. If a steady potential difference of E volts is applied to the ends of the circuit the normal steady value of the current is given by $I = \frac{E}{R}$ amps. Now when the voltage is first applied the current has to build up from zero to I amps., and in doing so it induces an electromotive force, e , proportional at every instant to the rate of growth of current, and by Lenz's law this E.M.F. acts in such a direction as to oppose the growth of the current, that is, it acts

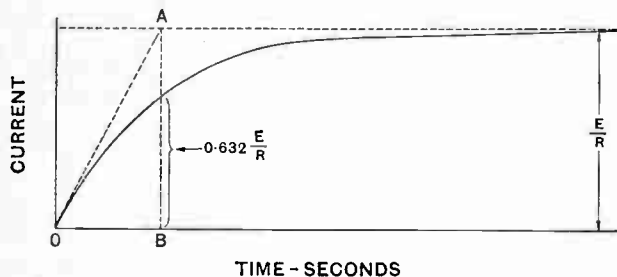

Fig. 1.—Growth of current in an inductive circuit.

in the opposite direction to the applied voltage E . Hence the current at any instant is given by $i = \frac{E - e}{R}$ amps., and thus we see that the current builds up gradually and not instantaneously. The "back E.M.F." e does not become zero until the current ceases to increase, and the current does not cease to rise until e is zero, so in theory the current never reaches the final steady value $\frac{E}{R}$, but it approaches so closely to it after a few seconds that the difference cannot be detected.

Another reason for the gradual growth of the current is that the energy stored in the magnetic field cannot be accumulated instantaneously, just as it is impossible to fill a tank with water in an infinitely short space of time. The growth of a current in a D.C. circuit is discussed here because the laws governing the building up of electrical oscillations are almost identical.

The manner in which the current builds up is indicated graphically in Fig. 1. The rate of growth is fairly rapid at first and then falls off to a slower rate of increase as the value of the current gets larger.¹

¹ The value of the current at any time t seconds after first switching on is given by $i = \frac{E}{R} (1 - e^{-\frac{R}{L}t})$, where $e = 2.71828$ etc. is the base of Napierian logarithms.

The *time constant* of an inductive circuit may be defined as the time which the current would take to reach its final steady value, $\frac{E}{R}$ if it continued to grow at the initial rate.

Thus in Fig. 1 the slope of the line OA represents the initial rate of growth, and the time constant is equal to OB seconds. The value of the time constant depends on the inductance and resistance of the circuit only, and may be found quite simply as follows:—

From the expression $i = \frac{E - e}{R}$ above we get induced E.M.F.

$$e = E - Ri \text{ volts.}$$

But we have already seen that the induced E.M.F. is equal to $L \times$ (rate of change of current), so that

$$L \times (\text{rate of change of current}) = E - Ri,$$

or rate of change of current = $\frac{E}{L} - \frac{R}{L}i$, amps. per sec. Now at the instant of switching on, the current is equal to zero, and therefore $\frac{R}{L}i = 0$, so that the initial rate of

growth is equal to $\frac{E}{L}$ amperes per second. If this rate of increase could be maintained the current would reach the final value $\frac{E}{R}$ in $\frac{E}{R} \div \frac{E}{L}$ seconds, that is, in $\frac{L}{R}$ seconds. We see then that the *time constant of the circuit is equal to the ratio of inductance to resistance*; the

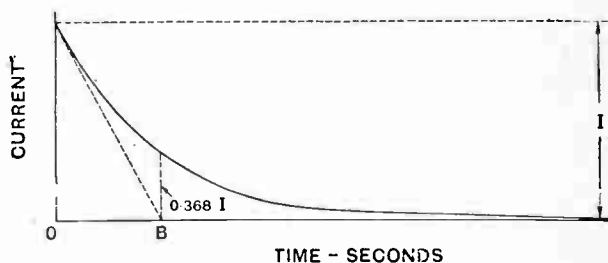

Fig. 2.—Decay of current in an inductive circuit.

higher the inductance and the lower the resistance, the greater will be the time constant. It can be shown that the current builds up to $0.632 \frac{E}{R}$ in a time equal to the time constant of the circuit.

Decay of a Current.

If the applied electromotive force maintaining the current in an inductive circuit is suddenly reduced to zero without breaking the circuit or in any way altering its resistance, the current will die away gradually, not in-

Wireless Circuits in Theory and Practice.—

stantaneously, because as soon as the current begins to fall in value the changing of the magnetic field induces an E.M.F. which tends to maintain the current round the circuit. The laws are practically the same as those considered for the building up of the current, except that now we have no applied voltage. The die-away curve is shown in Fig. 2, and it will be seen that the current falls fairly rapidly at first and then more gradually as its value gets smaller. The curve is exactly the same shape as that of Fig. 1, the only difference being that it is virtually upside down.

If I is the initial value of the current and i the value at any time t seconds after the applied E.M.F. is switched off, the equation to the curve is

$$i = Ie^{-\frac{R}{L}t} \text{ amps.,}$$

from which

$$\frac{i}{I} = e^{-\frac{R}{L}t}$$

where e is the base of natural logarithms and is equal to 2.71828, etc.

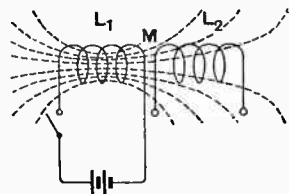

Fig. 3.—Mutual Inductance of two coils.

Taking logarithms to the base e of each side, the expression simplifies to

$$\log \frac{i}{I} = -\frac{R}{L}t.$$

This logarithmic law is very similar to that used in connection with damped oscillations, and will be referred to again when dealing with that branch of the subject.

As before, the time constant of the circuit is $\frac{L}{R}$ seconds,

and when $t = \frac{L}{R}$ seconds we have

$$i = Ie^{-1} = 0.368.I \text{ amps.}$$

Thus in a time equal to the time constant the current falls to a value of 0.368 of its initial value.

The time lag in an inductive circuit plays a very important part in relays as used for recording wireless signals, and in other electromagnetically operated devices where it is necessary to obtain sudden changes in the value of the current. The time constant of an inductive circuit can be reduced by adding extra resistance in series with it, but in order to get the same normal current as before a correspondingly larger applied voltage must be used, and this is not always practicable. When an extra resistance R_1 is connected in series with an inductive circuit of resistance R ohms, the time constant is reduced

from $\frac{L}{R}$ to $\frac{L}{(R + R_1)}$ seconds.

Comparison with Simple Laws of Mechanics.

It was mentioned in the previous instalment that the part played by inductance in the electric circuit is very similar to that played by *inertia* or *mass* in mechanics, and the following table shows the similarity of the laws obeyed in each case. Current and inductance in electricity correspond to velocity and inertia respectively in mechanics.

ELECTRICITY.

Self-inductance is that property of a circuit which tends to prevent any change in the value of the current.

When the current is changing an opposing (electromotive) force proportional to the inductance and to the rate of change of current is set up.

$$e = L \times (\text{rate of change of current}).$$

The current cannot be started instantaneously in a circuit possessing self-inductance, but takes time to reach a given value.

The energy stored in a magnetic field is proportional to the inductance and to the square of the current, being given by $W = \frac{1}{2}LI^2$.

MECHANICS.

Inertia is that property of matter which tends to prevent any change in the motion or velocity.

When the velocity is changing an opposing (mechanical) force proportional to the inertia or mass and to the rate of change of velocity (acceleration) is set up.

$$F = M \times (\text{rate of change of velocity}).$$

The velocity cannot be acquired instantaneously in a body possessing inertia, but takes time to reach a given value.

The energy (kinetic) stored in a moving body is proportional to the inertia and to the square of the velocity, being given by $K.E. = \frac{1}{2}MV^2$.

Mutual Induction.

Mutual induction is said to exist between two circuits or coils if a current in one of them causes lines of magnetic force to be linked with the other or if a varying current in one circuit causes an electromotive force to be induced in the other. The mutual inductance has a value of *one henry* if a current of one ampere in one circuit (called the *primary*) causes 10^8 line-linkages in the other (called the *secondary*). The mutual inductance between two circuits in henries is called the *coefficient of mutual induction*, and is usually denoted by M . Thus if a current of I_1 amps. flows in the primary coil, the number of line-linkages produced in the secondary will be $MI_1 \times 10^8$. If the current in the primary coil is varying

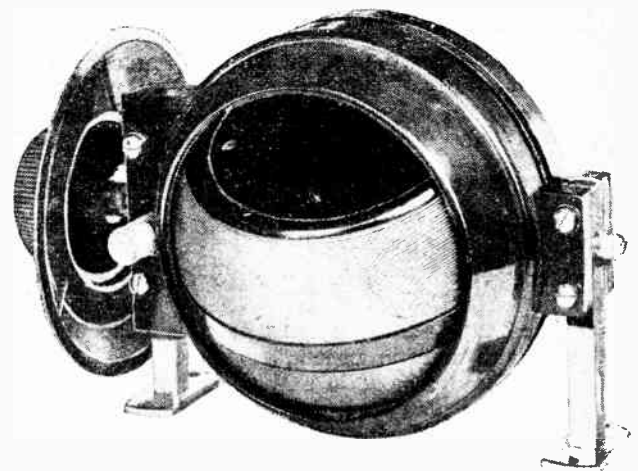

Typical variometer. Note small clearance between rotor and stator windings to increase coefficient of coupling.

in value the E.M.F. in volts induced in the secondary will be, by Faraday's Law.

$$\begin{aligned} e_2 &= (\text{rate of change of linkages}) \div 10^8 \\ &= [M \times (\text{rate of change of } I_1) \times 10^8] \div 10^8 \\ &= M \times (\text{rate of change of primary current}). \end{aligned}$$

Wireless Circuits in Theory and Practice.—

The mutual inductance between two coils is the same no matter which is taken as the primary. The value of the mutual inductance depends on the self-inductances of the individual coils and on their relative positions and proximity. Two coils which are arranged to have mutual inductance are said to be electromagnetically coupled together, and when they are brought close together so as to obtain a relatively large mutual inductance they are said to be tightly coupled; when they are moved apart so as to obtain a low value of mutual inductance they are said to be loosely coupled.

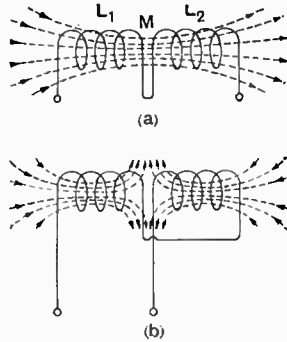

Fig. 4.—Principle of the variometer. Magnetic fields of the two coils (a) in the same sense, giving total inductance $L = L_1 + L_2 + 2M$, and (b) in opposition, giving $L = L_1 + L_2 - 2M$.

The degree of coupling is measured by the ratio of the mutual inductance, M , to the square root of the product of the individual self-inductances L_1 and L_2 , that is, the degree of coupling $= \frac{M}{\sqrt{L_1 L_2}}$. This is called the coefficient of coupling, sometimes the coupling is expressed as a percentage, so that

$$\text{percentage coupling} = \frac{M}{\sqrt{L_1 L_2}} \times 100.$$

In practice the coupling is always less than 100 per cent., but in theory a 100 per cent. coupling would occur when the whole of the lines of force produced by the current in the primary coil are linked with the whole of the turns of the secondary coil. Couplings will be considered in further detail in connection with oscillatory currents, etc.

When the secondary circuit is closed or completed a current will flow in it whenever the primary current is varying, and this secondary current produces a magnetic field of its own which links with and so reacts upon

the primary circuit. This has the effect of apparently altering the self-inductance of the primary, the apparent inductance being usually less than the true inductance L_1 when current is allowed to flow in the secondary.

Principle of the Variometer.

When two coils with self-inductances of L_1 and L_2 respectively, between which the mutual inductance is M , are connected in series in such a manner that the magnetic fields assist one another when a current is passed through the circuit, as in Fig. 4 (a), the resulting self-inductance of the circuit is given by

$$L = L_1 + L_2 + 2M \text{ henries.}$$

If the coils are connected so that the fields oppose each other as in Fig. 4 (b), the resulting self-inductance of the circuit is

$$L = L_1 + L_2 - 2M \text{ henries.}$$

This principle is made use of in the ordinary variometer for obtaining a continuously variable self-inductance; a movable coil, called the rotor, is mounted inside a fixed coil, called the stator, and is rotated about an axis at right-angles to the axes of both coils, so varying the value of M . To obtain the greatest range the individual self-inductances of the coils should be equal, and the coupling should be as tight as possible when the coils are co-axial. Taking as an example a maximum coupling of 80 per cent. and assuming the inductance of

each coil to be L henries, we see that $\frac{M}{\sqrt{L^2}} = \frac{M}{L} = 0.8$,

$M = 0.8L$. Then

$$\begin{aligned} \text{maximum inductance} &= 2L + 2M \\ &= 2(L + 0.8L) \\ &= 3.6L \text{ henries} \end{aligned}$$

and

$$\begin{aligned} \text{minimum inductance} &= 2L - 2M \\ &= 2(L - 0.8L) \\ &= 0.4L \text{ henry,} \end{aligned}$$

therefore $\frac{\text{maximum inductance}}{\text{minimum inductance}} = \frac{3.6L}{0.4L} = 9$,

or an inductance ratio of nine to one. With a 90 per cent. coupling the inductance ratio works out to nineteen to one.

BOOKS RECEIVED.

"How Radio Receivers Work" (Radio Broadcast Booklet No. 3), by Walter Van R. Roberts, B.S., E.C., Ph.D. pp. 53 with 65 diagrams, published by Doubleday, Page & Co., Garden City, New York. Price \$1.

"The Wireless Retailers' Handbook, 1925-6." Published by The Wireless Retailers' Association of Great Britain. 100 pp

"Radio Engineering, with Special Sections on Telegraphy and Telephony" (being Vol. III. of Electrical Engineers' Data Book). Compiled by J. H. Reyner, B.Sc., A.C.G.I. (Hon.) pp. 258 and 293 figs. with 195 pp. of appendices, tables, data, etc. Published by Ernest Benn, Ltd., 8, Bouverie Street, E.C.4. Price 15s.

"Pitman's Radio Year Book, 1926." pp. 182 with numerous illustrations and diagrams. Published by Sir Isaac Pitman & Sons, Ltd., London.

"Radio and High-Frequency Currents," by G. T. Larner (2nd edition, enlarged). pp. 64 with 25 diagrams and 5 half-tone plates. Published by Crosby, Lockwood & Son, London. Price 2s. 6d. net.

"Broadcast Reception in Theory and Practice," by J. Laurence Pritchard. pp. 259 with 160 diagrams and illustrations and 23 pages of tables and useful information. Published by Chapman & Hall, Ltd., London. Price 8s. 6d. net.

"Come funziona e come si costruisce una Stazione Radio sia ricevente

che trasmettente (4th edition), by Ing. E. Montu. pp. 677+XII, with 389 diagrams and illustrations and numerous tables. Published by U. Hoepli, Milan. Price 24 lire.

A useful booklet of pocket size for recording tuning data has been compiled by the Marconiophone Co., Ltd., 210-212, Tottenham Court Road, London, W.1. The pages are suitably ruled for recording call sign, location of station, wavelength, and dial settings. In addition advice on the operation of Marconi valves is included, followed by several pages giving valve data, while 16 pages are left blank for general notes.

The Log Book is intended for free distribution, and will be despatched to any reader on addressing a request by postcard to the Marconiophone Co., Ltd.

NEWS FROM THE CLUBS

Secretaries of Local Clubs are invited to send in for publication club news of general interest. All photographs published will be paid for.

"Short-Wave Reception."

On January 18th the Swansea Society was visited by Mr. F. H. Haynes, Assistant Editor of *The Wireless World*. It speaks much for the popularity of short-wave reception, the subject upon which Mr. Haynes lectured, that many people had to be turned away from this crowded meeting.

The speaker first dealt with the precautions and modifications necessary in the design of apparatus to receive on wavelengths below 100 metres. An interesting demonstration was then carried out with Mr. Haynes' short-wave transmitter, followed by successful reception on two short-wave receivers.

○○○○

Getting Results with a Crystal.

A demonstration showing the excellent results obtainable under good conditions with a crystal set was given by Mr. Symes before the Manchester Radio Scientific Society on January 13th. The speaker emphasised the importance of paying the utmost attention to design and the quality of components.

The question of efficient earths and counterpoises was discussed, and it was shown that from a reasonably good aerial a rectified current could be obtained of as much as 70 microamperes, whilst in exceptional cases it could be as much as 190 microamperes. Details were given as to the correct dimensions of coils, the demonstration set employing a coil of bare wire almost entirely air-spaced, movable contact being made by means of a special clip.

The hon. secretary of the Society is Mr. Geo. C. Murphy, Meadow View, The Cliff, Hr. Broughton, Manchester.

○○○○

Fighting Oscillation in Leytonstone.

In view of the persistent reports of annoying oscillation in the Leytonstone district, it is interesting to note that the Leyton Radio Association has now moved its headquarters to 683, High Road, Leytonstone, E.11, and will in future be known as the Leyton and Leytonstone Radio Association.

The Association is endeavouring to overcome the oscillation nuisance in the neighbourhood, and with this end in view would greatly appreciate the support of readers who reside in Leytonstone. Prospective members should apply to the hon. secretary, Mr. R. T. Kensey, 17, Station Rd., Leyton.

A 46

Neutrodyne Problems.

Why do we require to "neutrodyne" a set? Do we know how to "neutrodyne" a set? How can we apply this knowledge practically?

These questions were dealt with in an interesting manner by Mr. R. F. G. Holness, lecturing before the Tottenham Wireless Society on January 13th. Mr. Holness carefully explained how the phase changed in resonant circuits and how capacitive coupling in a valve was a cause of self-oscillation.

He then dealt with the elementary principles of the Wheatstone Bridge, showing how they could be applied to radio-frequency uses. Then from a bridge diagram he evolved in steps a capacity neutralised circuit, finally showing how this could be modified in order that tuning might be simplified without appreciably upsetting the state of balance.

The lecturer emphasised the necessity of careful design and lay-out of components, as it was important that there should be an almost complete absence of stray magnetic couplings and capacities between leads.

Faraday's "Text."

Taking as his subject "Faraday's Earlier History and Experiments," Mr. J. Ewles, M.A., delivered a fascinating lecture on January 8th before a large number of members of the Leeds Radio Society. The lecturer based his remarks on Faraday's "text": "There must be some connecting medium between forces which act upon one another."

Many interesting experiments were performed, including the famous example demonstrating that a current is set up in a wire rotated or otherwise moved in a magnetic field.

In congratulating Mr. Ewles at the conclusion of the lecture, Mr. Fox, Director of the Leeds Relay Broadcasting Station, said the lecture should have been comprehensible even to the man who refused to pay his wireless licence because he used the water pipe and was not connected to the electric light.

Hon. Secretary: Mr. R. Toynbee, 6, Roberts Avenue, Harehills, Leeds.

○○○○

Obtaining Selectivity.

Mr. Whitehouse, of the B.B.C., gave an interesting lantern lecture before the Norwich and District Radio Society on January 15th, taking as his subject "Selectivity." His very comprehensive survey of the question covered the various forms of coupling, the use of wave traps, directional properties of frame aerials, and, last but not least, the elimination of tram interference and A.C. hum.

The Society will shortly allot a special night for an exhibition of home-made sets, while an exchange and mart also figures in arrangements for the future.

Hon. secretary: Mr. J. Hayward, 42, Surrey Street, Norwich.

○○○○

All About Valves.

The non-technical members of the Ipswich and District Radio Society were specially catered for on January 12th, when Mr. F. E. Henderson, A.M.I.E.E., of the General Electric Co., Ltd., gave a very clear explanation of the history, development and working principles of the thermionic valve.

In designing the perfect valve, said Mr. Henderson, the aim should be to obtain low filament consumption, a minimum of danger of overrunning the filament, efficient characteristics giving range, volume and purity, robustness, reliability, and an efficient life of at least nine months of constant usage.

FORTHCOMING EVENTS.

WEDNESDAY, FEBRUARY 3rd.

Institution of Electrical Engineers (Wireless Section). At 6 p.m. (Light refreshments at 5.30 p.m.) At the Institution, Savoy Place, W.C.2. Lecture: "The Propagation of Electric Waves,"

by Mr. J. Hollingworth.
Muswell Hill and District Radio Society. At 8 p.m. At St. James' Schools, Fortis Green, N.10. Lecture: "Wireless Reception," by Mr. H. F. Klotz.

Barnsley and District Wireless Association. At 8 p.m. At 22, Market Street. Low Frequency and Resistance Amplification.

Edinburgh and District Radio Society. At 117, George Street. Business Meeting and Questions Evening.

THURSDAY, FEBRUARY 4th.

Tottenham Wireless Society. At 7.30 p.m. At Landsdowne Hall, High Road, Tottenham. Demonstration, Exhibition and Public Meeting.

FRIDAY, FEBRUARY 5th.

Sheffield and District Wireless Society. At 7.30 p.m. At the Dept. of Applied Science, St. George's Square. Competition.

Ipswich and District Radio Society. At 8 p.m. At the Museum, High Street. Lecture by the Edison Company.

MONDAY, FEBRUARY 8th.

Swansea Radio Society. Lecture: "Rectifiers," by Mr. J. C. Kirkman, B.Sc.

WEDNESDAY, FEBRUARY 10th.

Radio Society of Great Britain. Informal Meeting. At 6 p.m. At the Institution of Electrical Engineers, Savoy Place, W.C.2. Talk by Mr. E. Lawrence Wildy on "The Manufacture and Properties of Electrical Conductors."



A Review of the Latest Products of the Manufacturers.

SPARTA ANODE REACTION UNIT.

Among the range of components manufactured by Fuller's United Electric Works, Ltd., Woodland Works, Chadwell Heath, Essex, is an anode reaction coupling unit consisting of an inductance, which normally constitutes a tuned plate coil variably coupled, to which is another winding for providing reaction. The unit is totally enclosed in a moulded ebonite box, and the reaction coil is rotated by means of milled pinions controlled by an extension handle. The anode coil is an air-spaced winding of fine wire, and the reaction coil is carried on a slotted ebonite spool, reliable contact being made by means of a pair of coiled bronze springs. The unit shown is rated to have a tuning range of 280 to 600 metres, and by means of a base piece with spring clips units of other wavelength ranges can be substituted.

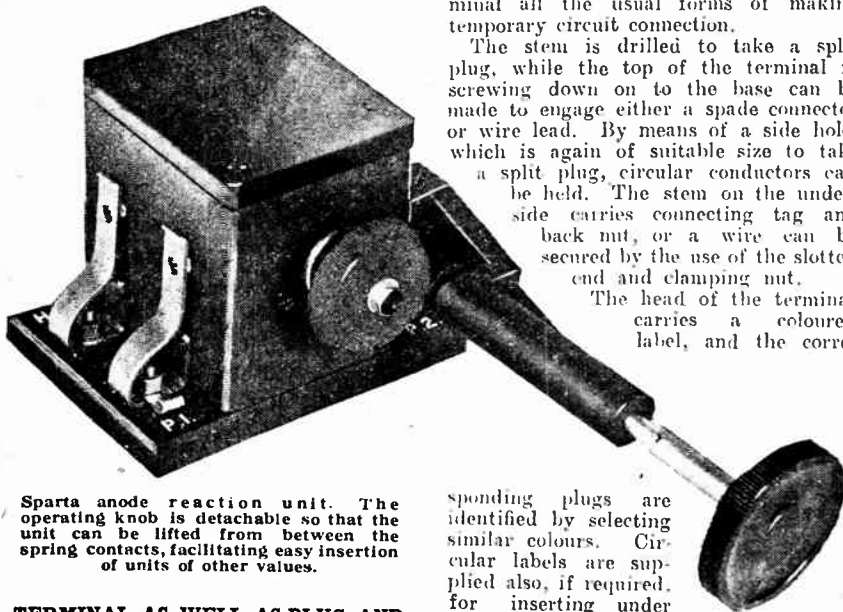

Sparta anode reaction unit. The operating knob is detachable so that the unit can be lifted from between the spring contacts, facilitating easy insertion of units of other values.

TERMINAL AS WELL AS PLUG AND SOCKET CONNECTOR.

A vast variety of terminal connectors is now available, but only a few designs possess outstanding merits sufficient to warrant their adoption in preference to the earlier forms of terminal. The new Eelex connector, manufactured by J. J.

Eastick and Sons, 2, St. Dunstan's Hill, London, E.C.3, combines in a single ter-

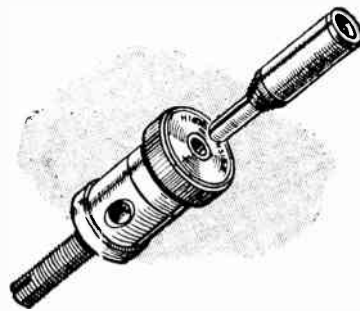

Eelex combined terminal and plug and socket connector.

minimal all the usual forms of making temporary circuit connection.

The stem is drilled to take a split plug, while the top of the terminal in screwing down on to the base can be made to engage either a spade connector or wire lead. By means of a side hole, which is again of suitable size to take a split plug, circular conductors can be held. The stem on the under-side carries connecting tag and back nut, or a wire can be secured by the use of the slotted end and clamping nut.

The head of the terminal carries a coloured label, and the corre-

sponding plugs are identified by selecting similar colours. Circular labels are supplied also, if required, for inserting under the coloured sleeve on the plug. The Eelex system of connectors makes use of small standardised parts, including eye, pin, and spade connectors, the shanks of which are drilled to engage on the split plugs, bridging bars to link up sockets to form pairs, and tubular connectors for joining together

plugs end on end, together with a wide range of circular coloured labels.

o o o o

BELLING LEE CRYSTAL DETECTOR.

Two small cups having serrated edges and pressed together by a spring firmly grip the crystal. The crystal can be revolved and almost the entire surface searched for points giving good detection. A simple form of mounting is adopted for the stem to which the wire is attached, yet critical adjustment is readily obtained. The interior of the metal box container, like the exterior, has a bright finish, and in consequence the point of contact can be easily seen through the colourless celluloid window.

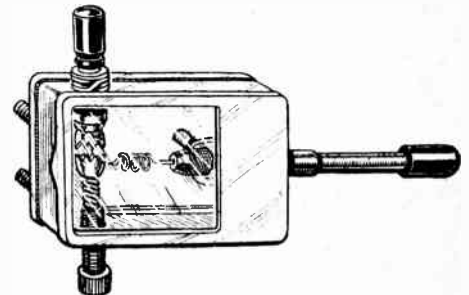

Belling Lee totally enclosed crystal detector.

This detector, which is produced by Belling and Lee, Ltd., Queensway Works, Ponders End, Middlesex, being of unusual outline, has an attractive appearance when fitted to an instrument panel.

o o o o

COSMOS VARIABLE CONDENSER.

This recent product of the Metropolitan-Vickers Electrical Co., Ltd., and which is sold by Metro-Vick Supplies, Ltd., 4, Central Buildings, Westminster, London, S.W.1, presents a robust appearance and is an example of a really good mass production instrument job, being assembled from substantial pressed and turned parts of somewhat intricate outline. The moving plates are assembled in the usual manner on a threaded spindle clamped together with spacing washers and nuts, other nuts being used to hold the spindle in its correct position.

Both the main knob and dial are fitted

with brass bushes and secured by screwing on to the spindle. Consequently the spindle, which is of small diameter, is left threaded where it passes through main bearing, an arrangement which is common in many condensers, though it is to be deprecated owing to the danger of slackness occurring in the bearing and resulting in side play. At either end of the spindle there is a supple packing washer compressed under the lock nuts to prevent end play in place of the customary method of using a spring washer.

In addition to the knob and dial attached to the spindle, an auxiliary control is provided for giving critical adjustment. The additional knob rotates a small pulley, which is coupled to a

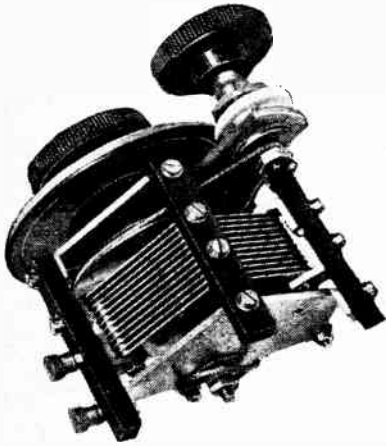

The Cosmos square law condenser.

pulley of much larger diameter on the main spindle. The pulleys are linked together by a tough coiled spring band, and, contrary to expectations, the moving plates when propelled from the fine adjustment knobs have no tendency to acquire a jerky movement brought about by the elasticity of the spring. On the other hand, however, when the main knob is revolved the position of the plates restores very slightly in the opposite direction to rotation, owing to uneven tension of the spring.

There is no room for criticism of the design electrically, three ebonite bars being employed to give rigid support for

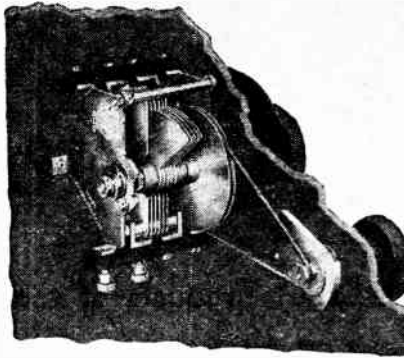

Fine adjustment of the Cosmos condenser is provided by means of an auxiliary knob and pulley. The fine control knob with its bearing can be detached from the end plate of the condenser and assembled on the instrument panel, a useful modification in certain receiver designs.

the fixed plates. The plates are securely clamped together, a plaited copper lead ensuring reliable connection with the spindle.

Excepting the plates, which are of aluminium, all metal parts are of brass with a dull nickel finish. The dial is of large diameter and the knobs are of new and attractive design.

o o o o

THE VARLEY ANODE RESISTANCE.

In a recent reference to the Varley wire-wound anode resistance it was stated that the silk-covered resistance wire was employed for winding the resistance spool. The Varley Magnet Co. point out, however, that bare wire is used, silk separated, the winding being carried out by the Varley "Bi-duplex" method.

o o o o

"RAVALD" TUBULAR CONNECTING WIRE.

Equivalent in gauge to No. 16 S.W.G., tubular connecting wire is now available from John Moores and Co., Ravalld Street Works, Salford. A reduction in high-frequency resistance as compared with the solid conductor is claimed, brought about

by the elimination of eddy current losses. The walls of the tube are of tinned copper.

o o o o

DECKO NEUTRALISING CONDENSER.

Some new features are to be found in the Decko neutralising condenser, shown in the accompanying illustration, a recent product of A. F. Bulgin & Co., 9-11, Cursitor Street, Chancery Lane, London, E.C.4.

An ebonite tube about 1½ in. in length is used to space the metal end pieces, the lower one being mounted on an ebonite base. The capacity charge is produced by revolving a threaded stem to which a brass disc nearly ¼ in. in diameter is attached. Although an exceedingly critical control is required, condensers of this type are very often fitted with an

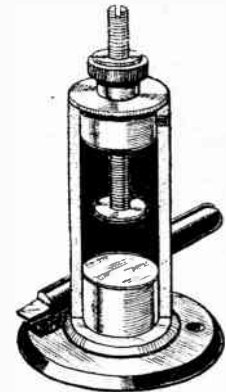

The "Decko" neutralising condenser is one of the few types designed for base-board mounting, although this component is invariably accommodated behind the instrument panel. A blade ended ebonite rod is supplied for adjusting, and when once the condenser is set the adjustment cannot be tampered with.

adjusting screw having a coarse B.A. thread, but in this instance a suitable fine thread is employed.

An ebonite rod with a blade shaped end is supplied with the condenser for obtaining adjustment, and the correct setting is maintained with the aid of a milled lock nut.

The ebonite has a polished finish and the metal parts are nickel-plated.

LOUD-SPEAKER DESIGN.

DR. N. W. McLACHLAN, M.I.E.E., in his lecture at the meeting of the Radio Society of Great Britain on January 27th, clearly defined the fundamental principles underlying loud-speaker design. Although he devoted his attention essentially to loud-speakers of the hornless type, the effects of combined resonances were carefully analysed and the response curves were given for various forms of diaphragm and drive. The designs described were based on the assumption that the loud-speaker was to be operated with a uniform input in which the various frequencies were present in their correct relative intensities, though in referring to the amplifying apparatus it was suggested that an increased amplification of the

higher note frequencies was desirable when the detector valve is preceded by one or more highly selective radio-frequency amplifiers due to curtailment of the side bands and consequent attenuation of the higher frequencies.

A point of importance was the interference occurring between sound waves emitted simultaneously on both sides of a vibrating diaphragm. The overlapping of the compressions and rarefactions coming at the same moment from opposite sides of the diaphragm brought about a reduction in the amplitude of the sound waves. This effect was most admirably demonstrated by interposing a screening board around the loud-speaker to increase the path of inter-action between the waves

emitted from the two sides of the parchment diaphragm. The withdrawal of the screen resulted in a considerable reduction in intensity.

Directional propagation in which the sound is emitted in the form of a beam was discussed, particularly in its reference to preventing inter-action between the loud-speakers and the microphone in public address systems.

The construction of a loud-speaker embodying the principles dealt with was described and subsequently demonstrated, and the desirable effects of tone control provided in the amplifier shown. The quality of reproduction undoubtedly substantiated the arguments appertaining to the design.

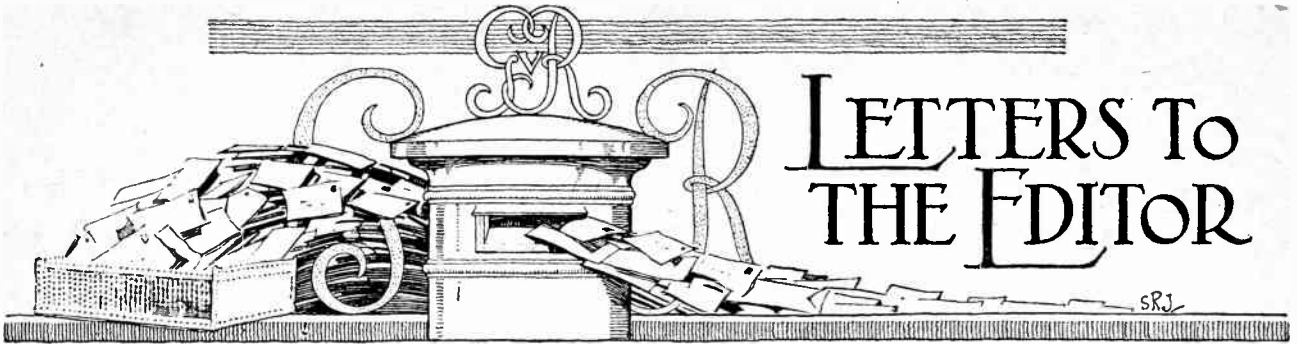

The Editor does not hold himself responsible for the opinions of his correspondents.

Correspondence should be addressed to the Editor, "The Wireless World," Dorset House, Tudor Street, E.C.4, and must be accompanied by the writer's name and address.

"DOING" THE ACCUMULATOR.

Sir,—In "News from the Clubs" in your issue of January 20th I note that you report a "lecture" on "Doing" the Accumulator" by a Mr. L. C. Holton. This gentleman remarks with horror that he has actually seen a garage proprietor washing down an accumulator with a hosepipe.

Presumably, when Mr. Holton's own battery requires cleaning externally he carries it tenderly to the bathroom and gently washes it with baby soap and a sponge.

It should be obvious that it cannot harm a battery to hose it down if the stoppers are in place. In the business with which I am connected, we sometimes receive accumulators for charging which have not only to be washed to rid them of filth, but we find that the oxygen flame sometimes has to be employed to loosen the terminals, and vigorous use of the wire brush is necessary before they are fit to put on charge without the risk of heating and possibly of fire.

The garage proprietor whom Mr. Holton condemns for hosing down the battery was merely doing his duty by seeing that it left his hands in a clean and serviceable state.

Although not personally in the motor trade, I feel that attacks of this kind are quite uncalled for, and do more harm to the user of accumulators, by misleading him, than to those upon whom they are directed.

Southport, Lancs.

J. B. TAYLER.

PROGRESS OF BROADCASTING—ENGLAND AND AMERICA COMPARED.

Sir,—An article in the February issue of the American journal, *Radio News*, dealing with the progress of the wireless industry, is not without interest, though, of course, it is founded on what can only be called pure guesswork. This guesswork shows that 17% of American homes are fitted with wireless receiving apparatus. In view of the exaggerated claims which they make for their position in radio, I think this is rather low.

Now consider the English figures, which can be based on definite fact. Accepting the American definition of a home as consisting of four persons, there are ten million homes in this country which are definitely fitted with one million six hundred thousand licensed sets, or 16%. Beyond this, the P.M.G. assumes there are a further six hundred thousand unlicensed sets, which would bring the total of radio-equipped homes up to something like 22%.

It seems to me to be a clear proof that this shows the advantages of a well organised system of broadcasting, for we certainly beat the Americans on their own ground.

Old Bond Street, W.1.

ARTHUR C. BANFIELD.

A QUESTION OF DISTANCE.

Sir,—Under the heading "A Question of Signal Strength" in *The Wireless World* of December 23rd your correspondent, H. E. Adshead, refers to my article of December 9th, viz., "Crystal Reception from 5XX."

It is stated that I have measured the distance from Chelmsford to Daventry incorrectly. I presume that the 40 miles has been subtracted from 130 miles, thus giving a greater distance than Mr. Adshead obtained by measuring from Chelmsford to Daventry. You will notice that in the diagram in the article mentioned a definite dimension was not put between these two places. I do not question the measurement given by Mr. Adshead, but perhaps if I state how my measurements were obtained it will be seen how the difference has originated.

The distances between that part of Birmingham concerned and Daventry, and between Birmingham and Chelmsford, according to a Bacon map, were 44 miles and 137 miles respectively. Using a Bartholomew differently projected map the distances were 35½ and 126 miles.

It will be seen that a compromise was made when giving 40 and 130 miles in the article. Measurements made from another Bartholomew map gave: Birmingham to Daventry, 35 miles; Birmingham to Chelmsford, 116 miles; these values agreeing fairly closely with those of your correspondent. I do not attach great importance to the discrepancy in the figures which are given, and as a matter of fact I hesitated whether or not to mention these values at all in the article. Mr. Adshead suggests that I am not aware that signal strengths received would follow a square law. I am not sufficiently pedantic to mention in a short article all that I have become acquainted with after many years' study of the subject concerned.

I purposely refrained from connecting the results which were given with any mathematical law owing to the fact that there are too many variable and unknown factors to be considered.

Aston, Birmingham.

H. L. CAPE.

NIGHT EFFECT ON 25 METRE SERIES.

Sir,—I have for the past few weeks been carrying out experiments in the reception of short waves down to 18 metres. I have come to the conclusion that the results obtained from the following stations are worthy of note:—

PCMM.—Signal strength at 13.00 G.M.T. on 25 metres: R6.

Signal strength at 18.00 G.M.T. on 25 metres: R7.8.

PCIL.—Signal strength at 18.00 G.M.T. on 55 metres: R9.

Signal strength at 18.00 G.M.T. on 27½ metres (same transmission): R5.6.

Unknown station on 25 metres at sunset: R9 at Ismailia.

The above stations have been observed on several occasions, with identical results. I append a diagram of the receiver used (one valve).

I would appreciate it very

much were any reader of *The Wireless World* who has had a similar experience to communicate with me.

EDWIN J. ALWAY, A.M.I.R.E.

(Cpl., Royal Air Force.)

Ismailia, Egypt.

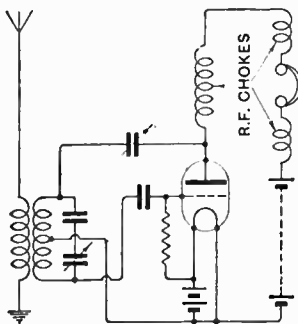
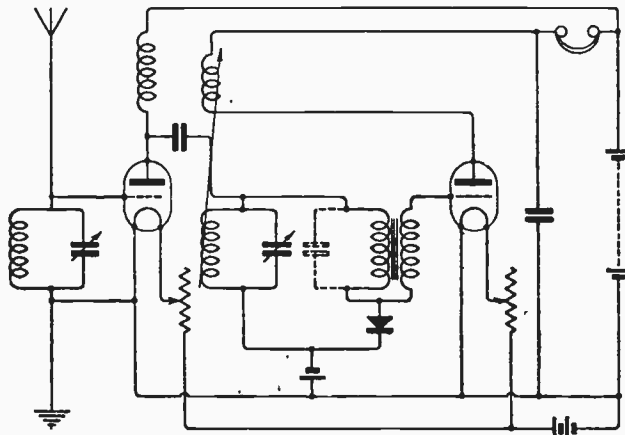

Diagram of G. Alway's short-wave receiver.

VALVE-CRYSTAL RECEIVERS.

Sir,—In *The Wireless World* of December 30th last, Mr. J. W. Canham described a valve-crystal receiver in which the usual positions of crystal and transformer primary are reversed, and the aerial inductance is included in the grid circuit of the valve. This receiver, as Mr. Canham pointed out, is particularly suitable for loud-speaker reception from the local station, but the basic circuit can, of course, be applied to a receiver for more distant working. One convenient method of providing for this is shown in the accompanying diagram, a stage of high-frequency amplification being employed without disturbing the essential valve-crystal circuit. This arrangement, which is described in Radio Engineering Company's Patent No. 234,965, covering the basic circuit, permits of closer adjustment of reaction, and, by reason of the additional tuned cir-



Modified valve-crystal circuit.

cuit, will give greater selectivity. It will be seen that the anode of the H.F. valve is coupled through a small condenser to the high potential end of the valve-crystal circuit, the anode feed current for the H.F. valve being carried through a high-frequency choke coil.

An alternative method of extending the usefulness of a receiver embodying this particular valve-crystal circuit has also been described in the same company's Patent No. 239,310, and consists in the use of a detector mounted within a telephone plug which can be inserted in a jack so connected that when the detector is removed the first valve functions as a rectifier with a condenser and leak in its grid circuit. The receiver is then suitable for headphone reception of distant stations, but on replacing the crystal the circuit described by Mr. Canham for loud-speaker reception of local broadcast is produced.

The self-capacities of various types of intervalve transformers when used in this circuit have been found to vary considerably, and with some of the latest types the capacity existing between the adjacent turns of the primary and secondary windings can be best utilised by connecting O.P. to aerial and I.S. to grid. In some cases a small condenser not exceeding 0.0001 mfd. may be placed between the aerial and grid; this is done with advantage when a low resistance detector of the galena type is used and a large amount of reaction applied to counteract the heavy damping in the circuit, or when the valves employed have grids of relatively high capacity, as in some of the recently developed valves having flattened electrodes. Selection of a suitable transformer ratio between the crystal and the grid should be facilitated by the use of an auto-transformer in place of the ordinary inter-valve transformer and is particularly useful where it is desired to use crystal combinations the impedances of which differ considerably. Other minor modifications will no doubt be obvious to those readers who have given attention to the possible applications of valve-crystal circuit arrangements, and the very favourable conclusions reached by writers in *The Wireless World* and *Experimental Wireless* on this subject fully justify further experimental work in this direction. One important advantage which the circuit described by Mr. Canham

possesses is its immunity from interference caused by electric light mains and kindred disturbances; this is mainly due to the absence of any large collective capacity across the grid and filament of the valve. It will be noticed upon examining the circuit that both the aerial and filament are substantially at zero low-frequency potential, a condition not easily realised in conventional reflex circuits. E. A. B. SNOADEN.

Southfields, S.W.18.

Radio Engineering Co., Ltd.

SLOW MORSE TRANSMISSION.

Sir,—With reference to the letter of Mr. E. H. Robinson (G5YM) in your issue of October 7th, I should like to state that, although I have been an operator for the last seven and a half years, it was only on reading that letter that I learnt that "SOS is sent at five w.p.m. by international rule." However, in Appendix X. to the P.M.G.'s Handbook for Wireless Operators it is stated that "the following special arrangements . . . are additional to the International Radiotelegraph Regulations," and about half-way down the page, under heading "Distress Signal," is the following:—"The first SOS signal should be transmitted at a speed equivalent to about five words (*i.e.*, about eight repetitions of --- per minute, special attention being given to the sending of long clear dashes."

It is not clear whether Mr. Robinson means that the call is made at a slow speed to attract the attention of operators, the majority of whom can read up to 30 w.p.m., but I feel I must say, in justice to all operators, that such is not the case. The slow call is primarily for the benefit of the "watchers," who on some ships take the place of fully qualified operators during the periods when the latter are not on watch.

A PROFESSIONAL BRASS-POUNDER.

Buenos Aires, Argentina.

THE WORK OF THE AMATEUR.

Sir,—Your correspondents, "C.W.B.," Captain. Eckersley, and others of like mind have missed the main point with regard to amateurs. These are of two classes:—(1) Research workers with adequate qualifications, (2) constructors engaged in a scientific hobby, making improvements, etc. The first class requires no comment; the second exists for the joy of a creative intellectual hobby. Such amateurs usually possess a knowledge of physics, etc., of Matriculation or Intermediate standard. I categorically deny "C.W.B.'s" statement that they are chiefly concerned in receiving broadcasting cheaply. Nine-tenths of their time is engaged in constructing, and the broadcasting is of secondary importance. This class—educated electrically—is here to stay, and should not be confused with the small minority of profit-making constructors, whose conduct is to be condemned.

Further, the tradesmen, for whom I presume Capt. Eckersley speaks (or writes), have overlooked a small fact. The public does not exist simply to supply them with delectable profits. On the contrary, the tradesmen exist to satisfy the public's need. The trader who attempts to sell things unrequired—exorbitantly priced multi-valve sets, for example—to the public will speedily find himself in the bankruptcy court.

The opinions of our leading component makers would be interesting to know.

Your delightfully curt correspondent, Mr. Beamish, is surely a Pelmanist!

L. H. ASHLEY.

Harlesden, N.W.10.

SURFACE INSULATION OF EBONITE.

Sir,—With reference to the article in *The Wireless World* of January 20th regarding surface insulation on ebonite panels, it may interest you to know that our Regal polished ebonite is entirely free from surface leakage, and, moreover, the polish is obtained without the use of tin foil, a special process being used to obtain the finish on the sheets.

We enclose copy of test made by the National Physical Laboratory on this material, and we enclose a small sample for your inspection.

For SPICERS, LTD.

London, E.C.4.

F. Walker, I.M. Dept.

[An examination of the N.P.L. Test Report referred to shows that the surface resistivity is so high as to preclude the possibility of any surface leakage.—Ed.]

SPEECH AMPLIFIER DESIGN.

Sir,—I was very interested in the article by Dr. McLachlan on "Speech Amplifier Design" in the issue of *The Wireless World* for January 13th.

In regard to the best mode of coupling the loud-speaker in the anode circuit of the last valve, I have found that, for high-resistance instruments, the choke-capacity feed method, coupled as the accompanying diagram shows, to be about the most useful from the practical point of view. In addition to the usual advantages of this feed, it puts the loud-speaker and its leads at earth potential, thereby minimising the chance of a shorted high-tension battery when long leads are used. If, when the electric mains are used for high tension, the loud-speaker lead is connected direct to the earth lead, a short circuit becomes still more remote.

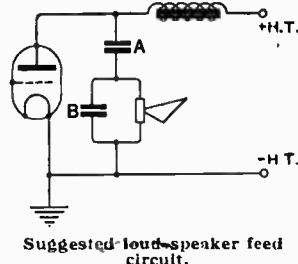

The two fixed condensers A and B control the exaggeration of frequencies, i.e., apparent pitch, similar to the diagrams in his Fig. 8. At the bottom of these he states that "a reduction in the value of the condenser (d), which is in parallel, decreases the high tones." Surely this is incorrect. With no condenser (in parallel) there at all, the high tones will be at full strength, but when a condenser is put across the speaker terminals the high tones will be weakened until, as the condenser is increased in value up to about 0.05 mfd., only the lowest tones will be audible.

I find that decreasing the value of the series condenser A is a much better method of exaggerating the high tones than the method of shunting the speaker with a high resistance or a choke, as is sometimes recommended. There seems to be little weakening of the low tones until A becomes smaller than 0.25 mfd., but by the time 0.005 mfd. is reached the tone has become very thin and high. Accordingly the correction values seem to lie between these two points.

It is not intended that a small value at A and the shunt condenser B should be both used at once, though this occasion-

ally makes a good method of weakening the output (i.e., decreasing both high and low tones simultaneously) when it is desired to do this without altering any of the other working characteristics of the whole receiver.

The impedance of the choke does not seem to be very critical in practice if one uses a D.E.5 or a B.4 valve in the last stage, but if a valve with a higher impedance is used the impedance of the choke must be watched carefully.

I shall be very interested in future articles on this subject, and in wishing *The Wireless World* a continuation of its successes, I would add that it is articles of this character that make the paper what it is.

Trusting that this may be of interest to your readers.

Preston, Lancs.

J. M. TOULMIN.

MORSE RECEPTION.

Sir,—I was very interested to see your remarks under the heading "An Unexplored Field" in the current issue of *The Wireless World and Radio Review*.

I am one of those who got most enjoyment out of Morse. I only had that to listen to in the days before Captain Eckerley was saying "Two emma toc, W-r-r-r-rittle calling," and have never lost interest in it. I have a tuner for coils, and coils up to 30,000 metres, a specially selective 300, 450 and 600 metre tuner for spark for my own use, and a Daventry tuner for the use of the family while I am away. I use a separate heterodyne for C.W. reception, and log much of the traffic between ships and Devises on 2,100 and 2,400 metres C.W., also on 600 metres, and have several times intercepted and listened to the finish of SOS calls on 600 metres.

I also have a home-made Morse inker (siphon type) which works very well on the high-speed traffic from and to Ongar.

Other interesting traffic includes Admiralty messages on 3,000 metres, aviation traffic messages on 1,400 metres, and Air Ministry traffic with G.H.A.

I think all the above is far more interesting than listening to entertainment, etc., besides being good exercise for the ears, eyes and brain.

Appledore, Kent.

W. G. PHILPOTT.

EXPERIMENTAL TRANSMITTING STATIONS.

Additional Call signs to the supplementary list to the "Wireless Annual for Amateurs and Experimenters," 1926, which we included in last week's issue.

URUGUAY.

- WOX J. R. Polero, 18 de Julio 1954.
- WOR F. Leborgne, Luis B. Cavia 2783.
- WOS A. Marroche, G. Ramirez 1870.
- WGH G. Pozzoli, 25 de Mayo 232.
- JGN J. G. Nores, Justicia 2149.
- WF W. Fernández, Durazno 1665.
- CR 3 C. M. Rubio, Mazzini 3141.
- JB 2 J. Beretervide, Larrañaga 572.
- 3 A F. García, Cerrito 419.
- CB 6 C. Butler, San José 828.
- CP 8 C. Piazensa, Avelino Miranda 2541.
- AC J. y A. Morelli, Canelones 982.

- Nos. 21 W. Figueira, Magallanes 1070.
- 24 Gálvez, Nicaragua.
- 26 E. Fernández, Agraciada 1896.
- 35 R. Luján, Lima 1570.
- 50 Paricetti, Sarmiento 2533.
- 54 P. Pose, Cerro Largo 1184.
- 78 J. P. Greco, Uruguay 1121.
- 79 A. V. Guerra, Rio Negro 1432.
- 83 O. Parodi, Buxareo 600.
- 124 J. Montaldo, 8 de Octubre 3035.
- 139 R. Elena, Garibaldi 2965.
- 155 Llaguno, Boulevard España 2401.
- 214 A. M. Pérez, Emilio Reus 2480.
- 245 J. Moscatelli, Fomento 19.
- 248 G. Baranda, Defensa 1056.
- 270 A. Torra, San Martín 3220.
- 346 J. C. Mussio, Gral. Urquiza 2528.
- 400 Biso, Av. España 2218.
- 472 F. Darrigrand, Joaquín Requena 1043.
- 455 M. Sibils, J. B. Blanco 746.
- 609 C. Stefani, Canelones 874.
- 622 H. Paganini, Colonia 2090.
- 704 A. Nin Ramos, Joaquín Requena 1455.
- 910 V. Zamora, Chucarro 58.
- 1161 S. Santamaría, Caridad 1365.
- 1180 E. Stagarro, Mercedes 1212.
- 1244 A. Giorello, hijo, Agraciada 2320.

- Radio Larrañaga—E. Legrand, Larrañaga 140.
- Radio Maroñas—P. Villamil, G. Flores 7058.
- Radio Victoria—M. González, Dante 2354.
- Radio Paysandú—Aragunde, Chaná 1834.
- Radio Chaña—Aragunde, Chaná 1834.
- Radio Blandengues—J. Peña, G. Flores 2881.
- Radio Minas—R. Walker, Minas 1721.
- Radio Canelones—L. Colombo, Canelones 1982.
- Radio Bella Vista—E. Lesieux, Canelones 961.
- Radio Yaguarón—R. Mauriño, Yaguarón 1700.
- Radio América—A. Camogli, Cerro Largo 2157.
- Radio Capurro—R. Casabó, Capurro 57.
- Radio Savaró—E. Bravo, Savaró.
- Radio Artigas—O. Domenech, Canelones 1622.
- Radio Unión—H. Cabral, 8 de Octubre 2769.
- Talleres de D. Bosco.

- DEPARTMENT OF SAN JOSE.
- No. 1 A. Daverde.
- No. 2 Santiago Vivas.
- No. 3 B. García.
- No. 4 Santiago Brucoleri.
- No. 5 J. Saquierez.
- No. 6 E. Borzone.

- DEPARTMENT OF CANELONES.
- Canelones 1. P. Ferrari.
- Canelones 2. C. Vidal y Vidal.
- R 1 H. Espiga.
- 1105 de Santa Rosa. G. Pertuso Santa Rosa Colegio del Manga. Manga.

- DEPARTMENT OF COLONIA.
- Dr. Arribillaga, Carmelo.
- E. Juele, C. Piamontesa.
- C 1 E. Vols, Tarariras.

- DEPARTMENT OF SALTO.
- 1000 F. Giordano.

- DEPARTMENT OF DURAZNO.
- RHEE R. Evangelist.

- DEPARTMENT OF SORIANO.
- Palmitas. A. Fernandez Goyechea, Palmitas.
- La Calera. Alberto Urtubey, Drable.

- DEPARTMENT OF TACUAREMBO.
- CK 15 A. H. Galli, Paso de los Toros.

SOUTH AFRICA.

- Additional Stations received since 27th January.
- A 6K H. J. Wilson, Hillrise, Meyerton, Transvaal.
- A 6L R. I. Beckley, 79, Auckland Av., Auckland Park, Johannesburg.
- A 6M C. P. Beckley, 79, Auckland Av., Auckland Park, Johannesburg. (Portable.)
- A 6O G. W. Smits, Estancia Estate, Hendrina, E. Transvaal.
- A 6P R. F. Olsen, 28, King Edward Rd., Bloemfontein.
- A 6Q A. Davidson, c/o D. R. Boyce, Orange Grove, Greenwood Park, Durban.
- A 6R E. Thorne, 3rd Av., Fishhoek, Cape Province.
- A 6S J. H. Cliff, "Alice Grange," Pietermaritzburg.
- A 6T The Registrar, University of Stellenbosch, Stellenbosch.
- A 6U P. E. Card, 9, Signal Hill, East London.
- A 6V R. J. Holmes, 21, 1st Infantry Lines, Roberts Heights, Transvaal.
- A 6W A. S. Faulk, 16, Main St., Strand, Cape Town.
- A 6X W. H. Bowles, Erf No. 109, Piet Retief.
- A 6Y R. E. S. Smith, 6, Sussex Rd., Observatory, Cape Town.
- A 6Z H. Betts, Queensville, Queen's Rd., Sea Point.
- A 7A D. R. Boyce, Orange Grove, Greenwood Park, Durban.
- A 7B R. N. Perrott, "Hifod," 1st Av., Walmer, Port Elizabeth.
- A 7C A. E. Neseiman, 13, Medusa St., Kensington, Johannesburg.
- A 7D H. J. Buckley, "Longaeres," Lot 5, Little Amanzimtoti, Natal.
- A 7E C. M. C. Bone, Bulawayo House, Celliers St., Pretoria.
- A 7F R. Suttner, 39, Ockerse St., Johannesburg.

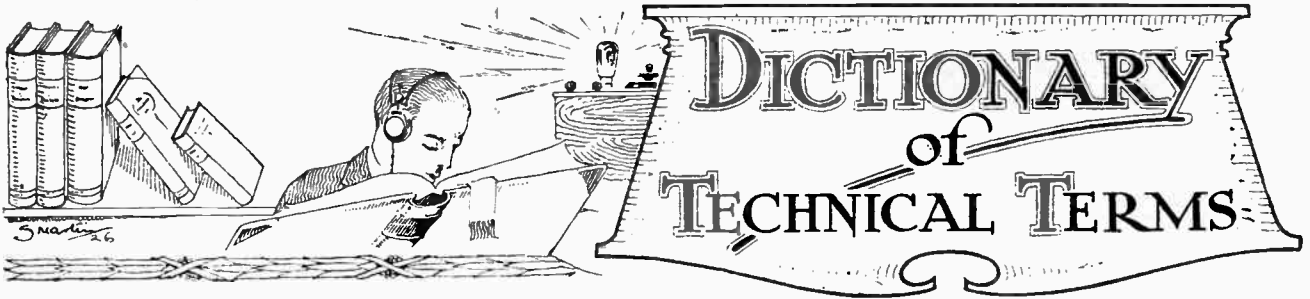

Definitions of Terms and Expressions commonly used in Wireless Telegraphy and Telephony.

This section is being continued week by week and will form an authoritative work of reference.

Spark Frequency. The number of sparks passing per second in a *spark transmitter*. This determines the pitch of the note heard in the telephones at the receiving station.

Spark Transmission. The sending of Morse signals in wireless telegraphy by trains of damped oscillations induced in the aerial circuit by *shock excitation* from a series of sparks passed between the electrodes of a suitable discharger connected in an oscillatory circuit.

Spark Gap. A small air space between two conductors or electrodes and across which a spark passes when the voltage becomes sufficiently high to break down the insulation of the intervening air. Usually provided as a protection against excessive voltages; e.g., a spark gap or safety gap is often provided between the leading-in wire of an aerial and the earth wire as a protection against lightning.

Specific Conductance or Specific Conductivity. The reciprocal of *specific resistance*, i.e., the conducting power of a substance in *ohms* per centimetre cube or per inch cube.

Specific Inductive Capacity (S.I.C.). A measure of the extent to which a *dielectric* permits electrostatic lines of force to pass through it. The S.I.C. of a material is defined as the ratio of the capacity of a condenser with that material as dielectric to the capacity of another condenser of identically the same shape and dimensions with dry air at normal pressure as the dielectric. A vacuum has the lowest S.I.C., being about 0.9985, whereas that of pure water is about 81 at 17° C. The S.I.C. of mica varies from 4 to 8, according to the quality.

Specific Gravity (of accumulator acid). The ratio of the mass of a given volume of the acid to the mass of an equal volume of water. The statement that the *specific gravity* of the acid is 1.2 means that the acid is 1.2 times as heavy as water.

Specific Resistance. The resisting properties of a material expressed as the *resistance* of a conductor of unit length and of unit cross section, i.e., the resistance measured between two opposite

faces of a cube of the material, the sides of the cube being of unit length and the current distribution through it uniform. It is usually expressed in *microhms* per centimetre cube or per inch cube. Another name, probably more suitable, is "volume resistivity." The specific resistance is usually denoted by the Greek letter ρ .

If l is the length of a conductor in centimetres, a its cross sectional area in square centimetres, and ρ is the specific resistance in *ohms* per centimetre cube at a given temperature, then the resistance of the conductor is given by

$$R = \frac{\rho l}{a} \text{—ohms at that temperature. See}$$

TEMPERATURE COEFFICIENT.

Speech Amplifier. A *low-frequency amplifier* for increasing the strength of speech signals in a wireless receiver, etc. See LOW-FREQUENCY AMPLIFIER.

Sp. Gr. Abbreviation for *specific gravity*.

Square Law Condenser. A *variable condenser* in which the plates are of such a shape that the capacity is proportional to the square of the angle of rotation of the dial from the zero position. Used for tuning in cases where it is desired

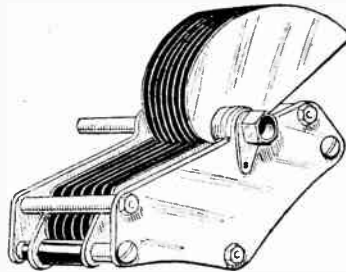

Square Law Condenser.

that the change in wavelength shall be proportional to the change in condenser reading, thus preventing the crowding of the lower values of wavelength at the lower end of the scale. Particularly useful in *wavemeter* construction.

S.S.C. Abbreviation for *single silk covered*.

Stand-Bi. A change-over switch is sometimes provided in a loose-coupled

receiving circuit enabling the *detector* to be connected either directly to the aerial circuit, giving comparatively *flat tuning*, or to the secondary circuit for sharp tuning. The former is termed "stand-bi" position, and facilitates in the searching for signals. Once the desired signal is found the detector is switched over to the secondary circuit, or "tuno" position as it is called, in order to get greater *selectivity*.

Standard Condenser. A condenser, either of variable or fixed *capacity*, specially constructed to be free from losses and to have a constant calibration. For wireless measurements standard condensers always have air *dielectric*.

Standard Wire Gauge. A series of numbers by means of which the diameters of wires are legally denoted in Great Britain, the sizes of wires being in a regular progression for successive numbers. No. 1 is 0.3in. in diameter, and No. 50 is 0.001in. in diameter. Other wire gauges are the Birmingham Wire Gauge (B.W.G.), also used to a certain extent in this country, and the Brown and Sharpe Wire Gauge used in America.

HIDDEN ADVERTISEMENTS COMPETITION.

The following are the correct solutions for "The Wireless World" Hidden Advertisement Competition for January 20th, 1926.

Cluc No.	Name of Advertiser.	Page
1	Nelson Electric Co., Ltd.	23
2	Brandes, Ltd.	11
3	Relfex Radio Co., Ltd.	21
4	Telsen Transformers	23
5	A. J. Stevens & Co. (1914) Ltd.	13
6	Halladay's Ltd.	111

The prizewinners are as follow:

W. Smalley, London, N.16	£5
G. M. Pargiter, Percy Main, Northumberland	£2
S. R. Nicholls, London, S.E.26	£1

Ten shillings each to the following four:

J. W. Mann, Mytholmroyd, Yorks.
F. W. Moffat, Birmingham.
C. E. White, Bournemouth.
G. E. H. Rawlins, Benbridge, I.O.W.



READERS PROBLEMS

"The Wireless World" Information Department Conducts a Free Service of Replies to Readers' Queries.

Questions should be concisely worded, and headed "Information Department." Each separate question must be accompanied by a stamped addressed envelope for postal reply.

Using a Double-reading Voltmeter.

I am building a three-valve set consisting of a conventional detector valve circuit employing the usual system of rectification with reaction on to the aerial coil followed by two stages of transformer-coupled L.F. amplification, my main object being to obtain plenty of volume coupled with purity on the stations that are well within my range with only a moderate degree of reaction. In order to ensure purity I have equipped myself with the proper types of valves in both detector and L.F. stages, the transformers being specially chosen to work with the valves. I have also a double reading voltmeter with a common negative terminal with scale readings of 0-6 volts and 0-120 volts. I desire to arrange switching on my panel so that I can measure the voltage of my accumulator and also measure accurately the voltage obtainable at each H.T. tapping in order to ensure that correct H.T. voltages are sufficient to each valve.

A.W.R.

The arrangement of switching the voltmeter in the manner which you suggest is perfectly feasible, and we give in Fig. 1 a diagram of the necessary connections to effect this result. You will need a double-pole, double-throw switch, which may be of the "Utility" or similar type, and also a selector switch and nine studs. By placing the double-pole switch to the left the voltage of the accumulator will be indicated, the low-

resistance side of the voltmeter connecting directly across the accumulator and indicating its voltage. It should not be forgotten that in order to obtain a correct indication of the voltage of the accumulator the test must be made when it is actually lighting the valve filaments. Upon throwing over the double-pole switch to the right the high-resistance winding of the voltmeter is substituted for the low-resistance winding. It might be thought by many that this operation could be performed by a single-pole switch, but a moment's thought will indicate the impossibility of this. With the selector switch on the first stud, of course, the voltmeter will be in the "off" position. Upon moving the switch to the third stud, the voltage being applied to the detector valve will be indicated, the fifth and seventh studs giving the readings of the first and second L.F. amplifiers respectively. The purpose of the ninth stud and the additional H.T. terminal is to enable a reading to be taken of the total voltage of the H.T. battery. Suppose, for instance, you were using a 120-volt H.T. battery, and the highest H.T. tapping applied to the set were 110 volts, the extra H.T. terminal should be connected to the 120-volt wander plug socket of the battery, and then an indication could be obtained of the total voltage of the battery. It is extremely useful to make use of a selector switch in conjunction with a voltmeter in this manner, in order to correctly adjust the H.T. voltages applied to the valves, and this more specially applies when special circuits are

used involving the necessity of the use of definite H.T. voltages on different valves, such as in a superheterodyne receiver, since, of course, the system is applicable to any number of valves. In the case of a new H.T. battery the different wander plug sockets are marked with the different voltage values, and adjustments can be made in this manner, but after a comparatively short period of use the voltage of the battery drops, and thus figures are then entirely misleading. The reason for the use of alternate blank studs is to prevent sections of the H.T. battery being short-circuited when the switch is passing from stud to stud, since, of course, the switch is then momentarily in contact with two studs simultaneously.

o o o o

Obtaining H.T. from Mains with an Earthed Positive.

I have recently tried out an arrangement for obtaining H.T. from D.C. mains using a 2 mfd. condenser in the earth lead. Every satisfaction was obtained by this method, but I was rather puzzled as to the reason why it should work, since the positive main is earthed. Later I substituted an ordinary 60-volt H.T. battery, still retaining the condenser in the earth lead, and earthed the H.T. terminal, and reception was perfectly normal. I fail to see how a receiver can function with the H.T. terminal at earth potential, and an explanation will oblige. J.J.M.

The results you have been obtaining are quite normal, and the explanation is quite simple. As you are aware, in the conventional receiver, the H.T. - is connected to earth, and therefore the positive terminal of the normal H.T. battery is 60 volts above earth potential, but only with respect to D.C. At all times the positive terminal of the H.T. battery is just as much at earth potential with respect to both H.F. and L.F. as is the H.T. - terminal, since the 1 mfd. condenser acts as a complete short circuit to both H.F. and L.F., but not, of course, to D.C. It will be seen, therefore, that it is quite irrelevant whether or no the positive main is earthed except that a 2 mfd. condenser must be placed in the earth lead in order to prevent the mains being short-circuited. When we use a tuned anode coupling it is important to connect the moving plates of the anode tuning condensers to H.T. + and not

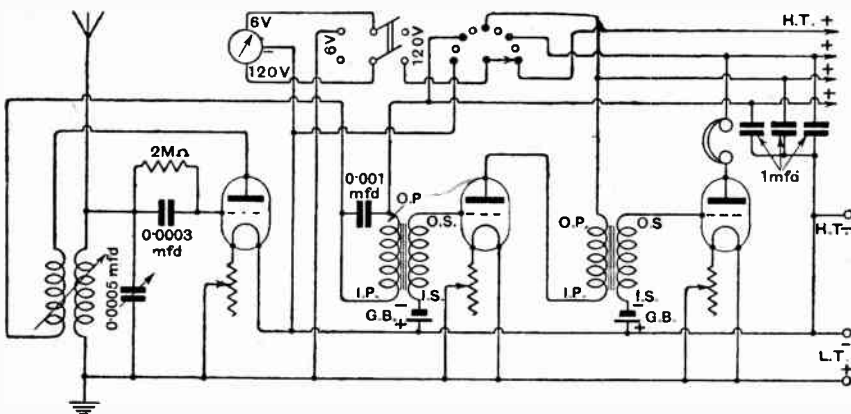

Fig. 1.—Double-range voltmeter connected in three-valve receiver to indicate voltage of L.T. battery and of each H.T. tapping.

The Re-creation of Speech & Music



A.J.S. Loud Speakers and Receivers may be obtained by easy payments from
H. Taylor & Co. Ltd.,
 49-50, 52, 53, Sussex Place,
 South Kensington, S.W.7.
 Write for particulars.

THERE is a world of difference between the varying quality of sounds which are emitted from some Radio Receivers, and the re-creation of the musical genius of great artists, as obtained when using an A.J.S. choke coupled circuit in conjunction with an A.J.S. Loud Speaker. The quality of radio reproduction depends almost entirely on the method of intervalve coupling and the type of loud speaker used, and for this reason A.J.S. have devoted a great amount of research to produce an ideal choke—one to do credit to the fine qualities of their loud speakers.

A.J.S. Loud Speakers are not black, unless you particularly desire them so. The most popular models have metal flares, hand coloured and grained in various shades of Oak, Mahogany, Walnut and Rosewood. They may also be obtained with Oak or Mahogany flares, truly fine instruments. The Junior model is not a "Baby," but the "Big Brother" of the Standard types. It is 19 inches high and produces full round tones. The A.J.S. Choke Unit is a most important component in a receiver, where the constructor desires the re-creation of speech and music which is absolutely true to life.

Publication No. 118 describes all A.J.S. Loud Speakers.

STANDARD LOUD SPEAKERS	
Height 24 inches.	
In Wood—	
Mahogany or Oak Flares	£4 15 0
In Metal—	
Black Matt or Stove Finish	£4 0 0
Grained, various wood finishes	£4 5 0
JUNIOR LOUD SPEAKERS.	
In metal, Height 19-in.	
Black Horn	£1 15 0
Grained wood finish	£1 17 6
Cabinet Model in Mahogany	£4 15 0
Pedestal Model in Mahogany or Rosewood	£22 10 0

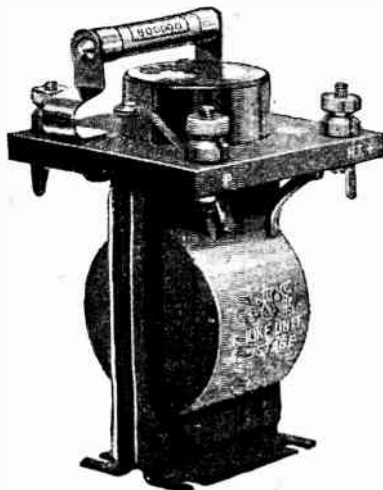

CHOKE UNITS.

Comprising shrouded choke, grid leaks, and fixed condensers, for first and second stage.

20/-

Choke only (shrouded),

15/-

Ask for publication No. 115.

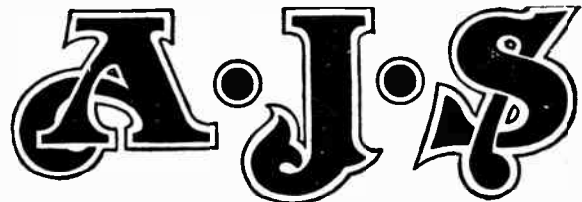

A. J. STEVENS & CO. (1914) LTD.
RADIO BRANCH, WOLVERHAMPTON.
 Telephone: 1743 (7 lines). Telegrams: "Reception, Wolverhampton."
London Showrooms: 122/124 Charing Cross Rd., London, W.C.2.

Telephone: Regent 7161 2. Telegrams: "Ajayessco, Westcent, London."
Glasgow Showrooms: 223, St. George's Road, Glasgow.
 Telephone: Douglas 3449. Telegrams: "Reception, Glasgow."

A. J. STEVENS & CO. (1914) LTD.,
RADIO BRANCH, WOLVERHAMPTON.

Please send publications No. 118 and 115 describing Loud Speakers and Chokes respectively

Name

Address

W.V. 3/2/26.

ISSUED BY THE PUBLICITY DEPT. A.J.S.

Advertisements for "The Wireless World" are only accepted from firms we believe to be thoroughly reliable.

£10 Weekly in Cash Prizes





A New and Simple Competition
for all Readers of "The Wireless World"

To be continued weekly until further notice.

HIDDEN ADVERTISEMENTS

Below will be found six reproductions of fragments cut from the Advertisement pages of this issue of "The Wireless World." Each fragment is a clue. Can you from these clues identify the Advertisements? Seven cash prizes will be awarded to the first seven readers who send us correct solutions. No technical skill is required, merely observation. There are no restrictions or entry fees and the conditions are simple.

£5
for the first
correct solution
opened.

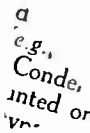
	
1	2
	
3	4
	
5	6

£1
for the third
correct solution
opened.

and
4
consolation
prizes of
10/-
Each

for the next four
correct solutions
opened.

£2
for the second
correct solution
opened.

CONDITIONS

1. All solutions must be written on the special coupon appearing on an advertisement page in this issue and addressed to *The Wireless World*, Dorset House, Tudor Street, London, E.C.4, and marked "Hidden Adverts." in bottom left corner.

2. Clues will not, of necessity, appear in the same way as in the advertisement page, but may be inverted or placed in some other position.

3. In order that town and country readers may compete on equal terms, solutions will not be dealt with until 10 a.m. on Monday next. All solutions received before that date will be retained until Monday morning. Competitors may submit any

number of entries. Erasures or alterations on a coupon will disqualify the entry.

4. The first prize of £5 will be awarded for the first correct solution opened; the second prize of £2 to the next correct solution; the third prize of £1 for the third, and four consolation prizes of 10/- each for the next four correct answers. In the event of no readers sending correct solutions the prizes will be awarded to the competitors whose solutions are most nearly correct.

5. The decision of the Advertisement Manager of *The Wireless World* is final, and no correspondence can be entered into. Competitors enter on this distinct understanding. No member of the staff of the paper is permitted to compete.

ENSURE PERFECT RECEPTION

by using



MILLIAMMETERS
VOLTMETERS
AMMETERS

Prices from 7/-

If your dealer is out of stock write to :-

SIFAM ELECTRICAL INSTRUMENT CO.,
Dept. W, 95 QUEEN VICTORIA STREET,
LONDON, E.C.4.

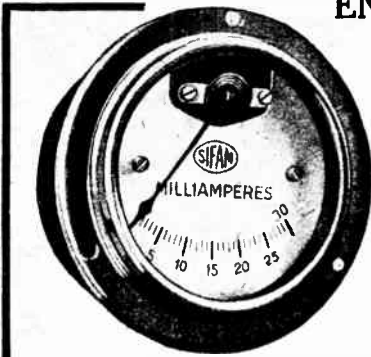

Flush or Projecting Types 25.-

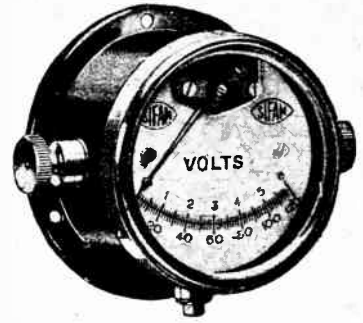

Flush or Projecting Types 27/6

Sangamo
The New Condenser
Stays Accurate

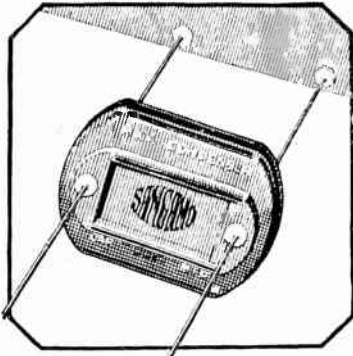

SIMPLICITY IN ASSEMBLY.—When connecting up in the ordinary way, simply clamp the leads under the terminal screws; if preferred, just tack with solder in addition. When connecting up with bus-bars remove the condenser terminal screws, pass the bus-bars through the screw-holes and tack up with solder. The soldering process can be carried out without any risk of burned fingers. No cutting of leads is required.

Moulded in smooth brown bakelite, the Sangamo Fixed Condenser presents a pleasing appearance that adds to the attractiveness of your set. It is guaranteed to be accurate and is entirely unaffected by temperature and humidity changes.

Sangamo Condensers are made in all standard capacities, and supplied with or without grid leak clips. Ask to see one at your usual supplier.



TRADE INQUIRIES INVITED.

THE BRITISH SANGAMO Co., Ltd.

Ponders End, Middlesex.



"ANVIL"

the only

GENUINE DUOLATERAL COIL FORMER

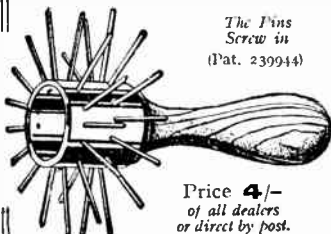

The Pins
Screw in
(Pat. 230944)

Price 4/-
of all dealers
or direct by post.

You will save 70% by making your own coils. The best type of Low-Loss, Duolateral and Honey-comb coils can only be wound on a 15 pin former. The "ANVIL" supplies this need.

Full instructions, together with wave and broadcasting charts supplied with each "ANVIL" FORMER.

Made entirely of brass with neat wooden handle. Write for full catalogue.

BURWOOD (Concessionaires) LTD., 41, 61, Queen St., W.C.2.

YOU want the **BEST**
BATTERY SERVICE
YOU CAN GET

—with a steady voltage on discharge; noiseless in operation; and easily and cheaply refilled AT HOME. You get this with the

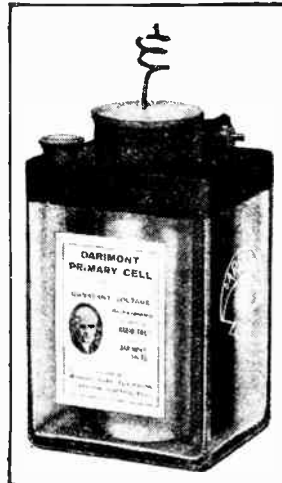

(Patented)

DARIMONT
HIGH EFFICIENCY
BATTERY

When used with Dull Emitter Valves.

Write or phone for LIST which fully describes the convenience and economy of the

"HOME SERVICE" BATTERY.

BUY BRITISH-MADE BATTERIES.

DARIMONT ELECTRIC BATTERIES LTD.

DARIMONT WORKS, ABBEY ROAD, PARK ROYAL, LONDON, N.W.10. Telephone: Wembley 2807.

"Japa" REGD

PLUG & SOCKET TERMINALS ARE THE FINEST TERMINALS IN THE WORLD FOR ALL WIRELESS CONNECTIONS.

BRITISH MADE.

If your Dealer cannot supply send direct to the maker.

W. J. CHARLESWORTH, 68 & 89, Aston Street, BIRMINGHAM. — Established 1897

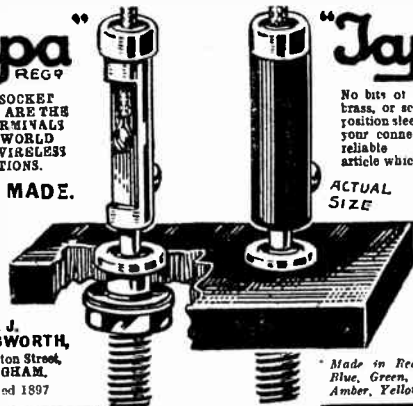

No bits of bent tin or brass, or screwed composition sleeves to make your connection, but a reliable mechanical article which has been copied by many but equalled by none.

ACTUAL SIZE

Insist upon the genuine article

6D. EACH Post free.

Made in Red, Black, Pale Blue, Green, Royal Blue, Amber, Yellow, Brown.

The most reliable wireless books are published by "The Wireless World"

RELIABILITY is the first and most important thing one expects from a textbook on wireless. Every possible care has been taken to ensure that "The Wireless World" publications contain only information that is strictly accurate and reliable.

ALL of the volumes are written by technical experts; men who have years of wireless experimental experience to their credit and whose names are a guarantee of the soundness and dependability of the advice and instruction that are given. Illustrations play an im-

portant and useful part in making the intricacies of modern apparatus clear to readers.

THE range of useful books is enormous — from the "Ezi-Wiring Series" for the beginner, to such authoritative works as "Wireless Valve Transmitters," by W. James (9s. net), or "The Thermionic Valve," by Dr. J. A. Fleming (25s. net).

BELOW are illustrated a few volumes chosen from our extensive library. They are representative of the high standard of technical writing which is a distinguishing feature of all publications issued by this paper.

A complete list of books published by "The Wireless World" will be sent free on request. This includes volumes dealing with all phases of wireless activity, and adapted to the needs of beginners, home constructors, experimenters and advanced workers. Remittance should accompany orders sent by post.



TUNING COILS and METHODS OF TUNING,
by W. James.

An exhaustive little manual discussing the principles and practice of tuning coils with explanations of spade, condenser and variometer tuning, etc.

Price 2/6 net. By post, 2/10.



THE HOME CONSTRUCTOR'S WIRELESS GUIDE,
by W. James.

A useful little encyclopedia of wireless technology, which will solve difficulties you meet with in practical work.

Price 3/6 net. By post, 3/10.

WIRELESS VALVE RECEIVERS AND CIRCUITS in Principle and Practice, by R. D. Bangay and N. Ashbridge, B.Sc.

Written to enable the amateur to understand the working of any circuit he constructs.

Price 2/6 net. By post, 2/10.

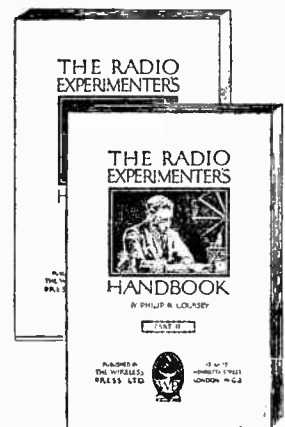
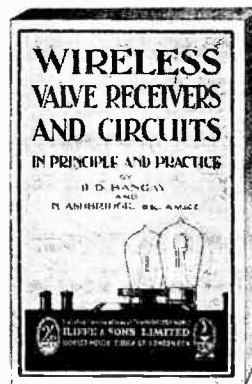

THE RADIO EXPERIMENTER'S HANDBOOK
in Two Volumes,
by P. R. Coursey, B.Sc.

These two volumes explain the principles of wireless telephony and constitute a reliable guide to working practice.

Price 3/6 net, per volume.
By post, 3/10 each.

Publishers: ILIFFE & SONS LTD., Dorset House, Tudor Street, LONDON, E.C. 4

21 INCHES!

That's the height of the "Hearth-side" Speaker. Don't mistake it for a "baby" because the price is low!
It gives full-size results with crystal-clear tone.

Send post card for new catalogue.
General Radio Co., Ltd., 235, Regent St., W.1.



IF YOU WANT THE FINEST VALVE MADE

COMBINING VOLUME, QUALITY and ECONOMY BUY

NELSON-MULTI

ALL BRITISH ALWAYS GET "A GOOD RECEPTION"



The Scissor Switch in the base of the Valve controls 3 filaments. With the switch closed, any one filament can be used, leaving 2 in reserve. Open the switch, placing 2 filaments in parallel, and the Valve is at once a POWER AMPLIFIER.

Each Valve fulfils the functions of H.F., Detector, L.F., or Power Amplifier.

FOUR IMPROVED TYPES

TYPE A.	PRICE, 9/3
4 to 5 VOLTS.	0.45 AMPS. per Filament.
TYPE D.E.A.	PRICE, 15/.
26 VOLTS.	0.18 AMPS. per Filament.
TYPE D.E.2.	PRICE, 15/.
18 to 2 VOLTS.	0.35 AMPS. per Filament.
TYPE D.E. '06.	PRICE, 16/6
3 VOLTS.	0.06 AMPS. per Filament.

ALL VALVES ARE GUARANTEED.

If unable to obtain from your local dealer, write to the makers:—

NELSON ELECTRIC CO., LTD.,
MERTON PARK, LONDON, S.W.19.

Telegrams: Valvenelso, Wimbie, London. Phone: Wimbledon 172.

THE LIFE OF THREE VALVES AT THE COST OF ONE

LOUD SPEAKER HORNS



Brown's pattern Loud Speaker Horns. Polished Aluminium. Complete with cast base solid brass and screwed cup to fit Brown's Sterling etc. phone. These horns have excellent reproducing qualities and give good volume. You can make this Loud Speaker for 6/6. We can supply Brown's "A" Type Phones to fit above, 22/6. Listen attachment 13/6 Postage 1/-.
Log Card and Catalogue FREE.



SERVICE QUALITY PRICE

6/6

PUGH'S WIRELESS, 95-101, Holloway Road, LONDON, N.7.

PRICE, complete and ready for use.
D.C. Unit £3 10 0
A.C. Unit £6 0 0
Royalty on A.C. Unit 12/6 extra

The Tudoradio Mains Unit

for D.C. or A.C. Mains (from 100 - 250 Volts)

If your H.T. battery or H.T. accumulator is a constant source of trouble to you, then write to us.

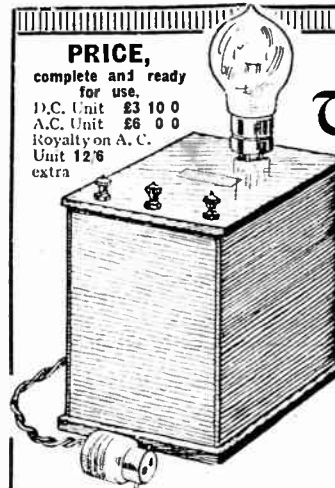

The Tudoradio Mains Unit costs less and is much smaller than a good H.T. accumulator and has none of its faults, and requires no maintenance. Owing to the extreme smoothness and constancy of supply the volume and tone from your set must be improved.

Absolutely safe — fully guaranteed.
Money refunded if you are not satisfied.

The Tudoradio Co., Ltd.,
Tudor Works, Park Royal, N.W.10.

Phone: Wembley 41.

The "GRIPPLESHELL"

Registered design No. 716927.

A device for simplifying Aerial Erection

These brackets are made from 1" best quality Wrought Iron painted with weather-proof enamel.

PRICES

Combined Corner bracket, Insulator and Pulley	3/6
6" Hold off bracket	3/-
9"	3/-
12"	3/6

FREE ON RAIL.

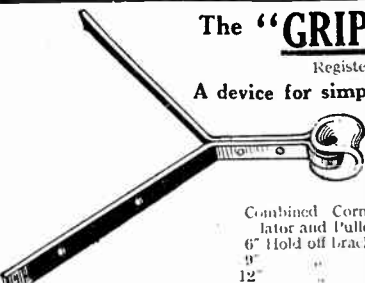

Manufactured by **PARTRIDGE & WILSON, ELECTRICAL ENGINEERS.**
217a, Loughborough Road, LEICESTER.
Telephone 5812.

EBONITE OF THE FINEST QUALITY

SHEETS
RODS &
TUBES.

PANELS CUT ANY SIZE AND ANY THICKNESS.

Egg Shell Matt or Polished Surface.

LARGE STOCKS. IMMEDIATE DELIVERY.

Awarded Silver Medal for Ebonite, Crystal Palace Electrical Exhibition, 1892.

BRITKAM-EBONITE (Britannia Rubber & Kamptulicon Co.Ltd.)

7, NEWGATE STREET, LONDON, E.C.1.

Telephone: Central 2169 (2 lines).

Telegrams: Britannia, London.

EXPERIMENTAL WIRELESS

& The WIRELESS ENGINEER

"EXPERIMENTAL WIRELESS" is published in the interests of all keen radio enthusiasts, and is widely read by professional wireless engineers and advanced amateur workers and experimenters.

Its articles are contributed by men who have made a prolonged study of the science of wireless communication and are recognised leaders in the experimental field. The correspondence columns, which are open to all, provide a forum for the discussion of readers' problems and experiences.

PRINCIPAL CONTENTS for FEBRUARY.

An Experimenter's Wireless Laboratory, by *Leonard A. Sayce, M.Sc., Ph.D., A.I.C.*, and *James Taylor, M.Sc., Ph.D., A.Inst.P.*

Valve Nomenclature, by *Prof. G. W. O. Howe, D.Sc.*

R.S.G.B. Lecture. Some Facts and Notions about Short Waves, by *Capt. Duncan Sinclair.*

Some Remarkable Effects of Large High-Frequency Electric Currents, by *G. H. Farnes, B.Sc.*

Monthly: One Shilling. Post free 1s. 3d.
Annual Subscription: 15s. post free.

Obtainable from Newsagents or direct from the Publishers:

ILIFFE & SONS LIMITED,
Dorset House, Tudor Street,
LONDON, E.C.4.

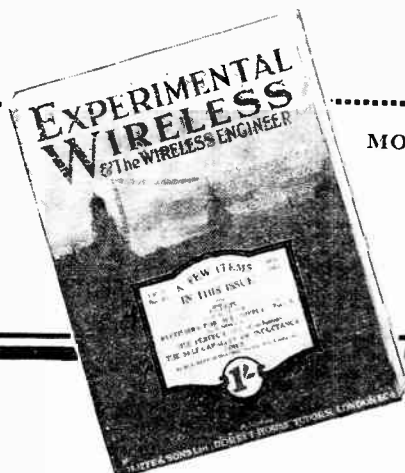

MONTHLY

1/-

W.W.2

A60

Mention of "The Wireless World," when writing to advertisers, will ensure prompt attention

A WORD TO HOME CONSTRUCTORS



Vols.
I-IV.

2/- each.
By post 2/2

Why Worry?

—about working out circuits when

The

EZI-WIRING Series

give you complete working instructions, detailed measurements and explanations of the components necessary for building highly-efficient sets at very moderate cost. A four-colour wiring diagram enables you to build the set without any possibility of incorrect wiring.

- No. 1. A Three-Valve Portable Receiver:** by *Hugh S. Pocock.* This receiver can be used in any situation with a temporary aerial or with the frame aerial incorporated in the receiver itself.
- No. 2. A Three-Valve Receiver:** by *F. H. Haynes.* The tuning arrangements of this receiver are self-contained. All the B.B.C. Stations are, therefore, within the range of this receiver when used in conjunction with an outdoor aerial.
- No. 3. A Two-Valve and Crystal Reflex Receiver:** by *W. James.* Reflex receivers are capable of giving a very high degree of amplification per valve. This two-valve and crystal reflex receiver, unlike many reflex receivers, will be found perfectly stable in operation, and will be capable of giving loud speaker strength within a radius of thirty miles of a main B.B.C. station.
- No. 4. A Four-Valve Combination Set:** by *W. James.* A four-valve receiver of this type is ideal for general reception both with telephones and a loud speaker. Switches are provided so that two, three or four valves may be used at will. An entirely new principle is used to cut out the H.F. valve, no switches being employed.

Price 2/- net each. By post 2/2 each.

Obtainable from the publishers of "The Wireless World":

ILIFFE & SONS, LTD.,
Dorset House, Tudor Street,
LONDON, E.C.4.

W.W.6a.

CAXTON 4-VALVE CABINET

Made for Editor of Wireless Magazine for Set "As good as money can buy" described in issue February, 1925.

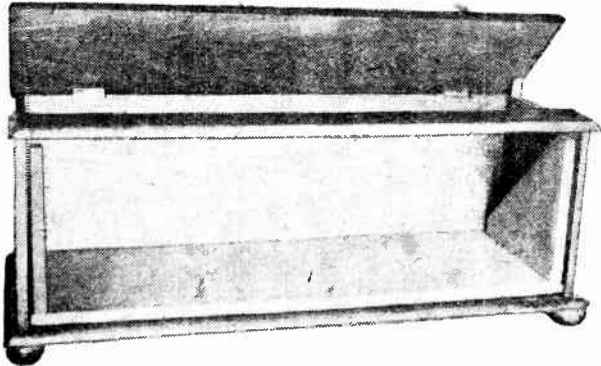

Cash with Order. Fumed Oak ... £1 5 0
 or Real Mahogany polished ... £1 14 0

With detachable recess fitted Base Board to mount 21 in. by 7 in. panel to slide out of Cabinet front.
 Extra 10/- with two beaded front doors totally enclosing fitted panel.
 Cabinet overall length 22½ ins. Width 8½ ins. Height 9 ins.
 Polished with the new enamel that gives a glass hard surface that cannot be soiled or scratched.
 SENT FREE.—Catalogue of standard Wireless Cabinets in various sizes and woods. Special Cabinets made to customer's orders.

PACKED AND DELIVERED FREE IN U.K.

CAXTON WOOD TURNERY CO., Market Harborough

GREAT SUCCESS OF THE LOWFORMA

This set, embodying a LOWFORMA, erected by the Technical Staff of the WIRELESS MAGAZINE and fully described in the February issue (1926) has received the KDKA (East Pittsburg) 62 metres transmission, at Loud Speaker strength, on a 21 ft. indoor aerial in London.

The LOWFORMA is a valuable unit which can be utilised in the erection of numerous Crystal and Valve Sets, frequently securing **50% BETTER RESULTS.**

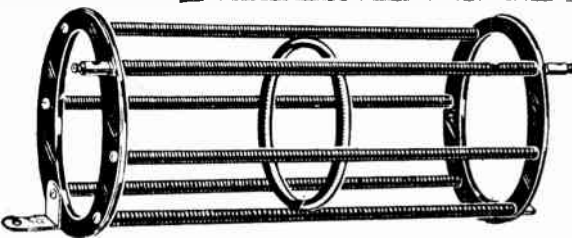
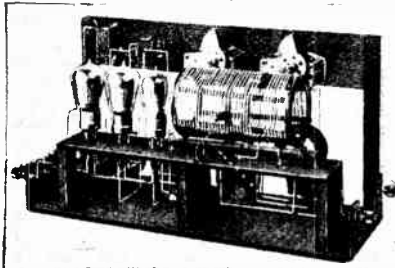

PRICES: 3½" diameter by 5" long, 4/9; 6", 5/-; 7", 5/6.
 OF ALL DEALERS. In case of difficulty write the makers.
 A. H. CLACKSON LTD., Dept. D, Head Offices, 119, Fleet St., London, E.C.4.

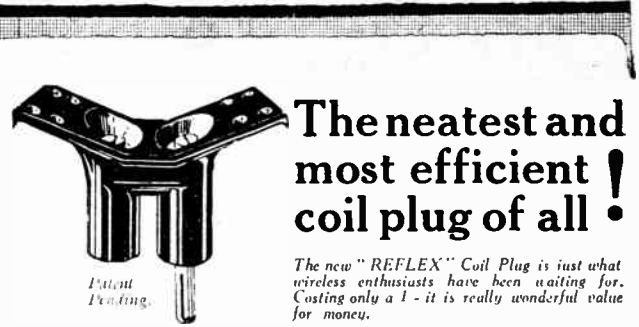

The neatest and most efficient! coil plug of all!

The new "REFLEX" Coil Plug is just what wireless enthusiasts have been waiting for. Costing only a 1 - it is really wonderful value for money.

Here are a few leading features:—
 Moulded throughout in genuine "Bakelite." Highly finished. Metal parts reduced to lowest possible minimum. Skeleton design, reduces losses to practically a negligible amount. Reversible pin. No external connections, these are made underneath coil. Tapered holes for taking twine to facilitate mounting coil. Tap is also provided, thereby offering two alternative methods of mounting, either through the holes or round the wing.

REFLEX COIL PLUG

Packed separately in attractive yellow cartons

Price 1/- Each.

From all good dealers.

REFLEX RADIO CO., LTD.,
 198, LOWER CLAPTON ROAD, E.5.
 Phone: Clissold 4852.



The Wireless World COUPON for "HIDDEN ADVT." COMPETITION

This coupon is available until Monday 10 a.m., Feb. 8th, 1926

Clue No.	Name of Advertiser.	Page
1		
2		
3		
4		
5		
6		

I enter the above solution subject to the published rules

Name (Please write clearly)

Address

3/2126

MISCELLANEOUS ADVERTISEMENTS.

NOTICES.

THE CHARGE FOR ADVERTISEMENTS in these columns is:

12 words or less, 3/- and 3d. for every additional word, e.g., 18 words, 4/6; 24 words, 6/- Name and address must be counted.

SERIES DISCOUNTS are allowed to Trade Advertisers as follows on orders for consecutive insertions, provided a contract is placed in advance, and in the absence of fresh instructions the entire "copy" is repeated from the previous issue: 13 consecutive insertions, 5%; 28 consecutive, 10%; 52 consecutive, 15%.

ADVERTISEMENTS for these columns are accepted up to **FIRST POST on THURSDAY MORNING** (previous to date of issue) at the Head Offices of "The Wireless World," Dorset House, Tudor Street, London, E.C.4, or on **WEDNESDAY MORNING** at the Branch Offices, 19, Hartford Street, Coventry; Guildhall Buildings, Navigation Street, Birmingham; 199, Deansgate, Manchester.

Advertisements that arrive too late for a particular issue will automatically be inserted in the following issue unless accompanied by instructions to the contrary. All advertisements in this section must be strictly prepaid.

Postal Orders and Cheques sent in payment for advertisements should be made payable to LILFEE & SONS Ltd., and crossed & Co. Treasury Notes, being untraceable if lost in transit, should not be sent as remittances.

All letters relating to advertisements should quote the number which is printed at the end of each advertisement, and the date of the issue in which it appeared.

The proprietors are not responsible for clerical or printers' errors, although every care is taken to avoid mistakes.

NUMBERED ADDRESSES.

For the convenience of advertisers, letters may be addressed to numbers at "The Wireless World" Office. When this is desired, the sum of 6d. to defray the cost of registration and to cover postage on replies must be added to the advertisement charge, which must include the words Box 000, c/o "The Wireless World." Only the number will appear in the advertisement. All replies should be addressed No. 000, c/o "The Wireless World," Dorset House, Tudor Street, London, E.C.4. *Readers who reply to Box No. advertisements are warned against sending remittance through the post except in registered envelopes; in all such cases the use of the Deposit System is recommended, and the envelope should be clearly marked "Deposit Department."*

DEPOSIT SYSTEM.

Readers who hesitate to send money to unknown persons may deal in perfect safety by availing themselves of our Deposit System. If the money be deposited with "The Wireless World," both parties are advised of its receipt.

The time allowed for decision is three days, during which time, if the buyer decides not to retain the goods, they must be returned to the sender. If a sale is effected we remit the amount to the seller, but, if not, we return the amount to the depositor. Carriage is paid by the buyer, but in the event of no sale, and subject to there being no different arrangement between buyer and seller, each pays carriage one way. The seller takes the risk of loss or damage in transit, or which we take no responsibility. For all transactions up to £10, a deposit fee of 1/- is charged; on transactions over £10 and under £50, the fee is 2/6; over £50, 3/-. All deposit matters are dealt with at Dorset House, Tudor Street, London, E.C.4, and cheques and money orders should be made payable to Lilfee & Sons Limited.

THE SALE OF HOME-CONSTRUCTED UNLICENSED APPARATUS.

A New Service to our Readers.

We have made an arrangement with the Patentees whereby readers who wish to dispose of a home-constructed receiver not licensed under the patents made use of, can do so by means of the Deposit System referred to above.

The person desiring to sell, in sending us particulars for his advertisement, will in every case make use of a Box No., and should add to the price which he requires the amount of royalty customarily paid by manufacturers, viz in the case of Marconi Patents the amount should be calculated at 12/6 per valve holder.

If the purchaser is satisfied with his purchase, the sum realised will be forwarded to the seller, less the amount due in respect of royalties, which amount will be paid by "The Wireless World" to the owners of the patents concerned, and a certificate will be handed on to the purchaser of the set.

FOR SALE.

HIGH-TENSION Accumulators, 60, 80, 110 volt sets, 30s., 40s., 55s.; transmitting sets, 200 volt, 132s. 6d. Good trade terms. Particulars free.—Pearson Bros., 110, Marston Road, Bedworth, Nuneaton. (1794)

For Sale.—Contd.

400 miles loud-speaker range on the Miracle 2-valve set. 72s. 6d. plus royalties. List free.—World's Wireless Stores, Wallington. (0008)

SAVE 10s. to 15s. in the £ by buying direct from us. All goods guaranteed. Carriage paid. Guinea headphones 10s.; 60-volt H.T. batteries, 6s.; flashlamp batteries, 25s. per 100; H.T. battery containers, 63-volt, 3s. 6d.; best condensers, 6s.; best quality L.F. transformers, 8s. 6d.; latest push-pull transformers, 12s. 6d., worth double, guaranteed no distortion whatever; 3-valve set, unit system, £6; valves, 3.8-4 volts, det., amp. and power, 3s.; 1.8-2 volt, 4s.; D.E., 3.8-4, 5s. 6d.; power, D.E., 3.8-4, 6s. 6d.; loud-speakers, 22s. 6d., 37s. 6d.; our famous model, 28in. high, 14½in. horn, 60s., equal to any costing £7 7s. Cash willingly refunded if not approved. We are direct importers. Dealers and set makers supplied.—Radio Import Co., 280, Sheffield Road, Chesterfield. (1426)

AMATEUR'S Surplus Apparatus.—Brown A Speaker, Neutrodyne Parts, Set Igranico Coils, etc. Half-price. Perfect.—Write list: G. Ford, Wentworth, Northwood, Middlesex. (1802)

BURNDEPT Wavemeter Rejector, nearly new, best offer secures.—Gamble, 9, Pretoria Road, Cambridge. (1798)

CONSTRUCTORS' Plans and Parts for every circuit.—Express Radio, Factory Square, Streatham. (1803)

B.T.H. Portable Receiver and Loud-speaker, frame aerial and covers as new.—Address: BM/BBFQ, W.C.1. (1805)

MISCELLANEOUS.

SECOND-HAND Apparatus taken in part-purchase of new ones. Leading lines supplied.—Wharton, 9, Victoria Street, Westminster. (1412)

WIRELESS Cabinets made in sections. Finest workmanship, best wood, nicely varnished. Send exact size and quantities required when writing for quotations.—J. E. Jacquemin, Premanon (Jura), France. (1434)

CHARGE Your Own Accumulator.—Send 3d. stamp to-day for lists of our small gas and petrol engines and dynamos, and complete charging sets, from 20 to 160 watts.—Tom Senior, Cleckheaton, Yorks. (0013)

GENUINE Clearance of Radio Stocks and Tools.—List free. S.L. geared ball-bearing condensers, .0005, 15s. 6d.; sets B.A. stocks, dies, and taps, 0-4, 6s. 9d.; double-gear hand-drills, 5s. 3d.; set 9 twist drills, 7½-7½, 1s. 9d.—Symax, 261, Lichfield Road, Aston. (1797)

PATENT AGENTS.

W. BRYSON, B.Sc., Chartered Patent Agent, 29, Southampton Buildings, W.C.2. Phone: Holborn 672. (1297)

REPAIRS.

TRANSFORMER Repairs.—Rewound to original efficiency and guaranteed 12 months 4s., post free. Phones 3s. 6d. Trade supplied.—Transform, 70a, Longley Road, Tooting. (0011)

TUITION.

INSTRUCTION in Morse, day or evening, easy terms.—Telegraph School, 29, Talfourd Road, Peckham, S.E. (1799)

WANTED.

WANTED.—Eliminator for 2LO, within 2 miles without losing strength. Trial before purchase.—6 L. Z., 13, Mercers Road, N.19. (1795)

AGENTS wanted everywhere. Everything wireless. Stamped envelope.—Garner, 31, Little Britain, E.C.1. (1801)

SITUATIONS WANTED.

YOUNG Man, experienced wireless experimenter, desires post; would prefer laboratory or design work; business experience in executive capacity; good draughtsman.—Box 5610, WIRELESS WORLD Office. (1796)

YOUNG Radio Engineer, certified, practical experience radio and electricity, requires any technical, commercial, or sales position; disengaged.—Box 6691, WIRELESS WORLD Office. (1804)

BUSINESSES & PROPERTY FOR SALE, TO BE LET, OR WANTED.

SHOP, Arcade, 10s. weekly.—Squibbs, Ltd., Bridgwater. (1786)

OLD-ESTABLISHED Electrical and Wireless Business; will sell for half-cost stock and plant or consider amalgamation with another firm.—Wright, 395, City Road, E.C.1. (1806)

BOOKS.

BACK numbers of THE WIRELESS WORLD and other wireless publications for sale.—Box 6502, WIRELESS WORLD Office. (1472)

WIRELESS WORLD, Vols. X to XVII; "Wireless Weekly," Vols. 1 to 6; "Experimental Wireless," Vols. 1 and 2; unbound, clean. Offers.—Beeson, Southwell, Notts. (1800)

PATENTS, DESIGNS AND TRADE MARKS.

J. S. Withers & Spooner.

CHARTERED PATENT AGENTS.

STAPLE HOUSE,
51 & 52, CHANCERY LANE,
LONDON, W.C.2.

Offices:—IMPROVABLE,
HOLBORN,
7th floor.—480 HOLBORN.

We put new life in Valves

REDUCED PRICES.

BE 4/6 DE 7/6 '06 9/6 POWER 12/6

Guaranteed Power and Tone as when New. Our Renewal Process ensures a Perfect Renewal. Genuine Seven Day Service. ALL MAKES UNDERTAKEN.

G.W.M. ELECTRICAL CO., LTD.
43 Grafton St., Tottenham Court Rd., London W.1.

HANDBOOKS

There is a handbook for every phase of Wireless. Send a post card for the complete list of books published in conjunction with

"THE WIRELESS WORLD"
Dorset House, Tudor St., London, E.C.4.

W.W.23



Tested low-loss condensers

Constructors! For your D.X. work plump for Ericsson Tested Condensers. They're the last word in accuracy. Losses are kept down to zero. Stout vanes accurately spaced — engineer-built all through. They pull their weight in long-distance work. Tens plate supplied. Ebonite end plates.

Prices:
"0005 10/6
"001 12/6

Write for lists to-day.
The BRITISH L.M. ERICSSON
Eng. Co. Ltd.,
67/73, Kingsway, London,
W.C.2.

Ericsson
TESTED
CONDENSERS

finston

LO-LOSS COILS

No. 25 - 1.3	No. 150 - 2/9
No. 35 - 1/6	No. 175 - 3/3
No. 50 - 1/9	No. 200 - 3/8
No. 75 - 2/0	No. 250 - 3/9
No. 100 - 2/6	No. 300 - 4/0

OBTAINABLE FROM ALL DEALERS
FINSTON MANUFACTURING CO., LTD.,
45, Horseferry Road, LONDON, S.W.
Phone: Victoria 1044

ELECTRADIX RADIOS

Have opened a large City Showroom at 218, UPPER THAMES STREET, E.C.4, and are selling an enormous stock of Radio and Electrical Goods of the highest grade—Marconi, Siemens, Sullivan, Brown, Western Electric, at bargain prices. Send 4d. for illustrated catalogue and price list. The Stores at 9, Colonial Avenue, Minorities, contain tons of goods at sacrifice prices to save removal. Callers only. Telephone Avenue, 4166.

NEW WESTERN ELECTRIC LOUD SPEAKERS.

Complete with Cord in Makers' Sealed Carton, 29/-
Cheaper than elsewhere.
4,000 ohms .. 22/8; 2,000 ohms .. 20/-;
70 ohms .. 17/6.

"THE CATALOGUE THAT SAVES YOU POUNDS."

Its scope ranges from a 5s. pair of British Headphones or a 12/6 milliammeter to a 30,000 volt Generator, and covers all requirements. If you cannot call and inspect goods in our showrooms between 9 a.m. and 6 p.m. it will pay you to send 4d. for our catalogue at once. Goods promptly despatched all over the world.

ELECTRADIX RADIOS

218, Upper Thames St., London, E.C.4.
Phone: City 191.

Address all Post Orders to City Showroom
218, Upper Thames Street, E.C.4.

A DIFFERENT HIGH-FREQUENCY SYSTEM.

For RANGE SELECTIVITY PURITY and VOLUME The "NEUTOROID" (Neutrodyne) KIT takes some beating!

Aerial Co. and 2 H.F. Couplings, with working diagrams, etc.. 25/- post free.

TOROIDAL COILS that can be handled!

Carefully wound, D.S.C. wire, for broadcast waves, with tappings for experimenters. With suggested circuits, 8/- each, post free.

KING, 4 Bank Street, NORWICH

Two Remarkable Coil Plugs

Each 1/3, Postage 2d.

"The Quick Fix" for Basket Coils with detachable Pin and Knob securely mounts all size Coils permits fullest action and quick adjustment. Low-Loss reversible Plug and Socket. Solid Ebonite.

"The Universal" Patent Expanding Plug is a marvel of efficiency and neatness. Expanding Band quickly and firmly mounts any size Coil. Perfect Low-Loss reversible Plug and socket. Adds fine finish to all Home-made Coils.

Trade Enquiries Solicited.

Send to-day to GOODMAN, TUTTLEY & HARRIS,
14, Broad Street Chambers, Broad Street, Sheffield.

AERMONIC

ANTI-CAPACITY AIR-SPACED VALVE HOLDER

Capacity and Voltage Leakage Losses cut down to the absolute minimum. Will improve any circuit.

Model "D" Base-Board Mounting, 2/6 each.
Model "E," Back of Panel, 2/6 each.

Manufacturers and Distributors for London and South England:
JAMES CHRISTIE & SONS Ltd., 246, West St., SHEFFIELD
London Agents: A. F. Bulgin & Co., 10, Cursitor Street, E.C.4.
Agents—Remainder British Isles:
Messrs. V. R. Pleasance, 56, Fargate, Sheffield.

TIME & WEATHER BY WIRELESS

By W. G. W. Mitchell,
B.Sc., F.R.A.S., F.R.Met.S.

THE first half of the book sets out to explain how time signals are sent and how they may be received with the utmost accuracy. Accuracy is, in fact, the key-note of the time-signal section. The latter part, which is devoted to the weather, will enable the amateur to distinguish the different weather telegrams, and for this he must acquire a knowledge of slow Morse. (Our book, Perry Morse System, 7d. post free, is ideal for this purpose.) Simple diagrams and illustrations show clearly how the apparatus works and how you can fit up similar mechanism for home use. Crown 8vo. 125 pages. 66 diagrams and illustrations.

Price 3/6 net. By post, 3/9.

Obtainable from the Publishers of "The Wireless World"
ILIFFE & SONS LTD.,
Dorset House, Tudor Street, London, E.C.4
w.w.16

STEEL LAKER MASTS

as supplied to H. M. GOVERNMENT, BRITISH BROADCASTING CO., and to all leading suppliers of Wireless Equipment.

Prices: 25 ft. .. 35/- 30 ft. .. 45/- 35 ft. .. 52/9
40 ft. .. 69/- 45 ft. .. 75/- 60 ft. .. 95/-

A "Laker" Steel Mast will improve your reception 50%. Procureable from all wireless dealers or supplied direct by the manufacturers.

J. & J. LAKER CO., Engineers,
BECKENHAM, KENT.
Write for Catalogue.
Wholesale Suppliers—Brown Bros., A. J. Dew & Co.
Houghtons Ltd.

REPAIRS SETS PHONES TFORMERS

— Officially approved by Radio Association —

ALL WORK GUARANTEED. LOWEST RATES. 24 HOUR SERVICE.

JOHN W. MILLER, 68, Farringdon Street, E.C.4
PHONE: CENTRAL 1950

PATENTS, DESIGNS & TRADE MARKS.

H. D. FITZPATRICK & CO.
Chartered Patent Agents,
49, Chancery Lane, London, W.C.2
Phone: Holborn 468.

INDEX TO ADVERTISEMENTS.

	PAGE		PAGE		PAGE
Accumulators Elite	...	Ferranti, Ltd.	...	Ormond Engineering Co.	5
Barton, J. & W.	24	Finston Manf. Co., Ltd.	23	Partridge & Wilson	19
Bowyer Lowe Co., Ltd.	4	Fitzpatrick, H. D., & Co.	23	Pickett Bros.	...
Brandes, Ltd.	11	Fuller's United Electric Works, Ltd.	...	Pugh Bros.	19
Britannia Rubber & Kautchulicon Co., Ltd.	19	General Electric Co., Ltd., The	12 and 13	Radio Communication Co., Ltd.	14
British Electrical Sales Organisation	2	General Radio Co., Ltd.	19	Radios, Ltd.	...
British I.M. Ericsson Manf. Co., Ltd.	23	Gladwell & Kell, Ltd.	6	Reflex Radio	21
British Sangamo Co., Ltd., The	17	Goodman, Uttley & Harris	23	Scientific Supply Stores	...
Burndopt Wireless, Ltd.	8	Graham, Alfred, & Co.	Cover ii	Sellar, J. Y.	4
Burwood (Concessionaires), Ltd.	17	G.W.M. Elec. Co., Ltd.	22	Shaw, H. J.	...
Caxton Wood Turnery Co.	21	Hayberd, F. C., & Co.	...	Sifam Elec. Inst. Co.	17
Charlesworth, W. J.	17	Igranic Electric Co., Ltd.	3	Silvertown Co., The	...
Chloride Electrical Storage Co., Ltd., The	...	International Radio Lamp Export Trade	24	Stevens, A. J., & Co. (1914), Ltd.	15
Christie, James, & Sons, Ltd.	23	King, A.	...	Stratton & Co., Ltd.	...
Clackson, A. H., Ltd.	21	Laker, J. & J., Co.	23	Taylor, J. H., & Co.	...
Clarke, H., & Co. (Manchester), Ltd.	...	Lamplugh, S. A., Ltd.	...	Telegraph Condenser Co., Ltd.	...
Cleartron Radio, Ltd.	17	Lissen, Ltd.	8	Tudoradio Co., Ltd., The	19
Darimont Electric Batteries, Ltd.	...	London Elec. Wire Co. & Smiths, Ltd.	...	Vandam, A.	...
Dixon, Leslie & Co.	23	Marconiphone Co., Ltd., The	1	Varley Magnet Co., Ltd.	...
Dubilier Condenser Co. (1925), Ltd.	Cover iv	Metro-Viek Supplies, Ltd.	2, 4 and 6	Watmel Wireless Co., Ltd., The	...
Edison Swan Electric Co., Ltd.	7	Miller, J.	23	Webber, N. V., & Co., Ltd.	24
Encore Manf. Co.	...	Mullard Wireless Service Co., Ltd., The	9	Wilkins & Wright, Ltd.	...
Energro Products, Ltd.	...	Nelson Electric Co., Ltd.	19	Withers, J. S., & Spooner	22

No More Short Circuits
if you use a
"CANTCROSS" CONNECTOR
(Patent Applied for.)



Consists of a Plug element for fitting to the panel, to replace the usual H.T. and L.T. terminals. The Socket element corresponds to the Plug element, and is arranged to receive the necessary leads from the respective batteries.

BURNT-OUT VALVES IMPOSSIBLE. ACTS AS A DISCONNECTING SWITCH. EASILY FITTED TO ANY SET.

3 Terminal 5/- each, 5 Terminal 8/- each, 7 Terminal 7/- each.
(Leads not included.)

Adaptable to all Circuits.
Example Wired as follows: 1. H.T.1. 2. H.T.2. 3. H.T.3. 4. H.T.— 5. L.T.+ 6. L.T.—

Post Free on receipt of Postal Order and Dealer's Name from
J. & W. BARTON, 22a, Virginia Street, SOUTHPORT.



IRET
INTERNATIONAL RADIOLAMP EXPORT TRADE

THE BEST LAMP IN THE WORLD
The model of perfection. The lowest price.
Our famous double-grid lamp.

Price list on demand—48, rue Greneta, PARIS, 2e

EXPERIMENTAL APPARATUS
Complete Transmitting Sets.

Broadcast. Receiving Sets.
Coil Formers. Low Loss Coils.
Short Wave. Receivers.
Panels Engraved. Condensers of all Kinds, etc.

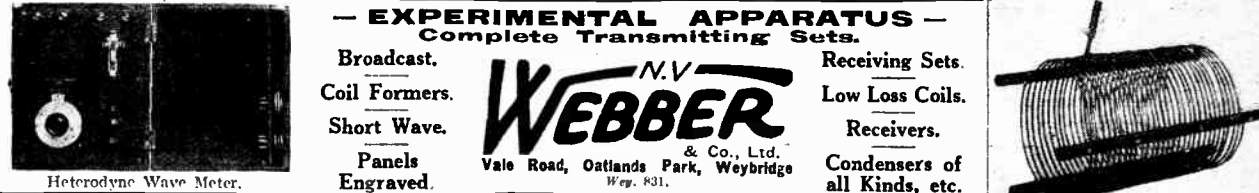

WEBBER N.V. & Co., Ltd.
Vale Road, Oatlands Park, Weybridge
Wesg. #31.

Heterodyne Wave Meter.

The BEST BOOKS on WIRELESS

The range of books published from the offices of "The Wireless World" covers every conceivable phase of wireless. Below are given a few selected titles. A complete list will be sent on request.

- "The Thermionic Valve and Its Development in Radio-Telegraphy and Telephony": by J. A. FLEMING, M.A., D.Sc., F.R.S. Price 15/- net. By Post 15/9.
- "Continuous Wave Wireless Telegraphy—Part I": by W. H. ECCLES, D.Sc., A.R.C.S., M.I.E.E. Price 25/- net. By Post 25/9.
- "Direction and Position Finding in Wireless": by R. KEEN, B.Eng., A.M.I.E.E. Price 9/- net. By Post 9/6.
- "Thermionic Tubes in Radio-Telegraphy and Telephony": by JOHN SCOTT-TAGGART, F.Ins.P., A.M.I.E.E. Price 15/- net. By Post 15/9.
- "Wireless Valve Transmitters": by W. JAMES. Price 9/- net. By Post 9/9.
- "Calculation and Measurement of Inductance and Capacity": by W. H. NOTTAGE, B.Sc. Price 7/6 net. By Post 8/-.
- "Wireless Telegraphy and Telephony": by H. M. DOWSETT, M.I.E.E. Price 9/- net. By Post 9/6.
- "Telephony without Wires": by R. A. COURSEY, B.Sc., F.Inst.P. Price 15/- net. By Post 15/6.

Obtainable from all booksellers or direct from the publishers:
ILIFFE & SONS LTD., Dorset House, Tudor Street, London, E.C.4. w.w.i.

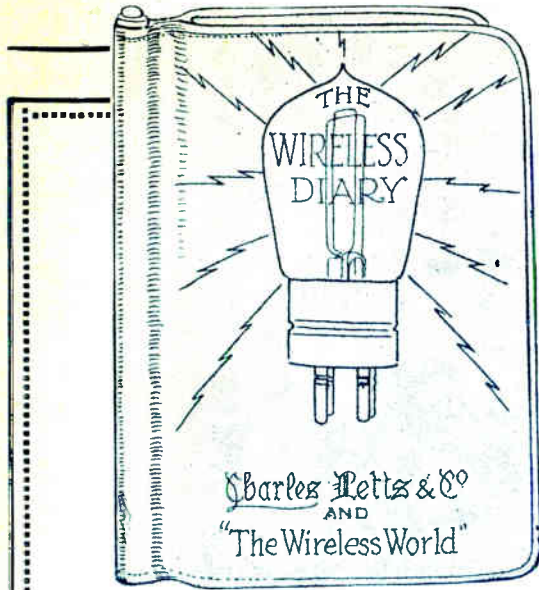

The DIARY for WIRELESS ENTHUSIASTS

THE WIRELESS DIARY 1926

Compiled by the Editorial Staff of "The Wireless World."

Contains over 75 pages of indispensable information for all who take a keen interest in this fascinating hobby, including:

A revised list of Experimental Transmitting Stations. Hints for Aerials and Earths. Efficient Crystal Receivers. Practical One-valve, Two-valve and Three-valve Circuits. Neutrodyne and Supersonic Heterodyne Receivers. In addition—a convenient and well-printed diary giving one week at an opening.

Obtainable at all Booksellers and Railway Bookstalls.

PRICES: Cloth Edition, 1/-, postage 13d. extra. Leather Case, with pockets, pencil and season ticket window, 2/6, postage 2d. extra.

Published jointly by

"The Wireless World," Dorset House, Tudor St., London, E.C.4., and Charles Letts & Co

W.W.31

A Service that gives Security!

MANY readers naturally hesitate to send money to unknown persons. We have therefore adopted a Deposit System which gives complete security both to buyer and seller.

If the money be deposited with "The Wireless World" both parties are advised of its receipt. The time allowed for decision is three days, after which time, if the buyer decides not to retain the goods, they must be returned to the sender. If

a sale is effected we remit the amount to the seller; but, if not, we return it to the depositor.

Full particulars may be found on the Miscellaneous advertisement page at the end of the book.

Use this service for your wireless requirements and avoid all risk! Sell the apparatus you no longer require! Write out your advertisement to-day and send to—

PREPAID ADVT. DEPT., "THE WIRELESS WORLD," DORSET HOUSE, TUDOR ST., LONDON, E.C.4.

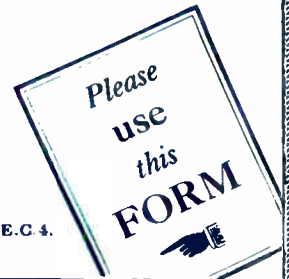

12
Words
or
Less
3/-

each
addi-
tional
word
3d.

Advertiser's name and address must be counted. If a box number is required, 6d. extra must be sent for postage on replies.

W.W.31

Advertisements for "The Wireless World" are only accepted from firms we believe to be thoroughly reliable.

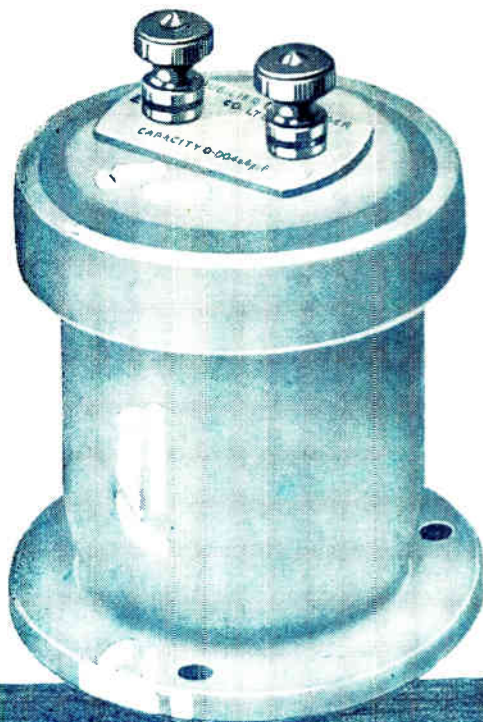

DUBILIER TRANSMITTING CONDENSERS

The small transmitting condenser illustrated here is one of the many specialised Dubilier products, and is particularly suitable for use in experimental and amateur transmitting stations.

Among the many purposes for which these condensers are used we would like to mention the following:—

- (a) For use in low power transmitters up to 100 metres as aerial series condensers, oscillating circuit condensers, grid condensers, etc. (Types S.W.A.F. 650, S.W.A.F. 700, S.W.A.F. 750, S.W.A.F. 800.)
- (b) As Anode Feed Condensers (Capacity range 0.00005 mfd. to 0.05 mfd. for working voltages up to 6,000 D.C.)

- (c) As high frequency by-pass condensers.
- (d) As grid condensers.

Condensers for the last three purposes are scheduled as types A.F. 650, A.F. 700, A.F. 750, and A.F. 800.

They are enclosed in porcelain containers, so as to insulate the whole condenser when used at a high potential above earth (e.g., as in the case of Anode Feed Condensers). The Terminals are mounted on the porcelain lid and this type of condenser is a most reliable and convenient unit for experimental use.

Prices from 25/- to 60/- according to requirements.



ALVERT. OF THE DUBILIER CONDENSER CO. (1925) LTD., DUCON WORKS, VICTORIA ROAD, N ACTON, LONDON. W.3. TELEPHONE : CHISWICK 2241-2-3. E.P.N. 104.

Printed for the Publishers, LUFFE & SONS LTD., Dorset House, Tudor Street, London, E.C.4, by The Cornwall Press Ltd., Paris Garden, Stamford Street, London, S.E.1.

Colonial and Foreign Agents:
 UNITED STATES—The International News Co., 83-85, Duane Street, New York. FRANCE—W. H. Smith & Son, 248, Rue Rivoli, Paris; Hachette et Cie, Rue Réaumur, Paris.
 BELGIUM—W. H. Smith & Son, 78, Marche aux Herbes, Brussels. INDIA—A. H. Wheeler & Co., Bombay, Allahabad and Calcutta. SOUTH AFRICA—Central News Agency, Ltd.
 AUSTRALIA—Gordon & Gotch, Ltd., Melbourne (Victoria), Sydney (N.S.W.), Brisbane (Queensland), Adelaide (S.A.), Perth (W.A.) and Launceston (Tasmania).
 CANADA—The American News Co., Ltd., Toronto, Winnipeg, Vancouver, Montreal, Ottawa, St. John, Halifax, Hamilton; Gordon & Gotch, Ltd., Toronto; Imperial News Co., Toronto, Montreal, Winnipeg, Vancouver, Victoria. NEW ZEALAND—Gordon & Gotch Ltd. Wellington, Auckland, Christchurch and Dunedin.

3 Star Radio Performers



Popular with countless listeners everywhere

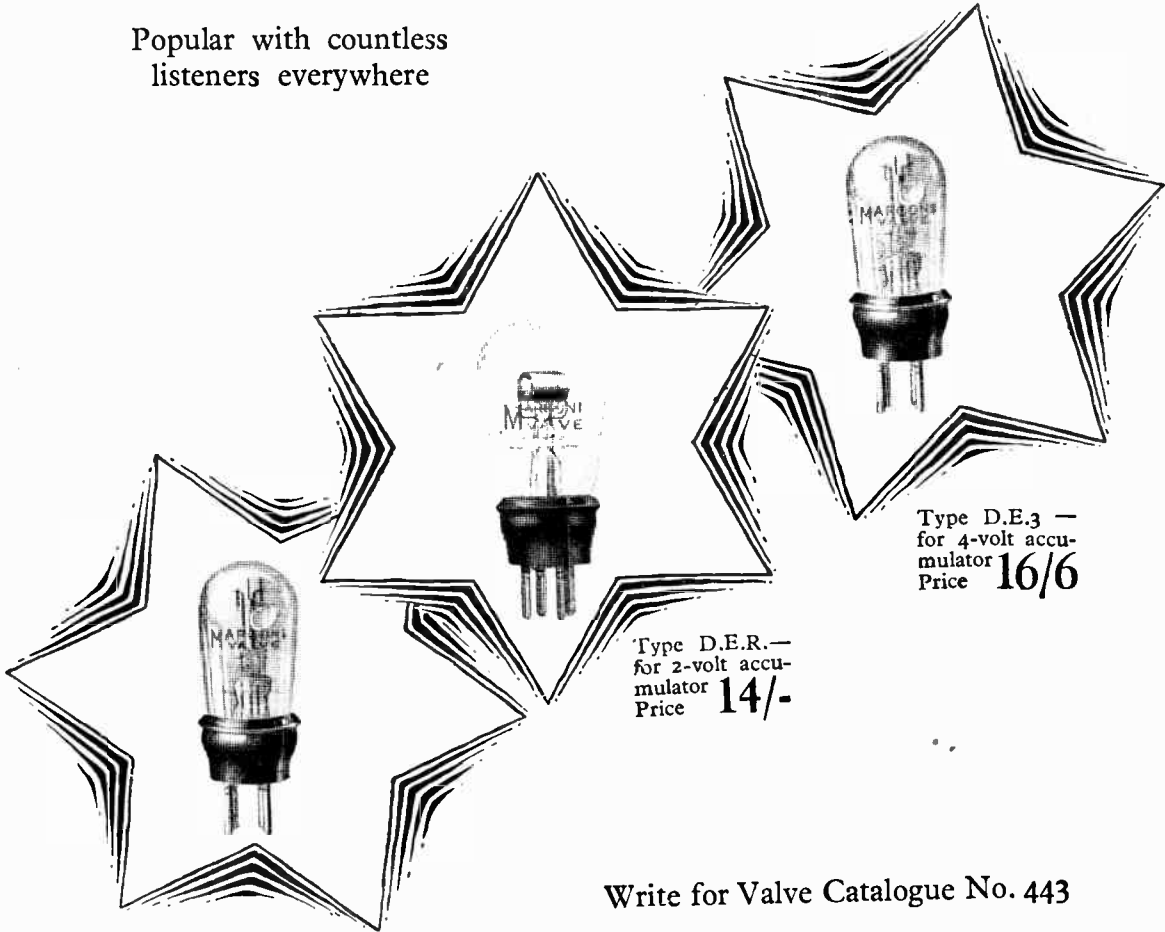

Type D.E.2—L.F. & H.F. for 2-volt accumulator. Price **15/6**

Type D.E.3 — for 4-volt accumulator Price **16/6**

Type D.E.R.— for 2-volt accumulator Price **14/-**

Write for Valve Catalogue No. 443

MARCONI VALVES

IN THE PURPLE BOX

THE MARCONIPHONE COMPANY LIMITED

Registered Office : Marconi House, Strand, London, W.C.2 Head Office : 210-212 Tottenham Court Road, London, W.1

Branches : Aberdeen, Bristol, Birmingham, Belfast, Cardiff, Cheltenham, Dublin, Glasgow, Leeds, Liverpool, Manchester, Newcastle, Nottingham, Southampton, Swansea.



"SPARTA" is a speaker that does its own sales talk. Its tone appeals at the first hearing. The reason lies in a construction that is different. That difference is the outcome of long experiment.

The large "Sparta" has a unique feature—an additional tone selector which enables very delicate refinement of tone values. The new patent magnetic compensator gives remarkably distinct rendering.

For 1-3 valves:
Types HHA, HHB,
or HHJ.

For 3-5 valves:
Types HA or HB.

For 5 valves
or more:
Types A or B.

PRICES.

Types A, HA,
HHA

£4 : 15 : 0

Type B

£5 : 15 : 0

Types HB, HHB

£6 : 0 : 0

Type HHJ

£2 : 10 : 0

Type B models

fitted with both

volume and tone

control.

London Depot :
176, Tottenham
Court Road, W.1
Telephone : Museum 9008.

FULLER'S UNITED ELECTRIC WORKS, LTD.
Chadwell Heath - - - - - Essex.

Telephone : Ilford 1200.

Telegrams : "Feller, Chadwell Heath."

-sells on the test of tone

174-11



EDISON BELL RADIO

BUY BRITISH GOODS

W
R
I
T
E

F
O
R

C
A
T
A
L
O
G
U
E
S

"THERE IS NOTHING BETTER THAN THE BEST."

WE SUPPLY YOU WITH THE BEST—

1st EXAMPLE

(OTHER EXAMPLES WILL APPEAR SHORTLY)

THE EDISON BELL "GEM" 2-VALVE SET



PRICE £3-0-0

(Valves, Batteries, and Marconi Licence extra.)

EVERY HOME SHOULD POSSESS THIS SET.

Manufactured by an ALL-BRITISH FIRM with 33 YEARS' REPUTATION FOR QUALITY.
J. E. HOUGH, LTD., Edison Bell Works, London, S.E.15, & Huntingdon.

SPECIFICATION :

12 10. 4" deep, highly polished base, fitted ebonite panel and nickel-plated fittings.

A Grid Bias battery is fitted in panel which enables good musical quality to be obtained. This set is supplied with Coils suitable for 300-500 metres. Coils for higher wave lengths can be supplied at extra cost.

This is a very efficient 2-Valve Set and will give good Loud Speaker results at 25 to 30 miles, it having one Detector and one Low Frequency Stage.

FOR PERFECT RECEPTION THIS SET CANNOT BE BEATEN.

W
R
I
T
E

F
O
R

C
A
T
A
L
O
G
U
E
S

ORMOND(E) still leading — as in 1886

MANY people will recall the victories of "ORMONDE," who in 1886 carried off the Triple Crown—winning the Two Thousand Guineas, the Derby, and the St. Leger. In the whole of his career *he was never beaten*, and is generally regarded *as the best horse of all times*.

Since then the name "ORMOND" has repeatedly been associated with success. To-day, in the World's Long Distance Race, the "ORMOND" Condenser Mount easily comes in first, leaving behind it a field of stragglers.

For a magnificent finish, back "ORMOND"

SELECTIONS FOR TO-DAY:—

BALL-BEARING FRICTION CONTROL CONDENSER

'0005	15/-
'0003	14/6
'00025	13/6

IDEAL RATIO: 55 — 1

Brass End-plates, highly nickelated finish.



ENGINEERING

ORMOND

COMPANY LTD. Regd. Trade Mark

199-205 PENTONVILLE ROAD
Phone. Clerkenwell 9344-5&6

KINGS CROSS, LONDON, N.1.
grams Ormondery, Kingcross.

Factory. WHISKIN ST. CLERKENWELL. E. C. 1

EASILY FIRST IN EVERY FIELD



IGRANIC - PACENT Universal Plug
(as illustrated). This is one of the most popular in use to-day. Standard equipment on many well-known makes of loud-speakers. To connect—insert cord tips in connector springs and clamp shells together. Polarity stamped on connector springs. Price, black, 1/6

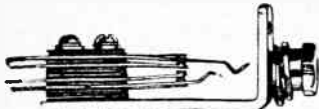

IGRANIC-PACENT Double Circuit Jack
Generally used between stages to permit of phones or loud speaker being plugged-in according to amplification required. Price 2/6.



IGRANIC-PACENT Six-spring Auto-matic Jack.
For the filament control of modern multi-valve circuits, and for switching in experimental circuits. Price 4/-

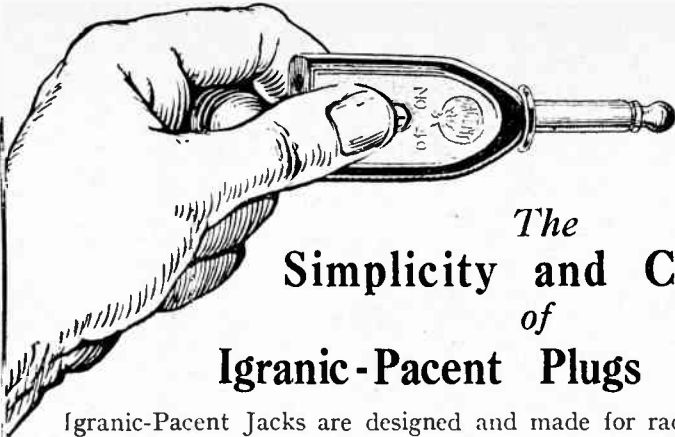

The
Simplicity and Certainty
of
IGranic-Pacient Plugs & Jacks

IGranic-Pacient Jacks are designed and made for radio work. The silver contacts make reliable and adequate contact—always. The German silver springs and the heavily plated non-magnetic frame all contribute to the sturdiness and reliability which have caused 40 prominent manufacturers in America to incorporate them in their receivers.

The 10 different patterns of IGranic-Pacient Jacks meet every switching requirement and make possible many operations which would be difficult with switches.

Various patterns of IGranic-Pacient Plugs complete a range of Plugs and Jacks to meet all needs.

IGranic-Pacient Radio Essentials are fully described in our List No. P43. May we send you a copy?

IGRANIC ELECTRIC CO., LTD., 119, Queen Victoria Street, Lon'don.

Exclusive manufacturing Licensees of Pacient Radio Essentials. Works: BEDFORD.

Branches: BRIMSINGHAM: 73-74, Exchange Buildings; BRISTOL: British Dominions House, Tramways Centre; CARDIFF: Western Mail Chambers; GLASGOW: 50, Wellington Street; LEEDS: Standard Buildings, City Square; MANCHESTER: 30, Cross Street; NEWCASTLE: 99, Pilgrim Street.

Mellowtone
Receivers

The MELLOWTONE FOUR
£24 - 0 - 0

Plus Licence Tax £2-10-0.

TWO VALVE SET £8-15-0. Tax £1-5-0.



Radio-Aids.

A4

Mention of "The Wireless World," when writing to advertisers, will ensure prompt attention.

— with the PATENTED
TONE CONTROL

Ⓒ All that is BEST in both electrical and mechanical components goes into the "MELLOWTONE"—it is the result of many years' research and testing—representing the highest standard of quality and excellence in Wireless Receivers. Economical production methods alone make the comparatively low price possible.

RANGE 150-2000 metres. The "MELLOWTONE" Four will normally receive any concert that atmospheric and other unavoidable conditions will permit. CONTROL TUNING by 100/1 Special Vernier Dials. TONE by three-way Switch giving normal, soft, or mellow results. STRENGTH by "Volume Control" and Last Valve Control. CABINET is beautifully made of real OAK and French polished. Size 2ft. 2in. high, 1ft. 11in. wide, 1ft. 2in. deep.

FULLY GUARANTEED. EASILY OPERATED.

Write NCW for Illustrated List, Folder which gives users' opinions, and address of nearest Agent.

MELLOWTONE

MIDLAND RADIOTELEPHONE MFRS LTD.

BRETTELL LANE WORKS

STOURBRIDGE

Telephone:
Stourbridge 318.

Experimental
Station 2WQ

31

THE HAPPY FAMILY

"Affinites"

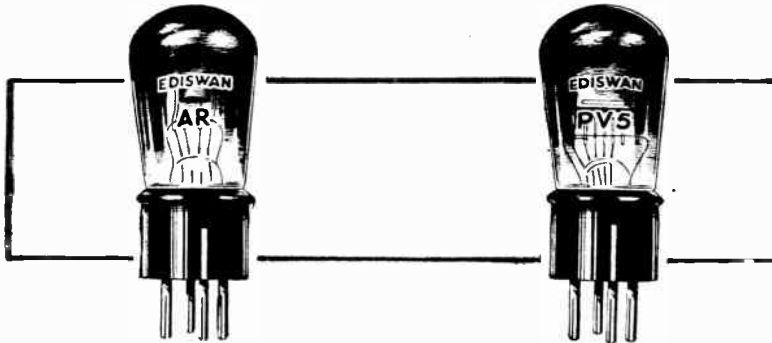

There is a decided affinity, a quite definite link between each Edison Receiving valve and Edison Power valve. The Receiving valves are supplied either H.F. or L.F. and the best Power valve to use is shown in the table opposite.

They always get on well together. It's like that in every large family. Always two that will work—or play—better with one another than with anybody else. Every Edison valve has its family affinity. It gives good service in any conditions — the best service when it is employed with its "tw.n."

The Valves to use.

Receiving.	Accumulator or Battery Volts.	Power.
AR	6	PV5
ARDE	2	PV6
AR'06	3	PV8

With these groups and Edison H.T. and L.T. Accumulators the ideal is attained.

THE EDISON SWAN ELECTRIC CO. Ltd.,
123-5, Queen Victoria Street, London, E.C.4.

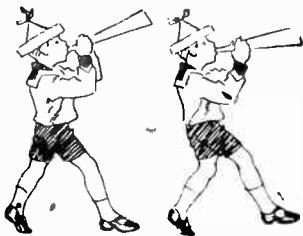

EDISWAN VALVES

Will Improve ANY Set

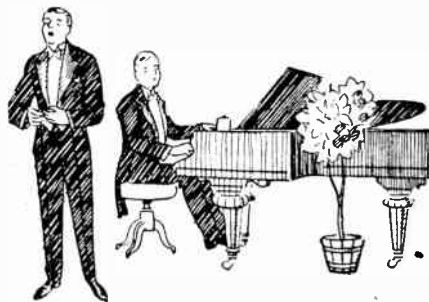

Ediswan Valves are entirely British made.

Announcing

the New Range of Six Sixty Valves



THE increasing demand for all types of Receiving Valves has proved to us that despite the excellent all-round qualities of the original 660 Electron Dull Emitter Valve, the general Radio public require specialised valves for definite circuits.

Our new range, embodying the latest developments of modern scientific research, will prove the continued and greater success of Electron 660 Valves.

And remember, no matter what type you choose, each valve is carefully designed to carry out its particular job, and bears the Six Sixty Mark of

PERFECTION OF QUALITY

- S.S.1 (Blue Disc). BRIGHT EMITTER GENERAL PURPOSE VALVE. Voltage—3.7 volts, consumption .06 amps. 8/-
- S.S.2 H.F. (Red Disc). D.E. SUITABLE AS A DETECTOR WHEN FOLLOWED BY RESISTANCE OR CHOKE. Voltage—2 volts, consumption .3 amps 14/-
- S.S.2 L.F. (Green Disc). D.E. SUITABLE FOR SMALL & MEDIUM-SIZED LOUD SPEAKERS. Voltage—2 volts, consumption .3 amps. 14/-
- S.S.3 H.F. (Red Disc). D.E. SUITABLE AS A DETECTOR WHEN FOLLOWED BY RESISTANCE OR CHOKE. Voltage—3 volts, consumption .06 amps. 16/6
- S.S.3 L.F. (Green Disc). D.E. SUITABLE FOR SMALL & MEDIUM-SIZED LOUD SPEAKERS. Voltage—3 volts, consumption .06 amps. 16/6
- S.S.4 D.E. L.F. AMPLIFIER AND LOUD SPEAKER VALVE. Voltage—5 volts consumption .25 amps. 22/6
- S.S.5 D.E. H.F. AMPLIFIER AND DETECTOR VALVE. Voltage—5.5 to 6 volts, consumption .06 amps. 24/6
- S.S.6 D.E. RESISTANCE CAPACITY AMPLIFIER & DETECTOR VALVE. Voltage—5 volts, consumption .25 amps. 22/6
- S.S.7 D.E. POWER VALVE. Voltage—3.7 volts, consumption .1 amp. 22/6



Write for leaflet S.S.1. 7 for full particulars.



BETTER BY SIX TIMES SIXTY

The Electron Co., Ltd., Triumph House, 139, Regent Street, London, W.1.

The PELICAN UNIVERNIER

Price **6/-** EACH

from your dealer

helps you to log distant stations

If previously you have found it difficult to tune in distant transmissions the fault probably lies in your tuning controls. Replace your present dials with the Pelican Univernier. The Univernier will prove in practical test that efficient tuning can make all the difference to the sensitivity of your receiver. It responds to your slightest touch, giving a "dead on wavelength" adjustment that brings in stations at full strength.

You can make the change to Pelican Univernier dials at once, simply unscrew the existing dials of your variable condensers or variometers, and replace with Univerniers.

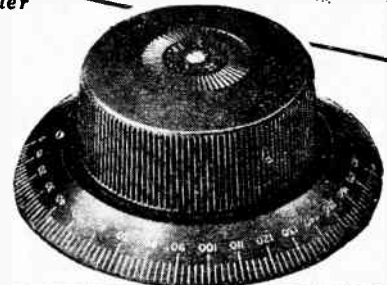

CAHILL AND COMPANY LTD.

64, Newman St., London, W.1

Telegrams: Pelcarad, Wesdo, London. Telephone: Museum 9236.

EXCELSIOR

A REALLY TRUE ANTI-CAPACITY VALVE HOLDER at a startling price

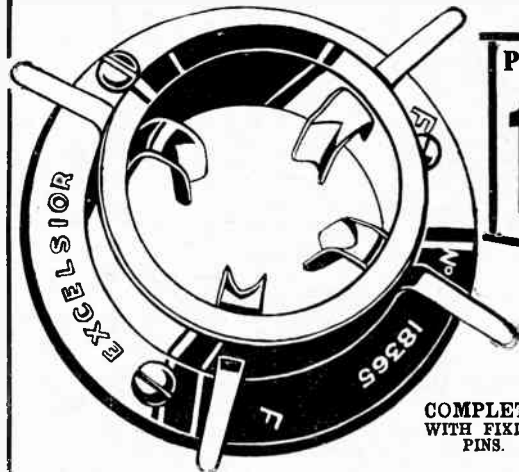

PRICE 1/-

COMPLETE WITH FIXING PINS.

Neatly boxed and fully guaranteed.

(Descriptive Leaflet of Complete Sets and Components on application.)

THE EXCELSIOR MOTOR COMPANY, LTD. WIRELESS DEPT., King's Road, Tyseley, Birmingham

London Distributors: BROWN BROTHERS, Ltd., Gt. Eastern St., E.C.2

ANNOUNCING

S.M. PARTS

for the SILVER MARSHALL
ALL WAVE SUPER-HETERODYNE

50-3,000 metres.

Ever since the first S.M. product was marketed, the reputation for quality apparatus of originally distinctive design has been growing steadily until to-day it is only logical to find S.M. with apparatus, not designed just for season 1925-6, but with equipment that will be adding to that reputation years hence.



TYPE 210 & 211 TRANSFORMERS.

S.M. Type 210 and 211 Charted Intermediate Transformers are produced under new and advanced manufacturing processes, and each transformer is supplied with an individual amplification chart showing its characteristic curve. Kit consisting of Two type-210 laboratory charted transformers and One type-211 filter with matched condenser
£6 : 5 : 3

AERIAL & OSCILLATOR COILS.

All bakelite low loss interchangeable coils with adjustable rotor.

AERIAL.	OSCILLATOR.
110A. 190-550 m.	111A. 190-550 m.
110B. 90-210 m.	111B. 90-210 m.
110C. 50-110 m.	111C. 50-110 m.
13/6 each	13/6 each
110D. 500-1, 250 m.	111D. 500-1, 250 m.
16/6 each	16/6 each
110E. 1,200 m. up	111E. 1,200 m. up.
17/6 each	17/6 each

TYPE 515 SOCKET, 5/6 each

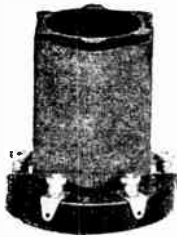

S.L.F. CONDENSERS.

S.M. Silver-plated condensers are at once the smallest and yet most efficient available.

Type 311, .00035, 30/- each.

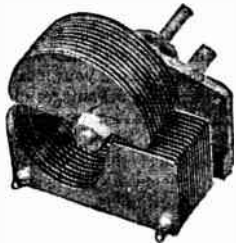

Write for:—

Complete Wiring Diagram and Instructions for the S.M. All-wave Super Heterodyne,] 6d. post free.

We have also in stock kits and components for the "SILVER SIX" Receiver.

Complete instructions and diagrams, 2/6 post free.

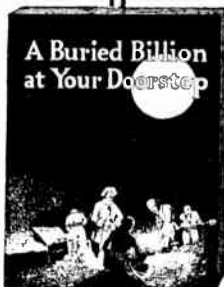

Our new and enlarged 1926 Radio Catalogue and Circuit Supplement is NOW READY. It contains the most exhaustive information on the World's Finest Radio Apparatus and a Supplement of America's Foremost Circuits. Post free, 9d.

ROTHERMEL RADIO CORPORATION of GREAT BRITAIN LTD.,

24-26, Maddox Street, Regent Street, LONDON, W.1.

Telephone: Mayfair 578-9.

Telegrams: Rothermel, "Wesdo," London.

ANNOUNCING

B.T. PARTS

for the BREMER-TULLY
COUNTERPHASE RECEIVERS

4, 5 and 6 valve.

We firmly believe the COUNTERPHASE will not be equalled for years to come. B.T. Products are the result of years of experimental work and have a habit of not going out of date.

COUNTERPHASE KITS.

Kits for building the Counterphase contain essential parts and complete blue prints with building instructions

Kit No. 6 for 6-valve Receiver (operating on short indoor antenna)
£9 : 18 : 6

Kit No. 5 for 5-valve Receiver (for outdoor antenna)
£7 : 8 : 6

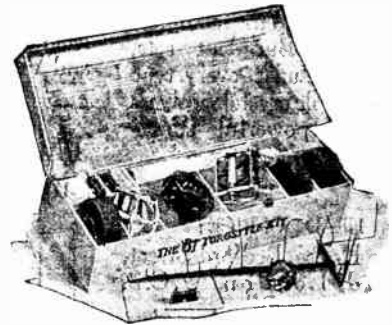

TOROSTYLE TRANSFORMERS.

The heart of the "Counterphase" A coil that reduces local pick-up to a minimum. Eliminates inter-coupling and stray feed-backs.

Type T.A. (Antenna Coupler) 21/- each.
Type T.C. (Interstage R.F.) .. 21/- each
Type T.4 for 4-valve Set .. 21/- each.



TANDEM CONDENSERS.

All the efficiency of the well-known B.T. Lifetime Condenser is now available in the Tandem.

One dial controls Two Condensers. Close balance between two units is obtained by the sensibly-designed B.T. Trimming Arrangement. Type L.D. 17, .00035 (employed with Torostyles) 4/9, 6 each.



Write for:—

"Better Tuning," 8th Edition. A 48-page Booklet of diagrams, hook-ups, and general advice. Post free, 6d.

The 9-Colour Wiring Diagrams for the "Counterphase" surpass all previous efforts.

A COLOUR FOR EVERY WIRE.
A WIRE FOR EVERY COLOUR.

POST FREE, 4/6

Music from 6 Countries on a G.W.R. train with the BURNDEPT ETHODYNE RECEIVER

This wonderful result was achieved last week on an experimental run between Bristol and Cardiff. Read what the special correspondent of the "Evening News" says:—

"A perfectly standard model Ethodyne, by Burndept's, was installed and no fewer than 20 loud speakers connected to it. Cardiff was quickly tuned in as the train drew out of Bristol station. On the return journey all 20 loud speakers were giving out dance music, at splendid strength, from San Sebastian, in Spain, 700 miles away. London, Manchester, Bournemouth, Birmingham, Toulouse, Oslo, Madrid, Munster, Barcelona and Vienna were logged on the rest of the way, most of them at loud speaker strength."

Evening News, Jan. 25th.

This achievement was accomplished with the aid of Burndept Super-Valves.

Ask your dealer to show you the complete range of Burndept sets, which includes every type from simple crystal receivers to the powerful super-heterodyne.

HEAD OFFICE:
Aldine House, Bedford Street,
Strand, London, W.C.2.
Branches and Agents Everywhere.



Telephone: Gerrard 9072
(4 Lines).
Telegrams: Burndept,
Westrand, London.

TESTIMONY

"... very pleased indeed with my purchase (No. 9 Chakophone) ... Berne, Toulouse, Madrid, Hamburg, Hilversum, etc., give good loudspeaker results, and almost any Continental station can be 'got' on the phones. ... the efficiency of your little machine seems extraordinary."

Chakophone "No. 9"
2-valve set
Royalty Paid

£6 . 15 . 0

Ask your dealer to demonstrate this 2-valver.

EAGLE ENGINEERING COMPANY, LIMITED, WARWICK.

London Showrooms: 8, Gt. Russell St., W.C.



"ENCORE" INDOOR AERIALS

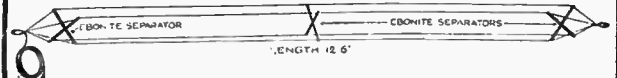

DE LUXE.

PRICE
5/6

Complete with 7' 6" lead-in.
Either aerial is erected or removed in a few moments.

An indoor aerial, being small, assists selectivity. By turning the condenser dial a few degrees you can tune out your local station. If you desire the advantages of an outdoor aerial without its disadvantages, try the **Encore de Luxe**. Strongly made and neat in appearance, this specially designed and constructed aerial has a crystal set range of 15-30 miles.

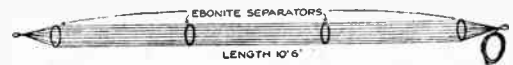

STANDARD.

PRICE
3/-

Complete with 7' 6" lead-in.
If unable to obtain these aerials through your local dealer, send P.O. with dealer's name and address, when we will send aerial post free.

Although not quite equal to the **Encore de Luxe** the "Standard" is the next best thing to the regulation 100 ft. P.O. Aerial. You have probably tried home-made indoor aerials with varying results, but the "Encore" will give exceptional results consistently. Over 15,000 satisfied users can substantiate our claims.

Sole Manufacturers of Encore Products.

Phone: Putney 3973.

THE ENCORE MANUFACTURING CO.,
16, Lower Richmond Road, Putney, London, S.W.15.
Sole Agents for Ireland:—The Briscoe Importing Co., Ltd., 9, Aston Quay, Dublin.

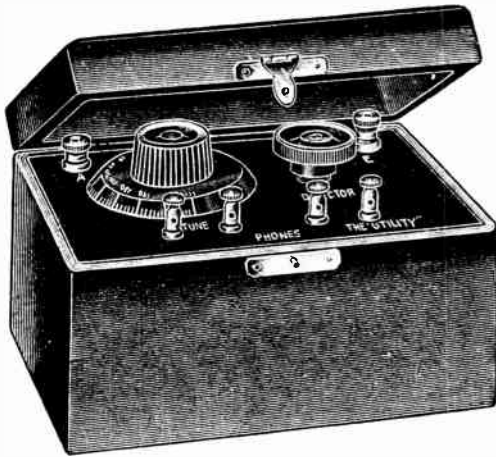

THE UTILITY CRYSTAL RECEIVER

First-class materials and finish throughout characterise the Utility Crystal Receiver. It is compact, highly efficient, and is fitted into a handsome polished wood box. It is designed to receive either the local Broadcasting station or Daventry by means of changing over a switch.

The Utility Automatic Detector which, by merely turning a knob, brings one sensitive spot after another in contact with the cat's whisker at a scientifically regulated pressure makes good reception a certainty at all times. Provision is made for using two pairs of telephones and instructions are supplied for operating each set.

UTILITY SWITCHES



Utility Switches are found in most of the first-class sets of to-day. The reason is not hard to find. They are simple, thoroughly reliable, electrostatic capacity has been reduced to the absolute minimum, they are most

reasonable in price, and, like every other Utility component, they carry our unconditional guarantee.

They are supplied either with knob or lever control with any number of poles from 1 to 6 and at prices from 3/6 for the knob type single pole to 10/- for the 6 pole lever type. Your dealer will gladly supply you.

Utility
GUARANTEED
COMPONENTS

WILKINS & WRIGHT, Ltd.,
 Utility Works, Kenyon Street, Birmingham.

E.P.S. 40.



NO CONDENSER NO VARIOMETER NO VERNIERS

THE RADIO ENTHUSIAST'S DREAMS OF AN INFINITELY VARIABLE ALL WIRE INDUCTANCE AND REACTION TUNER NEED WORRY HIM NO MORE. TO TUNE A STATION ON THE 200-600 METRE WAVEBAND IN BARE WIRE WITHOUT THE AID OF REACTIVE CAPACITY, IMAGINE THE ACCURACY, THE HIGH FIGURE OF INDUCTANCE, AND THE POWERFUL COUPLING WHICH THIS METHOD

WILL ALLOW.

NICK-O-TIME INDUCTANCE 25/-
NICK-O-TIME REACTION . . 25/-

This efficient and only correct method of Coil construction, which will permit of maximum volume combined with selectivity, has been applied in the production of two fixed inductance coils for use on the B.B.C. main waveband.



COIL No. 40 7/6
 .0005 TUNING CONDENSER
 IN PARALLEL.
 STANDARD AERIAL. 220-370 M.

COIL No. 50 8/-
 .0005 TUNING CONDENSER
 IN PARALLEL.
 STANDARD AERIAL. 300-500 M.

PATENTEES AND MANUFACTURERS—
TUNOMETER WORKS
 GOSFORD RD.,
 BECCLES, SUFFOLK, ENGLAND.

TELEGRAMS: TUNOMETERS, BECCLES.

£10 Weekly in Cash Prizes

A New and Simple Competition
for all Readers of "The Wireless World"

To be continued weekly until further notice.

HIDDEN ADVERTISEMENTS

Below will be found six reproductions of fragments cut from the Advertisement pages of this issue of "The Wireless World." Each fragment is a clue. Can you from these clues identify the Advertisements? Seven cash prizes will be awarded to the first seven readers who send us correct solutions. No technical skill is required, merely observation. There are no restrictions or entry fees and the conditions are simple.

£5
for the first
correct solution
opened.

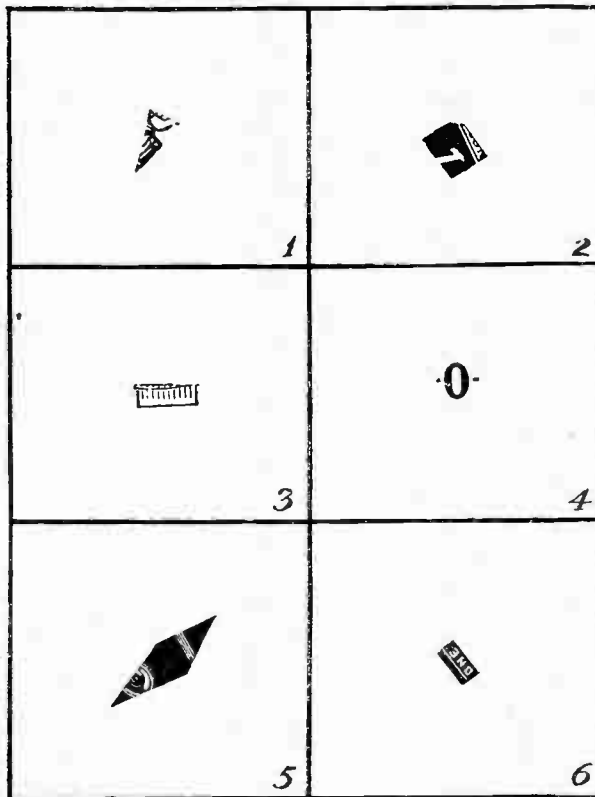

£1
for the third
correct solution
opened.

and
4
consolation
prizes of

10/-
Each
for the next four
correct solutions
opened.

£2
for the second
correct solution
opened.

CONDITIONS

1. All solutions must be written on the special coupon appearing on an advertisement page in this issue and addressed to *The Wireless World*, Dorset House, Tudor Street, London, E.C.4, and marked "Hidden Adverts." in bottom left corner.
2. Clues will not, of necessity, appear in the same way as in the advertisement page, but may be inverted or placed in some other position.
3. In order that town and country readers may compete on equal terms, solutions will not be dealt with until 10 a.m. on Monday next. All solutions received before that date will be retained until Monday morning. Competitors may submit any

- number of entries. Erasures or alterations on a coupon will disqualify the entry.
4. The first prize of £5 will be awarded for the first correct solution opened, the second prize of £2 to the next correct solution; the third prize of £1 for the third, and four consolation prizes of 10/- each for the next four correct answers. In the event of no readers sending correct solutions the prizes will be awarded to the competitors whose solutions are most nearly correct.
5. The decision of the Advertisement Manager of *The Wireless World* is final, and no correspondence can be entered into. Competitors enter on this distinct understanding. No member of the staff of the paper is permitted to compete.

BUY BY POST AND SAVE MONEY



The Little Giant.

A TWO VALVE SET COMPLETE

for **£6-15-0**

(Marconi Royalty included)

The above is typical of the value we are enabled to offer you as the result of our policy of selling through the post.

This policy in a few months has met with overwhelming success.

It enables us to maintain the high standard of quality for which Fellows apparatus has always been famous and at the same time we offer you value which defies competition.

When you compare the prices of Fellows sets offered in the Buyers' Guide, remember that our low prices are the result not of sacrificed efficiency or quality but of our policy of selling through the post.

You can inspect our apparatus and satisfy yourself as to quality at our London Showrooms (20, Store Street, Tottenham Court Rd., W.C.1., Telephone Museum 0200), at Nottingham (34, Bridlesmith Gate) and at Cardiff (Dominions House, Queen Street).

We will send you free our 40 page illustrated catalogue which shows all our products from insulators to Cabinet Sets, shows you how to effect a very substantial economy on all your wireless purchases, and explains how you can obtain wireless sets on the DEFERRED PAYMENT system.

You take no risk in ordering by post as all our goods are sent on SEVEN DAYS APPROVAL against cash.

Write for our catalogue to-day and kindly mention *The Wireless World*.

FELLOWS WIRELESS

The Fellows Magneto Co., Ltd.,
Park Royal, Willesden, N.W.10

E.P.S. 215.

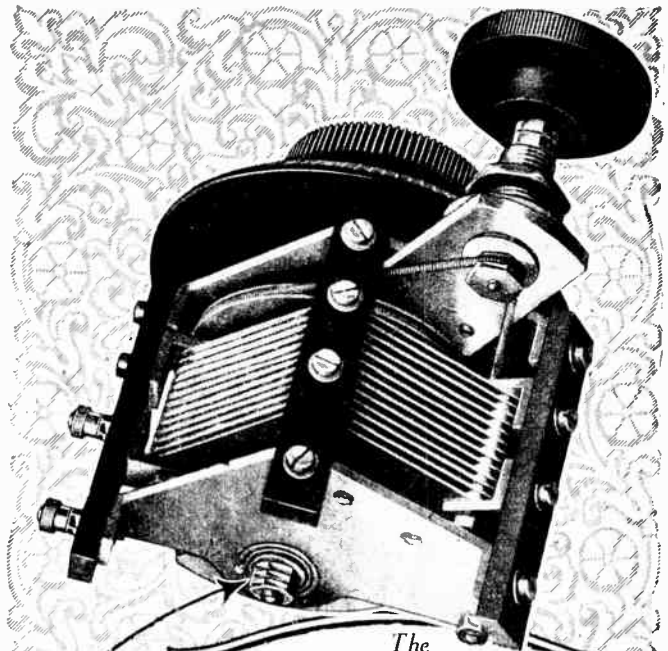

The "COSMOS" SLOW MOTION CONDENSER

COMPENSATED
SQUARE LAW
EFFECT

LOW LOSS

NO
BACK LASH

with its ratio of 10 to 1 makes it possible to dispense entirely with the customary vernier and its attendant losses. Particular stations can be logged. Backlash is avoided, not temporarily but permanently, and movement is smooth, permitting fine adjustment. This model can also be arranged for remote control, as shown in the illustration below. Also supplied without slow motion feature when the condenser is one-hole fixed. Both models are constructed to eliminate hand capacity, for low loss, and to give a compensated square law effect. Cone bearings of hardened steel ensure constant calibration and a pigtail connection gives permanent positive contact.

Metro-Vick Supplies Ltd.
4, Central Buildings, S.W.1 R.

Prices: P29
Ordinary Slow Motion
01025mf1. 0005mf1. 00025mf1. 0005mf1.
15 - 17/6 19 - 21/6

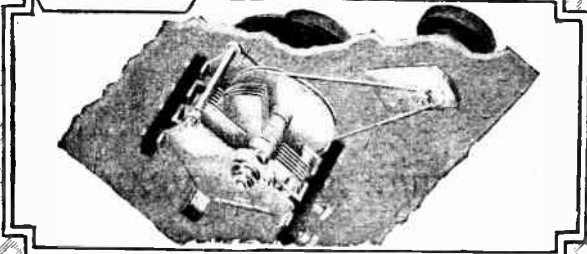
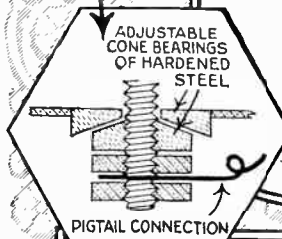

COSMOS

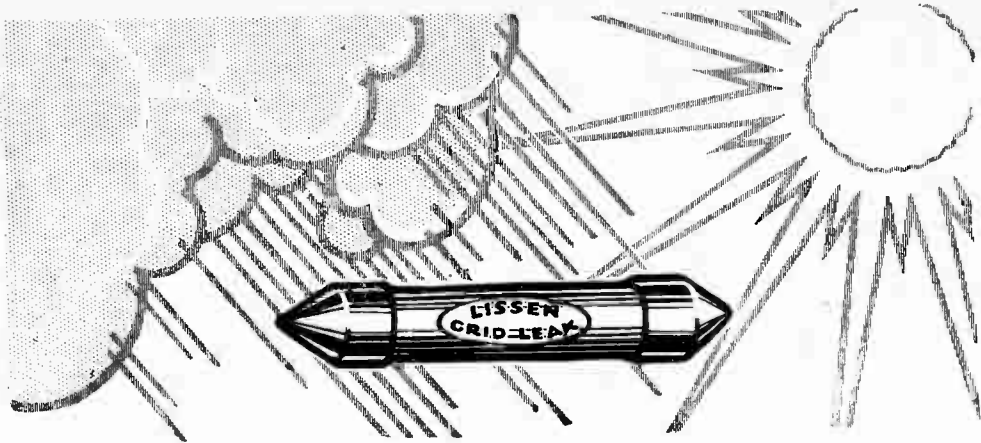

10 Days in Sun and Rain did not alter its resistance

Last Summer, when it rained in London for five days without stopping, an uncovered case of Lissen Fixed Grid Leaks was left the whole time upon the roof of our factory. When the rain stopped the case was left exposed to the sun through a heat-wave. Then it was handed over to our research department who carefully tested the contents. In every Grid Leak the resistance was found unvaried, and true to its marked value.

This points an obvious moral—fit Lissen Fixed Grid Leaks and be sure of your circuit. Their unalterable resistance goes a very long way towards making a circuit *silent*. Price 1/8.

In certain critical circuits a *variable* grid leak is necessary. With a "Lissen" you can obtain any resistance between $\frac{1}{4}$ and 15 megohms, smoothly, gradually and *noiselessly*. When using a Choke Coupled Amplifier it is always advisable to use the Lissen **Variable Grid Leak**. One hole fixing, of course. Price 2/6.



It is also well worth while to fit Lissen **Fixed Condensers**. Accurate to within 5% of their marked capacities, they will not vary and will not leak. Whatever the temperature behind your panel may be, the capacity of a Lissen Fixed Condenser always remains constant. Fit Lissen and make sure of trouble-free condensers.

NOTE THE NEW PRICES
'0001—'001 ... 1/3 '002—'006 ... 2/-

Mica dielectric.
(With each '0002 and '0003 there is included free a pair of clips to take a grid leak.)

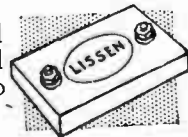

LISSEN

THERE IS NO 'WEAKEST LINK' IN THE LISSEN CHAIN

Lissen Limited, 21-25, Friars Lane, Richmond, Surrey

'Phone: Richmond 2285 (4 lines).

Grams: "Lissenium, Phone, London."

J

The Wireless World

AND
RADIO REVIEW
(13th Year of Publication)

No. 339.

WEDNESDAY, FEBRUARY 10TH, 1926.

VOL. XVIII. No. 6.

Assistant Editor:
F. H. HAYNES.

Editor:
HUGH S. POCOCK.

Assistant Editor:
W. JAMES.

Editorial Offices: 139-40, FLEET STREET, LONDON, E.C.4

Telephone: City 4011 (3 lines).

Advertising and Publishing Offices: DORSET HOUSE, TUDOR STREET, LONDON, E.C.4

Telephone: City 2847 (13 lines).

Telegrams: "Ethaworld, Fleet, London."

COVENTRY: Hertford Street.

BIRMINGHAM: Guildhall Buildings, Navigation Street.

MANCHESTER: 199, Deansgate.

Telegrams: "Cyelbet Coventry."
Telephone: 10 Coventry.

Telegrams: "Autopress, Birmingham."
Telephone: 2970 and 2971 Midland.

Telegrams: "Iliffe, Manchester."
Telephone: 8970 and 8971 City.

Subscription Rates: Home, £1 1s. 8d.; Canada, £1 1s. 8d.; other countries abroad, £1 3s. 10d. per annum.

As many of the circuits and apparatus described in these pages are covered by patents, readers are advised, before making use of them, to satisfy themselves that they would not be infringing patents.

ON BUYING A SET.

A GLANCE at the pages containing the special feature of this issue, which constitutes a Buyer's Guide to complete sets on the market, is quite sufficient to make anyone realise that it is no easy matter to pick out a set for one's own use or to undertake to help a friend in the choice, even if the consideration of how much to spend has already been decided.

There is to-day an enormous variety of sets with a very wide range of prices. It is not proposed here to enter into any discussion as to the merits of the products of different manufacturers, but merely to discuss the principal points which should be taken into consideration in the selection of a set under varying circumstances. In most cases the amount to be spent on a set will decide the limits of ambition, but having got clear on that point probably the next most important thing is to consider the location of the receiver and decide whether telephone or loud-speaker reproduction is wanted.

Crystal Sets.

The crystal set should not be despised because of its simplicity and cheapness. There are many occasions when the crystal set should be recommended in preference to a valve set, as, for instance, in the case of old people or invalids who would never use wireless at all if they thought that it involved the care of batteries and recharging of accumulators. Then, again, if there is no convenient means available for accumulator charging and electricity is not

laid on to the house, a crystal set may be preferable, provided the distance from the broadcasting station is not too great.

The Choice of a Valve Set.

It is always difficult to advise in the matter of the choice

of a valve set, especially as experience shows that people who come for help in the selection seldom really know what they want themselves if they have never owned a set before, and have not had the opportunity of knowing what there is to hear.

It is, of course, a mistake to recommend a super valve set to people who are really only interested in quality reception from the local station. If the location is near enough for good crystal reception a convenient arrangement where loud-speaker reproduction is required from the local station is to add a one- or two-valve low-frequency amplifier to the crystal set.

Next, it should be remembered that if you are located at no greater distance than two or three miles from your local station it will not be the simplest of valve sets which will give you reception from a second station, because the

simple valve sets will not be selective enough to cut out the local station so that others can be received.

Those most fortunately situated for the choice of programmes are those whose location is such that they are more or less equi-distant from two or more stations and can then, with a three-valve set where one valve is acting as a high-frequency amplifier, expect to get a choice of stations without mutual interference because no one

CONTENTS.

	PAGE
EDITORIAL VIEWS	193
IMPROVING LOUD SPEAKER QUALITY	195
By F. L. Devereux.	
BUYER'S GUIDE. INDEX TO SETS ON	
THE MARKET	199
CURRENT TOPICS	215
MUSIC WITHOUT MUFFLING	217
By N. P. Vincer-Minter.	
PATENT INFRINGEMENT AND EXPERIMENTAL USE	219
PIONEERS OF WIRELESS. 6.—WILLIAM SPURGEON	221
By Ellison Hawks.	
HINTS AND TIPS FOR NEW READERS	223
REGULATING THE H.T. POTENTIAL	225
By F. H. Haynes.	
WIRELESS IN A RAILWAY TUNNEL	228
BROADCAST BREVITIES	229
OSCILLATION WITHOUT RADIATION (concluded)	231
By W. James.	
LETTERS TO THE EDITOR	235
READERS' PROBLEMS	237

of the stations will be too powerful to be rejected from the wavelengths on which the others are working.

Many people who have not had experience get the impression that a super set, by which is meant one of five valves or over, ought to give them a choice of most of the programmes in Europe, or, at least, a very fair proportion of them, and that the reception will be good enough to be enjoyable at all times; but as things stand to-day one is forced to be considerably more conservative in an estimation of the possibilities of a super set. The best of the super sets to-day should be able to guarantee you a choice of four and perhaps, with good luck, five different programmes each evening, but not entirely without interference, so that super sets can scarcely be recommended to people who want to use their receiver as a means of entertainment, expecting much the same kind of thing they would get from an attendance at a concert or a lecture.

Limitations of Super Sets.

The people who will appreciate super sets are those who, in addition to getting their local station and Daventry with excellent quality, are yet sufficiently interested in wireless for its own sake to derive satisfaction and enjoyment from being able to listen-in to the foreign and other distant programmes, and are prepared to put up with the occasional or, in some instances, frequent, interruptions which will result from Morse transmissions, atmospheric disturbances, local interference from oscillators, and so forth. But the taste for distant reception is undoubtedly on the increase, and most people feel that they have been adequately rewarded if they can hear clearly two or three items from foreign programmes each evening.

In recommending a super set it must be remembered that the initial cost is considerably greater than for one which will give good reception from the local station and Daventry alone, and before persuading anyone to acquire a set of that description, it is well to make quite sure that its limitations as well as its capabilities are fully recognised, and that it will not, after a short while, be merely a source of disappointment because the owner really only wanted a means of entertainment, and derived no permanent enjoyment from distant reception.

Now, as regards the operation of loud-speakers, there seems to be a good deal of misunderstanding amongst the public, partly, we are afraid, due to the lack of explanatory literature with the apparatus sold by manufacturers.

Loud-Speakers and the Amplifier.

One of the most common sources of failure or inefficiency of wireless sets to-day is due to the well-advised employment of low-impedance power valves, but neglecting meanwhile to realise that such valves are a considerable drain on the high-tension battery, especially if the grid bias to the last stages of the amplifier is insufficient. It is quite unsatisfactory to use the ordinary type of dry cell of very small dimensions with power valves, because it can only have a limited life. If power valves are used (and we would naturally recommend that they should be employed for loud-speaker reproduction

wherever possible), then the H.T. battery should be of ample dimensions so that it can deliver six milliamps. of current, or whatever may be required of it, without putting an altogether disproportionate strain upon its resources. Where possible for good loud-speaker work with low-impedance valves, it is better to use accumulator high-tension batteries, or, alternatively, to supply the valve current from the house-lighting mains if electricity is available in the house. No valve set, however carefully designed, must be expected to give a good performance unless all the circumstances are in its favour. Just the same remarks apply in the case of a good many types of loud-speaker at present on the market. Not every loud-speaker can be expected to work at the end of any amplifier, and at least one particular make of loud-speaker on the market to-day is probably not achieving the popularity which it deserves simply for the reason that the average user is not employing it under the proper conditions which it should be the business of the manufacturer to stipulate quite clearly in instructions issued with the instruments when sold to the public.

In these days, when the facilities for demonstration have so increased, one would not recommend that a set should be bought, particularly an expensive super set, without the opportunity first being taken of hearing it demonstrated, and the demonstration should preferably be given in the location where the set is to be used because one can never be quite sure that local causes of interference may not exist which would render the use of a super set impracticable. There are, as a good many people have learned to their sorrow, certain artificial causes of interference, as, for example, from local electrical machinery, which the user of a wireless set may be powerless to cure on his own account, and equally unable to get remedied at the source.

Finally, as a word of advice in the selection of a set. Never let external appearances take too large a part in influencing the choice, because some of the best sets on the market to-day are by no means the best looking from the outside; and, again, expensive cabinets and beautiful finish may often hide bad design and poor workmanship within.

Standard Specification.

No doubt the time will come when every set will be definitely rated in such terms that the limits of its performance can be estimated without actually testing the set, provided that the manufacturer guarantees the specification. We shall no doubt get down eventually to artificial means of estimating the percentage of selectivity, efficiency, quality, and sensitivity (which, of course, will include range of reception), and there will also be taken into account in the specification of every set its economical rating, from the point of view of battery current consumption, both for high-tension and low-tension. At present no standard of measurement has been set up, although some attempts to arrive at an approximate result have been made in the United States of America. Some day, however, the choice of a set will be a comparatively simple matter, because the rating of the set will tell us all that we need to know about it, and any risk of a gamble in the purchase of a set will be practically eliminated.

IMPROVING LOUD SPEAKER QUALITY

Tone Control Unit for Adding to Existing Receivers.

By F. L. DEVEREUX, B.Sc.

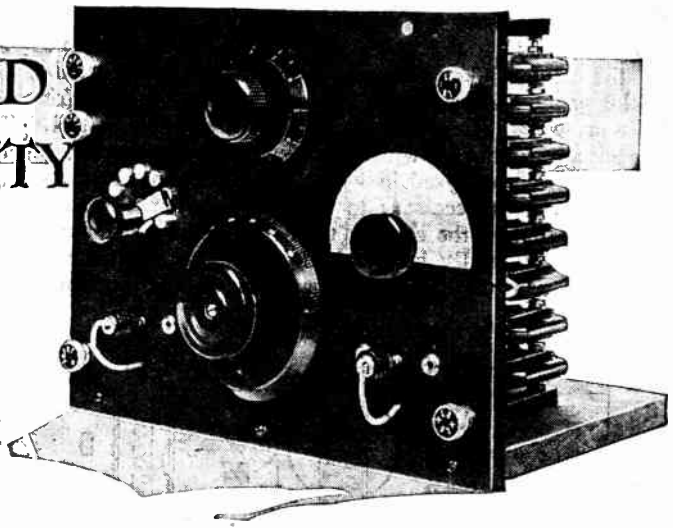

THE first consequence of the elimination of distortion in L.F. amplifiers has been to reveal the shortcomings of the average loud-speaker as a sound converter. Low-frequency amplifiers giving reproduction of speech and music that is for all practical purposes distortionless are quite common now that manufacturers are supplying the special valves, transformers, and wire-wound anode resistances for which keen amateurs have been kept waiting so long. The frequency response curve in Fig. 9 of Prof. Mallett's article on "Simple Acoustic Measurements on Loud-Speakers and Telephones," in the issue of November 11th, 1925, must have come as a shock to those accustomed only to the gentle undulations and slopes of transformer characteristics.

Introducing Controlled Distortion.

The experimenter, having produced an amplifier with a straight-line characteristic, has now to introduce distortion—this time under control—in order that the overall response of the amplifier plus the particular loud-speaker available may be uniform.

Regular readers of *The Wireless World* are already acquainted with the devices by means of which these effects may be produced both in resistance-capacity and

transformer-coupled amplifiers.¹ Where a commercial amplifier of standard design is being used, however, it is not always convenient or desirable to modify the connections in order to bring about the desired result, and it is to meet the requirements of owners of such instruments that a description of an independent tone control unit is given. There is a current belief that tone correction by means of a separate unit is not so efficient as tone cor-

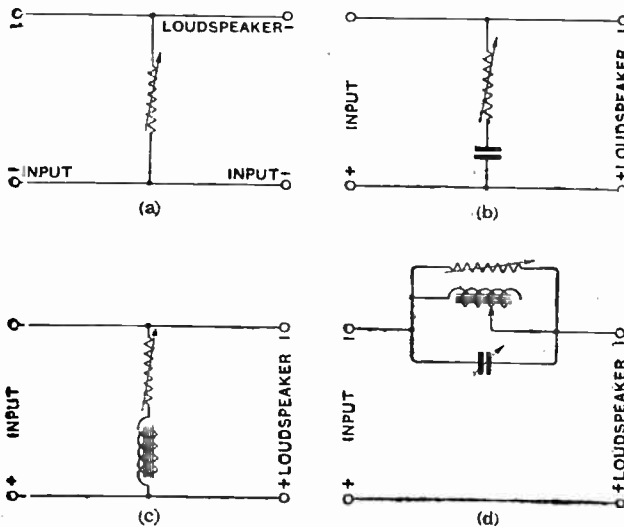

Fig. 1.—Alternative tone correction circuits provided by the unit. The wander plug positions in Fig. 2 for each circuit are as follows: (a) L, centre; C, centre; (b) L, centre; C, right; (c) L, right; C, centre; (d) L, left; C, left. In circuits (a), (b) and (c) the top left band input connection is joined to terminal R (Fig. 2.)

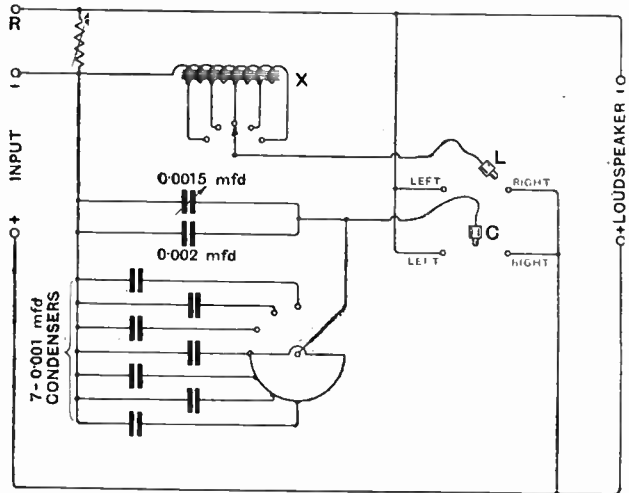

Fig. 2.—Complete circuit diagram of unit.

rection in the amplifier itself, and that a considerable margin of volume is necessary to allow for loss in the control unit. Tests on the instrument described in this article failed to substantiate this view, the reduction in volume being quite negligible.

Connections.

The control unit is connected between the output or loud-speaker terminals of the amplifier and the loud-speaker itself, the input terminals from the amplifier

¹ H. Lloyd, "Tone Correction in L.F. Amplifiers," Jan. 6th, 1926. N. W. McLachlan, "Speech Amplifier Design," Jan. 13th, 20th and 27th, 1926.

Improving Loud-Speaker Quality.—

being situated on the left-hand side, and the terminals for the loud-speaker connections on the right-hand side of the panel. A composite circuit has been adopted for the unit, which gives four distinct types of tone control. The circuits obtained with different methods of connection have been analysed in Fig. 1. The external connections of the unit necessary to produce these circuits have been indicated in the caption to the diagram. Although it was not originally intended to include a pure volume control, it was found that, by connecting the output leads

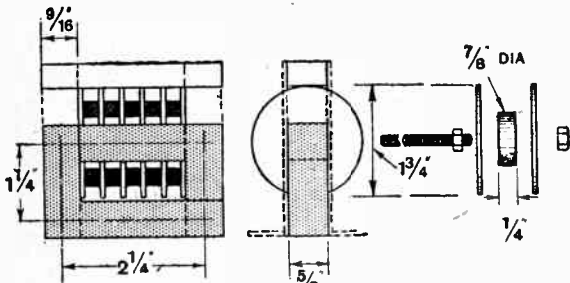

Fig. 3.—Details of the choke coil and former used for winding the sections.

from the amplifier to the terminals on the control unit marked R and Input — and by connecting the loud-speaker leads to the L.S. — and Input — terminals as indicated in Fig. 1(a), the variable resistance could be made to function as a volume control by being connected in parallel with the loud-speaker.

It is generally found that the higher frequencies predominate in the reproduction from the average loud-speaker, and that tones below, say, 500 cycles lack volume. This state of affairs is corrected by means of the circuit shown in Fig. 1(b), which enables any capacity between 0.002 and 0.01 mfd. to be connected across the loud-speaker terminals in series with the variable resistance. Now the resistance offered by a condenser to the passage of fluctuating currents decreases as the frequency of fluctuation increases, therefore a portion of the

higher frequencies is by-passed through the condenser and resistance circuit instead of passing through the loud-speaker. The low frequencies, on the other hand, are practically unaffected, and the result is an improved balance of tone. The variable resistance alters the degree to which this selection between the high and low tones takes place, thus, with the resistance all out (i.e., a very low resistance in series with the condenser), a marked diminution of the higher tones in relation to the low tones will be produced. As the resistance is increased, so will the higher tones become more prominent, until finally, with the full resistance of 0.5 megohms in series with the condenser, it will be difficult to detect any difference between the quality obtained with and without the control unit in circuit. The circuit in Fig. 1(c) produces the converse effect, viz., a reduction of the lower tones in relation to the high tones. This type of

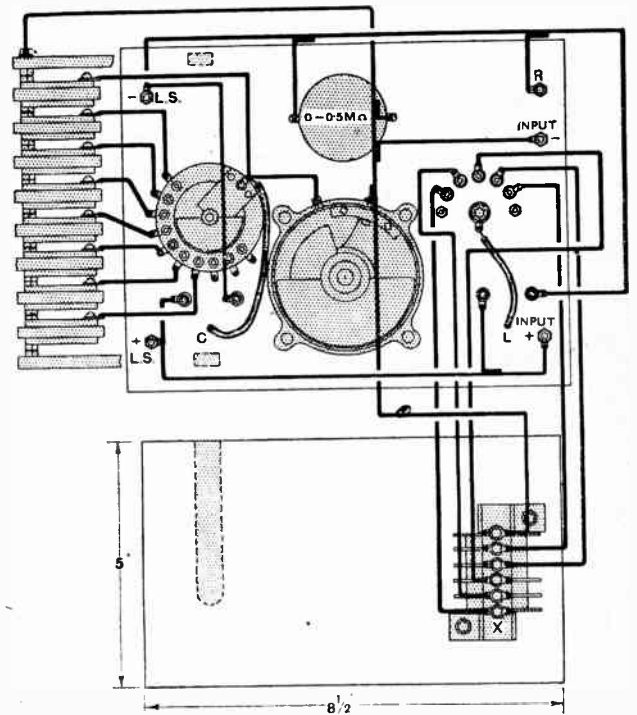

Fig. 5.—Wiring diagram indicating layout of components.

correction is seldom required, but is mentioned in order that the reader may learn to appreciate the general effect on the quality of speech and music produced by inadequate amplification of the lower tones.

Perhaps the most irritating form of distortion in loud-speakers is due to the presence of one or more sharply defined resonances. These can be easily detected by listening to scale passages in instrumental music. If resonances are present it will be observed that certain notes stand out above all others, and that these notes are accentuated every time the music falls within the resonant frequency. These resonant notes can be more clearly heard by listening in the next room; indeed, under these circumstances, it frequently happens that these are the only tones which can be heard. The circuit in Fig. 1(d) is arranged to suppress resonant frequencies of this

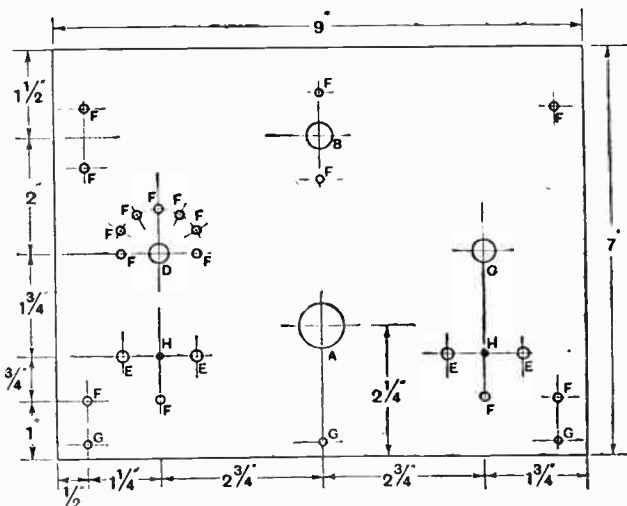

Fig. 4.—Drilling details of the front panel. Diameters of holes are as follow: A, 3/4in. dia.; B, 7/16in. dia.; C, 3/8in. dia.; D, 5/16in. dia.; E, 3/16in. dia.; F, 5/32in. dia.; G, 1/8in. dia.; H, drill to fit 6x6 plug.

Improving Loud-Speaker Quality.—

kind. It is capable of dealing only with one frequency or band of frequencies, but in general it will be found that there is only one major resonance in the loud-speaker which gives annoyance. If more than one major resonance is present, other tone control units would be required to deal individually with each frequency. The required result is achieved by introducing a tuned circuit into one of the loud-speaker leads, which offers a high resistance to alternating currents of the frequency to which the circuit is tuned.

A variable resistance (0 to 0.5 megohm) is connected in parallel with the circuit to broaden the tuning when it is desired to suppress a small band of frequencies in the neighbourhood of the major resonance. If very sharp tuning is required, the variable resistance may be entirely disconnected.

The Circuit.

A complete circuit diagram of the unit is given in Fig. 2. A special choke coil, having a total inductance of approximately 17 henries, with five equally spaced tapplings, is tuned by means of a composite condenser consisting of eight fixed mica condensers and a single variable condenser. The connections have been arranged so that the minimum capacity in parallel with the choke coil is 0.002 mfd. This capacity can be increased by steps of 0.001 mfd. by means of a special paralleling switch, and a variable condenser 0.0015 mfd. is provided to obtain a continuous variation of capacity between a minimum value of 0.002 mfd. and a maximum value of approximately 0.01 mfd. Actually, the maximum capacity came out to 0.0145 mfd., due no doubt to the additional capacity of the choke coil windings and the wiring

The variable resistance is of the graphite line type, and was found in practice to remain constant in value at any given setting.

Constructional Details.

The choke coil was built up on an interval transformer core (Ripault), the dimensions of which are given in Fig. 3. The sections of the winding were wound in the former shown at the right-hand side of Fig. 3, each section consisting of 800 turns of No. 38 D.S.C. copper wire. When each winding was finished the

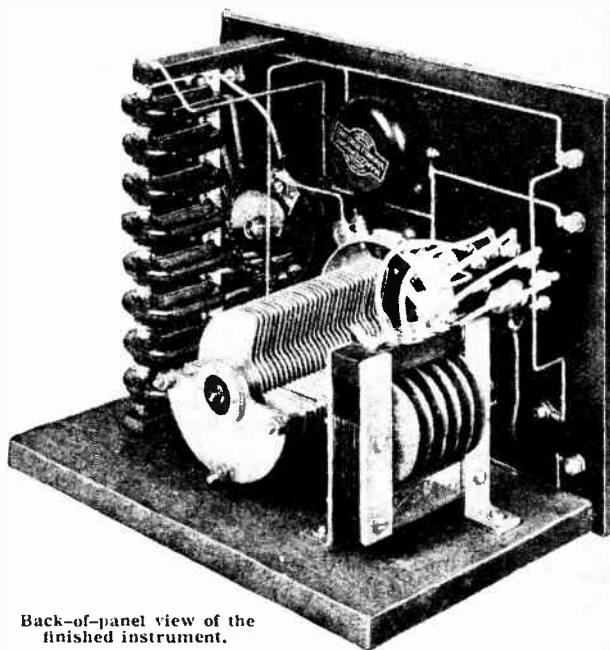

Back-of-panel view of the finished instrument.

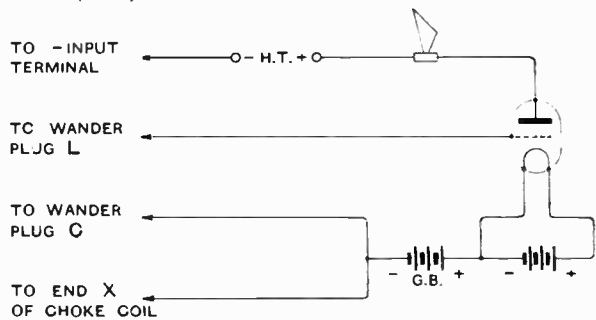

Fig. 6.—Valve connections for setting up the unit as a low-frequency oscillator.

of the unit. The frequency range provided by this combination of inductance and capacity is indicated in the table below.

No. of Sections.	Frequency in Cycles per sec.	
	0.002 mfd.	0.0145 mfd.
1	860	300
2	1,150	430
3	1,400	530
4	2,130	750
5	4,550	1,710

Clix sockets and wander plug connections enable the choke coil and the back of condensers to be connected in parallel or used independently.

former was removed from the lathe (or hand drill) and immersed for a few minutes in a bath of molten paraffin-wax. After shaking off superfluous wax and allowing to cool, the former was dismantled, and the 7/16 in. centre piece withdrawn from the coil. This operation will be facilitated if the centre piece is tapered slightly and polished to remove file marks. When five sections have been completed they are assembled with the direction of winding the same in each case on a square wooden mandrel having a cross-section equal to, or slightly larger than, that of the transformer core. The coils are spaced with cardboard discs 1 3/16 in. diameter and 1/16 in. thick, which have been previously soaked in paraffin-wax. If the coils and spacing discs are then slightly warmed a complete unit will be formed which can be removed from the mandrel, and which will withstand the handling necessary when assembling the core. A layer of empire cloth must be inserted between the windings and the iron core.

The transformer is mounted on brass legs extended at the top to carry an ebonite terminal block. Soldering tags are fixed to this block by means of No. 6 B.A. screws, and the ends of the winding and the tapplings from the junction between each section are soldered to the tags. The choke coil when finished is screwed to the left-hand side of the baseboard opposite the five-point switch and the Clix plug and sockets on the front panel.

Improving Loud-Speaker Quality.—

A neat method of mounting can be adopted with the particular type of fixed condensers used in the unit. These are threaded on to a length of No. 4 B.A. screwed rod with lock-nuts between each condenser. The unit so formed is mounted vertically between ebonite brackets extended from the front panel. The variable condenser should have a maximum capacity greater than 0.001 mfd., and should be preferably of the air dielectric type. The condenser actually used in the unit was taken from an ex-Government Mark III* crystal receiver, and has a nominal capacity of 0.0015 mfd.

Mica dielectric variable condensers are not recommended for this particular purpose. The variable condenser is mounted in the centre of the panel, and the switch and Clix sockets are mounted at the right-hand side corresponding to the choke coil switch and sockets. The variable resistance, which is not often used, is mounted in the centre of the panel above the variable condenser.

Drilling details for the front panel are given in Fig. 4.

Wiring and Testing.

As a result of arranging the choke coil and condenser unit opposite their respective switches on the front panel the wiring is simple and direct. No. 16 S.W.G. tinned copper wire is used throughout, with the exception of the connections for the choke coil and condenser tappings. For these No. 24 S.W.G. wire is used with Systoflex covering. A complete wiring diagram is given in Fig. 5.

In testing out the unit it is perhaps as well first to try the circuits (b) and (c) in Fig. 1, as their effect on quality is most marked and will give valuable information which will enable the reader to deal more effectively with the adjustment of the rejector circuit (d).

Without exact knowledge regarding the frequency range of each setting of the inductance and capacity in circuit (d) the search for the frequency which it is desired to suppress may well be a long one. It can be calibrated by systematic searching and careful observation, but a far better method is to set up the unit with a valve as a low-frequency oscillator. The external connections for the well-known single coil Hartley circuit are given in Fig. 6. It will be noticed that the centre tap grid connection is taken from the arm of the choke coil distributing switch, so that various tapping points can be obtained with the grid return lead from X. When the active turns are limited to two sections, only one tapping is possible, of course, and it is not possible to obtain a direct calibration of the first section only. The figures given for this section in the table were deduced from the fre-

quencies measured in the case of the other sections. A D.E.5A valve was used with anode voltages between 30 and 120, and a negative grid bias of 3 to 6 volts. An H.T. voltage of 60 and grid bias of $4\frac{1}{2}$ gave best results, as with 120 volts H.T. the amplitude of oscillation was so great that the variable condenser flashed over. During the tests the 0.5 megohm resistance was disconnected.

The note produced by the loud-speaker in the anode circuit of the valve was compared with a pianoforte and frequencies were worked out on the assumption that middle C is equal to 256 cycles. The results were remarkably consistent, particularly on frequencies below 1,000 cycles, where observed and calculated frequencies agreed to less than 1 per cent.

Knowing the frequencies corresponding to various capacities, it was possible to calculate the inductance of the choke coil by substituting in the formula

$$f = \frac{1,000}{2\pi\sqrt{LC}}$$

where f = frequency in cycles per second.

L = inductance in henries.

C = capacity in microfarads.

The inductance worked out as follows:—

No. of sections:—	1	2	3	4	5
No. of turns	800	1,600	2,400	3,200	4,000
Inductance (henries) . .	0.6	2.8	6.2	9.5	17.2

These results are given in case any reader should wish to construct a choke of higher inductance for the purpose of suppressing lower resonant frequencies. This is quite easy to do, remembering that the inductance is proportional to the *square* of the number of turns, to the cross-sectional area of the core, and to the reciprocal of the length of the magnetic circuit.

LIST OF COMPONENTS.

- 1 Ebonite panel, 9in. × 7in. × $\frac{1}{4}$ in.
- 1 Baseboard, $8\frac{1}{2}$ in × 5in. × $\frac{1}{4}$ in.
- 1 Variable condenser.
- 1 Fixed condenser, 0.002 mfd. (British Sangamo).
- 7 Fixed condensers, 0.001 mfd. (British Sangamo).
- 1 Ten-way switch (Silvertown).
- 1 Five-stud switch (Bowyer-Lowe).
- 1 Variable resistance, 0 to 0.5 megohm (Marconiphone).
- 2 Clix plugs.
- 4 Clix sockets.
- 5 Terminals (Belling Lee).
- Materials for choke—No. 38 D.S.C. wire, soldering tags, etc.

"Gaston E. Marbaix." (27-28, Anning Street, E.C.2.) Indian guide issued by the All-American Radio Corporation, Chicago. Also particulars of the "King Quality Products" rheo-switch (6 $\frac{1}{2}$ ohms).

o o o o

"Marconiphone Co. Ltd." 210-212, Tottenham Court Road, W.1.) Publications 396A, 439, and 440, dealing respectively with "Primax" loud-speaker, "Mellovox" loud-speaker, and "Miniloss" square law condenser.

A 18

**CATALOGUES
RECEIVED.**

"Ripaults." (1, King's Road, St. Pancras, N.W.1.) Catalogue of "Ripaults" productions, including accumulators, dry batteries, and L.F. transformers.

"W. & T. Lock" (15, St. Peter's Terrace, Bath). An illustrated price list of cabinets of distinction for wireless.

o o o o

"Hatton Supply Co." (Hatton, Middlesex). Leaflet describing the Sarbolt insulator.

o o o o

"Rockwood Co. Ltd." (147, Queen Victoria Street, E.C.4.) An illustrated price list of Rockwood radio tools, including Spinrite wrenches, panel cutters, taper reamers, etc.

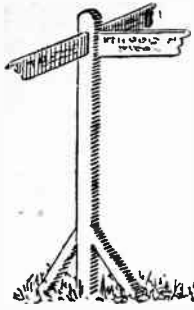

The Wireless World BUYER'S GUIDE

INDEX TO SETS ON THE MARKET



VERY considerable proportion of our daily correspondence is devoted to satisfying enquiries from our readers concerning the best type of receiver suited to the especial needs either of themselves or those who seek their advice. We have, therefore, compiled, from information furnished by the manufacturers, the following list of standard receivers, which, we believe, will prove of advantage to all concerned—our readers, the manufacturers, and ourselves—and will be a guide to purchasers in their choice.

In compiling a list in tabulated form derived from information supplied from so many individual sources, it is difficult to preserve absolute consistency in the very brief space available for the "general description and

remarks." In some cases the manufacturers, in furnishing us with particulars, have over-described their sets, while in a few instances the details sent in were almost too scanty for our purpose. We have, however, endeavoured to make these brief remarks as consistent and comprehensive as is possible in a few words, and for further details our readers are referred to the descriptions in our advertisement pages, and catalogues which the manufacturers send to prospective purchasers.

In the case of multivalve receivers or those with complex circuits, it is not always possible to apportion the valves under the respective headings of L.F., detector, and H.F. We have, therefore, in such cases, merely indicated the total number of valves.

CRYSTAL SETS.

Manufacturer.	Name of Set.	Type of Cabinet.	Price.	Description and Remarks.
Aurial Supplies Co., 31, Leys Avenue, Letchworth.	Premier	Sloping or enclosed	£ s. d. 0 14 6	Set only.
"	"	"	1 2 6	"
"	"	"	1 5 0	"
"	Clearcryst	Sloping	0 17 6	"
Belling & Lee, Ltd., Queensway Works, Ponder's End, Middlesex.	Aurialphone	Enclosed	1 10 0	"
"	"	Polished mahogany with lid.	1 5 0	Set only. With loading-coil sockets.
British Thomson-Houston Co., Ltd., Crown House, Aldwych, London, W.C.2.	B.T.H. Bijou	Box form (walnut)	1 7 6	With loading coil under panel.
"	"	"	1 0 0	Variometer tuning. 5XX loading-coil device, 3s. 6d. extra.
"	B.T.H. Model A ..	Box form (walnut) with sloping panel	1 15 0	As above, but with alternative crystals.
British Wireless Supply Co. (1924), Ltd., 6, Blenheim Terrace, Leeds.	Britphone 2B	Oak box	0 6 6	Variometer tuned.
"	" 3	"	1 5 0	Condenser and coil tuning.
"	" 2A	Enclosed, oak or walnut.	1 2 6	Similar to 2B but enclosed cabinet.
Burdett Wireless, Ltd., Aldine House, Bedford Street, Strand, London, W.C.2.	Ethophone I, Mark III.	Polished mahogany box.	3 3 0	Set only.
Cable Accessories Co., Ltd., Britannia Works, Tivdale, Tipton, Staffs.	Revophone	Mahogany case ...	2 10 0	Complete with all accessories for local and 5XX stations.
City Radio Service, 226, Warwick Road, Greet, Birmingham.	Warwick No. 1 ...	Oak, with lid.	1 6 0	Set only. Tuning 250 1900 metres.
Collins & John, Ltd., 52, Hatton Garden, London, E.C.1.	Amplex Model A.	Enclosed cabinet, oak or mahogany.	1 9 0	Fitted with Amplex patent detector.
"	Amplex Model B.	Open panel	0 15 0	"
"	Amplex Model C.	Enclosed cabinet, oak or mahogany.	1 17 6	Same as Model A, but with loading coil and fittings for 5XX.
"	Amplex 5XX	Enclosed cabinet, oak.	1 0 0	For 5XX only, fitted with patent detector.
Curtis, Peter, Ltd., 75a, Camden Road, London, N.W.1.	Radionette	Oak, enclosed.	1 5 0	Set only. Parallel detector.
Darzac Bros., Ltd., Simphon Technical Instrument Works, Halifax.	Simphon No. 1 ...	Box type	17 6	Set only.
"	" No. 2	" with lid.	1 10 0	Complete with headphones.
"	"	"	1 12 6	Set only.
"	"	"	2 5 0	Complete with headphones.
Dunham, C. S., 234/236, Brixton Hill, London, S.W.2.	Dunham Crystal Receiver.	C.S.D.31	1 5 0	Set only. Spare crystal.
"	"	"	2 5 0	With accessories. Coil for 5XX, 4s. 6d. extra.
Eagle Engineering Co., Ltd., Eagle Works, Warwick.	Chakophone " No. 3A.	Box type, with lid.	2 0 0	Set only. Slide tuned with 5XX plug-in coil and compartment for phones.
"	" No. 1	Open, box type ..	1 10 0	Set only. Self-contained condenser tuned 300-500 and 1,200-2,000 metres.
Edison Swan Electric Co., Ltd., 123/5, Queen Victoria Street, London, E.C.4	Ediswan WL 1924 Short Wave.	Tray, mahogany finish.	0 12 6	Set only.
"	"	"	1 18 4	With accessories.
"	WL 1924 L Long Wave.	"	0 15 0	Set only.
"	"	"	2 0 10	With accessories.



Buyer's Guide to Sets



CRYSTAL SETS—continued.

Manufacturer.	Name of Set.	Type of Cabinet.	Price.	Description and Remarks.
Edison Swan Electric Co., Ltd., 123/5, Queen Victoria Street, London, E.C.4	WL 1924 P for High Power Station.	—	£ s. d. 1 0 0	Set only.
Electrical Accessories Manufacturing Co., Progress Works, Low Hall Mills, Ilolbeck, Leeds.	2B Type	Polished Jacobean oak cabinet.	2 5 10 1 5 0	With accessories. Set only.
Ericsson, British L.M., Manufacturing Co., Ltd., 67/73, Kingsway, London, W.C.2.	0 1002	Oak case with lid..	1 1 0	Micrometer crystal detector—tunes from 300-700 metres, supersensitive crystal. Provision for loading coils.
" " "	0 1050 Miniature	Turned and polished ebonite case.	0 7 6	All mechanism concealed, adjustable cat-whisker and crystal, fine tuning, 300-500 metres. Set only.
Falk, Stadelmann & Co., Ltd., 83/93, Farringdon Road, London, E.C.1.	Efescaphone Benbow.	Mahogany, enclosed	2 1 0	"
" " "	Efescaphone Benbow Junior.	Mahogany, open ..	1 1 0	"
Fellows Magneto Co., Ltd., Cumberland Avenue, Park Royal, London, N.W.10.	Fellocryst Super ..	Oak case	1 15 0	Set complete with all accessories.
Flinders (Wholesale), Ltd., 18, Butt Road, and Essex Street, Colechester.	Flinderphone ...	—	1 7 6	Set only.
Fraser & Glass, Assembly Works, Middle Lane, Hornsey, London, N.3.	Fortevox, Junior Model No. 1.	Self contained with moulded bases.	0 6 0	Set only.
General Electric Co., Ltd., Magnet House, Kingsway, London, W.C.2.	Junior No. 2.	Mahogany, open type.	0 7 6 0 16 0	Set only. Wavelength 300-500 metres. Two aerial terminals for short or long aeri-als. (Two pair phones can be connected.) Plug-in coil for 5XX, 7s. 6d. extra.
" " "	No. 1	Matt ebonite box type.	2 5 0	Set only, with two 10-ft. lengths flexible wire for aerial and earth connections.
Henderson, W. J., & Co., Ltd., 351, Fulham Road, S.W.10.	B.R.C.1	Box type, with lid.	1 12 6 3 2 6	Set only. With phones and aerial equipment.
" " "	B.R.C.1A	" "	1 10 0	Set only.
Hirst Bros. & Co., Ltd., Roseoc Street, Oldham.	Tameside R.335 ..	Oak, open box type	3 9 0 0 10 0	With phones and aerial equipment. Set only. Sliding coil tuner. Glass-covered detector.
" " "	" R.542 ..	" "	1 2 6	Set only. Variometer tuned. Glass-covered detector.
" " "	" R.424 ..	Oak, open desk type	1 5 0	Set only. Condenser tuned. Glass-covered detector.
" " "	" R.515 ..	Oak, hinged lid....	1 10 0	Set only. Condenser or variometer tuned. Shorting plug for loading coil.
Holrose Manufacturing Co., 43, Lansdale Road, Kilburn, N.W.6.	The Holrose	Leatherette case ..	8 6	Set only.
Ignaphone Co., Ltd., 99, High Street, Dudley.	Ignaphone	Leatherette	0 15 6	Set only.
Johnson, Thos. T., 17/19, Catherine Street, Salisbury.	Sarumphone	Mahogany box with lid.	1 0 0	Set only.
Lamplugh, S. A., Ltd., King's Road, Tyseley, Birmingham.	No. 1030	Oak cabinet	1 10 0	Set only. Variometer tuned, 300-500 metres and 5XX.
" " "	No. 1052 Junior ..	Moulded ebonite ..	0 9 6	Set only. Solenoid inductance, 300-500 metres and 5XX.
" " "	No. 1018	Oak cabinet	4 4 0	Complete with accessories. Variometer tuned, 300-500 metres and 5XX.
Lissen Ltd., Lissenium Works, Friars Lane, Richmond, Surrey.	Lissen	—	0 10 0	Set only. Appropriate coil extra.
Liver Radio Manufacturing Co., Ltd., 30, Islington, Liverpool.	Liverphone	Sloping, oak or mahogany.	1 5 0	Set only. Variometer tuning.
" " "	" "	" "	2 0 0	Complete with headphones and aerial equipment.
M.A.P. Company, Great Lister Street, Birmingham.	M.A.P. Crystal...	Polished aluminium	1 7 6	Set only. For high and low wavelengths.
Marconiphone Co., Ltd., 210/212, Tottenham Court Road, London, W.1.	Marconiphone Universal Baby	Moulded base	1 7 0	Set only. 300-500 metres. Variometer tuned. Galena type crystal.
" " "	Sterling R.1550..	Walnut	1 15 0 3 3 0	Do. With loading coil for 5XX. Complete with 1 pair headphones. Variometer tuned. Semi-automatic crystal detector. 300-500 metres. Switching arrangement for 1,800 metres.
Master Radio Mfg. Co., 30, Rosamond Street East, All Saints, Manchester.	Master Junior ...	Mahogany	0 7 6	Set only. Open type detector. Tuning 250-600 metres.
" " "	Mastavox	" "	0 8 6	Set only. Dustproof detector. Tuning 250-600 metres. Socket for loading coil.
Metro-Vick Supplies, Ltd., 4, Central Buildings, Westminster, London, S.W.1.	Cosmos	—	1 5 0	Set only. Variable condenser tuning. Glass-enclosed detector. Includes 1 coil either for B.B.C. or 5XX. Additional coil, 4s. 6d.
National Wireless & Electric Co. (R. R. Goding, Ltd.), 42, Gray's Inn Road, London, W.C.1.	Gnat N.Mk.CI....	Wood	1 1 0	Set only.
" " "	" N.Mk.CL....	Mahogany, with lid	1 12 6	"
" " "	" N.Mk.CX....	" "	2 2 6	"
Radi-Arc Electrical Co., Ltd., Bennett Street, Chiswick, London, W.4.	Liberty Ironclad.	Iron cased	0 16 6	Set only. Liberty detector.
Radio Communication Co., Ltd., 31/35, Norfolk Street, London, W.C.2.	Polar	Oak, sloping	1 7 6	Set only. With Igranite plug-in coil.
Radio Instruments, Ltd., 12, Hlyde Street, London, W.C.1.	I.C.	Polished mahogany with lid.	2 2 0	Set only. Fitted with P.M. detector. 300-500 metres.
" " "	I.D.	" "	2 15 0	Set only. Do. Includes 1,600 metres wavelength.
Radio Supply Co., Superfone Works, Four Oaks, Birmingham.	Superfone Maxum.	Walnut, with lid ..	1 2 6	Set only. Variometer tuned, including 5XX coil.

Buyer's Guide to Sets

CRYSTAL SETS—continued.

Manufacturer.	Name of Set.	Type of Cabinet.	Price.			Description and Remarks.
			£	s.	d.	
Rigaut, J., 108, Euston Road, London, N.W.1.	L Type	Mahogany, closed, sloping panel.	0	19	6	Set only. Fine and coarse tuning and tapped inductance.
" " "	D Ty	Same as above ...	1	2	6	Set only. Wound for Daventry.
" " "	V Type	Init. mahogany, open sloping panel	0	11	6	" Variometer tuned.
Service Radio Co., Ltd., 67, Church Street, Stoke Newington, London, N.16.	S Type	Flat mahogany box	0	6	11	Slider movement.
" " "	Service	Mahogany, with hinged lid with phones and amplifier compartment.	1	10	0	Set only.
S.H.C.S., Co., 10, Clare Terrace, Sidecup, Kent.	Thor No. 5	Open, stained walnut	0	13	6	Set only.
" " "	Thor No. 6	Mahogany, with lid and clasp.	1	7	6	"
Sherman, P., 12, River Street, London, E.C.1.	O.O.	Leather covered, with clasp.	0	15	0	Set only. Nickelled fittings. Variometer tuning, socket and coil for Daventry.
" " "	O.	American type, oak	1	5	0	Set only. Nickelled fittings. Condenser tuning, semi-automatic detector. Change-over switch for local or 5XX stations.
Spa Radio Co., Ltd., 107a, Locksbrook Road, Bath.	Spa	Mahogany	1	7	6	Set only.
" " "	"	"	2	5	0	Set complete with all accessories.
Tant, W. H., & Co., Transant Works, Dollman Street, Birmingham.	Transant	Polished ebonite ..	1	1	0	Set only. Enclosed detector and U piece for Daventry coil.
" " "	"	Polished dark oak case and lid.	1	5	0	Set only. Do.
Telephone Manufacturing Co., Ltd., Hollingsworth Works, West Dulwich, London, S.E.21.	T.M.C. 2A.	Polished wood lid cover, flat panel.	1	9	6	Set only. 300-500 metres. Fixed loading coil for 5XX. No plug-in coils used. Slider tuned.
" " "	T.M.C. 8	Polished walnut sloping panel or grained ebonite.	2	7	6	Set only. 300-1,800 metres without use of plug-in coils. T.M.C. Air-wound Variometer tuned.
" " "	T.M.C. 9 Daventry.	Moulded case	0	12	6	Set only. 1,600 metres wavelength only. Variometer tuned.
Thames Electric Wireless Co., Ltd., 40, Old Town, Clapham, London, S.W.4.	Thames	Desk type	1	12	6	Set only. Also receives Daventry.
Ward & Goldstone, Ltd., Frederick Road (Pendleton), Manchester.	Goltone	--	0	7	6	Set only. Tunes to 1,860 metres without additional coils. Vertical dustproof detector. Sonyte crystal.
" " "	Goltone A.	Wood case with ebonite top.	1	1	0	Receiver only. Terminals for 300-400 metres, 400 metres and over and plug sockets for over 600 metres.
" " "	Goltone B.	Do. and fall down lid with special compartment for phones.	2	2	0	Receiver with phones and aerial.
" " "	"	"	1	10	0	Receiver only. Particulars as Goltone A.
Wates Bros., Ltd., 13/14, Great Queen Street, Kingsway, London, W.C.2.	Bijouphone	--	2	11	0	Receiver with phones and aerial.
" " "	"	"	0	7	6	Set only. Adaptable to high and low wavelengths.
Wilkins & Wright, Ltd., Utility Works, Kenyon Street, Birmingham	"	Polished wood	0	10	0	Do.
Wooten, F. E., Ltd., 56, High Street, Oxford.	Wootophone	Mahogany	2	2	0	Set only. Suitable for tuning in any station by means of plug and coils.
" " "	Type H.	"	4	10	0	Complete with accessories.
" " "	" H.2	"	1	12	0	Set only.
Yorkshire Radio Co., Ltd., Western Works, Rockingham Street, Sheffield.	Cheaper Model ..	"	3	0	0	Complete with accessories.
" " "	Spotter	Enclosed, Jacobean	0	6	6	Set only.
" " "	"	"	0	10	6	"
" " "	"	"	0	17	6	"
" " "	"	"	1	5	0	"

CRYSTAL-VALVE SETS.

Manufacturer.	Name of Set.	Type of Cabinet.	Valves.		Price.	Description and Remarks.
			H.F.	L.F.		
Burwood (Concessionaires) Ltd., 41, Great Queen Street, Kingsway, London, W.C.2.	D'Accord	Oak, American type.	1	2	£ s. d. 11 5 0	Receiver only. Crystal 2V. REFLEX.
Cable Accessories Co., Ltd., Britannia Works, Tivdale, Tipton, Staffs.	Revo	Mahogany case ...	--	1	5 2 6	Receiver only. Extra loading and anode coils for 5XX, #1 2s. extra.
Collins & John, Ltd., 9/10, Tenby Street, Birmingham.	Amplex A.V.	Enclosed cabinet, oak or mahogany.	--	1	3 17 6	Receiver only.
Edison Swan Electric Co., Ltd., 123/5, Queen Victoria Street, London, E.C.4.	W.L. 217	Tray	1	--	8 7 6	Receiver only.
" " "	"	"	1	--	10 12 9	With A.R. .06 valve, 60-v. H.T. battery, D.E.200 dry cell and aerial equipment.
Falk, Stadelmann & Co., Ltd., 83/93, Farringdon Road, London, E.C.1.	Efescaphone, St. Vincent.	Mahogany, oblong.	1	--	5 12 6	Receiver only. REFLEX.
" " "	"	"	1	1	8 10 0	"



Buyer's Guide to Sets



CRYSTAL-VALVE SETS—continued.

Manufacturer.	Name of Set.	Type of Cabinet.	Valves.		Price.	Description and Remarks.
			H.F.	L.F.		
Hough, J. E., Ltd., Edison Bell Works, 62, Glengall Road, Peckham, London, S.E.15.	Crystal valve ...	Oak, desk pattern, open.	1	1	£ s. d. 7 19 6	Receiver only. One valve dual.
	Crystal 2-valve ..	Mahogany, do.	1	1	8 7 6	..
	Oak or mahogany, Jacobean, folding doors, on pedestal.	1	1	10 14 0	.. R FLEX.
.. ..	Crystal 3-valve ..	Desk pattern, open	1	2	17 0 0	..
Metro-Vick Supplies, Ltd., 4, Central Buildings, London, S.W.1.	Cosmos	Circular, of moulded composition.	1	2	13 2 6	(The three last can be supplied with resistance amplifier if desired.)
	1	2	8 5 0	Receiver only. One dual valve with crystal detector and two additional resistance-coupled stages.
Radio Instruments, Ltd., 12, Hyde Street, New Oxford Street, London, W.C.1.	No. 209	Polished mahogany, with lid, folding doors.	—	2	14 10 0	Complete installation, valves, batteries, A. and E. equipment, loud-speaker.
.. ..	The S.T.100 Receiver.	Mahogany case ...	1	1	11 15 0	Receiver only. Wavelength 300-500 and 1,600 metres. Switch to cut out L.F. Pedestal base 30s. extra.
E.H.C.S. Co., 10, Clare Terrace, Sidcup, Kent.	Thor No. 8	Enclosed, with lid, solid mahogany.	—	1	10 4 4	Receiver only, with 1 pair plug-in coils, Nos. 50 and 75. REFLEX.
	Thor No. 9	—	2	6 15 0	Receiver with batteries in cabinet, and valve.
Service Radio Co., Ltd., 67, Church Street, Stoke Newington, London, N.16.	Service	Mahogany, hinged lid, compartment for phones, etc.	—	1	14 14 0	Do., with Brown H2 loud-speaker.
	—	1	3 0 0	Receiver only.
Sherman, P., 12, River Street, Clerkenwell, London, E.C.1.	I.	Americau type, oak	—	2	4 0 0	Receiver only. REFLEX. variometer tuning.
	—	—	5 0 0	H.F. transformer coupling, tunes local or 5XX without extra coils, semi-automat detector.
Tutills, Ltd., 7/9, Swan Street, Manchester.	Tinol Electric Main Set.	Oak (American type), lift-up lid.	—	2	13 10 0	Receiver for D.C. mains, with valves and loud-speaker.
Ward & Goldstone, Ltd., Frederick Road (Pendleton), Manchester.	Goltone	Polished hardwood case with ebonite top.	—	1	4 12 6	Receiver only.
..	—	1	7 7 6	Do., with valve, batteries and phones.

VALVE SETS (1 VALVE).

Manufacturer.	Name of Set.	Type of Cabinet.	Price.	Description and Remarks.
British Engineering Products Co., 370/2, Abbey House, Victoria Street, S.W.1.	Tonyphone I.	Box with lid.	£ s. d. 9 10 0	Complete with accessories.
Cable Accessories Co., Ltd., Britannia Works, Tivdale, Tipton, Staffs.	Revophone	Mahogany case ...	4 2 6	Receiver only. Adjustment for longer wavelengths by plug-in coils.
Collins & John, Ltd., 9/10, Tenby Street, Birmingham.	Amplex	Open panel	3 12 6	Receiver only. Reaction, special coil holder.
	Amplex-Reinartz.	4 17 6 Coil and low-loss condenser.
	Amplex roll top.	Roll top in real oak or mahogany.	6 2 6
Corrall, A. J., 226, Warwick Road, Greet, Birmingham.	Warwick IV.	Oak	7 0 0	With valve (D.E.2) accumulator, 60-v. H.T. battery, 1 pair phones, coils for 300-500 and 1,600 metres.
Dunham, C. S., 231/6, Brixton Hill, London, S.W.2.	Type C.S.D.37 ..	—	3 5 0	Receiver only. 150-3,000 metres.
Eagle Engineering Co., Ltd., Eagle Works, Warwick.	Chakophone, No. 1	Open box type.	3 12 6 300-2,000 metres with self-contained tuner.
.. No. 5a	Box cabinet with lid.	5 0 0	Receiver, with coils, 300-2,000 metres, space in cabinet for batteries and coils.
.. No. 11	Antique "Salt Box" with lid, oak.	5 17 6	Receiver only. 300-2,000 metres on tuner incorporated.
Electrical Accessories Manufacturing Co., Progress Works, Low Hall Mills, Holbeck, Leeds.	Prento D.1	Flat oak case	3 17 6	Receiver only.
Elliott, C. L., 12, Queen's Road, London, S.W.8.	Volitone	Oak	From 2 10 0
Fairbrother, John, 94, Prescott Road, Fairfield, Liverpool.	Fair-Fal	Polished mahogany box.	6 5 0	Receiver, complete with accessories.
Fellows Magneto Co., Ltd., Cumberland Avenue, Park Royal, London, N.W.10.	Fellophone Super One.	Leatherette cabinet.	4 17 6	Receiver complete with all accessories.
Flinders (Wholesale), Ltd., 18, Butt Road, and Essex Street, Colchester	Flinderphone	—	5 0 0	Set only.
General Electric Co., Ltd., Magnet House, Kingsway, London, W.C.2.	Super One	7 19 0	With valve, accessories and 1 pair phones.
	Gecophone	Mahogany	5 0 0	Receiver, with D.E.2 valve.
.. B.C.3000	7 16 6	Receiver, complete with battery and all accessories.
.. B.C.3001	7 16 6	Receiver only, with D.E.3 valve.
.. B.C.3050	5 5 0	Receiver, complete with battery and all accessories.
.. B.C.3051	7 16 6	Receiver, complete with battery and all accessories.

OURSELVES—AND THE

ELECTRICAL IMPULSE



his secrets are ours

Think of it! Seventeen years' patient study of the vagaries of our jolly impulsive friend, the electrical impulse. And our laboratory experts have come through with intellects unscathed. Nay! Not only unscathed, but brightly furbished. They were able to establish friendly contact with the electrical impulse; he helped them with their plans for building radio sound reproducing instruments and encouraged their scientific research. Now, this electrical impulse uses his electrical energy to bring the radio as far as your receiver. To get him to talk easily and naturally is an operation we have perfected with his own help and advice. Seventeen years' study of the best way to capture and transform this spirit of radio sound has helped us to build the best radio speakers of the age; his secrets are ours. Get a Brandes and you will know that the properties of radio sound are harnessed as effectually as you can possibly desire.

Any good dealer stocks Brandes

THE TABLE-TALKER

The new goose-neck design is the result of research in radio acoustics, which definitely establishes its value in relation to the diaphragm fitted. Patent material used in the construction of the horn eliminates metallic harshness. Volume and sensitivity controlled with small lever located at the rear of the base. Elegantly shaped, tasteful neutral brown finish, felt-padded base. Height 18 ins., bell 10 ins.

30/-

MATCHED TONE HEADPHONES

The whole secret of Matched Tone is that one receiver refuses to have any quarrel with its twin. Aply schooled in these generous sentiments by our specially erected Matched Tone apparatus, their synchronised effort discovers greater sensitivity and volume and truer tone. There is no possibility of the sound from one earpiece being half a tone lower than its mate.

20/-

THE AUDIO TRANSFORMER

Ratio 1 to 5. The main objects in view are high amplification of applied voltage, together with a straight line amplification-frequency curve. That is to say, for a given input voltage, the amplification is constant over a wide band of frequencies, thus eliminating resonance. Mechanically protected and shielded so that the transformers may be placed close together without interaction.

17/6

THE BRANDOLA

Specially built to bring greater volume with minimum current input and exceptional clarity over the full frequency range. A large diaphragm gives new rounded fullness to the low registers and new clarified lightness to the high. Reproduction controlled by a thumb screw on the base. Polished walnut plinth with electro-plated fittings. Height 26 ins., bell 12 ins.

90/-

Brandes, Limited, 296 Regent St., London, W.1. Works—Slough, Bucks.

Brandes



EXPERTS IN RADIO ACOUSTICS SINCE 1908

26/2:8

Advertisements for "The Wireless World" are only accepted from firms we believe to be thoroughly reliable.

Service Advertising

A 23

TWO COMPONENTS THAT WILL INCREASE THE EFFICIENCY OF THE H.F. STAGE

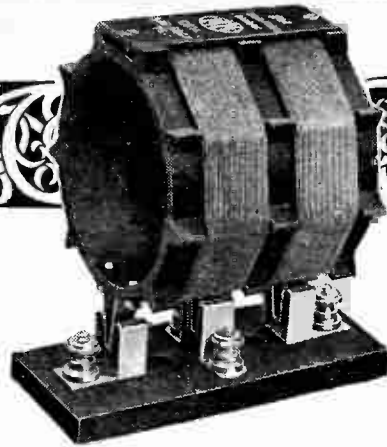

THE **MH** "DIMIC" COIL

TO those who, constructing their own sets for the first time, desire range, selectivity and stability, the "Dimic" Coil offers a certain and satisfactory solution. To those who wish to improve or add to existing sets this component gives an adaptability and efficiency hitherto unobtainable. To the advanced experimenter the design speaks for itself. The complete series will finally be available covering all wavelengths from 20 to 7,000 metres and fitting the standard base. In the accompanying diagram we indicate the application of the Dimic Coil to an H.F.

stage preceding a super-sonic receiver of the autodyne type. The excellent results obtained with MH super-sonic

outlets are enhanced enormously by this addition. It has a double advantage, giving even greater range to the set, and increasing the selectivity without interfering with the perfect tonal properties associated with MH Super-sonic outlets. It is applicable to any super-sonic system, however. The Diagram is self-explanatory, and the circuit is strongly recommended, giving as it does a very high degree of efficiency, ease of control and simplicity of layout.

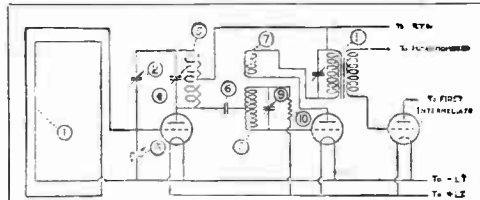

KEY TO DIAGRAM No. 2

- | | |
|--------------------------------|--------------------------------|
| 1. Loop Aerial. | 7. Reactor (MH) (Com-) |
| 2. Neutrodyne Condenser 2/10 | Reactor) (handy) 21 - |
| 3. Aerial Tuning Condenser | 8. MH Auto-dyne Unit |
| 0005 μ F. 10/6 | unit 300-600m |
| 4. H.F. Tuning Condenser | 9. Auto-dyne Tuning Con- |
| 0005 μ F. 10/6 | denser 0003 μ F. 8/6 |
| 5. DIMIC COIL, No. 1 10/- | 10. MH Grid Leak Mu. 2/6 |
| Base and Clips 2/6 | Base and Clips 1/- |
| 6. MH Mica Condenser 0003 2/6 | 11. MH Super-sonic Filter 21 - |
| Base and Clips 1/- | Succeeding stages as usual. |



MH H.F. TRANSFORMERS

"The Transformer that made H.F. Amplification popular."

Supplied in six ranges of wavelengths covering 80 to 7000 metres
 Price 10/- each. With H.F. Damper 12/- each.
 Special Neutrodyne Units and Super-heterodyne Couplers also supplied.
 All transformers are accurately matched.
 MH H.F. DAMPER, PRICE 2/- . The H.F. Damper is a device which, when inserted in the central hole of the H.F. Transformer, stabilises a circuit which otherwise could oscillate.

L.M. MICHAEL LTD

Manufacturers of Wireless and Scientific Apparatus

WREXHAM ROAD, SLOUGH, BUCKS.

Phone: SLOUGH 441-442.



Buyer's Guide to Sets

VALVE SETS (1 Valve)—continued.

Manufacturer.	Name of Set.	Type of Cabinet.	Price.			Description and Remarks.
			£	s.	d.	
Henderson, W. J., & Co., Ltd., 351, Fulham Road, S.W.10.	B.R.1	—	4	0	0	Receiver only.
Hirst Bros. & Co., Ltd., Roscoe Street, Oldham, Lancs.	Tameside, R.1000	Oak upright, panel.	7	12	0	Complete with accessories.
	" R.365	Oak desk, sloping panel.	3	2	6	Receiver only. Reaction.
Knight, A. W., Ltd., 167, Rye Lane, Peckham, London, S.E.15.	Kaynite (date Dulcivox).	Slope, with battery compartment.	7	15	0	Receiver only. Single knob REFLEX.
Marcophone Co., Ltd., 210 212, Tottenham Court Road, London, W.1.	V.I.	Mahogany	9	7	8	Complete with valve, batteries and 1 pair phones.
	Sterling Anodion, R.1560	Walnut	10	8	4	" " "
National Wireless & Electric Co. (R. R. Goding, Ltd.), 42, Gray's Inn Road, London, W.C.1.	N. Mk. 1*	Mahogany	5	5	0	Receiver only.
	" de Luxe	" with glass doors.	6	15	0	" " "
Radio Supply Co., Superfone Works, Four Oaks, Birmingham.	Superfone Maxum I.	Mahogany, portable	4	17	6	Receiver only. Tuned anode. 5XX coils embodied.
Sherman, P., 12, River Street, Clerkenwell, London, E.C.1.	6.	American type, in oak, with 2 folding doors.	12	0	0	Receiver only. ULTRA AUDION, four circuit, low-loss condensers with Accuratone geared dials, potentiometer, reaction control.
Spa Radio Co., Ltd., 107A, Locksbrook Road, Bath.	Spa	—	3	12	6	Receiver only, with pair coils.
Thames Electric Wireless Co., Ltd., 10, Old Town, Clapham, London, S.W.4.	Thames	Panel type	7	6	0	Receiver, complete with all accessories.
			3	2	6	Receiver only. Provision for loading coils.
Tutills, Ltd., 7 9, Swan Street, Manchester.	Tinol A.	Oak (American), lift-up lid.	3	17	6	Receiver only.
U.S. Radio Co., Ltd., Radio Works, Trenchard Road, Brockley, London, S.E.1.	Yew-ess I.	Walnut, open top, flat.	2	17	6	Receiver only, with 300-500 metre coils.
Ward & Goldstone, Ltd., Frederick Road (Pendleton), Manchester.	Goltone A.	Open type, polished oak.	3	2	6	Receiver only.
Wilson, W., & Son (Herts), Ltd., 1, London Road, Royston, Herts.	Exceedall	—	5	17	6	With phones, valve, H. and L.T. batteries.
Wooten, F. E., Ltd., 56, High Street, Oxford.	Wootophone Type E.	Mahogany or oak	2	17	6	Receiver only. Pola coil units.
		" "	5	13	0	Receiver only.
		" "	9	17	0	Complete with valve and accessories.

VALVE SETS (2 VALVES).

Manufacturer.	Name of Set.	Type of Cabinet.	Valves.			Price.	Description and Remarks.
			H.F.	Det.	L.F.		
Barnett & Soans, High Street, Kettering.	Barsons 2	Oak, lidded box...	—	1	1	13 5 0	Complete with all accessories. Transformer coupled.
Baty, Ernest J., 157, Dunstable Road, Luton, Beds.	The Baty Two ..	—	—	1	1	18 0 0	Receiver complete with all accessories. Direct current from main.
British Engineering Products Co., 570/2, Abbey House, Victoria Street, S.W.1.	Tonyphone Super Two.	Sloping desk	1	1	—	15 9 0	Complete with accessories.
	G.H.	Mahogany, American type.	1	1	—	15 9 0	" " "
	G.L.S.	" "	—	1	1	15 9 0	" " "
British Radio Corporation, Ltd., Elmgrove Road, Weybridge, Surrey.	B.R.C.	Plain walnut	—	1	1	7 15 0	Receiver only.
	"	"	—	1	1	14 4 6	Complete with all accessories including loud-speaker.
	"	Walnut, totally enclosed, to take batteries, etc.	—	1	1	13 0 6	Receiver only.
	"	"	—	1	1	19 10 0	Complete with all accessories including loud-speaker.
British Thomson-Houston Co., Ltd., Crown House, Aldwych, London, W.C.2.	B.T.H.	Flat top panel, valves sunken.	—	1	1	7 5 0	Receiver only. Fitted with dual rheostats. Loading coil for 1,500-1,800 metres, 18s. extra.
British Wireless Supply Co. (1924), Ltd., 6, Blenheim Terrace, Leeds.	Britphone 2E ...	Oak, desk type ...	1	1	—	6 10 0	Receiver only.
	" 2S ...	Oak, enclosed, flat	—	1	1	8 5 0	" " Transformer coupled.
Burndypt Wireless, Ltd., Aldine House, Bedford Street, Strand, London, W.C.2.	Ethophone-Duplex	Moulded Bakelite case.	—	1	1	6 10 0	Receiver, including 2 valves and 2 coils.
	Short wave	Polished mahogany, open front.	—	1	1	19 5 0	Receiver, with 3 valves, range 30-100 metres.
Cable Accessories Co., Ltd., Britannia Works, Tividale, Tipton, Staffs.	Revophone	Mahogany outer case with inner frame for mounting components.	—	1	1	9 5 0	Receiver, with H.T. battery. Wavelength 300-600 metres.
	Revo-Magna	Mahogany case ...	—	1	1	5 15 0	Receiver only.
Curtis, "Peter," Ltd., 75a, Camden Road, London, N.W.1.	Duodyne II.	Teak, open	—	1	1	8 15 0	Receiver only, with all coils for 250-500 metres.
	"	Teak, enclosed, folding doors.	—	1	1	11 15 0	" " " "
Dargue Bros., Ltd., Simplon Technical Instrument Works, Halifax.	Simplon	Enclosed, sloping panel.	—	1	1	8 7 6	Receiver only.
	Simplon Autodyne II.	Table cabinet type	—	1	1	10 0 0	" " "
Dunham, C. S., 234/6, Brixton Hill, London, S.W.2.	C.S.D. 58	Open model	—	1	1	5 17 6	Receiver only.
	C.S.D. 42	Desk model	1	1	—	8 15 0	" "
	C.S.D. 48	Cabinet model ...	1	1	—	10 18 0	" "



Buyer's Guide to Sets

VALVE SETS (2 Valves)—continued.

Manufacturer.	Name of Set.	Type of Cabinet.	Valves.			Prfee.	Description and Remarks.
			H.F.	Det.	L.F.		
Eagle Engineering Co., Ltd. Eagle Works, Warwick.	No. 2	Mahogany, sloping desk pattern.	1	1	—	£ s. d. 6 17 6	Receiver only, with B.B.C. coils.
" " "	" " "	" " "	1	1	—	5 17 6	Complete set of parts, B.B.C. coils and full instructions.
" " "	Super No. 9	Vertical panel, mahogany.	—	1	1	8 15 0	Receiver only. 200-2,000 metres. Tuner incorporated. H.T. compartment in base.
" " "	No. 7	Vertical panel, mahogany cabinet.	2 valves			12 3 0	Receiver only, with B.B.C. coils and plug. Coupled aerial circuit. H.T. compartment in base.
" " "	No. 9	Vertical panel, oak cabinet.	—	1	1	6 15 0	Receiver only. 300-2,000 metres on tuner incorporated with switch for one and two valves. H.T. battery compartment in base.
Edison Swan Electric Co., Ltd., 123/5, Queen Victoria Street, London, E.C.4.	Toovee	Mahogany, vertical	2 valves			11 15 0	Receiver only. REFLEX.
" " "	" " "	" " "	1	1	—	18 5 0	" " With 2 A.R. valves and all accessories.
" " "	Compactum	Moulded insulation	—	1	1	4 0 0	Receiver only.
" " "	" " "	" " "	—	1	1	11 11 0	" " With 2 P.V.S. valves, batteries, all accessories, and Duplevox loud-speaker.
" " "	Portable Toovee .	Mahogany, 2 doors	2 valves			16 5 0	REFLEX. Complete excepting valves.
Electrical Accessories Manufacturing Co., Progress Works, Low Hall Mills, Holbeck, Leeds.	Prento P2	Flat, walnut	1	1	—	6 10 0	Receiver only.
" " "	Prento D2	Flat, oak case	—	1	1	6 5 0	" " "
Elliott, C. L., 12, Queen's Road, London, S.W.8.	Volutone	Oak	—	1	1	From 4 4 0	Receiver only.
Emseo Radio, 21, Leytonstone Road, Stratford, London, E.15.	Emseo 1	—	—	1	1	13 0 0	Receiver, including batteries, valves and loud-speaker.
" " "	" 2	—	1	1	—	10 0 0	Receiver, including batteries, valves and phones.
Engineering Works (Electrical & General), Ltd., 17/21, Thurlow Park Road, West Dulwich.	Rayol 2V.	Jacobean fumed oak, glass panel.	1	1	—	10 14 0	Receiver only. Tuned anode.
Ericsson, British L. M. Manufacturing Co., Ltd., 67/73, Kingsway, London, W.C.2.	0/1001	Walnut, box type.	1	1	—	7 10 0	Receiver only. Wavelength 300-500 metres. (Tuned anode.)
" " "	0/1005	Sloping panel	1	1	—	7 15 0	Receiver only. Interchangeable coils. (Tuned anode.)
" " "	0/1082 Family Set	Oak folding doors, oak panel.	—	1	1	8 15 0	Receiver only. Transformer-coupled.
Fairbrother, John, 94, Prescott Road, Liverpool.	Fair-Pal	Mahogany folding doors, H.T. inside.	—	1	1	13 0 0	Receiver complete with accessories.
Falk, Stadelmann & Co., Ltd., 83/93, Farringdon Road, London, E.C.1.	Efescaphone Seymour.	Oak, with sliding shutter.	—	1	1	11 15 0	Receiver only.
Fellows Magneto Co., Ltd., Cumberland Avenue, Park Royal, London, N.W.10.	Little Giant	Leatherette case ..	—	1	1	6 15 0	Receiver complete with all accessories, including loud-speaker.
Flinders (Wholesale), Ltd., 18, Butt Road, and Essex Street, Colchester.	Fellophone Super2	Sloping, mahogany	1	1	—	7 17 6	Receiver complete with accessories.
" " "	Flinderphone Super Two.	—	—	1	1	6 10 0	Receiver only.
" " "	" " "	—	—	1	1	11 1 6	With all accessories and loud-speaker
Gambrell Bros., Ltd., 76, Victoria Street, London, S.W.1.	The Gambrell Cabinet 2.	Mahogany cabinet with folding doors.	—	1	1	15 15 0	Receiver only.
" " "	The Gambrell Baby Two.	Wax polished mahogany.	—	1	1	8 0 0	" " with 2 coils for B.B.C.
" " "	The Gambrell Baby Grand D.C. model.	Mahogany cabinet, all enclosed.	—	1	1	17 0 0	Receiver, with valves, B.B.C. coils, including 5XX.
General Electric Co., Ltd., Magnet House, Kingsway, London, W.C.2.	Gecophone B.C. 3250.	Mahogany, flat....	—	1	1	8 12 0	Receiver only, with 2 D.E.2 valves.
" " "	" " 3251	" " "	—	1	1	11 5 0	Receiver complete with all accessories and accumulator.
" " "	" " 3260	" " "	—	1	1	9 5 0	Receiver only, with 2 D.E.8 valves.
" " "	" " 3266	" " "	—	1	1	13 0 0	Receiver complete with all accessories and accumulator.
" " "	" " 3220	Mahogany, cabinet model.	—	1	1	11 15 0	Receiver only, with 2 leads and 2 D.E.2 valves.
" " "	" " 3200	" " "	—	1	1	15 7 6	Receiver complete with all accessories and accumulator.
" " "	" " 3205	" " "	—	1	1	15 15 0	Receiver complete with all accessories and dry battery.
" " "	" " 2000	" " "	1	1	—	11 15 0	Receiver only, with 2 leads and 2 D.E.8 valves.
" " "	" " 2001	" " "	1	1	—	17 8 0	Receiver complete with all accessories and accumulator.
" " "	" " 2003	" " "	1	1	—	11 0 0	Receiver only, with 2 leads and 2 D.E.2 valves.
" " "	" " 2002	" " "	1	1	—	15 10 0	Receiver complete with all accessories and accumulator.
Gent & Co., Ltd., Faraday Works, Leicester.	Tangent Radio-matic D.	Teak or oak	—	1	1	8 5 0	Valves and coils extra.
Gisbornes, 28/32, Longmore Street, Birmingham.	Il.	Oak, folding doors.	—	1	1	10 5 0	Receiver including valves, batteries and loud-speaker.
" " "	Silvertone	Portable, 2 cases rexine covered.	—	1	1	15 0 0	Complete. Second case for phones and all accessories.

Buyer's Guide to Sets

VALVE SETS (2 Valves)—continued.

Manufacturer.	Name of Set.	Type of Cabinet.	Valves.			Price.	Description and Remarks.
			H.F.	Det.	L.F.		
Henderson, W. J., & Co., Ltd., 351, Fulham Road, S.W.10.	B.R.2	—	—	1	1	4 s. d. 6 5 0	Receiver only, with coils, 350-500 metres.
" " "	" " " " "	—	—	1	1	10 15 0	With all accessories.
" " "	H.R.2A.	—	1	1	—	9 15 0	Receiver only.
" " "	" " " " "	—	1	1	—	14 19 0	With all accessories.
Hirst Bros. & Co., Ltd., Roscoe Street, Oldham, Lancs.	Tameside R1011 ..	Oak, upright panel	1	1	—	6 5 0	Receiver only. Tuned anode.
" " "	" " R1011B ..	" " " " "	—	1	1	6 5 0	" " Aerial reaction.
" " "	" " de Luxo R1147 ..	Oak, upright panel, folding doors.	1	1	—	11 5 0	" " Tuned anode.
" " "	" " R130 ..	Oak desk, sloping panel.	1	1	—	5 15 0	" " " " "
" " "	" " R555 ..	Oak, enclosed folding doors.	1	1	—	11 5 0	" " " " "
Hough, J. E., Ltd., Edison Bell Works, 62, Glengall Road, Peckham, London, S.E.15.	Bijou	Desk shape, dust-proof flap.	—	1	1	5 0 0	Receiver only. Grid bias.
" " "	Gem	Flat base, open top Cabinet, folding doors.	—	1	1	4 5 0	" " " " "
" " "	Era	" " " " "	—	1	1	5 15 0	" " " " Automatic grid bias.
Johnson, Thos. T., 17/19, Catherine Street, Salisbury.	Sarumphone	Mahogany cabinet, 2 doors and lid, drawer below for batteries.	1	1	—	10 0 0	Receiver with valves, coils, aerial equipment, 1 pair phones and H.T. battery.
Knight, A. W., Ltd., 167, Rye Lane, Peckham, London, S.E.15.	Kaynite (late Dulcivox).	Slope, with battery compartments.	—	1	1	9 17 0	Receiver only. REFLEX. Single knob.
Lampugh, S. A., Ltd., King's Road, Tysley, Birmingham.	Lampugh Desk Type.	Oak, sloping	1	1	—	7 15 0	Receiver only. Plug-in coils, open panel type.
" " "	Lampugh Popular 2-valve Loud-speaker.	Flat type	—	1	1	6 12 6	Receiver only. 300-2,000 metres, without extra coils.
Liver Radio Manufacturing Co., Ltd., 30, Islington, Liverpool.	Liverphone	Sloping	—	1	1	7 5 0	Receiver only.
McMichael, L., Ltd., Wexham Road, Slough.	B.R.2	Mahogany	1	1	—	16 5 0	Receiver only, with tuning coils for all wavelengths. Tuned anode.
" " "	B.R.2A.	" " " " "	—	—	2	11 5 0	Receiver only. Coils and tuning as above. Arranged for grid bias.
M.A.P. Company, Great Lister Street, Birmingham.	M.A.P. Minor ...	Mahogany, totally enclosed, vertical pattern.	—	1	1	12 15 0	Receiver complete with all batteries and valves.
Marconiphone Co., Ltd., 210-212, Tottenham Court Road, London, W.1.	V.2 Long Range..	Teak, walnut or mahogany.	1	1	—	15 16 2	Complete with valves, batteries and headphones. L.F. THROW-BACK.
" " "	V.2 Portable Model 21 Model	" " " " "	—	1	1	17 8 0	Receiver complete with accessories.
" " "	Sterling Anodion R1572.	Mahogany	—	1	1	13 4 6	Receiver complete with 1" pair headphones.
" " "	Sterling Long Range Anodion R1565.	Walnut	—	1	1	14 11 4	" " " " "
" " "	" " R1588	" " " " "	1	1	—	18 11 0	" " " " "
Midland Radiotelephone Manufacturers, Ltd., Brettell Lane Works, Stourbridge.	Mellowtone 2	Tray, oak or mahogany.	—	1	1	8 12 6	Receiver only. Self-contained.
National Wireless & Electric Co. (R. R. Goding, Ltd.), 42, Gray's Inn Road, London, W.C.1.	N. Mk.2 de Luxe	Mahogany, glass doors.	—	1	1	10 10 0	Receiver only.
" " "	N. Mk.2*	Mahogany	—	1	1	8 10 0	" " Transformer coupled.
Ormsby, L., & Co., 28, Page Street, Westminster, London, S.W.1.	Ormsby	Lidded, polished mahogany box.	—	1	1	9 10 0	Receiver only.
" " "	" " " " "	" " " " "	—	1	1	15 0 0	Complete with all accessories, including loud-speaker.
Radio-Are Electrical Co., Ltd., Bennett Street, Chiswick, London, W.4.	Liberty Short-Wave.	Oak or mahogany.	—	1	1	6 0 0	Receiver only. 40-100 metres.
Radio Communication Co., Ltd., 31-35, Norfolk St., London, W.C.2.	Polar Twin	Crystalline metal .	—	1	1	6 15 0	Receiver only.
" " "	" " " " "	Oak	—	1	1	8 2 6	" " " " "
Radio-Electric Co., 21, St. John Street, Wolverhampton.	R.E.V.B.	Oak or mahogany, enclosing H.T.	—	1	1	5 9 0	Receiver only. 1 control.
" " "	R.E.3V.B.	" " " " "	—	1	1	8 3 6	Receiver only. 1 control. 1 transformer and 1 resistance-coupled L.F.
Radio Instruments, Ltd., 12, Hyde Street, New Oxford Street, London, W.C.1.	No. 210	Mahogany, folding doors.	—	1	1	13 5 0	Receiver only. 300-4,000 metres. Pedestal base, £1 10s. extra.
" " "	Lyriquette	Mahogany, with cupboard for batteries.	—	1	1	20 8 0	Receiver, self-contained with valves, batteries and loud-speaker. 300-500 and 1,500 metres.
Radio, R.M. Ltd., 21, Garrick Street, London, W.C.2.	R.M.10	Oak or mahogany, space for batteries	—	1	1	11 11 0	Receiver only. Hand control reaction.
Radio Supply Co., Superfone Works, Four Oaks, Birmingham.	Superfone Maxum II. Table Model.	Mahogany, portable	—	1	1	7 7 0	Receiver only. Tuned anode. 5XX coils embodied.
" " "	" " " " "	Mahogany, sloping panel, shaped sides.	—	1	1	7 7 0	" " " " " " "
Fead & Morris, Ltd., 31, East Castle Street, W.1.	Mains Set D.C. Model.	—	—	1	1	15 19 0	Receiver only. D.C. mains supply.
" " "	" " " " "	—	—	1	1	20 3 0	" " " " A.C. " " "

Buyer's Guide to Sets

VALVE SETS (2 Valves)—continued.

Manufacturer.	Name of Set.	Type of Cabinet.	Valves.			Price.	Description and Remarks.
			H.F.	Det.	L.F.		
Reeves, A. W., M.I.M.E., 3, Edmund Street, Birmingham.	Reeves-Roberts . "	— —	— —	1 1	1 1	£ s. d. 15 0 0 21 0 0	Receiver only, with valves. Receiver complete with all accessories including loud-speaker.
Rotax (Motor Accessories), Ltd., Rotax Works, Willesden Junction, London, N.W.10.	Rotola Model A . " Model B " Portable	Black morocco case Mahogany or oak, with folding doors. Black morocco case	— — —	1 1 1	1 1 1	14 18 0 14 18 0 15 19 0	Receiver complete with all accessories, including loud-speaker. " " " Receiver complete with all accessories, including 1 pair phones.
Sherman, P., 12, River Street, Clerkenwell, London, E.C.1.	2.....	American type, oak	—	1	1	7 15 0	Receiver only, with coils for local and 5XX.
Standard Telephones and Cables, Ltd., formerly Western Electric Company, Ltd., Bush House, Aldwych, London, W.C.2.	Weconomy Set 44981.	Mahogany case ...	1	1	—	10 0 0	Receiver with valves.
Stevens, A. J., & Co. (1914), Ltd., Walsall Street, Wolverhampton.	2-valve Standard. Model Z.	Sloping Upright cabinet ..	1	1	—	16 17 6 8. 2 6	Receiver complete with all accessories. Receiver only.
Stirling, Ltd., 17/19, Clarence Street, Kingston-on-Thames, Surrey.	Stiradio II.	Sloping, open panel, valves enclosed.	—	1	1	9 0 0	Receiver only, including tuning unit for 2LO.
Stratton & Co., Ltd., Balnornal Works, Bromsgrove Street, Birmingham.	Eddystone Twin . " " " "	Oak, enclosed, plate glass front. " " " " " "	—	2 valves		8 15 0 11 5 0 15 15 0	Receiver only, with coils. " " " loud-speaker. Receiver complete with all accessories and loud-speaker.
Telephone Manufacturing Co., Ltd., Hollingsworth Works, West Dulwich, London, S.E.21.	T.M.C. 2A..... T.M.C. 7B.....	Walnut box, flat panel. Walnut, enclosed, sloping panel, glass doors.	— 1	1 1	1 —	6 0 0 13 5 0	Receiver only with 2 plug-in coils for 300-600 metres. Variable reaction. Receiver only. REFLEX COMBINATION. 300-2,700 metres. No plug-in coils necessary. Variable reaction.
Thames Electric Wireless Co., Ltd., 40, Old Town, Clapham, London, S.W.4.	Thames	Panel type	—	1	1	4 7 6	Receiver only. Provision for loading.
Tutills, Ltd., 7 and 9, Swan Street, Manchester.	Tinol Series A ...	Oak, American, lift-up lid.	—	1	1	5 15 0	Receiver only.
U.S. Radio Co., Ltd., Radio Works, Tyrwhitt Road, Brockley, London, S.E.4.	Yew-ess II..... " " " "	Open front, hinged lid, American style Oak, lock-up doors, to take all accessories. Oak, open	— — —	1 1 1	1 1 1	6 5 0 8 10 0 6 5 0	Receiver only, with 300-500 metres coils. " " " " Receiver only. With set of 5 basket coils covering all B.B.C. wavelengths including 5XX.
Ward & Goldstone, Fredrick Road (Pendleton), Manchester.	Goltone A..... " A..... " B..... " B.....	Oak, open	— — — —	1 1 1 1	1 1 1 1	9 18 0 7 17 7 11 7 6	Complete with phones, valves, H. and L.T. batteries and 5 basket coils. Receiver only. With set of 5 basket coils covering all B.B.C. wavelengths including 5XX.
Wootton, F. E., Ltd., 56, High Street, Oxford.	Wootphone Type D. " Type C " " " Type D.2	Mahogany or oak.. " " " " " " Cabinet	— — 1 1 —	1 1 1 1 1	1 — — 1 1	9 1 6 13 14 0 11 0 6 15 14 0 12 0 0 8 8 0	Receiver only. Complete with all accessories. Receiver only. Complete with all accessories. " " " Receiver only.
Yorkshire Radio Co., Ltd., Western Works, Rockingham Street, Sheffield.	Deucalion	Cabinet	—	1	1	8 8 0	Receiver only.
Young, A. M., & Co., 52, Bordesley Street, Birmingham.	Rondar	American pattern, oak. " "	1 1	1 1	— —	8 5 0 15 5 0	Receiver only. " " " With accessories, including plug-in coils and loud-speaker.

VALVE SETS (3 VALVES).

Manufacturer.	Name of Set.	Type of Cabinet.	Valves.			Price.	Description and Remarks.
			H.F.	Det.	L.F.		
Atherton & Hall, The Claremont Garage, General Street, Blackpool.	Athall Radio C.3	Oak or mahogany.	—	1	2	£ s. d. 14 17 6	Receiver only. 1 stage T.C. 1 stage R.C.
Beard & Fitch, Ltd., 31/36, Aylesbury Street, Clerkenwell, London, E.C.1.	Success, Reinartz.	Mahogany.....	—	1	2	30 0 0	Receiver, complete with all accessories and Sterling Mellavox loud-speaker.



Buyer's Guide to Sets



VALVE SETS (3 Valves)—continued.

Manufacturer.	Name of Set.	Type of Cabinet.	Valves.			Price.	Description and Remarks.
			H.F.	Det.	L.F.		
Ericsson, British L.M., Manufacturing Co., Ltd., 67/73, Kingsway, London, W.C.2.	0/1003	Sloping panel	1	1	1	£ 14 s. 0 d.	Receiver only. Transformer coupled. Switch for 2 or 3 valves, tuned anode.
	0/1083	Mahogany, folding doors.	1	1	1	20 0 0	" " "
Fairbrother, J., 91, Prescott Road, Fairfield, Liverpool. Falk, Stadelmann & Co., Ltd., 83/93, Farringdon Road, London, E.C.1.	Fair-Fal	Mahogany, folding doors, H.T. inside.	1	1	1	17 10 0	Receiver complete with accessories.
	Efescaphone " Nelson.	Mahogany, with roll front.	1	1	1	22 17 6	Receiver only.
	" Rodney " Hood..	Walnut, sloping front. Walnut, square, for table or wall.	1	1	1	15 17 6 13 17 6	" " " "
Fellows Magneto Co., Ltd., Cumberland Avenue, Park Royal, London, N.W.10.	Fellophone " Super 3	Sloping mahogany cabinet.	1	1	1	10 5 0	Receiver complete with accessories.
	" Portable 3	Leatherette case ..	1	1	1	12 0 0	(In "real cowhide," £1 10s. "extra.") Receiver, complete with accessories.
	" Grand 3	Oak or Sheraton, folding doors.	1	1	1	11 10 0	
Gambrell Bros., Ltd., 76, Victoria Street, London, S.W.1.	The Gambrell Cabinet 3	Polished mahogany cabinet, with folding doors.	—	1	2	21 17 6	Receiver only.
	" " " " 3A " " " " 3B	" " "	1 1	1 1	1 1	25 7 6 29 15 0	" "
General Electric Co., Ltd., Magnet House, Kingsway, London, W.C.2.	B.C.3350	Mahogany.....	—	1	2	19 2 6	Receiver only, with 2 leads, 2 D.E.3, 1 D.E.5 valves and grid battery.
	B.C.3351	"	—	1	2	23 9 5	Receiver complete with accessories and accumulator.
	B.C.3355	"	—	1	2	17 2 6	Receiver only, with 2 leads, 2 D.E.2, 1 D.E.6 valves and grid battery.
	B.C.3356	"	—	1	2	21 17 6	Receiver complete with accessories and accumulator.
	B.C.3301	Mahogany case, double hinged doors and drawer.	—	1	2	20 2 6	Receiver only, with 2 leads, 2 D.E.3., 1 D.E.5 valves and grid battery
	B.C.3300	" "	—	1	2	25 17 6	Receiver complete with accessories and accumulator.
Gent & Co., Ltd., Faraday Works, Leicester. Gisbornes, 28/32, Longmore Street, Birmingham. Henderson, W. J., & Co., Ltd., 351, Fulham Road, S.W.10. Hirst Bros. & Co., Ltd., Roscoe Street, Oldham, Lancs. " " " " " " " "	Tangent Radiomatic, Type B.	—	1	1	1	17 7 6	Receiver only, including valves and coils. Cabinet extra.
	III.	Oak, folding doors.	—	1	2	12 10 0	Receiver with valves, batteries and loud-speaker.
	H.R.3A	Vertical panel type	1	1	1	15 0 0	Receiver only.
	"	" "	1	1	1	21 2 0	Complete with valves and acces- sories.
	Tameside R.1013	Oak, upright panel	1	1	1	9 17 6	Receiver only. Tuned anode, trans- former coupled.
	" R.1013B " de Luxe " R.1148 " R.419	Oak, upright panel, folding doors. Oak desk for sloping panel.	— 1 1 1	1 1 1	1 1 1	9 17 6 13 7 6 8 17 6	Receiver only. Aerial reaction. Receiver only. Tuned anode circuit, H.F. amplification.
Johnson, Thos. T., 17/19, Catherine Street, Salis- bury.	Sarumphone	Mahogany, 2 fold- ing doors, top opens, drawer below for bat- teries.	1	1	1	16 0 0	Receiver complete with accessories.
Lamplugh, S. A., Ltd., King's Road, Tyseley, Birmingham.	Lamplugh 1078 ..	Oak, self-contained	1	1	1	13 7 6	Receiver only.
Liver Radio Manufacturing Co., Ltd., 30, Islington, Liverpool.	Liverphone	Sloping	—	1	2	12 5 0	Receiver only.
McMichael, L., Ltd., Wex- ham Road, Slough.	B.R.3	Mahogany.....	1	1	1	19 17 6	Receiver only.
Mareoniphone Co., Ltd., 210/212, Tottenham Court Road, London, W.1.	V.3A	Mahogany.....	1	1	1	33 13 8	Receiver, L.F. throw-back, complete with phones and all accessories.
	31.....	"	—	1	2	21 15 6	Receiver complete with all acces- sories, no phones, operates on 2 or 3 valves.
	Sterling Anodion R.1584 " " R.1603	Walnut	—	1	2	24 11 5	Receiver complete with phones and all accessories.
Midland Radiotelephone Manufacturers, Ltd., Brettell Lane Works, Stourbridge.	" " " " R.1578 " " " " Long Range.	Walnut, table cabinet.	—	1	2	36 0 1	" " "
	" " " " R.1578 " " " " Long Range.	Walnut	1	1	1	22 13 4	Receiver complete with phones and all accessories. Adaptable 10-5,000 metres.
	Mellowtone 3	Tray, oak or mahog- any.	1	1	1	16 17 6	Receiver only.
National Wireless & Electric Co. (R. R. Goding, Ltd.), 42, Gray's Inn Road, London, W.C.1.	" " " " 3	Popular, oak	1	1	1	20 17 6	" " "
	" " " " 3	De Luxe, oak	1	1	1	26 17 6	" " "
	" " " " 3	Mahogany	1	1	1	31 17 6	" " "
	N. Mk. 3* de luxe	Mahogany, glass doors.	—	1	2	14 10 0	Receiver only.
	N. Mk. 3*	Mahogany.....	—	1	2	12 10 0	" " Transformer coupled.
N. Mk. 3 Portable	"	—	1	2	11 17 6	" " "	

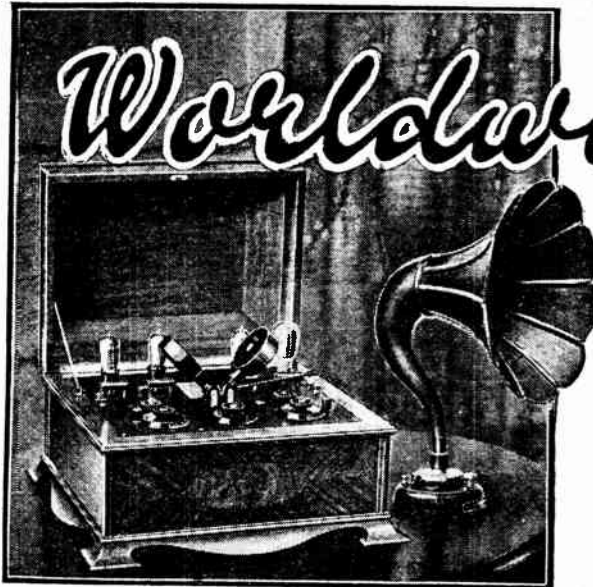

Worldwide Satisfaction

IT matters not whether a Radio Receiver is used for the artistic pleasure it gives, or for bringing in distant stations under the expert hand of a keen experimenter, it must, above all other things, be reliable.

SPECIFICATION.

- 2 45-50 volt Treble Capacity Giant H.T. Batteries.
- 1 A.J.S. Lucas 6 volt 50 amp. (actual) "Milam" Accumulator.
- 3 A.J.S. Mullard specially designed Valves and 1 A.J.S. Mullard Power Valve.
- 1 pair A.J.S. Headphones.
- 1 Coil (100 feet) Aerial Wire. Copper 7/22 gauge.
- 4 Shell Insulators. 1 9-m. Lead-in Tube.
- 1 Aerial and Earth Safety Gap.
- 1 Coil Holder. 1 each Coils Nos. 200 and 300.
- 1 set Connecting Wire.

Guarantee and Free Insurance Scheme.

Receiver illustrated above complete with accessories as per specification £30 10 0. Receiver only £21 5 0.
4 Valve Receivers from £18 10 0. Loud Speaker illustrated £4 10 0.

A.J.S. Receivers are highly efficient and give *WORLD-WIDE SATISFACTION*. The intervalve coupling is by A.J.S. Chokes, and this method cannot easily be surpassed when musical reproduction is being considered.

Moreover the standard receivers are more selective than usual, owing to the method of aerial coupling, and the fact that the coils for use on the lower Broadcast range are single layer wound, and that the variable condensers are of the A.J.S. low loss type. The wavelength range is from 150 metres upwards. When used above 550 metres, plug-in coils are employed. The standard type receivers are so constructed that the aerial cannot be energised by self-oscillation.

A.J.S.

2 Valve Loud Speaker Receiver complete with all accessories as illustrated and inclusive of Junior Loud Speaker. Price £13 18 6. Receiver only £8 2 6. Junior Loud Speaker from 35/-.



A. J. STEVENS & CO. (1914) Ltd., Radio Branch, WOLVERHAMPTON.

Telephone: 1748 (7 lines). Telegrams: "Reception, Wolverhampton."

LONDON SHOWROOMS: 122/124, Charing Cross Road, London, W.C.2.

Telephone: Regent 7161-2. Telegrams: "Ajayessco, Westcent, London."

GLASGOW SHOWROOMS: 223, St. George's Rd., Glasgow.

Telephone: Douglas 3449. Telegrams: "Reception, Glasgow."

A. J. STEVENS & CO. (1914) Ltd., Radio Branch, Wolverhampton.

Please send Publication No. 120.

Name

Address

W.W. 10/2/26.

ISSUED BY THE PUBLICITY DEPT. A.J.S.

The

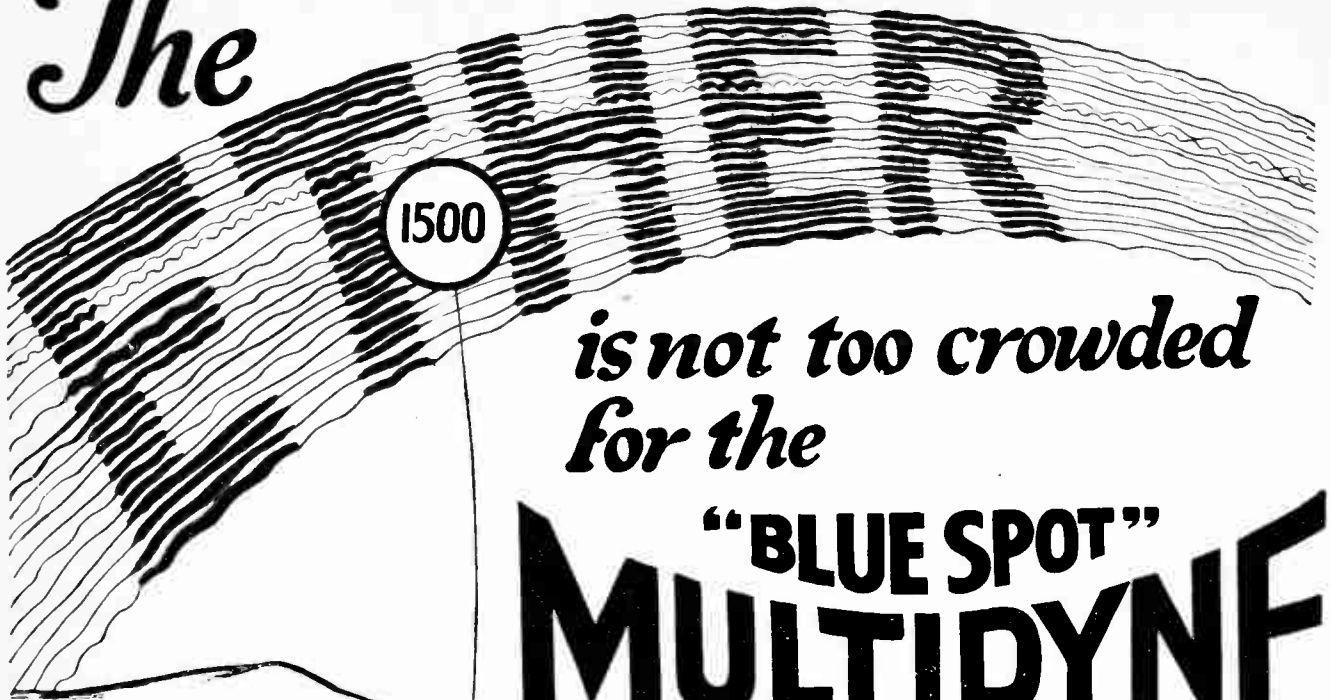

*is not too crowded
for the*

"BLUE SPOT" MULTIDYNE ALL-WAVE COIL

(Three Provisional Patents)

You can switch over in a second to the desired wave-length with the BLUE SPOT MULTIDYNE, and with the usual fine-tuning attachments of any set you can practically cut out interference.

The BLUE SPOT MULTIDYNE COIL is not a tapped coil—it incorporates a series of entirely separate coils that give the desired wave-length and the right inductance values by a simple turn of the switch. Instead of a series of plug-in Coils of various wave-lengths for different stations, the BLUE SPOT MULTIDYNE brings the world within your range without ever changing coils. Replace those obsolete sets of coils with a simple BLUE SPOT MULTIDYNE and you will *never* have to buy another Coil.

Wavelength Range 180 to 5,300 metres
—and **NOT A TAPPED COIL!**

NO DEAD-END EFFECT.

Price 13/6 only.

In case of difficulty in obtaining, WRITE TO-DAY TO

LINDALL'S LTD.,
64, LOMBARD STREET, BIRMINGHAM

Phone: Mid 596.

Telegrams: LIFELIKE.

Agents for London
and British Colonies

BARKER & Co. (Supplies), Ltd., 59 60, CHANCERY LANE,
LONDON W.C.2

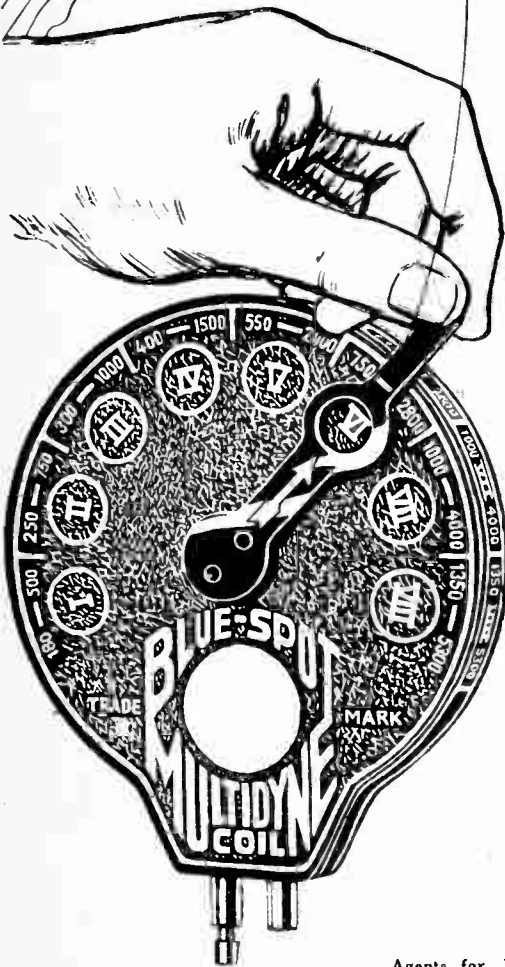

Buyer's Guide to Sets

VALVE SETS (3 Valves)—continued.

Manufacturer.	Name of Set.	Type of Cabinet.	Valves.			Price.	Description and Remarks.
			H.F.	Det.	L.F.		
Ormsby, L. & Co., 28, Page Street, Westminster, London, S.W.1.	Ormsby	Lidded polished mahogany box.	3 valves			£ s. d. 12 0 0	Receiver only. REFLEX.
"	"	" ..	"			18 7 6	Complete with all accessories, including loud-speaker.
R.M. Radio, Ltd., 21, Garrick Street, London, W.C.2	Carpenter	Period oak or mahogany, space for battery.	1	1	1	32 10 0	Receiver only. Single dial tuning control with automatic reaction compensation.
" ..	R.M.10	Oak or mahogany, space for all batteries.	—	1	2	14 10 0	Receiver only. Hand control reaction.
Radio Communication Co., Ltd., 31.35, Norfolk St., London, W.C.2.	Polar Blok B.3 ..	Cryst. metal or mahogany.	—	1	2	12 0 0	Receiver only. 1 R.C.C. coupled and reaction.
Radio Instruments, Ltd., 12, Hyde Street, New Oxford Street, London, W.C.1.	No. 211	Mahogany, folding doors.	1	1	1	13 0 0	Receiver only. "Wavelength 300-4,000 metres. Extra for pedestal base, £1 10s.
" ..	Lyriante	Mahogany, with cupboard for batteries.	—	1	2	25 9 6	Receiver, with valves, batteries and loud-speaker. Self-contained, 300-500 metres, and 1,600 metres.
Radio Supply Co., Superfone Works, Four Oaks, Birmingham.	Superfone Maxim III.	Mahogany, portable	—	1	2	12 12 0	Receiver only. Tuned anode. 5XX coils embodied. Transformer coupled L.F.
Read & Morris, Ltd., 31, East Castle Street, W.1.	Mains Set	Burr walnut	1	1	1	41 17 6	According to supply. Not including valves.
Rotax (Motor Accessories) Ltd., Rotax Works, Willesden Junction, London, N.W.10.	Rotola Model A ..	Mahogany	—	1	2	46 17 6	Receiver complete with all accessories, including loud-speaker.
" ..	" Model B ..	Mahogany or oak .	—	1	2	28 2 6	" .. Self-contained.
Sherman, P., 12, River Street, Clerkenwell, London, E.C.1.	3	Figured walnut ...	—	1	2	33 7 6	" .. " ..
Stevens, A. J., & Co. (1914) Ltd., Walsall Street, Wolverhampton.	3-valve Standard.	American type, oak	1	1	1	10 15 0	Receiver only. " ..
Telephone Manufacturing Co., Ltd., Hollingsworth Works, West Dulwich, London, S.E.21.	T.M.C. Trio-Portable.	Sloping	1	1	1	21 13 6	Receiver complete with accessories.
Thames Electric Wireless Co., Ltd., 10, Old Town, Clapham, London, S.W.1.	Thames	Enclosed, black leather - cloth covered.	3-valve reflex combination.			21 0 0	Receiver, variable reaction, with accessories, dull-emitter valves, 300-600 metres. REFLEX.
" ..	" ..	Panel type	1	1	1	11 0 0	Receiver only (5XX without loading)
" ..	" ..	Open cabinet type.	1	1	1	13 5 0	" .. " ..
" ..	" ..	Enclosed cabinet type.	1	1	1	14 10 0	" .. " ..
Tudoradio Co., Ltd., Tudor Works, Park Royal, N.W.10.	Tudoradio S.B.3 ..	Mahogany or oak, with folding doors.	1	1	1	30 0 0	Complete with valves, batteries and Amplion A.R.19.
Fulfills, Ltd., 7 and 9, Swan Street, Manchester.	Tinol Series A ..	Oak, American, lift-up lid.	1	1	1	8 5 0	Receiver only.
" ..	" Pure-Tone	Upright cabinet, folding doors, compartments for batteries.	—	1	2	14 10 0	" .. Resistance coupled.
" ..	Tinol Electric Mains Set.	Mahogany, American type, double doors.	1	1	1	26 10 0	With valves and loud-speaker. Direct current.
" ..	" ..	" ..	1	1	1	28 10 0	With valves and loud-speaker, alternating current.
U.S. Radio Co., Ltd., Radio Works, Tyrwhitt Road, Brockley, London, S.E.1.	Yew-ess III.	Oak cabinet to take all accessories, lock-up doors.	—	1	2	7 17 6	Receiver only, with coils.
Vard & Goldstone, Ltd., Frederick Road (Pendleton), Manchester.	Goltone Type A ..	Polished oak, open	—	1	2	9 7 6	Receiver only.
" ..	" Type B ..	" ..	—	1	2	13 14 6	With phones, valves and batteries.
" ..	" ..	" ..	—	1	2	10 17 6	Receiver only.
" ..	" de Luxe	Oak ..	—	1	2	15 1 6	With phones, valves and batteries.
" ..	" ..	" ..	—	1	2	18 12 6	Receiver only.
Wootton, F. E., Ltd., 56, High Street, Oxford.	Wootophone Type B.	Mahogany or oak .	—	1	2	24 2 6	Complete with all accessories.
Wong, A. M., & Co., 52, Bordesley Street, Birmingham.	Rondar	American pattern, oak.	—	1	2	17 0 0	Receiver only.
" ..	" ..	" ..	1	1	1	22 11 0	Complete with all accessories.
" ..	" ..	" ..	1	1	1	12 0 0	Receiver only.
" ..	" ..	" ..	1	1	1	19 11 6	Complete with accessories.

VALVE SETS (4 OR MORE VALVES).

Manufacturer.	Name of Set.	Type of Cabinet.	Valves.			Price.	Description and Remarks.
			H.F.	Det.	L.F.		
..therton & Hall, The Claremont Garage, General Street, Blackpool.	Athall Radio S.V.4	Oak or mahogany, folding doors.	1	1	2	£ s. d. 25 0 0	Receiver only.
Barnett & Soans, High Street, Kettering, Northants.	Barsons 4	Mahogany case with lid.	—	1	3	33 10 0	Resistance coupled, complete with all accessories, including £5 loud-speaker.

Buyer's Guide to Sets

VALVE SETS (4 or more Valves)—continued.

Manufacturer.	Name of Set.	Type of Cabinet.	Valves.			Price.	Description and Remarks.
			H.F.	Det.	L.F.		
Barnett & Sons, High St., Kettering, Northants.	Barsons 1	Jacobean cabinet, 2 sets folding doors and hinged lid.	—	1	3	£ s. d. 35 0 0	Resistance coupled, complete with all accessories, including £5 loud-speaker.
" " "	" 5	Mahogany case with lid.	1	1	3	42 10 0	" " " "
" " "	" 5	Jacobean, 2 sets folding doors and hinged lid.	1	1	3	47 0 0	" " " "
Baty, Ernest J., 157, Dunstable Road, Luton, Beds.	The Baty Four ..	—	4 valves.			12 0 0	Receiver complete with all accessories. Direct current from mains.
Beard & Fitch, Ltd., 34/36, Aylesbury Street, Clerkenwell, London, E.C.1.	Success	Mahogany	1	2	1 or 2	55 to 150 guineas.	SUPER-HETERODYNE. 2 intermediate, 1 oscillator valves.
Belling & Lee, Ltd., Queensway Works, Ponders End, Middlesex.	A.C.4	Mahogany, with lid, vertical panel.	1 rectifier.	1	2	42 10 0	Receiver only. Plugs into any A.C. mains (no batteries required).
British Radio Corporation, Ltd., Elmgrove Road, Weybridge, Surrey.	B.R.C.	In totally enclosed cabinet, Walnut, to take batteries, etc.	1	1	2	21 15 0	Receiver only.
" " "	"	Walnut cabinet ...	2	1	2	30 13 0	With all accessories and loud-speaker.
" " "	"	"	2	1	2	43 18 0	NEUTRODYNE. Receiver only.
" " "	"	"	2	1	2	59 13 6	Do. With all accessories, including loud-speaker.
British Thomson-Houston Co., Ltd., Crown House, Aldwych, London, W.C.2.	B.T.H.	Period mahogany cabinet, with 2 front doors and hinged top.	6 valves.			132 15 0	SUPER-HETERODYNE. Receiver complete with accessories and enclosed loud-speaker.
British Wireless Supply Co. (1924), Ltd., 6, Blenheim Terrace, Leeds.	Britphone 4E ...	Oak, desk type ...	1	1	2	11 0 0	Receiver only. Straight reaction circuit.
Burneapt Wirelless, Ltd., Aldine House, Bedford Street, Strand, London, W.C.2.	" 4S.	" swing door ...	2	1	1	22 10 0	Receiver only. Transatlantic.
" " "	Ethophone V. Mark IV.	Polished mahogany, open front.	1	1	2	32 10 9	Receiver with 4 valves and coils for 300-500 metres.
" " "	" Mark V.	Polished mahogany, double door.	1	1	2	37 10 0	" " " "
" " "	Ethodyne	Polished mahogany, open front.	2	2	2	80 12 6	Receiver with 7 valves (1 oscillator) and long- and short-wave frames.
" " "	Ethophone Grand	Polished mahogany, with full front.	2	1	2	78 2 6	Receiver with 8 coils.
Burwood (Concessionaires), Ltd., 41, Great Queen Street, Kingsway, London, W.C.2.	D'Accord Super 5	Mahogany, American type.	2	1	2	33 2 6	Receiver only.
Cable Accessories Co., Ltd., Britannia Works, Tivendale, Tipton, Staffs.	Revophone 4661.	Jacobean oak, pedestal type.	1	1	2	58 0 0	Complete with all accessories.
" " "	" 4663.	Mahogany, pedestal type.	1	1	2	60 10 0	" " " "
" " "	" 4662.	Jacobean oak cabinet.	1	1	2	40 10 0	" " " "
" " "	" 4666.	Mahogany cabinet.	1	1	2	41 10 0	" " " "
Curtis, Peter, Ltd., 75a, Camden Road, London, N.W.1.	Duodyne Portable IV.	Mahogany, totally enclosed.	1	1	2	21 0 0	Complete with accessories.
" " "	" " "	Art crocodile leather, totally enclosed.	1	1	2	22 0 0	" " " "
" " "	Duodyne V.	Teak, open	2	1	2	21 2 6	Receiver only.
" " "	" " "	Teak, enclosed, folding doors.	2	1	2	25 12 6	" " " "
" " "	Curtis	Mahogany, walnut or lacquer, open or enclosed.	Super het with 2			46 5 0 to 75 guineas.	Complete with frame aerial. May be used as 2-3-valve or 7-8-valve receiver. SUPER-HETERODYNE.
Dargue Bros., Ltd., Simpton Technical Instrument Works, Halifax.	Simpton IV.	Mahogany or oak, lifting top and folding doors.	4 valves.			34 0 0	NEUTRODYNE. Receiver only.
" " "	" " "	" " "	"			47 10 0	Complete with valves, batteries, loud-speaker and aerial.
" " "	Simpton	Mahogany, floor cabinet type.	1	1	2	35 7 6	" " " "
Dunham, C. S., 234/6, Brixton Hill, London, S.W.2.	C.S.D.37	Oak or mahogany, folding doors.	1	1	2	25 0 0	Receiver only.
" " "	" " "	" " "	4 valves.			27 10 0	Receiver only.
" " "	C.S.D.56	Mahogany or oak, sloping panel.	"	"	"	31 0 0	Complete with accessories.
" " "	" " "	" " "	"	"	"	18 10 0	Receiver only.
Dynamergy Mains Supply, Staines.	1-Valve Mains Supply Receiver.	" " "	1 valves.			27 10 0	Complete with accessories.
Eagle Engineering Co., Ltd., Eagle Works, Warwick.	De Luxe Pedestal	Pedestal, oak, with self-contained loud-speaker.	1	1	2	35 10 0	Receiver with valves. Direct current from mains.
" " "	No. 2	Mahogany, sloping desk pattern.	1	1	2	10 17 6	Receiver. Coupled aerial circuit, with B.B.C. coils and loud-speaker. Space in cabinet for batteries. Receiver only, with B.B.C. coils.
" " "	No. 2	" " "	1	1	2	9 7 6	Complete set of parts. B.B.C. coils and full instructions.
" " "	No. 7	Vertical panel, oak or mahogany cabinet, with folding doors.	1	1	2	21 18 0	Receiver. Coupled aerial circuit, with B.B.C. coils and plug. H.T. compartment in base.
" " "	No. 7	Vertical panel, oak cabinet.	1	1	2	18 13 0	" " " "

Buyer's Guide to Sets

VALVE SETS (4 or more Valves)—continued.

Manufacturer.	Name of Set.	Type of Cabinet.	Valves.			Price.	Description and Remarks.
			H.F.	Det.	L.F.		
Edison Swan Electric Co., Ltd., 123/5, Queen Victoria St, London, E.C.1.	Long-range Radiophone.	Mahogany, 2 doors	1 re-Hex.	1	2	£ 29 0 0	Receiver with 1 pair range blocks, H.T. and bias batteries, no valves.
Electrical Accessories Manufacturing Co., Progress Works, Low Hall Mills, Holbeck, Leeds.	Prento F.4	Flat, walnut	1	1	2	13 10 0	REFLEX. Receiver only.
	" C.B.1	Oak cabinet	1	1	2	19 10 0	"
	" C.4	"	1	1	2	16 10 0	"
	" 4D.2	" with doors	1	1	2	21 0 0	"
	" 4D.4	"	1	1	2	27 0 0	"
Elliott, C. L., 12, Queen's Road, London, S.W.8.	Volitone	Oak	1	1	2	From 10 10 0	Receiver only.
Emsco Radio, 24, Lexington-stone Road, Stratford, London, E.15.	Emsco 5	—	1	1	2	30 0 0	Complete with accessories and loud-speaker.
	" 6	—	4-valve reflex, with neutro-dyned H.F. valve.			32 0 0	NEUTROLISED REFLEX.
Engineering Works (Electrical & General), Ltd., 17/21, Thurlow Park Road, West Du'wich.	Radio-Pal	Self-contained, in crocodile leatherette case.	1	1	2	22 9 0	Receiver. Tuned anode, aerial reaction, with 2 H.T. batteries and accumulator, frame aerial in case and B.B.C. tuning coils. £1 ts. extra for 5XX frame aerial.
	Radio-Pal de Luxe	Self-contained, solid leather.	1	1	2	27 14 0	£1 5s. extra for "5XX frame" aerial.
Eriesson, British L.M. Manufacturing Co., Ltd., 67/73, King-way, London, W.C.2.	0/1041	Queen Anne period, in oak, walnut or mahogany.	1	1	2	77 10 0	Receiver only. Compartments for accumulator and other batteries.
	0.1084	Mahogany, folding doors, with lock-drawer for phones.	1	1	2	30 0 0	Receiver only.
Fairbrother, John, 94, Prescott Road, Fairfield, Liverpool.	Fair-Fal	Mahogany cabinet, folding doors, H.T. inside.	1	1	2	25 0 0	Complete with accessories.
Falk, Stadelmann & Co., Ltd., 83 92, Farringdon Road, London, E.C.1.	Erseaphone Nelson	Mahogany, with roll front.	1	1	2	32 10 0	Receiver only.
Fellows Magneto Co., Ltd., Cumberland Avenue, Park Royal, London, N.W.10.	Fellophone Super 5.	Oak folding doors.	1	1	3	24 0 0	Complete with accessories, 1 tri-coupled, 2 res-coupled L.F. stages.
Fuller's United Electric Works, Ltd., Woodland Works, Chadwell Heath, Essex.	Sparta	Oak bureau	1	1	3	50 0 0	Receiver only.
	"	"	1	1	2	19 6 0	"
Gambrell Bros., Ltd., 76, Victoria Street, London, S.W.1.	The Gambrell Cabinet 4.	Mahogany cabinet, with folding doors.	1	1	2	30 10 0	Receiver only.
	" " 4A	"	1	1	2	32 10 0	"
General Electric Co., Ltd., Magnet House, King-way, London, W.C.2.	B.C.4000	Mahogany, table model.	1	1	2	30 0 0	Receiver with 3 D.E.8 and 1 D.E.5 valves and grid battery.
	B.C.4020	"	1	1	2	29 0 0	Receiver with 3 D.F.2 and 1 D.E.6 valves and grid battery.
	B.C.4001	"	1	1	2	37 5 0	Complete with all accessories and accumulator.
	B.C.1021	"	1	1	2	35 10 0	"
	B.C.4444	Polished mahogany, cabinet model.	1	1	2	60 0 0	Complete with self-contained loud-speaker, 4 pairs phones, batteries and all accessories.
	B.C.2010	Polished mahogany, cabinet de Luxe model.	1	1	2	85 0 0	Receiver complete with self-contained loud speaker, 4 pairs phones, batteries, valves.
	B.C.3400 4-valve Combination Set.	Polished mahogany	1	1	2	29 10 0	2-Valve receiver and 2-stage amplifier, complete with all accessories. Receiver with valves.
	B.C.2050	Polished mahogany, cabinet model.	1	1	3	36 2 6	"
	B.C.2051	"	1	1	3	44 7 6	Receiver with valves, phone, H.T. batteries & accumulator. R-C. Cp. SUPERSONIC HETERODYNE, complete with frame aerial, valves, batteries and 1 pair phones.
	B.C.6000	Polished mahogany	6 valves.			52 10 0	"
	B.C.8800	"	8 valves.			73 10 0	"
Gent & Co., Ltd., Faraday Works, Leicester.	Tangent Radio-matic Type B.	"	1	1	2	22 5 0	Receiver with valves and B.B.C. coils. Cabinet extra.
Gladwell & Kell, Ltd., 258, Gray's Inn Road, London, W.C.1.	Liquitone	Mahogany cabinet, with batteries inside.	1	1	2	25 4 6	Receiver, with valves and grid battery.
	"	"	1	1	2	35 0 0	Complete with all accessories, including loud-speaker.
Graham, R. F., & Co., Norbex Works, 101, Gloucester Road, Kingston-on-Thames, Surrey.	Broadwood-Graham.	Floor type, self-contained.	1	1	2	68 10 0	Receiver complete with all accessories, loud-speaker horn carved out of solid piece of wood.
Henderson, W. J., & Co., Ltd., 351, Fulham Road, S.W.10.	H.R.1A	Oak or mahogany	1	1	2	20 0 0	Receiver only.
	"	"	1	1	2	26 10 0	Complete with valves and accessories.
Hirst Bros. & Co., Ltd., Roscoe Street, Oldham, Lancs.	Tameside R.1016	Oak, upright panel	1	1	2	13 10 0	Receiver only. Tuned anode circuit, 2 transformer-coupled L.F. stages.
	" de Luxe R.1149.	Oak, upright panel, folding doors.	1	1	2	16 0 0	Receiver only. Tuned anode circuit.
	" R.137	Oak desk for sloping panel.	1	1	2	11 0 0	"
	" R.444	Oak table, hinged lid, folding doors.	1	1	2	24 10 0	"

Buyer's Guide to Sets

VALVE SETS (4 or more Valves)—continued.

Manufacturer.	Name of Set.	Type of Cabinet.	Valves.			Price.	Description and Remarks.
			H.F.	Det.	L.F.		
Johnson, Thos. T., 17/19, Catherine Street, Salisbury.	Sarumphone	Mahogany, 2 folding doors.	1	1	3	£ s. d. 26 0 0	Complete with accessories.
King Quality Products, Inc. (G. E. Marbaix, Manager), 27/28, Auning Street, E.C.2.	King 10S.K.	Mahogany, American type.	2	1	1	26 0 0	Receiver only. NEUTRODYNE.
	.. Model 25 ..	Dark mahogany, American type.	2	1	2	32 0 0	Exposed metal parts gold-plated.
	.. Model 25S ..	Two tone dark mahogany, American type.	2	1	2	55 0 0	As No. 25, with Amplion loud-speaker incorporated and space for 2 I.L.T. batteries.
Lamplugh, S. A., Ltd., King's Road, Tyseley, Birmingham.	Desk Type	Oak, sloping	1	1	2	17 10 0	Receiver only.
Liver Radio Manufacturing Co., Ltd., 30, Islington, Liverpool.	Liverphone	Enclosed	4 valves.			17 10 0	Receiver only.
			22 10 0
McMichael, J., Ltd., Wexham Road, Slough.	Standard de Luxe	Mahogany, folding doors and provision for batteries in cabinet.	1	1	2	35 10 0	Receiver only, with tuning coils for all wavelengths.
M.A.P. Co., Great Lister Street, Birmingham.	M.A.P. Major ...	Mahogany, all enclosed, vertical panel.	1	1	2	24 10 0	Complete with accessories.
	M.A.P. Pedestal Grand.	Mahogany pedestal, with loud-speaker.	1	1	2	45 0 0	Complete with valves, batteries and loud-speaker, all enclosed.
Marconiphone Co., Ltd., 210, 212, Tottenham Court Road, London, W.1.	41	Mahogany	1	1	2	37 19 0	Complete with accessories. Rejector for main and high-power wavelengths.
	81 Straight 8	5	1	2	67 16 0	Complete with accessories.
	Sterling Threeflex R.1590.	Walnut	3	1	2	29 7 6	Frame aerial receiver, complete with phones.
	Sterling Anodion 4-V. Long Range	1	1	2	30 19 7	Complete with 1 pair headphones. Adaptable 40-5,000 metres.
	Sterling R.1615	1	1	2	43 4 7	Complete with battery, base and headphones, 40-5,000 metres.
	Sterling Regina R.1618.	Oak	1	1	2	65 10 0	Complete. Loud-speaker fitted in cabinet, 40-5,000 metres.
	Sterling Imperial R.1619.	Mahogany	1	1	2	71 10 0
	Sterling Floor Cabinet R.1620.	Walnut	1	1	2	98 10 0
 R.1621	1	1	2	122 10 0
 R.1621	1	1	2	22 5 0	Receiver only, with 1 coil box, 300-800 metres. REFLEX.
Metro-Vick Supplies, Ltd., 4, Central Buildings, Westminster, London, S.W.1.	Cosmos Universal V.S.6.	Hardwood case ...	1 Reflex Valve detector, 3 L.F. resistance-coupled.			28 10 0
..	Jacobean oak cabinet on legs.			30 10 0
..	Mahogany cabinet on legs.			42 0 0	Receiver only, with 1 coil box, 300-800 metres. Built-in loud-speaker.
.. ..	Cosmos Universal V.S.7.	Simple Jacobean oak cabinet on legs.			46 0 0
..	Simple mahogany cabinet on legs.			56 0 0
..	Rich Jacobean Oak.			63 0 0
..	Mahogany, Georgian Tray			22 10 0	Receiver only. Space in cabinet for all batteries.
Midland Radiotelephone Manufacturers, Ltd., Brettell Lane Works, Stourbridge.	Mellowtone 4	1	1	2	26 10 0
	.. 4 ...	Popular, oak	1	1	2	32 10 0
	.. 4 ...	De Luxe, oak	1	1	2	37 10 0
	.. 4 mahogany	1	1	2	28 2 6
	.. 5 ...	Tray	3	1	2	32 2 6
	.. 5 ...	Popular, oak	3	1	2	33 2 6
	.. 5 ...	De Luxe, oak	2	1	2	43 2 6
	.. 5 mahogany	3	1	2	67 13 0
.. 6 oak	2	1	3	73 13 0	
.. 6 mahogany	2	1	3	28 5 0	Receiver only.	
National Wireless & Electric Co. (R. R. Goding, Ltd.), 42, Gray's Inn Road, London, W.C.1.	N. MK. 4* de Luxe	Mahogany	1	1	2	28 5 0	Receiver only.
Ormsby & Co., Elstree, Herts.	Ormsby	Polished mahogany	4 valves.			27 0 0	Receiver only, with 7 tuning coils.
			39 10 0	Receiver complete with all accessories and A.R.19 Amplion.
R. M. Radio, Ltd., 21, Garrick Street, London, W.C.2.	Carpenter	Period oak or mahogany, with space for batteries.	1	1	2	23 0 0	Receiver only. Single dial tuning control with automatic reaction compensation.
Radi-Arc Electrical Co., Ltd., Bennett Street, Chiswick, W.4.	Liberty	Oak or mahogany.	4	2	2	38 10 0	SUPERSONIC. Receiver only.
	3	2	1	32 5 0
Radio Communication Co., Ltd., 34/35, Norfolk Street, London, W.C.2.	Polar 4	Polished mahogany	—	1	3	32 10 0	Receiver only. L.F. resistance-capacity coupled, 2 separate tuners, with distant control.
	.. Quartette	—	1	3	17 10 0	As above, but with single tuner, including grid bias battery.
	.. Blok B.1 ..	Cryst. metal or polished mahogany.	—	1	3	16 0 0	Receiver only. Res. Cap. coupled and reaction.
 C.4	1	1	2	15 0 0
.. .. D.4	2	1	1	16 0 0	

Buyer's Guide to Sets

VALVE SETS (4 or more Valves)—continued.

Manufacturer.	Name of Set.	Type of Cabinet.	Valves.			Price.	Description and Remarks.
			H.F.	Det.	L.F.		
Radio Instruments, Ltd., 12, Hyde Street, New Oxford Street, London, W.C.1.	No. 1 L.B.	Mahogany, folding doors, with base.	1	1	2	£ s. d. 24 0 0	Receiver only. 200-4,000 metres.
	No. 6	Mahogany cabinet, with lid.	1	1	2	24 0 0	" " 300-4,000 "
	No. 65A.	" "	1	1	3	30 5 0	" " " "
	No. 65	" "	2	1	2	30 5 0	" " " "
	Lyrian No. 4L. ...	Chippendale cabinet, with cupboard for batteries.	1	1	2	75 0 0	Complete with accessories, including self-contained loud-speaker, 300- 4,000 metres.
" " "	" "	" "	2	1	2	80 0 0	" " " "
" " "	" "	" "	2	1	2	80 0 0	" " " "
Radio Supply Co., Super- phone Works, Four Oaks, Birmingham.	Superphone Maxim IV.	Mahogany, sloping panel, 18 x 7, shaped sides.	—	1	3	15 15 0	Receiver only. Tuned anode. Single or double circuits at will. 5XX coils embodied. 1 tr.-coupled, 2 res.-coupled L.F. stages.
Read & Morris, Ltd., 31, East Castle Street, W.1.	Simplicity Five ..	—	2	1	2	53 3 0	According to cabinet. Receiver only.
Reeves, A. W., M.I.M.E., 3, Edmund Street, Birm- ingham.	Reeves - Roberts de Luxe.	—	4 valves.			73 3 0 21 5 0	Mains units extra according to mains supply. Receiver only, with valves.
" " "	" "	—	"			30 0 0	Do., complete with all accessories, including loud-speaker.
S.H.C.S. Co., 10, Clare Ter- race, Sidcup, Kent.	Thor No. 10	Mahogany, all en- closed, with lid.	1	1	2	25 4 0	Receiver, with batteries in cabinet and Brown H.2 loud-speaker.
Sherman, P., 12, River Street, Clerkenwell, London, E.C.1.	4.....	Oak, American type.	1	1	2	15 0 0	Receiver only, with coils for local and 5XX.
" " "	4A.....	Mahogany, Ameri- can type, with 2 folding doors.	1	1	2	20 0 0	" " "
" " "	5.....	" "	2	1	2	30 0 0	" " "
Stevens, A. J., & Co. (1911), Ltd., Walsall Street, Wol- verhampton.	Console	Mahogany.....	1	1	2	75 0 0	Complete with "concealed" loud- speaker and all accessories.
" " "	Pedestal de Luxe	" " or oak ..	1	1	2	65 0 0	" " " "
" " "	Pedestal	" " or oak ..	1	1	2	52 0 0	" " " "
" " "	Table de Luxe ...	" " or oak ..	1	1	2	35 0 0	" " " "
" " "	Table	" " or oak ..	1	1	2	30 10 0	Receiver complete with accessories.
" " "	1-Valve Standard	" sloping desk	1	1	2	26 15 0	" " " "
Telephone Manufacturing Co., Ltd., Hollingsworth Works, West Dulwich, London, S.E.21.	T.M.C. 4B.	Walnut, enclosed sloping panel, glass doors.	1	1	2	23 10 0	Receiver only. 300-2,700 metres.
Terry, Herbert, & Sons, Ltd., Redditch.	The Terry	Antique oak or mahogany.	4 valves.			45 0 0	Receiver complete with all acces- sories.
Thames Electric Wireless Co., Ltd., 40, Old Town, Clapham, London, S.W.4.	Thames	Mahogany cabinet.	7 valves.			32 14 6	SUPERSONIC HETERODYNE. Receiver only.
Tudoradio Co., Ltd., Tudor Wks., Park Royal, N.W.10.	Tudoradio S.B.4 ..	Mahogany or oak, folding doors.	1	1	2	36 0 0	Complete with accessories and Amplion A.R.19.
Ward & Goldstone, Ltd., Frederick Road (Pendle- ton), Manchester.	Goltone Type A ..	Oak	1	1	2	11 15 0	Receiver only.
" " "	" Type B	Polished oak ..	1	1	2	16 10 0	Complete with accessories.
" " "	" "	" "	1	1	2	13 0 0	Receiver only.
" " "	" de Luxe ..	Oak, "totally en- closed.	1	1	2	17 12 0	Complete with accessories.
" " "	" "	" "	1	1	2	21 5 0	Receiver only.
" " "	" "	" "	1	1	2	31 10 0	Complete with accessories.
" " "	" "	" "	1	1	2	28 2 6	Receiver only.
" " "	" "	" "	1	1	3	37 12 6	Complete with accessories.
Williamson, Robert, 56, Commercial Street, Ler- wick, Sheffland Isles.	Thulephone	Plain	1	1	2	25 0 0	Complete with accessories.
" " "	" de Luxe	Cabinet, with fold- ing doors.	1	1	2	30 0 0	Complete with accessories.
Wootton, F. E., Ltd., 56, High Street, Oxford.	Wootophone	Mahogany or oak	4 valves.			25 7 0	Receiver only.
" " "	Type A.	" "	"			30 18 0	Complete with valves and all accessories.
" " "	Type F.	pedestal type.	"			48 6 0	" " " "
Yorkshire Radio Co., Ltd., Western Works, Rocking- ham Street, Sheffield.	Deucalion	Cabinet	1	1	2	38 17 0 31 10 0	Receiver only. Receiver only.
Young, A. M., & Co., 52, Bordesley Street, Birm- ingham.	Rondar	American pattern, oak.	1	1	2	15 10 0 28 0 0	Receiver only. Complete with accessories and loud- speaker.

AMPLIFIERS.

Manufacturer.	Name of Set.	Type of Cabinet.	Valves.		Price.	Description and Remarks.
			H.F.	L.F.		
British Thomson-Houston Co., Ltd., Crown House, Aldwych, London, W.C.2.	R.T.H. Portable ..	Leather-cloth case, with carrying handle, 2 front doors.	—	2	£ s. d. 22 15 0	Combined amplifier and loud-speaker, complete with accessories.
" " "	B.T.H.	Mahogany.....	—	2	24 15 0	Amplifier only. "Single-stage."
" " "	"	Flat top panel, valve sunken.	—	1	3 18 6	" " " "
" " "	"	" "	—	2	7 10 0	" " " "Two-stage."

Buyer's Guide to Sets

AMPLIFIERS.—continued.

Manufacturer.	Name of Set.	Type of Cabinet.	Valves.		Price.	Description and Remarks.
			H.F.	L.F.		
British Wireless Supply Co. (1924), Ltd., 6, Blenheim Terrace, Leeds.	Britphone 1	Oak box	—	1	£ 2 0 0	Amplifier only. One-stage.
Burndept Wireless, Ltd., Aldine House, Bedford Street, Strand, London, W.C.2.	Power Amplifier Mk. 1.	Polished mahogany, open front.	—	1	11 12 6	With valve. Transformer coupled.
	Uniplex	Moulded Bakelite.	—	1	4 16 6	
	Power Amplifier Mk. IV.	Polished mahogany, open front.	—	2	23 5 0	With 2 valves. Transformer coupled.
Cable Accessories Co., Ltd., Britannia Works, Tividale, Tipton, Staffs.	Revo W.4584	Mahogany case	—	2	11 5 0	Valves and batteries extra.
	Revo Standard W.3196 New Type.	" " "	—	2	5 10 0	" " "
Corrall, A. J., 226, Warwick Road, Greet, Birmingham.	Revo W.4176	" " "	—	1	3 6 6	
Dunham, C. S., 231 G, Priton Hill, London, S.W.2.	Warwick IV.A.	Oak	—	1	3 0 0	Amplifier only, with valve.
	No. 1	Mahogany case	—	1	4 10 0	Amplifier only.
	"	" " "	—	1	8 14 6	" complete with power valve, H.T. supply and accumulator.
	No. 2	" " "	—	1	4 5 0	Amplifier only.
	Two Stage	" " "	—	2	8 2 6	Amplifier only.
	"	" " "	—	2	13 8 6	" complete with power valves, H.T. supply and accumulator.
Engineering Works (Electrical & General), Ltd., 17 21, Thurlow Park Road, West Dulwich.	Royal IV. Model A	Fume oak	—	1	5 17 6	
	" Model B	" " "	—	1	2 12 6	
	" 2V. Model A	" " "	—	2	8 12 0	Transformer coupled.
	" Model B	" " "	—	2	6 5 0	
General Electric Co., Ltd., Magnet House, Kingsway, London, W.C.2.	B.C.2585	Polished mahogany case.	—	1	5 1 6	Amplifier, with valve.
	B.C.2580	Polished mahogany, enclosed cabinet.	—	2	10 10 0	" with 2 valves.
Johnson, Thos. T., 17 19, Catherine St., Salisbury.	Sarumphone	Mahogany box	—	1	1 15 0	Amplifier only.
Lamplugh, S. A., Ltd., King's Road, Tyseley, Birmingham.	Lamplugh	Oak, sloping	—	2	6 10 0	Amplifier only.
Marooniphone Co., Ltd., 210/212, Tottenham Court Road, London, W.1.	No. H.3	Mahogany	1	—	8 16 9	Complete with valves and accessories. H.F. L.F.
	" A.1	" " "	—	1	9 9 3	" " " " " "
	" A.2	" " "	—	2	16 12 0	" " " " " "
	" B.2	" " "	—	2	21 1 0	" " " " " "
	Sterling R.1335	Walnut	—	2	11 3 0	Amplifier only.
	" R.1336	" " "	—	2	10 10 0	" " "
	" R.1333	Metal shield	—	1	3 3 6	" " "
	" R.1537	" " "	—	2	6 4 0	" " "
National Wireless & Electric Co. (R. R. Goding, Ltd.), 42, Gray's Inn Road, London, W.C.1	N. Mk. C.2	Wood	—	1	2 0 0	Amplifier only.
	N. Mk. C.3	Mahogany	1	—	2 5 0	" " "
Radio Communication Co., Ltd., 34/35, Norfolk Street, Strand, London, W.C.2.	Polar Blok A.2	Cryst. metal or polished mahogany.	—	2	9 10 0	Amplifier only. One stage trans. coupled One stage Res.-Cap. Coupled.
Radio Supply Co., Superphone Works, Four Oaks, Birmingham.	Superphone	Mahogany, portable	—	1	2 12 6	Amplifier only.
	Maxum I.	" " "	—	2	7 0 0	" " "
	" II.	" " "	—	3	8 0 0	" " "
	" III.	" " "	—	1	8 2 6	Amplifier, complete with valve and H.T. battery.
Rotax (Motor Accessories), Ltd., Rotax Works, Wileston Junction, London, N.W.10.	Rotola	Black morocco, mahogany or oak case.	—	1	8 2 6	
Sherman, P., 12, River Street, London, E.C.1.	No. 7	American type, in oak.	—	1	2 0 0	Amplifier only.
	" 8	" " "	—	2	4 15 0	
Sea Radio Co., Ltd., 107a, Locksbrook Road, Bath.	Spa	" " "	—	2	4 5 0	Amplifier only.
Standard Telephones & Cables, Ltd., Bush House, Aldwych, London, W.C.2.	Weconomy Power No. 44013.	Mahogany case	—	3	12 12 0	Amplifier only, with valve.
	Double Power No. 44014.	" " "	—	2	17 17 0	" " "
	Weconomy Small	Skeleton frame for fitting in crystal sets.	—	2	6 0 0	" " "
	Kone No. 44001	Skeleton built for fitting in any case or furniture.	—	2	12 17 6	" " "
	" No. 44901	Mahogany cabinet, self-contained. Room in cabinet for batteries.	—	2	15 5 0	" " "
Tutills, Ltd., 7 and 9, Swan Street, Manchester.	Tinol	Oak, American type, lift-up lid.	—	1	3 17 6	Amplifier only.
	"	" " "	—	2	6 5 0	
	"	" " "	—	2	11 11 0	Amplifier, with valves; for running off D.C. mains.
Ward & Goldstone, Ltd., Frederick Road (Pendleton), Manchester.	Goltone	" " "	—	1	2 17 6	Amplifier only.
	"	" " "	—	1	5 12 6	Complete with all accessories.
Wates Bros., 13/14, Great Queen Street, Kingsway, London, W.C.2.	Supratone	Mahogany	—	2	4 0 0	Amplifier only.
Young, A. M., & Co., 52, Bordesley Street, Birmingham.	Rondar	American pattern, oak.	—	2	7 10 0	Amplifier only (power).

CLEARTRON CHARACTERISTICS

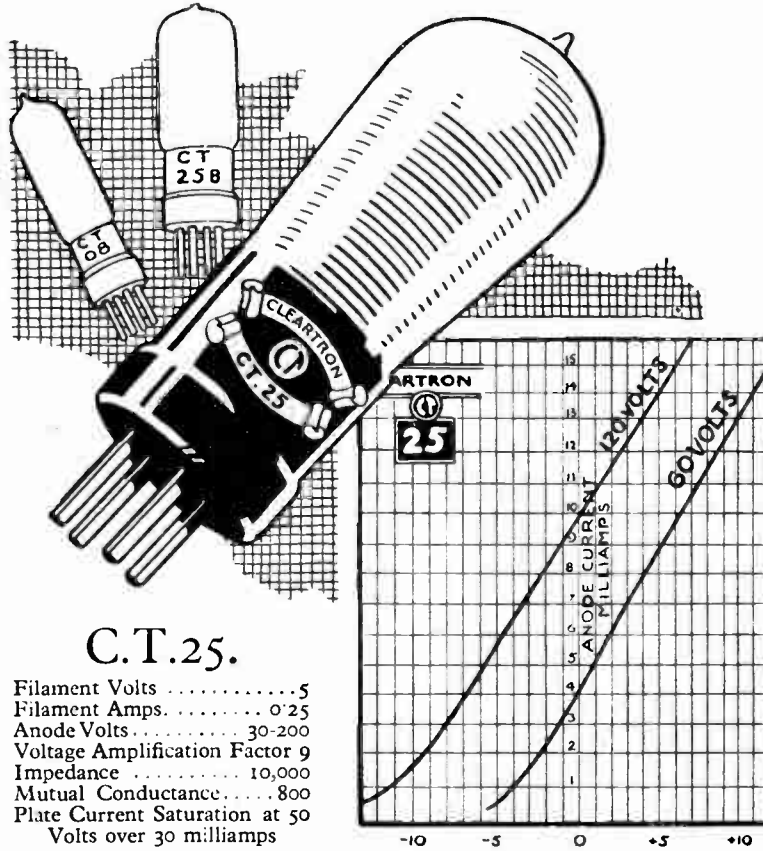

C.T.25.

Filament Volts 5
 Filament Amps. 0.25
 Anode Volts 30-200
 Voltage Amplification Factor 9
 Impedance 10,000
 Mutual Conductance 800
 Plate Current Saturation at 50
 Volts over 30 milliamps

Type	Accumulator or Battery volts	Fil.volts.	Fil. amp.	Purpose	Price
C.T.08.	Dry cells	3	0.08	H.F., L.F. Detector	12/6
C.T.15.	2 volt Accumulator	1.8	0.15	H.F., L.F. Detector	12/6
C.T.25.	6 volt Accumulator	5	0.25	H.F., L.F. Detector	15/-
C.T.25.B.	6 volt Accumulator	5	0.25	General purpose resistance coupled amplification	15/-

Here we show you the electrical characteristics of the CLEARTRON Dull Emitter C.T.25; we could talk to you for hours about its general excellence. But charts and talk cannot convince like an actual trial. Give it a "try out" and prove by your experience that CLEARTRON

valves in your set mean vastly increased volume and greater distance; operatic purity, keener selectivity and longer life. And unless the C.T.25 produces all these claims and advantages it will be replaced without cost or question — our IRONCLAD GUARANTEE sees to this.

CLEARTRON RADIO LIMITED

1 CHARING CROSS, LONDON
 AND BIRMINGHAM.

Telephone:
 Regent 2231/2.

Grams: Cleartron,
 Westrand, London.

British



Made

Service Advertising

96/324B

Advertisements for "The Wireless World" are only accepted from firms we believe to be thoroughly reliable. F7

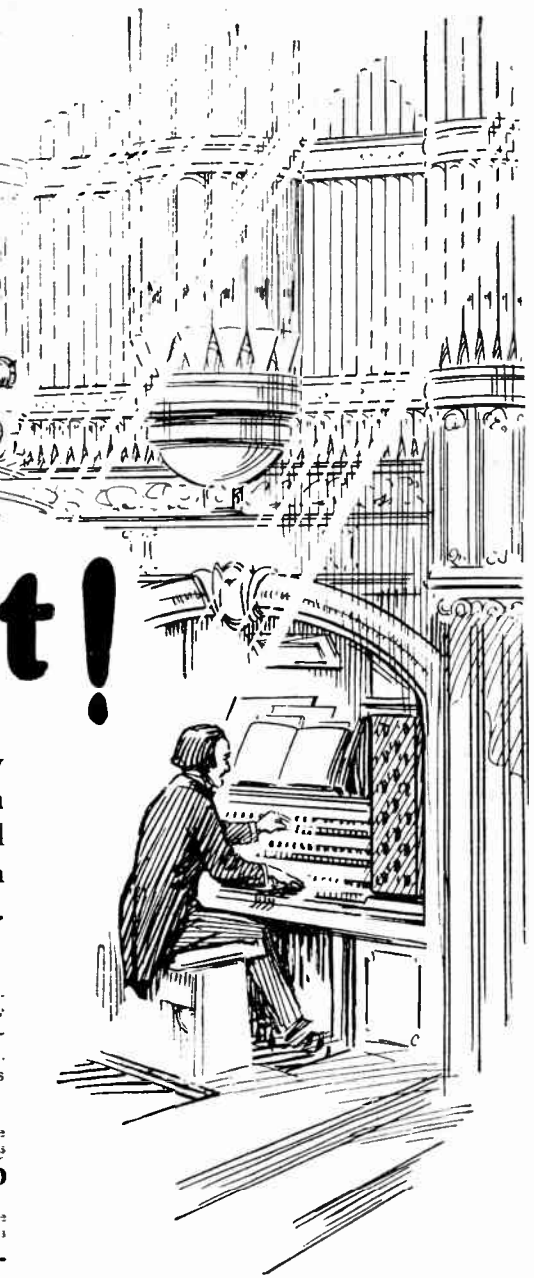
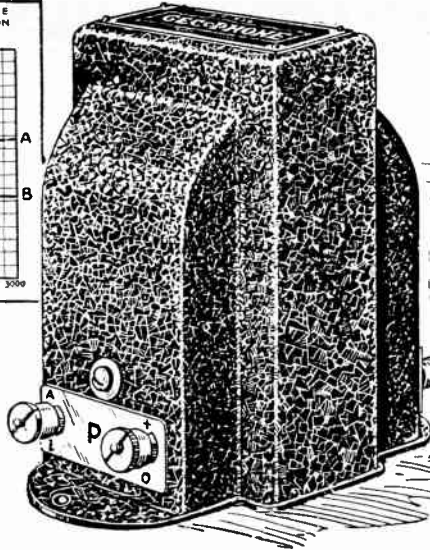
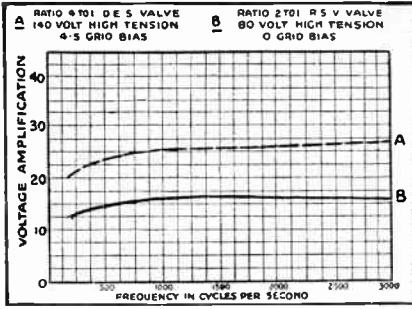

Tone-Perfect!

The GECoPHONE Transformer amplifies evenly over the main range of audio-frequencies. In other words, given a good loud speaker, it will ensure that closely life-like reproduction of speech and music which every radio user to-day demands.

For many years past the G.E.C. has made transformers for telephones. Thus a unique manufacturing experience lies behind the GECoPHONE radio transformer

Maximum amplification is assured—and leakage prevented—by high insulation between primary and secondary. Even amplification is assured by a primary of high inductance.

A neat drawn-metal case of crystalline finish contains the transformer. This guarantees effective shrouding

and prevents magnetic interaction. Coils and stampings, hermetically sealed in the case by a special compound, are absolutely moisture-proof. The conveniently spaced terminals are plainly marked for wiring.

RATIO 2 to 1. Recommended for use with general purpose valves, such as OSRAM types R., D.E.R., D.E.3., etc. Price **22/6**

RATIO 4 to 1. Recommended for use with low impedance valves, such as OSRAM types D.E.4., D.E.5., or D.E.6. Price **25/-**

Your wireless dealer sells it!



(Registered Trade Mark.)

Low Frequency TRANSFORMER

*The G.E.C.-
your guarantee*

KEEP YOUR WIRELESS
SET IN "TUNE"

Osram Valves

for Broadcasting

The G. E. C. - your guarantee

30 MILLION DUBILIER Condensers *Are now in use*

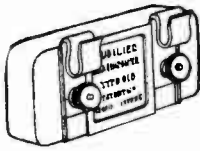

Type 610 Mica Condenser
for general use in receiv-
ing circuits. Capacities
0.0001-0.015 M.F.
From 3/-

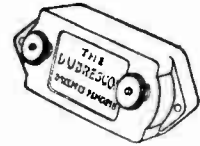

The Dubrescon
Permanent Valve
Protector - 6/-

These stupendous figures seem at first sight almost incredible. Yet they are correct, for Dubilier products are known and used all over the world.

The World's leading set manufacturers have standardised on Dubilier condenser equipment; the World's most important transmitting stations are equipped with banks of Dubilier Condensers, and every important Government department in the principal countries of the World makes use of Dubilier products for radio purposes.

The Dubilier Condenser Co. (1925) Ltd. manufacture Fixed Mica Condensers, Variable Air Condensers, Anode Resistances, Grid Leaks, the Dubrescon Valve Protector, the Ducon Aerial Adaptor, the Minicap Switch and the Mansbridge Variometer.

The Company are also sole concessionaires for the products of the Mansbridge Condenser Co. Ltd.

Specify Dubilier

REGISTERED  TRADE MARK

DUBILIER
CONDENSER CO (1925) LTD

ADVERT. OF THE DUBILIER CONDENSER CO. (1925) LTD., DUCON WORKS, VICTORIA ROAD, NORTH ACTON, W.3.

TELEPHONE: CHISWICK 2241-2-3.
E.P.S. 172



Events of the Week in Brief Review.

LIGHTHOUSE WIRELESS.

The Caspiets Lighthouse, situated on the dangerous reef to the west of Alderney, has been fitted with a wireless transmitting and receiving installation.

○○○○

DUBLIN ASKS FOR REPORTS

A steady improvement in quality has been a marked feature of recent transmissions from the Dublin broadcasting station. An appeal is now made for reports from British listeners, who are asked to address their communications to the Editor, *The Irish Radio Journal*, 179, Great Brunswick Street, Dublin. All such reports will be warmly appreciated.

○○○○

MARCONI AND A SOVIET CLAIM.

The claim which has been put forward by the Russian Soviet to the effect that Professor Alexander Popoff was the inventor of wireless was discounted in an amusing fashion by Senatore Marconi when interviewed a few days ago.

After referring to the conclusive judgments of American and French courts, Senatore Marconi said: "The Soviet's claim was never once put forward by Professor Popoff himself. When I visited Petrograd in 1902, Professor Popoff sent me a telegram, 'Greetings to the Father of Wireless!'"

"This obviously disposes of a claim which I know Popoff, were he alive, would never make himself."

○○○○

RADIO SOCIETY'S ANNUAL DINNER.

Dr. W. H. Eccles presided at the sixth annual dinner of the Radio Society of Great Britain, held again this year at the Waldorf Hotel, where the dining hall was filled to its maximum capacity. In the course of the evening a message was despatched to H.R.H. the Prince of Wales, Patron of the Society, wishing him a speedy recovery from his recent accident, and also to Sir Oliver Lodge, the president, whose regretted absence was occasioned by an enforced visit to Italy. The speakers included Mr. Reith, Earl Russell, and Commander Carter of the B.B.C., who, in responding to the toast of the guests, referred to the co-operation given by members of the Society in the service of broadcasting.

○○○○

BURNDEPT BATTERY TAPPINGS

In the advertisement of Messrs. Burndeft Wireless, Ltd., appearing in *The Wireless World* of February 3rd, it was stated erroneously that the Burndeft super radio battery is tapped at 20, 25, 28 and 50 volts. Actually the battery is tapped at 20, 45, 48 and 50 volts.

FOR THE EXPERIMENTER.

Two articles of special interest to the experimenter appear in the February number of *Experimental Wireless*. "An Experimenter's Wireless Laboratory," by Leonard A. Sayce, M.Sc., and James Taylor, M.Sc., is the first of a series on this subject. "The Piezo-Electric Effect and its Application to Wireless," by C. W. Goyder (2SZ-2HM), deals with the principles and practical application of the quartz crystal for frequency control. In the same issue there is also published the text of the lecture given by Capt. Duncan Sinclair before the Radio Society of Great Britain, entitled "Some Facts and Notions about Short Waves."

○○○○

THE TESTS THAT FAILED.

Great resourcefulness was shown last week in explaining why the experimental broadcast transmissions between America and Europe were such a failure.

The baneful influences at work were enumerated thus:—(a) The Heaviside Layer, (b) the full moon, (c) the Aurora Borealis, (d) shooting stars, (e) sunspots, and (f) abnormal weather conditions. Whether any or all of these factors played a mischievous part in ruining the transmissions remains open to conjecture, or, better still, research. No one, of course, had the temerity to suggest that the American stations lacked power!

THE WIRELESS STRIKE.

At the time of going to press no settlement had been reached in connection with the strike of wireless operators. Representatives of the Association of Wireless and Cable Telegraphists attended at the Ministry of Labour on Wednesday last, February 3rd, and had three hours' discussion with an official regarding the terms for a basis of settlement proposed by the employers. Further informal meetings were held on Thursday and Friday, but, as stated above, no settlement had been reached.

○○○○

B.B.C. AND LICENCE FEES.

That the activities of the British Broadcasting Company were being definitely curbed by the present limitation of revenue was one of the points urged by Mr. J. C. W. Reith, managing director of the B.B.C. in a supplementary memorandum presented at the final sitting of the Broadcasting Committee on Thursday last. It was becoming increasingly difficult, said Mr. Reith, to keep within the present figure of £500,000, and so far from restricting the 7s. 6d. proportion of the licence fee now payable to the Company it should be increased to 9s.

It was stated that the Company was proceeding with the scheme for the erection of four more high-power stations in different parts of the country.

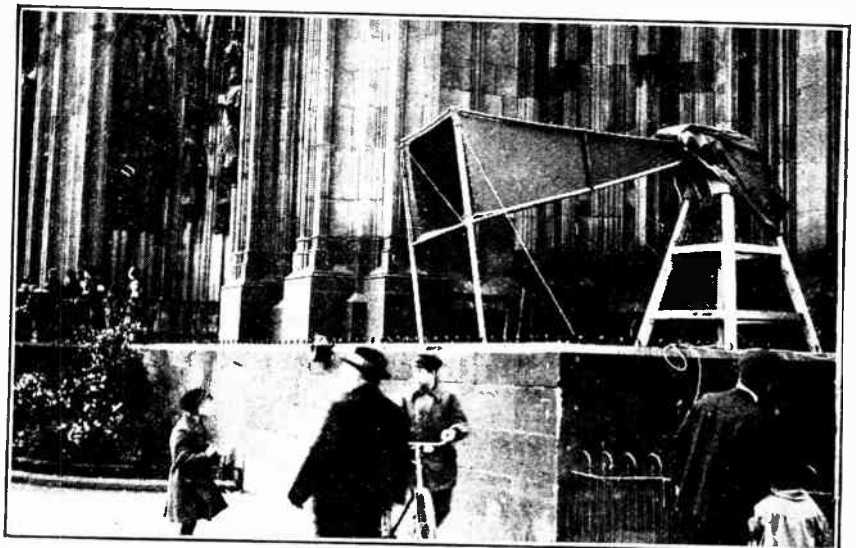

REJOICINGS IN COLOGNE. One of the large loud speakers in front of Cologne cathedral used for amplifying the speech of the Burgomaster after the evacuation by the British troops. The Burgomaster's address was also heard by wireless throughout Europe.

THE AMATEUR'S PART IN SHORT-WAVE DEVELOPMENT.

TWO letters of such unusual interest to readers of *The Wireless World* have recently appeared in our contemporary, *The Electrician*, that we have sought permission to reproduce them. The first letter, from Senatore G. Marconi, appeared in the issue of January 22nd, and was in reference to a contribution to *The Electrician* of January 8th by Mr. L. B. Turner, M.A., who has replied in the issue of January 29th. We publish the text of both letters below:—

Sir,—Will you permit me to endeavour to correct what seem to me inaccurate statements in "Notes on Wireless Matters," compiled by Mr. L. B. Turner, of Cambridge University, and appearing in your issue of the 8th instant.

In the article referred to the writer makes the following statement regarding the ascertained overstatement of the attenuation in the Austen-Cohen formula when this is applied to short-wave transmissions:—

Within the last two or three years it has been discovered that with much shorter waves the formula overstates the attenuation enormously. It is largely this discovery, made by wireless amateurs transmitting with the pitifully use-less wavelengths (as all thought) allotted to them by the authorities. . . .

I do not know whether Mr Turner intended to limit his statement—"as all thought"—to the experts at Cambridge, but it is only fair to point out that such a statement cannot apply to me and to certain engineers of the Marconi Co.

A paper read by Mr. C. S. Franklin on May 3rd, 1922, before the I.E.E., contains a detailed description of important tests carried out since 1916 by himself and myself with very short waves of a wavelength between 20 and 2 metres.

In a paper I read at a joint meeting of the American Institute of Electrical Engineers and the Institute of Radio Engineers on June 20th, 1922, before—so far as I can ascertain—any attention had been drawn by amateur results to the capabilities of short waves, I stated, forcibly I think, how important the study of short waves was likely to become.

I take the following passages from that paper:—

I propose to-night . . . to call your attention particularly to what I consider a somewhat neglected branch of the art, and which is the study of the characteristics and properties of very short electrical waves.

I have brought these results and ideas to your notice as I feel, and perhaps you will agree with me, that the study of short waves, although sadly neglected practically all through the history of wireless, is still likely to develop in many unexpected directions and open up new fields of profitable research.

These statements which were published more than "two or three years" ago, clearly show, I think, that I at least did not consider these short waves "pitifully useless."

With reference to the inapplicability of the attenuation factor of the Austen-Cohen formula, which is attributed by Mr. Turner to the "discovery" made by amateurs, I would like to point out that in my Royal Society of Arts paper of July 2nd, 1924, I stated:—

Perhaps one of the most remarkable results of the experimental work carried out on my yacht (in 1923) was to ascertain quite definitely that the coefficient of the well-known Austen-Cohen formula for the propagation of the waves was defective when applied to short wave phenomena.

I would be glad if Mr. Turner could kindly refer me to any earlier published statement or conclusion to the same effect concerning the work of amateurs, or others, based on the observed results of transmissions with wavelengths of less than 100 metres.—I am, etc.,

G. MARCONI.

London, W.C.2. January 19th, 1926.

Sir,—In last week's *Electrician* Mr. Marconi takes me to task for a statement in this month's "Notes on Wireless Matters," to the effect that the discovery of the remarkable carrying powers of short waves over long distances is attributable to the amateurs. He quotes my phrase: "the pitifully useless wavelengths (as all thought)" with special reference to the three words in brackets, for, he says, such a statement cannot apply to him and to certain engineers of the Marconi Co.

Of course, I admit that no statement as to what *all* thought about anything at any time is likely to be mathematically accurate; and only Mr. Marconi and Mr. Franklin can say what their own thoughts were. But I do not find any evidence that the new facts about the world-wide range of short waves were first brought to public notice by Mr. Marconi. He

cites two papers—by Mr. Franklin and himself respectively, published in 1922—describing experiments carried out since 1916 with wavelengths between 2 and 20 metres. As an argument against the tribute I paid to the significance of the amateur results, Hertz's experiments themselves might almost as well be quoted. The Franklin paper was entitled "Short-wave Directional Wireless Telegraphy"; the origin of the experiments was an effort to get secret beam signalling, and the whole emphasis was laid upon the return to Hertz's very short waves in order to utilise reflectors as Hertz did. The Marconi paper, though dealing with other topics as well, was to the same effect as regards short waves. The greatest range reported was 97 miles, in the Birmingham-Hendon experiment, and in this use was made of reflectors whose effect was estimated to increase the received power 200 times. It was a brilliant piece of work as regards the production and manipulation of very short waves; but, whatever may have been in the minds of the authors, I venture to assert that no reader of the papers would have been warned by them to expect world-wide ranges between low-power, non-directional, short-wave stations.

Mr. Marconi then refers to his paper before the Royal Society of Arts in July, 1924. This is a different story. Here the object of the experiments was to obtain long ranges; they were strikingly successful, culminating in June, 1924, in transmission between Poldhu and Buenos Aires, a distance of 5,820 miles, using a power of 21 kW and a wavelength of 92 m. This indeed proves that the Austen-Cohen attenuation does not hold with short waves. But the paper was published on July 25th, 1924, when amateur and other reports had already proved it. Mr. Marconi invites me to quote earlier published statements concerning the work of amateurs or others. These are wearisome to collect, but I have turned up a few. He must allow me to wander a few metres from his arbitrary limit of 100 m. The dates refer to issues of *The Wireless World*.

July 30th, 1924. Nauen to Buenos Aires, on very short wave Luxembourg to Finland; $\lambda=95$ m.; 0.25 A in aerial.

July 18th, 1924. Results of Eiffel Tower tests on 115-15 m., which had been in progress for some months.

July 16th, 1924. Argentine to N. America, New Zealand and England; $\lambda=118$ m.; 5 A in aerial.

June 25th, 1924. Mr. Haynes instructs amateurs how to build a receiver for 90-180 m.

May 28th, 1924. French amateur on 108 m. heard frequently in Brazil.

May 14th, 1924. Edinburgh to Canada; $\lambda=115$ m.; 0.65 A in aerial.

April 23rd, 1924. "Well-known Dutch transatlantic transmitter"; $\lambda=108$ m.; 500 watts.

Surely these show that the world did not await Mr. Marconi's Society of Arts paper to appreciate the astonishing qualities of short waves for long ranges.

The writer has a profound respect for the achievements of Mr. Marconi and his engineers. But virtue is not confined, nor is any person or corporation omniscient. It is apposite to conclude this defence of the amateur's achievement by a quotation from *The Times* expressing Mr. Marconi's own views at no remote date (January 6th, 1923). After an American amateur had visited this country to show his English confrères how best to receive American short-wave signals, systematic amateur transatlantic tests were made in December, 1923, on a wavelength of 200 m. In discussing the results with a representative of *The Times* Mr. Marconi said that

the tests undoubtedly reflected great credit on the experimenters and were extremely interesting. He did not, however, agree with the suggestion that they had proved that the existing high power wireless stations for long distance communication, using wavelengths up to 30,000 m., and power up to 350 kW, were needlessly large and expensive. Such a suggestion was likely to cause wrong impressions in the minds of the public. These tests were made at a time of the year, and at a time of the day when transatlantic signalling was least difficult. . . . During the rest of the year, and in the daytime generally, there would be no certainty of the reception of transatlantic and other long distance signals on such short wavelengths and low power. The commercial stations were established to maintain a rapid and reliable service under any atmospheric conditions, at any time during the twenty-four hours, and any time of the year. This called for installations such as were now in use. This was the considered view of the experts of America, France, and Germany, as well as of this country.

Well, we must wait and see. Meanwhile, let the surprised amateur receive the credit which is his due.—I am, etc.,
Cambridge. January 25th, 1926. L. B. TURNER.

MUSIC *without* MUFFLING



Single-wire Loud-speaker Extension Unit.

By N. P. VINCER-MINTER.

THE history of almost every person who has, in a moment of weakness, been induced by the blandishments of a misguided friend into joining the ever-growing army of wireless enthusiasts, follows more or less the same course. Having qualified for his (or her?) B.C.L. degree by purchasing or otherwise acquiring a wireless receiver, the victim settles down to the reception of the programmes which nightly fill the ether. Sooner or later (more often sooner) a feeling of restlessness makes itself felt, and no matter whether the receiver be a simple crystal set or a multivalve receiver complete with three passengers, one detector, and two L.F. valves, a desire manifests itself to make some addition to the receiver, this being the first symptom of a deadly disease finally leading to financial and moral bankruptcy, and the disintegration of the once happy home, this fell disease being classified in the American Medical Dictionary under the heading of *mordax cimicis lectularii radionis*.

One of the earliest desires which thus rears its ugly head, is to use the loud-speaker or telephones in some part of the house which is remote from the receiver, the remoter the better. Further good money is therefore expended in the purchase of a large number of yards of lighting "flex," and connections are duly made. Let it be said at once, that the nett result of this pioneer work is that the quality delivered by the loud-speaker is conspicuous by its absence, speech becoming "woolly" and muffled. The services of some "expert" friend are enlisted, and he, not wishing to display his ignorance of the real cause of the phenomenon, is prepared to seize on anything to save his reputation, like a drowning man clutching at a straw, and forthwith orders that a

power valve, price 22s. 6d., be obtained, and takes his departure. Once more, therefore, the children's money box is attacked, and the unfortunate novice, armed with 20s. and a burnt-out valve, hies him to the West End of London, and duly returns with a D.E.5, or some such valve, inserts it in the final stage, gets the same poor results, and decides to do what he should have done in the first place, namely, write to *The Wireless World* about it.

Remedies Considered.

Having written, therefore, and duly received his reply, he learns that the trouble is due to the excessive capacity between the two leads of the long extension wire, which has exactly the same effect in producing distortion as if a large condenser had been shunted across the loud-speaker terminals. One remedy, frequently advocated, is to obtain a 10 to 1 step-down transformer and a low-resistance loud-speaker. The trouble will then be eliminated, not because the actual capacity is eliminated, but because the effect of the capacity is approximately decimated. This is, however rather useless advice to the unfortunate wretch already possessing expensive high-resistance telephones and loud-speaker.

What then is the solution? In the opinion of the writer, who has experimented considerably on these lines, the first thing is to get rid of one of the wires by adopting the device which forms the subject matter of this article, and to use the earth as the return wire. A high impedance L.F. choke is connected permanently in the plate circuit of the output valve, and at the same time the telephones or loud-speaker are connected to the

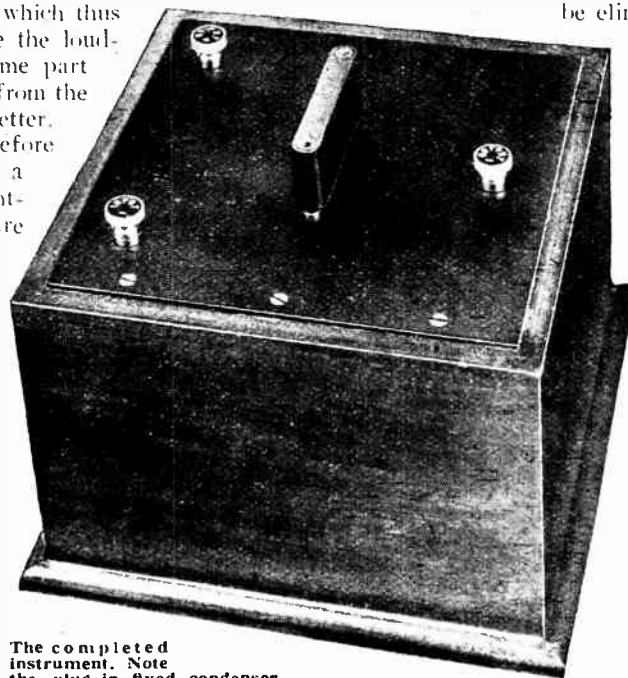

The completed instrument. Note the plug-in fixed condenser.

Music Without Muffling.—

plate of the valve through the intermediary of a large capacity fixed condenser, the far end of the telephones being merely connected to the actual earth, or to any earthed object such as a water pipe. The diagram of connections is self-explanatory, but those readers who prefer a theoretical diagram are referred to Fig. 2,

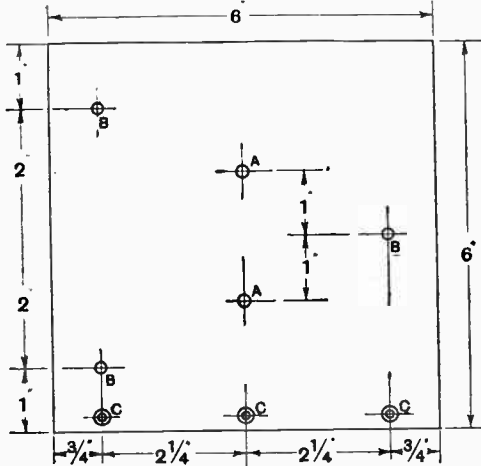
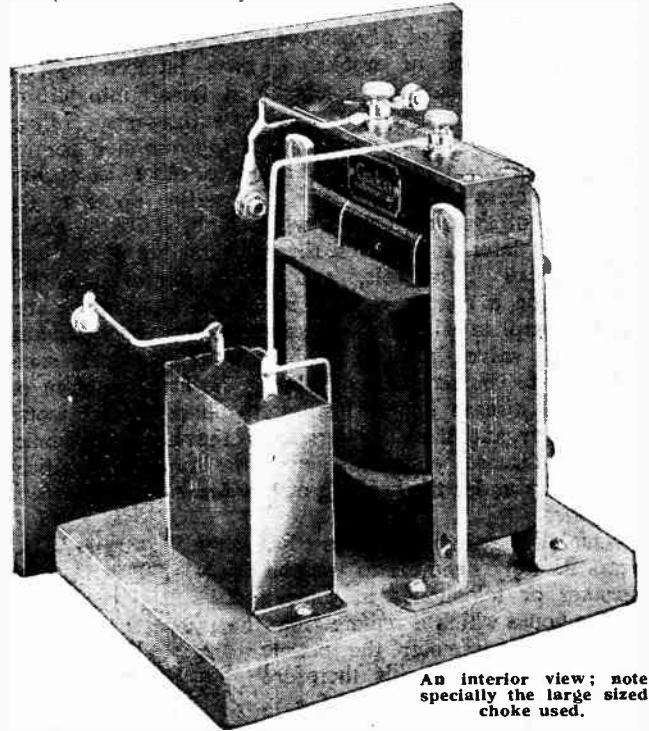

Fig. 1.—The panel layout. Drilling sizes are: A, 3/16in.; B, 5/32in.; C, 1/8in.; countersunk.

system. It will be noticed that in the title block of this article our tame artist, inspired no doubt by the approach of spring, has given full rein to his feelings and given us a picture of a large garden, presumably in Bethnal Green or Birmingham, showing the wire neatly suspended between two G.P.O. swan-neck "telegraph" insulators. It should be pointed out that two or more loud-speakers may be used on this continuous wire, and actually the writer used this method for operating a loud-speaker in the house of a friend over a distance of about 200 feet at the same time that a loud-speaker was operating in the same house as the receiver, and there was not the slightest trace of "muffling" or loss of volume associated with either of the loud-speakers.

With regard to the actual constructional details of the instrument there is very little that can be said: this being one of the very few wireless instruments in which



An interior view; note specially the large sized choke used.

page 953, of the December 30th, 1925, issue of this journal.

Practical Application of the Instrument.

Many may be deterred from adopting this scheme by the thought that a certain amount of volume will be lost. The writer can assure them from practical experience that provided a good choke of high impedance be used, it is impossible to detect any difference in volume between this method and the ordinary direct coupled method. Do not, however, economise on the choke, since it must not be forgotten that the system is also intended to be used for extension of telephones following a detector valve, which is in many cases of high impedance. With regard to the earthing of the far end, there is no special call for a good earth system, and the writer has obtained full volume by merely twisting the wire round

a brass water tap, by pushing the end of the wire into the lawn with a piece of wood, and by merely dropping the end into a bath full of water, whilst fair results were obtainable by merely dropping the end on a damp wood floor or holding it in the hand whilst standing on the aforementioned damp wood floor. If it is desired to use a loud-speaker at a very remote distance from the receiver, such as at the end of a garden, or in a neighbour's house, there is really no alternative to this

the home constructor can alter the layout and general design to his heart's desire without destroying its efficiency. The instrument as actually made by the writer cannot, by any stretch of the imagination, be described as "a thing of beauty and a joy for ever," and doubtless intending constructors can evolve a more artistic design. The small 0.001 mfd. condenser shunted across the choke should only be inserted when the instrument is used immediately following a detector valve.

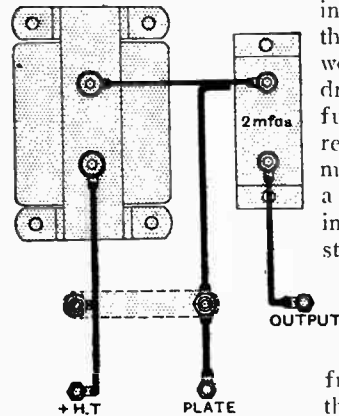

Fig. 2.—The wiring diagram. The 0.001 mfd. condenser across the choke is removable.

LIST OF COMPONENTS.

- 1 L.F. choke (Grafton Electric Co.).
- 1 2 mfd. fixed condenser (T.C.C.).
- 1 0.001 mfd. plug-in condenser (Peto Scott).
- 3 Indicating terminals (Belling Lee).
- 1 Ebonite panel, 6in. x 6in. x 1/4in.
- 1 Cabinet, 6in. x 6in. x 6in.

Approximate cost. 30/-.

PATENT INFRINGEMENT AND EXPERIMENTAL USE.¹

An Expression of Opinion.

By A PATENT AGENT.

LETTERS Patent for invention confer upon the patentee, *i.e.*, the owner whose name is for the time being entered on the Register of Patents, the sole and exclusive right to make, use, and sell under the patent. The patentee may share this monopoly with others in many ways. For example, he may grant licences to others to make, use, or sell or to do all these things. Again he may merely manufacture and sell and a straightforward sale without restrictions is an implied licence to use. The manufacture, sale, and use of a patented article, or process without the patentee's permission, however, constitutes infringement and is actionable at law. Manufacture of a single article for personal use undoubtedly constitutes infringement just as much as does manufacture in quantities for sale. It is a mistake therefore for manufacturers to imagine, as is too frequently the case, that if they buy a patented machine they are entitled to build and use replicas in their own factory. In a successful action for infringement the court grants the patentee an injunction to restrain the infringers from committing further infringement together, in the absence of peculiar circumstances, with damages. These damages are based not so much on the profit which the infringers have made but the damage which their action has done to the patentee.

Construction for Experimental Purposes.

To the foregoing there is, however, one notable exception. Use by way of *bona fide* experiment is no infringement. To quote Frost: "It is no actionable invasion of a patentee's rights for another person to use the invention, and thereby produce the finished product by way of *bona fide* experiment or amusement, without the intention of selling or making use of the thing so made for the purpose for which the patent was granted, but with the view merely of improving upon the invention the subject of the patent, or with the view of seeing whether an improvement can be made." The term "amusement" needs some qualification. One might build a wireless set for the enjoyment of building it, but assuming the set to be in accordance with an existing patent then the use of the set when once built for receiving broadcast programmes would unquestionably constitute infringement. The reasoning is simple. In building the set no damage or injury was done to the patentee, and the set, being built merely for the fun of building it, there was no intention of selling the set and therefore no intent to evade the patent. If the set is used, however, probably for amusement, the patentee's interests are injured. That is to say, he has the sole right to supply sets in accordance with his patent and would presumably have made a profit on the sale. To build a set in accordance with a patent and satisfy

oneself that it works does not constitute infringement, but it is the use after this satisfaction has been obtained that is an infringing action. If after the set has been made one experiments with it for the purpose of trying to improve upon it then again there is no infringement. The experiments may conceivably be quite exhaustive and extend over an appreciable period, and the behaviour of different apparatus may be tested in conjunction with the set provided that the experimental work has a direct bearing upon the set itself. To build a set in accordance with a patent, however, and then use the set for testing the qualities or properties of apparatus without relation to the set cannot be regarded as experimental use under this heading. As an example, the properties of loud-speakers might be tested with a set built in accordance with an existing patent. Assuming these tests could be carried out with practically any other type of set, then obviously there is no experimental use in so far as the set is concerned, and the use of the set for this purpose must be regarded as infringement.

Experimental Use—a Precedent.

Experimental use is a term which in common with many others is inclined to have somewhat different meanings applied, and a case, decided in 1885, is worthy of note. An English electrician purchased and imported certain articles made abroad in accordance with a British patent. In an action for infringement brought by the patentees the electrician defended his action on the grounds that the articles were bought for the purpose of experiment and examination by himself and his pupils. The articles were never sold or used for any other purpose, and it was submitted that the articles produced in this country under the patent were too costly to be used for taking to pieces. The Court, however, held that the use complained of was infringement, and an injunction was granted restraining the continuance of it.

Infringement by the User.

In another case, decided in 1889, a number of infringing machines were purchased on the understanding that if they were unsatisfactory or unsuccessful they were not to be paid for. These machines were installed by the purchasers in their factory and were used for a few months, after which use was discontinued. In a subsequent action for infringement the Vice-Chancellor of the Court of the County Palatine of Lancaster held that such use was not experimental and granted an injunction. The case was taken to appeal, when the injunction was dissolved, the ground being that even though infringement were proved the defenders were not manufacturers but only users, and the use complained of had not only been discontinued an appreciable time, but further, there was no evidence of further use or intention to continue in the act complained of.

¹ Reprinted from *Experimental Wireless*, Feb., 1926.

Patent Infringement and Experimental Use.—

Concerning the question of manufacture without sale, it is to be noted that this may constitute infringement. Two precedents are of interest. Firstly, if a retailer exposes for sale certain infringing articles but effects no sale, then there is no infringement. If the retailer was unaware at the time of purchasing the articles that they were infringing articles he would under no circumstances be liable provided no sale was effected, although innocence after sale is no excuse. To be a party to the manufacture, however, renders one liable, and in a case tried in 1860 infringement was held to have been committed when a defendant had manufactured articles and his traveller had offered them for sale, although none had been actually sold. A decision of the House of Lords

in 1900 should, however, be considered in connection with this latter case.

Concluding, it must, of course, be recognised that each case is one of fact and must be treated on its merits, but in the words of Jessel M.R., "patent rights were never granted to prevent persons of ingenuity exercising their talents in a fair way. But, if there be neither using nor vending of the invention for profit, the mere making for the purpose of experiment, and not for a fraudulent purpose, ought not to be considered within the meaning of the prohibition, and, if it were, it is certainly not the subject for an injunction."

[NOTE.—The Editor does not hold himself responsible for the views expressed above.]

Experiments with the Selenium Cell.

"The Control of Oscillatory Circuits by Light" formed the subject of a fascinating demonstration by Mr. G. G. Blake, M.I.E.E., before the Golders Green and Hendon Radio Society on January 20th. After describing the nature and function of the selenium cell, Mr. Blake performed a number of experiments with his apparatus.

An attractive syllabus is being prepared for this session, particulars of which will be gladly forwarded to interested persons by the hon. secretary, Lt.-Col. H. A. Scarlett, D.S.O., 357a, Finchley Road, N.W.3.

○○○○

Broadcast Programme Difficulties.

Before the Swansea Radio Society on January 11th, Mr. E. H. Jenkins ("Uncle Ernest" of the B.B.C.) gave a talk on "Broadcasting—A Public Service." Speaking on the difficulties in compiling acceptable programmes, Mr. Jenkins said that the only reliable way of ascertaining the wishes of listeners was by a careful study of correspondence. This was being done, and the results showed that of the letters received 90 per cent. were congratulatory, 5 per cent. embodied constructive criticism, and 5 per cent. were adverse.

The adverse criticism usually came from thoughtless folk who had no conception of the difficulty of catering for every taste. They forgot that a programme often took months to prepare and minutes to perform.

○○○○

Low Loss Coils.

Much useful information was gleaned by members of the Croydon Wireless Society on January 25th, when an informal talk took place with regard to the winding of low loss coils of 14 s.w.g. wire for the short wavelengths. The difficulty of working this gauge wire was recognised, but one member described a comparatively simple method of constructing a very efficient coil.

Various types of slow motion mechanism for variable condensers were also considered, particular interest being shown in a member's description of his method for making up a gearing of very high ratio. In this example twelve revolutions were necessary to complete the scale covered in one revolution by the ordinary

NEWS FROM THE CLUBS.

condenser. The arrangement of the condenser dial took the form of a clock face and pointers, the settings being accurately recorded in time measurements of hours and minutes.

Information regarding the Society will be given at any of the Monday evening meetings at 128, George Street, or by the hon. secretary, Mr. H. T. P. Gee, 51-52, Chancery Lane, W.C.2.

FORTHCOMING EVENTS.**WEDNESDAY, FEBRUARY 10th.**

Radio Society of Great Britain. Informal meeting. At 6 p.m. At the Institution of Electrical Engineers, Savoy Place, W.C.2. Talk by Mr. E. L. Wildy on "The Manufacture and Properties of Electrical Conductors."

Tottenham Wireless Society.—At 8 p.m. At 10, Bruce Grove. Lecture: "Aericon Apparatus," by Mr. Ford, of Messrs. R. A. Rothermel, Edinburgh and District Radio Society. At 117, George Street. Lecture: "The Function of Broadcasting," by Mr. G. L. Marshall.

Barnsley and District Wireless Association.—At 8 p.m. At 22, Market Street. Lantern Lecture: "The Ether," by Mr. J. Fletcher.

Muswell Hill and District Radio Society. At 8 p.m. At St. James's Schools, Fortis Green, N.10. Lantern Lecture: "Broadcasting, Past, Present and Future," by Mr. J. H. A. Whitehouse of the B.B.C.

FRIDAY, FEBRUARY 12th.

Sheffield and District Wireless Society.—At 7.30 p.m. At the Dept. of Applied Science, St. George's Square. Lecture by Mr. H. Lloyd, M.Eng.

Radio Experimental Society of Manchester.—At 7.30 p.m. At the Athenaeum, Princess Street. Lecture: "The Armstrong Super-Regenerative Receiver," by Mr. F. Charley.

MONDAY, FEBRUARY 15th.

Swansea Radio Society.—Lecture (with lantern illustrations): "Supersonic Heterodyne Reception," by Mr. Goss of the Iqonic Electric Co., Ltd.

WEDNESDAY, FEBRUARY 17th.

Royal Society of Arts.—At 8 p.m. At Headquarters, John Street, Adelphi London, W.C.2. Lecture: "The Propagation of Electric Waves," by Mr. J. E. Taylor, M.I.E.E. In the choir: "Admiral of the Fleet Sir Henry Jackson, K.C.B., F.R.S."

A Visit to 2LO.

On January 20th fifteen members of the Muswell Hill and District Radio Society paid an enjoyable visit to the London broadcasting station. The party was first conducted round the studios and the control room by Mr. Menzies, a B.B.C. engineer, who provided much interesting information. A trip was then made to Messrs. Selfridges, where the party was able to inspect the transmitting apparatus. Much amazement was shown at the strong directional effects obtainable with a frame aerial working a loud-speaker at full strength from a single valve set.

The Society has great pleasure in announcing that Capt. H. J. Round, M.C., M.I.E.E., has consented to become President.

Particulars of membership and a syllabus of lectures and demonstrations can be obtained from the hon. secretary, Mr. Gerald S. Sessions, 20, Grasmere Road, N.10.

○○○○

Loud-speaker Efficiency.

A striking array of British loud-speakers was on view at the headquarters of the Lewisham and Bellingham Radio Society on January 19th.

The feature of the evening was a test of the different loud-speakers operated behind a screen, the members voting on a 100 per cent. basis of efficiency. The result of the ballot was astonishing, in that the verdict given in a similar test held recently was completely reversed. It was also obvious that in certain individuals the sense of hearing is incapable of distinguishing tone differences and changes of volume in loud-speakers.

Hon. secretary: Mr. C. E. Tynan, 62, Ringstead Road, Catford, S.E.6.

○○○○

A "Superhet" at Oxford.

The Oxford University Radio Society held its first meeting this term on Wednesday, January 27th, when the treasurer, Mr. C. E. G. Bailey, of Balliol College, gave an instructive lecture on practical aspects of the Super Heterodyne, with which type of instrument he has had considerable experience.

The hon. secretary, Mr. Eric Cuddon, of Merton College, will be glad to hear from members of the University who would like to join.

'Polar-Twin' and 'Polar-Four' between them meet every need

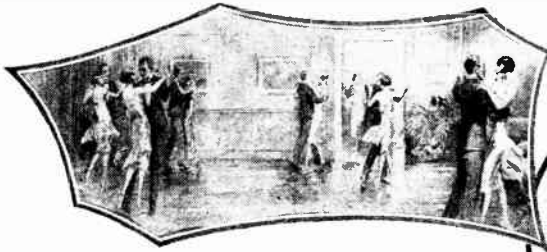

The Polar Remote Control Box.

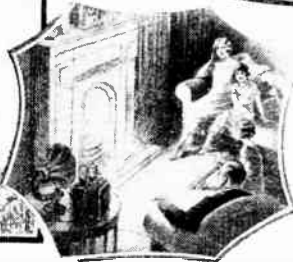
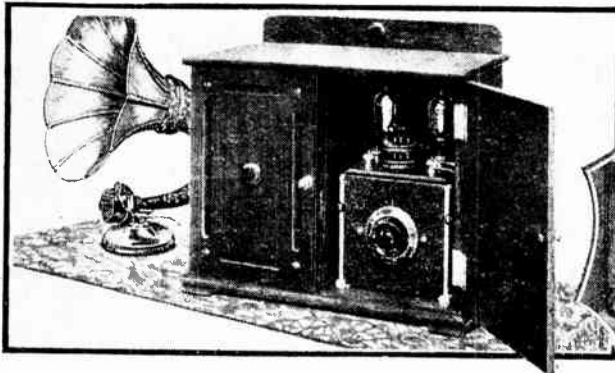

POLAR-TWIN achieves distinction by its remarkable simplicity and by its very moderate cost. It will give you surprisingly long Loud-Speaker range—the standard distance, within 60 miles of a Main Station or 120 miles of Daventry, often being exceeded.

One user has received Dance Music on the Loud-Speaker from a Station 400 miles away; Headphone reception of all B.B.C. and many Continental Stations is continually being reported by satisfied customers.

And with "Polar-Twin" this remarkable performance is under the control of a single knob, making it the ideal family Set. The Set alone costs 40-15-0 (Royalties paid); complete installation, as below, ready to connect to aerial

£12-12-0

Accessories include: 2 Mullard Polar D.3 valves; 2 66-v. H.T. Batteries, and plugs; 1 C.A.V. 2-v. Unspillable Accumulator, completely charged; 1 Short-wave Coil Unit; 1 Daventry ditto; 1 Amplion AR.35 Loud-Speaker, and necessary connecting wires.

Cabinet-de-Luxe, in highly finished Dark Oak, to house Set, Batteries and Accumulator, as illustrated

£1-7-6 extra.

POLAR-FOUR is the latest development in the design of high-class Radio Sets. This powerful 4-valve Set gives remarkable volume of pure music, totally free from distortion.

The circuit adopted consists of a duplicated tuning system, detector and three stages of L.F., inter-valve coupling being effected by means of standard "Polar" Resistance-Capacity Coupling Units. Once set, the dual tuner enables alternative programmes to be switched on at will, without any further adjustment being necessary, by a system of Remote Control.

Whenever a "Radio-de-Luxe" installation is required, "Polar-Four" fills the need. The "Polar-Four" may be placed inconspicuously in any part of the house, or out in the Garage. A number of Loud-Speakers may be operated simultaneously from a house-wiring system, with no more trouble than just plugging-in the Remote Control.

Price, without accessories, but with Remote Control and L.S. Jack, Coil Units for two Stations, and all necessary leads (Royalties paid)

£32-10-0

Polar Receiving Sets



We will gladly put you in touch with the nearest "Polar" Service Agent, who will freely demonstrate either the "Polar-Twin" or "Polar-Four." He will give any required assistance in installing and maintaining.

Sold by all reputable Radio Dealers.

There are other "Polar" Receiving Sets. Write to-day for booklets—sent gratis—giving full details of these outstanding achievements in Radio Set Design, and ask for name of your nearest Agent.

Radio Communication Co. Ltd.
34-35, Norfolk Street, Strand, W.C.2.

Wireless Operators still Wanted. There are now vacancies on our Sea-going Staff for Junior Wireless Operators, trained on our apparatus. Youths of good education, preferably between 17 and 25 years of age, wishing to enter the Wireless Profession, should communicate with the Managing Director, London Radio College, 82-83, High Street, Brentford, Middlesex, who will be pleased to furnish particulars of the training course necessary to qualify for our Service.



THE CHOICE OF RADIO EXPERTS



In case of difficulty remit direct—we pay postage.

AMERICAN EXPERIENCE

In case of difficulty remit direct—we pay postage.

The American Ether is much more congested than that of Great Britain, and for successful reception in U.S.A. wireless components must be ultra-efficient and selective. The products listed below are made by the leading Radio Company of America and cannot be surpassed.

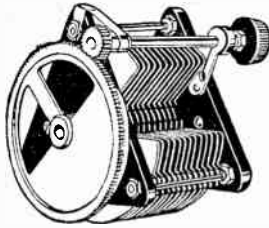

LOW LOSS VARIABLE CONDENSER.

With Vernier Gear.

Designed to separate stations only a few metres apart. No metal spacers are employed. Inter-spacing secured by grouping rotor and stator plates in special jig and soldering them while in alignment. This means minimum resistance, more rigid assembly, perfect alignment. Plate resistance and capacity always constant. Drilling Template supplied.

PRICES:

0005 Micro-Parad	27/6	each.
00035 "	25/6	"
00025 "	24/6	"

Type 247H.



TYPE 368. MICRO-CONDENSER.

Low Loss.

A splendid small condenser that enjoys the same soldered interspacing method as employed on Type 247H. One Hole Fixing. 00012 Micro-Parad Max. (minimum not measurable). PRICE 7/6 Each

Type 231A.

L.F. TRANSFORMER

A superior transformer that gives maximum amplification with splendid tone quality. No resonance point within the audio range. Ratio 3:1 to 1. Suits all stages of amplification. Shell type closed core of high grade silicon steel. PRICE 18/6

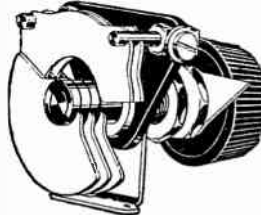

Type 247W. WAVE-METER and FILTER.

Increased selectivity and less interference are the results of fitting this component. The filter coil can be connected in Series or Parallel with the receiving set. In Series a single interfering station can be cut out. In Parallel several stations can be cut out simultaneously and only one station within the filter range accepted. The range of the filter is 200 to 600 metres. PRICE 57/6

When longer or shorter wave lengths are required the following extension coils can be interchanged:—

EXTENSION COILS.	
Type 247-W3 (400-1200 metres)	PRICE 12/6
" 247-W1 (190-300 ")	" 12/6
" 247-W2 (50-150 ")	Each.

Sole Concessionaires for Great Britain:—

SEND FOR FREE BOOKLET "The Truth about Variable Condensers."

Radio Specialist.

CLAUDE LYONS
76, Old Hall St., LIVERPOOL

Established 1918.

SEND FOR FREE BOOKLET "Stop Interference."

'Phone: Central 4641.

'Grams: "Minnetkem" L'pool.

GENERAL RADIO CO. OF AMERICA

OUR FREE OFFER

TEN DAYS ONLY

To introduce our New

"VARIODENSER"

We will send to all purchasers of this article during the next ten days a Halladay VERNIER DIAL free upon receipt of Coupon included with the order.

The "Variodenser" will, in ten seconds, give you any one of 65 values of fixed condenser simply by depressing one or more of the six knobs shown. 65 condensers at 2/6 each would cost you £8 2 6. We offer you the equivalent for

32/6

POST FREE

This instrument has been thoroughly tested by Birmingham Research Laboratories and also by some of the largest firms in the country; copies of report sent on request.

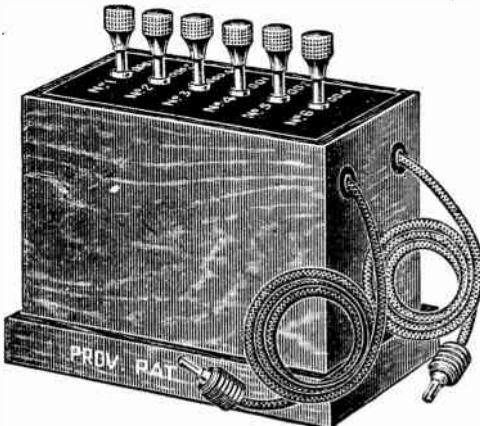

Send for the only Condenser of its kind and utility NOW.

HALLADAY'S LTD.
(RADIO SUPPLIES DEPT.),
TAME ROAD WORKS, WITTON,
BIRMINGHAM

VERNIER DIAL

PRICE 4/6

EACH
Postage & Packing 6d. extra.

FOR SUPER PRECISION TUNING WITHOUT HAND CAPACITY.

In vernier position quite a considerable movement of the handle produces such a minute rotation of the Dial that it would be difficult to see that any had actually taken place, unless the vernier scale was provided. Coarse tuning is about six times finer than direct tuning, and yet when necessary the time occupied in covering the whole 180° is only slightly longer. Will fit any standard condenser; please specify whether plain or screwed spindle. To be obtained from the actual manufacturers.



No. NAME _____
ADDRESS _____

PIONEERS OF WIRELESS.

By ELLISON HAWKS, F.R.A.S.

6.—William Sturgeon.

AN announcement of great importance to electricity in general and wireless in particular was made in 1825. This was the discovery by Sturgeon of the electro-magnet, an appliance that is the basis of nearly all the technical applications of electricity. The electro-magnet is also of the greatest service to the physicist, and many of Faraday's brilliant discoveries were made by its aid.

William Sturgeon was born on May 22nd, 1783, at Whittington, near Kirkby Lonsdale, Lancashire. His father, John, an ingenious but idle shoemaker, who neglected his family to poach fish and rear gamecocks, came from Dumfries. In 1796 he married Betsy Adcock, daughter of a small shopkeeper at Whittington.

Military Service.

William had little or no education, and was apprenticed to a cobbler at Old Hutton, where he was starved and ill-used. As he saw no hope of advancing in his trade he enlisted (in 1802) in the Westmorland militia. Two years later, at the age of 21, he enlisted as a private in the Royal Artillery, with the 2nd Battalion of which he served 20 years. He went out with them to Newfoundland, and a terrific thunderstorm caused him to turn his attention to natural science, particularly electricity and magnetism.

In order that he might understand what had been written on the subject he educated himself in barracks, and, with the help of a friendly sergeant who lent him books, studied mathematics, Latin, and Greek. When he returned to Woolwich his models and electrical apparatus attracted some considerable attention, and we are told that the cadets of the Royal Military Academy "used to swarm on the barrack field to get shocks from his exploring kites."

Sturgeon left the army on October 1st, 1820, when 37 years of age, his commanding officer testifying that his conduct had been "altogether unimpeachable." Curiously enough, in spite of his intelligence he never rose above the rank of gunner. On discharge, as his pension was only 1s. per day, he resumed his old trade of shoemaker, and during his spare time constructed scientific apparatus and lectured to schools. He produced, in a modified form, Ampère's rotating cylinders, which he described in the *Philosophical Magazine* for 1823, and in 1824

he contributed to the same journal four able papers on thermo-electricity. Through the influence of several scientific men, with whom his work had brought him into contact, he was appointed lecturer in natural science and philosophy at the East India Company's Royal Military College.

In November, 1823, Sturgeon noticed that when a core of soft iron was placed within an electrical coil, the iron immediately became a strong magnet, and that the instant the current was broken the magnetism disappeared. In May 1825, he presented to the Society of Arts his improved apparatus for electro-magnetic experiments, including his first soft iron electric-magnet, but unfortunately these early historic relics have since disappeared.

Sturgeon's original electro-magnet consisted of an iron bar, half an inch in diameter and a foot in length. This was bent in the form of a horse-shoe and coated with an insulating varnish. Eighteen turns of bare copper wire, each separated from the other, encircled the iron bar and were connected to a voltaic battery with an area of 130 sq. in.¹ Although this crude electro-magnet weighed only 7 ozs. it was capable of supporting a weight of 9 lb.—quite a remarkable performance in those early days.

Sturgeon was awarded the Society's silver medal and a premium of 30 guineas on his agreeing not to patent the electro-magnet.

Sturgeon's Numerous Contributions to Science.

In recent years Sturgeon's work has often been overlooked, credit for the discovery of the electro-magnet generally being claimed for Joseph Henry, in America. In this connection it is interesting to find that J. P. Joule said that to Sturgeon "is undoubtedly due the credit of being the original discoverer, he having constructed electric-magnets in soft iron, both in the straight and horse-shoe shape as early as 1823." What Henry did was to greatly improve Sturgeon's primitive device, and, as we shall shortly learn, it was chiefly his researches, and the remarkable discoveries resulting therefrom, that placed the science of electro-magnetism on a sound basis.

In 1826 Sturgeon experimented with the firing of gunpowder by electric discharges, and in 1830 he made the important discovery of the now well-known process of

¹ *Society of Arts Transactions*, 1825, Vol. XLIII., pp. 38-52.



William Sturgeon.

Pioneers of Wireless.—

amalgamating the zinc plate of a voltaic cell with a film of mercury, thus effecting a considerable economy in zinc waste when the cell was not in use. Shortly after this he experimented with the phenomenon of the magnetism of rotation, discovered by Arago, and came to the conclusion that the results were due to a disturbance of the "electric fluid" by magnetic action—a kind of reaction to that taking place in electro-magnetism. The actual cause of the phenomenon was brilliantly explained by Michael Faraday in 1831 in his researches on electro-magnetic induction. In 1832 Sturgeon constructed an "electro-magnetic rotary engine," which Joule assures us was the first contrivance by means of which any considerable mechanical force was developed by the electric current.

In the same year an exhibition of models and inventions was held at the Adelaide Gallery,² in the Strand, and Sturgeon was appointed to the lecturing staff, but the appointment was only of short duration, for the Galleries did not achieve any degree of popularity and were closed. In 1836 he established a new monthly publication, *The Annals of Electricity*, the first journal to be solely devoted to the subject. This continued until 1843, and it is interesting to note that it was to this publication that James Prescott Joule, the Manchester brewer,

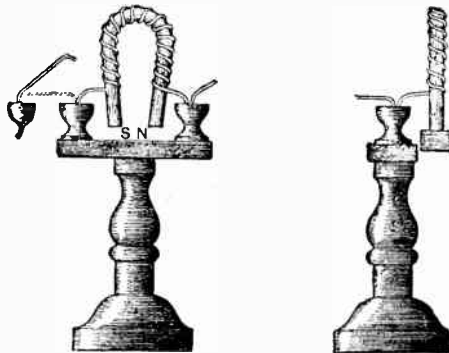

Sturgeon's original horseshoe electro-magnet.

contributed the results of his own researches in electro-magnetism. In passing it may be mentioned that Joule succeeded in making an electro-magnet, of which the core was an iron tube, weighing only 15 lb., but capable of supporting nearly 1 ton!

In 1837 Sturgeon invented his electro-magnetic coil machine for giving shocks. About this time, too, he discovered an effective means of preventing the frequent fracture of Leyden jars by heavy electric discharges.

Efforts to Stimulate Public Interest in Science.

In 1840, at the age of 57, he went to Manchester to act as superintendent of the Royal Victoria Gallery of Practical Science. This was an institution intended to increase popular interest in science and was a pioneer of the present day technical schools. But, as was the case of the Adelaide Gallery and the Royal Polytechnic in London, the movement was in advance of its time,

² The site of this building is now occupied by Gatti's Restaurant.

and after four years the gallery was closed. Sturgeon then lectured in the towns around Manchester, carrying his apparatus about in a cart. In this manner, although he added to his reputation, he only managed to eke out a bare livelihood.

The last five years of Sturgeon's life were spent in great penury and he keenly felt the pinch of poverty. Influential friends, including the Bishop of Manchester, succeeded in obtaining for him a grant of £200 from the Civil List, and (in 1849) a pension of £50 per annum. In 1847 his health compelled him to remove for a time to Kirkby Lonsdale, where he continued his observations on atmospheric electricity. He later returned to Manchester, however, and died at Prestwich on December 4th, 1850. He was buried in the churchyard there.

and a marble tablet was subsequently erected to his memory in Kirkby Lonsdale Church.



Bar-type magnet used by Sturgeon.

Personal Characteristics.

Sturgeon is described as having been a tall, well-built man, with a high forehead and strongly marked features. He had an animated manner and a lucid and vigorous literary style. Jacobi, of St. Petersburg, has claimed him as co-discoverer with Oersted of the principle of the electro-magnetic engine. Certainly Sturgeon was the first constructor of this apparatus, and there seems to be no doubt that he clearly perceived the possibilities of the electro-magnet as a source of mechanical power.

Sturgeon was the first to discover and perfect an apparatus for what was then termed "throwing opposing currents in one direction"—a contrivance now known as the commutator. He foresaw the possibilities of electric light, and at one of his lectures (in 1849) exhibited an electric light, the current for which was obtained from a 100-cell galvanic battery. "I quite anticipate," he said, "that the electric light will supersede gas for public, whatever it may do for private, purposes."

Sturgeon was constantly endeavouring to simplify and cheapen his apparatus so that his discoveries might be more readily available for practical purposes. It is interesting to learn that in his day a Grove's battery cost £7 and a Daniel cell £6, both of which Sturgeon superseded with his own battery, costing £3 10s.

EXPERIMENTS FROM RADIO-BERNE.

FROM January 31st to February 6th some interesting test transmissions were carried out from Radio-Berne using a wavelength of 434 metres, instead of the usual 315 metres, with the object of determining whether better results could be achieved by such a change.

Readers who may have heard and compared the transmissions on these two wavelengths are kindly requested to communicate with "Radio-Berne," Kursaal, Schänzli, Berne, Switzerland. Acknowledgment will be made by Q.S.L. card in every case.



A Section Devoted to the Practical Assistance of the Beginner.

INTERCONNECTED UNITS.

Some of our readers have learnt, to their cost, that care must be exercised when adding an amplifier unit to an existing receiver, the two instruments being supplied by the same set of batteries. Unless the connection between the negative side of the high-tension battery and the accumulator or dry cells feeding the filaments corresponds in both cases, the low-tension battery will be short-circuited. The reason for this will be made clear by consideration of

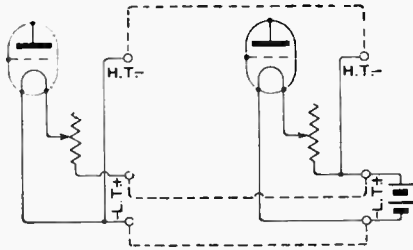

Fig. 1.—Interconnected units, showing the danger of short-circuiting the L.T. battery.

Fig. 1, where the -H.T. is connected to +L.T. in one case, and to -L.T. in the other. When the interconnecting leads, shown in dotted lines, are joined up, a short-circuit will occur.

This difficulty may be overcome by either re-arranging the wiring of one of the units, or else by omitting the connection between the two -H.T. terminals, as will be possible in many instances.

o o o o

CAPACITY CONTROLLED REACTION.

A certain amount of care should be exercised in the choice of a variable condenser for use as a reaction control in modifications of the so-called "Reinartz" or "Weagant" circuits. The first point which should receive attention is the insulation

between the fixed and moving vanes, and there should also be no risk of a possible short-circuit, due to bent or distorted plates. A consideration of the circuit diagram will show that, if this occurs, the high-tension battery will be short-circuited.

A reasonably low minimum capacity is desirable, otherwise, if the reaction coil is excessively large, it may be impossible to prevent oscillation.

o o o o

RANGE.

It is almost impossible to give an adequate answer to the often-asked question as to what range should be obtainable from a given type of receiver. The matter is so entirely dependent on the conditions under which it is to be used, and there are so many factors to be taken into consideration. Conditions are conceivable under which a good eight-valve superheterodyne would be inferior to a simple detector valve with a stage of low-frequency amplification, the latter being used in the most favourable possible manner, and the former, perhaps, in a steel-framed building.

The skill of the operator, efficiency of the aerial, quality of the components, freedom from misplaced high-resistance connections and leakages, the presence of strong interference, screening and absorption by neighbouring buildings and other objects, will all have a bearing on the range obtainable. Those living in large towns are, as a rule, distinctly handicapped, and it may be said that, to a very great extent, "situation is more than set." Receiving conditions also vary from day to day; in spite of the use of directional reception, the most elaborate balancing and filtering devices, and a carefully chosen site for the

receiving station, commercial long-distance communication is sometimes interrupted by atmospherics, so the amateur, however great his knowledge and experience, or however long his purse, must not expect *always* to be able to receive the more distant transmissions.

Sufficient emphasis is seldom laid on the difference between night-time and day-time reception. Many constructors of well-made receivers of efficient design would be offended if told that their fairly consistent reception of a station such as Rome, over 900 miles distant, was a freak; yet it would almost certainly be true. Night reception of any station not normally receivable in daylight is, in the language of the professional wireless man, freak reception, and, though perhaps fairly consistent, signals will be subject to periodic fading at times. Incidentally, experiments involving comparisons of sensitivity should always be carried out in the day-time, otherwise quite misleading results may be obtained, as the signal under observation may have changed in intensity during the time occupied in carrying out an experimental alteration in either circuit or components, even if this has only taken a few moments.

In the same way, statements as to ranges obtained with any receiver should specifically state whether the tests were made under day or night conditions; if the latter, the statement will be almost valueless, as American broadcasting stations have often been received on a single-valve set at night, but, as far as is known, have never been heard when daylight conditions prevail over the whole path of the signals, even on the most elaborate superheterodyne. These latter remarks, of course, apply to the normal broadcasting waveband, and

not to the ultra-short wavelengths. Apart from adding to the number of H.F. amplifying stages, there is probably nothing which gives such an

increase in respect of range obtainable as does improvement to the aerial-earth system. Very occasionally, it is admitted, an increase in

height may give only a disappointingly small improvement, but in the vast majority of cases such an alteration will be found well worth while.

DISSECTED DIAGRAMS.

No. 17.—A Neutralised H.F. Amplifier with Crystal Detector and Reflexed L.F. Amplification.

For the benefit of readers who find difficulty in reading circuit diagrams, we are giving weekly a series of sketches showing how the complete circuits of typical receivers are built up step by step. The receiver shown below is sensitive, selective, and economical, but like all sets containing two stages of H.F. amplification calls for a certain amount of care in layout and wiring-up.

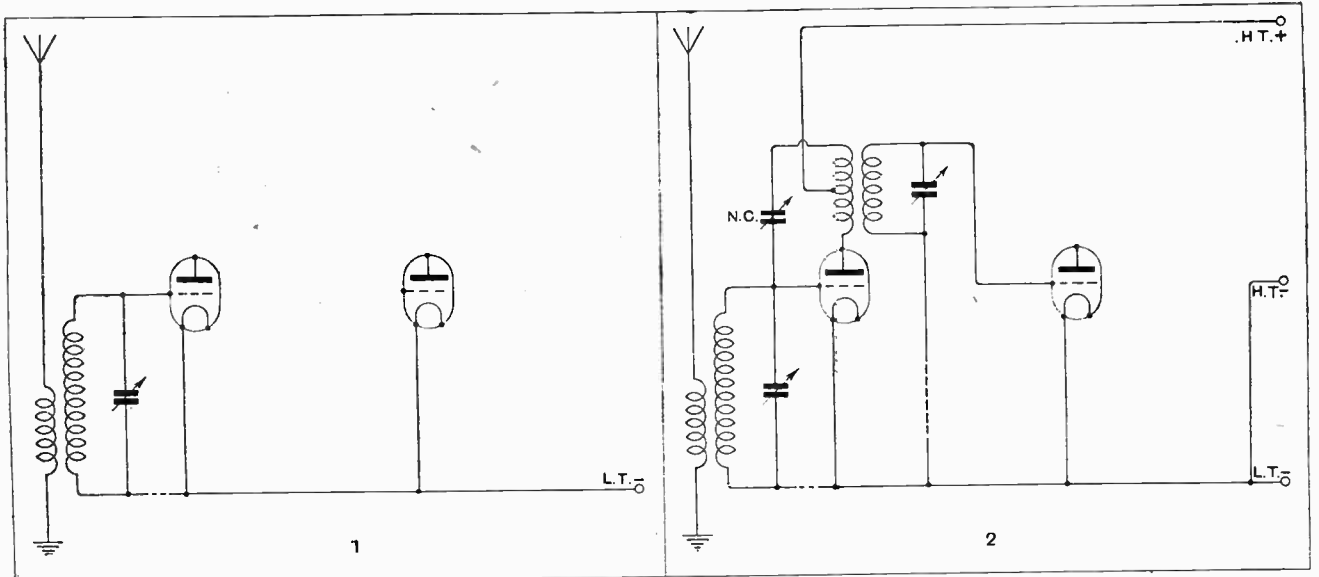

Two valves, the grid circuit of the first being connected across the tuned secondary of a conventional coupler, of which the aerial circuit is not separately tuned. For the sake of simplicity, the filament circuits are not completed.

Amplified high-frequency currents in the anode circuit of the first valve are passed on to the grid of the next through a "neutrodyne" transformer with a tuned secondary winding. The anode circuit is completed through the H.T. battery.

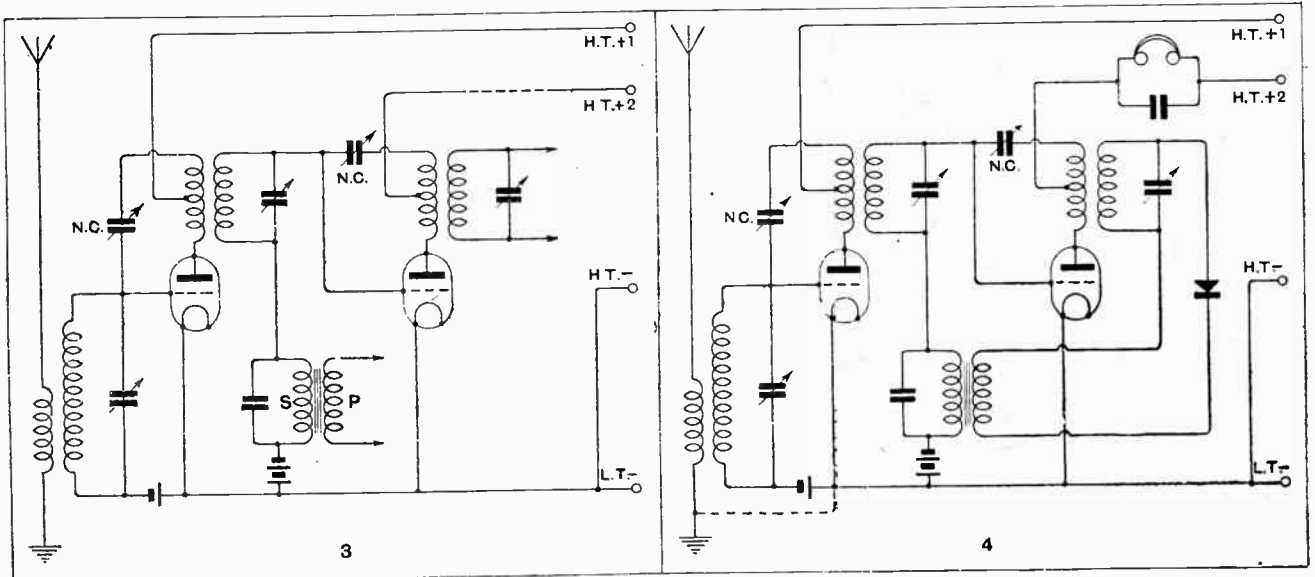

A small grid bias battery (optional, but recommended) is inserted in the first grid circuit, and the secondary of an L.F. transformer, and another bias battery in that of the second. The primary of a neutralised transformer is connected in the anode circuit of this valve—

—the amplified output being rectified by a crystal and passed back to the grid circuit through the L.F. transformer. The rectified pulses are again amplified and operate the phones in the anode circuit. Damping due to the crystal may be reduced by connecting it across only a part of the transformer secondary.

REGULATING THE HT POTENTIAL

A Plate Current Meter and its Uses.

By F. H. HAYNES.

ALTHOUGH much has been said concerning the operation of the various valves in a receiving set, steps are rarely taken to ensure that the valves are correctly run and adjusted to operate within their normal working limits.

Purpose of a Plate Circuit Milliammeter.

A sensitive moving coil milliammeter connected in the lead from the high-tension battery will show, in the case of a high-frequency amplifying valve, whether the grid and plate potentials are correctly adjusted, and will indicate whether the circuit has any tendency to oscillate before any audible sign of oscillation is apparent. Connected in the lead to the detector valve, the battery voltage can be regulated, and the meter here again serves as a sensitive indicator of oscillation. In the case of a low-frequency amplifying valve the reading shown by the meter reveals whether the correct adjustments of grid bias and plate voltage are applied by reference to the anode current grid voltage characteristic.

The fitting of a milliammeter permanently in any part of the circuit of a multi-valve receiver is rarely undertaken owing to the comparative high price of a sensitive moving coil instrument, but, by incorporating with it a switch so that it can be transferred to the plate circuit of any of the valves, its utility will be extended, making the initial cost less prohibitive. The object is, therefore, to set up a switching system so that the meter can be interposed in any of the high-tension battery leads, and the design shown here, in which the meter and its switch are combined as a separate unit, is, perhaps, the most convenient, as it can be used in conjunction with any set.

The Switching Circuit.

The circuit changes to transfer the meter are not as simple as at first thought. The leads to the meter's two terminals must in turn both be separated from all except one of the high-tension battery leads, whilst other leads which, for switching purposes, cannot have one pole common, need to be connected through to by-pass the plate current requisite to keep the receiver in normal operation while testing.

Three double-pole, two-position, change-over switches can be wired together to throw the meter into the plate

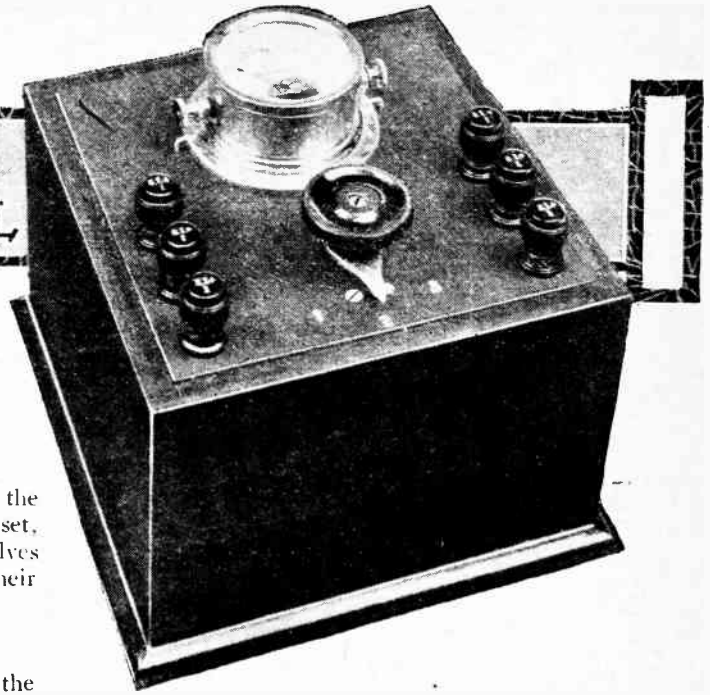

lead of any one valve, yet the necessary wiring up will occupy considerable space, the exposed brass levers are liable to be accidentally short-circuited, whilst if two of the switches are accidentally thrown simultaneously on to the meter terminals a section of the high-tension battery will be injured. A barrel switch has therefore been used to bring about the circuit changes, and the largest model available, which is fitted with five pairs of contacts, will show the current passed in any one of three leads and also provide an "off" position for the high-tension supply.

Constructional Details.

The construction is extremely simple. A cabinet is obtained with sufficient top area to accommodate a cheap model moving coil meter, the barrel switch and the three pairs of terminals. The drawing shows the drilling positions, the meter being secured by means of two 6 B.A. screws with back nuts. The fillets provided in the box are $\frac{3}{16}$ in. below the top, and thus a panel $\frac{1}{4}$ in. in thickness will be raised by $\frac{1}{16}$ in., a detail which adds to the finished appearance.

The wiring up is not difficult if followed systematically from the practical wiring diagram, using bare No. 16 tinned copper wire.

What the Meter Indicates.

The effects obtained by connecting the meter in the various valve circuits may be classified as follows:—

H.F. Amplifiers.—In the case of a single-stage amplifier employing a tuned anode or tuned transformer, it is customary to apply a negative bias to the grid of the H.F. valve. A slight fall in the value of the current passing will be observed when receiving a moderately strong signal, assuming that some system of stabilising is employed to prevent self-oscillation. If self-oscillation

A 10

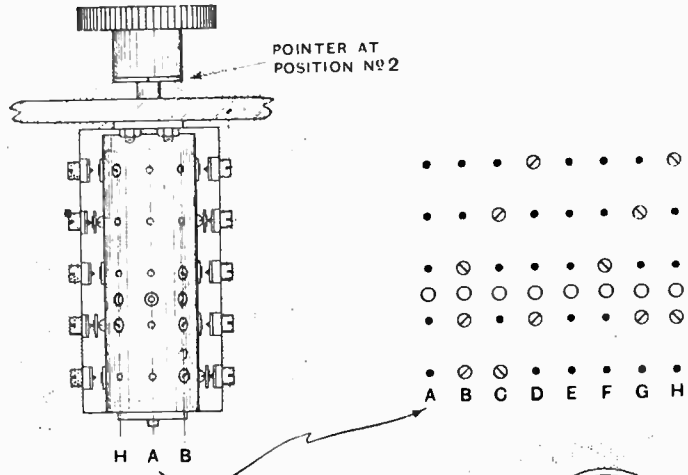
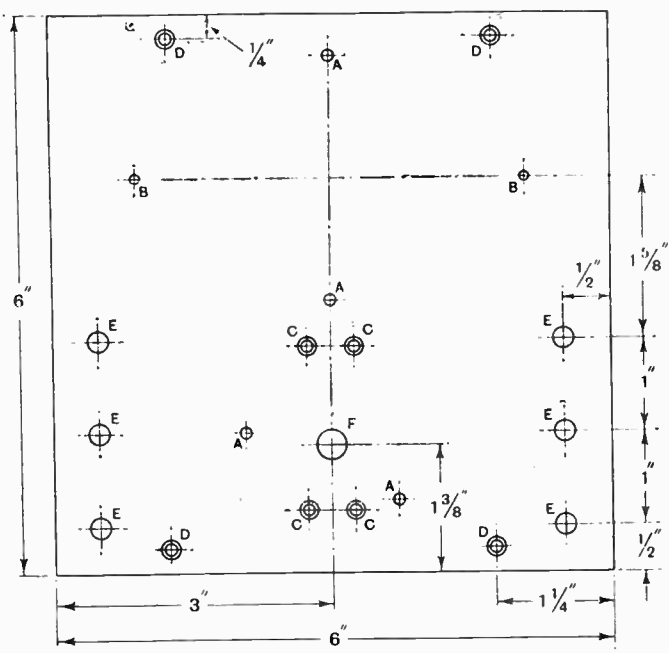

- PANEL DRILLING**
- A = 1/8" E = 7/32"
 - B = 3/32" F = 5/16"
 - C = 1/8" AND COUNTERSUNK FOR NO 6. B.A. SCREWS
 - D = 1/8" AND COUNTERSUNK FOR NO 4. WOOD SCREWS

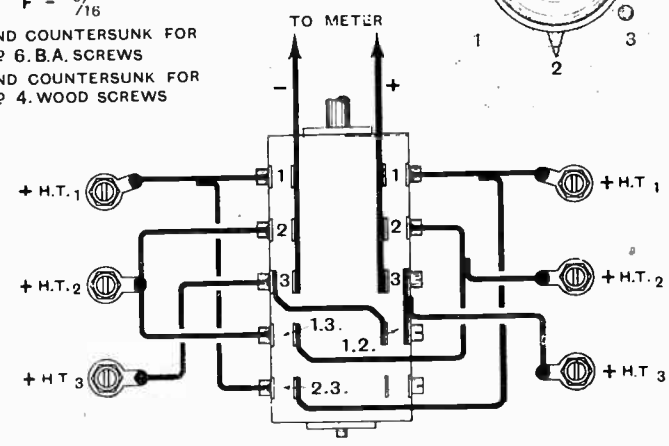
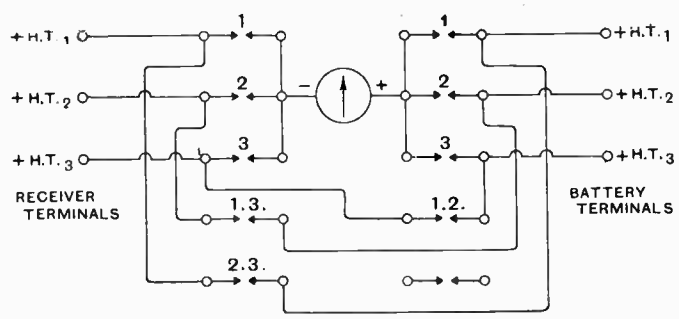
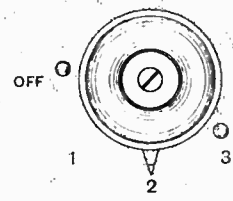

WORKING DRAWINGS. The panel (drawn to scale 2/3 full size) is made from 1/4in. matt surface ebonite. Holes are shown for stop pins to limit the movement of the knob. In the wiring diagrams, the contacts which are bridged across are given with the position numbers indicated by the pointer. To simplify the adjustment of the switch the rows of holes in the cylinder are shown side by side. Starting with the pointer at Position 2 the screws should be inserted in each row in turn by rotating the knob in a clockwise direction.

Regulating the H.T. Potential.—

occurs as the aerial and anode circuits come into step a slightly increased falling off in the plate current reading will result.

Sometimes an H.F. amplifier is stabilised by connecting the earth side of the tuned grid circuit to the L.T. positive instead of the L.T. negative terminal, a change which will considerably increase the value of the plate current. Should self-oscillation occur in this case the ammeter reading will rapidly diminish as the oscillating point is approached.

Detector Valve.—Employing grid condenser and leak to produce rectification, and with a positive potential applied to the grid either directly through the leak or by connecting the earth side of the tuned input circuit to the L.T. positive, the ammeter will indicate whether the circuit is oscillating long before the usual click or "breathing" sound is detected in the telephone receivers.

A typical general purpose valve used as a detector and employing a plate potential of about 30 to 40 volts will register, probably, from 4 to 6 milliamperes. As self-oscillation sets in the meter reading will fall off, and at the "silent point" probably only 1 milliampere will be recorded. Particularly is this the case if the tuned input circuit of the detector is a loose coupled oscillation transformer connected to a high-frequency valve stabilised by the neutrodyne arrangement. If the input H.F. amplifier is stabilised by grid current, or if the detector valve is coupled up directly to the aerial without being preceded by a high-frequency amplifier, the decrease in plate current when oscillation occurs will not be so great, yet nevertheless will be well marked and will give a deflection easily readable in the milliammeter.

H.F. Amplifiers.—The utility of the meter lies chiefly in its use as a means of indicating when a correct adjustment of grid and plate volts has been obtained by refer-

ence to the grid current—anode volts curves supplied by the valve makers. Taking the curve showing the applied anode volts, the grid bias should be regulated to conform with the plate current reading obtainable from the curve read off from a point some half-way down the straight part on the negative side of the grid volts scale. Signals produce a swinging of the pointer, and the effect of an excessive negative bias is evidenced by an increase in the mean reading when tuning to a strong signal.

How to Determine Voltage Amplification Factor.

A simple direct method for determining the amplification factor of a valve consists merely in increasing the plate potential and regulating the grid bias so that the plate current is restored to its original value. The relationship between the increase in applied battery potential and change in grid bias determines with sufficient accuracy for practical purposes the amplifying properties of the valve.

Thus, taking a practical example, a current of 6 milliamperes may be registered when the H.T. battery potential is 80 volts and the negative grid bias is 3 volts. On increasing the battery voltage to 100 the meter reading increases perhaps to 9, but a readjustment of the grid battery so that 7 volts negative is applied may be found to bring the reading back again to 6 milliamperes. The amplification is given by dividing the increase in plate potential by the change in the grid bias voltage, and in this case is

$$\frac{20}{4} \text{ or } 5.$$

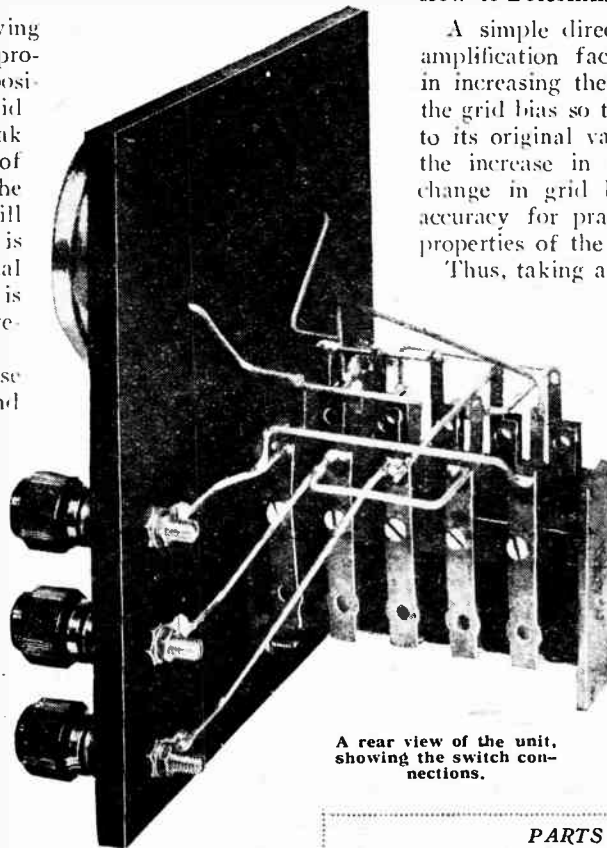

A rear view of the unit, showing the switch connections.

PARTS REQUIRED.

- Ebonite panel, 6in. x 6in. x 1/4in.
 - Polished box container, 6in. x 6in. x 1 1/4in. (Fleel Radio Stores, Fleel Street, London, E.C.).
 - Five-section barrel switch, with screw and nuts (Sterling Telephone & Elec. Co., Ltd.).
 - Milliammeter 0-10 mA. (Fonteyn Gilbert & Co., Ltd.).
 - 6 Terminals (Belling & Lee).
 - Small quantity of No. 16 S.W.G. tinned connecting wire.
 - 2 No. 6 B.A. x 1/2in. round headed screws with nuts.
 - 4 No. 4 x 3/4in. wood screws.
- The cost of these parts is £2 12s. 6d.

WIRELESS TELEPHONY AT SEA.

THE Great Western Railway Company announces the completion of some unusually interesting experiments in which wireless telephony communication has been successfully maintained between the company's Channel Islands steamer and a private station in Guernsey dispensing with both aerial and earth

Conversation was carried on with the s.s. *Reindeer*, en route from the Channel Islands to Weymouth, the inventor

of the system, Mr. D. B. S. Shannon, of Sutton Coldfield, operating the land station.

Using for test purposes an ordinary telephone instrument connected to a special portable transmitter, an operator on board could be heard speaking over a distance varying from 10 to 70 miles. The company's own operator was able to transmit two messages from the ship's wireless cabin simultaneously with the inventor's without causing interference.

WIRELESS IN A RAILWAY TUNNEL.

An Account of Superheterodyne Experiments in a Train.

A VERY interesting wireless experiment was carried out by members of the Great Western Railway (Bristol) Radio Society in conjunction with Burndept Wireless, Ltd., on Saturday, January 23rd. A suggestion was made to Mr. R. L. Armstrong, chairman of the society, by Mr. W. J. Haros, the secretary, that a powerful wireless receiver should be installed on a train and an attempt made to pick up broadcasting whilst passing through the Severn Tunnel. Eventually, Burndept Wireless supplied one of their Ethodyne receivers for this purpose, the set chosen being quite standard in every respect. Four corridor coaches were reserved; the coach in which the Ethodyne was installed, by the way, had been used some years previously by the G.W.R. for experiments in spark transmission from a moving train. Twenty low-resistance Ethovox loud-speakers were wired up in the various compartments of the train, in order that all present could listen in comfort.

Microphonic Noises Absent.

When it is stated that certain stations were received at "good loud-speaker strength," it should be remembered that not *one* but a *score* of loud-speakers were in use. With regard to the instrument, a seven-valve superheterodyne receiver employing two stages of power amplification, it is rather interesting to note that, although dull-emitter valves were in use, the movement of the train caused no microphonic noises. The valves were wobbling about all the time, and the Anti-Phonic valves holders in which they were supported certainly proved their efficiency in preventing trouble of this kind.

When the first test took place about two hundred persons—mostly members of the G.W.R. Radio Society—boarded the 2.35 Bristol-to-Cardiff train, to which the four special coaches had been coupled. At the commencement, gramophone music, broadcast by special arrangement with the Cardiff station, was received at excellent strength, and shortly after the departure a special message to the party on the train was read by the announcer. A little later, signals faded considerably as the carriage in which the set was working went under a small steel bridge. No fading effect, however, was observed as a large gasometer close to the line was passed. Patchway Tunnel, which is very damp, caused signals to fade completely, and the effect was just the same on the return journey at night.

Signals in the Tunnel.

On entering the Severn Tunnel, signals faded, but the carrier wave of the Cardiff station could be heard faintly. Half a mile from the Welsh end music was picked up at good strength immediately after the train had travelled clear of the waters of the Bristol Channel.

Manchester, Munster, and London were received on

the headphones, and shortly before the train entered Cardiff station the Bournemouth transmission was reproduced at good loud-speaker strength.

During their visit to Cardiff the members of the Radio Society visited the local broadcasting station, where a new studio is being built and the offices are being re-decorated. When the work is completed, the station will have a very bright appearance.

The return journey to Bristol, which commenced at 9.5 p.m., was very interesting indeed. Before the train left the station, and when corrugated iron roofs were shielding the set, Brussels was received at good loud-speaker strength. Cardiff was much stronger than before, and at 9.15 p.m. San Sebastian came through exceptionally well. In fact, of all the distant stations received, San Sebastian was by far the best for volume and purity.

Stations received at loud-speaker strength during the journey included Daventry (on six valves only), Radio-Paris, Dortmund, Berne, Hamburg, Bournemouth, Madrid, London (on six valves), Birmingham, Manchester, Radio Catalana (Barcelona), and Swansea. Other stations heard on the headphones were Koenig-wusterhausen, Vienna, Oslo, and Radio Toulouse.

Reception Under Water.

The results of the second test in the Severn Tunnel may best be judged by this extract from the log:—

9.55 p.m.—On entering the Severn Tunnel, full volume from Cardiff was maintained for fifty seconds.

9.56 p.m.—About three-quarters of a mile in the tunnel signals faded, and a few seconds later the carrier wave could not be heard. By this time the train was passing under water.

9.57 p.m.—Carrier wave heard again in the tunnel.

10.1 p.m.—Emerged from the tunnel and later discovered that there had been a short interval before the time-signal and weather forecast.

The Severn Tunnel, it may be added, is about four-and-a-half miles in length, has a maximum depth below the surface of about fifty feet, and at some points it is covered by between sixty and a hundred feet of water, according to the tides. The thickness of the tunnel casing is fifty bricks. To receive a wireless concert through such a mass of material is something which can be put on record as a distinct feat.

After the train arrived at Bristol the four special coaches were shunted into a shed built of steel and corrugated iron. With only one Ethovox in operation an attempt was made to receive an American station on the Ethodyne. Shortly after 11.30 p.m. KDKA, Pittsburg, was received at sufficient volume on the loud-speaker to enable it to be identified by all present in one saloon.

*"Just listen to the difference
this LEWCOS Coil makes!"*



*In the LEWCOS
Coil the makers
of "Glazite"
have achieved
another outstand-
ing success.*



CLEAR as a bell the typical French Orchestra came through as the listener tuned in with his LEWCOS coil. Coil after coil had been tried and discarded in an endeavour to realise that rare selectivity and sharpness of tuning so essential to complete radio enjoyment.

A LEWCOS Coil makes all the difference—try one and judge for yourself. Each LEWCOS Coil is tested in our laboratory. It is then boxed and sealed up, and reaches you in perfect condition. Ask your radio dealer for a demonstration.

Does your set need a

LEWCOS

Inductance Coil?

The LONDON ELECTRIC WIRE CO. & SMITHS LTD.
(Makers of Electric Wire for over 40 years),
Playhouse Yard, Golden Lane, London, E.C.1

Why

LEWCOS COILS

give better tuning

1. The LEWCOS Coil embodies high electrical efficiency with great mechanical strength.
2. The LEWCOS Coil is very selective, giving extremely sharp tuning.
3. The LEWCOS Coil has an exceptionally low high-frequency resistance, with a corresponding increase in signal strength.

**All LEWCOS Coils
bear this LEW seal**

*This
Mark*



*Guarantees
Quality*

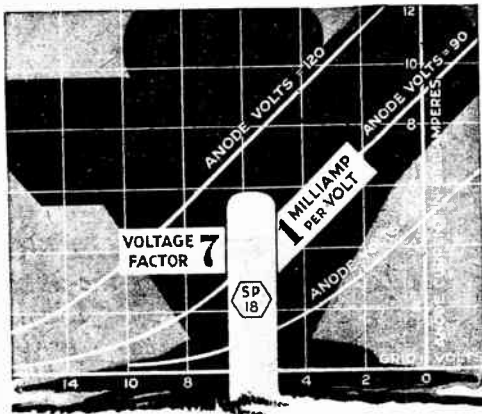

CLIMBING THE GRADIENT TO LOUD-SPEAKER LEVEL

AS the gradient board on the railway ascended by the train, so the characteristic curve of a valve shows its capability of raising the power of incoming signals of Loud-Speaker Level.

The "Cosmos" **SHORTPATH S.P.18 RED SPOT VALVE** has a very steep characteristic curve representing a plate current of 0.9 to 1 milliamp per volt.

In the inner circles of Wireless, the S.P.18 Valves have been known and sought after for some time. They are now available to the general public.

An entirely new principle of construction is applied in their manufacture, enabling the path which the electrons travel between the filament and the anode to be shortened to a minimum. The shortened gap gives greater amplification, greater output without distortion, and exceptionally good rectification.

The Red Spot valve is the only real power valve taking as low a filament current as 0.3 amp. It compares with other power valves requiring 3 cells instead of one and costing nearly twice as much.

The Green Spot valve designed primarily for H.F. Detector, or intermediate amplifying stages, gives twice the amplification of any similar valve on the market, takes less current, and is 10% cheaper.

All S.P.18 Valves work off a one cell accumulator and are priced at

12/6

METRO-VICK SUPPLIES LTD.

(Proprietors: Metropolitan-Vickers Electrical Co., Ltd.)

4, Central Bldgs., Westminster, London, S.W.

Cosmos
SP.18 **SHORTPATH VALVES**

PAY FOR THEMSELVES BY THE CURRENT THEY SAVE

R
D21

THE SIMPLEST LOUD SPEAKER SET IN THE WORLD

THE **GAMBRELL BABY GRAND** uses NO BATTERIES or ACCUMULATORS of any description. Draws all currents from ordinary D.C. Electric Light Mains.

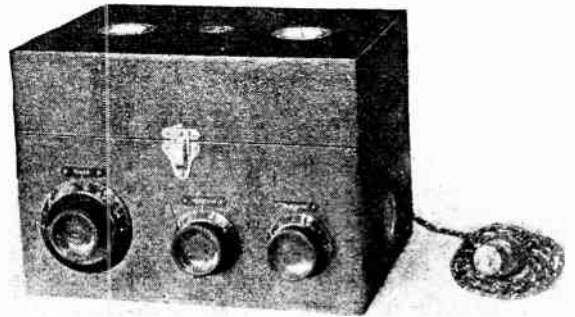

PRICE, including Valves, coils for 300/500 metres and Daventry, length of flex and adaptor and loud speaker leads, £15 15 0. Marconi Royalty £1 5 0.

GAMBRELL BROADCAST RECEIVERS

Extract from cable received from the Michael Terry Expedition which by means of Guy Tractor Cars is exploring the uncharted lands of the North Western Territory of Australia. Great use of their Gambrell Wireless Set has been made by keeping in touch with civilisation and checking their chronometers with Broadcast Time signals.

"Most excellent results obtained with your Wireless Set. Local authorities very impressed."

Prices range from £8 for a compact, highly-efficient 2-valve set to £32 10 0 for a super 4-valve cabinet set.

For full particulars write to:

GAMBRELL BROS. LTD.,

76, VICTORIA STREET, LONDON, S.W.1.

Telephone: Victoria 9938.

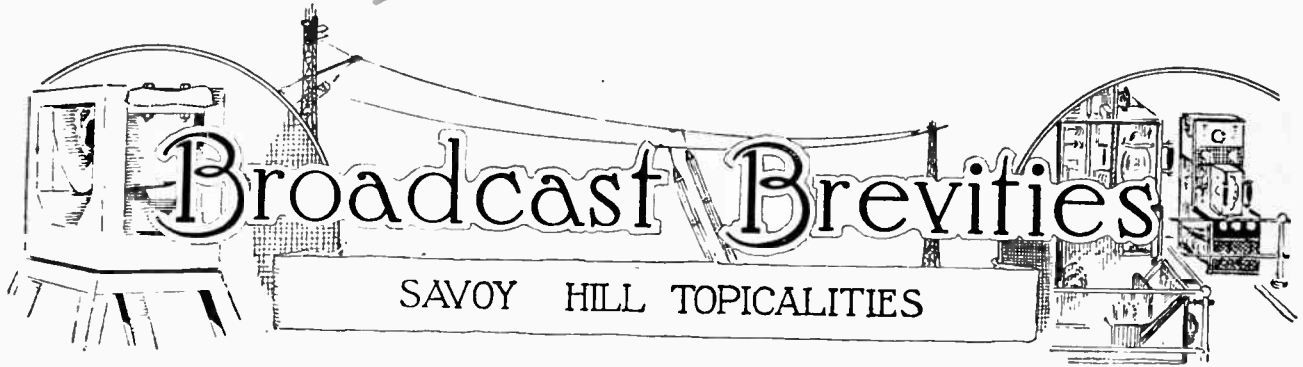

By Our Special Correspondent.

Sunday Mornings on the Continent.

A good deal of interest is taken in the Sunday morning transmissions of Continental stations, and British listeners find them particularly welcome, coming as they do when a very large number of people can follow them with minds temporarily freed from business worries.

○○○○

Concerts at 8 a.m.

Hamburg can usually be tuned in on 392.5 metres for an excellent concert at 8.15 a.m. and for another at 12.45 p.m.; between those times the station broadcasts lessons in Esperanto and German.

○○○○

What You Can Hear?

A Daventry coil will in most cases enable one to receive the Berlin (Voxhaus) concert transmission at 10.30 a.m. on 1,300 metres. Radio-Paris broadcasts a concert at 12.45 p.m. on 1,750 metres, consisting frequently of well-known British music, and Hilversum (Holland) transmits a service from one of the Dutch churches or from the Cathedral at Amsterdam round about 9.30 a.m. on 1,050 metres. A morning service is broadcast by Oslo on 382 metres at 10 a.m.; and Berne (315 metres), and Zurich (515 metres) both start their morning broadcasts at 10 a.m. with very good concerts.

○○○○

Sunday Morning Transmissions in England.

Listeners may be interested to learn that the question of Sunday morning transmissions in this country is under frequent consideration; but there would be no likelihood of any but church service transmissions taking place during the actual Hours of divine service. Several quite interesting broadcasts have been banned on Sunday mornings for the reason that they would have clashed with church hours.

○○○○

Something in Their Favour.

The fact that freshness of mind, a natural condition in the morning, plays an important part in the appreciation of good music has been indicated time and again by the letters received from listeners, who express the opinion that the 11 a.m. week-day transmissions from

Daventry contain much better material than the evening concerts. This, of course, is not really so; but it is, perhaps, a case for early Sunday morning concerts.

○○○○

A Parallel Case.

The feeling at Savoy Hill is, I gather, one of relief rather than dismay over the action of the Musicians' Union in refusing to allow their members in the Adelphi Theatre orchestra to play during that part of the evening in which the proposed broadcasting of an excerpt from "Betty in Mayfair" was to be carried out. These theatrical broadcasts have been taking place for some months past, and it is rather late in the day for this question to be raised: it should have been settled last June, when the B.B.C. was arranging matters amicably with the theatrical associations. A point that has to be borne in mind is that no extra work on the part of the players is involved, whether a microphone is in the footlights or not. A journalist working for a newspaper belonging to a corporation which owns journals in various parts of the country can appreciate the position. How often does he find that an

article which he has contributed to his particular paper is published simultaneously in several other papers!

○○○○

Broadcasting Charades.

Charades is so well-known as a popular feature of private entertainment that the game does not need any explanation here. In the wireless charades which have been specially written by Captain Frank H. Shaw, the radio dramatist, and to be broadcast on February 17th, listeners will have to depend solely on the spoken word—in this connection a real test of ingenuity. The solution of the charades will be given at the end of the programme. It is this sort of programme that will make listeners sigh for the speedy coming of the days of television.

○○○○

Tracking Down the Oscillator.

A few letters have reached me, suggesting that the B.B.C. gives too much publicity in cases of heterodyning and other interference, and I have seen it stated in a weekly paper that prospective buyers of receiving sets are deterred from purchasing, as they are led to believe that the prospects of unhampered reception are

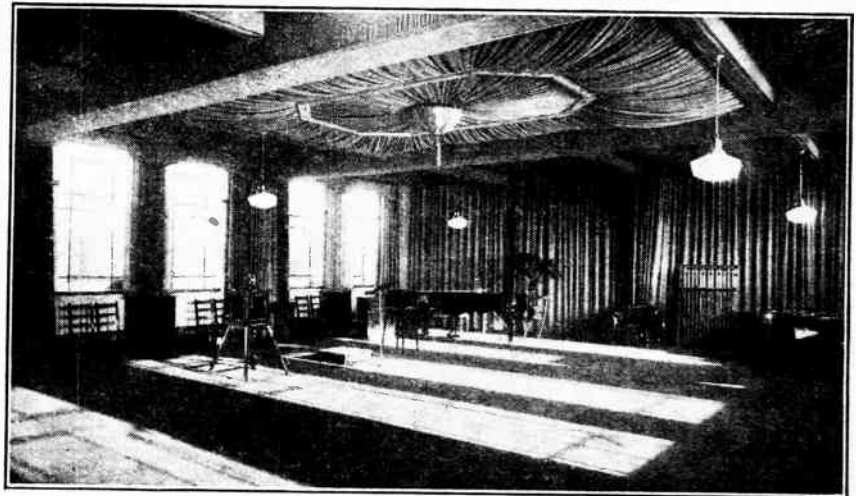

BRITAIN'S LARGEST BROADCASTING STUDIO.—This photograph gives a good idea of the unusual size of the new studio at the Birmingham station. The extensive draping, while serving a useful purpose, also enhances the artistic effect.

not at all rosy. The reason for such wide publicity is that by this means only can the nuisance be stopped and the conditions improved so that more sets can be sold.

o o o o

Value of Public Opinion.

It is not sufficient merely to say that as the authorities at the Post Office and the B.B.C. are cognisant of the trouble it can be dealt with quietly and without any fuss. Public opinion and co-operation count for a very great deal in such matters. When the B.B.C. announced that, in order to assist the investigation of the heterodyne position, all sets should be shut down on February 9th from 10.30 to 10.45, little useful purpose would have been served if listeners had not co-operated by maintaining the period of silence demanded, to enable Keston and the wireless engineers in other parts of the country to trace the Continental interference to its source. Several cases of persistent interference have recently been traced and stopped through the extensive publicity given by the Press, and it is all to the ultimate good of the listener that this policy should continue.

o o o o

"The Blue Kitten."

The broadcast of "The Blue Kitten," which was to be given on February 12th, has been postponed till April 23rd.

o o o o

A Somerset Night.

The Society of Somerset Folk will hold their annual dinner in London on February 15th, and part of the function will be broadcast from 2LO. Starting at 8.30, Mrs. French will give a dialect recitation, "Visiting London," by Dan'l Grainger; Lord St. Andries will propose the toast of "Somerset, our County"; Miss Helen Alston will sing "The Tune of Open Country"; Sir Robert Sanders, Bt., M.P., will propose the toast "Society of Somerset Folk," and Mr. Clay Thomas will sing "Up from Somerset."

o o o o

Prosecuting the Unlicensed.

At a recent "round-up" in a village in the Home Counties no fewer than twelve unlicensed listeners were discovered, including some of the most important people in the place. Prosecutions are to follow.

o o o o

International Radio Tests.

Here is an interesting summary of information compiled from reports received respecting the New Year transmissions between Great Britain and the United States: 26 out of the 48 States of America received our signals. None of these was west of a central line down America, with the exception of one report from California, on the extreme west coast. While no reports came from the mountainous States, a fair number were received from States which are separated from us by the Alleghany Mountains.

A 46

FUTURE FEATURES.

Sunday, February 14th.

LONDON.—3.30 p.m., Classical Favourites. 9.15 p.m., De Groot and the Piccadilly Orchestra.

BIRMINGHAM.—3.30 p.m., Hadyn Programme, including Overture in D and Symphony No. 19 in B, also excerpts from the "Creation," soloists, choir and orchestra.

BOURNEMOUTH.—3.30 p.m., The Elijah, Parts I. and II.

Monday, February 15th.

LONDON.—8 p.m., "Somerset," a programme of typical old Somersetshire. Songs and Dances. 9.30 p.m., Speech by H.R.H. the Prince of Wales.

DAVENTRY.—8 p.m., The Luton Red Cross Band.

ABERDEEN.—9 to 10 p.m., A Fantasia of Spring.

LIVERPOOL.—8 p.m., Light Symphony and an Hour in the Open Country. The Augmented Station Orchestra.

Tuesday, February 16th.

LONDON.—8.30 p.m., A. J. Alan—Telling a Story. 9.5 p.m., "Carmen," performed by The British National Opera Co.

CARDIFF.—8 p.m., An Hour's Comedy.

GLASGOW.—8 p.m., Folk Song Recital. 10.30 p.m., Dance Music by The Plaza Band.

Wednesday, February 17th.

LONDON.—9 p.m., Edward German Programme.

DAVENTRY.—11 to 12 p.m., Dance Music by the Savoy Orpheans, Havana and Tango Bands.

GLASGOW.—8 p.m., Symphony Concert.

Thursday, February 18th.

LONDON.—8 p.m., A Variety Programme. 8.45 p.m., The Halé Orchestra and Raoul Girard.

ABERDEEN.—8.55 p.m., Special Feature. "What is it?"

BIRMINGHAM.—7.30 p.m., Military Band Programme by The City of Birmingham Police Band.

NEWCASTLE.—6 p.m., An Early Evening Programme of Humour and Song.

Friday, February 19th.

LONDON.—8 p.m., The Hungarian String Quartet and Vivienne Chatterton (soprano).

DAVENTRY.—8 p.m., Programme from the Liverpool Station. Programme from the London Station. 12 p.m., Dance Music.

BELFAST.—8 p.m., Concert by Dublin Artists.

MANCHESTER.—8 p.m., Coleridge Taylor Programme.

Saturday, February 20th.

LONDON.—8 p.m., More Musical Comedy Memories. The Fifth Edition of "Winners."

ABERDEEN.—8 p.m., Scottish Hour.

5XX Heard 2,000 Miles Away on Crystal

On board ship, at 100 to 200 miles from Land's End, signals had not dropped in signal strength owing to heavy rolling; but the transmissions of 1½kW. American stations were found to fade and then come back to normal when rolling heavily, owing to the movement of the aerial. Crystal reception was obtained from 5XX when transmitting from England to the United States at 2,000 miles.

o o o o

American Stations Heard in England.

The power of KDKA, WGY, WBZ, and WLW during the experimental transmissions has been from 100 per cent. to 150 per cent. increased on all wavelengths. KDKA on 63.68 metres has been received with 100 per cent. more power off Land's End than on 309 metres. The two wavelengths were tested simultaneously.

o o o o

The New Broadcasting Scheme.

Appropos my recent remarks on the remoulding of the present system of transmitting stations, I understand that the Broadcasting Committee has been placed in possession of the scheme which the B.B.C. has drawn up for covering the country with stronger signals and with alternative programmes at such strength as to exceed the strength of extraneous interference. These transmissions, it is suggested, should be capable of reception on crystal sets, or at any rate on simple and cheap apparatus, so as to benefit the greatest number of listeners.

o o o o

Four High-Power Stations.

It is to be hoped that the matter will not be held up until a new broadcasting authority (if any) is constituted. A considerable part of the new scheme would be common to any other suggested; and the immediate construction of four high-power stations in different parts of the country is desirable. Delay till next year would be regrettable.

o o o o

Restrictions should be Removed.

Whatever form the new broadcasting authority may take, the B.B.C. feel that in the public interest no bureaucratic policies and restrictions should be introduced to hinder the development of the service. If the ban on controversy, which enables men to form opinions of their own, were removed, suitable safeguards for impartiality and the exclusion of certain subjects would be necessary; but as things are at present a highly important function of broadcasting is being retarded by the restrictions which were imposed in the early days and have never been removed.

o o o o

"Henry VIII." to be Broadcast.

The Cardinals Scene from "Henry VIII." will be relayed from the Empire Theatre, Leicester Square, to 2LO on February 26th at approximately 9.50 p.m. The Queen Katharine is Miss Sybil Thorndike; E. Lyall Swete takes the part of Cardinal Wolsey; H. R. Hignett that of Cardinal Campeius, envoy from the Pope; and Lewis Casson takes the part of Griffith.

Oscillation without Radiation.

Constructional Details of a Three-Valve Reflex Receiver.

By W. JAMES.

(Concluded from page 161 of the February 3rd issue.)

IN the first part of this article the main principles underlying the arrangement of the receiver were discussed, one reason for the inclusion of design notes in what is primarily a description of how to build and operate a successful three-valve reflex receiver being to show the close dependence of one component on another. We started by fixing the grid bias for the reflex valve, and then found a valve which would take this grid bias with a reasonable anode voltage. Having discovered the right type of valve, we found its differential¹ resistance and then designed couplings to suit it, compromising with selectivity and magnification to meet our requirements.

Thus there is an intimate relationship between the valves and the couplings, and those who ignore the exist-

¹ "Differential Resistance," a new term suggested as more appropriate than "anode impedance" by Prof. Howe in the February issue of *Experimental Wireless*.

ence of this close connection ask for trouble—and usually get it, at least, with properly designed receivers. Of course, if we are told by the designer of a set of this type that any valves will do, we are presumably at liberty to find the best combination ourselves; but then we should not be far wrong if we concluded that the designer himself was not sure of what he was doing.

The almost self-evident truths which we have been discussing can be concisely expressed as equations, thus:—

Right valves + right couplings = best possible results. and

± Right valves ∓ right couplings = indifferent results.

Wiring the Receiver.

Turning now to the wiring of the set, it was found advisable to divide the wiring diagram into two parts,

which are given in Figs. 8 and 9. In Fig. 8 the connections which appear on the upper surface of the ebonite sub-panel and the upper part of the front panel are shown, while Fig. 9 gives the wiring of the under side of the sub-panel and the lower part of the front panel. The wires which pass through holes in the sub-panel are lettered, similar letters being given to the ends of the same wire in Figs. 8 and 9.

The wiring is simplified if the panel and sub-panel are taken apart. Then a large proportion of the wires shown in Fig. 9 which connect the parts on the sub-panel can be put in. For instance, the aerial and earth terminals can be connected, also the grid condensers, by-pass condensers, grid leak and intervalve transformers. Many of these wires can be seen

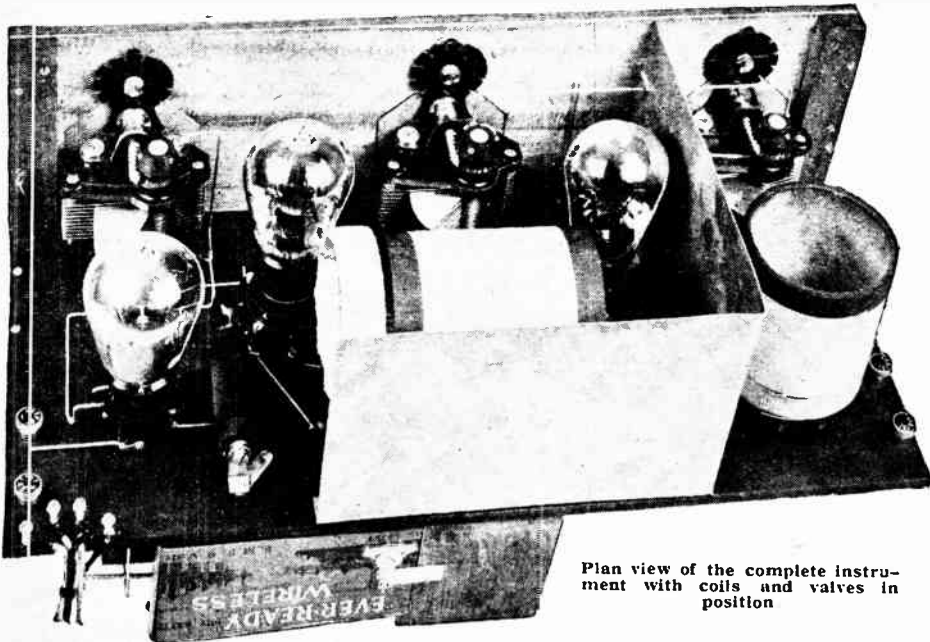
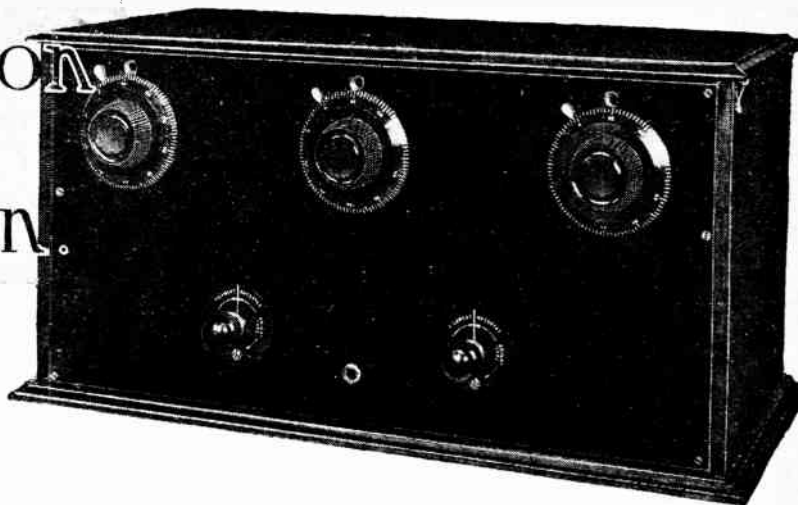

Plan view of the complete instrument with coils and valves in position

Oscillation without Radiation.—

in the illustrations which appeared on pages 159 and 160 of the February 3rd issue. Afterwards the sub-panel can be screwed to the front panel, and the jack, filament rheostats and condensers joined up. No. 16 tinned copper wire is used for wiring.

The neutralising capacity comprises two condensers connected in series, one having a small fixed capacity, while the second is adjustable. These are shown in Fig. 8, and are situated, of course, on the upper side of the sub-

the connecting wire and the second electrode the few turns of wire soldered together on the surface of the Systoflex. One end of a wire is now soldered to the wire covering of the Systoflex, and this is bent to the shape shown in the diagram and has its other end soldered to the grid contact of the first valve-holder. This wire now has about $\frac{1}{4}$ in. cut out of it at a place roughly $2\frac{1}{2}$ in. from the grid connection of the first valve and the piece of Systoflex 2 in. long having a covering of No. 22 S.W.G. copper wire for $1\frac{1}{2}$ in. of its length is slipped over one of

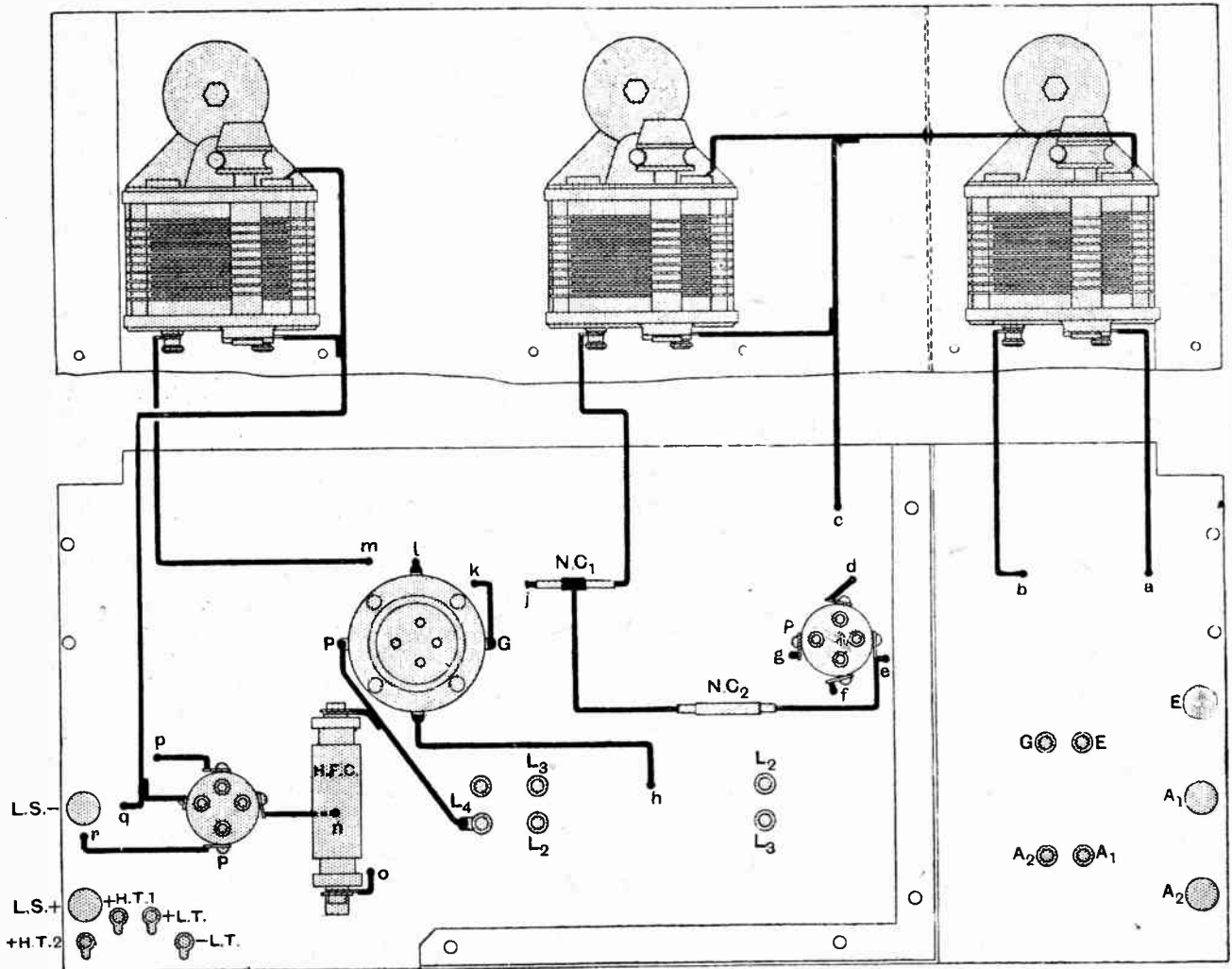

Fig. 8.—Wiring of variable condensers and components on the upper side of the ebonite sub-panel.

panel. A commercial type of balancing condenser is not used, the small fixed condenser (NC_1), consisting of a piece of Systoflex, $\frac{1}{2}$ in. long, fitted over the wire connecting the condenser tuning the grid circuit of the detector to one side of the grid condenser, with a partial covering of 6 turns of bare No. 22 S.W.G. copper wire. The copper wire is wrapped over the middle portion of the short length of Systoflex and the turns are soldered. Then the Systoflex is slipped over the wire connecting the tuning condenser to the grid condenser, as indicated in the diagram. Thus a condenser is formed, one electrode being

the wires which has been cut. The Systoflex should be a fairly tight fit on the wire, and obviously the capacity of the two connecting wires (NC_2) depends upon the position of the Systoflex with its metal covering. If the Systoflex carrying its covering of copper wire, which is soldered, is central relative to the gap in the connecting wire which was made by cutting out a $\frac{1}{4}$ in. length, the capacity of the condenser so formed is a maximum. By moving the Systoflex the capacity is varied, and an extremely fine adjustment can be obtained because of the small fixed condenser connected in series. The balancing capacity

Oscillation without Radiation.—

required in this set is very small because it is connected between the grids of the two valves, which are coupled by a transformer having a 5 or 6:1 turn ratio.

Flexible wires are employed to connect the grid bias battery and for the L.T. and H.T. connections.

The H.F. Transformers.

Two sets of transformers are required: one set for connecting the aerial-grid and anode-grid circuits for short waves and another set for longer waves. For tuning over 200-530 metres the coils are wound with No.

be very carefully constructed to ensure a good fit. Details will be found in Fig. 10. To complete the aerial-grid transformer for the lower waves, commence from the lower end of the former, *i.e.*, the end carrying the plugs and sockets. Solder one end of the No. 26 D.S.C. wire to the contact shown in Fig. 10 and wind 16 turns, taking a tap at the eighth turn to the socket for the alternative aerial connection and terminating this winding by connecting the end to a socket. From this socket connect the beginning of the grid coil and, winding in the same direction as before, put on 65 turns; the turns should be slightly spaced to occupy an overall length of 3in.

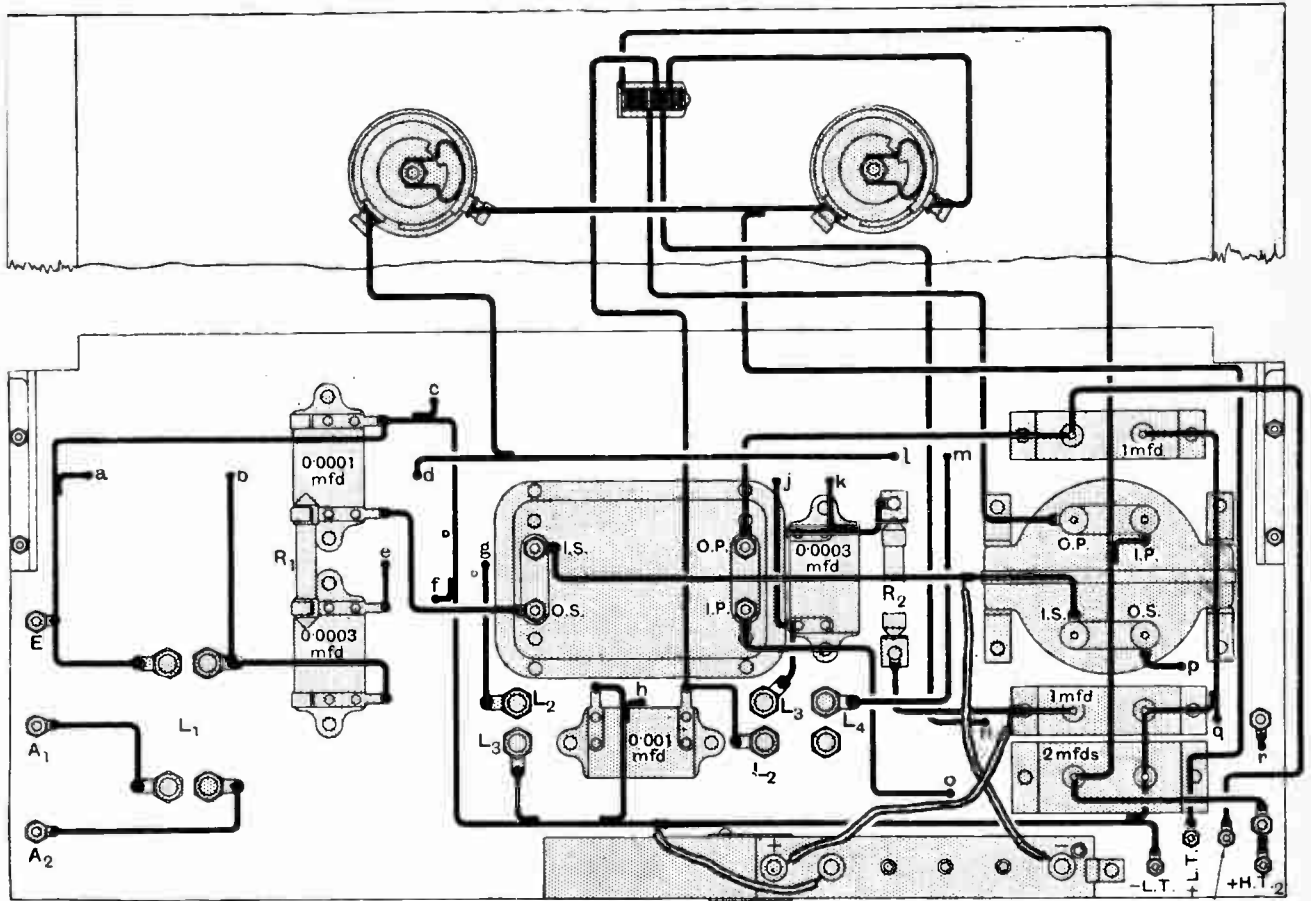

Fig 9.—Connections of components on underside of sub-panel. The small lettering indicates points of correspondence between the two wiring diagrams.

26 D.S.C. wire, and for 700-1,850 metres with No. 34 S.S.C. wire. The coil formers are sketched in Fig. 10, the aerial-grid coil former comprising an ebonite tube 3in. diameter and 4in long, with a piece of 3/4in. ebonite carrying the coil plugs and sockets fitted to one end. Great care has to be taken in the construction of these formers, and it is advisable to cut out two pieces of ebonite and fit the coil plugs and sockets, first making them so that they are a good smooth fit in the sockets already mounted on the sub-panel. When this has been done the two pieces carrying the plugs and sockets can be shaped to fit inside the lower ends of the two cylindrical formers.

The formers for the anode-grid transformer should also

For the aerial-grid 700-1,850 metres coil, No. 34 S.S.C. wire is used, the aerial-earth portion having 50 turns with a tap at the 25th turn and the grid coil 220 turns. The anode-grid transformers are wound with No. 26 D.S.C. and No. 34 S.S.C. wire for the short and long waves respectively, the short-wave coil having a primary of 10 turns and a secondary of 65 turns. The ends are connected to the plugs and sockets, as indicated in Fig. 10, and both windings are wound in the same direction. For the longer wave coil a primary of 25 turns is used with a secondary of 220 turns. These coils give a satisfactory degree of selectivity when the set is used 2 1/2 miles from 2LO, and those who do not have to

Oscillation without Radiation.—

pay so much attention to the problem of selectivity may increase the number of turns in the primary windings. For instance, the aerial-earth winding of the lower-wave transformer may be given 24 turns with a tap at the twelfth turn and the anode coil of the anode-grid transformer be given 15 turns instead of 10 turns.

Operating the Set.

The valves to be used in this set are a D.E.8 L.F. or closely similar type in the first stage, a D.E.8 H.F. or L.F. for the detector, and a D.E.5 in the last stage. D.E.8 L.F. and H.F. valves are recommended because they work off a 6-volt accumulator and consume a filament heating current of only 0.12 ampere. If the best quality of reproduction is required, a D.E.8 L.F. should be used in the detector stage, although a D.E.8 H.F. will work satisfactorily enough for most listeners and give louder signals. With a D.E.8 H.F. an anode voltage of 80 will be suitable, with the grid leak connected to positive 1.5 volts on the grid bias battery, the D.E.8 L.F. working with about 45 anode volts. A battery of 120-150 volts is required for the reflex and L.F. stages which are connected to a single H.T. terminal.

Care should be taken that the grid bias is properly connected, the flexible wire from the two L.F. transformers being put into the negative end of the grid battery and the grid leak return in the positive end. The remaining flexible wire, which has one end joined to L.T. negative, should be put in the first tap from the positive end. Then the grid leak return is 1.5 volts positive with respect to the L.T. negative, while the grids of the first and third valves are biased 7.5 volts negatively. The grid bias battery has a maximum value of 9 volts.

Connect the batteries, the aerial and earth and the lower-wave coils, and join a pair of telephones to a plug and insert it in the jack. When this plug is inserted the filament circuit of the third valve is disconnected and the telephones are connected in the anode circuit of the first valve in place of the primary winding of the 4-1 "Ideal" transformer. Now put a plug-in coil having about 15 turns in the reaction coil holder, and notice whether the set oscillates when the reaction condenser is increased in capacity. As certain plug-in coils are wound in the reverse direction to others, it might be found necessary to undo the coil plug and turn it round so as to reverse the direction of the H.F. currents through the coil when it is put back in the set. With the set connected and arranged so that it can be made to oscillate, endeavour to tune in a weak signal, and then adjust the balancing condenser to prevent the oscillations generated in the detector-valve circuit from passing back through the first valve to the aerial. The adjustment is not a difficult one, although it is necessary to take considerable care. When the correct adjustment has been made, it will be found possible to cause the detector-grid circuit to oscillate feebly without affecting the aerial in any way. Once the balancing condenser has been properly set it will not be necessary to touch it again unless the first valve is changed, and when this condition of balance has been obtained it will be noticed that adjustment of the aerial-grid tuning condenser alters the strength of a heterodyne note and not its pitch.

The final adjustment to be made is in the reaction circuit. For the best results the size of the reaction coil should be adjusted so that the set will just oscillate when the condensers are set at their maximum capacities, and turns should be taken off or added as the case may be. Preferably use a reaction coil of about the same diameter as the transformer, that is, 3in., or a little less. A bigger coil cannot be used.

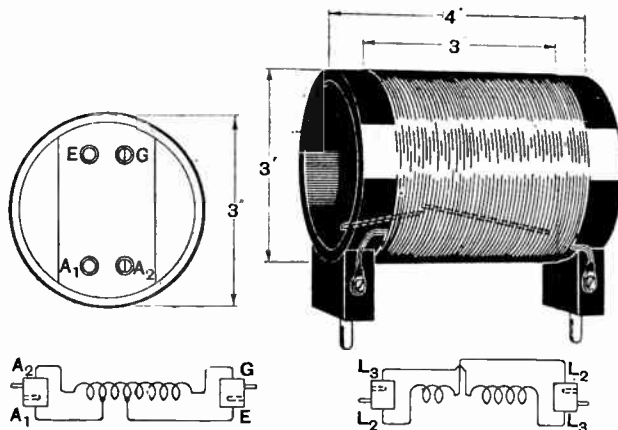

Fig. 10 — Dimensions and connections of the tuning coils and H.F. transformers

If the set is properly balanced on the lower wave band, it will be found that it is perfectly stable on the longer waveband, as the transformers have been designed with this requirement in mind. The long wave transformers are wound with a relatively fine gauge of wire and are quite effective, but of course a larger reaction coil is required than for the lower waves. A No. 50 coil will be found suitable if it is about 3in. in diameter; 75 turns or thereabouts will be required if the coil is a small one, the best number of turns being found by trial.

HIDDEN ADVERTISEMENTS COMPETITION.

The following are the correct solutions for "The Wireless World" Hidden Advertisement Competition for January 27th, 1926.

Clue No.	Name of Advertiser.	Page
1	Alfred Graham & Co.	ii
2	Chloride, Electrical Storage Co., Ltd.	3
3	The Formio Company	8
4	The Silvertown Company	iv
5	Metro-Vick Supplies, Ltd.	9
6	J. & W. Barton	21

The prizewinners were as follow:

W. J. Baden, Brussels	£5
C. A. Wuy, Milan	£2
Horace Bold, Bryn, nr. Wigan	£1

Ten shillings each to the following:

- Frank Dobbins, Chester.
- J. V. Cross, Watford.
- (Mrs.) Minnie Robinson, Moss Side, Manchester.
- Stephen L. Stoker, North Shields.

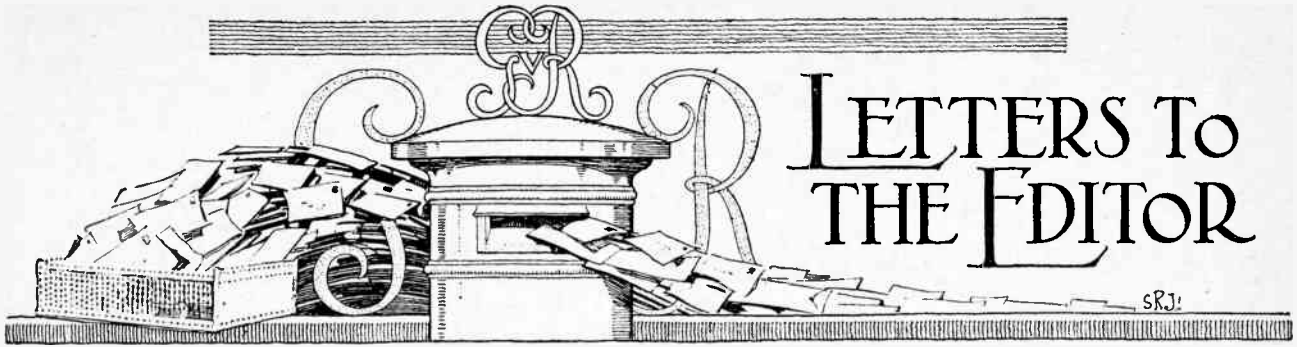

The Editor does not hold himself responsible for the opinions of his correspondents.

Correspondence should be addressed to the Editor, "The Wireless World," Dorset House, Tudor Street, E.C.4, and must be accompanied by the writer's name and address.

ROYALTIES AND THE HOME CONSTRUCTOR.

Sir,—I see you have given publication to the text of my letter and a reply from the Marconi Wireless Telegraph Co., Ltd., regarding royalties, for which I beg to thank you.

My first question, which they state is not clear to them, is partly answered by their reply to my second, because the vast majority of amateurs, when constructing a wireless set, would not be aware whether they were infringing a Marconi patent or not unless they knew exactly what those patents covered. Apparently any receiving apparatus involves the use of these patents.

Now with regard to the payment of royalties I do not think the majority of amateurs wish to escape the payment of same provided they can be convinced of the justice of the claims put forward by the Company, and it would also be useful to know exactly what these royalties amount to and where they are payable.

With regard to the Company's remarks as to the unfairness to manufacturers of sets who have to pay royalties, it appears to me that the wireless trade generally derives an enormously greater profit from the sale of components and other accessories to the constructor than they do by the sale of complete sets, and to put any hindrance or discouragement in the way of the constructor would have a disastrous effect on the huge manufacturing and retail trade which has sprung up in the last few years.

Lastly, I think that most constructors make their own sets not so much from the point of view of saving money but for the pleasure of doing so, and thereby studying this latest and most fascinating science.

My own 4-valve set has probably cost me twice as much as a similar set purchased complete from a manufacturer, because of the scrapping and renewing of various components which has taken place in the course of my experiments, without which I should soon lose interest in wireless.

Putney, S.W.15.

H. COTBY HARPOUR.

Sir,—I have read with interest the announcement regarding Marconi royalties which you publish on page 174 of your issue of February 3rd. I have not, so far, had time to consider the statement in detail, but I would like to ask the Marconi Company whether it is their intention to have licence plates on sale at various shops for anyone to purchase, or are these plates to be sold only to purchasers of complete sets of parts. If the plates are to be on sale generally, then, presumably, those who wish to manufacture and sell in a small way need no longer apply to the Marconi Company for an elaborate licensing agreement, since all they require can be purchased from some local dealer.

Birmingham.

E. W. MASON.

Sir,—As an amateur constructor I note with considerable interest the letter relative to the Marconi royalties on page 174 of your issue of February 3rd.

I agree that question No. 1 is not clear, and suggest that it might have been put as follows:—

"What are the numbers and dates of the British Patent

Specifications for which the Marconi Co. demand 12s. 6d. per valve-holder in each set as royalty?"

Put this way the question leaves no loop-hole.

On Jan. 12th a letter was published in the *Birmingham Post* over my name on this subject.

At the present moment I am in the midst of searching the whole of the British Patent Office matter, and will be pleased to let you know the results of my work in due course.

It is necessary for me to add that I have no manufacturing interest in wireless goods; as an amateur I am keenly interested and systematically peruse *The Wireless World*, which together with an American journal are the only two I have time to read.

I do hope that you will press this question further.

Birmingham.

C. Y. HOPKINS.

CONCERNING A DISTRESS CALL.

Sir,—In your issue of January 13th, under the heading of "Current Topics," you have an item headed "A Misread Distress Call," which gives a truly fantastic explanation of the mystery regarding the supposed distress call on December 29th from the Elders and Fyffes liner *Coronado*.

It is suggested that the operator of the Spanish steamer *Maria Victoria* heard the *Coronado* transmit CQ and interpreted this to mean "Want assistance." In support of this it is recalled that before the present distress call SOS was adopted the call used to be CQD, and it is suggested that the mistake was due to some freak of memory on the part of the Spanish operator.

We desire to deny most emphatically the possibility of any operator, whatever his nationality, making such a mistake. It is doubtful if the Spanish operator was ever aware that the old distress call was CQD, for that call was withdrawn about fifteen years ago, shortly before the *Titanic* disaster, and the operator of the *Maria Victoria* is but twenty-four years of age and has been an operator at sea only five years.

The truth of the matter is that during the present strike of marine wireless operators the Board of Trade has relaxed the regulations provided by the Merchant Shipping (Wireless Telegraphy) Act, 1919, and permitted British ships to proceed to sea with no operators on board, or, in some cases, with only partially qualified and totally inexperienced persons in charge of the wireless installations. The legality of this action is open to question, but, in any case, both the Board of Trade and the shipowners are doing their utmost to prevent the public becoming aware of their callous disregard for the safety of human life at sea, and the "explanation" of the *Coronado* incident is but one instance of their methods of cloaking the real facts.

When the *Maria Victoria* arrived at Glasgow her operator was interviewed by representatives of the shipowners, the Marconi Co., Lloyds, and the Board of Trade, and apparently made a statement favourable to their interests. This statement was issued to the Press for publication. Nevertheless, in an interview with this Association the Spanish operator definitely insists that the *Coronado* sent out "CQ de *Coronado* Lat. 50° N. Long. 5.07° W. want assistance." Thereafter the coast stations in the region—Land's End, Fishguard, Valencia

Letters to the Editor.—

and Ushant—and several ships, failed to obtain any answer to their calls from the *Coronado*.

It is significant that the *Coronado* sailed with a youth of 16 years of age in charge of her wireless installation, who failed in his examination for the P.M.G.'s first class certificate early in December last. He had never been to sea or handled wireless gear before, and, when interviewed by our picket at Avonmouth prior to sailing, he admitted his inefficiency and even asked our picket to show him how to operate the apparatus! And yet such a person was given a "restricted certificate" and permitted by the Board of Trade to take charge of a passenger liner's wireless apparatus!

There are now at sea without operators over 800 British vessels, including 50 passenger ships, and a considerable number of others have only highly inefficient persons aboard. These figures are increasing daily, and a position greatly accentuating the danger to life at sea is being rapidly created. It is calculated that over 35,000 persons are now at sea without the protection directly conferred by the Wireless Telegraphy Act of 1919.

We have made a formal request for a Court of Enquiry to be held to investigate the action of the Board of Trade. A similar request made in the early stages of the dispute was refused, both in Parliament and to our representatives in an interview with the Ministry of Labour.

We shall be greatly indebted to you, Sir, if you will afford space in your esteemed journal for the publication of this letter, so that the false impression created by the above-referred-to note in your last issue may be corrected.

A DINSDALE, Honorary Delegate,
Association of Wireless and Cable Telegraphists.
Strand, W.C.2.

DAME NELLIE MELBA'S FAREWELL.

Sir,—Amid the sadness of bidding good-bye to so many good friends of mine up and down the country it has been a pleasure to note almost everywhere a quickening in musical appreciation. To-day there are gratifying signs that the British audience begins to hear as well as listen; and if the result is to be a musical revival the credit for it will be due in no small degree to men like Halle, Henry Wood, Eugene Goossens, Landon Ronald, Albert Coates, Hamilton Harty, and a number of other pioneers in London and certain provincial centres.

Yet mainly, so it seems to me, the secret of this new interest is to be found in the astonishing enlargement of the audience for music accomplished by the gramophone and broadcasting. Although I believe I was the first *prima donna* to make a gramophone record and the first to broadcast, I have not, whilst recognising the possibilities of these devices, ever accepted either of them uncritically, and I am well aware of the flaws in wireless as that science is practised to-day. But, just as I have followed the gradual perfecting of the gramophone, so I think one may look forward to like improvements in wireless. Broadcasting and the gramophone are certainly the two most eloquent missionaries to the musical heathen in our midst.

London, S.W.1. NELLIE MELBA.

[This graceful tribute to the value of wireless broadcasting from the famous *prima donna* will serve to remind readers that Dame Nellie Melba has always been unsparing in her efforts to advance the cause of the new art. Readers will recall her early broadcasts from the experimental station at Chelmsford.—Ep.]

MORSE AND THE AMATEUR.

Sir,—Your editorial article about Morse reception in *The Wireless World* of January 27th interested me very much. I am like the reader you mention inasmuch that I have forsaken my broadcast set for a short-wave receiver, which gives me hours of pleasure. It appeals to my imagination, and it is with difficulty that I can be persuaded to retire to bed!

South Normanton, Derbyshire. H. BISHOP.

Sir,—In *The Wireless World* of January 27th appears a statement that "there is much of interest which the average

listener ignores merely because he does not take the small initial effort required to learn the Morse code."

I venture to say that during the summer months a fair percentage of listeners temporarily neglect their hobby for the cause of brighter evenings and fresh air, which incidentally presents an opportune time to learn the Morse code.

Allowing for this, it is my suggestion that if, say, you printed two letters of the Morse code weekly (in either the consecutive manner of the alphabet or haphazardly) in very bold type, it would become impressed on a reader's mind to a greater extent than a complete Morse code system you might possibly offer as, say, a supplement.

The "initial effort" is hardly negligible, and requires no small amount of concentration to become proficient at memorising this code, and I feel sure that if it were put to the vote among your readers this suggestion would meet with cordial support.

Henlow, Beds.

[Readers' opinions regarding our correspondent's suggestion are welcomed.—Ed.]

A. DAVENPORT.

TANTALUM RECTIFIERS.

Sir,—On page 132 of the issue of *The Wireless World* of January 27th you refer to an article by Prof. E. V. Appleton on the subject of "Tantalum Rectifiers."

The wording of your reference might, in our opinion, lead the uninitiated to believe that the use of a Tantalum Rectifier is covered by a patent.

The rectifying properties of aluminium anodes immersed in solutions has been known for at least 20 years, so that, whilst it is possible to patent a tantalum rectifier in combination with some special feature or features, the basic principle is by now common knowledge.

Willesden Green, London, N.W.2.

L. F. FOGARTY.

AN IMPORTANT MINORITY.

Sir,—With the future of broadcasting in abeyance and the present contest of rival interests laying their grievances before the Broadcasting Committee, several endeavours have been made to sweep aside the amateur, and the suggestions advanced by the scientific radio bodies, on the grounds that the experimenters constitute such a small minority.

Surely it is of the utmost importance for the development of the industry that the experimenter should continue with his work of sowing the seeds for a desire to derive just a little more out of broadcasting than that which is obtained by listening to the programmes. Permit me to just once more lay emphasis on the progress for which the amateur alone is responsible.

Northampton.

J. S. DENHAM.

COSMOS SQUARE LAW CONDENSERS.

Sir,—In your issue of February 3rd, page 185, appears a test report of the Cosmos square law condenser. We are gratified to see that you regard the instrument as "a really good mass production instrument job," and that your comments on the condenser are favourable in all respects with one small exception. We refer to your criticism of the fact that the spindle is threaded where it passes through the main bearing. This is, of course, a fault in design found in many condensers fitted with conventional types of bearing. The design of the bearings of the Cosmos condensers is, however, an evident improvement over most types, and we submit that with this design the fact that the spindle is threaded is not in any way objectionable. The bearings are arranged in such a way that the threaded portion does not form the bearing surface or take any part in maintaining the spindle in alignment. For this purpose cone bearings are employed at either end of the spindle, with ample surface to guard against wear. These bearings are adjustable so that the user may, if he so desires, alter the amount of friction to suit any special requirements. Furthermore, such adjustment, however made, cannot alter the alignment of the vanes, and even if the bearings are completely dismantled it is impossible to re-assemble the condenser with the vanes otherwise than in perfect alignment.

London, E.C.4. Metro-Vick Supplies, Ltd.

Readers Problems

"The Wireless World" Information Department Conducts a Free Service of Replies to Readers' Queries.

Questions should be concisely worded, and headed "Information Department." Each separate question must be accompanied by a stamped addressed envelope for postal reply.

Connections of the Grid Return Lead.

I am greatly puzzled by the connections of the grid leak in different wireless circuits, in some receivers it is placed across the grid condenser, and the L.T.+ is earthed, whilst in others it is connected directly between grid and L.T.+, and I should be greatly obliged if you could give me a brief explanation of these apparent anomalies.
R.J.C.

The explanation of these apparent differences in wiring diagrams is really quite straightforward. It is generally known that in order to produce cumulative grid rectification it is necessary to bias the grid of the valve positively, whilst a negative bias is necessary if the valve is to be used as an amplifier. When we say that the grid must be biased positively or negatively, we invariably mean that the grid must be made more positive or more negative than the negative side of the filament of the particular valve with which we are concerned, and if the grid is connected via a tuning coil or the secondary of a transformer to the negative side of the filament, the grid is at zero potential. Let us therefore consider the case of a conventional single valve receiver. We desire to make the grid positive in order to bring about rectification. Now the amount of positive bias required by the grid of any valve in order to bring about efficient grid rectification is nearly always equal to the filament voltage requirements of the valve. This is deliberately brought about by the manufacturer of the valve so that different valves can be used as rectifiers without any alteration to the wiring of the receiver. Thus a D.E.R. valve which requires a filament voltage of 1.8 to 2

volts works best as a rectifier when the grid is made 2 volts positive, a 0.06 type valve is designed to give of its best as a rectifier when the grid is made 3 volts more positive than the negative side of its filament, and so on. This is very convenient, since it means that we need only connect the grid return lead directly to the positive side of the valve filament in order to get the correct value of grid bias. Let us glance for a moment at Fig. 1 (A). Here the leak is placed across the grid condenser, and bias is applied via the aerial tuning coil and grid leak, the grid return lead (marked G.R.L.) being connected to the positive side of the filament. It may be asked, why not take the G.R.L. direct to L.T.+ in Fig. 1 (A). This, however, would give the grid a greater positive potential with respect to the filament negative than is possessed by the filament positive owing to the voltage drop across the rheostat. This would not matter greatly if we were using, say, an 0.06 valve with a 3- or 4-volt source of filament supply, but if we were using a 6-volt accumulator and a 50 ohm rheostat in conjunction with this valve, then the grid would have far too much positive bias. Incidentally, also, any variation of the rheostat would also alter the value of the grid bias.

We can arrange, however, to connect our G.R.L. to L.T.+, and still obtain the correct bias by the simple expedient of putting our rheostat in the negative lead where it will have no effect whatsoever on the value of grid bias, as in Fig. 1 (B). It will be noticed that this entails the earthing of L.T.+ instead of the more customary earthing of L.T.-. This is a point that puzzles many, but actually it does not matter in the slightest whether we earth L.T.+ or L.T.-, the earthing

of either pole of the battery being merely incidental to the connection of the G.R.L. If you have a foible for earthing L.T.- you can easily do it by following out the connections of Fig. 1 (D), where the grid leak is returned direct to L.T.+ and the aerial coil no longer forms part of the G.R.L. In Fig. 1 (D) either L.T.- or L.T.+ may be earthed as fancy dictates, this circuit being exactly the same fundamentally as Fig. 1 (B). Fig. 1 (C)

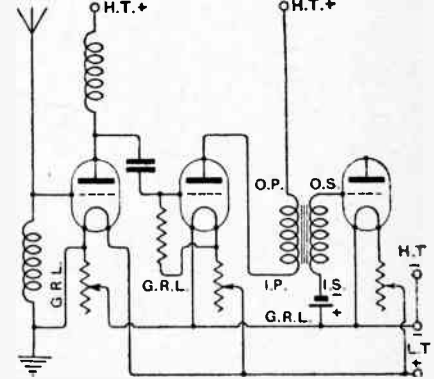

Fig. 2.—Correct grid return lead connections in a three-valve receiver.

is exactly the same as Fig. 1 (A) except that the grid leak is no longer placed across the grid condenser, and so it is immaterial which pole of the battery we earth. There is no magic in placing the grid leak across the grid condenser or otherwise, it being a matter of personal taste. Fig. 2 gives the grid return leads for the other valves of a conventional 1-v-1 receiver. The H.F. valve requires that its grid be not less negative than the negative side of its filament. Therefore we connect our G.R.L. direct to the negative side of the filament. Do not connect it to L.T.-, or the result will be that any variation of the filament rheostat will alter the grid potential. Matters could be simplified and made more conventional by placing the rheostat in the negative lead and connecting the G.R.L. to L.T.-. In the case of an H.F. valve it so happens that the L.T.- is always earthed and not L.T.+, but this, again, is only incidental to the G.R.L. connection, and has no virtue in itself. With regard to the detector valve a moment's thought will reveal to us that following a tuned anode stage it is impossible to place the grid leak across the grid condenser, as this would permit the

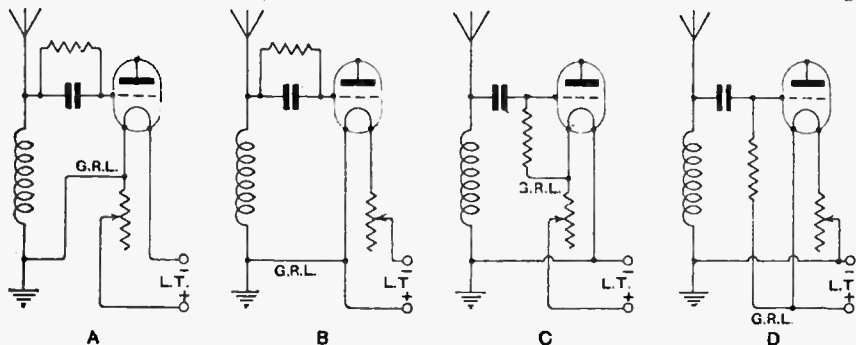

Fig. 1.—Alternative grid return lead connections.

H.T. battery to interfere and give the grid a heavy positive bias. The bottom end of the grid leak can be connected as shown, or the rheostat could be put in the negative lead, and the bottom end of the leak connected to L.T.+ direct. In the case of the L.F. valve it is necessary to make the grid more negative than the negative side of the filament. This is done by means of a small biasing battery. It is important to note, however, that the positive end of this biasing battery must be connected to the negative side of the valve filament. Brief consideration will reveal why. Let us assume that we want to make the grid $\frac{1}{2}$ volts more negative than the negative side of the filament. Therefore by following the connections shown, only one dry cell ($1\frac{1}{2}$ volts) is needed. Assuming that we are using a D.E.5 valve and a 6-volt accumulator, and have connected the positive of this biasing battery to the filament positive: we shall then require a biasing battery of $7\frac{1}{2}$ volts, since we have first to overcome the 6 volts positive bias, given to the grid by returning the G.R.L. to filament positive before we can start to put actual negative bias on the grid. However, no disadvantage would be given by this method, other than having to use an unnecessarily bulky grid battery. An excellent rule to remember is as follows: Place all rheostats of amplifying valves, whether H.F. or L.F., in the negative lead and return the G.R.L. direct to L.T.—. In the case of valves used for grid rectification, place all rheostats in the L.T.— lead and connect the G.R.L. direct to L.T.+ . Place the grid leak across the grid condenser or otherwise as fancy dictates, except in cases where the coupling to the preceding valve is by means of the tuned anode method, as in the case of the detector valve in Fig. 2. Do not trouble about such points as the earthing of L.T.— or L.T.+ , which will automatically determine themselves according to the connections of the G.R.L.

ccoo

Economical Charging of H.T. Accumulators.

I have recently purchased a 120-volt H.T. accumulator made up of six 20-volt sections. It is of 1 ampere-hour capacity. Can you suggest a suitable way of charging it in series with my mains, which are 240-volt D.C.? I should like, if possible, to do this at the time when lights in the house are normally in use, in order to economise in current. For your guidance I might say that two 60-watt lamps are habitually in use during the course of an evening.

K.T.D.

It should be quite a simple matter to charge this accumulator, the method being very economical, since actually the cost is nil. Since your accumulator is of 1 ampere-hour capacity, its charging rate is easily found by dividing this figure by 10, which gives us 0.1 amp. Now if we were to connect this battery in series with the mains, we should, owing to the back E.M.F. of the accu-

BOOKS FOR WIRELESS BEGINNERS

Issued in conjunction with "The Wireless World."

"YOUR FIRST STEPS IN WIRELESS,"

by HUGH S. POCOCK. Price 9d. net. By Post, 11d.

"WIRELESS TELEPHONY," by R. D. BANGAY. Price 2/6 net. By Post, 2/9.

"THE WIRELESS TELEPHONE," by P. R. COURSEY, B.Sc. Price 2/6 net. By Post, 2/9.

"CAPT. ECKERSLEY EXPLAINS," by CAPT. P. P. ECKERSLEY. Price 2/- net. By Post, 2/2.

"UNCLE JACK FROST'S WIRELESS YARNS ON GOOD RECEPTION AND HOW TO GET IT," by CAPT. C. C. J. FROST. Price 2/- net. By Post, 2/2.

"DICTIONARY OF TECHNICAL TERMS USED IN WIRELESS TELEGRAPHY," by HAROLD WARD. Price 2/6 net. By Post, 2/8.

Obtainable by post (remittance with order) from

ILIFFE & SONS LIMITED,
Dorset House, Tudor St., London, E.C.4,
or of Booksellers and Bookstalls.

mulators, reduce the effective voltage across our lamps to 120 volts, which would cause them to glow only a dull red, and so inhibit their use for lighting purposes. Besides this, the current passing would still exceed the requisite 0.1 amp., and would be detrimental to the battery plates. Since they are 20-volt units, it is obvious that it would be quite a quick and simple operation to connect the units in parallel for charging purposes. The requisite charging rate would now be 0.6 amp., and the back E.M.F. only 20 volts. The lighting of the two 60-watt lamps would not be appreciably reduced, and since these lamps would pass approximately 0.25 amps. apiece, the charging rate will be correct, with an adequate margin of safety. It would take about twelve hours to fully charge the battery, and thus at this time of the year about two evenings' charging would be sufficient. That the cost would be nil does not indicate any circumvention of the laws of the conservation of energy. The slight and negligible dimming of the two lamps in use would represent the "cost" of the charge. A fuse should be placed in one of the accumulator leads.

oooo

Methods of H.F. Amplification.

In order to settle an argument between myself and several friends, I should be glad if you could inform me what is the maximum number of H.F. stages used in any existing commercial broadcasting receiver. D.J.B.

So far as we are aware, the maximum amount of H.F. amplification employed in any broadcasting receiver consists of five tuned neutralised stages. There are, of course, a large number of superheterodyne receivers on the British market, employing a maximum of three stages of intermediate high-frequency amplification, whilst in America it is possible to obtain such instruments with four intermediate stages. Since these intermediate stages usually operate on very long wave-

lengths where the amplification per stage is greatly in excess of that obtainable on the broadcasting band of wavelengths, it is probable that the actual overall H.F. amplification obtained by a good commercial superheterodyne receiver is about the same as that obtainable by the receiver employing the five neutrodyne stages to which we have referred, and this surmise is borne out in actual practice if two such receivers are tested together under the same conditions. In neither case is an outside aerial necessary. From the point of view of economy in valves, the direct H.F. receiver is to be preferred, since, exclusive of the L.F. amplifiers, which are, of course, the same in both cases, one more valve is used in the superheterodyne which employs an oscillator valve, two detectors, and three H.F. stages, as against the five H.F. stages and the detector of the other type of instrument. In the case of many superheterodynes, of course, matters are equalised in this respect by combining the function of first detector and oscillator.

oooo

Loading a Variometer Tuned Set.

I have a crystal receiver employing a variometer for tuning which has a wavelength range covering the normal broadcast band, and I desire to alter the set so that I can receive the Daventry programme. I am not sure, however, whether I ought to add a loading coil in series, or shunt the variometer with a fixed condenser when desiring to receive the long-wave station. I should be glad of your advice in this matter.

T.N.T.

It will be better if you arrange to connect a loading coil in series with the variometer for the long wavelength rather than to add a shunting condenser. In all probability your variometer is one of the small type and would need a shunting capacity of not less than 0.602 mfd. for the purpose of tuning up to the long-wave station. The only disadvantage of adding a loading coil in series is that only a very small band of wavelengths will be covered with the same loading coil when rotating the variometer owing to the very small change which the variometer will bring about in the total inductance of the circuit. The loading coil should therefore be chosen so that when used in conjunction with the variometer it tunes the circuit to approximately 1,600 metres whatever the variometer setting. No difficulty will be experienced in this respect, however, as the tuning of Daventry is by no means sharp. It will be found that in nearly all cases on a normal aerial and earth system a No. 200 loading coil will be called for when used to load the typical variometer and not the No. 150 coil which it is customary to use in conjunction with a variable condenser for the reception of Daventry. The basket coil usually sold under the somewhat vague title of "5XX loading coil" is not suitable for use with a variometer, since it generally contains only 150 instead of the required 200 turns.

"GOLTONE" (REGD.)
BRITISH MADE.
PRODUCTS

represent the very best in Design and Construction.
To ensure the maximum possible efficiency from your set use the "Goltone" range.

Large Illustrated Radio Catalogue, No. R 113, of interest to all, post free on request. Dealers should enclose Business Card for Trade Terms.

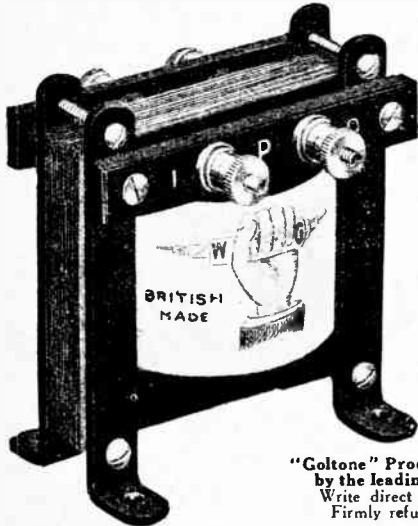

"GOLTON LOW FREQUENCY TRANSFORMER"

Unsurpassed for Volume of sound and Purity of tone. Remarkable amplification with entire absence of distortion. No make of Transformer gives better results. Ratio 2 to 1 and 5 to 1. Price 17 6. Firmly refuse substitutes.

"Goltone" Products are stocked by the leading Radio Stores. Write direct if unobtainable. Firmly refuse substitutes.

"GOLTONE" CONDENSERS.

So much depends upon a good condenser that the utmost care and precision is absolutely necessary. "Goltone" Condensers are made from the finest quality materials and undergo double laboratory tests before despatch. In all standard values. Prices from 1 3 each.

Extracts from "Wireless Weekly," Nov. 25 1925 :-
LABORATORY TESTS:
"Rated capacity correct." "Insulation Resistance infinite." "After exposure for two days in damp grass capacity and insulation unaltered." "Mechanically and Electrically sound."
See Catalogue R 113 for full particulars.

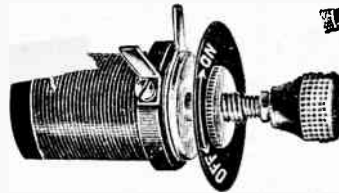

"GOLTONE" MICROMETER REGULATING COIL HOLDERS.
Patent No. 4037/24.

Give that refinement and precision to the Receiving Set so vital to maximum reception and selectivity. Two-Coil Type (as illus.) Price 7/- Three-Coil Type, Price 10 6 Two-Coil Panel Mounting Type, Single hole fitting. Price 6.- Firmly refuse inferior imitations and insist on the Trade Mark on box.

Specially recommended by the leading Technical Journals.



"GOLTONE" MICROMETER FILAMENT RHEOSTAT.
Improved Model.

Smooth velvety action, ball contact. Takes minimum space. Single hole fitting. Complete with Knob and Dial

6 ohms	2/6
12 ..	2 9
30 ..	3 6

The BEST of ALL COIL HOLDERS.

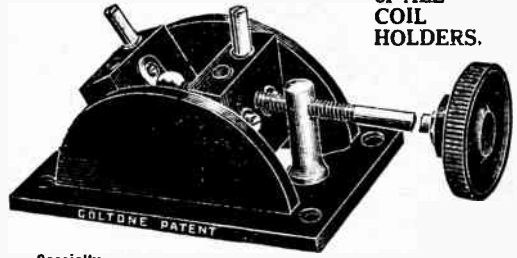

THERE ARE NUMEROUS MAKES OF SETS and VARIOUS TYPES OF VALVES BUT **ONE BATTERY** ONLY WITH THESE REMARKABLE FEATURES:

Practically constant voltage on continuous or intermittent discharge. Easily and cheaply re-chargeable AT HOME without attaching to any electrical supply.

THE

DARIMONT

(PATENTED)

"HOME-SERVICE" BATTERY

is an efficient aid to perfect reception.

is noiseless in operation.

Size No.	2 1/2	5	10
Cells	4/-	5/-	6 6 each
Charges	1 -	1 4	2/3 "

WRITE NOW FOR LIST (fully descriptive) and a GUIDE FOR USE WITH VALVES

DARIMONT ELECTRIC BATTERIES LTD.
DARIMONT WORKS, ABBEY ROAD, PARK ROYAL, LONDON, N.W.10. Telephone: Wembley 2807.



They cost less now!

Watmel—the better fixed condensers—are now sold at reduced prices, made possible by the great demand. Wherever a fixed condenser is needed you should specify Watmel and make sure of trouble-free results. Mica sheets securely clamped between the plates render it impossible for the capacity to vary. No wax whatsoever is used in their construction. One hole fixing is provided, and remember that every Watmel is guaranteed to be correct within 5% of its marked capacity.

NOTE THE NEW PRICES:

0005 to 002 reduced from 2/6	2/-	Combined grid leak and condenser reduced from 3/-	2/6
0025 to 006 reduced from 3/6	2/6	Combined variable grid leak and condenser, New Model	3/6
Other Watmel products worth buying:			
Grid Leak (Black Knob) 5 to 5 megohms			2/6
Anode Resistor (Red Knob) 50,000 to 100,000 ohms			3/6

THE



WIRELESS CO. LTD.,
332a, Goswell Road, London, E.C.1.

Telephone: 7990 Clerkenwell.
Lancashire and Cheshire Representatives:—Mr. J. B. Leves, 23, Hartley Street, Levenshulme, Manchester.

NOT REQUIRED
 H.T. Batteries, L.T. Batteries and Accumulators (or distortion)
THE NEW ELVIN MAINS 3-VALVE RECEIVER.
 This set is worked direct from the Electric Light Mains and is
 the most perfect set yet manufactured. Plug in on the nearest
 Lamp Holder, switch on and you go. London or Daventry.
Log Card and Illustrated Catalogue FREE.

DIRECT OR ALTERNATING CURRENT



SERVICE QUALITY PRICE

£22-14

PUGH'S WIRELESS, 95-101, Holloway Road, LONDON, N.7.

**FULL SIZE RESULTS
 HALF SIZE COST!**

The secret of the crystal-clear reproduction is the new cast-in diaphragm. Fully guaranteed.

Send for your **FREE** copy of our new catalogue.

General Radio Co. Ltd, 235, Regent St., W.1.



ALL GOOD DEALERS DEMONSTRATE - SEE IT TO-DAY

35/-



General Radio ★

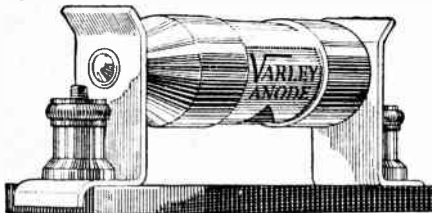

The Varley Constant Wire Wound Anode Resistance.

A resistance wound on the famous Varley Bi-Duplex System eliminating all inductance between turns. It is absolutely immune from the effects of heat, damp, or any atmospheric change and therefore perfectly constant in action. The maximum current carrying capacity is from twelve to fifteen milliamperes.

For intervals coupling where freedom from distortion is the first consideration, use the Varley Wire Wound and Weatherproof.

SEE THAT YOU HAVE A VARLEY for Silence, Perfect Tone and Efficiency.

Complete with Clips and base **7 6**
 Without Clips and base **6 -**

60,000, 80,000 and 100,000 ohms.
 Write for Leaflet.



Constant always

Oliver Pell Control Ltd.
Woolwich, S.E.18.
 Telephones: Woolwich 58, 58A.

MOST LOSSES occur in the VALVE HOLDER



Capacity and Voltage leakage losses between valve legs are reduced to a minimum in the "AERMONIC."

Strongly recommended where Radio Frequency Currents are dealt with—as in a Neutrodyne H.F. Amplifier, Super-Heterodyne Detector and Oscillator, and any H.F. Amplifier Cuts out the "howl" in a L.F. Amplifier.

Moulded from the Finest Material available for Strength, Heat Resisting and Di-electric Properties.

MODEL "D"
 Base-Board Mounting,
 2 6 each.

MODEL "E"
 Back of Panel,
 2 6 each.

THE NEW **AERMONIC** AIR-SPACED VALVE HOLDERS

ANTI-CAPACITY

Manufacturers & Distributors for London & South England:
JAMES CHRISTIE & SONS Ltd.,
 246, WEST STREET, SHEFFIELD.
 London Agents: A. P. Bulgin & Co., 10, Cursitor St., E.C.4.
 Agents—Remainder British Isles:
 Messrs. V. R. Pleasance, 54, Fargate, Sheffield.

Reduction in Price of THE MAYWOOD L.T. SUPPLY UNIT.

Work your set direct from the mains. Better, Easier and Cheaper to run than accumulators. Perfectly Safe—Absolutely Reliable.



ALWAYS READY FOR USE. Just plug into the lamp socket or wall plug and you have a continuous H.T. and L.T. Supply entirely free from "hum and ripple."

Reduced price of L.T. UNIT, £5. 10. 0

The MAYWOOD UNIT can also be obtained for
 H.T. Supply. Model 7. **£5. 15. 0.**
 H.T. & L.T. **79. . . £10. 10. 0.**

Further particulars may be had from your Radio Dealer, or from the Manufacturers:—

THE MAYWOOD ENGINEERING & ELECTRICAL MFG. CO., LTD.,
 Maywood Works, Charles St., Holland Park, London, W.11
 Telephone: Park 639.



FORMO

RADIO COMPONENTS OF ADVANCED DESIGN. NEW CATALOGUE NOW READY.

Straight Line Frequency. Ultra Low Loss Condenser. Micro-Vernier Dial. High Efficiency. Low Loss Variable-Coupler, etc.

The FORMO Company,
 Crown Works, Cricklewood, N.W.2

10/6
 Manchester: Mr. J. B. Levee, 23 Hartley St., Levenshulme.



CRYSTALS COME & CRYSTALS GO

RUSSELLS PURPLE LABEL HERTZITE REMAINS

THE FAVOURITE & UNRIVALED

PRICE 1/6 FROM ALL FIRST CLASS WIRELESS DEALERS
 THE LG RUSSELL LABORATORIES 1-7 HILL ST BIRMINGHAM

Once you've "used" EnergO

you'll never fit other components. Whether your circuit be reflex or straight, "EnergO" components will certainly get the best from it.

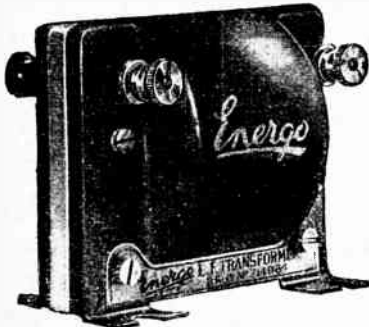

The "Orphean."

A Shrouded L.F. Transformer of unique design, the "Orphean" gives remarkably distortionless reproduction throughout the complete range of audible frequencies. Combining purity of tone with reliability and extra mechanical strength it should be in every experimenter's and music lover's receiver. That it is used by a number of leading receiver manufacturers is additional proof of its superiority.

Ratio 1-3, 19/6. Ratio 1-5, 21/-. Other Ratios, 21/-. Open Type, 15/-.



"EnergO" H.F. Transformers

Wound with silk-covered wire. The most attractive and efficient component of its kind. Use shunted with "0002 Condenser across primary.

"EnergO" Battery Switch. For perfect battery control—H.T. or L.T. Just screw it on your L.F. or H.T. terminal. 1/3.
"EnergO" Tuning Coils. Elongate shielded. Specially designed low-capacity coil; they add selectivity and distance to any receiver.

No.	Wavelength in Metres.	Price.
1	150—450	3/9
2	250—700	4/-
3	450—1200	4/3
4	900—2500	4/6
5	1800—3000	4/9
6	2000—5000	5/-

Send for illustrated list of our many products. Of all dealers. If you cannot obtain send direct.

EnergO PRODUCTS, LIMITED,
1 St. James's Street, E.C.1
Telegrams: "EnergOrad, Smith, London."
Telephone: Clerkenwell 7360.

EFESCA Vernistat



**DELICATE
FILAMENT CONTROL**

THE Efesca Vernistat provides the most delicate filament control yet invented, and is particularly useful in circuits requiring individual control of valves, where filament temperature plays an important part in efficient reception. It is especially suitable for the control of H.F. and detector valves.

The Vernistat absolutely safeguards valves from accidental burn outs, as three complete turns of the knob are required to bring in or take out the whole resistance. For Bright or Dull Emitter Valves, 5 or 30 ohms, 6/- each.

Ask your Wireless Dealer to show you the Efesca Vernistat and the complete range of



Write for Catalogue No. 559/6 describing all Efesca Components
WHOLESALE ONLY:
FALK, STADELMANN & Co., Ltd.,
Efesca Electrical Works,
83-93, FARRINGTON RD.,
LONDON, E.C.1,
and at
Glasgow, Manchester and Birmingham.

EFESCA
COMPONENTS
£200
CASH PRIZES
Ask your dealer for entry form or write direct to FALK, STADELMANN & CO. LTD., 83-93 FARRINGTON ROAD, LONDON E.C.1

Get more out of your Set

Fit a LOTUS Geared Vernier COIL HOLDER

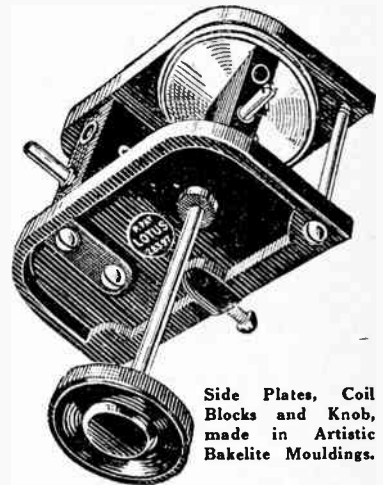

Side Plates, Coil Blocks and Knob, made in Artistic Bakelite Mouldings.

You have experienced that annoying and irritating fading away of volume after tuning your coils. This is due to the moving block falling. The Lotus Moving Block CANNOT FALL.

The Vernier movement comprises three sets of enclosed precision machine-cut gears, and reduces the speed of the moving coil block by eight times.

Has the Largest Sale of any type of Vernier Coil Holder

There are Two Types of Lotus Coil Holders:

For Outside Panel Mounting: Two-way, 7/-; Three-way, 10/6.
For Inside Baseboard Mounting with 6 in. handle: Two-way, 8/-; Three-way, 12/6.

From all first-class Radio Dealers

GARNETT WHITELEY & Co.,
LIMITED,
BROADGREEN RD., LIVERPOOL.



Athol

TRADE MARK

For any circuit, any set, anywhere.

Bracket for back-of-panel mounting, 2d. each extra.

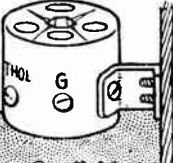

VALVE HOLDER

Gives perfect insulation, brass sockets almost entirely air-spaced, minimum capacity effects. One-hole fixing to base board, or above panel; easily mounted below the panel. Complete with soldering tags and fixing bolt.

ATHOL ENGINEERING CO.,
Cornet Street, Higher Broughton, MANCHESTER.



No More Burnt-Out Valves!
if you use a
"CAN'TCROSS" CONNECTOR
(Patent applied for.)

Consists of a plug element for fitting to panel to replace the usual H.T. & L.T. Terminals. The socket element corresponds to the plug element, and is arranged to receive the necessary leads from the respective batteries.

SHORT CIRCUITS IMPOSSIBLE. ACTS AS A DISCONNECTING SWITCH. EASILY FITTED TO ANY SET.

Adaptable to all Circuits.
Example wired as follows: 1. H.T.1. 2. H.T.2. 3. H.T.3. 4. H.T.- 5. L.T.+ 6. L.T.-

1 Terminal 5/- each 5 Terminal 6/- each
7 Terminal 7/- each

Post Free on receipt of Postal Order and Dealer's name from—
J. & W. BARTON, 22a, Virginia St., SOUTHPORT

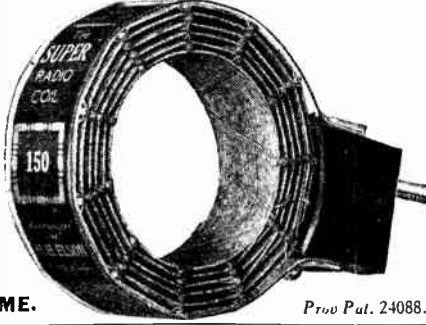

FOR TONE AND VOLUME.

Prod Pat. 24088.

SUPER COILS.

Wave Length using '001 Variable Condenser, in Parallel.			Wave Length using '001 Variable Condenser, in Parallel.		
Coil	Maximum	Price	Coil	Maximum	Price
25	400	2/-	150	2300	3/10
35	520	2/3	175	2700	4/3
40	680	2/6	200	3150	4/6
50	840	2/6	250	3700	5/-
60	1000	2/9	300	4350	5/6
75	1250	2/9	350	4750	6/-
100	1820	3/-	400	5000	6/6

These coils are wound on an entirely new principle, producing a low loss coil of highest efficiency, and can be relied on to increase volume and improved tone of Radio signals. They are extremely robust in construction and highly finished.

If unable to obtain from your local dealer we will supply direct, upon receipt of your order with Cash, post free.

Patentee and Sole Manufacturer: **H. H. ELSON, 36, Digbeth, Birmingham**
Telephone No.—VICTORIA 787.

The "REEVES'-ROBERTS" RECEIVER.

(2-Valves)

Most British & Continental Stations ON LOUD SPEAKER.



- The laboratory built instrument—precision built—not mass produced.
- Built to work the Western Electric "Kone" Speaker, a combination resulting in tone quality of highest possible parity.
- Efficiency on either local or distant broadcast—without change of coil.
- Simplicity of tuning—two dials only, each reading alike—giving definite "logability."
- Extremely low running cost, 9/33 amps consumption for filaments.
- Selectivity approaching that of a super-heterodyne.
- Particularly it is non-radiating, i.e., it cannot cause interference to other listeners, even if improperly used.

Complete in cabinet with valves and inclusive of royalties **£15 0 0 nett.**

In preparation—Particulars of our 4-Valve receiver with MONO-CONTROL—an engineering achievement. Price £25 inclusive of valves and royalties. Western "Kone" Loud Speaker and complete accessories - £3 19 0 extra for either model.

A. W. REEVES, Electrical Engineer, 3, EDMUND STREET, BIRMINGHAM.



The "GRIPPLESHELL"
Registered design No. 716927.

A device for simplifying Aerial Erection
These brackets are made from 1" best quality Wrought Iron painted with weather-proof enamel.

PRICES
Combined corner bracket, insulator & pulley 3/6
6" Hold-off bracket 1/6
9" " " " " 1/6
12" " " " " " 3/6

Manufactured by **PARTRIDGE & WILSON, ELECTRICAL ENGINEERS.**
217a, Loughborough Road, LEICESTER.
Telephone 5812.

FREE ON RAIL.



HIGHEST CAPACITY METEOR BEST QUALITY
HIGH TENSION DRY BATTERY FOR WIRELESS

60 volts in 3-volt steps. Pitch (top) full voltage guaranteed. A long-life 5/9
Battery of moderate cost. 63" x 4-1/2" x 3-1/2". Carriage paid.
METEOR POCKET LAMP BATTERIES with Special Terminals soldered and Each
slotted for connection in series. 3/9 per dozen, carriage paid.

WIRELESS CATALOGUE FREE ON REQUEST.
MASSEY MOTOR Co. Ltd. 35, Mincing Lane, BLACKBURN.

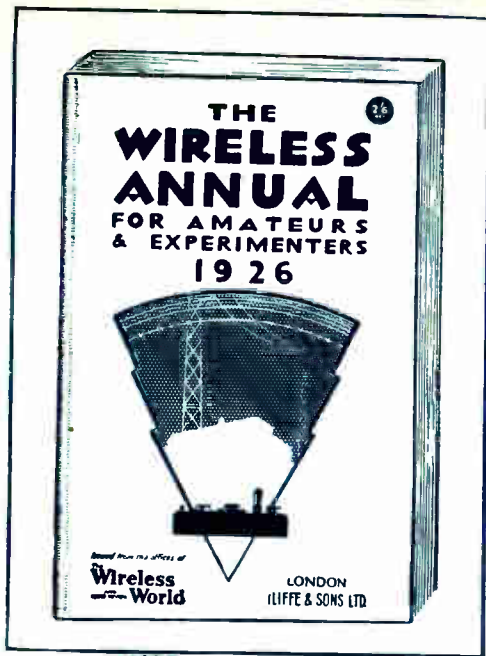

THE WIRELESS ANNUAL

FOR AMATEURS AND EXPERIMENTERS
1926

A volume of particular interest to every wireless enthusiast, containing amongst a mass of other features the following special items:

CALL SIGNS of ALL KNOWN AMATEUR TRANSMITTING STATIONS in Great Britain, France, Holland, Germany, Sweden, Finland, Italy, Spain, South Africa, India, Australia, New Zealand, and South America; **REGULAR TRANSMISSIONS** (Morse and telephony); **RECEIVER CIRCUITS** (16 pages of diagrams and notes); **GLOSSARY OF TECHNICAL TERMS**; **CLASSIFIED DIRECTORY OF MANUFACTURERS**; **VALVE DATA, USEFUL TABLES, FORMULÆ AND INFORMATION** on all subjects of interest to AMATEURS

PRICE 2/6 net. BY POST 2/8½

Obtainable from all booksellers or direct from the offices of "The Wireless World," Dorset House, Tudor St., London, E.C.4

This book should be your wireless guide and companion throughout 1926.

A Service that gives Security!

MANY readers naturally hesitate to send money to unknown persons. We have therefore adopted a Deposit System which gives complete security both to buyer and seller.

If the money be deposited with "The Wireless World" both parties are advised of its receipt. The time allowed for decision is three days, after which time, if the buyer decides not to retain the goods, they must be returned to the sender. If

a sale is effected we remit the amount to the seller; but, if not, we return it to the depositor.

Full particulars may be found on the Miscellaneous advertisement page at the end of the book.

Use this service for your wireless requirements and avoid all risk! Sell the apparatus you no longer require! Write out your advertisement to-day and send to—

PREPAID ADVT. DEPT., "THE WIRELESS WORLD," DORSET HOUSE, TUDOR ST., LONDON, E.C.4.

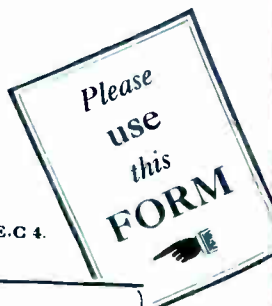

12 Words or Less 3/-

each additional word 3d.

Advertiser's name and address must be counted. If a box number is required, 6d. extra must be sent for postage on replies.

w.w.39

Advertisements for "The Wireless World" are only accepted from firms we believe to be thoroughly reliable.

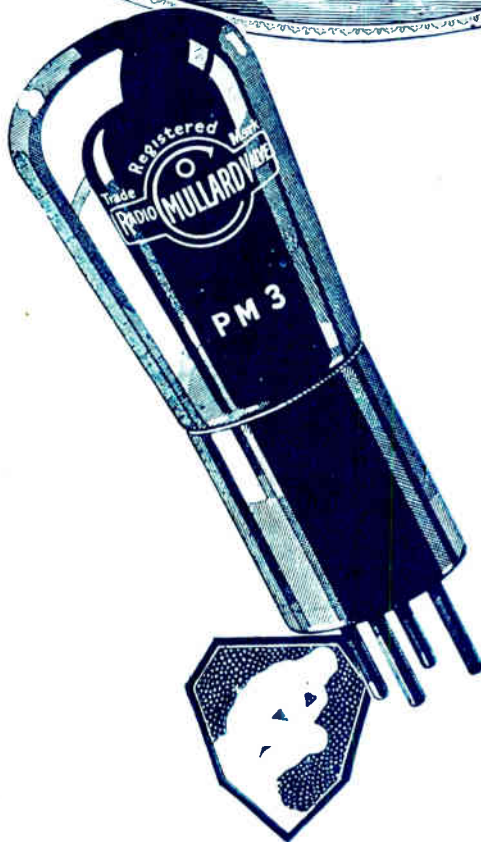
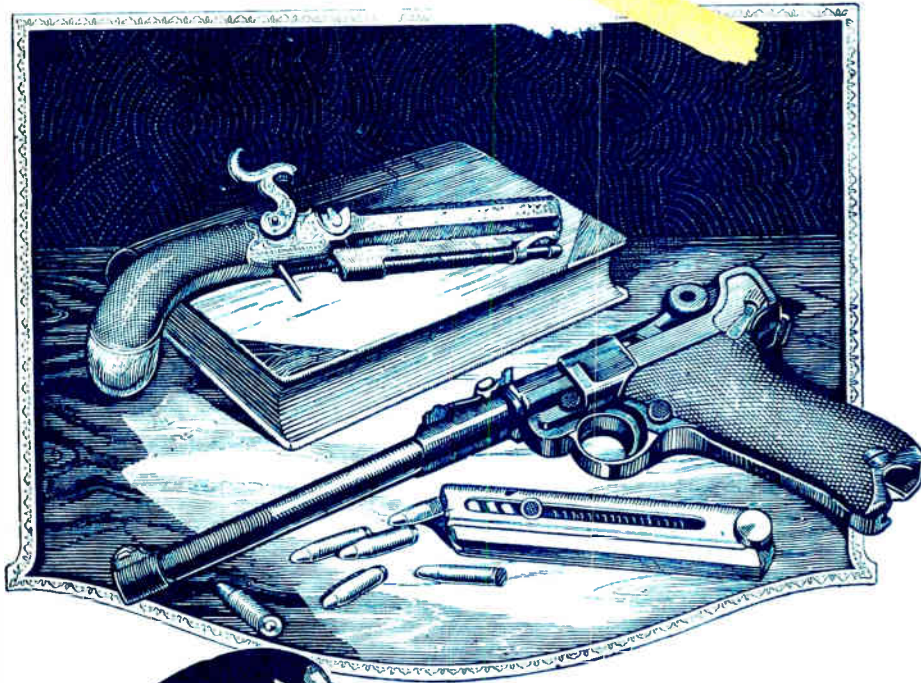

Less Recharging

THE boon of less recharging—a happy gift of modern science. Not a single valve in your receiver need consume more than *one-tenth ampere* if you take advantage of the wonderful "N" Filament. This filament is so economical of heating power that *no sign of glow* can be discerned and its low current consumption makes each accumulator charge last seven times as long.

You can now have the P.M.3, a general purpose valve with the wonderful "N" filament that reduces the total consumption of your set to **ONE-SEVENTH** and gives pure and powerful reception free from microphonic disturbances.

The ideal combination—P.M.3 Valves followed by a P.M.4 in the last stage—the finest loud speaker valve ever produced.

Ask for the P.M.3 16/6
and the P.M.4 22/6

THE WONDERFUL "N" FILAMENT VALVES

Mullard

THE · MASTER · VALVE

ADVT. THE MULLARD WIRELESS SERVICE CO., LTD., BALHAM, LONDON, S.W.12

Printed for the Publishers, LIFFE & SONS LTD., Dorset House, Tudor Street, London, E.C.4, by The Cornwall Press Ltd., Paris Garden, Stamford Street, London, S.E.1.
 Colonial and Foreign Agents:
 UNITED STATES—The International News Co., 83-85, Duane Street, New York. FRANCE—W. H. Smith & Son, 248, Rue Rivoli, Paris; Hachette et Cie, Rue Réaumur, Paris.
 BRISBANE—W. H. Smith & Son, 78, Marche aux Herbes, Brussels. INDIA—A. H. Wheeler & Co., Bombay, Allahabad and Calcutta. SOUTH AFRICA—Central News Agency, Ltd.
 AUSTRALIA—Gordon & Gotch, Ltd., Melbourne (Victoria), Sydney (N.S.W.), Brisbane (Queensland), Adelaide (S.A.), Perth (W.A.) and Launceston (Tasmania).
 CANADA—The American News Co., Ltd., Toronto, Winnipeg, Vancouver, Montreal, Ottawa, St. John, Halifax, Hamilton; Gordon & Gotch, Ltd., Toronto; Imperial News Co., Toronto, Montreal, Winnipeg, Vancouver, Victoria. NEW ZEALAND—Gordon & Gotch Ltd., Wellington, Auckland, Christchurch and Dunedin.

72

The Wireless World

4^D

RADIO REVIEW

The Paper for Every Wireless Amateur

Wednesday, February 17th, 1926



LOW LOSS COILS?

Test ANY Loud Speaker of other make against this

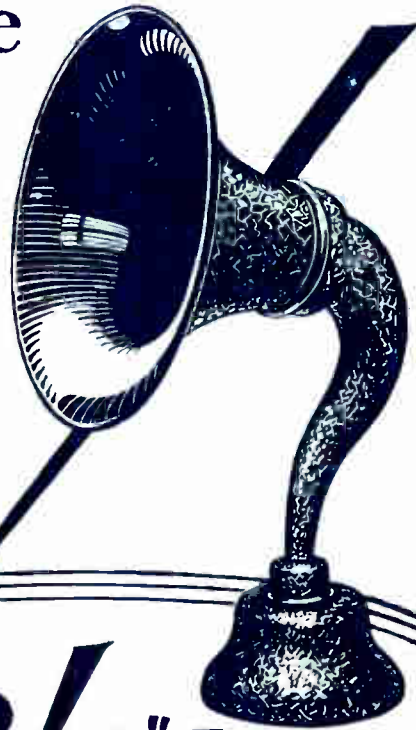

38/- "Junior" SWAN-NECK AMPLION

The "Junior" Swan-Neck AMPLION (A.R.38) may not, of course, come out best against them all, but it will hold its own EASILY and CONCLUSIVELY against "twice the size" and "double the price"

Because of this exceptionally meritorious performance, the "Junior" Swan-Neck has quickly become so great a favourite that it has been necessary to provide for an enormously increased output. All who desire "BETTER RADIO REPRODUCTION," with a reasonably moderate outlay, will be glad to know that quantity supplies are now forthcoming and that, therefore, they can secure just what they want—by ordering now an

THE
WORLD'S
STANDARD

AMPLION

WIRELESS
LOUD
SPEAKER

Obtainable from AMPLION STOCKISTS, Radio Dealers or Stores.

Demonstrations gladly given during business hours at the AMPLION Showrooms:
25-26, Savile Row, London, W.1.; 10, Whitworth Street West, Manchester;
79-82, High Street, Clapham, S.W.4; 101, St. Vincent Street, Glasgow.

Ask your dealer to let you hear it

Announcement of Alfred Graham & Co. (E. A. Graham), St. Andrew's Works, Crofton Park, London, S.E.4.

Mention of "The Wireless World," when writing to advertisers, will ensure prompt attention.

The biggest little thing on your set

The Marconiphone "IDEAL" and Ideal Junior Transformers

By experts and amateurs alike, Marconiphone "IDEAL" Transformers are freely acknowledged to be the most efficient on the market because they are made to a standard of quality and not of price.

The "IDEAL" Transformer, which is guaranteed to amplify with minimum distortion at all frequencies, is subjected to rigorous test at every stage of manufacture. Every transformer sold is guaranteed to conform to the individual curve supplied with the instrument, and not to a general laboratory standard.

The windings are impregnated with MARCONITE—a specially prepared insulating material which protects it from all risk of deterioration and corrosion.

The performance of the "Ideal Junior" is consistent with that of the "Ideal" and is designed chiefly to follow the detector valve which is usually of high impedance. In this way a modification of design, different from that of the large model, has been effected solely for this purpose, thus enabling a special purpose transformer with the highest guaranteed performance to be produced at a minimum cost. Write for publication 304 F.

THE MARCONIPHONE Co., Ltd.

Regd. Office:
Marconi House, Strand, London, W.C.2

Head Office:
10-12, Tottenham Court Road, London, W.
Branches in all principal towns.



"Ideal Junior" Transformer

"IDEAL" Transformer
Type 'A' Ratio 2.7 to 1
" 'B' " 4 to 1
" 'C' " 6 to 1
" 'E' " 8 to 1
30/-

"IDEAL JUNIOR" Transformer
Ratio 3 to 1
21/-

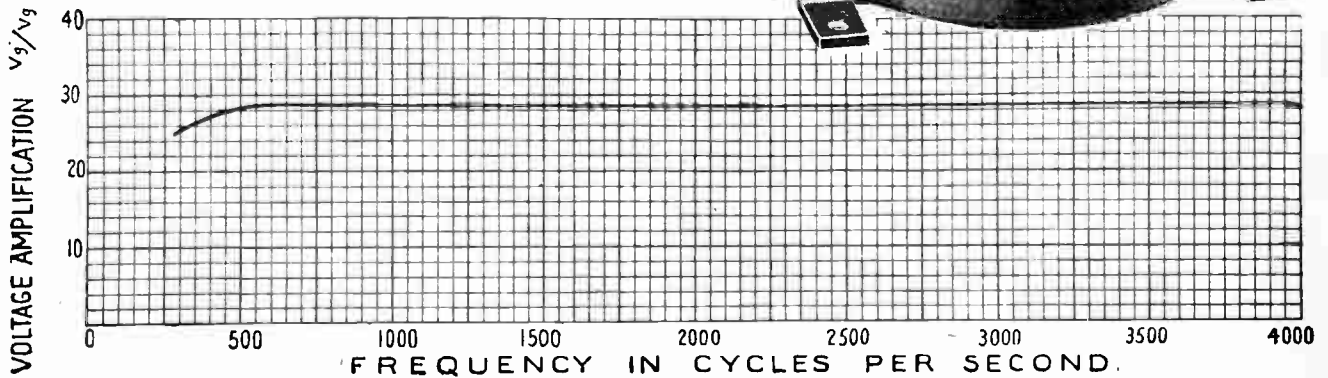
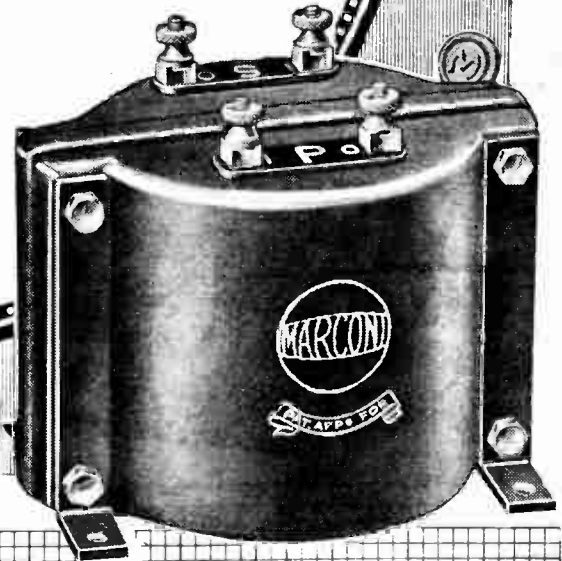

REALLY EFFICIENT PRODUCTIONS

The GAMBRELL NEUTROVERNIA CONDENSER

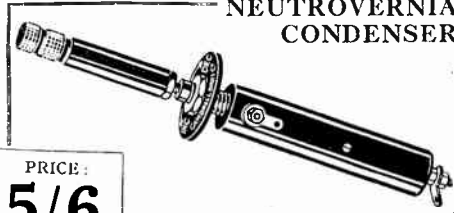

PRICE: **5/6**

A REMARKABLE instrument, manufactured with the utmost precision. Note the extraordinary range of capacity. Min. Cap. 2 micro microfarads. Max. Cap. 38 micro microfarads. Only six revolutions of the knob to cover from minimum to maximum capacity. Each revolution of the knob covers six micro microfarads. Takes less panel space than that covered by a sixpenny piece. It is not possible to short the moving and fixed elements. The Condenser is totally enclosed—damp, dust and fool proof. The best condenser ever devised for either neutrodyne circuits or as vernier condenser.

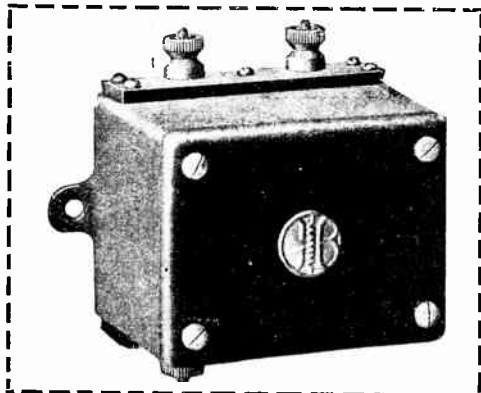

GAMBRELL L.F. TRANSFORMER

These units have shewn hundreds of set builders that transformer coupled L.F. amplification WILL give purity of reproduction without sacrificing volume. Made in Two Models for first and second stages of amplification.

STAGE I .. 27/6 STAGE II .. 27/6

Write for full details of the famous Gambrell Coils and other productions which include Receiving Sets, Wavometers, etc.

GAMBRELL BROS. LIMITED

76, VICTORIA STREET, LONDON, S.W.1

Phone—Victoria 0938

IF YOU WANT THE FINEST VALVE MADE

COMBINING VOLUME, QUALITY and ECONOMY BUY



NELSON-MULTI

Three Filament VALVES

ALL BRITISH ALWAYS GET "A GOOD RECEPTION"



THE LIFE OF THREE VALVES AT THE COST OF ONE

The Scissor Switch in the base of the Valve controls 3 filaments. With the switch closed, any one filament can be used, leaving 2 in reserve. Open the switch, placing 2 filaments in parallel, and the Valve is at once a POWER AMPLIFIER.

Each Valve fulfils the functions of H.F., Detector, L.F., or Power Amplifier.

FOUR IMPROVED TYPES

TYPE A.	PRICE, 9/6
4 to 5 VOLTS.	0.45 AMPS. per Filament.
TYPE D.E.A.	PRICE, 15/.
2.6 VOLTS.	0.18 AMPS. per Filament.
TYPE D.E.2.	PRICE, 15/.
1.8 to 2 VOLTS.	0.35 AMPS. per Filament.
TYPE D.E. '26.	PRICE, 16/0
3 VOLTS.	0.06 AMPS. per Filament.

ALL VALVES ARE GUARANTEED.

If unable to obtain from your local dealer, write to the makers:—

NELSON ELECTRIC CO., LTD.,
MERTON PARK, LONDON, S.W.19.

Telegrams: Valvenelso, Wimble, London. Phone: Wimbledon 172.

CAXTON 4-VALVE CABINET

Made for Editor of Wireless Magazine for Set "As good as money can buy" described in issue February, 1925.

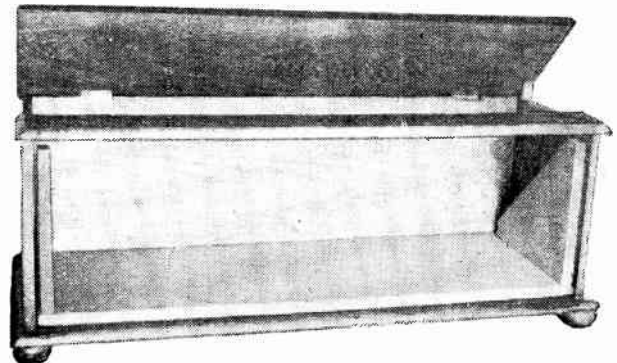

Cash with Order. Fumed Oak ... £1 5 0
or Real Mahogany polished ... £1 14 0

With detachable recess fitted Base Board to mount 21 in. by 7 in. panel to slide out of Cabinet front. Extra 10/- with two beaded front doors totally enclosing fitted panel.

Cabinet overall length 22½ ins. Width 8½ ins. Height 9 ins.

Polished with the new enamel that gives a glass hard surface that cannot be soiled or scratched.

SENT FREE.—Catalogue of standard Wireless Cabinets in various sizes and woods. Special Cabinets made to customer's orders.

PACKED AND DELIVERED FREE IN U.K.

CAXTON WOOD TURNERY CO., Market Harborough

Dubilier

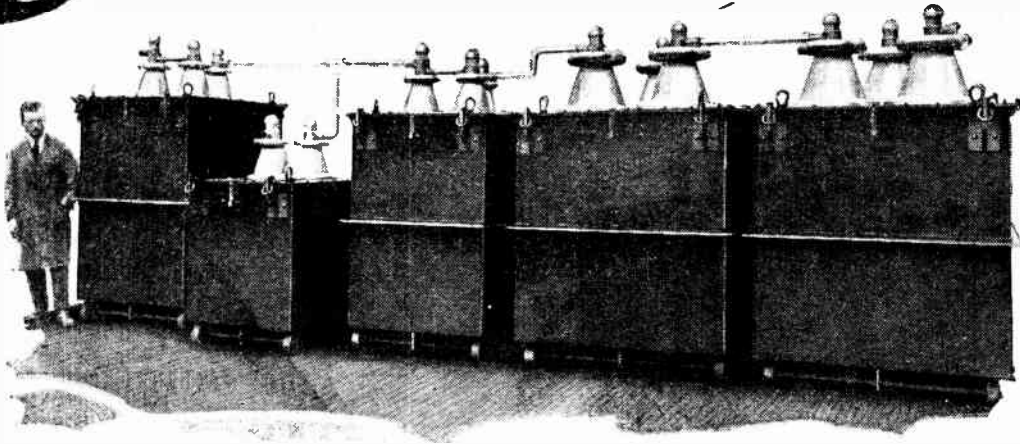

Condenser Specialists



THE bank of Dubilier Condensers illustrated above is composed of the largest Mica Condensers in the world. It was designed for installation in the British Government's new transmitting station at Rugby, and consists of four large Condenser units connected in series for the main C.W. circuit, together with an anode feed condenser tapped on to the series. This condenser operates continuously at 12,000 Volts D.C., with

an additional super-imposed radio frequency current of over 60 amps. The last condenser in the series is insulated from the earthed containing tank for a potential of over 90,000 Volts. The capacity of the C.W. condensers in series is 0.021 mfd.

By far the greater proportion of government and commercial transmitting stations employ Dubilier Condensers, and the leading manufacturers of wireless receiving sets use Dubilier products.

Dubilier Products include:—Fixed Mica Condensers, Variable Air Condensers, Anode Resistances, Grid Leaks, the Ducon Aerial Adaptor, the Minicap Switch, the Dubrescon Valve Protector, and the Mansbridge Variometer. The Company are also sole concessionaires for the products of the Mansbridge Condenser Co., Ltd.

Specify Dubilier

REGISTERED  TRADE MARK

DUBILIER
CONDENSER CO (1925) LTD

VERT. OF THE DUBILIER CONDENSER CO. (1925) LTD., DUCON WORKS, VICTORIA RD., NORTH ACTON, W.3 TELEPHONE: CHISWICK 2241-2-3
E.P.S. 167

Advertisements for "The Wireless World" are only accepted from firms we believe to be thoroughly reliable.

OUR FREE OFFER

TEN DAYS ONLY

To introduce our New

"VARIODENSER"

we will send to all purchasers of this article during the next ten days a Halladay VERNIER DIAL free upon receipt of Coupon included with the order.

The "Variodenser" will, in ten seconds, give you any one of 65 values of fixed condenser simply by depressing one or more of the six knobs shown. 65 condensers at 2/6 each would cost you £8 2 6. We offer you the equivalent for

32/6 POST FREE

This instrument has been thoroughly tested by Birmingham Research Laboratories and also by some of the largest firms in the country: copies of report sent on request.

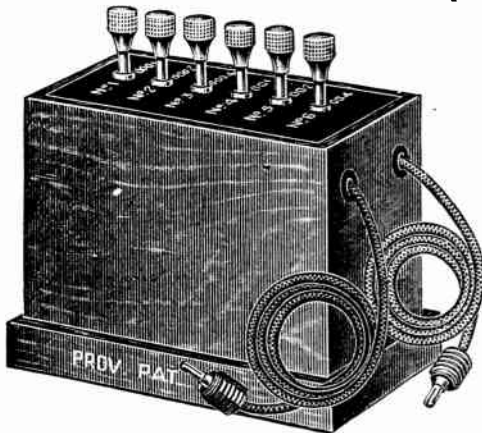

Send for the only Condenser of its kind and utility NOW.

HALLADAY'S LTD.
(RADIO SUPPLIES DEPT.),
TAME ROAD WORKS, WITTON, BIRMINGHAM

VERNIER DIAL



PRICE

4/6

EACH

Postage & Packing 6d. extra.

FOR SUPER PRECISION TUNING WITHOUT HAND CAPACITY.

In vernier position quite a considerable movement of the handle produces such a minute rotation of the Dial that it would be difficult to see that any had actually taken place, unless the vernier scale was provided. Coarse tuning is about six times finer than direct tuning, and yet when necessary the time occupied in covering the whole 180° is only slightly longer. Will fit any standard condenser: please specify whether plain or screwed spindle. To be obtained from the actual manufacturers.

No. NAME _____
ADDRESS _____

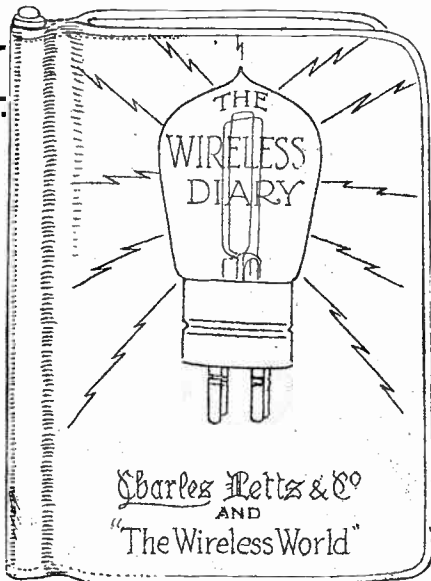

Charles Letts & Co
AND
"The Wireless World"

PRICES: Cloth Edition, 1/-, postage 1 1/2d. extra. Leather Case, with pockets, pencil and season ticket window, 2/6, postage 2d. extra.

Published jointly by

"The Wireless World," Dorset House, Tudor St., London, E.C.4., and Charles Letts & Co

W.W.31

The DIARY for WIRELESS ENTHUSIASTS

THE WIRELESS DIARY 1926

Compiled by the Editorial Staff of "The Wireless World."

Contains over 75 pages of indispensable information for all who take a keen interest in this fascinating hobby, including:

A revised list of Experimental Transmitting Stations. Hints for Aerials and Earths. Efficient Crystal Receivers. Practical One-valve, Two-valve and Three-valve Circuits. Neutrodyne and Supersonic Heterodyne Receivers. In addition—a convenient and well-printed diary giving one week at an opening.

Obtainable at all Booksellers and Railway Bookstalls.

PERFECT UNITY.

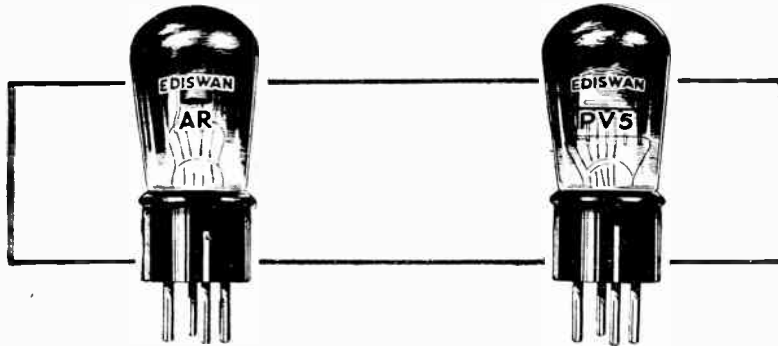

Use them together. Individually an Edison valve is always better—very robust—very long in life—very reliable in service. But it is in co-operation that Edison valves give their most remarkable results. You can test this on your own set.

Ediswan A.R. is a bright emitter type made to function either as a H.F. amplifier or detector (red line); or as a L.F. amplifier (green line). Ediswan PV5 is a dull emitter type requiring a filament voltage of 5 and particularly suitable for use with type A.R. The table below indicates the several combinations of Edison valves giving the best results.

EDISWAN VALVES

Will Improve ANY Set

The Valves to use.

Ediswan Valves are entirely British made.

Receiving.	Accumulator or Battery Volts.	Power.
AR	6	PV5
ARDE	2	PV6
AR'06	3	PV8

With these groups and Edison H.T. and L.T. Accumulators the ideal is attained.

THE EDISON SWAN ELECTRIC CO. Ltd.,
123-5, Queen Victoria Street, London, E.C.4.

ENSURE PERFECT RECEPTION

by using



**MILLIAMMETERS
VOLTMETERS
AMMETERS**

Prices from 7/-

If your dealer is out of stock write to:—

SIFAM ELECTRICAL INSTRUMENT CO.,
Dept. W, 95 QUEEN VICTORIA STREET,
LONDON, E.C.4.

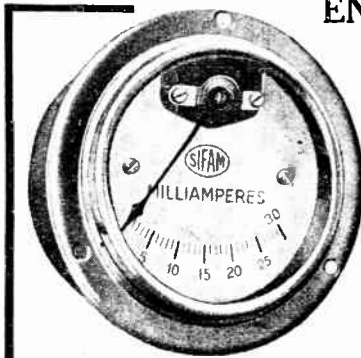

Flush or Projecting Types 25/-

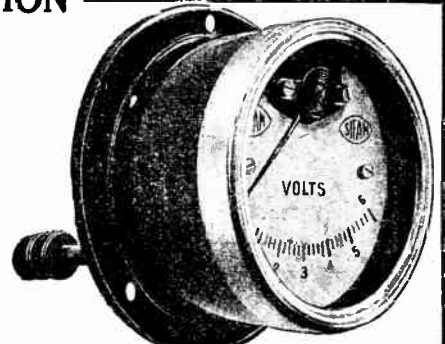

Flush or Projecting Types 25/-

THE CHOICE OF  RADIO EXPERTS

**Combined
WAVEMETER and FILTER**

Send for
**FREE
BOOKLET**
and
**COMPLETE
CATALOGUE.**



Type 237-W.

CUT OUT INTERFERENCE!

THREE INSTRUMENTS IN ONE! 1. Geared vernier precision condenser. 2. A direct reading wavemeter. 3. A series or parallel filter, made by the Leading American Radio Manufacturers and guaranteed. As a filter in series a single interfering station can be cut out. In parallel several stations can be cut out simultaneously and only one station within the filter range accepted. Range, Type 237-W, 200 to 600 metres. Guaranteed CALIBRATED. PRICE **57/6** Post Free.

When longer or shorter wavelengths are required the following extension coils can be interchanged:—

EXTENSION COILS.

Type 247-W ₂ (400/1200 metres)	} 12/6 Each.
" 217-W ₁ (100/300 "	
" 247-W ₁ (50/150 "	

Sole Concessionaire for Great Britain:—

Radio Specialist. **CLAUDE LYONS** Est. 1918.
76, Old Hall St., LIVERPOOL

'Phone: 4641 Cent.

'Grams: "Alfanetrom."

GENERAL RADIO CO.
OF
AMERICA

and now

The
**REFLEX
COIL**
mounted!

A combination of two such outstanding components as the Reflex Coil and the Reflex Coil Plug cannot fail to be appreciated by Wireless Enthusiasts who insist upon getting the utmost out of their sets. This new addition to the Reflex family more than makes its hereditary efficiency and its cost is remarkably low.

No. 25 ... 28	No. 200 ... 49
" 30 ... 28	" 250 ... 53
" 35 ... 28	" 300 ... 62
" 40 ... 29	" 400 ... 7-
" 50 ... 2 10	" 500 ... 7 6
" 60 ... 2 11	" 600 ... 8-
" 75 ... 3-	" 750 ... 9-
" 100 ... 3 2	" 1000 ... 10-
" 125 ... 3 6	" 1250 ... 11-
" 150 ... 3 8	" 1500 ... 12-
" 175 ... 4 3	

From all good dealers.
Get one for your set to-day!
REFLEX COIL CO. LTD.,
198, Lower Clapton Road,
London, E.5.
'Phone: CHassold 4853.

**REFLEX
means
BETTER
RECEPTION**

The BEST BOOKS on WIRELESS

The range of books published from the offices of "The Wireless World" covers every conceivable phase of wireless. Below are given a few selected titles. A complete list will be sent on request.

"The Thermionic Valve and Its Development in Radio Telegraphy and Telephony": by J. A. FLEMING, M.A., D.Sc., F.R.S. Price 15/- net. By Post 15/9.

"Continuous Wave Wireless Telegraphy—Part I": by W. H. ECCLES, D.Sc., A.R.C.S., M.I.E.E. Price 25/- net. By Post 25/9.

"Direction and Position Finding in Wireless": by R. KEEN, B.Eng., A.M.I.E.E. Price 9/- net. By Post 9/6.

"Thermionic Tubes in Radio-Telegraphy and Telephony": by JOHN SCOTT-TAGGART, F.Inst.P., A.M.I.E.E. Price 15/- net. By Post 15/9.

"Wireless Valve Transmitters": by W. JAMES. Price 9/- net. By Post 9/9.

"Calculation and Measurement of Inductance and Capacity": by W. H. NOTTAGE, B.Sc. Price 7/6 net. By Post 8/-.

"Wireless Telegraphy and Telephony": by H. M. DOWSE, M.I.E.E. Price 9/- net. By Post 9/6.

"Telephony without Wires": by R. A. COURSEY, B.Sc., F.Inst.P. Price 15/- net. By Post 15/6.

Obtainable from all booksellers or direct from the publishers:

LILFEE & SONS LTD., Dorset House, Tudor Street, London, E.C.4.

w.w.1

Figures to Remember



PETER PAN

— to be remembered

for the pleasure he gives, he has given, he will give. Besides there is the charm of his eternal youth. You want your valves to give you pleasure, to satisfy you; you would like them never to grow old. None will give you longer life or better service than 660 Valves. You have a wide range to choose from and each valve is specially designed to carry out its particular job.

There's the S.S.2 (Red Disc)—a 2-volt Valve for H.F. Amplification, suitable as a detector when followed by resistance or choke. Or again, the S.S.2 (Green Disc)—for L.F. Amplification—just the valve you want for small and medium-sized loud speakers.

Now let's consider the question of economy. These valves have a current consumption of only .3 amps. and further work at such a low temperature that the life of the filament is immeasurably increased—surely economy in the true sense.

And this is only the beginning of our interesting story. The S.S.3 valves have a current consumption of only .06 amps., while with the S.S.7—a wonderful Dull Emitter Power Valve, current consumption .1 amps.—no glow from the filament is visible when operating at the correct voltage.

For long life, good service, perfect tone, insist on Six Sixty Valves.



S.S.2 L.F.
(Green Disc)

Voltage - 2.0 volts
Consumption .3 amps.

PRICE 14 -

Ask your Dealer for
Leaflet S.S.1.7 for
full particulars.



BETTER BY SIX TIMES SIXTY

The Electron Co., Ltd., Triumph House, 109, Regent Street, London, W.1.

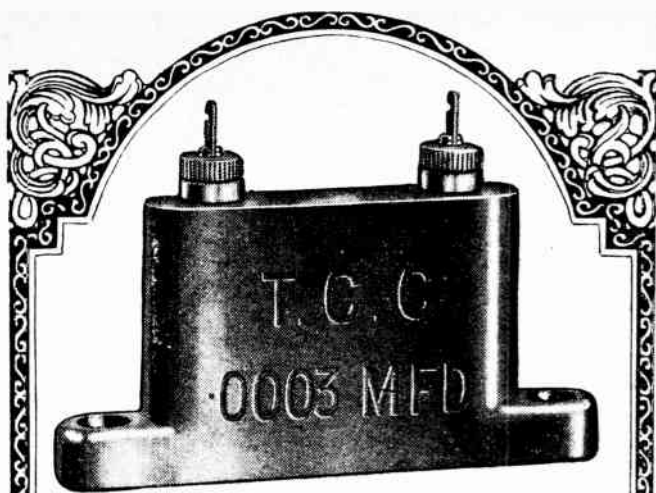

The new T.C.C. Mica Condenser

Here is the latest T.C.C. production—an accurate mica Condenser in a green moulded case with duplex terminals. Owing to its convenient shape it takes up very little room on the panel, and because it is sealed from below instead of from above it is proof against the heat of the soldering iron. For those who do not wish to solder their connections, a convenient milled head is provided to ensure a perfect electrical contact.

No need to ask if it is accurate —the name T.C.C. guarantees it.

Every T.C.C. Condenser—whether Mica or Mousbridge—has to pass so many tests before it is released for issue that its accuracy within a very small percentage of error is a foregone conclusion. Your fixed Condenser—on which so much depends—is one of the least expensive of all the components you buy. The difference in cost between one of doubtful reputation and a genuine T.C.C. may only be a copper

or two, yet the difference in results may be phenomenal. Experts say that the majority of faults in home-built receivers are traceable to the use of inferior and badly insulated condensers. If your own Set is not giving the results you should expect, suspect the condensers—substitute T.C.C. Mica (for small values) and T.C.C. Mousbridge (for large values) and you obtain a permanent insurance against Condenser breakdown.

Prices :

- No. 33, all capacities between .004 and .001 mfd. 2/4
- No. 34, all capacities between .0009 and .0001 mfd. 2/4

From all Wireless Shops.

T.C.C. Mica Condenser

Advertisement of Telegraph Condenser Co., Ltd., Kew, Surrey.

Gilbert Ad. 4641.

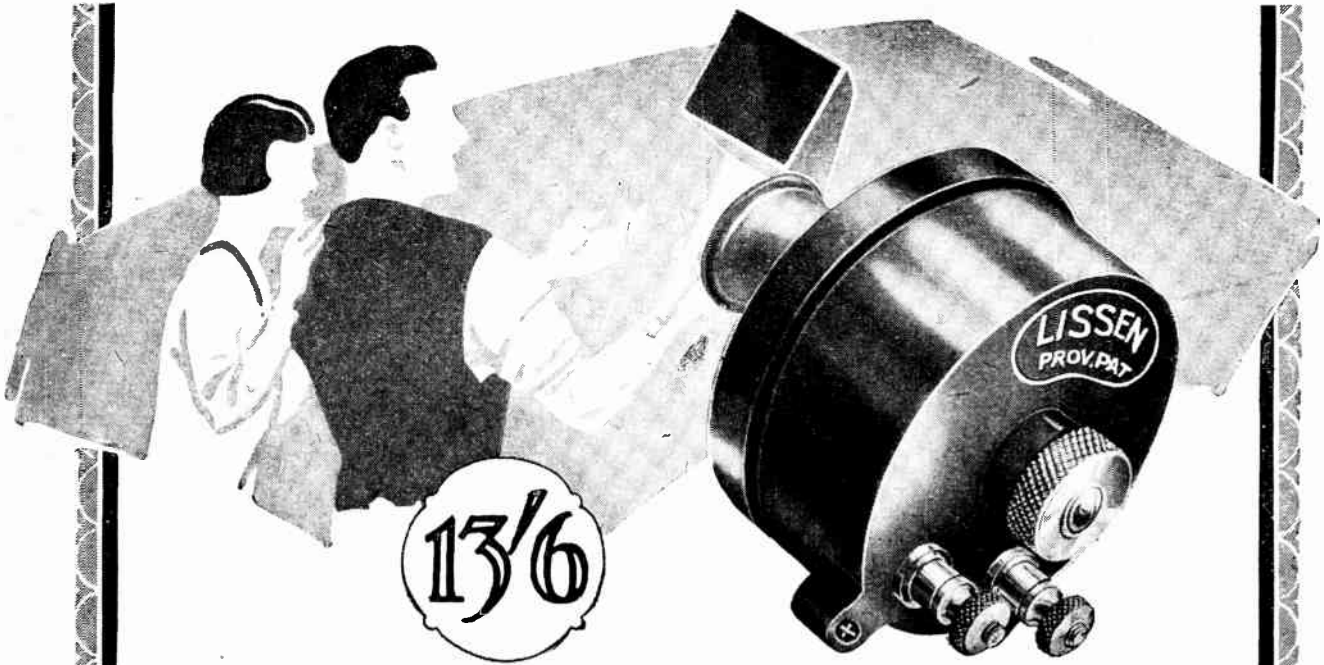

Now no home need lack a Loud Speaker

The introduction of the LISSENOLA at the amazingly low price of 13/6 has created an unparalleled stir. Unbiased critics seated behind a screen and asked to distinguish between a thirteen-and-sixpenny LISSENOLA and other loud speakers selling at several pounds have been completely at a loss.

Make the test for yourself: go to your nearest dealer and ask him to put on the best loud speaker in his stock. Then use the same horn on the Lissenola, and see if you can notice any difference.

THE LISSENOLA is sold exactly as illustrated above, and with every instrument are simple directions and full-size exact patterns which show you clearly how for a few pence to make a horn of proved efficiency to attach to it. Or if you possess a gramophone or any loud-speaker horn—or any horn or trumpet—that will serve admirably.

GET A LISSENOLA for your home—and build yourself a loud speaker fully equal in performance to the finest that money can buy. You can cover the horn with fancy paper, or wallpaper, and paint it to resemble a factory article. Also by using the "Lissen" Reed (sold separately for 1/-) the Lissenola will carry a cone, or any other diaphragm working on the reed principle.

Your dealer will gladly demonstrate and supply—or send postal order direct

BUY THE LISSENOLA and build your own loud speaker

LISSEN LTD., Lissenium Works, 16-20, Friars Lane, Richmond, Surrey.
 'Phone: RICHMOND 2285 (4 lines). 'Grams: "Lissenium, Phone, London."

Mention of "The Wireless World," when writing to advertisers, will ensure prompt attention



The "Lissenola" instantly converts any gramophone into a loud speaker.



A cone diaphragm loud speaker can easily be constructed. The illustration shows one method of mounting

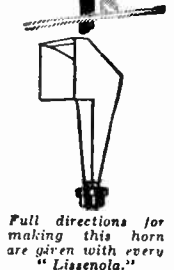

Full directions for making this horn are given with every "Lissenola."

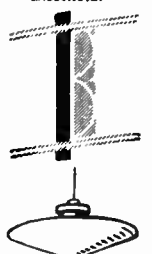

Another way of utilising the cone diaphragm method of construction



The "Lissen" R-A Attachment (pat. pending) for use with cone diaphragm loud speaker. Price 1/-.
 1/-

The Wireless World

AND
RADIO REVIEW
(13th Year of Publication)

No. 340.

WEDNESDAY, FEBRUARY 17TH, 1926.

VOL. XVIII. No. 7.

Assistant Editor:
F. H. HAYNES.

Editor:
HUGH S. POCOCK.

Assistant Editor:
W. JAMES.

Editorial Offices: 139-40, FLEET STREET, LONDON, E.C.4

Telephone: City 4011 (3 lines).

Advertising and Publishing Offices: DORSET HOUSE, TUDOR STREET, LONDON, E.C.4.

Telephone: City 2847 (13 lines).

Telegrams: "Ethaworld, Fleet, London."

COVENTRY: Hertford Street.

BIRMINGHAM: Guildhall Buildings, Navigation Street.

MANCHESTER: 199, Deansgate.

Telegrams: "Cyclist Coventry."
Telephone: 10 Coventry.

Telegrams: "Autopress, Birmingham."
Telephone: 2970 and 2971 Midland.

Telegrams: "H.50, Manchester."
Telephone: 2970 and 2971 City.

Subscription Rates: Home, £1 1s. 8d.; Canada, £1 1s. 8d.; other countries abroad, £1 3s. 10d. per annum.

As many of the circuits and apparatus described in these pages are covered by patents, readers are advised, before making use of them, to satisfy themselves that they would not be infringing patents.

RELATIVE STRENGTH IN BROADCAST RECEPTION.

IN the struggle after the ideal of quality in broadcast transmission and reception we are inclined to think that there is a tendency to overlook another consideration which may be regarded as of equal importance in obtaining the desirable ultimate result of absolute faithfulness in reproduction of the original.

Considering first of all the reproduction of music, it must be remembered that the "compass," as we may call it, of sound volume over which the broadcast microphone and transmitter can respond without producing loss of quality is limited. That is to say, if in any orchestral work, for example, the sound energy becomes very great, it is necessary to control the transmitter and reduce the amplification in order to bring the intensity within the compass of the transmitter. Similarly, with very weak passages it may become necessary to over-amplify the sound energy before transmission, so that the net result in a musical work of pronounced contrast in sound energy is that a certain amount of artificial levelling may take place.

Music in the studio is almost always played at what may be termed "concert strength," and concert strength is quite loud enough, if not a little too loud, to be pleasing in our homes when reproduced by the loud-speaker. Now, when an announcement is made or a talk is broadcast, what usually happens is that our set, being adjusted just as it was for music, now reproduces the voice with

a volume almost as great as was produced by an entire orchestra which performed the last item, whereas if a natural effect is required the voice should be very much weaker indeed. This unnatural amplification of the human voice produces an unpleasant effect which is only removed when either our receiver or the transmitter control is re-adjusted so as to reproduce the voice at a strength approximating to the original. This defect is, we believe, rather accentuated at the studio for two reasons: first, because speakers are often too near the microphone, and secondly because the speaker, knowing that he can rely on the amplifiers to boost up his voice to any required strength, may actually speak quite quietly, thereby losing a good deal of the character of the voice. If, now, we listen to a much amplified loud-speaker version of the original, it will certainly sound harsh and unnatural, for an artificially amplified weak voice will sound very much worse than a strong voice reproduced below natural strength. No doubt this is one of the reasons why crystal sets with head phones are so often preferred when listening to the human voice. A few simple tests on your receiver to ascertain the proper degree of

amplification to give to music and speech respectively will be found worth while by those who strive after quality and faithfulness, but we would much prefer that the correction should be made at the transmitter. This observation was raised in the interests of music in evidence given before the Broadcasting Committee, and it was suggested that certain works might be specially "scored" to suit the particular requirements of broadcasting.

CONTENTS.

	PAGE
EDITORIAL VIEWS	239
LOW LOSS COIL TESTS	240
COMPLICATIONS OF CRYSTAL RECEPTION	245
By W. H. F. Griffiths.	
AMATEUR EXPERIMENTAL STATION 6RJ	251
By A. H. Howe.	
SUPERHETERODYNE OSCILLATOR DESIGN	254
By Harold H. Warwick.	
CURRENT TOPICS	257
NEWS FROM THE CLUBS	259
PRACTICAL HINTS AND TIPS	261
PIONEERS OF WIRELESS.—7. MICHAEL FARADAY	265
By Ellison Hawks.	
READERS' NOVELTIES	265
BROADCAST BREVITIES	267
WIRELESS CIRCUITS IN THEORY AND PRACTICE	269
By S. O. Pearson.	
NEW APPARATUS	272
DICTIONARY OF TECHNICAL TERMS	274
LETTERS TO THE EDITOR	276
READERS' PROBLEMS	279

to ascertain the proper degree of amplification to give to music and speech respectively will be found worth while by those who strive after quality and faithfulness, but we would much prefer that the correction should be made at the transmitter. This observation was raised in the interests of music in evidence given before the Broadcasting Committee, and it was suggested that certain works might be specially "scored" to suit the particular requirements of broadcasting.

Low Loss Coil Tests

Results of High-
Frequency Measurements
on Readers' Coils.

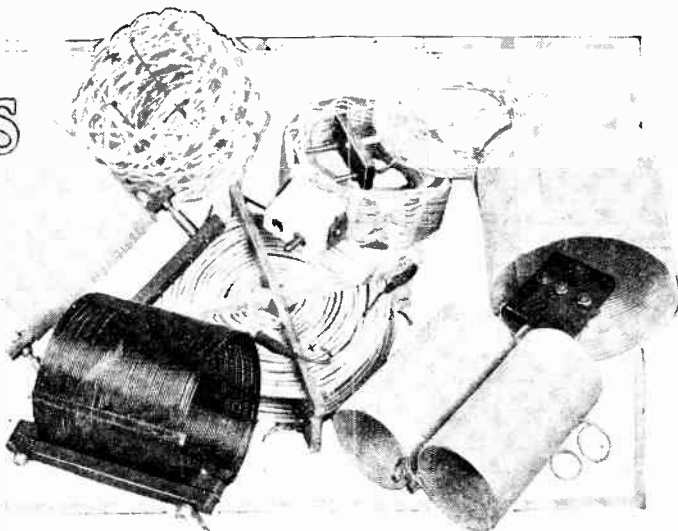

THE subject of the design of the most efficient type of inductance coil has always been of interest both to the professional and to the amateur, but the constant and casual use of the expression "Low-loss coil" prompted us some time ago to undertake to test specimen coils of different types submitted by readers with a view to providing valuable data on this most important subject.

The number of coils submitted ran into hundreds, and this provides the explanation for the delay in publishing results, because, partly in view of the fact that a prize of £5 was offered for the best coil submitted, it was necessary that all coils should be tested before commencing the publication of reports. It will, of course, be understood that the number is far too great for us to deal with every coil through the pages of the journal, but particulars are being sent to every entrant when his coil is returned to him, and the most interesting and representative types will be dealt with here and in a further article which will appear later. We hope next week to announce the winning coil of the competition,

and we also hope to make some comments on any outstanding points of technical interest which these tests have revealed.

If a tuning coil is measured it is found to possess inductance capacity and resistance. The inductance, of course, is what we want, and part of the problem when designing a tuned circuit is to determine the dimensions of a coil which will tune over a given wavelength range with a variable condenser. This is relatively a simple matter in practice, for the manufacturer of the condenser it is proposed to use will give its maximum and minimum values, the stray circuit capacities can be allowed for, and it is easy enough to construct a coil of the required value as found from the wavelength and inductance formula. But even when we know the exact inductance of the coil at the frequency or wavelength at which it is to be used and the exact values of the capacities shunted across it, we cannot work out the precise wavelength to which the circuit will tune, because we have neglected the capacity of the coil itself.

In coils of the low-loss type this capacity, which may



Multilayer coil of stranded wire. Inside diameter, 2in.; outside diameter, 3 1/8in.; length, 1 1/8in. Inductance, 115 microhenries; resistance, 4.5 ohms.



Multilayer coil of No. 22 D.C.C. Inside diameter, 2 3/4in.; outside diameter, 4 1/4in.; inductance, 131 microhenries; resistance, 4.2 ohms.

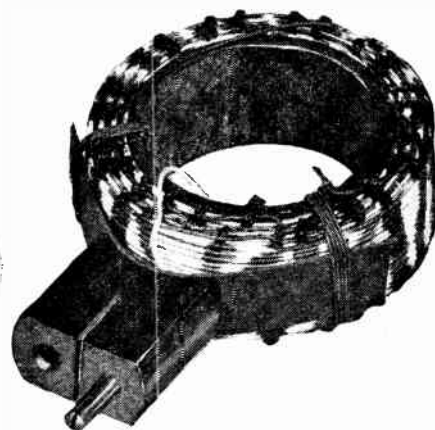

Multilayer coil of 70 turns of No. 24 D.C.C. Inside diameter, 2 1/4in.; outside diameter, 2 7/8in.; length, 1in.; inductance, 100 microhenries; resistance, 28.5 ohms. The high resistance is due to the type of winding employed

Low Loss Coil Tests.—

be considered as in shunt with the terminals of the coil, is quite small, just a few micromicrofarads. But still, it is there and acts to reduce the extreme tuning range with a given variable condenser, although this is rarely a matter of any account in actual practice. For instance, in a tuned anode circuit—a parallel or rejector circuit—

we need not worry unduly as to the harmful effects produced by self-capacity as such, the self-capacity limiting the wavelength range to only a negligible extent, because coils of the type we are considering for the lower broadcast band of wavelengths will normally have a self-capacity of only a few micromicrofarads, which is generally lower than the useful minimum of the tuning condenser. What we must not lose sight of, however, is the fact that the condenser formed by the turns of wire

of the coil, the end connections, etc., is generally a bad one, that is, its dielectric is such that there is a loss of power. In other words, the self-capacity of a coil acts to increase its effective high-frequency resistance, and efforts to reduce one of these properties usually result in a reduction in the other. It is a fact that low H.F. resistance and low self-capacity go together, provided the

point of view. On the other hand, if selectivity is the main requirement, tuned circuits can be designed to have the lowest possible losses, for then the selectivity will be a maximum.

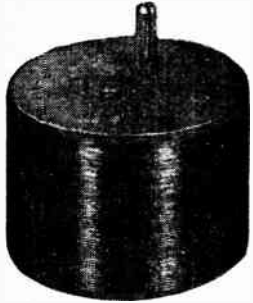

Small single-layer coil of No. 30 enamelled wire. Diameter, 1 7/8 in.; length of winding, 1 1/4 in.; inductance, 140 microhenries; resistance, 6.3 ohms.

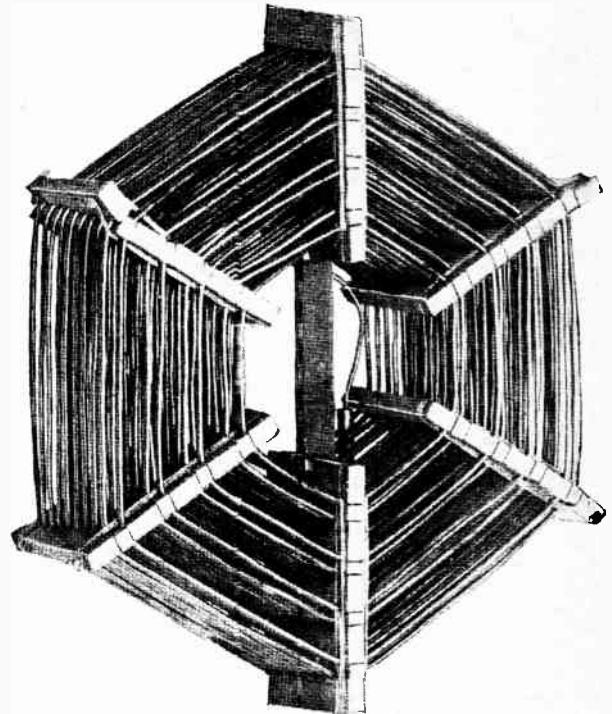

Large multi-layer coil, with ebonite spacers wound with 70 turns of No. 18 enamelled wire. Inside diameter, 1 7/8 in.; outside diameter, 4 1/8 in.; length, 1 1/4 in.; inductance, 292 microhenries; resistance, 14 ohms.



A cardboard former is used, and the construction will be seen from the illustration. There are 40 turns of No. 27 D.C.C. Inside diameter, 1 1/2 in.; outside diameter, 3 1/8 in.; inductance, 88 microhenries; resistance, 3.1 ohms.

There is a close connection between circuit losses and signal strength, their exact dependence being governed by the circuit arrangement employed. For instance,

self-capacity feature is not overdone and we confine ourselves to normal coils.

To provide coil-condenser combinations which will cover the desired wavelength range, however, is but a portion of the problem which has to be faced when designing the high-frequency circuits of a receiver. We do not always want the coil with the lowest losses. To put a "low-loss" coil in a circuit having a relatively high series resistance is not wise, for probably a smaller coil with larger losses will serve equally as well and reduce stray coupling difficulties. Again, if we intend to use three or four filter circuits in a broadcast receiver, the circuits can have too low a resistance from the quality

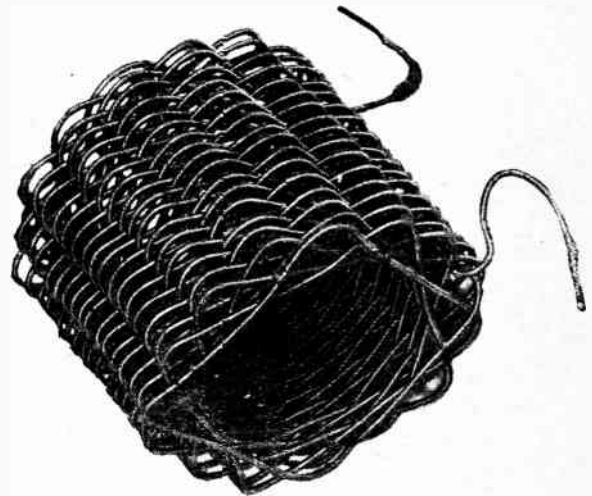

A loosely wound basket weave coil. 64 turns of No. 16 D.S.C.; mean diameter, 3 in.; length, 3 in.; inductance, 130 microhenries; resistance, 3.8 ohms.

in a simple tuned anode circuit the effect of the loss due to resistance of the circuit upon amplification depends upon the impedance of the valve and the ratio of tuning

Low Loss Coil Tests.—

capacity to inductance. A certain amount of resistance can usually be tolerated here, for the amplification obtained depends on the ratio of the circuit impedance to the impedance of the valve, this being a maximum when the circuit is tuned to resonance with the incoming signal. No practical advantage is to be gained by making this impedance ratio too large, so that the losses of the circuit, which are practically wholly confined to

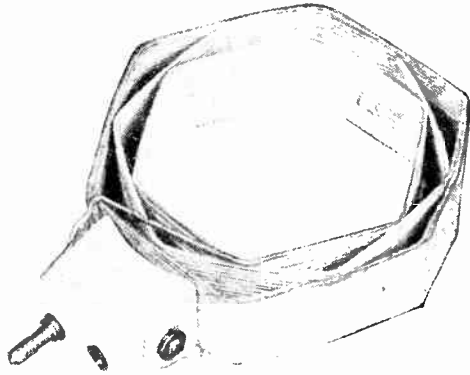

Three-layer plug-in coil, having 60 turns of No. 20 D.C.C. Distance between two inner faces, 2.58 in.; and between the two outer faces, 3.12 in.; inductance, 253 microhenries; resistance, 16.2 ohms.

the coil (except when the condenser is set at its low reading end) can be allowed to be higher than when the circuit is connected direct to the grid-filament of a valve and is loosely coupled to the preceding circuit.

When Losses are Permissible.

The losses can also be permitted to be higher the lower the impedance of the valve that is used. The magnification will be about the same. For example, from a tuned anode stage comprising a 10,000-ohm valve and a 200-microhenry coil with a 15-ohm loss resistance at

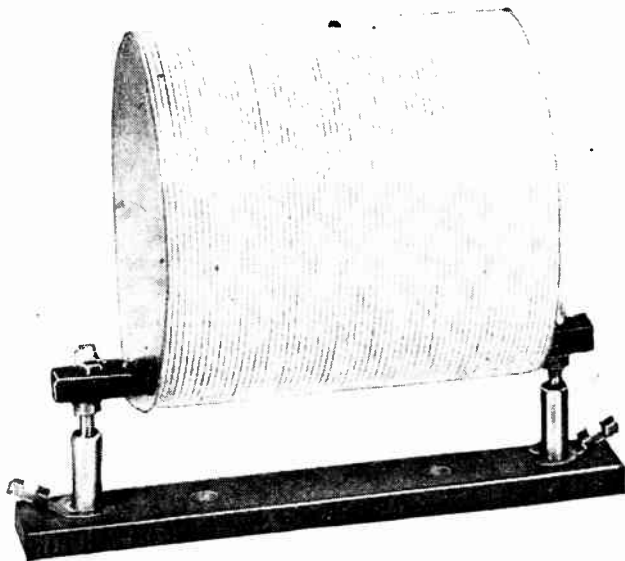

Single-layer coil wound on celluloid, 0.01 in thick, having 64 turns of No. 22 D.C.C. wire with No. 30 S.W.G. spacing. Impregnation, thin solution of celluloid in acetone; length, 3.18 in.; diameter, 3 in.; inductance, 179 microhenries; resistance, 4 ohms.

400 metres as with a similar circuit but substituting a 30,000-ohm valve and a 3-ohm coil, assuming both valves to have the same amplification factor.

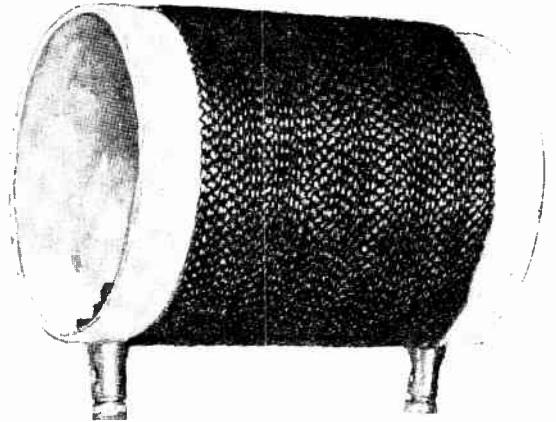

Coil wound on fused quartz (Vitreosil) former. 3 in. diameter; 51 turns, wound with Belling-Lee air-spaced wire, No. 24 gauge; inductance, 130 microhenries; resistance, 2.8 ohms.

What, then, is the use of a "low loss" coil? With a "low loss" coil properly connected, we can get higher magnification and better selectivity, and a practical ex-

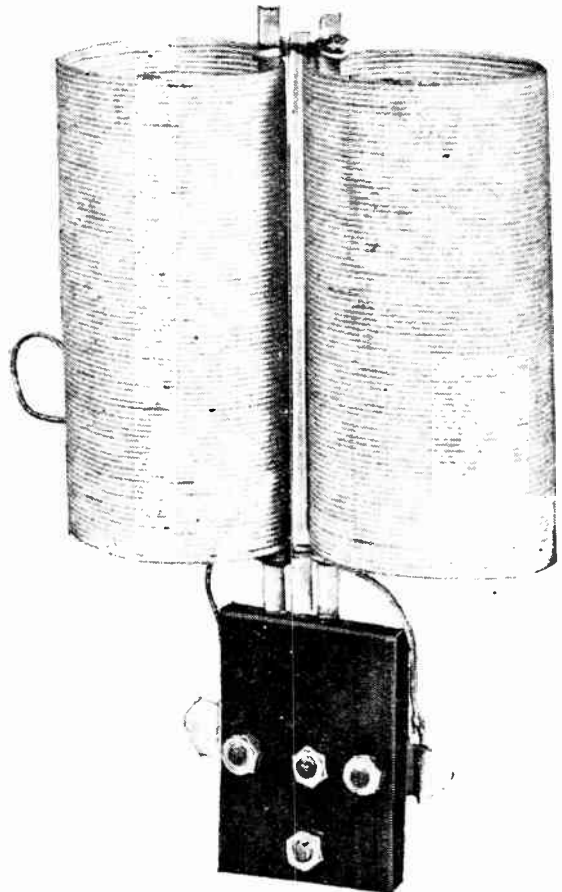

A rather special coil having two windings joined in series. The coils are 1.58 in. in diameter, and 2.58 in. long; both have 86 turns. The coils are connected together at the top. The wire is No. 22 D.C.C. Inductance, 225 microhenries; resistance, 8.5 ohms. Coils of this type have been called "binocular" coils.

Low Loss Coil Tests.—

ample of this was given in the article "Oscillation Without Radiation," which has recently appeared in this journal.

Measuring H.F. Resistance.

There are several methods of measuring the high-frequency resistance of a circuit, two of them being of

the desired frequency. The circuit containing the coil is tuned to resonance, as indicated by the maximum reading of the ammeter: then a resistor of known H.F. resistance is inserted in the circuit, and the current at resonance is

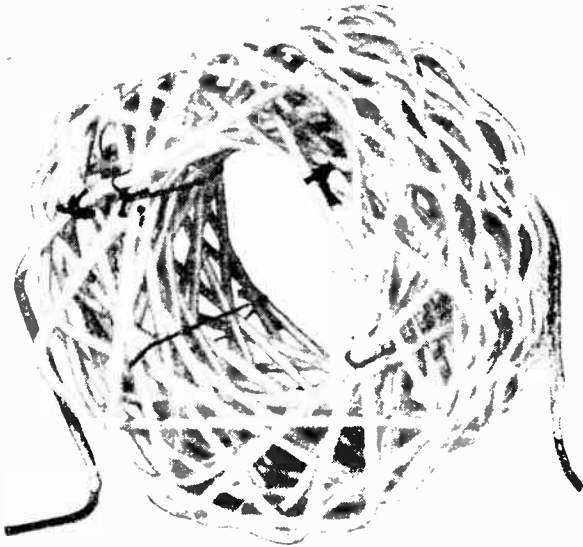

Coil of No. 15 D.C.C. wire, having an inductance of 35 microhenries, and a resistance of 1.2 ohms. The coil is about 2 1/4 in. long and 3 3/4 in. in outside diameter.

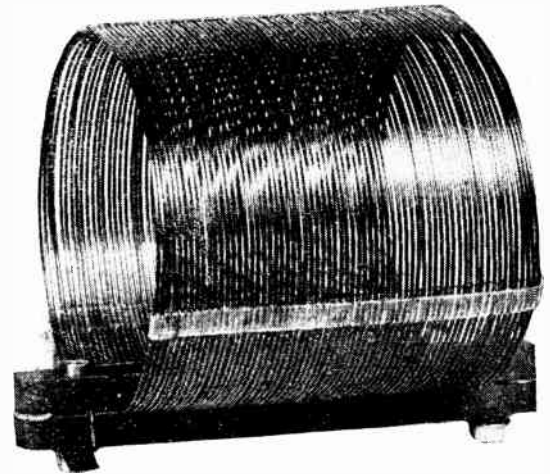

Single-layer coil, 3 1/4 in. long, 3 in. in diameter, of No. 22 enamelled wire. The turns are held together by three strips of celluloid and an ebonite clamp, which also carries the contacts. Inductance, 180 microhenries; resistance, 3.8 ohms.

again measured. The resistance of the circuit is given by

$$R = \frac{I_r}{I - I_r} R_r \text{ ohms}$$

where

- R = the resistance of the circuit.
- R_r = the resistance of the added resistor,
- I = the current at resonance without the resistor,
- I_r = the current when the resistor is in circuit.

special interest. These are known as the resistance variation and the reactance variation methods. In the resistance variation method the coil to be tested is joined in series with a tuning condenser and ammeter, and current is induced from a valve oscillator generating currents of

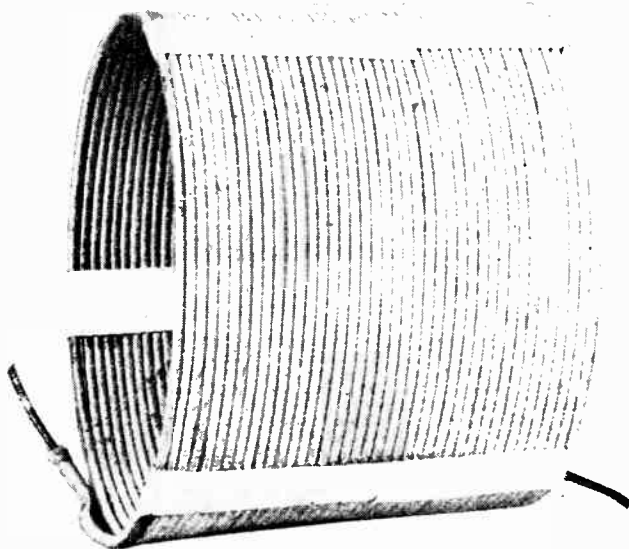

Thick wire self-supported coil, 3 3/4 in. diameter, having 42 turns of No. 16 D.C.C. Inductance, 102 microhenries; resistance, 1.5 ohms.

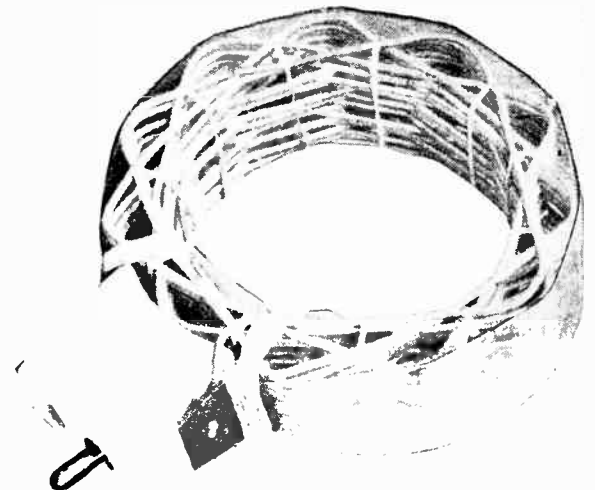

Plug-in coil, having a mean diameter of 3 1/4 in. and a winding length of 1 1/4 in., wound with No. 18 D.C.C. The inductance is 56 microhenries and resistance 1.2 ohms.

The accuracy of the result will depend a good deal on the care taken during the experiment. It is necessary, for instance, to employ a powerful source of oscillations, so that a weak coupling can be used with the circuit being tested, and to limit so far as possible electrostatic coupling.

The reactance variation method employs a calibrated

Low Loss Coil Tests.—

tuning condenser, and the coil to be tested is connected in series with this condenser and an ammeter, while the source of undamped oscillation is loosely coupled to the coil. To determine the resistance of the circuit, the ammeter reading is noted when the condenser is adjusted to tune the circuit to resonance with the source, and then the condenser is varied a little, and the new condenser reading and the current are noted. Then the resistance of the circuit is given by

$$R = X_1 \sqrt{\frac{I_1^2}{I^2 - I_1^2}} \text{ ohms.}$$

R being the resistance of the circuit in ohms,
 X_1 the reactance of the condenser,
 I_1 the current when the circuit is detuned,
 I the current at resonance.

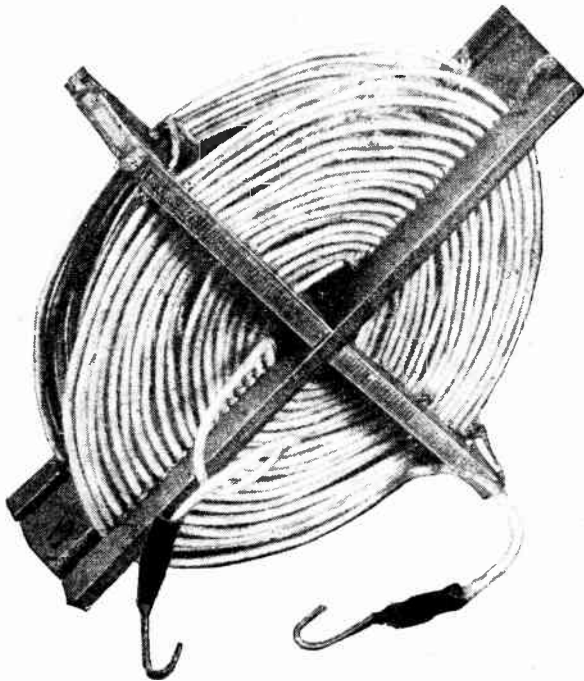

A coil consisting of two separate flat coils mounted side by side, connected in series. The inner diameter of each coil is 1 in. and the outer diameter 4 1/2 in. The wire is No. 16 D.C.C. The coils are mounted 3/4 in. apart. A former of 3-ply wood is used to hold the coils in position. The inductance came out at 250 microhenries, and the resistance at 5 ohms.

This method is perhaps not such a good one to employ as the resistance substitution method first described, for the reason that only a very small change in the condenser is usually required. The resistance variation method was used in the "low loss" coil tests, and all measurements were made at 400 metres.

From the value of resistance obtained by either of the above methods, the resistance of the meter and the condenser must be subtracted. The resistance of the meter is usually several ohms, while that of the condenser is often only a fraction of an ohm, and for many purposes there is no need to bother about the condenser resistance, provided it is a reasonably well-made instrument. When comparing coils, for instance, the tuning condenser which

will be used for tuning the coil in the receiver can be employed in the test circuit, and no attempt need be made to allow for its losses.

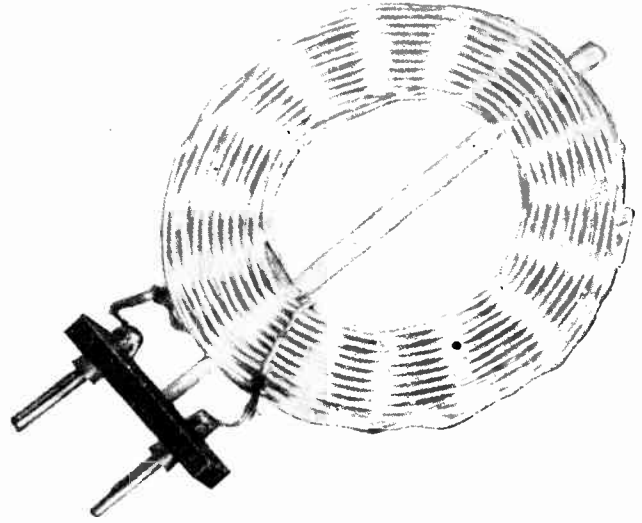

Basket coil fitted with a home-made plug mounting. Inside diameter, 2 1/4 in.; outside diameter, 4 in.; wound with No. 20 D.C.C. wire. Inductance, 128 microhenries; resistance, 5.8 ohms.

The coils tested are of all shapes and sizes, and, unfortunately, part of the value of the tests is lost because the coils vary so widely in inductance value. But the material obtained from the tests is of great interest, for it shows the H.F. resistance and inductance of the coils at 400 metres, and general conclusions of great value can

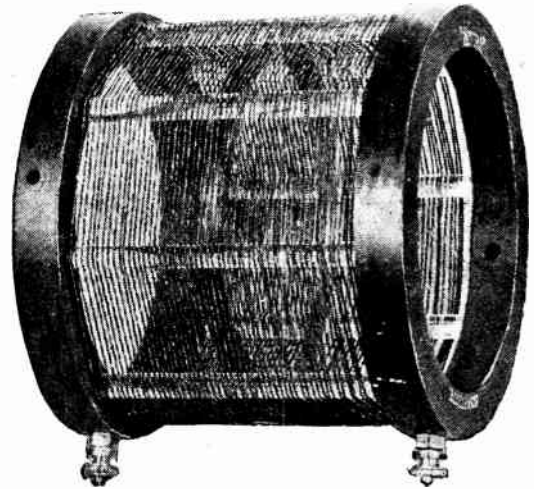

Single-layer coil wound on a Quartzite former, comprising two ebonite rings, having a mean diameter of 2 15/16 in. and a winding length of 2 3/8 in. Eight glass rods are used, the coil having 55 turns of Litz wire. The inductance of the coil is 164 microhenries, and its resistance is 3.2 ohms. Another coil of similar construction is No. 18, with ebonite rings having a mean diameter of 2 15/16 in. and 55 turns of Litz wire, occupying a length of 3 3/16 in. The inductance of this coil is 141 microhenries, and its resistance is 2 ohms.

be drawn from the figures. Some from amongst the more interesting coils are illustrated here, and beneath each figure will be found the details of the coil illustrated. Further illustrations and data on individual coils will be included in a further instalment.

W. J.

COMPLICATIONS OF CRYSTAL RECEPTION.

Effect of Crystal Loading on Signal Strength.

By W. H. F. GRIFFITHS.

THE chief complication which occurs in a crystal receiver is, of course, due to the heavy loading of the tuned aerial system with which the crystal detecting circuit is associated. In other words, the whole of the energy for actuating the telephone receivers has to be obtained directly from the aerial circuit, only a portion of that actually received in the form of electromagnetic waves being available. This is the great point of difference between the crystal and valve receiver, the latter being merely a thermionically operated relay, the energy from the resonant aerial being required only to operate the relay *potentially* so that the load resulting does not limit the current in the receiving aerial. Due to this fact that the input circuit of a valve receiver does not very appreciably augment the losses in the aerial circuit, the full aerial current is available for producing a high potential difference across the aerial tuning inductance; and, moreover, as is well known, in the case of a regenerative valve receiver the initial losses of the aerial circuit itself are still further reduced by means of this relay principle, thus, by increasing the aerial current I , and very considerably increasing the reactive potential ωLI across the aerial tuning inductance L , the signal strength is enormously increased and tuning wonderfully sharpened. Even the loading of a valve receiver acts as an aerial current limiting factor when the aerial is of the frame or loop form and the experimenter is tempted to push up the ratio of inductance to capacity of the loop circuit in order to obtain more "area-turns." When ωLI of the loop becomes comparable with the input impedance of the valve across which it is connected, then the load augmentation by the latter very often more than negatives any E.M.F. increase due to an increase of "area-turns."

Ratio of Inductance to Capacity.

This state, however, does not occur until the ratio of inductance to capacity becomes very high, and in this respect is the loop-fed valve receiver an extreme case of the crystal receiver, for, in the latter case, the load impedance (of necessity since its energy is required for actuating, directly, the telephone receivers) is of a suffi-

Since the commencement of Broadcasting several excellent articles, mathematical and otherwise, have been published in this journal and elsewhere dealing with the complications of crystal reception and showing methods of obtaining the greatest possible efficiency from crystal receivers. It is thought, however, that an article written expressly with the intention of showing clearly, with the aid of curves, some of the complications which occur, and how they can be analysed, will be of interest to a large number of experimenters.

ciently low order to be comparable with even the moderate values of " ωL " met with in ordinary open aerial practice with single-circuit tuning. The degree of detector circuit loading and consequent damping varies even with different classes of detecting crystals, becoming more important, naturally, with the lower resistance crystals, notably with the galena-catwhisker variety, and the figures and curves given in this article will contrast the behaviour of "Perikon" combinations and galena in this respect.

Effect of Crystal Loading on Resonant Voltage.

It is difficult to make a choice of crystal and type of aerial tuning circuit if one has no knowledge of the effect of the loading of the latter by the former, more especially for a given type and size of aerial. The choice of aerial for any crystal receiver is not, however, difficult, as this becomes for crystal circuits, "the larger the better," the limits to dimensions being nearly always of a practical constructional nature rather than of electrical constants. The notes and curves which follow nearly all refer to practice with a moderately large aerial of twin "T" form about 30ft. high and 70ft. long.

The effect of loading by a crystal upon an aerial tuning circuit is clearly shown by the curves of Fig. 1, which were plotted from results obtained with the above-described aerial when tuned with an inductance of about 100 mhys. and a parallel variable air condenser of about 0.0005 mfd. maximum capacity. The actual value of inductance was, in each case of loading, adjusted to such a value that absolute resonance or tuning occurred at the same point of the condenser scale, 17.6 degrees. Curve V_0 is the resonance curve of the aerial circuit when no crystal load is applied to it, which may be called the no-load resonance curve. The only loading was that, negligible in the present case, introduced by the thermionic voltmeter by which the potential differences across the aerial inductance were measured.

The test circuit showing the voltmeter connected across the inductance is given in Fig. 2 (a), and the curve V_0 gives the P.D. across the coil "L" for various settings of the condenser when the latter is varied through the

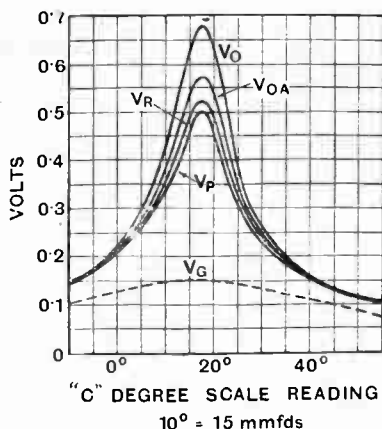

Fig. 1.—Resonance curves of potential difference across the aerial tuning inductance.

Complications of Crystal Reception.—

resonance point. The voltage thus measured by the voltmeter must not be confused with the E.M.F. induced into the aerial by the advancing electromagnetic wave-front. This latter initial E.M.F. is a constant, quantitatively given by the product of the potential gradient of the advancing waves (in millivolts per metre) and the effective height of the aerial. It is constant irrespective of the

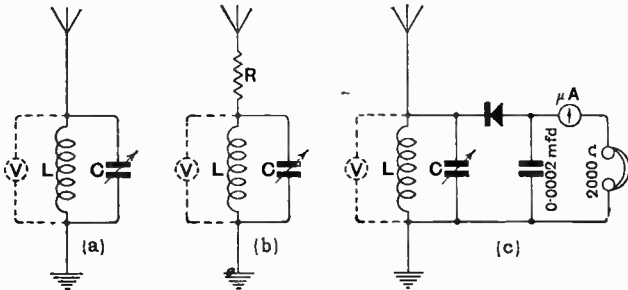

Fig. 2.—Circuits with which the curves of Figs. 1, 4, 5 and 6 were obtained.

tuning of the aerial, this latter operation merely reducing the impedance of the aerial system so that, at resonance, a maximum current will flow as a result of this applied E.M.F.

Aerial Current at Resonance.

At resonance the aerial current is limited only by the effective high-frequency resistance of the aerial system as augmented by that of the aerial coil and any other apparatus associated with it, and it is this current which, in flowing through the aerial inductance L , produces the reactive voltage ωLI , much greater than the applied E.M.F. of the impinging wave-front. It is this reactive voltage which is measured by the voltmeter V .

When receiving from 2LO on 365 metres 10 miles distant, the maximum P.D. obtained across the coil at resonance will be seen to be 0.68 volt and the sharpness of tuning such that a capacity change of 10 mmfd. reduced the voltage to half this value. As an illustration of the effect of damping upon this curve, a non-reactive resistance of 10 ohms was inserted in the aerial lead as shown by R in Fig. 2 (b), the voltage was thereby reduced to about 0.52 volts maximum and the curve V_R (Fig. 1) was obtained. Besides reducing the maximum "resonant" voltage this added resistance has the effect, of course, of rendering the "tuning" somewhat less sharp as the curve shows, a detuning of 17 mmfd. being now required to produce a 50 per cent. reduction in voltage.

While studying resonance curves it will, no doubt, be

interesting to the reader to see the effect produced upon the voltage by the energy absorbed by an adjacent aerial of quite small dimensions. The curve V_{0A} was taken when an aerial only 10ft. high and 25ft. long and 25ft. away from the receiving aerial was tuned to resonance with the received wave, the absorption having the effect of reducing the resonant voltage by 16 per cent., and it will be seen later that the signal strength is correspondingly reduced (see Fig. 3). For other phenomena in connection with the interference from adjacent aeri-als the reader is referred to an article specially dealing with this subject by the present author.¹

Crystal Damping.

Now, instead of damping the aerial circuit by the introduction of additional series resistance, the detector circuit of Fig. 2 (c) was joined across L . The circuit consisted of a Perikon crystal, moving coil microammeter and telephone receivers of 2,000 ohms resistance, with the usual by-pass condenser of 0.0002 mfd. capacity. Upon referring to Fig. 1 it will be seen that the resonance curve V_P obtained with this parallel loading of actual practice is not far different from that obtained with 10

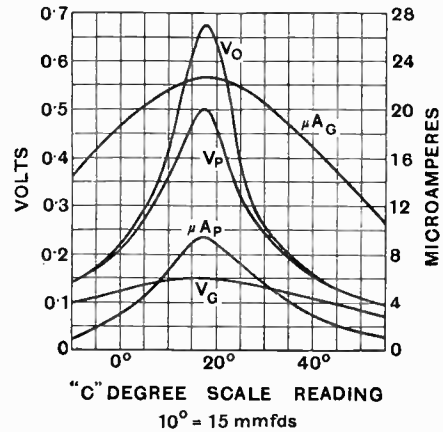

Fig. 4.—Resonance curves of voltage and rectified telephone current obtained with galena (G) and Perikon (P).

ohms in series, showing that the Perikon crystal loading may be regarded as an equivalent series resistance of this order. From the curve V_P it is seen that the voltage available for application across the Perikon detector circuit is only 73 per cent. of the no-load voltage, while the tuning is made less sharp to an extent that can be gauged by the fact that a capacity detuning of 18 mmfd. is now required to effect a 50 per cent. voltage reduction. This reduction of voltage and selectivity is not very serious, because Perikon has a fairly high effective resistance, but a much more serious case for consideration is that of a galena crystal.

The resonance curve of voltage obtained when a galena crystal is substituted for the Perikon combination is given approximately by the curve V_G (Fig. 1), and here it is at once seen that the loading effect of a low-resistance crystal is extremely serious. The maximum voltage at resonance is reduced to about 22 per cent. of the no-load resonant voltage and a capacity detuning of about 60

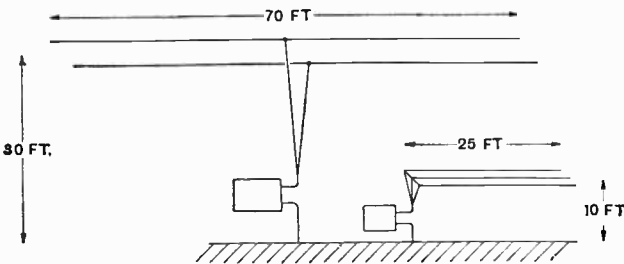

Fig. 3.—Large receiving and small absorbing aeri-als.

¹ *Wireless World and Radio Review*. Vol. XVI., Nos. 303 (page 550) and 304 (page 591). June, 1925.

Complications of Crystal Reception.—

mmfd. is required to effect a 50 per cent voltage reduction.

In view of this serious loading effect it may at first be thought to be impossible to get a great overall efficiency from the galena crystal receiver, but this is certainly not the case, for, leaving for the moment the flatness of tuning

reception from 2LO (365 metres) at a distance of 10 miles. It is, perhaps, of interest here to show the effect of tuning the neighbouring aerial upon the voltage and rectified telephone current when using Perikon (Fig. 5) and galena (Fig. 6). In each case the dotted curves indicate the reduction of voltage and rectified current due to energy absorption by this very small aerial ; with Perikon a 20 per cent. signal strength reduction and

with galena only a 5 per cent. reduction owing to the fact that, in this case, the augmentation of the effective resistance of the large receiving aerial by the absorption of the small aerial was not so appreciable compared with the total effective resistance of the aerial system (as already augmented by the parallel loading of the detector circuit) as was the case when Perikon was used.

It has previously been explained that serious damping effects, such as that of the galena crystal detector circuit just described, become even more serious with smaller

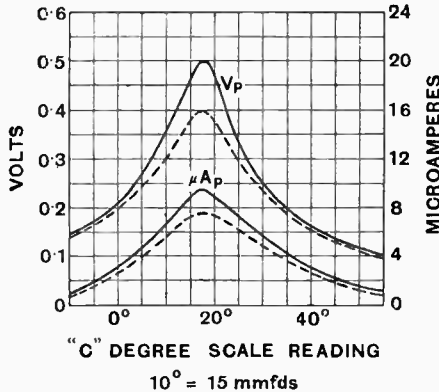

Fig. 5.—Reduction of volts and rectified current (Perikon) due to absorption by neighbouring aerial.

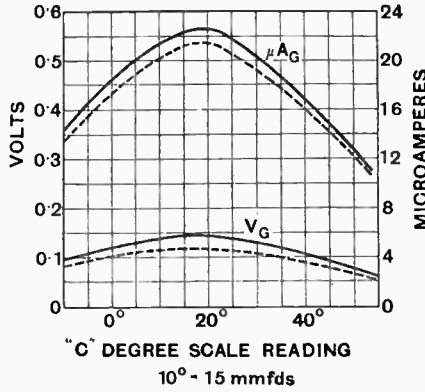

Fig. 6.—Curves corresponding to those of Fig. 5, with galena as the rectifying crystal.

objection, a far greater rectified telephone current is obtained from galena than would be obtained from Perikon for the same potential across the inductance, so much so that, although Fig. 1 shows so decidedly in favour of Perikon as regards resonant voltage, the rectified telephone current obtained when using this crystal combination is only 42 per cent. of that obtained when using galena. The complete curves of rectified telephone current plotted against tuning settings about resonance are given in Fig. 4.

The curve μA_P indicates the rectified current obtained with the Perikon crystal and μA_G that obtained when

aerials or when tuning circuit adjustments increase the value of the aerial tuning inductance. As proof of this the circuit of Fig. 7 was used in order to obtain larger values of inductance by employing a series tuning condenser C₁ of 0.0012 mfd. maximum capacity.

Effect of Tuning with Series Condenser.

The results from the use of this circuit for reception from 2LO give the very interesting set of curves of Fig. 8. These curves show resonant voltages across the inductance L and rectified telephone currents for various

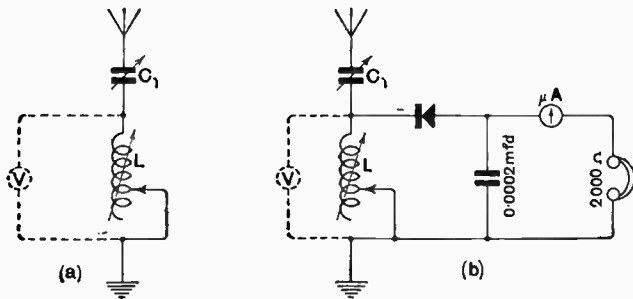

Fig. 7.—Circuits for curves in Figs. 8, 9, 10 and 11.

using galena; whilst for a comparison of curve shape the voltage curves V_O, V_P and V_G of Fig. 1 have been reproduced in this figure. Although the rectified telephone current from galena at resonance (22.8 microamperes) is so much greater than that from Perikon, it obviously suffers from the disadvantage of tuning flatness as was to be expected from its corresponding voltage curve V_G. It is necessary to detune from resonance by a capacity change of 52 mmfd., in order to effect a 50 per cent. signal strength reduction, whereas with Perikon a capacity detuning of only 22 mmfd. will effect a similar reduction. All these curves were plotted from results of

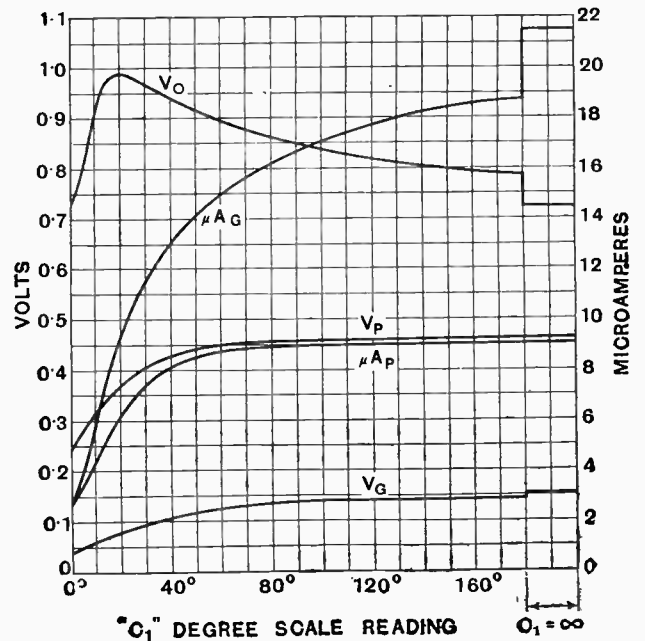

Fig. 8.—Effect of series aerial condenser upon resonant voltage and rectified telephone current.

Complications of Crystal Reception.—

values of series capacity, the inductance for each capacity setting being adjusted to tune the aerial circuit to resonance with the incoming signal wave. The curve V_0 shows how the resonant voltage increases in value as the series capacity is reduced, *i.e.*, as ωL is increased, when no crystal load is applied [circuit as Fig. 7 (a)]. Under this condition a maximum resonant voltage of 0.99 volt was obtained when the series condenser was adjusted to 20

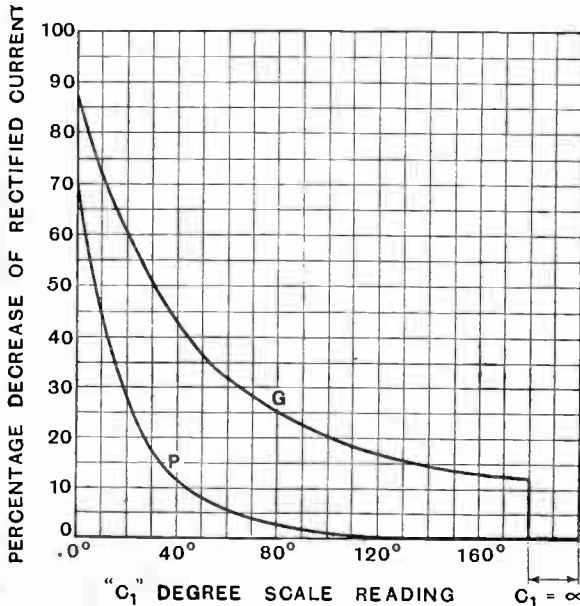

Fig. 9.—Decrease of signal strength due to use of series condenser (P = Perikon, G = galena).

degrees, an increase of 38 per cent. over the volts obtained when using only a variometer to tune the aerial, *i.e.*, when $C_1 = \infty$ (infinity).

For values of series capacity below 20 degrees the resonant volts fell off sharply due to a variety of causes, among which may be mentioned the increase in apparent resistance of the inductance L caused by its distributed capacity becoming comparable to the total capacity of the aerial circuit.

Crystal Damping with Series Tuning.

Upon completing the crystal detector circuit as Fig. 7 (b), however, the curves of resonant volts and rectified telephone current, instead of showing an increase of signal strength with lower values of series capacity, show a large decrease. From previous results one would expect to find a much more rapid falling off of signal strength with reduction of series capacity when the galena crystal was used, owing to its resistance being lower than that of Perikon, and that this is so is very remarkably shown by a comparison of the curves μA_P and μA_G (Fig. 8) for Perikon and galena respectively. The resonant voltages which are available across the inductance L when Perikon and galena detector circuits are shunted across it are also shown by the curves V_P and V_G . These voltages do not fall off so rapidly as the rectified telephone current produced by them, since the law connecting these two quantities is not, of course, a linear one. It will be observed that there was practically no reduction of

rectified telephone current due to the use of the series condenser when Perikon was the detector until a scale reading of about 60 degrees was reached, whereas when galena was employed for detecting a reduction of 30 per cent. was observed with this setting of the condenser.

At the value of series capacity (20° of the condenser), where the no-load resonant voltage V_0 was found to be a maximum, the actual load voltage and rectified current obtained with both Perikon and galena were very seriously reduced in value, the rectified current for galena being reduced by 60 per cent. and that for Perikon by 30 per cent.

The percentage reduction in rectified telephone current due to the use of a series condenser, C_1 , of various values is given in Fig. 9 by the curves (derived from Fig. 8), P and G for Perikon and galena respectively.

Perikon and Galena Compared for Series Tuning.

In Fig. 10 is given another interesting curve (also derived from Fig. 8), in which the ratio of rectified telephone current obtained with galena to that obtained with Perikon is plotted against degree scale readings of the series condenser C_1 . This makes it quite clear that for low values of resultant capacity of the aerial circuit (or low-capacity aerials) the gain by using a low resistance sensitive galena crystal becomes very much smaller unless steps are taken to relieve in some manner the aerial circuit of the loading due to its use. A method of doing this will be explained later in the article, but for the moment attention will be confined to the ordinary circuits which have already appeared.

Although, as was seen from Fig. 8, the parallel loading by the crystal detector circuits caused a reduction of resonant voltage across the aerial inductance as the series aerial capacity was decreased in value, other causes of damping, such as the tuning of the miniature aerial, nearby, to resonance and the insertion of a resistance in series with the receiving aerial, will not do so. Fig. 11

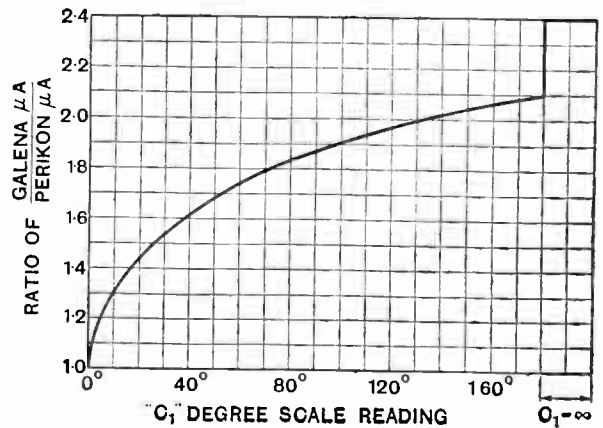
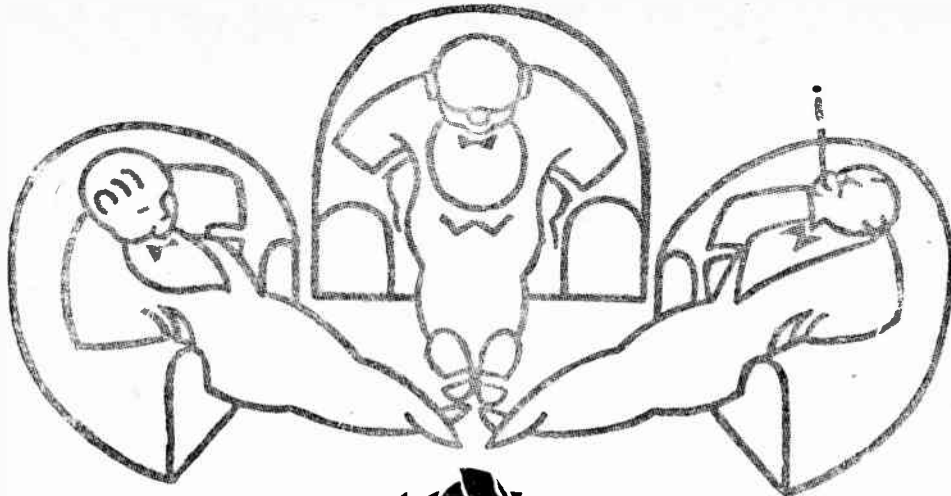

Fig. 10.—Comparison between galena and Perikon with series aerial condenser.

shows the increase in no-load resonant voltage as the condenser C_1 was reduced in value whether the nearby aerial was open-circuited (curve V_0) or tuned (curve V_{0A}). The curve V_{0B} was obtained with the neighbouring absorbing aerial tuned, and with a non-reactive resistance of 10 ohms in series with the receiving aerial.

OURSELVES — AND THE ELECTRICAL IMPULSE



Brandes

"That radio contrivance of yours, Smith; it talks very naturally. The fellow holding forth on what to plant in the garden might well be in this room."

"Ah yes! It's a Brandes; an old friend of mine. Always did sound clearly and well. Thank Heaven the fellow is not in the room, anyhow. It too easily reminds me that my wife will probably lend her moral support to my doing some gardening on Sunday morning."

"Yes, but why is it so appreciably better than most? I had dinner with Brown-Jones last week. His port is excellent, but his radio is excruciating; I wanted to throw things."

"Well, these Brandes fellows claim that they build their instruments from an expert knowledge of radio acoustics."

"I don't know what radio acoustics is from Adam."

"My dear Jackson, of course you don't. Neither do I, technically."

"Well, tell me what you know about it."

"You perhaps know that acoustics is the science of sound?"

"Well, ye-es!"

"Right! Radio acoustics is the science of transforming the electrical impulse into audible sound."

"Do you mean that the electrical impulse is the electrical energy which carries the transmitted power from the studio to the receiver?"

"Precisely!"

"And that the Brandes instrument is constructed with the correct scientific elements for a most able transformation into audible sound?"

"As you say, dear fellow! Brandes are thoughtful radio builders and seventeen year's intimate association with the electrical impulse must have given them a lift above the others."

"Well, that youngster of mine is pestering me for a loud-speaker—I'll see that it's a Brandes."

"I should! You have heard mine—ah! the Savoy Bands coming through. Don't give John any more whisky. He'll probably want us to fox-trot with him."

"No sir! On the contrary, I am thinking of investing in a Brandes."

MATCHED TONE HEADPHONES

THE TABLE-TALKER

THE BRANDOLA

AUDIO TRANSFORMER

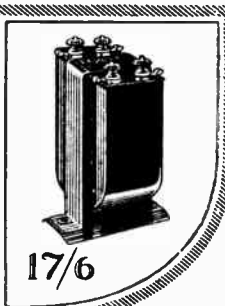
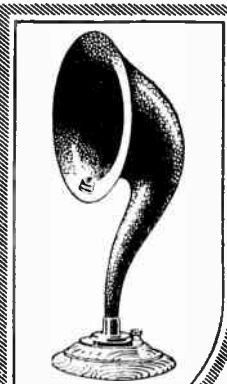

Send for particulars of our Dealers Service

BRANDES LIMITED
296 Regent Street W.1

EXPERTS IN RADIO

ACOUSTICS SINCE 1908

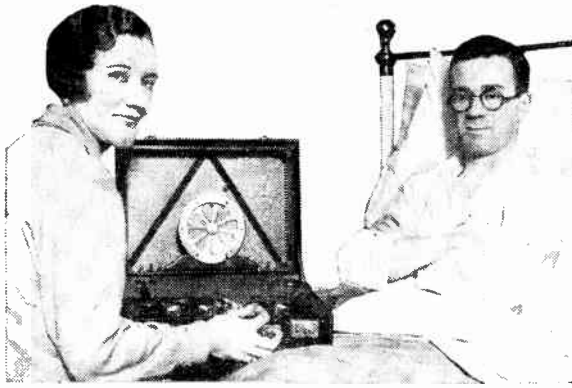

Miss Phyllis Monkman and her fiancé, Mr. Laddie Cliff, with their "Beco" Hornless Loud Speaker.

Popular Entertainers

THE source of entertainment which pleases—be it human or otherwise—quickly becomes popular. A concrete example is the "Beco" Hornless Loud Speaker. Reproducing with excellent volume, and exceptional purity of tone and clarity, the "Beco" is a vast improvement in loud speaker design and is rapidly becoming popular.

The "Beco-de-Luxe" (British Made) is an artistic piece of furniture for any home and the volume from it will fill a large hall. Obtainable fitted in either oak or mahogany cabinet. Height 13".

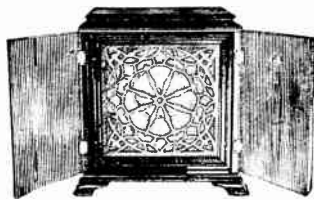

"The BECO-DE-LUXE."

Oak . . . £5 - 0 - 0
Mahogany £5 - 5 - 0

The small 1926 "Beco," a very efficient model with a very pleasing and attractive appearance, gives unusual volume, with crystal clarity. Height 6".



"The 1925-26 BECO."

Nickel Plated **52/6** Oxydised Silver or Copper **55/-**

BECO

HORNLESS LOUD SPEAKERS

Dept. W, British Electrical Sales Organisation,
623, Australia House, Strand, W.C.2.

Telegrams "Becospeker, Weststrand, London."



Telephone:
CITY 7665



ELECTRADIX RADIOS

(Leslie Dixon & Co.)

LONDON'S LATEST RADIO EXHIBITION

of SURPLUS GOVERNMENT BARGAINS

now open at Lambeth Hill
and 218, Upper Thames
Street, E.C.4

Great Sale of Surplus
Radios at Sacrifice Prices.
The wide range of our
Huge Stock is World
Renowned.

Call early as prices cannot
be repeated. Our Show-
rooms are easy of access—
Blackfriars or Mansion
House Station on the
Underground Railway;
Cannon Street or St. Paul's
on the Southern Railway
are close by. 1d. Bus from
the Bank lands you at the
top of Lambeth Hill. We
are at the bottom corner,
nearly opposite Siemens
Bros. Colonial Avenue is
closed for retail now.
Phone City 191, and all
orders should be sent to
218, UPPER THAMES
STREET.

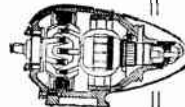

200 WATT, 500
CYCLE
ALTERNATOR
and EXCITER.



MIDGET M.C.
0.10 m/a. 22/6



TESTING
SILVERTOWN
GALVOS.



EDISWAN
VALVES
R.A.F. "C" Type.



CRYSTAL
SETS
Mark III Tuners.

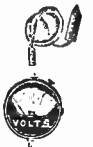

MIDGET M.C.
CELL TESTER
2 range.



H.T. VOLT-
METERS,
G.E.C., 2-range
1,000 and 2,000
volts.



DISTANT
SWITCHES.

ELECTRADIX RADIOS

218, UPPER THAMES ST., LONDON, E.C.4

Phone: City 191.

Address all Post Orders to City Showroom:

218, Upper Thames Street, E.C.4

Complications of Crystal Reception.—

If the loading effect of a crystal upon an aerial circuit were negligible, one would expect the rectified telephone current to fall very rapidly as the ratio $\frac{L}{C}$ was reduced, since the reactance ωL , and consequently the reactive volts at resonance, would be reduced in value. As the left-hand curve of rectified current in Fig. 12 shows, this is far from being the case with a galena detector receiver because the reduction of the ratio $\frac{L}{C}$ is almost compensated for by the reduction of the loading effect due to this change of aerial circuit constants.

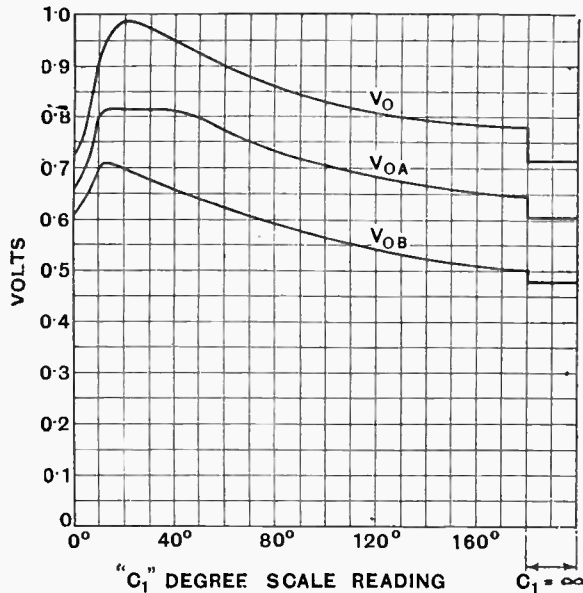

Fig. 11.—Variation of resonant voltage with change of capacity of series aerial condenser (no crystal loading)

The curves of Fig. 12 show the reduction of telephone current obtained with a very small aerial (of about 0.0001 mfd. capacity only) when tuning was effected by parallel or series capacities of various values. From curve A it will be seen that, although the reactance values of the circuit were reduced by 75 per cent., the rectified telephone current was only reduced by about 18 per cent.

Before proceeding further a few values of aerial current and voltage may, perhaps, as examples, be computed to give some idea as to the relative order of things to be expected in a fairly large receiving aerial due to the transmission of 2L.O or similar station at a distance of 10 miles.

$\lambda = 365$ metres, $f = 8.25 \times 10^5$, $\omega = 2\pi f = 5.2 \times 10^6$, $L = 1.30$ microhenries, and the reactance of this inductance at 365 metres is $\omega L = 676$ ohms.

The no-load reactive volts across L at resonance = $\omega L I$ (where I is the aerial current). This voltage was measured by a thermionic voltmeter and found to be 0.72 volts, corresponding to the point on curve V_0 (Fig. 8) where $C_1 = \infty$.

Aerial current I at resonance

$$= \frac{\omega L I}{\omega L} = \frac{0.72}{676} = 0.00106 \text{ ampere.}$$

The total effective resistance of the aerial-earth system plus the tuning variometer at 365 metres = 25 ohms (the method of estimating this will be shown later).

The total E.M.F. effective in producing the aerial current I at resonance = IR
 $= 0.00106 \times 25$
 $= 0.0257$ volt,
 or nearly 26 millivolts.

This E.M.F. is constant whatever the conditions of the aerial or detector circuits, and is produced by a potential gradient of the advancing wave-front of about 4 millivolts per metre of height, this being therefore the approximate field strength due to 2L.O's radiation at 10 miles radius.

Numerical Results for Galena.

If now the galena crystal detector circuit be shunted across L , the reactive voltage at resonance across the latter is found to be only 0.15 volt by measurement (corresponding to the point on the curve V_G of Fig. 8, where $C_1 = \infty$).

Since the value of L has been unchanged, the aerial current must have been reduced from 0.00106 ampere to

$$I_1 = \frac{V}{\omega L} = \frac{0.15}{676} = 0.00022 \text{ ampere}$$

and from this the total effective resistance of the aerial system has been increased from 25 ohms to

$$R_1 = \frac{\text{E.M.F.}}{I_1} = \frac{0.0257}{0.00022} = 115 \text{ ohms.}$$

Now the total effective resistance of an oscillatory circuit having a parallel damping resistance can be shown to be

$$R_1 = R + \frac{(\omega L)^2}{r}$$

where R is the ordinary effective H.F. resistance of the circuit (25 ohms in this case), and $\frac{(\omega L)^2}{r}$ is a term accounting for the effect of the shunt resistance " r " (in this case " r " is the effective resistance of the galena crystal and its circuit).

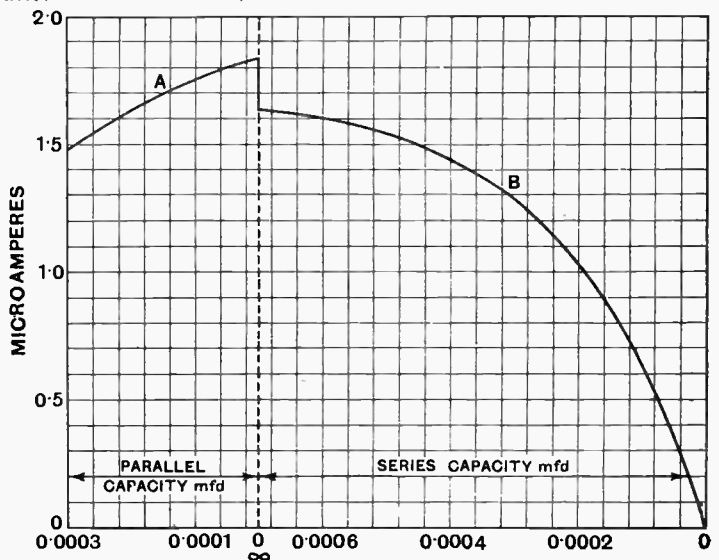

Fig. 12.—Reduction of signal strength due to use of parallel and series tuning condensers with an aerial of small dimensions.

Complications of Crystal Reception.—

$$\text{Therefore } R + \frac{(\omega L)^2}{r} = 115$$

$$\text{and } \frac{(\omega L)^2}{r} = 115 - 25 = 90,$$

from which $r = 5,080$ ohms = effective H.F. resistance of the galena crystal detector circuit at the low values of voltage being dealt with here.

Now that a value for the shunting resistance introduced by the galena crystal has been deduced, it is possible, roughly, to estimate its effect, quantitatively, upon the current and reactive voltage of the aerial for other proportions of inductance and capacity.

As an instance, when the series condenser Fig. 7 (b) is adjusted to 20 degrees scale reading, the inductance L has to be increased to 290 microhenries to bring the aerial circuit again into resonance with the incoming signal wave.

The value of ωL becomes 1,500 ohms,

$$\begin{aligned} \text{and the new value for } R_1 \text{ becomes } & 25 + \frac{1,500^2}{5,080} \\ & = 25 + 44.3 \\ & = 468 \text{ ohms.} \end{aligned}$$

The aerial current for this new condition becomes

$$\frac{\text{E.M.F.}}{R_1} = \frac{0.0257}{468} = 0.000055 \text{ ampere,}$$

(To be concluded.)

and the reactive volts at resonance (ωLI)

$$\begin{aligned} & = 1,500 \times 0.000055 \\ & = 0.0824 \text{ volt.} \end{aligned}$$

This voltage will be found to agree with that measured by the thermionic voltmeter for this particular case (see curve V_G , Fig. 8).

Although the above reasoning does not take into account all the variable factors involved, it will at least be useful in giving an idea of the quantities being dealt with, and of the shunt loading effect of the crystal detector upon an oscillatory circuit. It has been assumed, in the above computations, that the effective high-frequency resistance of the crystal is constant for all values of applied voltage, and although this is not strictly true it is approximately correct over the range of voltages with which we are dealing.

It should be noted, also, that the effective high-frequency resistance of the crystal varies with the resistance of the telephones in series with which it is connected, and for that reason the same telephones have been used throughout the experiments.

The Perikon crystal detector circuit would, by the same reasoning, be found to have had a resistance " r " of nearly 34,000 ohms (at the voltages being dealt with here), and so it is easy to see why the two classes of crystal behave so differently.

A NEW DULL EMITTER VALVE.

Tungsten Superseded as a Carrier Metal for Thorium.

THE firm of Radiowerk E. Schrack, of Vienna, is manufacturing a type of valve which is of considerable interest in that it differs in many respects from the valves hitherto in general use. In this valve, for example, a filament is used which is not made of tungsten, but of a metal with low melting point. What the metal is precisely is not stated, however, presumably for reasons connected with the patent, but it may be assumed that it is one of the platinum group of metals.

Properties of the New Metal.

The melting point of the new material used for the cathode, however, is certainly lower than that of tungsten, as the cathode has never to be heated at more than red heat, a circumstance which is not especially unfavourable. On the other hand, the new material possesses the advantage that it can take a considerably greater amount of thorium than does tungsten. Whilst the latter, for instance, can only be alloyed with thorium up to a maximum amount of 2.5 per cent., the material now used by Messrs. Schrack for the manufacture of cathodes can take 10 per cent. The lower melting point of the carrier material used has, however, the special advantage that thorium, even at red heat, diffuses relatively easily to the surface of the filament, with the result that there is no decrease of emission in consequence of the too rapid evaporation of the thorium layer. The new valves, it is claimed, do not undergo a change in their working conditions, however long they may have been in use.

The same firm is producing valves with a new kind of

grid. This takes the form of a double cone, for which reason it is claimed that the capacity between the grid and the anode is reduced to about 1.5 cm., or half the normal capacity. These valves are therefore of use for waves as low as 5 metres.—H. K.

HIDDEN ADVERTISEMENTS COMPETITION.

The following are the correct solutions for "The Wireless World" Hidden Advertisements Competition for February 3rd issue, 1926.

Clue No.	Name of Advertiser.	Page
1	Burndept Wireless, Limited	8
2	Britannia Rubber and Kamptulicon Co., Ltd. ..	19
3	Darimont Electric Batteries, Ltd.	17
4	Gladwell & Kell, Ltd.	6
5	General Electric Co., Ltd.	12
6	Dubilier Condenser Co. (1925), Ltd.	iv

The following were the prizewinners :

E. W. Weston, London, W.2	£5
— White, Winton, Bournemouth	£2
C. C. Pratley, Ealing, W.5	£1

Ten shillings each to the following :

- Miss A. Lines, Acocks Green, Birmingham.
- E. Lamerton, Woolston, Southampton.
- Mrs. Ella Baker, Rotherham, Yorks.
- Herbert Tucker, Colchester.

AMATEUR EXPERIMENTAL STATION 6 R J

A Description of
the Transmitting and
Receiving Apparatus.

By A. H. HOWE.



THE aerial is of the inverted L type and is supported by two 40ft. masts of the light tubular steel type.

That the station is not troubled by local screening will be seen by the open character of the aerial system shown in the photograph in the title of this article.

The general lay-out of the instrument itself is of unusual character, being built into an old French bureau; an idea of the neat appearance obtained by this system is given by Figs. 1 and 4. Compactness with adaptability has been obtained by making use of the unit system of assembly. The units are screwed to wooden battens

and external wiring from unit to unit is used. By this means it is possible to take out individual units and examine them for faults or to change from one arrangement to another for experimental purposes at a moment's notice.

The Receiver.

The receiving portion of the station is shown in Fig. 4 and also in the lower portion of Fig. 1. It consists of seven valves in all, and may be followed better perhaps by reference to the diagram given in Fig. 2.

A series-parallel switch controls the aerial tuning condenser, which is of 0.001 mfd. capacity. Direct- or loose-coupled circuit can be obtained by means of the "Tune-Stand-by" switch used in conjunction with the three-coil holder.

The first panel consists of two high-frequency stages. Transformer coupling is used on these stages, either semi-aperiodic or tuned copper-wound type. The next panel is also a high-frequency amplifier, being a tuned anode unit. Arrangement is made to use any number of stages of high-frequency amplification or to couple direct to the detector by alteration of plugs in the respective grid leads. As a general rule, D.E.R. or D.E.2 type valves are used in both H.F. and detector positions.

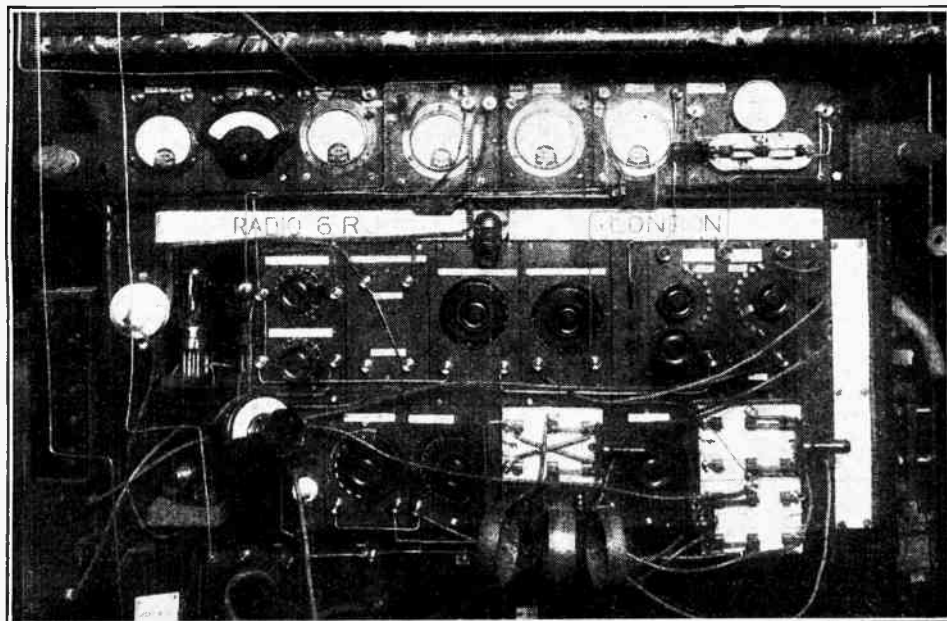

Fig. 1.—General view of the receiving and transmitting equipment.

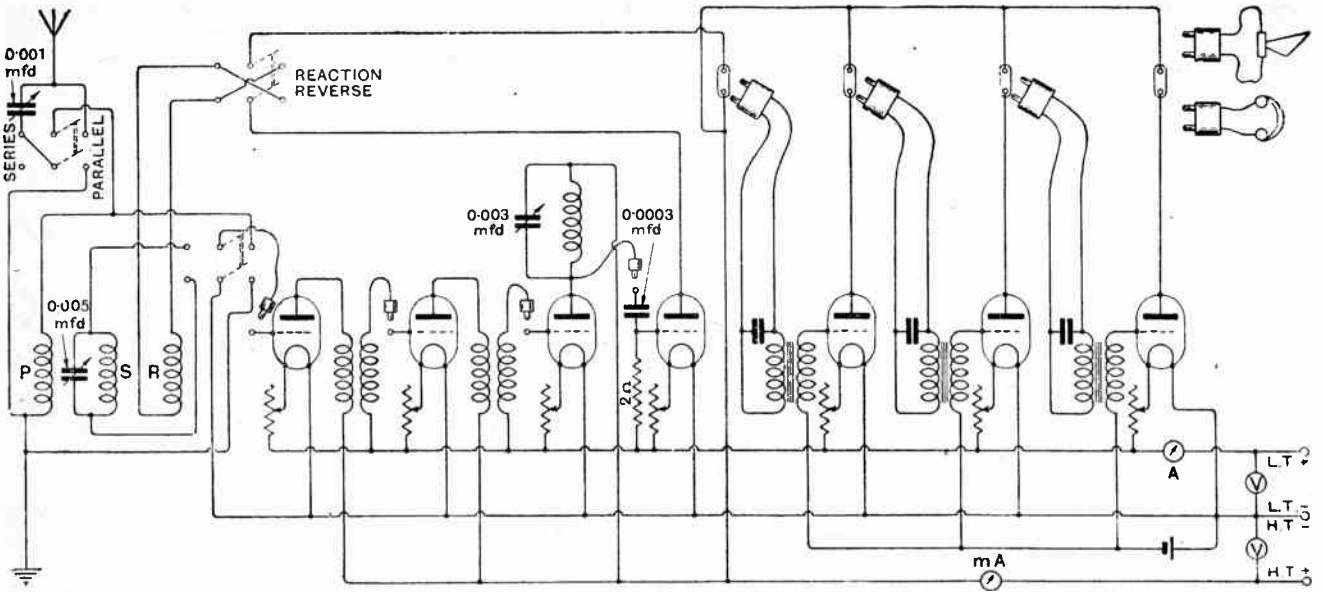

Fig. 2.—The receiving circuit, showing method of switching H.F. and L.F. valves.

The detector is followed by three stages of audio-frequency amplification. The number of stages of low-frequency amplification required is controlled by means of plugs and jacks. D.E.5 and L.S.5 type valves are used in these stages with transformer coupling. Provision is made for a H.T. supply of up to 200 volts on the L.F. valves with a negative grid bias of up to 20 volts. Arrangement is made to change over from the main aerial system to a smaller external aerial, or to an

indoor aerial or frame. In a similar manner the earth system can be changed from one earth to another or to a counterpoise. These changes are carried out by means of the large plugs and sockets shown on the extreme right of Fig. 1. This method of changing aerial and earth systems applies to both transmitter and receiver:

The Transmitter.

The transmitting circuit is shown in Fig. 3. The main supply is 220 volts A.C. at 50 cycles. Full-wave rectification is obtained by means of a 1,500-volt transformer with a split secondary and two U.3 type valves. Smoothing is accomplished by means of the bank of condensers and iron-core chokes shown in the diagram. The condensers are each of two microfarads capacity, and the reason of the series-parallel arrangement shown is that difficulty was found in obtaining condensers at a reasonable price to stand up to full line voltage without breaking down. After many experiments and numerous break-downs it was found that cheap ex-Government Mansbridge condensers, used two in series, would meet the existing conditions. The chokes are of 10 henries impedance, but each has a low ohmic resistance. From reports received it would appear that this smoothing arrangement gave little or no A.C. component.

The oscillator consists of either two experimental T.15 valves (which have been made dull-emitting) or else two D.E.T.1 valves run in parallel. The modulator is an L.S.5 type valve or else a D.E.T.1A.

The filaments of the two U.3 type rectifying valves are run off a small transformer with a secondary giving about ten volts, and insulated for 2,000 volts both between winding and above earth. The filaments of the oscillators and modulator are run off a 6-volt 60-ampere-hour accumulator. In view of the need for accurate measurements in a number of the experiments carried out, first-class instruments have been incorporated in the set; the greater part of these can be seen at the top of Fig. 1. These are all "Weston" instruments with the exception

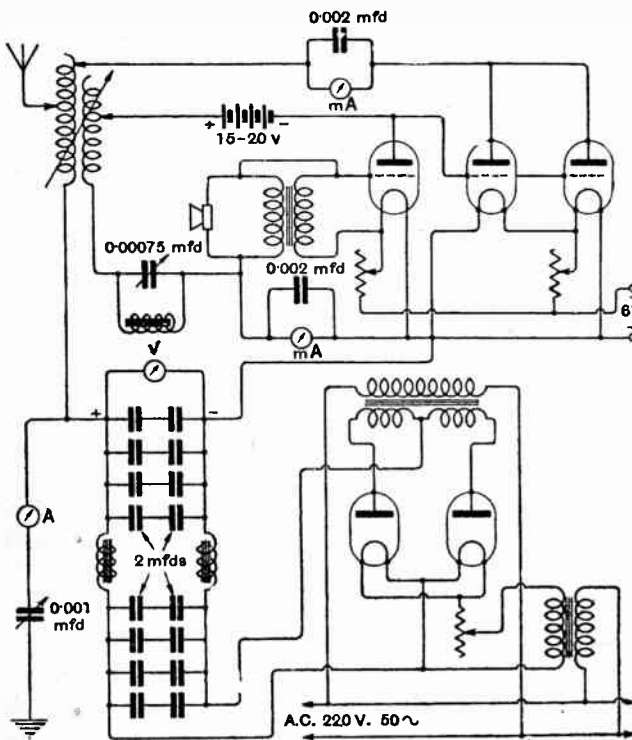

Fig. 3.—Transmitting circuit and rectified A.C. supply connections.

**Amateur Experimental Station
6R.J.—**

of the "Sullivan" hot-wire ammeter for aerial current. The range of this instrument is 0.1 amperes, and can be seen in the right-hand top corner. Next to this is the plate current meter of the transmitter: this has a range of 0.100 milliamperes, and, like all the Weston instruments, is of the moving coil type. The other instruments in the transmitter circuit are the plate voltmeter with a range of 0-1,500 volts and the microphone current meter with a range of 0.100 or 0.1,000 milliamperes. In the receiver circuit there is a plate current milliammeter with a range of 0.25 milliamperes and a plate voltmeter with a range of 0-250 volts. In addition to these a Weston student's model galvanometer is used for recording received aerial current, in conjunction with a crystal rectifier. There are three microphones, all of the solid back type. The wave-meter is an ex-War Office buzzer pattern with three ranges, covering from 100 to 2,900 metres: a home made C.W. meter is also used. In conclusion, it must be stated that

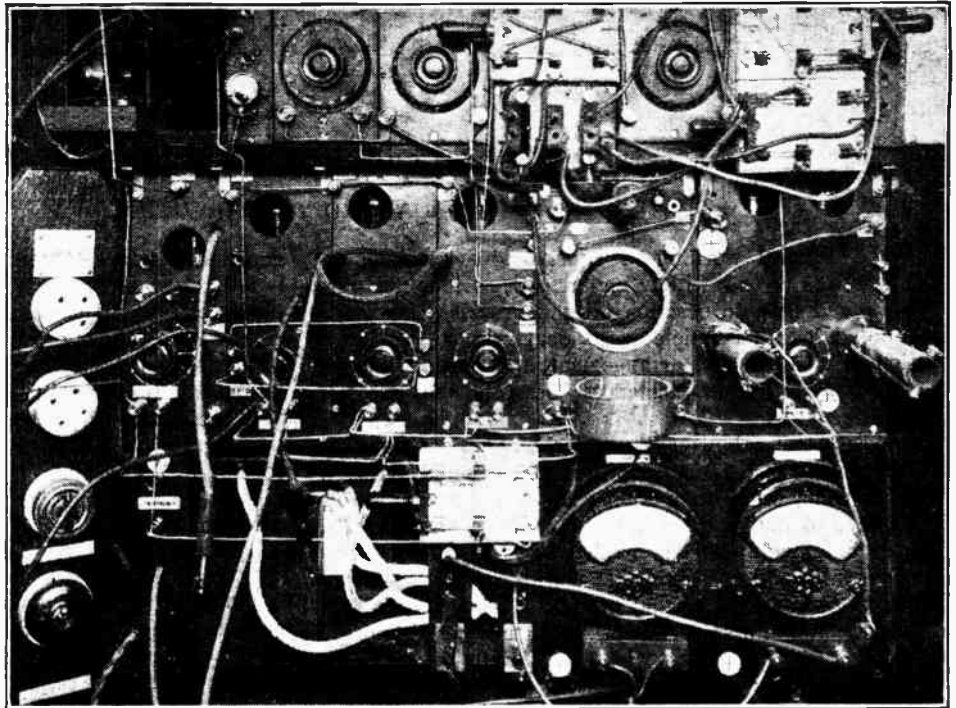

Fig. 4.—The unit receiver and, below, filament battery ammeter and voltmeter.

little D.X. work of outstanding merit has been accomplished, but many important experiments in connection with low power dull-enitter transmitting valve design have been carried out at this station and brought to a successful conclusion.

Where was that Station?

How often it happens that, having picked up a distant and elusive transmission, no record is taken of the condenser setting and coils which obtained the marvellous result! Consequently, when we attempt to repeat the performance for the benefit of a sceptical friend, there is "nothing doing." To assist the listener in this plight, Messrs. Cartwright and Ratray, Ltd., of Hyde, have published an extremely useful "Radio Tuning Record," which consists of a stout cardboard folder bearing the names and wavelengths of the principal broadcasting stations, and ruled in divisions for the insertion of particulars of coils and condenser readings required for receiving each station. At the top of the card is printed the appeal: "Please Don't Oscillate!"

o o o o

An Igranic Dance.

A jolly party of 500, including contingents from London, Birmingham, Manchester and Leeds, attended the annual carnival dance of the Igranic Electric Co., Ltd., at the Café Dansant, Bedford, on January 15th. A large number of the dancers were in fancy dress, and 20 valuable prizes were awarded by a special judging committee.

TRADE NOTES.

Neutrodynes and Autodynes.

North of England readers who are seeking a well-constructed neutrodyne or autodyne receiver may be interested to learn that the well-known manufacturers of technical instruments, Messrs. Dargue Brothers, Ltd., of Halifax, have opened a wireless branch and are specialising in the production of these instruments.

Their range of receivers, distinguished in each case by the name "Simplon," also includes two types of crystal set, a two-valve set, and a handsome four-valve tuned anode cabinet receiver.

o o o o

A Handsome "Gecophone" Catalogue.

Some interesting price reductions are announced in the new art catalogue issued by the General Electric Co., Ltd., Magnet House, Kingsway, London, W.C.2. This really handsome publication, printed on art paper, covers receiving sets, amplifiers, components, and accessories, and contains a useful abridged glossary of wireless terms and definitions.

New Premises.

Owing to increase of business the Maywood Engineering and Electrical Manufacturing Co., Ltd., late of Thurloe Park Mews, South Kensington, have been under the happy necessity of moving to more extensive premises. The company's address is now: Maywood Works, Charles Street, Holland Park, W.11.

o o o o

General Radio Co. Receivers.

Messrs. General Radio Co., 235, Regent Street, W.1, send us particulars of their new two-valve broadcast receiver, Type 15. This receiver is of the one-control type, all tuning being effected by a single knob, and ranging from 250 to 2,400 metres. The component parts are mounted on a one-piece solid aluminium panel and baseboard, and arranged to swing outward from the containing walnut cabinet so that every component is easily accessible. Price of receiver only (including royalty) £6 15s., or complete with valves, batteries, phones, loud-speaker, and all accessories, £13 5s. This firm also manufacture the G.R.C.6 crystal receiver, £2 10s.; the G.R.C.501 single-valve receiver, £9; the G.R.C.502 single-valve H.F. amplifier, £6; the G.R.C.503 single-valve L.F. amplifier, £6; and the G.R.C.504 single-valve power amplifier, £7.

SUPERHETERODYNE OSCILLATOR DESIGN.

Advantages of the Four-electrode Valve as an Oscillator.

By HAROLD H. WARWICK.

THE general working of supersonic heterodyne receivers is now widely understood, so it is not purposed here to describe all the processes involved. The object of this article is to deal with a particular portion of a supersonic arrangement, the portion that in the vast majority of instances presents the greatest difficulties.

The fundamental principle underlying an arrangement of this nature is the decreasing of the original received high-frequency wave to a high-frequency wave of lower frequency, so that greater and more stable amplification may be obtained. This is arranged by generating oscillations locally and combining them with the original high-frequency oscillations, so that the two series of oscillations alternately add and subtract as they get into, or go out of, step, thus forming beats which will still be at high-

generating waves of different frequency at all well, it is unlikely that precisely the same filament brilliancy and plate voltage will be required for optimum results in each case. Also, during the course of operation, should it be desired to alter the amplitude of the generated oscillations by varying either the plate or the filament voltage, rectification may be affected. Indeed, an impartial investigator will find that, for ease and simplicity of control of oscillation as opposed to rigid economy, a separate oscillator valve is unbeatable, provided its circuits be well designed.

The Use of a Separate Oscillator.

Having now decided that a separate valve be used, an overwhelming number of valve circuits capable of generating oscillations command attention, but many may be at once dismissed owing to their failure to embody one or other of the following points:—

- (1) Free oscillation over a given continuous range.
- (2) Ease of control of amplitude of oscillations.
- (3) Few controls.

No. 1 above is sufficiently obvious not to merit any further explanation.

No. 2 may not be immediately clear, but a few moments' thought will suffice to realise that, if an extremely weak signal is being received, and the local valve generator is oscillating violently, the weaker oscillation may be damped right out. Conversely, if a signal is strong and local oscillations are too weak, maximum input will not be supplied to the intermediate frequency amplifier and following apparatus, so that the fullest strength will not be obtained. Further thought will make it clear that both sets of oscillations should be comparable in intensity or amplitude, in order to make the best use of the energy collected from the ether.

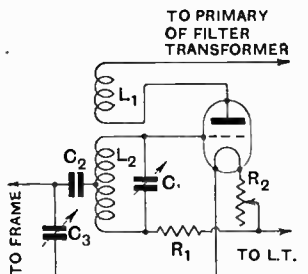

Fig. 1.—The well-known tropadyne system of connections.

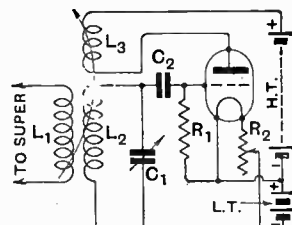

Fig. 2.—Local oscillator circuit in common use in superheterodynes.

frequency if the difference between the two sets of oscillations be adjusted correctly.

How, then, to generate these local oscillations? Assuming that the only practical method of performing this operation is by the use of a thermionic valve, it is first necessary to consider whether an entirely separate valve be used for the work or whether a valve, already doing certain work, may be cajoled into doing further work of a different nature. On the grounds of economy this latter method has something to be said for it, and a circuit known as the "Tropadyne" oscillator is given in Fig. 1.

The Tropadyne Oscillator.

It is claimed that it is not a difficult matter to locate the nodal point at the centre of the coil L_2 , so that there is no energy transference to preceding circuits due to a potential difference between the tapped point and the filament. Practically, although it is by no means impossible to find the centre point or to locate it so nearly that fine adjustment may be made with the leak R_1 , it is certainly no easy matter. Apart from this, even if it be allowed that a valve can perform these two operations of rectifying waves of one frequency and

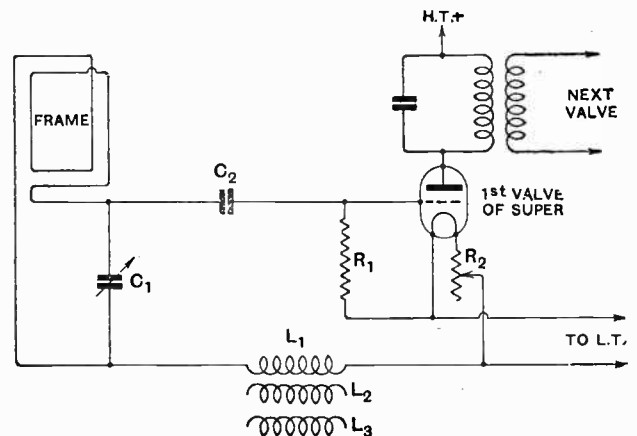

Fig. 3.—An arrangement of coils L_1 , L_2 and L_3 (Fig. 2), which justifies fixed coupling.

Superheterodyne Oscillator Design.—

No. 3 deals with controls. Consistent with adequate control, as few variables as possible should be incorporated, and it is not difficult to arrange for as few as three controls, a tuning condenser, variable coupling, and filament rheostat, but with fewer controls trouble is encountered.

A circuit in common use against which there is nothing to be said, except multiplicity of controls, is shown in Fig. 2. This embodies two moving coils, a variable condenser, and filament rheostat, and is an arrangement from which many modifications have been evolved. Those adaptations that are of interest here are those which eliminate variables.

Fixed or Variable Couplings ?

The modified arrangements which have had even greater use than the original are those in which there is a fixed coupling between L_1 and L_2 , or L_2 and L_3 , or L_1 , L_2 , and L_3 , and, admittedly, it is very straightforward; but the question arises as to whether any or all of these are strictly justifiable arrangements in accordance with point (2) above. The answer is that the efficiency of the original arrangement, Fig. 2, is not approached except in a particular case when L_1 and L_2 are fixed, and this in such a circuit as Fig. 3. Here L_1 consists only of few turns of wire, so that maximum coupling is always required between L_1 and L_2 .

In every other case there is good and sufficient reason why fixed coupling should not be used, and the simplest way of explaining this is to point out that the coupling L_2, I_3 is used primarily to adjust the generated oscillations and maintain them over a given range, whilst the coupling L_1, L_2 is used to vary the energy transference from oscillator to receiver. There is no doubt that some degree of success may be attained with fixed couplings if

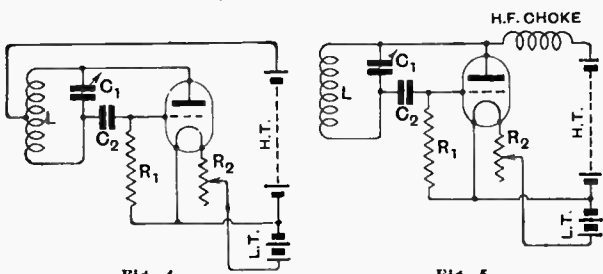

Fig. 4. Two forms of the Ultra-audion oscillator circuit.

windings are well chosen, but it is impossible to cover any but a very short frequency range unless some other means is provided to control oscillation intensity.

Filament Control of Oscillation.

There is another means, but it is not good. It is to adjust the filament brilliancy of the valve. Any person who takes the trouble to control oscillation by this means will find two things—firstly, that control is very bad; secondly, that at least one other adjustment has to be made to restore stability. This is because there is a particular optimum plate voltage for every degree of filament temperature, so that a decrease in filament temperature without alteration in H.T. voltage results in oscillation hysteresis, or overlap. To put this right an attempt

may be made to adjust the H.T., but if there are only $4\frac{1}{2}$ volt tapplings, as are usual, the chances are thousands to one that an exact adjustment may be made.

Out of all this comes the question as to whether the arrangement as given in Fig. 2, and its modifications as discussed above, are of real value, despite their continued use in super-hets.

The answer is, emphatically, No!

For the moment let us ignore oscillation intensity control and examine circuits that employ as little apparatus as possible to obtain oscillations.

Two simple circuits are given in Figs. 4 and 5.

Fig. 4 shows a single oscillatory circuit comprising a coil, L , and condenser, C_1 , a tapping being taken from a point on L . If desired, L may be made up of two plug-in coils coupled together. The remarks applicable to the operation of this circuit are very much the same as those applicable to the circuit arrangement of Fig. 5, which is even simpler than that of Fig. 4.

This is really the De Forest Ultra-audion oscillating detector and one with which the writer has noticed some curious phenomena.

The Four-Electrode Valve Oscillator.

The first point that made itself evident was that oscillation was much better over the lower broadcast band than on the higher wavelength; in fact, only with difficulty was oscillation obtained at a frequency of 150 kilocycles sec. Below broadcast waves it was about as easy, or difficult, to procure oscillations as with such a circuit as that in Fig. 2, so long as the value of C_1 is kept low. No amount of manipulating would induce regeneration when the full 0.0005 mfd. capacity of the variable condenser C_1 was placed in shunt with honeycomb inductance winding having 50 turns; 0.0003 mfd. was found to be a practical working maximum value. The next point discovered was that oscillations were just as easily developed with 10 volts H.T. as with 60 volts, although their intensity was much decreased, and it was afterwards found that oscillations could be kept up with no H.T. battery—that is to say, no potential on the plate other than that due to the drop across the filament battery. Naturally, the strength of regeneration under these conditions was not sufficient to overcome any but the very slightest damping external to the circuit L, C_1 , and a closely coupled coil stopped oscillation altogether.

Now the discovery that a 3-electrode tube would oscillate under these conditions was inestimable, for it was at once appreciated that if stronger oscillations could be produced, their amplitude might be varied by the filament brilliancy *only*, owing to the absence of an H.T. battery. To do this, a 4-electrode valve was requisitioned, and the circuit was adapted by connecting the inner grid, G , to either A or B ; the connection to B was thought to give hardly appreciably better results than that to A , but in both cases oscillation was greatly facilitated.

This result was due, of course, to the simple expedient

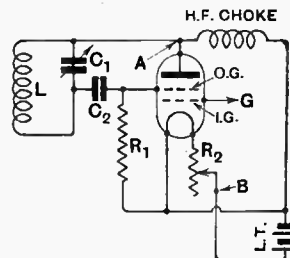

Fig. 6.

Superheterodyne Oscillator Design.—

of reducing the space charge, and the whole arrangement savours very greatly of Numan's oscillator.

Results with this arrangement were almost beyond expectation, as oscillation control was perfect when a first-class filament rheostat was used. Variable coupling was used between L and the receiver coil, and oscillations were found adequate for all stations that could be received except a B.B.C. station at a distance of some five miles.

Similarly, Fig. 4 can be adapted to suit a 4-electrode valve by connecting the inner grid to +L.T. and removing the H.T. battery, but regeneration is not nearly so good.

From the foregoing it would appear that this arrangement (Fig. 6) is one of the simplest and most effective,

as well as being, from a current consumption point of view, the most economical oscillator unit available to the amateur who is looking for a circuit in which the disadvantages of the more usual oscillators are absent.

It is a strange thing that the most troublesome portion of a superonic receiver—the oscillator—has been, relatively speaking, neglected, or, if not exactly neglected, no serious attempt has been made to adapt the lesser-used valve generator circuits; but, instead, games of trial and error in windings and couplings have been played, in order to simplify the system shown diagrammatically in Fig. 2.

Therefore it is to be hoped that the remarks made in this article will do something to stimulate the tendency to break away from conventional but inefficient oscillator designs.

London, S.W.18.

(December 17th to January 18th.)

Great Britain: 2QD, 2BL, 2KG, 2ST, 2AQ, 2OZ, 2VY, 5BV, 5UN, 5OX, 5BT, 5BY, 5TV, 5CP, 5IS, 5VP, 5PU, 5UL, 6KJ, 6MB, 6TX, 6QO, 6BO. Belgium: W5, Y5. France: 8IA.

(0-v-2. All above 150 metres.)

A. G. Binnie.

Burnham-on-Crouch.

(January 1st to 17th.)

Great Britain: 2AU, 2AYP, 2BGO, 2BM, 2KT, 2MI, 2PX, 2QC, 2SV, 2UD, 5AR, 5BY, 5GA, 5OY, 5QV, 5UL, 5UO, 5XW, 5ZG, 5ZR, 6HC, 6KA, 6QO, 6TX, 6WQ.

(0-v-1. All telephony.)

R. C. Horsnell.

Lowestoft.

(January 1st to 20th.)

Great Britain: 1RW, 2WZ, 5AG, 5KU, 5KZ, 5SO, 5US, 5WV, 6DW, 6GW, 6LV, 6KB, 6KK, 6KO, 6OG, 6YC, 6YD, 6YK, 6YV, 6YX, 6ZM, 6ER. France: 8JC, 8JYZ, 8JNF, 8MAC, 8XP, 7VX. Holland: A1Q, OCMV, NOSB, NOWB. Sweden: SMZQ, SMXU, SMTN, SMXT, SMVR, SMYZ, SDK, SKA. Denmark: 7MT, 7BX, 7XP. Belgium: B2, G6, M2, S4, S5. Finland: S 2CO, S2ND, S PH. Italy: 1GN, 1AF, 1MV, 1RM, 1GW, 1SS. Germany: K WS, K PL, K W7. Spain: EAR10, EAR23. U.S.A.: 2ASM, U.S.S. "Pillsbury." Porto Rico: PR4SA. Yugo-Slavia: 7XX. Australia: 3BD. Norway: LA 1A. India: CRP (Delhi). Chile: CH 9TC. S. Africa: 2AO, A6G, A6N. Palestine: PE 6ZK. Miscellaneous: L 1JW, L 1AG.

(0-v-1. All below 50 metres.)

P. L. Savage (G2MA).

Harrow.

U.S.A.: 6VC, 6CQW, 6ASE, 6OI, 6JI, 6DAG, 6SB, 6AWT, 6CPT, 6CAX, 6CTO, 6BCS, 6KB, 6AMM, 7ADQ, 7UZ. Hawaii: NPM, FX1, 6BUC. Japan: GFUP, 1PP (phone). Canada: 4GT. Philippines: NUQG, NEQQ, NAJD. IHR, 1CW, 1AW, 1FN, NPM. China: NPP, FI8QQ, FI8LBT. South Africa: A4Z, A3E, A3N, A6N, A3B (all above on 40 metres). U.S.A.: 8CBI, 1UW, 1ABJ, 1RD, 2CTH, 2CXL, 2NI, 6NG, 8AKS, 8AVL, 9AOT. Canada: 1AR, 2FO (all on 20 metres).

T. A. and F. C. Studley.

Calls Heard.

Extracts from Readers' Logs.

London, W.1.

(During January, 1926.)

Great Britain: 2JJ, 2ZA, 2XV, 2FM, 2GO, 2WJ, 2AKG, 2SZ, 2OD, 2UN, 2BGO, 2MA, 2NM, 2VL, 2SH, 2SV, 2QM, 2KF, 2DS, 2IH, 2LZ, 2CC, 2IA, 2ZB, 2VG, 2PO, 2BZ, 2XP, 2MI, 2VQ, 2LF, 2BM, 2VR, 2EK, 2FK, 2DR, 5MB, 5MA, 5ZA, 5FF, 5KU, 5KZ, 5YK, 5LF, 5WV, 5JW, 5NW, 5HA, 5XY, 5WQ, 5HS, 5TZ, 5GW, 5RB, 6YC, 6BT, 6OC, 6DA, 6DW, 6PG, 6LJ, 6YV, 6YU, 6TM, 6OP, 6QB, 6ME, 6FT, 6TX, 6VP, 6TI, 6LB, 6IV. Ireland: 2IT, 6YW, 6IB. France: 8IL, 8EU, 8MJM, 8UT, 8LP2, 8NN, 8JN, 8TV, 8R, 2JR, 8GRA, 8CG, 8EF, 8HU, 8NA, 8FN, 8RBP, 8NH, 8LZ, 8EX, 8PEP, 8UWA, 8BDY, 8LX, 8OM, 8LDR, 8SD, 8RRR, 8TVI, 8SSS, 8XP, 8WW, 8JRK, 8RM, 8AR, 8DS, 8AWI, 8ML, 8PKX, 8WKY, 8IP, 8HM, 8DV, 8HFD. Germany: Q2, Q5, LO, L4, Y8, 1UZ, 2HR, 4FR, 4LD, 4PF, 4LV, 4GA. Belgium: B2, C5, C22, D4, E9, O8, P7, K5, S1, S2, U5, Z1, Z22, 4RS. Holland: OAT, OAW, OGA, OPX, OWC, OKV, ORO, OPM, OGN, OF3, PCLL, 2PZ. Sweden: SMVG, SMXU, SMUF, SMWQ, SMZS, SMWT, SMWU, SMWS, SMXT. Italy: 1KA, 1NC, 1AM, 1LP, 1AY, 1BW, 1GW. Finland: 2CO, 2ND. Portugal: 1AF. Switzerland: 9FR. Spain: EAR20, EAR13. Denmark: 7ZM. U.S.A.: 1AKZ, 1AAO, 1BK, 1RTN, 2ACS, 2CJJ, 2GK, 2AB, 2XAF, 2XAC, 3JW, 3AHL, 8GZ, KDKA, WIZ, WIR, WQO. Brazil: 1AB. Porto Rico: 4KT. New Zealand: 1AC. Unknown: 9CH, 1LX, 8BD, 4J, GBZ2AF, NBA, FV, M. Williams.

(0-v-1 on 30-100 metres.)

Birmingham.

(January 17th to 21st.)

Great Britain: 2CC, 2FM, 2GY, 2IT, 2IT, 2MA, 2NK, 2OD, 2PC, 2XY, 5PM,

5KS, 5KZ, 5SZ, 5WQ, 6JO, 6NF, 6RJ, 6RY, 6TD, 6YU. France: 8CR, 8HU, 8IX, 8JN, 8NA, 8NN, 8WW, 8HSF. Germany: I2, S2. Finland: 7NT, 2CO. Italy: 1AF, 1AY, 1BW, 1GN, 1RW.

(0-v-1. Small indoor aerial. On 38 to 100 metres.)

K. R. Brecknell (G2AHH).

South Normanton, Derbyshire.

(January 27th to 29th.)

Portugal: P1AF. Spain: EAR6, EAR21, EAR22. Sweden: 1GW, 2NN, SMXR, SMSR, SMXX, SSM. Norway: LA1A. Germany: POW. Holland: OHB, NPC2, OMS, NOST, OGG. France: 8AIX, 8CDJ, 8DP, 8GEP, 8GL, 8HS, 8KIR, 8JT, 8JR, 8JB, 8JN, 8JNF, 8IDR, 8IP, 8NA, 8NN, 8PKX, 8PEP, 8PY, 8RZ, 8WW, 8RBP, 8USS, 8UWA, 8ROY, 8YOR. Palestine: PE-6ZK, 6YX. Africa: O-A6N. Belgium: G6, J9, S6, 4RS, Z1, D4, S2. India: CRP. Canada: 2AZ. U.S.A.: 1AB, 1AF, 1AFY, ARM, AWY, 1ACI, 1ADF, 2AWF, 1AXA, 1ADS, 1AY, 6ARF, 1BHS, 1BV, 1BG, 4ME, 4RM, 1RD, 1RF, 9EG, 6KX, 3KA, 1VC, 2ND. Great Britain: 2MX, 2FK, 2SD, 2OX, 2SW, 2VN, 2DX, 2WJ, 6VP, 6YI, 6NA. Various: OCDJ, OCTU, MAROC, GHS, GCS, NORP, 3BMS, 1WT, PT2.

(0-v-1. Indoor aerial. 15 to 50 metres.)

H. Bishop.

Hammermith, W.6.

(December and January.)

India: HBK, CRP. Palestine: 6ZK, 6YX. Brazil: 1AB, 1AF, 1IA, SQ1, PT1, AABZ, 5AB, 1AC, 1AP. Argentina: FH4, BAI. Porto Rico: 4JE, 4UR. Canada: 1AR, 2BE, 2BG. Egypt: GEH. Australia: 3BD, 3EF, 2YI. New Zealand: 4AR, 4AC, 2AC. French Indo-China: FI8QQ. South Africa: A3Z, A4Z, A6N. Philippine Islands: 1HR. Mesopotamia: 1DH, GHB. Spain: EAR23, EAR22, EAR21. Germany: KW7, KXH, KPL, KW3. Norway: LA4Z, NW3K, NW3Z. China: NEQQ. Finland: 2CO, 1NA, 2NX, 3NX, 2NM, 2ND. Russia: NRL, 1FL. Japan: 1PP, 1AA. Java: ANE, ANF. Morocco: FW, 8VX, MAROC, 8EV. Italy: 1AY, 1AF, 1CO, 1MT, 1RM, 1GW. U.S.S. Scorpion: NTT (in the Adriatic). Yugo-Slavia: OKI, 7XX.

(0-v-1.) H. E. Whatley.

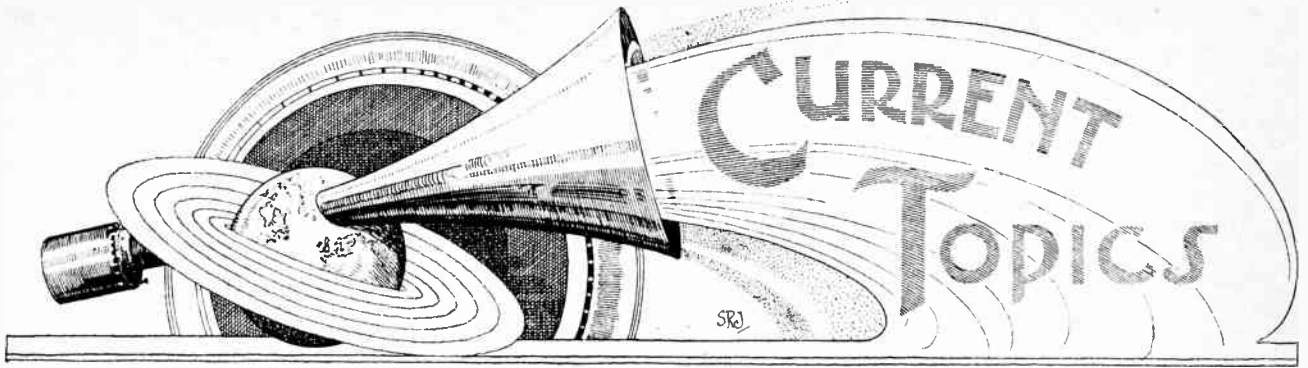

News of the Week in Brief Review.

RED RADIO.

A Moscow message states that the Executive Committee of the Communist International has elaborated a project for using radio as a propaganda medium.

NOT A LUXURY.

The French Wireless Union, in a vehement protest against proposed new "luxury" taxes on wireless apparatus, points out that wireless is by no means a luxury, 90 per cent. of the sets belonging to modest employees and workers.

NEW VIENNA BROADCASTING STATION.

The announcement of the completion of a new broadcasting station—stated to be the second most powerful in Europe—has been made by the Austrian Broadcasting Company. The new station, which is situated at Rosenhugel, near Vienna, is transmitting on the temporary wavelength of 590 metres.

NOT PAYING THE PIPER.

Dissatisfaction is expressed by Mr. Walsh, Minister of Posts and Telegraphs in the Irish Free State, in regard to the number of wireless licences taken out up to the present. A total of £2,900 has been received in licence fees, including £1,300 from the Dublin area.

The Dail has already agreed to an estimate of £14,385 for continuing the broadcasting service from the Dublin station.

SPANISH TRANSATLANTIC FLIGHT.

The successful Transatlantic seaplane flight from Spain to South America, accomplished by the Spanish officers, Major Franco and Captain Ruiz Alda, is of definite interest to wireless amateurs.

Captain Alda, who acted as observer and wireless operator, is a recognised wireless expert in his own country. The equipment carried consisted of a Marconi A.D.6 aircraft telephone transmitter, together with a direction finder. Prior to the flight arrangements were made by the Marconi Company for its affiliated companies in South America to establish touch with the aeroplane when approaching the coast and during the continuance of the flight from Pernambuco to Buenos Aires.

BROADCASTING AND THE "IDEAL HOME."

Among the attractions at the *Daily Mail* Ideal Home Exhibition, to be held at the Olympia, London from March 2nd to 27th, will be glimpses behind the scenes in broadcasting. The B.B.C. will erect a special Olympia studio, and on Tuesdays and Saturdays, from 4 to 7 p.m., the 2LO programme will be actually broadcast from the Ideal Home Exhibition.

WIRELESS AND THE HAIRLESS.

An outbreak of baldness among the male population of Kittanning, Pa., has been ascribed to the effects of the powerful transmissions from KDKA, 35 miles distant. We know there would be a "snag" in this short-wave business.

RUSSIA HEARD IN INDIA.

An enthusiast in Calcutta has reported that he has been receiving almost nightly the programmes from RDW, the Moscow broadcasting station, working on 1,450 metres. Considering that RDW employs a power of 12 kW., there should be no great difficulty in hearing it in this country.

LOUD-SPEAKER EXPERIMENTS.

At the next ordinary meeting of the Radio Society of Great Britain, to be held at the Institution of Electrical Engineers on February 24th, Professor E. Mallett, M.Sc., will deliver a lecture entitled "Some Loud-speaker Experiments."

THE PERFECT WIRELESS ENGINEER.

The perfect radio engineer of to-day requires an extraordinary number of qualifications, according to Dr. J. H. Dellinger, of the United States Bureau of Standards.

Speaking at the first annual convention of the Institute of Radio Engineers, Dr. Dellinger remarked of the radio engineer that he must be "an electrical engineer, a physicist, a mechanical engineer, an expert on accounts, a musician, and last, but not least, a diplomat."

BINDING CASES.

Binding cases and indexes are now ready for the volumes of *The Wireless World* and *Experimental Wireless* completed in December last.

The cost of binding case and index for *The Wireless World* is 2s. 10d., post free. For *Experimental Wireless* the index separate is 7d. post free, binding case separate 3s. 3d. post free, or together 3s. 9d. post free. These are obtainable from the publishers, Iliffe and Sons Ltd., Dorset House, Tudor Street, London, E.C.4.

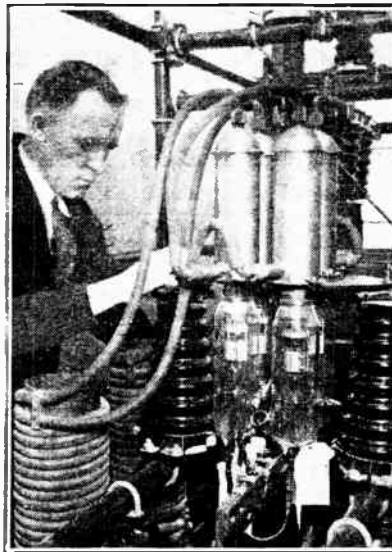

BROADCASTING VALVES OF TO-DAY.
A few of the 64 ten-kilowatt valves in use at WJZ, the high-power broadcasting station at Bound Brook, N.J. Note the elaborate water-cooling arrangement.

HAVE YOU HEARD ICELAND?

Working on a wavelength of 430 metres, the new broadcasting station at Reykjavik, Iceland, is understood to be conducting test transmissions nightly at 11 o'clock (G.M.T.). Reykjavik is approximately 800 miles from Great Britain, and as the station employs a power of only 500 watts any British listener who picks up the transmissions may be justifiably proud of his receiver.

GERMAN WIRELESS PICTURE TRANSMISSIONS.

Experiments in the transmission and reception of photographs by wireless are being conducted between the Telefunken station in Berlin and the physical laboratory at Leipzig University.

○○○○

WIRELESS TO BULGARIA AND YUGOSLAVIA.

A new Marconi service has been inaugurated for the exchange of messages between Great Britain, Bulgaria and Yugoslavia. High-speed automatic duplex apparatus is used.

○○○○

LACK OF "PEP."

"For the physical as well as the mental welfare" of the girl students, President William Wesley Guth, of Goucher College, Baltimore, is reported to have banned the use of wireless sets in the college.

Dr. Guth explained that radio was responsible for late hours and consequent loss of efficiency and "pep."

○○○○

D.F. ON CANADIAN LAKES.

Successful tests have been carried out with direction finding equipment installed by the Canadian Marconi Co. on the steamer *Glenclois*, which is engaged on passenger service on the Great Lakes, Ontario. During the coming navigation season the system will be operated in conjunction with lake-shore stations.

○○○○

WIRELESS FOR THE BLIND.

A praiseworthy scheme for distributing spare wireless sets to blind people is being set afoot by *The Daily Express*, in co-operation with the National Institute for the Blind and the Wireless League.

Readers desirous of helping in this excellent movement should send their spare sets or apparatus direct to the Secretary-General, National Institute for the Blind, Great Portland Street, London, W.1. Members of the Wireless League have agreed to undertake the installation of the sets in the homes of the blind in different parts of the country.

○○○○

FLOATING LABORATORY NO MORE.

A severe loss has been sustained by members of the Société Française d'Etudes de T.S.F. by the sinking of their wireless equipped launch, the *Commandant Tissot*. This unhappy accident occurred last month, when the *Commandant Tissot*, which was moored in the Quai de Tokio, Paris, was struck by floating ice.

Believed to be the only floating wireless laboratory owned by amateurs, the *Commandant Tissot* was equipped with a collection of apparatus which will be difficult to replace. In an appeal for contributions, however small, towards the replacement of their loss, the Society points out that the work carried out on the vessel had evoked the interest of all amateurs, especially in America. Communications should be addressed to the Secrétariat General, 12, rue Hoche à Juvisy-sur-Orge (S. et O.), France.

A 30

"SOMETHING SPECIAL."

For stealing an accumulator through a hole in the wall of a garage, Baden Powell Chetwood was fined 30s. at Ellesmere (Salop). He admitted that he had wished to hear "something special on the wireless."

○○○○

U.S. BROADCASTING LICENCES WITHHELD.

Owing to the present congestion of the American ether the U.S. Department of Commerce is discouraging the erection of new broadcasting stations. For the present no new licences are being granted.

○○○○

DANCE BAND ECONOMY.

Owing to the comparatively high cost of dance bands, the Smethwick Borough Council proposes to install a broadcast

PERMANENT WIRELESS EXHIBITION.

With the idea of running a permanent exhibition and market of every kind of wireless part, a company has been formed in New York to be known as the Radio Centre, Inc.

Sound-proof booths will be installed, and there will also be a library, reception room, and a hall for trade gatherings and conventions.

○○○○

RADIO IN WRANGELL ISLAND.

Wireless is to play a part in the colonisation of Wrangell Island, the barren piece of land off the north-east coast of Siberia. The Russian Government intends to send ten families of Eskimos to form the nucleus of the future population. The settlers are to be kept in touch with the outer world by wireless and a new station is shortly to be erected.

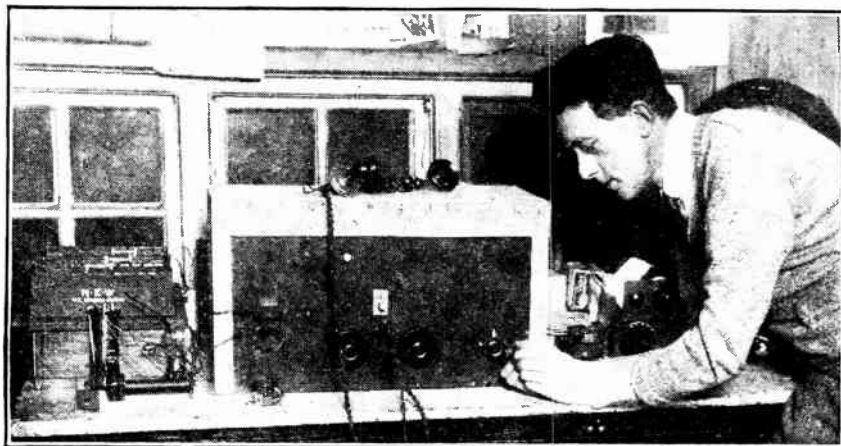

WIRELESS TELEPHONY AT SEA. Mr. Derek Shannon, of Sutton Coldfield, with his duplex telephony transmitter and receiver. As described in our issue of last week, Mr. Shannon has exchanged telephonic conversation with the operator of the s.s. "Reindeer," when the vessel was 70 miles out in the Channel. The land station was situated at Guernsey.

receiver and a loud-speaker in the local assembly hall to provide music for small dances.

○○○○

AIRCRAFT WIRELESS MECHANICS.

The Air Ministry invites applications for five hundred vacancies for aircraft apprentices between the ages of 15 and 16½, providing training for several trades including that of wireless operator-mechanic. Enquiries should be addressed to the Royal Air Force (Apprentice Department), 4, Henrietta Street, W.C.2.

○○○○

BRITISH WIRELESS EXPORTS.

During 1925 the British wireless industry exported goods to the value of £1,335,087, according to interesting figures given in *The Wireless Trader*, which justly remarks that a total annual figure of one-and-a-third millions is one that an industry scarcely three years old can view with satisfaction.

The highest figures relate to Japan, to which goods were exported to a value of over £200,000. Australia purchased an almost equal quantity. European countries appearing high in the list are Holland, Spain, Italy, and Denmark.

TRANSATLANTIC TELEPHONY FROM RUGBY.

As was recently predicted, the engineers at the Rugby high-power station have lost no time in establishing wireless telephonic communication with the United States.

On Sunday, February 7th, conversation was successfully carried on between the Rugby station and Long Island, New York, where a powerful transmitter has been installed by the American Telephone Company.

The trial lasted throughout the day, in broad daylight, and during the whole time speech was maintained with greatest ease and clearness.

That the problem of privacy has been solved is doubtful, in view of reports from amateurs in the Midlands that they picked up one-way conversations.

The tests were, of course, purely experimental, and although the results exceeded the expectations of all who participated, it is felt that further progress must be made before telephone conversation with America is made available to the general public.

No details are available regarding the wavelength used during the transmissions.



Headphones

IT is only with the aid of a good pair of headphones, such as those by A.J.S., that you can do real justice to your receiver. It is surprising what people miss who try to search for stations with a loud speaker. Undoubtedly the best procedure is to tune in with headphones till the best results are obtainable, then switch over.

A.J.S. Headphones are unique in many respects. First of all they are ultra-sensitive, they are comfortable to wear by ladies or gentlemen. There is nothing grotesque in their appearance, as their lines follow the contour of the head. There are no adjustment screws to get lost or damaged, yet they are easily adjusted. When once the correct setting has been found, they "stay put" until such time as a fresh adjustment is required, and they do not flop about when removed from the head.

Price per pair 20/-

A.J.S. Loud Speakers should be used when it is desired to obtain the very best acoustical results for your receiver. On demonstration you will find them difficult to beat, either for purity or by overloading.

Prices from 35/- Fully described in Publication No. 118.

A.J.S.

A. J. STEVENS & CO. (1914) LTD.,
RADIO BRANCH, WOLVERHAMPTON.

Telephone: 1748 (7 lines). Telegrams: "Reception, Wolverhampton."
LONDON SHOWROOMS: 122/121, Charing Cross Road, W.C.2.
 Telephone: Regent 7161-2. Telegrams: "Ajayessen, Westcott, London."
GLASGOW SHOWROOMS: 223, St. George's Road, Glasgow.
 Telephone: Dunghis 3449. Telegrams: "Reception, Glasgow."

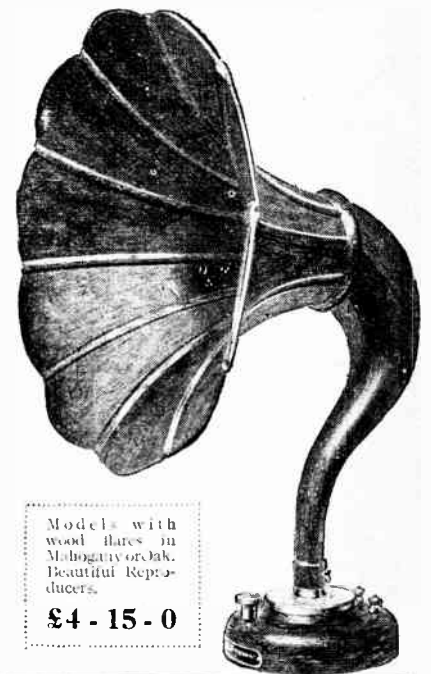

Models with wood flares in Mahogany or Oak. Beautiful Reproducers.
£4 - 15 - 0

A. J. STEVENS & CO. (1914) LTD.,
 Radio Branch, Wolverhampton.

Please send Publication No. 118, describing Loud Speakers and Headphones.

Name.....

Address.....

W.W.17/2/26.

ISSUED BY THE PUBLICITY DEPT. A.J.S.

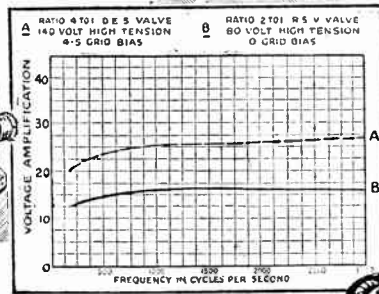
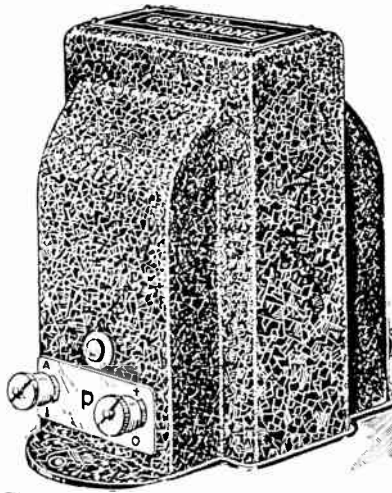

for
**Life-like
 Reproduction**

The GECOPHONE Transformer will better any set. It provides that long-elusive factor, *even* amplification over the audio-frequency range. It puts tone-perfect music and natural speech within the reach of any good loud speaker. Fit it and *hear* the difference!

GECOPHONE

(Registered Trade Mark)

**Low Frequency
 TRANSFORMER**

High insulation between primary and secondary assures *maximum* amplification. High inductance primary gives *even* amplification. A drawn-metal case containing the whole provides adequate shielding and prevents magnetic interaction. Moisture-proof coils. Conveniently marked and placed terminals.

RATIO 2 to 1. Recommended for use with general purpose valves, such as OSRAM types R., D.E.R., D.E.3., etc. **PRICE 22/6**

RATIO 4 to 1. Recommended for use with low impedance valves, such as OSRAM types D.E.4., D.E.5., or D.E.6. **PRICE 25/-**

Your wireless dealer sells it!

The G.E.C.—your guarantee

Advt. of The General Electric Co., Ltd., Magnet House, Kingsway, London, W.C.2.

A Need Supplied!

2-VOLT VALVES

Giving a 6-Volt Result

Osram D.E.2

Only 12 amp. Filament Current Consumption at 1.8-Volts

The introduction of D.E.2 H.F. and L.F. OSRAM VALVES marks another big step in radio progress, and one which will be welcomed by every wireless user. The most severe practical tests have proved conclusively that it is possible to get the same volume and tone from these new 2-volt OSRAM VALVES as from many valves requiring 4 or 6-volt accumulators. *The use of D.E.2 OSRAM VALVES means that accumulator expenses are halved or reduced by one-third for the same, if not better, results.*

D.E.2 H.F. and L.F. OSRAM VALVES are developments from the well-known and popular D.E.R. class, but possessing better characteristics, a third of the current consumption and the same immunity from possible destruction by over-running. You cannot over-run the D.E.2 with a 2-volt accumulator and a standard 5 ohms filament resistance.

Users of 4 or 6-volt accumulators can, by arranging the cells in parallel, make their accumulators last two or three times as long on one charge and still get the same volume and purity.

D.E.2 H.F. and L.F. OSRAM VALVES employ the latest form of thoriated tungsten filament, which ensures a steady and lasting emission throughout a long, useful life.

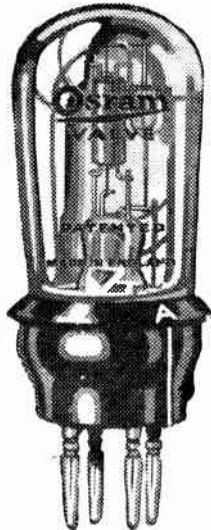

The electron emission of the D.E.2 L.F. OSRAM VALVE is exceedingly liberal, and, as the internal resistance is markedly low, the D.E.2 L.F. proves a most sensitive *Detector* for picking up distant stations. The anode current it passes also makes this type excellent as an L.F. amplifier for providing full mellow tone and plenty of volume.

The D.E.2 H.F. OSRAM VALVE is specially designed to provide the utmost sensitivity to weak signals when used in the H.F. stage; and in addition gives surprisingly increased volume in a choke or resistance-coupled amplifier. *Use a D.E.6 OSRAM VALVE in the last stage.*

For 2-volt accumulators an ideal combination is the D.E.2 H.F. as H.F. Amplifier, and D.E.2 L.F. as Detector and L.F. Amplifier, with the D.E.6 OSRAM VALVE as Power Valve.

Characteristics
H.F. Type

Filament Volts .. 1.8
 Filament Current .. 0.12
 Anode Volts .. 40/120
 Impedance .. 45,000 ohms
 Amplification Factor .. 12

Price 15/6 each

Osram Valves

for Broadcasting

THE G.E.C.—YOUR GUARANTEE.

Characteristics
L.F. Type

Filament Volts .. 1.8
 Filament Current .. 0.12
 Anode Volts .. 20/80
 Impedance .. 22,000 ohms
 Amplification Factor .. 7

Price 15/6 each

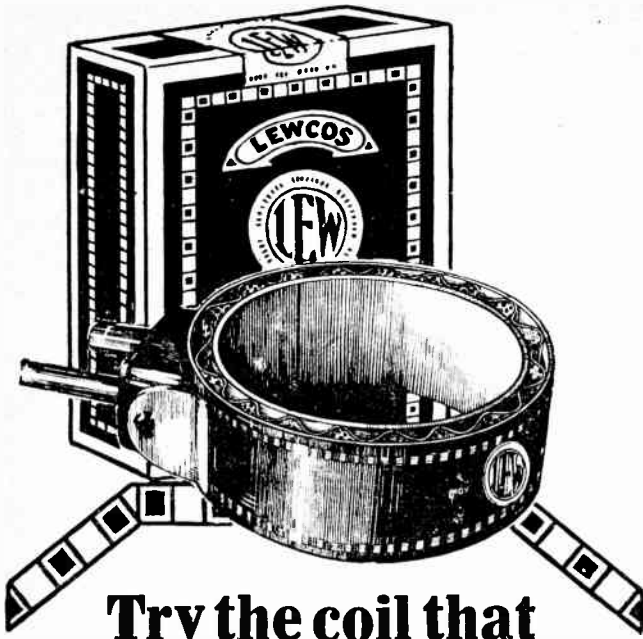

**Try the coil that
"makes all the difference"!**

Every listener who has tried the new LEWCOS Coil is talking about the difference it makes. Some say that this coil in the blue box is as different from ordinary coils as "Glazite" is from the old connecting wire.

The Lewcos Coil embodies high electrical efficiency with great mechanical strength. It gives extremely fine tuning and, having an exceptionally low high frequency resistance, increases signal strength.

Try the LEWCOS COIL for yourself—it makes *all* the difference! Your radio dealer stocks or can obtain this new coil.

LEWCOS

Inductance Coil

The LONDON ELECTRIC WIRE COMPANY & SMITHS, LTD.

Manufacturers of Glazite Connecting Wire

Playhouse Yard, Golden Lane, London, E.C.1



J.C.D.D.

Trouble-free building the Ezi-Wiring Way

All wireless amateurs want a trouble-free set. By means of "The Wireless World" EZI-WIRING Series, the difficulties and trials of home-construction are banished for ever.

These volumes give you complete working instructions, detailed measurements and explanations of the components necessary for building a highly-efficient set at a very moderate cost. A FOUR-COLOUR WIRING DIAGRAM enables you to build the set without any possibility of incorrect wiring.

- No 1. A Three-Valve Portable Receiver : by Hugh S. Pocock. This receiver can be used in any situation with a temporary aerial or with the frame aerial incorporated in the receiver itself.
- No 2. A Three-Valve Receiver : by F. H. Haynes. The tuning arrangements of this receiver are self-contained. All the B.B.C. Stations are, therefore, within the range of this receiver when used in conjunction with an outdoor aerial.
- No 3. A Two-Valve and Crystal Reflex Receiver : by W. James. Reflex Receivers are capable of giving a very high degree of amplification per valve. This two-valve and crystal reflex receiver, unlike many reflex receivers, will be found perfectly stable in operation, and will be capable of giving loud-speaker strength within a radius of thirty miles of a main B.B.C. station.
- No 4. A Four-Valve Combination Set : by W. James. A four-valve receiver of this type is ideal for general reception both with telephones and a loud speaker. Switches are provided so that two, three, or four valves may be used at will. A entirely new principle is used to cut out the H.F. valve, no switches being employed.

Obtainable from the publishers of "The Wireless World":

HLIFFE & SONS LIMITED,
Dorset House, Tudor St.,
LONDON, E.C.4

EZI-WIRING

The W.P. EZI-WIRING Series No 1

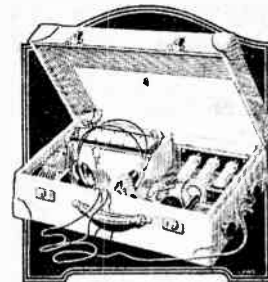

By HUGH S. POCOCK

PRICE:
2/- net
per volume.
BY POST
2/2
each.

**A THREE VALVE
PORTABLE
RECEIVER**

*Containing
COMPLETE INSTRUCTIONS
& WORKING DRAWINGS*



PRICE
2/- NET

H. WIRELESS LTD.
14 & 15, HENRIETTA STREET, W.C.2

Many other books for the home constructor are published by "The Wireless World." A full list will be sent you FREE on REQUEST.

W.W.6.

NEWS FROM THE CLUBS

Secretaries of Local Clubs are invited to send in for publication club news of general interest.

All photographs published will be paid for.

A Good Start!

No fewer than eighty persons have already been enrolled for membership of a new radio society which is being formed at Teignmouth, Devon. The inaugural meeting was held on February 11th.

There is every indication that the society will continue to grow, and all amateurs will wish the new venture every success. The hon. secretary (pro. tem.) is Mr. A. L. Rose, Leicester House, Teignmouth.

○○○○

L.F. Amplification Problems.

The difficulties associated with the use of L.F. amplification were dealt with in an interesting lecture given recently before the Southport and District Radio Society by Mr. A. Hall, A.R.C.Sc.

A successful demonstration was given in which remarkable amplification was obtained with very few valves.

The hon. secretary is Mr. T. G. Storry, 67, Virginia Street, Southport.

○○○○

A Radio "Dinner."

The first dinner of the "Oglander Radio Fellowship" was held, with great success, at the Oglander Hotel, E. Dulwich, on February 4th. An excellent repast, provided by Mr. C. L. Wright, was followed by a musical programme which was much appreciated.

The Fellowship, which meets every Wednesday at 8 p.m., has a number of vacancies for membership. Applications should be addressed to the hon. secretary, J. L. Sewell, 25, Wingfield Street, Peckham, S.E.

○○○○

Why Oscillatory Circuits Oscillate.

The above title was chosen by Mr. J. F. Stanley, B.Sc., when he addressed an interested gathering of members of the Northampton and District Amateur Radio Society on Monday, January 25th.

Mr. Stanley made good use of physical analogies to explain the phenomena of electric circuits, referring to the two properties, inertia and elasticity, which were necessary for the physical oscillation or vibration of any body. An ingenious experiment was performed showing exactly what happened when a condenser was charged and discharged, and how this phenomena corresponded with elasticity in a physical object. An interesting discussion followed on various technical points which had troubled the members, and Mr. Stanley supplied much useful information.

The hon. secretary is Dr. D. S. Steward, Regent Square, Northampton.

Wireless at Worthing.

An encouraging report was read by the hon. secretary at the First Annual Meeting of the Worthing Wireless Society on January 26th. The Society, which has been in existence for only seven months, now has a membership of 78.

One of the most noteworthy activities during the year has been the supervision of the installation of wireless apparatus at the Worthing Hospital.

FORTHCOMING EVENTS.

WEDNESDAY, FEBRUARY 17th.

Hijior Wireless Club.—Discussion evening, to be opened by Mr. H. H. Stanfield, Barnsley and District Wireless Association. At 8 p.m. At 22, Market Street. Simple calculations.

Muswell Hill and District Radio Society.—At 8 p.m. At St. James's Schools, Farris Green, N.10. Lecture: "Valve Characteristics," by Mr. Hirschfeld, B.Sc.

Edinburgh and District Radio Society.—At 117, George Street. Lecture: "The Audyne Receiver," by Mr. A. P. Taylor. *Tottenham Wireless Society.*—At 8 p.m. At 10, Bruce Grove. Lecture and demonstration by Mr. Lucy, of S. G. Brown, Ltd.

THURSDAY, FEBRUARY 18th.

Golders Green and Hendon Radio Society.—At 8 p.m. At the Club House, Willimond Way, N.W.11. Debate with demonstration: "Superheterodyne versus Neutrodyne," to be opened by Mr. J. H. Reeves, M.A.

FRIDAY, FEBRUARY 19th.

Sheffield and District Wireless Society.—At 7.30 p.m. At the Department of Applied Science, St. George's Square. Experimental work. (4) "Taking Characteristic Curves."

MONDAY, FEBRUARY 22nd.

Royal Society of Arts. At 8 p.m. At John Street, Adelphi, London, W.C.2. Cantor lecture by Dr. G. W. C. Kaye, O.B.E.: "The Production and Measurement of High Vacuum" (11). *Saunders Radio Society.* Freak set night.

WEDNESDAY, FEBRUARY 24th.

Radio Society of Great Britain.—Ordinary meeting. At 6 p.m. (Gen. at 5.30). At the Institution of Electrical Engineers, Savoy Place, W.C.2. Lecture: "Some Load-speaker Experiments," by Prof. E. Mallett, M.Sc.

Power Transformers.

The problems met with in the design of commercial transformers were dealt with by Mr. L. H. Crowther, A.M.I.E.E., lecturing before the Sheffield and District Wireless Society on January 29th. Of special interest were the particulars given by the lecturer of the design, construction and performance of a 200-watt 200/2,000-volt transformer built for his transmitting station, G2LH. A comparison of the calculated and measured losses showed a very close approximation and an overall efficiency of 86 per cent.!

Hon. Secretary: Mr. T. A. W. Blower, 129, Ringinglow Road, Sheffield.

○○○○

The Social Side.

The wisdom of paying attention to the social side of club activities is being recognised by the Ipswich and District Radio Society, who announce that a club dinner is to be held on Friday, February 26th.

An "exchange" night has been arranged, and members who have unwanted apparatus for disposal will have an opportunity of parting with it on advantageous terms.

○○○○

Wireless in the Home.

A clever film entitled "The English Home and Radio" was exhibited by Mr. D. Barbrook on his portable cinematograph before the Ipswich and District Radio Society on Monday, February 1st. The film depicted the introduction of a broadcast receiver in a typical English home, the pleasure it gave, and, later, the insatiable curiosity of "Johnny," the boy of the family, who demanded an explanation of "how it worked." The explanation was provided by a series of instructive scenes, including a visit to the 2LO transmitter and a glimpse of the studio.

On Friday, February 5th, members of the Society enjoyed a lecture on the testing of valves, given by Dr. Hiatt, of the Edison Electric Co., Ltd.

○○○○

Wireless at L.C.C. Institute.

A gratifying period of work is dealt with in the Annual Report for 1925 of the Beaufoy Institute Radio Society, Prince's Road, Vauxhall Street, S.E.11.

The most important feature of the year was the Annual Exhibition of the Schools Radio Society, which lasted for four days, and was held in the hall of the Institute.

The membership of the Society has been maintained. Visits to places of interest have been welcome items in the Society's programme. The first visit was made to 2LO, where the members were shown round the control room and the studio. Another interesting visit was that paid to the wireless department at the Croydon Aerodrome.

Arrangements are being made for a visit to the telephone works of Messrs. S. G. Brown, Ltd. Hon. Secretary: Mr. F. Newson, L.C.C. Beaufoy Institute, Prince's Road, Lambeth, S.E.11.

Woolwich Society's Move.

Owing to the rebuilding of the Y.M.C.A. premises, the Woolwich Radio Society has had to seek "fresh fields and pastures new." Very convenient headquarters have now been found at Cottingham's College, Plumstead Common Road, Woolwich, S.E.18, where the Society meets every Wednesday at 7.30 p.m. In tending members are welcomed at these meetings, and applications for membership may also be made to the hon. secretary, Mr. H. J. South, 42, Greenvale Road, Eltham, S.E.

The current issue of "The Oscillograph," the Society's monthly journal, reflects the spirit of animation which has always characterised this active organisation.

○○○○

Distortion and its Cause.

Promises of some excellent lectures in the early future were held out by Mr. C. F. Spencer, President of the Southport and District Radio Society, in addressing the members on February 1st. The services of a number of highly qualified lecturers are to be enlisted, and members will enjoy the additional advantage of experimenting with new apparatus which is to be placed at their disposal.

An informative discussion took place after Mr. R. F. Gregson had delivered his interesting lecture on "The Causes of Distortion."

Applications for membership should be made to the hon. secretary, Mr. T. Godfrey Storey,

67, Virginia Street, Southport, Lancashire.

○○○○

Oscillations Controlled by Light.

An unusually interesting lecture, entitled "The Control of Oscillating Currents by Visible Light," was delivered by Mr. G. G. Blake, M.I.E.E., before the Oxford University Radio Society on February 3rd. The lecture was illustrated by numerous experiments and lantern slides. Mr. Blake also demonstrated his model to show the effect of anode and grid potentials and filament current on the characteristics of valves.

Hon. Secretary: Mr. Eric Cuddon, Merton College.

○○○○

Future of the Oscillating Crystal.

Mr. A. Hinderlich, M.A., lectured on "Oscillating and Transmitting Crystals" at a meeting of the Ilford and District Radio Society on January 19th.

The lecturer was strongly of the opinion

that a great future still lay before the crystal. Certain crystals, it was probable, could be applied to the rectification of current from the mains, and there was a distinct possibility that the valve rectifier would ultimately be superseded by the crystal for this purpose.

Mr. Hinderlich's remarks on grinding quartz for transmitting control were both instructive and entertaining. The grinding of quartz crystal presented more difficulty than cutting diamonds! The procedure was attended by constant observation through the microscope, as every thousandth of an inch in thickness represented approximately two and a-half metres in wavelength.

The Society now meets at the Wesleyan Institute, Ilford.

○○○○

Valves and their Curves.

Lantern slides, kindly lent by the Edison Swan Electric Co., Ltd., added to the interest of a lecture given before the

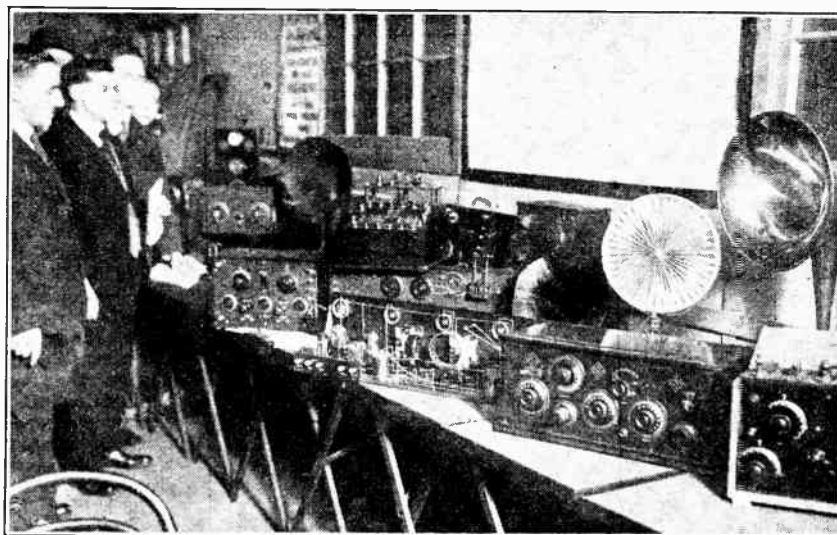

AN AMATEUR DISPLAY. Some of the home-built receivers which were on view at a recent meeting inaugurating a local branch of the Wireless League, under the auspices of the Tottenham Wireless Society.

Croydon Wireless Society by Mr. W. T. Pearson on Monday, February 1st. Taking as his subject "The Manufacture of Wireless Valves," the lecturer described the various processes in the production of the Ediswan AR .06 dull emitter.

Mr. Pearson announced that the following Monday's meeting would be devoted to the actual plotting of valve curves, members being requested to bring along their own valves for this purpose.

A pleasing feature of the meeting was the influx of several visitors, who received a warm welcome.

Hon. Secretary: Mr. H. T. P. Gee, 51-52, Chancery Lane, London, W.C.2.

○○○○

Facts About Condensers.

A lantern lecture of absorbing interest was delivered before the Muswell Hill and District Radio Society on January 27th by Mr. H. Andrewes, of the Dubilier Company.

Taking as his subject "Mica Condensers for Transmitting and Receiving," Mr. Andrewes described the various stages through which the mica passes, from the mica mines of India to the finishing bench in the Dubilier Co.'s works. The slides depicted the native miners in India chopping and sorting the mica, the arrival of the raw material at the factory, and the many processes involved in the construction of the small fixed condenser so familiar to the listening public. Finally some excellent slides were shown of the giant condensers constructed for the new Rugby station.

Hon. Secretary: Mr. Gerald S. Sessions, 20, Grasmere Road, Muswell Hill, N.10.

○○○○

Short-wave Reception.

Captain H. J. B. Hampson (G6JV), who has kindly undertaken to give a series of lectures before the Norwich and

District Radio Society, delivered the first on January 29th, taking as his subject "Short Wave Tuners."

Captain Hampson recounted how the amateur transmitter had been restricted by the Post Office to the lower wavelengths, with results which showed the hitherto unsuspected merits of short waves. Particular interest was shown in the lecturer's short-wave coils, which were passed round for inspection. In conclusion, Captain Hampson described a modified Reinartz circuit (0-v-1) of a type which could be made to oscillate on a wavelength of 8 metres.

Hon. Secretary: Mr. F. G. Hayward, 42, Surrey Street, Norwich.

○○○○

A Successful "Reflex."

"An Efficient Reflex Receiver" was the title of a paper given by Mr. J. H. Forbes at the meeting of the North Middlesex Wireless Club on January 20th.

Although Mr. Forbes made no claim to originality in the circuit he used, it was evident that he had carefully tried out many variants of the original circuit, and the receiver he had constructed, and brought with him, gave a very creditable performance.

The fact that no crystal was used tended to make the set more certain in operation, and the care devoted to details like best sizes of condensers, etc., contributed to the success of the demonstration.

Hon. Secretary: H. A. Green, 100, Pellatt Grove, Wood Green, N.22.

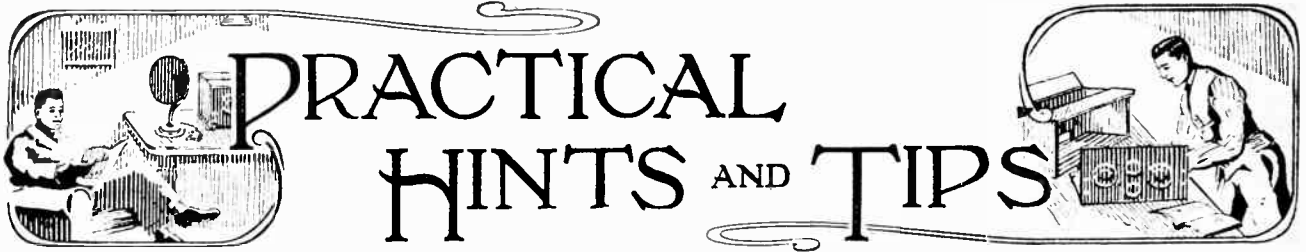

A Section Mainly for the New Reader.

AMPLIFIER SWITCHING.

The design of switching arrangements to eliminate a stage of low-frequency amplification is not as simple a matter as might appear at first sight. In a well-designed receiver, probably using a detector valve of the general-purpose type, the first L.F. transformer will have a higher primary impedance (and consequently lower step-up ratio) than will the second. Also, from motives of economy, the first L.F. valve may be of a type incapable of handling large input voltages. A little consideration will therefore show that if, for example, when receiving loud signals, we arrange to transfer the loud-speaker to the anode circuit of the first L.F. valve, and switch off the second, this former valve will probably be overloaded. Further, rather complicated switching connections may be necessary in order to assure that the H.T. voltage applied is of the same value as when both valves are in use.

Another possible (and probably

better) alternative arrangement consists in keeping the loud-speaker in the anode circuit of the last valve, and changing over the output of the detector to the primary of the second transformer, which, however, may very possibly have an incorrect impedance value.

In Fig. 1 is shown a simple method of switching, having none of these disadvantages, and requiring a three-pole change-over switch. When this switch is "up," both L.F. valves are in operation; when it is "down," the filament of the first amplifier is extinguished, and the output of the (presumably) low-ratio transformer in the anode circuit of the detector valve is transferred to the grid-filament circuit of the output power valve. The bias voltage applied to this valve remains unchanged.

An ordinary D.P.D.T. switch may be used if the refinement of automatic filament switching is not required. The modifications necessary in this case are fairly obvious: instead of

connecting the rheostat to filament through the switch, a direct connection is made between these points.

The only disadvantage of this arrangement lies in the fact that the grid battery is at the high-potential end of the circuit. This may be overcome by taking care that it is adequately insulated and also by choosing a battery having very small cells and consequently small capacity. Such cells have a rather short life, but it must be remembered that, in a properly adjusted amplifier, they supply practically no current, and should last as long when connected in circuit as if they were standing idle. Leads to the battery should, for obvious reasons, be as short as possible.

o o o o

LOST EMISSION.

Many types of dull-emitter valves will, after more or less prolonged use, be found to lose their emission, although the filament is still intact. In fact, it will generally be found that the life of many of the more robust valves will be determined by failure of emission rather than by filament burn out. This is rather puzzling to amateurs who have graduated in the "bright-emitter" school, and who are apt to regard a valve whose filament glows at an apparently normal brilliancy as being beyond question in good working order.

Those who are in possession of a milliammeter will have no difficulty in deciding if loss of emission is the cause of a falling-off in volume and quality of reproduction. In cases where such an instrument is not available, a rough and ready test may be made by inserting the suspected valve in a regenerative receiver, and noticing if a very much tighter reaction coupling is needed to produce oscillation than is required where a

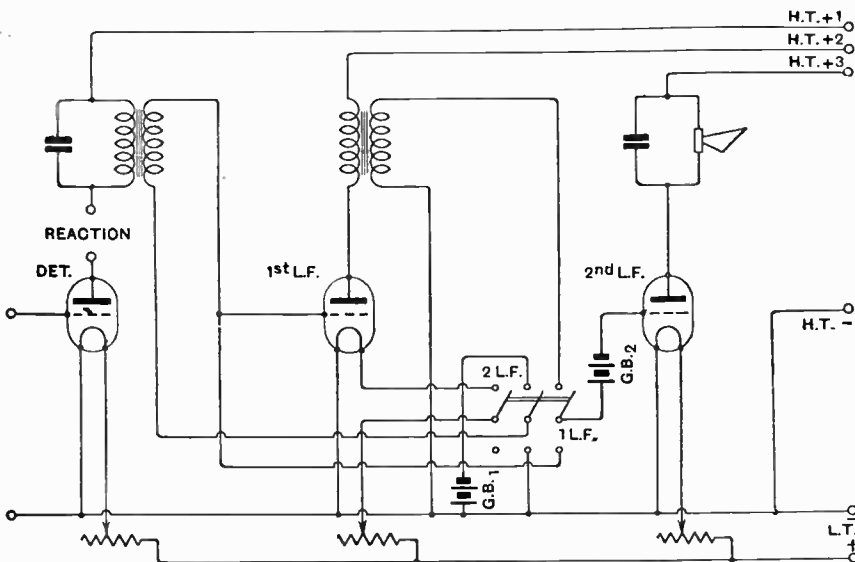

Fig. 1.—Switching an L.F. amplifier.

valve of the same type, and known to be in order, is used.

It will generally be found that a dull-emitter valve which has partially lost its emission may be made to function correctly by increasing its filament temperature. This improvement will not, however, be permanent, and it will be necessary gradually to increase the filament voltage until the valve is operating as a bright emitter; under these conditions it will have a very short life.

Some manufacturers issue instructions with their products for the recovering of lost emission; this is generally done by applying a normal voltage to the filament for a short period, with no H.T. on the plate. It should be pointed out that these remarks only apply to valves with thoriated filaments; those with coated filaments cannot be reconditioned.

o o o o

A WORKSHOP HINT.

Amateur constructors not provided with a set of taps sometimes find difficulty in inserting metal screws into ebonite. It is useful to know that ordinary brass or iron wood screws may be used if a hole of the

correct diameter (which will best be ascertained by trial) is drilled and the screw is heated before it is driven in. It is recommended that the screw be inserted when cold, and a few turns given; a hot soldering iron should then be applied to its head for a few moments, when it will be found quite easy to complete the operation, as a thread will be formed in the softened ebonite.

It is probable that a small screw, used in this manner, will hold even more securely than would a metal screw of the same diameter inserted into a tapped hole. Care must be taken, however, not to strip the thread while the ebonite is in a semi-plastic state. If it is desired to remove the screw on a subsequent occasion, it will often be found necessary again to warm its head with the tip of a soldering iron.

o o o o

FILAMENT RHEOSTAT CONNECTIONS.

Many of our readers will have noticed that in almost every circuit diagram appearing in *The Wireless World* the filament rheostats are shown in series with the positive low-

tension lead, the other side of the filament being joined directly to the negative terminal; all the "grid return" leads are connected to this negative bus-bar.

There can be little doubt that this arrangement is the best that can be adopted, except under very exceptional circumstances. Occasionally when a volt or two of grid bias is required one is tempted to adopt another possible alternative, and to insert the rheostat in the negative lead, connecting the grid return lead to the negative bus-bar. In this way the drop of voltage across the resistance will be applied to the valve, and we obtain a gratuitous source of grid bias, amounting to about 2 volts when 4-volt valves are used with a 6-volt battery.

Unfortunately, however, the grid voltage of the valve will be varied with changes of filament brilliancy, thus introducing a variable adjustment which is not under complete control. In the case of a sensitive and none too stable H.F. valve, or a regenerative detector, the operation of the set will be unnecessarily complicated by this scheme of connections.

DISSECTED DIAGRAMS.

No. 18.—A "Hartley" Single-valve Receiver.

For the benefit of readers who find difficulty in reading circuit diagrams, we are giving weekly a series of sketches showing how the complete circuits of typical receivers are built up step by step. The arrangement shown below is a modification of the well-known transmitting circuit.

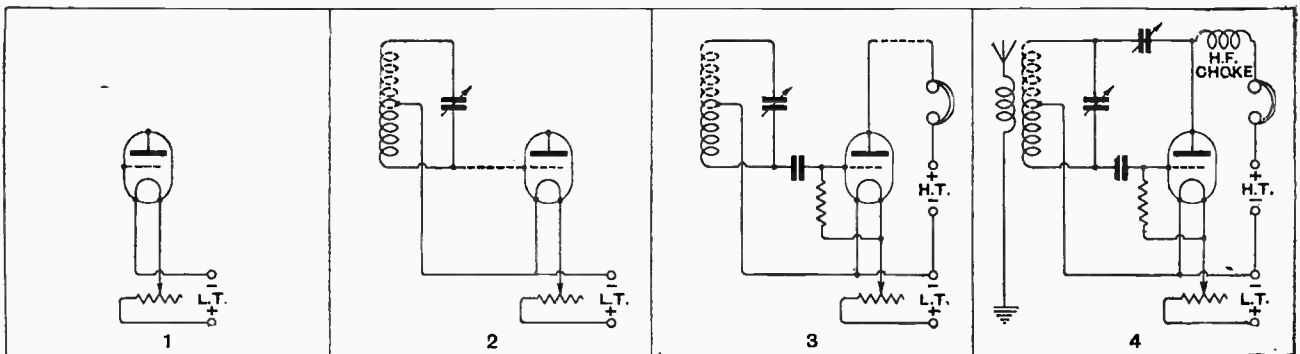

A valve with its filament heated by current from a low tension battery, controlled by a variable rheostat connected, as usual, in the positive lead of the L.T. battery to avoid grid bias complications.

An oscillatory circuit, consisting of a coil and variable condenser, is added. The coil is tapped in the centre, and only half of its inductance (as shown in full lines) is in the grid circuit

A grid condenser and leak are inserted for rectification. The external anode-filament circuit is completed through 'phones and high-tension battery. An aerial-earth system may be—

—coupled to the grid coil as shown. Reaction may be obtained by connecting the plate through a small variable condenser to the "free" end of the grid coil, a choke being inserted to deflect H.F. impulses.

PIONEERS OF WIRELESS.

By ELLISON HAWKS, F.R.A.S.

7.—Michael Faraday.

MICHAEL FARADAY, the son of a blacksmith in moderate circumstances, was born at Newington Butts, London, on September 22nd, 1791. After a lifetime of brilliant research and experiment he died at Hampton Court on August 25th, 1867.

When twelve years of age, this boy, who was destined to become one of the most distinguished of British scientists, started life as an errand boy to a bookbinder named Ribeau, who bound odd lots of books bought from printers. Ribeau was so pleased with Faraday's work that he subsequently took him as an apprentice without premium.

The Bookbinder's Apprentice.

Faraday remained with Ribeau until twenty-one years of age, devoting his leisure hours to science. He made numerous experiments with electric machines of his own construction, attended scientific lectures, and made many friends.

In 1812 a happy chance determined his future. One day a customer called at the shop about the binding of some books, and found young Faraday deeply engrossed in the perusal of an article on electricity in an encyclopaedia he was binding. Hearing of the young apprentice's industry, the customer—who was a member of the Royal Institution—presented him with a series of four tickets for admission to the chemical lectures of Sir Humphry Davy. Needless to say, Faraday attended the lectures and took copious notes, which he later wrote out fully in a quarto volume.

He tells us that, in his opinion, "trade is vicious and selfish," while, on the other hand, "science makes its pursuers amiable and liberal." "My desire to escape from trade," he wrote, "induced me at last to take the bold step of writing to Sir Humphry Davy, expressing my wishes and a hope that if an opportunity came in his way he would favour my views. At the same time I sent the notes I had taken of his lectures."

One night, soon after this letter had been despatched, there came a loud knocking at Ribeau's door. The splendid carriage of Davy was in the street, and a liveried servant handed Faraday a note instructing him to call on Sir

Humphry next morning. The outcome of the interview was that Faraday was appointed Sir Humphry's assistant at a salary of 25s. per week. In later years, when being congratulated on his discoveries, Sir Humphry Davy would say: "Yes, but my best discovery was Michael Faraday!"

Demonstrator to Davy.

Faraday soon assisted Davy in his lectures and experiments, which were sometimes of a perilous nature. When Davy went abroad Faraday accompanied him as his valet and secretary. Davy's wife behaved badly to Faraday, never allowing him to forget he was a menial, and insisting on occasion that he took his food with the grooms! This does not appear to have perturbed Faraday, however, who had a beautiful character and a charm of manner that endeared him to those with whom he came in contact.

In 1827 the blacksmith's son and bookbinder's apprentice succeeded Sir Humphry Davy as Professor of Chemistry at the Royal Institution, where he remained for forty-one years in all.

On succeeding Davy, Faraday began the great work that will for ever remain a monument to this gifted scientist. Oersted had produced magnetism by electricity, and this suggested to Faraday the possibility of obtaining electricity from magnets. Following this line of thought, and reversing Oersted's experiment, Faraday found (in 1831) that if a magnet be moved towards or from a coil of wire, an electric current is induced in the wire.

By this discovery Faraday even more definitely connected the lodestone of the ancients with the current electricity of Volta. He showed that there is a close relationship between electricity, magnetism, and motion. Bodies that are electrified and are in rapid motion produce magnetic fields around themselves, while a magnet in motion has the power of creating currents of electricity in conductors that are close to it. These two discoveries are now in everyday use, and form the basic principle of the electric motor and the dynamo.

The great value of Faraday's work as a pioneer of wireless is difficult to determine. His discoveries subse-



Michael Faraday.

Pioneers of Wireless.—

quently made possible the electric telegraph and the telephone. They made possible the many applications of electricity and electromagnetism that are to-day part of the great driving force of every civilised country. At the time Faraday made his discovery radio was, of course, quite unknown, and he could not have had any idea of the use that would be made of his discovery for communicating without wires.

In addition to other important discoveries arising from it, Faraday's pioneer work was subsequently of the utmost consequence to wireless, for it was the means of leading another great scientist, Clerk Maxwell, to investigate

electromagnetism with brilliant results, as we shall read later. It is a remarkable fact that Faraday avoided all distinctions, with the exception of D.C.L., and even refused the Presidency of the Royal Institution.

In private life he was a gentle and affectionate man, always willing to extend a helping hand to those endeavouring to climb the ladder of learning. "I am no discoverer," he once said, "but simply one of a vast crowd of workers scattered over the earth who in the providence of God are invested with some proportion of the Divine afflatus. . . ." A charming man and a brilliant genius, whose work as a pioneer of wireless we cannot but pause to admire.

General Notes.

Mr. F. R. Neill (GI 5N.J), Chesterfield, Whitehead, Co. Antrim, writes that he was in two-way communication at an early hour on January 25th with Y 1WP, Risselpur, India, whose signals on 38 metres were about R7-B. Mr. Neill was working on 44 metres 96 watts, and his signals were reported to be very good.

○○○○

Swedish Amateurs.

We are indebted to Mr. Hugo Francke (SMUK), of Saltsjöbaden, for the following list of Swedish transmitters:—

SMSL.—Hudiksvalls Radioforening, Hudiksvall.

SMSM.—Karlskrona Radio Club.

SMSN.—Umea Radio Club.

SMSO.—Varberg Radio Club.

(The above stations relay broadcast news, etc.)

SMSP.—A. Bertilsson, Järntorget 4, Göteborg.

SMSQ.—N. Larsson, Blekingegat, Stockholm.

*SMSR.—Radiobyran, Stockholm.

SMSS.—S. Carlsson, Garden 93a, Askersund.

(* Another correspondent gives the QRA of this station as P. H. Svensson, Lindgatan 6, Liljeholm, nr. Stockholm. This is probably the address of the authorised operator.)

○○○○

The following steamers trading between Sweden and South America are equipped with short-wave (45-metre) stations:—

SGC.—Ss. "San Francisco."

SDK.—Ss. "Kiruna."

SGT.—Ss. "Suecia."

SKA.—Ss. "Axel Johnson."

The secretary of the Swedish Radio Club, Dr. Bruno Rolf, is now sailing for Columbia on ss. "Axel Johnson" with an experimental station working on 30-35 metres, call-sign COS, and will welcome reports of his transmissions, which should be addressed to Mr. Hugo Francke, at the Radio Club, Hamngatan 1, Stockholm.

○○○○

Austrian Amateurs.

The secretary of the Organisationskomitees der Oesterrishischen Amateursender has kindly forwarded us the following list of the call-signs and wavelengths used by amateurs in Austria. The wavelengths, in metres, are printed after each call-sign. These stations use the international prefix Ö. As they are

TRANSMITTERS' NOTES AND QUERIES.

not yet officially licensed, the names and addresses cannot be published, but communications may be sent *via* Mr. G. E. Roth, c/o "Radiowelt," Rüdengasse 11, Vienna III.

AA (150-200), AF (under 100), AR (20 and 100), AW (25-100), BE (200-400 and 450), BH (3 and 75), CV (35), DA (101), FG (80-100), FH (25, 100 and 300-450), FL (150 and 580), FM (80-100), FZ (under 150), GG (100-150), HF (under 100), HI (95), HM (425), HR (310-315), JA (under 50), JL (425 and 530), KH (100), KK (90-105), LA (100), LM (320).



AN ITALIAN TRANSMITTING STATION. 11BD, owned and operated by Signor Enrico Pirovano, at Viale Varese 11 Como. The transmitter is of the Hartley Direct-coupled type. 1BD has been in two-way communication with New Zealand, India, Canada, and all the nine districts of U.S.A.

LP (85), MH (500-650), NA (70-75), OA (77), OP (35, 50 and 70), RF (200), RG (20-50), RH (75-80), SF (73), SJ (70-80), SV (45), TA (75-80), TM (93), TO (50, 70, 120 and 440), WA (115), WM (under 20), WR (10, 45 and 60).

○○○○

New Call-signs Allotted and Stations Identified.

G 2BHR (Art. A.).—R. G. Bonner, 39, Abbey Road, Bush Hill, Enfield.

G 2PLV (Art. A.).—J. White, 22, Reynolds Close, Hampstead Way, N.W.1.

G 2IA (in place of 2AWS).—T. H. Colebourn, "Ardehalligan," Selbourne Drive, Douglas, Isle of Man.

G 5IA (late 2BJM).—G. M. Whiteley, "The Hollins," Sowerby Bridge, Yorks.

G 5XO.—Capt. L. A. Pratt, 24, Marriott Road, Barnet.

G 5YG.—J. Wylie, 105, Mossiel Road, Newlands, Glasgow, transmits on 45-90 and 150-200 metres.

G 5YZ.—G. H. Houghton, 110, Heathwood Gardens, Charlton, S.E.7.

G 6KT.—K. E. Willson, "Hedgerows," Main Road, Dovercourt Bay, Essex, transmits on 150-200 metres. (This call-sign was formerly that of Mr. F. Burns, Birkdale.)

G 6LL.—J. W. Mathews, 178, Eversing Road, Clapton, E.5.

G 6MI.—R. Maynard, 44, Demesne Road, Douglas, Isle of Man.

G 6NX.—J. T. McDade, 8, Monteith Row, Glasgow, S.E.

G 6YX.—R. F. G. Holness, 34, Dunloe Avenue, Tottenham, N.15.

G 6ZC.—Marconi (Chelmsford) Wireless Society, Marconi Works, Chelmsford, transmits on 45 and 150-200 metres.

GI 6QD.—J. C. Pollock, 1, Notting Hill, Belfast, transmits on 23, 45 and 150-200 metres.

F 8JZ.—A. Crémaille, 15, Rue de Vitré, Rennes (I and V).

F 8FY.—M. Courtenisse, 23 bis, Rue de l'Industrie, Tourcoing (in place of M. Boulet, Paris).

SMLZ.—J. Lagercrankz, Djursholm, nr. Stockholm.

○○○○

A Correction.

The call-sign of Mr. A. Marzoli, Via Bramanti 3, Rome, is I 1MA, and not I 1AM, as printed, in error, on page 142 of our issue of January 27th. The owner of I1BD is Mr. Enrico Pirovano, whose name, we regret, was incorrectly spelt in the supplementary list of experimental stations.

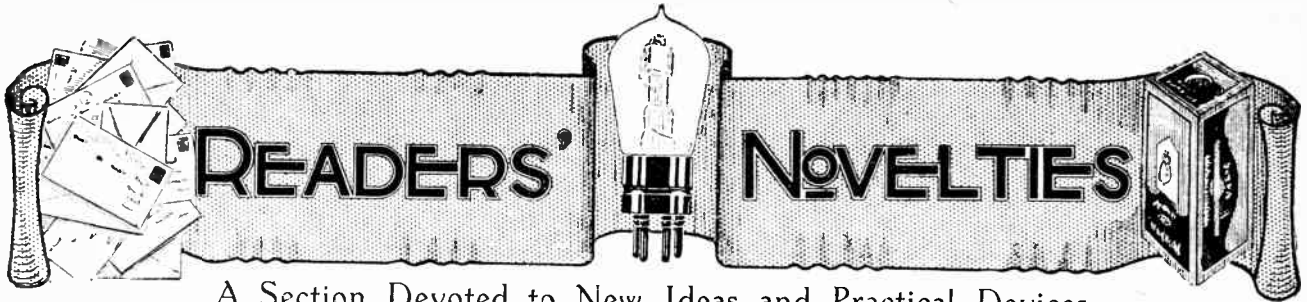

A Section Devoted to New Ideas and Practical Devices.

TELEPHONE TAGS.

The diagram shows a form of telephone tag which enables telephones to be connected either in series or in parallel. The tag is constructed from No. 16 S.W.G. hard-drawn copper wire, which is wound in the form of a spiral on a steel spit equal in diameter to the wire itself.

When the coil is released from the spit, the internal diameter increases slightly, thus allowing the ends of the tags to fit inside. The tag end is bent slightly out of line with the axis of the spiral, so that when two tags

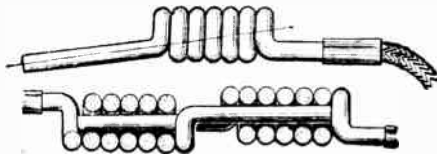

Spiral telephone tags.

are joined together good contact is formed by the spring action so produced.

When connecting telephones in series across a single pair of telephone terminals, one tag of each pair of phones is inserted in the terminals, the remaining tags being connected together as shown in the diagram.—S. C.

o o o o

REACTION CONTROL.

The diagram shows a neat method of obtaining critical control over the coupling between the reaction coil and A.T.I. or secondary coil in a short-wave low-loss tuner.

The reaction coil is pivoted to brass supports screwed to the front panel of the receiver, a hole being drilled for this purpose in one of the ebonite strips supporting the coil. This strip is cut to a special shape, with a projection at one corner which is normally in contact with an adjusting screw passing through a threaded

bush in the panel. There is an entire absence of back-lash, since the projection is always pulled into contact

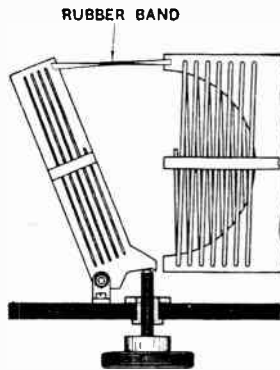

Reaction control for short-wave tuner.

with the head of the adjusting screw by means of a rubber band fixed between the upper end of the reaction coil and one of the A.T.I. supports.—A. T. C.

o o o o

FUSES.

In experimental work fuses are frequently required for currents of the order of 0.1 amp. or less. As copper wire of No. 47 S.W.G. has a fusing current of 1 amp., it will be necessary to use some conductor other than wire. For this purpose tin foil is excellent. A narrow strip of the foil is clamped on an ebonite base underneath terminals or screws and washers. The tin foil is then cut away with a sharp penknife or

VALVES FOR IDEAS.

Readers are invited to submit brief details, with rough sketches, where necessary, of devices of experimental interest for inclusion in this section. A receiving valve will be despatched to every reader whose idea is accepted for publication.

Letters should be addressed to the Editor, "Wireless World and Radio Review," Duncot House, Tudor St., London, E.C.4, and marked "Ideas."

safety razor blade until the required fusing current is obtained. A few experiments with an ammeter connected in series with a variable resistance and battery will serve to indicate the current-carrying capacity of strips of varying width.—J. L. H.

o o o o

AERIAL-EARTH SWITCH.

Many readers prefer to use plug and socket connections for the aerial and earth leads to their receivers. A simple earthing switch enabling this method of connection to be retained is shown in the diagram.

Two sockets are screwed into a small ebonite panel and a short-circuiting arm of springy brass is pivoted in the centre of the panel by means of a No. 4 B.A. round-head screw fitted with a spring washer and locknuts.

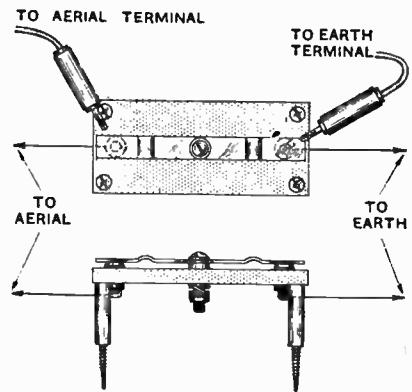

Earthing switch.

When it is desired to connect the aerial through to earth the aerial and earth leads to the set are withdrawn and the brass contact strip is turned horizontally, as shown in the diagram, thus short-circuiting the faces of the aerial and earth sockets.

Normally, with the set in use the strip is turned at right angles to the direction shown in the diagram.—J. J.

LIGHTNING ARRESTER.

A lightning arrester can easily be made in the following way. Two telephone-type terminals are mounted on two separate strips of ebonite about 2in. long and $\frac{3}{4}$ in. wide, holes being drilled at one end of each strip in order that telephone terminals may be fixed.

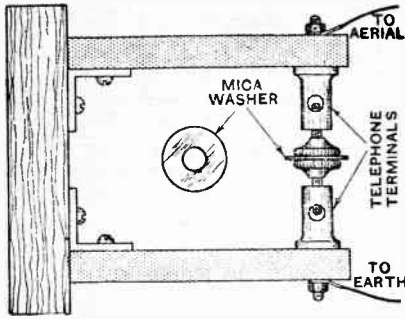

Simple lightning arrester.

These two strips are now secured to a piece of wood of suitable size by means of small angle brackets in such a way that the heads of the screws of the terminals are almost touching.

A thin mica washer is placed between the screw heads, and the space formed between the heads of the screws will provide an efficient arrester. The drawing explains this quite clearly.—A. V. C.

o o o o

TUNING HINT.

When operating a loud-speaker in a part of the house distant from the receiver it is frequently necessary to make tuning adjustments which involve some method of listening-in at the receiver. If the set is so constructed that telephones can be plugged into the plate circuit of the detector valve no difficulty is experienced, but where this is not the case the signal strength in telephones would be excessive if connection be made directly to the output terminals. It will generally be found that sufficient volume for tuning purposes is obtained in the telephones if one side only is connected to the plate or negative output terminal. If more volume is required the other terminal tag may be held in the hand, but this is not recommended, as variations of volume would be produced which might be attributed to tuning effects.—R. K.

A 42

ADJUSTABLE DIAPHRAGMS.

Telephone receivers of the flat Stalloy diaphragm type can be made adjustable for experimental purposes by placing a thin rubber washer between the edge of the casing and the underside of the diaphragm. The distance between the diaphragm and the face of the magnets can then be varied by tightening or unscrewing the ear cap.

Rubber washers of suitable dimensions are, however, somewhat difficult to cut, but it will be found that a film of Chatterton's compound, which contains a large percentage of rubber, makes an excellent substitute. The compound should be warmed and applied to the edge of the casing and not to the diaphragm, as this method will be found to give a more even distribution.—J. L. H.

o o o o

TELEPHONE CONNECTORS.

The diagram shows a simply constructed connector for fitting to telegraph type terminals when it is desired to use several pairs of phones in parallel. The connector is constructed from brass rod of square or rectangular section, vertical holes being drilled to take the telephone tags, with corresponding lateral holes drilled and tapped for No. 6 B.A.

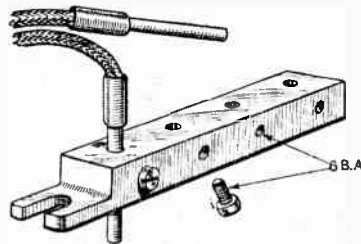

Multiple telephone connector.

set-screws. The bar is filed down at one end to a thickness suitable for insertion in the terminal, a slot being cut in the lip so formed to pass the centre screw of the terminal.—H. R. W.

o o o o

LEAD-IN SWITCHING.

It is frequently desired to transfer a receiving set from the ground floor to a room on the floor above. If a change in the position of the set is to be made frequently, it may be worth while to introduce a system of switching into the aerial lead-in which will

reduce the time required to connect up the set. A double-throw knife switch may be fitted outside each window, the aerial lead-in being connected as indicated in the diagram. The connections for a single-pole double-throw switch used in conjunction with

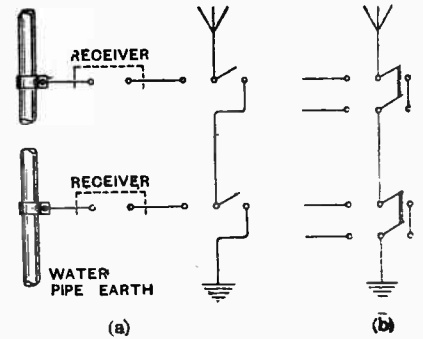

Lead-in connections.

a waterpipe earth are shown at (a), while the connections for D.P.D.T. switches are shown at (b).—A. W. I.

o o o o

IDENTIFYING EXTENSION LEADS.

Loud-speakers should always be connected in such a way that the field produced by the steady anode current passing through the windings tends to assist the permanent magnet. In order to ensure the correct method of connection the terminals of most loud-speakers are marked + and -, the + terminal being connected to + H.T. and the negative terminal to the plate of the power valve. When the loud-speaker leads are extended, say, by means of lighting flex in order that the instrument may be used in another room, it is difficult without the aid of a milliammeter to tell which is the positive and which the negative lead. A simple method of identifying the leads is to connect them at the receiver end to the grid bias terminals instead of the output terminals, and to connect the grid bias battery at the other end of the leads in the next room. When the battery is connected wrongly the reproduction from the loud-speaker will be badly distorted and of poor volume, while normal operation will be obtained with the battery connected in the correct manner. It is then only necessary to tie knots in the positive leads for identification.—A. J. B.



Broadcast Brevities

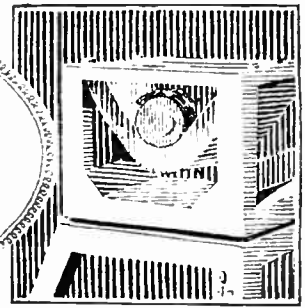

Savoy Hill Topicalities : By Our Special Correspondent.

Redistribution of Wavelengths.

Great store is set on the success of the conference which has been summoned to Geneva on March 25th to consider propositions concerning the redistribution of broadcasting wavelengths between European stations. These propositions are the result of investigations extending over four months. The conference will consist of all existing or projected broadcasting organisations, and will be held at the Palais de Nations, which has been lent by the Secretariat of the League of Nations. The conference will be preceded by a general assembly of old and new members of the International Broadcasting Union.

o o o o

Birmingham Breakdowns.

One of the speakers at the opening of the new Birmingham premises of the B.B.C. fell into error in stating that the percentage of breakdowns of the station

was equal to .12 per cent., or twelve hours in every thousand. It will, of course, be apparent that he should have said twelve hours in every ten thousand. Simple as the sum is, most readers of the statement would accept it at its face value without troubling to check its accuracy, unless their attention was called to the mistake, which, as it happens, was a very important one.

o o o o

A Village Concert.

Mr. Vivian Foster, the "Vicar of Mirth," will be in the chair at a village concert which is to be broadcast on February 26th. This production was postponed from a date in January, to the disappointment of many listeners. Mr. Foster is the son of a clergyman who reproduces from first-hand observation the little mannerisms and foibles of the clergy, and he does it without giving any trace of offence.

The Broadcasting Inquiry.

In his supplementary evidence before the Broadcasting Committee, the Managing Director of the B.B.C. was misunderstood by some of his hearers to refer to the importance, or "pretended" importance, of the amateur experimenter. This is a misconception which I am asked to correct; and the best way of doing that is to quote verbatim from the shorthand report of the inquiry, viz. :—

Q. : You maintain that their (the amateur experimenters') fears and their apprehensions have been overstated?

A. : But I do not overlook their importance, or their potential importance.

o o o o

The Quest of Elizabeth.

It is a fact worth recording that the B.B.C. has broadcast 250 plays, and on less than half-a-dozen occasions has a reference or criticism of any of them appeared in the Press. The particular paper which described "The Quest of Elizabeth," the play by Capt. Reginald Berkeley, which was broadcast from 2LO and other stations recently, as "gruesome" and "Grand Guignol," had on only one previous occasion commented on any of the plays that have been transmitted. Is this a tribute to the excellence of the other 240-odd plays, or an awakening to the fact that broadcasting is now so much part and parcel of the life of the community that its news value cannot be ignored?

o o o o

Only Two Complaints.

To my mind, a great deal too much capital has been made out of the Berkeley play incident. The play was sent out last autumn from Glasgow, Cardiff, Bournemouth, Manchester, Birmingham, Aberdeen, and Belfast. Although some millions of listeners presumably heard it, only two complaints were received that it was too dramatic for people who had relatives in hospital. Further, on not more than two occasions has the play been broadcast in exactly the same form.

o o o o

No Limit.

So far as radio plays are concerned, we are still in the experimental stage and it is difficult to see how the B.B.C. can

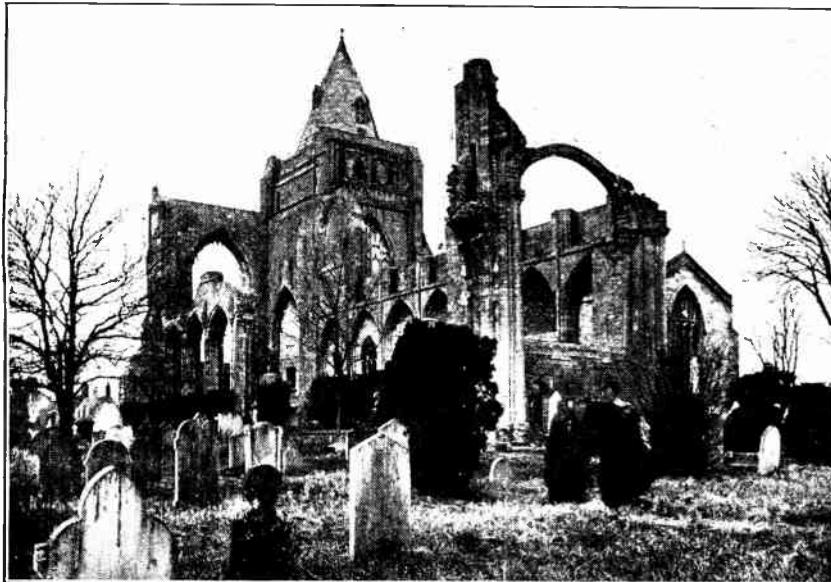

BROADCASTING THE BELLS. A picturesque view of Crowland Abbey, Lincolnshire, to which the B.B.C. has connected a permanent land line. Crowland was the first English Abbey to possess a peal of tunable bells.

limit the field of selection, either in respect of pure romance or of plays dealing with the hard facts of life.

o o o o

An Interesting Forecast.

From the day when it was announced in some sections of the Press that the broadcasting of the Savoy Bands would cease at the end of February, a desire seems to have become apparent to represent broadcasting as being deserted by its friends. This is far from being the case. Indeed, I will make a definite forecast, viz., that within a week of the publication of this note the news about the future of the Savoy Bands in connection with broadcasting will show that the amicable relations which have hitherto existed between the two interests remain undisturbed in spite of the gloomy prophets.

o o o o

A Thomas Hardy Broadcast.

The London Radio Players are to give two excerpts from "The Dynasts," the great epic drama by Thomas Hardy, on February 25th. In these scenes Mr. Milton Rosmer, the well-known actor, will take the part of Napoleon. The same evening will be a real Napoleon evening. The programme will not be an attempt to analyse the career of Napoleon Bonaparte, much less to give a historic *resumé* of his life. What is actually proposed is to give a picture of Napoleon and his times as reflected in music and poetry.

o o o o

What Station was That?

A listener has expressed to me his bewilderment at an incident which occurred last Sunday. He was listening to a church service, and in the middle of it heard the church clock strike six. The clock, he says, must have been wrong, as the actual time was 5 o'clock. I rather think that he must have been receiving the English church at Malmö or some other place where the time was an hour in advance of England.

o o o o

The "Silent" Test.

Perhaps the most surprising thing about the "silent" test which was carried out by the B.B.C. last week was that unexpectedly few Continental stations were found to be off their wavelengths, and the amount of heterodyning was not so serious as it had been on some recent occasions. The scheme arranged was that the B.B.C. and a small band of amateurs, acting under the directions of the B.B.C., undertook to try and establish the identity of Continental stations which had been causing inconvenience to British listeners by heterodyning. For this purpose it was necessary for all B.B.C. stations to close down and for an appeal to be made to everyone to refrain from using their wireless apparatus for a quarter of an hour.

o o o o

Locating Offending Stations.

Previous to the test, the B.B.C. engineers ascertained the wavelengths of the majority of stations and noted which

FUTURE FEATURES.

Sunday, February 21st.

LONDON.—3.30 p.m., "The Casano Octet"; 5 p.m., "Will o' the Wisp," a one-act play by Doris Halman; 9 p.m., "Elijah."

ABERDEEN.—3.30 p.m., Military Band Concert, City of Aberdeen Military Band.

BOURNEMOUTH.—3.30 p.m., Military Band Programme; 9 p.m., Light Symphony Concert.

Monday, February 22nd.

LONDON.—8 p.m., Radio Radiance Orchestra; 9.55 p.m., Lord Lonsdale—Preliminaries to a Fight; 10.35 p.m., Sapellnikoff in a Chopin Recital.

DAVENTRY.—8 p.m., Callender's Band, The Novelty Trio; 11-12 p.m., Dance Music.

BIRMINGHAM.—8 p.m., Variety Programme.

CARDIFF.—3.45 p.m., Afternoons with the Romantics (III).

NEWCASTLE.—8 p.m., Music and Merriment.

Tuesday, February 23rd.

LONDON.—8 p.m., The History of Napoleon Bonaparte in Music and Story; 10.30 p.m., Dance Music.

BELFAST.—8 p.m., Herbert T. Scott's Male Voice Choir and the Station Orchestra.

GLASGOW.—8 p.m., "The Passing of the Third Floor Back"—A Prologue, A Play, and an Episode by Jerome K. Jerome.

Wednesday, February 24th.

LONDON.—8 p.m., The Roosters in Nigger Minstrelsy; 9 p.m., The Savoy Augmented Symphonic Orchestra.

DAVENTRY.—11-12 p.m., Dance Music by the Savoy Bands.

BIRMINGHAM.—8 p.m., The Orchestra and Jack Venables.

DUNDEE.—8 p.m., A Choral Evening. The Caledonian Male Voice Choir.

EDINBURGH.—8 p.m., An Evening of Folk Music.

GLASGOW.—8 p.m., The Works of British Composers.

HULL.—8 p.m., An Evening of Variety.

LIVERPOOL.—8 p.m., "The Showman's Cabarette."

LEEDS.—8 p.m., The Station Quintet. The Apollo Glee Singers. The Three Tykes and Percy Frostick (solo violin).

MANCHESTER.—8 p.m., A Popular Concert.

NEWCASTLE.—8 p.m., Popular Arias and Lieder.

NOTTS.—8 p.m., Popular Concert. Fourth Evening with Nottingham Artists.

PLYMOUTH.—8 p.m., Popular Programmes. The Winifred Blight Trio—Songs and Syncopations.

stations were being heterodyned. The list was completed during the interval. Those stations which were heterodyning British stations were all measured up during the "silent" period, and the B.B.C. definitely located certain stations heterodyning the transmissions of British stations. Other stations which were off their proper wavelength were located, and also a number of foreign stations which were heterodyning each other. The experiment showed that the slightest changes would be sufficient to put the whole system of European broadcasting out of joint. A lot of useful information was gained which would not be available if the B.B.C. stations had not closed down; and it was satisfactory to note that in the main the appeal to listeners and those not directly concerned in the test was successful in inducing them to refrain from using their wireless apparatus during the test.

o o o o

Unauthorised Experiments.

I have been specially asked by the B.B.C. to point out that none but the company's engineers and the few private experts already referred to had any authority to take part in the test, and it is regrettable that a few cases occurred where unauthorised persons ignored the B.B.C.'s appeal to refrain from listening and from interfering with the work by attempting to measure wavelengths on their own authority.

o o o o

A New Accountancy System.

An artist who makes a tour of six broadcasting stations receives his fee in the form of six cheques. Although on the face of it this may appear to be an extravagant method of paying artists' fees, it is actually an economy over the system of payment by one cheque "in bulk," and has enabled the B.B.C. to save seventeen "clerk days" per month. The system of cheque writing is based on the principle of a cheque-writing machine. No counterfoil is necessary, and the need for writing up a cash book is abolished. The allocation of programme expenditure as between the stations also becomes automatic.

o o o o

Many Advantages.

The above are some of the internal economies effected; but the system of sending a separate cheque in respect of each station has other advantages. When an artist is booked to tour several stations, it may be found later that on a certain date the artist could not for some reason or other perform. By the method now in practice it is possible to pay artists each fee as it becomes due, and no doubt they find this far more satisfactory than having to wait until the whole amount becomes due and the actual fulfilment of each engagement has been checked at the end of the tour. The broadcasting system of cheque writing is being investigated by other commercial concerns and will, it is understood, be adopted shortly by one of our leading railway corporations.

ORMOND(E) still leading — as in 1886

"ORMONDE" was bred by the late Duke of Westminster in 1883. He was never beaten, winning among other victories the Triple Crown in 1886. ORMONDE is generally regarded as the best horse of all times.

To-day ORMOND still leads in Condenser construction—and the finest product we have ever put on the market is our NEW BALL-BEARING FRICTION CONTROL CONDENSER. Superlatively smooth and absolutely silent—it has a ratio high enough for finest tuning and low enough for easy searching, whilst there is also a direct drive for rough setting. The three self-adjusting ball-bearings ensure total absence of backlash—permanently.

**ASK YOUR DEALER FOR THE NEW
ORMOND
BALL-BEARING FRICTION CONTROL CONDENSER**

·0005	15/-
·0003	14/6
·00025	13/6

Complete with Knob and Dial.

IDEAL RATIO: 53 - 1

Brass End-plates, high nickelled finish.

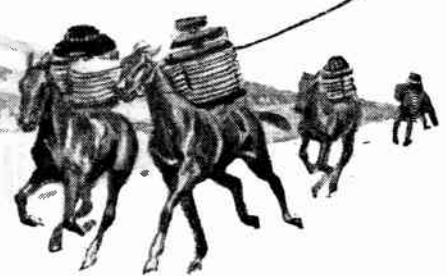

199-205 PENTONVILLE ROAD
Phone. Clerkenwell 9344-5&6

Regd. Trade Mark
KINGS CROSS, LONDON, N.1.
Grams Ormondengi-Kincross.

Factory. WHISKIN ST CLERKENWELL. E. C. 1.

EASILY FIRST IN EVERY FIELD

£10 Weekly in Cash Prizes

A New and Simple Competition
for all Readers of "The Wireless World"







To be continued weekly until further notice.

HIDDEN ADVERTISEMENTS

Below will be found six reproductions of fragments cut from the Advertisement pages of this issue of "The Wireless World." Each fragment is a clue. Can you from these clues identify the Advertisements? Seven cash prizes will be awarded to the first seven readers who send us correct solutions. No technical skill is required, merely observation. There are no restrictions or entry fees and the conditions are simple.

£5
for the first
correct solution
opened.

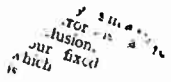
£2
for the second
correct solution
opened.

	
1	2
	
3	4
	
5	6

£1
for the third
correct solution
opened.

and
4
consolation
prizes of

10/-

Each
for the next four
correct solutions
opened.

CONDITIONS

- All solutions must be written on the special coupon appearing on an advertisement page in this issue and addressed to *The Wireless World*, Dorset House, Tudor Street, London, E.C.4, and marked "Hidden Adverts." in bottom left corner.
- Clues will not, of necessity, appear in the same way as in the advertisement page, but may be inverted or placed in some other position.
- In order that town and country readers may compete on equal terms, solutions will not be dealt with until 10 a.m. on Monday next. All solutions received before that date will be retained until Monday morning. Competitors may submit any

- number of entries. Erasures or alterations on a coupon will disqualify the entry.
- The first prize of £5 will be awarded for the first correct solution opened; the second prize of £2 to the next correct solution; the third prize of £1 for the third, and four consolation prizes of 10/- each for the next four correct answers. In the event of no readers sending correct solutions the prizes will be awarded to the competitors whose solutions are most nearly correct.
- The decision of the Advertisement Manager of *The Wireless World* is final, and no correspondence can be entered into. Competitors enter on this distinct understanding. No member of the staff of the paper is permitted to compete.

WIRELESS CIRCUITS

in Theory and Practice.

4.—Alternating-current Circuits.

S. O. PEARSON, B.Sc., A.M.I.E.E.

THE operation of wireless circuits depends to such a large extent on the effects of inductance and capacity in alternating-current circuits that it is essential for the reader to have a clear conception of these effects in order to appreciate the principles involved in the various types of receiving circuits in use at the present time, and this section is devoted to the more important relationship between the various quantities and particularly to the use of inductance and capacity for purposes of tuning.

Rotating Vectors and Sine Waves.

In dealing with alternating currents, voltages, etc., which vary according to a sine law, *i.e.*, whose wave shape is a sine wave, it is much more convenient to give their values in terms of the sine of an angle which varies

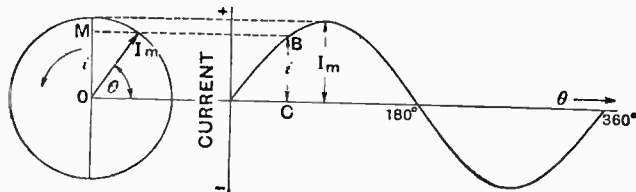

Fig. 1.—Development of a sine curve from a rotating vector

with time and to plot the values to an angle base when drawing a graph rather than to a time base. The reason for this will be seen below.

In Fig. 1 a sine wave of alternating current whose maximum value is I_m amperes has been plotted to an angle base, the length of the base line corresponding to one complete cycle representing 360° . When this is done, the sine wave can be fully represented by a straight line of constant length rotating about one end with constant speed. Such a straight line is called a *rotating vector*, and the use of rotating vectors instead of sine curves greatly simplifies calculations and reasoning in all alternating-current work, and their use in a simplified manner is adopted here. From the diagram of Fig. 1 can be seen the relationship between a rotating vector and the corresponding sine wave. The length of the vector is made equal to the maximum value, I_m , of the current, and at any instant the current is given by OM or BC. It is important to note that the vector makes one complete revolution for each cycle, so that if the frequency of the current is f cycles per second, the vector makes f revolutions per second. We see, then, that there are only two simple conditions to be fulfilled, namely, that the length of the vector must be equal, to some scale, to the maximum value reached by the current, and that it must make as many revolutions per second as there are cycles per second. The direction of rotation is usually taken as being counter clockwise, and it is essen-

tial to know this because when we have two vectors it is necessary to know which one is leading the other in phase.

It will be found that, in the great majority of alternating-current formulae, the expression " 2π " is involved, π being the ratio of the circumference of a circle to its diameter and having a numerical value of 3.1416. Now the simple vector which we have just been considering shows us how this number 2π finds its way into the fundamental expression for a sine wave of current. We have seen that the vector makes f revolutions per second, and, therefore, passes through a total angle of $360 \times f$ per second; thus the angle passed through in t seconds will be $360 \cdot ft^\circ$, and the instantaneous value of the current will be equal to the maximum value of the current multiplied by the sine of this angle:

$$i.e., \quad i = I_m \sin (360 \cdot ft).$$

Now it is well known that the angle subtended at the centre of a circle by an arc equal in length to the radius is called a *radian*, and, since the whole circumference is 2π times as long as the radius, it follows that 360° are equal to 2π radians, and, substituting this in the above expression, we get

$$i = I_m \sin 2\pi ft \text{ amperes.}$$

Effect of Inductance.

We are now in a position to consider the effects of inductance in an alternating-current circuit. For the present it will be assumed that no resistance is present in any part of the circuit.

When a sine wave of alternating current passes through a coil of inductance L henries, the resulting magnetic flux

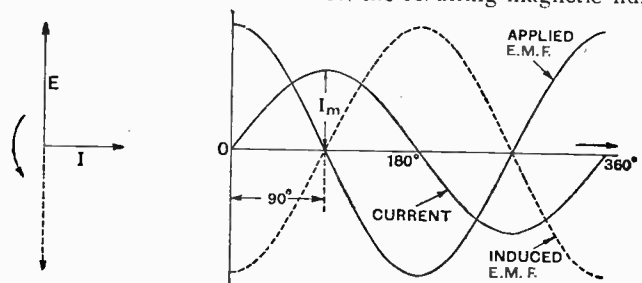

Fig. 2.—Curves and vector diagram, showing phase relations of applied e.m.f., current and induced e.m.f. in a pure inductance. It will be observed that the current lags behind the applied e.m.f. by 90° .

will vary according to a sine law also, being at every instant proportional to the current. Now, as explained in Part 2 of this series,¹ the changing of the flux will induce an E.M.F. at every instant proportional to the rate of change of current and to the inductance, this E.M.F. being in such a direction as to oppose the change of current. When the current is passing through its

¹ See *The Wireless World*, Jan. 27th, 1926, p. 122.

Wireless Circuits in Theory and Practice.—

maximum positive and negative values, its rate of change is zero, and, therefore, at these points the induced E.M.F. will be zero. If a diagram is drawn to scale and the rate of change of current plotted for various points along the current curve, we find that the new curve is also a sine shaped curve but displaced from the current curve by 90°, or a quarter of a cycle. Hence the induced E.M.F. curve will also be sine shaped.

Now obviously the slope of the current curve is steepest when the current is passing through its zero values and it can be shown that the maximum rate of change of current = $2\pi f \times I_m$ amperes per second. Therefore the maximum value of the induced E.M.F.

$$E_m = (\text{max. rate of change of current}) \times L \\ = 2\pi f L \times I_m \text{ volts.}$$

Since the induced E.M.F. is opposing the change of current it is called the "back E.M.F.," and will have a negative value whenever the current is changing towards a more positive value and *vice versa*. The induced E.M.F. found in this manner is shown by the dotted curve of Fig. 2. As there is no resistance in the circuit an applied voltage exactly equal and opposite at every instant to the induced E.M.F. will have to be provided in order to maintain the current, so that the maximum value of the applied E.M.F. is also equal to $2\pi f L \times I_m$ volts.

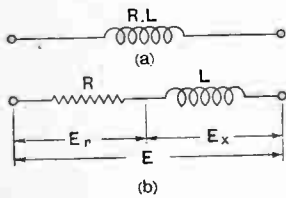

Fig. 3.—Equivalent circuit (a) of an inductance coil (b) containing resistance.

The three curves and their phase relations are shown in Fig. 2 and also the corresponding vectors. This diagram serves to show also how two sine waves which are not in phase can be represented by two vectors, the angle between them being equal to the angle of phase difference between the waves. Henceforth vectors only will be used and the sine waves omitted. The R.M.S. value of the voltage is 0.707 times the maximum value, and is therefore given by

$$E = 2\pi f L \times 0.707 \cdot I_m \\ = 2\pi f L \times I \text{ volts,}$$

where I is the effective value of the current.

Reactance,

The ratio of applied E.M.F. to current $\frac{E}{I} = 2\pi f L$ is called the *reactance* of the circuit and is measured in ohms, being usually denoted by the symbol X, thus

$$\text{reactance } X = 2\pi f L \text{ ohms.}$$

It should be noted that the reactance is not a constant quantity like resistance, but is directly proportional to the frequency.

It will be seen from the diagram that the current reaches its maximum positive value a quarter of a cycle after the applied E.M.F. has passed through its maximum positive value, and thus the *current lags by 90° behind the applied E.M.F.* These relations are very important, and will be frequently referred to in connection with valve circuits. A further important fact to remember is that the average power taken by a pure inductance is zero, because there is no resistance to convert the electrical energy into heat.

A coil of inductance L and resistance R is equivalent to a circuit consisting of a resistance R connected in series with a coil of pure inductance L, as shown in Fig. 3, because it is the same current which produces the heat in the resistance that produces the magnetic field linked with the coil, and in a series circuit the current is the same at every part of the circuit. When a sine wave of current is passed through such a coil the usual back E.M.F. is produced, and in order to maintain the current the applied E.M.F. must be just sufficient to counterbalance the induced E.M.F. and to overcome the resistance. The component necessary to overcome the resistance will be $E_r = I \times R$ volts (R.M.S.) in phase with I (see Part 1, p. 84 of the issue of January 20th, 1926), and that required to counterbalance the induced E.M.F. will be $E_x = I \times X = 2\pi f L \cdot I$ volts *leading the current by 90°.*

Impedance.

The vector diagram is shown in Fig. 4, and in adding together the components E_r and E_x it must be remembered that they are 90° out of phase, so that their resultant is given by the diagonal vector in the vector diagram. Thus $E^2 = E_r^2 + E_x^2$ and applied voltage

$$E = \sqrt{I^2 R^2 + I^2 X^2} \\ = I \sqrt{R^2 + X^2},$$

where $X = 2\pi f L$ ohms ;

$$\text{or } I = \frac{E}{Z} \text{ amperes,}$$

where $Z = \sqrt{R^2 + (2\pi f L)^2}$.

Z is called the *impedance* of the circuit and is measured in ohms. Thus *impedance is that quantity by which the voltage must be divided in order to get the current in an A.C. circuit*, and is for this reason sometimes called the *apparent resistance* of the circuit for a given frequency. We see then that

$$\text{Impedance} = \sqrt{(\text{resistance})^2 + (\text{reactance})^2}.$$

Hence in a circuit where no reactance is present the impedance is equal to the resistance, and in a circuit with reactance but no resistance the impedance is equal to the reactance.

Referring to Fig. 4 again, it will be seen that the current lags by an angle ϕ , which is less than 90°, behind the applied E.M.F. We have seen that for a pure resistance there is no angle of lag, and that for a pure reactance the angle of lag is exactly 90°, and therefore it follows that for a circuit possessing both inductance and resistance the greater the ratio of reactance to resistance the greater will be the angle of lag. At the high frequencies used in wireless circuits the reactance of an inductance coil is so large compared with the resistance that the angle of lag may always be assumed to be 90° without the introduction of any serious error.

The average power taken by the circuit is represented by that consumed in the resistance only, as we have already seen that inductance does not take any power. The *true power* is thus given by $I^2 R$ or $E_r I$ watts, where E_r is the component of the applied voltage necessary to drive the current through the resistance alone (see Fig. 4).

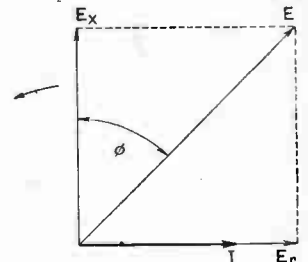

Fig. 4.—Vector diagram showing phase relations of E.M.F.'s and current in a circuit consisting of resistance and inductance in series.

Wireless Circuits in Theory and Practice.—

Now since E_r is obviously less than the total voltage E across the ends of the circuit we see that the true power $E_r I$ is less than the product of the total voltage and current, $E I$, or *apparent power*. Thus, in order to get the true average power it is necessary to multiply the apparent power by a factor which is less than unity, and this factor is called the *power factor* of the circuit, so that

$$\begin{aligned} \text{Power Factor} &= \frac{\text{True Power}}{\text{Apparent Power}} = \frac{E_r I}{E I} \\ &= \frac{E_r}{E} = \cos \phi \text{ (from Fig. 4),} \end{aligned}$$

i.e., the power factor is given by the *cosine of the angle* of phase difference between the applied E.M.F. and the current, and the true power is therefore

$$P = E I \cos \phi \text{ watts,}$$

where E and I are the R.M.S. values of the applied voltage and the current respectively. Since E_r is equal to the product of current and resistance, and E = product of current and impedance, we see that the power factor is equal to the ratio of resistance to impedance, that is, power

$$\text{factor} = \frac{R}{Z}.$$

WIRELESS IN GUY'S HOSPITAL.

The System Installed by the Marconiphone Company.

THE numerous wireless installations in hospitals which are being installed through the agency of the *Daily News* Fund are being added to daily, the latest addition of note being that of Guy's Hospital.

In a hospital such as Guy's, where there are numerous X-ray rooms installed and practically every known method of electrical treatment for massage, etc., together with several automatic lifts, it was necessary to select a position where the most efficient aerial, capable of reception from both the London and Daventry stations, could be erected in order to minimise interference.

After very careful consideration, and having located practically every conceivable thing which was likely to cause any difficulty, the engineers of the Marconiphone Co., Ltd., decided upon installing the apparatus in the

Old Biology Room, where a space of approximately 6ft. x 8ft. was allocated and a substantial partition erected.

By the position selected being almost in the centre of the buildings, the engineers who undertook the formidable task of supplying practically every bed in the hospital with a point for headphone reception found their task of distribution much easier.

Aerial and Earth System.

The aerial used is of the indoor type, and consists of about 50ft. of rubber-covered wire held into position by means of special insulated hooks. The earth, which plays a very important part in the reception of wireless, was by means of about 6ft. of the same type of cable as used for the aerial connected to a main water pipe.

The instrument used for the reception of the broadcast programmes was a standard type Marconiphone V.2 model. The amplifier used was built to the specification prepared by the engineer-in-charge of the work, and a very compact and efficient instrument was turned out, consisting of three stages of audio-frequency amplification.

The output of the amplifier is taken to six specially designed transformers connected in the 'phone lines, five of which have a step-down ratio of 5 to 1. The object of these transformers is to ensure that the electrical load is evenly delivered at each of the headphone points. There are approximately 100 points on each line. The sixth transformer has a winding ratio of 1 to 1, and is connected in the line circuit of the loud-speakers.

An elaborate instrument board is mounted on the wall, on which were fixed the transformers mentioned, together with special damping resistances arranged so that the control of each line can be balanced to suit the load or number of 'phones in circuit.

Telephone Distribution.

The wiring throughout the system is composed of lead-covered cable, of which some two miles has been used, all of which, being fixed on the outside of the building, necessitated the use of special cradles, ladders, etc. The object of placing the wiring on the outside was to meet the requirements of the hospital authorities in preserving the hygienic principles which have been the outstanding features in the design of the wards, which does not allow of any dust-collecting object being fixed on the walls inside the wards.

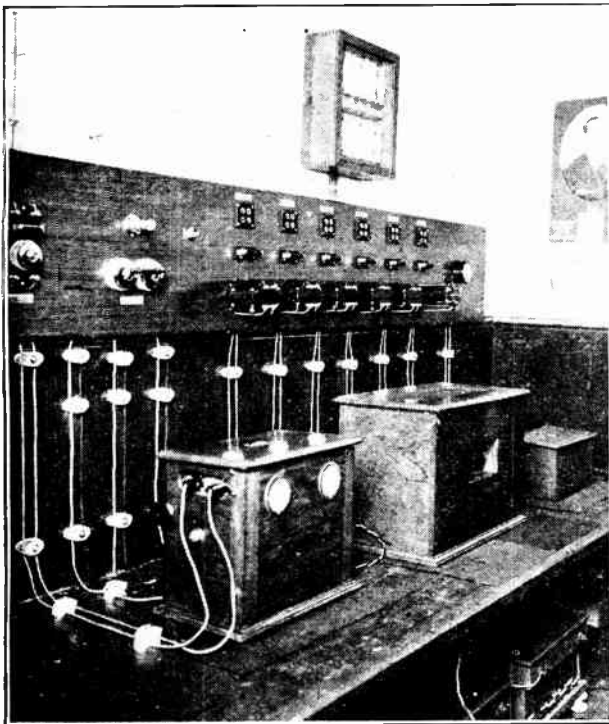

Receiver, amplifier and control board of the wireless installation at Guy's Hospital.



REVIEW of APPARATUS

A Review of the Latest Products of the Manufacturers.

GECOPHONE FILAMENT RHEOSTAT.

The requirements of a filament rheostat are that the resistance value at any setting shall remain constant, that it will not overheat, and that the adjustment shall be smooth and effective. The Gecophone universal filament rheostat, a recent product of the General Electric Co., Ltd., is designed to comply in all details with these requirements, and furthermore is suitable for controlling either bright or dull emitter valves.

The resistance winding consists of two coils of wire connected in series, one having a total resistance of 5 ohms and a second coil of finer wire having a resistance of 25 ohms. The body of the rheostat is of brass, and the wire is insulated from the casing by a heat-resisting composition. A circular black dial is sup-

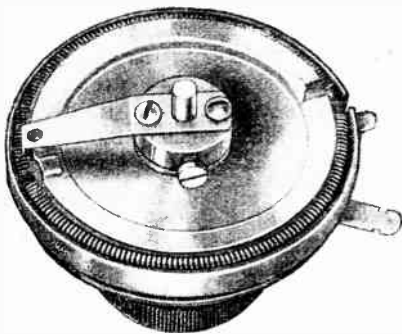

The Gecophone universal filament rheostat is provided with two windings so that it can be used with bright or dull emitter valves.

plied with the rheostat, engraved in white and calibrated in ohms, while between the high and low resistance sections a stop is provided to serve as a safeguard against overrunning dull-emitter valves.

The rheostat is made for one-hole fixing. Tension of the contact arm is adjustable, so that a very smooth action can be obtained. The instrument is neat and compact, and of excellent finish.

o o o o

"ENCORE" INDOOR AERIALS.

Those listeners who are prevented from erecting an outdoor aerial will find either of the two indoor aerials produced by the Encore Manufacturing Co., 16, Lower

Richmond Road, Putney, London, S.W.15. a good substitute, as every endeavour has been made to produce an aerial possessing the lowest possible high-frequency resistance.

One model consists of four multi-strand (15/36 S.W.G.) silk-covered wires, spaced apart by means of ebonite cross pieces

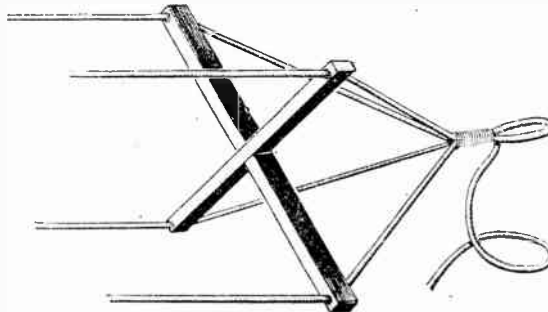

The "Encore" aerial for indoor use.

5½ in. in length. The total length of the aerial as supplied is 12ft. 6in. and the lead-in is 7ft. 6in. With such a small spacing between the wires the capacity, and hence the wavelength, produced by this aerial is inappreciably greater than that of a single wire of equivalent length, yet this form of construction undoubtedly produces an aerial of low resistance.

The other type, in which eight conductors are supported around a circumference of insulating rings, is a form of construction which can be recommended

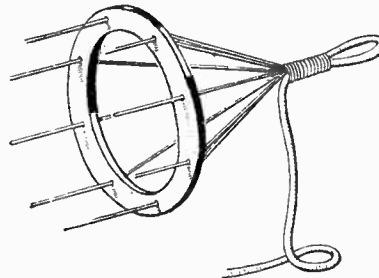

Another form of "Encore" aerial, which consists of eight enamelled wires spaced by means of insulating loops of small diameter.

when, owing to screening or other adverse condition, it becomes necessary to employ an aerial possessing a minimum of resist-

ance. The strands are just over ½ in. apart, and thus here, again, the capacity is scarcely greater than that of the single conductor, but the cage form of construction is generally employed for the purpose of improving aerial efficiency. This aerial is 10ft. 6in. in length, 1½ in. in diameter, with 7ft. 6in. of lead-in.

o o o o

THE "TIGER" COIL HOLDER.

Already the Athol Engineering Co., Cornet Street, 11r. Broughton, Manchester, have produced a number of components in which porcelain has been substituted for ebonite. The Athol valve holder, for instance, consists of a porcelain mount, in which the valve pins are inserted, and again a coil mount has been produced in which porcelain is used to give support to the plug and socket connectors.

The "Tiger" single coil holder is another application of porcelain as an insulator between connectors carrying radio frequency currents. It is of simple con-

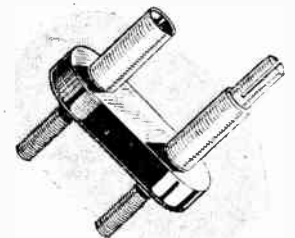

In the "Tiger" coil holder porcelain is used to give support to the pin and socket in preference to the customary practice of using ebonite or other moulded material.

struction, consisting of a porcelain base, to which the plug and socket are attached by means of back-nuts. In spite of the difficulties of working porcelain to exact dimensions, this holder will be found to engage quite easily on to the socket of the standard plug-in coil.

In securing the holder to an ebonite instrument panel the reader is advised to drill clearance holes liberal in size and

to clamp up the back nuts under $\frac{1}{2}$ in. brass washers. By this means air spacing is obtained between the stems of the plug and socket and the ebonite panel, so that the merit of the porcelain mount is not lost by bridging the connectors with the ebonite panel to which it is attached.

o o o o

KAYNITE WINDING MACHINE.

Messrs. A. W. Knight, Ltd., 167, Rye Lane, Peckham, London, S.E.15, have specialised in the manufacture of small coil-winding machines, and were probably first in the field in providing the amateur with an inexpensive winder with which he could construct coils of high efficiency and of sizes to suit his special requirements. The new model winds a different form of coil to that produced by the earlier types of machine, with which readers are probably acquainted.



Kaynite duplex coil winding machine with examples of the type o. coil produced.

As will be seen in the accompanying illustration, a former similar in principle to that employed for the construction of basket coils is mounted on a shaft, which is rotated by a handle drive. A wheel is fitted to this shaft, and by means of a chain drive is coupled to a smaller pinion on an auxiliary shaft operating a cam and throw. The wire is fed through an eye and guided by means of the throw, so that it traverses the winding former. The wire is not arranged in a zigzag fashion between alternate spokes, but is made to pass over two of the spokes before moving across to the other side.

The number of turns run on is automatically recorded upon an indicating dial operating through a worm pinion. On completion of the winding the coil is finished by binding the sections together with thread, an operation which is easily accomplished with the aid of a needle, and is removed from the winding former by withdrawing the pegs.

This machine is entirely original in design and can be used either by the amateur or the professional for the construction of compact inductances of low self-capacity. It is robustly built and will give prolonged service.

DIMIC COIL.

The serious experimenter is now devoting considerable attention to the design of tuning coils of high efficiency, a development that has probably arisen from the general use of high-frequency amplifiers in which stability is obtained by the neutrodyne method.

In receivers in which the effects of inter-electrode capacity in the valve tending to produce self-oscillation is overcome by the employment of a tapped coil and balancing condenser, it is important that the tuning inductance shall possess the lowest possible high-frequency resistance in order to maintain sharp tuning and maximum signal strength.

The Dimic coil recently introduced by L. McMichael, Ltd., Hastings House, Norfolk Street, Strand, London, W.C.2, is probably the first low-loss solenoid inductance to appear on the British market. Manufactured in a range of sizes, coil No. 1 is the most popular, as it covers a tuning range of 300 to 600 metres. The turns of wire composing the inductance are as far as possible air supported, being carried by the nine ridges arranged on the face of an ebonite cylinder. An air spacing is provided between the turns which undoubtedly improves the efficiency of the coil, the turn-to-turn capacity being set up across an air dielectric. The winding is rigidly held in position by recessing the turns in a thread cut on the outside of the supporting fins. The ratio of length of winding to diameter is probably a good one, and in data supplied by the manufacturer it is stated that a resistance of 0.055 ohm per microhenry is obtained, measured at an oscillation frequency of 800 kilocycles.

This type of coil has many applications, and in addition to its use for intervalve coupling it may be adopted as an auto- or loose-coupled transformer in an aerial

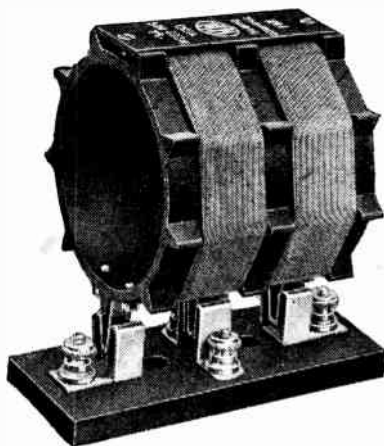

The new Dimic low-loss coil.

circuit, neutrodyne transformer, oscillation coupler in a reflex circuit, or as an oscillator in a supersonic heterodyne receiver.

The No. 1 coil has an inductance of approximately 200 microhenries and will tune from 300 to 600 metres when bridged with a variable condenser having a maximum capacity of 0.0005 mfd. This data

is engraved on the top plate of the coil, in addition to which is a figure, which in this instance is 75, indicating the nearest equivalent in the Igranic series. A base piece to provide interchangeability is supplied, fitted with four terminals so that the two halves of the inductance may be connected up independently.

The introduction of coils of high efficiency will certainly meet with the favour of the scrutinising amateur, whilst their undoubted superiority to many of the tuning coils available on the market will ensure a widespread popularity.

**CATALOGUES
RECEIVED.**

"Sphinx Electric Supplies." (112, High Holborn, W.C.1.) Catalogue of "Sphinx" radio apparatus, including receivers, loud-speakers, headphones, accumulators, etc.

o o o o

"S. A. Cutters, Ltd." (18, Berners Street, Oxford Street, W.1.) "Salient Features," being a catalogue of wireless receivers and containing "Hints and Tips" by "Pilgrim." Price 6d.

o o o o

"Portable Utilities Co., Ltd." (Eureka House, Fisher Street, W.C.1.) Particulars of "Eureka" products, including transformers, chokes, and frame aeri-als.

o o o o

"Metro-Vick Supplies, Ltd." (4, Central Buildings, Victoria, S.W.1.) An illustrated catalogue descriptive of Cosmos wireless components and accessories.

o o o o

"Igranic Electric Co., Ltd." (149, Queen Victoria Street, E.C.4.) Leaflet illustrating Igranic-Pacnet components. Also Publication No. 6,197, giving particulars of Igranic Tone Control and Damping Resistance, also Publication No. 6,198, referring to Igranic Fixed Anode Resistance.

o o o o

"Edison Swan Electric Co., Ltd." (123-125, Queen Victoria Street, E.C.4.) The Wireless Catalogue, an art production dealing with Ediswan sets, components, accessories, valves, batteries, etc., etc. 84 pages.

o o o o

"Marconiphone Company, Ltd." (210-212, Tottenham Court Road, London, W.1.) Publication No. 443, a comprehensive and handy guide to all Marconi receiving valves.

o o o o

"Star Wireless Supplies" (101, Hitchin Street, Biggleswade). Illustrated pamphlet describing "Star" radio components and accessories.

o o o o

"Chloride Electrical Storage Co., Ltd." (Clifton Junction, nr. Manchester). Leaflet No. 4045, relating to the Exide battery and describing methods and apparatus for testing portable batteries.

DICTIONARY OF TECHNICAL TERMS

Definitions of Terms and Expressions commonly used in Wireless Telegraphy and Telephony.

This section is being continued week by week and will form an authoritative work of reference.

Stalloy. A special steel alloy containing silicon, manganese, sulphur and phosphorus, having better magnetic properties than ordinary iron or steel, the permeability being greater and the hysteresis effect less. Used almost universally for transformer cores, etc., and telephone diaphragms.

Static or Statics. A term sometimes used for *atmospherics*.

Static Characteristics (of Thermionic Valves). The "static" characteristics of a thermionic valve are the curves showing the relation between the various voltages and currents when these voltages and currents have steady values. The chief characteristic curves of a *three-electrode valve* are (a) that showing the relation between the plate

potential with respect to the filament, (b) the relation between the *grid voltage* and the plate current when the plate potential is maintained constant, and (c) the relation between the grid voltage and the grid current. The filament current is kept constant at the normal value in all three cases.

The curve represented by case (b) is the most important, being the operating characteristic of the valve, and usually called the "anode characteristic." There is a separate anode characteristic for each value of the plate potential, the straight portion of each having more or less the same slope; increasing the plate potential merely has the effect of shifting the curve bodily to the left without appreciably changing its shape.

For efficient operation as a *thermionic amplifier* the grid voltage for a given plate potential should be adjusted so that the valve operates at or near the middle point of the particular anode characteristic concerned.

For operation as a thermionic rectifier or detector by means of *anode rectification* the grid voltage is adjusted so that the valve operates at the lower bend in its anode characteristic curve. (See ANODE RECTIFICATION and GRID RECTIFICATION.)

Static Charge. See CHARGE (a).

Static Component (of wireless waves). See ELECTROSTATIC COMPONENT.

Static Coupling. See ELECTROSTATIC COUPLING.

Static Transformer. See TRANSFORMER.

Stationary Waves. The state which occurs when electric oscillations are propagated along a straight wire of definite length so that the waves are reflected back from the end, and, interfering with the oncoming waves, produces *nodes and loops* of potential along the wire, and also *nodes and loops* of current, the current nodes coinciding with the voltage loops and *vice versa*. See NODES AND LOOPS.

Step-Down Transformer. A transformer in which the *secondary* voltage is lower than the *primary* voltage.

Step-Up Transformer. A transformer in which the *secondary* voltage is greater than the *primary* voltage.

Storage Battery. A battery of *accumulators*, or *storage cells*.

Storage Cell. See SECONDARY CELL.

Strap Coil. An inductance coil made of flat copper strip wound in the form of

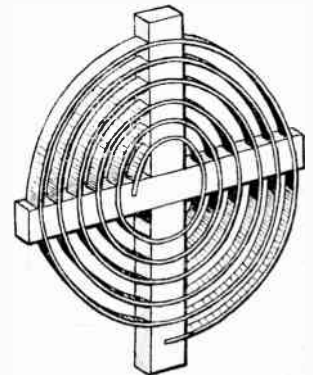

Strap Inductance Coil.

a flat spiral, used extensively for transmitting inductances.

Stray Field. A magnetic field which is present in a place other than in the desired *magnetic circuit* of a piece of apparatus, the *lines of force* representing this field being called "leakage lines."

Strays. Another term for *atmospherics*.

String Galvanometer. See EINTHOVEN GALVANOMETER.

Sulphating. The formation of white lead sulphate on the plates of a lead-acid accumulator cell due to being left in an uncharged condition after having been over-discharged. Such a deposit is insoluble in the acid and renders the cell incapable of giving its full rated *capacity*.

Superheterodyne Reception or Supersonic Heterodyne Reception. A system of *beat reception* which can be employed for the reception of telephony, and which provides a remarkable degree of *high-frequency amplification and selectivity*. Local oscillations are superimposed upon the incoming signal oscillations so that a beat frequency is produced (see BEAT RECEPTION), the frequency of the local oscillations being so adjusted that the beat frequency produced is itself a *radio frequency* of a moderately long *wavelength*, i.e., a *supersonic frequency*. These beats are *rectified* in

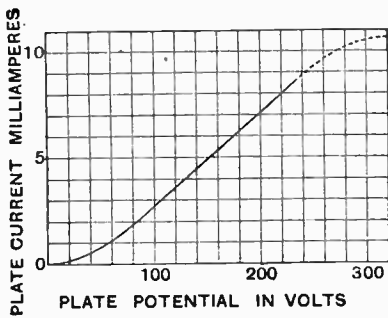

(a)

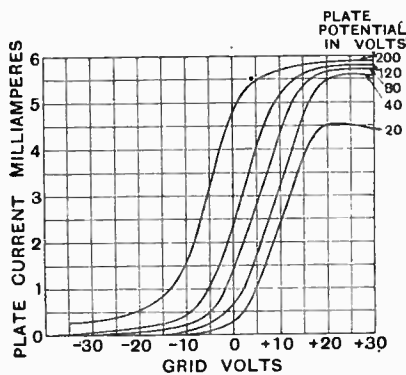

(b)

Static valve characteristic, (a) plate potential—plate current curve; (b) grid potential—plate current curves for various plate potentials.

potential and the plate current with the grid maintained at constant poten-

Dictionary of Technical Terms.—

the ordinary way and then applied to an intermediate frequency amplifier which, if desired, may be sharply tuned to the supersonic frequency. After amplification in this manner, the supersonic frequency oscillations are rectified by a second detector, giving audio-frequency signals which may be applied directly to the telephones or further amplified by a low frequency amplifier.

Super-Regenerative Receiver (Armstrong).

A special type of valve receiver in which *reaction* is employed to such an extent that the set would oscillate continuously if it were not for the provision of a means of stopping the oscillations about 15,000 times per second. This is done by means of a second oscillating circuit, which operates at a long wavelength on the grid of the detector valve.

The oscillations in the receiver take time to build up, and during a given short interval of time they build up to a strength which is proportional to the strength of the incoming signal at the time of their commencement. Thus each time the oscillations in the receiving circuit are stopped by the long wave "interrupter" they build up again to a value proportional to the strength of the incoming oscillations at the time of interruption, and so reproduce moderately accurately, but greatly amplified, the variations of the oscillations received by the aerial, which is usually a frame aerial.

Supersonic Frequency. A frequency which is above the audible range of frequencies, but is not sufficiently high to be considered a radio frequency.

Surface Leakage. The leakage of a current of electricity over the surface of an insulator due to a deposit of moisture or dirt which acts as a partial conductor.

Surge. A sudden rush of electricity in a circuit, as sometimes occurs when switching a transformer primary on to the supply mains; or a sudden violent wave of high voltage due to various causes, such as a sudden short circuit in a circuit.

S.W.G. Abbreviation for *Standard Wire Gauge*.

Synchronism. Two or more machines or other pieces of apparatus with moving parts are said to be in synchronism when they are running at exactly the same speed and are in step. Two currents which are in phase are sometimes said to be "in synchronism."

Syntony. Two tuned oscillating circuits are said to be "in syntony" when their natural frequencies of oscillation are equal, in which case one circuit will respond to free oscillations in the other. An example is given by the oscillation transformer of a spark transmitting set.

"Systoflex." A flexible insulating tubing through which bare wires can be threaded for purposes of insulation.

Various colours may be used to facilitate the tracing out of circuits.

T

"T" Aerial. An aerial with one or more horizontal wires, the down lead being taken from the centre of the horizontal portion.

Tap or Tapping. A connection made to an intermediate point between the ends of a winding such as that of a transformer or an inductance coil.

Telephone. In its true sense the word applies to the whole of the apparatus employed for the conveyance of speech from one point to another by electrical means; but the word "telephone" is now commonly used to denote "telephone receiver," or the instrument which converts electrical pulsations in a telephone circuit into audible sound vibrations in the air.

Telephone Condenser. A small fixed-capacity condenser connected in parallel with a telephone receiver in order to by-pass high-frequency currents or to by-pass partially the higher pitched audio-frequencies of speech and music to produce a more mellow tone.

Telephone Jack. See JACK.

Telephone Transmitter. (a) An instrument for converting sound vibrations into electrical vibrations or pulsations of a similar wave form, now commonly called a "microphone." (b) In wireless, an apparatus employed for the sending of telephone messages, music, etc.

Telephone Transformer. A transformer for coupling telephone receivers to a wireless receiving circuit, such an arrangement having two main advantages: (a) the telephone is insulated from high voltage circuits (if any) of the receiving apparatus, and (b) low resistance telephones, which are more robust, may be employed.

The primary winding of the transformer is connected to the output side of the receiving apparatus, the winding being designed to have the proper impedance to suit the circuit, and the telephones are connected to the secondary winding, which should have a resistance about equal to that of the telephones.

Television. The transmission by electrical means of a scene with moving objects and its reproduction at a distance as a "moving picture," i.e., what may be termed as "seeing by wire or by wireless." This is at present only in an experimental state.

Temperature Coefficient. The resistance of most conductors varies with temperature, the resistance usually increasing with increase of temperature, and the "temperature coefficient" of a material is defined as the fractional increase of resistance per degree Centigrade rise in temperature. For carbon the resistance decreases with increase of temperature, so that carbon has a negative temperature coefficient.

If R_{t_1} is the resistance of a conductor at $t_1^{\circ}\text{C.}$, and R_{t_2} is its resistance at $t_2^{\circ}\text{C.}$, then

$$R_{t_2} = R_{t_1} \{1 + a(t_2 - t_1)\},$$

where a is the temperature coefficient. The same formula may be applied to specific resistances.

Tension. A term sometimes used for voltage or potential difference, e.g., high tension, low tension, etc.

Terminals. Convenient screws, blocks, or clamping devices to which the ends of the electrical circuit of a piece of apparatus are connected, enabling rapid connection and disconnection of external wires to the apparatus. Usually called "binding posts" in America.

Thermal Ammeter. A hot wire ammeter. Not to be confused with thermo-ammeter.

Thermal Detector, or Thermo-Detector. A device for detection of high-frequency oscillating currents by their heating effects.

Thermal Telephone. A telephone receiver which depends for its action on the heating effects of the telephone current. In one type the expansion and contraction of a wire heated to varying degrees by the telephone current operates a diaphragm which sets up the sound waves in the air, whereas in another type there is no diaphragm at all, the sound waves being produced by direct expansion and contraction of the air surrounding the heating element.

Thermionic Amplifier. A three-electrode thermionic valve used as an amplifier or magnifier of electrical oscillations (see THREE-ELECTRODE VALVE). The term also applies to an amplifier employing a number of thermionic valves in cascade.

Thermionic Detector. A thermionic valve, either a three-electrode valve or a Fleming valve, used as a detector of high-frequency oscillations. (For action of a three-electrode valve as a detector see ANODE RECTIFICATION and GRID RECTIFICATION). The Fleming valve acts as a detector in virtue of its rectifying properties, possessing unilateral conductivity between the anode or plate and the filament.

Thermionic Emission. The electron emission which takes place from the heated cathode or filament of a thermionic tube, the stream of electrons constituting the current flowing between the filament and the plate or anode.

Thermionic Oscillator. A three electrode valve used as a generator of electrical oscillations, the connections being similar to those of a regenerative circuit as used for reception. Any desired frequency of oscillation can be obtained, depending on the constants of the circuit (see OSCILLATION CONSTANT). Thermionic oscillators are used to a large extent for continuous wave transmission of Morse signals, and almost exclusively for telephony transmission. See THREE-ELECTRODE VALVE.

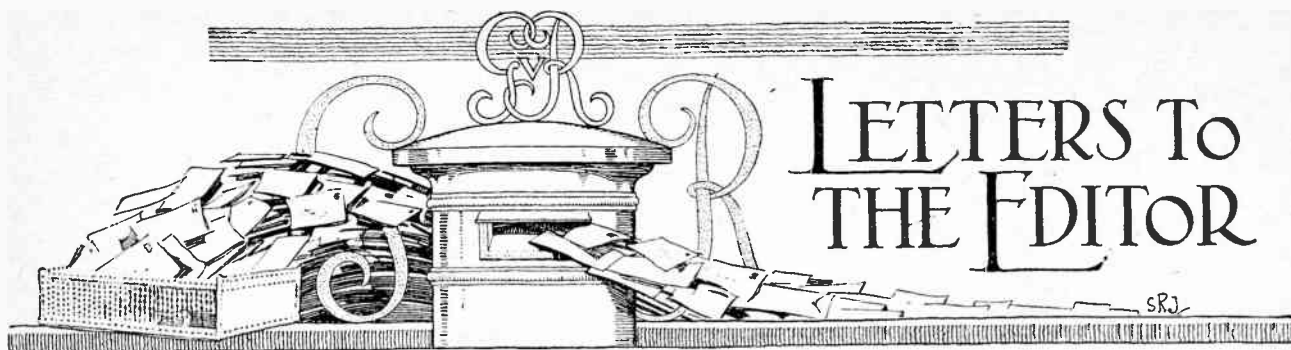

LETTERS TO THE EDITOR

The Editor does not hold himself responsible for the opinions of his correspondents.

Correspondence should be addressed to the Editor, "The Wireless World," Dorset House, Tudor Street, E.C.4, and must be accompanied by the writer's name and address.

THE BEST "ALL-ROUND" WAVELENGTH.

Sir,—I have been trying to investigate as far as possible the reasons for some of the phenomena known to exist on the ultra-short waves, and accordingly have devoted a considerable amount of time in reception under all conditions and times. Following is a brief summary of what I experienced, leading me to the conclusion that the ideal wavelength for good all-round day and night communication exists on about 27 metres. I am open to contradiction on this, and should like to hear other views on this subject.

We all know of the appalling "fade-out" of local signals on 45 metres at night, while they remain audible at tremendous distances.

For several nights I made observations on stations working during the period, and principally on one amateur station which was luckily near enough to enable me to pick up his harmonics, although I know his power is no more than 8 watts.

Before the "fade-out" periods he was distinctly strong on his fundamental; his second harmonic was hardly audible, but his third was several times the strength of the second, until the "fade-out" period, when his second harmonic entirely disappeared, while his third gained in strength until it nearly equalled the strength of his fundamental. Also at this time other harmonics became quite audible, and I read several stations on these harmonics which I knew were using the 45 metre band, while some remained inaudible on their fundamentals. During the whole time I listened in no case did I observe a single signal suffering from fading on this wave, i.e., 26-28 metres, and the conclusion I am forced to is that here is perhaps what we are searching for, an all-round frequency suitable for day or night communication.

I should like to hear any other readers' results in this direction, and should be happy to compare notes with them.

London, W.8.

G. A. EXETER (G-6YK).

OVERLOADING THE VALVE.

Sir,—May we refer to the letter published in your correspondence columns in your issue of January 13th, from Mr. J. F. Sutton, which was in response to the points we raised in his article on the Philips rectifying valve.

In this letter Mr. Sutton states that the factor which limits the charging current in the Philips rectifying valve is the power wasted in the valve itself, which must be dissipated in the form of heat from the glass bulb, and although we agree that in this way it is possible to obtain a considerably larger current from the valve than 1.3 amps, we feel that the life of the valve is of far more importance to the user, so that we have always stressed the fact that overloading shortens the life of the filament. This also occurs when the arc-discharge is maintained without the filament current, in which case the arc is directed to a small part of the filament only when as high a load is carried by this small part as would otherwise be borne by the whole of the filament.

Whilst we greatly appreciate Mr. Sutton's good opinion of the usefulness and solidity of our apparatus, we feel bound to

warn your readers that pushing the charging current beyond the value which we give is liable to result in a shorter life of the valve.

PHILIPS LAMPS, LTD.

Sir,—I regret that I fail to see any need for replying in more detail than I have already done to the comments on my article by Messrs. Philips Lamps, Ltd.

It would be very much more interesting to hear from them of the results of systematic experiments on the valve than to read random conjectures which carry no weight.

Forest Hill, S.E. JOHN F. SUTTON, B.Sc. (Eng.).

MORSE PRACTICE MESSAGES DURING BROADCASTING.

Sir,—Of the several Morse code transmissions which tend to spoil long-distance broadcast reception, I would draw attention to a somewhat serious offender. The transmission of which I complain emanates from an army station at Aldershot, which, working on c.w. with a wavelength of about 1,600 metres, emits a sufficiently powerful harmonic in the broadcast band to spoil the reception of the Birmingham programme when listening on a superheterodyne receiver situated in a South London suburb.

The messages, which are transmitted slowly, are easy to read and are apparently sent out purely for practice in the reception of Morse signals.

Is not this a class of transmission which could be better conducted with a non-radiating set—all that is required is a buzzer and a key?

A. HOWTON.

Charlton.

BROADCASTING PROBLEMS IN WESTERN EUROPE.

Sir,—I should like to say something about the general question of broadcast reception as it exists at present and with a view to the future, especially from the point of view of those who, like myself, live in districts where there is no "local" station, and where, consequently, all listening on the 300-500 metre waveband is more or less long-distance reception.

Practically what it amounts to is that, in places like this, Daventry is the only station which is of any real use so far as regular and reliable entertainment is concerned. This opinion is practically universal amongst my acquaintances. With reasonably selective receiving sets, such as are available to people of ordinary means, reception on the 300-500 metre waveband is merely an exasperation. I have had no experience of reception within a short distance of any transmitting station, but only in this district, which must be fairly typical of that enormously greater part of the country which is outside the "swamping area" immediately around each broadcasting station. Dissatisfaction is becoming increasingly apparent among those who have purchased or constructed receiving sets which they were given to understand would receive distant stations satisfactorily, at least on head telephones. Of course, the cause of the trouble is the jamming resulting from the excessive number of stations working in Western Europe on an inadequate wavelength separation.

Letters to the Editor.—

We were informed not long ago that, as the result of large-scale tests, it had been definitely proved to be impossible to eliminate heterodyne interference so long as stations, even of small power, were working within less than a ten kilocycle separation in an area the size of Western Europe.

In apparent contradiction, we are now told of a scheme based on "exclusive" and "common" wavelengths for the elimination of this interference, but in view of the first statement, and of other facts one remains hardly convinced that anything but a reduction in the present number of stations, or, at the very least, a drastic limitation on the number to be erected in future, can ever achieve more than a partial and temporary success, unless present theories as to what is possible in selective transmission and reception are upset by some new discovery.

It looks, to the interested onlooker, as if the nations of Western Europe were just waiting for a lead in this common-sense scheme to limit the number of broadcasting stations, and it also appears rather as if this country's representatives were taking the line that, on account of our seniority in broadcasting, we have established a prior right to the ether, and that later comers ought to give way to us. If such an attitude exists, it can only increase difficulties and postpone a solution. Is it not possible for us to set an example which involves a good deal of courage and sacrifice, for others to copy?

From the point of view of manufacturers of wireless apparatus, and of all wireless publications, this matter of overcoming the interference bugbear is of extreme importance. New receiving apparatus, designed for selective long-distance reception, is continually being developed and improvements to older designs are frequently published, but under existing and prospective conditions are all these improvements of very much practical use? As I understand it, no receiver, however selective, can properly separate stations which actually heterodyne each other unless selectivity be carried to the point of cutting off the essential "side-bands." Already there are very few stations which are not definitely heterodyned most, or all of the time. A further aggravation is that all efforts to secure satisfactory I.P. amplification with clear, natural loud-speaker reproduction are nullified except on Daventry, to which no one wishes to listen exclusively, although very many are already compelled to do so, *not* because other stations are beyond the range for reliable reception.

If, eventually, it must come to be generally recognised that owing to the unavoidably congested state of the ether receiving sets designed for selective long-distance reception are of very little practical utility, it will not mean merely that the demand for some of the more elaborate types, and the components for constructing them, will diminish, with a compensating increase in the demand for simpler apparatus. The great majority of listeners in this country are not, and never will be, contented merely to listen to the local station (if there be one) and Daventry, and why should it be expected of them? The fascinating possibility of being able to hear distant stations has helped the growth of radio broadcasting in this country to an enormous extent. Can it be doubted that the removal of that stimulus to existence and growth would have a very serious effect?

Much, or all of the foregoing, may be wide of the mark, but it is an attempt to sum up the situation as it strikes the average listener, based on practical reception results as they are, and on such information as is available to the general public.

J. H. S. FIELDS.

Llanudno Junction, North Wales.

A QUESTION OF DISTANCE.

Sir,—With reference to the letter from Mr. H. L. Cape on the above subject, I think he hardly appreciates the effect on the ordinary and less learned readers (like myself) of incorrect figures being given in an article in *The Wireless World*, which has established a well-earned reputation for accuracy. If figures are worth giving at all they are worth giving accurately in such a periodical. No experienced wireless amateur would knowingly use two measuring instruments which differed in their readings by about 20 per cent., and then effecting a "compromise" between them; the same should apply to maps used for wireless purposes.

The difference between two maps Mr. Cape explains by their being "differently projected." Any error of this sort, measured over the distance in question, would be a matter of yards rather than of miles. The fact is that both maps were hopelessly inaccurate. Measured on a large scale Ordnance Survey map (which can always be relied upon), I make the distances the same as Mr. Adshead. Mr. Cape's reference to pedantry sounds dignified, but not convincing; obviously he did *not* consider the square law effect, but rather sought an explanation in the "improvement of plant."

High Wycombe.

V. G. P. WILLIAMS.

Sir,—In reply to H. L. Cape in *The Wireless World* of February 3rd, any map which shows a distance of 114 miles as either 125 or 137 miles is not "projected" but drawn free-hand by a draughtsman with his eyes shut. On a scale of even 10 miles to an inch this is an error of $2\frac{1}{4}$ inches in plotting! The distance from Birmingham Town Hall to Chelmsford aerial is 113.90 miles calculated by trigonometry, and the bearing is $116^{\circ} 14' 08''$.

H. E. ADSHEAD.

Braintree, Essex.

MARCONI ROYALTIES.

Sir,—I was interested to read your remarks on the above subject, including the letter from the General Manager of Marconi's Wireless Telegraph Co., Ltd.

In reply to question 2, wherein your correspondent asks whether a certain construction would infringe any Marconi patent, the General Manager of the Marconi Company answers positively "Yes."

Now, will he kindly tell us the number or numbers of the patents infringed, because we want to know where we are, and, hitherto, the Marconi announcements have seemed to me unnecessarily vague? One naturally understands that the Company holds a large number of patents, but there must be certain basic ones which might be mentioned by number, to prevent the amateur tripping up. I believe that the Marconi Company hold a patent, the number of which, I fancy, is 147,148, covering grid rectification. If this is the case, why don't they say so, and state that amateurs must not use grid rectifications unless they pay royalties?

It is not generally known that a person may *not* make up an article which is the subject of a patent without the patentee's permission, even if it is for his own use. There is a widespread misunderstanding on this point, the popular idea being that one can make up infringing articles with impunity as long as they are not sold. The patent law prohibits this, although, of course, the Marconi Company or any other patentees may grant what permission they like.

I write with no feeling in the present matter, but as a chartered patent agent of something over twenty years' practice, and a wireless experimenter from the early days, I am merely anxious to obtain definite information as to the numbers of the chief patents which makers of ordinary sets are likely to infringe.

Coventry.

E. W.

Sir,—I am interested in the "New Marconi statement on Royalties" in *The Wireless World* of February 3rd.

The Marconi Company seem to claim an overriding patent on all wireless apparatus whether they hold particular patents or not, and judging by their letter they would answer in the affirmative if asked whether the purchase of a reel of insulated wire constituted an infringement of their rights.

I would suggest that the Marconi Company be asked to state the number of the patents alleged to be infringed in the case of the ordinary three-valve arrangement. The validity of the individual patents could then be examined.

Then comes the question of enforcement, which, in view of the difficulty of collecting ordinary broadcast licence fees, would appear almost impossible.

It should be noted that a change of policy has occurred since the inception of broadcasting. It will be recalled that when broadcasting started no apparatus could be licensed which did not bear the licence plate of the B.B.C. To my knowledge several constructors applied to the B.B.C. for licence plates in respect of home constructed apparatus, offering to pay the royal-

Letters to the Editor.—

ties. Their applications were refused. (The B.B.C. and Marconi's are not, of course, identical, but in those days the B.B.C. consisted almost exclusively of Marconi's and the large electrical companies.)

Now the Marconi Company appear to be endeavouring to force constructors to buy licence plates.

The Wireless World has done a great service to its readers by challenging this "Warning notice," and it is hoped that the matter will not be allowed to drop until a satisfactory conclusion is reached.

UNCONVINCED.

London, N.W.2.

INTERFERENCE FROM A ROTARY RECTIFIER.

Sir,—In the issue of *The Wireless World* for January 20th one of your readers (G.M.G., London, N.) asks for a method of eliminating interference by a rotary rectifier. I have found that this can be done by placing a large fixed condenser (1 or 2 mfd.) across the D.C. terminals of the rectifier.

The whole rectifier is then put in an earthed metal box: an old biscuit box will do very well. Care should be taken that the box is thoroughly closed.

My personal experience is that this method will cure the trouble entirely.

Amsterdam, Holland.

H. W. VAN VEEN.

CONDENSER DIALS.

Sir,—A number of British-made condensers and dials with slow-motion mechanism incorporated are making their appearance, and they are all graduated with the old-fashioned 0-180 system. Surely the makers could easily offer a choice of 0-100 if they chose. In past times one could buy separate 0-100 dials and put on oneself, but this cannot be done now. Perhaps some of the manufacturers will give us their views. At present I carry on with American goods.

H. E. ADSHEAD.

Braintree, Essex.

B.B.C. WAVELENGTH TESTS.

Sir,—We should like to take this opportunity of thanking our listeners through the columns of your paper for the whole-hearted co-operation which they showed in our engineering test on Tuesday night. This test, we are glad to say, was an unqualified success, and far exceeded our anticipations. That this is so is to a very large extent due to the admirable way in which listeners complied with our request to switch off their receivers.

Our receiving station at Keston reports that it was possible to carry out all and more than was anticipated during this brief space of a quarter of an hour without once being subjected to interference by oscillation.

It is extremely gratifying to us to realise the extent to which we have sympathy of our listeners in experiments of this nature, which must necessarily cause inconvenience to them.

C. F. ATKINSON, Director of Publicity.

The British Broadcasting Co., Ltd.

MORSE AND THE AMATEUR.

Sir,—As one who had a prolonged and agonising experience of teaching the Morse code during the war, I should like to give my vote against your devoting space to this purpose. There is one way, and only one way, of learning to read Morse with any degree of proficiency by ear, and that is to listen to it. Let two friends and a buzzer get together and let the one send to the other: De-daa, Daa-de-de-de, Daa-de-daa-de, with, maybe, two or three more letters and then dodge about. And let the other fellow write down what is sent in terms of the alphabet until, quite automatically, he writes the correct letters for the correct sounds, and when, say, five letters have been mastered, let more be added. And let them bother as little as they possibly can about dots and dashes. That is by far the quickest and the best way to get ahead with it.

It is also advisable to get somebody who is a proficient sender

A 56

to give a few lessons in that gentle art. It is very far from being easy to send well, as anybody who knows Morse and listens to the amateurs knows full well. If you could institute a movement for better *sending* on the part of amateurs it would be a great help. It is sheer torture to listen to a great deal of the stuff.

E. C. RICHARDSON.

West Byfleet.

INDIAN RECEPTION OF 5XX.

Sir,—Readers may be interested in the results of the reception of the New Year programme, as broadcast by the B.B.C., from 5XX on New Year's eve and morning.

The whole of this programme was picked up here in Bombay on a four-valve (1-v-2) receiver without any difficulty whatever. Announcements were clear and loud, and could on this receiver be heard on a Claritone loud-speaker in a quiet room 5ft. away. This is not an exaggerated report at all. We do not state that it could be heard in the next room on a loud-speaker, but we do think this good on the part of the transmitter to be able on such a receiver to get strength to operate a loud-speaker at all.

There has been no time to get any information from London as to what took place other than by direct wireless reception as above mentioned. The greetings to the Colonies and to Scotland, followed by those to Ireland and Wales and then to all the different parts of England with the different dialects of the different counties, was amusing and very clearly received.

For the past few months our Mr. Hulme Smith has been broadcasting programmes from his bungalow on a 100-watt set using two 50-watt valves—one oscillator and one modulator. The results have been greatly appreciated. This means that there are actually two stations in operation in Bombay, the other being that of the Radio Club, 2FV. Our call-sign is 2AX. We have reports from many parts of India, some up to 700 miles away who claim to have heard us. We do not have to doubt these claims for usually programmes have been reported promptly, whilst we do not previously announce our programmes any more than announcing the time.

Such distance for a low-powered set is remarkable. We are regularly picked up at places like Poona. There is no doubt but there is excellent scope for practice at long-distance reception and transmission. These reports have come in fairly regularly and from different sources. Loud-speaker results are regular at 50 miles away. 2FV is rated as a 100-watt set, whilst it actually has three 80-watt valves. This station has had reports from so far away as Rawalpindi. This is good going, and we do not think that the Americans are the only real long-distance men!

Mr. Hulme Smith will be experimenting on a 100-watt 30-metre set in the course of the next few weeks, and he will definitely let you know more later. Will you be good enough to let your readers know? We believe it is possible to get through on the wave: 2AX is the call-sign. When in communication with Britain the usual V will precede this sign.

Telephony and telegraphy are provided for and both will be tried.

We are still taking *The Wireless World*, as we have been for some years now, and pass on our sincerest wishes for its progress during the year 1926.

WALTER ROGERS & CO.

Bombay.

BROADCASTING TO THE DOMINIONS.

Sir,—The main object of most of us out here is to pull in one of the British broadcasting stations. Short wave reception is too easy to be interesting, and one tires of getting up at 3 a.m. to hear KDKA or other Yankee stations. It would be a great thing for the Empire if the B.B.C. would transmit on 60 metres from 6 p.m. to 9 p.m. (G.M.T.) as all the Dominions want to hear from the Old Country, and the B.B.C. income ought to enable it to do this without thought of payment. Only two-valve sets would be required, and if money is needed I think quite a sum could be raised and donated to the B.B.C. by those who would listen. We are all fed up with our own programmes, but we recognise that it is not the fault of the stations. Talent is naturally limited in such a small population, and distances between towns prevent much exchange of artists.

Cape Town.

E. H. BYSSHE.

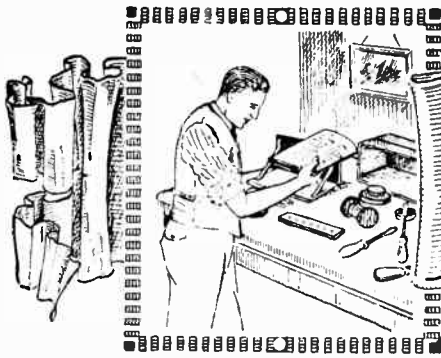

READERS' PROBLEMS

"The Wireless World" Information Department Conducts a Free Service of Replies to Readers' Queries.

Questions should be concisely worded, and headed "Information Department." Each separate question must be accompanied by a stamped addressed envelope for postal reply.

Alternative Choke-filter or Direct Output Circuit.

I have had a conventional detector and L.F. valve receiver in use for a considerable period, and find that on my two nearest broadcasting stations excellent loud-speaker results are obtainable. I am now desirous of using the loud-speaker in a room adjoining that wherein the receiver stands, and propose to use a choke-filter output circuit in order to keep the steady anode current out of the extension leads and loud-speaker windings, but wish to include a simple switching arrangement so that I can change over quickly to the ordinary direct-coupled loud-speaker circuit when required. L.T.H.

This switching can, of course, be provided in a very simple way indeed by provision of a two-way stud switch or a simple single pole change-over switch. In Fig. 1 we illustrate clearly the necessary connections to your particular receiver, although, of course, the scheme is equally suitable for use with any type of set. It is important that a good value of choke having a high inductance be used, the value being not less than 20 henries, even if a suitable low impedance valve be used. Even then it will be found that if the utmost is to be obtained from the arrangement, it is advisable to use a

still higher value. The fixed condenser should, of course, be of such value that it offers a low impedance to the passage of all audio-frequency pulses, 2 mfd. being a good value to use.

o o o

The Inverse Reflex System.

What is meant by "inverse reflexing," and how does it differ from "direct reflexing"?

F.V.N.

In a direct reflex circuit in which both valves amplify at a dual frequency the incoming signal first passes to the grid of No. 1 valve where it is amplified at high frequency and then passed to the grid of the second valve, where it is similarly dealt with, afterwards being rectified by either a crystal or another valve. The rectified signal is then passed back to the grid of No. 1 valve where it is amplified at low frequency, and after being further amplified by No. 2 valve it passes to the loud-speaker, which is, of course, in the plate circuit of No. 2 valve. This is the system which is in general use. In the "inverse" reflex system, however, the signal, after being rectified, is passed back directly to the grid of No. 2 valve instead of to that of No. 1, and after being amplified at low frequency is passed back to the grid of No. 1 valve, is further amplified by this

valve, and then passes to the loud-speaker, which in this case is in the plate circuit of No. 1 valve instead of in the plate circuit of the second valve. This latter system was first developed by a Dr. Grimes of America, and it is claimed that better quality is obtained owing to the fact of the "load" on the two valves being more equalised, as, of course, No. 1 valve which deals with strong L.F. handles the H.F. component initially when it is weakest, No. 2 valve dealing with weak L.F. but stronger H.F. It is claimed also that his system tends to give greater stability than the more conventional method.

o o o

The Meaning of Push-pull Amplification.

I have recently constructed the push-pull amplifier-receiver described recently in "The Wireless World," and am more than satisfied both with the quantity and quality of the signals obtained from it, and was immediately struck by the idea of applying the system to H.F. amplification, but my experiments have not been very fruitful. Can you explain why this is? J.R.M.

It is evident that you have not correctly understood the reason for the use of this method whereby distortion due to the overloading of the final valve of a receiver can be prevented by the use of ordinary bright or dull emitter valves instead of by using an expensive power valve. The system actually provides no more amplification than would be provided by a power valve, but it does enable the same quality to be obtained, using ordinary valves, as would be obtained by the use of a power valve. It can, of course, be used in the first stage of an L.F. amplifier, as well as in the final or any intermediate stages, but since the input to the grid of the first L.F. valve is small, and the valve is not likely to be overloaded, there is nothing to be gained by using it. Now in the case of an H.F. amplifier, we are dealing with a far smaller input than is the case with our L.F. valves, and we can easily keep on the straight line working portion of our valve curve, and so the use of push-pull amplification, even if it could really be successfully adapted to H.F. work, would be rather futile.

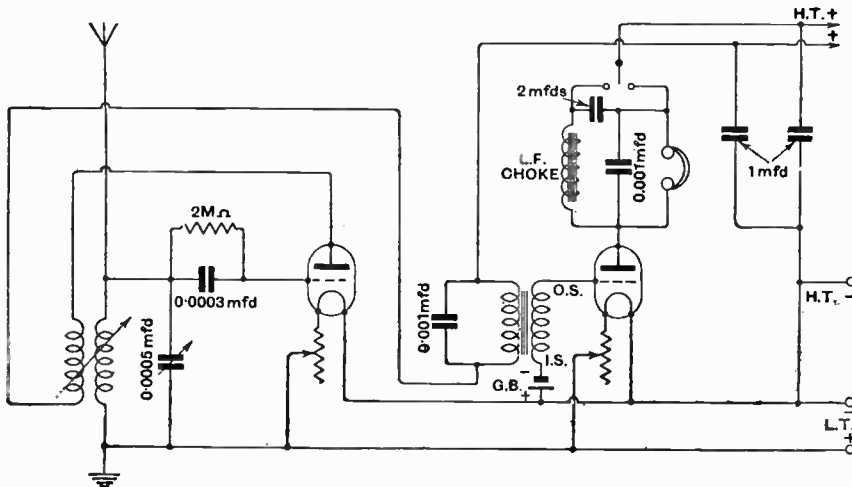

Fig. 1.—Alternative choke-feed or direct coupled output circuit in a two-valve receiver.

A Smoothly Controlled Superheterodyne.

I understand that there are a number of superheterodyne receivers on the American market which employ the "Weagant" oscillator system, and having obtained excellent results from the "Weagant" single-valve circuit given by you in reply to "R.J.H." in your November 25th issue, I should like to adopt the system in a superheterodyne receiver which I am building, if you can give me the circuit. J.H.

This circuit, attributable to Roy Weagant, erstwhile Chief Engineer of the Radio Corporation of America, is given in Fig. 2. It will be seen that the method of obtaining oscillation is precisely the same as that given in the reply to which you make reference. It is advisable to use a good H.F. choke coil, such as the "Cosmos" choke, by Metro-Vick Supplies, Ltd., or one of similar characteristics. Alternatively the home-constructed choke referred to on page 119 of our January 27th issue would answer the purpose. The reaction coil is mounted close against the grid coil, and is not variable in respect to its coupling with this latter coil. It should be large enough to cause the valve to oscillate strongly when the reaction condenser is full in, but at the same time it should not be too large, and the coil size should be carefully chosen by experiment, so that the valve goes out of oscillation before the reaction condenser reaches its absolute minimum position. The grid coil should, on the normal B.B.C. wavelength, consist of a No. 50 or 60 plug-in coil or a Gambrell "B," a No. 250 or Gambrell "F" being substituted on the Daventry wavelength. The two coils may be mounted side by side in two fixed single coil holders, and the usual experiments carried out for the correct connections of the reaction coil, as in the case of an ordinary single-valve regenerative receiver. With regard to the two "pick-up" coils situated in the grid circuit of the detector valve and plate circuit of the oscillator valve respectively, there is not the slightest need, with this circuit,

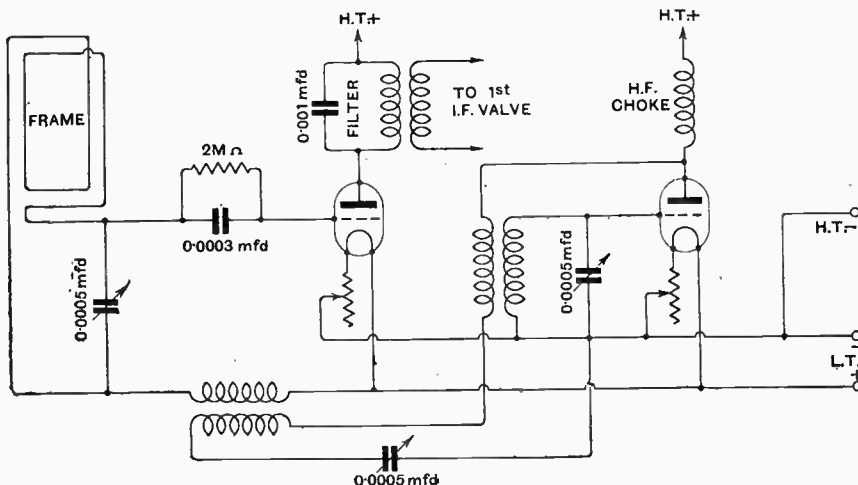

Fig. 2.—Combined magnetic and electrostatic reaction in a superheterodyne receiver.

**BOOKS FOR THE
HOME CONSTRUCTOR**

Issued in conjunction with "The Wireless World."

"THE HOME CONSTRUCTOR'S EASY-TO-BUILD WIRELESS SETS," by F. H. HAYNES. Price 1/6 net. By Post, 1/9.

"TUNING COILS AND METHODS OF TUNING," by W. JAMES. Price 2/6 net. By Post, 2/10.

"HOW TO BUILD AMATEUR VALVE STATIONS," by P. R. COURSEY, B.Sc. Price 1/6 net. By Post, 1/8.

"THE CONSTRUCTION OF AMATEUR VALVE STATIONS" by Alan L. M. DOUGLAS. Price 1/6 net. By Post, 1/8.

"THE HOME CONSTRUCTOR'S WIRELESS GUIDE," by W. JAMES. Price 3/6 net. By Post, 3/9.

"MAST AND AERIAL CONSTRUCTION FOR AMATEURS," by F. J. AINSLEY, A.M.I.C.E. Price 1/6 net. By Post, 1/8.

Obtainable by post (remittance with order) from
ILIFE & SONS LIMITED,
Dorset House, Tudor St., London E.C.4,
or of Booksellers and Bookstalls

to use variable coupling between these coils as is customary, since control of the strength of the oscillations fed into the grid circuit of the detector valve is effected by varying, by means of the reaction condenser, the actual strength of oscillations generated. In the conventional circuit, of course, a variably coupled pick-up arrangement is necessary, owing to the fact that there is no control of the strength of oscillations actually generated. The intermediate amplifier can be of the conventional type, and of any wavelength determined upon by the constructor. A frame aerial may be used or an ordinary aerial system employed by substituting a plug-in coil for the frame. This, however, is not advised, owing to the fact that radiations would occur, to the annoyance of other listeners. Using this receiver, it will be found that control over the strength of oscillations fed to the detector valve is remarkably smooth and simple. Furthermore, since plug-in coils are used throughout, the circuit is

equally adaptable both for the normal B.B.C. wavelengths and also for the reception of Daventry and similar long-wave stations. Since H.F. chokes such as the "Cosmos" are constructed to cover a waveband of from 250 to 4,000 metres, there is, of course, no need for this component to be interchangeable.

o o o o

"Distortionless" Transformers.

I have taken a great interest in recent articles on speech amplifier design, designed by Dr. McLachlan, and should be greatly indebted to you if you can inform me where I can purchase a transformer having a 200 henry primary, such as he described, since I am specially interested in obtaining the highest possible quality from my loud-speaker. G.M.

A transformer such as is described by Dr. McLachlan is not, of course, available on the market, nor would it be a practicable proposition for any manufacturer to attempt to put one forward, for two very good reasons. The first is that such an instrument would have to be of such comparatively large bulk that set builders would probably be chary of sparing the necessary space for it in their sets. Secondly, it must be remembered that in designing an instrument having such a necessarily large number of primary turns, the secondary would have to possess two or three times this number of turns if the customary turns ratio of a high impedance primary transformer were to be maintained. Now in an instrument of such dimensions, it must be remembered that extraordinary precautions would have to be taken in the design and construction in order to avoid defeating the object of perfect quality by the introduction of parasitic capacities in the large secondary winding. Indeed, the successful construction of such an instrument would call for such meticulous care and precision that production by ordinary factory methods would be out of the question, and each instrument would virtually become a separate laboratory "job." Fortunately, however, there is not the slightest need to make use of such an instrument in order to design a high quality amplifier, which will deliver a high percentage of the possible purity obtainable from the transmissions of the B.B.C. stations. It should be pointed out, also, that it would be quite useless to use such a transformer without taking all the other precautions mentioned by Dr. McLachlan for so adjusting the characteristic of the output that it is a true reproduction of the musical balance obtained in the actual studio. Such an arrangement is really only feasible when it is desired for some particular purpose to obtain the last iota of quality regardless of cost or trouble. Provided that one uses the best transformers one can get, and takes care that after the ordinary medium or high impedance detector valve a transformer having a suitable primary impedance is used, the quality will fall very little short of such perfection as is obtainable in our present knowledge of radio science.

'EDDYSTONE' RADIO PRODUCTS

The SHINING LIGHT of the WIRELESS WORLD.

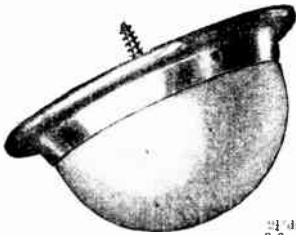

" ABSORBOS "

The IDEAL Radio set mount

They take up all outside shock, thus giving longer life to the valves. Prevent microphonic noises and in addition they add an elegant touch to the cabinet. They prevent marking or scratching any polished surface the set may be placed upon.

PRICES:—

2 1/2" diam.—nickel finish—for heavy cabinets, 3/6 per set of four, 2" diam.—untarnishable gold finish, 3/- per set of four.

'EDDYSTONE' SHORT WAVE COILS

THESE coils are ideal for short wave reception, there being no unwanted insulation to cause losses, while the self capacity of the coil is very low. Adaptable for ordinary sets.

PRICE : 10/6 per set of Three.

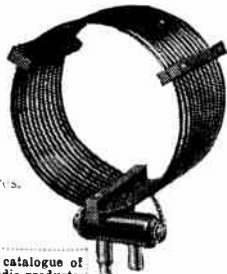

No. 9—25 80 metres.
No. 12—50 110 "
No. 15 80 150 "

Send for our latest catalogue of "EDDYSTONE" radio products.

Obtainable from all high-class dealers. If any difficulty write direct to Manufacturers:—
STRATTON & CO., Ltd., Bromsgrove Street, BIRMINGHAM.

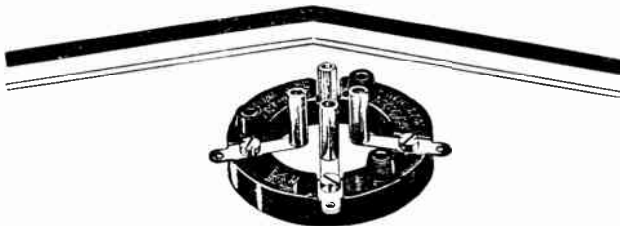

The Valve Saver

Threefold protection for your valves. Fitted in "Antipong" holders they are safe from accidental shocks, safe from microphonic vibration, safe from interelectrode losses.

This triple safety is only found in Antipong Holders,

which, with their universal fitting, can be used in every kind of set.

Phosphor bronze springs; heatproof Bak-Eite Mounting; Low Loss design, all contribute to your satisfaction with "Antipong." Fit it in every set, for every valve.

BOWYER - LOWE ANTIPONG VALVE HOLDER

From good dealers or direct.

3/-

Bowyer-Lowe Co. Ltd., Letchworth.



COSMOS PERMACONS

FIXED CONDENSERS GIVING FIXED RESULTS

The "Cosmos" Permacon is an ideal fixed condenser, being light in weight, of guaranteed accurate capacity, and having the lowest possible losses.

The dielectric is mica and each condenser is tested at 500 Volts during inspection. Nickel plated cases give them a particularly neat appearance.

0001 mfd	1/6
0002	1/6
0005	1/6
0003	1/8 (with clip for grid leak)
001	1/8
002	1/10
005	2/8
01	3/9

"COSMOS" GRID LEAKS

are uniform and permanent, 1/2, 1, 2 and 3 megohms, each 1/6

Ask for copy of the Cosmos Components Brochure.

METRO-VICK SUPPLIES LTD.
(Proprietors Metropolitan-Vickers Elec. Co. Ltd.)
4 Central Buildings, Westminster, LONDON, S.W.1



The Best Books on Wireless

TUNING COILS AND METHODS OF TUNING. By W. JAMES. A manual discussing the principles and practice of tuning coils, with explanations of spade, condenser and variometer tuning. Price 2/6 net. By post, 2/10.



WIRELESS VALVE RECEIVERS AND CIRCUITS: In Principle and Practice. By R. D. HARGAY and V. ASHBIDGE, B.Sc. Written to enable the amateur to understand the working of any circuit he constructs. Price 2/6 net. By post, 2/10.

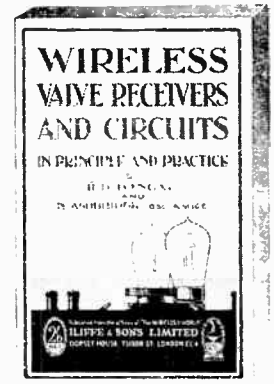

THE BEST way to solve wireless problems is to read the right books. You thus take advantage of other people's experience to overcome your own difficulties. Books on wireless matters are plentiful, but it is difficult to choose which are really helpful among them. The most reliable wireless books are published by "The Wireless World," every possible care being taken to ensure accuracy and to express facts and explanations in an understandable way.

The books are written by men with wide experience of wireless theory and practice, and all sets described in books dealing with home-constructional work have been thoroughly tested.

A Guide to Wireless Literature

A booklet has been compiled, giving a list of the volumes published in conjunction with "The Wireless World."

There is a book for every wireless worker, from the beginner to the amateur experimenter and research worker. Send for a FREE copy to-day.



THE HOME CONSTRUCTORS' EASY TO BUILD WIRELESS SETS, by F. H. HAYNES. Well illustrated with working drawings and diagrams. Price 1/6 net. By post, 1/9.

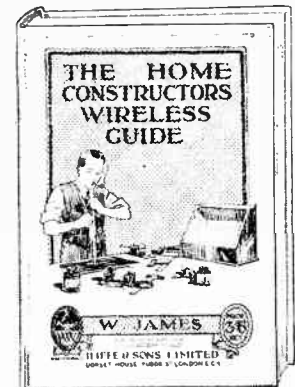

THE HOME CONSTRUCTORS' WIRELESS GUIDE. By W. JAMES. A useful little encyclopaedia of wireless technology which will solve difficulties met with in practical work. Price 3/6 net. By post, 3/10.

Publishers: ILIFFE & SONS LIMITED, Dorset House, Tudor Street, London, E.C.4

THE MOST RELIABLE WIRELESS BOOKS ARE PUBLISHED BY "THE WIRELESS WORLD" W.W. 1

VOLUME

Ample volume, but clear as crystal—full, round, natural tone—that's the "Hearthside" Speaker. With the new cast-in diaphragm and non-resonant horn. You must hear it—to-day! Fully guaranteed.

Send now for your FREE copy of our new catalogue.

General Radio Co. Ltd., 235, Regent St., W.1.

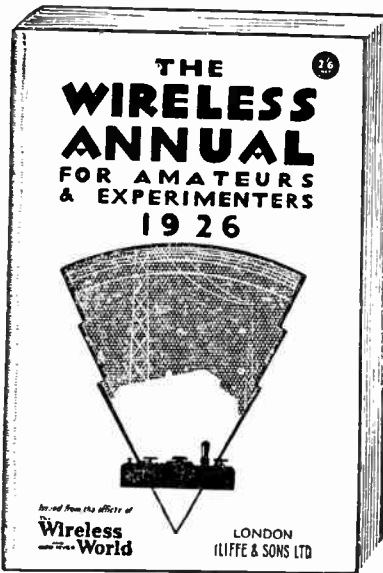

Do not fail to GET a COPY of this invaluable BOOK!

ORDER TO-DAY!

"The Wireless Annual" for 1926 is a volume of indispensable information for every keen radio amateur. It contains a whole mass of facts which are of daily assistance in amateur wireless work. Get your copy to-day!

Price 2 6. By post 2 8½.

From all new agents and book-sellers, or direct from: DUFFE & SONS LTD., Dorset House, Tudor Street, London, E.C.4

W.W.8a.

No More Short Circuits if you use a "CANTCROSS" CONNECTOR

(Patent Applied for.)

Consists of a Plug element for fitting to the panel, to replace the usual H.T. and L.T. terminals. The Socket element corresponds to the Plug element, and is arranged to receive the necessary leads from the respective batteries.

BURN-OUT VALVES IMPOSSIBLE. ACTS AS A DISCONNECTING SWITCH. EASILY FITTED TO ANY SET.

3 Terminal, 5 - each, 5 Terminal, 8 - each, 7 Terminal, 7 - each. (Leads not included).

Adaptable to all Circuits.

Example Wired as follows: 1. H.T.A. 2. H.T.B. 3. H.T.C. 4. H.T.— 5. L.T.+ 6. L.T.—

Post Free on receipt of Postal Order and Dealer's Name from

J. & W. BARTON, 22a, Virginia Street, SOUTHPORT.



A LOUDER CRYSTAL SET

"CAMBRIAN" 1-VALVE AMPLIFIER fitted complete with H.T. and L.T. Leads and Grid Bias Terminals 30/- Postage FREE.

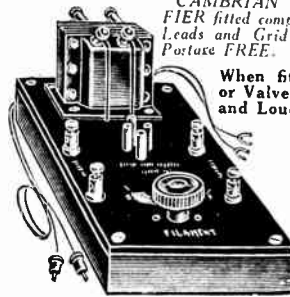

When fitted to your Crystal or Valve set it will give pure and Loud signals.

Valves, Batteries, Accumulators, extra.

Our sets are manufactured under Marconi patents and Royalties are included

LOG CARD and illustrated catalogue FREE.



SERVICE QUALITY PRICE

30/- Post: FREE.

PUGH'S WIRELESS, 95-101, Holloway Road, London, N.7.

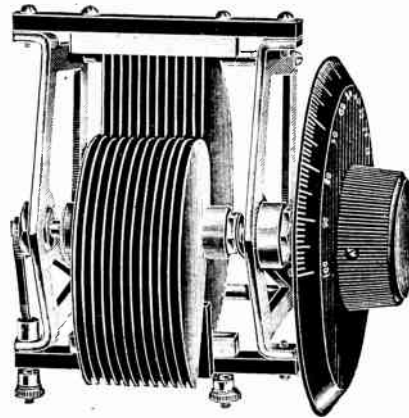

THE NEW "Wootophone" Square Law LOW LOSS CONDENSER

ANOTHER PERFECT AND VERY POPULAR MODEL.

The design is of solid rigid skeleton type. Special features are fixed vanes insulated outside electrostatic field, thus reducing losses. Heavy well fitting bearings for central spindle, brass vanes soldered in position, pigtail connection making permanent contact from moving vanes to aluminium end plates. One hole fixing.

This Condenser has been specially designed for short wave work, and results on test justify its introduction. Price complete with improved 1 in. Knob, Dial, packed in strong cardboard box:

.0003 - 16/6 .0005 - 17/6

F. E. WOOTTEN, LTD., WIRELESS MANUFACTURERS, OXFORD.

You will get 25% Power Increase BY USING RADIAX H.F. TRANSFORMERS

owing to their effective step-up ratio. (Each pin clearly marked for connections.)



Wavelength Metres	Wavelength Metres
170-330, 3/6	500-900, 4/3
300-500, 3/6	900-1600, 4/9
	1500-2600, 5/6

Four pin Anode Coils at same prices. Supplied also aperiodic for T.A.T. Coupling. Complete Catalogue of these and other components including Super Het., stamps 3d.

Radiax Reactance Unit without Transformer 300/1000 6/9

RADIAX LTD. 30 RADIO HOUSE, 16 PALMER PLACE, HOLLOWAY ROAD, N.7.

MISCELLANEOUS ADVERTISEMENTS.

NOTICES.

THE CHARGE FOR ADVERTISEMENTS in these columns is:

12 words or less, 3/- and 3d. for every additional word, e.g., 18 words, 4/6; 24 words, 6/- Name and address must be counted.

SERIES DISCOUNTS are allowed to Trade Advertisers as follows on orders for consecutive insertions, provided a contract is placed in advance, and in the absence of fresh instructions the entire "copy" is repeated from the previous issue: 13 consecutive insertions, 5%; 26 consecutive, 10%; 52 consecutive, 15%.

ADVERTISEMENTS for these columns are accepted up to **FIRST POST ON THURSDAY MORNING** (previous to date of issue) at the Head Offices of "The Wireless World," Dorset House, Tudor Street, London, E.C.4. or on **WEDNESDAY MORNING** at the Branch Offices, 19, Hertford Street, Coventry; Guildhall Buildings, Navigation Street, Birmingham; 199, Deansgate, Manchester.

Advertisements that arrive too late for a particular issue will automatically be inserted in the following issue unless accompanied by instructions to the contrary. All advertisements in this section must be strictly prepaid.

Postal Orders and Cheques sent in payment for advertisements should be made payable to **ILLIFFE & SONS Ltd.**, and crossed **Treasury Notes**, being untraceable if lost in transit, should not be sent as remittances.

All letters relating to advertisements should quote the number which is printed at the end of each advertisement, and the date of the issue in which it appeared.

The proprietors are not responsible for clerical or printers' errors, although every care is taken to avoid mistakes.

NUMBERED ADDRESSES.

For the convenience of advertisers, letters may be addressed to numbers at "The Wireless World" Office. When this is desired, the sum of 6d. to defray the cost of registration and to cover postage on replies must be added to the advertisement charge, which must include the words Box 000, c/o "The Wireless World." Only the number will appear in the advertisement. All replies should be addressed No. 000, c/o "The Wireless World," Dorset House, Tudor Street, London, E.C.4. *Readers who reply to Box No. advertisements are warned against sending remittance through the post except in registered envelopes; in all such cases the use of the Deposit System is recommended, and the envelope should be clearly marked "Deposit Department."*

DEPOSIT SYSTEM.

Readers who hesitate to send money to unknown persons may deal in perfect safety by availing themselves of our Deposit System. If the money be deposited with "The Wireless World," both parties are advised of its receipt.

The time allowed for decision is three days, during which time, if the buyer decides not to retain the goods, they must be returned to the sender. If a sale is effected we remit the amount to the seller, but, if not, we return the amount to the depositor. Carriage is paid by the buyer, but in the event of no sale, and subject to there being no different arrangement between buyer and seller, each pays carriage one way. The seller takes the risk of loss or damage in transit, for which we take no responsibility. For all transactions up to £10, a deposit fee of 1/- is charged; on transactions over £10 and under £50, the fee is 2/6; over £50, 3/-. All deposit matters are dealt with at Dorset House, Tudor Street, London, E.C.4, and cheques and money orders should be made payable to Illiffe & Sons Limited.

THE SALE OF HOME-CONSTRUCTED UNLICENSED APPARATUS.

A New Service to our Readers.

We have made an arrangement with the Patentees whereby readers who wish to dispose of a home-constructed receiver not licensed under the patents made use of, can do so by means of the Deposit System referred to above.

The person desiring to sell, in sending us particulars for his advertisement, will in every case make use of a Box No., and should add to the price which he requires the amount of royalty customarily paid by manufacturers, 1/2 in the case of Marconi Patents the amount should be calculated at 12/6 per valve holder.

If the purchaser is satisfied with his purchase, the sum realised will be forwarded to the seller, less the amount due in respect of royalties, which amount will be paid by "The Wireless World" to the owners of the patents concerned, and a certificate will be handed on to the purchaser of the set.

FOR SALE.

TWO Zenith Transformers, one H.T., 3,300v., 175 watts, one 12v., 5 amps., both have centre taps, and are wound for 200v., 50 cycles, brand new.—Write: G2XY, "Esholt," Wedgewood Drive, Roundhay, Leeds. (1818)

For Sale.—Contd.

CROIX Transformers, 5:1 and 3:1, guaranteed genuine, 4s. each, postage 4d.—Continental Supplies, 497, Old Ford Road, London, E. (1815)

CRYSTAL Amplifiers increase range five times. Price, complete, 25s. Oscillating zincite 1s. 6d. Original circuit 1s. All parts stocked.—Particulars: Ledsham's, 297, King Street, Hammersmith. (1817)

EXPERIMENTER has for disposal, excellent condition, two-thirds cost or nearest, Lissen M.K.2 condenser, grid-leak, Lissen-stats, Watmel grid-leak and anode resistance, Burndopt crystal detectors, Bowyer-Lowe wood mounting valve-holders and S.P. switch, microstats, Leigh Bros.' terminals and ebonite bushes, G.E.C. headphones, 4,000 ohm.—Box 6869, WIRELESS WORLD Office. (1819)

EXPERIMENTER selling up highly-efficient wireless apparatus, 3-valve power amplifier, 6-valve superheterodyne, 2H.F. det. set, 20-40-metre set, large Western electric speaker, Morse inker with relay and special amplifier, expensive model German frame aerial, 18 coils, A. type telephones, Milliamperemeter, etc.; the lot £70, cost £135.—Griswell, Wittersham, Kent. (1820)

6-VALVE Neutrodyne Receiver, perfect condition, high-class components, highest offer.—R. Mford, The Avenue, Sunbury. (1821)

A.C. Charger, 9 cells, 8 amps., Rotary rectifier, particulars, £4; do, as above, 20-40-60 volts to 6 amps., new last September, complete switchboard, £6.—County Garage, 343, Trinity Road, S.W.18. (1822)

3-VALVE Wireless Set, with large Amplifier, loud-speaker; £19 15s., including Royalties.—Box 6879, WIRELESS WORLD Office. (1823)

MISCELLANEOUS.

SECOND-HAND Apparatus taken in part-purchase of new ones. Leading lines supplied.—Wharton, 9, Victoria Street, Westminster. (1412)

CHARGE Your Own Accumulator.—Send 3d. stamp to-day for lists of our small gas and petrol engines and dynamos, and complete charging sets, from 20 to 160 watts.—Tom Senior, Cleckheaton, Yorks. (0013)

A WIRELESS Doctor.—If your set is giving trouble or you want advice a competent expert will call (anywhere in Greater London) and put you right. No result, no charge.—Alexander Black, 2a, Woodville Grove, N.16. Clissold 3687. (1811)

PATENT AGENTS.

W. BRYSON, B.Sc., Chartered Patent Agent, 29, Southampton Buildings, W.C.2. Phone: Holborn 672. (1297)

REPAIRS.

TRANSFORMER Repairs.—Re-wound to original efficiency and guaranteed 12 months. 4s., post free. Phones 3s. 6d. Trade supplied.—Transform, 70a, Longley Road, Tooting. (0011)

SITUATION WANTED.

YOUNG Radio Engineer, college trained, thorough practical knowledge radio and electricity, draughtsman, etc., requires position; disengaged.—Box 6867, WIRELESS WORLD Office. (1816)

PATENTS, DESIGNS AND TRADE MARKS.

J. S. Withers & Spooner.

CHARTERED PATENT AGENTS.

ETABLE HOUSE,
61 & 62, CHANCERY LANE,
LONDON, W. 1.

GRAMS:—IMPROVABLE,
HOLB., LONDON,
110k.:—480 HOLBORN

LOW LOSS NEUTRODYNE TRANSFORMERS

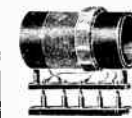

As described in several recent issues of this paper.

Considering them the most efficient type evolved, we are making them for the benefit of "The Wireless World" readers. Send stamp for details.

Price with base 15/-

TORDA PRODUCTS—COTTON & CLARKE,
55/59, Lacy Road, Putney, S.W.

PATENTS, DESIGNS & TRADE MARKS.

H. D. FITZPATRICK & CO.

Chartered Patent Agents,

49, Chancery Lane, London, W.C.2

Phone: Holborn 459.

The G.W.M. RESISTANCE CAPACITY UNIT

purifies the distortion in your receiver.

Send for full particulars and TWO FREE CIRCUITS.

G.W.M. ELECTRICAL CO., LTD.,
42, Grafton Street, Tottenham Court Road, London, W.1.

REPAIRS SETS PHONES TRANSFORMERS

— Officially approved by Radio Association

ALL WORK GUARANTEED. LOWEST RATES. 24 HOUR SERVICE.

JOHN W. MILLER, 68, Farringdon Street, E.C.4
PHONE: CENTRAL 1950

EBONITE BUSHES

FOR MOUNTING ON WOOD.



PERFECT INSULATION

Two required for each hole

Orders under 1/- send 1 1/2d. Postage

NUMBER	1	2	3	4	5
Size of hole	4BA,	2BA,	1 1/4",	5/16",	3/8"
Price each	1d.	1d.	1 1/2d.	2d.	2d.

DAREX RADIO CO.,

Standard Works, Forest Hill, S.E.23



KAY'S CABINETS

This Cabinet, 36" x 15", for panels 15", 19", or 20" by 12". Can be adapted to other sizes at slightly extra cost, or supplied with shelf to house your set. Strongly made of Oak and polished rich Jacobean

50/-

Actual makers of every description of Wireless Cabinet. Quotations for Specials by return.
H. KAY, Cabinet Manufacturer, MOUNT PLEASANT ROAD, LONDON, N.16.



Finston

LO-LOSS COILS

No. 25 - 1/3	No. 150 - 2/9
No. 35 - 1/4	No. 175 - 3/3
No. 50 - 1/8	No. 200 - 3/6
No. 75 - 2/0	No. 250 - 3/9
No. 100 - 2/6	No. 300 - 4/0

OBTAINABLE FROM ALL DEALERS
FINSTON MANUFACTURING CO., LTD.,
 45, Horseferry Road, LONDON, S.W.
 Phone: Victoria 1044



The ideal Rheostat for any valve.

Only the special spring arm, the perfected bearing and winding of the Ericsson Dual Rheostat permits such velvety smoothness. By means of small auxiliary knob the resistance of 6 ohms can be altered to one of 60 ohms. Price complete with pointer, knob, scale and screws, **8/6.** Write for lists to-day.

THE BRITISH I.M. ERICSSON MFG. Co., Ltd., 87/78, Kingsway, London, W.C.2.

Ericsson

DUAL RHEOSTATS.

Another "Lotus" Triumph!

THE delicacy of your Valve filaments is subject to microphonic elements from numerous sources. The LOTUS Buoyancy Valve Holder has been specially designed and constructed to counteract and dissipate these disturbances, and will, by its original and unique spring construction absorb any shock, protect your valves and eliminate all microphonic noises.

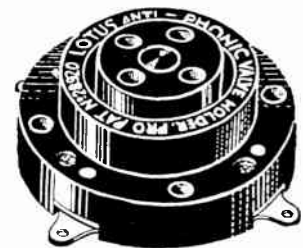

TOP VIEW.

Valve sockets and springs are locked together by a mechanical process, making a definite and permanent connection. Bakelite mouldings, nickel silver springs and phosphor bronze valve sockets. Nickel plated.

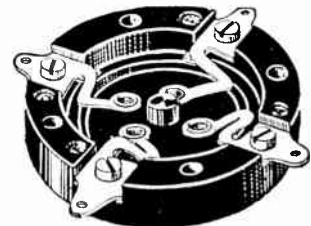

UNDERSIDE SHOWING SPRINGS.

The LOTUS

Buoyancy VALVE HOLDER

Anti-Microphonic

Designed and made by the manufacturers of the LOTUS VERNIER COIL HOLDER and obtainable from all reliable Radio Dealers.

23

Garnett, Whiteley & Co., Ltd.,
 "LOTUS" WORKS,
 BROADGREEN ROAD - - LIVERPOOL.



Two Remarkable Coil Plugs

Each 13 Postage 2/-
"The Patent Universal Expanding Plug" is a marvel of efficiency and neatness. Expanding Band quickly and firmly mounts any size coil. Perfect Low-loss reversible Plug and Socket. Adds fine finish to all Home-made Coils. Send to-day to Goodman, Utley & Harris, 14, Broad Street Chambers, Broad Street, Sheffield.

"The Quick Fix" in Basket Coils, with detachable Pin and Knob, securely mounts all size coils, permits instant action and quick adjustment. Low-loss reversible Plug and Socket. Solid Epoxy.



Trade Enquiries Solicited



NO MORE —
 Capacity and Voltage Leakage losses between Valve legs.

MODEL "D" Base-Board Mounting 2/5 each.
 MODEL "E" Back of Panel 2/6 each.

THE NEW AERMONIC

VALVE HOLDERS

Manufacturers & Distributors for London & South England:
JAMES CHRISTIE & SONS Ltd.,
 248, WEST STREET, SHEFFIELD.
 London Agents: A. F. Bulgin & Co., 10, Curator Street, E.C.4.
 Agents—Rest British Isles:
 Messrs. V. R. Pleasance, 50, Farzate, Sheffield.

ANTI-CAPACITY AIR-SPACED

The Home Constructor's Wireless Guide

by W. James

THIS book forms a most convenient little encyclopedia of wireless technology: the kind of volume to refer to when in difficulties. It solves them for you.

A few of the main features:

Outdoor, Indoor and Frame Aerials; Earths; Variometers for Broadcast Wavelengths, Basket Coils, Plug-in Coils, etc.; Coupled Circuits; Common Faults in Tuners; Reaction and Self-Oscillation; Special Chapter on Sensitive Single-Valve Receivers; Double Magnification; Points on Dry Cells and Accumulators, etc., etc.

PRICE **3/6** NET.

By post, 3/10.

Obtainable from Booksellers and Wireless Stores, or direct from the Publishers of "The Wireless World."

ILIFFE & SONS Ltd.,
 Dorset House, Tudor St.,
 London, E.C.4.

W.W.10

INDEX TO ADVERTISEMENTS.

	PAGE		PAGE		PAGE
Barton, J. & W.	19	Ferranti, Ltd.	21	Miller, J.	20
Bowyer-Powe Co., Ltd.	17	Finston Manf. Co., Ltd.	21	Mullard Wireless Service Co., Ltd., The	2
Brandes, Ltd.	9	Fitzpatrick, H. D., & Co.	20	Nelson Electric Co., Ltd.	15
Britannia Rubber & Kampulicon Co., Ltd.	10	Fuller's United Electric Works, Ltd.	2	Ormond Engineering Co.	22
British Electrical Sales Organisation	10	Gambrell Bros., Ltd.	21	Partridge & Wilson	19
British L.M. Ericsson Manf. Co., Ltd.	21	Garnett, Whiteley & Co., Ltd.	12 and 13	Pickett Bros.	19
Burndep Wireless, Ltd.	2	General Electric Co., Ltd., The	19	Pugh Bros.	19
Caxton Wood Turnery Co.	2	Goodman, Uttley & Harris	21	Radiax, Ltd.	19
Charlesworth, W. J.	21	Graham, Alfred, & Co.	Cover ii	Radio Communication Co., Ltd.	6
Chloride Electrical Storage Co., Ltd., The	21	G.W.M. Elec. Co., Ltd.	20	Reflex Radio	6
Christie, James, & Sons, Ltd.	21	Halladay's, Ltd.	4	Sifam Elec. Inst. Co.	6
Clarke, H., & Co. (Manchester), Ltd.	20	Heayberd, F. C., & Co.	Cover iv	Silvertown Co., The	11
Cleartron Radio, Ltd.	20	Igranite Electric Co., Ltd.	22	Stevens, A. J., & Co. (1914), Ltd.	17
Cotton & Clarke	20	Jones & Stewart	20	Stratton & Co., Ltd.	7
Darex Radio, Ltd.	20	Kay, H.	8	Telegraph Condenser Co., Ltd.	7
Darimont Electric Batteries, Ltd.	10	Lampugh, S. A., Ltd.	14	Varley Magnet Co., Ltd.	22
Dixon, Leslie & Co.	5	Lissen, Ltd.	6	Watmel Wireless Co., Ltd., The	22
Dubilier Condenser Co. (1925), Ltd.	3	London Elec. Wire Co. & Smiths, Ltd.	6	Webber, N. V., & Co., Ltd.	20
Edison Swan Electric Co., Ltd.	7	Lyons, Claude	1	Wilkins & Wright, Ltd.	20
Electron Co., Ltd.	7	Marconiphone Co., Ltd., The	17	Withers, J. S., & Spooner	19
Encore Manf. Co.	19	Metro-Viek Supplies, Ltd.	17	Wootton, F. E., Ltd.	19

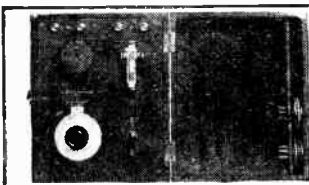

Heterodyne Wave Meter.

— EXPERIMENTAL APPARATUS —
Complete Transmitting Sets.

Broadcast.
Coil Formers
Short Wave
Panels
Engraved



Vale Road, Otlands Park, Weybridge
Wey. 831.

Receiving Sets
Low Loss Coils.
Receivers.
Condensers of
all Kinds, etc.

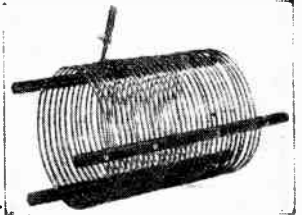

HANDBOOKS!

Published from the offices of
"THE WIRELESS WORLD"

There are handbooks for every phase of wireless! Read them! You will find they will make your hobby more interesting and you will get better results from your set. The books published from the offices of "The Wireless World" are written by

ILIFFE & SONS LTD., Dorset House, Tudor Street, London, E.C.4.

men with years of wireless experience to their credit. Send for a complete list to-day. It includes books for the home constructor, the enthusiastic amateur and the research worker—make your choice among them!

W.W.23

The Wireless World COUPON for "HIDDEN ADVT." COMPETITION

This coupon is available until Monday, 10 a.m., Feb. 22nd, 1926

Clue No.	Name of Advertiser.	Page
1		
2		
3		
4		
5		
6		

I enter the above solution subject to the published rules.

Name
(Please write clearly)

Address
17/2/26

Scrap your H.T. Batteries!!



Use your Electric Lighting Mains!—
With the "DYNIC" D.C. REGULATOR

It plugs into any convenient lamp socket and provides a smooth H.T. supply, in 5 voltages, from any D.C. mains above 100.
Type N.—For General Use Price, £3 0 0
Type N.—Uses the Mains as Aerial and Earth in addition to H.T. Price, £3 10 0
Type G.—Provides 6 tappings to negative Grid Mains in addition to H.T. Price, £4 0 0
Type GN.—Combines N. and G. Price, £4 10 0
All Models in De Luxe finish to instructions Postage 1/- at £1 extra.

Send for Folder and state your Mains Voltage.
JONES & STEWART
59, Robertson Street, GLASGOW, C.2.
Telegrams: "Gadget," Glasgow. Phone: Central 4392.
Please mention this Journal.

The "GRIPPLESHELL"

Registered design No. 719927.

A device for simplifying Aerial Erection

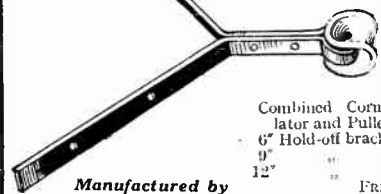

These brackets are made from 1" best quality Wrought Iron painted with weather-proof enamel.

PRICES

Combined Corner bracket, Insulator and Pulley	3/6
6" Hold-off bracket	3/-
9" "	3/-
12" "	3/6

Manufactured by

FREE ON RAIL.

PARTRIDGE & WILSON, ELECTRICAL ENGINEERS,
217a, Loughborough Road, LEICESTER.
Telephone 5812.

WIRELESS VALVE RECEIVERS & CIRCUITS IN PRINCIPLE AND PRACTICE

By R. D. BANGAY & N. ASHBRIDGE, B.Sc.

THIS BOOK will add to the pleasure of the amateur wireless experimenter by extending his theoretical knowledge of the whys and wherefores of valve receivers.

The subject is treated from a standpoint that will enable the home constructor to understand the working of any circuit which he may evolve, and he thus becomes independent of published diagrams and specifications. The volume is well illustrated.

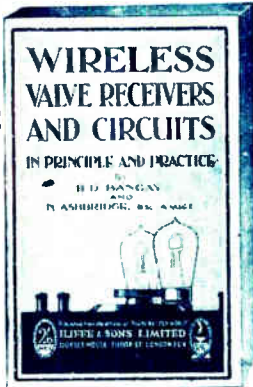

PRICE net **2/6**
By Post 2/10

Obtainable from all leading booksellers, or direct from the publishers:

ILIFFE & SONS LTD., Dorset House, Tudor St., London, E.C.4

W.W.40.

ELECTRONS ELECTRIC WAVES AND WIRELESS TELEPHONY

By Dr. J. A. Fleming, F.R.S.

A course of popular lectures delivered by the author at the Royal Institute of Great Britain forms the basis of this work. By means of simple analogies, Dr. Fleming paves the way to a discussion of the elements of electromagnetism and an explanation of the scientific laws upon which wireless telephony depends.

The whole book is written in a singularly clear and fascinating manner, and all who are anxious to understand wireless cannot do better than read Dr. Fleming's able work. It is an excellent starting point for further studies.

PRICE **7/6** NET
Post Free 8/-

Obtainable from all leading booksellers or direct from the publishers:

ILIFFE & SONS LIMITED
Dorset House, Tudor St., London, E.C.4

W.W.41.

A Guide to WIRELESS LITERATURE

This booklet, describing all books published in conjunction with "The Wireless World," including some other volumes by Dr. Fleming, will be sent FREE on REQUEST.

A Service that gives Security!

MANY readers naturally hesitate to send money to unknown persons. We have therefore adopted a Deposit System which gives complete security both to buyer and seller.

If the money be deposited with "The Wireless World" both parties are advised of its receipt. The time allowed for decision is three days, after which time, if the buyer decides not to retain the goods, they must be returned to the sender. If

a sale is effected we remit the amount to the seller; but, if not, we return it to the depositor.

Full particulars may be found on the Miscellaneous advertisement page at the end of the book.

Use this service for your wireless requirements and avoid all risk! Sell the apparatus you no longer require! Write out your advertisement to-day and send to—

PREPAID ADVT. DEPT., "THE WIRELESS WORLD," DORSET HOUSE, TUDOR ST., LONDON, E.C.4.

Please use this FORM

12 Words or Less **3/-**

each additional word **3d.**

Advertiser's name and address must be counted. If a box number is required, 6d. extra must be sent for postage on replies.

W.W.30

Advertisements for "The Wireless World" are only accepted from firms we believe to be thoroughly reliable.

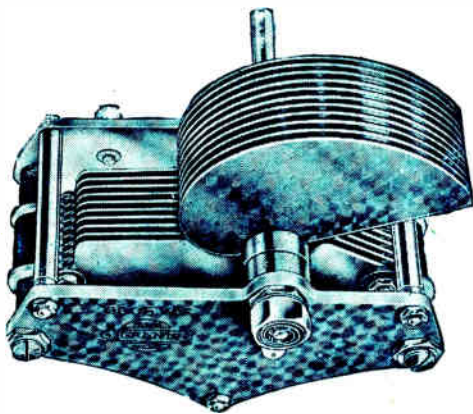

IGRANIC LOW LOSS SQUARE LAW VARIABLE CONDENSER.

(Pat. No. 220312).

Made in four sizes:—

·00015 mfd.	19/6
·0003 mfd.	21/-
·0005 mfd.	24/-
·001 mfd.	27/6

Send us your name and address so that we may send you our list No. U158 containing further particulars of Igranich Condensers and other radio devices.



Exclusive manufacturing Licensees of PACENT Radio Essentials.

149, Queen Victoria Street, London.
Works: Bedford.

Branches:—BIRMINGHAM: 73-74, Exchange Buildings. BRISTOL: British Dominions House, Tramways Centre. CARDIFF: Western Mail Chambers. GLASGOW: 50, Wellington St. LEEDS: Standard Buildings, City Square. MANCHESTER: 30, Cross St. NEWCASTLE: 90, Pilgrim St.

The test of short Wavelengths

Look through the technical journals and you will notice that most of the short wavelength and DX receivers contain Igranich Low Loss Square Law Variable Condensers.

The designers of the receivers availed themselves of the most efficient condenser made; you have only to examine an Igranich Variable Condenser to understand why it is chosen by experts for receivers which must possess the utmost efficiency.

Heavy gauge brass plates which will not warp; robust framework of specially hardened aluminium alloy; continuous electrical connection from the moving plates; accurate square law characteristics; the small amount of high grade insulating material and the earthed rotor all contribute to the high efficiency of the Igranich Variable Condenser.

The ball bearings give a silky movement which permits of the delicacy of adjustment so necessary for short wave and DX reception.

You cannot fail to appreciate the perfection of construction which gives the Igranich Variable Condenser the strength and durability of expensive machinery combined with the precision of a delicate scientific instrument.

The IGRANIC Instructional Carton

contains a comprehensive, fully illustrated descriptive handbook, full-size general arrangement drawings, wiring diagrams and drilling template for constructing a six-valve Supersonic Heterodyne Receiver according to the Igranich design. Obtain a copy from your dealer. PRICE 2/6.



Printed for the Publishers, JIFFE & SONS LTD., Dorset House, Tudor Street, London, E.C.4, by The Cornwall Press Ltd., Paris Garden, Stamford Street, London, S.E.1.

Colonial and Foreign Agents:
 UNITED STATES—The International News Co., 83-85, Duane Street, New York. FRANCE—W. H. Smith & Son, 248, Rue Rivoli, Paris; Hachette et Cie, Rue Réaumur, Paris.
 BRISLOUM—W. H. Smith & Son, 78, Marche aux Herbes, Brussels. INDIA—A. H. Wheeler & Co., Bombay, Allahabad and Calcutta. SOUTH AFRICA—Central News Agency, Ltd.
 AUSTRALIA—Gordon & Gotch, Ltd., Melbourne (Victoria), Sydney (N.S.W.), Brisbane (Queensland), Adelaide (S.A.), Perth (W.A.) and Launceston (Tasmania).
 CANADA—The American News Co., Ltd., Toronto, Winnipeg, Vancouver, Montreal, Ottawa, St. John, Halifax, Hamilton; Gordon & Gotch, Ltd., Toronto; Imperial News Co., Toronto, Montreal, Winnipeg, Vancouver, Victoria. NEW ZEALAND—Gordon & Gotch Ltd., Wellington, Auckland (Christchurch and Dunedin).

4^D

The Wireless World

The Paper for Every Wireless Amateur

Wednesday, February 24th, 1926.

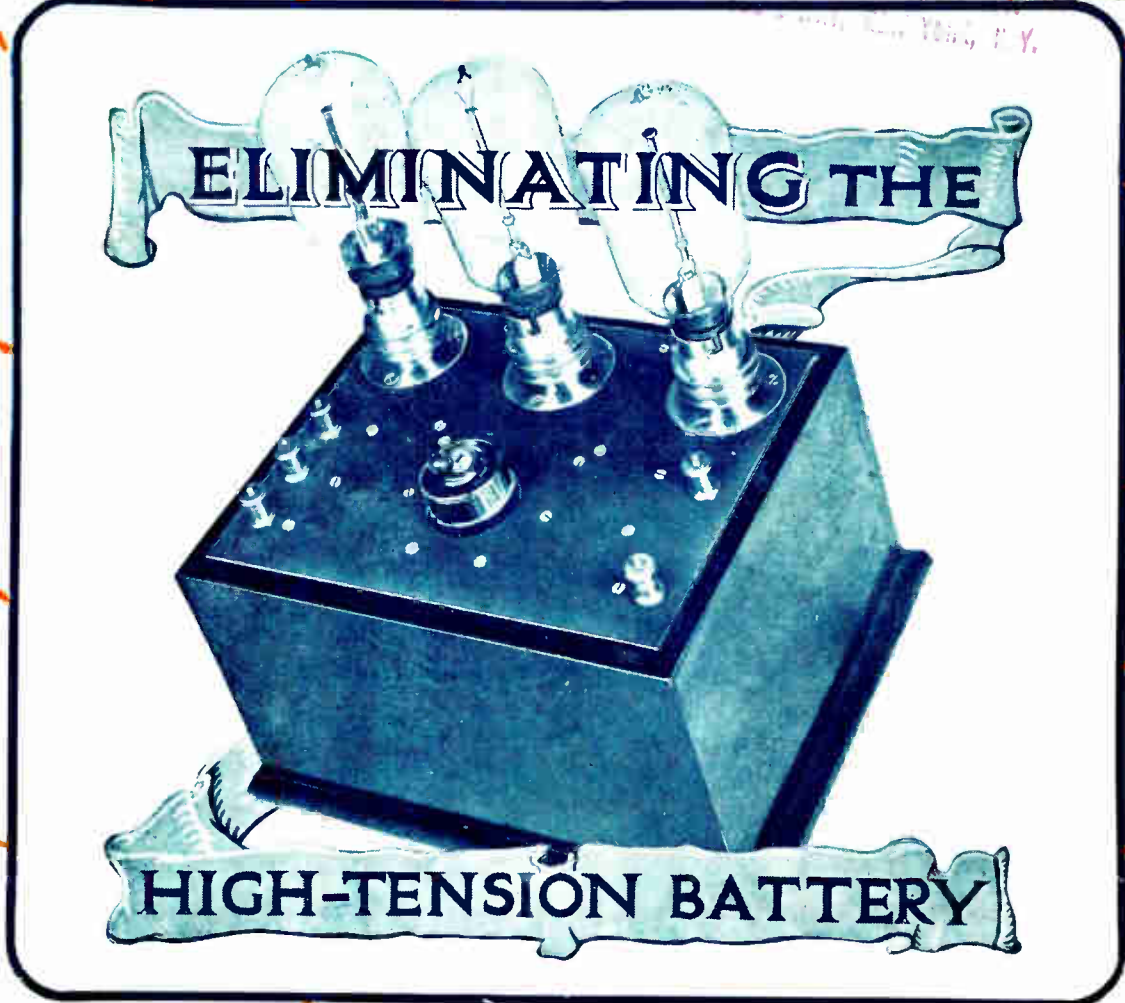

Every Part an Exclusive Feature

The exclusive features here described are incorporated in all "Dragon" AMPLIONS, "Senior" and "Junior" alike.

Equally important and exclusive features are present in the "RADIO-LUX" AMPLION, £4.15.0 to £13.13.0, and the "Swan-neck" AMPLION, 38/- to £5.10.0.

The sound conduit is provided with a rubber bush at each end to ensure freedom from objectionable resonance. That at the wide end is threaded to receive the trumpet.

Contour of the sound conduit gives a duct of considerable length without unduly increasing the overall dimensions, and the sweeping curve allows an unobstructed path for the sound waves.

The conduit is hinged to the weighted electro-plated base, giving stability and freedom of movement, in order that the horn may be tilted to suit the acoustics of any apartment.

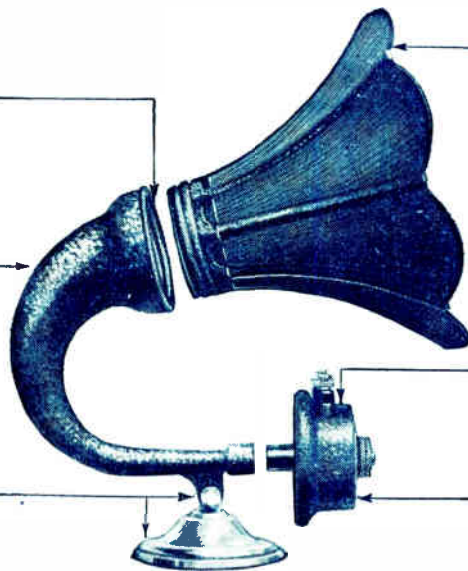

Bell-mouth trumpet of polished oak or mahogany, furnished with threaded metal termination, which screws into a rubber bush in the sound conduit. Complete insulation from the sound conduit is thereby effected.

Improved Loud Speaker Unit incorporating a "floating" diaphragm. It is completely "insulated" from the sound conduit.

Name plate with Type and Serial numbers thereon by which the House of Graham unconditionally guarantees complete satisfaction to any purchaser.

These are some of the points which make the

AMPLION

The World's Standard Wireless Loud Speaker

Obtainable from AMPLION STOCKISTS, Radio Dealers or Stores.

Demonstrations gladly given during business hours at the AMPLION Showrooms:

25-26, Savile Row, London, W.1.
79-82, High St., Clapham, S.W.4.
10, Whitworth St. West, Manchester.
101, St. Vincent Street, Glasgow.

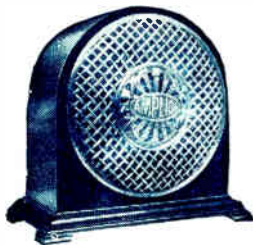

Radiolux Style
Type R.S.10
£7.7.0

Announcement of ALFRED GRAHAM & CO. (E. A. Graham), Crofton Park, S.E.4.

Mention of "The Wireless World," when writing to advertisers, will ensure prompt attention.

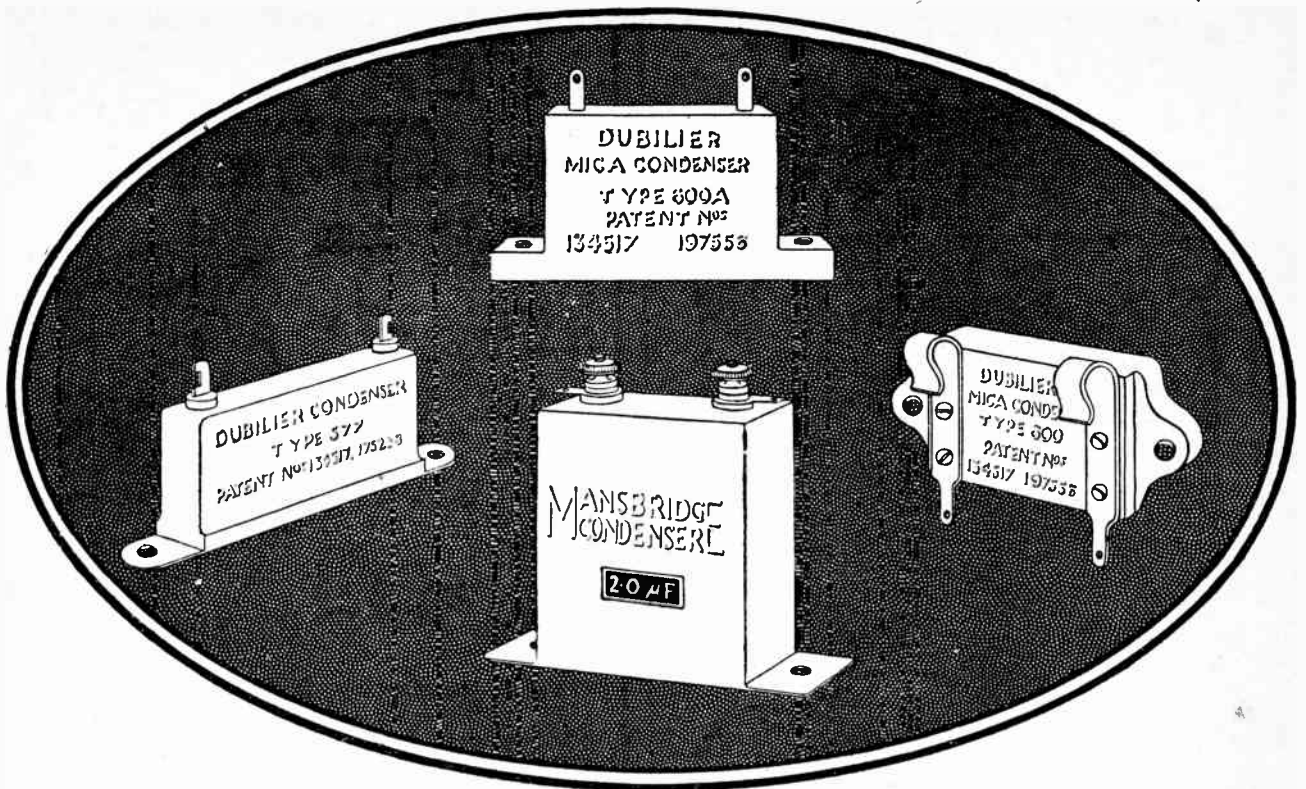

Condensers

For whatever purpose you may require a condenser, Dubilier make it. Type 577, for example, is suitable for all receiving sets, and also for low power transmission. 0.0001 μ F to 0.01 μ F - - - - 7/6

Types 600 and 600A are for general use in radio reception. Absolutely reliable and of guaranteed accuracy, they can be obtained in capacities from 0.0001 μ F to 0.006 μ F - - - - Prices, 2/6 and 3/-.

The Mansbridge Condenser, manufactured by the Mansbridge Condenser Co., Ltd., is made in capacities from 0.02 μ F to 2.0 μ F, at prices from 2/6 to 5/-. It is a genuine Mansbridge as originally designed by Mr. G. F. Mansbridge, and is the only condenser of its type that carries the Dubilier guarantee.

For condensers of all types always

Specify Dubilier



ADVERT. OF THE DUBILIER CONDENSER CO. (1925) LTD., DUCON WORKS, VICTORIA ROAD, NORTH ACTON, LONDON, W.3.

R.P.S. 775
TELEPHONE: CHISWICK 2241-2-3

Utility GUARANTEED COMPONENTS

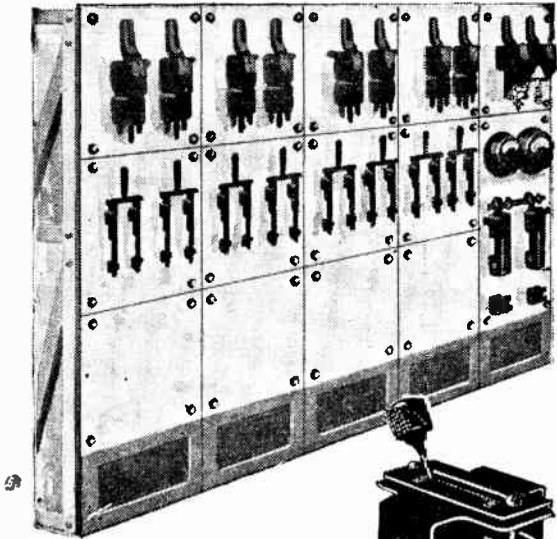

Switches

The familiar Utility switches which figure in most British wireless sets have one great point in common with the Power Station switches controlling the lighting and tramways of our cities—they are designed by electrical engineers specially for the work they have to do.

Utility switches can be supplied with either knob or lever control and with 1, 2, 3, 4, 5, or 6 poles, at prices between 3/6 and 10/6, according to size, type and finish.

The contacts are of the rubbing type and are therefore self-cleaning.

Electrostatic capacity, one of the greatest sources of loss of signal strength, has been reduced to the absolute minimum, while the switches are extremely compact.

The knob control type has one-hole fixing, and the lever type has been introduced for those who prefer this method of control.

Furthermore, they are all completely guaranteed and will be replaced if they fail to give entire satisfaction.

Obtainable of all good dealers.

WILKINS & WRIGHT, Ltd.
Utility Works, Kenyon Street, Birmingham
E.P.S. 32

READ WHAT IS SAID BY DELIGHTED USERS OF

FERRANTI INTERVALVE TRANSFORMERS

"... There is no doubt your AF3 is far ahead of any other at the present time..."

"... the deep notes and the roll of drums are splendidly reproduced..."

"... have yet to find a Transformer which will equal the 'almost perfect' results which yours gives."

"... am so pleased with the great increase in volume and the perfect purity of reproduction that I have decided to scrap all my other transformers and replace throughout with Ferranti AF3's."



25/-

ASK YOUR DEALER FOR FERRANTI AF3
"The nearly perfect Transformer."

FERRANTI LIMITED HOLLINWOOD LANCASHIRE.

CAXTON 4-VALVE CABINET

Made for Editor of Wireless Magazine for Set "As good as money can buy" described in issue February, 1925.

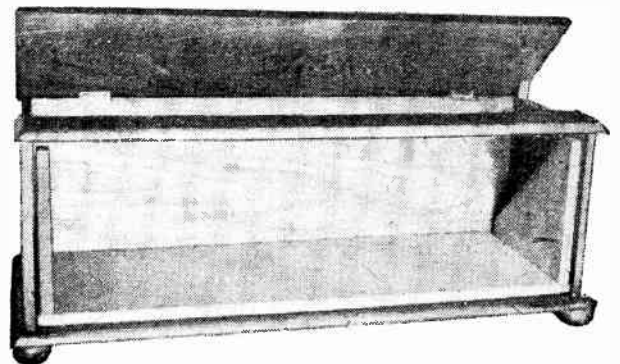

Cash with Order. Fumed Oak ... £1 5 0
or Real Mahogany polished ... £1 14 0

With detachable recess fitted Base Board to mount 21 in. by 7 in. panel to slide out of Cabinet front.
Extra 10/- with two beaded front doors totally enclosing fitted panel.
Cabinet overall length 22½ ins. Width 8½ ins. Height 9 ins.

Polished with the new enamel that gives a glass hard surface that cannot be soiled or scratched.

SENT FREE.—Catalogue of standard Wireless Cabinets in various sizes and woods. Special Cabinets made to customer's orders.

PACKED AND DELIVERED FREE IN U.K.

CAXTON WOOD TURNERY CO., Market Harborough

EDISWAN VALVES ARE ENTIRELY BRITISH MADE

THE PERFECT PAIR—

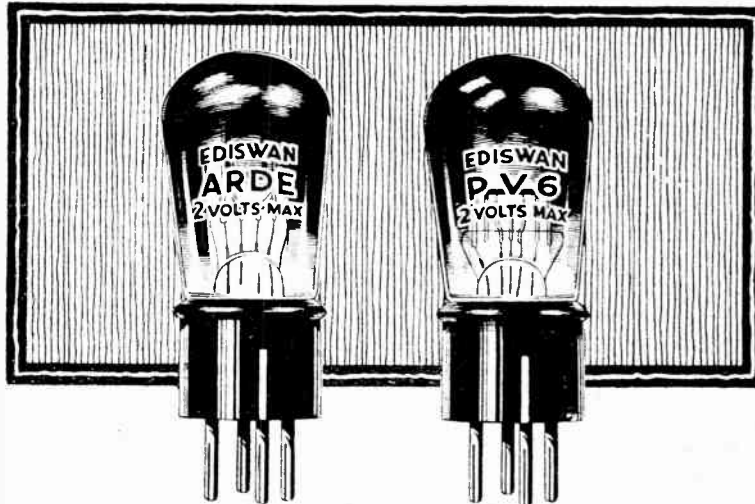

Use them *together*. It is the only way to get the real Edison quality of reproduction. Individually, Edison Valves are always better—very robust; very long in life; very reliable in service. But it is in co-operation that Edison Valves give the most remarkable results—you can test this on your own set.

Ediswan A.R.D.E. is made to function either as a H.F. amplifier or detector (red line) or as a L.F. amplifier (green line). Ediswan P.V.6 is specially designed for use when A.R.D.E. is used in the preliminary stages.

The following table indicates the combinations of Edison Valves that give the best results:—

Receiving.	Accumulator or Battery Volts.	Power.
AR	6	PV5
ARDE	2	PV6
AR'06	3	PV8

With these groups and Edison H.T. and L.T. Accumulators the ideal is attained

THE EDISON SWAN ELECTRIC CO., LTD.,
123-5, Queen Victoria Street, London, E.C.4.

EDISWAN VALVES

The PIONEER VALVE

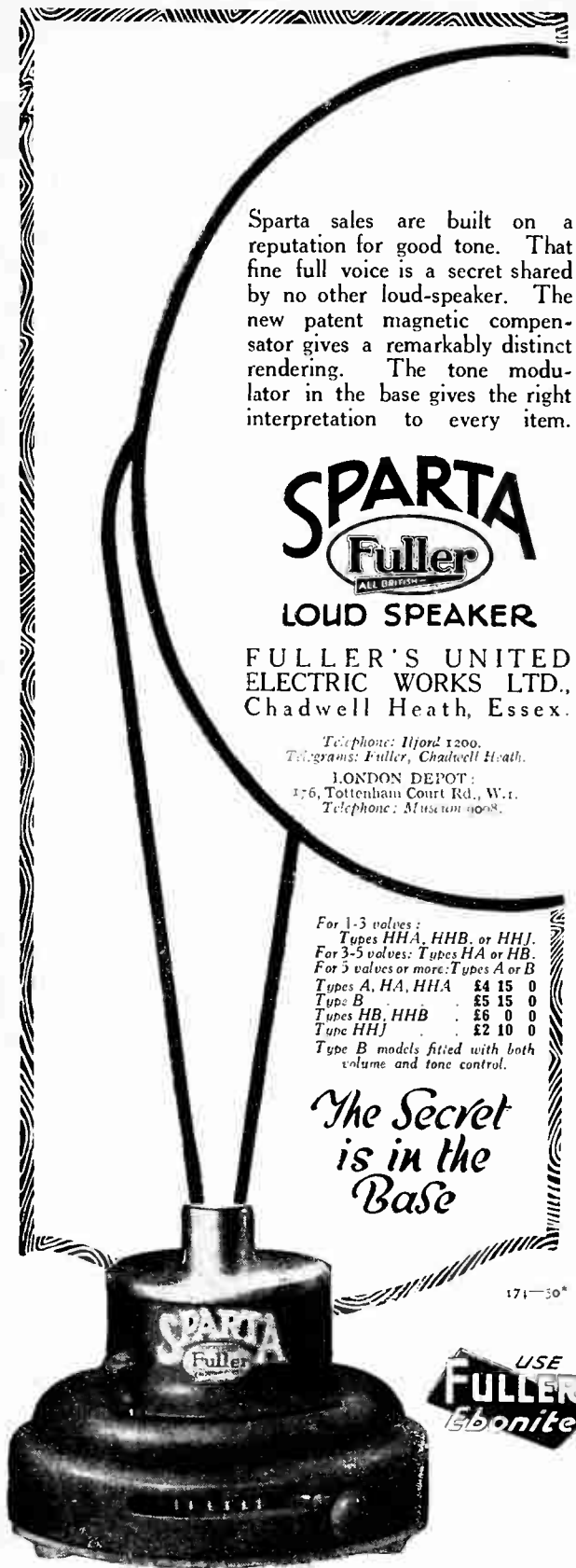

Sparta sales are built on a reputation for good tone. That fine full voice is a secret shared by no other loud-speaker. The new patent magnetic compensator gives a remarkably distinct rendering. The tone modulator in the base gives the right interpretation to every item.

SPARTA
Fuller
ALL BRITISH

LOUD SPEAKER

FULLER'S UNITED
ELECTRIC WORKS LTD.,
Chadwell Heath, Essex.

Telephone: Hford 1200.
Telegrams: Fuller, Chadwell Heath.

LONDON DEPOT:
176, Tottenham Court Rd., W.1.
Telephone: Museum 9008.

For 1-3 valves:
Types HHA, HHB, or HHJ.
For 3-5 valves: Types HA or HB.
For 5 valves or more: Types A or B

Types A, HA, HHA	£4 15 0
Type B	£5 15 0
Types HB, HHB	£6 0 0
Type HHJ	£2 10 0

Type B models fitted with both volume and tone control.

*The Secret
is in the
Base*

171-50*

USE
FULLER
Ebonite

The Radio EXPERIMENTER'S Handbook in two Volumes

By Philip R. Coursey, B.Sc., P.Inst.P.

The second edition of this popular handbook in two volumes, which deals with the theory and practice of modern wireless telegraphy, has been thoroughly revised and brought up to date.

Written by a wireless authority of wide experience, "The Radio Experimenter's Handbook" is the best and safest guide to all amateurs who wish to build sets which will fulfil their own particular requirements. These two volumes furnish all the information necessary to secure a successful result.

PART ONE deals with the general principles underlying the design of radio receiving equipment, and explains in clear and simple language the fundamental properties of the Aerial and the Aerial Circuit, Receiving Tuners, Receiving Amplifiers and Detectors, Heterodynes, etc., etc.

PART TWO is devoted to data and actual quantitative design, as well as to the description of many suitable high-frequency measurements which can readily be carried out by the experimenter. A few of the subjects discussed are the Measurements of High-Frequency Currents and Voltages, Fundamental Formulae and Data, Aerials and Tuning Circuits, Tuning Coils and Inductances, Condensers, Valves and their Constants, etc.

PRICE
3/6 per volume.
By post 3/10 each.

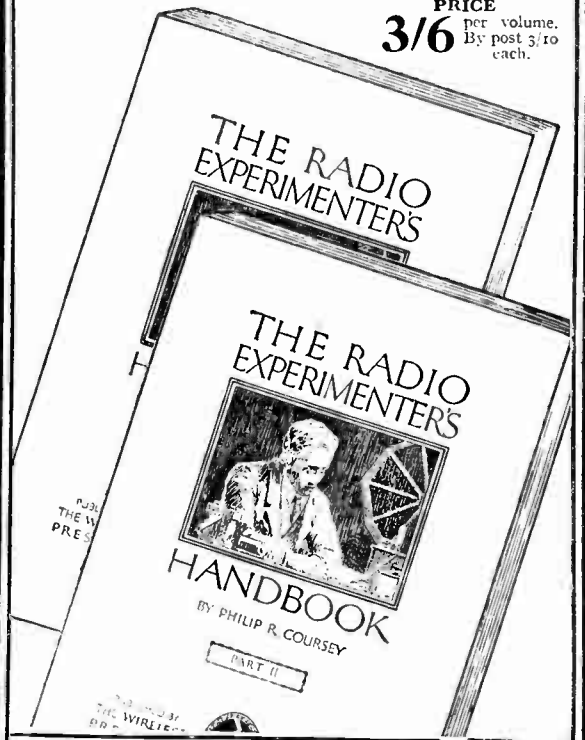

Obtainable from the publishers of "The Wireless World":
LILFFE & SONS LTD., Dorset House, Tudor St., London, E.C.4.

W.W.S.

PUT AN END TO BIG RE-CHARGING BILLS



USE the wonderful "N" filament valves and get SEVEN TIMES the life from your 4-volt accumulator charges.

Cut down the cost of upkeep and reduce recharging journeys to ONE-SEVENTH.

This unique "N" filament is so economical of heating power that NO SIGN OF GLOW can be discerned.

Ask for the P.M.3. . 16/6

A general purpose valve suitable for every circuit. Gives clear strong signals free from microphonic disturbances.

Ask for the P.M.4. . 22/6

A power valve for majestic loud speaker volume. The finest loud speaker valve ever produced.

These valves can also be run from 3 dry cells
**BETTER RESULTS WITHOUT
 ACCUMULATOR EXTRAVAGANCE**



Mullard

THE MASTER VALVE

ADVT. THE MULLARD WIRELESS SERVICE CO., LTD., BALHAM, LONDON, S.W.12



The Condenser for reflex circuits

In reflex circuits, more than in any other type of receiver, *accuracy* in the exact capacity of the fixed condensers used is essential for good results. Here is where Igranic-Freshman Condensers can help you. Designed upon an entirely new principle, the construction is such that variations in capacity are guaranteed within 5%. The plates are composed of highest quality brass, and the finest selected Ruby-Mica is used for the dielectric. The special method of assembly precludes the entrance of moisture and they will give the highest performance under all climatic and atmospheric conditions. The small space required, and ease of fixing, appeal to all radio enthusiasts.

Obtainable in the following capacities:—

·0001 mfd.,	·0003 mfd.,	·001 mfd.,	Price 2,- each.
·0002 mfd.,	·0005 mfd.,	·002 mfd.,	
·003 mfd.,	·005 mfd.,	·005 mfd.,	Price 2/6 each.

IGRANIC RADIO DEVICES include:

Honeycomb Duolateral Coils, Variable Condensers, Fixed Condensers, Filament Rheostats, Intervalve Transformers, Variable Grid-leaks, Variometers, Variocouplers, Coil Holders, Potentiometers, Combined Instruments, Vernier Tuning Devices, Anti-Microphonic Valve Holders, Switches, Stand-off Insulators, Knobs and Dials, etc., etc. Also the Supersonic-Heterodyne Receiver Outfit.

All carry the IGRANIC guarantee.

IGRANIC-PACENT RADIO ESSENTIALS include:

The Super "Audioformer," Porcelain and Bakelite Rheostats and Potentiometers, the True Straight-Line Frequency Variable Condenser, the elegant Microvorn Dial, The Balcon, the most complete line of Plugs, Jacks and Switches in the world, Jack Nameplates, The Radiofile, The Radiodye, etc.

Write for

List U 159.



Exclusive Manufacturing Licensees of PACENT Radio Essentials.

149, Queen Victoria Street, London.
Works: BEDFORD.

Branches:

BIRMINGHAM: 73-74, Exchange Bldgs.
BRISTOL: British Dominions House,
Tramways Centre.
CARDIFF: Western Mail Chambers.
GLASGOW: 50, Wellington Street.
LEEDS: Standard Buildings, City Sq.
MANCHESTER: 30, Cross Street.
NEWCASTLE: 90, Pilgrim Street.

SAVE 50%

by using a

MELLOWTONE COUPLER

—in place of COILS and HOLDERS!

PRICES
from
5/6

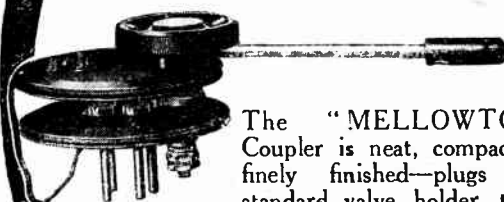

The "MELLOWTONE" Coupler is neat, compact and finely finished—plugs into standard valve holder, takes up small panel space and replaces coils and holders. It is designed to avoid distortion, giving excellent selectivity and perfectly smooth reaction control.

Obtainable at all dealers. Write for Illustrated List.



Britain's Best in Radio!

LAMPLUGH Anode Reaction UNIT

INTERCHANGEABLE ANODE COIL

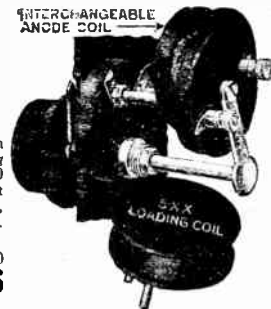

Constructed for reception of all stations operating on wavelengths from 300 to 2,000 metres without extras. Increased range, volume, and selectivity.

No. 1070-300 to 2,000 metres.
Price complete 12/6

POTENTIOMETER Micrometer Control

Unique in design and occupying little panel space, strongly built, and permits of very fine adjustment. Is also supplied as Filament Resistances, and highly recommended for Detector Control.

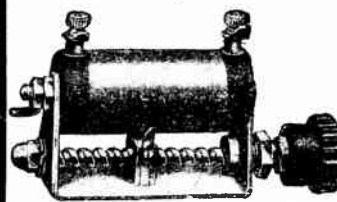

No. 1049. 400 OHMS 4/6.

2

FINE COMPONENTS

This mark is our guarantee.



S. A. LAMPLUGH, Ltd.
King's Road, Tyseley,
BIRMINGHAM.

If your dealer cannot supply—we can.

Figures to Remember



CHARLEY'S AUNT

The remembrance of sheer enjoyment. Sheer enjoyment for the wireless enthusiast is born of perfect reception. You can be sure of perfect reception and know that each and every evening will be full of real pleasure if you use Six Sixty Valves.

Our new range embodying the latest improvements of modern research marks a real advance in scientific Valve design. We have studied the needs of every section of the Radio Public, and the most exacting wireless enthusiast can get a Six Sixty Valve to suit his own special requirements.

Here's one particular type—the S.S.7, a wonderful Dull Emitter Power Amplifier capable of handling output to work the largest Loud Speaker without distortion.

The design of this Valve is such that prolific emission is obtained at temperatures so low that the filament does not glow when operating under its rated conditions. Consider for a moment what this means. The destroying influence of high temperature and the alternate expansion and contraction of the filament is almost eliminated, with the result that the life of the valve is proportionately increased. Remember, too, this valve is entirely non-microphonic, and owing to the low filament current consumption can be satisfactorily operated from dry cells or 4-volt accumulator.

For long life, good service and Perfect Tone insist on 660 Valves.



S.S.7.

Voltage 37 volts.
Consumption 1 amp.
PRICE 22/6.

Ask your Dealer for Leaflet S.S.1.7 for full particulars of complete range.



BETTER BY SIX TIMES SIXTY

The Electron Co., Ltd., Triumph House, 189, Regent St., London, W.1.

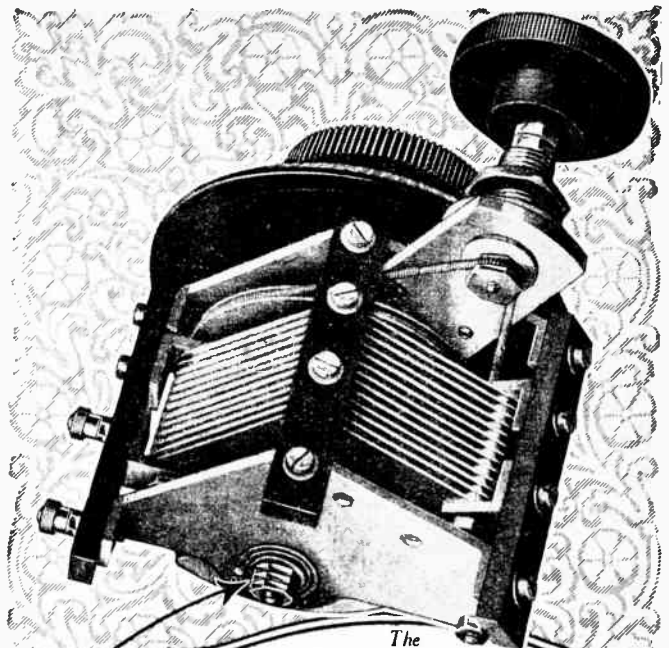

The "COSMOS" SLOW MOTION CONDENSER

COMPENSATED SQUARE LAW EFFECT

LOW LOSS

NO BACK LASH

with its ratio of 10 to 1 makes it possible to dispense entirely with the customary vernier and its attendant losses. Backlash is avoided not temporarily but permanently and movement is smooth, permitting fine adjustment. This model can also be arranged for remote control, as shown in the illustration below. Also supplied without slow motion feature when the condenser is one-hole fixed. Both models are constructed to eliminate hand capacity, for low loss and to give a compensated square law effect. Cone bearings of hardened steel ensure constant calibration and a pigtail connection gives permanent positive contact.

Metro-Vick Supplies Ltd.
4, Central Buildings, S.W.1

Prices:
Ordinary. Slow Motion.
00025 mfd. 0005 mfd. 00025 mfd. 0005 mfd.
15/- 17/6 19/- 21/6

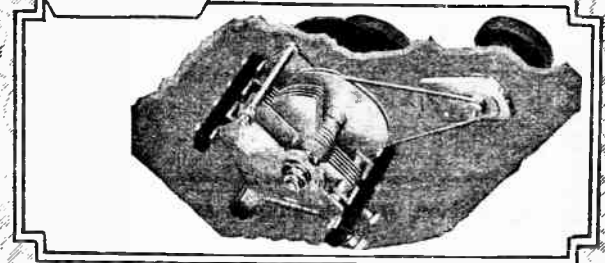
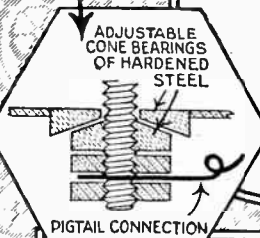

COSMOS

THE CHOICE OF  RADIO EXPERTS

AMERICA'S LEADING TRANSFORMERS



Type 285.
Ratio 1-6.
For First Stage.



Type 285L.
Ratio 1-2.
For Second Stage.

A real advance in L.F. Transformer design particularly suitable for Loud Speaker work where utmost tonal purity is desired. Designed in such a way as to improve the upper and lower ends of the amplification curve. For most uses a single stage of amplification using the 1 to 6 ratio transformer is satisfactory. For additional amplification the 1 to 2 Transformer is recommended, and gives amazing volume and purity of tone. *Send for special booklet, post free.*

Type 285. Ratio 1-6 **24/6**
" 285L. " 1-2 **24/6**

Type 285A.
A splendid L.F. Transformer of good Tone quality at a moderate price. No resonance point within the audio range. Ratio 1 to 1. Suitable for all stages of multi-stage amplification.
PRICE 18/6 Each.

Sole Concessionaire for Great Britain:—
Radio Specialist. CLAUDE LYONS Est. 1918.
78, Old Hall St., LIVERPOOL
Phone: Central 4641. Telegrams: "Minnetken, Liverpool."

GENERAL RADIO CO.
OF
AMERICA

"It's contact that counts!"
says **CLIXIE**



"CLIXIE"

Retail Prices:

- CLIX with Locknut, 3d.
- CLIX Adapter with Locknut, 2d.
- CLIX Insulators (6 colours), 1d. each.
- CLIX Bushes (6 colours), 1d. pair.
- CLIX Twin Plug, complete, 1/-

"A radio circuit is as efficient as its weakest connection," says CLIXIE. "So, when you suspect faults in your wiring, look to your connections first.

"Two-point' contact—and 'touching' contact at that—is perhaps the commonest form of weakness. It's the outstanding attribute of those ingenious silly little wiring gadgets to which the sanest of us occasionally falls victim. And it simply won't do.

"Nothing will do short of full surface contact, constantly maintained. And that's why nothing will do but the plugsocket CLIX.

"The ingenious design of CLIX provides a large area of contact surface with the minimum of capacitive metal in both plug and socket. Hence the CLIX supremacy over every other form of plug, switch or terminal."

Are you well connected? Try

CLIX

The Electro-Link with 159 Uses

AUTOVEYORS LTD., 84 VICTORIA ST., LONDON, S.W.1

The Wireless World **COUPON**
and **Radio Review** *for*
World

"HIDDEN ADVT." COMPETITION

This coupon is available until Monday, 10 a.m., March 1st, 1926

Clue No.	Name of Advertiser.	Page
1		
2		
3		
4		
5		
6		

I enter the above solution subject to the published rules.

Name _____
(Please write clearly)

Address _____
24/2/26

The Wonderfully Efficient Reactone Low-Loss Coils.

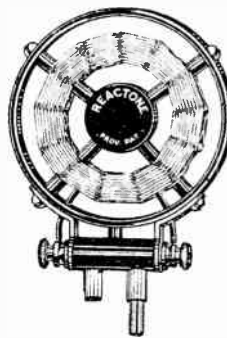

Wound with double silk-covered wire, under constant tension, on the same principle as the Standard Reactone Coil. Mounted in a low-loss frame, giving absolute rigidity—no shellac, tape, wax, or fibre.

No.	Price.	No.	Price.
25	3/9	75	4/9
30	4/-	100	5/9
35	4/3	150	6/9
40	4/3	200	7/6
50	4/3	250	8/-

Reactone
PROV. PATENT
Low Loss Coil

All good Radio Dealers sell Reactone Low-Loss Coils, and also the Standard Reactone Coils. In case of difficulty, write to the manufacturers:—

Reactone Ltd., 88-89, Chancery Lane, LONDON, W.C.



Take the SHORTPATH to Better Reception

"COSMOS" S.P.18 Valves, by reason of the unique construction of their electrodes whereby the path—filament—grid—anode is reduced to an absolute minimum, provide a—
SHORTPATH to: **MORE POWER FAITHFUL REPRODUCTION GREATER ECONOMY**

Obtainable from most Wireless Dealers.

METRO-VICK SUPPLIES, LTD.,
 (Proprietors—Metro-Vitan Vickers Elec. Co., Ltd.)
 4, Central Buildings, Westminster, London, S.W.1.

S.P.18 Valves consume 0.3 Amp. at from 1.6 to 1.8 volts. and require only a single-cell 2-volt ACCUMULATOR.

Made in Two forms—

Green Spot } **12/6**
 Red Spot }

Get a copy of "A Talk to Valve Users."

Cosmos

RADIO VALVES

EDDYSTONE RADIO PRODUCTS

The SHINING LIGHT of the WIRELESS WORLD.

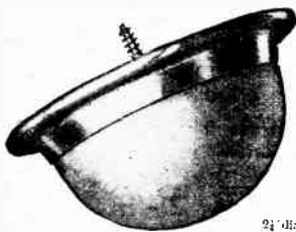

"ABSORBOS"

The IDEAL Radio set mount

They take up all outside shock, thus giving longer life to the valves. Prevent microphonic noises and in addition they add an elegant touch to the cabinet. They prevent marking or scratching any polished surface the set may be placed upon.

PRICES:—

2 1/2" diam.—nickel finish—for heavy cabinets, 3/6 per set of four. 2" diam.—untarnishable gold finish, 3/6 per set of four.

EDDYSTONE SHORT WAVE COILS

THESE coils are ideal for short wave reception, there being no unwanted insulation to cause losses, while the self capacity of the coil is very low. Adaptable for ordinary sets.

PRICE: 10/6 per set of Three.



- No. 9—25.80 metres.
- No. 12—50.110 "
- No. 15—80.150 "

Send for our latest catalogue of "EDDYSTONE" radio products.

Obtainable from all high-class dealers. If any difficulty write direct to Manufacturers:—
STRATTON & CO., Ltd., Bromsgrove Street, BIRMINGHAM.

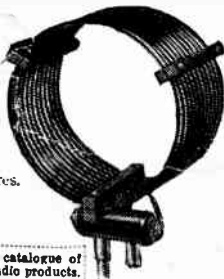

An irresistible combination



The REFLEX Coil and The REFLEX Coil Plug mounted!

The coil is scientifically wound with correctly proportioned air spaces. No capacity causing fittings whatsoever. The coil plug is moulded in Bakelite. Skeleton design reduces losses to practically nil. A highly efficient product at a remarkably low price. Get one for your set to-day.

From all good dealers.

- | | | | |
|-------------|-------------|-------------|---------------|
| No. 25—2/8 | No. 75—3/0 | No. 250—5/3 | No. 1000—10/0 |
| No. 30—2/8 | No. 100—3/2 | No. 300—6/2 | No. 1250—11/0 |
| No. 35—2/9 | No. 125—3/6 | No. 400—7/0 | No. 1500—12/0 |
| No. 40—2/9 | No. 150—3/8 | No. 500—7/6 | |
| No. 50—2/10 | No. 175—4/3 | No. 600—8/0 | 5XX Lead- |
| No. 60—2/11 | No. 200—4/9 | No. 750—9/0 | ing Coil 3/6 |

REFLEX COIL PLUG.
 Neat, highly finished.
 Very efficient.
 Low priced.
 1/- each.

REFLEX RADIO CO. LTD
 198, Lower Clapton Road, London, E.5.
 Phone: Clissold 4652.

REFLEX Unmounted COILS.

The only successful self-supporting coils made. From No. 25 at 9d. to No. 1500 at 10/-

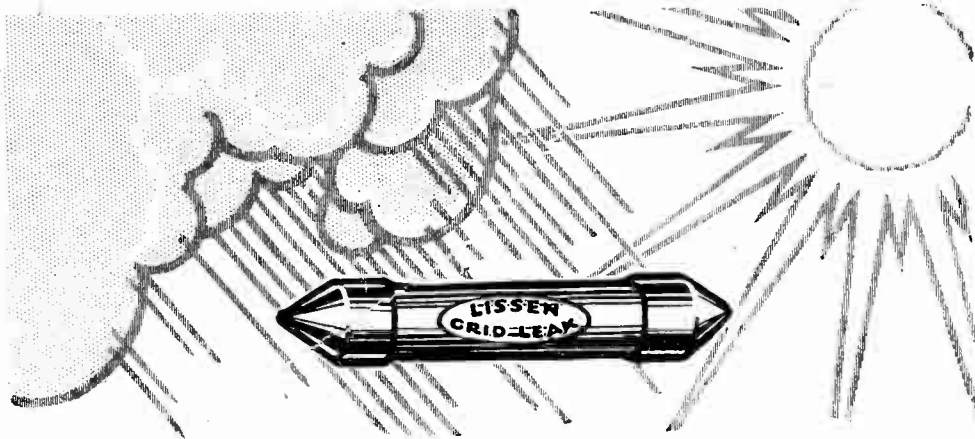

10 Days in Sun and Rain did not alter its resistance

Last Summer, when it rained in London for five days without stopping, an uncovered case of Lissen Fixed Grid Leaks was left the whole time upon the roof of our factory. When the rain stopped the case was left exposed to the sun through a heat-wave. Then it was handed over to our research department who carefully tested the contents. *In every Grid Leak the resistance was found unvaried, and true to its marked value.*

This points an obvious moral—fit Lissen Fixed Grid Leaks and be sure of your circuit. Their unalterable resistance goes a very long way towards making a circuit *silent*. Price 1 8.

In certain critical circuits a *variable* grid leak is necessary. With a "Lissen" you can obtain any resistance between $\frac{1}{4}$ and 15 megohms, smoothly, gradually and *noiselessly*. When using a Choke Coupled Amplifier it is always advisable to use the Lissen **Variable Grid Leak**. One hole fixing, of course. Price 2 6.



It is also well worth while to fit Lissen **Fixed Condensers**. Accurate to within 5% of their marked capacities, they will not vary and will not leak. Whatever the temperature behind your panel may be, the capacity of a Lissen Fixed Condenser always remains constant. Fit Lissen and make sure of trouble-free condensers.

NOTE THE NEW PRICES
 '0001—'001 ... 1/3 '002—'006 ... 2/-
 Mica dielectric.
 (With each '0002 and '0003 there is included free a pair of clips to take a grid leak.)

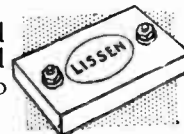

LISSEN

THERE IS NO 'WEAKEST LINK' IN THE LISSEN CHAIN

Lissen Limited, 21-25, Friars Lane, Richmond, Surrey

'Phone: Richmond 2285 (4 lines).

Grams: "Lissenium, Phone, London."

The Wireless World

AND
RADIO REVIEW
(13th Year of Publication)

No. 341.

WEDNESDAY, FEBRUARY, 24TH, 1926.

VOL. XVIII. No. 8.

Assistant Editor:
F. H. HAYNES.

Editor:
HUGH S. POCOCK.

Assistant Editor:
W. JAMES.

Editorial Offices: 139-40, FLEET STREET, LONDON, E.C.4

Telephone: City 4011 (3 lines).

Advertising and Publishing Offices: DORSET HOUSE, TUDOR STREET, LONDON, E.C.4.

Telephone: City 2847 (13 lines).

Telegrams: "Ethaworld, Fleet, London."

COVENTRY: Hertford Street.

BIRMINGHAM: Guildhall Buildings, Navigation Street.

MANCHESTER: 199, Deansgate.

Telegrams: "Cyclist Coventry."
Telephone: 10 Coventry.

Telegrams: "Autopress, Birmingham."
Telephone: 2970 and 2971 Midland.

Telegrams: "Hilite, Manchester."
Telephone: 8970 and 8971 City.

Subscription Rates: Home, £1 1s. 8d.; Canada, £1 1s. 8d.; other countries abroad, £1 3s. 10d. per annum.

As many of the circuits and apparatus described in these pages are covered by patents, readers are advised, before making use of them, to satisfy themselves that they would not be infringing patents.

THE PROPOSED HIGH-POWER STATIONS.

IT seems clearly evident now that the B.B.C. is directing its attention towards the establishment of a limited number of high-power stations, with which it is hoped it will be possible to serve this country adequately with broadcasting, thereby paving the way for the elimination of many of the existing smaller stations, and, incidentally, helping to reduce mutual interference in Europe and giving listeners a better choice of programmes. Any effort which the B.B.C. can make towards achieving the desirable goal of alternative programmes for every listener is very much to be commended, but there are points which occur to us as being of paramount importance if this policy is to be proceeded with on lines to give general satisfaction.

In our opinion, the most important question of all in this connection is the location of the proposed high-power stations. We are most strongly of the opinion that as far as possible these stations should be located in the more sparsely populated areas, and that they should most certainly not be placed in the immediate vicinity of large towns. An increase in power of any of the stations at present located in the larger towns would result in adding to the difficulties of reception of alternative programmes for listeners in the neighbourhood of the stations. We recognise that it is highly desirable that the studios should be located in the larger towns because of the advantages thereby gained in facilitating the organisation of programmes and the

attendance of those taking part in them at the studio. But there seems to be no reason whatever why, with the present stage of development of broadcasting, the studios should not be linked up with the transmitters, the latter being located at some considerable distance. No doubt the B.B.C. will give careful consideration to

this point, but it is well that they should realise, before proceeding too far with arrangements, how important a consideration this is to the vast majority of listeners whose sets are not adequately selective to ensure the elimination of the local station, more especially if the power of the local station is to be increased.

o o o o

B.B.C. FINANCE.

MR. REITH, the managing director of the B.B.C., in his evidence before the Broadcasting Committee recently, appealed for special consideration of the financial position of the Company. He pointed out that whereas in the early days of broadcasting it was understood that the proportion of the annual 10s. licence fee which should go to the B.B.C. was 7s. 6d., with the remaining 2s. 6d. to meet the expenses of the Post Office in-

curring in collecting the licence fees, the Post Office was now withholding a very much larger proportion of the receipts and limiting the B.B.C. expenditure to £500,000 yearly.

It is only natural that those who pay the 10s. licence for broadcasting should want to know exactly how the amount so derived is expended. Some months ago, in the issue of *The Wireless World* for November 25th,

CONTENTS.

	PAGE
EDITORIAL VIEWS	281
ELIMINATING THE H.T. BATTERY	283
By H. F. Smith.	
BERLIN'S NEW BROADCASTING STATION	286
WHAT CONSTITUTES INVENTION?	287
By Dr. J. A. Fleming.	
NOVELTIES FROM OUR READERS	290
LOW-LOSS COIL TESTS	291
CURRENT TOPICS	297
NEW APPARATUS	299
GENERATING ELECTRICAL OSCILLATIONS	300
VALVE-CRYSTAL REFLEX SET	301
By F. Gordon Cook.	
WIRELESS CIRCUITS IN THEORY AND PRACTICE	304
By S. O. Pearson.	
HINTS AND TIPS FOR NEW READERS	307
COMPLICATIONS OF CRYSTAL RECEPTION (Concluded)	309
By W. H. F. Griffiths.	
BROADCAST BRIEVITIES	313
PIONEERS OF WIRELESS. VIII.—	
JOSEPH HENRY	315
DICTIONARY OF TECHNICAL TERMS	317
LETTERS TO THE EDITOR	319
READERS' PROBLEMS	321

1925. we commented editorially on the very large sum which the Post Office was accumulating as a result of the introduction of broadcasting, and we stated then that it was in the interests of the public to know to what use this sum was being placed. More recently statements have been reported, which we can only imagine are unfounded, of a possible raid on the "surplus" funds arising out of the collection of broadcasting licences, with the intention of utilising this amount to assist the Treasury in general expenditure. Mr. Reith, in his evidence, claimed that additional revenue for the B.B.C. was essential before any active steps could be taken to improve the broadcast service and particularly the programmes; that, in fact, a stage had now been reached when, in order to keep within the sum which the Post Office had chosen to consider adequate, most careful attention had to be paid to general economy, and he thought that the public were entitled to see a bigger proportion of their annual licence fees devoted to the improvement of broadcasting.

Whilst we do not feel competent to discuss whether or not the present revenue of the B.B.C. is adequate to provide a satisfactory service, yet we are entirely with Mr. Reith in the view that the Post Office should not arbitrarily decide what proportion of the revenue from licences should be devoted to the interests of broadcasting. This is not a matter which should be left in the hands of the Post Office, but should be decided by some disinterested, and consequently more competent authority, and, in any case, the public will want to know exactly to what use any surplus revenue from their annual licence payments is put.

Our editorial comments in the issue of *The Wireless World* for November 25th, 1925, were written at a time when we had no information to indicate to us whether or not the revenue of the B.B.C. was considered adequate for their requirements, and we then proposed certain special uses to which the surplus might be put. In view of Mr. Reith's statement these suggestions require reconsideration, although we still hold very definitely to the view that whatever the allocation of the funds the public should be accurately informed as to their distribution.

o o o o

EARLY WORK OF PROF. A. S. POPOFF.

UNDER Correspondence in this issue there is published a letter from M. Victor Gabel which we regard as of considerable interest and importance, as it clears up a misunderstanding which had arisen regarding priority over the claims of Marconi and other inventors on the subject of the first demonstration of the application of wireless to communication utilising the Morse code.

A good deal of propaganda has been put out from Russia claiming for the late Prof. A. S. Popoff priority in the matter of demonstration of the application of wireless telegraphy, and it has been stated that Prof. Popoff transmitted the words "Heinrich Hertz" at a demonstration given before the Russian Physico-Chemical Society as early as May 7th, 1895. The letter published under Correspondence in this issue, which is supported by reliable first-hand evidence, corrects this statement, and

makes it clear that the transmission of Morse code, although given at a demonstration before the same society, did not take place until March 24th, 1896.

o o o o

THE SILENT TESTS.

THE B.B.C. has made the announcement that the success of the silent period tests of wavelength was even more successful than they had anticipated, and enabled them to ascertain that several foreign stations were heterodyning the British transmissions, whilst others were off their published wavelength. This test is all the more interesting, as it has been conducted just prior to a meeting which, we understand, will take place in Geneva shortly to discuss the question of European broadcast wavelengths.

We understand that, on the whole, the B.B.C. was very well satisfied with the attitude adopted by listeners-in closing down their sets during the silent period, but keen disappointment was felt that this observance of a silent period was not respected in all quarters.

o o o o

THE SHORT-WAVE CONTROVERSY.

THE correspondence between Senatore Marconi and Mr. L. B. Turner, which we reproduced from our contemporary, *The Electrician*, in the issue of *The Wireless World* for February 10th, opens up again an old wound which we thought had been healed by the process of time with the aid of public opinion.

We think it unfortunate that any commercial concern should appear to be so little in sympathy with the important contributions which undoubtedly have been made by the amateur investigator. The amateur does not profess to be in a position, nor does he desire to enter into competition with commercial enterprise, but he is fully entitled to recognition of what he has done towards the objects which both he and the professional engineer have in common. We quite appreciate that in consequence of competition with rival concerns commercial firms may often find it necessary to withhold publication of their investigations until the right time arrives for giving the information to the world, but, on the other hand, commercial firms must not expect to be able to stop the clock until they are ready. They must take the risk that by delaying publication of their investigations, others who have been working along the same lines, may be the first to make known their discoveries. This, it would appear to us, has been the case with regard to the development of short waves. The amateur, for the very reason that he is an amateur, has not been concerned with concealing the successive stages by which he has achieved his results, whereas in other directions whatever prior work might have been done, the fact remains that results were not disclosed in time for the claim of priority to be made.

In an interesting article in this issue entitled "What Constitutes Invention?" Prof. J. A. Fleming, F.R.S., contributes his own observations, and we feel sure that his views will be read with the keenest interest, especially as he makes clear the distinction between priority in disclosure and priority in practical application on commercial lines.

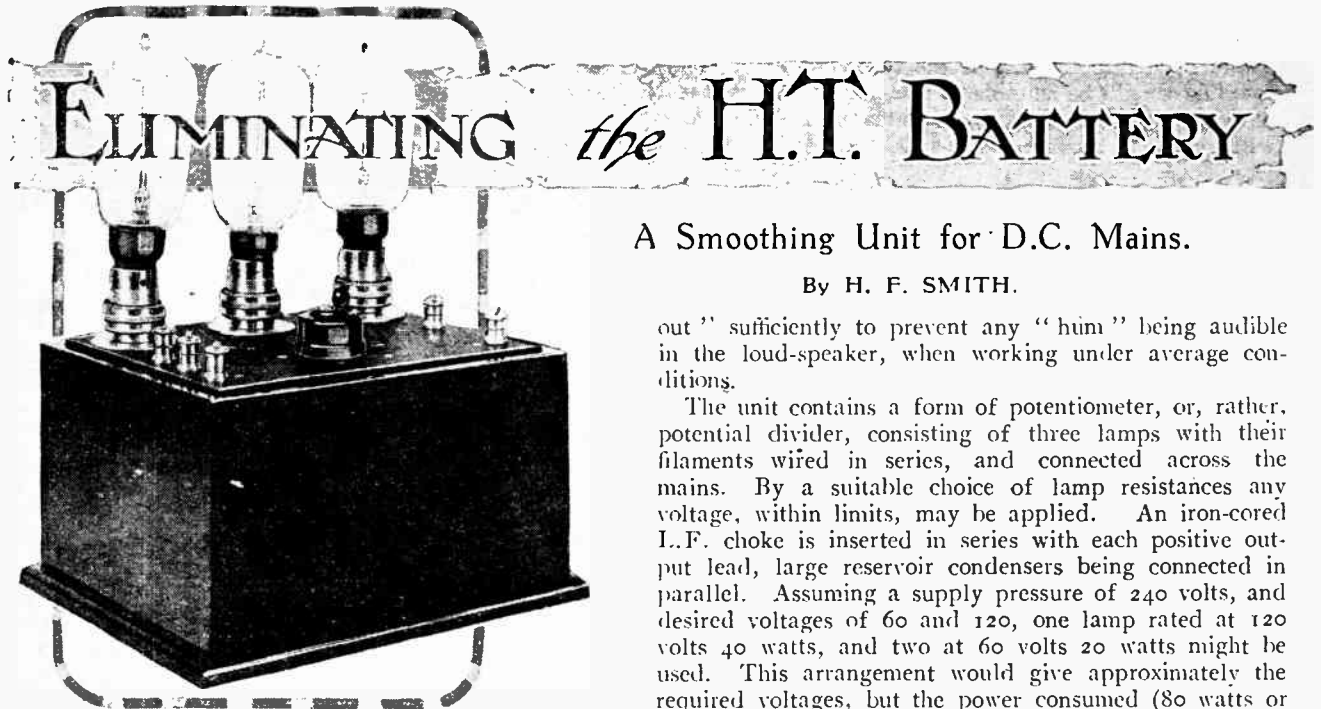

A Smoothing Unit for D.C. Mains.

By H. F. SMITH.

out" sufficiently to prevent any "hum" being audible in the loud-speaker, when working under average conditions.

The unit contains a form of potentiometer, or, rather, potential divider, consisting of three lamps with their filaments wired in series, and connected across the mains. By a suitable choice of lamp resistances any voltage, within limits, may be applied. An iron-cored L.F. choke is inserted in series with each positive output lead, large reservoir condensers being connected in parallel. Assuming a supply pressure of 240 volts, and desired voltages of 60 and 120, one lamp rated at 120 volts 40 watts, and two at 60 volts 20 watts might be used. This arrangement would give approximately the required voltages, but the power consumed (80 watts or one B.O.T. unit in 12½ hours) may be regarded as excessive unless large power valves are being used. In practice we can use one lamp rated at 240 volts 40 watts and two at 120 volts 20 watts. These lamps will burn dimly and consume only 40 watts. Whatever may be the supply voltage, lamps of the correct proportionate resist-

THE high tension dry battery is responsible for a large proportion of the upkeep cost of a broadcast receiver, and, due to unexpected variations in voltage and the development of high internal resistance, is liable to give rise to puzzling faults. Small-size cells have been found definitely unsuitable for providing a steady current of the order of some 10 milliamperes required by most modern sets capable of operating a loud-speaker, while even batteries of the largest size and of the highest grade often have a disappointingly short life. Any method of eliminating this source of expense and trouble is clearly worthy of careful consideration.

Obtaining Several Voltages.

Where a D.C. supply is available, a simple arrangement can generally be devised for obtaining appropriate voltages. Unless very special precautions are taken, the current obtained in this way is unlikely to be suitable for operating super-sensitive sets for long-distance reception, but will certainly be capable of supplying a simple set working on the local station. Mechanically generated current, as supplied for lighting and heating purposes, is seldom free from

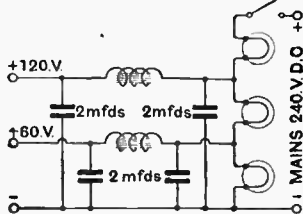

Fig. 1.—The theoretical circuit diagram, showing how the drop of potential across the lamps is used to obtain various output voltages.

"ripple" or irregularities, and, as often as not, is at an excessive pressure for direct application to the average receiver. By the use of the unit of which the circuit diagram is given in Fig. 1, the voltage may be reduced, and potential fluctuations will be "smoothed

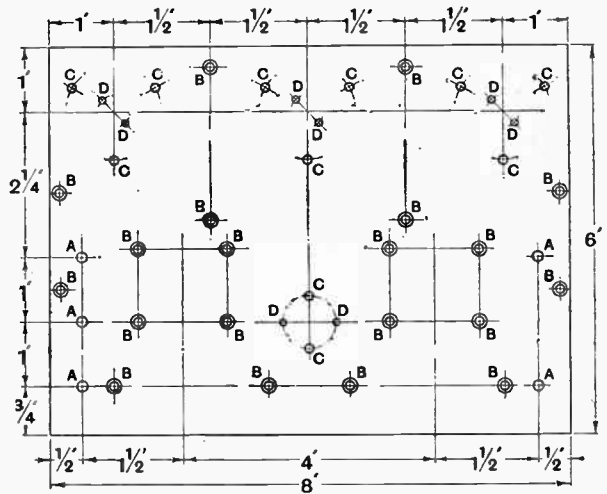
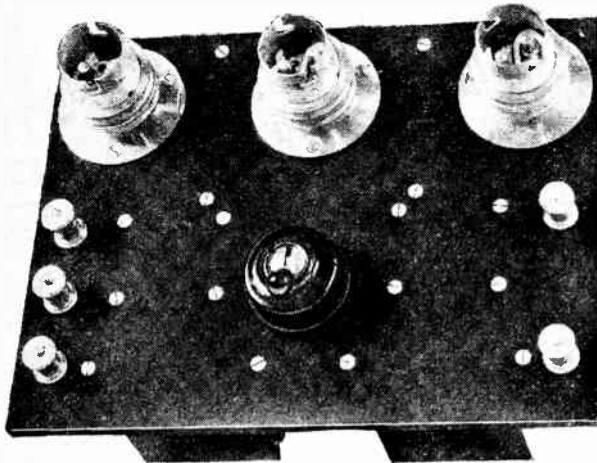

Fig. 2.—Drilling details of the panel. Sizes of holes are as follow: A, 5/32in. dia.; B, 1/8in. dia., countersunk; C, 1/8in. dia.; D, 3/32 in. dia.

ance should be used, although to avoid the necessity for obtaining special lamps it may be permissible to use three bulbs rated at that of the supply (240 volts), and perhaps 30 or 40 watts. In this case, neglecting the incidental drop of voltage due to the resistances in the circuit, we have applied voltages of 80 and 160, which may not be excessive, provided the valves are heavily biased.

Eliminating the H.T. Battery.—

The chokes should have as large an inductance as possible; any good make of the type sold for intervalve coupling should be suitable. The condensers can hardly have too high a capacity, but a value of two microfarads will generally be found sufficient. An on-off switch is



View of the top panel, with lamps removed.

fitted, and is shown as connected in the positive lead, although if this happens to be the earthed side of the mains, it would be better to connect it in the negative.

If components of the same make as those used by the writer are chosen, the drilling dimensions of the panel may be taken directly from Fig. 2. If chokes of considerably larger size are included, it may be necessary to make slight modifications, or even to increase the size of both the panel and containing case. Those latter were selected as being of standard size and readily obtainable.

The wiring of the components is clearly shown in

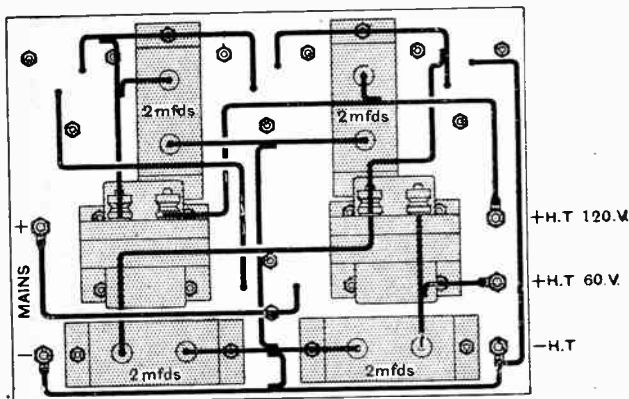

Fig. 3.—The practical wiring diagram.

Fig. 3; special care should be taken in providing adequate insulation, and it must be remembered that rather higher voltages than those usually handled by the amateur constructor are being dealt with, and any risk of causing a short-circuit should be avoided.

A length of twin flexible wire of suitable length should be fitted with an adaptor for connection to a lamp socket or other fitting. The correct polarity may be ascertained

by the use of a piece of pole-finding paper, or the bared ends of the wire may be immersed in a glass of water: that giving off the *most* bubbles is the negative. These wires are now connected to the input terminals of the unit, the output being joined to the set in the usual manner.

It will be noted that no allowance has been made for the drop of voltage across the chokes. The amount of this drop will depend entirely on the consumption of the set, and it may generally be neglected, from a practical point of view. If the current is heavy a rearrangement of the lamps will allow a higher initial voltage to be applied.

Precautions to be Observed,

When using this source of supply a large condenser should be inserted between the earth terminal of the receiver and the earth connection. Even if the negative

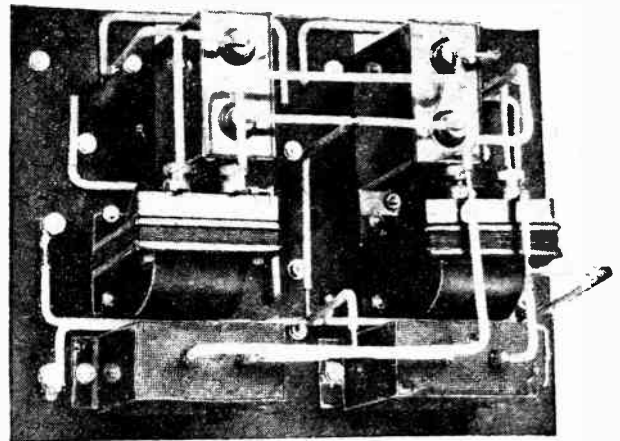

The underside of the panel, showing arrangement of the components and wiring.

main is earthed a difference of potential often exists between the "receiver earth" and the "main earth." Under certain conditions it may be desirable to omit an earth connection, allowing the mains to act in this capacity.

If in spite of these precautions an excessive amount of "hum" is audible, the effect of changing from grid to anode rectification should be tried. To do this remove the grid leak, short-circuit the grid condenser, and insert a bias battery in the grid return lead. The connections to this battery should be such that the grid is made from about three to six volts negative, depending on the characteristics of the valve and the high-tension voltage applied to it. Alternatively, crystal rectification may be tried with or without high-frequency amplification. If it is desired to retain the grid rectifying valve its anode current may be obtained from an ordinary dry-cell battery if the main supply is found unsuitable.

In the February issue of *Experimental Wireless*, editorial comment is made on the differing characteristics of various D.C. supplies; mention is made, on the one hand, of current so free from ripple and irregularities that it could be sufficiently well smoothed by the use of a

Eliminating the H.T. Battery.—

non-inductive resistance and a single condenser; and, on the other hand, of a supply with such violent fluctuations superimposed on it that a voltmeter needle was not steady enough for an accurate reading to be obtained! The writer is sincerely thankful that he has not found it necessary to attempt to obtain H.T. current from such mains, and would say at once that the simple unit described in this article would be totally inadequate. When "ripple" of only moderate intensity is present, a double smoothing circuit, as shown in Fig. 4 (a), will probably meet the case. The largest available values of capacity and inductance should be chosen.

If it is found that a persistent "hum" having a steady predominant note is still present, it is suggested that a "band rejector" circuit be added and tuned to eliminate the particular frequency giving rise to this interference. This may be constructed on the lines of the loud-speaker tone control unit described in the issue of *The Wireless World* dated February 10th. The construction may be simplified considerably, as we only require the rejector, and not the other alternative circuits made possible by the scheme of connections of this unit. It should be added that, fortunately, the need for this somewhat elaborate arrangement seldom exists.

Low-voltage Supplies.

A number of our readers will find that their current is supplied at a pressure between 100 and 120 volts. Taking the latter voltage, the unit as described will be quite suitable, with the exception that the first lamp (that connected directly to the switch) will obviously not be required. If higher voltages than those of the supply mains are desired, there is, practically speaking, no alternative but to connect a dry battery or accumulators in series; such a course is quite permissible. Those wishing for the utmost simplicity may adopt the arrangement suggested in Fig. 4, using the circuit shown in (a) or (b), depending on the "smoothness" of the supply. Only one voltage (that of the mains, ignoring the voltage drop in the chokes) will be obtainable, but may be quite suitable for certain simple sets, such as would be used for local work.

Experimenters are generally in the habit of using the same set of batteries both for their long-distance work

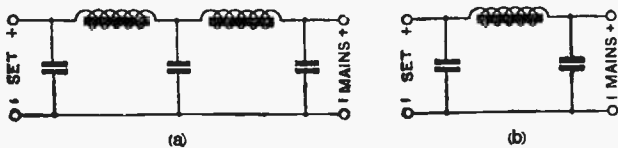

Fig. 4.—Alternative smoothing circuits without voltage-reducing resistances.

and for the domestic reception of broadcasting. Although they will probably wish to retain their batteries for the former purpose, they should certainly consider the construction of a "mains" set for the latter, complete with self-contained smoothing arrangements; it will be realised that it is not the intermittent use of the long-range set, generally with headphones, and without much L.F. amplification, which accounts for the rapid deterioration of dry cells. The steady load imposed by a broadcast loud-

speaker receiver with one or two power valves working daily for three or four hours continuously has a much more destructive effect, and in the long run the economy effected by using the D.C. current will more than compensate for the small initial expenditure involved. There would be no need to duplicate the L.T. battery, particularly if a system of plug connectors and sockets, permitting of a quick change-over, are used.

In Fig. 5 is given the circuit diagram of a "local station" receiver which has been found to operate excellently under these conditions, even when the current as supplied is by no means ideal, provided that really strong

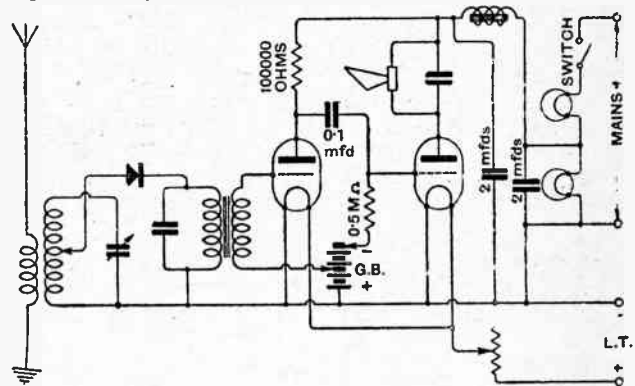

Fig. 5.—A valve-crystal receiver for the local station, suitable for operating on H.T. supply from the mains.

rectified signal currents are available for amplification. Sufficient volume for ordinary requirements is obtainable, together with high-quality reproduction.

The aerial coil, consisting of some 12 or 15 turns of wire, is tightly coupled to the lower end of the tuned secondary coil, the crystal detector being tapped across only a portion of this coil—the best position for the tapping will be found by test, and will depend on the resistance of the crystal. The rectified crystal output is passed on to the first amplifying valve through an L.F. transformer of suitable ratio (which should be high if a galena crystal is used). This valve, with a high resistance in its anode circuit, may with advantage be of the high-magnification type.

The second valve, as usual, should be of a type capable of handling sufficient power to operate the loud-speaker. The chokes and by-pass condensers are as already described, while the foregoing remarks as to the choice of lamp resistances apply equally in this case. To avoid complication it is suggested that a voltage of about 120 be applied to both valves, although this may be increased considerably as far as the first one is concerned.

It may be of advantage to fit a double-pole switch, instead of the single-pole one as shown, arranged to break both the L.T. and H.T. circuits simultaneously. If this is done, the set may be switched on and off by the totally inexperienced in the simplest manner possible.

LIST OF PARTS.

- 2 L.F. chokes (A.J.S.).
- 4 Fixed condensers, 2 mfd. (T.C.C.).
- 3 Lamp holders, battery type.
- 1 Ebonite panel, 6in. x 8in. x 1/4in.
- 5 Terminals.
- 1 Switch, on-off.
- 1 Box, 6in. x 8in. x 4 1/2in. deep.
- Screws, wire, sleeving, etc.

Approx. cost £9.

BERLIN'S NEW BROADCAST STATION.

The Transmitting Plant at Witzleben.

THE accompanying photographs show the aerial system and transmitter of the Witzleben broadcasting station, which has now established another alternative daily service for the Berlin district. While the transmitter itself is situated at Witzleben, the actual performance of the programmes takes place in the special studio which occupies a central position in the Potsdamer Platz. The microphone is of the marble block type developed by the well-known broadcast engineer Reisz.

The Aerial System.

The aerial system at Witzleben is of the "T" type, the horizontal portion consisting of five equally spaced wires, a down lead being taken

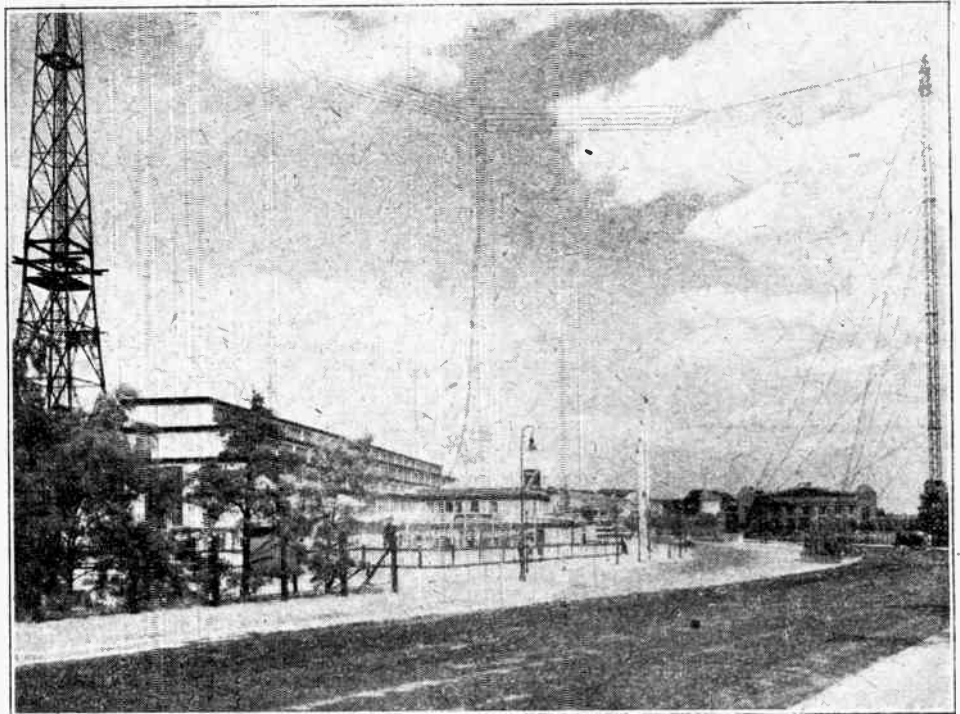

The aerial system at the Witzleben transmitting station.

from the centre of each wire. The aerial is supported between two lattice masts 262ft. and 440ft. in height; the former is of the self-supporting type, and is seen at the left-hand side of the photograph.

The Transmitter.

Power is drawn from the mains, and suitable machinery has been installed to provide filament heating current and also D.C. high-tension supply at 4,000 volts. A bank of accumulators and petrol-electric generators have also been installed in the basement in case of failure of the external supply.

The 8-kw. transmitter is designed for wavelengths between 250 and 600 metres. At the present time a wavelength of 505 metres is in use, and the range for simple detector receivers is estimated at 100 kilometres.

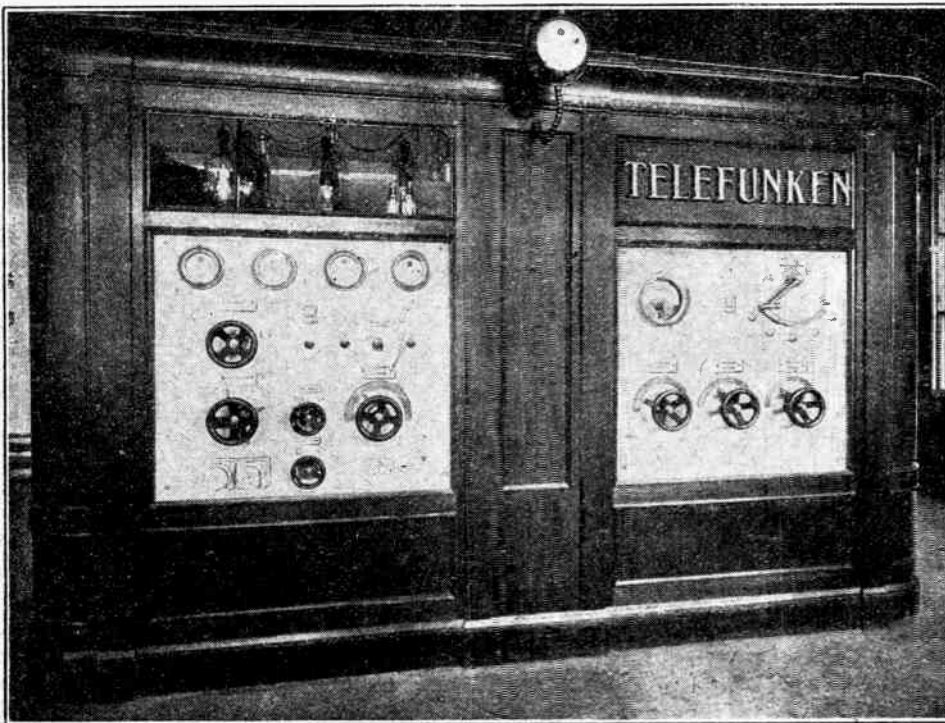

The 8-kw. transmitter which radiates on a wavelength of 505 metres.

WHAT CONSTITUTES INVENTION?

By

Dr. J. A. FLEMING,
F.R.S.

Prof. Fleming, whose pioneer work in the development of the thermionic valve is remembered with gratitude by valve users the world over, has always taken a keen interest in the amateur movement. This fact, together with his high standing as an electrical engineer, enables him to see both sides of the question of priority in the development of short waves, and this article, specially written for "The Wireless World," should be of immediate interest both to the amateur and to the professional worker in the field of radio research.

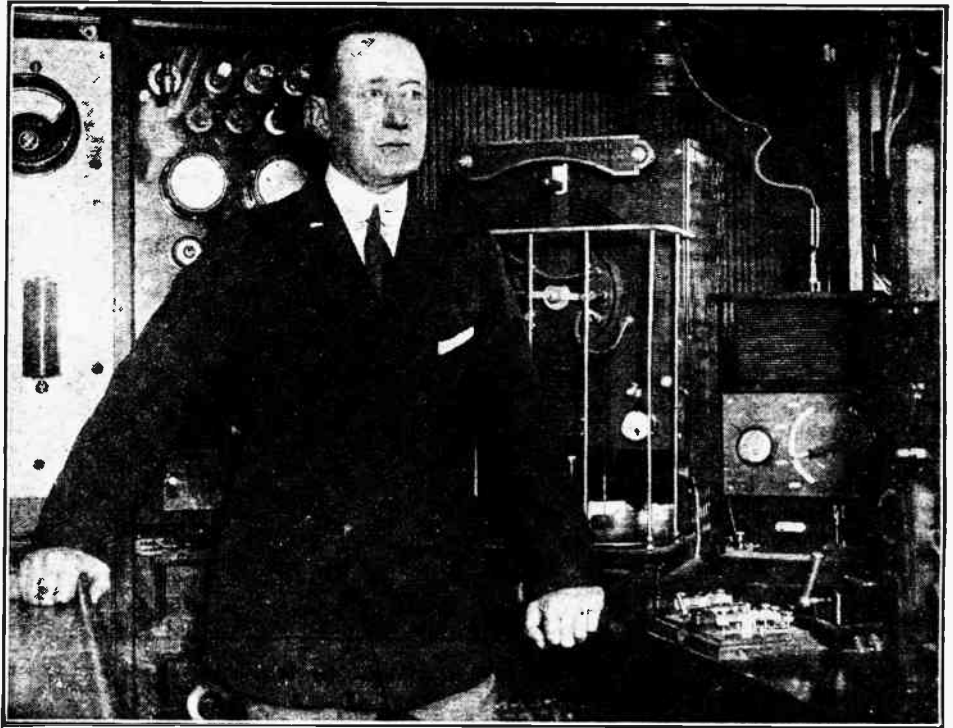

Senatore Marconi on board his yacht the "Elettra" which has played an important part in the commercial development of short waves.

A RECENT controversy in a contemporary journal between

Senatore Marconi and Mr. L. B. Turner, some part of which was reproduced in *The Wireless World* for February 10th last, suggests certain reflections on invention in general. The subject of this controversy was short-wave radio and the amateur's part in its development. The writer has no intention of intervening in the discussion between the distinguished controversialists, but merely ventures to offer a few remarks on a point which generally receives insufficient attention in questions of priority in invention. The growth of all invention is controlled by the law of evolution, and, like everything else, it begins for the most part as a germ of microscopic size. It very seldom springs into existence full grown, as Minerva is said to have sprung from the head of Jove.

At a certain stage it begins to be useful in some way to the community, and then we generally have more than one claimant to be the originator of it. Not only personal, but national, pride is involved, and, in proportion to the utility of the perfected invention, so much the more is national eagerness increased to claim it as their own child. The patent actions in Courts of Justice bear evidence to the difficulties which sometimes surround the settlement of these questions of priority and invention. The upbuilding of an invention is, in fact, very much like that of a house. It is not until the house is finished and can be inhabited that it becomes of use to the community, and it is the person who carries it on to this point who, in fact and custom, is the real benefactor of the public and is recognised as such.

Very often a builder starts to build, say, a palatial

private residence as a speculation. He puts in the foundations in a certain fashion, but then he may go into liquidation or die or cease to go on with it. Someone else then comes in and has perhaps the idea to convert it into an hotel, and he carries it up a certain way, but then from various causes may fail to complete the job. Finally, someone else with more capital and perseverance and clearer idea of what the public require most has the idea of finishing off the so-far-useless building as a set of flats for which there is an immediate demand.

The public always apply, and rightly so, the test of final utility of some kind to an invention. Novelty alone is not enough, or even an isolated performance or the accomplishment of some feat possible only to the original worker or to people of very special skill as an occasional achievement. If it is to be any good and bring credit to the inventor, he must carry it forward to the point at which other people can do the same thing and at which it becomes of general utility in adding to the comfort, convenience, or pleasure of life.

Invention and Public Utility.

Hence it is that we attach the names of certain persons to inventions which in a certain form were in existence before their time. James Watt did not invent the steam engine, but he invented separate condensation in a condenser and not in the cylinder, and made Newcomen's extravagant engine a useful one. Cooke and Wheatstone did not invent the electric telegraph, but they certainly gave it a form in which it became of public utility.

What Constitutes Invention?

Marconi was not the first to suggest the employment of electric waves for the transmission of intelligence to a distance. That was suggested verbally, at least, in Crookes' prophetic article in 1892, based on the rudimentary and ill understood prior experiments of D. E. Hughes.

Marconi and Wireless Development.

Marconi, by his invention of the aerial wire and by his final perseverance and clear grasp of the fundamental principles, was the first to produce in 1896 or 1897 an apparatus which could be worked by anyone, and did communicate, slowly though it was, intelligible messages to a distance. He gave to the world not an isolated personal performance, but the definite possibility of it being done by anyone with no particular skill at any time and at any place. Hence he is properly given the credit of being the inventor of electric wave

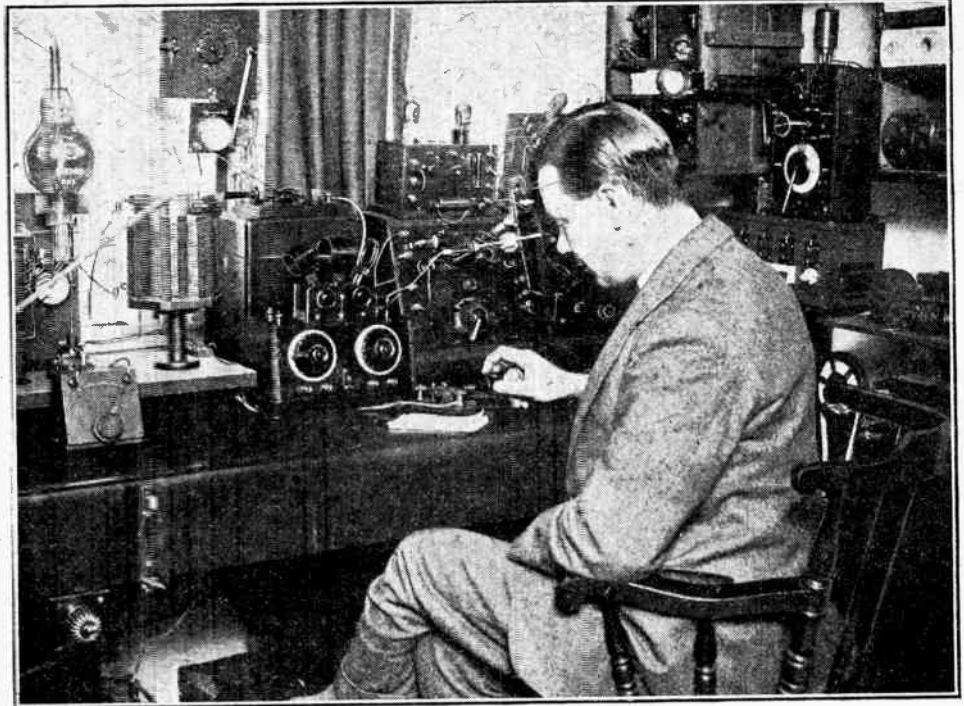

Mr. O. D. Simmonds (G2OD) the first British amateur to establish two-way communication with the Antipodes.

wireless telegraphy. It is just in this quality of progressive and persistent work, directed to bringing a

desired achievement to the point at which it becomes independent of the skill or life of the originator, that the amateur usually fails.

Either he has not the resources, time or perseverance necessary, or he rests satisfied with an initial feat or a single achievement which is not easily or perhaps at all repeatable by others.

Credit Due to the Pioneers.

A good deal of credit may be due to him for a new idea or first attempt to put it in practice, but that cannot be properly used to minimise the value and importance of the work of the man who gathers up the unfruitful or pioneering gains of others and presents the community with a practical and efficient appliance effective for general use.

Very often this depends on the combination of two such perfected inventions as in the case of the tele-

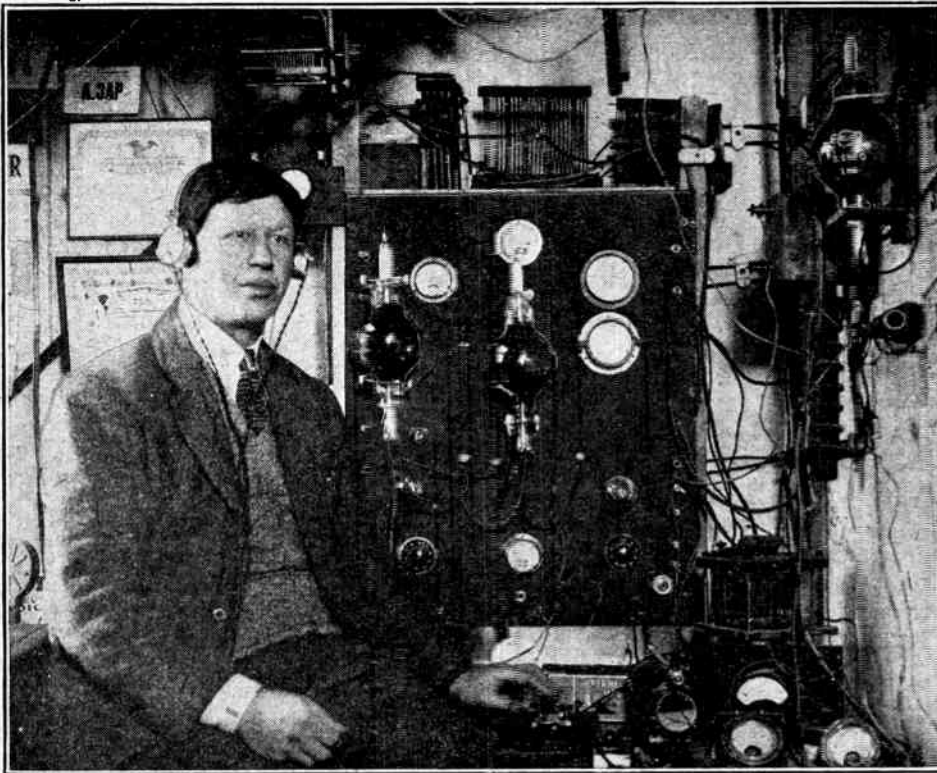

Mr. Gerald Marcuse (G2NM), secretary of the Transmitter and Relay Section of the Radio Society of Great Britain, whose short-wave transmissions have been heard in all parts of the world.

What Constitutes Invention?—phone. The magneto telephone was brought by Alexander Graham Bell up to the utility stage as a receiver, but as a transmitter it was inefficient, and not until Edison and Hughes had given us the carbon microphone could practical telephony be said to be accomplished.

In the particular controversy relating to short-wave transmission the questions that require consideration are how far any amateur had gone prior to the date when Senatore Marconi and his talented coadjutors took up the work, in achieving results which could be regularly repeated and constantly obtained with apparatus capable of being worked by a sufficiently skilled person.

How far were these long-distance amateur short-wave performances rather of the nature of freak transmissions or exceptional events?

We have certainly now a large amount of accumulated knowledge on the powers of electric waves of wavelengths less than 100 metres to travel vast distances over the earth's surface both by day and night. How far is this knowledge due to the orderly and persistent radio research of amateurs or other investigators outside of that which has been done by Senatore Marconi, Mr. Franklin, and their assistants?

Isolated instances of short-wave transmission do not prove that the knowledge of their working or what could be done with them was at all general. Nor that the employment of them had arrived at a stage of invention at which it could be said that a new chapter had opened

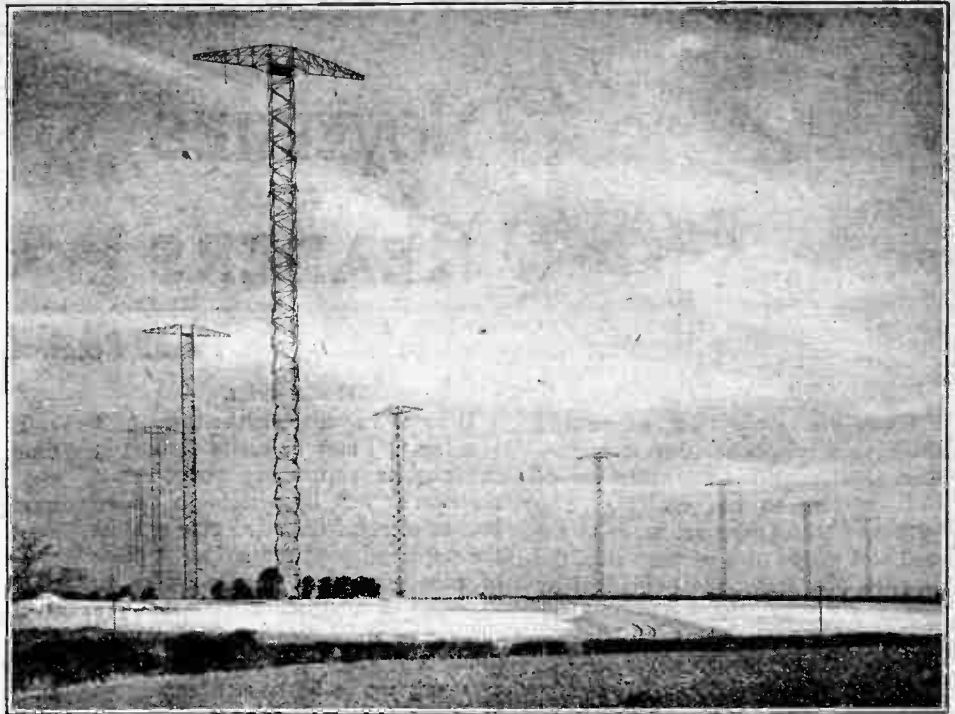

Short waves in the public service. The beam receiver at Bridgewater erected for high speed reception from the Dominions.

in radio working. Questions of priority always depend to some extent on the point of view of the enquirer, but in all practical accomplishments the cardinal question ought to be: Who was it to whose steady, persistent and successful work we owe the opening of a new field of useful achievement, the working of which is now confined to a few experts, but is thereby thrown open to cultivation by innumerable other followers and workers?

Nevertheless, it is clear that the skilled labours of amateur radiotelegraphists have in this matter of short-wave transmission been of very great value and contributed to prove the practical possibilities of using for telegraphic and telephonic purposes wavelengths which were formerly regarded almost as waste products of scientific research.

EXPERIMENTAL TRANSMITTING STATIONS.

Additions and Corrections to the Lists published in the "Wireless Annual for Amateurs and Experimenters, 1926."

ARGENTINE REPUBLIC.

FEDERAL CAPITAL.

- AB9 J. L. Maurete, Adolfo Berro 3557.
- AE8 J. M. Sánchez, Costa Rica 5929.
- AG1 A. Gatti, Argerich 800.
- AH5 F. A. Aguirre, Calle 1 No. 752, Versailles.
- AK2 M. L. B. de Castro, Cangallo 1966.
- AN7 A. Peñalva, Directorio 345, Dep. 3.
- AS7 D. E. Vacocotti, Alberti 1668.
- AU9 E. R. Zanibra, Independencia 3953.
- AX4 H. Mastro, Rivadavia 3133, Dep. 7.
- AX8 A. Bracht, J. E. Uriburu 1909.
- AY3 N. Caffaro Marra, Camacua 81.
- AZ5 P. A. Gilardoni, Pringles 463.
- BB5 H. Cordero, Quito 4164.
- BB6 A. E. Loustau, Añasco 339.
- BC4 P. Cuzzaniga, Caseros 2048.
- BE1 E. S. Roulier, Carlos Pellegrini 669.
- BE2 R. Leymaric, Yatay 66.
- BE4 P. Bassenave, Pieiras 470.
- BK5 J. F. Branca, Alberti 1020.
- BK6 C. A. Videla, Bartolomé Mitre 1980.
- BL1 J. L. Laguri, Olleros 3215.
- BL5 M. Bravo, Independencia 2501.

- BN1 F. Bez, Donato Alvarez 2025.
- BN2 C. Wappers, Callao 1405.
- BM4 C. Cattáneo, Cangallo 1241.
- BM5 V. R. Christensen, 11 de Septiembre 909.
- BM6 C. Assorati, Paraná 761.
- BM7 H. J. Simoni, Bogota 129.
- BM8 J. Galderisi, Nicasio Oroño 1524.
- BM9 J. Villico, Esnerakla 576.

PROVINCE OF BUENOS AIRES.

- DB3 P. Frers, Juncal 331, Temperley.
- DE3 G. Chescotta, Calle 50 No. 809, La Plata.
- DE5 N. Souilla, Calle 57 No. 572, La Plata.
- DE8 A. Bensch, Julio Pourouge 630, Lomas.
- DE9 Radio Club La Plata, Diagonal 74 No. 1254.
- DJ6 A. H. Scotti, General Paz, Ranchos (F.C.S.).
- DO5 L. Varano, Paunero 3642, Lanús.
- DO6 E. Estebanez, Caá-Guazú 1049, Lanús.
- DQ6 J. Linares de Espora, Dolores, Buenos Aires.
- DW1 R. Bernotti, Leandro N. Alem 642, Quilmes.
- DW2 F. G. Langley, M. Pellica 1925, Olivos.

PROVINCE OF SANTA FE.

- FI2 P. C. Aguirre, Avellaneda 147 Su 1, Santa Fé.

URUGUAY.

MONTEVIDEO.

- RS1 W. Soré, Cerrito 585.
- R5 E. Elena, Curules 1511.
- R6 C. Sapelli, Pedernal 1922.
- R10 A. da Silva, Rio Branco 1284.
- R11 C. H. Siringhelli, Bella Vista 101.
- CK4 P. Buencristiano, Defensa 923.
- CK7 R. y E. Anaya, Cerrito 315.
- CK12 T. Evangelista.
- CK15 A. Galli, Paso de los Toros (Tacuarembó).
- CK21 C. L. Ronay, Mercedes 1015.
- CK32 D. Valverde, 8 de Octubre 2790.
- CK35 V. Alonzo, J. Rousseau 2001.
- CKE O. Chiappe, Convención 1280.
- CKM A. Mantegani, Vázquez 1427.
- CKD D. Veracierto, 8 de Octubre 2481.
- KOR P. Mestre, Brandzen 2174.
- RCS C. Stefani, Canelones 874.
- JCP J. C. Primavesi, Nueva York 1500.
- FWX J. Henderson, San Eugenio 1156.
- FLG A. R. Frederick, Millán 3032.

* Indicates that these names and addresses supersede those originally published in the "Wireless Annual for Amateurs and Experimenters."

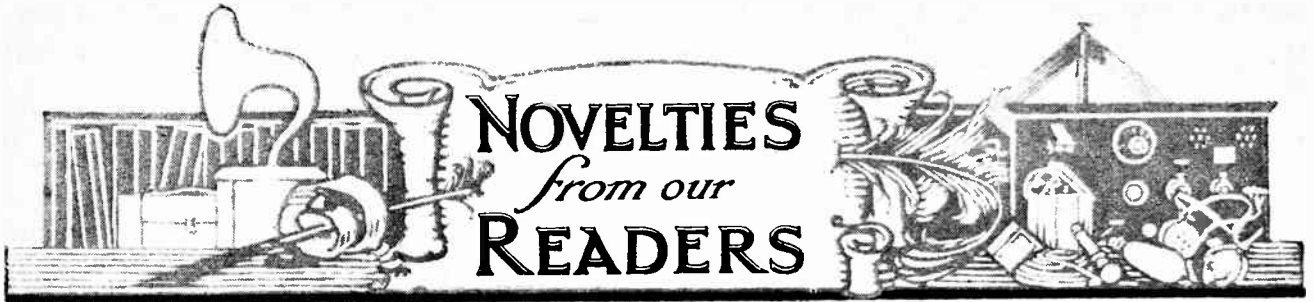

A Section Devoted to New Ideas and Practical Devices.

Telephone Plug.

Using the 4-pin base of an old valve as a telephone plug it is possible to arrange for the switching of I.T. current to the receiver. The telephone connections are made to the grid and anode pins of the valve, the filament pins being short-circuited by

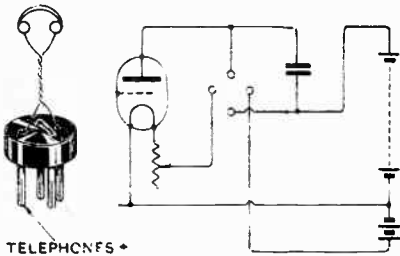

TELEPHONE S •

Telephone and filament switching jack.

means of a piece of thick wire. The connections of the valve socket in which the improvised telephone plug is inserted are shown at the right-hand side of the diagram. An additional advantage of this arrangement is that it is impossible to reverse the telephone connections, and demagnetisation of the permanent magnets due to the steady anode current is avoided.—W. B. S.

o o o o

Hydrometer Holder.

Unless a definite place is allotted for a hydrometer it is certain that sooner or later it will be laid down on a table or in some place where the acid is likely to cause damage, or where the hydrometer itself may be broken. A simple holder can be made by wrapping a length of wire (preferably enamelled) round the neck of a test tube which is then hung in a convenient position near the I.T. battery.—H. M.

A 20

Spacing Strips.

Grooves for spacing the turns of a low loss coil may be easily formed in the ebonite supporting strips of a skeleton former by pressing a heated bolt or piece of threaded pipe against the upper edge of the strip. A piece of pipe gives best results owing to its large diameter, but unfortunately the range of pitches used in jointing pipes is limited: the most convenient spacings are to be found among the Whitworth bolt threads.—F. G.

o o o o

Distortion of Telephone Diaphragms.

In sensitive telephone receivers the clearance between the diaphragm and the pole pieces of the permanent magnets is often very small, and under the continuous pull of the magnets is liable to become distorted, thus rendering the telephones inoperative.

When trouble due to this cause is suspected the ear cap of the telephones should be removed and the diaphragm reversed. This will present the concave surface of the diaphragm to the pole pieces and thus increase the clearance. After some months of use it is probable that the diaphragm will again fall in towards the magnets, when the process may be repeated.—F. G.

VALVES FOR IDEAS.

Readers are invited to submit brief details, with rough sketches, where necessary, of devices of experimental interest for inclusion in this section. A receiving valve will be despatched to every reader whose idea is accepted for publication.

Letters should be addressed to the Editor, "Wireless World and Radio Review," Dorset House, Finsbury St., London, E.C.4, and marked "Idea."

A Simple Galvanometer.

The diagram shows the construction of a simple galvanometer which can be built up with components usually possessed by the wireless amateur.

Two coil holders are mounted on a wooden baseboard, the plugs and sockets being connected in series in such a way that when a current is passed through the plug-in coils the magnetic fields surrounding each coil are in the same direction. A small compass, which can be obtained for a shilling or so, is supported on a platform in line with the centres of

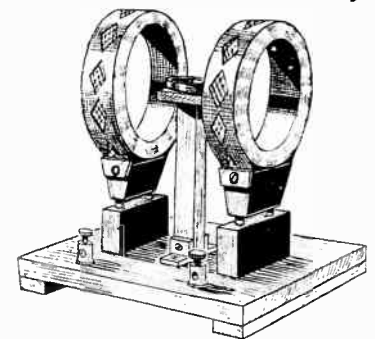

Improvised tangent galvanometer.

the coils, and is deflected when a current is flowing. By using coils of various sizes the sensitivity of the galvanometer may be altered to suit the particular conditions of any experiment, and if the compass is of good quality it should be possible to calibrate the galvanometer with sufficient accuracy for most purposes.

If the instrument is used as a filament voltmeter or plate current milliammeter, long wavelength coils with a large number of turns should be used, while short-wavelength coils with few turns will serve when it is used as an ammeter.—A. C.

26

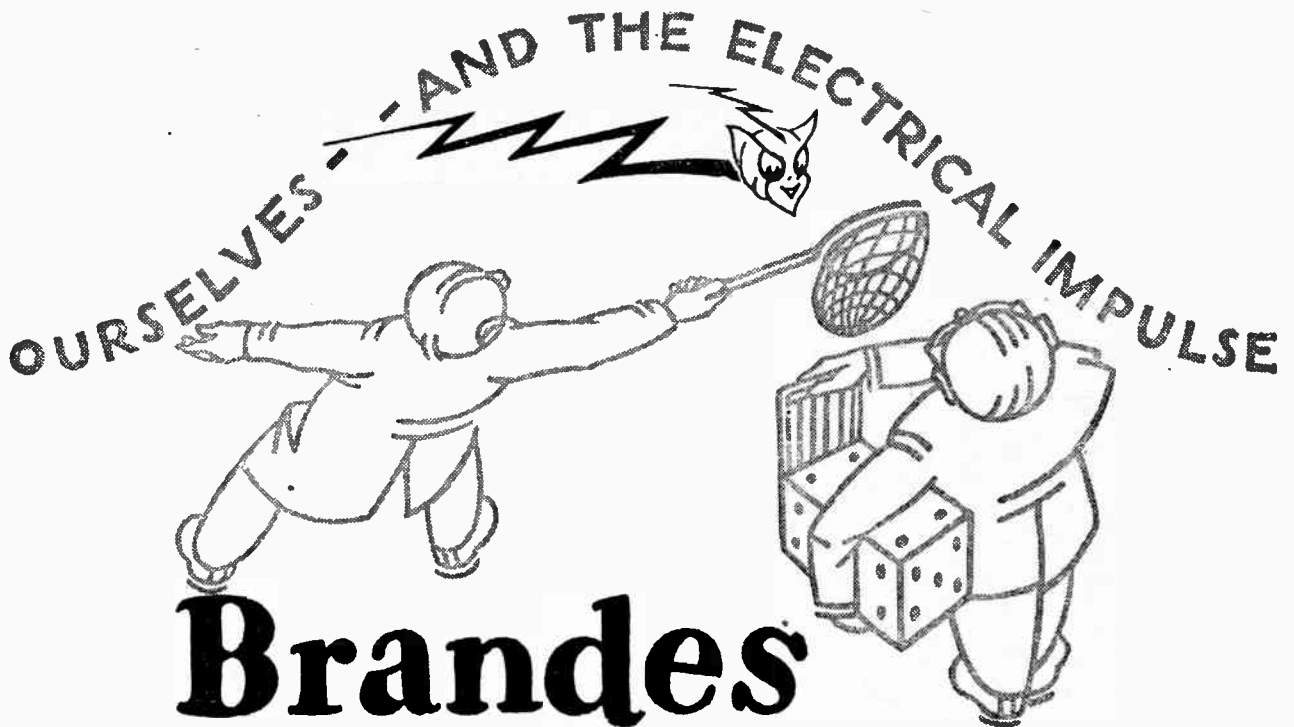

"HULLO! What do you fellows want me for now?"
 "Come along, you young imp. Our laboratory experts want a word with you?"
 "Shades of Geneva! They want my advice again. Still, take the net and cage away, and I'm with you. You Brandes people have a little more understanding than most; you consult me with due humility. Others, without any knowledge of what I demand, force me to speak. I become refractory; their instruments reproducing radio sound talk less naturally in consequence. You know, they really ought to study me a little more. Here I am, at the beck and call of every soul interested in radio, from a high power station to myriads of embryo Senatore Marconis. I recommend a study of radio

acoustics, which means the study of transforming myself, the electrical impulse, into audible sound. I, being the electrical energy, walk right into the receiver of Tom, Dick or Harry, carrying the voice from the studio. To be able to talk just as naturally as the people in that studio I must have the correct scientific elements built into the instrument which reproduces the sound. You chaps have been the only radio builders to consult me to that end. I know you've worried me for seventeen years, but I appreciate the tactful consideration which went with it. I hope you have benefited by my advice; by what I hear of Brandes instruments, you have. Well, lead on to the laboratory, gentlemen; I have an appointment at 2 LO after lunch."

MATCHED TONE HEAD- PHONES.
 The synchronised effort of both receivers discovers greater sensitivity and volume and truer tone. Light, comfortable & sturdy.

THE TABLE-TALKER.
 Material used in the construction of goose neck horn eliminates metallic harshness. Adjustable. Height 18 ins., neutral brown finish, padded base.

THE BRANDOLA.
 Greater volume with minimum current input. Large diaphragm gives fullness to upper and lower registers. Walnut plinth, electro-plated fittings.

THE AUDIO TRANS- FORMER.
 Ratio 1 to 5. High amplification of applied voltage, together with straight line amplification frequency curve.

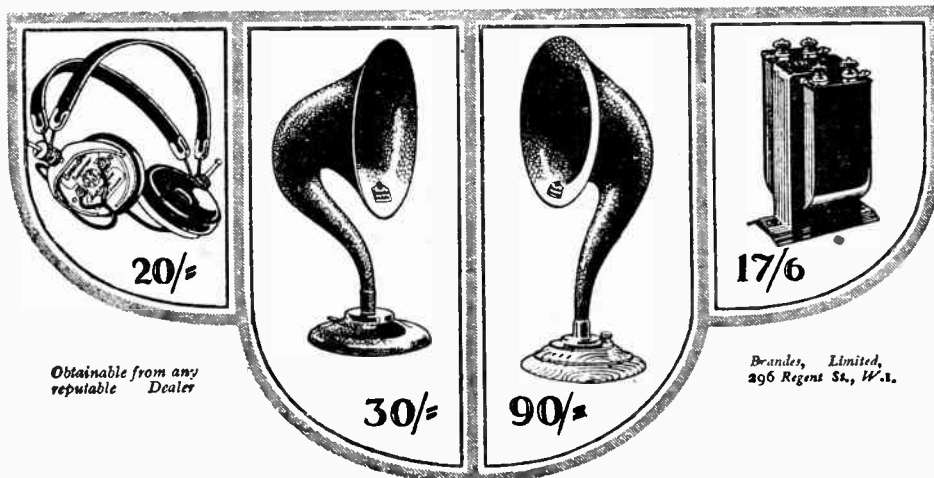

Obtainable from any reputable Dealer

Brandes, Limited, 296 Regent St., W.1.

EXPERTS IN RADIO

ACOUSTICS SINCE 1908

26/238

Service Advertising

America's foremost valve
BRITISH MADE

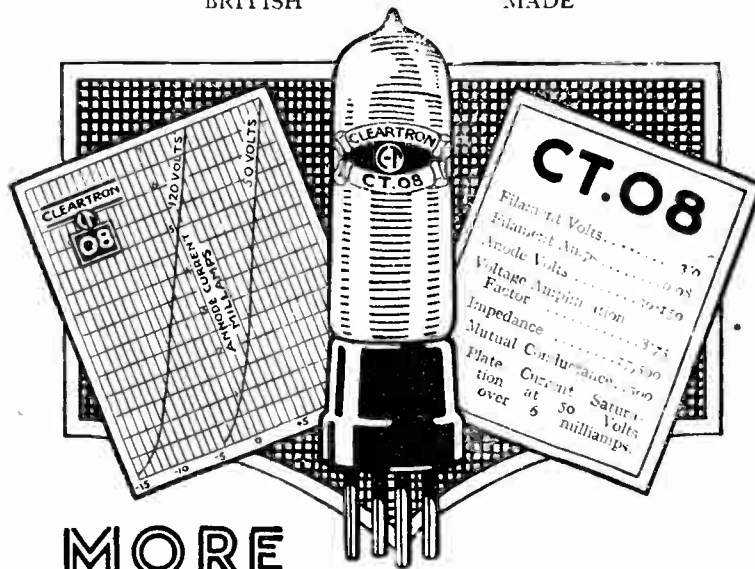

MORE CLEARTRON CHARACTERISTICS

NOW we have the characteristics of the CT.08, another excellent example among the seven different types of the CLEARTRON range. It is an every purpose Dull Emitter which will work equally well as a high or low frequency amplifier or as a detector. However used, it gives maximum volume without

distortion. In your set it means greater distance, operatic purity, keener selectivity, lowest current consumption, and moderate initial cost. The "Ironclad" Guarantee goes with every valve. Your Dealer in giving you this knows that both you and he are fully protected by the efficient principles of the CLEARTRON organisation

CLEARTRON RADIO LIMITED

1 CHARING CROSS, LONDON: AND BIRMINGHAM

Telephone: Regent 2221 2. Grams: Cleartron, West End, London

Type	Accumulator or Battery volts	Fil.volts.	Fil. amp.	Purpose	Price
C.T.08.	Dry cells	3	0.08	H.F., L.F. Detector	12/6
C.T.15.	2 volt Accumulator	1.8	0.15	H.F., L.F. Detector	12/6
C.T.25.	6 volt Accumulator	5	0.25	H.F., L.F. Detector	15/-
C.T.25.B.	6 volt Accumulator	5	0.25	General purpose resistance coupled amplification	15/-

Send for illustrated Price List -post free.

Send for illustrated Price List -post free.

British



Made

LOW LOSS COIL TESTS

Further Results of High-
Frequency Measurements on
Readers' Coils.

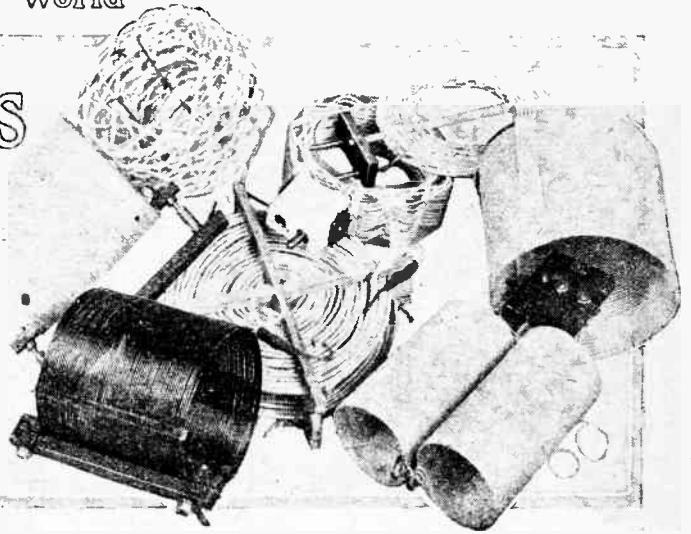

IN our last issue we commenced to deal with the results obtained from tests carried out on the large number of coils of all types, which were submitted as a result of *The Wireless World* Low-loss Coil competition announced some time ago.

In this issue we continue the publication of data on a further number of representative types of coils. Unfortunately, it is not possible at the time of going to press to announce the winning coil of the competition as we had stated last week we hoped to be in a position to do, for there are a number of coils which may be classed in the first rank, and it will be necessary, before the best of these can be picked out, to judge them on the basis of ohms per unit of inductance.

Factors to be Considered.

In devoting special attention to this question of the relative efficiency of different types of low-loss coils, food for considerable thought has been obtained, and a number of questions might be asked relating to the subject. We would like to know, for instance, what size of wire is best to use; what shape the former should be; whether the turns should be spaced, and whether bare wire or covered wire is preferable—in fact, we want to arrive at answers to all the questions relating to the points to be taken into consideration in setting out to design a really low-loss coil. But, after all, is this the most important consideration? What do we propose to do with our low-loss coil of super-efficiency when we have got it, because it does not by any means stand to reason that such a super coil is going to be best to use under varying circumstances? First, we should satisfy ourselves as to the results aimed at and the circumstances under which we are going to employ our coils when they are built. We should decide first of all how many tuned circuits we can afford, for if we have got to be satisfied with two tuned circuits only, we must be more careful to employ efficient coils; that is to say, coils with lower losses than is the case if we are going to use, say, five tuned circuits.

With the question of low losses is intimately related the more important qualities of selectivity, distortion and magnification. Low loss is not the ultimate goal, but merely a means to an end, and the wise man is

one who fashions his coils with the real end in view—a judicious combination of selectivity, quality, and magnification, for undoubtedly each of these is of first-rate importance. With several filters we can very easily get razor-edge tuning if we so desire, but the signals will then be unintelligible. We can, with equal ease, provide for a very good transmission characteristic with negligible attenuation of the higher-modulation frequencies, but then the result may be that the tuning is too broad and we shall not be able to select the signals we desire.

These observations may, perhaps, be regarded as beside the point. Coils with low losses can have a proper place in a receiver, but we desire to point out here that there is a limit to the size of the coils which may be used. The limit is a physical one, large size usually being synonymous with large stray fields which can be the cause of quite a lot of trouble. It is, of course, largely a matter of design, because coils can be made to have a small stray magnetic field, as, for instance, the Toroidal coil, which may take the form of an enclosed winding or a ring of any convenient cross-section; another instance is the astatic arrangement of coils, a typical specimen being illustrated on page 242 of the last issue.

Coupling and Other Difficulties.

This particular problem, of the permissible physical dimensions, just happens to work out nicely in practice. Thus, if we are limited to one or two tuned circuits, the aim will usually be to secure the utmost selectivity. With only two coils to arrange, no serious difficulty need be encountered in stopping undesired coupling between them. Hence the coils can be large ones, and their design may be dealt with from a purely detached point of view with the single object of cutting down their losses. With four or more circuits, coupling difficulties are met with at once. Some form of screening is necessary, and this together with the practical consideration of the bulk of the receiver, renders it essential in the majority of cases, to cut down the dimensions of the coils to proportions compatible with tuning and magnification requirements.

It is, therefore, perfectly correct to say that the best coil for one particular receiver may be quite unsuitable for another. If we have one or two tuned circuits, for in-

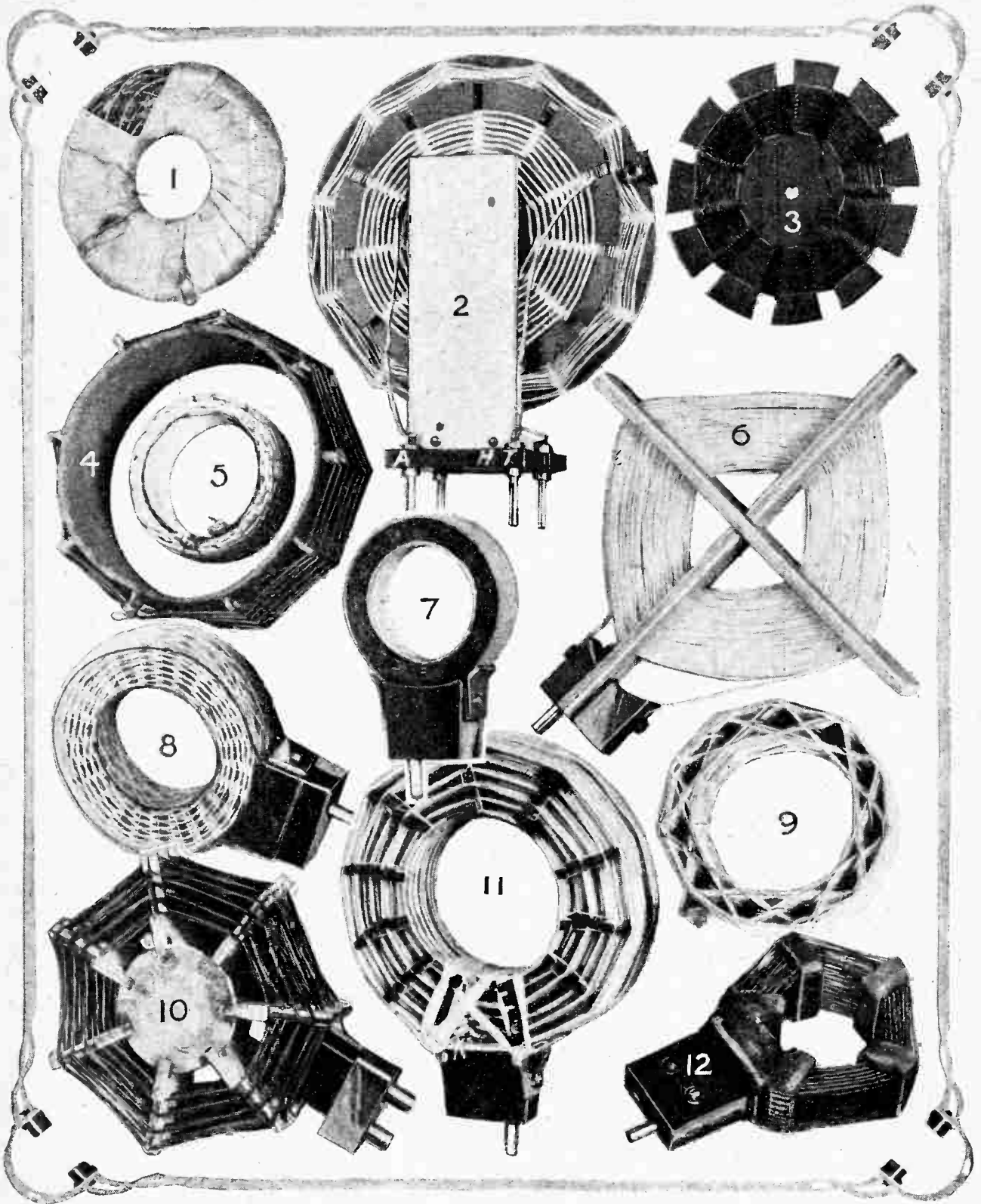

A few of the interesting coils submitted to us by readers for the low loss coil tests—

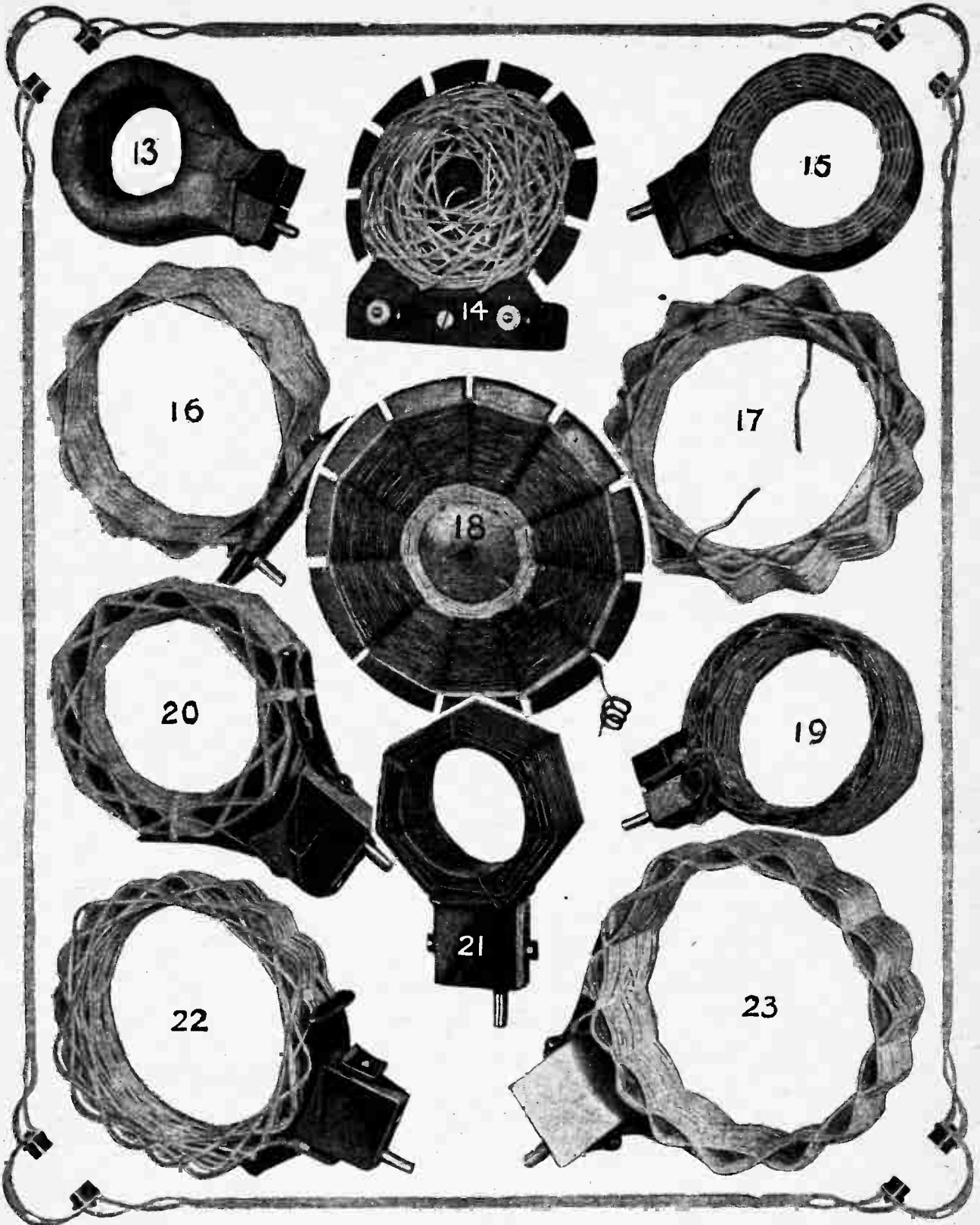

—they are of all shapes and sizes, and truly represent present day practice.

Low Loss Coil Tests.—

stance, our coils can, in the majority of cases, be four or more inches in diameter, and they would normally be single-layer coils, or coils of the cylindrical basket weave type. Then, if No. 22 or 24 D.S.C. wire is used, and the turns are spaced by a distance of about the diameter of the wire, the coils will have a reasonably low resistance.¹ Tests show that the resistance will not be much reduced by using thicker wire, the turns still being spaced, and for a given inductance the length of the coil rapidly

4 $\frac{3}{4}$ in. Inductance 410 microhenries and resistance 20 ohms.

3.—A basket coil of 44 turns of No. 28 S.W.G. enamelled wire, with an inside diameter of 1 $\frac{1}{2}$ in. and an outside diameter of 2 $\frac{3}{4}$ in. The inductance of this coil is 110 microhenries and its resistance 5.6 ohms.

4.—A three-layer coil of No. 24 S.W.G. enamelled wire. The diameter of the cardboard former is 4in. and it is 1 $\frac{1}{2}$ in. long. The layers are spaced at 9 points with

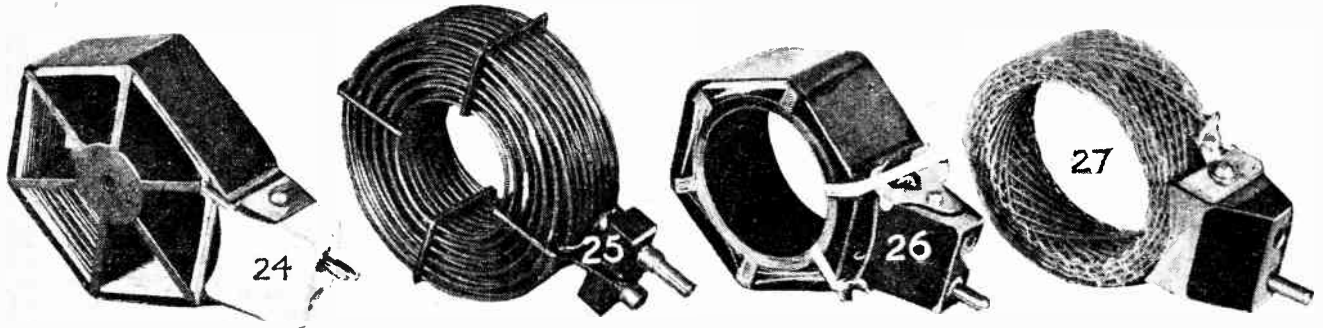

increases as the wire sizes are increased. It is a step in the wrong direction to use thick wire and to attempt to keep the length of the coil down by tight winding. If the winding length is an important factor, it is better to use No. 24 or No. 26 D.S.C. tight wound. We then have the advantage of a favourable length to diameter ratio, the best ratio according to theory, which is confirmed in practice, being rather less than one-half; that is, the length of the coil should be rather less than the radius.

Below we have set out the details of the various coils illustrated, and we hope to complete our reports on the tests in a further instalment to appear next week.

1.—A multi-layer coil of No. 22 D.C.C. wire, having

match sticks. The inductance was found to be 250 microhenries and the resistance 7.8 ohms.

5.—A small multi-layer coil, 1 $\frac{3}{4}$ in. inside diameter by $\frac{7}{8}$ in. long. The inductance is 72 microhenries and the resistance 2.9 ohms.

6.—Flat coil of No. 24 S.C.C. wire, wound in a slotted wire on a former. The length of the inner face is 1 $\frac{1}{2}$ in. and of the outer face 3 $\frac{1}{2}$ in. Its inductance is 212 microhenries and resistance 11 ohms.

7.—Compact multi-layer coil of No. 26 D.C.C. wire. Inside diameter 1 $\frac{3}{8}$ in., outside diameter 2 $\frac{1}{4}$ in., length $\frac{5}{8}$ in. The inductance is 78 microhenries and the resistance 3 ohms.

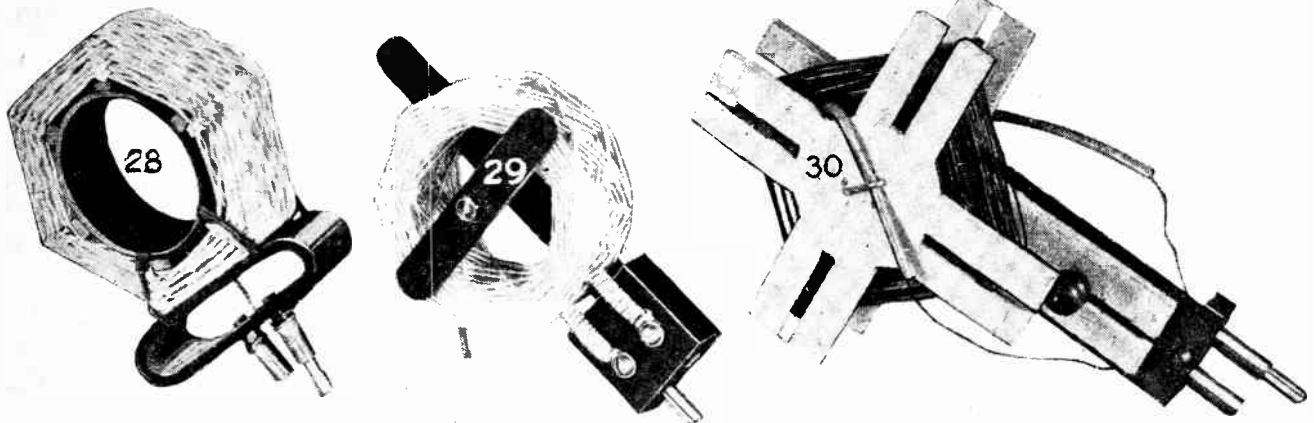

an inside diameter of 1 $\frac{1}{4}$ in. and an outside diameter of 3 $\frac{3}{8}$ in. The inductance was found to be 122 microhenries and the resistance 2.3 ohms.

2.—A large basket coil of No. 26 D.C.C. wire, having an inside diameter of 1 $\frac{1}{2}$ in. and an outside diameter of

8.—Duolateral coil of 76 turns of No. 24 D.C.C. wire. Its inside diameter is 1 $\frac{3}{4}$ in., outside diameter 3in., length $\frac{5}{8}$ in. Its inductance was found to be 315 microhenries and resistance 22.7 ohms.

9.—A 75 turn coil of No. 24 D.C.C., having a mean diameter of 2 $\frac{1}{2}$ in. and length 1 $\frac{1}{2}$ in. Its inductance is 220 microhenries and its resistance 17.5 ohms.

¹ The discussion is confined to coils for the 200-550 metres band.

Low Loss Coil Tests.—

10.—A coil of Litz cable, having a mean inside diameter of $2\frac{1}{4}$ in. and an outside diameter of $3\frac{1}{2}$ in. There are five layers of wire and the inductance was found to be 150 microhenries and the resistance 4.4 ohms.

11.—A multi-layer coil of No. 18 D.C.C. wire. Inside diameter $2\frac{1}{2}$ in., outside diameter 4 in., length 1 in. Its inductance was found to be 140 microhenries with a resistance of 5.3 ohms

inside diameter of 2 in., an outside diameter of $4\frac{1}{2}$ in., an inductance of 143 microhenries, and a resistance of 5 ohms.

19.—This coil has a form of basket weave winding which gives a self-supporting coil. The winding has a mean diameter of 3 in., is $1\frac{1}{2}$ in. long, has an inductance of 134 microhenries and a resistance of 4.9 ohms. No. 22 D.C.C. wire is used.

20.—A winding of No. 24 D.C.C. wire, with a mean

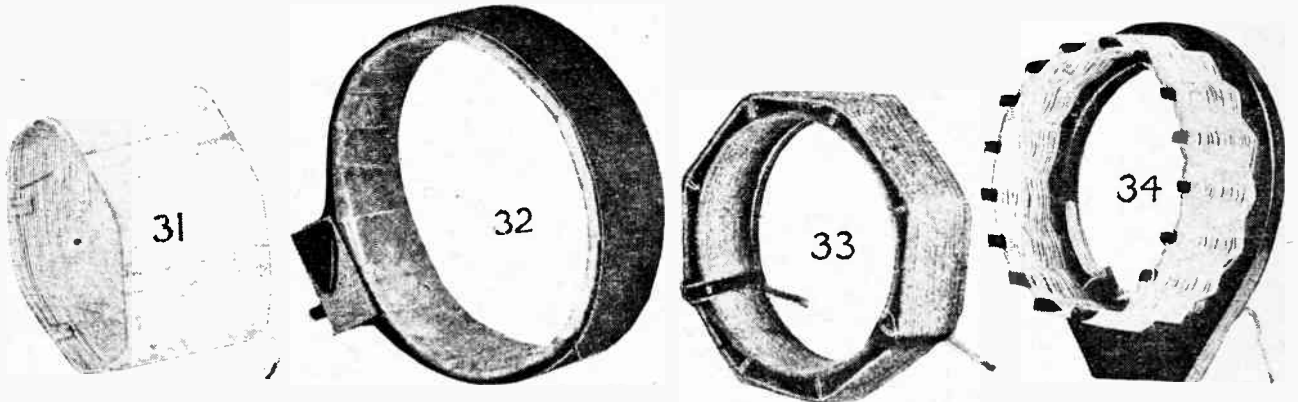

12.—A seven-layer coil. No. 22 enamelled wire, having an inductance of 220 microhenries and a resistance of 9.2 ohms.

13.—Multi-layer coil of No. 24 D.C.C. wire. Inside diameter $1\frac{3}{4}$ in. by 1 in. long. Its inductance is 125 microhenries and resistance 5 ohms.

14.—A peculiar coil of No. 20 D.C.C. wire, inside diameter about 1 in., outside diameter 3 in. The inductance of this coil is 126 microhenries and its resistance is 9.6 ohms.

diameter of 3 in., length 1 in. Its inductance was found to be 310 microhenries and its resistance 30.4 ohms.

21.—A 30-turn coil of No. 20 S.W.G. wire, the mean inside diameter being $1\frac{7}{8}$ in. and the outside diameter $2\frac{3}{4}$ in. The inductance is 60 microhenries and the resistance 2 ohms.

22.—A large basket weave type of coil of heavy wire. There are 26 turns of No. 18 D.C.C., with a mean diameter of 4 in. The inductance is 120 microhenries and the resistance 3.7 ohms.

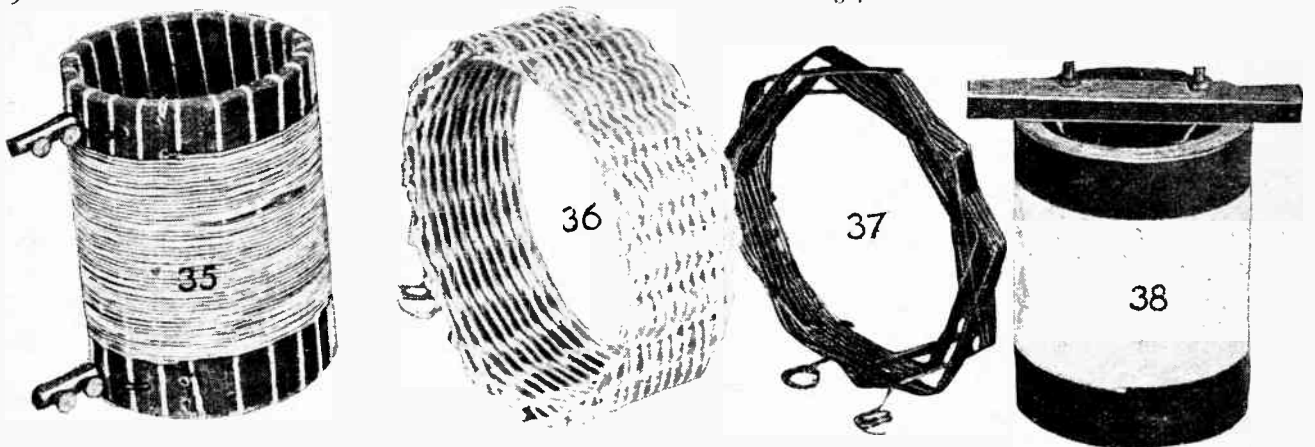

15.—Plug-in coil of No. 22 D.C.C., having an inductance of 118 microhenries and resistance of 10.5 ohms.

16.—Basket weave coil of No. 20 D.C.C. wire. Mean diameter $3\frac{3}{4}$ in., length $1\frac{1}{4}$ in. The inductance is 96 microhenries and resistance 3.6 ohms.

17.—A basket weave coil. Mean diameter $3\frac{5}{8}$ in., 42 turns of No. 20 D.C.C. Its length is $1\frac{1}{2}$ in., inductance 134 microhenries, and resistance 2.7 ohms.

18.—Stranded wire space wound basket coil, having an

23.—A basket weave coil, fitted with a plug. Its mean diameter is $3\frac{3}{4}$ in., length $1\frac{1}{2}$ in., and No. 20 D.C.C. wire is used. The inductance came out at 113 microhenries and the resistance 1.9 ohms.

24.—A nicely made plug-in coil, having an ebonite former with 14 slots about $\frac{1}{4}$ in. deep in the edge of each spoke. The hub is 1 in. in diameter and the spokes project $1\frac{1}{2}$ in. Wound with No. 30 D.S.C. wire, its inductance is 300 microhenries and resistance 14.5 ohms.

Low Loss Coil Tests.—

25.—Wound with No. 17 S.W.G. bare copper wire, the coil has 50 turns. Inductance 118 microhenries and resistance 4.6 ohms. Its inside diameter is $1\frac{3}{8}$ in., depth $\frac{3}{4}$ in., and length 1 in.

26.—A two-layer plug-in coil. Inside diameter about $2\frac{1}{16}$ in., $1\frac{1}{16}$ in. long, wound with No. 28 D.C.C. The inductance is low, being 48 microhenries, and the resistance is 1.55 ohms.

27.—A 150 microhenry plug-in coil, having a resistance of 9.7 ohms. Wound with No. 26 D.C.C. wire, its inside diameter is $2\frac{3}{8}$ in., depth $\frac{5}{16}$ in., and length $\frac{3}{4}$ in.

28.—Multi-layer coil with 60 turns of No. 20 D.C.C. wire. Its inside diameter is $2\frac{1}{2}$ in. and length 1 in. The

34.—A basket weave coil $2\frac{3}{8}$ in. diameter and $\frac{7}{8}$ in. long, wound with No. 30 D.C.C. wire. The inductance of the coil is 164 microhenries and its resistance 5.6 ohms.

35.—A single-layer coil, having 52 turns, each turn comprising 3 wires of No. 36 S.S.C. The former is a cardboard tube with lengths of string tied on, which has the effect of raising the turns of the wire a little above the surface of the tube. The coil is $2\frac{3}{8}$ in. in diameter, $2\frac{1}{2}$ in. long, has an inductance of 140 microhenries and a resistance of 3.5 ohms.

36.—A basket weave coil 4 in. diameter, $1\frac{1}{2}$ in. long, having 22 turns of No. 18 D.C.C. wire. Its inductance is 92 microhenries and resistance 1.9 ohms.

37.—A coil of No. 22 S.W.G. enamelled wire, about

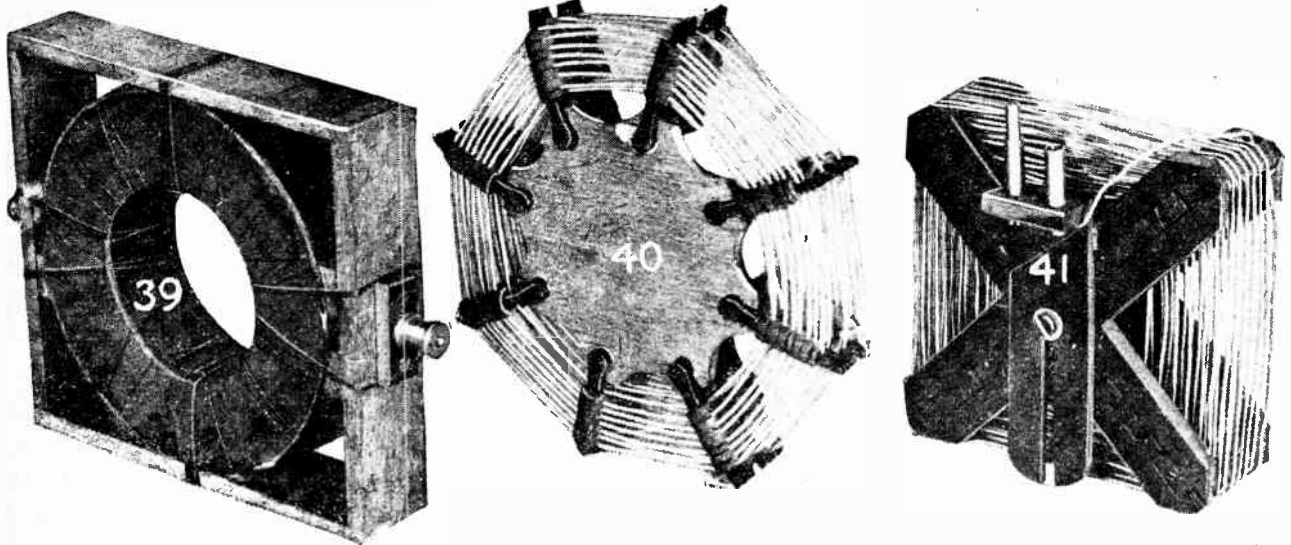

inductance of this coil was found to be 225 microhenries and the resistance 12 ohms.

29.—This plug-in coil has an inside diameter of 2 in., is $\frac{1}{2}$ in. deep and 1 in. long. Wound with No. 22 D.C.C. wire, its inductance is 63 microhenries and its resistance 2.1 ohms.

30.—A multi-layer coil of No. 26 S.W.G. enamelled wire, having a former of 2 wooden cheeks and 5 sets of ebonite spacers. The length of the inner face is $1\frac{3}{4}$ in. and of the outer face $2\frac{3}{8}$ in., while the length of the winding is $\frac{7}{8}$ in. The inductance was found to be 112 microhenries and the resistance 2.6 ohms.

31.—Pickle bottle coil. Equivalent diameter $2\frac{3}{8}$ in., length $1\frac{3}{8}$ in., having 47 turns of No. 22 D.C.C. wire. The binding strips of tape are fixed to the coil with seccotine. This coil has an inductance of 122 microhenries and a resistance of 3.3 ohms.

32.—A plug-in coil, wound with thin copper tape $\frac{7}{16}$ in. wide with a layer of paper between each turn. The mean diameter is 4 in. and the length 1 in., while its inductance was found to be 101 microhenries and its resistance 8.2 ohms.

33.—Two-layer coil of heavily insulated No. 26 gauge wire, the diameter of the inner winding being $2\frac{3}{8}$ in. and the length $\frac{7}{8}$ in. The coil has 27 turns; its inductance being 63 microhenries and its resistance 1.8 ohms.

3 in. between opposite inner faces and $\frac{3}{8}$ in. long; having an inductance of 70 microhenries its resistance is 2.1 ohms.

38.—A single-layer coil of No. 22 D.C.C. wire $2\frac{1}{2}$ in. in diameter by 2 in. long, wound on a wooden tube $\frac{1}{4}$ in. thick. It has an inductance of 142 microhenries and a resistance of 4.4 ohms.

39.—This coil is wound with Litz and is completely enclosed, the coil being packed with cotton wool. The inside diameter of the covering is $2\frac{3}{8}$ in., and the outside diameter $5\frac{1}{4}$ in., with a length of $1\frac{1}{4}$ in. The inductance was found to be 181 microhenries and the resistance 8.5 ohms.

40.—A coil in which the turns are wound in slots cut in pieces of ebonite, rubber bands being used as spacers. This coil has only 22 turns of No. 20 D.C.C., its inside diameter being $4\frac{3}{8}$ in., outside diameter $5\frac{3}{8}$ in., and length 1 in. This coil has an inductance of 70 microhenries and a resistance of 1.1 ohms.

41.—The former of this coil has crossed pieces of wood and 7 sets of ebonite spacers, making a coil of square shape, $4\frac{1}{2}$ in. outside and $2\frac{1}{2}$ in. inside. The winding itself is $1\frac{1}{8}$ in. long, and the inductance and resistance are 123 microhenries and 3 ohms respectively.

W. J.

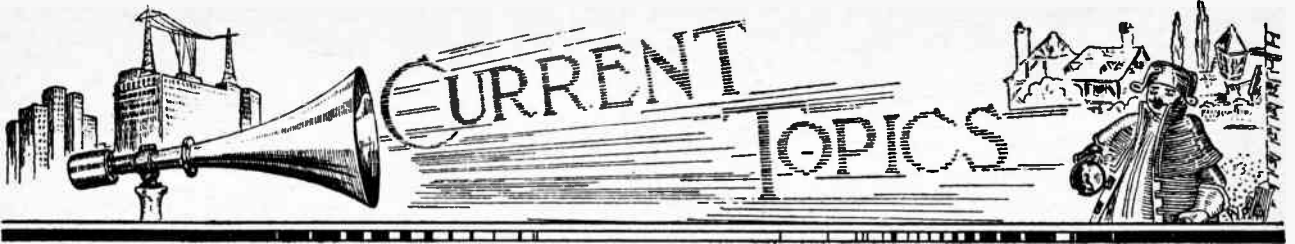

Events of the Week in Brief Review.

BROADCAST LICENCES.

The Postmaster-General states that the total number of wireless licences in force on January 31st last was approximately 1,841,000.

o o o o

MUNICIPAL BROADCAST MUSIC.

The Parks Committee of the London County Council is considering a proposal to establish a municipal orchestra for broadcasting to the people of London.

o o o o

LISTENERS AND THE LAW.

In fining a delinquent under the Wireless Act, the Hull Stipendiary ruled that a wireless licence must be obtained before the parts are put together and whether results are good or bad.

o o o o

A CASE OF DISTORTION?

Referring to the recent telephone test between Rugby and New York, the wireless news bulletin stated that the voice from Rugby "sounded as if it had come from some other part of the United States."

The engineers must eliminate this form of distortion.

ELY'S ELEVEN.

Eleven residents of Ely Haddenham, Cambridgeshire, have been fined at the Ely Police Court for contravening the Wireless Act.

o o o o

LOUD-SPEAKERS AT RAILWAY STATIONS

A scheme for the installation of loud-speakers for directing passengers at Paddington terminus is under consideration by the Great Western Railway authorities. The system would be used for emergency working only, and, if successful, may be extended to other stations on the line.

o o o o

AN ANOMALY.

Any alien in England can secure a broadcast receiving licence on payment of ten shillings at a post office. In France the British resident experiences the greatest difficulty in obtaining a licence, and the procedure involved has been known to take twelve months. The Wireless League is hoping to remedy this state of affairs by making friendly representations to the French Government.

R.S.G.B. MEETING CANCELLED.

From the Radio Society of Great Britain we learn that, owing to unforeseen circumstances, the ordinary meeting which was to have been held this evening (Wednesday) at the Institution of Electrical Engineers is cancelled.

o o o o

END OF WIRELESS STRIKE

After a struggle lasting three months the strike of wireless operators terminated shortly before midnight on Thursday last. The men are to accept provisionally the wage reduction of 22s. 6d. a month demanded by the employers, and further negotiations are to take place regarding all matters in dispute. If no agreement is reached the case will be submitted for arbitration.

o o o o

THE BRITISH INDUSTRIES FAIR.

Three more evenings are available for visiting the British Industries Fair at the White City, which closes its doors to the general public at 8 p.m. on Friday next.

A representative range of wireless apparatus is on view in the wireless section, including transmitting and receiving sets and components. The Fair will be open to the public during the next three days from 5 to 8 p.m.

o o o o

DEAD LETTER PROGRAMMES.

The fact that the Dublin station officials are experiencing difficulty in securing suitable broadcasting material hardly seems to justify the adoption of a rather perturbing suggestion made in *The Irish Radio Review*.

"Let them," says the writer, "broadcast lists of the names of people for whom letters or parcels are in the Dead Letter Office. . . . Who knows but that broadcasting can add to its numerous powers that of bringing 'dead letters' to life?"

Personally, we would rather listen to the birthday greetings during the Children's Hour!

o o o o

BOOMING BOOKS BY BROADCAST.

The Edinburgh Library authorities are finding that the demand for books is increasing to an embarrassing extent as a direct result of broadcasting.

The Duchess of Atholl mentioned this fact at a farewell meeting to South African students of the London University.

"If," said the Duchess, "one of those wonderfully eloquent speakers whom the British Broadcasting Company seem to have at its beck and call mentions a book overnight, the library is flooded out next day by people coming to ask for it."

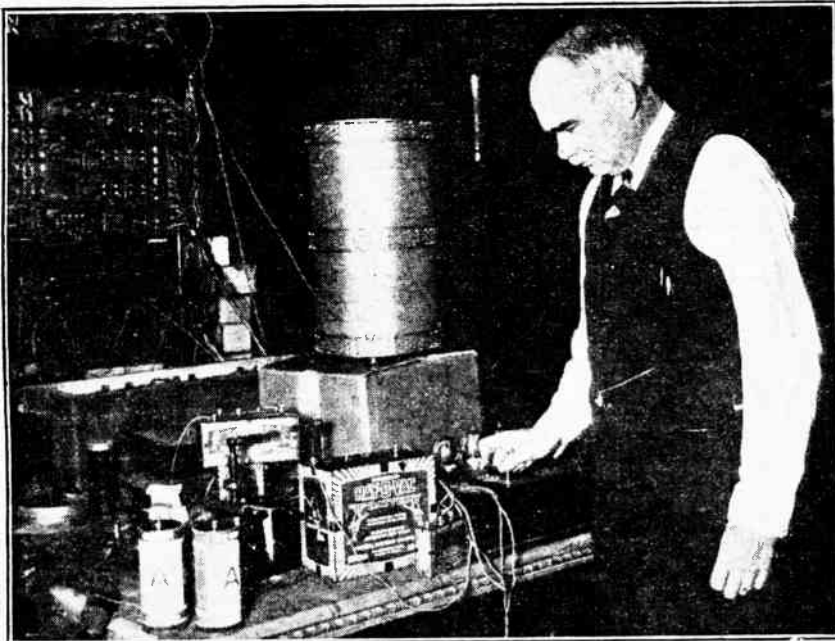

THE DE FOREST LOUD-SPEAKER. A recent photograph of Dr. Lee de Forest, who is seen testing the "Audalon," the loud-speaker of his own invention, in which a paper cylinder receives vibrations from a reed. It is claimed that the instrument radiates sound uniformly in all directions.

BROADCASTING IN PARAGUAY

A site has been chosen at Asuncion, Paraguay, for the erection of a large broadcasting station to be controlled by the municipality.

□ □ □ □

DUBLIN ASKS FOR REPORTS.

Reports from English listeners on the quality of transmission from the Dublin broadcasting station will be warmly welcomed by the editor of *The Irish Radio Review*, 179, Great Brunswick Street, Dublin.

□ □ □ □

P.O. WIRELESS LICENCE SURPLUS.

The Post Office accounts, just issued, for the year ending March 31st, 1925, reveal the interesting fact that on the issue of wireless receiving licences there was a surplus of income over expenditure of £54,346. The actual receipts from licences issued to the public amounted to £685,593.

□ □ □ □

INDIAN BROADCASTING SUCCESS.

The Indian Radio Telegraph Co.'s broadcasting station, 5AF, using a power of one kilowatt, has been picked up as far away as Ceylon and Burma in the south, and Rawalpindi and Peshawar in the west, writes a correspondent. The distances covered in some cases were well over 2,000 miles.

□ □ □ □

ANTI-DARWIN BROADCASTING STATION.

The erection of a large wireless station on the Stone Mountain, Atlanta, for the purpose of "broadcasting the old hymns," is the reported project of a Fundamentalist Secret Society in America which is engaged in combating the Darwin theory. The station will have a power of 5 kilowatts.

□ □ □ □

WHY NOT A MONOMARK?

Amateurs in general, and transmitters in particular, would do well to consider the advantages of possessing a monomark.

The new Monomark system is peculiarly suited to the needs of transmitting amateurs, many of whom would receive far more QSL cards if only their addresses were known or their listeners could forward communications with a minimum of trouble. A private monomark, such as BM XYZ3, could be easily transmitted, and the response would probably be surprising.

□ □ □ □

S.B. PLAN FOR SHEFFIELD SCHOOLS.

The establishment of a central wireless receiving station in Sheffield, with telephone lines to schools in the district, is being strongly urged by Mr. F. Lloyd, supported by the *Sheffield Telegraph* and the *Yorkshire Telegraph and Star*.

Loud-speakers and suitable amplifying apparatus would be installed at each school. It is claimed that the system would not only effect an economy over the alternative scheme of supplying each school with a elaborate wireless set, but would permit of simple switching arrangements which could be operated by inexperienced pupils.

A 30



WIRELESS IN THE HOSPITAL. A happy flashlight photograph, showing Captain P. P. Eckersley, Chief Engineer of the B.B.C., selling his autograph in support of the Hounslow Hospital Wireless Fund, at an inaugural meeting in the Hounslow Council House.

VOX POPULI.

America's latest in educational broadcasting "stunts" is a course in voice culture. KOA, the Denver station of the General Electric Company, is supplying the lessons, which will be illustrated by selected pupils who will demonstrate the correct uses of the vocal organs before the microphone.

JAMMING IN THE U.S.

Public resentment is growing in America against the disturbance to broadcast reception by naval coast stations.

□ □ □ □

WIRELESS JOURNALISM IN IRELAND.

Mr. W. R. Burns has been appointed editor of the *Irish Radio Journal* and the *Irish Radio Trader*. Correspondence should be addressed to 34, Dame Street, Dublin.

□ □ □ □

AMERICAN BROADCASTING ANNIVERSARY.

On Saturday last, February 20th, the famous broadcasting station WGY, at Schenectady, N.Y., celebrated its fourth anniversary by the transmission of a special programme.

□ □ □ □

IRISH AMATEURS, FORWARD!

The International Amateur Radio Union is promised an accession of a contingent of Irish members if success attends the efforts now being made in Dublin to form an Irish section of the Union.

Communications from amateurs interested in such an enterprise will be warmly welcomed by the organisers, Messrs. D. Fisher and D. Barton Bradshaw, 115, Anglesea Road, Balls Bridge, Dublin.

□ □ □ □

FOUR-ELECTRODE VALVES CHEAPER.

Considerable reductions in the price of four-electrode valves are announced by the General Electric Co., Ltd. The F.E.3 type (bright emitter), formerly priced at 27s. 6d., is now available at 16s. 6d., while the D.E.7 (dull emitter), which originally sold at 37s. 6d., has been reduced to 22s. 6d.

The Mullard Wireless Service Co., Ltd., are also producing a four-electrode dull-emitter valve, manufactured on the Philips pattern, obtainable at 22s. 6d.

FORTHCOMING EVENTS.**WEDNESDAY, FEBRUARY 24th.**

Muswell Hill and District Radio Society. At 8 p.m. At St. James's Schools, Fortis Green, N.10. Lecture: "Wireless Transmission," by Mr. J. R. Miller, Edinburgh and District Radio Society. At 11.7, George Street. Lecture: "Sound," by Mr. W. Anderson.
Birnley and District Wireless Association. At 8 p.m. At 22, Market Street. Lecture: "Broadcasting," by Mr. Lionel Harvey, of the Leeds-Bradford Relay Station.

FRIDAY, FEBRUARY 26th.

Sheffield and District Wireless Society. At 7.30 p.m. At the Dept. of Applied Science, St. George's Square. Lecture: "Direction Finding and Directional Reception," by Mr. R. Keen, B.Eng.
Radio Experimental Society of Manchester. Experimental evening.

SATURDAY, FEBRUARY 27th.

Grimshy and District Radio Society. Visit to the Hull Relay Station.

MONDAY, MARCH 1st.

Ipswich and District Radio Society. Open night.
Southport and District Radio Society. At 7.30 p.m. At St. Andrew's, Part Street. Lecture by Mr. Buggs, of the Manchester Radio Scientific Society.
Swansea Radio Society. Lecture: "Recent Improvements in Valve Receivers," by Mr. T. Macnamara.

WEDNESDAY, MARCH 3rd.

Institution of Electrical Engineers (Wireless Section). At 6 p.m. (Light refreshments at 5.30.) At the Institution, Savoy Place, W.C.2. Lecture: "The Directional Recording of Atmospherics," by Mr. R. A. Watson Watt, B.Sc. (Eng.).

The Re-creation of Speech & Music



WHEN using an A.J.S. Loud Speaker you are most certainly getting the best out of your receiver. You can hear the high and low as well as the middle notes of a passage of music, and these high and low notes are in tune, not flat. Also you can hear all the overtones. It is this property of reproducing the overtones which gives to the A.J.S. Loud Speakers the soul of a rare violin. These speakers can handle all the power you can give them without any tendency to rattle. A.J.S. Loud Speakers are not black unless you particularly desire them so. They may be obtained with Metal Flares, coloured and grained by hand, to resemble various fine woods.

The most popular models are those with flares of Mahogany or Oak. They look well and sound better.

Junior Models may be obtained with metal flares only. These are not "Baby" models, but stand 19 inches high and produce full round tone. The Junior Cabinet models in Mahogany are exceedingly pleasing to the eye, as well as being faithful reproducers of all music.

A.J.S. Loud Speakers and Receivers may be obtained by easy payments from H. Taylor & Co., Ltd., 49-53, Sussex Place, South Kensington, S.W 7 (nr. Kensington Station).

Write for particulars.

A.J.S.

STANDARD LOUD SPEAKERS.

Height 24 inches.
In Wood—
Mahogany or Oak Flares
£4 15 0

In Metal—
Black Matt or Stove Finish
£4 0 0

Grained, various wood finishes
£4 5 0

JUNIOR LOUD SPEAKERS.

In metal, Height 19-in.
Black Horn
£1 15 0

Grained wood finish
£1 17 6

Publication No. 118 is fully illustrated, and describes all our models. May we send you a copy to-morrow?

A. J. STEVENS & CO. (1914) LTD.
Radio Branch, WOLVERHAMPTON.

'Phone: 1746 (7 lines). 'Grams: "Reception, Wolverhampton."

London Showrooms: 122/124, Charing Cross Rd., W.C.2.

'Phone: Regent 7161-2. 'Grams: "Ajayess-co, Westcent, London."

Glasgow Showrooms: 223, St. George's Road, Glasgow.

'Phone: Douglas 3449. 'Grams: "Reception, Glasgow."

A. J. Stevens & Co. (1914) Ltd., Radio Branch, Wolverhampton.

Please send Publication No. 118.

NAME

ADDRESS

W.W. 21/2/26.

Issued by the Publicity Dept. A.J.S.

Whatever your set a Gecophone Condenser will better it because—

1.—It gives micrometer adjustment.

The patent friction-drive micrometer movement is the most ingenious design in the history of condenser manufacture. It is assisted by a control knob of extra large size.

"The beautiful slow adjustment, which is perfectly smooth and without the slightest backlash, far surpasses that of any condenser I have yet tested."

Mr. S. MacDonald Ashe. Dublin.

"You cannot miss a station."

Capt. Baker, M.C. Tewkesbury.

2.—There is no hand-capacity.

The square-law rotary plates are connected to the frame, a feature of design which completely eliminates hand-capacity.

"Hand-capacity effects, which previously had been troublesome, disappeared when using the GECOPHONE Condenser."

Mr. W. A. Andrews B.Sc. Bristol.

3.—It is really low-loss.

The fixed plates are insulated outside the electrostatic field, and insulation is reduced to a minimum in bulk and contact area. Dielectric loss is thus the smallest possible.

"Every theoretical consideration tending to reduce the loss of high-frequency energy appears to have been given adequate attention."

Electrical Industries.

4.—It has low minimum capacity—

A National Physical Laboratory report gives the minimum capacity of the GECOPHONE Condenser as 1.50 of the maximum. That of the .0005 type is .00001—lower than in any other condenser built.

"A point which impressed me was the increase of one's tuning range, due no doubt to the unusually low minimum capacity of this condenser."

Mr. T. MacNamara. Swansea.

5.—and excess maximum capacity.

The N.P.L. report further states that the maximum capacity of the GECOPHONE Condenser is in excess of rated value.

6.—It is an engineering product.

"It seems to be made with the accuracy of a chronometer. The plates are so closely meshed that only the best workmanship could produce such alignment."

Mr. Mark Potter, in "Leeds Mercury."

Your wireless dealer sells it!

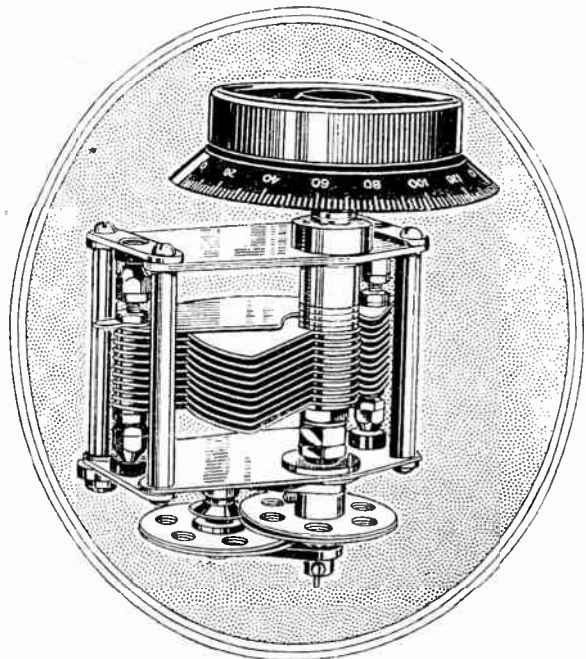

GECOPHONE

LOW LOSS-SLOW MOTION VARIABLE CONDENSER

Capacity	Price
mfd	
.0002	22 -
.00025	23 -
.0003	24 -
.0005	27/6
.001	32/6

*The G.E.C.—
your guarantee.*

The Latest Development

THE 2-VOLT VALVE
with a Current Consumption of
·12 AMP.

Osram
D.E. 2
H.F. & L.F.

Osram Valves

for Broadcasting

2-Volt Valves with a
6-Volt Result

The G.E.C. - your guarantee

EDISON BELL RADIO

COIL NUMBERS

15, 20, 25,
35, 40, 50,
75, 100, 120,
150, 200,
250, 300,
400.



"THERE IS NOTHING BETTER THAN THE BEST"—
WE SUPPLY YOU WITH THE BEST.

ASK YOUR DEALER FOR FULL RANGE OF CATALOGUES
IF UNABLE TO OBTAIN WRITE DIRECT TO THE MANUFACTURERS.

EDISON BELL INDUCTANCE COILS

PRICES: Coils number 15-50, 2/6; 75-150, 3/6; 200-400, 4/6.

J. E. HOUGH, LTD., Edison Bell Works, LONDON & HUNTINGDON.

TESTED 500 VOLTS
FLAT TYPE



TESTED 500 VOLTS
UPRIGHT TYPE

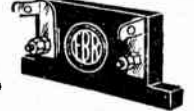

INSIST ON EDISON BELL CONDENSERS

THEY ARE BRITISH MADE AND GUARANTEED BY A NAME WITH 30 YEARS REPUTATION BEHIND IT

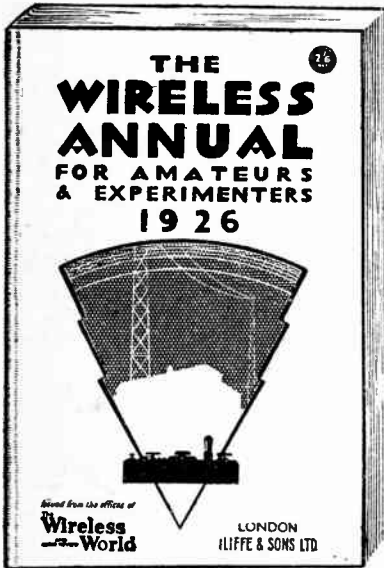

Do not fail to GET a COPY of this invaluable BOOK!

ORDER TO-DAY!

"The Wireless Annual" for 1926 is a volume of indispensable information for every keen radio amateur. It contains a whole mass of facts which are of daily assistance in amateur wireless work. Get your copy to-day!

Price 2/6. By post 2/8½.

From all newsagents and booksellers or direct from:
ILIFFE & SONS, LTD., Dorset House, Tudor Street, London, E.C.4
W.W.5a.

The Diary for Wireless Enthusiasts is The Wireless Diary 1926

Compiled by the Editorial Staff of "The Wireless World."

Contains over 75 pages of indispensable information for all who take a keen interest in this fascinating hobby, including:

A revised list of Experimental Transmitting Stations; Hints for Aerials and Earths; Efficient Crystal Receivers; Practical One-valve, Two-valve, and Three-valve Circuits; Neutrodyne and Supersonic Heterodyne Receivers. In addition—a convenient and well-printed diary giving one week at an opening.

PRICES

Cloth Edition 1/-, postage 1½d. extra;
Leather Case, with pockets, pencil, and season ticket window, 2/6, postage 2d. extra.

Obtainable at all Booksellers and Railway Bookstalls.

Published jointly by

"The Wireless World," Dorset House, Tudor St., London, E.C.4, and Messrs. Chas. Letts & Co.



A Review of the Latest Products of the Manufacturers.

KING FILAMENT RHEOSTAT.

Among the American apparatus handled by Gaston E. Marbaix, 27-28, Auning Street, E.C.2, is a series of well-made components manufactured by King Quality Products, Inc. The rheostat manufactured by this company is fitted with an "on and off" switch so that the filament current circuit can be broken without changing the setting of the rheostat.

The body of the rheostat, as well as the operating knobs, are of moulded Bakelite, and possess a bright, clean appearance. The contact arm makes smooth contact with the resistance wire, and at the maximum current setting rests on a strip of metal so that the end turns of the resistance spool are excluded from the filament circuit.

It is interesting to note that the one-

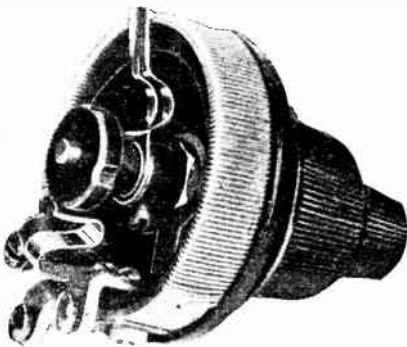

The King filament rheostat is fitted with an "on and off" switch operated from a knob concentric with the main operating knob.

hole method of fixing is abandoned, the resistance being attached to the instrument panel by a pair of screws, a method which is at least as simple as the one-hole system and is probably more reliable.

○○○○

THE J.J.R. TERMINAL.

An almost essential feature with regard to the terminals employed in wireless receiver construction is that they shall carry identification lettering to indicate the connections which are to be made to them.

The J.J.R. terminals manufactured by Messrs. J. Rowe, 7-8, Ross Parade, Wallington, Surrey, are fitted with polished inset top pieces carrying lettering to indicate the circuit connections. A

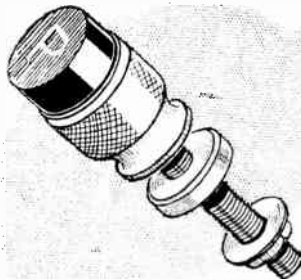

J.J.R. indicating terminal fitted with non-rotating top.

special merit in the design of these terminals is that the centre piece does not rotate, while both black and red centre pieces are fitted to indicate the positive and negative leads. Close examination reveals that the centre piece carrying the lettering is securely attached to the spindle and cannot unscrew.

○○○○

COSMOS ANTI-VIBRATION VALVE HOLDER.

Included in the range of component parts recently introduced by Metro-Vick Supplies, Ltd., 4, Central Buildings, Westminster, London, S.W.1, is the Cosmos anti-vibration valve holder.

The sockets which make contact with the valve pins are carried on a plate of insulating material, and contact is made with the fixing screws through four coiled bronze springs. A small ebonite stud secured to the centre of the holder limits the movement of a valve when inserted in the holder, and also prevents the plate which carries the sockets from lifting when the valve is withdrawn.

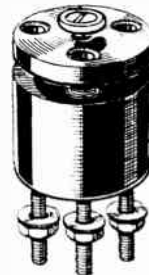

The new Cosmos valve holder.

STERLING MINLOSS CONDENSER.

Progress in condenser design still continues, and a further advance has been made by the Sterling Telephone and Electric Co., Ltd., 210-212, Tottenham Court Road, London, W.1, with the introduction of the new "Minloss" variable condenser.

New features include the use of Pyrex glass insulators for giving support to the fixed plates, the bonding together of the fixed plates by soldering, the use of a braided connector for ensuring good contact with the moving plates, the adoption of a pointer and engraved scale in place of the usual graduated dial, and a reduction gear drive operated by an auxiliary spindle. The pointer, which is secured to the shaft by means of a pin, can be set in several different positions.

The reduction gearing is of particular interest, as every endeavour has been made to eliminate back-lash between the operating knob and the spindle carrying the moving plates. The mechanism of the drive is shown in detail in the accompanying illustration, and consists of

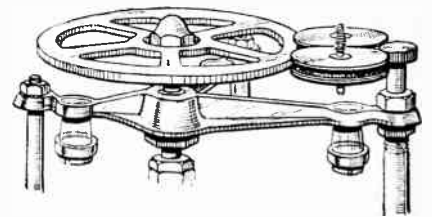

Reduction gear adopted in the new Sterling Minloss condenser.

two rubber-faced wheels held together with tension springs producing a friction contact with the milled pinion on the auxiliary shaft and a large diameter wheel attached to the condenser spindle. A smooth, silent movement is obtained, with absence of backlash, whilst the elasticity of the indiarubber on the intermediate wheels prevents undue strain being applied to the moving plates at the positions of maximum and minimum setting.

Apart from the electrical and mechanical merits of this new condenser, the good appearance of the black and silvered dial and cleanly finished Bakelite pointer will recommend it to the amateur who gives careful attention to an attractive panel layout.

GENERATING ELECTRICAL OSCILLATIONS.

A Lecture at Oxford by Dr. W. H. Eccles, F.R.S.

DR. W. H. ECCLES, F.R.S., addressed a meeting of the Oxford University Radio Society, at Oxford, on Wednesday, February 17th, on the subject of "Some Recent Methods of Generating Electrical Oscillations."

The meeting, which took place in the Electrical Laboratory, Parks Road, was the fifth held by the Society, which commenced operations only at the beginning of this term. Mr. H. Field, of New College, who is operating Station 6ZX, is President of the Society, and was in the Chair.

Dr. Eccles, in his lecture, discussed methods, with which he has been concerned for the last year or two, of generating electrical oscillations, and which are based on the utilisation of harmonics. The idea, he said, is to take a low-frequency vibration which is impure to begin with, or can be made impure, and the impurities are picked out, magnified and utilised. In the case of acoustic vibrations it is well known to musicians that one does not get a pure sine wave. The tuning fork, perhaps, gives one of the purest sine wave curves, but even that has some impurities.

Application of Harmonic Frequencies.

In the first place, Dr. Eccles showed how a tuning fork can be made to give a sustained vibration of constant amplitude and constant frequency by the use of two electro-magnets, of which one is in the grid circuit, and the other in the anode circuit, of a triode valve. It is found that the current running in the anode circuit contains harmonics, and that one can pick out any particular harmonic by the aid of suitable apparatus. Using a tuning fork with a frequency of 2,000 vibrations per second, for instance, one can pick up a harmonic with a frequency of 16,000 per second, by putting into the anode circuit a coil and condenser connected in parallel and of such inductance and capacity as to resonate to the frequency of 16,000 per second.

As an example of the application of a harmonic frequency, Dr. Eccles described what has been done by the Post Office engineers at the new station at Rugby. A fork is used, the frequency of which can be adjusted by lengthening or shortening the prongs by means of a set-screw. The fork has a frequency of 2,000 cycles, and the current of 16,000 frequency in the fork circuits is amplified in five stages until 50 kW. of high-frequency energy is produced. The engineers have not yet dared, or needed, to use the whole 540 kW., however. On the first occasion on which the antenna was excited, only 50 kW. were used, *i.e.*, one-tenth part of that which it was possible to use. The Post Office immediately received a cable from Java, to the effect that Rugby was jamming the Dutch station which was sending to Java. That was very encouraging (laughter). As the tests proceeded the number of valves was increased, and at present they are using about 250 kW. on the antenna, *i.e.*, about half power. With half power there is a current of about 550 amps. in the antenna, and that seems to be sufficient to reach every part of the globe.

Advantages of the Tuning Fork.

The application of the tuning fork to the production of high-frequency oscillations has many advantages over other methods, but its value is not limited to the transmitting end alone. If one has a fork of 2,000 periods per second, and utilises a frequency of 16,000 periods per second for inducing radiation, after magnification, the wavelength or frequency is just as constant, proportionately, as the fork. A fork has a very small rate of change of period per degree of temperature. If the fork were to vary one degree in temperature, the output frequency would vary only from 16,000 to 16,001.4. That of course, is immeasurable by ordinary wireless telegraph apparatus. By using a fork made of the alloy "Invar," however, or by putting the fork box in ice, even that small change of temperature can be abolished.

The same method can be used for receiving, and the fork apparatus which he exhibited has been successfully used for receiving Rugby. A harmonic of the fork, of a frequency about 15,000, was used to heterodyne the 16,000, and one got a constant heterodyne note. Using note tuning, there is no trouble by disturbance from other stations, however close, providing there is a difference of more than 40 cycles between them.

The triode valve is in itself capable of distorting a sine wave electromotive force applied to its grid. Many inventors have suggested ingenious circuits for selecting desired harmonics, and Dr. Eccles went on to deal with some of his own work in this connection. One method which he suggested was to use the currents from the fork to produce motions of a beam of cathode rays in the vacuum tube. One can apply a fork to a cathode tube so as to produce a rotation of the cathode beam, which will make a ring pattern on a fluorescent screen. Instead of having a fluorescent screen on the end of the tube, he had tried to put some wires there, so that, when the cathode stream passed over the wire, that wire acted as an anode and received a stimulus.

When seeking methods for exaggerating harmonics, *i.e.*, methods of distorting a sine wave, he had made experiments with neon tubes. It is known that the current starts suddenly at about 140 volts, and the curve rushes up suddenly. If the voltage is increased further, the current increases steadily again. When the voltage is reduced, however, it comes down to 130 volts before the sudden drop occurs.

A Demonstration.

Quite a number of experimenters have used neon tubes to produce harmonics which will receive signals by the heterodyne method. In a circuit which is well known, when the battery is switched on the current flows through a resistance and charges a condenser. The current flows in slowly at first, but when it attains 140 volts the lamp flashes, the condenser is discharged, and then commences to charge again. It can be made to charge and discharge 50,000 times per second, and harmonics can be produced in that way. In his apparatus Dr. Eccles has arranged electro-magnets and a fork so that the neon tube current can act upon it. When the fork moves in such a direction as to induce another two volts the lamp flashes. When the fork goes in the opposite direction it reduces the voltage and the lamp is extinguished.

The apparatus, which had been made up for the lecturer by Dr. Leyton, was demonstrated. The battery used puts about 138 volts on to the tube, but, in order to obtain fine adjustment, he has also put in series a potentiometer with 6 volts across it. The potentiometer enables him to vary the applied electromotive force. As soon as the fork vibrates, and the vibration is maintained by the pulsating currents, one can be sure that the period of the flashes will remain constant. That is the whole point of introducing the fork. Without it, the frequency varies from moment to moment. Even the warmth from one's hand warms the tube and alters the vacuum, so altering the frequency, whereas if a fork is used and sustained in vibration it coerces the tube over a very wide range and keeps it going.

Asked if the Rugby station has yet used speech transmission, Dr. Eccles replied in the affirmative. There is a telegraph plant, he said, capable of giving 540-kW. to the aerial, using 8 masts; a telephonic plant capable of giving about 300-kW. to a 4-mast aerial; and there is short-wave plant. The set of which he had been speaking was the telegraph set. The telephony set was started up for speech operation at 3 a.m. on Sunday, February 7th, and, after preliminary tests, speech was commenced with New York at 4 or 5 o'clock, being transmitted continuously both ways until 7.30 p.m. It could go on all night, however, and since then it has been working many mornings from 2 until 7 o'clock.

VALVE-CRYSTAL REFLEX SET

An Economical Receiver of Simple Construction.

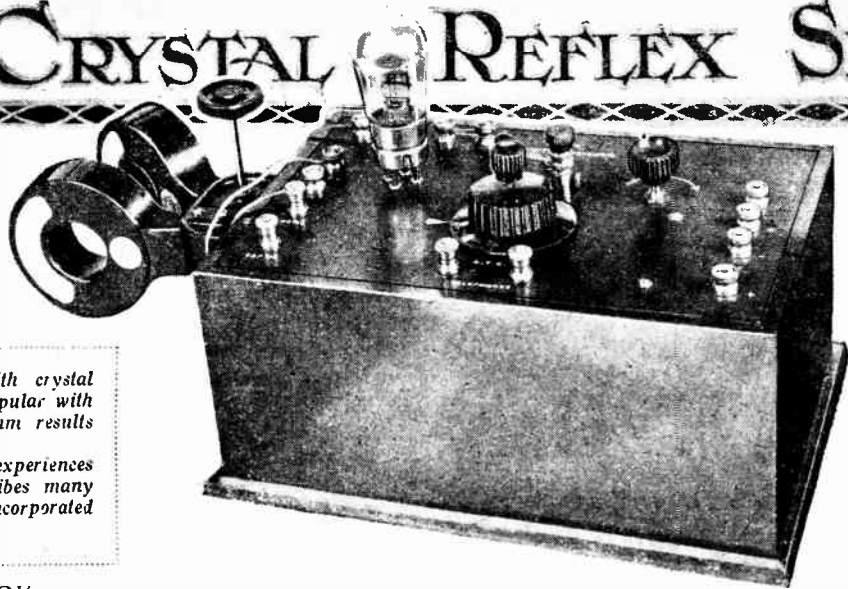

The single-valve reflex set with crystal rectification has always been popular with experimenters requiring maximum results for a minimum outlay. Our contributor in giving his experiences with this type of circuit describes many improvements which have been incorporated in the design here presented.

By F. GORDON COOK.

EXPERIMENTS with various types of single-valve circuits have gone to show that an efficiently constructed reflex, or "dual amplification," receiver, utilising a crystal for rectifying, gives better range and power than any in which the valve performs solely as a detector.

With the reflex type of circuit the valve is made to act both as a high-frequency and a low-frequency amplifier, and if this can be done successfully the results, for a one-valve set, are most gratifying. The trouble with reflex circuits of this type has been in the use of reaction. In the usual form of reflex receiver, where reaction is carried out in the plate circuit of the valve, the slightest attempt at proper regeneration either tends to make the valve detect, which upsets the whole arrangement of double-amplifying, or a low-frequency buzz, peculiar to this type of circuit, is set up, both conditions making for a serious loss of efficiency. The circuit shown in Fig. 1 will be found to obviate these troubles in a marked degree.

Novel H.F. Transformer Design.

Here, high-frequency amplification is obtained by means of a transformer of special design. This is

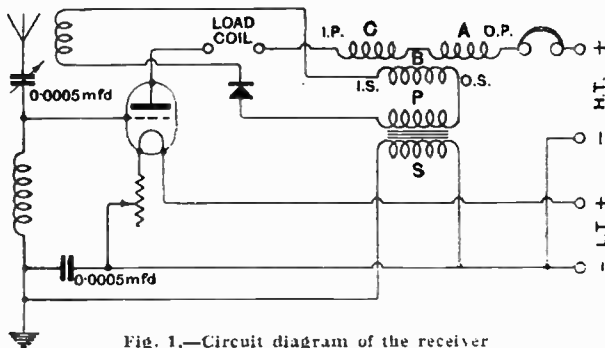

Fig. 1.—Circuit diagram of the receiver

extremely simple and cheap to construct, and the process is as follows:—Obtain an ordinary reel insulator—these can be purchased at any radio dealer's for one penny—and in the centre ridge wind 100 turns of fine D.S.C. wire, making your winding in clockwise direction, and taking care to note which ends of the wire are the beginning and the end of the winding. Having done this, bind a single turn of empire tape over the layer, and then proceed to wind another layer of 100 turns in the same manner. Bind a turn of empire tape over this second winding, and then wind a third layer of 100

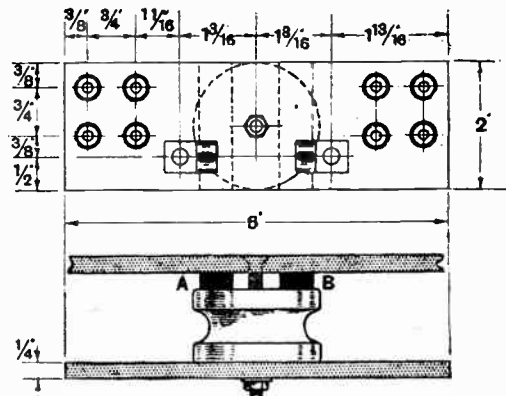

Fig. 2.—Details of the H.F. transformer and sub-panel.

turns, joining the commencement of this winding to the finishing wire of your first winding. The whole may then be bound round with more empire tape, so that a neat finish is given to the transformer. The end of the wire which finishes the third winding will be IP, and the commencement of the first winding will be OP, whilst the centre winding will form the secondary, the end of the wire with which you commenced winding being OS and the finishing end representing IS. There is no special method in winding the wire, and the only care necessary is to see that the ends of the windings do not get mixed

Valve-Crystal Reflex Set.—

up, otherwise the transformer will not work. This transformer appears in the circuit diagram with the three windings clearly marked. A is the first winding on the reel, B the middle, and C the outer, and the connections are shown.

The signals to be received, having passed through a stage of high-frequency amplification, are detected by the crystal, and then fed back to the grid of the valve through an iron core transformer of usual design and ratio. So far, the circuit follows ordinary practice, but the main point of difference lies in the disposition of the reaction coil, which, instead of being in the anode circuit, is in the transformer secondary circuit, prior to the detector. For Broadcast wavelengths this coil may be a No. 50, and, to give further selectivity and ease of control, may be tuned with a 0.0003 mfd. variable condenser, in parallel. The reaction coil is coupled to the A.T.I. in the usual manner, and it is best to use a two-way coil holder giving critical adjustment, at the same time making sure that the coil is properly connected. Should no reaction take place the coil leads should be reversed.

Crystal Detectors for Reflex Sets.

This method of retroactive coupling in a reflex circuit will be found a distinct advantage over the usual anode reaction; the degree of amplification is considerable, while the receiver does not so readily tend to break into self-oscillation.

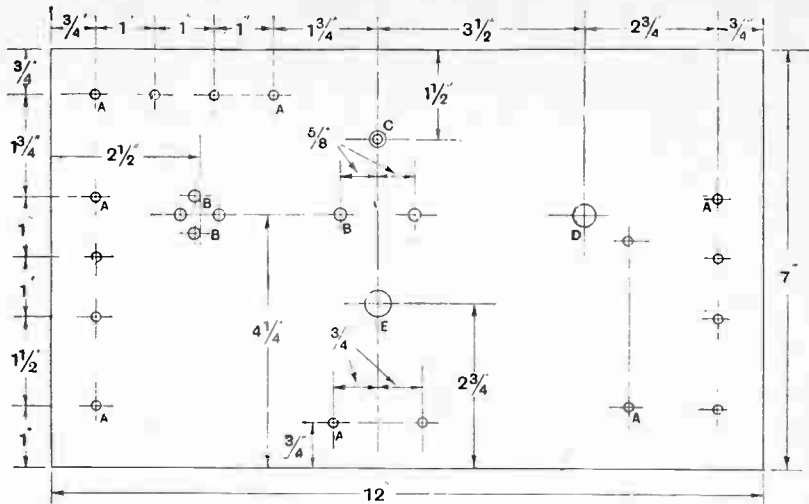

Fig. 3.—Drilling details of the receiver panel. Sizes of holes are as follow: A 5/32in. dia.; B, 3/16in. dia.; C, 3/16in. dia.; D, 3/8in. dia.; E, 7/16in. dia.

A most important point in the construction of the actual receiver is the choice of a crystal detector. The automatic catwhisker type of detector, of which there are several now on the market, may be used with confidence, but any instrument calling for continuous adjustment of the catwhisker should be studiously avoided. A carborundum-steel combination has much to recommend it, from the point of view of stability and permanence of adjustment, and this, of course, necessitates the use of a small battery and a potentiometer. Excellent all-round results have, however, been obtained with a perikon type of detector using a combination of zincite and tellurium.

There is another crystal on the market, though little known, called "Ghane", and this, in conjunction with tellurium, gives results which cannot be surpassed. The crystals should be gently, but firmly, brought into contact, and, when once set, may be left untouched for a long period. The certain harshness of tone associated with a catwhisker or carborundum detector is entirely non-existent in the perikon type, which has a full, rich tonal quality. A good quality L.F. transformer should be used, and the fixed condenser shunting the secondary winding should also be of reputable make. The value of this condenser is not critical, 0.0005 mfd. having been found very suitable.

It will be noted that in this receiver the lead from the plate to IP of the H.F. transformer has been broken, these points being taken to two extra terminals, marked "load coil" provided on the panel. These are shorted by a metal strip when the receiver is being used on the lower broadcast wavelengths, but are made the connections for a primary loading coil when tuning up to

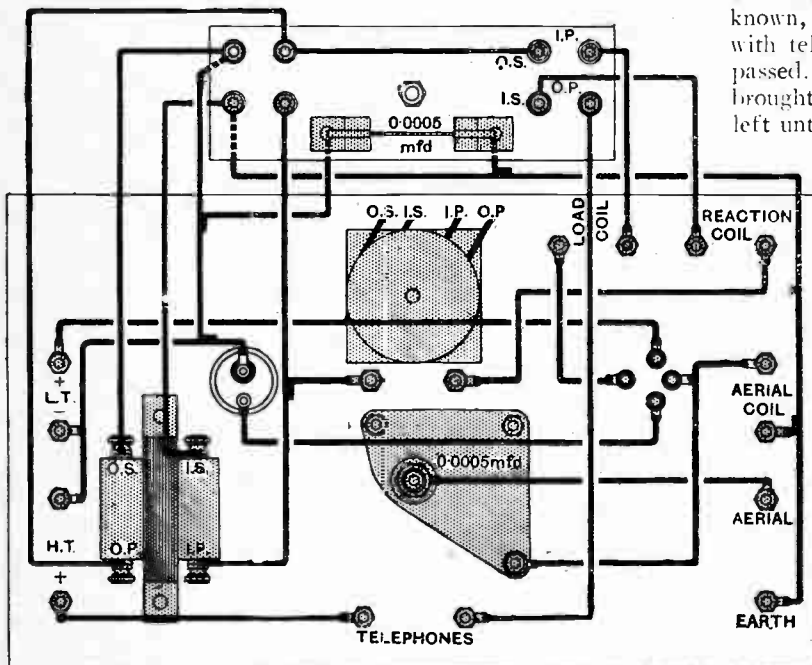

Fig. 4.—Wiring diagram. The leads from the H.F. transformer, marked O.S., I.S., O.P. and I.P., are joined to the four terminals in the top right-hand corner of the diagram.

¹ Obtainable from Messrs. A. Hinderlich, 1, Lechmere Road, London, N.W.2.

COMPONENTS AND MATERIALS REQUIRED.

- 1 Ebonite panel, 12in. × 7in. × ¼in.
- 1 Ebonite panel, 6in. × 2in. × ¼in.
- 1 0.0005 mfd. variable condenser (preferably square law, with vernier).
- 1 0.0005 mfd. fixed condenser (McMichael plug-in type).
- 1 Crystal detector (Elwell).
- 1 2-way coil holder (Lotus).

- 1 L.F. transformer.
- 1 Filament resistance (Microstat or Lissenstat).
- 1 Valve holder; 2¼in. 2 B.A. screwed rod, nuts and washers; 18 terminals; ebonite or wood distance pieces, 2in. × ¼in. ¼in.; 1 china reel insulator; quantity No. 30 enamelled or D.C.C. wire; connecting-up wire; screws, etc., for mounting components.

Approximate Cost - - - £3 1s. 6d. including polished cabinet.

the higher band. This coil can be of the basket type, consisting of 50 turns, clamped to the reaction coil with its winding in the same direction. When both are basket coils they may be mounted together on an ordinary basket coil holder, the whole forming a loading H.F. transformer for wavelengths of 1,000 metres and over. Again, the secondary terminals may be "loaded" and the reaction coil connected direct to the primary circuit, this method being quite effective on the longer waves.

Details of Construction.

The construction of the receiver is quite a straightforward job if the design given here is followed. In addition to the main panel, a sub-panel is used, which in the first place is made up as a separate unit and, when mounted, is wired up with the rest of the components. The H.F. transformer is fixed to the middle of the sub-panel by means of a length of No. 2 B.A. screwed rod passing through the centre hole of the reel, as shown in Figs. 2 and 4. The sub-panel also carries the by-pass condenser, and on the end opposite to the H.F. terminals are four other terminals which are wired up in the circuit as for the L.F. transformer, and are marked IP, OP, and IS, OS respectively. In this manner, a complexity of wiring is avoided and assembly is simplified. The L.F. transformer itself, mounted on the main panel, is connected to the corresponding terminals on the sub-panel.

The details for constructing and wiring the sub-panel unit are given in Figs. 2 and 4. The plug-in condenser may, of course, be substituted by a condenser of standard design, but the former is to be preferred, both on account of its adaptability and because it may readily be changed if the constructor, in experimenting, desires to use a condenser of higher capacity.

Having finished the sub-panel unit, it may be set aside and the main panel prepared. The dimensions given in Fig. 3 are those of the original receiver shown in the photograph, and the constructor need not deviate from them, unless he desires to use a larger crystal detector than the one shown, or a bulkier transformer: in which case the size of the panel will be slightly increased accordingly. The measurements given, however, are sufficient to accommodate the average transformer; and as regards the detector, the instrument shown has been found very

suitable for the circuit, and has the additional advantage of being supplied complete with zincite and tellurium crystals conveniently mounted.

Having mounted the components on the main panel, the wiring may be proceeded with. A and B (Fig. 2) are two distance pieces of ebonite or wood, which are placed parallel between the transformer reel and the main panel,

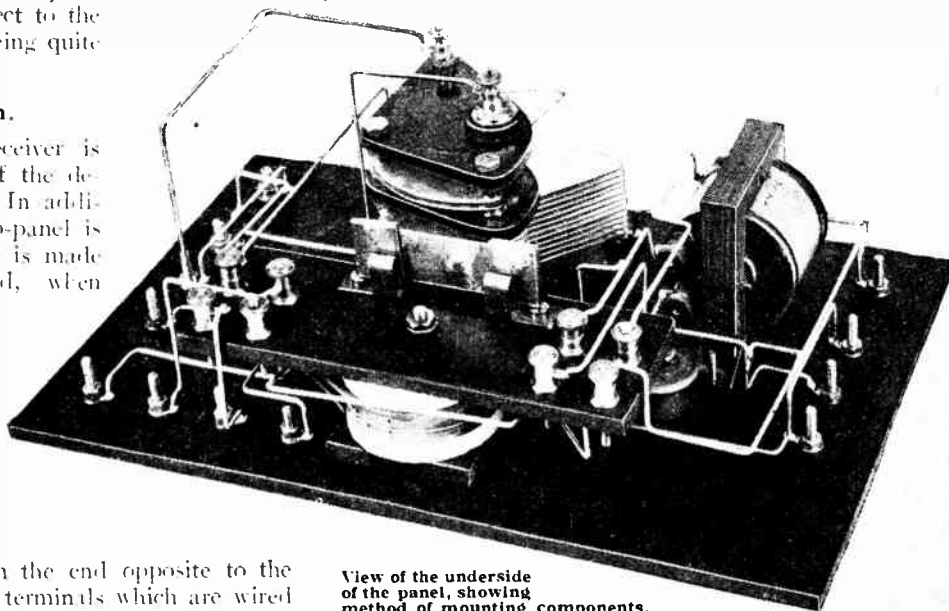

View of the underside of the panel, showing method of mounting components.

so that by tightening the nuts on the centre rod the whole may be clamped up with sufficient rigidity for the purpose.

With the sub-panel in position the wiring may be completed in accordance with the practical wiring diagram (Fig. 4).

To obtain best results the constructor need hardly be reminded that only components of indubitable quality should be used. The coil holder should be of a type capable of giving fine adjustment, as also the filament rheostat and the variable condenser. A fixed condenser of 0.002 mfd. may be shunted across the telephones, although this is not absolutely necessary. A loud-speaker may be worked comfortably on the local station, while for distant reception it is as well to bear in mind that a little "tuning" with the filament resistance may enable a distant and elusive station to be more easily logged.

The feature of this receiver is the absence of low-frequency buzzing, and the consequent ease with which reaction may be used. A set built on the lines suggested here can be experimented with considerably, and, carefully handled, will be found to give excellent results for a "one-bottle" receiver.

WIRELESS CIRCUITS

in Theory and Practice.

5.—Capacity and Resonance in A.C. Circuits.

By S. O. PEARSON, B.Sc., A.M.I.E.E.

CAPACITY, as the name implies, is the extent to which a condenser is capable of holding a charge or quantity of electricity when a given potential difference or voltage exists between the two sets of plates. It is unnecessary to describe here the construction of a condenser; suffice it to say that the quantity of electricity held by a condenser is directly proportional to the voltage between the plates and to the capacity. A condenser has a capacity of one *farad* if the potential difference between the two sets of plates is raised by one volt when a current of one ampere flows into it for one second; or, more briefly, the capacity is one farad if the condenser holds a charge of one coulomb of electricity when the potential difference is one volt. Thus, if the charge is Q coulombs when the potential difference between the plates is E volts, the capacity will be

$$C = \frac{Q}{E} \text{ farads.}$$

This is an extremely large unit, and no single condenser exists the capacity of which is even one-hundredth part of a farad. For practical purposes the capacity of a condenser is expressed in *microfarads* (millionths of a farad), usually denoted by mfd. or μF , but the *farad* must be used for purposes of calculation. Even the microfarad is a large unit for wireless purposes, tuning condensers not, as a rule, exceeding 0.0015 mfd., and for very small values of capacity, such as that between the electrodes of a valve, the capacity is usually expressed in micromicrofarads (millionths of a microfarad), denoted by mmfd. or $\mu\mu F$.

When a current is flowing into a condenser the charge accumulates at a rate proportional to the current, and in terms of the practical units we may write

$$\begin{aligned} \text{current } i &= \text{rate of change of charge} \\ &= C \times (\text{rate of change of voltage}), \end{aligned}$$

because $Q = C \times E$.

Note that this relationship is akin to $e = L \times (\text{rate of change of current})$ as found previously in connection with inductance.

Conditions Existing in Charged Condensers.

When a condenser is in the uncharged state, i.e., when there is no potential difference between the plates, it is assumed that both sets of plates carry an equal number of electrons or elements of negative electricity. As the condenser is being charged some of these electrons pass round the external circuit from the plate which is

acquiring a positive potential to the plate which is becoming relatively negative, the electrons themselves constituting the negative charge, and deficiency of electrons constituting the positive charge. The passage of these electrons round the external circuit represents a current in that circuit, the magnitude of the current in amperes being equal to the product of the capacity in farads and the rate of change of potential difference in volts per second as explained above.

Capacity in an A.C. Circuit.

When an alternating potential difference is applied to the terminals of the condenser it becomes charged alternately in each direction as the voltage reverses, and so the electrons will be surging backwards and forwards round the external circuit from one plate to the other, and will therefore constitute an alternating current in that circuit, the frequency being the same as that of the voltage. It must be noted that no electrons pass from one set of plates to the other *through* the insulating material or *dielectric* separating the plates—that is to say, no current actually passes through a condenser of perfect insulation, although this is apparently the case.

Suppose that a condenser of capacity C farads is suddenly connected to a source of alternating pressure, obeying a sine law, at an instant when the voltage is passing through one of its zero values and increasing towards a positive maximum value. A current

proportional to the rate of change of voltage will immediately commence to flow into the condenser, and, as we have already seen that the rate of change of a sine wave is another sine shaped curve displaced by a quarter of a cycle, it follows that the current taken by the condenser also obeys a sine law. Now, as the current is equal to the product of capacity and rate of change of voltage, the current will have a positive value when the voltage is increasing in a positive direction. This means that the current will pass through its maximum positive value some time before the voltage reaches its maximum positive value so that the condenser takes a current which *leads* the voltage in phase. Since the voltage is changing at its greatest rate at those instants when it is passing through its zero values the current will have a maximum value when the voltage is zero. We see then that the condenser current is another sine shaped wave *leading the applied voltage by 90°*. Note that this is just the reverse effect as compared with a pure inductance, where the current *lags* by 90°. The phase relation

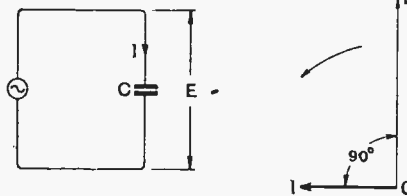

Fig. 1.—Vector diagram, showing phase relation between applied e.m.f. and current for a condenser. The current leads the voltage by 90°.

Wireless Circuits in Theory and Practice.—

between the current taken by a condenser and the applied voltage is shown by the vector diagram of Fig. 1, where OE represents the R.M.S. value of the applied voltage and OI is the R.M.S. value of the resulting condenser current leading the voltage by 90°.

The next important step is to find the relationship between the magnitudes of the voltage and the current. Just as in the case of the current wave considered in the last section in connection with a pure inductance we see that the maximum rate of change of voltage across the condenser will be $2\pi f \times E_m$ volts per second, where E_m is the maximum value reached by the voltage in either direction. Therefore the maximum value of the condenser current will be $I_m = C \times (\text{max. rate of change of voltage})$

$$= 2\pi f C \times E_m \text{ volts.}$$

The R.M.S. value of the current is 0.707 times the maximum value, and is therefore given by

$$I = 2\pi f C \times E \text{ amperes, where } E = 0.707 E_m$$

is the R.M.S. value of the applied voltage. The ratio of voltage to current

$$\frac{E}{I} = \frac{1}{2\pi f C}$$

is the reactance of the condenser at the frequency f , being measured in ohms and usually called *capacity reactance* or *condensive reactance* to distinguish it from inductive reactance as discussed last week. Now since a condenser takes a current which leads the voltage by 90°, its effects in an alternating current circuit are exactly opposite to those of inductance, and its reactance must therefore be considered as negative with respect to inductive reactance; so that

$$\text{condensive reactance } X_c = -\frac{1}{2\pi f C} \text{ ohms.}$$

It should be particularly noted that the reactance is inversely proportional to the frequency, and therefore the higher the value of the frequency or the shorter the wavelength, the lower is the reactance and the more current will be permitted to flow "through" the condenser.

Inductance and Capacity in the Same Circuit.

We come now to consider the combined effects of resistance, inductance, and capacity in an alternating current circuit, and the *series circuit* will be discussed first. Suppose that an alternating potential difference of E volts (R.M.S.)

(value) of frequency f cycles per second is applied to the ends of the circuit of Fig. 2 (a), where R is in ohms, L is in henries, and C is in farads. Then the R.M.S. value of the current taken will be equal to the voltage

divided by the impedance, i.e., $I = \frac{E}{Z}$ amperes, where Z

is the impedance of the circuit in ohms. Now we have seen that $\text{impedance} = \sqrt{(\text{resistance})^2 + (\text{reactance})^2}$, the reactance in this case being that due to the combined effects of the inductance and the capacity. The inductive reactance is $X_l = 2\pi f L$ ohms and the condensive reactance is $-X_c =$

$$-\frac{1}{2\pi f C} \text{ ohms, the latter being negative because, as explained above, its effects are opposite to those of the former. Thus the resultant reactance is } X = (X_l - X_c) \text{ ohms, and the current is therefore}$$

$$I = \frac{E}{\sqrt{R^2 + X^2}}$$

$$= \frac{E}{\sqrt{R^2 + (2\pi f L - \frac{1}{2\pi f C})^2}} \text{ amperes.}$$

This is the fundamental equation for a circuit in which all three of the constants are present in series.

Resonance in a Series Circuit.

From the last equation it is clear that the condensive reactance and the inductive reactance partially neutralise each other if they are unequal, and one completely neutralises the other if they are equal, viz., when $X_c = X_l$, the resultant reactance in the circuit is zero, and the current is then given by

$$I = \frac{E}{\sqrt{R^2 + 0}} = \frac{E}{R} \text{ amperes.}$$

This is obviously the greatest value which the current can have for a given applied E.M.F., because no matter whether the resultant reactance is positive or negative, this quantity is always positive when squared, and therefore the impedance can never be less than R ohms. When the condensive reactance and the inductive reactance are equal the potential difference E_c across C is exactly equal to the potential difference E_l across L , but as the former lags behind the current by 90° and the latter leads the

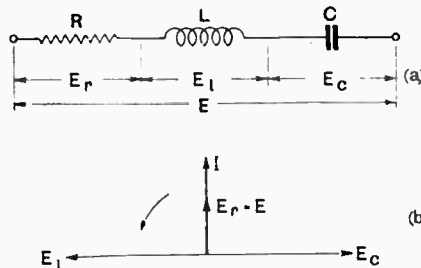

Fig. 2.—Circuit (a) with resistance, inductance and capacity in series; and (b) vector diagram for this circuit when tuned to resonance.

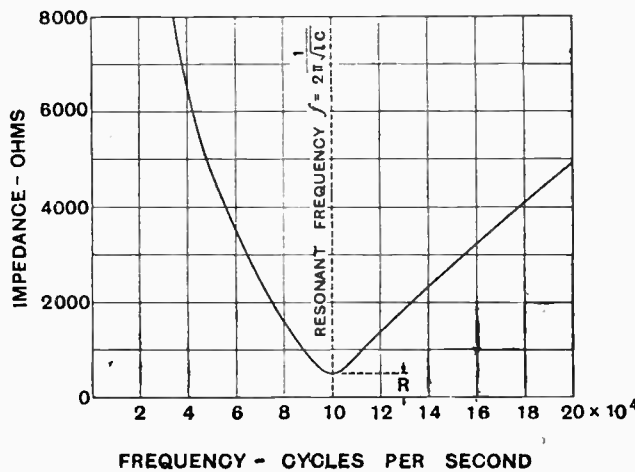

Fig. 3.—Curve showing relation between impedance and frequency when the resistance of the circuit is 500 ohms.

Wireless Circuits in Theory and Practice.—

current by 90°, these two voltages balance out, as shown by the simple vector diagram of Fig. 2 (b). Therefore the voltage E_r across the resistance portion is equal to the applied voltage E when $X_L = X_C$, and further, the applied voltage and current are exactly in phase. Under these conditions the circuit is said to be tuned to complete resonance or to be tuned to the frequency f . In tuning a wireless circuit to a given wavelength or frequency what we are really doing is to adjust, say, the capacitive reactance X_C so that it is equal to, and completely neutralises, the inductive reactance X_L . For complete resonance then

$$2\pi fL = 1/2\pi fC$$

$$(2\pi f)^2 = 1/LC$$

or $f = \frac{1}{2\pi\sqrt{LC}}$ cycles per second.

This is called the *resonant frequency* of the circuit and is that frequency for which the current is a maximum for a given applied voltage, or for which the impedance of the circuit has a minimum value equal to R ohms.

A numerical example will make this clear. Suppose that an alternating voltage of constant R.M.S. value is applied to the ends of a circuit such as that of Fig. 2 (a) and that the frequency is gradually varied from zero to a value of 2×10^5 , i.e., 200,000 cycles per second. Let the inductance be 0.005065 henry or 5,065 microhenries, the capacity 0.0005 microfarad, and the resistance 500 ohms. This resistance is really too high for a practical wireless circuit, but it is chosen in order that the effect of resistance at the point of resonance may be clearly shown. At zero frequency (equivalent to a D.C. voltage) the reactance of the condenser is infinitely great and no current can flow. As the frequency is increased the capacitive reactance X_C decreases, being proportional to $1/f$, and the inductive reactance X_L increases, being directly proportional to f .

The values of X_C and X_L have been worked out for a number of values of the frequency, and also the values

of the resultant reactance X and the impedance Z . These are given in ohms in the following table:—

Frequency f .	$X_L = 2\pi fL$.	$X_C = 1/2\pi fC$.	$X = (X_L - X_C)$	$Z = \sqrt{R^2 + X^2}$
0	0	∞	$-\infty$	∞
10,000	318	31,820	-31,500	31,510
20,000	636	15,910	-15,270	15,280
40,000	1,272	7,960	-6,690	6,720
60,000	1,908	5,310	-3,400	3,438
80,000	2,544	3,980	-1,436	1,520
100,000	3,182	3,182	0	500
120,000	3,816	2,657	1,160	1,260
150,000	4,770	2,123	2,637	2,685
175,000	5,565	1,820	3,745	3,780
200,000	6,360	1,591	4,770	4,800

In calculating the impedance here it is assumed that the resistance is constant at all frequencies.

It will be seen from the table that as the frequency is increased the value of X_L increases and X_C decreases, and that when the frequency is 100,000 cycles per second (corresponding to a wavelength of 3,000 metres), X_L and X_C are each equal to 3,182 ohms, so that the resultant reactance X is zero at this frequency and the impedance Z is therefore equal to the resistance, 500 ohms, this being the minimum value reached by the impedance. Plotting the impedances given in the last column of the table as a graph against the corresponding values of frequency in the first column we obtain the V-shaped impedance curve shown in Fig. 3. It is clear from the table and the curve that no matter whether the resultant reactance X is positive or negative the impedance is *always* positive, and in this case it reaches a minimum value equal to 500 ohms at the resonant frequency where the effects of the inductance are exactly balanced out by the equal and opposite effects of the capacity. If there were no resistance present the impedance would be exactly equal to the resultant reactance X at all frequencies, being positive at all frequencies, even when X is negative, and the V-shaped impedance curve would then come to a sharp point touching the zero axis instead of being rounded off at a height R above the axis as shown.

o o o o

In the next instalment a number of impedance curves will be given for various values of circuit resistance to show how very important the effect of resistance is in a circuit which is tuned to complete resonance.

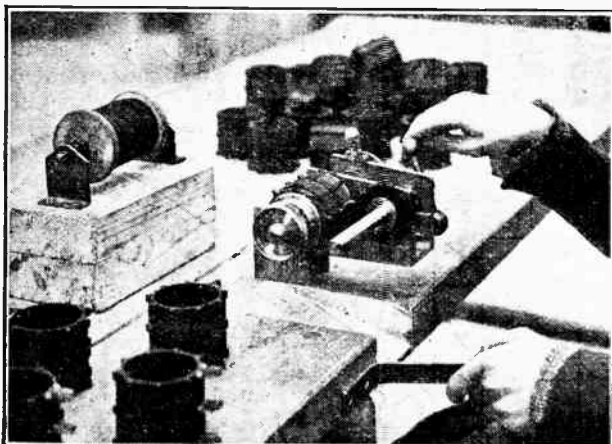

WINDING DIMIC COILS. The air-spaced winding of the Dimic coils is obtained by feeding the wire over a threaded spindle, geared to the mandril which carries the former.

HIDDEN ADVERTISEMENTS COMPETITION.

The following are the correct solutions for "The Wireless World" Hidden Advertisements Competition for Feb. 10th issue, 1926.

Clue No.	Name of Advertiser	Page
1	General Electric Co., Ltd.	18
2	Massey Motor Co., Ltd.	28
3	Haliday's Ltd.	22
4	Tunom-ter Works	9
5	Eagle Engineering Co., Ltd.	8
6	Ward & Goldstone, Ltd.	25

The prizewinners are as follow:

John Cormack, Edinburgh	5
Edward Awcock, Southampton	22
E. C. Rogers, Lowestoft	21

Ten shillings each to the following:

Michael A. Kelly, Kilrush, Co. Clare.	F. G. Jones, Croydon.
Mrs. E. G. Neal, North Harrow.	J. Tastenoj, Brussels.

HINTS and TIPS for NEW READERS

A Section Devoted to the Practical Assistance of the Beginner.

CONSTRUCTING AN H.F. CHOKE.

A high-frequency choke, to be effective over a wide range of wavelengths, must have a very large inductance combined with the lowest possible self-capacity. It is also an advantage, as a rule, if the coil is of small dimensions, in order to reduce its external magnetic field. For this reason, very fine double-silk-covered wire should be used, if a convenient method of construction is to be adopted.

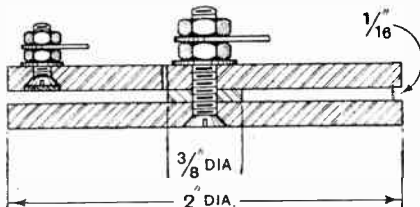

Fig. 1.—Sectional sketch of a bobbin former for an H.F. choke coil.

Such a choke coil may be wound on a bobbin former as shown in Fig. 1. Two discs of ebonite, $\frac{1}{8}$ in. thick and 2 in. in diameter, spaced by a third disc $\frac{1}{16}$ in. thick and $\frac{3}{8}$ in. in diameter, are held together by a screw and nut passing through a clearance hole drilled through their centres, the commencing end of the winding being soldered to a tag held under a second nut. A terminal for the other extremity of the coil is provided by drilling another clearance hole as near as possible to the edge of one of the checks, countersinking it deeply on the inside, and securing another soldering tag by means of nuts. The screw head should be covered with wax or similar insulating material, which filling is smoothed off level with the surface of the ebonite.

The centre screw should project sufficiently to allow it to be held in the chuck of a lathe or geared drill,

and No. 45 or 47 D.S.C. copper wire is wound on until the slot is nearly full. The ends of the wire are connected to the soldering tags already mentioned. Too much tension should not be applied when winding, as there is considerable risk of breaking this extremely fine wire. The winding may be carried out without the use of a lathe or drill, but will be found rather a tedious process, even if a handle is mounted on the centre screw.

No provision has been made for mounting the choke, as due to its small size and light weight it may be adequately supported by its connecting wires; if desired, however, a simple fixing may easily be devised.

In certain circumstances, where a still higher inductance than that provided by this choke is required, it will be found desirable to connect two such coils in series; if they are mounted side by side, and on a common axis, the windings should be in the same direction, and the end of the winding of the next, the external circuit being joined to the beginning of the first coil and the end of the second.

APPLICATIONS OF THE H.F. CHOKE.

Probably the commonest use of the H.F. choke is in receivers of the "Reinartz" or "Weagant" type, using capacity reaction, where it is connected in the anode circuit of the detector valve, and serves to deflect a part of the H.F. current through the reaction condenser and coil. The exact proportion (and therefore the degree of reaction) is, of course, determined by the setting of the condenser: when this is low, a very high impedance is offered, and only a very small percentage of the total oscillating anode current is fed back to the grid circuit.

The H.F. choke also has a strictly limited application as an anode impedance for coupling together high-frequency amplifying valves, but, unfortunately, will have only a low efficiency on the shorter wavelengths, even if the most elaborate precautions are taken to ensure a high value of inductance with low self-capacity. In spite of this, its simplicity may make it worthy of adoption under certain circumstances. Any capacity across the coil may be considered as a partial short-circuit, and must obviously be reduced to as low a value as possible.

Another and perhaps rather neglected application of the choke is for separating the high and low-frequency currents in a reflex or dual-amplification receiver. At the same

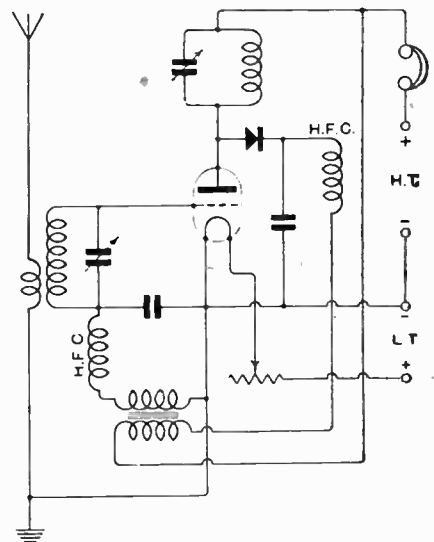

Fig. 2.—The use of H.F. chokes in a valve-crystal reflex receiver.

time, it should be borne in mind that there is little point in inserting a large impedance in an H.F. circuit unless

we provide an alternative path of lower effective resistance for the currents we wish to deflect; this can generally be done by connecting fixed condensers in an appropriate manner.

Referring to Fig. 2, which represents a more or less conventional type of single-valve reflex receiver, with crystal detector, it will be seen that the choke in the grid circuit is connected in such a manner that high-frequency currents are made to flow entirely through the by-pass condenser, and are kept out of the secondary winding of the L.F. transformer. In a similar manner, such anode currents as may escape rectification by the crystal are deflected by the action of the choke through the condenser provided for this purpose, and do not reach the transformer primary. In reflex circuits, where a valve detector is used, the properties of the H.F. choke may often be turned to good account.

H.F. amplifiers operating on the so-called "tuned grid" principle, of which a good example is the "Four-valve Quality Receiver" described in *The Wireless World* dated September 16th, 1925, also call for an efficient type of choke.

o o o o

ELIMINATING INTERFERENCE FROM POWER CIRCUITS.

Induction effects from near-by electrical apparatus or circuits give rise, at the best, to a noisy back-

ground which is apt to be annoying, and, in particularly bad cases, may render impossible the reception of even a local station. A few hints as to simple methods which often effect at least a partial cure may be of interest to those who are troubled in this respect.

In the great number of cases the addition of a loose coupled aerial circuit will greatly improve matters, and should be the first alternative to be tried, remembering that, if the set has a stage of tuned H.F. amplification, some form of stabilising will probably be necessary.

A direct "earth" to a large metal plate buried as deeply as possible in the ground, in place of the more usual connection to a water pipe, is also well worth while trying, as is the use of a counterpoise. This latter is very likely to assist materially in reducing induction noises, but it is realised that many will be unable to allot sufficient space for this sometimes rather inconvenient arrangement. It is also recommended that the effect of changing from grid to anode or crystal rectification should be tried.

When a coupled aerial circuit is used, there will normally be no direct connection between the batteries and earth. A lead should be joined between the negative L.T. and earth terminals, noting carefully if results are improved by this connection.

LOUD-SPEAKER FILTER CIRCUITS.

Many readers have fitted a large power valve, passing a very high anode current, in the last stage of their L.F. amplifiers, hoping that distinctly better quality reproduction of loud signals will result. In some cases failure to obtain the hoped-for improvement is possibly due to magnetic saturation of the loud-speaker itself. It will be fairly obvious that if the value of steady anode current flowing is sufficient to bring about a condition of even partial saturation, the variations due to the magnified signal voltages will not have the proportional magnetising effect required for good reproduction. It will be realised that many loud-speakers were designed before the use of valves having really low impedances were envisaged. Alterations to the instrument itself are sometimes possible, but such work is rather beyond the amateur, and a better course is to use either a transformer, or preferably a so-called filter circuit, consisting of a choke and large-capacity condenser, arranged so that only the pulsating signal currents are passed through the loud-speaker windings, and the D.C. is fed to the anode through the choke. It is, of course, a comparatively easy matter to design the core and windings of the latter so that saturation is not reached with any value of anode current likely to flow through its windings.

DISSECTED DIAGRAMS.

No. 19.—A Flewelling Receiver.

For the benefit of those who find difficulty in reading circuit diagrams we are giving weekly a series of sketches, showing how the complete circuits of typical receivers are built up step by step. The sensitive receiver shown below has been favoured by some experimenters, but, due to difficulties in operation, can only be recommended in exceptional cases.

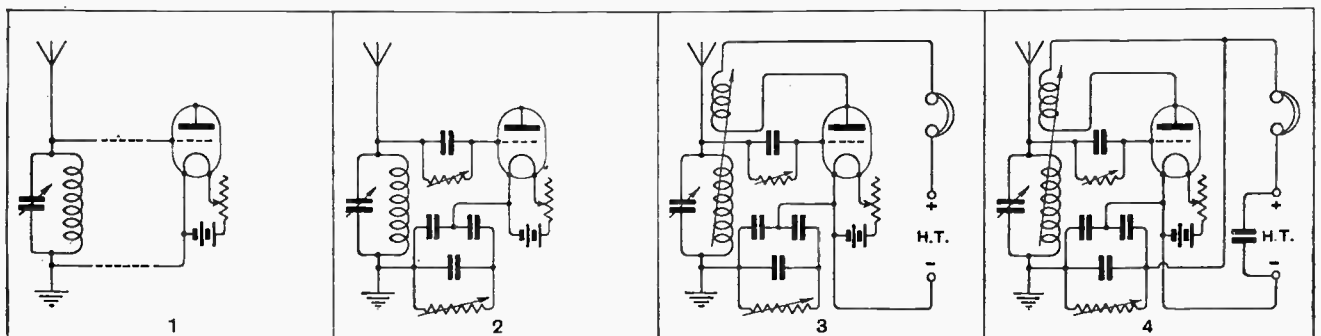

1 A tuned aerial-earth circuit, connected in the usual manner between grid and filament of a valve with normal connections of the low-tension circuit.

2 A leaky grid condenser is added, while a bank of large condensers, shunted by a variable high resistance, is inserted in the grid return lead.

3 The plate circuit is completed through a reaction coil (variably coupled to the grid coil), telephones, and the high-tension battery.

4 A "feed-back" connection is made by joining the low potential end of the reaction coil to the grid circuit, through the condenser bank.

COMPLICATIONS OF CRYSTAL RECEPTION.

Practical Methods of Reducing Crystal Loading.

By W. H. F. GRIFFITHS.

(Continued from page 250 of previous issue.)

SINCE the rectified telephone current obtained by the use of sensitive galena is greater than that obtained from Perikon, even though the potential producing that current is much less due to its heavy loading, it is obvious that it may be economical to shunt the detector circuit across only a portion of the aerial inductance L in order to reduce its loading effect, and so, to some extent, obviate the tremendous reduction of resonant potential across the latter.

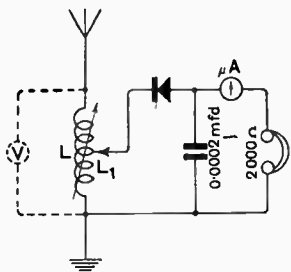

Fig. 13.—Circuit for reduction of the loading effect of a crystal. (Used in obtaining the curves of Figs. 14 and 15.)

By this means the increase in reactive voltage across the total inductance (as an indication of the aerial current flowing through L at resonance) may more than compensate for the loss of potential applied to the detector circuit by not shunting the latter across the whole of the available inductance. This applies, of course, more particularly to crystals of low resistance, to galena rather than to Perikon, as the curves of Figs. 14 and 15 will show. These figures refer to the circuit of Fig. 13, in which the crystal detector circuit is tapped across a portion L_1 of the total inductance L . In Figs. 14 and 15 the resonant reactive volts across the whole of the inductance L and the rectified telephone current are plotted against the inductance of the

portion L_1 across which the crystal is tapped. Fig. 14 was obtained with Perikon and Fig. 15 with galena. The total value of L was 130 microhenries in each case, and it will be seen that in the case of the Perikon detector, although the volts gradually decreased as L_1 was made more nearly equal to L , the rectified telephone current was still increasing, even when $L_1 = L$. The curves for galena, however, show a sharp increase of rectified current when the value of L_1 is increased from 0 to 30 microhenries, and after this becomes very flat, and actually falls after reaching an ill-defined maximum value at 60 to 70 microhenries. The flatness of this curve, of course, agrees with the rapid falling off of voltage V .

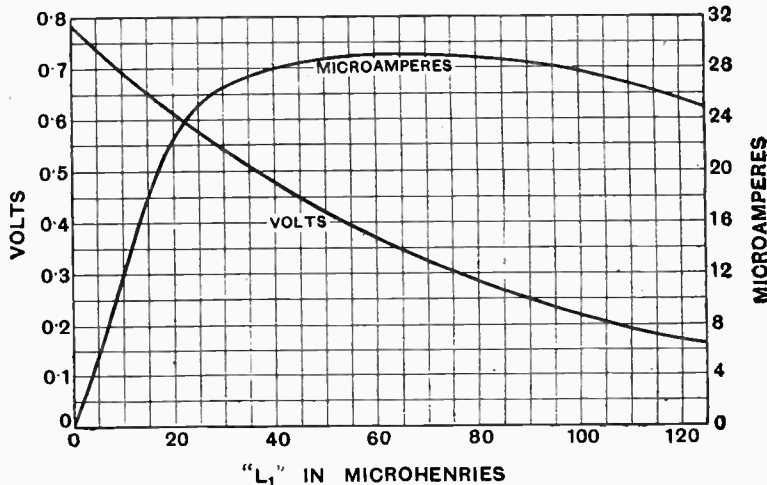

Fig. 15.—Effect of varying the crystal tapping point—Galena.

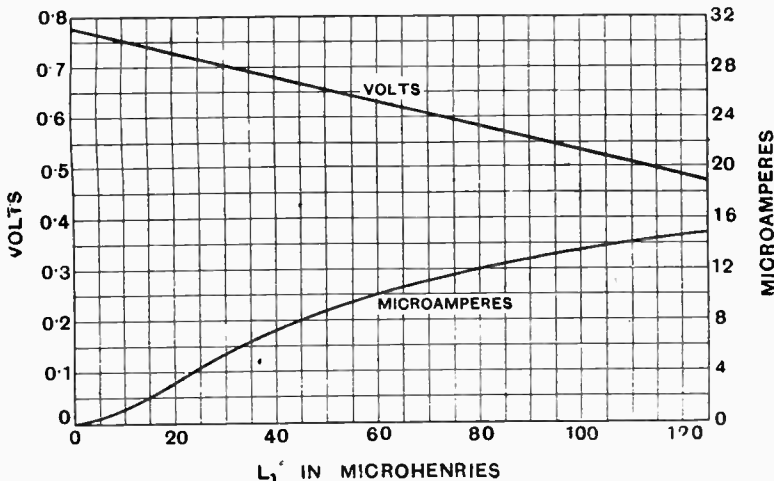

Fig. 14.—Effect of varying the crystal tapping point—Perikon

which is an indication of the enormous loading introduced as L_1 is made larger.

Since the rectified telephone current for galena shows very little increase for values of L_1 greater than, say, 30 microhenries, it is clear that by reducing L_1 to this value a much sharper resonance curve will be obtained without appreciably sacrificing the signal strength.

Crystal Damping with Parallel Tuning.

The effect of reducing crystal loading by tapping L is shown to a much greater extent with an aerial of the dimensions in use for these experiments when receiving the transmission from the higher power broadcasting station "5XX" on a wavelength of 1,600 metres.

For reception from this station (75 miles distant) the circuit of Fig. 16 was used. "C"

Complications of Crystal Reception.—

being a variable condenser having a maximum capacity of 0.0003 mfd. and L being a multi-layered air-spaced inductance of about 2,000 microhenries total value, and having a low effective resistance. Fig. 17 shows, plotted against values of L_1 , the values of resonant voltage and rectified telephone current obtained with this circuit using galena crystal. It will be seen that there is a distinct optimum value for L_1 at about 230 microhenries (or about 12 per cent. only of the total value of L), and at this point a very steep drop in resonant volts occurs.

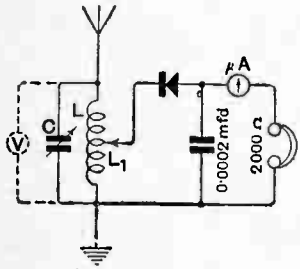

Fig. 16.—Circuit from which the curves of Figs. 17, 18 and 19 were obtained.

From the shape of the curve of rectified current in Fig. 17, it is natural to expect a very flat resonance curve with L_1 adjusted to, say, 2,000 microhenries, but a comparatively sharp resonance curve when $L_1 = 200$ microhenries, because at this latter point, although the current is high, the voltage across L is scarcely reduced from its no-load value. Because of the excellent shape of the curves of Fig. 17, resonance curves of rectified current were plotted against degree scale readings of the parallel variable condenser C for the various values of L_1 ,

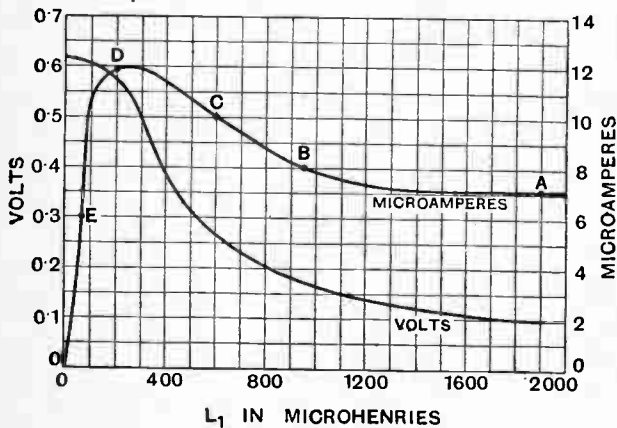

Fig. 17—Curves with various crystal tapping points—Galena.

corresponding to the points A, B, C, D, and E on the rectified current curve. The extremely interesting set of resonance curves of Fig. 18 were the result.

Extent of Damping produced by Galena.

The gradual increase in amplitude at resonance and sharpening of tuning as the value of L_1 is reduced is a beautiful illustration of the additional damping introduced by galena when the latter is shunted across an oscillatory circuit of high reactance value. The reson-

ance curve of voltage V_0 across L with no crystal load is plotted beside the rectified current curves in Fig. 18 for purposes of comparison. It should be noted that when the value of L_1 was reduced below 120 microhenries the rectified current was practically proportional to the inductance across which the detector circuit was tapped, since the loading effect under these conditions was practically negligible.

Comparison of Galena and Perikon.

It is interesting to note that, even with this high value of reactance in circuit, the best possible position of tapping when Perikon was used for detection was when $L = L_1$, reductions of L_1 effecting reductions of signal strength, although sharpening the tuning somewhat as illustrated by the resonance curves of rectified telephone current depicted in Fig. 19. This figure is drawn to the

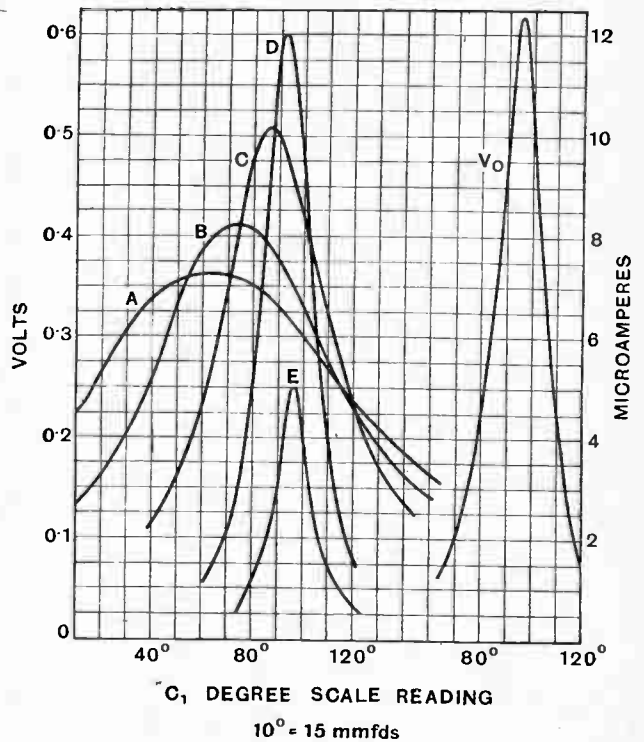

Fig. 18.—Tuning curves obtained with various crystal tapping points (Galena crystal).

same scale as the curves of Fig. 18, and the same tapping notation has been employed.

The curves of resonant voltage and rectified telephone current shown in Fig. 21 may be of interest. They are plotted against values of resistance inserted in series with the aerial lead under the conditions of circuit given in Fig. 20, where the crystal loading is almost negligible. From the voltage curve V , it will be noted that with a series resistance of 25 ohms added to the aerial circuit the voltage across L was almost exactly halved; this means that the aerial current had also been halved, since the reactive volts are proportional to the current. The total effective resistance of the aerial circuit must therefore have been doubled, since the E.M.F. remains constant, and so we have an approximate value for the effective resistance of the aerial system, as augmented by that

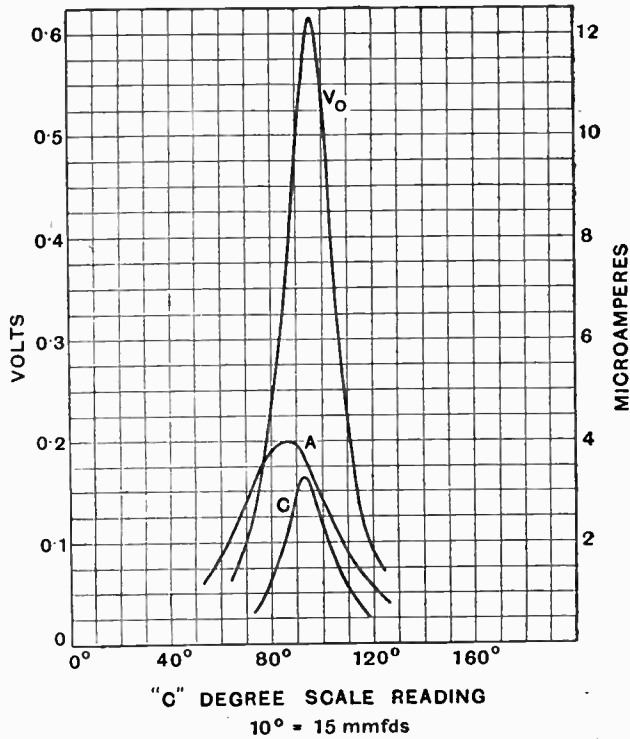

Fig. 19.—Tuning curves obtained with various crystal tapping points (Perikon crystal).
10° = 15 mmfds

of the aerial tuning inductance, of 25 ohms. This figure only holds good, of course, at, or very close to, the frequency corresponding to the wavelength at which the last test was made, *i.e.*, 365 metres.

The decrease of rectified telephone current caused by adding a greater number of telephone receivers in series with a galena crystal detector is shown in Fig. 22. This curve clearly indicates the economy effected by connecting additional telephones in series rather than in parallel with those already in circuit, due to the previously mentioned fact that the effective resistance of the crystal varies with the series resistance associated with it, even though a by-pass condenser is employed. It is clear,

therefore, that the greater the number of telephone receivers there are in series the smaller will be the effect of crystal loading upon the aerial tuned circuit, resulting in the interesting shape of the curve of Fig. 22.

One example will serve to show the use of this curve in determining the best method of connecting additional telephones.

Let it be assumed that two pairs of 2,000-ohm receivers are in series; from the curve it is found that the rectified telephone current is 18.3 microamperes. It is now required to add a further two pairs to make four pairs in all. If they are connected in parallel with those already in circuit the total current flowing in the detector circuit will (from the curve) be 20.6 microamperes, and therefore the current flowing through each telephone will be only 10.3 microamperes. If, however, these additional receivers are connected in series with those already in use, a total resistance of 8,000 ohms will result, and, from the curve, it is seen that the current through each receiver will be 15.3 microamperes, a very marked improvement.

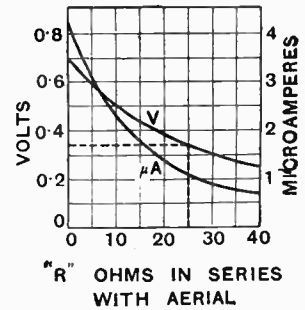

Fig. 21.—Reduction of volts and rectified current due to the insertion of series resistance in the aerial circuit.

In order to demonstrate the decrease of loading by the detector circuit when a large number of telephones are used in series, two resonance curves are plotted in Fig. 23. The first (curve 2,000Ω) is plotted from results obtained with one pair of 2,000-ohm telephone receivers in series with the microammeter and galena crystal, and the second (curve 26,000Ω) from those obtained with thirteen pairs of similar receivers in series with the same crystal. The tuning, it will be noted, is remarkably sharpened by this

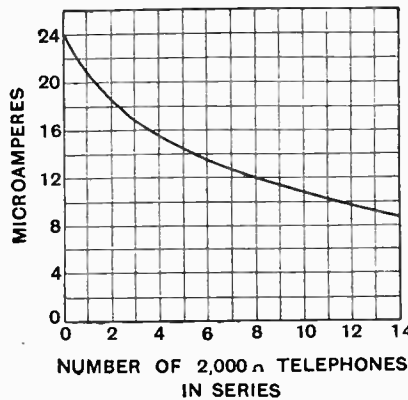

Fig. 22.—Effect of increasing the number of telephone receivers in series.

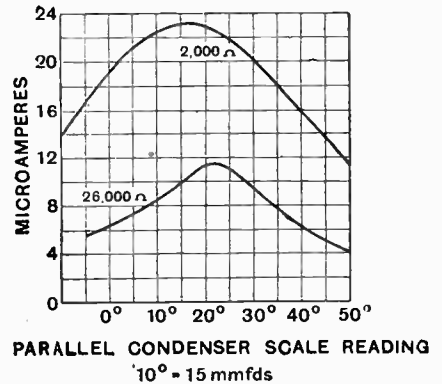

Fig. 23.—Sharpening tuning by increasing the number of telephones

increase of total telephone resistance, a detuning from resonance of 15 mfd. reducing the rectified current in the first case by only 7 per cent., and in the second case by 25 per cent.

The rectified telephone current curve of Fig. 24 shows that the use of a high-frequency by-pass condenser C_2 across the telephones is justified. It will be seen from the curve that the value 0.0002 mfd. adopted throughout the experiments described in this article was quite sufficient. Had the microammeter not been in series with the telephones, however, the capacity of the twin lead of the latter would probably have been sufficient to have efficiently functioned as a by-pass.

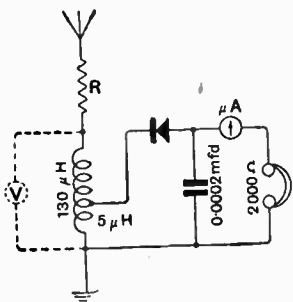

Fig. 20.—Circuit for the curves of Fig. 21.

Complications of Crystal Reception.—

In order to ascertain the degree of loading (due to either resistance and/or capacity shunting) introduced by the thermionic voltmeter, the rectified telephone current obtained when using the circuit of Fig. 20 with and without this instrument connected was measured. The decrease in telephone current upon connecting the voltmeter was found to be only 0.1 in 4.3 microamperes, or a little over 2 per cent.

It is interesting to note, also, that a 4 per cent. reduction of no-load resonant voltage across the aerial tuning inductance was caused by merely connecting the detector circuit to the latter with the crystal itself open-circuited, due to the augmentation of the distributed capacity of the tuning coil by the opened detector circuit.

In conclusion, the writer would like to apologise for the somewhat laboured descriptions and reasonings employed, but would like to be permitted to take refuge in the excuse that the whole subject is an extremely difficult one to explain clearly in general language without intro-

ducing mathematics or higher technicalities. It is hoped, however, that at least the curves, which have been care-

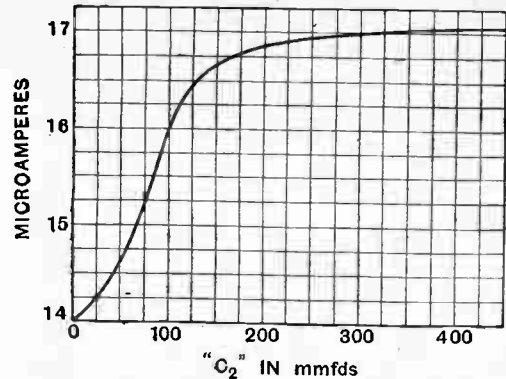

Fig. 24—Effect of a by-pass condenser.

fully drawn, will help to make clear some of the complications met with in crystal circuits.

Successful Year at Southend.

The sixth year of the existence of the Southend and District Radio Society concluded with the holding of the Society's Annual General Meeting on Friday, January 29th.

The membership for 1925 totalled 79, including one lady. Mr. H. H. Burrows, in his annual report, referred to the Society's experiments with portable transmitting apparatus during the summer, when two-way communication was established with many amateurs at Clacton, Margate, Chelmsford, Sydenham, etc. Mention was also made of the wireless exhibition held at the Boys' School on January 9th, when 53 amateur entries were judged by Mr. Hugh S. Pocock, Editor of *The Wireless World*, and Mr. Dent.

The Mayor of Southend (Ald. H. A. Dowsett) has been elected President of the Society.

o o o o

Home-made Loud-speakers.

A demonstration showing the surprisingly good results obtainable with home-made loud-speakers was given by members before the Ilford and District and the Southend and District Radio Societies when the two clubs met at the Wesleyan Institute, Ilford, on Tuesday, February 2nd. The Lissen attachment with paper diaphragm used by Mr. Carr was the success of the evening. The workmanship of a unit embodying a Brown's reed phone, operated by a Southend member was by reason of its excellent finish deserving of praise. The demonstration was carried out by means of a seven-valve "superhet" constructed by Mr. Lambert, of Ilford.

Hon. Secretary: Mr. D. S. Richards, "Swinford," Empress Avenue, Ilford, Essex.

o o o o

Plotting Valve Curves.

Members of the Croydon Wireless Society spent a profitable evening on Monday, February 8th, in the plotting of valve characteristic curves. It is in-

A 48

NEWS FROM THE CLUBS.

tended to carry the subject a step further at a future meeting by the reception on a loud-speaker set, demonstrating exactly the kind of signals one obtains at various points of a characteristic curve.

A short-wave receiver is being built for the use of members, and it is hoped that many long-distance signals will be picked up on the short waveband.

It is a healthy sign that excellent attendances have been recorded at recent meetings. A cordial invitation is extended to visitors.

Hon. Secretary: Mr. H. T. P. Gee, 51-52, Chancery Lane, London, W.C.2.

o o o o

The Wireless League at Tottenham.

A unanimous decision to form a local branch of the Wireless League was made at a recent public meeting held by the Tottenham Wireless Society. Prof. A. M. Low, the principal speaker, explained how a local branch could do much useful work as a nucleus of public opinion and instruction.

An interesting feature of the evening was a handsome display of apparatus made by members of the Tottenham Wireless Society. A photograph of several of the receivers and loud-speakers appeared in last week's issue of *The Wireless World*. With the co-operation of local retailers an additional attraction was provided in the form of an exhibit incorporating samples of all the components used.

o o o o

American Apparatus.

Late-comers had to be content with standing room at the Tottenham Wireless Society's meeting on February 10th, when an interesting address on "American Apparatus" was given by Mr. Ford,

Radio Manager of Messrs. R. A. Rothermel, Ltd.

Samples of almost all the best makes of components were available for examination. The speaker referred to the prevailing impression that, whilst the Americans were ahead of British practice in the matter of H.F. components, British manufacturers produced the finest apparatus in the world so far as the L.F. side was concerned. With this Mr. Ford did not entirely agree, stating that, in his opinion, some excellent L.F. transformers were being produced in U.S.A.

o o o o

The Story of a Condenser.

A lantern lecture dealing with the construction of condensers was delivered before the Barnsley and District Wireless Association on February 3rd by Mr. B. Heywood, of the Dubilier Condenser Co. The members were able to follow all the processes through which the mica passed from the mica mines in Bengal to the finishing bench at the Dubilier Co.'s works.

Special interest was shown in the photograph of the enormous condensers, each weighing five tons, which are used in the G.P.O. station at Rugby.

o o o o

Making Valves.

The many intricate processes involved in the manufacture of wireless valves were admirably explained by Major F. P. G. Telfer, M.C., of the General Electric Co., Ltd., at a recent meeting of the Lewisham and Bellingham Radio Society.

Among the many processes described were the gas freeing of component parts, the sealing in of electrodes, and the exhaustion of the bulbs. Interesting details were given regarding the production of power transmitting valves and of the special types of valves, such as the dull-emitter types, loud-speaker valves, and water-cooled valves.

Joint Hon. Secretaries: Mr. E. J. Chapman, 56, Crofton Park Road, Brockley, S.E.4; Mr. J. A. Clark, 35, Boones Road, Lee, S.E.13.

Broadcast Brevities



TOPICALITIES FROM

Speeding Up the Programmes.

Several listeners are complaining of the delays that are occurring in programmes, and one period in particular is mentioned by all who have written to me. It is the time round about 10.30 p.m., when 2LO has finished its local news bulletin and the programme has to be held up while the provincial stations finish their local news. These stations sometimes exceed their time limit for local news, and an effort is, therefore, to be made to speed up the reading of the items. So far as 2LO listeners are concerned, they are to suffer the least inconvenience possible, and in future, instead of having to wait on the provincial stations, they will be regaled with pianoforte improvisations to fill up the gap.

○○○○

Accompanists to be Announced.

An innovation is to be introduced by the Music Department, namely, the announcement on special occasions of the names of accompanists. It is a long time since the inclusion of the announcers' names in the programmes was dropped, and the B.B.C. has rigidly adhered to that omission, somewhat to the disappointment of many listeners. Accompanists are subject to separate consideration, and are entitled to be placed in the same category as other artists. This point of view has at length prevailed at Savoy Hill, and names will in future be announced at the discretion of the musical director.

○○○○

Rugby Testing.

Enquiries are reaching me from listeners on Daventry respecting the transmissions from the Hillmorton Station (Rugby) of the Post Office. Listeners on Radio Paris wavelength have also called my attention to the Hillmorton transmissions. I can only say that while the new station is testing it is not certain what wavelength will ultimately be used, and listeners must necessarily be tolerant of any tests that are taking place. My correspondence bag proves, at all events, that listeners everywhere are interested in Hillmorton's activities.

○○○○

"Poy" by Wireless.

A second drawing lesson will be given to listeners on March 5th. The first, it will be recalled, was broadcast by Mr. Heath Robinson six weeks ago, and thousands of listeners took part in it. The second lesson will be given by "Poy," the cartoonist, who probably

SAVOY HILL.

"Quest of Elizabeth," a fair percentage were from hospital patients and invalids. To these, in spite of the Press campaign, the play was evidently not so gruesome as the critics alleged. The adverse criticisms of the broadcast numbered only 25.

○○○○

Mrs. Patrick Campbell to Broadcast.

Mrs. Patrick Campbell, who will broadcast from 2LO on Sunday next, is too well known not only in England and on the Continent, but also in America, to need any introduction to listeners. Those who remember her as the original Mrs. Tanqueray in "The Second Mrs. Tanqueray," and as Eliza Doolittle in Bernard Shaw's "Pygmalion," will welcome this opportunity of hearing her by wireless.

○○○○

Interference ad Nauseam.

The B.B.C. engineers are baffled by a problem which they declare to be the most difficult of any that has been presented to them in three years and a half of broadcasting. For over two years past a St. John's Wood listener has been the victim of a system of high-frequency interruption, and he has spent in the aggregate fruitless days and weeks in trying to trace the trouble to its source.

By Our Special Correspondent.

makes more people laugh in a year than anyone, with the exception of Charlie Chaplin —

○○○○

Charlie Chaplin.

And Charlie may be expected soon to succumb to the spell of the microphone at 2LO.

○○○○

"The Quest of Elizabeth."

It is singular that of the 103 letters of appreciation which, I learn, were received by the B.B.C. in connection with the broadcasting of the hospital play, "The

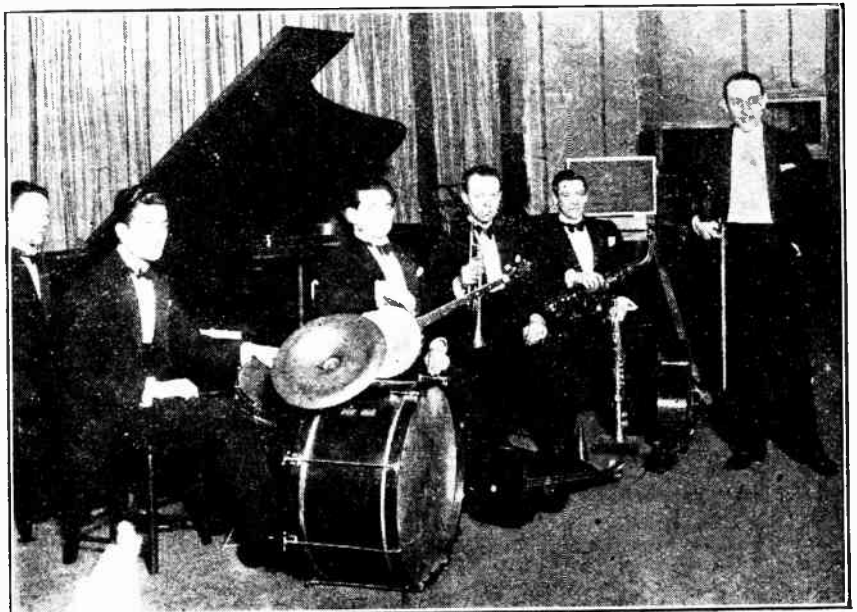

B.B.C.'s OWN DANCE BAND. The B.B.C. has shown its musical independence by forming a dance band of its own, under the leadership of Mr. Sidney Firmin. The above photograph was taken in the London studio.

Help Welcomed.

The interference consists of a series of protracted rattles which might be compared with the noise made by an express train; but, unfortunately for this theory, there are no express trains in his neighbourhood. He has narrowed down his investigations to the point where all sources of interference have been proved to be immune. Originally the trouble started after 2FO had closed down. Then it occurred in the afternoon. Now it extends to the evening. The only free period is, as a rule, from 7 p.m. on Saturdays until 10.20 p.m. on Sundays. If any listener deserved help in the campaign to discover and put a stop to almost perpetual interference with his broadcast reception it is this listener, and the B.B.C. would like to enlist all the help that it can in his behalf.

○○○○

The Savoy Bands.

The Press of the whole country, with the single exception of *The Wireless World*, has been engaged for many weeks past in assuring the public that the Savoy Bands would broadcast no more after Saturday next (I have even seen within the past week a "farewell" article by a Savoy conductor in a weekly contemporary). My forecast that the Savoy Bands would continue to broadcast is, however, now shown to be correct, and the critics who said that the B.B.C. was showing too much independence in its dealings with the broadcasting artists are proved to have been ill-informed.

○○○○

Censorship.

On another point, also, I am asked by the officials at Savoy Hill to put matters in their true perspective; that is, in reference to the cutting of plays. In stating that its retention of the right of censorship was vitally necessary in the interests of the service and of listeners, the B.B.C. did not imply that it had any intention of riding rough-shod over the opinions of an author to the extent of interfering with his work without his approval. Very isolated cases might occur where, owing to the pressure of time, it would be impossible to communicate with an author and get his approval to some slight alteration in the manuscript; but in normal cases no alteration has ever been, nor would be, made except in consultation with the author. I remember one case where extensive revisions were made in a play which had been submitted to the Dramatic Department—with the author's consent—and the play was subsequently voted one of the best that had been broadcast.

○○○○

The "Silent" Test.

Some unauthorised "experts" who assumed the duty of checking the wavelength experiments taken by the B.B.C. on foreign stations during the recent "silent" quarter-hour subsequently circulated a list of measurements which they alleged they obtained with their own apparatus. Such lists should be accepted with a good deal of reserve. The B.B.C.

FUTURE FEATURES.**Sunday, February 28th.**

LONDON.—3.30 p.m., The Modern Trio. 9.15 p.m., Albert Sandler and the Grand Hotel, Eastbourne, Orchestra.

BIRMINGHAM.—9.20 p.m., Schubert Programme.

MANCHESTER.—9.15 p.m., The Adamson Military Band.

NEWCASTLE.—8 p.m., The Newcastle Cathedral Quartet.

Monday, March 1st.

LONDON.—7.52 p.m., "Romeo and Juliet" (Act II), performed by the British National Opera Company. 8.20 p.m., St. David's Day—A Programme of Traditional Welsh Music. 9.5 p.m., The London Radio Dance Band.

DAVENTRY.—8.10 p.m., Welsh Programme from Cardiff.

ABERDEEN.—8 p.m., St. David's Day Programme. 9.25 p.m., Scottish Programme.

BOURNEMOUTH.—8 p.m., St. David's Day Programme. 9 p.m., A Popular and Varied Programme.

CARDIFF.—8 p.m., A Song of the Welsh.

GLASGOW.—8 p.m., The Pianoforte Sonatas of Beethoven. 8.25 p.m., A Short Welsh Programme.

Tuesday, March 2nd.

LONDON.—8.5 p.m., The Wireless Military Band.

BIRMINGHAM.—7.30 p.m., The City of Birmingham Orchestra.

BELFAST.—8 p.m., Musical Comedy.

Wednesday, March 3rd.

LONDON.—8 p.m., "The Pied Piper," a new Musical Comedy by Reginald Benyon.

BOURNEMOUTH.—8 p.m., Winter Gardens Night. A Programme of Russian Music.

EDINBURGH.—8 p.m., Military Band Night.

Thursday, March 4th.

LONDON.—7.30 p.m., The Hallé Orchestra conducted by Sir Hamilton Harty, relayed from Manchester.

ABERDEEN.—9.30 p.m., Half-hour with Cesar Frank.

GLASGOW.—8.40 p.m., Scottish Regiments, The Royal Scots.

MANCHESTER.—7.30 p.m., The Hallé Orchestra.

Friday, March 5th.

LONDON.—8.35 p.m., H. Fearon ("Poy," the Cartoonist).

BOURNEMOUTH.—8 p.m., Some Old Masters.

Saturday, March 6th.

LONDON.—8 p.m., 2nd Edition of "Listening Time." 9 p.m., Sir Harry Lauder. 10.30 p.m., Final episode of "Which?"

GLASGOW.—8 p.m., The Staff celebrating the third anniversary of the Station.

did not, of course, publish any list, but has reported the results of its test to Geneva. The wavemeters used at Keston receiving station are calibrated by the National Physical Laboratory, and are checked at frequent intervals to ensure as high a degree of accuracy as possible. Excellent as the best type of wavemeter are, however, they still give a margin of 0.05 per cent. to 0.1 per cent. error.

○○○○

When Changes are Contemplated.

In the criticisms concerning varying quality in B.B.C. transmissions, the question has cropped up whether it is desirable or not to issue a preliminary warning to listeners when any change is made or contemplated either in the apparatus or studio fixtures. Some listeners suggest that it is well nigh useless to introduce improvements at the transmitting end if they are not to be notified and given the opportunity of adapting their receivers to the altered conditions. Whenever the engineers make any changes, either by the substitution of the carbon microphone for one of another type, the adjustment of wall or ceiling draping, or the utilisation of the echo room, officials of the engineers' department are deputed to investigate and report on the effect from different localities within a certain radius of the transmitter. They are therefore in the position of listeners, and their training, in which acoustics play a large part, enables them to judge if any necessity exists for warning the ordinary listener of an impending change.

○○○○

Not Always Necessary.

In most cases there is no need to do so, but in some instances, such as the opening of a new studio, the alteration of the S.B. system or experiments with transmissions on all frequencies, with the view of avoiding or overcoming distortion, changes would be duly announced. In the ordinary way, it is far better from the standpoint of engineering investigation to receive reports from listeners whenever they suspect that alterations have been made, and these reports, besides being of the utmost value in research work, are very welcome.

○○○○

Interference by Amateurs.

Crystal users have complained of interference by amateurs working on 45 metres when their receiving sets were tuned to Daventry. This matter has been investigated, and it has been found that some commercial crystal receivers, when tuned to 5XX, will suffer interference from transmissions on 45 metres, if situated a few yards away. It used to be said that while it was impossible to ensure that broadcast programmes should be completely immune from interference, the difficulties could be minimised if receiving sets were used which were capable of close tuning to the wave which it was desired to receive. This does not obviate the difficulty in which some crystal users find themselves when Daventry is working and further control of amateur transmissions at such times seems necessary.

PIONEERS OF WIRELESS.

By ELLISON HAWKS, F.R.A.S.

8.—Joseph Henry.

WHILE Faraday was at work in England, another scientist, Joseph Henry, was studying electricity and magnetism in America. Born on December 17th, 1797, at New York, Henry was apprenticed to a watchmaker on leaving school. This work did not appeal to him particularly, however, for he wanted to become an actor. He took part in amateur theatrical performances and spent a good part of his time reading popular fiction in the library at Albany.

After attending a series of lectures on scientific subjects his interest in the theatre waned, and, having saved sufficient to pay his fees, he took a course of instruction at the famous Old Albany Academy. Later he took a post as teacher here, and carried out his earlier experiments, which were to be brilliantly continued after he became a professor at Princeton University.

Experiments with Electro-Magnets.

At Albany Henry had little time for leisure, for his teaching duties claimed his attention for seven hours each day. He found it necessary to commence work early in the day, and some of his classes were held at 6 a.m. Half his time was occupied in guiding large classes of boys through the elements of arithmetic, but we may well imagine that on many occasions his thoughts were elsewhere. Except during holiday time, he had access to no laboratory, and as his salary was only £16 a month he had very little spare cash for the purchase of apparatus or equipment.

Notwithstanding these discouraging circumstances, Henry developed the electro-magnet while at Albany Academy, and he shares the honour of this pioneer work with Faraday. By wrapping wire in silk and winding it on an iron core, Henry obtained electro-magnets that performed extraordinary feats. "My new magnet," he wrote, "weighs 21 lb. and lifts more than thirty-five times its own weight. It is probably, therefore, the most powerful magnet ever constructed."

Meanwhile (in 1823) he had been appointed Professor of Natural Philosophy at Prince-

ton University, where his researches made him a worthy contemporary of Faraday, and perhaps even a greater pioneer of wireless. Unlike Faraday, who was no mathematician, Henry became a mathematical professor, and, working in the same field, but with a different method of approach, these two brilliant men had much in common, and it is pleasing to us to learn that they became firm friends.

Prepares the Way for Morse.

At Princeton Henry continued his researches and made a magnet of an improved type for Yale University. This magnet weighed 82½ lb. and lifted 2,300 lb., while another powerful magnet, made by Henry for Princeton, lifted 3,000 lb. In his laboratory experiments with these magnets Henry liked to startle his pupils by suddenly cutting off the supply of current from one of his magnets, causing it momentarily to drop its load; then, instantly switching on the current again, he caused it to seize the load before it had fallen beyond the sphere of attraction.

Henry's researches prepared the ground for Professor Morse, who, as we shall shortly see, invented one of the earliest practical systems of wireless telegraphy by "conduction." In his discovery of how a magnet might be made to ring a bell at a distance of half a mile from the operator, Henry had in his hands the principle that subsequently made possible the Morse telegraph. Amazing to relate, he refused to patent it, because he did not think such a course consistent with his position as a scientist! Ten years after Henry discovered the principle, Morse patented his first telegraph, and obtained a grant from Congress in order that he might continue his work. "The principles I had developed," Henry modestly wrote, "rendered Morse's instruments effective at a distance."

Discovery of Induction.

Soon Henry made another interesting discovery in the "extra spark," as he called it. "A wire coiled into a helix," he stated, "gives a more



Joseph Henry.

Pioneers of Wireless.—

intense spark than the same wire uncoiled. A ribbon of copper coiled into a spiral gives a more intense spark than any other arrangement yet tried." Without knowing it, Henry was doing pioneer work in wireless research, for his "flat spiral" is in use to-day in wireless equipment.

Henry's experiments with the Leyden jar showed him that its discharge is of an oscillatory nature. He made a galvanometer with a darning needle, and, connecting this to a Leyden jar, he noticed that, although the needle was magnetised on each occasion, it was not always magnetised in the same manner. Sometimes it pointed north, and at other times it pointed south. "The phenomena require us to admit," he said (in 1842). "the existence of a principal discharge in one direction, and then several reflex actions backward and forward, each more feeble than the preceding, until equilibrium is obtained."

Here, again, Henry was handling forces that make possible wireless to-day, for he had discovered the high-frequency oscillations now obtained with condensers in place of a Leyden jar.

Continuing unknowingly to explore the fundamental principles of wireless, Henry next discovered induction, by which a current of electricity, passing through one

coil of wire, induces another current in a second wire nearby, but not connected to the first coil.

"In extending these researches," he wrote, "a remarkable result was obtained. It would appear that a single spark is sufficient to disturb perceptibly the electricity of space throughout at least a cube of 400,000ft. of capacity, and . . . it may be further inferred that the diffusion of motion in this case is almost comparable with that of a spark from flint and steel in the case of light."

"Comparable it is indeed," Sir Oliver Lodge has commented, "for we now know it to be the self-same process."

Henry died at Washington on May 13th, 1878, but lived long enough to be hailed as a genius and a prophet, but he never saw the splendid results of his pioneer experiments. Both Hertz and Morse took up his work, the latter developing the telegraph and signalling without wires by conduction. Hertz studied Henry's "extra spark," and also continued Henry's investigation of the oscillatory nature of condenser discharges.

Henry's researches and discoveries brought him some measure of recognition, and in 1846 he was elected first secretary of the Smithsonian Institution. His name is perpetuated in the "henry," the unit of inductance.

Portsmouth.

(December, 1925, and to January 18th, 1926.)

Great Britain: 6KO, 2MI, 5YI, 5ZA, 6DA, 5FF, 6BT, 2PO, 6YC, 5IO, 6YV, 5MA, 2XY, 6QB, 6DO, 2LF, 6UZ, 5HS, 2OQ, 6RY, 6TD, 6NF, 2LZ. Germany: K5A, KLO, KW3, KQ7, K2HR. Italy: 1CE, 1AM. Sweden: SMUF. Holland: OPM, PC2. Spain: EAR20, EAR13. Belgium: BO8, BC22. France: 8HM, 8JC, 8GRA, 8LZ, 8NN, 8USS, FL. U.S.A.: KDKA, NKF, WIR, U 1CJ, 2CAN. Unknowns: S4, 3TR, SAB, GFP, TSA44.

(0-v-1. Mostly indoor aerial. 40-150 metres.) L. E. Newnam.

Bishopston, Bristol.

(January 9th to 18th.)

Australia: A2CG, 2CM, 2VD, 3BD, 3EF, 3XO, 5NJ, 6AG. New Zealand: Z2EC, 2XA, 4AH. U.S.A.: 1AAM, 1AAO, 1AI, 1AIU, 1AMZ, 1ASR, 1ATJ, 1AY, 1BKL, 1CD, 1CF, 1CH, 1CAL, 1CMF, 1CMP, 1CMX, 1HJ, 1JE, 1JW, 1NAR, 1RD, 1SZ, 1XE, 1YK, 2AGB, 2ANM, 2BRB, 2GK, 2MK, 3BTA, 3BVT, 3BWJ, 3CDK, 3FW, 3JO, 3JW, 3LD, 3LRV, 3QT, 4AX, 4EA, 4PY, 4UR, 5WUZ, 8ADM, 8BYN, 8CES, 8DFR, 8GZ, 8RE, 8RH, 8RZ, 9BND, 9GV. S. Africa: A3B, A4W, A4Z, A6E, A6N. Miscellaneous: L 2CX, L 2TR, LA 4X, LA 1A, PR 4JE, PR 4SA, P 4FZ, P 3GX, PE 6ZK, PI 1HR, PI 6JD(?), FI 8QQ, NPM, NPO, NTT, NOT, CH 8DU, NA 1F, BZ 1AB, BZ 1AC, BZ 1IA, C 1AR, X 3YY, HBK, EGEH, LSI, GHA, GHK, GFP, GCS, EAR1, EAR9, EAR21, EAR23, MB2, S 5NB, E1BH, 1DH. J. Monckton, Jun. (G 2BAZ).

Calls Heard.

Extracts from Readers' Logs.

Chingford.

(During January.)

Great Britain: 2BGO, 2CC, 2LF, 2MA, 2MY, 2NJ, 2NX, 2QB, 2VQ, 2XY, 2ZA, 2ZF, 5AX, 2FF, 5HL, 5KV, 5NK, 5NW, 5SK, 5ST, 6BG, 6KK, 6RY, 6TD, 6UZ. 'Phone: 2XV, 5XO, 6GF, 6OH, 6YT. France: 8DK, 8DP, 8GGA, 8HS, 8JX, 8NN, 8NS, 8PA, 8PEP, 8PRD, 8RAT, 8SSS, 8UT, 8UU, 8ZD. Belgium: U3, U4, S1, S4, P2, P7, G6, C22, 4RS, 4C. Holland: OAR, OBL, OCZ, OGG, OHB, OMS, ONM, ORW, OWC. Spain: EAR2, EAR22. Italy: 1AR, 1BB, 1AY, 1BQ, 1GW, 1MT, 1RM, 1SS. Sweden: SAB, SAJ, SMTX, SMUV, SMVR, SMYV, 2CO. U.S.A.: 1AAP, 1AHB, 1AJO, 1AKZ, 1ALK, 1BAL, 1BI, 1BVB, 1CO, 1CRT, 1KMX, 1MB, 1RD, 2ACW, 2BG, 2BIR, 2BM, 2DS, 2CGK, 2CV, 2CY, 2CJL, 2ICI, 2MKB, 3BMS, 3AHL, 3CAO, 3CAJ, 3AV, 3CC, 3QT, 4AT, 5HY, 5UP, 8AJ, 8ADG, 9ADK. Brazil: 1AB, 1AN, 1AW, 2AB, 2AF, 5AA. S. Africa: O A6N. Malta: GHA. Indo-China: FI 8QQ. Palestine: 6ZK. Various: RPB, UP 1AE, NOT, LX1, LA 5X, H 9XF, C 1AW, C 3NI, DBR, BS 1DE (?).

(0-v-1 Reinartz.)

L. Outridge.

Hford.

(January 10th to 31st.)

France: 8BF, 8BYU, 8CAX, 8DGS, 8DK, 8EF, 8FP, 8GI, 8HM, 8HSF, 8HU, 8HW, 8IL, 8IP, 8JA, 8JJA, 8JN, 8LMU, 8MAR, 8MB, 8NN, 8NS3, 8PAL, 8PEP, 8PY, 8RBP, 8RZ, 8XH, 8WW, OCDJ, OCMV, FW. Holland: OAAA, OBL, OHB, OWC, PA9, PC2, PCLL, PCXX, PCJP, 2PZ. Belgium: E9, G6, J9, O2, P7, Q2, S2, S5, D3, V2, W4, Z22, OCA, 4RS. Sweden: SMSR, SMTX, SMUA, SMUF, SMUJ, SMUV, SMVJ, SMXU, SMYD, SGC. Italy: 1AS, 1BD, 1BK, 1BO, 1GW, 1RM, 1MT. Finland: 2CO, 2ND, 2NM, 2NN, 2RVX. Germany: I2, W3, POF, POW. Portugal: 3FZ, 1CN. Malta: GHA. Morocco: MAROC. Yugo Slavia: 7XX. Egypt: 1DH, 6YX, 6ZK, 6ZH, GEH. Norway: S1, A1A, 7MT. Spain: EAC5, EAR21, EAR23. French Indo-China: 8QQ, 8LBT. U.S.A.: 1ABX, 1ASR, 1AAO, 1AXA, 1BPB, 1BZ, 1CIR, 1CMF, 1CMK, 1AFY, 1BAD, 1CMP, 1CMX, 1CRE, 1ED, 1FJ, 1GA, 1II, 1KMX, 1ML, 1SW, 1SZ, 1WL, 1XM, 1ZW, 2ACS, 2AJX, 2ARM, 2BW, 2CZY, 2UHM, 2LS, 2MK, KG, 2XQ, 3BD, 3BWJ, 3HG, 3LD, 4IT, 4SX, 5YB, 8AVK, 8BPL, 8CCS, 8DAJ, 8DK, 9JI, WIR, WIZ, NOTT. Canada: 1AR, 1DD, 2AX, 3NI, 8AR. Porto Rico: 4JE, 4SA. South Africa: A3E, A4Z, A6N. India: 2BG. Australia: 3EF, 3BD, 3XO. Brazil: 1AB, 1AC, 1AP, 1AW, 2AF. Various: NAR1, M 8MX, MA 8MB, VNM, X GB1, DA GFD, GFP.

(0-v-1) 30-45 metres.

J. Lion.

A Correction.—The dates of the calls heard by Mr. H. Bishop, South Normanton, on page 256 of our issue of February 17th, should read "January 17th to 29th."

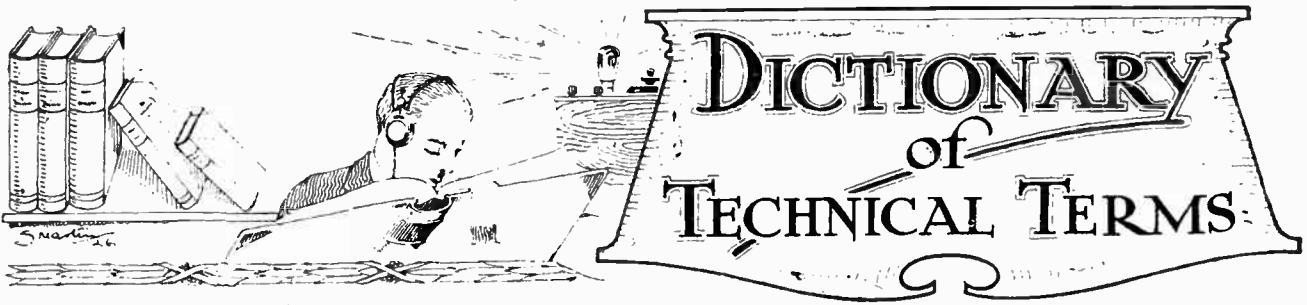

Definitions of Terms and Expressions commonly used in Wireless Telegraphy and Telephony.

This section is being continued week by week and will form an authoritative work of reference.

Thermionic Tube or Thermionic Valve.

A vacuum tube containing two or more electrodes, one of them, the *cathode*, being a heated filament. In a two-electrode thermionic valve the cathode is surrounded by a cylindrical *anode* or plate made of sheet metal. When the anode is given a positive potential with respect to the filament, a stream of electrons is emitted from the filament, these electrons reaching the anode and constituting a current between the filament and plate. When the plate is given a negative potential with respect to the filament, no current whatever passes, and thus such an arrangement acts as a *rectifier* or electrical valve. The *three-electrode valve* has now almost completely superseded the two-electrode valve, and is dealt with separately under **THREE-ELECTRODE VALVE**.

Thermionic Voltmeter. An instrument in which a *three-electrode valve* is used for measuring small voltages of either high or low frequency. The voltage to be measured is applied to the grid circuit of the valve and the change of *plate current* is indicated by a microammeter connected in the plate circuit, the scale being calibrated to read directly in volts. The instrument is calibrated on low-frequency alternating voltage, the readings being more or less independent of frequency. An instrument of this type manufactured commercially is known as the "Moullin Voltmeter."

Thermo-Ammeter. An ammeter suitable for the measurement of high-frequency currents. The current to be measured is passed through a heater or heating element which raises the temperature of one junction of a *thermo-couple* to an extent depending on the strength of the current. The thermo-couple is connected to a sensitive *moving coil* micro-voltmeter, the scale of which is graduated to read directly the current passing through the heating element. The instrument is calibrated on direct current. The instrument obeys roughly a square law, the deflection being nearly proportional to the square of the current in the heating element. Cf. **THERMO GALVANOMETER**.

Thermo-Couple, Thermo-Electric Couple,

Thermo-Electric Junction, Thermo-Junction. An arrangement in which two dissimilar metals, such as antimony and bismuth, are joined together, forming part of an electric circuit. When the temperature of the junction is raised above that of the other parts of the circuit an E.M.F. is produced which drives a current round the circuit. The E.M.F. produced is proportional to the difference in temperature between the junction and the remainder of the circuit. See **THERMO-AMMETER** and **THERMO-GALVANOMETER**.

Thermo-Electric Current. The current produced by a *thermo-couple* when the circuit is a closed one.

Thermo-Galvanometer. A galvanometer for the measurement of small high-frequency or low-frequency currents. The current to be measured is passed through a resistance and the heat liberated is caused to heat the junction of a thermo-couple which is fixed to the moving coil of a sensitive galvano-

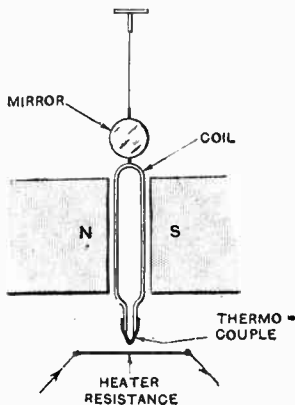

Principle of the thermo-galvanometer.

meter, the thermo-couple itself moving with the coil of the galvanometer, whilst the heating element is fixed. The calibration is effected in the same way as for a *thermo-ammeter*.

Thermophone. See **THERMAL TELEPHONE**.

Thermophile. A number of *thermo-couples* connected in series in such a manner that the temperature of alternate junc-

tions can be raised above that of the remainder. Used for the measurement of small amounts of radiated heat.

Thoriated Filament. A special form of filament used in one form of dull emitter valve. Thorium is incorporated by a special process in the tungsten of the filament.

Three-Coil Holder. A compact arrangement for supporting three *plug-in coils* in such a manner that the *coupling* between them can be varied.

Three-Electrode Valve or Three-Electrode Thermionic Valve.

A *thermionic tube* which has a third or auxiliary electrode made of wire gauze or in the form of a wire spiral mounted intermediately between the filament and *plate* or anode. This auxiliary electrode is called the *grid*. The flow of electrons from the filament to the plate is controlled by the *potential* of the grid relatively to the filament; for instance, if the grid is given a moderately high negative potential it will assist the *space charge* (i.e., the electric field due to the electrons themselves) in preventing the electrons from leaving the filament and no plate current will be obtained. When the grid is given a considerable positive potential it has the effect of neutralising the space charge so that very little opposition is offered to the passage of the electrons and a comparatively large plate current is obtained. For intermediate potentials it offers varying degrees of opposition. The curve showing the plate current for various values of the grid voltage is called the "anode characteristic" of the valve (see **STATIC CHARACTERISTICS**).

It is due to the fact that a small change of grid potential causes a comparatively large change in the plate current that the three-electrode valve has its great usefulness as an *amplifier*. A given change of grid voltage causes a far greater change of plate current than an equal change in plate voltage (see **AMPLIFICATION FACTOR**) when the valve is operated on the steep portion of its *static characteristic*. Thus, if a suitable resistance or impedance is connected in the plate circuit, the variations of voltage across this resistance which are produced by

Dictionary of Technical Terms.—

the changing plate current when an oscillating voltage is applied to the grid may be several times greater than the voltage applied to the grid (see VOLTAGE AMPLIFICATION).

By the use of a *regenerative circuit* a three-electrode valve can be made to act as a generator of electrical oscillations, and when used in this capacity is known as *thermionic oscillator* or valve oscillator.

For the action of a three-electrode valve as a detector of high-frequency oscillations and as a rectifier generally, see ANODE RECTIFICATION and GRID RECTIFICATION.

Three Phase. An alternating current system in which there are three distinct sets of currents and E.M.F.s displaced in *phase* by 120°.

Ticker or Tikker. An *interrupter* which was used extensively for the reception of *continuous waves* before the advent of *beat reception*. The interrupter breaks up the received signal current into an intermittent current, the frequency of the current pulsations being such as to give an audible sound in the telephones when a signal is being received.

Tickler Coil. Another term, extensively used in America, for *reaction coil*.

Tight Coupling. Two circuits are said to have tight coupling or to be tightly coupled when they are placed close together so that the majority of the *magnetic flux* is linked with both coils, *i.e.*, when the ratio of the *mutual inductance* to the square root of the product of the *self inductances* of the individual coils is a large fraction, or when the *coefficient of coupling* is large. Cf. LOOSE COUPLING.

Time Constant. If a steady voltage is suddenly applied to the ends of a circuit possessing *self-inductance* the resulting current does not instantaneously reach its final steady value but builds up gradually. This is explained by the fact that the increasing magnetic field linked with the circuit generates a *back E.M.F.* which opposes the growth of the current, this self-induced E.M.F. being at every instant proportional to the rate at which the current is increasing. Thus, if E is the steady applied voltage, and e is the back E.M.F. at any instant, the current at that instant will be $i = (E - e) / R$, where R is the resistance of the circuit, *i.e.*, the current is proportional to the difference between the applied voltage and the back E.M.F., and since at the start when the current is zero the back E.M.F. has its greatest value it follows that the rate of growth of current is greatest at the start. If this initial rate of growth could be maintained the current would reach its final steady value E/R in a definite time, and this time is called the "time constant" of the circuit. It can be shown that the time constant is equal to L/R seconds, where L is the inductance of the circuit in henries and R the resistance in ohms.

An *oscillating circuit* also has a time constant because the oscillations can only be built up gradually, the value of

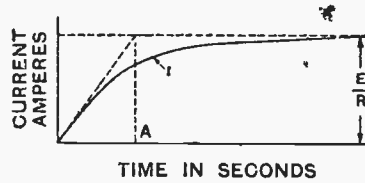

Growth of current in an inductive circuit
Time constant = α .

the time constant being in this case given by $2L/R$ in seconds.

Time Period. The time of one complete *cycle* of an alternating current, voltage, etc.

Timed Spark System. A system of spark transmission in which a number of spark gaps is used and the passing of the sparks in the various gaps is so timed that the oscillations are superimposed in a manner which gives in effect a *continuous wave* transmission.

Tone. Term applied to the audible note which is produced in a telephone receiver when an intermittent current, pulsating current, or alternating current is passing through it.

Tone Wheel. A rotary interrupter used in connection with the *interrupted C.W.* system of wireless communication.

Tonic Train. The name given to the system of transmission of Morse signals in which a *carrier wave* is *modulated* at an audible frequency by means of a buzzer or other device capable of giving *audio-frequency* pulsations. This is not the same as "interrupted C.W.", where the actual high-frequency oscillations are started and stopped at an audible frequency. The latter causes less interference than the former.

Topping Up. The addition of distilled water to an accumulator cell to compensate for loss by evaporation. As the acid itself does not evaporate, further acid need not be added when topping up unless some of the acid has been spilled out of the cell.

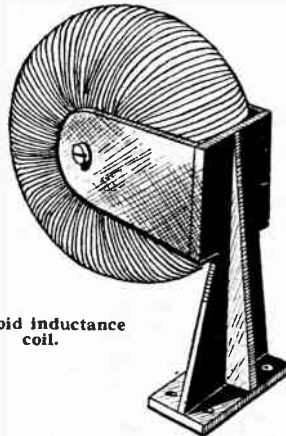

Toroid inductance
coil.

Toroid. A coil wound on a ring-shaped core. A coil with turns closely wound and covering the complete surface of a ring-shaped core has very little magnetic leakage, even when the core is made of non-magnetic material, *i.e.*, practically the whole of the magnetic flux remains inside the coil. Self-supporting toroidal coils are now quite common.

Total Characteristic (of three-electrode valve). The curve showing the relation between the *lumped voltage* and the plate current of a three-electrode valve. See LUMPED VOLTAGE.

Transformation Ratio. See RATIO OF TRANSFORMATION.

Transformer. An apparatus for converting alternating current at one voltage to alternating current at another and more convenient voltage without the use of moving parts, and for this reason sometimes a "static transformer." A transformer consists essentially of two windings so situated relatively to each other that the *mutual inductance* between them is as great as possible, so that energy can be transferred from one coil to the other by *electromagnetic induction*. For ordinary low-frequency or power work the windings are mounted on a *laminated iron core*. When an alternating potential difference is applied to the terminals of one of the windings an alternating magnetic flux is set up in the core, and this generates or induces an E.M.F. in each of the windings. If, therefore, an electric circuit is connected across the terminals of the second winding, a current will flow, and thus the second winding will give out power. The winding to which the supply voltage is applied is called the *primary winding*, *i.e.*, the primary winding is the one which absorbs electrical power from the source of supply, whereas the winding which gives out electrical power is called the *secondary winding*.

Now, since the same alternating magnetic flux is linked with both primary and secondary windings, it follows that the E.M.F. induced per turn in each winding will be the same, and therefore the total voltage of each winding will be proportional to the respective number of turns in the windings, *i.e.*, neglecting resistance losses in the windings, the ratio of primary to secondary voltage is equal to the ratio of primary to secondary turns. (See RATIO OF TRANSFORMATION.)

When no current is drawn from the secondary circuit the current in the primary is only that which is necessary to produce the magnetic field and supply the no-load losses, if any; this is sometimes called the "magnetising current." If the voltage applied to the primary is kept constant it follows that the magnetic flux must have a constant amplitude, whatever current is drawn from the secondary, and therefore the demagnetising effect of the secondary current on the core must be exactly neutralised by extra current being drawn from the supply by the primary winding, this extra (above the magnetising current) being of such a value that the primary *ampere-turns* are equal and opposite to the secondary *ampere-turns*. Thus, neglecting losses in the transformer, the product of primary volts and amperes is equal to the products of secondary volts and amperes, or the ratio of voltages is approximately equal to the inverse ratio of the currents. See AIR-CORE, also INTERVALVE TRANSFORMER.

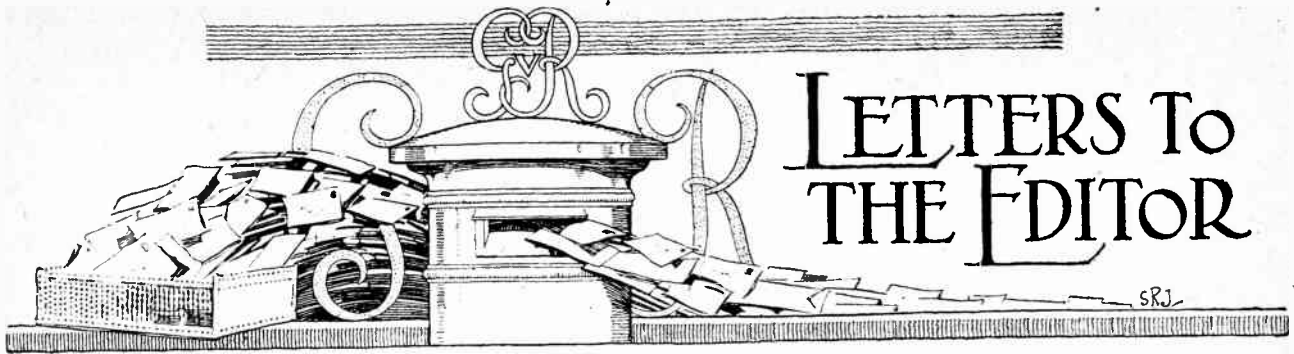

LETTERS TO THE EDITOR

The Editor does not hold himself responsible for the opinions of his correspondents.

Correspondence should be addressed to the Editor, "The Wireless World," Dorset House, Tudor Street, E.C.4, and must be accompanied by the writer's name and address.

ROYALTIES AND THE HOME CONSTRUCTOR.

Sir,—To the mind of the average man, the principal point in connection with the above is that the royalty claimed, in the present stage of development of radio communication, is scandalously excessive. What may have been quite fair in the infancy of wireless, when receivers were practically only used for commercial purposes, is out of the question now, when broadcasting has altered the whole aspect of the question, and when "valve-holders" are in existence by the million. Had the patentees contented themselves with, say, 1s. per valve-holder, payable on small neat plates, I am certain they would greatly have increased their revenue, and could still do so, but if they continue their present charge, not one amateur in 1,000 will go out of his way to meet them, and the only sufferers will be themselves and the manufacturers of complete sets, whose business would have been infinitely greater had this royalty been a more reasonable one.

As it is, the result of a few prosecutions of amateurs might very well create such a feeling against an absolutely unfair charge as would cause political action to be taken. If this last statement appears a little wild, it might be noted that in face of an outcry it might be impossible to give Government contracts to the unreasonable firm.

W. SMITH.

Glasgow.

INTERFERENCE ON SHORT WAVES.

Sir,—In the article "Recent Short-wave Work" in *The Wireless World* of January 20th, a complaint is made regarding those European stations working on the waves allotted to U.S.A., Brazil, New Zealand, Australia, Philippine Islands, etc.

The number of European stations on these waves is still increasing, and if there is not a stop put to it, good "long-distance" work will soon be impossible.

On February 6th I worked A 3XO, Brighton, Victoria, at 20.00 G.M.T. and could manage to keep him till 21.35 G.M.T. After that time A 3XO was blown away by a European station.

As A 3XO stated that he had never worked Europe so long after the sun had risen, I certainly was out of temper when I had to send: "Sorry—most QRM pse don't waste your powder any longer—too many QRM stns. Hope to cuagn on better conditions."

After that I sent the following message to every station I lay ears on:—"CQ de N STB QST QSR—Please boycott any European station working on waves between 43 and 30 metres, as they spoil DX work for the others."

I have complained to Mr. Tappenbeck, Traffic Manager, Dutch section A.R.R.L. and beg you kindly also to lend a hand to maintain the rules issued by the International Radio Amateur Congress held at Paris.

J. RUIZENAAR.

Chief Operator, Dutch Military Aerodrome, Soesterberg, Holland. Station N STB.

EARLY WORK OF PROF. POPOFF—A CORRECTION.

Sir,—In the issue of *The Wireless World* of May 6th, 1925, there appeared an article relative to Prof. A. S. Popoff, which was based on information supplied by me. I regret that on

account of some unfortunate misunderstanding my information regarding the transmission by means of Hertzian waves of the words "Heinrich Hertz" in the Morse alphabet at the meeting on May 7th, 1895, was incorrect. On that occasion Prof. A. S. Popoff demonstrated only with a receiving set consisting of a Branly coherer, a relay, and an electric bell which automatically tapped the coherer. All the apparatus was enclosed in a metallic case, out of which protruded a small antenna. By taking away the antenna Prof. Popoff demonstrated the decrease of reception. A receiving set was operated from a Hertz vibrator.

The transmission of words in the Morse alphabet was demonstrated by him on March 24th, 1896; also at a meeting of the Russian Physico-Chemical Society. Transmission was conducted at a distance of about 250 metres (with two antennas, one for receiving and one for transmitting).

I beg you to publish this letter in one of the numbers of your esteemed journal.

VICTOR GABEL.

Leningrad.

INTERFERENCE FROM A.C. MAINS.

Sir,—A short time ago a correspondent in *The Wireless World* asked if there were any means of reducing interference from A.C. mains, etc.

While at Woolwich recently I found that the A.C. hum on a single-valve reflex receiver was so bad as to completely drown the 2LO transmission, which otherwise comes in at weak loud-speaker strength. I fitted up the arrangement shown in

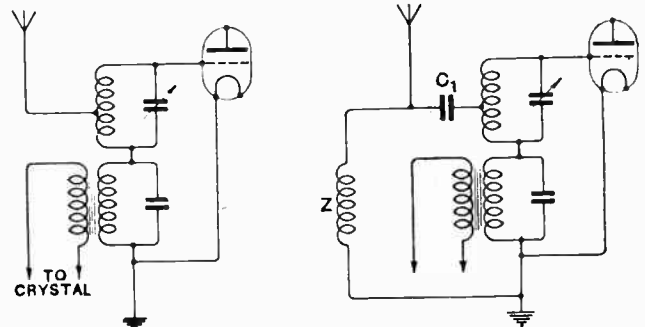

Circuits for eliminating A.C. mains noises.

the diagram and the hum was reduced to such an extent as to be unnoticeable. The diagrams show the grid and aerial circuits before and after conversion. C_1 is of 0.0001 mfd. capacity, and Z any good radio-frequency choke.

London, S.W.7.

N. G. NEWELL,

2nd Lieut., R. Signals.

MORSE RECEPTION.

Sir,—I have read with great interest your recent paragraph on Morse reception and the correspondence thereon, and I am extremely glad to see that someone has at last had the courage to champion Morse work against the ever-increasing

partiality to broadcast reception. For myself, I learnt the code last summer and built a short-wave set at the same time; since then I have been wondering why on earth I spent so much time listening to broadcasting, when there was "ham" reception simply waiting to be enjoyed!

Surely there is nothing so fascinating and thrilling as listening to brother "hams" all over the world, and in the case of the more lucky among us, conversing with them. These men have done some of the most important radio work yet accomplished, and their investigations of short-wave phenomena are of utmost value. Such calls as 2SZ, 2NM, 6LJ, 2OD, 5SI, etc., are familiar at almost every "ham" station in the world, for just as their work is great, so are their signals!

One thing I cannot understand is that so large a number of B.C.L.'s build high-frequency receivers merely to hear KDKA and WGY. How a person can possess a short-wave set and not be a "died in the wool 'ham'" in a month passes my comprehension!

With reference to Mr. Davenport's suggestion regarding the

publication of the Morse code in *The Wireless World*, I think it good, but two letters a week seems rather few. After all, it is not the actual memorising of the various symbols that takes time, but attaining proficiency in actual reading. I think that the B.B.C. might broadcast, say, ten minutes' slow Morse a week for practice; the only stations I know sending slow Morse schedules are GGB on 1,900 metres, and French YZ on about 80 metres. Amateurs are, however, often heard sending quite slowly on short waves. Once get a working knowledge of Morse and you will never regret it, so long live the "important minority"!

K. E. B. JAY
Amersham, Bucks.

(G2BMM).

[We agree with our correspondent that memorising the Morse characters is the least difficult part of the task of mastering the code. Incidentally, we do not feel that any demand exists among our readers for inclusion of the Morse code in these columns. The "Perry Auto-Time Morse System," obtainable at 7d. post free from the publishers of *The Wireless World* is an excellent aid.—Ed.]

General Notes.

The transmitting station 50Y, of the Belvedere, Erith and District Radio and Scientific Society, is carrying out telephony tests on small powers, with rectified A.C. at 50 cycles, every Sunday morning at the following times:—11 to 11.30 a.m. on 440 metres, 11.30 to 12 noon on 180 metres, 12 to 12.30 p.m. on 440 metres, 12.30 to 1 p.m. on 180 metres. Reports from listeners beyond 5 miles radius will be welcomed and acknowledged by the hon. sec., Mr. S. G. Meadows, 85, Hengist Road, Erith.

B W5 asks us to correct the note published on page 180 of our issue of February 3rd. He transmits by telephony on 180-200 metres every Tuesday, Wednesday, and Friday after 2200 G.M.T., and on Sunday from 9.30 to 12.30 p.m., and wishes to get into communication with British amateurs who are asked to speak very slowly unless they can converse in French and repeat their call-signs frequently. Reports may be sent to M. J. Mahieu, Le Manoir, Peruwelz, Belgium, or via Mr. A. G. Binnie, 1, Cromford Road, West Hill, S.W.18

The Manchester Wireless Society is anxious to carry out tests on 23 metres on power varied from 5 watts to 250 watts. Transmissions can be arranged for any time during the day or night. The members operating are Y. W. P. Evans (G 6MX and G 2YO), hon. secretary, 66, Oxford Road, Manchester; W. H. Lamb (G 5MB), 808, Stockport Road, Manchester; and R. Hallam (G 5WX), 81, New Street, Altrincham. They would also like to co-operate with other stations on 8 metres and compare circuits, etc., with a view to obtaining information about this particular wavelength.

Mr. N. N. Gardner, the youthful operator of Z 2BL, the Wellington College Radio Club, New Zealand, sends us some interesting details of that station. A shunt-feed loose-coupled Hartley circuit is used with a UV 202 5-watt transmitting valve, power being supplied by 500-v. chemically rectified A.C. Mr. Gardner has worked with 12 American stations in the 2nd, 5th, 6th, 7th, 8th and 9th districts, Hawaii, Samoa, and

TRANSMITTING NOTES AND QUERIES.

s.s. *Sir James Clark Ross* when near the South Pole. He transmits on about 39 metres almost every evening between 6.30 and 9.30 p.m. N.Z.M.T. (about 6.30-9.30 a.m. G.M.T.), and will welcome reports from British amateurs.

Mr. A. O. Milne (G 2MI), 41, Victoria Road, Northdown, Margate, is willing to forward cards to F 8JMS.

Mr. A. Paey (G 6IY) is now transmitting on 23 and 45 metres, and will be glad to receive reports of his transmissions.

H.M.S. *Durban* (GFUP), at present stationed at Hong Kong, is transmitting on 37 metres, and will welcome reports from British amateurs.

The Belgian amateur, B R6, is transmitting on 90 metres and will welcome reports from British amateurs who should forward cards via Réseau Belge, 11, Rue du Congrès, Brussels.

Mr. L. F. Aldons (2ZB), 48, Harpenden Road, West Norwood, S.E.27, is transmitting on 90 metres and will be glad to arrange for tests with any British amateur on this wavelength.

New Call Signs Allotted and Stations Identified.

G 2AYX.—R. H. Hall, 41, Pollard Street, South Shields.

G 2BDI (Art. A.).—T. E. G. Black, 142, Adelaide Street, Blackpool.

G 2BKI.—C. R. Waterer, 123, Upper Brockley Road, S.E. (who will also forward communication for G 2BMA).

G 5GU. (late 2AVP).—J. J. Hudson, 79, Huxley Road, Upper Edmonton, N.18.

G 6KS (late 2BCA).—F. G. Kelshaw, Queen Victoria Seamen's Rest, Poplar, E.14, transmits on 45 and 158 metres.

EG BH.—Radio Station, Villa Victoria, Cairo.

EG EH.—J. F. Hall, Villa Victoria, Cairo.

F SJE.—Radio Club de Levallois, 17, Rue Froment, Levallois-Perret.

F 8JO.—Breand, Hammam Bou Hadjar, Oran, Algeria.

F 8JQ.—Cahen Gilbert, 7, Avenue Niel, Paris.

F 8JS.—De Massia, Axat (Aude).

F 8JT.—Huchet, 28, Rue Général Bédan, Nantes.

BZ 1IN.—Post Box 522, Rio de Janeiro.

P 3FZ.—Ferraz, Rua de St. Maria 261, Funchal, Madeira.

G 5FM.—F. A. King, 35, Oakmead Road, Balham, S.W.12, transmits on 23 and 45 metres.

G 5IN.—A. H. Cooper, 58, Greyswood Street, Streatham, S.W.16.

G 6YZ.—F. G. Bettles, Brownsea Island, Poole, Dorset.

G 6RA.—The Wireless Dept., The Polytechnic, 309, Regent Street, W.1, transmits on 130 to 200 metres.

2BPN.—(Art. A.), P. Shurety, 100, Uphall Road, Ilford.

2BPP.—(Art. A.), J. V. Parsons, "Holland House," Sutton Coldfield, near Birmingham.

F 8ER.—M. Stauffer, 9, rue Jean Jacques Rousseau, Montmorency (Seine et Oise), in place of 98, rue Réaumur.

QRA's Wanted.

G 2AHM, G 2AQ, G 2BL, G 2BAV, G 2ST, G 2ZA, G 5GQ, G 5HT, G 5MF, G 5RY, G 5SR, G 5SO, G 5UN, G 5VA, G 5WX, G 6JH, ANF, AV 1S, PI 1HV, R DG2, X 2BG, G 2BGI, G 2EC (?), G 2ST, G 2ZA, G 5A (?), G 5UN, G 5VA, G 1DL (?), BC44, EVEA, EAR23, I 8SG, L6C, L 9K, LX 4LK, N 1GN (calling CQ on January 24th), N 8AP, R 1ND, R 8GN, TRRG (calling TRRA on January 10th), W 8HC.

G 2BQ.—6YX (Palestine), AG 5MA, IRA, MAOO, MIGB, SP.

A Correction.

The call-sign of the Lewisham and Bellingham Radio Society, 136, Bromley Road, Catford, S.E., is 2BKJ, and not 2BJK, as printed in error on their letter paper and in the "Wireless Annual."

2 BJF is the call-sign allotted to Mr. C. Brookes, 7, Merivale Road, Putney, S.W.15, for artificial aerial only.

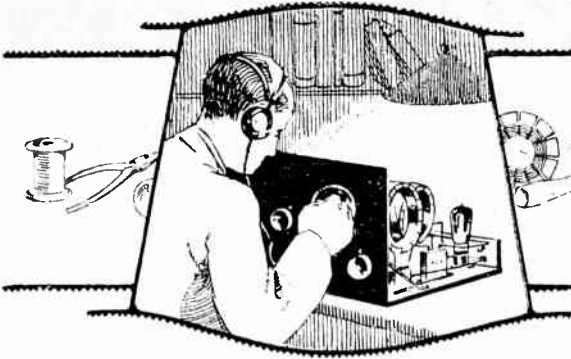

READERS' PROBLEMS

"The Wireless World" Information Department
Conducts a Free Service of Replies to Readers' Queries.

Questions should be concisely worded, and headed "Information Department." Each separate question must be accompanied by a stamped addressed envelope for postal reply.

An Unusual Fault.

Having to hand a 1:1 ratio output transformer which I use very successfully for the purpose of operating my high resistance loud-speaker in conjunction with a conventional four-valve set, I thought I would like to try the effect of using a choke filter output circuit, and accordingly connected the primary and secondary of this transformer in series to form a high impedance choke, connecting up with a 1 mfd. condenser in the conventional manner. To my surprise no results whatever were obtained, very faint speech, extremely distorted, being heard by placing the ear close to the loud-speaker. Concluding that the impedance of the two windings in series was much too high, I tried the arrangement, using first the primary only, and then the secondary only as a choke, and found my suspicions confirmed, loud-speaker volume and quality being good. I shall be glad if you will explain how it is that the high impedance of the two windings in series prevented results being obtained. A.J.R.

When connecting the two windings of a transformer in series to bring about a high inductance value we get not only the added effect of the individual inductances of primary and secondary, but get an enormously increased total inductance due to the mutual inductance existing between the two tightly coupled windings. That is, of course, provided that we have placed our two windings in series in the correct manner. If incorrectly connected, the magnetic fields associated with each winding will oppose each other. Now, in the case of an L.F. transformer, having one winding much larger than the other, the two opposing magnetic fields will not completely balance each other out, with the result that there will be a proportion of the field associated with the larger secondary which is not balanced out, and so a certain amount of inductance will be left, but the value will be sufficiently low to offer only a very small impedance to the lower musical frequencies and not a very large one to the higher musical frequencies, and the output will lack both quantity and quality. In the case of a 1:1 ratio transformer, the two windings

are, of course, equal, and the two magnetic fields will be exactly balanced out, leaving no inductance, and therefore no impedance, and so none of the musical frequencies will set up a voltage across the choke available for passing along to the loud-speaker, via the 1 mfd. condenser. Actually, of course, it is highly improbable that the constants of the two windings are exactly equal, or that the coupling is so tight, that there are no "free" lines of force, and so a certain small residue of inductance will be left to offer a slight impedance to the highest speech frequencies, which is what you hear in your loud-speaker in a very weak and distorted form. You should reverse the connections to either one of the two windings, and your trouble will be cured, and you will be able to take full benefit from the high impedance offered by the two windings correctly connected in series.

Calculating Fixed Resistances for Dull Emitters.

I have been endeavouring to calculate the various values of fixed filament resistances necessary to be used in series with each of my various types of dull-emitter valves, but have been greatly confused by different methods shown in various periodicals. Will you please tell me how to calculate these values correctly? R.S.T.

Possibly the simplest method of calculating the required resistance is to adopt the formula

$$R = \frac{\text{Volts to be dropped in the resistance}}{\text{Amps. taken by the valve}}$$

For example, take the case of running a 0.06 type of dull-emitter from a six-volt accumulator. These valves are rated at 3 volts, so that the voltage to be dropped in the resistance is three volts, viz. :—

$$R = \frac{3}{0.06} = 50,$$

therefore we require a value of 50 ohms.

Do not forget that in the case of running two similar valves in parallel, the resistance of the filament circuit is halved and the current is doubled.

Thus, supposing it were required to find the resistance necessary for two 0.06 type valves in parallel from a 6-volt accu-

mulator. Three volts are still required to be dropped in the resistance, but the current taken is doubled. Therefore :—

$$R = \frac{3}{0.12} = 25.$$

Therefore we require a resistance of 25 ohms. Perhaps a better method to adopt in order to get a real understanding of the matter as distinct from the mechanical following of a formula is to find out the filament current rating of the valve as given by the maker, and say "What resistance do I require in the circuit in order to maintain the current at this value when using a pressure of six volts?"

Ohm's law $R = \frac{E}{I}$ renders this operation simple.

In the case of the valve we have already considered, we know that the current is 0.06 amps, and our accumulator gives a voltage of six. Therefore

$$R = \frac{6}{0.06} = 100.$$

Therefore we require a total resistance of 100 ohms. But the valve filament itself possesses a certain amount of resistance, and we must first find this in order to be able to subtract it from our total requirement of 100 ohms. Since we find that the valve will pass 0.06 amps if connected directly to a 3-volt battery, it is a simple matter to ascertain the resistance of the filament from the same formula :—

$$R = \frac{E}{I} = \frac{3}{0.06} = 50.$$

Therefore 50 ohms resistance is present in the valve filament itself, and in order to make up a total of one hundred ohms we require an external resistance of 50 ohms.

In the case of two such valves in parallel working from a six-volt accumulator the process is similar. We know that if two valves are in parallel the total current flow will be double that present if only a single valve were used. Therefore

$$R = \frac{6}{0.12} = 25 \text{ ohms.}$$

50 ohms is therefore the total resistance required in the circuit, from which must be subtracted as before the actual resistance present in the parallel filaments. We

know that if these two valves are connected in parallel across a 3-volt battery a total current of 0.12 amps will flow. Therefore the resistance of the two filaments in parallel can be found from the formula

$$R = \frac{E}{I} = \frac{3}{0.12} = 25.$$

which, being subtracted from our total resistance requirements of 50 ohms, leaves us 25 ohms as the value of our added external resistance.

o o o o

Methods of Detecting Oscillation.

If using a regenerative receiver at a time when no broadcasting is taking place how is it possible to detect whether or no the receiver is oscillating in the absence of a carrier wave by beating with which an audible heterodyne note indicative of oscillation is produced.

T.P.M.

In the first place it may be said that if a conventional single valve receiver be thrown into a state of oscillation and the tuning condenser moved through the whole of its tuning range during a period when broadcasting stations are not operating, a few heterodyne notes will nearly always be heard, due to the radiations of the receiver forming beat notes with the emissions of distant C.W. stations, both professional and amateur, and also by means of it forming beat notes with the radiations from neighbouring receiving sets which are also in a state of oscillations. In any case when the local station is silent a "plocking" sound heard in the phones when touching the aerial terminal of the receiver will readily indicate that the receiver is oscillating, although of course when the local station is radiating a carrier wave this "plocking" sound will be heard, also when the receiver is not oscillating, due to the change brought about in the current set up in the aerial circuit by the powerful radiation of the local station.

o o o o

Clicking from Electric Light Mains.

I am greatly troubled by a loud click emitted by my loud-speaker every time a light is switched on and off. This is very objectionable as I am a good distance from my nearest broadcasting station, and it so happens that in my establishment lights are switched on and off in various rooms a great deal during the course of an evening. My mains are 240 volts D.C. Can you suggest a remedy?

W.H.M.

This phenomenon is present in every household having electric light and utilising a wireless receiver, but is not generally troublesome, as in the average household lights are not very frequently switched on and off during the course of an evening. It is recommended that you shunt a condenser of large capacity such as 1 or 2 mfd. across each switch in frequent use. This should enable this annoying trouble to be completely eliminated.

A 58

BOOKS FOR THE WIRELESS STUDENT

Issued in conjunction with "The Wireless World."

"THE PERRY AUTO-TIME MORSE SYSTEM" by F. W. PERRY. Price 6d. net. By Post, 7d.

"MAGNETISM AND ELECTRICITY FOR HOME STUDY" by H. E. PENROSE. Price 6/- net. By Post, 6/6.

"THE OSCILLATION VALVE—THE ELEMENTARY PRINCIPLES OF ITS APPLICATION TO WIRELESS TELEGRAPHY" by R. D. BANGAY. Price 6/- net. By Post, 6/3.

"ELECTRONS, ELECTRIC WAVES AND WIRELESS TELEPHONY" by Dr. J. A. FLEMING, M.A. Price 7/6 net. By Post, 8/-

Obtainable by post (remittance with order) from
ILIFFE & SONS LIMITED
Dorset House, Tudor St., London, E.C.4
or of Booksellers and Bookstalls

A Series-Parallel Accumulator Switching Arrangement.

I have a range of 2-volt valves, and also a range of 6-volt valves which I use in the course of my experimental work, and I find that much time is wasted in changing over the connections of my 6-volt accumulator to put the three cells in series or parallel as desired. I therefore propose to incorporate a switching arrangement to put my accumulator cells in series or parallel as desired, and have frequently spent much time in attempting to work out the necessary switching arrangements, and am therefore seeking your assistance in the matter.

G.P.K.

Your proposal of a switching arrangement to place your accumulator cells in series or parallel can be very easily carried out by the use of a four-pole,

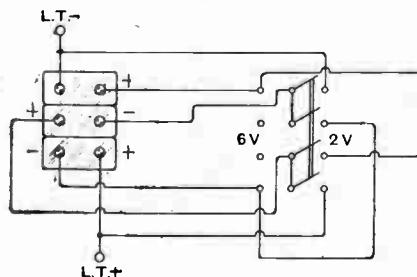

Fig. 1. Series-parallel switch for accumulator cells.

double-throw switch, which may be either of the ordinary type or one of those sold specially for panel mounting, such as the "Utility" switch. The necessary connections are given in Fig. 1. Since it is quite common practice nowadays to place the accumulator in an enclosed box the switch may very well be mounted on the box in some convenient position.

o o o o

Adjusting the "Roberts" Reflex Neurodyne.

I have recently constructed the reflex neurodyne receiver described in your

July 1st, 1925, issue, using a somewhat larger baseboard than was used in the original receiver, and have very carefully spaced all components and wiring. I find that when attempting to neutralise some difficulty is experienced, and the nearest approach to stability occurs when the neutralising condenser is at its minimum position. I shall be grateful for any suggestions you might offer in this matter.

H.J.R.

You are, in the first place, advised to read carefully the further information regarding this receiver which was given in the following numbers:—Page 46, July 8th issue; page 171, August 5th issue; and page 270, August 26th issue: in this latter issue the author of the article deals with the point you raise. The trouble is due to the fact that you have so disposed your components and wiring that the inter-electrode and associated capacity of your first valve have been "over neutralised," and it is impossible, therefore, to find the point of balance with the neurodyne condenser, and it becomes necessary deliberately to introduce a little capacity between the grid and plate of the valve, in order that the neurodyne condenser can be used to find the point of balance. This may be done in the manner suggested by the author, but there are also other methods which may be tried. Sometimes it is only necessary to move the wiring associated with grid and plate slightly in order to introduce this capacity. This may be done by rewiring that portion of the circuit, bringing the wiring into somewhat closer proximity, or it may only be necessary to bend one or two wires slightly out of their present position. Another method is to obtain two short lengths (4 to 6 inches) of stiff insulated wire, such as No. 22 D.C.C., attaching one wire to the grid socket of the valve, and one to the plate socket of the valve. If these two wires are now twisted together they will form a capacity across grid and plate, and you should try to neutralise in the usual manner. Lacking success, you should untwist one turn of the two wires and try again, and so on, untwisting the wires one turn at a time until success is obtained. The projecting ends of the two wires may then be cut off short, and the ends of the two twisted together and sealed with sealing wax. Many readers cure this trouble by using two neurodyne condensers, the extra one being connected between the grid and plate of the valve, and one condenser being balanced against the other. In many cases where the set has been constructed carelessly the amount of stray capacity existing between grid and plate is high, and it may be found that the neurodyne condenser fails to find the point of balance, even when adjusted to the position of maximum capacity. Many readers have succeeded in neutralising by using a single plate vernier for the purpose, this component having, of course, a somewhat larger capacity than the neurodyne condenser, but the best remedy is partially or completely to rewire, or even rebuild, the receiver, in order that some of the stray capacity may be eliminated.



They cost less now!

Watmel—the better fixed condensers—are now sold at reduced prices, made possible by the great demand. Wherever a fixed condenser is needed you should specify Watmel and make sure of trouble-free results. Mica sheets securely clamped between the plates render it impossible for the capacity to vary. No wax whatsoever is used in their construction. One hole fixing is provided, and remember that every Watmel is guaranteed to be correct within 5% of its marked capacity.

NOTE THE NEW PRICES:

'0005 to '002	2/-	Combined grid leak and condenser	2/6
reduced from 2/6		reduced from 3/-	
'0025 to '006	2/6	Combined variable grid leak and condenser, (Size '006 is the ideal condenser with choke & resistance coupling.)	3/6
		New Model	3/6

Other Watmel products worth buying:
 Grid Leak (Black Knob) 5 to 5 megohms .. 2/6
 Anode Resistance (Red Knob) 50,000 to 100,000 ohms .. 3/6

THE **Watmel**

WIRELESS CO. LTD.,
 332a, Goswell Road, London, E.C.1.
 Telephone: 7990 Clerkenwell.
 Lancashire and Cheshire Representative:—Mr. J. E. Lowe,
 23, Harleby Street, Levenshulme, Manchester.

Plug in a LEWCOS Coil — and listen!

THAT'S the test. It makes all the difference when you tune in with a LEWCOS Coil. Listeners everywhere have been quick to realise the quality and advantages of this guaranteed coil.



Ask your dealer for a demonstration. Each LEWCOS Coil is tested in our laboratory. It is then boxed, sealed up, and reaches you in perfect condition. Be sure the LEW seal is unbroken.

LEWCOS Inductance Coil



3 LEWCOS advantages:

- 1 High electrical efficiency with great mechanical strength.
- 2 Great selectivity resulting in extremely fine tuning.
- 3 Exceptionally low high frequency resistance with increased signal strength.

THE **LONDON ELECTRIC WIRE CO. and SMITHS LTD.,**
 Manufacturers of Glazite

Playhouse Yard, Golden Lane, London, E.C.1.

THE BEST WIRELESS SET IS IMPROVED WHEN YOUR BATTERIES ARE RIGHT.

You must have noiselessness in operation, and steady current on continuous or intermittent discharge—therefore you need the

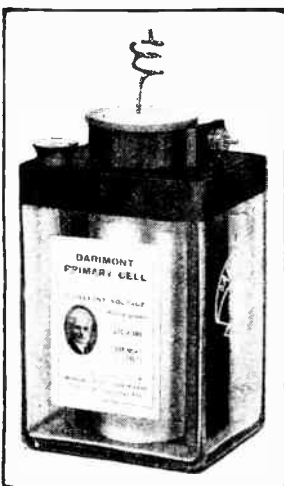

DARIMONT

"HOME-SERVICE" BATTERY,

ideal for use with Dull Emitter Valves.

E.M.F. 1.5 volts.

One of the great advantages of this Battery is that **IT CAN BE CHARGED AT HOME.** The charges are sold in clean compact cartons, and are simple to use, as no electric supply is needed. Think of the ease with which you get **CONTINUOUS RECEPTION,** and

(PATENTED)
 WRITE TO-DAY FOR DESCRIPTIVE LIST.

DARIMONT ELECTRIC BATTERIES LTD.,
 DARIMONT WORKS, ABBEY ROAD, PARK ROYAL,
 LONDON, N.W.10. Telephone: Wembley 2807.

£10 Weekly in Cash Prizes

A New and Simple Competition for all Readers of "The Wireless World"

To be continued weekly until further notice.

HIDDEN ADVERTISEMENTS

Below will be found six reproductions of fragments cut from the Advertisement pages of this issue of "The Wireless World." Each fragment is a clue. Can you from these clues identify the Advertisements? Seven cash prizes will be awarded to the first seven readers who send us correct solutions. No technical skill is required, merely observation. There are no restrictions or entry fees and the conditions are simple.

£5

for the first
correct solution
opened.

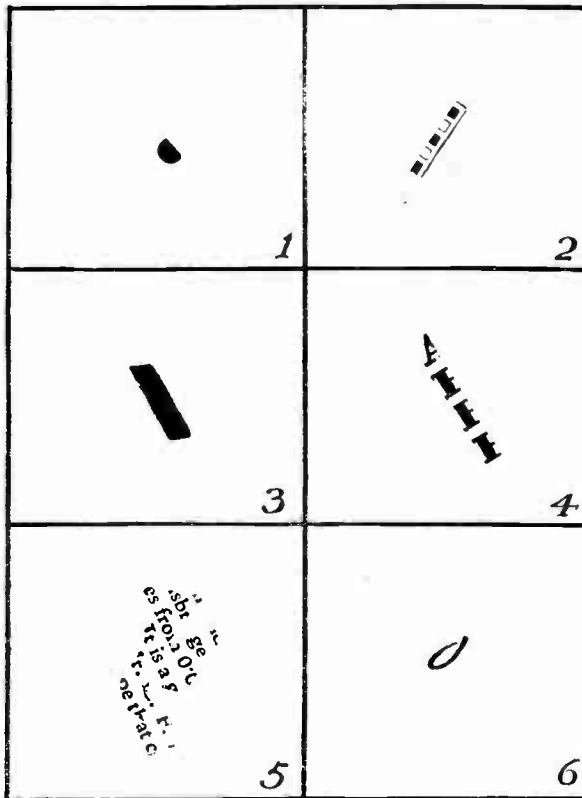

£1

for the third
correct solution
opened.

and
4
consolation
prizes of
10/-

Each
for the next four
correct solutions
opened.

£2
for the second
correct solution
opened.

CONDITIONS

1. All solutions must be written on the special coupon appearing on an advertisement page in this issue and addressed to *The Wireless World*, Dorset House, Tudor Street, London, E.C.4, and marked "Hidden Adverts." in bottom left corner.
2. Clues will not, of necessity, appear in the same way as in the advertisement page, but may be inverted or placed in some other position.
3. In order that town and country readers may compete on equal terms, solutions will not be dealt with until 10 a.m. on Monday next. All solutions received before that date will be retained until Monday morning. Competitors may submit any

- number of entries. Erasures or alterations on a coupon will disqualify the entry.
4. The first prize of £5 will be awarded for the first correct solution opened; the second prize of £2 to the next correct solution; the third prize of £1 for the third, and four consolation prizes of 10/- each for the next four correct answers. In the event of no readers sending correct solutions the prizes will be awarded to the competitors whose solutions are most nearly correct.
5. The decision of the Advertisement Manager of *The Wireless World* is final, and no correspondence can be entered into. Competitors enter on this distinct understanding. No member of the staff of the paper is permitted to compete.



**Paragon Fixed
Condensers are
Equally Essential:**

**ANELS
ROMOTE
ROFICIENCY AND ARE ESSENTIAL TO A
ERFECT SET**

Ask your Dealer, or write direct to
**The PARAGON RUBBER MANUFACTURING CO. LTD.,
SCULCOATES, HULL.**

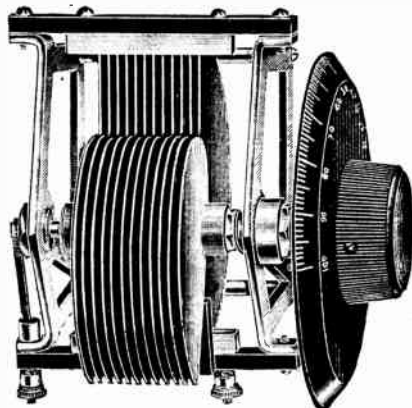

**THE NEW
"Wootophone"
Square Law
LOW
LOSS
CONDENSER**

**ANOTHER PERFECT AND
VERY POPULAR MODEL.**

The design is of solid rigid skeleton type. Special features are fixed vanes insulated outside electrostatic field, thus reducing losses. Heavy well fitting bearings for central spindle, brass vanes soldered in position, pigtail connection making permanent contact from moving vanes to aluminium end plates. One-hole fixing.
This Condenser has been specially designed for short wave work, and results on test justify its introduction. Price complete with improved 4 in. Knob/Dial, packed in strong cardboard box:

.0003 - 16/6 .0005 - 17/6

**F. E. WOOTTEN, LTD.,
WIRELESS MANUFACTURERS,
OXFORD.**

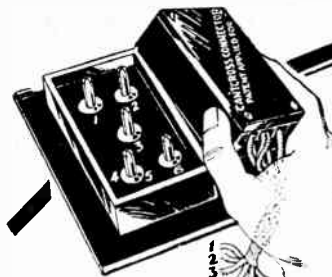

**No More
Burnt-Out Valves!**
If you use a
**"CAN'TCROSS"
CONNECTOR**
(Patent applied for.)

Consists of a plug element for fitting to panel to replace the usual H.T. & L.T. Terminals. The socket element corresponds to the plug element, and is arranged to receive the necessary leads from the respective batteries.

**SHORT CIRCUITS IMPOSSIBLE.
ACTS AS A DISCONNECTING SWITCH.
EASILY FITTED TO ANY SET.**

Adaptable to all Circuits.

Example wired as follows: 1. H.T.1. 2. H.T.2.
3. H.T.3. 4. H.T. - 5. L.T. + 6. L.T. -

7 Terminal 5/- each 5 Terminal 6/- each
7 Terminal 7/- each

Post Free on receipt of Postal Order and Dealer's name from—

J. & W. BARTON, 22a, Virginia St., SOUTHPORT

*Your
Loudspeaker*

WILL SING

THE PRAISES OF

**NELSON MULTI
3-FILAMENT VALVES**



Here is a Valve giving you finest Quality and Volume with Economy. It is of equally high grade as H.F., Detector, L.F., or Power Amplifier.

The little switch places at your command each of Filaments separately, or any 2 in parallel for Power Amplification. Each Filament gives the Valve a New Life.

ALL VALVES are Guaranteed.

FOUR IMPROVED TYPES:

Obtainable at All London's Largest Stores.	A. 4 to 5 VOLTS, 0.45 AMPS. per Filament - 9/6
	D.E.A. 2.6 VOLTS, 0.15 AMPS. per Filament - 15/-
	D.E.2. 1.8 to 2 VOLTS, 0.35 AMPS. per Filament - 15/-
	D.E.08. 3 VOLTS, 0.65 AMPS. per Filament - 18/6

If unable to obtain from your dealer, write direct to—

**NELSON ELECTRIC COMPANY LIMITED,
Merton Park, London, S.W.19.**

Telegrams: Valneleco, Wimpole, London.

Phone: Wimblesden 172.

"CAST-IN"

The diaphragm of the "Hearthside" Speaker is die-cast into a solid ring—that means no "rattle" or "overload." The horn is non-resonant—that means "tone." A new magnetic system—that means "volume."
You must hear this new Speaker—to-day!

Send now for your FREE copy of our new catalogue.

General Radio Co Ltd., 235, Regent St., W.1



FORMO
RADIO COMPONENTS
OF ADVANCED DESIGN.
NEW CATALOGUE NOW READY.
Straight Line Frequency. Ultra Low Loss Condenser. Micro-Vernier Dial. High Efficiency. Low Loss Vario-Coupler, etc.
The FORMO Company,
Crown Works, Cricklewood, N.W.2
Manchester:
Mr. J. B. Levee, 23 Hartley St., Levenshulme.
10/6

MISCELLANEOUS ADVERTISEMENTS.

NOTICES.

THE CHARGE FOR ADVERTISEMENTS in these columns is:

12 words or less, 1/- and 1d. for every additional word, e.g., 18 words 1/6; 24 words, 2/-.

Name and address must be counted.

SERIES DISCOUNTS are allowed to Trade Advertisers as follows on orders for consecutive insertions, provided a contract is placed in advance, and in the absence of fresh instructions the entire "copy" is repeated from the previous issue: 13 consecutive insertions, 5%; 28 consecutive, 10%; 52 consecutive, 15%.

ADVERTISEMENTS for these columns are accepted up to **FIRST POST ON THURSDAY MORNING** (previous to date of issue) at the Head Offices of "The Wireless World," Dorset House, Tudor Street, London, E.C.4, or on **WEDNESDAY MORNING** at the Branch Offices, 19, Hartford Street, Coventry; Guildhall Buildings, Navigation Street, Birmingham; 199, Deansgate, Manchester.

Advertisements that arrive too late for a particular issue will automatically be inserted in the following issue unless accompanied by instructions to the contrary. All advertisements in this section must be strictly prepaid.

Postal Orders and Cheques sent in payment for advertisements should be made payable to **ILLFFE & SONS Ltd., and crossed Treasury Notes**, being untraceable if lost in transit, should not be sent as remittances.

All letters relating to advertisements should quote the number which is printed at the end of each advertisement, and the date of the issue in which it appeared.

The proprietors are not responsible for clerical or printers' errors, although every care is taken to avoid mistakes.

NUMBERED ADDRESSES.

For the convenience of advertisers, letters may be addressed to numbers at "The Wireless World" Office. When this is desired, the sum of 6d. to defray the cost of registration and to cover postage on replies must be added to the advertisement charge, which must include the words Box 000, c/o "The Wireless World." Only the number will appear in the advertisement. All replies should be addressed No. 000, c/o "The Wireless World," Dorset House, Tudor Street, London, E.C.4. Readers who reply to Box No. advertisements are warned against sending remittance through the post except in registered envelopes; in all such cases the use of the Deposit System is recommended, and the envelope should be clearly marked "Deposit Department."

DEPOSIT SYSTEM.

Readers who hesitate to send money to unknown persons may deal in perfect safety by availing themselves of our Deposit System. If the money be deposited with "The Wireless World," both parties are advised of its receipt.

The time allowed for decision is three days, during which time, if the buyer decides not to retain the goods, they must be returned to the sender. If a sale is effected we remit the amount to the seller, but, if not, we return the amount to the depositor. Carriage is paid by the buyer, but in the event of no sale, and subject to there being no different arrangement between buyer and seller, each pays carriage one way. The seller takes the risk of loss or damage in transit, for which we take no responsibility. For all transactions over £10, a deposit fee of 1/- is charged; on transactions over £10 and under £50, the fee is 2/6; over £50, 5/-. All deposit matters are dealt with at Dorset House, Tudor Street, London, E.C.4, and cheques and money orders should be made payable to Illffe & Sons Limited.

THE SALE OF HOME-CONSTRUCTED UNLICENSED APPARATUS.

A New Service to our Readers.

We have made an arrangement with the Patentees whereby readers who wish to dispose of a home-constructed receiver not licensed under the patents made use of, can do so by means of the Deposit System referred to above.

The person desiring to sell, in sending us particulars for his advertisement, will in every case make use of a Box No., and should add to the price which he requires the amount of royalty customarily paid by manufacturers, viz. in the case of Marconi Patents the amount should be calculated at 12/6 per valve holder.

If the purchaser is satisfied with his purchase, the sum realised will be forwarded to the seller, less the amount due in respect of royalties, which amount will be paid by "The Wireless World" to the owners of the patents concerned, and a certificate will be handed on to the purchaser of the set.

FOR SALE.

TELEPHONES.—Pair Brown's A type, 2,000 watts; pair 120 watts, ditto; offers. 2 Lissen-T1 L.F. transformers, 15s. each. All perfect.—14, Brook Avenue, Wembley. (1831)

3-VALVE Portable Set, 10 E.T., 2 L.F., with 3 D.E.R. valves, good order, 300-3,000 A; £9.—Box 6952, WIRELESS WORLD Office. (1828)

For Sale.—Contd.

CRYSTAL Amplifiers increase range five times. Price, complete, 25s. Oscillating zincite 1s. 6d. Original circuit 1s. All parts stocked.—Particulars: Ledsham's, 297, King Street, Hammersmith. (1817)

GENERATOR, 600 volts, Marconi, new, hand or power driven, motor 1/2 A.C., 220 to 250 volts, or D.C. 220 to 250 volts, £8; var. condenser £1; Microphone 7s. 6d.; Microphone transformer 7s. 6d.; transmitting valves, 25 watts, 15s. each; accumulator, Exide, new, 180 amps., 6 volts., £2 15s.; offers accepted.—2XO, 13, Elgin Avenue, London, W.9. (1827)

500 to 2,500 Electrostatic Voltmeter, exchange for Milliampmeter or high-resistance moving coil voltmeter.—Lottimer, The Croft, Newton Mearns, Renfrewshire, N.B. (1826)

4-VALVE "Wireless Equipment" Receiver; "Sparta" loud-speaker, 300-3,000 metres; particulars, offers.—Robertson, 1, New Square, Cambridge. (1825)

FOR SALE.—4-valve Set, bargain, complete with Brown loud-speaker, batteries, phones, 250 coil.—Box 6898, WIRELESS WORLD Office. (1824)

H.T. Motor Generator, belt drive, 200v., A.C. Crypto, 600v., 100 ma., £12; Mark III. tuner, polished case, complete, £4; both as new, seen by appointment.—Box 6969, WIRELESS WORLD Office. (1833)

MISCELLANEOUS.

A WIRELESS Doctor.—If your set is giving trouble or you want advice a competent expert will call (anywhere in Greater London) and put you right. No result, no charge.—Alexander Black, 24, Woodville Grove, N.16. Clissold 3687. (1811)

FREE.—Home Constructors' Catalogue.—Stamp: Garner, Everything Wireless, 31, Little Britain, E.C.1. (1830)

SECOND-HAND Apparatus taken in part-purchase of new ones. Leading lines supplied.—Wharton, 9, Victoria Street, Westminster. (1412)

PATENT AGENTS.

W. BRYSON, B.Sc., Chartered Patent Agent, 29, Southampton Buildings, W.C.2. Phone: Holborn 672. (1297)

PATENTS and Trade Marks Obtained.—H. T. P. Gee, Patent Agent, Member R.S.G.B., A.M.I.R.E., 51-52, Chancery Lane, London, W.C.2. Phone: Holborn 1525. (0001)

KING'S PATENT AGENCY, LTD. (B. T. King, Registered Patent Agent, G.B., U.S., and Can.). Free "Advice Handbook" and Consultations. 40 years' references.—146A, Queen Victoria Street, London, E.C.4. (0002)

REPAIRS.

TRANSFORMER Repairs.—Rewound to original efficiency and guaranteed 12 months. 4s., post free. Phones 3s. 6d. Trade supplied.—Transform, 70A, Longley Road, Tooting. (0011)

SITUATION WANTED.

WIRELESS Expert.—3 years' experience and study; competent in designs, circuits, theory, practice.—Box 6957, WIRELESS WORLD Office. (1832)

BOOKS.

BACK Numbers of all Wireless Publications. —Fangs, Ltd., 11, Tavistock Square, W.C.1. (1829)

BOOKS You Want.—Foyles Can Supply.—Immense stock, second-hand and new, every conceivable subject. State requirements. 21 catalogues issued. Books purchased.—Foyles, 121, Charing Cross Road, W.C.2. (0004)

PATENTS, DESIGNS AND TRADE MARKS,

J. S. Withers & Spooner.

REGISTERED PATENT AGENTS.

ESTABLISHED
61 & 62, CHANCERY LANE,
LONDON, W.C.2.

GRANTS.—IMPROVABLE,
HOLLAND, LONDON.
Phone:—480 HOLBORN

REPAIRS SETS PHONES TFORMERS

—Officially approved by Radio Association—
ALL WORK GUARANTEED. LOWEST RATES. 24 HOUR SERVICE.

JOHN W. MILLER, 68, Farringdon Street, E.C.4
PHONE: CENTRAL 1950

LOW LOSS NEUTRODYNE TRANSFORMERS

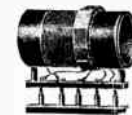

As described in several recent issues of this paper. Considering them the most efficient type evolved, we are making them for the benefit of "The Wireless World" readers. Send stamp for details. Price with base 15/-

TORDA PRODUCTS—COTTON & CLARKE,
55/59, Lacy Road, Putney, S.W.

TROLITE PANELS

Mahogany Grain ..	3/6 lb.
Black Engraved wavy	3/9 lb.
Black plain polished	3/- lb.

Machine cut to your own measurements. Tested to 2000 Volts. & 1/2"

PUGH'S WIRELESS, 95-101, Holloway Road, London, N.7

H.T. Accumulators 37/6
60 Volts 3 Actual Amp.-hour



The finest H.T. Accumulator in the world.

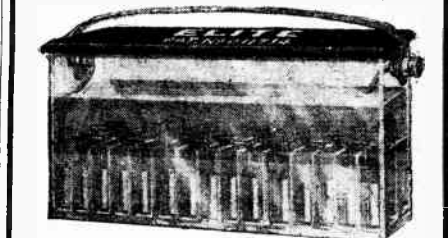

60-volt, 3-amp.-hour, oil submerged. Will last a lifetime. Write for descriptive Folder. **MONEY RETURNED IF NOT SATISFIED.** Obtainable only from **ACCUMULATORS ELITE, 31, Waterhouse St., Halifax.** Trade Supplied. Telephone: 1304.



THE "ORPHEAN"

If you would have ample volume and yet still retain distortionless, clear-toned reproduction of every kind of broadcast entertainment, specify the Energio L.F. Transformer—the "Orphean." A shrouded transformer in a burnished case, it combines purity of tone with extreme mechanical strength. That it is used by a number of leading manufacturers is additional proof of its superiority.

Ratio 1-3, 19/6d. Other Ratios, 21 - Open Type, 15 -.

Ask your Dealer to show you them, also the "Energio" battery switch—for H.T. or L.T. Just screw it on your H.T. or L.T. terminal—that's all. Price 1/3d.

Send a card for full particulars of these and other "Energio" products.

Energio PRODUCTS, LIMITED,
1, St. James's Street, E.C.1.
Telegrams: "Energio", Smith, London."
Telephone: Clerkenwell 7300.



Tested low-loss condensers

Constructors! For your D.X. work planup for Ericsson Tested Condensers. They're the last word in accuracy. Losses are kept down to zero. Stout vanes—accurately spaced—engineer-built all through. They pull their weight in long-distance work. Template supplied. Ebonite end plates.

Prices: 10005 10/6
1001 12/6
Write for lists to-day.
The BRITISH L.M. ERICSSON Mfg. Co. Ltd.,
67, 73, Kingsway, London, W.C.2.

Ericsson
TESTED CONDENSERS

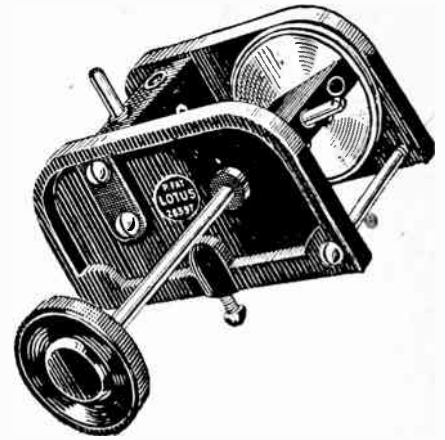

Tuning remains accurate because the Moving Block cannot fall back.

Do away with that irritating, time wasting, fading away of volume caused by the falling of your Moving Block.

Fit a Lotus Geared Vernier Coil Holder and get really accurate tuning. The Lotus Moving Block cannot possibly fall back. Has an easy Vernier movement which reduces the speed by eight times, and stays where it's put—exactly! Fit in any position, with any weight of coil—you'll be satisfied with the results.

Bakelite mouldings for the side plates, coil blocks and knobs; heavy Nickel Plating for the metal parts.

LOTUS

VERNIER COIL HOLDERS

From all reliable Radio Dealers.
GARNETT, WHITELEY & CO., LTD.,
Lotus Works,
Broadgreen Road, Liverpool.

Makers of the famous Lotus Buoyancy Valve Holder.

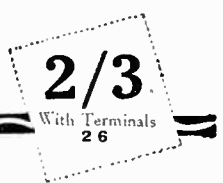

Valve-Holder Losses

Capacity and Voltage Leakage between the valve legs of ordinary valve-holders are the chief reasons for the unsatisfactory working of most sets. The "AERMONIC" reduces these to the absolute minimum.

A wonderful improvement where Radio Frequency Currents are dealt with as in a Neutrodyne H.F. Amplifier, Super-Heterodyne Detector and Oscillator, and any H.F. Amplifier. Reduces the "howl" in a L.F. Amplifier.

Moulded from the best possible material for strength, heat resisting, and Dielectric Properties.

MODEL "D"
Base-Board Mounting
2/6 each.



MODEL "E"
Back of Panel
2/6 each.

THE NEW AERMONIC VALVE HOLDERS

ANTI-CAPACITY AIR-SPACED

Manufacturers & Distributors for London & South England:
JAMES CHRISTIE & SONS Ltd.,
246, WEST STREET, SHEFFIELD.
London Agents: A. F. BULGIN & CO., 10, Cursitor St., E.C.A.
Agents—Rest British Isles:
Messrs. V. R. PLEASANCE, 66, Fargate, Sheffield.

Two Remarkable Coil Plugs

Each 13 Postage 2d. "Universal" Expanding Plug is a marvel of efficiency and neatness. Expanding Band quickly and firmly mounts any size coil. Perfect Low-loss reversible Plug and Socket. Ad. Size finish to all Home-made Coils.

Send to-day to Goodman, Uttley & Harris, 14, Broad Street Chambers, Broad Street, Sheffield.

"The Quick Fix" for Basket Coils, with detachable Pin and Knob, securely mounts all size coils, permits fullest action and quick adjustment. Low-loss reversible Plug and Socket. Solid Ebonite.

Trade Enquiries Solicited.

Amateurs! Let us make your Cabinets

In Beautiful Polished Mahogany or Oak—& SENT ON APPROVAL, De Luxe Models—Parlour Models, etc. from 25/- to 25. Crystal Cabinets from 1/8. Any size MADE TO ORDER. Designs and Lists Free. Estimates per Return Post. Panels and Accessories Post Free.

Send to actual Makers: Piskett Brothers, Members B.B.C. (W.W.) Cabinet Works, Boxley-beath. It will repay!

PATENTS, DESIGNS & TRADE MARKS.

H. D. FITZPATRICK & CO.
Chartered Patent Agents,
49, Chancery Lane, London, W.C.2
Phone: Holborn 459.

DE VALVES for DX WORK

•06. 3—4 volts. 86 Post Free.

These valves are strongly recommended for long distance reception owing to their excellent performance as detectors.

Immediate delivery.

K. A. ROBINSON, F.R.G.S.,
325, Hamlet Court Road, Westcliff-on-Sea.

The Wireless World

AND RADIO REVIEW

INDEX TO ADVERTISEMENTS.

	PAGE		PAGE		PAGE
Accumulators Elite	20	Fitzpatrick, H. D., & Co.	21	Ormond Engineering Co.	
Athol Engineering Co.		Formo Company	19	Paragon Rubber Manf. Co., Ltd.	19
Autoveyors, Ltd.	8	Fuller's United Electric Works, Ltd.	4	Partridge & Wilson	22
Barton, J. & W.	19	Gambrell Bros., Ltd.		Pickett Bros.	21
Beard & Fitch, Ltd.		Garnett, Whiteley & Co., Ltd.	21	Pitman, Sir Isaac & Sons, Ltd.	22
Brandes, Ltd.	11	General Electric Co., Ltd., The	14 & 15	Pugh Bros.	20
British L.M. Ericsson Mfg Co., Ltd.	21	General Radio Co., Ltd.	19	Radio Communication Co., Ltd.	
Burndept Wireless, Ltd.		Goodman, Uttley & Harris	21	Reflex Radio	9
Caxton Wood Turnery Co.	2	Graham, Alfred, & Co.	Cover ii	Robinson, K. A.	21
Charlesworth, W. J.		Halladay's, Ltd.		Rothermel Radio Corpn. of Gt. Britain, Ltd.	
Christie, James & Sons, Ltd.	21	Hough, J. E., Ltd.	16	Silvertown, Co., Ltd.	
Cleartron Radio, Ltd.		Igranic Electric Co., Ltd.	6	Stevens, A. J. & Co. (1914), Ltd.	13
Cotton & Clarke	12	Lamplugh, S. A., Ltd.	6	Stratton & Co., Ltd.	9
Darex Radio Co.		Lissen, Ltd.	10	Taylor, J. H., & Co.	
Darimont Electric Batteries, Ltd.	17	London Elec. Wire Co. & Smiths, Ltd.	17	Telegraph Condenser Co., Ltd.	
Dixon, Leslie & Co.		Lyons, Claude	8	Tanometer Works	
Dubilier Condenser Co. (1925), Ltd.	1	Marconiphone Co., Ltd., The	Cover iv.	Varley Magnet Co., Ltd.	
Edison Swan Electric Co., Ltd.	3	Maywood Eng. & Elec. Manf. Co., Ltd.		Ward & Goldstone, Ltd.	
Electron Co., Ltd., The	7	McMichael, J., Ltd.		Watmel Wireless Co., Ltd., The	17
Encore Manf. Co.		Metro-Vick Supplies, Ltd.	7 & 9	Webber, N. V., & Co., Ltd.	
Energo Products, Ltd.	21	Midland Radiotelephone Manfs., Ltd.	6	Wilkins & Wright, Ltd.	2
Falk, Stadelmann & Co., Ltd.		Miller, J.	20	Withers, J. S., & Spooner	20
Ferranti, Ltd.	2	Mullard Wireless Service Co., Ltd., The	5	Wootten, F., Ltd.	19
Finston Manf. Co., Ltd.		Nelson Electric Co., Ltd.	19		

NOW ON SALE

PRICE 1/6

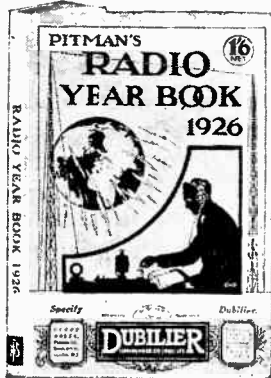

Pitman's 1926

RADIO YEAR BOOK

The 1926 RADIO YEAR BOOK contains

nearly 200 pages of Entertainment, Information and Instruction with 70 Photographs of Prominent Broadcast Artists—many actually as they appeared at the microphone—38 Instruction Drawings and Diagrams and useful lists.

RADIO HISTORY IN PICTURES—Official Articles contributed by the B.B.C. **Authoritative Articles by Prominent Radio Engineers. Among others—**

Seeing by Wireless, by T. Thorne Baker, F.P.S.: Amateur Aerials and Earths, by J. A. Fleming, M.A., D.Sc., F.R.S.: Amateur Technical Progress, by Norman Edwards, Editor of "Popular Wireless": Workshop Rust, by James Swinburne, F.R.S.: How to Telegraph Pictures by Wire and Wireless, by T. Thorne Baker, F.P.S.: Speaking Pictures, by C. F. Elwell.

"Full of good things."—
Radio Times.

"Full of valuable and authoritative information both for the amateur and the expert... the volume is profusely illustrated."—
Daily Express

"Better than ever."—
Nottingham Evening News.

PRICE 1/6
at Bookstalls
(1/9 post paid)

SIR ISAAC PITMAN & SONS, LTD., Parker St., Kingsway, London, W.C.2

The "GRIPPLESHELL"
Registered design No. 716927.

A device for simplifying Aerial Erection
These brackets are made from 1" best quality Wrought Iron painted with weather-proof enamel.

PRICES
Combined corner bracket, insulator & pulley 3/6
6" Hold-off bracket 3/-
9" " " 3/6
12" " " 3/6

Manufactured by
PARTRIDGE & WILSON, ELECTRICAL ENGINEERS,
217a, Loughborough Road, LEICESTER.
Telephone 5812.

FREE ON RAIL.

A Guide to WIRELESS LITERATURE

HAVE YOU YET RECEIVED YOUR COPY of our booklet, "A Guide to Wireless Literature," which describes all the volumes published in conjunction with "The Wireless World"? There is a book for every phase of wireless and for all wireless workers, from the beginner to the advanced experimenter and research worker.

Write for your copy to-day.
FREE on REQUEST.

BLIFFE & SONS LTD., Dorset House, Tudor St., London, E.C.4